



CL

Operator's Manual

Symbols

Trademarks®:

- Bluetooth® is a registered trademark of Bluetooth SIG Inc.
- ESP® and PRE-SAFE® are registered trademarks of Daimler.
- HomeLink® is a registered trademark of Prince, a Johnson Controls Company.
- LOGIC7® is a registered trademark of Harman International Industries, Incorporated.
- SIRIUS and related marks are trademarks of SIRIUS Satellite Radio Inc.

The following symbols are found in this Operator's Manual:

Warning!

Warning notices draw your attention to hazards that may endanger your health or life, or the health or life of others.

 Highlights hazards that may result in damage to your vehicle.

 Helpful hints or further information you may find useful.

▶ This symbol points to instructions for you to follow.

▶ A number of these symbols appearing in succession indicates a multiple-step procedure.

▷ page This symbol tells you where to look for further information on a topic.

▷▷ This continuation symbol marks a warning or procedure which is continued on the next page.

Display Text in displays, such as the control system, are printed in the type shown here.

Our company and staff congratulate you on the purchase of your new Mercedes-Benz.

Your selection of our product is a demonstration of your trust in our company name. Furthermore, it exemplifies your desire to own an automobile that will be as easy as possible to operate and provide years of service.

Your Mercedes-Benz represents the efforts of many skilled engineers and craftsmen. To help assure your driving pleasure, and also the safety of you and your passengers, we ask you to make a small investment of time:

- Please read this manual carefully, then return it to your vehicle where it will be handy for your reference.
- Please follow the recommendations contained in this manual. They are designed to acquaint you with the operation of your Mercedes-Benz.
- Please pay attention to the warnings and cautions contained in this manual. They are designed to help improve the safety of the vehicle operator and occupants.

We extend our best wishes for many miles of safe, pleasurable driving.

Mercedes-Benz USA, LLC

A Daimler Company

Index 3

Introduction 19

At a glance 25

Safety and security 41

Control systems 77

Controls in detail 289

Operation 419

Practical hints 471

Technical data 563

- 1, 2, 3 ...**
- 4-ETS**
see ETS/4-ETS
- 4MATIC**
see All-wheel drive (4MATIC)
- 9 11 emergency call** 154
- A**
- ABC (Active Body Control)** 364
Messages in the multifunction
display 505
- ABS (Antilock Brake System)** 65
Indicator lamp 528
Messages in the multifunction
display 491, 499
- Accessory weight** 449
- Accidents** 332
Air bag deployment 43
Emergency calls (Tele Aid) 406
- Active Bi-Xenon headlamps**
see Headlamps
- Active Body Control**
see ABC
- Adaptive Brake** 68
- Adaptive Brake Lights** 68
- Adaptive Damping System**
see ADS
- Additives**
Engine oil 580
Gasoline 581
- Address book** 170
- Address change** 21
- ADS (Adaptive Damping System)** ... 363
- Advanced Parking Guidance** 373
Canceling 377
Detecting a parking space 374
Messages in the multifunction
display 485
Parking 375
- Advanced Tire Pressure
Monitoring System (Advanced
TPMS)** 438
Messages in the multifunction
display 488, 524
- Air bags** 43
Children 43
Emergency call upon deployment . 406
Front, driver and passenger 46
Front passenger front air bag off
indicator lamp 51, 538
Knee bag 47
Messages in the multifunction
display 478
Safety guidelines 45
Side impact 47
Window curtain 48
- Air conditioning refrigerant and
lubricant** 580
- Air distribution** 390
- AIRMATIC**
ADS (Adaptive Damping System) .. 363
Introduction 363
Messages in the multifunction
display 506
Vehicle level control 363
- Air pressure**
see Tire inflation pressure
- Air pressure (tires)** 449
- Air recirculation mode** 392
- Air volume** 390
- Alarm system**
see Anti-theft systems
- Alignment bolt (vehicle tool kit)**
..... 472, 549
- All-wheel drive (4MATIC)** 366
- Alternator** 574
Messages in the multifunction
display 487, 516
- AMG menu** 239
- Anticorrosion/antifreeze** 582
- Antilock Brake System**
see ABS
- Anti-theft systems** 75
Anti-theft alarm system 75
Immobilizer 75

- Aquaplaning**
see Hydroplaning
- Ashtray** 402
- Aspect ratio (tires)** 449
- Assistance menu** 244
- Audio menu** 238
- Auto-dimming rear view mirrors** 312
- Automatic central locking** 295
- Automatic headlamp mode** 317
- Automatic interior lighting control** 321
- Automatic shift program** 340
- Automatic transmission** 335
- Automatic shift program 340
- Emergency operation (limp-home mode) 344
- Gear range indicator 340
- Gear ranges 340
- Gear selector lever 336
- Gearshifting malfunctions (limp-home mode) 344
- Hill start assist system 349
- Kickdown 339
- Kickdown (manual shift program) 344
- Manual shift program 342
- One-touch gearshifting 341
- Program mode indicator 341
- Program mode selector switch 341, 343
- Shifting procedure 338
- Steering wheel gearshift control 342
- Transmission position indicator 338
- Transmission positions 338
- AUX**
- Audio 207
- Socket 206
- Video 207
- Axle oils** 578
- B**
- Backrest**
see Seats
- Backup lamps**
Messages in the multifunction display 522
- Replacing bulbs 543
- Bar (air pressure unit)** 449
- BAS (Brake Assist System)** 66
- Batteries, SmartKey**
Checking condition 294
- Replacing 541
- Battery, Vehicle**
Charging 553
- Jump starting 554
- Messages in the multifunction display 487, 516
- Bead (tire)** 449
- Beverage holders**
see Cup holders
- Blind Spot Assist** 382
- Messages in the multifunction display 484
- Bluetooth® settings** 180
- Brake fluid**
Messages in the multifunction display 490
- Brake lamps**
Cleaning lenses 464
- High-mounted brake lamp 543
- Replacing bulbs 543
- Brake pads**
Messages in the multifunction display 498
- Brakes** 455
- High-performance brake system 457
- Break-in period** 420
- Bulbs**
see Replacing bulbs
- C**
- CAC (Customer Assistance Center)** 23
- California retail buyers and lessees, important notice for** 20
- Calls (phone)** 242
- Can holders**
see Cup holders
- Capacities and recommended fuel/lubricants** 577

- Carpets, cleaning** 468
- CD player** 195
- Central locking**
 - Automatic 295
 - Locking/unlocking from inside . . . 295
- Central locking/unlocking switch** . . 295
- Certification label** 565
- Children in the vehicle**
 - Air bags 43
 - Blocking of rear side window operation 63
 - Child seat anchors – LATCH-type . . 62
 - Indicator lamp, front passenger front air bag 51
 - Infant and child restraint systems . . 59
 - Occupant Classification System (OCS) 48
 - Safety notes 59
 - Tether anchorage points 62
 - Top tether 59
- Child safety**
 - see Children in the vehicle
- Child seat anchors – LATCH-type**
 - see Children in the vehicle
- Chrome-plated exhaust tip, cleaning** 469
- Cigarette lighter** 403
- Climate control system**
 - Air conditioning, cooling 388
 - Air conditioning refrigerant 580
 - Air distribution 390
 - Air recirculation mode 392
 - Air volume 390
 - Automatic mode 388
 - Deactivating system 387
 - Front defroster 391
 - Maximum cooling MAX COOL 391
 - Residual engine heat (REST) 392
 - Temperature 388
- Cockpit** 28
- Cold tire inflation pressure** 449
- Collapsible wheel chock** 472
- COMAND**
 - Address book 170
 - Audio CD/audio DVD/MP3/PCMCIA card 195
 - AUX 206
 - Components 79
 - Controller 81
 - FM/AM Radio 184
 - Introduction 78
 - Navigation 95
 - Operating 83
 - Phone book 165
 - Satellite radio 189
 - Switching on or off 79
 - System settings 91
 - Telephone 151
 - Vehicle settings 216
- Video DVD 209
- Voice Control 248
- Combination switch** 319
- Controller (COMAND)** 81
- Control system** 231
 - Multifunction display 233
 - Multifunction steering wheel 232
- Control system menus** 234
 - AMG 239
 - Assistance 244
 - Audio 238
 - Navigation 237
 - Service 245
 - Settings 246
 - Telephone 242
 - Trip computer 235
- Coolant**
 - Anticorrosion/antifreeze 582
 - Capacities 578
 - Checking level 427
 - Messages in the multifunction display 513, 514, 515
 - Temperature gauge 345
- Cruise control** 347
 - Last stored speed 349
 - Resume function 349
- Cup holders** 401
- Curb weight** 449
- Customer Assistance Center (CAC)** . . 23

- D**
- Dashboard**
 - see Instrument cluster
 - Data recording** 24
 - Daytime running lamp mode** 318
 - Setting 246
 - Deep water**
 - see Standing water
 - Defogging (windshield)** 391
 - Defroster**
 - Rear window 393
 - Windshield 391
 - Department of Transportation**
 - see DOT
 - Difficulties**
 - While driving 332
 - With starting 330
 - Digital speedometer**
 - Additional speedometer 247
 - Dimensions (vehicle)** 575
 - Direction of rotation (tires)** 431
 - Displays**
 - DISTRONIC Plus 352
 - Maintenance service indicator 460
 - Messages in the multifunction display 475
 - Multifunction display 233
 - Text messages 476
 - Trip computer 235
 - Vehicle status message memory 245
 - Display settings** 92
 - DISTRONIC Plus** 350
 - Cleaning system sensors 465
 - Displaying the distance graphic 353
 - Displays in the multifunction display 352
 - Driving 356
 - Driving hints 360
 - Lever 355
 - Messages in the multifunction display 482
 - Resume function 359
 - Sensor cover 465
 - Speed settings 358
 - Stopping 357
 - Warning and indicator lamps 352
 - DISTRONIC Plus lever** 355
 - Door control panel** 39
 - Doors**
 - Locking/unlocking (KEYLESS-GO) 292
 - Locking/unlocking (SmartKey) 290
 - Locking/unlocking from outside 290
 - Messages in the multifunction display 509
 - Opening from inside 294
 - Remote door unlock (Tele Aid) 411
 - Unlocking (Mechanical key) 539
 - DOT (Department of Transportation)** 449
 - Drinking and driving** 455
 - Driving**
 - Abroad 458
 - Hydroplaning 458
 - Instructions 328, 454
 - In winter 453
 - Problems 332
 - Safety systems 65
 - Systems 346
 - Through standing water 458
 - With DISTRONIC Plus 360
 - Driving and parking**
 - Safety notes 328
 - Driving off** 330, 457
 - Driving safety systems** 65
 - ABS 65
 - Adaptive Brake 68
 - Adaptive Brake Lights 68
 - BAS 66
 - EBP 68
 - ESP® 69
 - ETS/4-ETS 70
 - PRE-SAFE® Brake 72
 - Driving systems**
 - Active Body Control (ABC) 364
 - Advanced Parking Guidance 373
 - AIRMATIC 363
 - All-wheel drive (4MATIC) 366

- Blind Spot Assist 382
 - Cruise control 347
 - DISTRONIC Plus 350
 - Hill start assist 349
 - Night View Assist 380
 - Park Assist 369
 - Parktronic system 366
 - Rear view camera 377
 - Driving tips, automatic transmission** 339
 - DVD, audio** 195
 - DVD, video** 209
- E**
- EBP (Electronic Brake Proportioning)** 68
 - Electrical system**
 - Improper work on or modifications 22
 - Power outlet 403
 - Technical data 574
 - Electronic parking brake** 333
 - Electronic Stability Program**
 - see ESP®
 - Electronic Traction System**
 - see ETS/4-ETS
 - Emergency, in case of**
 - Battery, jump starting 554
 - First aid kit 472
 - Flat tire 547
 - Hazard warning flasher 320
 - Roadside Assistance 21
 - Towing the vehicle 555
 - Emergency calls**
 - Tele Aid 406
 - Telephone 154
 - Emergency engine shutdown** 561
 - Emergency operations**
 - Limp-home mode 344
 - Locking/unlocking the vehicle 539
 - Remote door unlock 411
 - Trunk lid, emergency release 299
 - Trunk lid, unlocking 540
 - Emergency Tensioning Device**
 - see ETD
 - Emission control** 459
 - Information label 566
 - System warranties 20
 - Engine**
 - Brake-in recommendations 420
 - Cleaning 463
 - Compartment 423
 - Malfunction indicator lamp 536
 - Maximum engine speed 567
 - Messages in the multifunction display 513
 - Number 566
 - Starting 328
 - Technical data 567
 - Turning off 334
 - Engine coolant**
 - see Coolant
 - Engine oil**
 - Adding 426
 - Additives 580
 - Checking level 424
 - Consumption 424
 - Oil dipstick 425
 - Recommended engine oils and oil filter 579
 - ESP® (Electronic Stability Program)** 69
 - ETS 70
 - Messages in the multifunction display 491, 500
 - Warning lamp 533
 - ETD (Emergency Tensioning Device)** 56
 - Safety guidelines 45
 - ETS/4-ETS (Electronic Traction System)** 70
 - Express operation**
 - Power windows 325
 - Tilt/sliding sunroof 394
 - Exterior lamp switch** 316
 - Exterior rear view mirrors** 311
 - Parking position 313, 315
 - Power folding 313
 - Exterior view of vehicle** 26

- F**
- Fastening the seat belts** 54
 - First aid kit** 472
 - Flat tire** 547
 - Lowering the vehicle 550
 - Mounting the spare wheel 547
 - Preparing the vehicle 547
 - Spare wheel 547, 573
 - Floormats** 416
 - Fluids**
 - ABC fluid 427, 578
 - Automatic transmission fluid 577
 - Brake fluid 578
 - Capacities 577
 - Engine coolant 578
 - Engine oil 577
 - Power steering fluid 578
 - Washer and headlamp cleaning system 579
 - Fog lamps** 318
 - Messages in the multifunction display 522
 - Replacing bulbs 543
 - Four-wheel drive**
 - see All-wheel drive (4MATIC)
 - Front air bags**
 - see Air bags
 - Front lamps**
 - see Headlamps
 - Front passenger front air bag** 46
 - Messages in the multifunction display 478
 - Front passenger front air bag off indicator lamp** 47, 538
 - Fuel** 454
 - Additives 581
 - Capacity, fuel tank 578
 - Fuel consumption statistics 235
 - Fuel filler flap and cap 421
 - Fuel tank reserve warning lamp 535
 - Premium unleaded gasoline 421, 578, 580
 - Refueling 421
 - Requirements 581
 - Fuel filler flap** 421
 - Fuel gauge** 346
 - Fuels, coolants, lubricants etc.**
 - Capacities 577
 - Fuel tank**
 - Capacity 578
 - Fuel filler flap and cap 421
 - Refueling 421
 - Fuses** 558
- G**
- Garage door opener** 412
 - Gasoline**
 - see Fuel
 - GAWR (Gross Axle Weight Rating)** 449
 - Gear range**
 - Automatic transmission 340
 - Indicator 340
 - Limiting 342
 - Shifting into optimal 342
 - Gear selector lever** 336
 - Cleaning 468
 - Gearshift pattern 336
 - Messages in the multifunction display 486
 - Shifting procedure 338
 - Transmission position indicator 338
 - Transmission positions 338
 - Generator**
 - see Alternator
 - Global locking/unlocking**
 - see Key, SmartKey
 - Glove box** 398
 - Gross Axle Weight Rating**
 - see GAWR
 - Gross Vehicle Weight**
 - see GVW
 - Gross Vehicle Weight Rating**
 - see GVWR
 - GVW (Gross Vehicle Weight)** 449
 - GVWR (Gross Vehicle Weight Rating)** 449

- H**
- Hard plastic trim items, cleaning** . . . 468
 - Hazard warning flasher** 320
 - Headlamp cleaning system** 320
 - Headlamps**
 - Active Bi-Xenon headlamps 316
 - Automatic headlamp mode 317
 - Bi-Xenon 316, 543
 - Cleaning lenses 464
 - Cleaning system 320
 - High-beam flasher 319
 - High-beam headlamps 319
 - Low-beam headlamps 317
 - Replacing bulbs 543
 - Switch 316
 - Headliner and shelf below rear window, cleaning and care of** 469
 - Head restraints** 303
 - Folding back 308
 - Rear seat, removing and installing . . . 308
 - Heated seats** 309
 - Heated steering wheel** 311
 - Height adjustment**
 - Seats 304
 - Vehicle level control 363
 - High-beam flasher** 319
 - High-beam headlamps** 319, 543
 - Indicator lamp 31
 - Replacing bulbs 543
 - High-mounted brake lamp** 543
 - Replacing bulbs 543
 - High-performance brake system** . . . 457
 - Hill start assist system** 349
 - Hood** 423
 - Messages in the multifunction display 508
 - Horn** 29
 - Hydroplaning** 458
- I**
- Identification labels** 565
 - Identification number, vehicle (VIN)** 565
 - Ignition** 301, 302, 329
 - Immobilizer** 75
 - Indicator lamps**
 - see Lamps, indicator and warning
 - Infant and child restraint systems**
 - see Children in the vehicle
 - Inflation pressure**
 - see Tires, Inflation pressure
 - Infrared reflecting windshield** 417
 - Inside door handle** 39, 294
 - Instrument cluster** 30, 345
 - Illumination 345
 - Lamps 527
 - Multifunction display 233
 - Instrument lighting**
 - see Instrument cluster, Illumination
 - Instrument panel**
 - see Instrument cluster
 - Instruments and controls**
 - see Cockpit
 - Interior lighting**
 - Emergency lighting 322
 - Front 321
 - Front reading lamps 321
 - Interior rear view mirror** 311
 - Auto-dimming rear view mirrors . . . 312
 - Interior storage spaces**
 - see Storage compartments
 - Intermittent wiping**
 - Windshield wipers 323
- J**
- Jack** 473
 - Jump starting** 554
- K**
- Key, Mechanical** 539
 - Loss of 294
 - Valet locking 300
 - Key, SmartKey**
 - Battery check lamp 291
 - Checking batteries 294
 - Factory setting 291, 293

- Global locking (KEYLESS-GO) 293
- Global locking (SmartKey) 291
- Global unlocking (KEYLESS-GO) 293
- Global unlocking (SmartKey) 291
- Important notes on KEYLESS-GO 292
- Locking/unlocking 290
- Loss of 294
- Messages in the multifunction display 509
- Opening, Trunk 296
- Opening and closing the power tilt/sliding sunroof 327
- Opening and closing the windows 327
- Remote control 290
- Replacing batteries 541
- Restoring to factory setting 291, 293
- Selective setting 291, 293
- Starter switch positions 301
- KEYLESS-GO**
- Starter switch positions 301
- Keypad (COMAND)** 81
- Kickdown** 339
- Kickdown (manual shift program)** 344
- Kilopascal (air pressure unit)** 450
- Knee bag** 47

L**Labels**

- Certification 565
- Emission control information 566

Lamps, exterior

- Exterior lamp switch 316
- Front 543
- Messages in the multifunction display 519
- Rear 543
- Switching on/off 316

Lamps, indicator and warning

- ABS 31, 528
- Battery (SmartKey) 291
- Distance warning lamp 352, 534
- Engine malfunction 536
- ESP® 31, 533
- Fog lamps 318
- Front passenger front air bag off 47, 538
- Fuel tank reserve 535
- High-beam headlamps 31
- Instrument cluster 527
- Low tire pressure/TPMS malfunction telltale 537
- Seat belt telltale 31, 55, 531
- SRS 43, 532
- Turn signals 31

Language settings 94**LATCH-type child seat anchors**

see Children in the vehicle

License plate lamps 543

- Messages in the multifunction display 521
- Replacing bulbs 543

Light alloy wheels, cleaning 468**Lighter**

see Cigarette lighter

Lighting 316

- Daytime running lamp mode 318
- Exterior 316
- Interior 321

Limp-home mode 344**Loading**

see Vehicle loading

Locking the vehicle 290, 292

- Manually 541

Loss of

- Key 294
- Service and Warranty Information booklet 565

Low-beam headlamps 317

- Exterior lamp switch 316
- Replacing bulbs 543
- Switching on 317

Lubricants 577

- M**
- Maintenance** 20
 - Maintenance Call, automatic (Tele Aid)** 411
 - Maintenance System** 460
 - Service indicator 460
 - Service indicator, resetting 461
 - Service indicator display 461
 - Service indicator message 460
 - Service indicator message, clearing 460
 - Service term exceeded 461
 - Manual headlamp mode (Low-beam headlamps)** 317
 - Manual shift program** 342
 - Maximum loaded vehicle weight** 450
 - Maximum load rating (tires)** 450
 - Maximum permissible tire inflation pressure** 450
 - Mechanical key** 539
 - Memory function** 314
 - Menus**
 - see Control system menus
 - Minispare wheel**
 - see Spare wheel
 - Mirrors**
 - Auto-dimming rear view mirrors . . . 312
 - Exterior rear view mirror parking positions 313, 315
 - Exterior rear view mirrors 311
 - Interior rear view mirror 311
 - Memory function 314
 - MON (Motor Octane Number)** 581
 - Motor Octane Number**
 - see MON
 - MP3** 195
 - Multifunction display** 233
 - Text messages 476
 - Vehicle status messages 475
 - Multifunction display messages**
 - ABC (Active Body Control) 505
 - ABS 491, 499
 - Advanced Parking Guidance 485
 - Advanced TPMS 488, 524
 - Air bags 478
 - AIRMATIC 506
 - Alternator 487, 516
 - Automatic transmission
 - 486
 - Backrests 509
 - Battery 487, 516
 - Blind Spot Assist 484
 - Brake fluid 490
 - Brake pads 498
 - Coolant 513, 514, 515
 - Corner-illuminating lamps 519
 - Cruise control 481
 - Display malfunction 475
 - DISTRONIC Plus 482
 - Doors 509
 - EBP 491
 - ESP® 491, 500
 - Fog lamps 522
 - Front passenger front air bag 478
 - Gas cap 518
 - Gear selector lever 486
 - High-beam lamps 521
 - Hood 508
 - License plate lamps 521
 - Light sensor 520
 - Low-beam lamps 519
 - Night View Assist 507
 - Park Assist 483
 - Parking lamps 522
 - PRE-SAFE® 476
 - Radar sensors 486
 - Reserve fuel 518
 - Reverse lamp 522
 - Side marker lamps 523
 - SmartKey 510
 - SmartKey with KEYLESS-GO 509
 - SRS 502
 - Tele Aid 502
 - Tire pressure 488, 524
 - Tires 488, 524
 - Trunk 508
 - Turn signals 520

Multifunction steering wheel

Adjusting	310
Buttons	232
Cleaning	468
Gearshift control	342
Heating	311
Memory function	314

N**Navigation**

Destination memory	145
Entering a destination	107
Introduction	95
Last destinations	150
Points of interest (POI)	128
Route guidance	135
Traffic information	143

Navigation menu 237**Nets, parcel** 397**Night security illumination** 319**Night View Assist** 380

Cleaning the windshield in front of the camera	466
Messages in the multifunction display	507

Normal occupant weight 450**Number, vehicle identification****(VIN)** 565**O****Occupant Classification System**

see OCS

Occupant distribution 450**Occupant safety** 42

Air bags	43
Children and air bags	43
Children in the vehicle	59
Child seat anchors – LATCH-type ..	62
Fastening the seat belts	54
Front passenger front air bag off indicator lamp	49, 538
Infant and child restraint systems ..	59
OCS	48
PRE-SAFE®	56
Seat belts	45, 52

OCS (Occupant Classification**System)** 48Self-test

Odometer 235

Oil

see Engine oil

Oil level

see Engine oil, Checking level

On-board computer

see Control system

One-touch gearshifting 341

Operating safety 22

Ornamental moldings, cleaning 464

Overhead control panel 38

P

Paintwork, cleaning 463

Paintwork code 565

Panic alarm 64

Parcel nets 397

Park Assist 369

Activating/deactivating

Cleaning system sensors

Collision warning

Messages in the multifunction

display

Range

System sensors

Warning indicators

Parking 332

Advanced Parking Guidance

Park Assist

Parktronic system

Parking Guidance, Advanced 373

Parking position

Exterior rear view mirrors ... 313, 315

Transmission position

Parktronic system

Cleaning system sensors

Malfunctions

Minimum distance

Range

12

- System sensors 366
 - Warning indicators 367
 - Parts service** 564
 - PASS AIR BAG OFF indicator lamp**
see Front passenger front air bag
off indicator lamp
 - Passenger safety**
see Occupant safety
 - PCMCIA card** 200
 - Pedals** 455
 - Phone**
see Telephone
 - Phone book** 165
 - Plastic parts, cleaning** 468
 - Power assistance** 455
 - Power closing assist for doors and
trunk lid** 300
 - Power outlet** 403
 - Power seats**
see Seats
 - Power tilt/sliding sunroof**
Operation 394
Synchronizing 396
 - Power washer** 463
 - Power windows** 325
Cleaning 467
Operation 325
Rear side window, blocking
operation 63
Synchronizing 326
 - Practical hints** 472
 - PRE-SAFE®** 56
Messages in the multifunction
display 476
 - PRE-SAFE® Brake** 72
 - Problems**
While driving 332
With vehicle 23
 - Product information** 19
 - Production options weight** 450
 - Program mode selector switch**
Automatic shift program 341
Manual shift program 343
 - Proximity key**
see Key, SmartKey
 - PSI (air pressure unit)** 450
 - Push-start**
see Tow-start
- R**
- RACETIMER** 240
 - Radar sensors**
Messages in the multifunction
display 486
 - Radio** 184
Satellite radio 189
Selecting stations 238
 - Radio transmitters** 458
 - Rain sensor** 323
 - Rear axle oil** 578
 - Rear fog lamp**
see Fog lamps
 - Rear seat head restraints**
see Head restraints
 - Rear side window**
Blocking operation 63
 - Rear view camera** 377
cleaning the lens 466
 - Rear window defroster** 393
 - Recommended tire inflation
pressure** 435, 450
 - Recovery services, Stolen vehicle
(Tele Aid)** 412
 - Refrigerant, air conditioning** 580
 - Refueling** 421
 - Regular checks** 422
 - Reminder, Seat belt**
see Seat belts, Telltale
 - Remote control**
see Key, SmartKey
 - Remote door unlock (Tele Aid)** 411
 - Replacing bulbs** 543
 - Reporting safety defects** 23
 - Research Octane Number**
see RON
 - Reserve fuel**
Messages in the multifunction
display 518

- Restraint systems**
see Occupant safety
- Retaining hook** 397
- Rims** 450, 569
- Roadside Assistance** 21, 407
- RON (Research Octane Number)** . . . 581
- Route guidance**
see Navigation system
- Rubber parts, cleaning** 468
- S**
- Safety**
Driving safety systems 65
Occupant safety 42
Reporting defects 23
- Safety belts**
see Seat belts
- Satellite radio** 189
- Seat belt force limiter** 56
- Seat belts** 52
Automatic comfort-fit feature 56
Children in the vehicle 59
Cleaning 469
Fastening 54
Proper use of 53
Safety guidelines 45
Safety notes 52
Telltale 31, 531
Warning lamp 531
- Seating capacity** 433
- Seats** 303
Adjusting 304
Heating 309
Memory function 314
Messages in the multifunction
display 509
Ventilation 309
- Selective setting**
see Key, SmartKey
- Selector lever**
see Gear selector lever
- Self-test**
OCS 52
Tele Aid 405
- Service**
see Maintenance
- Service, parts** 564
- Service and warranty information** . . 20
- Service intervals**
see Maintenance System, Service
indicator
- Service life (tires)** 430
- Service menu** 245
- Settings**
Automatic locking 218
Display settings 92
Easy-entry/exit feature 219
Exterior mirror convenience
settings 218
Factory setting (SmartKey) . . . 291, 293
Individual (vehicle) 246
Interior ambient lighting 220
Interior lighting delayed switch-off . 220
Language 94
Locator lighting 217
Memory function 314
Night security illumination 216
Rear window sunshade 221
Selective setting (SmartKey) . . 291, 293
Time 92
Trunk opening-height restriction . . 222
Voice Control 93
- Shelf below rear window, cleaning** . 469
- Side impact air bags** 47
- Side marker lamps**
Cleaning lenses 464
Messages in the multifunction
display 523
Replacing bulbs 543
- Sidewall (tires)** 450
- Side windows**
see Power windows
- SmartKey**
see Key, SmartKey
- SmartKey with KEYLESS-GO**
see Key, SmartKey
- SMS messages** 182
- Snow chains** 453

Snow tires

see Winter tires

Spare wheel 474, 569

Mounting 547

Speedometer 31

Speed settings

DISTRONIC Plus 358

Resume function 359

SRS 43

Indicator lamp 31, 43, 532

Messages in the multifunction display 502

Standing water, driving through 458

Starter switch positions 301

Starting difficulties (engine) 330

Starting the engine 328

Steering column

see Multifunction steering wheel,

Adjusting

Steering wheel

see Multifunction steering wheel

Steering wheel gearshift control 342

Stolen Vehicle Recovery services 412

Storage compartments 32, 398

Storing tires 431

Sunroof

see Power tilt/sliding sunroof

Sun visors 402

Suspension tuning

see AIRMATIC

T

Tachometer 31, 346

Overspeed range 346

Tail lamps 543

Cleaning lenses 464

Replacing bulbs 543

Tar stains 463

Technical data

Air conditioning refrigerant 579, 580

Brake fluid 578, 580

Capacities fuels, coolants, lubricants etc. 577

Coolant 578, 582

Dimensions 575

Electrical system 574

Engine 567

Engine oil additives 580

Engine oils 577, 579

Fuel requirements 581

Gasoline additives 581

Identification labels 565

Premium unleaded gasoline 580

Rims and tires 569

Spare wheel 573

Washer and headlamp cleaning system 579, 583

Weights 576

Tele Aid 405

Automatic Maintenance Call 411

Emergency calls 406

Information button 408

Initiating an emergency call manually 407

Messages in the multifunction display 502

Remote door unlock 411

Roadside Assistance button 407

Search and send 410

SOS button 407

Stolen Vehicle Recovery services 412

System self-test 405

Telephone 151, 404

Answering/ending a call 243

Call lists 158

Emergency call "911" 154

Menu 242

Operation 242

Phone book 165, 243

Redialing 244

Telephone keypad 81

Temperature

Coolant 345

Interior temperature 388

Outside 346

Tether anchorage points

see Children in the vehicle

Tightening torque

Spark plugs 574

Wheels 551

- Time settings** 92
- TIN (Tire Identification Number)** . . . 450
- Tire and Loading Information**
- Placard** 432
- Tire and loading terminology** 449
- Tire Identification Number**
see TIN
- Tire inflation pressure**
Checking 437
Important notes on 436
Placard on driver's door B-pillar . . . 432
- Tire labeling** 441
- Tire load rating** 451
- Tire ply composition and material used** 451
- Tires** 429, 569
Advanced Tire Pressure
Monitoring System (Advanced
TPMS) 438
Advanced TPMS low tire pressure
telltale 537
Air pressure 435
Care and maintenance 430
Cleaning 431
Direction of rotation, spinning . . . 431
Important notes on tire inflation
pressure 436
Inflation pressure 436, 437
Information placard 432
Inspection 430
- Labeling 441
- Load rating 451
- Messages in the multifunction
display 488, 524
- Ply composition and material used . . 451
- Problems under-/overinflation 436
- Retreads 429
- Rims and tires (technical data) 569
- Rotation 451
- Service life 430
- Sizes 569
- Snow chains 453
- Speed rating 443, 451
- Storing 431
- Temperature 436, 448
- Terminology 449
- Tire Identification Number 450
- TPMS low tire pressure/
malfunction telltale 537
- Traction 448, 451
- Tread 451
- Tread depth 430, 452
- Treadwear indicators 430, 451
- Vehicle maximum load on 451
- Wear pattern 451
- Winter tires 452, 569
- Tire speed rating** 443, 451
- Top tether**
see Children in the vehicle
- Total load limit** 451
- Towing eye bolt** 556
- Towing the vehicle** 555
- Tow-start** 554, 555
- Traction** 451
- Transmission**
see Automatic transmission
- Transmission fluid level** 427
- Transmission gear selector lever**
see Gear selector lever
- Transmission positions** 338
- Traveling abroad** 458
- Tread (tires)** 451
- Tread depth (tires)** 430, 452
- Treadwear indicators (tires)** 430, 451
- Trip computer menu** 235
- Trunk**
Closing 297
Messages in the multifunction
display 508
Opening 296
Opening/closing system 298, 299
Trunk lid emergency release 299
Unlocking in an emergency 540
Valet locking 300
- Turning off the engine** 334
- Turn signals** 319
Additional in mirrors 543
Bulbs 543
Cleaning lenses 464
Indicator lamps 31

- Messages in the multifunction display 520
- Replacing bulbs 543

U

- Uniform Tire Quality Grading Standards** 447, 451
- Units, Settings**
 - Speedometer 247
- Unleaded gasoline, premium** 580
- Unlocking the vehicle** 290, 292
 - Manually 539
- Upholstery, cleaning** 469
- Useful features** 401

V

- Valet locking** 300
- Vehicle**
 - Battery 551
 - Care 462
 - Control system 231
 - Dimensions 575
 - Individual settings 246
 - Locking/unlocking 290, 292
 - Locking/unlocking manually 539
 - Lowering (wheel change) 550
 - Modifications and alterations, Operating safety 22
 - Towing 555

- Vehicle jack**
 - see Jack
- Vehicle level control**
 - see AIRMATIC
- Vehicle lighting** 316
- Vehicle loading**
 - Instructions 396
 - Load limit 433
 - Terminology 449
- Vehicle maximum load on the tire** 451
- Vehicle Recovery services, Stolen (Tele Aid)** 412
- Vehicle status message memory** 245
- Vehicle tool kit** 472
- Vehicle washing**
 - see Vehicle care
- Video** 209
- Voice Control**
 - Address book 264
 - CD/DVD changer/MP3 269
 - Command list 271
 - Individualization 287
 - Introduction 248
 - Navigation 252
 - Radio 267
 - Settings 93
 - Telephone 259
 - Troubleshooting 283

W

- Warning sounds**
 - Advanced Parking Guidance 375
 - DISTRONIC Plus 352
 - Driver's or passenger's seat belt 55
 - Electronic parking brake 496
 - Park Assist 371
 - Parktronic system 369
 - Seat belt telltale 531
- Warranty coverage** 564
- Washer and headlamp cleaning system** 583
- Washer fluid**
 - Mixing ratio 583
 - Refilling 428
 - Wiping 324
- Washing the vehicle** 462
- Wear pattern (tires)** 451
- Wheel**
 - Changing 547
 - Removing 549
 - Spare 547
 - Tightening torque 551
- Wheels, sizes** 569
- Wheels, Tires and** 429
- Window curtain air bags** 48
- Windows**
 - see Power windows
- Windows, cleaning** 467

Windshield

Cleaning wiper blades	467
Defogging	391
Infrared reflecting	417
Washer fluid	324, 583
Wipers	323

Windshield wipers

Rain sensor	323
Replacing wiper blades	545

Winter driving

Snow chains	453
Tires	452

Winter driving instructions 453**Winter tires** 452, 569**Wood trims, cleaning** 469

Product Information

Please observe the following in your own best interest:

We recommend using Genuine Mercedes-Benz Parts as well as conversion parts and accessories explicitly approved by us for your vehicle model.

We have tested these parts to determine their reliability, safety and special suitability for Mercedes-Benz vehicles.

We are unable to make an assessment for other products and therefore cannot be held responsible for them, even if in individual cases an official approval or authorization by governmental or other agencies should exist. Use of such parts and accessories could adversely affect the safety, performance or reliability of your vehicle. Please do not use them.

Genuine Mercedes-Benz Parts and pre-approved conversion parts and accessories are available at any authorized Mercedes-Benz Center. In addition, you will receive comprehensive information on permissible technical modifications and expert installations.

Operator's Manual

Notes

This Operator's Manual contains a great deal of useful information. We urge you to read it carefully and familiarize yourself with the vehicle before driving.

For your own safety and longer service life of the vehicle, we urge you to follow the instructions and warnings contained in this Operator's Manual. Ignoring them could result in damage to the vehicle or personal injury to you or others. Vehicle damage caused by failure to follow instructions is not covered by the Mercedes-Benz Limited Warranty.

We continuously strive to improve our product, and ask for your understanding that we reserve the right to make changes in design and equipment. Therefore, information, illustrations and descriptions in this Operator's Manual might differ from your vehicle.

Vehicle equipment

Your vehicle may have some or all of the equipment described in this manual.

Therefore, you may find explanations for optional equipment not installed in your vehicle. If you have any questions about operating any equipment, any authorized Mercedes-Benz Center will be glad to demonstrate the proper procedures.

Optional equipment is also described in this manual, including operating instructions wherever necessary. Since they are special-order items, the descriptions and illustrations herein may vary slightly from the actual equipment of your vehicle.

If there are any equipment details that are not shown or described in this Operator's Manual, any authorized Mercedes-Benz Center will be glad to inform you of correct care and operating procedures. The Operator's Manual and Maintenance Booklet are important documents and should be kept with the vehicle.

Operator's Manual

Service and warranty information

The Service and Warranty Information booklet contains detailed information about the warranties covering your Mercedes-Benz, including:

- New Car Limited Warranty
- Emission System Warranty
- Emission Performance Warranty
- California, Connecticut, Maine, Massachusetts, New York, Pennsylvania, Rhode Island, and Vermont Emission Control System Warranty
- State Warranty Enforcement Laws (Lemon Laws)

Important notice for California retail buyers and lessees of Mercedes-Benz automobiles

Under California law you may be entitled to a replacement of your vehicle or a refund of the purchase price or lease price, if after a reasonable number of repair attempts Mercedes-Benz USA, LLC and/or its authorized repair or service facilities fail to fix one or more substantial defects or malfunctions in the vehicle that are covered by its express warranty. During the period of 18 months from original delivery of the vehicle or the accumulation of 18 000 miles (approximately 29 000 km) on the odometer of the vehicle, whichever occurs first, a reasonable number of repair attempts is presumed for a retail buyer or lessee if one or more of the following occurs:

- (1) the same substantial defect or malfunction results in a condition that is likely to cause death or serious bodily injury if the vehicle is driven, that defect or malfunction has been subject to repair two or more times, and you have directly notified Mercedes-Benz USA, LLC in writing of the need for its repair,
- (2) the same substantial defect or malfunction of a less serious nature than

category (1) has been subject to repair four or more times and you have directly notified us in writing of the need for its repair, or

- (3) the vehicle is out of service by reason of repair of the same or different substantial defects or malfunctions for a cumulative total of more than 30 calendar days.

Written notification should not be sent to a dealer, it should be addressed to Mercedes-Benz USA, LLC Customer Assistance Center One Mercedes Drive Montvale, NJ 07645-0350

Maintenance

The Maintenance Booklet describes all the necessary maintenance work which should be performed at regular intervals.

Always have the Maintenance Booklet with you when you take the vehicle to an authorized Mercedes-Benz Center for service. The service advisor will record each service in the booklet for you.

Roadside Assistance

The Mercedes-Benz Roadside Assistance Program provides factory-trained technical help in the event of a breakdown. Calls to the toll-free Roadside Assistance number

1-800-FOR-MERCEdes (in the USA)
1-800-387-0100 (in Canada)

will be answered by Mercedes-Benz Customer Assistance Representatives 24 hours a day, 365 days a year.

For additional information refer to the Mercedes-Benz Roadside Assistance Program brochure (in the USA) or the Roadside Assistance section of the Service and Warranty Information Booklet (in Canada) in your vehicle literature portfolio.

Change of address or ownership

If you change your address, be sure to send in the "Change of Address Notice" found in the Service and Warranty Information Booklet, or simply call the Mercedes-Benz Customer Assistance Center (in the USA) at 1-800-FOR-MERCEdes, or Customer Service (in Canada) at 1-800-387-0100. This will assist us in contacting you in a timely manner should the need arise.

If you sell your Mercedes, please leave all literature with the vehicle to make it available to the next operator.

If you bought this vehicle used, be sure to send in the "Notice of Purchase of Used Car" found in the Service and Warranty Information Booklet, or call the Mercedes-Benz Customer Assistance Center (in the USA) at 1-800-FOR-MERCEdes, or Customer Service (in Canada) at 1-800-387-0100.

Operating your vehicle outside the USA or Canada

If you plan to operate your vehicle in foreign countries, please be aware that:

- service facilities or replacement parts may not be readily available,
- unleaded gasoline for vehicles with catalytic converters may not be available; the use of leaded fuels will damage the catalysts,
- gasoline may have a considerably lower octane rating, and improper fuel can cause engine damage.

Certain Mercedes-Benz models are available for delivery in Europe under our European Delivery Program. For details, consult an authorized Mercedes-Benz Center or write to:

In the USA:

Mercedes-Benz USA, LLC
European Delivery Department
One Mercedes Drive
Montvale, NJ 07645-0350

In Canada:

Mercedes-Benz Canada, Inc.
European Delivery Department
98 Vanderhoof Avenue
Toronto, Ontario M4G 4C9

Operating safety

Operating safety

Warning!

Work improperly carried out on electronic components and associated software could cause them to cease functioning. Because the vehicle's electronic components are interconnected, any modifications made may produce an undesired effect on other systems. Electronic malfunctions could seriously impair the operating safety of your vehicle. Contact an authorized Mercedes-Benz Center for repairs or modifications to electronic components.

Other improper work or modifications on the vehicle could also have a negative impact on the operating safety of the vehicle.

Some safety systems only function while the engine is running. You should therefore never turn off the engine while driving.

Warning!

Heavy blows against the vehicle underbody or tires/wheels, for example when running over an obstacle, road debris or a pothole,

may cause serious damage and impair the operating safety of your vehicle. If you feel a sudden significant vibration or ride disturbance, or you suspect that damage to your vehicle has occurred, you should turn on your hazard warning flashers, carefully slow down, and drive with caution to an area which is a safe distance from the road.

Inspect the vehicle underbody and tires/wheels for possible damage. If the vehicle appears unsafe, have it towed to the nearest authorized Mercedes-Benz Center or other qualified maintenance or repair facility for further inspection or repairs.

Proper use of the vehicle

Proper use of the vehicle requires that you are familiar with the following information and rules:

- the safety precautions in this manual
- the "Technical data" section in this manual
- traffic rules and regulations
- motor vehicle laws and safety standards

Warning!

Various warning labels are attached to your vehicle. These warning labels are intended

to make you and others aware of various risks. You should not remove any of these warning labels unless explicitly instructed to do so by information on the label itself. Removal of any of these labels may cause you and others to be unaware of certain risks which may result in an accident and/or personal injury.

Reporting safety defects**Problems with your vehicle**

If you should experience a problem with your vehicle, particularly one that you believe may affect its safe operation, we urge you to contact an authorized Mercedes-Benz Center immediately to have the problem diagnosed and corrected if required. If the matter is not handled to your satisfaction, please discuss the problem with the Mercedes-Benz Center management or, if necessary, contact us at one of the following addresses:

In the USA:

Customer Assistance Center
Mercedes-Benz USA, LLC
One Mercedes Drive
Montvale, NJ 07645-0350

In Canada:

Customer Relations Department
Mercedes-Benz Canada, Inc.
98 Vanderhoof Avenue
Toronto, Ontario M4G 4C9

Reporting safety defects

For the USA only:

The following text is published as required of manufacturers under Title 49, Code of U.S. Federal Regulations, Part 575 pursuant to the “National Traffic and Motor Vehicle Safety Act of 1966”.

Reporting safety defects

If you believe that your vehicle has a defect which could cause a crash or could cause injury or death, you should immediately inform the National Highway Traffic Safety Administration (NHTSA) in addition to notifying Mercedes-Benz USA, LLC.

If NHTSA receives similar complaints, it may open an investigation, and if it finds that a safety defect exists in a group of vehicles, it may order a recall and remedy campaign. However, NHTSA cannot become involved in individual problems between you, your dealer, or Mercedes-Benz USA, LLC.

To contact NHTSA, you may call the Vehicle Safety Hotline toll-free at 1-888-327-4236 (TTY: 1-800-424-9153); go to

www.safercar.gov; or write to:

Administrator, NHTSA Headquarters,

1200 New Jersey Avenue, SE, West Building,
Washington, DC 20590.

You can also obtain other information about motor vehicle safety from **www.safercar.gov**.

Vehicle data recording

Vehicle data recording

Information regarding electronic recording devices

(Including notice pursuant to California Code § 9951)

Please note that your vehicle is equipped with devices that can record vehicle systems data and, if equipped with the Tele Aid system, may transmit some data in certain accidents.

This information helps, for example, to diagnose vehicle systems after a collision and to continuously improve vehicle safety.

Daimler may access the information and share it with others

- for safety research or vehicle diagnosis purposes
- with the consent of the vehicle owner or lessee
- in response to an official request by law enforcement or other government agency
- for use in dispute resolution involving Daimler, its affiliates or sales/service organization and/or
- as otherwise required or permitted by law.

Please check the Tele Aid subscription service agreement for details regarding the

information that may be recorded or transmitted via that system.

Exterior view	26
Cockpit	28
Instrument cluster	30
Storage compartments	32
Control systems	34
Center console	37
Overhead control panel	38
Driver's door control panel	39



Exterior view

Exterior view

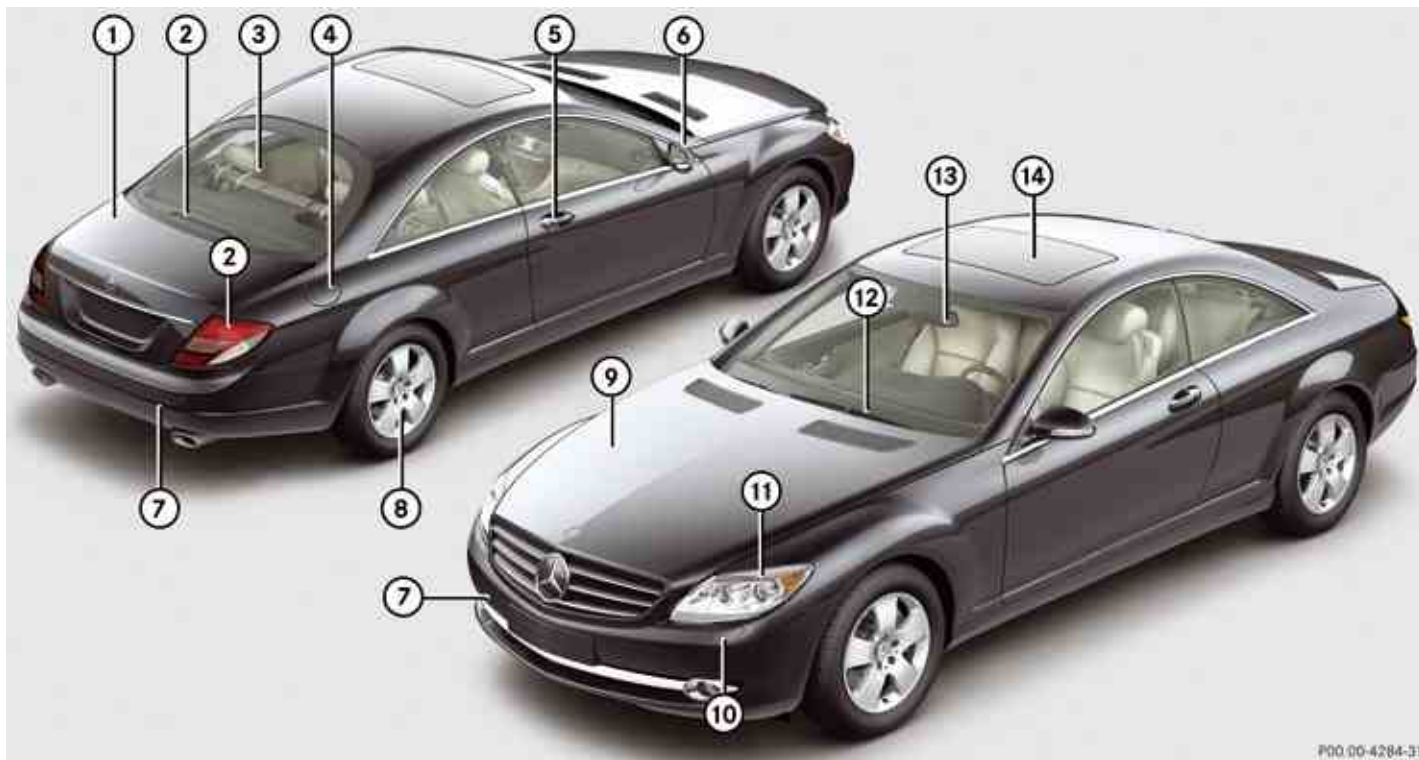

P00.00-4284-31

i This Operator's Manual describes all features, standard or optional, potentially available for your vehicle at the time of purchase. Please be aware that your vehicle might not be equipped with all features described in this manual.

	Function	Page
①	Trunk:	
	Locking and unlocking	290
	Opening and closing	296, 297
	Valet locking	300
	Vehicle tool kit	472
②	Rear lamps	543
③	Rear window defroster	393
④	Fuel filler flap	421
	Fuel requirements	581
⑤	Doors:	
	Locking and unlocking	290
	Opening	294

	Function	Page
	Locking and unlocking manually	539, 541
⑥	Exterior rear view mirrors	311
	Parking position	313
	Power folding	313
⑦	Towing eye	556
⑧	Tires and wheels	429, 569
	Checking tire inflation pressure	437
	Spare wheel	474
	Flat tire	547
	⑨	Hood

	Function	Page
	Engine oil	424
	Coolant	427
⑩	Headlamp cleaning system	320
⑪	Front lamps	543
⑫	Wipers	322
	Wiper blades, replacing	545
	Wiper blades, cleaning	467
⑬	Windshield:	
	Cleaning with washer fluid	324
	Cleaning	467
⑭	Roof:	
	Power tilt/sliding sunroof	394

Cockpit

Cockpit



P66_00_5410-31

	Function	Page
①	Combination switch:	
	Turn signals	319
	Wipers	322
	High beam	319
②	Cruise control lever:	
	Cruise control	347
	DISTRONIC Plus	350
③	Horn	
④	Multifunction steering wheel	232
⑤	Instrument cluster	30, 345
⑥	Steering wheel gearshift control	341
⑦	Gear selector lever for automatic transmission	336
⑧	Control panel with: Front passenger front air bag off indicator lamp	51

	Function	Page
	Vehicle level control switch	363, 364
	Electronic Stability Program (ESP®) switch	70
	Parktronic/Park Assist deactivation switch	368, 372
	Swivel COMAND display	81
	COMAND display illumination	80
	Instrument cluster display illumination	345
⑨	COMAND display	345
⑩	Overhead control panel	38
⑪	Climate control	385
	Center console	37
⑫	Glove box lock	398
⑬	Cover of compartment with:	

	Function	Page
	CD/DVD changer	198
	PCMCIA card slot	200
⑭	Control systems	34
⑮	Starter switch	301
	KEYLESS-GO start/stop button	301
⑯	Steering wheel adjustment stalk	310
	Heated steering wheel	311
⑰	Electronic parking brake	333
⑱	Door control panel	39
⑲	Hood lock release	423
⑳	On-board diagnostics (OBD) socket	
㉑	Night View Assist	380
㉒	Exterior lamp switch	316



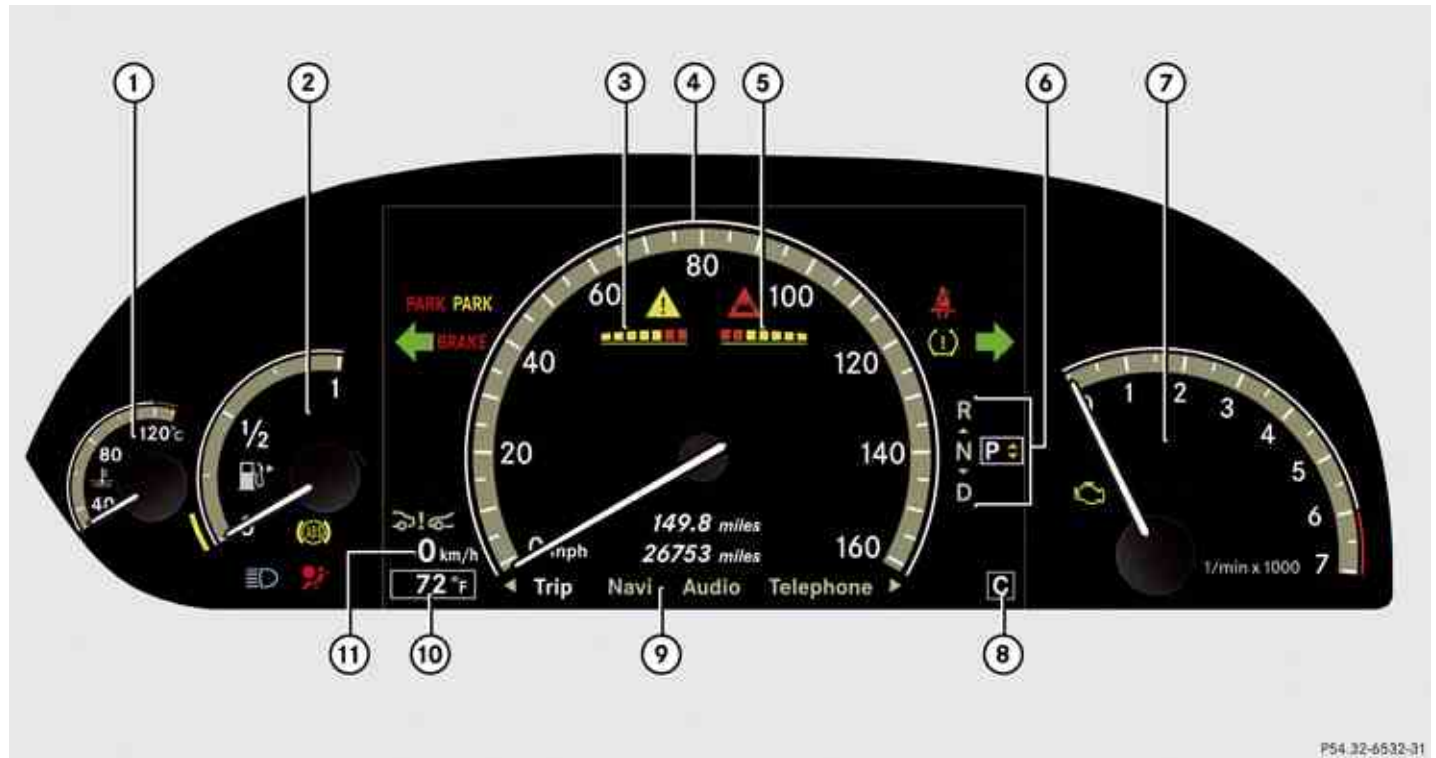

Instrument cluster









Instrument cluster





P54.32-6532-31

Instrument cluster

	Function	Page
①	Coolant temperature gauge	345
②	Fuel gauge with:	
	Fuel tank reserve warning lamp	535
	 High-beam headlamp indicator lamp	319
	 Antilock Brake System (ABS) indicator lamp	528
	 Supplemental Restraint System (SRS) indicator lamp	532
③	Parktronic/Park Assist warning indicator for left front area	368, 371
④	Multifunction display with:	
	Speedometer	
	 Electronic parking brake warning or indicator lamps, USA only	529

	Function	Page
	 Electronic parking brake warning or indicator lamps, Canada only	529
	 Brake warning lamp, USA only	528
	 Brake warning lamp, Canada only	528
	 Seat belt telltale	531
	 Combination low tire pressure/TPMS malfunction telltale, USA only	537
	 Low tire pressure telltale, Canada only	537
	 Left turn signal indicator lamp	
	 Right turn signal indicator lamp	
	 ESP® warning lamp	531

	Function	Page
	 Distance warning lamp ¹	534
⑤	Parktronic/Park Assist warning indicator for right front area	368, 371
⑥	Gear position/range indicator	340
⑦	Tachometer with:	
	 Engine malfunction indicator lamp	536
⑧	Program mode indicator	341
⑨	Main menus for control system, multifunction display	233
⑩	Outside temperature	346
⑪	Display with:	
	Additional speedometer	247
	 PRE-SAFE® Brake indicator	244

¹ Vehicles without DISTRONIC Plus: Warning lamp without function. It illuminates when the ignition is on. It should go out when the engine is running.

Storage compartments

Storage compartments

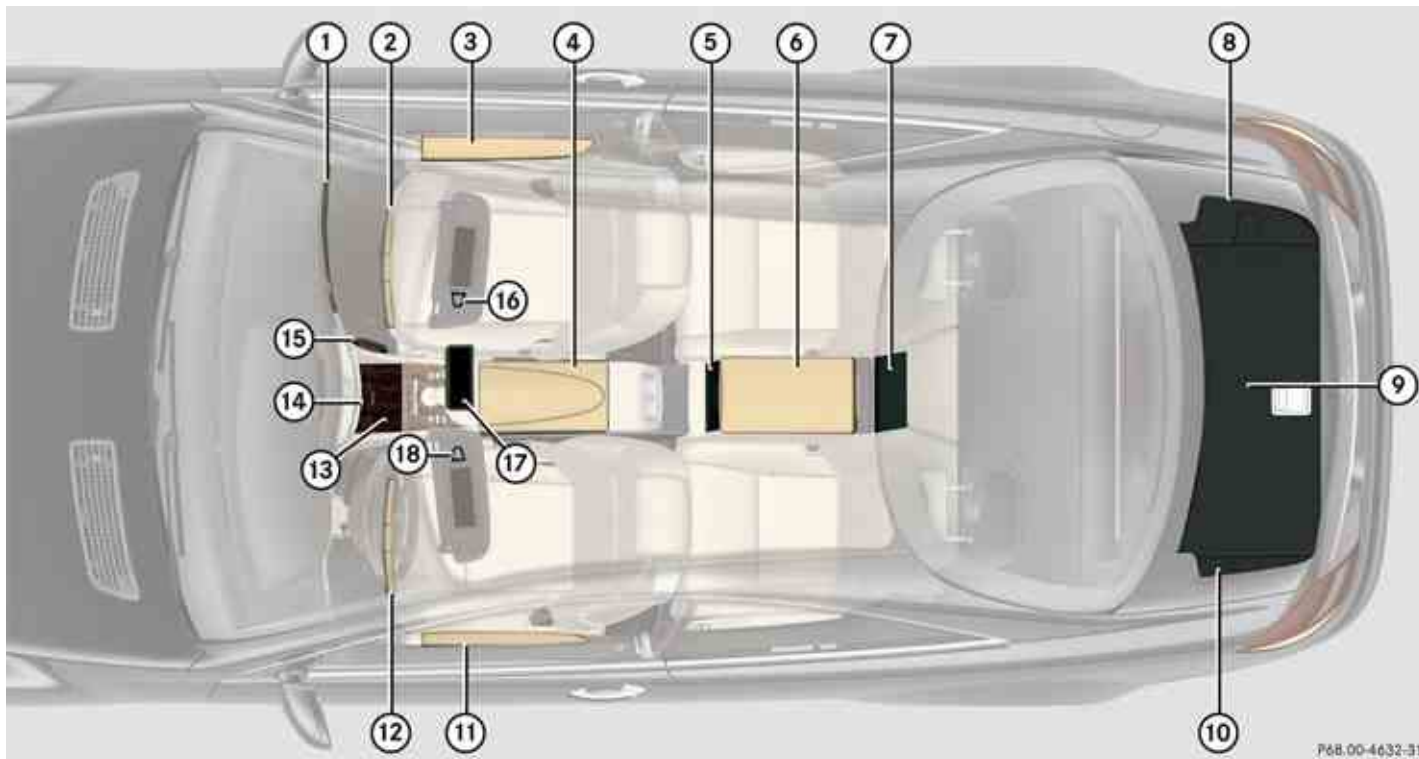

Storage compartments

	Function	Page
①	Glove box	398
②	Front passenger seat storage compartment	398
③	Door pocket	
④	Front center armrest with: Storage tray/telephone compartment Storage compartment	399
⑤	Cup holder in the rear center armrest	401
⑥	Rear center armrest with storage compartment Storage compartment between rear seats	399

	Function	Page
⑦	Rear storage box	399
⑧	Side storage pocket in trunk Retainer for Operator's Manual pouch	
⑨	Storage spaces under trunk floor	400
⑩	Side storage pocket in trunk	
⑪	Door pocket	
⑫	Driver's seat storage compartment	398

	Function	Page
⑬	Cup holder in the front center console	401
⑭	Ashtray Cigarette lighter	402
⑮	Parcel net in front passenger footwell	397
⑯	Document holder in sun visor	402
⑰	Eyeglasses compartment in overhead control panel	398
⑱	Document holder in sun visor	402







Control systems





Control systems







P8A.00-5409-31

Control systems

	Function	Page
①	<p>Press button briefly  to cancel Voice Control System, back, confirm messages</p> <p>Press and hold button  to select the standard display</p>	
②	<p>Press button  or  to select menus</p> <p>Press button briefly  or </p> <ul style="list-style-type: none"> to select function or scroll through lists within Audio menu to select previous or next track, scene or stored station within Telephone menu to switch to the phone book and select a name or number 	

	Function	Page
	<p>Press and hold button  or </p> <ul style="list-style-type: none"> within Audio to select previous or next station in station list or wave band within Telephone menu to start the quick search in the phone book <p> to confirm selection or messages</p>	
③	Multifunction display	233
④	<p>Press button </p> <ul style="list-style-type: none"> to take a call to dial to redial 	160 161

	Function	Page
	<p>Press button </p> <ul style="list-style-type: none"> to end a call to reject an incoming call <p>Press button  to mute</p> <p>Press button  or </p> <ul style="list-style-type: none"> to set the volume to operate the RACETIMER² 	164 160
⑤	<p>Press button </p> <ul style="list-style-type: none"> to activate Voice Control System to accept a call 	251 160
⑥	Instrument cluster illumination	345
⑦	Swivel COMAND display	81
⑧	COMAND display illumination	80

² AMG vehicles only

Control systems

	Function	Page
⑨	COMAND display	80
⑩	CD/DVD changer	198
⑪	PCMCIA card slot	200
⑫	Favorite button	94
⑬	Head restraint release switch	308
⑭	Program mode selector switch for:	
	Automatic transmission shift program	340
	AIRMATIC suspension tuning	363
	ABC suspension tuning	364
⑮	Shortcut button for:	
	CD/DVD	202
	Radio	185
⑯	Back button	86
⑰	Hazard warning flasher switch	320
⑱	Seat menu button	227

	Function	Page
⑲	Shortcut button for:	
	Telephone	79
	Navigation	102
⑳	COMAND on/off button	79
㉑	Volume control	88
㉒	Mute button	88
㉓	Telephone keypad	154
㉔	COMAND controller	81

Center console

Center console

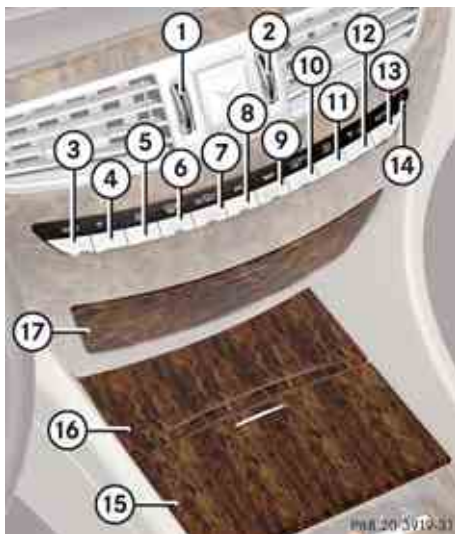

	Function	Page
①	Thumbwheel for air volume control for left center air vent	389
②	Thumbwheel for air volume control for right center air vent	389
③	Air distribution and air volume, driver's side (automatic mode)	388
④	Temperature control, driver's side	388
⑤	Manual fan speed adjustment, driver's side	390
⑥	Front defroster	391
⑦	Air recirculation	392
⑧	Climate control on/off	387
⑨	Residual engine heat and ventilation (REST)	392
⑩	Rear window defroster	393
⑪	Manual fan speed adjustment, passenger side	390

	Function	Page
⑫	Temperature control, passenger side	388
⑬	Air distribution and air volume, passenger side (automatic mode)	388
⑭	Alarm system indicator lamp	76
⑮	Cup holder	401
⑯	Cover of compartment with: Ashtray	402
	Cigarette lighter	403
⑰	Cover of compartment with: CD/DVD changer	198
	PCMCIA card slot	200

Overhead control panel

Overhead control panel

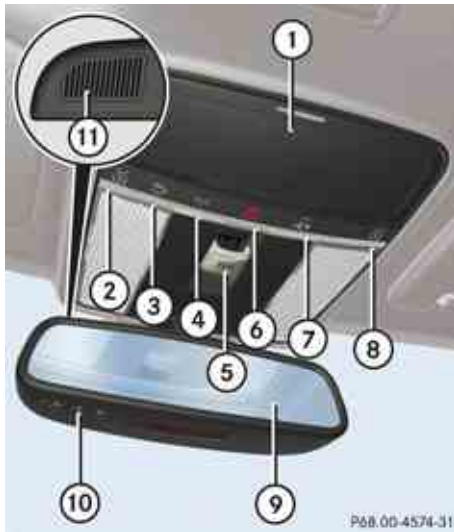

P68.00-4574-31

	Function	Page
①	Eyeglasses compartment	398
②	Left reading lamp on/off	321
③	Rear interior lighting on/off	321
④	Front interior lighting on/off	321
⑤	Power tilt/sliding sunroof switch	394
⑥	Tele Aid (emergency call system) button	405
⑦	Interior lighting control	321
⑧	Right reading lamp on/off	321
⑨	Rear view mirror	311
⑩	Garage door opener	412
⑪	Hands-free microphone for:	
	Tele Aid (emergency call system)	405
	Telephone	404
	Voice Control	248

Driver's door control panel

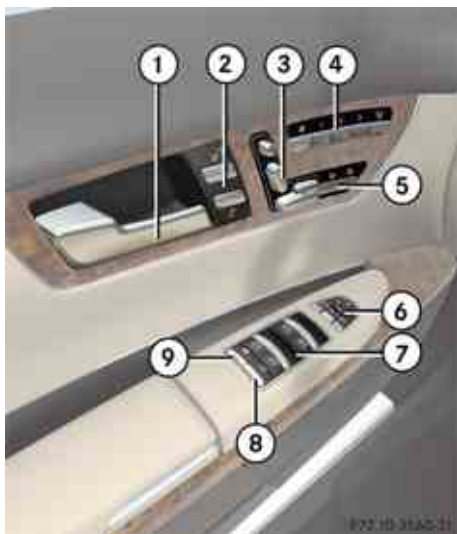

	Function	Page
①	Inside door handle	294
②	Central unlocking switch	295
	Central locking switch	295
③	Seat adjustment switch	304
④	Memory function (for storing seat, exterior mirror, and steering wheel settings)	314
	Selector button for front passenger seat	304
⑤	Seat heating	309
	Seat ventilation	309
⑥	Exterior rear view mirror adjustment	311
	Power-folding exterior rear view mirrors	313
⑦	Switches for opening/closing front and rear door windows	325

Driver's door control panel

	Function	Page
⑧	Remote trunk opening/closing switch	296
⑨	Override switch	63

Vehicle equipment	42
Occupant safety	42
Panic alarm	64
Driving safety systems	65
Anti-theft systems	75



Occupant safety

Vehicle equipment

i This Operator's Manual describes all features, standard or optional, potentially available for your vehicle at the time of purchase. Please be aware that your vehicle might not be equipped with all features described in this manual.

Occupant safety

Introduction

In this section you will learn the most important facts about the restraint system components of the vehicle.

The restraint systems are

- Seat belts
- Child restraints
- Lower Anchors and Iethers for Children (LATCH)

Additional protection potential is provided by:

- Supplemental Restraint System (SRS) with
 - Air bags
 - Air bag control unit (with crash sensors)
 - Emergency Intensioning Device (ETD) for seat belts
 - Seat belt force limiter
- Preventive occupant safety (PRE-SAFE®)
- Air bag system components with
 - Front passenger front air bag off indicator lamp
 - Front passenger seat with Occupant Classification System (OCS)

Although the systems are independent, their protective functions work in conjunction with each other.

Warning!



Modifications to or work improperly conducted on restraint system components or their wiring, as well as tampering with interconnected electronic systems, can lead to the restraint systems no longer functioning as intended.

Air bags or Emergency Tensioning Devices (ETDs), for example, could deploy inadvertently or fail to deploy in accidents although the deceleration threshold for air bag deployment is exceeded. Therefore, never modify the restraint systems. Do not tamper with electronic components or their software.

i For information on infants and children traveling with you in the vehicle and restraint systems for infants and children, see "Children in the vehicle" (▷ page 59).

SRS indicator lamp

The SRS system conducts a self-test when the ignition is switched on and in regular intervals while the engine is running. This facilitates detection of system malfunctions.

The  indicator lamp in the instrument cluster comes on when the ignition is switched on and goes out no later than a few seconds after the engine has been started. The SRS components are in operational readiness if the  indicator lamp is not lit when the engine is running.

A malfunction in the system has been detected if the  indicator lamp

- fails to go out after approximately 4 seconds after the engine is started
- does not come on at all
- comes on after the engine was started or while driving

Warning!

In the event that the  indicator lamp comes on while driving or does not come on at all, the SRS self-check has detected a malfunction. For your safety, we strongly recommend that you contact an authorized Mercedes-Benz Center immediately to have the system checked; otherwise the

SRS may not deploy when needed in an accident, which could result in serious or fatal injury, or it might deploy unexpectedly and unnecessarily which could also result in injury.

In addition, improper work on the SRS creates a risk of rendering the SRS inoperative or causing unintended air bag deployment. Work on the SRS must therefore only be performed by qualified technicians. Contact an authorized Mercedes-Benz Center.

If it is necessary to modify an air bag system to accommodate a person with disabilities, contact an authorized Mercedes-Benz Center or call our Customer Assistance Center at 1-800-FOR-MERCEdes (1-800-367-6372) for details.

Air bags

Warning!

Air bags are designed to reduce the potential of injury and fatality in certain frontal impacts (front air bags, driver side knee bag), side impacts (side impact air bags and window curtain air bags), or rollovers (window curtain air bags). However, no system available today can completely eliminate injuries and fatalities. The deployment of the air bags temporarily releases a small amount of dust from the air bags. This dust, however, is neither injurious to your health, nor does it indicate a fire in the vehicle. The dust might cause some temporary breathing difficulty for people with asthma or other breathing trouble. To avoid this, you may wish to get out of the vehicle as soon as it is safe to do so. If you have any breathing difficulty but cannot get out of the vehicle after the air bag inflates, then get fresh air by opening a window or door.

Warning!

To reduce the risk of injury when the front air bags inflate, it is very important for the driver and front passenger to always be in

Occupant safety

a properly seated position and to wear their respective seat belt.

For maximum protection in the event of a collision always be in normal seated position with your back against the seat backrest. Fasten your seat belt and make sure it is properly positioned on your body. Since the air bag inflates with considerable speed and force, a proper seating position and correct positioning of the hands on the steering wheel will help to keep you at a safe distance from the air bag. Occupants who are not wearing their seat belt, are not seated properly or are too close to the air bag can be seriously injured or killed by an air bag as it inflates with great force instantaneously:

- Sit with the seat belt properly fastened in a position that is as upright as possible with your back against the seat backrest.
- Move the driver seat as far back as possible, still permitting proper operation of vehicle controls. The distance from the center of the driver's chest to the center of the air bag cover on the steering wheel must be at least 10 inches (25 cm) or more. You should be able to accomplish this by adjusting

the seat and steering wheel. If you have any difficulties, please contact an authorized Mercedes-Benz Center.

- Do not lean your head or chest close to the steering wheel or dashboard.
- Keep hands on the outside of the steering wheel rim. Placing hands and arms inside the rim can increase the risk and potential severity of hand/arm injury when the driver front air bag inflates.
- Adjust the front passenger seat as far as possible rearward from the dashboard when the seat is occupied.
- Occupants, especially children, should never place their bodies or lean their heads in the area of the door where the side impact air bag inflates. This could result in serious injuries or death should the side impact air bag be deployed. Always sit as upright as possible, wear the seat belt properly and use an appropriately sized infant restraint, toddler restraint, or booster seat recommended for the size and weight of the child.

Failure to follow these instructions can result in severe injuries to you or other occupants.

If you sell your vehicle, it is important that you make the buyer aware of this safety information. Be sure to give the buyer this Operator's Manual.

Warning!

Accident research shows that the safest place for children in an automobile is in the rear seat.

There is a possibility for a side impact air bag-related injury if occupants, especially children, are not properly seated or restrained when next to a side impact air bag which needs to deploy rapidly in a side impact in order to do its job.

To help avoid the possibility of injury, please follow these guidelines:

- (1) Occupants, especially children, should never place their bodies or lean their heads in the area of the door where the side impact air bags inflates. This could result in serious injuries or death

should the side impact air bags be deployed.

- (2) Always sit as upright as possible, properly use the seat belts, and for children 12 years old and under, use an appropriately sized infant restraint, toddler restraint, or booster seat recommended for the size and weight of the child.
- (3) Always wear seat belts properly.

If you believe that, even with the use of these guidelines, it would be safer for your rear seat occupants to have the rear mounted side impact air bags deactivated, then deactivation can be carried out upon your written request at an authorized Mercedes-Benz Center at an additional cost.

Please contact an local authorized Mercedes-Benz Center or call the Customer Assistance Center (in the USA) at 1-800-FOR-MERcedes (1-800-367-6372), or Customer Service (in Canada) at 1-800-387-0100 for details.

Air bags are designed to deploy only in certain frontal impacts (front air bags, driver side knee bag), side impacts (side impact and

window curtain air bags) which exceed preset deployment thresholds, and in certain rollovers (window curtain air bags). Only in the event of such a situation will they provide their supplemental protection.

The driver and passengers should always wear their seat belts. Otherwise it is not possible for the air bags to provide their supplemental protection.

In case of other types of impacts and impacts below air bag deployment thresholds, air bags will not deploy. The driver and passengers will then be protected to the extent possible by a properly fastened seat belt. A properly fastened seat belt is also needed to provide the best possible protection in a rollover.

Air bags are not a substitute for seat belts. Always wear your seat belt, regardless of whether or not your vehicle is equipped with air bags.

It is important to your safety and that of your passengers that you replace deployed air bags and repair any malfunctioning air bags to make sure the vehicle will continue to provide supplemental crash protection for occupants.

Safety guidelines for the seat belt, Emergency Tensioning Device (ETD) and air bag

Warning!

- Damaged seat belts or seat belts that have been subjected to stress in an accident must be replaced and their anchoring points must also be checked. Only use seat belts installed or supplied by an authorized Mercedes-Benz Center.
- Air bags and pyrotechnic Emergency Tensioning Devices (ETDs) contain perchlorate material, which may require special handling and regard for the environment. Check with your local government's disposal guidelines. California residents, see www.dtsc.ca.gov/HazardousWaste/Perchlorate/index.cfm.
- Air bags and ETDs are designed to function on a one-time-only basis. An air bag or ETD that is deployed must be replaced.
- Do not pass seat belts over sharp edges. They could tear.

Occupant safety

- Do not make any modification that could change the effectiveness of the seat belts.
- Do not bleach or dye seat belts as this may severely weaken them. In a crash they may not be able to provide adequate protection.
- No modifications of any kind may be made to any components or wiring of the SRS. This includes changing or removing any component or part of the SRS, the installation of additional trim material, seat covers, badges, etc. over the steering wheel hub, front passenger front air bag cover, outboard sides of the seat backrests, door trim panels, or door frame trims, and installation of additional electrical/electronic equipment on or near SRS components and wiring. Keep area between air bags and occupants free of objects (e.g. packages, purses, umbrellas, etc.).
- Do not hang items such as coat hangers from the coat hooks or handles over the door. These items may be thrown around in the vehicle and cause head and other injuries when the window curtain air bag is deployed.
- Air bag system components will be hot after an air bag has inflated. Do not touch them.
- Never place your feet on the instrument panel, dashboard, or on the seat. Always keep both feet on the floor in front of the seat.
- In addition, improper repair work on the SRS creates a risk of rendering the SRS inoperative or causing unintended air bag deployment. Work on the SRS must therefore only be performed by qualified technicians. Contact an authorized Mercedes-Benz Center.
- For your protection and the protection of others, when scrapping the air bag unit or ETD, our safety instructions must be followed. These instructions are available from any authorized Mercedes-Benz Center.
- Given the considerable deployment speed, required inflation volume, and the material of the air bags, there is the possibility of abrasions or other, potentially more serious injuries resulting from air bag deployment.

If you sell your vehicle, we strongly recommend that you inform the subsequent

owner that the vehicle is equipped with SRS and refer them to the applicable section in the Operator's Manual.

Front air bags

⚠ Observe Safety notes, see page 45.



- ① Driver front air bag
- ② Front passenger front air bag
- ③ Knee bag

The front air bags are designed to provide increased protection for the driver and front passenger against the risk of injuries to the head and thorax.

Driver and front passenger front air bags and driver's side knee bag are deployed

- in the event of certain frontal impacts
- if impact exceeds a preset deployment threshold
- if the system determines that air bag deployment can offer additional protection to that provided by the seat belt
- depending on whether the seat belt is in use
- independently of the side impact air bags and/or the window curtain air bags

The front air bags in this vehicle have been designed to inflate in two stages. This allows the air bags to have different rates of inflation that are based on the vehicle deceleration rate as assessed by the air bag control unit.

On the front passenger side, front air bag ② deployment is additionally influenced by the passenger's weight category as identified by the Occupant Classification System (OCS) (▷ page 48).

The lighter the front passenger side occupant, the higher the vehicle deceleration rate required for second stage inflation of front air bag ②.

The air bags will not deploy in impacts which do not exceed the system's preset deployment thresholds. You will then be protected by the fastened seat belts.

The front air bags will not deploy in the event of a rollover unless the vehicle's rate of longitudinal deceleration or acceleration exceeds the preset deployment threshold for the front air bags.

The front passenger front air bag ② will only be deployed if

- the system, based on OCS weight sensor readings, detects that the front passenger seat is occupied
- the  PASS AIR BAG OFF indicator lamp in the center console is not lit (▷ page 51)
- the impact exceeds a preset deployment threshold

Knee bag

Knee bag ③ is located on the driver side lower instrument panel. It is designed to operate together with the driver front air bag in certain frontal impacts exceeding a preset deployment threshold. Knee bag ③ operates best in conjunction with a properly positioned and fastened seat belt.

Side impact air bags

 **Observe Safety notes, see page 45.**



- ① Front side impact air bag
- ② Rear side impact air bag

When deployed, the side impact air bags are designed to provide increased protection for the thorax (but not the head, neck and arms) of the occupants on the side of the vehicle on which the impact occurs.

The side impact air bags are deployed

- on the impacted side of the vehicle
- in side impacts exceeding a preset deployment threshold
- regardless of whether the seat belt is in use



Occupant safety

- independently of the front air bags
- independently of the ETDs

The front passenger side impact air bag will not deploy if the OCS senses that the front passenger seat is empty and the front passenger seat belt is not fastened (latch plate is not inserted into the buckle). With an empty front passenger seat and the seat belt fastened (latch plate properly inserted into buckle) the front passenger side impact air bag will deploy independently of the empty seat.

The side impact air bags are not deployed in side impacts which do not exceed the system's deployment threshold.

The side air bags will not deploy in the event of a rollover unless the vehicle's rate of lateral deceleration or acceleration exceeds the preset deployment threshold for the side air bags.

⚠ Warning!

Only use seat covers which have been tested and approved by Mercedes-Benz for your vehicle model. Using other seat covers may interfere with or prevent the deployment of the side impact air bags.

Contact an authorized Mercedes-Benz Center for availability.

Window curtain air bags

⚠ Observe Safety notes, see page 45.



① Window curtain air bag

When deployed, window curtain air bags ① are designed to provide increased protection for the head (but not the chest or arms) of the occupants on the side of the vehicle on which the impact occurs.

Window curtain air bags ① are deployed

- on the impacted side of the vehicle
- in side impacts exceeding a preset deployment threshold

- independently of the front air bags
- regardless of whether the front passenger seat is occupied
- regardless of whether the seat belt is in use
- in certain vehicle rollovers, if the system determines that air bag deployment can offer additional protection to that provided by the seat belt

Window curtain air bags ① are not deployed in impacts which do not exceed the system's deployment threshold.

Window curtain air bags ① deploy in the area indicated by the arrows.

Occupant Classification System

The Occupant Classification System (OCS) automatically turns the front passenger front air bag on or off based on the classified occupant weight category determined by weight sensor readings from the front passenger seat.

The system does not deactivate the front passenger side impact air bag, the window curtain air bag and the Emergency Tensioning Devices (ETDs).

Occupants must sit with the seat belt properly fastened in a position that is as

Occupant safety



upright as possible with their back against the seat backrest and feet on the floor to be correctly classified. If the occupant's weight is transferred to another object in the vehicle (e.g. by leaning on armrests), the OCS may not be able to properly approximate the occupant's weight category.

- i** If your seat, including the trim cover and cushion, needs to be serviced in any way, take the vehicle to an authorized Mercedes-Benz Center.

Only seat accessories approved by Mercedes-Benz may be used.

Both the driver and the front passenger should always use the  **PASS AIR BAG OFF** indicator lamp as an indication of whether or not the front passenger is properly positioned.





Warning!

If the  **PASS AIR BAG OFF** indicator lamp illuminates when an adult or someone larger than a small individual is in the front passenger seat, have the front passenger re-position himself or herself in the seat until the  **PASS AIR BAG OFF** indicator lamp goes out.

In the event of a collision, the air bag control unit will not allow front passenger front air bag deployment when the OCS has classified the front passenger seat occupant as weighting as much as or less than a typical 12-month-old child in a standard child restraint or if the front passenger seat is classified as being empty. When the OCS senses that the front passenger seat occupant is classified as being up to or less than the weight of a typical 12-month-old child in a standard child restraint, the  **PASS AIR BAG OFF** indicator lamp will illuminate when the engine is started and remain illuminated, indicating that the front passenger front air bag is deactivated.

When the OCS senses that the front passenger seat is classified as being empty, the  **PASS AIR BAG OFF** indicator lamp will illuminate when the engine is started and remain illuminated, indicating that the front passenger front air bag is deactivated.

When the OCS senses that the front passenger seat occupant is classified as being heavier than the weight of a typical 12-month-old child seated in a standard child restraint or as being a small individual

(such as a young teenager or a small adult), the  **PASS AIR BAG OFF** indicator lamp will illuminate for approximately 6 seconds when the engine is started and then, depending on occupant weight sensor readings from the seat, remain illuminated or go out. With the  **PASS AIR BAG OFF** indicator lamp illuminated, the front passenger front air bag is deactivated. With the  **PASS AIR BAG OFF** indicator lamp out, the front passenger front air bag is activated. When the OCS senses that the front passenger seat occupant is classified as an adult or someone larger than a small individual, the  **PASS AIR BAG OFF** indicator lamp will illuminate for approximately 6 seconds when the engine is started and then go out, indicating that the front passenger front air bag is activated. If the  **PASS AIR BAG OFF** indicator lamp is illuminated, the front passenger front air bag is deactivated and will not be deployed.

Occupant safety

If the  **PASS AIR BAG OFF** indicator lamp is not illuminated, the front passenger front air bag is activated and will be deployed

- in the event of certain frontal impacts
- if impact exceeds a preset deployment threshold
- independently of the side impact air bags

If the front passenger front air bag is deployed, the rate of inflation will be influenced by

- the rate of relevant vehicle deceleration as assessed by the air bag control unit
- the front passenger's weight category as identified by the OCS

For more information on air bag display messages, see (▷ page 478).

Warning!

According to accident statistics, children are safer when properly restrained in the rear seating positions than in the front seating position. Thus, we strongly recommend that children be placed in the rear seats whenever possible. Regardless of seating position, children 12 years old and under must be seated and properly

secured in an appropriate infant restraint, toddler restraint, or booster seat recommended for the size and weight of the child.





The infant or child restraint must be properly secured with the vehicle's seat belt, the seat belt and top tether strap, or lower anchors and top tether strap, fully in accordance with the child seat manufacturer's instructions.

Occupants, especially children, should always sit as upright as possible, wear the seat belt properly and use an appropriately sized infant restraint, toddler restraint, or booster seat recommended for the size and weight of the child.

Children can be killed or seriously injured by an inflating air bag. Note the following important information when circumstances require you to place a child in the front passenger seat:

- Your vehicle is equipped with air bag technology designed to deactivate the front passenger front air bag in your vehicle when the system senses the weight of a typical 12-month-old child or less along with the weight of a standard

appropriate child restraint on the front passenger seat.

- A child in a rear-facing child restraint on the front passenger seat will be seriously injured or even killed if the front passenger front air bag inflates in a collision which could occur under some circumstances, even with the air bag technology installed in your vehicle. The only means to completely eliminate this risk is to never place a child in a rear-facing child restraint in the front seat. We therefore strongly recommend that you always place a child in a rear-facing child restraint in a backseat.
- If you must install a rear-facing child restraint on the front passenger seat because circumstances require you to do so, make sure the  **PASS AIR BAG OFF** indicator lamp is illuminated, indicating that the front passenger front air bag is deactivated. Should the  **PASS AIR BAG OFF** indicator lamp not illuminate or go out while the restraint is installed, please check installation. Periodically check the  **PASS AIR BAG OFF** indicator lamp while driving to make sure the  **PASS AIR BAG OFF** indicator lamp is

Occupant safety

illuminated. If the  **PASS AIR BAG OFF** indicator lamp goes out or remains out, do not transport a child on the front passenger seat until the system has been repaired.

A child in a rear-facing child restraint on the front passenger seat will be seriously injured or even killed if the front passenger front air bag inflates.

- If you have to place a child in a forward-facing child restraint on the front passenger seat, move the seat as far back as possible, use the proper child restraint recommended for the age, size and weight of the child, and secure child restraint with the vehicle's seat belt according to the child seat manufacturer's instructions. For children larger than the typical 12-month-old child, the front passenger front air bag may or may not be activated.

Deployment of the driver front air bag does not mean that the front passenger front air bag also should have deployed.

The OCS may have determined:

- that the seat was empty or occupied by the weight up to or less than that of a typical 12-month-old child seated in a standard

child restraint – both instances where the system suppresses deployment of the front passenger front air bag even though the impact met the criteria and was of sufficient severity to deploy the driver front air bag



- that the seat was occupied by a small individual (such as a young teenager or a small adult) or a child who weighs more than the weight of a typical 12-month-old child in a standard child restraint – both of which are instances where the system may suppress deployment of the front passenger front air bag even though the impact met the criteria and was of sufficient severity to deploy the driver front air bag



① Front passenger front air bag off indicator lamp

The  **PASS AIR BAG OFF** indicator lamp ① will be illuminated, except with the SmartKey removed from the starter switch or with the starter switch in position **0**.

Warning!

If the  indicator lamp and the  **PASS AIR BAG OFF** indicator lamp are lit at the same time, there is a malfunction in the OCS. The front passenger front air bag will be deactivated in this case. Have the system checked as soon as possible by qualified technicians. Contact an authorized Mercedes-Benz Center. Only have the seat repaired or replaced at an authorized Mercedes-Benz Center.





Occupant safety

In order to ensure proper operation of the air bag system and OCS:

- Sit with the seat belt properly fastened in a position that is as upright as possible with your back against the seat backrest.
- While seated, an occupant should not position him/herself in such a way as to cause the occupant's weight to be lifted from the seat bottom as this may result in the OCS being unable to correctly approximate the occupant's weight category.
- Read and observe all warnings in this chapter.

Occupant Classification System Self-test

After turning the SmartKey in the starter switch to position **1** or **2** or pressing the KEYLESS-GO start/stop button once or twice, the  **PASS AIR BAG OFF** indicator lamp illuminates. If an adult occupant is properly sitting on the front passenger seat and the system classifies the occupant as an adult, the  **PASS AIR BAG OFF** indicator lamp will illuminate and go out after approximately 6 seconds.

If the seat is not occupied and the system classifies the front passenger seat as being empty, the  **PASS AIR BAG OFF** indicator lamp will illuminate and not go out.

Warning!

If the  **PASS AIR BAG OFF** indicator lamp does not illuminate, the system is not functioning. You must contact an authorized Mercedes-Benz Center before seating any child on the front passenger seat.

For more information, see the “Practical hints” section (▷ page 538).

Warning!

Never place anything between seat cushion and child seat (e.g. pillow), since it reduces the effectiveness of the OCS. The bottom and back of the child seat must make full contact with the passenger seat cushion and backrest.

If necessary, adjust the tilt of the passenger seat backrest.

An incorrectly mounted child seat could cause injuries to the child in case of an accident, instead of increasing protection for the child.

Follow the manufacturer's instructions for installation of child seats.

Seat belts

Safety notes

The use of seat belts and infant and child restraint systems is required by law in all 50 states, the District of Columbia, the U.S. territories and all Canadian provinces.

Even where this is not the case, all vehicle occupants should have their seat belts fastened whenever the vehicle is in motion.

For information on infants and children traveling with you in the vehicle and restraint systems for infants and children, see “Children in the vehicle” (▷ page 59).

Warning!

Always fasten your seat belt before driving off. Always make sure all of your passengers are properly restrained. You and your passengers should always wear seat belts.

Failure to wear and properly fasten and position your seat belt greatly increases your risk of injuries and their likely severity in an accident.

If you are ever in an accident, your injuries can be considerably more severe without your seat belt properly buckled. Without your seat belt buckled, you are much more likely to hit the interior of the vehicle or be ejected from it. You can be seriously injured or killed.

In the same crash, the possibility of injury or death is lessened if you are properly wearing your seat belt. The air bags can only protect as intended if the occupants are properly wearing their seat belts.

Warning!

Never ride in a moving vehicle with the seat backrest in an excessively reclined position as this can be dangerous. You could slide under the seat belt in a collision. If you slide under it, the seat belt would apply force at the abdomen or neck. That could cause serious or even fatal injuries. The seat backrest and seat belt provide the best restraint when the wearer is in a position that is as upright as possible and the seat belt is properly positioned on the body.

Warning!

Never let more people ride in the vehicle than there are seat belts available. Make

sure everyone riding in the vehicle is correctly restrained with a separate seat belt. Never use a seat belt for more than one person at a time.

Warning!

Damaged seat belts or seat belts that have been subjected to stress in an accident must be replaced and their anchoring points must also be checked.

Only use seat belts which have been approved by Mercedes-Benz.

Do not make any modifications to the seat belts. This can lead to unintended activation of the ETDs or to their failure to activate when necessary.

Do not bleach or dye seat belts as this may severely weaken them. In a crash they may not be able to provide adequate protection. Have all work carried out only by qualified technicians. Contact an authorized Mercedes-Benz Center.

Proper use of seat belts

Warning!

USE SEAT BELTS PROPERLY

- Seat belts can only work when used properly. Never wear seat belts in any other way than as described in this section, as that could result in serious injuries in case of an accident.
- Each occupant should wear their seat belt at all times, because seat belts help reduce the likelihood of and potential severity of injuries in accidents, including rollovers. The integrated restraint system includes SRS (driver front air bag, driver side knee bag, front passenger front air bag, side impact air bags, window curtain air bags for side windows), Emergency Tensioning Devices (ETDs), seat belt force limiters, and front seat knee bolsters.

The system is designed to enhance the protection offered to properly belted occupants in certain frontal (front air bags, driver side knee bag, and ETDs) and side (side impact air bags, window curtain air bags, and ETDs) impacts which exceed preset deployment



Occupant safety

thresholds and in certain rollovers (window curtain air bags and ETDs).

- Never wear the shoulder belt under your arm, against your neck or off your shoulder. In a frontal crash, your body would move too far forward. That would increase the chance of head and neck injuries. The seat belt would also apply too much force to the ribs or abdomen, which could severely injure internal organs such as your liver or spleen. Adjust the seat belt so that the shoulder section is located as close as possible to the middle of the shoulder (it should not touch the neck). Never pass the shoulder portion of the seat belt under your arm.
- Position the lap belt as low as possible on your hips and not across the abdomen. If the lap belt is positioned across your abdomen, it could cause serious injuries in a crash.
- Never wear seat belts over rigid or breakable objects in or on your clothing, such as eyeglasses, pens, keys etc., as these might cause injuries.

- Make sure the seat belt is always fitted snugly. Take special care of this when wearing loose clothing.
- Never use a seat belt for more than one person at a time. Do not fasten a seat belt around a person and another person or other objects at the same time.
- Seat belts should not be worn twisted. In a crash, you would not have the full width of the seat belt to distribute impact forces. The twisted seat belt against your body could cause injuries.
- Pregnant women should also always use a lap/shoulder belt. The lap belt portion should be positioned as low as possible on the hips to avoid any possible pressure on the abdomen.
- Place the seat backrest in a position that is as upright as possible.
- Check your seat belt during travel to make sure it is properly positioned.
- Never place your feet on the instrument panel, dashboard, or on the seat. Always keep both feet on the floor in front of the seat.
- When using a seat belt to secure infant restraints, toddler restraints, or children

in booster seats, always follow the child seat manufacturer's instructions.

Warning!

Do not pass seat belts over sharp edges. They could tear.

Do not allow the seat belt to get caught in the door or in the seat adjustment mechanism. This could damage the seat belt.

Never attempt to make modifications to seat belts. This could impair the effectiveness of the seat belts.

Fastening the seat belts

Warning!

According to accident statistics, children are safer when properly restrained in the rear seating positions than in the front seating position. Thus, we strongly recommend that children be placed in the rear seats whenever possible. Regardless of seating position, children 12 years old and under must be seated and properly secured in an appropriately sized infant restraint, toddler restraint, or booster seat recommended for the size and weight of the

child. For additional information, see “Children in the vehicle”.

A child’s risk of serious or fatal injuries is significantly increased if the child restraints are not properly secured in the vehicle and/or the child is not properly secured in the child restraint.



- ① Seat belt outlet
- ② Latch plate

- ③ Buckle
- ④ Seat belt release button

- ▶ With a smooth motion, pull the seat belt out of seat belt outlet ①.
- ▶ Place the shoulder portion of the seat belt across the top of your shoulder and the lap portion across your hips.
- ▶ Push latch plate ② into buckle ③ until it clicks.
- ▶ If necessary, tighten the lap portion to a snug fit by pulling shoulder portion up.

Releasing the seat belts

- ▶ Press seat belt release button ④ (▷ page 55). Allow the retractor to completely rewind the seat belt by guiding latch plate ② (▷ page 55).

! Make sure the seat belt retracts fully so that the seat belt and/or latch plate cannot get caught or pinched in the door or in the seat mechanism. This can damage the seat belt and impair its effectiveness, and/or cause damage to the door and/or door trim panel. Such damage is not covered by the Mercedes-Benz Limited Warranty.



Damaged seat belts must be replaced. Contact an authorized Mercedes-Benz Center.

Enhanced seat belt reminder system

When the engine is started, the seat belt telltale  will always illuminate for 6 seconds to remind you and your passengers to fasten your seat belts.

If the driver’s seat belt is not fastened when the engine is started, an additional warning chime will also sound for a maximum of 6 seconds or until the driver’s seat belt is fastened.



If after these 6 seconds the driver’s or the front passenger’s seat belt (with the front passenger seat occupied) is not fastened with both doors closed,

- the seat belt telltale  remains illuminated for as long as either the driver’s or front passenger’s seat belt is not fastened.
- and if the vehicle speed once exceeds 15 mph (25 km/h), the seat belt telltale  starts flashing and a warning chime sounds with increasing intensity for a maximum of 60 seconds or until the



Occupant safety

driver's and front passenger's seat belt are fastened.

If you and/or your passenger release the seat belt during driving, the seat belt telltale  starts flashing and the warning chime sounds as described before. If the driver's or the front passenger's seat belt remains unfastened after 60 seconds, the warning chime stops sounding, the seat belt telltale  stops flashing but continues to be illuminated.

After a vehicle standstill, the warning chime is reactivated and the seat belt telltale  is flashing again if the vehicle speed once exceeds 15 mph (25 km/h).

The seat belt telltale  will only go out if both the driver's and the front passenger's seat belt (with the front passenger seat occupied) are fastened, or the vehicle is standing still and a door is opened.

For more information, see "Practical hints" (> page 531).

Emergency Tensioning Device (ETD), seat belt force limiter

The seat belts are equipped with ETDs and seat belt force limiters.

The ETDs are designed to activate in the following cases:

- in frontal or rear-end impacts exceeding the system's preset deployment threshold
- in side impacts exceeding the system's preset deployment threshold on the far side of the impact
- in certain vehicle rollovers
- if the restraint systems are operational and functioning correctly, see  indicator lamp (> page 43)

The ETDs for the front seats will only activate if the front seat belts are fastened (latch plate properly inserted into buckle).

The ETDs for the rear seats will activate with or without the respective seat belts fastened.

In an impact, the ETDs remove slack from the seat belts in such a way that the seat belts fit more snugly against the body. Seat belt force limiters, when activated, are employed to help reduce the peak force exerted by the seat belts on occupants during a crash.

-  The ETDs do not correct an incorrect seat position or incorrectly worn seat belts. The ETDs do not pull occupants back toward the seat backrest.

Warning!

Pyrotechnic ETDs that were activated must be replaced.

For your safety, when disposing of the pyrotechnic ETDs always follow our safety instructions. These are available at any authorized Mercedes-Benz Center.

Automatic comfort-fit feature seat belt

An automatic comfort-fit feature for the front seats reduces the retracting force of the seat belts when they are in normal use.

Preventive occupant safety (PRE-SAFE®)

Warning!

PRE-SAFE® is intended to reduce the effects of an accident on vehicle occupants who are wearing their seat belt properly. Despite having the PRE-SAFE® system in your vehicle, the possibility of injuries occurring as a result of an accident cannot be eliminated. Therefore, you should always drive carefully and adjust your driving to the prevailing road, weather, and traffic conditions.

Your vehicle takes preventive measures to better protect the occupants in the following hazardous situations automatically.

PRE-SAFE® takes preventive measures in

- emergency braking situations, e.g. if the Brake Assist System (BAS) (▷ page 66) is activated or when BAS Plus (▷ page 66) or the PRE-SAFE Brake (▷ page 72) is strongly intervening
- critical dynamic driving situations, e.g. when the vehicle is understeering or oversteering because it has exceeded its physical limitations or in case of evasive steering maneuvers at speeds above approximately 85 mph (140 km/h)

When you are driving faster than 20 mph (30 km/h), PRE-SAFE® takes the following measures in such situations:

- If the passenger seat is in an unfavorable position, it will be adjusted to a better position.
- The system increases the air pressure in the air pockets (on the sides of the seat

cushion and backrest) of the drive-dynamic multicontour front seats.

- If the vehicle is in a critical dynamic driving situation, the front side windows and the tilt/sliding sunroof also closes until only a small gap remains.

If the closing procedure of the side windows or tilt/sliding sunroof is blocked, the side windows or tilt/sliding sunroof will stop and open slightly.

Once the hazardous situation is over without an accident occurring, PRE-SAFE® decreases the air pressure in the air pockets of the drive-dynamic multicontour front seats. You can readjust all of the settings made by PRE-SAFE®.

If the seat belts do not release:

- ▶ Adjust the seat backrest to the rear until the seat belt tension is diminished. The locking mechanism releases.

! When adjusting the seat backrests, make sure there are no items behind the seats. Otherwise, you could damage the seats.

Correct driver seat adjustment

Warning!

In order to avoid possible loss of vehicle control, all seat, head restraint, steering wheel, and rear view mirror adjustments, as well as fastening of seat belts, must be done before the vehicle is put into motion.

Occupant safety



- ① Steering wheel
- ② Seat belt
- ③ Seat

Steering wheel

⚠ Observe Safety notes, see page 310.

- ▶ Position steering wheel ① properly (> page 310).

Make sure:

- You can reach steering wheel ① with your arms slightly bent at the elbows.
- You can move your legs freely.
- All displays (including malfunction and indicator lamps) on the instrument cluster are clearly visible.

Seat belt

⚠ Observe Safety notes, see page 52.

- ▶ Fasten and position your seat belt ② (> page 54) correctly.

Make sure:

- Seat belt ② is always fitted snugly.
- Adjust seat belt ② so that the shoulder section is located as close as possible to the middle of the shoulder.
- Place the lap portion of seat belt ② as low as possible on your hips.

Seat and head restraint

⚠ Observe Safety notes, see page 303.

- ▶ Position seat ③ (> page 304) and head restraint properly (> page 306).

Observe the following points:

- Always be in a properly seated position.
- The position should be as far rearward from the front air bag in steering wheel ① as possible, while still permitting proper operation of vehicle controls.
- Adjust seat ③ to a comfortable seating position that still allows you to reach the accelerator/brake pedal safely.
- Seat ③ must be adjusted so that you can correctly fasten and position your seat belt ②.
- The seat backrest must be in a position that is as nearly upright as possible.
- Adjust the seat cushion so that the front edge of the seat cushion lightly supports your legs.
- Adjust the head restraint so that it is as close to the head as possible and the center of the head restraint supports the back of the head at eye level.
- Never place hands under seat ③ or near any moving parts while seat ③ is being adjusted.

Children in the vehicle

Safety notes

If an infant or child is traveling with you in the vehicle:

- ▶ Secure the child using an infant or child restraint appropriate to the age and size of the child.
- ▶ Make sure the infant or child is properly secured at all times while the vehicle is in motion.

Warning!

When leaving the vehicle, always remove the SmartKey from the starter switch. Always take the SmartKey with you and lock the vehicle. Do not leave children unattended in the vehicle, even if they are secured in a child restraint system, or with access to an unlocked vehicle. A child's unsupervised access to a vehicle could result in an accident and/or serious personal injury. The children could

- injure themselves on parts of the vehicle
- be seriously or fatally injured through excessive exposure to extreme heat or cold
- injure themselves or cause an accident with vehicle equipment that can be operated even if the SmartKey is removed from the starter switch or removed from the vehicle, such as seat adjustment, steering wheel adjustment, or the memory function.

If children open a door, they could injure other persons or get out of the vehicle and injure themselves or be injured by following traffic.

Do not expose the child restraint system to direct sunlight. The child restraint system's metal parts, for example, could become very hot, and the child could be burned on these parts.

Warning!

Do not carry heavy or hard objects in the passenger compartment unless they are firmly secured in place.

Unsecured or improperly positioned cargo increases a child's risk of injury in the event of

- strong braking maneuvers
- sudden changes of direction
- an accident

For more information on loading, please refer to the "Loading and storing" (▷ page 396) chapter.

Infant and child restraint systems

 **Observe Safety notes, see page 59.**

We recommend all infants and children be properly restrained at all times while the vehicle is in motion.

Occupant safety

All lap/shoulder belts except the driver's seat belt have special seat belt retractors for secure fastening of child restraints.

To fasten a child restraint, follow child restraint instructions for mounting. Then pull the shoulder belt out completely and let it retract. During seat belt retraction, a ratcheting sound can be heard to indicate that the special seat belt retractor is activated. The seat belt is now locked. Push down on child restraint to take up any slack. To deactivate, release the seat belt buckle and let the seat belt retract completely. To deactivate the special seat belt retractor for the front passenger seat, the front passenger seat must be in the most backward position. The seat belt can again be used in the usual manner.

Warning!

Never release the seat belt buckle while the vehicle is in motion, since the special seat belt retractor will be deactivated.

 Information on child seats with mounting fittings for tether anchorages (▷ page 62).

For information on LATCH-type child seat anchors (▷ page 62).

The use of infant or child restraints is required by law in all 50 states, the District of Columbia, the U.S. territories and all Canadian provinces.

Infants and small children should be seated in an appropriate infant or child restraint system, properly secured in accordance with the manufacturer's instructions for the child restraint, that complies with U.S. Federal Motor Vehicle Safety Standards 213 and 225 and Canadian Motor Vehicle Safety Standards 213 and 210.2.

A statement by the child restraint manufacturer of compliance with these standards can be found on the instruction label on the restraint and in the instruction manual provided with the restraint.

When using any infant restraint, toddler restraint, or booster seat, make sure to carefully read and follow all manufacturer's instructions for installation and use.

Please read and observe warning labels affixed to the inside of the vehicle and to infant or child restraints.

Warning!

According to accident statistics, children are safer when properly restrained in the rear seating positions than in the front

seating position. Thus, we strongly recommend that children be placed in the rear seats whenever possible. Regardless of seating position, children 12 years old and under must be seated and properly secured in an appropriate infant restraint, toddler restraint, or booster seat recommended for the size and weight of the child.

The infant or child restraint must be properly secured with the vehicle's seat belt, the seat belt and top tether strap, or lower anchors and top tether strap, fully in accordance with the child seat manufacturer's instructions.



Occupants, especially children, should always sit as upright as possible, wear the seat belt properly and use an appropriately sized infant restraint, toddler restraint, or booster seat recommended for the size and weight of the child.

Children can be killed or seriously injured by an inflating air bag. Note the following important information when circumstances require you to place a child in the front passenger seat:



- Your vehicle is equipped with air bag technology designed to deactivate the

Occupant safety

front passenger front air bag in your vehicle when the system senses the weight of a typical 12-month-old child or less along with the weight of a standard appropriate child restraint on the front passenger seat.

- A child in a rear-facing child restraint on the front passenger seat will be seriously injured or even killed if the front passenger front air bag inflates in a collision which could occur under some circumstances, even with the air bag technology installed in your vehicle. The only means to completely eliminate this risk is to never place a child in a rear-facing child restraint in the front seat. We therefore strongly recommend that you always place a child in a rear-facing child restraint in a backseat.
- If you must install a rear-facing child restraint on the front passenger seat because circumstances require you to do so, make sure the  **PASS AIR BAG OFF** indicator lamp is illuminated, indicating that the front passenger front air bag is deactivated. Should the  **PASS AIR BAG OFF** indicator lamp not illuminate or go out while the restraint is installed, please

check installation. Periodically check the  **PASS AIR BAG OFF** indicator lamp while driving to make sure the

 **PASS AIR BAG OFF** indicator lamp is illuminated. If the  **PASS AIR BAG OFF** indicator lamp goes out or remains out, do not transport a child on the front passenger seat until the system has been repaired.

A child in a rear-facing child restraint on the front passenger seat will be seriously injured or even killed if the front passenger front air bag inflates.

- If you have to place a child in a forward-facing child restraint on the front passenger seat, move the seat as far back as possible, use the proper child restraint recommended for the age, size and weight of the child, and secure child restraint with the vehicle's seat belt according to the child seat manufacturer's instructions. For children larger than the typical 12-month-old child, the front passenger front air bag may or may not be activated.

Warning!

Infants and small children should never share a seat belt with another occupant.

During an accident, they could be crushed between the occupant and seat belt.

A child's risk of serious or fatal injuries is significantly increased if the child restraints are not properly secured in the vehicle and/or the child is not properly secured in the child restraint.

Children too big for a toddler restraint must ride in seats using regular seat belts.

Position shoulder belt across chest and shoulder, not face or neck. A booster seat may be necessary to achieve proper seat belt positioning for children over 41 lb (18 kg) until they reach a height where a lap/shoulder belt fits properly without a booster.

When the child restraint is not in use, remove it from the vehicle or secure it with the seat belt to prevent the child restraint from becoming a projectile in the event of an accident.

Occupant safety

Installation of infant and child restraint systems

⚠ Observe Safety notes, see page 59.

This vehicle is equipped with tether anchorages for a top tether strap at each of the rear seating positions.

Top tether straps enable an additional connection to be made between child restraint systems secured with LATCH-type anchors and rear seats. This can further reduce the risk of injury.

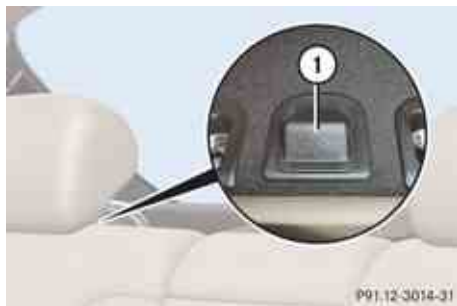

① Anchorage ring cover

- ▶ Remove anchorage ring cover ① from the anchorage ring of the seat on which a child seat is to be installed.
- ▶ Store anchorage ring cover ① in a convenient place (e.g. glove box).

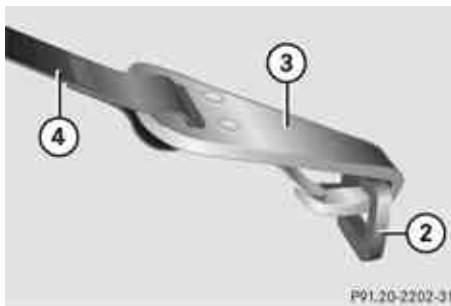

- ② Anchorage ring
- ③ Hook
- ④ Top tether strap

- ▶ Guide top tether strap ④ between the head restraint and top of the seat backrest. The head restraint must be positioned such that top tether strap ④ can pass freely between the head restraint and top of the seat backrest.
- ▶ Make sure top tether strap ④ is not twisted.

- ▶ Securely fasten hook ③, which is part of top tether strap ④, to anchorage ring ②.
- ▶ For safety, make sure hook ③ is attached to anchorage ring ② beyond the safety catch, as illustrated.

Once hook ③ is attached, the child restraint itself can be secured.

- ▶ Install the child restraint system and tighten top tether strap ④ according to the child restraint manufacturer's instructions.

After removing the child restraint system and top tether strap ④.

- ▶ Reinstall anchorage ring cover ①.

Child seat anchors – LATCH-type

⚠ Observe Safety notes, see page 59.

This vehicle is equipped with two LATCH-type anchors (at each of the rear seats) for the installation of a LATCH-type child seat with matching mounting fittings.

⚠ Warning!

Children too big for a toddler restraint must ride in seats using regular seat belts.

Child safety

Override switch

⚠ Observe Safety notes, see page 59.

With the override switch you can disable the rear side window switches in the rear trim panels.

⚠ Warning!

Activate the override switch when children are riding in the back seats of the vehicle. The children may otherwise injure themselves, e.g. by becoming trapped in the window opening.

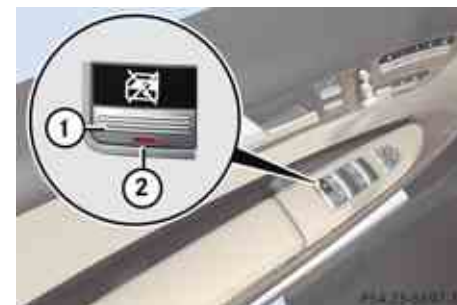

- ① Override switch
- ② Indicator lamp

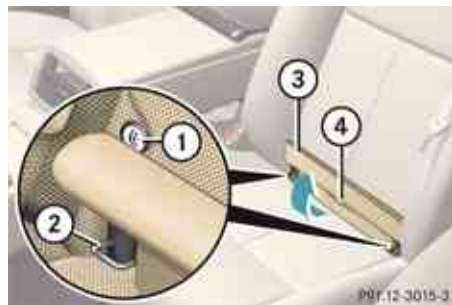

- ① Indicates the position of the anchors
- ② Anchors
- ③ Upholstery blend
- ④ Installation device

- ▶ Fold upholstery blend ③ upward to access anchors ②.
- ▶ Turn installation device ④ to a vertical position so that upholstery blend ③ does not fold down.
- ▶ Install a LATCH-type child seat according to the manufacturer's instructions. A rigid connection between the child seat and the body of the vehicle is established.

Position shoulder belt across chest and shoulder, not face or neck.

A booster seat may be necessary to achieve proper seat belt positioning for children over 41 lb (18 kg) until they reach a height where a lap/shoulder belt fits properly without a booster.

Install child seat according to manufacturer's instructions.

The child seat must be firmly attached to the right and left side anchors.

An incorrectly mounted child seat may come loose during an accident which could result in serious injury or death to the child.

Damaged or impact damaged child seats or child seat mounting fittings must be replaced.

Non-LATCH-type child seats may also be used and can be installed using the vehicle's seat belt system. Install child seat according to the manufacturer's instructions.

The LATCH-type anchors are covered with upholstery blends.

Panic alarm

- ▶ **Activating:** Press override switch ①. Indicator lamp ② comes on.

The rear side windows can no longer be operated using the respective switch located in the rear trim panels.

It is still possible to operate the rear side windows using the switches located on the door control panel of the driver's door.

- ▶ **Deactivating:** Press override switch ① again. Indicator lamp ② goes out.

The rear side windows can again be operated using the respective switch located in the rear trim panels.

For more information on power windows, see the "Controls in detail" section (▶ page 325).

Panic alarm



① PANIC button

i USA only:

This device complies with Part 15 of the FCC Rules. Operation is subject to the following two conditions:

1. This device may not cause harmful interference, and
2. this device must accept any interference received, including interference that may cause undesired operation.

Any unauthorized modification to this device could void the user's authority to operate the equipment.

i Canada only:

This device complies with RSS-210 of Industry Canada. Operation is subject to the following two conditions:

1. This device may not cause interference, and
2. this device must accept any interference received, including interference that may cause undesired operation of the device.

Any unauthorized modification to this device could void the user's authority to operate the equipment.

- ▶ **Activating:** Press and hold button ① for at least 1 second. An audible alarm and flashing exterior lamps will operate briefly.
 - ▶ **Deactivating:** Press button ① again.
- or
- ▶ Insert the SmartKey in the starter switch.
- or
- ▶ Press the KEYLESS-GO start/stop button. The SmartKey with KEYLESS-GO must be inside the vehicle.

Driving safety systems

Introduction

This section contains information about the following driving safety systems:

- ABS (Antilock Brake System)
- Adaptive Brake
- Adaptive Brake Lights
- BAS (Brake Assist System)
- BAS Plus (Brake Assist System Plus)
- EBP (Electronic Brake Proportioning)
- ESP® (Electronic Stability Program)
- PRE-SAFE® Brake (Preventive Occupant Safety System)

i In winter operation, the maximum effectiveness of most of the driving systems described in this section is only achieved with winter tires, or snow chains as required.

Safety notes

Warning!

The following factors increase the risk of accidents:

- Excessive speed, especially in turns
- Wet and slippery road surfaces
- Following another vehicle too closely

The driving safety systems described in this section cannot reduce these risks or prevent the natural laws of physics from acting on the vehicle. They cannot increase braking or steering efficiency beyond that afforded by the condition of the vehicle brakes and tires or the traction afforded. Only a safe, attentive, and skillful driver can prevent accidents.

The capabilities of a vehicle equipped with the driving safety systems described in this section must never be exploited in a reckless or dangerous manner which could jeopardize the user's safety or the safety of others.

Always adjust your driving style to the prevailing road and weather conditions and keep a safe distance to other road users and objects on the street.

If a driving system malfunctions, other driving safety systems may also switch off. Observe indicator and warning lamps that may come on as well as messages in the multifunction display that may appear.

ABS

 **Observe Safety notes, see page 65.**

Warning!

Do not pump the brake pedal. Use firm, steady brake pedal pressure instead. Pumping the brake pedal defeats the purpose of the ABS and significantly reduces braking effectiveness.

The Antilock Brake System (ABS) regulates the brake pressure so that the wheels do not lock during braking. This allows you to maintain the ability to steer your vehicle.

The ABS is functional above a speed of approximately 5 mph (8 km/h) independent of road surface conditions.

On slippery road surfaces, the ABS will respond even to light brake pressure.

The  indicator lamp in the instrument cluster comes on when you switch on the



Driving safety systems

ignition. It goes out when the engine is running.

Braking

At the instant one of the wheels is about to lock up, a slight pulsation can be felt in the brake pedal, indicating that the ABS is in the regulating mode.

- ▶ Keep firm and steady pressure on the brake pedal while you feel the pulsation.

Continuous, steady brake pedal pressure yields the advantages provided by the ABS, namely braking power and the ability to steer the vehicle.

The pulsating brake pedal can be an indication of hazardous road conditions and functions as a reminder to take extra care while driving.

Emergency brake maneuver

- ▶ Keep continuous full pressure on the brake pedal.

Warning!

If the ABS malfunctions, other driving safety systems such as the BAS or the ESP® are also switched off. Observe indicator and warning lamps that may come

on as well as messages in the multifunction display that may appear.

If the ABS malfunctions, the wheels may lock during hard braking, reducing steering capability and extending the braking distance.

For more information, see “What to do if ...?” (▷ page 528).

BAS

 **Observe Safety notes, see page 65.**

The Brake Assist System (BAS) operates in emergency situations. If you apply the brakes very quickly, the BAS automatically provides full brake boost, thereby potentially reducing the braking distance.

- ▶ Apply continuous full braking pressure until the emergency braking situation is over. The ABS will prevent the wheels from locking.

When you release the brake pedal, the brakes function again as normal. The BAS is then deactivated.

Warning!

If the BAS malfunctions, the brake system still functions, but without the additional

brake boost available that the BAS would normally provide in an emergency braking maneuver. Therefore, the braking distance may increase.

BAS Plus (USA only)

The Brake Assist System Plus (BAS Plus) operates in emergency braking situations and uses radar sensors to assess the traffic situation. BAS Plus assists you in braking at speeds above approximately 20 mph (30 km/h).

When traveling in Canada in a vehicle not registered in Canada, you must switch off the radar sensor system (▷ page 247). Canadian law does not permit the use of the radar sensor system for vehicles from outside of Canada.

When you switch off the radar system, the following functions are deactivated:

- BAS Plus
- PRE-SAFE® Brake (▷ page 72)
- DISTRONIC Plus (▷ page 350)
- Park Assist (▷ page 369)
- Blind Spot Assist (▷ page 382)
- Advanced Parking Guidance (▷ page 373)

Driving safety systems

⚠ Warning!

BAS Plus is a convenience system designed to assist the driver during vehicle operation. The responsibility for the vehicle speed and the distance to the vehicle ahead, including most importantly brake operation to assure safe stopping distance, always remains with the driver.

Always pay attention to traffic conditions even while BAS Plus is switched on. Otherwise, you may not be able to recognize dangerous situations until it is too late and could cause an accident resulting in personal or fatal injury to you or others.

i This device has been approved by the FCC as a “Vehicular Radar System”. The radar sensor is intended for use in an automotive radar system only. Removal, tampering, or altering of the device will void any warranties, and is not permitted by the FCC. Do not tamper with, alter, or use in any non-approved way.

Any unauthorized modification to this device could void the user’s authority to operate the equipment.

BAS Plus detects obstacles that are in your driving path for a sufficient period of time to

permit the system to recognize these obstacles. If you approach the detected obstacle quickly, BAS Plus calculates the level of brake power boost appropriate for the circumstance to supply when the driver applies the brakes.

When you step quickly on the brake pedal in an emergency braking situation, BAS Plus automatically regulates the brake power boost to a level that is suitable for the traffic situation.

If BAS Plus requires a particularly high brake power boost, PRE-SAFE® is activated at the same time.

- ▶ Keep constant pressure on the brake pedal until the emergency braking situation is over.
- During this process, the ABS prevents the wheels from locking up.

The brakes will resume normal operation after

- the brake pedal is released
- no obstacles are detected in your path
- the system no longer senses a risk of a collision

BAS Plus is then deactivated.

BAS Plus can react to stationary obstacles such as standing or parked vehicles at road speeds of up to approximately 40 mph (70 km/h).

BAS Plus can only assist you when the radar sensors are switched on and functional. You can check whether the sensors are active by switching on DISTRONIC Plus (▷ page 350) or using the Radar sensors function (▷ page 247) in the instrument cluster control system.

⚠ Warning!

BAS Plus will only respond with brake assistance if it has clearly detected an object. Detection can be impeded by

- dirty or covered sensors
- snowfall or heavy rain
- disturbance from other radar sources
- strong radar reflection such as in parking garages

BAS Plus uses radar signals that are not reflected well by narrow objects and absorptive materials. For this reason BAS Plus will not react to persons, animals, and approaching traffic or cross-traffic.

BAS Plus may not detect narrow vehicles driving in front of you, such as motorcycles



Driving safety systems

and vehicles driving offset from your vehicle center.

After a hard collision or damage to the front of the vehicle from an accident, have the adjustment and operation of the radar sensors checked by an authorized Mercedes-Benz Center.

If BAS Plus is not available due to a radar sensor malfunction, the braking system will continue to function normally with full brake boost and full standard BAS function.

Adaptive Brake

Adaptive Brake provides a high level of braking safety as well as increased braking comfort. It is coupled with the ABS, the ESP® and the BAS. Adaptive Brake takes driver and vehicle characteristics into consideration, thus achieving an optimal braking effect.

For more information on the brake system, see (▷ page 455).

Adaptive Brake Lights

i This function is only available for the CL 600 (USA only).

The brake lamps flash in quick intervals while you are braking hard at a speed of more than 30 mph (50 km/h) or when you are braking with the aid of BAS or BAS Plus. This helps to alert drivers behind you.

If you bring the car to a complete stop by hard braking at a speed of more than 40 mph (70 km/h), the hazard warning flasher automatically comes on as soon as the vehicle is at a standstill. While the vehicle is stationary, the brake lamps are continuously lit up. Once you drive faster than 6 mph (10 km/h) afterward, the hazard warning flasher goes out.

EBP

⚠ Observe Safety notes, see page 65.

The Electronic Brake Proportioning (EBP) enhances braking effectiveness by allowing the rear brakes to supply a greater proportion of the braking effort in straight line braking without a loss of vehicle stability.

⚠ Warning!

If the EBP malfunctions, the brake system will still function with full brake boost. However, the rear wheels could lock up during emergency braking situations, for example. You could lose control of the vehicle and cause an accident.

Adapt your driving style to the changed driving characteristics.

Driving safety systems

ESP®

 **Observe Safety notes, see page 65.**

The Electronic Stability Program (ESP®) is operational as soon as the engine is running and monitors the vehicle's traction (force of adhesive friction between the tires and the road surface) and handling.

The ESP® recognizes when a wheel is spinning or if the vehicle starts to skid. By applying brakes to individual wheels and by limiting the engine output, the ESP® works to stabilize the vehicle. The ESP® is especially useful while driving off and on wet or slippery road surfaces. The ESP® also stabilizes the vehicle during braking and steering maneuvers.

The ESP® warning lamp  in the instrument cluster comes on when you switch on the ignition. It goes out when the engine is running.

The ESP® warning lamp  in the instrument cluster flashes when the ESP® is engaged.

 **Warning!**

Never switch off the ESP® when you see the ESP® warning lamp  flashing in the instrument cluster. In this case proceed as follows:

- When driving off, apply as little throttle as possible.
- While driving, ease up on the accelerator pedal.
- Adapt your speed and driving style to the prevailing road conditions.

Failure to observe these guidelines could cause the vehicle to skid. The ESP® cannot prevent accidents resulting from excessive speed.

 **Vehicles with 4MATIC:**

Only conduct operational or performance tests on a two-axle dynamometer. If such tests are necessary, contact an authorized Mercedes-Benz Center. You could otherwise seriously damage the brake system or the transfer case which is not covered by the Mercedes-Benz Limited Warranty.

 **Vehicles with 4MATIC:**

Because the ESP® operates automatically, the engine and ignition must be shut off (SmartKey in starter switch position **0** or **1** or KEYLESS-GO start/stop button in position **0** or **1**) when the electronic parking brake is being tested on a brake test dynamometer.

Active braking action through the ESP® may otherwise seriously damage the brake system which is not covered by the Mercedes-Benz Limited Warranty.

 **Vehicles without 4MATIC:**

Because the ESP® operates automatically, the engine and ignition must be shut off (SmartKey in starter switch position **0** or **1** or KEYLESS-GO start/stop button in position **0** or **1**) when the electronic parking brake is being tested on a brake test dynamometer or when the vehicle is being towed with one axle raised.

Active braking action through the ESP® may otherwise seriously damage the brake system which is not covered by the Mercedes-Benz Limited Warranty.

 **The ESP® will only function properly if you use wheels of the recommended tire size**



Driving safety systems

as specified in the “Technical data” section of this Operator’s Manual.

- ① The DISTRONIC Plus and cruise control switch off automatically when the ESP® engages.

Electronic Traction System (ETS/4-ETS)

⚠ Observe Safety notes, see page 65.

The ETS (Electronic Traction System) and 4-ETS (four-wheel Electronic Traction System, vehicles with 4MATIC only) are components of the ESP®. The ETS/4-ETS improves the vehicle’s ability to utilize available traction, especially under slippery road conditions by applying the brakes to a spinning wheel. Vehicles with 4MATIC also transfer more power to the wheel(s) with traction.

When you switch off the ESP®, the ETS/4-ETS is still enabled.

Switching off the ESP®



- ① ESP® switch

Switching off the ESP® (except CL 63 AMG)

⚠ Warning!

The ESP® should not be switched off during normal driving other than in the circumstances described below. Disabling the system will reduce vehicle stability in driving maneuvers.

Do not switch off the ESP® when a spare wheel is mounted.

To improve the vehicle’s traction, switch off the ESP® in driving situations in which it would be advantageous to have the drive wheels spin and thus cut into surfaces for better grip such as:

- when driving with snow chains
- in deep snow
- in sand or gravel

⚠ Warning!

Switch on the ESP® immediately if the aforementioned circumstances do not apply anymore. Otherwise the ESP® will not stabilize the vehicle when it is starting to skid or a wheel is spinning.



When you switch off the ESP®,

- the ESP® does not stabilize the vehicle
- the engine output is not limited, which allows the drive wheels to spin and thus cut into surfaces for better grip
- the ETS/4-ETS will still apply the brakes to a spinning wheel
- the ESP® continues to operate when you are braking

Driving safety systems

- you cannot activate the cruise control or the DISTRONIC Plus
- the cruise control or the DISTRONIC Plus switch off if activated

i When the ESP® is switched off and one or more drive wheels are spinning, the ESP® warning lamp  in the instrument cluster flashes. However, the ESP® will then not stabilize the vehicle.

- ▶ With the engine running, press ESP® switch  until the ESP® warning lamp  in the instrument cluster comes on. The ESP® is switched off.

Warning!

When the ESP® warning lamp  is illuminated continuously, the ESP® is switched off or is not operational due to a malfunction. Vehicle stability in standard driving maneuvers is reduced.

Adapt your speed and driving to the prevailing road conditions and to the non-operating status of the ESP®.

- !** Avoid spinning of a drive wheel for an extended period with the ESP® switched off. This may cause serious damage to the

drivetrain which is not covered by the Mercedes-Benz Limited Warranty.

Switching off the ESP® (CL 63 AMG only)

Warning!

The ESP® should not be switched off during normal driving.

Disabling of the system will result in the following:

- no restriction to engine torque
- loss of system supported traction control

“ESP® OFF” is designed for driving on closed tracks when the vehicle’s natural oversteer and understeer characteristics are desired and requires a highly skilled and experienced driver able to handle these critical driving situations.

You could lose control of your vehicle and cause an accident.



Please be aware of these limits when you switch off the ESP®.

Do not switch off the ESP® when a spare wheel is mounted.

When you switch off the ESP®,

- the ESP® does not stabilize the vehicle
- the engine output is not limited, which allows the drive wheels to spin
- the ETS will still apply the brakes to a spinning wheel
- the ESP® operates while you are braking
- you cannot activate the cruise control or the DISTRONIC Plus
- the cruise control or the DISTRONIC Plus switch off if activated

i When the ESP® is switched off and one or more drive wheels are spinning, the ESP® warning lamp  in the instrument cluster flashes. However, the ESP® will then not stabilize the vehicle.

- ▶ With the engine running, press ESP® switch  until the ESP® warning lamp  in the instrument cluster comes on. The ESP® is switched off.

Warning!

When the ESP® warning lamp  is illuminated continuously, the ESP® is switched off or is not operational due to a



Driving safety systems

malfunction. Vehicle stability in standard driving maneuvers is reduced.

Adapt your speed and driving to the prevailing road conditions and to the non-operating status of the ESP®.

- ❗ Avoid spinning of a drive wheel for an extended period with the ESP® switched off. This may cause serious damage to the drivetrain which is not covered by the Mercedes-Benz Limited Warranty.

Switching on the ESP®

- ▶ Press ESP® switch  until the ESP® warning lamp  in the instrument cluster goes out.
You are now again in normal driving mode with the ESP® switched on.

PRE-SAFE® Brake

In vehicles equipped with DISTRONIC Plus, the PRE-SAFE® Brake can assist you in minimizing the risk of a rear-end collision with a vehicle in front of you and in reducing the severity of an accident. At speeds above approximately 20 mph (30 km/h), it will

- warn you of a possible collision
- automatically begin to brake the vehicle lightly in a speed range of up to 112 mph (180 km/h)
- activate preventative occupant safety measures (PRE-SAFE®) (▶ page 56)

Warning!

PRE-SAFE® Brake is a convenience system designed to assist the driver during vehicle operation. The responsibility for the vehicle speed and the distance to the vehicle ahead, including most importantly brake operation to assure safe stopping distance, always remains with the driver.

Always pay attention to traffic conditions even while PRE-SAFE® is switched on. Otherwise, you may not be able to recognize dangerous situations until it is too late and could cause an accident

resulting in personal or fatal injury to you or others.

USA only:

This device has been approved by the FCC as a “Vehicular Radar System”. The radar sensor is intended for use in an automotive radar system only. Removal, tampering, or altering of the device will void any warranties, and is not permitted by the FCC. Do not tamper with, alter, or use in any non-approved way.

Any unauthorized modification to this device could void the user’s authority to operate the equipment.

Canada only:

This device complies with RSS-210 of Industry Canada. Operation is subject to the following two conditions:

1. This device may not cause interference, and
2. this device must accept any interference received, including interference that may cause undesired operation of the device.

Removal, tampering, or altering of the device will void any warranties, and is not

Driving safety systems

permitted. Do not tamper with, alter, or use in any non-approved way.

Any unauthorized modification to this device could void the user's authority to operate the equipment.

PRE-SAFE® will only assist you by initiating braking automatically when the driver and front passenger have their seat belts fastened.

Using the radar sensors, PRE-SAFE® Brake detects obstacles that are in your driving path for a sufficient period of time for the system to recognize it. If you approach a vehicle and PRE-SAFE® Brake has established that the distance to the vehicle ahead at your current speed is so close that PRE-SAFE® Brake will not be capable of slowing the vehicle sufficiently, the system will initially warn you visually and acoustically.

When traveling in Canada in a vehicle not registered in Canada, you must switch off the radar sensor system (▷ page 247). Canadian law does not permit the use of the radar sensor system for vehicles from outside of Canada.

When you switch off the radar system, the following functions are deactivated:

- PRE-SAFE® Brake
- BAS Plus (▷ page 66)
- DISTRONIC Plus (▷ page 350)
- Park Assist (▷ page 369)
- Blind Spot Assist (▷ page 382)
- Advanced Parking Guidance (▷ page 373)

Warning!

PRE-SAFE® Brake will only respond with brake assistance if it has clearly detected an object. Detection can be impeded by

- dirty or covered sensors
- snowfall or heavy rain
- disturbance from other radar sources
- strong radar reflection such as in parking garages

PRE-SAFE® uses radar signals that are not reflected well by narrow objects and absorptive materials. For this reason PRE-SAFE® will not react to persons, animals, and approaching traffic or cross-traffic.

PRE-SAFE® may not detect narrow vehicles driving in front of you, such as motorcycles

and vehicles driving offset from your vehicle center.

When the distance to the forward vehicle is too small, the distance warning lamp  in the instrument cluster comes on. If you approach the forward vehicle very quickly, you will hear a warning signal.

If you do not apply the brakes yourself or maneuver around a sensed obstacle, the vehicle will brake lightly automatically. PRE-SAFE® (▷ page 56) is activated when the distance to the vehicle ahead at your current speed is so close that PRE-SAFE® Brake will not be capable of slowing the vehicle sufficiently.

Warning!

PRE-SAFE® Brake brakes your vehicle with a maximum of 13 ft/s² (4 m/s²). This corresponds to about 40% of the maximum deceleration ability of your vehicle. This automatic braking is intended only to initiate the braking if the driver has not already done so. The driver must apply the brakes in order to prevent a collision.

PRE-SAFE® Brake applies the brake pedal automatically which results in the brake pedal moving. Therefore keep driver's foot



Driving safety systems

area clear at all times, including the area under the brake pedal. Objects stored in this area may impair pedal movement which could interfere with the braking ability of the PRE-SAFE® Brake.

Do not place your foot under the brake pedal – your foot could become caught.

To maintain the proper distance to the vehicle in front of you and thus prevent a rear-end collision, you must apply the brakes yourself.

- ▶ Brake the vehicle immediately to avoid a collision.

Under no circumstances should the driver await the intermittent warning sound before braking. Observe the following warning note.

The intermittent warning sound ceases and the distance warning lamp  goes out when the necessary distance to the vehicle ahead is again established.

Warning!

An intermittent warning sounds and the distance warning lamp  in the instrument cluster is illuminated if PRE-SAFE® Brake calculates that the distance to the vehicle ahead and your vehicle's

current speed indicate that PRE-SAFE® Brake will not be capable of slowing the vehicle sufficiently to maintain the preset following distance, which creates a danger of a collision.

Immediately brake your vehicle to increase the distance between your vehicle and the vehicle driving in front of you. The warning sound is intended as a final caution that you have not interceded with your own braking inputs to avoid a potentially dangerous situation. Do not wait for the operation of the warning signal to intercede with your own braking, as that will result in potentially dangerous emergency braking which will not always result in an impact being avoided.

Tailgating increases the risk of an accident.

PRE-SAFE® Brake can react to stationary obstacles such as standing or parked vehicles at road speeds of up to approximately 40 mph (70 km/h).

Warning!

If you do not receive visual or acoustic warning signals, PRE-SAFE® Brake has either not recognized the collision risk, has been deactivated or is malfunctioning.

Apply the brakes yourself to avoid a collision.

- ▶ **Activating and deactivating:** Activate or deactivate PRE-SAFE® Brake using the instrument cluster control system (> page 244).

After the function has been activated, indicator  appears on the left-hand side of the multifunction display.

PRE-SAFE® Brake does not always clearly interpret complex traffic situations. If a visual and/or acoustic warning is issued in an uncritical driving situation, or if the vehicle brakes lightly, you can interrupt the PRE-SAFE® Brake maneuver by pressing down all the way on the accelerator pedal, using kickdown, or releasing the brake pedal.

The PRE-SAFE® Brake maneuver is terminated immediately when

- you avoid the obstacle by evasive steering
- you drive less than 9 mph (15 km/h)
- an obstacle can no longer be identified ahead of you
- the system no longer senses the risk of a collision

Anti-theft systems

- i** PRE-SAFE® Brake will remain passive while DISTRONIC Plus is switched on (▷ page 350).

After a hard collision or damage to the front of the vehicle from an accident, have the settings and operation of the radar sensors checked by an authorized Mercedes-Benz Center.

Anti-theft systems

Immobilizer

The immobilizer prevents unauthorized persons from starting your vehicle.

When leaving the vehicle, always take the SmartKey with you and lock the vehicle. The engine can be started by anyone with a valid SmartKey that is left inside the vehicle.

Activating

- ▶ **With SmartKey:** Remove the SmartKey from the starter switch.
- ▶ **With KEYLESS-GO:** Turn off the engine and open the driver's door.

Deactivating

- ▶ Switch on the ignition.

- i** Starting the engine will also deactivate the immobilizer.

In the event that the engine cannot be started (yet the vehicle's battery is charged), the system is not operational. Contact an authorized Mercedes-Benz Center or call 1-800-FOR-MERCEdes (in the USA), or 1-800-387-0100 (in Canada).

Anti-theft alarm system

Once the alarm system has been armed, a visual and audible alarm is triggered when someone opens

- a door
- the trunk
- the hood

The alarm will stay on even if the activating element (a door, for example) is immediately closed.

The alarm system will also be triggered when

- the vehicle is opened with the mechanical key
- a door is opened from the inside

To cancel the alarm after it has been triggered, see "Canceling the alarm" (▷ page 76).

- i** If the alarm stays on for more than 30 seconds, a call to the Response Center is initiated automatically by the Tele Aid system provided that you have subscribed to the Tele Aid service and that it has been activated properly, and that the necessary mobile phone, power supply and GPS coverage are available.

Anti-theft systems



① Indicator lamp

▶ **Arming:** Lock the vehicle with the SmartKey or with KEYLESS-GO. The turn signal lamps flash three times to indicate that the vehicle is locked. Indicator lamp ① flashes to indicate that the alarm system is armed.

i If the turn signal lamps do not flash three times, a door or the trunk may not be properly closed. Close the respective element.



▶ **Disarming:** Unlock the vehicle with the SmartKey or with KEYLESS-GO. The turn signal lamps flash once to indicate that the alarm system is disarmed.

i The vehicle will lock and the alarm system will rearm automatically again after

approximately 40 seconds unless you open a door or the trunk.

Canceling the alarm

To cancel the alarm, do one of the following:

- ▶ Insert the SmartKey in the starter switch.
- ▶ Press button  or  on the SmartKey.

In vehicles with KEYLESS-GO:

- ▶ Grasp an outside door handle. The SmartKey must be within 3 ft (1 m) of the vehicle.
- ▶ Press the KEYLESS-GO start/stop button. The SmartKey must be inside the vehicle.

Vehicle equipment	78	COMAND AUX	206
COMAND introduction	78	COMAND video DVD	209
COMAND system settings	91	COMAND vehicle menu	216
COMAND navigation (introduction) ...	95	COMAND automatic climate control	223
COMAND navigation system (entering a destination)	107	COMAND seats	227
COMAND navigation system (Point of interest entry)	128	Instrument cluster control system .	231
COMAND navigation system (route guidance)	135	Voice Control introduction	248
COMAND navigation system (dur- ing route guidance)	141	Voice Control navigation	252
COMAND navigation system (real- time traffic)	143	Voice Control telephone	259
COMAND navigation system (des- tination memory)	145	Voice Control address book	264
COMAND navigation system (last destinations)	150	Voice Control radio	267
COMAND telephone	151	Voice Control CD/DVD changer/ MP3	269
COMAND FM/AM radio	184	Voice Control command list	271
COMAND satellite radio	189	Voice Control troubleshooting	283
COMAND audio CD/audio DVD/ MP3	195	Voice Control individualization	287

COMAND introduction

Vehicle equipment

i This Operator's Manual describes all features, standard or optional, potentially available for your vehicle at the time of purchase. Please be aware that your vehicle might not be equipped with all features described in this manual.

COMAND introduction

COMAND operating safety

COMAND (Cockpit Management and Data System) is an information and operating center for vehicle sound and communications systems, including the radio and navigation system, as well as other optional equipment (satellite radio, telephone, etc.).

Warning!

Any alteration of electronic components or software can cause malfunctions.

Radio, satellite radio, amplifier, CD/DVD changer, navigation module, telephone and Voice Control Systems are interconnected. Therefore, if one of the components is not operational, or has not been removed/replaced properly, the function of other components could be impaired.

Such conditions might seriously impair the operating safety of your vehicle.

We recommend to have any service work on electronic components carried out by an authorized Mercedes-Benz Center.

Warning!

In order to avoid distraction which could lead to an accident, the driver should enter

system settings while the vehicle is at a standstill, and operate the system only when permitted by road, weather and traffic conditions.

Bear in mind that at a speed of just 30 mph (approximately 50 km/h), your vehicle is covering a distance of 44 feet (approximately 14 m) every second.

COMAND supplies you with information to help you select your route more easily and guide you conveniently and safely to your destination. For safety reasons, we encourage the driver to stop the vehicle in a safe place before answering or placing a call, or consulting the COMAND screen to read navigational maps, instructions, or downloaded information.

Warning!

While the navigation system provides directional assistance, the driver must remain focused on safe driving behavior, especially attention to traffic and street signs, and should utilize the system's audio cues while driving.

The navigation system does not supply any information on stop signs, yield signs, traffic regulations or traffic safety rules. Their observance always remains in the

COMAND introduction

driver's personal responsibility. DVD maps do not cover all areas nor all routes within an area.

Availability of functions while the vehicle is in motion

For safety reasons, certain COMAND functions are not available while the vehicle is in motion or they are only available to a limited extent. You will notice this, for example, by the fact that certain menu items cannot be selected or that the COMAND display shows a corresponding message.

Switching COMAND on or off

► Press the **ON** shortcut button in the center console (▷ page 79). COMAND calls up the menu last selected.

i When you switch off COMAND, you also switch off the currently playing audio source. During a telephone call, you cannot switch off COMAND.

COMAND components

In your vehicle, COMAND can be used to operate:

- audio functions
- the navigation system
- the telephone and communication functions (SMS)
- external audio and video sources
- video DVD
- various vehicle settings

COMAND consists of the following:

- COMAND shortcut buttons
- COMAND display
- telephone keypad
- COMAND controller

COMAND shortcut buttons

i During rear view camera operation (▷ page 377) it is not possible to operate the COMAND shortcut buttons.

Use the COMAND shortcut buttons to select main functions directly.



	Function
①	* Favorite button (▷ page 94)
②	DISC RADIO Shortcut button for: <ul style="list-style-type: none"> • CD/DVD/PCMCIA (▷ page 202) • radio (▷ page 185)
③	← Back button (▷ page 86)
④	🪑 Seat menu button (▷ page 227)
⑤	TEL NAVI Shortcut button for: <ul style="list-style-type: none"> • telephone (▷ page 151) • navigation (▷ page 95)
⑥	ON COMAND on/off button (▷ page 79)

COMAND introduction

	Function
⑦	VOL Volume control (▷ page 88)
⑧	Mute Mute button (▷ page 88)

Example:

► Switching directly to Radio or CD

menu: Press **DISC RADIO** once or twice.

COMAND display

In the COMAND display, you will find the function currently selected and the corresponding menus. The COMAND display is divided into several areas.



- ① Status line
- ② Main functions

- ③ Main area
- ④ Submenus
- ⑤ Climate control settings

A white bar under main functions ② indicates the active area.

Once you have selected a main function ②, main area ③ is active.

- ① The layout of the menus may vary depending on your vehicle's equipment. This manual shows the menus for a fully equipped vehicle.

Instrument cluster multifunction display

This section describes features and controls via the COMAND controller, display and shortcut buttons only.

Please refer to the “Instrument cluster control system” section of this manual (▷ page 231) for function descriptions and operation of the instrument cluster multifunction display and multifunction steering wheel buttons as they relate to COMAND features described in this section.

Adjusting COMAND display illumination

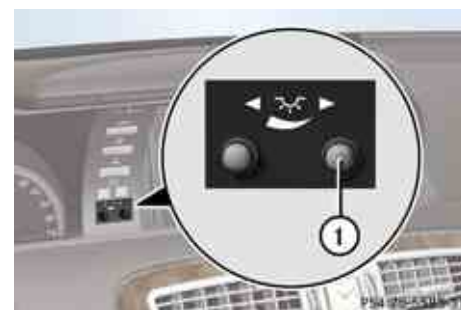

- ① Knob

- **Brightening illumination:** Turn knob ① clockwise.
- **Dimming illumination:** Turn knob ① counterclockwise.

Swiveling COMAND display



- ① Button for swiveling display to the left
- ② Button for swiveling display to the right

You can swivel the COMAND display to the left or right. The buttons are on the right-hand side of the instrument cluster.

Telephone keypad

With the help of the telephone keypad, you can use your mobile phone if it is inserted in the cradle.



- ① Telephone keypad
- ① Folding cover

With the telephone keypad you can:

- Enter and clear numbers and special characters.
- Reject, accept, connect and end calls (▷ page 151).
- Select preset radio stations and enter the frequency manually (▷ page 187).
- Select preset satellite radio stations and enter the channel number (▷ page 193).
- Select a medium from the DVD changer (▷ page 203).
- Select a track from CD, DVD-Audio or MP3 (▷ page 204).

COMAND introduction

- Select a scene/chapter from a video DVD (▷ page 213).
- Select a street in the navigation entry (▷ page 116).

COMAND controller

Use the COMAND controller to select menu functions shown on the COMAND display.



- ① COMAND controller

You can operate the COMAND controller as follows:

- press briefly or press and hold
- rotate to the left or right
- slide to the left, right, up, down or diagonally

COMAND introduction



In this way, you can move through the menus, select menu items or exit menus.

You can move through the menus either by rotating or sliding the controller.



Operating COMAND controller

Symbol	How to use the COMAND controller	Function
🔄	▶ Press briefly.	<ul style="list-style-type: none"> • Confirming the selection of a menu item or list entry. • Exiting full-screen image with Navi.
	▶ Press and hold until the selected action has been carried out.	<ul style="list-style-type: none"> • Saving a station. • Accepting a destination for navigation.
🌀	▶ Rotate.	<ul style="list-style-type: none"> • Moving through vertical or horizontal menus. • Moving through text. • Selecting program settings.
↕🌀↕	▶ Slide.	<ul style="list-style-type: none"> • Moving through vertical menus. • Exiting horizontal menus.
	▶ Slide and hold.	<ul style="list-style-type: none"> • Moving through a navigation map.

Symbol	How to use the COMAND controller	Function
	▶ Slide.	<ul style="list-style-type: none"> • Moving through horizontal menus. • Exiting vertical menus.
	▶ Slide and hold.	<ul style="list-style-type: none"> • Fast forward or reverse for audio CD or audio DVD playback. • Moving through a navigation map.
	▶ Slide and hold.	<ul style="list-style-type: none"> • Moving through a navigation map.

Operating COMAND

Menu overview

The table below shows the structure of the main functions and their main menus.

Each main function has a main menu. Each menu item in the main menu in turn has several submenu items.

Commands/menus

Navi

- Map Display (▷ page 104)
- Mode (▷ page 106)

Audio

- FM/AM Radio (▷ page 184)
- Sat Radio (▷ page 189)
- CD (▷ page 195)
- DVD-Audio (▷ page 195)
- MP3 (▷ page 195)
- Audio OFF (▷ page 91)
- AUX (▷ page 206)

Commands/menus

Telephone

- Telephone ON (▷ page 151)
- Address Book (▷ page 170)
- Telephone OFF (▷ page 154)

COMAND introduction

Commands/menus

Video DVD

- Video DVD (▷ page 209)
- Submenu overview (▷ page 210)
- Switching to video DVD mode (▷ page 211)
- Pause playback (▷ page 212)
- DVD menu (▷ page 213)
- Video AUX (▷ page 207)

Vehicle

- Exterior Lighting Delayed Switch-off (▷ page 216)
- Locator Lighting (▷ page 217)
- Exterior Mirror Convenience Settings (▷ page 218)
- Automatic Locking (▷ page 218)
- Easy Entry/Exit Feature (▷ page 219)
- Interior Lighting Delayed Switch-off (▷ page 220)
- Interior Ambient Light (▷ page 220)

Commands/menus

- Rear Window Sunshade (▷ page 221)
- Trunk Opening-height Restriction (▷ page 222)

Calling up the main menu



Example illustration: Audio main menu

You can call up the main menu of a main function in the following manner:

- ▶ **Moving to the main function line:** Slide ↑⊙.
- ▶ **Selecting a main function:** Slide ←⊙→ or rotate ⏪⊙⏩.
- ▶ **Confirming selection:** Press ⊙.

Vertical menus



- ▶ **Moving through the menu:** Slide ↑⊙↓ or rotate ⏪⊙⏩.
- ▶ **Selecting a menu item:** Press ⊙.
- ▶ **Exiting a menu without making a selection:** Slide ←⊙→ in the opposite direction of the list orientation or press back button ⏪ in the center console (▷ page 86).

Horizontal menus



- ▶ **Moving through the menu:** Slide ←○→ or rotate ⏸.
- ▶ **Selecting a menu item:** Press ⏸.
- ▶ **Exiting a menu without making a selection:** Slide ↑○↓ in the opposite direction of the list orientation or press back button ←□.

Entering characters



Example illustration: Entering a navigation destination

Selecting characters

- ▶ Slide ←○→ or rotate ⏸.
- ▶ **Confirming selection:** Press ⏸.
COMAND completes your entry as soon as it can be clearly identified. In this case, you do not need to switch to the list.

Deleting individual characters

- ▶ Select and press □ repeatedly in the bottom line.

Deleting entire words or numbers

- ▶ Press and hold □ in the bottom line until the word or number is deleted.

Exiting character entry

- ▶ Select and press Back in the bottom line.
or
- ▶ Press back button ←□ in the center console (▶ page 86).

Switching to the list

- ▶ Slide ↑○.
- or
- ▶ Select and press □ in the second line from the bottom.
- ▶ **Exiting list:** Slide ←○ to select Back.

Accepting first entry

- ▶ Press ⏸ until you exit the character entry window.

COMAND introduction

Selecting list item



Example illustration: List of cities for navigation

① Symbol for other selection options (e. g. county)

▶ **Selecting a line:** Slide $\uparrow \odot \downarrow$ or rotate $\{\odot\}$.

▶ **Confirming selection:** Press \odot .

Additional selection options are available for list entries featuring symbol ①. For example, cities marked with symbol ① indicate that the selected country has more than one city featuring that name. Confirming such a list entry opens up another submenu.

Back button

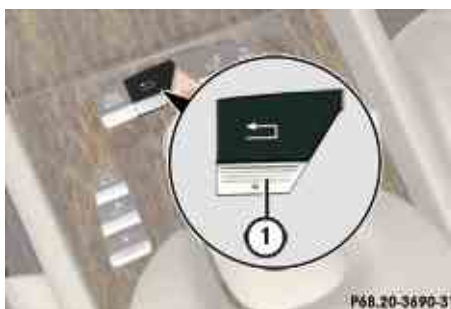

① \leftarrow Back button

▶ **Switching to the next highest menu:**

Press back button \leftarrow briefly. COMAND switches to the next highest menu level within the currently active operating mode.

▶ **Switching to the main menu:** Press and hold back button \leftarrow .

You will hear a signal, and COMAND switches to the main menu of the currently active operating mode.

Example of how to use COMAND

In the descriptions below, the main functions always serve as the starting point for locating the individual menu items.

Example: Audio \rightarrow Audio \rightarrow FM/AM Radio \rightarrow Radio \rightarrow Save Station

i In the COMAND display, you will see the submenu previously called up for each main menu.

If you already see one of the submenus on the screen (e.g. the Audio \rightarrow Audio \rightarrow Radio submenu), it is not necessary to perform the first steps.

The individual steps for the above-mentioned example are described below.

▶ **Switching to the main function line:**

Slide $\uparrow \odot$.

▶ **Selecting Audio main function:** Slide

$\leftarrow \odot \rightarrow$ or rotate $\{\odot\}$.

▶ **Confirming selection:** Press \odot .

The audio operating mode last selected appears.

COMAND introduction



PB2.86-9148-31

- ▶ **Selecting Audio in the main menu:** Slide ↑⊙.
 - ▶ **Confirming selection:** Press ⊙.
- A selection list with the functions of the Audio main menu appears.



PB2.86-9146-31

- ▶ **Selecting FM/AM Radio:** Slide ↑⊙ or rotate ⊙.
 - ▶ **Confirming selection:** Press ⊙.
- The FM/AM Radio menu appears.



PB2.86-9149-31

- ▶ **Selecting Radio:** Slide ⊙↓ and rotate ⊙.
 - ▶ **Confirming selection:** Press ⊙.
- The Radio submenu appears.



PB2.86-9150-31

- ▶ Select Save Station from selection list by rotating ⊙ or sliding ↑⊙↓.
- ▶ Press ⊙.
- ▶ Select desired position.



PB2.86-7335-31

COMAND introduction

- ▶ **Confirming selection:** Press .
The selected station is saved at the designated position. The display switches back to the Radio display.

Main menus of COMAND



- i** The components and operating principles of COMAND can be found on (▶ page 78).

Sound

- ▶ **Muting:** Press shortcut button  in the center console (▶ page 79).
The sound of the current audio source is switched on or is muted.

- i** When the sound is muted, you will see the symbol  in the status line. When you change the audio source, the sound is automatically switched on. You will be able to hear announcements from the navigation system even when the sound is muted.

Switching off navigation announcements entirely

- ▶ **Canceling navigation message:** Briefly press shortcut button  during an announcement.
- ▶ **Switching off navigation messages:** Press and hold  during an announcement until the announcement is switched off.
You will see the message The driving instructions have been muted. for a short while.

- i** The announcements remain switched off even if you start a new route guidance or if COMAND is switched off/on with the **ON** button. If you switch COMAND off by removing the SmartKey from the starter switch and then switch the ignition back on after more than 3 minutes, the announcements are automatically switched back on.

Adjusting volume

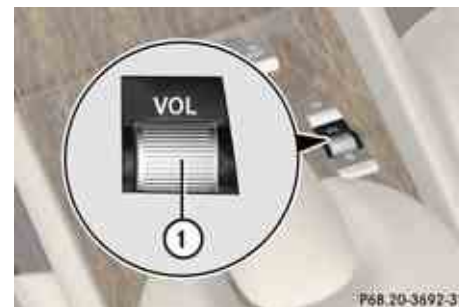



- ① Thumbwheel

- ▶ **Adjusting:** Turn thumbwheel .
The volume of the currently selected audio source changes.

Volume of navigation announcements

You can adjust the volume of the navigation announcements independently from the volume of the respective audio source.

During a navigation announcement:

- ▶ Turn thumbwheel .
- or
- ▶ Press  or  on the multifunction steering wheel.

Adjusting volume for telephone calls

In hands-free mode, you can adjust the volume of a telephone call while the call is currently active.

During a telephone call:

▶ Turn thumbwheel **VOL**.

or

▶ Press **+** or **-** on the multifunction steering wheel.

Selecting sound settings

You can select different sound settings for each individual audio source. The respective sound menu can be found via the submenu for which you wish to make settings.

Example: Audio → Audio → FM/AM Radio → Sound

Adjusting treble or bass

▶ Select Sound → Treble or Bass.

The setting last selected is indicated by an outlined bar.



Adjusting treble and bass

- ① Setting last selected
- ② Current setting

▶ **Changing setting:** Slide **↑**/**↓** or rotate **⌚** until desired treble or bass setting is reached.

▶ **Exiting menu:** Press **⌚**, **←** or slide **⌚**.

The setting is saved.

Adjusting balance or fader

Balance is used to determine whether the sound focus should be shifted toward the driver's side or the passenger's side.

Fader is used to determine whether the sound focus should be shifted toward the front or rear of the vehicle.

COMAND introduction

▶ Select Sound → Balance/Fader.

The setting last selected is indicated by an outlined bar.

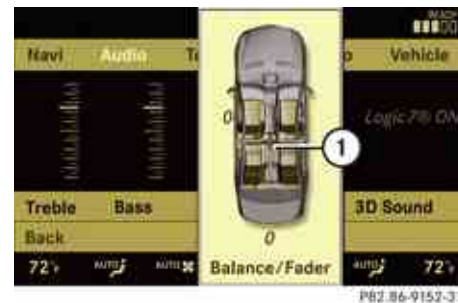

Adjusting balance and fader

① Current setting indicated by orange cross hair symbol

▶ **Changing setting:** Slide **↑**/**↓** or **←**/**→** until desired balance/fader setting is reached.

▶ **Exiting menu:** Press **⌚** or **←**.
The setting is saved.

Surround sound

With surround sound, you can choose between LOGIC7® ON and LOGIC7® OFF.

COMAND introduction

Harman/kardon LOGIC7® surround sound is available for the following operating modes:

- Audio DVD (MLP, DTS, PCM, and Dolby Digital audio formats)
- Video DVD (DTS, PCM, and Dolby Digital audio formats)
- Audio CD
- MP3
- Radio (FM, AM, WB, Satellite)
- PCMCIA
- AUX

i Since some DVDs contain both stereo as well as multi-channel audio formats, it may be necessary to adapt the audio format (▷ page 205).

i The LOGIC7® ON function of the harman/kardon LOGIC7® surround sound system makes it possible to play discrete 5.1 and stereo recordings with optimal surround sound for every passenger. Music on CDs or audio DVDs with high-resolution surround formats such as MLP, DTS or Dolby Digital is played back optimally. For an ideal sound experience on all seats, LOGIC7® distributes 5.1 surround

information via the 13-channel system architecture. The result is a sound as intended by the sound engineers during the original recording.

harman/kardon LOGIC7® converts all two-channel stereo sound material into multi-channel surround sound. With the help of LOGIC7®, surround information stored during the original recording are read out and distributed through the 13 channels. No effects are created during this process; only that which was already there becomes audible.

In addition, harman/kardon LOGIC7® moves the perceived sound source away from the individual loudspeakers, thus generating a natural 360° sound experience for every passenger.

i By selecting LOGIC7® OFF, all compatible formats as they are present on the medium are played back. Due to the vehicle's spatial characteristics, an optimal sound experience is not ensured on all seats.

Adjusting surround sound

With surround sound, you can choose between LOGIC7® ON and LOGIC7® OFF.

▶ Select Sound → 3D Sound.

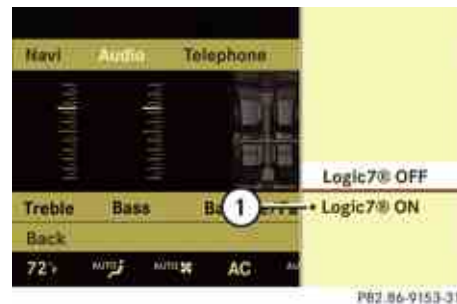

Adjusting surround sound

① Current setting

▶ **Selecting a setting:** Slide ↑↓ or rotate (↻).

▶ **Saving setting:** Press (⏻).

The setting is saved and the menu is closed.

▶ **Exiting menu without saving changes:** Press (⏪) or slide ←→.

i Please note the following:

- For an ideal sound experience at all seats, the balance and fader should be adjusted to the center of the passenger

COMAND system settings

COMAND system settings

System settings menu overview

- i** The components and operating principles of COMAND can be found on (▷ page 78).

- compartment with LOGIC7[®] switched on.
- The best sound results are achieved by playing high-quality audio CDs and audio DVDs.
 - For MP3 tracks, the bit rate should be at least 128 kbit/s.
 - Surround sound does not function for mono-signal sources.
 - In the event of poor radio reception quality, e. g. inside a tunnel, you should switch off LOGIC7[®], as a dynamic switch from Stereo to Mono could occur, resulting in temporary sound distortion.
 - With some stereo recordings, the resulting sound may deviate from conventional stereo playback.

- ▶ **Switching off:** Select Audio → Audio → Audio OFF.
The audio source is switched off; Audio OFF appears in the display.
 - ▶ **Switching on:** Select Audio, then the desired audio source.
- or
- ▶ Load CD/DVD (▷ page 198) or a PCMCIA card (▷ page 200).

Switching off/on the audio source



- i** When you insert an audio CD or audio DVD, it automatically becomes the active audio source.

COMAND system settings

Display (▷ page 92)	Time (▷ page 92)	Voice Control (▷ page 93)	Language (▷ page 94)	Favorite (▷ page 94)	Reset (▷ page 95)
Display settings	Time settings	Voice Control settings	Language settings	Assign favorite button	Reset COMAND to factory settings

Display settings

Switching the display on or off







- ▶ **Switching off:** Select Vehicle → Display OFF.
- ▶ **Switching back on:** Rotate  or slide .

Setting the display design

- ▶ Select Vehicle → System Settings → Display.
- ▶ Select Day Mode, Night Mode or Automatic.
- i** In the Automatic setting, COMAND analyzes the automatic vehicle light sensor and switches between the display design automatically.

Time settings

Setting the time

- i** The correct time must be set for the following navigation system functions to operate correctly:
 - Route guidance on routes with time-dependent traffic guidance
 - Calculation of estimated arrival time
- ▶ Select Vehicle → System Settings → Time → Time.
- ▶ **Selecting hour or minute(s):** Slide   .
- ▶ **Setting value:** Rotate  or slide .
- ▶ **Saving setting:** Press .
- i** The increment value for setting the minutes depends on the situation. If GPS reception is available, it is 30 minutes. If GPS reception is not available, it is one minute.

Setting the time zone and switching between Daylight Saving Time and standard time

- i** The correct time zone and Daylight Saving Time/standard time must be set for the following navigation system functions to operate correctly:
 - Route guidance on routes with time-dependent traffic guidance
 - Calculation of estimated arrival time
- ▶ **Setting time zone:** Select Vehicle → System Settings → Time → Time Zone. The country list appears. The dot • in front of a list entry indicates the current setting.
- ▶ Select the country in which you are currently driving. A time zone list may also be displayed, depending on the country selected.
- ▶ Select desired time zone.

Subsequent operation depends on:

- whether your navigation system has GPS reception
- which country you have previously set

You may either:

- manually switch between Daylight Savings Time (Summer) and Standard time (Winter) in a list
or
- switch automatic Daylight Saving Time to standard time changeover (and vice versa) on or off

- ▶ **Switching manually:** Select Daylight Savings Time (Summer) or Standard time (Winter).
The dot • in front of a list entry indicates the current setting.





- ▶ **Switching automatic changeover on or off:** Select Automatic Daylight Savings Time.
You have switched the function on or off. A checkmark appears when the function is switched on.

- i** Availability of the automatic daylight saving time feature depends on the country selected.

- ▶ **Saving setting and exit the menu:** Slide .

- 1** If you have switched off the automatic changeover function, you must change Daylight Saving Time to standard time and vice versa yourself.

Setting the date

- ▶ Select Vehicle → System Settings → Time → Date.
- ▶ **Selecting month, day or year:** Slide .
- ▶ **Setting value:** Rotate  or slide .
- ▶ **Saving setting:** Press .

Setting the time/date format

- ▶ Select Vehicle → System Settings → Time → Format.
The format list appears. The dots • in front of the list entries indicate the current setting.
- ▶ **Changing format setting:** Select desired format.
- ▶ **Saving setting and exit the menu:** Slide .

COMAND system settings

Voice Control settings

Switching help window on or off

- ▶ Select Vehicle → System Settings → Voice Control.
- ▶ Select Help Window.
You can switch the help window on or off. A checkmark appears when the help window is switched on.

Individualization

Using individualization, you can fine-tune Voice Control to your own voice and thus improve voice recognition. The ability of the system to recognize the commands of other users does not deteriorate as a result.

Individualization consists of two parts. You train the system to recognize digits in the first part and specific commands in the second part.

Starting new individualization

- i** It is only possible to start individualization with the vehicle stationary. After starting the session, the system will guide you through the individualization by means of acoustic instructions.

COMAND system settings

- ▶ Select Vehicle → System Settings → Voice Control → Start new individualization.
A prompt appears asking whether you would like further information.
- ▶ Select Yes or No.
If you select No, the first part of individualization begins.
If you select Yes, an information display will be shown with audio instruction.
- ▶ **Closing display:** Select OK.
The first part of individualization begins.
At the end of the first part, you will see a prompt asking whether you want to begin the second part.
- ▶ Select Yes or No.
If you select No, individualization will be canceled. The data from the first part is saved automatically.
If you select Yes, the second part begins.
Individualization is completed at the end of the second part. You will see a message to this effect. The data from the second part is saved automatically.

Canceling during the first or second part of individualization

- ▶ Select Cancel.
A prompt appears asking whether you really do want to cancel.
- ▶ Select Yes or No.
If you select Yes, individualization will be canceled. The data from the part at which you exited is not saved.
If you select No, the part at which you stopped begins again.

Deleting existing individualization data

- ▶ Select Vehicle → System Settings → Voice Control → Delete individualization.
A prompt appears asking whether you really do want to delete.
- ▶ Select Yes or No.
The individualization data will either be deleted or not, depending on your selection.

Setting the system language

- ▶ Select Vehicle → System Settings → Language.
The language list appears. A dot • indicates the current setting.
- ▶ **Changing setting:** Select desired language.
The language is set.

Assigning the favorite button



① Favorite button

You can assign the following predefined functions to the favorite button **★**:

- Rear Window Sunshade (▷ page 221)

COMAND navigation (introduction)

COMAND navigation (introduction)

Safety notes

 **Warning!**

For safety reasons, only enter a destination when the vehicle is stationary. When the vehicle is in motion, a passenger should enter the destination. Study manual and select route before driving.

Bear in mind that at a speed of just 30 mph (approximately 50 km/h), your vehicle is covering a distance of 44 feet (approximately 14 m) every second.



COMAND calculates the route to the destination without taking account of the following, for example:

- Traffic lights
- Stop and right-of-way signs
- Parking or stopping prohibited areas
- Lane merging
- Other road and traffic rules and regulations
- Narrow bridges

COMAND may give incorrect navigation commands if the data in the digital map does not correspond with the actual road/



You can use the favorite button to extend or retract the rear window sunshade. This is the default setting.

- Display OFF (▷ page 92)
You can use the favorite button to switch the COMAND display on or off.
- Repeat Navigation Command (▷ page 140)
You can use the favorite button to recall the last announcement issued by the navigation system.
- ▶ Select Vehicle → System Settings → Favorite.
The list of predefined functions appears. The dot ● in front of the list entry indicates the current setting.
- ▶ **Changing setting:** Rotate  and select desired function.
- ▶ **Saving setting and exit the menu:**
Press .

Reset

-  You can reset COMAND back to its factory settings.
In this case, all personal data (e.g. address book entries, entries in the destination memory and the list of last destinations of the navigation system), among other things, are deleted.
- ▶ Select Vehicle → System Settings → Reset.
A prompt appears asking whether you really want to reset.
- ▶ Select Yes or No.
If you select Yes another prompt will appear asking whether you really want to reset.
- ▶ Select Yes or No.
If you select Yes, COMAND will be reset and restarted.

COMAND navigation (introduction)

traffic situation. DVD maps do not cover all areas nor all routes within an area. For example, if the traffic routing has been changed or the direction of a one-way road has been reversed.

For this reason, you must always observe applicable road and traffic rules and regulations during your journey. Road and traffic rules and regulations always have priority over the navigation commands generated by the system.

Warning!

Navigation announcements are intended to direct you while driving without diverting your attention from the road and driving.

Please always use this feature instead of consulting the map display for directions. Consulting the symbols or map display for directions may cause you to divert your attention from driving and increase your risk of an accident.

Map software

The digital maps generated by the map software become outdated in the same way as conventional road maps. Optimum route guidance can only be provided by the navigation system in conjunction with the most up-to-date map software. Information about new map software versions can be obtained from an authorized Mercedes-Benz Center.

Updating the map software

You can update the map software yourself using a DVD.

Notes about handling DVDs

- Only hold discs by the edge.
- Handle discs carefully to prevent read problems.
- Avoid getting scratches, fingerprints and dust on discs.
- Use a commercially-available cleaning cloth to clean discs. Do not wipe them with a circular motion, but only in straight lines from the center outwards.

- Place discs back in their boxes after use.
- Protect discs from heat and direct sunlight.

Updating process

The updating process has the following phases:

- Loading a DVD into the DVD changer (> page 97)
 - Updating process (> page 98)
- i** The updating process can take between 10 and 60 minutes, depending on the size of the map software. If the radio was switched on before you started the updating process, you can still adjust the volume. You can also use COMAND to operate the automatic air conditioning and to cancel the process. Other functions are not operational. If possible, carry out the update when the vehicle is stationary.
- i** If you carry out the update with the engine switched off and the vehicle battery has insufficient power, COMAND may automatically switch off during the process in order to protect the battery. If this occurs, restart the update with the engine running period. Similarly, if the SmartKey

position is unintentionally switched to **0**, restart the update.

Warning!

Never leave the engine running in an enclosed space. Inhalation of exhaust gas is hazardous to your health. All exhaust gas contains carbon monoxide (CO), and inhaling it can cause unconsciousness and possible death.

Loading a DVD into the DVD changer

Warning!

COMAND is classified as a Class 1 laser product. You must not open the casing. There is a risk of exposure to invisible laser radiation if you open the casing, or if the casing is faulty or damaged.

COMAND does not contain any parts that you are able to maintain yourself. For safety reasons, all maintenance work must be carried out by qualified technicians.

Warning!

Only carry out the following when the vehicle is stationary:

- Inserting a disc
- Ejecting a disc

There is a risk of accident by being distracted from road and traffic conditions if you load a CD/DVD while the vehicle is in motion.

Bear in mind that at a speed of just 30 mph (approximately 50 km/h), your vehicle is covering a distance of 44 feet (approximately 14 m) every second.



- ① Disc slot
- ② Magazine tray buttons 1 - 6

COMAND navigation (introduction)

- ① Each magazine tray button ② indicates the status of the corresponding magazine tray by means of an LED.
 - LED off = magazine tray is empty
 - LED constantly lit = magazine tray is loaded
 - LED flashes = CD/DVD changer requesting disc to be loaded
- ▶ Switch on COMAND (▷ page 79).
- ▶ Press one of magazine tray buttons ②. If a disc is loaded, it will be ejected.
- ▶ Take disc out of slot ①.
- ▶ Wait until LED for magazine button ② which you pressed flashes quickly.
- ▶ Slide DVD into slot ① with printed side facing upwards. COMAND loads the DVD.

COMAND navigation (introduction)

Updating

After you have loaded the DVD, you will see a message to the effect that the disc does not contain a recognizable audio format.

- ▶ **Confirming message:** Press .
COMAND checks whether the map software on the DVD is compatible with the vehicle's navigation system and whether it is compatible with the current system software.

Map software is compatible with the navigation system and the current system software

COMAND now checks whether the map data on the DVD is already installed.

Map data is not yet installed

You will see a comparison of the version statuses in the display and a prompt will appear asking whether you want to continue with the update.

- ▶ Select Yes or No.
If you select No, COMAND automatically ejects the DVD and the map data is not updated.
Take DVD out of the slot.

If you select Yes, the map data is updated.

Map data is already installed

You will see a message that the map data is already installed and a prompt will appear asking you whether you want to continue with the update.

- ▶ Select Yes or No.
If you select No, COMAND automatically ejects the DVD and the map data is not updated.
Take DVD out of slot.
If you select Yes, the existing map data is saved again.

Updating the map data

While the update is running, you will see a message to this effect and a progress bar. The progress bars fills up from left to right during the update.



① Progress bar

You can either cancel the update or allow it to run to the end without canceling.

- ▶ **Canceling an update on the DVD changer:** Press corresponding magazine tray button ② (> page 97).

The DVD will be ejected in both cases.

- ▶ Take DVD out of slot.

- i** If the update is canceled, the navigation system remains fully operational with the previous map data. You can restart the update at a later date. It will then continue from the point where it was canceled.

- ▶ **To allow the update to run to the end without canceling:** Take no further action. If the update is successfully completed, you will see a message to this effect.
- ▶ **Confirming message:** Press . COMAND ejects the DVD.
- ▶ Take DVD out of slot. The update is complete.

If the update is not successfully completed, you will see a message that the map update is not possible.

- ▶ **Confirming message:** Press . COMAND ejects the DVD.
- ▶ Take DVD out of slot.

 The navigation system remains fully operational with the previous map data.

The update may not be successfully completed for the following reasons:

- DVD dirty or scratched
 - ▶ Clean DVD. See the “Notes about handling DVDs” section (▷ page 96).
 - ▶ Restart update.
- Overheating due to excessive temperatures in the vehicle interior

- ▶ Wait until vehicle interior has cooled down.
- ▶ Restart update.
- The storage medium (hard disk) integrated in COMAND is defective.
 - ▶ Contact an authorized Mercedes-Benz Center.

Map software is not compatible with the navigation system



You will see a message that the update is not possible.

- ▶ **Confirming message:** Press . COMAND ejects the DVD.
- ▶ Take DVD out of slot.
- ▶ Load a DVD which is compatible with the vehicle’s navigation system.

Map software is not compatible with the current system software

You will see a message that the system software and the map software are not compatible.

COMAND navigation (introduction)

- ▶ **Confirming message:** Press . COMAND ejects the DVD.
- ▶ Take DVD out of slot.
- ▶ Have the system software updated at an authorized Mercedes-Benz Center.
-  The map software cannot be updated until the system software has been updated.

General notes

Operational readiness of the navigation system following a system software update by an authorized Mercedes-Benz Center

After a system software update by an authorized Mercedes-Benz Center, the installed map software may no longer be compatible. If this is the case, the navigation system will not be operational.

You will know if this is the case, when the following message will appear when you switch to navigation mode: The system software has been updated. The map software must be updated now. Please insert the DVD with the map software.

- ▶ **Updating map software:** Proceed as described in the “Updating the map software” section (▷ page 96). Use map



COMAND navigation (introduction)

software which is compatible with the system software.

- i** Please note that the update must be allowed to run to the end in this case. If you interrupt it, the navigation system will continue to be non-operational.

Initial use or use following a system software update

In both these cases, the navigation system must determine the position of the vehicle. You may have to drive for a while before precise route guidance is possible.

GPS reception

Correct functioning of the navigation system depends on GPS reception, among other things. In certain situations, GPS reception may be impaired, there may be interference or no reception at all, e. g. in tunnels, in multistorey parking garages or there is snow covering the trunk lid where the GPS antenna is located. If there is snow on the trunk lid it should be removed.

Route guidance after vehicle transportation

COMAND has to redetermine the position of the vehicle if the vehicle has been transported (e. g. by ferry, by train or after towing).

Positioning takes place automatically even when COMAND is switched off. The duration varies from one case to another.

Route guidance may be restricted as follows during vehicle positioning:

- Navigation announcements, route guidance displays and displayed street names are not consistent with the actual location of the vehicle.
- COMAND does not generate navigation announcements.
- Instead of the route guidance displays, you see the Off Road display and a direction arrow. The direction arrow shows the compass heading to the destination.

When positioning is complete, route guidance is once again possible using navigation announcements and route guidance displays.

Interrupting the journey during route guidance

The following applies if you interrupt the journey during route guidance and continue the journey later:

- COMAND resumes route guidance automatically if you continue the journey within 2 hours.
- Route guidance is canceled if you continue the journey after more than 2 hours. It will be necessary to resume the canceled route guidance manually (▷ page 141).

- i** The journey is interrupted if you park the vehicle and switch off COMAND. The journey is continued when you switch COMAND back on and start driving on.

Hard disk errors

COMAND has an integrated hard disk on which the map software is saved.

If an area of the hard disk has an error, COMAND can no longer access the map data in this area, for example, when calculating a route.

The message **Navigation Unavailable**. Please refer to the operating instructions. appears.

► **Deleting message:** Switch COMAND off and back on.

i If you switch the navigation system off/on, it will be operational again until it has to access the faulty area of the hard disk again. The message will then appear again. Consult an authorized Mercedes-Benz Center.

Units of measurement

The units of measurement in navigation mode are identical to those set in the instrument cluster (▷ page 247).

Input restrictions

The input restrictions are imposed starting at a particular vehicle speed. The restrictions are canceled as soon as the speed drops below a certain value.

When the restriction is active, certain operations or entries are not possible.

You will notice this by the fact that some menu items cannot be selected or certain operations will not be possible.

COMAND navigation (introduction)

Navigation system menu overview

i The components and operating principles of COMAND can be found on (▷ page 78).

COMAND navigation (introduction)

Info (only with route guidance active)	Traffic (TMC)	Route (only with route guidance active)	Position	RPT (only with route guidance active)	Destination
Information about the active route guidance	Calling up real-time traffic messages	<ul style="list-style-type: none"> • Calling up route info • Calling up route browser • Calling up the detour function 	<ul style="list-style-type: none"> • Calling up the save position memory function • Centering the map on the vehicle's position • Centering the map on the destination position 	Repeating the current navigation announcement	Selecting: <ul style="list-style-type: none"> • a destination • stopover • save destination • cancel route guidance

Calling up the map display and switching to navigation mode

- ▶ In the main function line, select **Navi**.
- or
- ▶ Press the **TEL NAVI** shortcut button once or twice.

i The number of times you have to press the **TEL NAVI** shortcut button depends on the operating mode currently selected.

Both of these will call up the map display. You will see the map with the menu system either shown or hidden.



Example illustration: Map with route guidance inactive and with the menu system shown

- ① Current vehicle position



Example illustration: Map with route guidance inactive and with the menu system hidden (full screen mode)

- ① Current vehicle position
- ② Set map orientation (▷ page 105)
- ③ Map scale selected (▷ page 103)

Hiding or showing the menu system

- ▶ **Hiding:** Slide ↑⊙.

The Full Screen menu item appears in the main area of the display; it is automatically selected.

- ▶ Press ⊙.

The menu system is hidden. The map can be seen in the full screen.

- ▶ **Showing:** Press ⊙ in the full-screen map display.

Adjusting the map scale

- ① It is only possible to adjust the map scale with the menu system hidden (full-screen map display).
- ▶ Rotate ⊙ until the desired map scale is set.



- ① Currently set map scale as number
- ② Scale
- ③ Currently set map scale as a needle on the scale
- ④ Previously set value before calling up the scale

As soon as you rotate ⊙, scale ② appears. Rotating clockwise zooms in, rotating counterclockwise zooms out.

COMAND navigation (introduction)

Saving current vehicle position as destination in last destinations list

- ▶ **Showing menu system, if necessary:** Press ⊙.
- ▶ **Saving:** Select Position → Save Position.
COMAND saves the current vehicle position as a destination in the last destinations (▷ page 151).

Moving the map

- ① It is only possible to move the map with the menu system hidden.
- ▶ Slide ↑⊙↓, ←⊙→ or ↗⊙↖.

A cross hair appears on the map.

COMAND navigation (introduction)



- ① Cross hair
- ② Details of the cross hair position
- ③ Map scale

i Display ② may be the name of a road, for example, provided the digital map contains the necessary data.

If no data is available, display ② shows:

- the coordinates of the cross hair if the geocoordinate display is switched on (▷ page 106) and the GPS signal is strong enough
- no display if the geocoordinate display is switched off (▷ page 106)

Adjusting the map scale

- ▶ Rotate . Rotating clockwise zooms in, rotating counterclockwise zooms out.

Saving cross hair position as destination in last destinations list

- ▶ **Showing menu system, if necessary:**
Press .
- ▶ **Saving:** Select Position → Save Position.
COMAND saves the cross hair position as a destination in the last destinations list (▷ page 151).

Hiding the cross hair

- ▶ Press back button in the center console (▷ page 86).
The cross hair disappears and the map is centered on the vehicle position.
- or
- ▶ Set the map to the vehicle or destination position, see the explanation below.

Centering the map on the vehicle or destination position

- i** If you have moved the map, you can use this function to rapidly return the map to

the position of the vehicle or destination. It is only possible to center the map on the destination position when route guidance is active.

- ▶ **Centering on the vehicle's position:**
Select Navi → Position → Vehicle Position Map.

or

- ▶ Press back button when the cross hair is displayed.
- ▶ **Centering on the destination:** Select Navi → Position → Destination Position Map.

Basic settings

- i** You can make the following settings regardless of whether route guidance is active or inactive.

Map perspective

COMAND can display the map from a bird's eye view or in the normal map view.

- ▶ **Select map perspective:** Select Navi → Navi → Map Display.

The map display list appears. A dot • indicates the current setting.

- ▶ Select Bird's-eye view.

The bird's eye view is switched on or off, depending on the previous status.



- i** If you scroll the map in the bird's eye view, COMAND switches back to the normal map view.

Map orientation



- ① Current map orientation

The following may be displayed:

-  = Heading Up (the map is displayed so that the direction of travel is always up; the orange point of the icon points north)
-  = North Up (the map view is displayed so that north is always up)

- ▶ **Setting map orientation:** Select Navi → Navi → Map Display.

The map display list appears. A dot • indicates the current setting.

- ▶ Select North Up or Heading Up.

- ▶ **Exiting menu:** Slide ←⊙→.

The map orientation changes accordingly.

Setting POI symbols

You can set which points of interest (POIs) should be displayed as symbols in the map. POIs are garages, hotels, movie theaters or restaurants, for example.

- i** Depending on the map scale on the map, POI symbols may not be visible on the map although their display is activated. In addition, POI symbols may be covered by the map's labels.

The following settings are possible:

- Standard symbols (symbol determined by the factory settings)
- Personal symbols (you can determine the symbols yourself)
- No symbols

COMAND navigation (introduction)

- ▶ **Adjusting:** Select Navi → Navi → Map Display.

The map display list appears. A dot • indicates the current setting.

- ▶ Select Standard symbols, Personal symbols or No symbols.

If you select Personal symbols, the list of POIs appears.

- ▶ **Switching POI symbol display on or off:** Select the desired POI.

The corresponding symbol displays are switched on or off, depending on the previous status. A checkmark indicates which status is active. You can switch on the symbol displays for more than one POI.

- i** The list shows all symbols that are contained in the digital map across all states (USA) and/or provinces (Canada). Not all POIs in all states (USA) or in all provinces (Canada) are available, however. Certain POI symbols may not be displayed on the map, even if the symbol display is switched on.

- ▶ **Exiting menu:** Slide ←⊙→ or press back button  in the center console (> page 86).

COMAND navigation (introduction)

Arrival time and distance

You can set whether the estimated arrival time and the distance to the destination should be displayed in the map.

- ▶ **Displaying:** Select Navi → Navi → Map Display.
The map display list appears. A dot ● indicates the current setting.
- ▶ Select Arrival Time/Distance.
Depending on the previous status the display showing the arrival time and distance is switched on or off.

Current street

You can set whether the current street you are driving on should be displayed in the map.

- ▶ **Displaying:** Select Navi → Navi → Map Display.
The map display list appears. A dot ● indicates the current setting.
- ▶ Select Current Street.
Depending on the previous status the display showing the current street is switched on or off.

Geocoordinate display



Example illustration: Map with geocoordinate display switched on

- ① Current height above sea level
- ② Number of GPS satellites from which signals for positioning can be received
- ③ Coordinate display

- ❗ There must be sufficient GPS reception for displays ①, ② and ③ to be shown. Height display ① is an approximation because the navigation system uses the GPS signals for the calculation.

Display options with geocoordinate display switched on

If the cross hair is displayed on the map view (map was moved manually), only display ③ is visible.

It shows either the coordinates of the cross hair or other data on the cross hair position, e. g. a street name. The digital map must

contain relevant data in order for this other data to be displayed.

- ❗ If there is no cross hair on the map view, displays ①, ② and ③ are visible. Display ③ shows the coordinates of the current vehicle position.

Switching the geocoordinate display on or off

- ▶ Select Navi → Navi → Map Display.
The map display list appears.
- ▶ Select Coordinates.
The geocoordinate display is switched on or off, depending on the previous status. A checkmark indicates which status is active.
- ▶ **Exiting menu:** Slide ←→ or press back button  in the center console (▷ page 86).

Setting route type

You can set the following route types:

- Fast Route: COMAND calculates a route with the shortest possible (minimized) driving time.
- Short Route: COMAND calculates a route with the shortest possible (minimized)

COMAND navigation system (entering a destination)

distance taking distance and driving time into account.

- ▶ Select Navi → Navi → Mode.
The mode list appears. A square ■ indicates the current setting.
- ▶ **Select route type:** Fast Route or Short Route.
- ▶ **Exit menu:** Slide ←⊙→ or press back button  in the center console (▷ page 86).

i If you change the route type setting during active route guidance, COMAND calculates a new route. If you change the setting when route guidance is inactive, COMAND uses the new setting for the next route guidance.

Setting route mode

- i** This function allows you to set the following options for route guidance:
- Minimize Highways
 - Minimize Toll Roads
 - Minimize Tunnels
 - Minimize Ferries/Motorail

- ▶ Select Navi → Navi → Mode.
The mode list appears.
- ▶ **Switching mode on or off:** Select desired modes.
Depending on the previous status, the mode is switched on or off. A checkmark indicates that the mode is switched on. It is possible to switch on more than one mode.
- ▶ **Exiting menu:** Slide ←⊙→ or press back button  in the center console (▷ page 86).
COMAND will verify whether it can incorporate the modes if you select them with route guidance active.
If it can, COMAND calculates a new route while incorporating the modes selected.
If it cannot, you will see and hear a corresponding message.
- ▶ Select OK.
COMAND calculates a new route. Only those modes which can be incorporated are used.

COMAND navigation system (entering a destination)

Introduction

Warning!

For safety reasons, only enter a new destination when the vehicle is stationary.

- i** It is possible to enter a destination regardless of whether route guidance is active or inactive.

The following destination entry options are available:

- Entering a destination by address
- Entering a destination from the destination memory
- Entering a destination from the list of last destinations
- Entering a destination from the map
- Entering a stopover
- Entering a POI

COMAND navigation system (entering a destination)

Entering a destination by the address

Introduction

- i** It is not possible to enter an address when the vehicle has exceeded a certain speed. As soon as the vehicle speed drops below a certain value, the function is available again.
- i** If Russian or Chinese is set as the system language, the address must be entered using Latin letters. Setting the system language (▷ page 94).

To enter an address you may proceed as follows:

- Enter state (USA) or province (Canada), street and city
- Enter state (USA) or province (Canada), city and street
- Enter state (USA) or province (Canada), city and center
- Enter state (USA) or province (Canada), zip code and center
- Enter state (USA) or province (Canada), zip code and street

- i** As additional information to the street entry, you can enter either a house number or an intersection. A zip code entry replaces the city entry.

Calling up the address input menu

- ▶ Select Navi → Destination → Address Entry.

The address input menu appears. It shows a state (USA) or a province (Canada). Which state or province is shown depends on the vehicle's location.



- ① State (USA) or province (Canada)

Menu items in the address input menu

Some menu items will not or not yet be available, depending on the sequence in

which you enter the address and the data version.

Example: If you have not made any entries, menu items House No., Center, Intersection, POI, Start and Save will not yet be available. And the Zip Code menu item will not be available if the digital map does not contain any zip codes.

Entering a state (USA)

- i** You can only enter those states which are saved on the digital map.
- ▶ In the address input menu, select State/Prov → States (U.S.). A list of states appears with input characters; the input characters are automatically activated.

COMAND navigation system (entering a destination)

List of states with input characters



- ① Top list entry based on the input data up to that point
- ② Characters entered by the user
- ③ Characters automatically added by the system
- ④ Clear last character entry
- ⑤ Currently selectable characters
- ⑥ Currently non-selectable characters
- ⑦ Input characters
- ⑧ List of states
- ⑨ Currently selected characters

i In the list of input characters ⑦, you can only select currently selectable characters. Which characters are included depends on the sequence in which you have entered

your destination and the data version of the digital map.

While the numbers are being selected as described below, the top list entry ① always shows the state which best corresponds to the input data as it has been entered up to that point.

At the same time, COMAND automatically supplements characters ② entered by the user with other likely input characters ③.

- ▶ **Selecting characters:** Slide ←↻→ or rotate (↻).
- ▶ **Confirming character selection:** Press ↵.
- ▶ **Deleting individual characters:** Select [c] in the bottom line and press ↵.
- ▶ **Deleting an entire entry:** Select [c] in the bottom line and press ↵ until the entire entry is deleted.
- ▶ **Canceling an entry:** Select Back in the bottom line and press ↵.

or

- ▶ Press back button [←] in the center console (▷ page 86).

As soon as COMAND can clearly attribute the characters entered to a state, the input characters ⑦ disappear automatically. You

see the list of states without the input characters. Here you can confirm the current entry or make another selection.

During character entry, you can also manually switch to the list of states without input characters at any time.

- ▶ **Switching manually to list of states without input characters:** Slide ↻↻.

or

- ▶ Select [ok] in the second line from the bottom and press ↵.

List of states without input characters



COMAND navigation system (entering a destination)

▶ **Selecting a state:** Slide or rotate .

▶ **Canceling selection:** Select Back by sliding and press .

or

▶ Press back button in the center console (▷ page 86).

▶ **Confirming selection:** Press .

The address input menu appears again. It shows the abbreviation for the selected state.

The following menu items are now available:

- Map: Entering a destination from the map (▷ page 126)
- State/Prov: Reenter state (USA) or province (Canada)
- City: Entering a city (▷ page 112)
- Street: Entering a street (▷ page 115)
- Zip Code: Entering the zip code (▷ page 111)

i It is not possible to enter zip codes if the digital map does not contain any zip codes for the selected state.

▶ **Continuing destination entry:** Select one of the menu items mentioned above.

Entering a province (Canada)

▶ In the address input menu, select State/Prov → Provinces (Canada).
A list of provinces appears.

▶ Select desired province.

The address input menu appears again. It shows the abbreviation for the selected province.

The following menu items are now available:

- Map: Entering a destination from the map (▷ page 126)
- State/Prov: Reenter state (USA) or province (Canada)
- City: Entering a city (▷ page 112)
- Street: Entering a street (▷ page 115)
- Zip Code: Entering the zip code (▷ page 111)

i It is not possible to enter a zip code if the digital map does not contain any zip codes for the selected province (Canada).

▶ **Continuing destination entry:** Select one of the menu items mentioned above.

Quick access to most recently entered states (USA) or provinces (CDN)

▶ In the address input menu, select State/Prov → Last States/Provinces.

The list of most recently entered states (USA) or provinces (Canada) appears. The last entry is at the top of the list.

▶ Select desired state (USA) or desired province (Canada).

The address input menu appears again. It shows the abbreviation for the selected state (USA) or province (Canada).

The following menu items are now available:

- Map: Entering a destination from the map (▷ page 126)
- State/Prov: Reenter state (USA) or province (Canada)
- City: Entering a city (▷ page 112)
- Street: Entering a street (▷ page 115)
- Zip Code: Entering the zip code (▷ page 111)

i It is not possible to enter a zip code if the digital map does not contain any zip codes

for the selected state (USA) or province (Canada).

- **Continuing destination entry:** Select one of the menu items mentioned above.

Entering the zip code

- i** It is not possible to enter a zip code if you have already entered other address data aside from the state (USA) or province (Canada).

You can only enter those zip codes which are saved on the digital map.

The available zip codes depend on the state (USA) or province (Canada) most recently entered.

- In the address input menu, select Zip Code. A list of zip codes appears with input characters; the input characters ④ are automatically activated.

List of zip codes with input characters

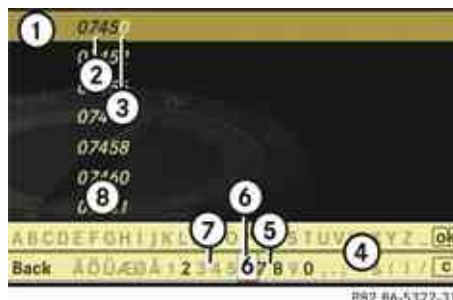

- ① Top list entry based on the input data up to that point
- ② Numbers entered by the user
- ③ Numbers automatically added by the system
- ④ Input characters
- ⑤ Currently selectable numbers
- ⑥ Currently selected numbers
- ⑦ Currently non-selectable numbers
- ⑧ List of zip codes

- i** In the list of input characters ④, you can only select numbers which can be currently entered. Which characters are included depends on the sequence in which you have entered your destination and the data version of the digital map.

COMAND navigation system (entering a destination)

While the numbers are being selected as described below, the top list entry ① always shows the zip code which best corresponds to the input data as it has been entered up to that point.

At the same time, COMAND automatically supplements numbers ② entered by the user with other likely numbers ③.

- **Selecting numbers:** Slide $\leftarrow \odot \rightarrow$ or rotate \odot .

or

- Enter numbers with the telephone keypad using the $\boxed{0}$ - $\boxed{9}$ \boxed{WXYZ} buttons (▷ page 81).

- **Confirming number selection:** Press \odot .

- **Deleting individual numbers:** Select \boxed{c} in the bottom line and press \odot .

- **Deleting an entire entry:** Select \boxed{c} in the bottom line and press \odot until the entire entry is deleted.

- **Canceling an entry:** Select Back in the bottom line and press \odot .

or

- Press back button $\boxed{\leftarrow}$ in the center console (▷ page 86).

As soon as COMAND can clearly attribute the numbers entered to a zip code, input

COMAND navigation system (entering a destination)

characters ④ disappear. You see the list of zip codes without the input characters. Here you can confirm the current entry or make another selection.

During character entry, you can also manually switch to the list of zip codes without input characters at any time.

▶ **Switching manually to list of zip codes without input characters:** Slide .

or

▶ Select in the second line from the bottom and press .

List of zip codes without input characters

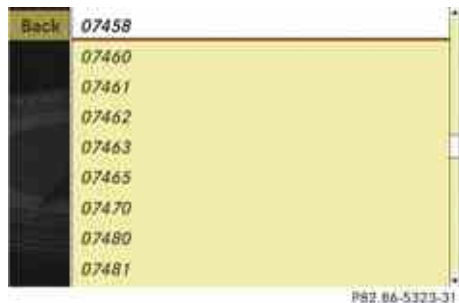

▶ **Selecting a zip code:** Slide or rotate .

▶ **Canceling selection:** Select Back and press .

or

▶ Press back button in the center console (▷ page 86).

▶ **Confirming selection:** Press .

You will see the address input menu again.

It shows one of the following items of information:

- Street and if necessary, house number, city, state (USA) or province (Canada)
- City, state (USA) or province (Canada) and zip code
- State (USA) or province (Canada) and zip code

i The street and, if necessary, the house number, will then appear as soon as COMAND can attribute the zip code to an appropriate address.

Which of the following menu items are now available depends on the situation, or may depend on the data version of the digital map. The menu items which are not available cannot be selected.

• Map: Using the map to enter a destination (▷ page 126)

i In this case, using the map for destination entry is based on the city seen in the address input menu.

• Street: Entering a street (▷ page 115)

• Center: Entering a center (▷ page 117)

• POI: Entering a point of interest (▷ page 128)

i In this case, entering a POI is based on the city seen in the address input menu.

• Save: Saving a destination in the destination memory (▷ page 145)

• Start: Starting the route calculation (▷ page 123)

▶ **Continuing or completing destination entry:** Select one of the menu items mentioned above.

Entering a city

i You can only enter those cities which are saved on the digital map.

It is not possible to enter a city when you have already entered a street which COMAND can clearly attribute to a city.

COMAND navigation system (entering a destination)

If COMAND cannot clearly attribute a previously entered street to a city, only those cities are available which have a street of that name.

If you have not yet entered a street before entering the city, or cities within the state (USA) or province (Canada) previously entered are available.

- ▶ In the address input menu, select **City**. The list of cities appears either with or without the input characters (▷ page 114).

Whether or not the input characters appear depends on how many cities are available for the desired state (USA) or province (Canada).

List of cities with input characters

When this list appears, the input characters ④ are automatically activated.



- ① Top list entry based on the input data up to that point
- ② Characters entered by the user
- ③ Characters automatically added by the system
- ④ Input characters
- ⑤ Currently non-selectable characters
- ⑥ Currently selectable character
- ⑦ List of cities
- ⑧ Currently selected character

- ▶ **i** In the list of input characters ④, you can only select currently selectable characters. Which characters are included depends on the sequence in which you have entered your destination and the data version of the digital map.

The top list entry ① at first shows either the city in which the vehicle is currently located or the city which best corresponds to the input data as it has been entered up to that point.

- ▶ **i** The current city is shown if:

- you have accepted the current state (USA) or province (Canada) when entering the state (USA) or province (Canada)
- and if you select city entry immediately afterward

As soon as you enter a character from input characters ④, the top list entry ① shows the city that best corresponds to the input data as it has been entered up to that point. At the same time, COMAND automatically supplements characters ② entered by the user with appropriate characters ③.

- ▶ **Selecting characters:** Slide ←→ or rotate (↻).
- ▶ **Confirming character selection:** Press (✓).

COMAND navigation system (entering a destination)

▶ Deleting individual characters:

Select **[c]** in the bottom line and press **[↶]**.

▶ Deleting an entire entry:

Select **[c]** in the bottom line and press **[↶]** until the entire entry is deleted.

▶ Canceling an entry:

Select **Back** in the bottom line and press **[↶]**.

or

▶ Press back button **[↶]** in the center console (▷ page 86).

As soon as COMAND can clearly attribute the characters entered to a city, the input characters **④** disappear automatically. You see the list of cities without the input characters. Here you can confirm the current entry or make another selection.

During character entry, you can also manually switch to the list of cities without input characters at any time.

▶ Switching manually to the list of cities without input characters:

Slide **[↕]**.

or

▶ Select **[ok]** in the second line from the bottom and press **[↶]**.

List of cities without input characters

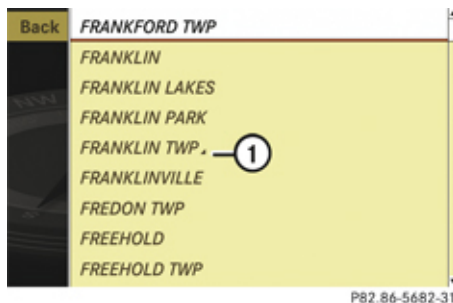

① Symbol for more selection options

▶ Selecting a city:

Slide **[↕]** or rotate **[↻]**.

▶ Canceling selection:

Select **Back** and press **[↶]**.

or

▶ Press back button **[↶]** in the center console (▷ page 86).

▶ Confirming selection:

Press **[↶]**. Cities with symbol **①** mean that there is more than one in the selected state (USA) or province (Canada). Confirming one of these cities will take you to a further sub-selection.

If there are no other selection options, the address input menu appears again.

It shows one of the following items of information:

- City and state (USA) or province (Canada)
- Street, city and state (USA) or province (Canada)

i The street is visible if you have entered it before entering the city.

Which of the following menu items are now available depends on the situation, or may depend on the data version of the digital map. The menu items which are not available cannot be selected.

- Map: Using the map to enter a destination (▷ page 126)

i In this case, using the map for destination entry is based on the city seen in the address input menu.

- Street: Entering the street (▷ page 115)
- House No.: Entering the house number (▷ page 119)
- Center: Entering the center (▷ page 117)
- Intersection: Entering the intersection (▷ page 121)
- POI: Entering a point of interest (▷ page 128)

COMAND navigation system (entering a destination)

- i** In this case, entering a POI is based on the city seen in the address input menu.
 - Save: Saving a destination in the destination memory (▷ page 145)
 - Start: Starting the route calculation (▷ page 123)
- ▶ **Continuing or completing destination entry:** Select one of the menu items mentioned above.

Entering a street

- i** It is not possible to enter a street if:
 - you have already entered a center
 - you have already entered a zip code that COMAND can clearly attribute to a street
- i** You can only enter those streets which are saved on the digital map.

If you have not entered a city before entering the street, only those streets within the state (USA) or province (Canada) previously entered are available. If you have already entered a city, streets within that city are available.

If you have entered a zip code before entering the street, only those streets within the zip code area are available.

- ▶ In the address input menu, select **Street**. The list of streets appears either with or without the input characters (▷ page 116). Whether or not the input characters appear depends on how many streets are available for the selected city.

Street list with input characters

When this list appears, the input characters ⑥ are automatically activated.



- ① Top list entry based on the input data up to that point
- ② Characters entered by the user
- ③ Characters automatically added by the system
- ④ Currently non-selectable characters
- ⑤ Currently selectable character
- ⑥ Input characters

- ⑦ Street list
- ⑧ Currently selected character

- i** In the list of input characters ⑥, you can only select currently selectable characters. Which characters are included depends on the sequence in which you have entered your destination and the data version of the digital map.

The top list entry ① first shows the street first alphabetically and best corresponds to the input data as it has been entered up to that point.

As soon as you enter a character from input characters ⑥, the top list entry ① shows the street which best corresponds to the input data as it has been entered up to that point. At the same time, COMAND automatically supplements characters ② entered by the user with appropriate characters ③.

- ▶ **Selecting characters:** Slide ←○→ or rotate ⤴⤵.
- ▶ **Confirming character selection:** Press ⏹.

COMAND navigation system (entering a destination)

▶ Deleting individual characters:

Select **[c]** in the bottom line and press **[↶]**.

▶ Deleting an entire entry:

Select **[c]** in the bottom line and press **[↶]** until the entire entry is deleted.

▶ Canceling an entry:

Select Back in the bottom line and press **[↶]**.

or

▶ Press back button **[↶]** in the center console (▷ page 86).

As soon as COMAND can clearly attribute the characters entered to a street, the input characters **[6]** disappear. You see the street list without the input characters. Here you can confirm the current entry or make another selection.

During character entry, you can also manually switch to the street list without input characters at any time.

▶ Switching manually to the street list without input characters:

Slide **[↑/↓]**.

or

▶ Select **[ok]** in the second line from the bottom and press **[↶]**.

Street list without input characters



[1] Symbol for more selection options

▶ Selecting a street:

Slide **[↑/↓]** or rotate **[⌂]**.

or

▶ Enter a street number with the telephone keypad using the **[0]** - **[9]** buttons (▷ page 81).

[i] Example: Pressing button **[2 ABC]** jumps to the 2nd Avenue.

▶ Canceling selection:

Select Back and press **[↶]**.

or

▶ Press back button **[↶]** in the center console (▷ page 86).

▶ Confirming selection:

Press **[↶]**.

Streets with symbol **[1]** run through several suburbs. Confirming one of these streets takes you to a further sub-selection.

If there are no other selection options, the address input menu appears again after the confirmation.

It shows one of the following items of information:

- Street and state (USA) or province (Canada)
- Street, city and state (USA) or province (Canada)

[i] The city is visible if you have entered it before entering the street, or if COMAND can clearly attribute the street entered to a city.

Which of the following menu items are now available depends on the situation, or may depend on the data version of the digital map. The menu items which are not available cannot be selected.

- Map: Using the map to enter a destination (▷ page 126)

COMAND navigation system (entering a destination)

i In this case, using the map for destination entry is based on the city seen in the address input menu.

- House No.: Entering the house number (▷ page 119)
- Intersection: Entering the intersection (▷ page 121)

i Entering an intersection is restricted to streets within the vicinity of the street entered.

- POI: Entering a point of interest (▷ page 128)

i In this case, entering a POI is based on the city seen in the address input menu.

- Save: Saving a destination in the destination memory (▷ page 145)
- Start: Starting the route calculation (▷ page 123)

▶ **Continuing or completing destination entry:** Select one of the menu items mentioned above.

Entering a center

- i** It is not possible to enter a center if:
- you have not yet entered a city
 - you have already entered a street
 - you have already entered a zip code that COMAND can clearly attribute to an address

You can only enter those centers which are saved on the digital map. Depending on the previous entry, centers are available either for the city entered or the zip code area entered.

- ▶ In the address input menu, select Center. The list of centers appears either with or without the input characters (▷ page 118). Whether or not the input characters appear depends on how many centers are available in the selected city.

List of centers with input characters

When this list appears, the input characters ⑦ are automatically activated.



- ① Top list entry based on the input data up to that point
- ② Characters entered by the user
- ③ Characters automatically added by the system
- ④ Currently non-selectable characters
- ⑤ Currently selectable character
- ⑥ Currently selected character
- ⑦ Input characters
- ⑧ List of centers

i In the list of input characters ⑦, you can only select currently selectable characters. Which characters are included depends on the sequence in which you have entered your destination and the data version of the digital map.

COMAND navigation system (entering a destination)

While the characters are being selected as described below, top list entry ① always shows the center which best corresponds to the input data as it has been entered up to that point. At the same time, COMAND automatically supplements characters ② entered by the user with appropriate characters ③.

- ▶ **Selecting characters:** Slide ←⊙→ or rotate {⊙}.
- ▶ **Confirming character selection:** Press ⊙.
- ▶ **Deleting individual characters:** Select [c] in the bottom line and press ⊙.
- ▶ **Deleting an entire entry:** Select [c] in the bottom line and press ⊙ until the entire entry is deleted.
- ▶ **Canceling an entry:** Select Back in the bottom line and press ⊙.

or

- ▶ Press back button [←] in the center console (▷ page 86).

As soon as COMAND can clearly attribute the characters entered to a center, input characters ⑦ disappear. You see the list of centers without the input characters. Here you can confirm the current entry or make another selection.

During character entry, you can also manually switch to the list of centers without input characters at any time.

- ▶ **Switching manually to the list of centers without input characters:** Slide ↑⊙.

or

- ▶ Select [ok] in the second line from the bottom and press ⊙.

List of centers without input characters



- ▶ **Selecting a center:** Slide ↑⊙↓ or rotate {⊙}.

- ▶ **Canceling selection:** Select Back and press ⊙.

or

- ▶ Press back button [←] in the center console (▷ page 86).

- ▶ **Confirming selection:** Press ⊙.

After the confirmation, the address input menu appears again. It shows the center, city and state (USA) or province (Canada).

Which of the following menu items are now available may depend on the data version of the digital map. The menu items which are not available cannot be selected.

- Map: Using the map to enter a destination (▷ page 126)
- i** In this case, using the map for destination entry is based on the center seen in the address input menu.
- POI: Entering a point of interest (▷ page 128)
- i** In this case, entering a point of interest is based on the center seen in the address input menu.

COMAND navigation system (entering a destination)

- Save: Saving a destination in the destination memory (▷ page 145)
- Start: Starting the route calculation (▷ page 123)

- ▶ **Continuing or completing destination entry:** Select one of the menu items mentioned above.

Entering a house number

- i** The house number can only be entered after the street has been entered. You can only enter those house numbers which are saved on the digital map. The digital map does not contain all house numbers for all streets.

How the house number is entered depends on whether you have already entered just the street or both the street and the city (▷ page 120).

With only the street entered previously

When COMAND can clearly allocate the street to a city, the house number appears without input characters. Select a house number from the list (▷ page 121).

When COMAND cannot clearly allocate the street to a city, a house number screen appears. You can now enter a house number.

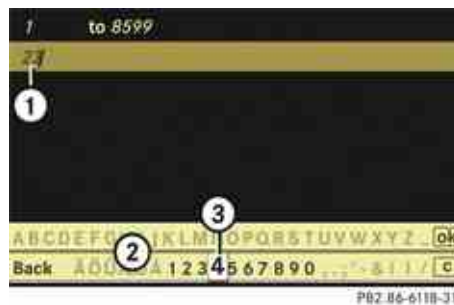

- ① Numbers entered by the user
- ② Input characters
- ③ Currently selected number

- ▶ **Selecting numbers:** Slide $\leftarrow \odot \rightarrow$ or rotate $\left\{ \odot \right\}$.

- ▶ **Confirming number selection:** Press \odot .
or

- ▶ Entering a number with the telephone keypad using the $\boxed{0}$ - $\boxed{9}$ buttons (▷ page 81).

- ▶ **Deleting individual numbers:** Select \boxed{c} in the bottom line and press \odot .

- ▶ **Deleting an entire entry:** Select \boxed{c} in the bottom line and press \odot until the entire entry is deleted.

- ▶ **Canceling an entry:** Select Back in the bottom line and press \odot .

or

- ▶ Press back button \leftarrow in the center console (▷ page 86).

- ▶ **Confirming entry:** Select \boxed{ok} in the second line from the bottom and press \odot . If COMAND cannot clearly attribute the house number to a city, the city input menu appears.

Entering city: Proceed as described in the “Entering a city” section (▷ page 112). After the city has been entered, the address input menu appears again.

If COMAND can clearly attribute the house number to a city, the address input menu also appears.

In both cases, the address input menu shows the house number, street, city and state (USA) or province (Canada).

Which of the following menu items are now available may depend on the data version of the digital map. The menu items which are not available cannot be selected.

- Map: Using the map to enter a destination (▷ page 126)

COMAND navigation system (entering a destination)

i In this case, using the map for destination entry is based on the city seen in the address input menu.

- POI: Entering a point of interest (▷ page 128)

i In this case, entering a POI is based on the city seen in the address input menu.

- Save: Saving a destination in the destination memory (▷ page 145)
- Start: Starting the route calculation (▷ page 123)

▶ **Continuing or completing destination entry:** Select one of the menu items mentioned above.

With the street and city previously entered

▶ In the address input menu, select House No. . .
The list of house numbers appears either with or without the input characters (▷ page 121). Whether or not the input characters appear depends on how many house numbers are available in the selected street.

List of house numbers with input characters

When this list appears, the input characters ④ are automatically activated.

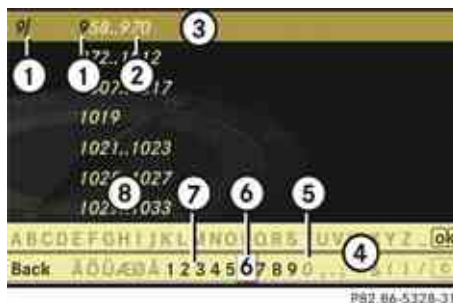

- ① Numbers entered by the user
- ② Numbers automatically added by the system
- ③ Top list entry based on the input data up to that point
- ④ Input characters
- ⑤ Currently non-selectable numbers
- ⑥ Currently selected number
- ⑦ Currently selectable numbers
- ⑧ List of house numbers

i In the list of input characters ④, you can only select currently selectable characters.

Which characters are included depends on the sequence in which you have entered your destination and the data version of the digital map.

While the numbers are being selected as described below, the top list entry ③ always shows the house number which best corresponds to the input data as it has been entered up to that point. At the same time, COMAND automatically supplements numbers ① entered by the user with appropriate numbers ②.

▶ **Selecting numbers:** Slide ◀⊙▶ or rotate ⏪⊙⏩.

or

▶ Entering a number with the telephone keypad using the **0** - **9** buttons (▷ page 81).

▶ **Confirming number selection:** Press **⏩**.

▶ **Deleting individual numbers:** Select **[C]** in the bottom line and press **⏩**.

▶ **Deleting an entire entry:** Select **[C]** in the bottom line and press **⏩** until the entire entry is deleted.

COMAND navigation system (entering a destination)



- ▶ **Canceling an entry:** Select Back in the bottom line and press .

or



- ▶ Press back button  in the center console (▷ page 86).

As soon as COMAND can clearly attribute the numbers entered to a house number, the input characters  disappear. You see the list of house numbers without the input characters. Here you can confirm the current entry or make another selection.

During number entry, you can also manually switch to the list of house numbers without input characters at any time.



- ▶ **Switching manually to the list of house numbers without input characters:** Slide  .

or

- ▶ Select  in the second line from the bottom and press .

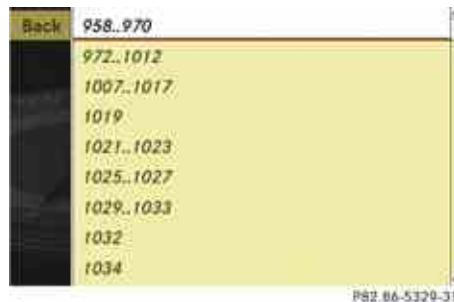
List of house numbers without input characters



- ▶ **Selecting house numbers:** Slide   or rotate .

- ▶ **Canceling selection:** Select Back and press .



or

- ▶ Press back button  in the center console (▷ page 86).

- ▶ **Confirming selection:** Press . After the confirmation, the address input menu appears again. It shows the house number, street, city and state (USA) or province (Canada).

Which of the following menu items are now available may depend on the data version of

the digital map. The menu items which are not available cannot be selected.

- Map: Using the map to enter a destination (▷ page 126)
-  In this case, using the map for destination entry is based on the city seen in the address input menu.
- POI: Entering a point of interest (▷ page 128)
-  In this case, entering a POI is based on the city seen in the address input menu.
- Save: Saving a destination in the destination memory (▷ page 145)
- Start: Starting the route calculation (▷ page 123)
- ▶ **Continuing or completing destination entry:** Select one of the menu items mentioned above.

Entering an intersection

-  The intersection can only be entered after the street has been entered. You can only enter those intersections which are saved on the digital map.

COMAND navigation system (entering a destination)

- ▶ In the address input menu, select Intersection.
The list of intersections appears either with or without the input characters (▷ page 123). Whether or not the input characters appear depends on how many intersections are available for the selected street.

List of intersections with input characters

When this list appears, the input characters ④ are automatically activated.



- ① Top list entry based on the input data up to that point
- ② Characters entered by the user
- ③ Characters automatically added by the system
- ④ Input characters

- ⑤ Currently non-selectable characters
- ⑥ Currently selectable character
- ⑦ List of intersections
- ⑧ Currently selected character

❶ In the list of input characters ④, you can only select currently selectable characters. Which characters are included depends on the sequence in which you have entered your destination and the data version of the digital map.

While the characters are being selected as described below, the top list entry ① always shows the intersection which best corresponds to the input data as it has been entered up to that point.

At the same time, COMAND automatically supplements characters ② entered by the user with appropriate characters ③.

- ▶ **Selecting characters:** Slide ←○→ or rotate [○].
- ▶ **Confirming character selection:** Press [○].
- ▶ **Deleting individual characters:** Select [c] in the bottom line and press [○].
- ▶ **Deleting an entire entry:** Select [c] in the bottom line and press [○] until the entire entry is deleted.

- ▶ **Canceling character entry:** Select Back in the bottom line and press [○].

or

- ▶ Press back button [←] in the center console (▷ page 86).

As soon as COMAND can clearly attribute the characters entered to an intersection, the input characters ④ disappear. You see the list of intersections without the input characters. Here you can confirm the current entry or make another selection.

During character entry, you can also manually switch to the list of intersections without input characters at any time.

- ▶ **Switching manually to the list of intersections without input characters:** Slide ↑○.

or

- ▶ Select [ok] in the second line from the bottom and press [○].

COMAND navigation system (entering a destination)

List of intersections without input characters



▶ **Selecting an intersection:** Slide \uparrow \odot \downarrow or rotate \odot .

▶ **Confirming selection:** Press \odot .
Either the address input menu appears again, or the city input menu.

i The city input menu appears if the intersection entered cannot be clearly attributed to a city.

▶ **Canceling selection:** Select Back and press \odot .

or

▶ Press back button \leftarrow in the center console (▷ page 86).

▶ **If the city input menu appears:** Enter a city.

i A detailed description of how to enter a city can be found in the “Entering a city” section (▷ page 112).

After the city has been entered, the address input menu appears again.

Which of the following menu items are now available may depend on the data version of the digital map. The menu items which are not available cannot be selected.

- Map: Using the map to enter a destination (▷ page 126)

i In this case, using the map for destination entry is based on the city seen in the address input menu.

- POI: Entering a point of interest (▷ page 128)

i In this case, entering a POI is based on the city seen in the address input menu.

- Save: Saving a destination in the destination memory (▷ page 145)

- Start: Starting the route calculation (▷ page 123)

▶ **Continuing or completing destination entry:** Select one of the menu items mentioned above.

Starting the route calculation

i You cannot start the route calculation until all the necessary address data has been entered.

i With Change Name you can change the name of the chosen entry from the destination memory before starting the route calculation.

▶ After entering the destination, select Start.
The route calculation will start if route guidance has not already been activated. If route guidance has already been activated, a prompt will appear asking

COMAND navigation system (entering a destination)

whether you want to end the current route guidance.

- ▶ Select Yes or No.

If you select Yes, COMAND will stop the route guidance and start the route calculation for the new destination.

If you select No, COMAND will continue with the active route guidance.

The new destination is discarded.

During the route calculation, an arrow will indicate the linear direction to the destination. Below this, you will see the message *Calculating Route*. Once the route has been calculated, route guidance begins (▷ page 135).

- i** Route calculation requires a certain amount of time. The time depends on the distance from the destination, for example. COMAND calculates the route using the digital map data. The calculated route may differ from the actual road situation, e. g. due to road construction or incomplete map data. Please make sure that you observe the notes about the digital map (▷ page 96).

Entering a destination from the destination memory

- ▶ Select Navi → Destination → From Memory.

The destination memory list appears either with or without the input characters (▷ page 125). Whether the input characters appear depends on the number of entries in the destination memory.

- i** The destination memory always contains an entry called *My Address*. You can save your home address, for example, under this entry (▷ page 147).

Destination memory list with input characters

When this list appears, the input characters

- ④ are automatically activated.



- ① Top list entry based on the input data up to that point
- ② Characters entered by the user
- ③ Characters automatically added by the system
- ④ Input characters
- ⑤ Currently non-selectable characters
- ⑥ Destination memory list
- ⑦ Currently selected character
- ⑧ Currently selectable characters

- i** In the list of input characters ④, you can only select currently selectable characters. Which characters are included depends on the sequence in which you have entered your destination and the content of the destination memory.

COMAND navigation system (entering a destination)

While the characters are being selected as described below, the top list entry ① always shows the destination which best corresponds to the input data as it has been entered up to that point.



At the same time, COMAND automatically supplements characters ② entered by the user with appropriate characters ③.

► **Changing language for the input characters:** Select .



► Select desired language.

► **Changing character set for the input characters:** Select .

Depending on the previous setting, you will change to letters with special characters or to numbers with special characters.

► **Selecting characters:** Slide  or rotate .

► **Confirming character selection:** Press .

► **Deleting individual characters:** Select  in the bottom line and press .

► **Deleting an entire entry:** Select  in the bottom line and press  until the entire entry is deleted.

► **Canceling an entry:** Select Back in the bottom line and press .

or



► Press back button  in the center console (▷ page 86).

As soon as COMAND can clearly attribute the characters entered to a destination, the input characters ④ disappear. You see the destination memory list without input characters. Here you can confirm the current entry or make another selection.

You can also manually switch to the destination memory list without input characters at any time.



► **Switching manually to the destination memory list without input characters:** Slide .

or

► Select  in the second line from the bottom and press .

Destination memory list without input characters



► **Selecting a destination:** Slide  or rotate .

► **Canceling selection:** Press back button  in the center console (▷ page 86).

or

► Select Back and press .

i The Back menu item is only present if this list was called up from the list with input characters.

► **Confirming selection:** Press .

► **Starting route calculation:** Select Start, see also (▷ page 123).

COMAND navigation system (entering a destination)

Entering a destination from the list of last destinations

- ▶ Select Navi → Destination → From Last Destinations.
The list of last destinations appears. The most recent destination is at the top of the list.
- ▶ Select desired destination.
- ▶ **Starting route calculation:** Select Start, see also (▷ page 123).

Entering a destination from the map

- i** Depending on the factory settings of the vehicle, it may not be possible to enter a destination while the vehicle exceeds a preset speed. As soon as the vehicles speed drops to below the preset speed, the function is available again. You can enter a destination via the map if the digital map does not contain the address of the destination, but the destination must be within the area of the digital map.

Calling up the map

- ▶ In the address input menu, select Map (▷ page 108).
You will see the map with a cross hair. The map is set to the address set in the address input menu.

or

- ▶ Select Navi → Destination → Via Map.
You will see the map with a cross hair.



- ① Cross hair
- ② Details of the cross hair position
- ③ Map scale

- i** Display ② may be the name of a road, for example, provided the digital map contains the necessary data.

If no data is available, display ② shows:

- the coordinates if the geocoordinate display is switched on (▷ page 106)
- no display if the geocoordinate display is switched off (▷ page 106)

Moving the map and selecting the destination

- ▶ **Moving map:** Slide ↑⊙↓, ←⊙→ or ↻⊙↻.

- ▶ **Adjusting map scale:** Rotate ⏪⊙⏩.
Rotating clockwise enlarges the map, rotating counterclockwise reduces it.

- ▶ **Selecting a destination:** Press ⊙.
If the cross hair is located off the edge of the digital map, a route cannot be calculated to this destination and you will see the message The destination is located off the map..

- ▶ Select OK.

- ▶ Move the map and select a destination again.

If the destination is within the limits of the digital map, COMAND attempts to attribute the destination to the map, which can take approximately 2 seconds.

If the destination can be attributed, you will see the address of the destination. If not,

COMAND navigation system (entering a destination)

you will see the display Destination from map.

- ▶ **Starting route calculation:** Select Start, see also (▷ page 123).

Entering a stopover

i When route guidance is active, you can enter a stopover. Stopovers can be predefined destinations from the following predefined categories:

- Mercedes-Benz Center
- Hospital
- Gas station
- Parking lot
- Restaurant

However, you can also enter destinations other than the predefined ones.

i You can use the stopover function to influence the route guidance calculation to the main destination. When you have reached your stopover, COMAND automatically calculates the route to the main destination.

Entering predefined destinations

- ▶ Select Navi → Destination → Stopover.
If a stopover has already been entered, you can change it.

Changing: Select Change Stopover.
You can now select a category.

- ▶ **Selecting a category:** Select category, e.g. Gas station.
COMAND first looks for destinations within the immediate vicinity of the vehicle and near the vehicle's route. If there are no destinations available there, COMAND searches for destinations in an area around the vehicle position.
If COMAND does not find any destinations, you will see a message to this effect.
Select OK.

You can now select a different category.

If COMAND finds destinations, you will see a list of the destinations and details of how far away they are in the right-hand side of the display. The information about how far away the destinations are can take a few seconds to be displayed.

The left-hand part of the display shows the destinations on the map. The destination marked in the list is highlighted in the map.

- ▶ **Selecting a destination:** Select the desired destination from list.
The address of the destination appears.
- ▶ **Starting route calculation:** Select Start, see also (▷ page 123).

Entering another destination as a stopover

- ▶ Select Navi → Destination → Stopover.
- ▶ **Entering:** Select Other.
You can select between the following menu items:
 - Address Entry
 - From Memory
 - From Last Destinations
 - From POIs
- ▶ Select a menu item.

Subsequent destination entries may differ, depending on your selection:

- Address Entry selection:
 - ▶ Enter a destination by address (▷ page 108).
- From Memory selection:

COMAND navigation system (Point of interest entry)

- ▶ Enter a destination from the destination memory (▷ page 124).
- From Last Destinations selection:
 - ▶ Enter a destination from the list of last destinations (▷ page 126).
- From POIs selection:
 - ▶ Enter a special destination (▷ page 128).
- ▶ **Starting route calculation:** After entering a destination, select Start (▷ page 123).
- ▶ Select Navi → Destination → Stopover → Delete Stopover. COMAND deletes the stopover and calculates the route to the main destination.

Changing a stopover

If a stopover has already been entered, you can change it.

- ▶ Select Navi → Destination → Stopover → Change Stopover.
- ▶ Enter another destination as a stopover.

Deleting the stopover

If a stopover has already been entered, you can delete it.

COMAND navigation system (Point of interest entry)

Entering a POI in the surrounding area

- ▶ In the map view while the menu system is displayed, select Destination → From POIs → Current Position (▷ page 103).
- ▶ Continue with designating the POI category (▷ page 129).

Entering a POI in the surroundings of a given city

Option 1

- ▶ In the map view while the menu system is displayed, select Destination → From POIs → Other City (▷ page 103).
- ▶ If necessary, enter state (USA) (▷ page 108) or province (Canada) (▷ page 110).
- ▶ **Entering city:** Select City. The city input menu appears.

COMAND navigation system (Point of interest entry)

- ▶ Then proceed as described in the “Entering a city” section (▷ page 112).
- ▶ After entering the city, continue with designating the POI category (▷ page 129).

Option 2

- ▶ Enter an address in the address input menu (▷ page 108).
- ▶ Select POI.
- ▶ Continue with designating the POI category (▷ page 129).

Entering a POI in a different region

i This function gives you quick access to POIs which are of national interest in the state (USA) or province (Canada) you have selected. The following categories may be available:

- AIRPORT
- BORDER CROSSING
- HIGHWAY ACCESS

Not all categories are available in all states (USA) or provinces (Canada).

▶ In the map view while the menu system is displayed, select *Destination* → *From POIs* → *Global POI* (▷ page 103). The category list appears. The state (USA) or province (Canada) currently selected is shown in the first list entry.

▶ **Selecting another state (USA) or province (Canada):** Select the first list entry.

A list of states/provinces appears.

▶ Select desired state (USA) or province (Canada).
If there are no POIs for the selected state (USA) or province (Canada), you will see a corresponding message.

Closing message: Select *OK*.

You can again select a state (province).

If there are POIs, you will see the category list again.

▶ Proceed as described in the “Selecting a category” paragraph in the “Main category list without input characters” section (▷ page 131).

Designating a POI category

The categories and POIs available depend on the distance from the vehicle position you have set for the POI.

- POI in the surrounding area:
categories sorted alphabetically and POIs sorted by distance within a radius of about 12 mi around the vehicle position are available. You can extend the search radius using the list options (▷ page 133).

- POI within a given city:
If you have only entered the state (USA) or province (Canada) and the city, alphabetically sorted categories and alphabetically sorted POIs within the city are available.

If you have entered more than the state (USA) or province (Canada) and the city, alphabetically sorted categories and POIs sorted by distance within a radius of about 12 mi around the address entered are available. You can extend the search radius and the category selection using the list options (▷ page 133).

- POIs in a different region:
Alphabetically sorted categories and alphabetically sorted POIs are available.



COMAND navigation system (Point of interest entry)

Entering a category

Depending on the number of available categories, the main category list appears for category entry either with or without input characters (▷ page 131).

Main category list with input characters

When this list appears, the input characters ⑤ are automatically activated.



- ① Top list entry based on the input data up to that point
- ② Characters entered by the user
- ③ Characters automatically added by the system
- ④ Symbol for available POIs or other available subcategories
- ⑤ Input characters
- ⑥ Currently non-selectable characters

- ⑦ Currently selectable character
- ⑧ Currently selected character
- ⑨ Main category list

① In the list of input characters ⑤, you can only select currently selectable characters. Which characters are included depends on the sequence in which you have entered your destination and the data version of the digital map.

While the characters are being selected as described below, the top list entry ① always shows the category which best corresponds to the input data as it has been entered up to that point.

At the same time, COMAND automatically supplements characters ② entered by the user with appropriate characters ③.

- ▶ **Selecting characters:** Slide ←⑨→ or rotate [↻].
- ▶ **Confirming character selection:** Press [↵].
- ▶ **Deleting individual characters:** Select [c] in the bottom line and press [↵].
- ▶ **Deleting an entire entry:** Select [c] in the bottom line and press [↵] until the entire entry is deleted.

▶ **Canceling an entry:** Select Back in the bottom line and press [↵].

or

▶ Press back button [←] in the center console (▷ page 86).

As soon as COMAND can clearly attribute the characters entered to a category, the input characters ⑤ disappear. You see the list of main categories without the input characters. Here you can confirm the current entry or make another selection.

You can also manually switch to the main category list without input characters at any time.

▶ **Switching manually to the main category list without input characters:** Slide [↵].

or

▶ Select [ok] in the second line from the bottom and press [↵].

COMAND navigation system (Point of interest entry)

Main category list without input characters

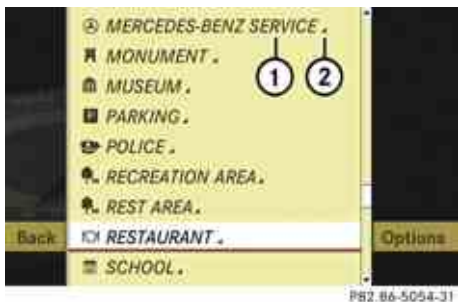

Example illustration: Main category list for POIs in the surrounding area

- ① Category
- ② Symbol for available POIs or other available subcategories

▶ **Selecting a main category:** Slide ↑⊙↓ or rotate ⊙.

▶ **Canceling selection:** Select Back and press ⊙.

or

▶ Press back button ← in the center console (▷ page 86).

▶ **Confirming selection:** Press ⊙.

Main categories with symbol ② contain either POIs or subcategories. Further

operation depends on whether the selected main category contains subcategories or only POIs.

Selected main category contains subcategories:

Selecting such a main category opens a list of subcategories. The illustration below shows by way of example the RESTAURANT main category with available subcategories ④.



- ① Main category
- ② To show all POIs for all subcategories under category ①
- ③ Symbol for available POIs
- ④ Subcategory

▶ **Selecting a subcategory:** Slide ↑⊙↓ or rotate ⊙.

▶ **Canceling selection:** Select Back and press ⊙.

or

▶ Press back button ← in the center console (▷ page 86).

▶ **Confirming selection:** Press ⊙.

After selecting a subcategory, a list of POIs appears. It contains the POIs available within the search radius of the subcategory.

i If you have selected list item ②, the POI list contains all POIs for all subcategories within the search radius of main category ①.

Selected main category contains no subcategories, but only POIs:

Selecting such a main category immediately opens a list of POIs. The POI list contains the available POIs within the search radius of the main category.

POI list

Depending on the situation, COMAND first shows the following list or the POI list with input characters.



COMAND navigation system (Point of interest entry)

The illustration below shows by way of example the POI list for the RESTAURANT main category, FRENCH CUISINE subcategory within the surrounding area.



- ① Compass heading to the destination
- ② Linear distance to the destination
- ③ Special destination

i Displays ① and ② are not visible if you have already entered a POI within a particular city. Displays ① and ② are static; they do not change while you are driving.

In the POI list, you can either select a POI or enter the name of the POI.

Selecting a POI

- ▶ Select desired POI.
The POI list disappears and the address of the POI appears.
- ▶ **Back to POI list:** Select Back and press .

or

- ▶ Press back button  in the center console (▷ page 86).
- ▶ **Starting route calculation:** Select Start, see also (▷ page 123).

Entering name of POI

- ▶ Select Options → Spell.
The POI list appears with input characters; the input characters are automatically activated.

POI list with input characters

- i** For POIs in other regions, this list also shows the compass heading to the destination as well as the linear distance to the destination, as in the previous illustration.



- ① Top list entry based on the input data up to that point
- ② Characters entered by the user
- ③ Characters automatically added by the system
- ④ Input characters
- ⑤ Currently selectable character
- ⑥ Currently non-selectable characters
- ⑦ POI list
- ⑧ Currently selected character

i In the list of input characters ④, you can only select currently selectable characters. Which characters are included depends on the sequence in which you have entered your destination and the data version of the digital map.

COMAND navigation system (Point of interest entry)

While the characters are being selected as described below, the top list entry ① always shows the POI that best corresponds to the input data as it has been entered up to that point.

At the same time, COMAND automatically supplements characters ② entered by the user with appropriate characters ③.

- ▶ **Selecting characters:** Slide ←⊙→ or rotate Ⓜ.
- ▶ **Confirming character selection:** Press ⊕.
- ▶ **Deleting individual characters:** Select [c] in the bottom line and press ⊕.
- ▶ **Deleting an entire entry:** Select [c] in the bottom line and press ⊕ until the entire entry is deleted.
- ▶ **Canceling an entry:** Select Back in the bottom line and press ⊕.

or

- ▶ Press back button ← in the center console (▷ page 86).

As soon as COMAND can clearly attribute the characters entered to a POI, the input characters ④ disappear.

You see the POI list without input characters. Here you can confirm the current entry or make another selection.

You can also manually switch to the POI list without input characters at any time.

- ▶ **Switching manually to the POI list without input characters:** Slide ↑⊙.

or

- ▶ Select [ok] in the second line from the bottom and press ⊕.

POI list without input characters



- ▶ **Selecting a destination:** Slide ↑⊙↓ or rotate Ⓜ.

- ▶ **Canceling selection:** Select Back and press ⊕.

or

- ▶ Press back button ← in the center console (▷ page 86).

- ▶ **Confirming selection:** Press ⊕.

- ▶ **Starting route calculation:** Select Start, see also (▷ page 123).

List options

Options in category and POI lists

If you enter a POI in the surrounding area, initially, only categories and POIs within a radius of approximately 12 mi around the vehicle position are available.

The same applies if you enter a POI within a given city and have previously entered more than the state (USA) or province (Canada) and the city.

If you expand the list, the search radius increases to around 90 mi. This gives you access to all categories and POIs within a radius of about 90 mi.

COMAND navigation system (Point of interest entry)

- ▶ **Expanding list:** In one of the lists select Options → Expand Search. The list is expanded.

Options only in POI lists

- ▶ **Displaying details of the selected entry:** Select Options → Details. The detailed view appears.
- ▶ **Closing detailed view:** Select OK.

Entering a POI from the map

- ① If the cross hair is shown on the map, you can enter POIs in the vicinity of the cross hair. If the cross hair is not shown on the map, you can enter POIs in the vicinity of the vehicle's current position.
- ▶ Select Guide in the map view with the menu system displayed (▷ page 103). You will see POI symbols on the map, depending on whether POIs are available and which map scale is set. The scale at which the symbols are displayed on the map varies according to the symbol. You can set which symbols COMAND should display (▷ page 105).

The POI closest to the center of the screen is automatically marked.

If there are no POIs available, the Back menu item is automatically highlighted and you cannot select other menu items.



- ① Highlighted POI
- ② Information about the highlighted POI

- ▶ **Selecting a POI:** Select Next or Previous. The next or the previous POI is marked.
- ▶ **Displaying details of the selection:** Select Details.

- ▶ **Starting route calculation:** Select Start, see also (▷ page 123). A prompt appears asking whether the POI should be used as the destination.
- ▶ Select Yes or No. If you select Yes, the route calculation begins. If you select No, you can select a new POI.

COMAND navigation system (route guidance)

COMAND navigation system (route guidance)

Route guidance

⚠ Observe Safety notes, see page 95.

COMAND guides you to the destination using navigation commands in the form of audible navigation announcements and route guidance displays.

i The route guidance displays can only be seen if the display is switched to navigation mode.

If, for any reason, you do not follow the navigation commands or if you leave the calculated route, COMAND automatically calculates a new route to the destination.

If the map data contains the relevant information, COMAND tries to avoid roads that only have limited access, e. g. roads closed to through-traffic and non-residents.

Roads that have time restrictions (e. g. closed on Sundays and public holidays) are not considered for route guidance, if the digital map contains the relevant information.

Examples of displays and announcements for a driving maneuver

Driving maneuvers have three phases:

- Preparation phase
- Announcement phase
- Maneuver phase

Preparation phase

COMAND prepares you for the upcoming driving maneuver. Based on the example display below, the driving maneuver is announced with the Prepare to turn left message. The display is not split and shows the map over the full screen.



- ① Point at which the driving maneuver takes place (light blue dot)
- ② Route (highlighted blue)
- ③ Current vehicle position; the triangle points in the vehicle's direction of travel

Announcement phase

COMAND announces the next driving maneuver. Based on the example display below, the driving maneuver is announced 700 feet in advance with the Turn left in 700 feet to your destination message. The display is divided in two. In the left half, you see the normal map view. In the right half, there is either an enlarged view of the area surrounding the intersection (intersection zoom) or simply a symbol for the next driving maneuver.



COMAND navigation system (route guidance)

The following example illustration shows the intersection zoom in the right half.

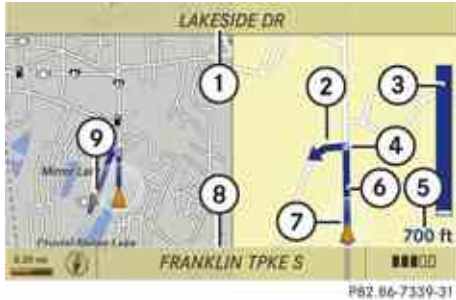

- ① Next road
- ② Driving maneuver (turn left)
- ③ Graphical representation of the distance to the driving maneuver
- ④ Point at which the driving maneuver takes place (light blue dot, shown in both the left and right displays)
- ⑤ Information about distance to the next driving maneuver
- ⑥ Route (highlighted in blue; shown in both the left and right displays)
- ⑦ Current vehicle position; the triangle indicates the vehicle's direction of travel (shown in both the left and right displays)

⑧ Street on which you are currently driving, if included on the digital map

⑨ Destination

- ① The filled-in section of distance graphic
 ③ gets shorter the nearer you get to the announced driving maneuver.

Maneuver phase

COMAND announces the next driving maneuver. Based on the example display below, the driving maneuver is announced 150 feet in advance with the Now turn left message. The display is also split into two halves, as for the announcement phase.

- ① Once the maneuver is completed, COMAND automatically switches back to the non-split screen.



- ① Graphical representation of the distance to the next driving maneuver
- ② Information about distance to the next driving maneuver

COMAND navigation system (route guidance)

Example of a display without driving maneuvers



- ① Main destination
- ② Stopover (only visible if a stopover has been entered)
- ③ Route (highlighted blue)
- ④ Current vehicle position; the triangle indicates the vehicle's direction of travel
- ⑤ Set map orientation – for an explanation and settings, see [▷ page 105](#)
- ⑥ Set scale – for an explanation and settings, see [▷ page 103](#)

Destination or destination area reached

Once you have reached your destination, you will hear the announcement You have reached the destination. For certain POIs (airports or highway junctions), you will hear the announcement You have reached the destination area. In addition, you will see a corresponding display and route guidance is automatically ended.



- ① Destination on the map
- ② Destination flag

Partially digitized areas

- i** The digital map may contain areas that are only partially digitized although they are within a digitized region.

⚠ Warning!

Due to incomplete digitization, the route shown on the map may differ from the actual road/traffic situation.

If you follow the route shown on the map, for example, it is possible that you could drive the wrong way down a one-way street or that a street cannot be driven on.

When using route guidance in a partially digitized area, you must therefore be sure to observe all relevant traffic regulations and the course of the road.

All relevant traffic regulations and the course of the road always take priority over the route shown on the map.

If the destination is within a partially digitized area

COMAND guides you through fully digitized areas for as long as possible. Route guidance is conducted in the usual manner, i. e. with navigation announcements and route guidance displays.



COMAND navigation system (route guidance)

Before the vehicle reaches a partially digitized area, COMAND notifies you of this with the following announcements:

- Be prepared to enter an area where turn by turn guidance cannot be provided.
- In 700 feet you will enter an area where turn by turn guidance cannot be provided.

i The indicated distance can be seen here by way of example. In reality, it may be different.

- You are about to enter an area where turn by turn guidance cannot be provided.

i When you call up the route info to this type of destination, (▷ page 141) the following data shown there may differ from the actual situation:

- Distance to the destination
- Estimated driving time to the destination
- Estimated arrival time

Route guidance within a partially digitized area

If you start route guidance in this type of area, you will hear the following announcement: You are currently in an area where turn by turn guidance cannot be provided.

Route guidance is provided by means of a direction arrow showing the compass heading to the destination. COMAND will not generate automatic navigation announcements.

If you try to call up an announcement manually, (▷ page 140) you will hear the announcement You are currently in an area where turn by turn guidance cannot be provided.

During route guidance, the display is divided. On the right-hand side you will see the direction arrow showing the compass heading to the destination.

On the left-hand side of the display you will see the map with the suggested route. The suggested route is highlighted blue. However, it may not be possible to follow the suggested route because, for example, the road is closed or not open for car traffic.

If, during route guidance, COMAND leads you back into a fully digitalized area, route

guidance will simply continue in the usual manner.

Off-road and off-map

Route guidance to an off-road destination

Warning!

The COMAND navigation system may direct you to off-road routes that your vehicle may not be capable of traversing through without damaging your tires, wheels or vehicle. It is the driver's sole responsibility to determine the suitability of the route. Off-road routes may be of varying conditions and their appropriateness for use may be affected by various factors such as time of day, time of year and immediate weather conditions that cannot be judged or taken into consideration by the COMAND system.

COMAND can guide you to destinations within the area covered by the digital map, even if a destination is not located at a road known to the system.

These destinations are shown as off-road destinations, which you can enter using the map, for example. In these cases, COMAND

COMAND navigation system (route guidance)

guides you for as long as possible with navigation announcements and displays on roads known to the system.

Shortly before you reach the last known point to leave the digitized road network, you will hear the announcement The destination is nearby. Follow the arrow on the display.

You will then see an arrow that indicates the direction to the off-road destination. When the off-road destination is close to the road, Area of dest. reached appears in addition below the arrow.

The section of the route from the last known point on the map to the off-road destination is indicated with a dashed line after a certain length. It simply shows the direction to the off-road destination without taking account of any type of obstacles in the way.

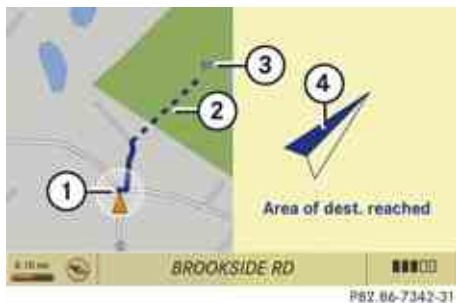

- ① Current vehicle position; the triangle indicates the vehicle's direction of travel
- ② Off-road section of the route
- ③ Off-road destination
- ④ Direction arrow, shows compass heading to destination

On the off-road section of the route, direction arrows showing the compass heading to the destination guide you. You will also see the Direction to destination display.

Route guidance from an off-road location to a destination

If there is no road available on map at current position of the car, vehicle is off road. COMAND is also able to guide you to a destination from such a location.

At the start of the route guidance, you will see the Off Road message and a direction arrow. The direction arrow shows the compass heading to the actual destination.

The route is highlighted blue from the nearest road known to the system.

As soon as the vehicle is back on a road known to the system, route guidance continues in the usual way.

Route guidance from an off-map location to a destination

If the vehicle position is outside the area covered by the digital map, then the vehicle is in an off-map location.

COMAND is also able to guide you to a destination from such a location.

At the start of the route guidance, you will see the Off Map message and a direction arrow. The direction arrow shows the compass heading to the actual destination.

The route is highlighted blue from the nearest road known to the system.

As soon as the vehicle is back on a road known to the system, route guidance continues in the usual way.

COMAND navigation system (route guidance)

Off-road during route guidance

The road layout may differ from the data on the digital map, due to road construction measures, for example.

In such cases, the system cannot allocate the vehicle position to the digital map and the vehicle is therefore in an off-road position.

The Off Road message and an arrow showing the compass heading to the destination appear on the display.

As soon as the system can allocate the vehicle position to the map again, route guidance continues in the usual way.

Navigation announcements

Warning!

Navigation announcements are intended to direct you while driving without diverting your attention from the road and driving.

Please always use this feature instead of consulting the map display for directions. Consulting the symbols or map display for directions may cause you to divert your attention from driving and increase your risk of an accident.

i If Russian or Chinese is set as the system language, the navigation announcements are in English. You will find how to set the system language on (▷ page 94).

Navigation announcements are muted during telephone calls. You can, however, call up a current announcement at any time. You can also call up a current announcement at any time if you have missed an announcement.

Route guidance is already active.

▶ **Calling up a current announcement:**
Select **Nav i** → **RPT**.

or

▶ Press  favorite button if the button has been programmed with this function (▷ page 94).

▶ **Switching off navigation messages:**
Press  during an announcement. You will see the message **The driving instructions have been muted. for a short while.**

i The announcements remain switched off even if you start a new route guidance or if COMAND is switched off/on with the **ON** button.

If you switch COMAND off by removing the SmartKey from the starter switch and then switch the ignition back on after more than 3 minutes, the announcements are automatically switched back on.

▶ **Switching navigation announcements back on manually:** Select **Nav i** → **RPT**.

▶ **Adjusting volume of the messages:**
Adjust the volume during an automatic announcement (▷ page 88).

or

▶ Call up an announcement manually using **Nav i** → **RPT** and adjust the volume (▷ page 88).

COMAND navigation system (during route guidance)

COMAND navigation system (during route guidance)

Cancel route guidance

- ▶ Select Destination → Cancel Route Guidance in map view with the menu system displayed (▷ page 103).

Continuing canceled route guidance

- ▶ Select Destination → Continue Route Guidance in map view with the menu system displayed (▷ page 103). COMAND calculates the route.

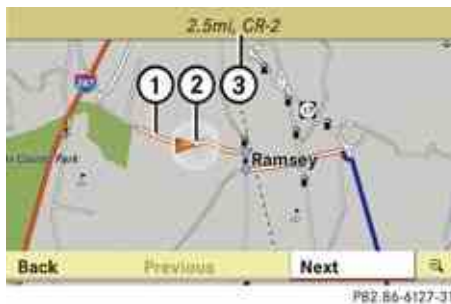

Route browser

- i** The route browser shows an overview of the route. You can use the route browser to move along the route section by section and view information about and details of each section of the route.
- ▶ Select Route → Route Browser in map view with the menu system displayed (▷ page 103). The route browser appears.



- 1 Highlighted route section
- 2 Current vehicle position; the triangle indicates the vehicle's direction of travel
- 3 Information about the highlighted route section

- 1 Information 3 about the marked route section shows the street name and the length of the route section. Marked route section 1 is always highlighted in white and outlined in red.



- ▶ **Displaying next or previous route section:** Select Next or Previous.
- ▶ **Increasing or reducing size of the map:** Select  or .
- ▶ **Closing route browser:** Select Back.

Displaying info

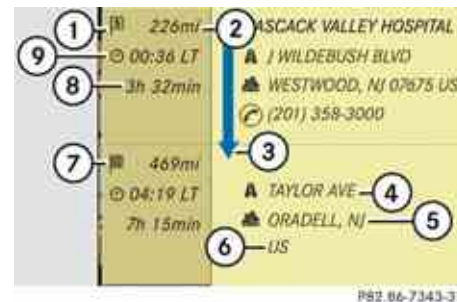
- ▶ Select Info in map view with the menu system displayed (▷ page 103). The route information appears.



Example illustration: Display with main destination and stopover

- 1 Symbol  for stopover
- 2 Distance to the destination
- 3 Sequence of destinations (appears with at least one stopover)
- 4 Street
- 5 City and abbreviation for province (Canada) or state (USA)
- 6 Country
- 7 Symbol  for main destination
- 8 Estimated driving time to the destination
- 9 Estimated arrival time

COMAND navigation system (during route guidance)

i COMAND uses the time set in COMAND as the basis for calculating the estimated arrival time. The clock must be set correctly in COMAND (▷ page 92). The calculation of the estimated arrival time does not additionally take into account whether Daylight Saving Time or standard time is applicable at the destination. If the destination is in a different time zone, arrival time display **9** is in local time. This is indicated by LT in the display.

The following data cannot be seen until the route calculation has been completed:

- Distance to destination **2**
- Estimated arrival time **9**
- Estimated remaining travel time **8**

If the destination is located within a partially digitized area, the following data may differ from the facts:

- Distance to destination **2**
- Estimated arrival time **9**
- Estimated remaining travel time **8**

Displaying route information

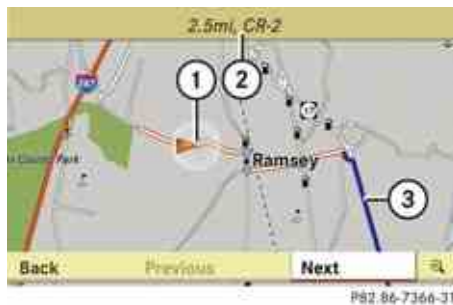

- ▶ Select Route → Route Info in map view with the menu system displayed (▷ page 103).
The route information appears.



- 1** Highlighted portion of route
- 2** Info for highlighted portion of route
- 3** Next portion of route

- ▶ **Closing route info:** Slide ◀⊙▶ or press back button  in the center console (▷ page 86).

- ▶ **Displaying next or previous route section:** Select Next or Previous.

- ▶ **Increasing or reducing size of the map:**
Select  or .
- ▶ **Closing route browser:** Select Back.

Detour function

- i** The detour function blocks a section of the route ahead of you. You can set the length of the blockage. If possible, COMAND calculates a detour route.
- i** The detour function may direct you to off-road routes. See Off-road and Off-map for additional routes and cautions (▷ page 138).
- ▶ Select Route → Detour in map view with the menu system displayed (▷ page 103).
The detour function display appears.
- ▶ **Setting length of the blockage:** Select More or Less until the desired length is set.

COMAND navigation system (real-time traffic)

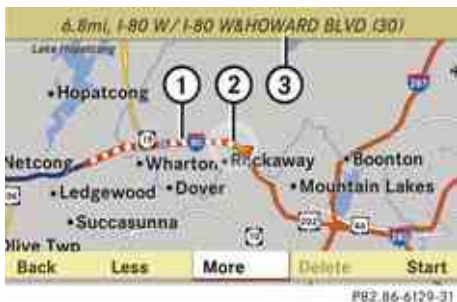

- ① Blocked route section
- ② Current vehicle position; the triangle indicates the vehicle's direction of travel
- ③ Information about the blocked route section

i Blocked route section ① is always highlighted in red/white. The information about blocked route section ③ shows which section of the route is blocked and the length of the blocked section.

- ▶ **Starting route calculation:** Select Start, see also (▷ page 123).
- ▶ **Deleting blockage:** Select Navi → Route → Detour → Delete.
- ▶ Select Back.

COMAND navigation system (real-time traffic)

Introduction

A RDS-TMC (Radio Data System-Traffic Message Channel) radio transmitter broadcasts traffic reports COMAND can receive and incorporate into the navigation system. Traffic report messages and map symbols can then be viewed in the COMAND display. Events displayed are those within receivable range of the vehicle's location.

- i** Actual road and traffic conditions may be different from the received messages.

Real-time traffic notifications in the map

COMAND can display certain traffic events in the map. The notifications are shown at the map scales from 0.05 mi (50 m) to 500 mi (500 km).

- ▶ **Set the map scale:** Turn  until the desired map scale is set. Turning clockwise enlarges the map, turning counterclockwise reduces it.



Example illustration: Display for a traffic jam on the route

- ① Symbol for event on the route
 - ② Marker symbols for the affected route section
 - ③ Current vehicle position and direction of travel
 - ④ Map scale
- i** COMAND marks the entire route section affected with appropriate symbols ②, independently of its actual length on the route section. Symbols ② are shown in the direction of travel on the left or right of the route. Thus, they also indicate which side of the roadway is affected by the event.

COMAND navigation system (real-time traffic)

The following shows the possible symbol displays.



PB2.86-6766-31

- ① Traffic jam on the route (symbol with red border)
- ② Traffic jam away from the route (symbol with gray border)
- ③ Stop-and-go traffic on the route (symbol with red border)
- ④ Stop-and-go traffic away from the route (symbol with gray border)
- ⑤ Blocked section on the route
- ⑥ Traffic jam
- ⑦ Stop-and-go traffic

Displaying real-time traffic reports

Displaying the message list

- ▶ Select Navi → TMC.
COMAND searches for real-time traffic transmitters. When no traffic reports are present, you will see a display to this effect.

List for inactive route guidance

When route guidance is inactive, the list displays all streets for which messages are present.

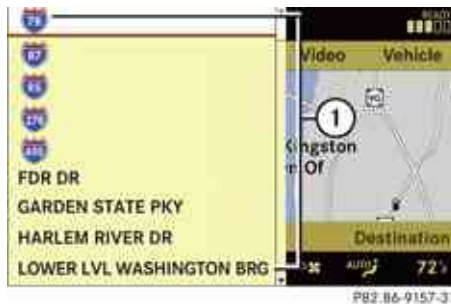

PB2.86-9157-31

- ① Affected street list
- i** Instead of a street, an area or a region can also be affected by a message, for example, when visibility is limited due to fog.

- ▶ **Read a message:** Select a street.
You can find an example message on (▷ page 145).
- ▶ **Close the list:** Slide ←⊙→.

List for active route guidance

When route guidance is active, the list displays only the streets which are part of the route and for which messages are present.



PB2.86-6766-31

- ① Show all messages (including those which do not affect the route)
- ② Affected streets (only shown when messages which affect the route are present)

COMAND navigation system (destination memory)

- ▶ **Display all messages:** Select Display All Messages.
All streets are shown for which messages are present, as well as for those which are not on the route.
- ▶ **Read a message:** Select a street.
You can find an example message below.
- ▶ **Close the list:** Slide ←○→ once or repeatedly.

Example message

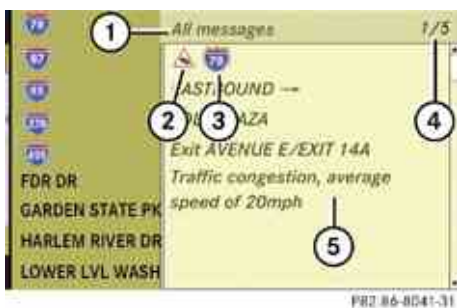

- ① Selection display (Messages On Route or All messages)
- ② Symbol for message event (e.g. traffic jam)
- ③ Street affected by the message

- ④ Message 1 of 5 for the affected street
- ⑤ Message text

The symbols for the possible message events are shown in the following.

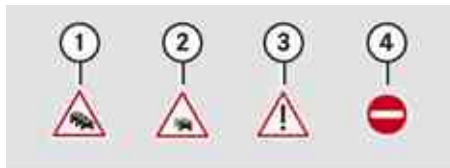

P82 86-6770-31

- ① Traffic jam symbol
 - ② Stop-and-go traffic symbol
 - ③ Warning message symbol
 - ④ Blocked section symbol
- ▶ **Scroll through the contents or to the next message:** Turn ⏪⏩ or slide ⬆️⬆️⬆️.

COMAND navigation system (destination memory)

Saving a destination in the destination memory

i This function also saves the destination in the address book. There COMAND creates an address book entry containing complete, navigable address data. You can then select this entry in the address book and start navigation to the address.

Saving after the address has been entered

- ▶ Select “Save” after entering the address (▷ page 108).
You can now select save options.

Saving during route guidance

- ▶ Select Destination → Save Destination during route guidance.
You can now select save options.

COMAND navigation system (destination memory)

Saving a destination from the list of last destinations

- ▶ Select Navi → Destination → From Last Destinations.
The list of last destinations appears.
- ▶ Select desired destination.
The address of the destination is displayed.
- ▶ Select Save.
You can now select save options.

Selecting save options

Saving a destination without a name

- ▶ Select Save Without Name.
COMAND saves the destination in the destination memory and uses the address as the destination name.

or

- ▶ Select Save as 'My Address'.
- ▶ Select desired category, e.g. Home.
COMAND saves the destination in the destination memory as your own address.

Saving a destination with a name

- ▶ Select Save new entry.
- ▶ Select desired category, e.g. Home.
The input menu appears with the data fields and the input characters.

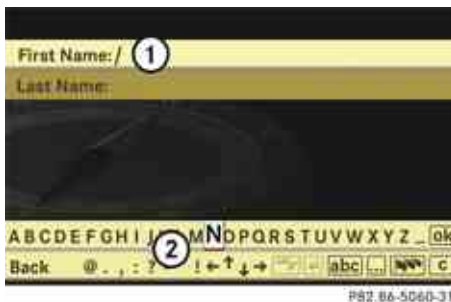

① Selected data field with input mark (cursor)

② Input characters

- ▶ **Entering data:** Proceed as described in the “Changing the data field” operating step in the “Creating a new address book entry” section (▷ page 171).

Assigning a destination to an address book entry

- ① This function assigns the complete, navigable address data to an already existing address book entry. You can then select this entry in the address book and start navigation to the address from there.

- ▶ Select Assign Address Book Entry.
- ▶ Select desired category, e.g. Home.
The menu appears for searching for an address book entry.
- ▶ Select desired address book entry.
Proceed as described in the “Searching for an address book entry” section (▷ page 172).
If the selected address book entry does not yet contain any navigable address data, COMAND saves the data.
If the selected address book entry already contains navigable address data, you will see a question asking you if the previous data should be overwritten.
- ▶ Select Yes or No.
If you select Yes, COMAND saves the data.

COMAND navigation system (destination memory)

Deleting a destination from the destination memory

- ▶ Select Navi → Destination → From Memory.
Depending on the number of entries in the destination memory, you will see the destination memory list with or without input characters.



Example illustration: Destination memory list without input characters



Example illustration: Destination memory list with input characters

- ① Input characters
 - ▶ Select desired destination. Proceed as described for destination entry in the “Entering a destination from the destination memory” section (▷ page 124).
 - ▶ Select Delete after selecting the destination to be deleted. A prompt appears asking whether you want to delete the destination.
 - ▶ Select Yes or No. If you select Yes, COMAND deletes the destination.
- ① If the navigable address data of the destination to be deleted has also been assigned to an address book entry,

COMAND deletes the data there as well. If the corresponding address book entry does not contain any further data, such as telephone numbers, COMAND deletes the entire address book entry.

Own address

- ① The destination memory always contains an entry called My Address. You can save your home address, for example, under this entry.

Assigning your address for the first time or changing your own address

Assigning and/or changing your own address

- ▶ Select Navi → Destination → From Memory.
Depending on the number of entries in the destination memory, you will see the destination memory list with or without input characters.

COMAND navigation system (destination memory)



Example illustration: Destination memory list without input characters

In the destination memory list without input characters, the My Address entry is automatically highlighted.



Example illustration: Destination memory list with input characters

① Input characters

In the destination memory list with input characters ①, the input characters are automatically activated.

▶ **Destination memory list without input characters:** Press immediately.

or

▶ **Destination memory list with input characters:** Slide repeatedly until the input characters disappear.

The list entry My Address is automatically highlighted as long as you have not entered any characters using the input characters.

If you have entered characters from the list of input characters: Rotate or slide repeatedly until the list entry My Address is highlighted.

▶ Press .

Further operation depends on whether you want to enter the address manually or use an address book entry as your own address.

Entering an address manually

▶ **If you want to assign your own address for the first time:** Select Save new entry.

or

▶ **If you want to change your own address:** Select Change → Save new entry.

In both cases, the address input menu appears.

▶ Enter the address. Proceed as described for destination entry in the “Entering a destination by address” section (▷ page 108).

▶ Select Save after entering the address. Your address is saved.

Using the address book entry as your own address

▶ **If you want to assign your own address for the first time:** Select Assign Address Book Entry.

or

▶ **If you want to change your own address:** Select Change → Assign Address Book Entry.

In both cases, the menu appears for searching for an address book entry.

COMAND navigation system (destination memory)

- ▶ Select desired address book entry. Proceed as described in the “Searching for an address book entry” section (▷ page 172).

Once the address data is complete and if it matches the digital map data, COMAND saves the entry as your own address in the destination memory.

If address data is still missing or if it cannot be found on the digital map, a message appears indicating that the address is incomplete.

- ▶ **Closing message:** Select OK.

- ❗ In the address book entry, the city and street must be spelled in the same way as the destination entry so that the data matches the digital map data.

In order for the state (USA) or province (Canada) to match the map data, you may either enter the entire name or the abbreviation in the address book.

Examples:

- Florida or FL
- Colorado or CO
- Alberta or AB
- Ontario or ON

Depending on which data is missing or cannot be found on the digital map, you must now enter either:

- select a state (USA) or province (Canada)
- or enter a city
- or enter a street
- or enter a house number

- ▶ **Selecting a state (USA) or province (Canada):** Select desired state (USA) or province (Canada) from the list.

- ▶ **Entering a city:** Proceed as described for destination entry in the “Entering a city” section (▷ page 112).

- ▶ **Entering a street:** Proceed as described for destination entry in the “Entering a street” section (▷ page 115).

- ▶ **Entering a house number:** Proceed as described for destination entry in the “Entering a house number” section (▷ page 119).
If all data is available and matches the digital map data, you can save the address.

- ▶ **Saving:** Select Save.

Displaying your own address

- ▶ Select Navi → Destination → From Memory.
The destination memory list appears either with or without the input characters. Whether the input characters appear depends on the number of entries in the destination memory.
- ▶ Press .

Destination memory list without input characters

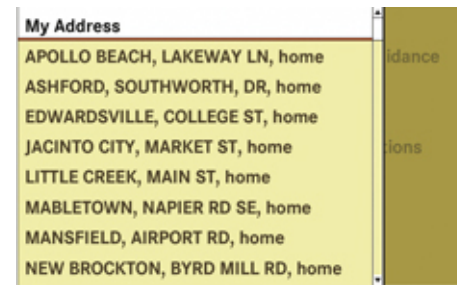

In the destination memory list without input characters, the My Address entry is automatically highlighted.

COMAND navigation system (last destinations)

- ▶ Press .
If your own address has already been assigned, you will see the menu for starting route guidance with your own address data.
- ▶ **Exiting menu:** Select Back.



Destination memory list with input characters



① Input characters

In the destination memory list with input characters ①, the input characters are automatically activated.

- ▶ Slide  repeatedly until the input characters disappear.
The list entry My Address is automatically highlighted as long as you have not entered any characters using the input characters.

If you have entered characters from the list of input characters: Rotate  or slide  repeatedly until the list entry My Address is highlighted.

- ▶ Press .
If your own address has already been assigned, you will see the menu for starting route guidance with your own address data.
- ▶ **Exiting menu:** Select Back.

COMAND navigation system (last destinations)

- i** COMAND automatically saves the last destinations for which the route calculation was launched. It is stored in the “last destinations” memory. If this memory is full, COMAND deletes the oldest destination. You can also save one destination from the list of last destinations in the destination memory. It will be saved there permanently.

Saving a destination permanently in the destination memory

- ▶ Proceed as described in the “Saving a destination from the list of last destinations” section (▷ page 146).

Saving the vehicle position in the list of last destinations

- ▶ **Centering map on the vehicle's position:** Select Navi → Position → Vehicle Position Map.
- ▶ **Saving:** Select Navi → Position → Save Position.
COMAND saves the current vehicle position as a destination in the list of last destinations.

Saving the cross hair position in the list of last destinations

- i** If you have manually moved the map, you will see a cross hair on the map (> page 103). You can save the cross hair position as a destination in the list of last destinations.
- ▶ **Showing menu system, if necessary:**
Press .
- ▶ Select Position → Save Position.
COMAND saves the cross hair position as a destination in the list of last destinations.

Deleting one of the last destinations

- ▶ Select Navi → Destination → From Last Destinations.
The list of last destinations appears.
- ▶ Select desired destination.
The address of the destination appears.
- ▶ Select Delete.
- ▶ Select Yes or No.

COMAND telephone

Safety notes

Warning!

Some jurisdictions prohibit the driver from using a cellular telephone while driving. Whether or not prohibited by law, for safety reasons, the driver should not use the cellular telephone while the vehicle is in motion. Stop the vehicle in a safe location before placing or answering a call.

If you nonetheless choose to use the mobile phone³ while driving, please use the handsfree feature and be sure to pay attention to the traffic situation at all times. Use the mobile phone only when road, weather and traffic conditions permit. Otherwise, you may not be able to observe traffic conditions and could endanger yourself and others.

Bear in mind that at a speed of just 30 mph (approximately 50 km/h), your vehicle is covering a distance of 44 feet (approximately 14 m) every second.

Warning!

Never operate radio transmitters equipped with a built-in or attached antenna (i.e.



³ Observe all legal requirements

COMAND telephone

without being connected to an external antenna) from inside the vehicle while the engine is running. Doing so could lead to a malfunction of the vehicle's electronic system, possibly resulting in an accident and/or serious personal injury.

General notes

i USA only:

This device complies with Part 15 of the FCC Rules. Operation is subject to the following two conditions:

1. This device may not cause harmful interference, and
2. this device must accept any interference received, including interference that may cause undesired operation.

Any unauthorized modification to this device could void the user's authority to operate the equipment.

i Canada only:

This device complies with RSS-210 of Industry Canada. Operation is subject to the following two conditions:

1. This device may not cause interference, and
2. this device must accept any interference received, including interference that may cause undesired operation of the device.

Any unauthorized modification to this device could void the user's authority to operate the equipment.

Calls disconnected while the vehicle is in motion

A call may be disconnected if:



- there is insufficient network coverage
- you move from one transmitter/receiver area (cell) into another and no channels are free or the cell is full

Operating options

i The components and operating principles of COMAND can be found on (▷ page 78).

i Various mobile phone cradles can be installed in the front center armrest, see separate installation instructions for the mobile phone cradle. These mobile phone cradles can be obtained from an authorized Mercedes-Benz Center. For more information about telephone (▷ page 404) and (▷ page 242).

When the mobile phone is inserted in the cradle, you can operate the telephone using the following devices:

- mobile phone keypad
- COMAND telephone keypad
- buttons  and  on the multifunction steering wheel (▷ page 232)
- Voice Control (▷ page 259)
- Bluetooth® headset (▷ page 164)

Please note that these functions are only available with Mercedes-Benz approved mobile phones. Please contact an authorized Mercedes-Benz Center for information on features available for your mobile phone of choice.

You can control other functions of the mobile phone via the COMAND, instrument cluster

control system (▷ page 242) or Voice Control.

i In order for the functions described in this section to work correctly, the Bluetooth® headset must be linked to COMAND (▷ page 180). Please make sure any Bluetooth® headset linked with the mobile phone is switched off or that the headset is linked with COMAND before you insert the mobile phone in the cradle, see separate installation instructions for the cradle, and use the telephone functions with COMAND.

The descriptions in this section assume that the mobile phone is inserted in the cradle. Exceptions to this are clearly stated.

Unless otherwise indicated, the descriptions and illustrations in this section refer to COMAND and the telephone keypad. Operation using the mobile phone and Bluetooth® headset is described in the respective separate Operating Instructions.

Caller ID

COMAND can display the telephone number and the name of the caller, e. g. for an incoming call and also in other menus or displays.

For the telephone number to be displayed, the caller must transmit their telephone number.

This is also the case for name displays. For this, the telephone number and the name of the caller must also be saved in the mobile phone book.

Functional restrictions

You will not be able to use the telephone, or you may have to wait a while, in the following situations:

- If the telephone has not yet logged into the network.
The telephone automatically tries to log into a network. If no network is available, you will also not be able to make a “911” emergency call. If you attempt to make an outgoing call, the No Service message will appear for a short while.
- If the mobile phone is not inserted in the cradle.
- SIM card is not inserted in GSM type phone.

Notes about COMAND telephone features using a Bluetooth® connection

Many of the Mercedes-Benz approved mobile phones, cradles and adaptors available for use in your vehicle utilize Bluetooth® technology to communicate with each other and the vehicle. Depending on your phone brand and model, the number of in-vehicle or on-display COMAND telephone features supported via Bluetooth® communication, and thus available for your use, may vary.

The descriptions and illustrations in this section are based on the use of fully compatible Mercedes-Benz approved mobile phones and cradles that do not utilize Bluetooth® technology to communicate with each other. If your vehicle is equipped with integrated Bluetooth® functionality, a Bluetooth® capable mobile phone, headset, Laptop, PDA, etc. is required to utilize those features.



For additional information about Mercedes-Benz approved Bluetooth® mobile phones and related accessories please contact the Mercedes-Benz Customer Assistance Center at 1-800-FOR-MERCEdes or the nearest authorized Mercedes-Benz Center.

COMAND telephone

Switching telephone on or off

- ▶ **Switching on:** Insert mobile phone into cradle when COMAND is switched on.
or
- ▶ Switch on the mobile phone (see mobile phone operating instructions).
- ▶ **Switching off:** Select Telephone → Telephone → Telephone OFF.
or
- ▶ Switch off mobile phone (see mobile phone operating instructions).

Activating telephone mode



- ▶ Select Telephone → Telephone.
or
 - ▶ Press  on telephone keypad.
or
 - ▶ Press the  shortcut button once or twice.
- i** The number of times you have to press the  shortcut button depends on the operating mode currently selected.



Telephone keypad



- ① Telephone keypad
- ② Folding cover

With the telephone keypad you can:

- Enter and clear numbers and special characters.
- Reject, accept, connect and end calls.
- ▶ **Entering characters:** Select Telephone.
- ▶ Fold up cover ②.
- ▶ Enter characters using the  -  buttons.
- i** You can enter the * character by pressing  once. Pressing this button again within 1.5 seconds enters the + character.

- ▶ **Deleting individual characters:** Press .
- ▶ **Deleting an entire word or number:** Press and hold  until the word or number is deleted.

“911” emergency call

- i** The “911” emergency call system is a public service. Using it without due cause is a criminal offense.
- i** This function places a call to the local “911” provider. It does not initiate a Tele Aid call.

The following conditions must be fulfilled in order to make a “911” emergency call:

- The phone is switched on.
- A mobile network is available.
- There is a valid SIM card in the phone (not necessary in all mobile networks).
- i** If no SIM card is inserted in the mobile phone, you can only initiate a “911” emergency call by using COMAND and the mobile phone.

COMAND telephone

If you cannot make an emergency call, you must initiate rescue measures yourself. The “911” emergency call is a public service. Any misuse is punishable by law.

Placing a “911” emergency call before entering PIN/PIN2, PUK/PUK2 or unlock code

Entering the number using the COMAND controller

- ▶ Select Telephone → Dial 911.

Entering the number using the telephone keypad

- ▶ Enter digits 9-1-1 (▷ page 154).
- ▶ Press .

Placing a “911” emergency call after entering PIN/PIN2, PUK/PUK2 or unlock code

Entering the number using the COMAND controller

- ▶ Select Telephone.
- ▶ Select all the digits in sequence.
- ▶ Select .

Entering the number using the telephone keypad

- ▶ Enter digits 9-1-1 (▷ page 154).
- ▶ Press .

Confirming the emergency call





After the digits have been entered, you will see the question Do you want to dial the 911 emergency number?.

- ▶ Use COMAND controller to select Yes. The telephone makes the connection.
- ▶ Wait until the emergency call center answers and describe the emergency situation.





Entering the PIN

- i** Your PIN code (Personal Identification Number code) prevents unauthorized persons from using your GSM mobile phone. The PIN code is a number string, which you have to enter when switching on the telephone. The PIN entry applies only to GSM mobile phones.

Entering using the COMAND controller

- ▶ Select Telephone.
- ▶ **Entering:** Select all the digits in sequence.
- ▶ **Deleting a digit:** Select  and briefly press .
- ▶ **Deleting an entire number:** Select  and press and hold  until the number is deleted.
- ▶ **Confirming an entry:** Press .

Entering using the telephone keypad

- ▶ **Entering:** Enter digits using the  -  buttons (▷ page 154).
- ▶ **Confirming an entry:** Press  or press .

COMAND telephone

Entering the PIN2

- i** The PIN2 entry applies only to GSM mobile phones.

The phone may request the PIN2 in order to use certain functions. A corresponding message appears in the display.

- ▶ Enter PIN2 digits into mobile phone.

Entering the PUK/PUK2

- i** The PUK/PUK2 entry (Personal Unlocking Key) applies only to GSM mobile phones.

If you enter the PIN or PIN2 incorrectly three times, the SIM card will be locked. A corresponding message appears in the display. It is necessary to enter the PUK/PUK2 to unlock it. The PUK and/or PUK2 are provided by your telephone service provider.

- ▶ Enter PUK/PUK2 digits into mobile phone.

Entering the unlock code

Many mobile phones can be protected from unauthorized use with an unlock code (see mobile phone operating instructions). If you wish to use the phone functions when the unlock code is active, a screen appears requesting that you enter the unlock code. You cannot use the phone functions (except “9 1 1” emergency call) until you have entered the unlock code.

- ▶ Proceed in the same way as entering the PIN (> page 155).

Telephone submenu overview

- i** The components and operating principles of COMAND can be found on (> page 78).

COMAND telephone

Name (only when the mobile phone is inserted in the cradle)	Data/Connections	Call lists (not during a call)	Text message (not during a call)	DTMF (only during a call)	Mic OFF/ON (only during a call)
Display COMAND phone book	<ul style="list-style-type: none"> • Address book • Bluetooth® 	Display call list selection: <ul style="list-style-type: none"> • Calls received • Calls dialed 	Call up SMS inbox	Send numerical sequence	Switch hands-free microphone on/off

Main telephone menu



► **Calling up main menu:** Select Telephone.

or

► Press  on the telephone keypad (▷ page 154).

i If you press  when the main telephone menu has already been called up, the Calls Dialed list will appear (▷ page 158).



- ① Numbers/characters to enter telephone number
- ② Symbol  for new voice message in mailbox
- ③ Symbol  for unread SMS messages in SMS inbox (▷ page 182)

- ④ Signal strength and network status display
 - Network status READY = mobile phone is logged in with its own provider's network
 - Network status READY ROAM = mobile phone is logged in with another provider's network
 - Network status No Service = No network available
- ⑤ To show COMAND phone book (Name) (▷ page 165)

COMAND telephone

- ⑥ To call up text message (SMS)
(▷ page 182)
- ⑦ To display call list selection
(▷ page 158)

Mailbox

The symbol  in the example illustration above indicates that your mailbox contains new voice messages. You will have to call the mailbox in order to retrieve the messages.

You can call your mailbox by:

- speed dialing (▷ page 162)
- entering a telephone number using the telephone keypad (▷ page 161)
- entering the telephone number using the COMAND controller (▷ page 161)
- ① Once connection with your mailbox has been established, the mailbox system will guide you through the next steps.

Call lists

COMAND can display the following calls in separate lists:

- Calls received
- Calls dialed

Calling up a list

- ▶ Select **Call Lists** from main telephone menu.
- ▶ Select **Calls Received** or **Calls Dialed**.
The corresponding list appears.
- ① The **Calls Received** and **Calls Dialed** menu items do not function if the respective list has no entries. The **Call Lists** menu item does not function if neither list has any entries.

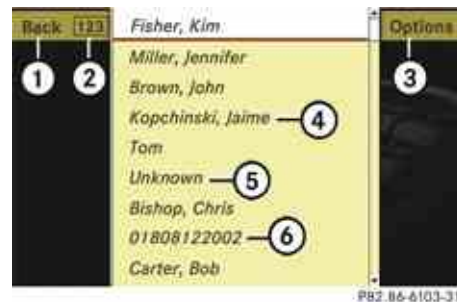

Example illustration: List of calls received

- ① To close list
- ② To switch list display (**123** or **ABC**)
- ③ To call up options
- ④ Name or telephone number of a caller
- ⑤ Unknown caller
- ⑥ Telephone number of a caller
- ① In the list of calls received, you will see the name of caller ④ if
 - the caller transmitted the telephone number
 - the name and telephone number are saved in the COMAND address book or in the phone book on the mobile phone
 - the telephone number is saved in the same way in which the caller transmits it

You will see the telephone number of caller ⑥ if

- the caller transmitted the telephone number
- no caller data is saved in either the COMAND address book or the phone book on the mobile phone

An unknown caller ⑤ has not transmitted his or her telephone number.

i In the list of dialed calls, you will see the name of the person called if you have saved his or her telephone number and name in the COMAND address book or in the phone book on the mobile phone. If no data has been saved, you will see the telephone number.

► **Switching to list display:** Select [123] or [ABC].

The display changes to telephone number or name display.

► **Closing list:** Slide ←⊙→ and select Back.

► **Selecting a list entry:** Slide ↑⊙↓ or rotate ⌚⊙ and select entry.

Displaying details of a list entry

COMAND can also show a shortened list entry in its entirety.

► Select list entry (▷ page 158).

► Slide ←⊙→ and select Options → Details.

The detailed view appears.

► **Closing detailed view:** Slide ↑⊙↓ or ←⊙→ or press ⊙.

Saving a list entry in the address book

i List entries that show a telephone number are neither saved in the COMAND address book, nor in the phone book on the mobile phone. You can save such entries in the COMAND address book. You can also save list entries in the COMAND address book which have already been saved in the phone book on the mobile phone.

Saving as a new entry in the COMAND address book

► Slide ←⊙→ or rotate ⌚⊙ and select list entry (▷ page 158).

► Select Options → Save → New Entry.

i Save does not function if the selected list entry is already saved in the COMAND address book.

► Select a number category, e.g. Home.

► Select a telephone category, e.g. Land Line.

► Select Save.

The input menu appears with the data fields. The data field for the telephone number is filled in automatically. The data field for the last name is also filled in automatically if the entry to be saved contains a name.

► **If you would like to save the entry now:** Select [ok] .

COMAND telephone



- ① Data field
- ② Input mark (cursor)
- ③ Input characters

▶ **If you want to change the available characters:** Proceed as described in the “Changing data field” paragraph in the “Assigning a New Entry in the Address Book” section (▷ page 167).

Adding to an existing entry in the COMAND address book

- ▶ Slide or rotate and select list entry (▷ page 158).
- ▶ Select Options → Save → Add.

i Save does not function if the selected list entry is already saved in the COMAND address book.

- ▶ Select a number category to add, e. g. Home.
- ▶ Select a telephone category to add, e. g. Land Line.
- ▶ Select Save.
The search menu for COMAND address book entries appears.
- ▶ Search for desired entry.

i There is a detailed description of searching for an COMAND address book entry in the “Searching for an address book entry” section (▷ page 172).

- ▶ Press when you have finished searching. COMAND saves the data if there are fewer than four numbers assigned to the entry you are searching for in the selected number category.
If four numbers are saved for the entry you are searching for, a prompt will appear asking whether you want to overwrite one of the existing numbers.

- ▶ Select Yes or No.
If you select Yes, a selection list will appear containing the four existing numbers.
- ▶ Select the number to be overwritten.
COMAND overwrites the selected number with the new data.

Incoming call

Rejecting or accepting the call

▶ **Rejecting:** Select Reject.

or

▶ Press on the telephone keypad or on the multifunction steering wheel.

i If you have a CDMA/TDMA mobile phone and reject a call, only the ring tone will stop. The call itself can only be ended by the caller.

▶ **Accepting:** Select Accept.

or

▶ Press on the telephone keypad or on the multifunction steering wheel.

or

▶ Press on the multifunction steering wheel.

COMAND telephone

- ▶ Use the mobile phone (see mobile phone operating instructions).

or

- ▶ Use the Bluetooth® headset (see headset operating instructions).





- i** The use of a Bluetooth® headset requires Bluetooth® to be activated and the Bluetooth® headset to be authorized (▷ page 180).

If you have accepted the call using COMAND, the telephone keypad, the multifunction steering wheel or the mobile phone, the call will be conducted via the hands-free system. The volume of the call can be adjusted (▷ page 88).

If you have accepted the call using the Bluetooth® headset, the call will be conducted via the headset.

Further operating functions can be found in the “Functions during a single-call connection” section (▷ page 163).









You can also accept a call if the COMAND display is showing a screen other than the telephone mode screen. After accepting the call, you will see the caller’s data in a window.

- ▶ **Closing window:** Slide  or  or  or  or press .

Making an outgoing call

- i** If you place an outgoing call and receive a busy signal, the telephone automatically starts to redial as long as the provider and the mobile phone support this function (see mobile phone operating instructions). While the call is connecting, you can also send character strings (▷ page 163).





Entering the telephone number using the COMAND controller

- ▶ **Switching screen to telephone mode:** Call up main telephone menu (▷ page 157).
- ▶ **Entering digits:** Select desired digits by rotating  or sliding  and press .
- ▶ **Deleting individual digits:** Select  and briefly press .
- ▶ **Deleting an entire telephone number:** Select  and press and hold  until the telephone number is deleted.
- ▶ **Connecting a call:** Select .

Entering a telephone number using the telephone keypad

- ▶ **Switching screen to telephone mode:** Call up main telephone menu (▷ page 157).
- ▶ Use telephone keypad to enter digits.
- i** A detailed description of how to enter digits using the telephone keypad can be found on (▷ page 154).
- ▶ **Connecting a call:** Press .

Redial

- ▶ **Switching screen to telephone mode:** Call up main telephone menu (▷ page 157).
 - ▶ Use COMAND controller to select .
- or
- ▶ Press  on the telephone keypad (▷ page 154). The list of dialed numbers appears. The most recently dialed number is at the top.
 - ▶ Select desired entry.
 - ▶ **Connecting a call:** Press .
 - i** If the list of dialed calls contains no entries, the  menu item cannot be

▷▷

COMAND telephone

selected and the  button on the telephone keypad does not function.

Placing a call to a call list entry or COMAND phone book entry

- ▶ Call up a call list and select an entry (▷ page 158).

or

- ▶ Call up COMAND phone book and select an entry (▷ page 165).
- ▶ **Connecting a call:** Press .

Speed dialing

You can save telephone numbers in the speed-dial preset locations on the mobile phone and call up the speed-dial presets (see mobile phone operating instructions).

- i** By default, the mailbox number is preset in the speed dial memory unless you have modified it. For more information on the mailbox (▷ page 158).

You can also call up speed-dial numbers using COMAND.



- i** Operation during call connection depends on the speed-dial preset position called up.

Calling up speed-dial presets using the COMAND controller

- ▶ **Switching screen to telephone mode:** Call up main telephone menu (▷ page 157).

- ▶ **Entering number of a speed-dial preset:** Select all the digits in sequence.

Deleting individual digits: Select  and briefly press .

Deleting entire number: Select  and press  until the number is deleted.

- ▶ **Connecting a call (speed-dial presets 1 - 99):** Select .

or



- ▶ **Connecting a call (speed-dial presets 100 - 999):** Select # after the digits → .

In both cases, the telephone connects the call to the saved telephone number. If the speed-dial memory contains no telephone numbers, you will see a corresponding message.

- ▶ **Deleting message:** Press .

Calling up speed-dial numbers using the telephone keypad

- ▶ **Switching screen to telephone mode:** Call up main telephone menu (▷ page 157).



- ▶ **Single-digit numbers:** Press and hold the  -  buttons.

or

- ▶ **Single- and two-digit numbers:** Enter number using the  -  buttons.

- ▶ Press .

or

- ▶ **Three-digit numbers:** Enter number using the  -  buttons.

- ▶ Press , and then .

In all three cases, COMAND connects the call to the saved telephone number. If the speed-dial memory contains no telephone numbers, you will see a corresponding message.

- ▶ **Deleting message:** Press .

COMAND telephone

Functions during a single-call connection



Example illustration: Telephone mode during a call

- ① Symbol for active telephone connection (also visible in other operating modes)
 - ② Signal strength display
 - ③ To switch hands-free microphone on or off
 - ④ Length of call display
 - ⑤ To send character strings
 - ⑥ To end a call
 - ⑦ Person you are calling
- i** The name of the person you are speaking with can only be seen in display ⑦ if his or her telephone number and name have been saved in the COMAND address book or

phone book on the mobile phone. The telephone number must also be saved in the same way in which the person you are talking to transmits it.

Switching the hands-free microphone on or off

- ▶ **Switching screen to telephone mode:** Call up main telephone menu (▶ page 157).
- ▶ **Switching off microphone:** Select Mic OFF and press .

or

- ▶ Press shortcut button. If the microphone is switched off, the symbol appears in the main area.
- ▶ **Switching on microphone:** Select Mic ON.

or

- ▶ Press shortcut button. The symbol disappears.

Sending a character string via DTMF

- ① This function is not possible with every mobile phone. If the mobile phone supports the function, you can use it during the call connection and also during a call.

Answering machines or other devices can be controlled by character strings (e.g. for remote query functions).



Sending character strings via the DTMF menu

- ▶ During a call, select DTMF. The DTMF dialing display appears.



- ① Back to the call display
- ② Character entry
- ③ To call up the phone book

COMAND telephone

- ▶ **Sending individual characters:** Rotate  or slide  and select desired character.
Each character you select can be seen in the main area and is sent immediately.
- ▶ **Sending a phone book entry as a character string:** Select Name.
- ▶ Select desired phone book entry.
The entry is immediately sent as a character string.

i Telephone numbers containing the + character may impair the function.



- ▶ **Switching back to the call display:**
Select .

Sending character strings via the telephone keypad

- ▶ Press corresponding button on telephone keypad.
Each character you select is immediately sent.

i The + character may impair the function.

Ending an active call

- ▶ **Ending a call:** Select  END in the call display.
- or
- ▶ Press  on the telephone keypad or on the multifunction steering wheel.
The COMAND display will change to the previously selected display, if applicable.

Transferring a call

From the hands-free system to the Bluetooth® headset

- i** The use of a Bluetooth® headset requires Bluetooth® to be activated and the Bluetooth® headset to be authorized (▷ page 180).

The call transfer is controlled by pressing the PTT button on the Bluetooth® headset (see headset operating instructions). Normally, it is sufficient to press the PTT button once, but under certain circumstances you may have to press it a second time.

Once the call has been transferred to the Bluetooth® headset, all the functions will be available to you which are described in the

“Functions during a single-call connection” section (▷ page 163).

Exception: “Switching the hands-free microphone on or off” function (▷ page 163).

From the Bluetooth® headset to the hands-free system

On most Bluetooth® headsets, you press the PTT button on the headset twice quickly to transfer the call (see headset operating instructions).

From the hands-free system to the mobile phone

- ▶ **If the mobile phone has a folding upper section:** Flip upper section open.
- ▶ Take mobile phone out of cradle.
The No telephone inserted message appears on the COMAND display.
Subsequent operation is only possible using the mobile phone.

From the mobile phone to the hands-free system

- ▶ Insert mobile phone into cradle.
Once the call has been transferred to the hands-free feature, all the functions will be

COMAND telephone

available to you which are described in the “Functions during a single-call connection” section (▷ page 163).

COMAND phone book

The COMAND phone book contains both the COMAND address book entries and mobile phone entries that have at least one telephone number.

The COMAND address book entries are permanently available even when a mobile phone is not inserted in the cradle.

When the mobile phone is inserted in the cradle, COMAND will read the phone book entries in the mobile phone and compares them with the COMAND address book entries.

If any of the telephone numbers of a phone book entry in the mobile phone are the same as an address book entry, COMAND will only display the address book entry.

If the entries are not the same, the COMAND phone book will show the phone book entry in the mobile phone.

Calling up the COMAND phone book

- ▶ Select Telephone → Name.
The COMAND phone book appears.



Example illustration: Phone book with name display and smart speller activated

- ① Category symbol
- ② Upper entry from address book (without category symbol)
- ③ Symbol for several telephone numbers (subentries) under the main entry
- ④ Symbol for summarized entries from the mobile phone with the same name but different telephone numbers
- ⑤ Smart speller
- ⑥ Voice entry symbol
- ⑦ To close the phone book

Entries with category symbol ① come from the mobile phone. The following category symbols are possible:

- = symbol for Mobile category
- = symbol for Home category
- = symbol for Work category
- = symbol for Fax category
- = symbol for Pager category
- = symbol for Main category or for unknown category or for phone entries that are saved on the SIM card of a GSM mobile phone

Entries without a category symbol or with the symbol come from the COMAND address book.

Entries with the symbol contain a voice entry. Voice entries can be added to the address book (▷ page 170). This function is available in vehicles with Voice Control.

COMAND telephone

Switching between the smart speller and the list

- ▶ **Switching from the smart speller to the list:** Slide repeatedly or press until the smart speller is hidden.

or

- ▶ Rotate or slide and select .

The smart speller is hidden.

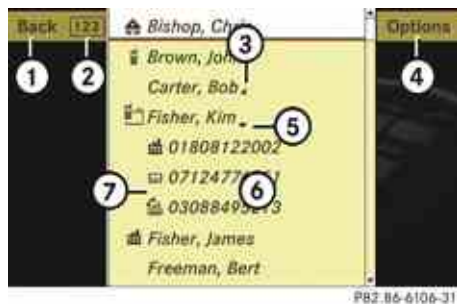

Example illustration: List of phone book entries with name display and hidden smart speller

- 1 Back to smart speller
- 2 To switch phone book display (or)
- 3 Symbol for several telephone numbers (subentries) under the main entry, subentry list is closed

- 4 To call up options
- 5 Symbol for open subentry list
- 6 List of phone book entries
- 7 Subentry list with category symbols and telephone numbers

- 1 The following options are available under Options menu item :

- Displaying details about an entry (▶ page 167)
- Creating a new entry in the address book (▶ page 167)
- Deleting an entry (▶ page 168)
- Saving a phone book entry from mobile phone in the address book (▶ page 169)
- Adding a telephone number to an address book entry (▶ page 170)

- ▶ **Switching from the list to the smart speller:** Select Back from the list.

or

- ▶ Press back button in the center console (▶ page 86).

- ▶ **Changing phone book display in the list:** Select or .

The screen changes to telephone number or name display.

Closing the COMAND phone book

- ▶ In the smart speller, select Back.

or

- ▶ Press back button in the center console (▶ page 86).

Selecting an entry in the COMAND phone book

Selecting entries using the smart speller





- ▶ Switch from the list to the smart speller if necessary.

- ▶ **Changing smart speller language:** Select .



- ▶ Select desired language.

- ▶ **Changing smart speller character set:** Select .







Depending on the previous setting, you will change to letters with special characters or to numbers with special characters.

- ▶ **Entering characters:** Select the characters of the entry you are searching for one by one.
- ▶ **Deleting individual characters:** Select  and briefly press . Each time you enter or delete a character, the closest match will be displayed at the top of the list.
- ▶ **Deleting an entire entry:** Select  and press and hold  until the entry is deleted.
- ▶ **Canceling search:** Switch from the smart speller to the list. The entry at the top of the list is automatically highlighted.

Selecting using the list





- ▶ If necessary, switch from the smart speller to the list.
- ▶ Rotate  or slide   until the desired entry is highlighted.

Selecting subentries





- ▶ Select an entry with the  symbol and press . The  symbol changes to  and the subentries are displayed.
- ▶ Rotate  or slide   until the desired subentry is highlighted.

Displaying details of an entry

COMAND can also show a shortened entry in its entirety. For entries featuring subentries, the detailed view is only available for the subentries and not for the main entry.

- ▶ Select entry (▷ page 166).
- ▶ Select Options → Details. The detailed view appears.
- ▶ **Closing detailed view:** Slide   or  or press  or back button  in the center console (▷ page 86).

Starting to dial the number of an entry

- ▶ Select entry (▷ page 166).
 - ▶ Press .
- or
- ▶ Press  on the telephone keypad. A list appears if the entry contains subentries.
 - ▶ Select desired subentry.
 - ▶ Press  again.
- or
- ▶ Press  on the telephone keypad.

Assigning a New Entry in the Address Book

- ▶ **i** This function is used to create a new entry in the address book and to enter the data (first name, last name and telephone number) manually.
- ▶ Select Options → New Entry in the COMAND phone book list.
- ▶ **Selecting a number category:** Select a category, e. g. Home.

COMAND telephone

- ▶ **Selecting a telephone category:** Select a category, e.g. Land Line.
- ▶ **Confirming selection:** Select Save. The input menu appears with the data fields.



- ① Data field
- ② Input mark (cursor)
- ③ Input characters

▶ **Changing data field:** Slide \uparrow \odot \downarrow repeatedly until desired data field is highlighted.

or

▶ Select \uparrow or \downarrow repeatedly until desired data field is highlighted.

- ▶ **Entering data into a field:** Select all characters one by one from the input characters line ③.
- ▶ **Toggling upper and lower case for the input characters:** Select ABC or abc .
- ▶ **Changing language for the input characters:** Select [Language] .
- ▶ Select desired language.
- ▶ **Changing character set for the input characters:** Select [Character Set] . Depending on the previous setting, you will change to letters with special characters or to numbers with special characters.
- ▶ **Displaying special characters as input characters:** Select [Special] → Symbols.
- ▶ **Returning input characters to normal characters:** Select [Special] → the desired language.
- ▶ **Moving cursor in the data field:** Select [Left] or [Right] .
- ▶ **Deleting individual characters:** Select [C] and briefly press [Delete] . The character to the left of the cursor is deleted.
- ▶ **Deleting an entire entry:** Select [C] and press and hold [Delete] until the entry is deleted.
- ▶ **Saving an entry:** Select [OK] .

- ▶ **Canceling an entry:** Select Back. If one of the data fields contains data, a prompt will appear asking whether you want to save the entry.
- ▶ Select Yes or No. The entry will either be saved or not, depending on your selection.

Deleting an entry

i It is not possible to delete a phone book entry from the mobile phone using the COMAND phone book.

The deletion rules may vary, depending on the entry selected:

- Upper entry selected from the address book: The entry is deleted from the COMAND phone book and also from the address book, if the address book entry only contains telephone numbers.
- Subentry of an address book entry selected: The subentry is deleted from the COMAND phone book and from the address book.

COMAND telephone

- ▶ **Deleting:** Select entry (▷ page 166).
- ▶ Select Options → Delete.
A prompt appears asking whether the entry should be deleted.
- ▶ Select Yes or No.
Once Yes has been selected, the entry will be deleted according to the rules mentioned above.

Saving a phone book entry from the mobile phone in the address book

i This function is used to save an existing phone book entry from the mobile phone in the address book. The following options are available:

- Saving as a new address book entry
- Adding a telephone number to an existing address book entry

Saving as a new address book entry

- ▶ Select phone book entry from mobile phone (▷ page 166).
- i** All entries with category symbols (📞, 🏠, 🏢, 📺, 📠 or 📞) are phone book entries in the mobile phone (▷ page 165).

- ▶ Select Options → Save → New Entry.
- ▶ **Selecting a number category:** Select a category, e. g. Home.
- ▶ **Selecting a telephone category:** Select a category, e. g. Land Line.
- ▶ **Confirming selection:** Select Save.
The input menu appears with the data fields. The data field for the telephone number is filled in automatically. The data field for the last name is also filled when the entry to be saved contains a name.



- ① Data field
 - ② Input mark (cursor)
 - ③ Input characters
- ▶ Proceed as described in the “Changing data field” paragraph in the “Assigning a

New Entry in the Address Book” section (▷ page 167).

Adding a telephone number to an existing address book entry

- ▶ Select phone book entry from mobile phone (▷ page 166).
- i** All entries with category symbols (📞, 🏠, 🏢, 📺, 📠 or 📞) are phone book entries in the mobile phone (▷ page 165).
- ▶ Select Options → Save → Add.
- ▶ **Selecting a number category:** Select a category, e. g. Home.
- ▶ **Selecting a telephone category:** Select a category, e. g. Land Line.
- ▶ **Confirming selection:** Select Save.
The search menu for address book entries appears.
- ▶ Search for desired entry using smart speller function.







i There is a detailed description of how to search for an address book entry in the “Searching for an address book entry” section (▷ page 172).

COMAND telephone

- ▶ After selecting an entry, press .
If there are fewer than four numbers assigned to the selected entry in the selected number category, COMAND will save the data.
If four numbers are saved for the selected entry, a prompt will appear asking whether you want to overwrite one of the existing numbers.
- ▶ Select Yes or No.
If you select Yes, a selection list will appear containing the four existing numbers.
- ▶ Select number to be overwritten.
COMAND overwrites the selected number with the new data.

Adding a telephone number to an address book entry

- ❗ This function is used to add a telephone number to an existing address book entry. The telephone number can be entered manually.
- ▶ Select address book entry (▷ page 166).
- ❗ All entries with the  symbol or without a symbol are address book entries.
- ▶ Select Options → Add Number.

- ❗ Add Number does not function if you have selected the main entry for an address book entry with subentries.
- ▶ **Selecting a number category:** Select a category, e.g. Home.
- ▶ **Selecting a telephone category:** Select a category, e.g. Land Line.
- ▶ **Confirming selection:** Select Save.
If four numbers are saved for the entry in the selected number category, a prompt will appear asking whether one of the existing numbers should be overwritten.
Select Yes or No.
If you select Yes, a selection list will appear containing the four existing numbers.
Select number to be overwritten.
The input menu appears with the data field for entering the new telephone number.
- ▶ **Entering digits:** Select all digits one by one from the input characters.
- ▶ **Moving cursor in the data field:** Select  or .
- ▶ **Deleting individual digits:** Select  and briefly press .
The digit to the left of the cursor is deleted.
- ▶ **Deleting an entire number:** Select  and press and hold  until the number is deleted.

- ▶ **Saving entry:** Select .
- ▶ **Canceling an entry:** Select Back.
If you have already entered data, a prompt will appear asking whether the entry should be saved.
- ▶ Select Yes or No.
The entry will either be saved or not, depending on your selection.

COMAND address book

Warning!

Please devote your attention first and foremost to the traffic situation you are in. Before your journey, please familiarize yourself with the address book functions. Only use the COMAND when road and traffic conditions permit you to do so. Otherwise you could be involved in an accident in which you or others could be injured.

General notes

The address book contains the entries that are saved in the COMAND address book memory. The entries are permanently available even if the phone is not inserted in the cradle. When you insert the mobile phone

COMAND telephone

into the cradle, COMAND reads-in the phone book entries saved in the mobile phone and stores the entries as a separate list from the COMAND address book. This list is a copy of the phone's phone book. This can take several minutes, depending on how many entries the phone book and the address book contain. After the read-in process, the COMAND compares the phone book entries with the address book entries. If all of the telephone numbers of a phone book entry in the mobile phone are present in an address book entry, the address book shows only the address book entry. If not, the address book also shows the phone book entry in the mobile phone.

Address book menu overview

i The components and operating principles of COMAND can be found on (> page 78).

Search	New Entry
Search for an address book entry	Create new address book entry

Calling up the address book

- ▶ Select Telephone → Data/Connections → Address Book. The main address book display appears.



- i** For phone book entries in the mobile phone that contain a name and a telephone number, you will see the name and the number. If a phone book entry in the mobile phone contains several telephone numbers, you will see the message Multiple Numbers instead of a telephone number.

Selecting an entry in the main address book display

- ▶ Slide ↑⊙ to select the main area.
 - ▶ Slide ↑⊙↓ or rotate (⊙) to select an entry.
- or
- ▶ Search for an entry with the smart speller (> page 172).

Creating a new address book entry

- i** Please observe the following when creating a new address book entry: You can define your own address in the destination memory in navigation mode. When defining the address, you can transfer data already entered as an address book entry. In the address book entry, the city and street must be spelled in the same way as the destination entry so that the data matches the digital map data. In order for the state/province to match the map data, its complete name or abbreviation may be entered.

COMAND telephone

Examples:

- Florida or FL
- Colorado or CO
- Alberta or AB
- Ontario or ON

- ▶ Select Telephone → Data/Connections → Address Book → Options → New Entry. The input menu appears with the data fields and the input characters.



Example illustration: Input menu for private data

- ① To switch between work and home data (🏠 or 🏢 symbol)
- ② Selected data field with input mark (cursor)

- ③ Display of set data type – in example display, home data is set (🏠 symbol and Home display)
- ④ Input characters

- ▶ **Switching between private and business data:** Select symbol ①. The display switches to private or business data, depending on the previous status.
- ▶ **Changing data field:** Slide ↑Ⓞ↓ repeatedly until desired entry is highlighted.

or

- ▶ Select ↑ or ↓ repeatedly until desired entry is highlighted.
- ▶ **Entering data into a field:** Select desired characters one by one from the input characters.
- ▶ **toggling upper and lower case for the input characters:** Select **ABC** or **abc**.
- ▶ **Changing language for the input characters:** Select **🌐**.
- ▶ Select desired language.
- ▶ **Changing character set for the input characters:** Select **☑☑☑**. Depending on the previous setting, you will change to letters with special characters or to numbers with special characters.

- ▶ **Moving cursor in the data field:** Select **←** or **→**.
- ▶ **Deleting individual characters:** Select **ⓐ** and briefly press **Ⓜ**. The character to the left of the cursor is deleted.
- ▶ **Deleting an entire entry:** Select **ⓐ** and press and hold **Ⓜ** until the entry is deleted.
- ▶ **Saving an entry:** Select **ok**.
- ▶ **Canceling an entry:** Select Back. If one of the data fields contains new data, a prompt will appear asking whether you want to save the entry.
- ▶ Select Yes or No. The entry will either be saved or not, depending on your selection.

Searching for an address book entry

- ▶ Select Telephone → Data/Connections → Address Book. The search menu appears with the smart speller.



- ① Symbol for complete address data from the navigation system
- ② Symbol for summarized entries from the mobile phone with the same name but different telephone numbers
- ③ Category symbol
- ④ Smart speller
- ⑤ Symbol for voice entry
- ⑥ Back to the main address book display

Entries with category symbol ③ come from the mobile phone. The following category symbols are possible:

- = symbol for Mobile category
- = symbol for Home category
- = symbol for Work category
- = symbol for Fax category

- = symbol for Pager category
- = symbol for Main category or for unknown category or for phone entries that are saved on the SIM card of a GSM mobile phone

Entries without a category symbol or with the or symbols come from the COMAND address book. All other entries come from the mobile phone and are only visible when the mobile phone is in the cradle.

It is possible to add voice entries. Entries with the symbol contain a voice entry (▷ page 178).

Entries with the symbol contain complete, navigable address data from the navigation system that correspond to digital map data. It is possible to quickly start route guidance to these types of entry (▷ page 177).

Switching from the smart speller to the list

- ▶ Slide repeatedly or press until the smart speller is hidden.

or

- ▶ Select .

Switching from the list to the smart speller

- ▶ Select Back from the list.

Searching via the smart speller

- ▶ Switch from the list to the smart speller if necessary.

▶ Changing smart speller language:

Select .

- ▶ Select desired language.

▶ Changing smart speller character set:

Select .

Depending on the previous setting, you will change to letters with special characters or to numbers with special characters.

- ▶ **Entering characters:** Select the characters one by one of the entry you are searching for.

▶ Deleting individual characters:

Select and briefly press .

Each time you enter or delete a character, the closest match will be displayed at the top of the list.

- ▶ **Deleting an entire entry:** Select and press and hold until the entry is deleted.

COMAND telephone

► **Canceling search:** Switch from the smart speller to the list (▷ page 173). The entry at the top of the list is automatically highlighted.

► **Going back to main address book display:** If necessary, switch from the list to the smart speller (▷ page 173) and select Back in the smart speller.

Searching via the list

► If necessary, switch from the smart speller to the list (▷ page 173).

► Rotate or slide until desired entry is highlighted on the list.

Displaying a complete address book entry

Searching for the desired entry

► Search for an address book entry (▷ page 172).

or

► Select an address book entry in the main address book menu (▷ page 171).

► Press .

The detailed view appears.



Example illustration: Detailed view for private data

- ① To go back to the previous menu
- ② To switch between work and home data (symbol or)
- ③ Selected data field
- ④ Display of set data type – in example display, home data is set (symbol and Home display)
- ⑤ To call up options

i The options available under Options menu item ⑤ depend on which data field ③ is selected.

The following options may be available:

- Displaying abbreviated content in full (▷ page 175)
- Changing an address book entry (▷ page 175)
- Changing the description of a telephone number data field (▷ page 176)
- Adding a telephone number data field (▷ page 176)
- Calling a number saved in an entry (▷ page 177)
- Starting route guidance to an entry (▷ page 177)
- Options for voice entries (▷ page 178)

Switching between private or business data

► Select symbol ②.

The display switches to private or business data, depending on the previous status.

Selecting a different data field

► Rotate or slide .

COMAND telephone

Displaying abbreviated content in full

- ▶ Select Options → Details.
The display is shown in full.
- ▶ **Closing entire display:** Slide ←⊙→ or press ⊙.

Closing the detailed view

- ▶ Select Back.

Displaying of a complete phone book entry in the mobile phone

- i** The mobile phone must be inserted in the cradle.

Searching for the desired entry

- ▶ Search for a phone book entry in the mobile phone (▷ page 166).
- ▶ Press ⊙.
The detailed view appears.

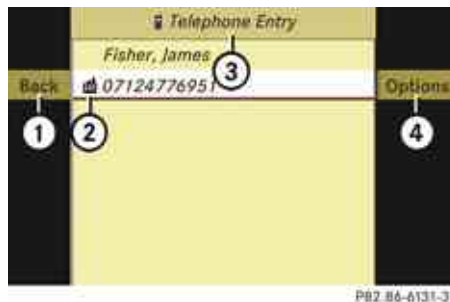

- ① To go back to the previous menu
 - ② Category symbol
 - ③ Display for phone book entry in mobile phone
 - ④ To call up options
- i** If a phone book entry in the mobile phone has more than one telephone number, you will see all telephone numbers with the respective category symbol ② in the detailed view.
 - i** The options available under Options menu item ④ depend on which data field ③ is selected.

The following options may be available:

- Calling a number saved in an entry (▷ page 177)
- Saving a phone book entry from mobile phone in the address book (▷ page 169)

Closing the detailed view

- ▶ Select Back.

Changing an entry**Changing an address book entry**

- ▶ Search for an address book entry (▷ page 172).

or

- ▶ Display the details of an address book entry (▷ page 174).
The input menu appears with the data fields.
- ▶ Select Options → Change.
- ▶ Proceed as described in the “Switching between private and business data” paragraph in the “Creating a new address book entry” section (▷ page 171).

COMAND telephone

Changing the description of a telephone number data field

- i** This function is not possible for phone book entries in the mobile phone.
- ▶ Display the details of an entry and highlight the telephone number data field (▷ page 174).
- ▶ Select Options → Change Category.
- ▶ Select a number category, e.g. Home.
- ▶ Select a telephone category, e.g. Land Line.
- ▶ Select Save.
COMAND saves the data if there are fewer than four numbers assigned to the entry you are searching for in the selected number category.
Otherwise, you will see a prompt asking whether one of the existing numbers should be overwritten.
- ▶ Select Yes or No.
If you select Yes, a selection list will appear containing the four existing numbers.
- ▶ Select number to be overwritten.
COMAND overwrites the selected number with the new data.

Adding to a telephone number data field

- i** One address book entry may contain up to four data fields for private telephone numbers and four data fields for business telephone numbers.
This function is not possible for phone book entries in the mobile phone.
- ▶ Display the details of an entry and highlight the telephone number data field (▷ page 174).
- ▶ Select Options → Add Number.
- ▶ Select a number category, e.g. Home.
- ▶ Select a telephone category, e.g. Land Line.
- ▶ Select Save.
COMAND adds the data field to the entry if there are fewer than four numbers assigned to the entry in the selected number category. You can now enter a number into the data field.
- ▶ Proceed as described from the “Entering data into a field” operating step in the “Creating a new address book entry” section (▷ page 171).
If four numbers are already saved for the entry in the selected number category, a

prompt will appear asking whether one of the data fields should be overwritten.

- ▶ Select Yes or No.
If you select Yes, a selection list will appear containing the four data fields.
- ▶ Select field to be overwritten.
COMAND deletes the number of the selected field. You can now enter a new number into the data field.
- ▶ Proceed as described from the “Entering data into a field” operating step in the “Creating a new address book entry” section (▷ page 171).



Deleting an entry

- i** You cannot delete phone book entries from the mobile phone.
- ▶ Search for desired entry (▷ page 172).
- ▶ Select Options → Delete.
A deletion prompt appears.
- ▶ Select Yes or No.
The entry will either be deleted or not, depending on your selection.

Calling a number saved in an entry

- i** To do this, COMAND must be equipped with a telephone. The mobile phone must be inserted in the cradle.
 - ▶ Display the details of an entry and highlight the telephone number data field (▷ page 174).
 - ▶ Press  and select Call.
- or
- ▶ Select Options → Call.
- In both cases, the telephone connects the call. The COMAND display is showing the telephone mode screen.

Starting route guidance to an entry

- ▶ Search for an address book entry (▷ page 172).
 - ▶ Display the details of an entry and highlight the address data field (▷ page 174).
 - ▶ Select Options → Navigate.
- or
- ▶ Press .
- i** Pressing  only functions if one of the address data fields contains data.

Further operation depends on whether the address data is complete and matches the digital map data of the navigation system. It does not match, for example, if it is not spelled in the same way as the destination entry.

Address data is complete and matches digital map

If Navigate is selected, the navigation system starts the route calculation.

Address data is incomplete or does not match digital map

- i** For the route calculation, the navigation system requires the correct spellings of the state (province), the city or zip code, the street and under some circumstances, the house number. The city and street must be spelled in the same manner as the destination entry. The state (province) can be spelled as an entire name or as an abbreviation.

Examples:

- Florida or FL
- Colorado or CO
- Alberta or AB
- Ontario or ON

If Navigate is selected, a message appears indicating that the address is incomplete.

- ▶ **Closing message:** Select OK.

Depending on which data is missing or cannot be found on the digital map, you must now either:

- select a state (province)
- select a county
- or enter a city
- or enter a street
- or enter a house number

- ▶ **Selecting a state (province):** Select desired state (province) from the list.
- ▶ **Selecting a county:** Select desired county from the list.
- ▶ **Entering a city:** Proceed as described for destination entry in the “Entering a city” section (▷ page 112).
- ▶ **Entering a street:** Proceed as described for destination entry in the “Entering a street” section (▷ page 115).
- ▶ **Entering a house number:** Proceed as described for destination entry in the “Entering a house number” section (▷ page 119).

COMAND telephone

- ▶ **i** If you have added data, COMAND saves your additions. This means that you do not need to reenter this additional data later on. The COMAND memory saves the additional data in a special field, which cannot be displayed. The data, which you have entered in the address book initially in the display, remains unchanged.

If all data is available and matches the digital map data, the navigation system starts the route calculation.

Voice entries

- ▶ **i** For voice entries, your vehicle must be equipped with Voice Control. You can not add voice entries to address book entries that have been read-in from the phone book of the mobile phone.

Adding or changing a voice entry

- ▶ **i** You can add one voice entry per address book entry.

- ▶ Search for the address book entry with or without a voice entry (▷ page 172).
- ▶ Select Options → Voice Name → Add or Change. Subsequent operation is controlled by voice. Voice Control guides you through the dialogs.

Deleting a voice entry

- ▶ Search for the address book entry with a voice entry (▷ page 172).
- ▶ Select Options → Voice Name → Delete. A deletion prompt appears.
- ▶ Select Yes or No. COMAND deletes the voice entry depending on your selection.

Listening to a voice entry

- ▶ Search for the address book entry with a voice entry (▷ page 172).
- ▶ Select Options → Voice Name → Read Aloud. You will hear the voice entry.

Saving a phone book entry from mobile phone in the COMAND address book

Saving a phone book entry from mobile phone as new address book entry

- ▶ **i** The mobile phone must be inserted in the cradle and the COMAND have read out the mobile phone book data. This can take several minutes, depending on how many entries each phone book contains.

- ▶ Search for phone book entry in mobile phone (▷ page 172).

or

- ▶ Display details of a phone book entry in the mobile phone (▷ page 167).
- ▶ Select Options → Save → New Entry.
- ▶ Select a number category, e.g. Work.
- ▶ Select a telephone category, e.g. Mobile.
- ▶ Select Save.

The input menu appears with the data fields. The name and the telephone number are entered automatically.



① Data field

② Input mark (cursor)

③ Input characters

- ▶ Proceed as described in the “Changing a data field” paragraph in the “Creating a new address book entry” section (▷ page 171).

Saving a phone book entry from the mobile phone in an existing address book entry

i The mobile phone must be inserted in the cradle.

- ▶ Search for a phone book entry in the mobile phone (▷ page 172).

or

- ▶ Display details of a phone book entry in the mobile phone (▷ page 167).

- ▶ Select Options → Save → Add.
- ▶ Select a number category, e. g. “Home.”
- ▶ Select a telephone category, e. g. Land Line.
- ▶ Select Save.
The search menu for address book entries appears.
- ▶ Search for desired entry.

i There is a detailed description of how to search for an address book entry in the “Searching for an address book entry” section (▷ page 172).

- ▶ After selecting an entry, press .
COMAND saves the data if there are fewer than four numbers assigned to the selected entry in the selected number category. Otherwise, you will see a prompt asking whether one of the existing numbers should be overwritten.
- ▶ Select Yes or No.
If you select Yes, a selection list will appear containing the four existing numbers.
- ▶ Select the number to be overwritten.
COMAND overwrites the selected number with the new data.

Importing data from external Bluetooth® devices

You can import vCards from external Bluetooth® devices into the address book. Please keep the following in mind:

- Bluetooth® is activated in COMAND (▷ page 180) and in the device concerned.
- The external device must be able to send vCards by Bluetooth®.
- The external device is inside the vehicle, switched on and authorized (▷ page 180).
- ▶ **Importing:** Start data transfer on the external device (see operating instructions of the device concerned).
If there is no address book entry with the same first name and last name, COMAND imports the data.
If there is already an address book entry with the same first name and last name, a prompt will appear asking whether the existing data should be overwritten.
- ▶ Select Yes or No.
The existing address book entry will be overwritten or not, depending on your selection.

COMAND telephone

Bluetooth® settings

General information about Bluetooth®

Bluetooth® technology is the standard for short-range wireless technologies, suitable for transmitting voice and data. Bluetooth® can be used to exchange vCards or make calls using a headset.

Bluetooth® technology uses the freely available ISM (Industrial Scientific Medical) wireless network that works at 2.45 GHz. Ranges of up to 33 ft (10 m) are possible with Bluetooth®.

Activate or deactivate Bluetooth®

► Select Telephone → Data/Connections → Bluetooth → Deactivate Bluetooth.

You have activated or deactivated Bluetooth®. A checkmark appears when Bluetooth® is deactivated.

Connecting Bluetooth® devices

i To connect a Bluetooth® device, the Bluetooth® function must be activated in COMAND and in the device concerned. The Bluetooth® device must also be set to

“visible” or “findable” in order for COMAND to find and display it. For the setting procedures, please see the operating instructions for the Bluetooth® device.

It is possible to establish a Bluetooth® connection between COMAND and the following types of device:

- Mobile phone (only for transferring business cards)
- Headset
- Laptop/PDA

You can connect up to twelve devices to COMAND but only one device can be active at a time.

The connection process includes searching for the device and its subsequent authorization.

Calling up the Bluetooth® device list and searching for devices

► **Calling up the list:** Select Telephone → Data/Connections → Bluetooth → Search for Bluetooth devices.

When you call up the list for the first time after switching on COMAND, the search for devices in the reception range starts

automatically. You will see a display to this effect.

The device list appears after a short while.

► **Canceling search:** Select Cancel.

The second time you call up the list, and each time thereafter, the device list appears immediately if COMAND has not been switched off and on again in the meantime.

► **Starting search manually:** Select Update.

The device list can contain the following devices:

- All detected devices, whether authorized or not.
- All authorized devices, whether detected or not.

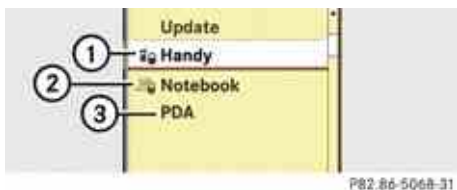

- ① Authorized and detected device – device and padlock symbol are the same color
 - ② Device which was not detected, but which has been authorized in the past – device and padlock symbol are different colors (the device may be switched off or not in the vehicle, for example)
 - ③ Newly detected device - not yet authorized (no symbol)
- i** If the device list already contains twelve authorized devices, you must revoke authorization for one of the authorized devices. Then you must switch this device off and then restart the search. Any new devices for which you would like to search will otherwise not appear in the list.

Displaying details of a Bluetooth® device

- ▶ Call up the Bluetooth® device list (▷ page 180).
- ▶ Select desired device.
- ▶ Select Details.
The detailed display for this device appears.
- ▶ **Closing detailed display:** Slide $\uparrow \odot \downarrow$ or $\left\{ \odot \right\}$.

Authorizing a Bluetooth® device

- ▶ Call up the Bluetooth® device list (▷ page 180).
- ▶ Select unauthorized device.
- ▶ Select Authorize.
The input menu for the passkey appears.
- ① The passkey is any one to sixteen-digit number which you can set yourself. You must enter the same number in COMAND and also in the device to be authorized.
- ① On devices which do not have an input keypad (e. g. headsets), the passkey is predetermined. In this case, it is not necessary to enter the number on the device itself. You will usually find the

passkey in the operating instructions for the device.

- ▶ **Entering passkey into COMAND:** Select the digits one by one.
- ▶ **Deleting digits:** Select \square and briefly press \odot .
- ▶ **Canceling entry into COMAND:** Select Back.
- ▶ **Confirming entry into COMAND:** Select \square .
- ▶ If necessary, enter the same passkey into the Bluetooth® device (see the operating instructions for the device).
The device is authorized.

Deauthorizing a Bluetooth® device

- ▶ Call up the Bluetooth® device list (▷ page 180).
- ▶ Select authorized device.
- ▶ Select De-authorize.
A prompt appears asking whether you really want to deauthorize this device.
- ▶ Select Yes or No.
If you select Yes, the device will be deauthorized.

COMAND telephone

i If you de-authorize a device which has been authorized in the past and which is not detected in the search, this device will no longer be displayed in the device list. Devices which have been authorized in the past but which are not detected in the search are either not switched on or not in the vehicle.

SMS messages (Short Message Service)

SMS functions

The following functions are available:

- Receive
- Read

The following conditions must be fulfilled in order to use the functions:

- The mobile phone is inserted in the cradle and switched on.
- The PIN has been entered (only GSM mobile phones).
- The mobile phone is logged into a mobile network.
- The mobile phone book must be downloaded and available in COMAND.

Inbox

Calling up the SMS inbox

- ▶ Select Telephone.
The main telephone menu appears.



- ① Symbol  for unread messages in the SMS inbox

i The  symbol only appears for those messages which are received while the mobile phone is inserted in the cradle.

- ▶ Select Text Message.
The SMS inbox appears.

i Text Message does not function if the SMS inbox contains no SMS messages. The SMS inbox only shows the messages which

are received while the mobile phone is inserted in the cradle.



- ① Date and time the highlighted SMS message was received
- ② To call up options
- ③ Highlighted SMS message
- ④ Symbol  for unread SMS message
- ⑤ Back to main telephone menu

i The SMS messages are sorted by the date and time they were received. The most recent message is at the top of the list. If the name and telephone number of the sender is saved in the address book or phone book of the mobile phone, you will see the name of the sender in the SMS inbox. Otherwise, you will see the telephone number of the sender.

COMAND telephone

Selecting an SMS message

- ▶ Rotate or slide and then press .

Showing abbreviated sender display in full

- ▶ Select SMS message → Options → Details.
The detailed view appears.
- ▶ **Closing detailed view:** Slide or press .

Calling an SMS sender

- ▶ Select SMS message → Options → Call.
The telephone connects the call.

Saving SMS sender as new COMAND address book entry

- ▶ **Selecting an SMS message:** In the SMS inbox, select a message → Options → Save Number → New Entry.
- ▶ **Selecting a number category:** Select a category, e.g. Home.

- ▶ **Selecting a telephone category:** Select a category, e.g. Land Line.
- ▶ **Saving:** Select Save.
The input menu appears with the data fields. The data field for the telephone number is filled in automatically.



- ① Data field
- ② Input mark (cursor)
- ③ Input characters

- ▶ Proceed as described in the “Changing data field” paragraph in the “Assigning a New Entry in the Address Book” section (▷ page 167).

Adding an SMS sender's telephone number to an existing address book entry

- ▶ **Selecting an SMS message:** In the SMS inbox, select a message → Options → Save Number → Add.
- ▶ Proceed as described in the “Selecting a number category” paragraph in the “Adding a telephone number to an existing address book entry” section (▷ page 169).

Exiting the SMS inbox

- ▶ Select Back.
The main telephone menu appears.

Reading an SMS message

- ▶ In the SMS inbox, select an SMS message and press .
- The SMS message appears.

COMAND FM/AM radio

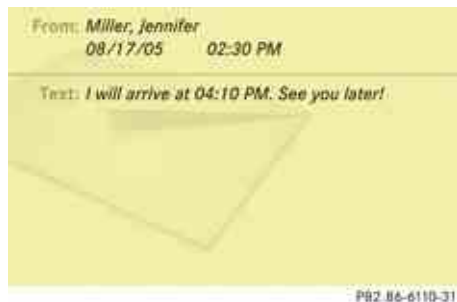

Using data in a text message

i If the SMS message contains telephone numbers or navigable address data, you can select this data and place a telephone call or transfer the address data to the navigation system.

- ▶ **Selecting data from the text:** Rotate or slide .
- ▶ **Using data:** Press → Use.
If you have selected a telephone number, the telephone connects the call. If you have selected a navigable address, it is transferred to the navigation system.

Calling an SMS sender

i This function is not possible with all SMS senders.

- ▶ Press → Call.
The telephone connects the call.

Saving SMS sender as new address book entry

- i** This function is not possible with all SMS senders.
- ▶ Press → Save Number → New Entry.
- ▶ Proceed as described in the “Selecting a number category” paragraph in the “Saving SMS sender as new COMAND address book entry” section (▶ page 183).

Adding an SMS sender's telephone number to an existing address book entry

- ▶ Press → Save Number → Add.
- ▶ Proceed as described in the “Selecting a number category” paragraph in the “Adding a telephone number to an existing address book entry” section (▶ page 169).

Closing an SMS message and returning to SMS inbox

- ▶ Press → Back.

COMAND FM/AM radio

Safety notes

Warning!

Please devote your attention first and foremost to the traffic situation you are in. Before your journey, please familiarize yourself with the radio functions. Only use the COMAND when road and traffic conditions permit you to do so. Otherwise you could be involved in an accident in which you or others could be injured.

Submenu overview

i The components and operating principles of COMAND can be found on (▶ page 78).

COMAND FM/AM radio

Radio (except Weather Band)	Presets (except Weather Band)	Channel (only Weather Band)	FM or AM or WB	Sound
Station List (in FM wave band only)	Autostore	Channel list	Switch to FM wave band	Treble
Save Station	Preset station list		Switch to AM wave band	Bass
Frequency Entry			Switch to Weather Band	Balance/Fader
Show Station Info (in FM wave band only)				3D Sound

Switching to radio mode

- ▶ Select Audio → Audio → FM/AM Radio.

or

- ▶ Press the **DISC RADIO** shortcut button once or twice.

The radio display appears once you have switched to radio mode. You will hear the station/channel last tuned in in the previously selected wave band, provided that the station/channel can be received.

- i** The number of times you have to press the **DISC RADIO** shortcut button depends on the operating mode currently selected.

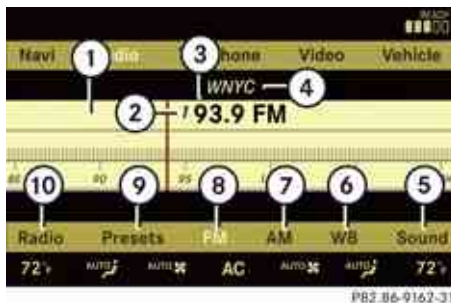

Example illustration: Radio mode in FM wave band

- ① Main area with frequency display
- ② Preset position of selected station
- ③ Frequency of selected station
- ④ Name of selected station
- ⑤ Sound settings

- ⑥ To switch to Weather Band
- ⑦ To switch to AM wave band
- ⑧ Selected wave band
- ⑨ Preset options
- ⑩ Radio options

- i** Station name display ④ is available for the FM wave band and can only be seen when it is switched on (> page 188) and if the station transmits a name.

COMAND FM/AM radio

Switching wave bands

You can switch between the FM, AM and WB (Weather Band) wave bands.

- ▶ Select Audio → Audio → FM/AM Radio → FM or AM or WB.

You will hear the station last tuned in on the selected wave band.



Selecting stations/channels

You have the following selection options:



- The station list
- The search function
- The station presets
- The manual frequency entry
- The channel list

Selecting stations using the station list

- i** The station list is only available for the FM wave band. It contains all the stations that can be currently received and is sorted by station frequencies.

- ▶ Select → Audio → Audio → FM/AM Radio → FM.
- ▶ Select Radio → Station List. The station list appears. The dot • in front of a list entry indicates the currently selected station. A number in front of the list entry indicates the preset position in the station preset memory.
- ▶ Select a station by rotating  or sliding  and press .

Selecting stations/channels using the search function

- ▶ Slide  or rotate  when the main area is selected. Depending on the direction in which the controller is being slid or rotated, the system searches upward or downward and stops at the next receivable station/channel.





Selecting stations using station presets

- i** This function is not available for Weather Band.



- ▶ Select Audio → Audio → FM/AM Radio → FM or AM.

- ▶ Select Presets.

or

- ▶ Press  when the main area is selected. The preset menu appears. The dot • in front of a preset position indicates that the currently selected station is saved there.
- ▶ Select station preset by rotating  or sliding  and press .

or

- ▶ Enter a position number with the telephone keypad using the  -  buttons (> page 81).



Selecting stations by entering the frequency manually

- i** This function is not available for Weather Band.



- ▶ Select Audio → Audio → FM/AM Radio → FM or AM.

COMAND FM/AM radio

Entering the frequency using the COMAND controller



- ▶ Select Radio → Frequency Entry. The menu for manual frequency entry appears.
- ▶ **Exiting menu without making an entry:** Press  back button in the center console (▷ page 86).
- ▶ **Increasing or decreasing number:** Slide  or rotate .

i You can only select currently permitted numbers.





- ▶ **Selecting the next number:** Slide .
- ▶ **Confirming frequency entry:** Press .

i If you enter a frequency in the AM wave band which is outside the frequency range, COMAND tunes in to the next lowest frequency.

Entering the frequency using the telephone keypad

- ▶ Press  on the telephone keypad (▷ page 81).
- ▶ Enter frequency using the  -  buttons. COMAND tunes in to the frequency entered.

Selecting channels using the channel list

- i** This function is only available for Weather Band.
 - ▶ Select Audio → Audio → FM/AM Radio → WB → Channel.
- or
- ▶ Press  when the main area is selected. The channel list appears. The dot  in front of a list entry indicates the currently selected channel.
 - ▶ Select channel by rotating  or sliding  and press .

Saving stations

i Twenty stations can be saved in each wave band except for Weather Band.

You have the following options:

- Saving stations manually
- Saving stations using the autostore function

Saving stations manually**Option 1**

- ▶ Select Audio → Audio → FM/AM Radio → FM or AM.
- ▶ Select Radio → Save Station.

Option 2

- ▶ Press  when the main area is selected.

Option 3

- ▶ Select Audio → Audio → FM/AM Radio → FM or AM.
- ▶ Select Presets.

All three of these will call up a station preset screen. The dot  in front of a preset position indicates that the currently selected station is saved there.



COMAND FM/AM radio

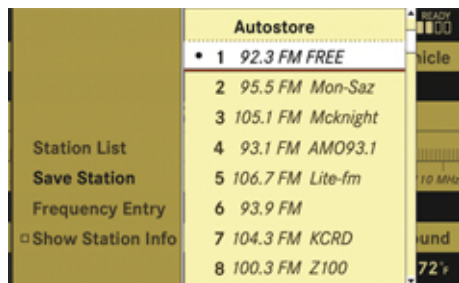

PB2.86-7335-31

- ▶ **Selecting a preset position:** Slide or rotate .

Saving a station to a selected preset position

If you have called up the station preset screen using option 1:

- ▶ Press briefly.

In options 2 and 3:

- ▶ Press and hold until you hear a signal. The station is saved.

Saving using the autostore function

- i** This function is not available for Weather Band. The autostore function saves receivable stations as presets in order of

their reception quality. All stations saved manually in the preset memory will be lost if COMAND finds 20 stations. If COMAND finds less than 20 stations, for example 9, then the stations saved in preset positions 1 – 9 will be over written.

Option 1

- ▶ Press when the main area is selected.
- ▶ Select Autostore.

Option 2

- ▶ Select Audio → Audio → FM/AM Radio → FM or AM.
- ▶ Select Presets → Autostore.

Option 3

- ▶ Select Audio → Audio → FM/AM Radio → Radio → Save Station → Autostore.

Station name display

- i** In the FM wave band, COMAND can show the name of the station currently tuned in. Station name display can only be seen when it is switched on and if the station transmits a name.



PB2.86-9163-31

- Station name display

- ▶ **Switching the station name display on/off:** Select Audio → Audio → FM/AM Radio → FM → Radio → Show Station Info.

The display is switched on or off, depending on the previous setting. When the display is switched on, a checkmark appears in front of the Show Station Info menu item.

COMAND satellite radio



COMAND satellite radio

Safety notes

Warning!

Please devote your attention first and foremost to the traffic situation you are in. Before your journey, please familiarize yourself with the radio functions. Only use the COMAND when road and traffic conditions permit you to do so. Otherwise you could be involved in an

accident in which you or others could be injured.

Submenu overview

i The components and operating principles of COMAND can be found on (> page 78).

Sat Radio	Presets	Info	Category	Sound
Channel List	Station presets	Showing program info	Selecting category	Treble
Save Channel				Bass
Channel Entry				Balance/Fader
Service				3D Sound

COMAND satellite radio

Introduction to satellite radio

i A subscription to SIRIUS Satellite Radio service provider is required for the satellite radio operation described in this section. Contact an authorized Mercedes-Benz Center for details and availability for your vehicle.

SIRIUS Satellite Radio provides over 130 channels of digital-quality radio, including 100% commercial-free music, sports, news and entertainment. SIRIUS Satellite Radio uses a fleet of high-power satellites to broadcast 24 hours per day, coast to coast, in the contiguous U. S. and Canada.

This diverse, satellite-delivered programming is available for a monthly subscription fee.

For more information and service availability call the SIRIUS Service Center at 1-888-539-7474, or contact

- www.sirius.com (USA)
- www.siriuscanada.com (Canada)

i Satellite radio service may be unavailable or interrupted from time to time for a variety of reasons, such as environmental or topographic conditions and other things we cannot control. Service might also not

be available in certain places (e. g., in tunnels, parking garages, under leafy trees, or within or next to buildings) or near other technologies. In such situations, the satellite radio's main menu shows the Acquiring signal... screen. At this point, the radio's functions are restricted.

Switching to satellite radio

▶ Select Audio → Audio → Sat Radio.
or

▶ Press the  shortcut button once or twice. The Satellite radio menu appears if it was the last active radio mode. The screen which then appears depends on the activation status of the satellite radio service.

The following conditions are possible:

- Satellite radio service is not activated (only the preview channel is displayed).
- Satellite radio service is activated.

Satellite radio service is not activated

The telephone number of the SIRIUS Service Center and the twelve-digit electronic serial number (SIRIUS-ID) of the particular receiver are displayed.



This information is required when calling the SIRIUS Service Center for an activation request.

i Activating the satellite radio service might not be available in certain places (e. g., in tunnels, parking garages, under leafy trees, or within or next to buildings). If a subscription is not included with system purchase, credit card information is required to activate your account. The activation process takes approximately 5 to 10 minutes after calling the SIRIUS Service Center.

i It is also possible to activate the satellite radio service online. To do so please visit SIRIUS Satellite Radio's website at

www.sirius.com (USA) or
www.siriuscanada.com (Canada).

► **Closing screen:** Press .

Preview channel



i If the satellite radio service has not been subscribed to, only the preview channel is available. You cannot tune in another channel. If you try to do this, you will see the screen described in the section “Satellite radio service is not activated” (► page 190).

Satellite radio service is activated

The main satellite radio menu appears. You will hear the channel last tuned in, provided that it can be received.

Main satellite radio menu

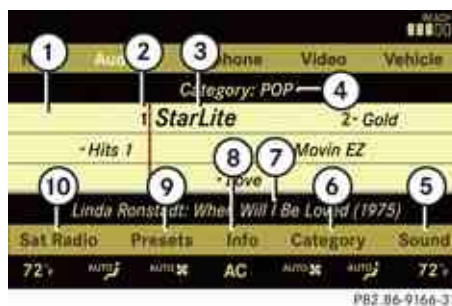

- ① Main area with channel display
- ② Preset position of selected channel
- ③ Selected channel
- ④ Selected program category
- ⑤ Sound settings
- ⑥ To select program category
- ⑦ Artist and song title
- ⑧ Other channel information
- ⑨ Preset options
- ⑩ Satellite radio options

COMAND satellite radio

i Main area ① can show all channels included in your subscription. Which channels are shown depends on the selected program category ④. Note that categories and channels shown in illustrations are dependent on programming content delivered by the service provider. Programming content is subject to change. Therefore, channel and categories shown in illustrations and descriptions contained in this manual may differ from the channels and categories delivered by the service provider.

Selecting program category

i The channels are categorized. Categories allow you to tune to stations broadcasting a certain type of program.

Satellite radio channels are split up into categories such as News, Sports, Rock, or Country, if available.

► Select Audio → Audio → Sat Radio → Category.
 The category list appears.

COMAND satellite radio

- ▶ Select category by rotating or sliding and press .

When selecting a channel using the channel search function or the channel list, you have access to the channels you subscribe to and which are included in the selected category.

- i** When you select the category All Channels, you have access to all the channels you subscribe to, regardless of category, when you are tuning in a channel using the channel search function or the channel list.

Tuning in channels

You have the following selection options:

- The channel search function
- The channel presets
- The manual channel number entry
- The channel list

Tuning in channels using channel search function

- i** If you try to tune in a channel when the satellite radio service is not activated, you

will see the screen described in the section “Satellite radio service is not activated” (▶ page 190).

- ▶ Slide or rotate when the main area is selected. Depending on the direction in which the controller is being pressed or rotated, the system searches upward or downward and stops at the next receivable channel.

- i** Which channels are found by the channel search function depends on which channels you have subscribed to and the program category you have selected (▶ page 191).

Tuning in channels using channel presets

- ▶ Select Audio → Audio → Sat Radio → Presets.
- or
- ▶ Press when the main area is selected. The preset menu appears. The dot • in front of a preset position indicates that this is the channel currently selected and being listened to.



- ▶ Select station preset and briefly press .
- or
- ▶ Enter a position number with the telephone keypad using the - buttons (▶ page 81).

COMAND tunes in the corresponding channel as long as it is included in your subscription and is still available.

If the channel is not included in your subscription, you will see the message described in the section “Satellite radio service is not activated” (▶ page 190).

If the channel is no longer available, you will see the message Invalid Channel.







- ▶ **Closing message:** Press .

COMAND satellite radio



Tuning in channels using manual channel number entry

- i** If you try to tune in a channel when the satellite radio service is not activated, you will see the screen described in the section “Satellite radio service is not activated” (▷ page 190).

Entering the channel number using the COMAND controller

- ▶ Select Audio → Audio → Sat Radio → Sat Radio → Channel Entry.
The menu for manual channel number entry appears.
- ▶ **Exiting menu without making an entry:** Press  back button in the center console (▷ page 86).
- ▶ **Increase or decreasing number:** Slide   or rotate .
- ▶ **Selecting next number:** Slide  .
- ▶ **Confirming channel entry:** Press .
Further operation depends on whether the selected channel number is valid or if the channel is included in your subscription.

Entering the channel number using the telephone keypad

- ▶ Press  on the telephone keypad (▷ page 81).
- ▶ Enter channel number using the  -  buttons.
Further operation depends on whether the selected channel number is valid or if the channel is included in your subscription.

Channel number is valid and channel is included in subscription

COMAND tunes in the channel entered.

Channel number is invalid

You will see the message *Invalid Channel*.





- ▶ **Closing message:** Press .

Channel number is valid but channel is not included in subscription

You will see the screen described in the section “Satellite radio service is not activated” (▷ page 190).

- ▶ **Closing display:** Press .

Tuning in channels using the channel list

- ▶ Select Audio → Audio → Sat Radio → Sat Radio → Channel List.
The channel list appears. The dot  in front of a list entry indicates the currently selected channel.
- ▶ Select channel by rotating  or sliding   and press .

- i** The contents of the channel list depends on which channels are included in your subscription and which program category you have selected (▷ page 191). If satellite radio service is not activated, the channel list contains only the preview channel.

Saving channels

- i** There are 20 preset positions available.

Option 1

- ▶ Select Audio → Audio → Sat Radio → Sat Radio → Save Channel.

COMAND satellite radio

Option 2

- ▶ Press when the main area is selected.

Option 3

- ▶ Select Audio → Audio → Sat Radio → Presets.

All three of these will call up a preset menu. The dot • in front of a preset position indicates that this is the channel currently selected and being listened to.



- ▶ **Selecting a preset position:** Slide or rotate .

Saving a channel to a selected preset position

If you have called up the channel preset screen using option 1:

- ▶ Press briefly.

In options 2 and 3:

- ▶ Press and hold until you hear a signal. The channel is saved.

Show program info

- ▶ Select → Audio → Audio → Sat Radio → Info.

- i** If the program provider does not offer any information, the Info menu item cannot be selected.

You will see a screen that may contain the following information:

- Selected program category
- Selected channel
- Artist of the track currently being played
- Name of current track
- i** The program provider determines what information is displayed on the screen.

COMAND shows no more than two lines per item of information. If an item of information is too long, COMAND shortens it.

- ▶ **Closing screen:** Slide or press .

Channel update

The service provider may conduct a channel update.

During the update, the message Updating channels... will appear on the display. No functions can be operated in satellite radio mode during the update.

Calling SIRIUS Service Center

- i** It may be necessary to call the SIRIUS Service Center if, for example:
 - You want to cancel the subscription or resubscribe at a later date.
 - You have forgotten to pay the bill.
 - You sell the vehicle.

- ▶ Select → Audio → Audio → Sat Radio → Sat Radio → Service. The telephone number of the SIRIUS Service Center and the twelve-digit electronic serial number (SIRIUS-ID) of the particular receiver are displayed.
- ▶ **Closing screen:** Slide ←⊙→ or press ⊙.

COMAND audio CD/audio DVD/MP3

Safety notes

Warning!

COMAND is classified as a Class 1 laser product. You must not open the casing. There is a risk of exposure to invisible laser radiation if you open the casing, or if the casing is faulty or damaged.

COMAND does not contain any parts that you are able to maintain yourself. For safety reasons, all maintenance work must be carried out by qualified technicians.

Warning!

Only carry out the following when the vehicle is stationary:

- Inserting a disc
- Ejecting a disc

There is a risk of accident by being distracted from road and traffic conditions if you load a CD/DVD while the vehicle is in motion.

Bear in mind that at a speed of just 30 mph (approximately 50 km/h), your vehicle is

COMAND audio CD/audio DVD/MP3

covering a distance of 44 feet (approximately 14 m) every second.

Notes about MP3 mode

Permissible media for MP3/WMA files

- CD-R and CD-RW
- DVD-R and DVD-RW
- PCMCIA card (▷ page 200)

Permissible file systems

- ISO9660/Joliet for CDs
- UDF for DVDs
- FAT16 or FAT32 for PCMCIA cards with storage medium

Multisession CDs

For multisession CDs, the first session type of the CD determines how COMAND will process the CD.

For example, if the first session type is according to the audio CD standard and the second session type is according to the data CD standard containing MP3/WMA tracks, COMAND will treat the CD as a conventional audio CD. This means that it is only possible



COMAND audio CD/audio DVD/MP3

to access the audio CD tracks. Access to the MP3/WMA tracks is not possible.

Similarly, if the first session type is according to the data CD standard containing MP3/WMA tracks and the second session type is according to the audio CD standard, COMAND will treat the CD as a data CD. This means that it is only possible to access the MP3/WMA tracks. Access to the audio CD tracks is not possible.

File structure on a disc

When you create an MP3/WMA disc, the MP3/WMA tracks can be organized in folders. A folder can also contain other folders. A disc can contain a maximum of 255 folders. Each folder can contain a maximum of 255 tracks and 255 folders. A data medium may contain a maximum of 500 tracks.

Track and folder names

When you create an MP3/WMA disc, you can assign names to the MP3/WMA tracks and folders.

COMAND uses these names for the corresponding display in MP3 mode. Empty folders or folders which contain data other

than MP3/WMA tracks are not displayed by COMAND.

If MP3/WMA files are saved in the root directory itself (uppermost directory on storage medium), the root directory will also be treated as a folder. COMAND will then show the name of the root directory as the folder name.

You must observe the following when assigning track names:

- Track names must have at least one character.
- Track names must have the extension “mp3” or “wma”.
- There must be a period between the track name and the extension.

Example of a correct track name:
Track 1.mp3

COMAND is unable to recognize an MP3/WMA track if:

- there is no period between the track title and the extension
- there is no extension

i COMAND does not support ID3 tags.

Compatible file systems and compression methods

The following compression methods are compatible:

- MP3
- WMA

i If music files created using different compression methods other than MP3 are stored together on a disc, the loading process may take longer.

Permissible MP3 formats

COMAND supports the MPEG 1 Audio Layer 3 format.

i This format is generally known as “MP3”.

Permissible bit and sampling rates

- Fixed and variable bit rates up to 320 kbit/s
- Sampling rates from 24 kHz to 48 kHz

i Only use MP3 tracks with a bit rate of at least 128 kbit/s and a sampling rate of at least 44.1 kHz. Smaller rates can cause a noticeable deterioration in sound quality.

This is especially the case if you have activated the surround sound function.

WMA (Windows Media Audio)

Windows Media Audio (WMA) is an audio data compression technology developed by Microsoft.

The audio system supports the following types of audio files:

- fixed bit rates of 5 kBit/s up to 384 kBit/s
- sampling rates from 8 kHz to 48 kHz

The audio system does not support the following WMA files:

- DRM (Digital Rights Management) coded files
- variable bit rates
- WMA Pro
- 5.1 Surround

Notes on copyright

The music tracks that you create and play back in the MP3 or WMA format are generally subject to copyright protection in accordance with the applicable international and national regulations.

In many countries, reproductions are not permitted without the prior consent of the copyright holder, not even for private use. Make sure that you know the applicable copyright regulations and that you comply with these.

If you own these rights yourself, e. g. for your own compositions and recordings, or the copyright holder has granted you permission, these restrictions do not apply.

Notes about audio DVD operation

COMAND can playback commercially available, prerecorded audio DVDs that bear the following label. You will usually find the label on the DVD booklet, the inlay, or the DVD itself.



- i** Audio DVDs differ from recordable DVD-R and DVD-RW discs.

Data on audio DVDs are stored either in uncompressed format or in lossless compressed format. The sound quality on audio DVDs is therefore better than on recordable DVDs that contain MP3 data

COMAND audio CD/audio DVD/MP3

because the MP3 format uses a lossy type of compression.

You cannot delete data from or record additional data to commercially available, prerecorded audio DVDs.

Please note the following information about CDs/DVDs and pay special attention to the notes on copied and/or self-written CDs/DVDs.

Notes about CDs/DVDs

- i** Audio CDs with copy protection are not compatible with the CD audio standard and therefore may not be able to be played by COMAND.

There may be playback problems when playing copied discs.

There is a large variety of discs, disc-writing software and writers available. This variety means that there is no guarantee that the system will be able to play discs that you have written/copied yourself.

There may be playback problems if you use CD-R or CD-RW type discs you have copied yourself with a storage capacity of more than 700 MB. These CDs are not compatible with currently applicable standards.

COMAND audio CD/audio DVD/MP3

❗ Do not affix stickers or labels to the discs.

These could peel away and damage COMAND. COMAND is designed to hold discs which comply with the IEC 60908 standard. You can therefore only use discs with a maximum thickness of 1.3 mm.

If you insert thicker discs, e.g. those that contain data on both sides (DVD on one side and audio data on the other), they cannot be ejected and can damage COMAND.

Do not use CDs with a diameter of 8 cm. Attempting to play discs with a diameter of 8 cm or playing such discs with an adapter may cause damage COMAND.

Such damages are not covered by the Mercedes-Benz Limited Warranty.

Only use round discs with a diameter of 12 cm.

Notes about handling CDs/DVDs

- Only hold discs by the edge.
- Handle discs carefully to prevent playback problems.
- Avoid getting scratches, fingerprints and dust on discs.
- Clean discs from time to time with a commercially-available cleaning cloth. Do

not wipe them with a circular motion, but only in straight lines from the center outwards.

- Only use a pen designed for such a purpose to label discs.
- Place discs back in their boxes after use.
- Protect discs from heat and direct sunlight.

Inserting CDs and DVDs

⚠ **Observe Safety notes, see page 195.**

- ❗ If the CD/DVD has a printed side, this must face upwards when the CD/DVD is inserted. If neither side is printed, the side to be played should face downwards.

Loading the CD/DVD changer

The CD/DVD changer can hold up to a total of 6 audio CDs or DVDs.



- ① Disc slot
- ② Load button (all magazine trays)
- ③ Magazine tray buttons 1 – 6

- ❗ Each magazine tray button ③ indicates the status of the corresponding magazine tray by means of an LED.
 - LED off = magazine tray is empty
 - LED constantly lit = magazine tray is loaded
 - LED flashes = CD/DVD changer requesting disc to be loaded

Loading an individual magazine tray

- ▶ Press desired magazine tray button ③. If a disc is loaded, it will be ejected.
- ▶ Take disc out of slot ①.

- ▶ Wait until LED for magazine tray button ③ which you pressed flashes quickly.
- ▶ Insert disc into slot ①.
The DVD changer draws the disc in and begins playback if:
 - it has been loaded correctly
 - it is a permissible type of disc

Loading all six magazine trays

- ▶ Press load button ②.
The DVD changer checks the load status of all magazine trays and switches to the first empty tray.
 - ▶ Wait until LED for corresponding magazine tray button ③ flashes quickly.
 - ▶ Insert disc into slot ①.
The DVD changer switches to the next empty magazine tray.
- i** If a disc is not inserted within approximately 15 seconds COMAND resumes playback of the last disc.

- ▶ Repeat last two steps until all trays are loaded.

The DVD changer will play the last disc you have loaded if:

- it has been loaded correctly
- it is a permissible type of disc

Ejecting CDs and DVDs

⚠ Observe Safety notes, see page 195.



- ① Disc slot
- ② Magazine tray buttons 1 – 6
- ③ Eject button (all discs)

- i** If you eject one disc while playing another disc, the DVD changer interrupts playback.

COMAND audio CD/audio DVD/MP3

Playback continues once the disc has been ejected.

- ▶ **Ejecting one disc:** Press desired magazine tray button ②.
- ▶ Take disc out of slot ①.
If you do not take the disc out of slot ①, the DVD changer will draw it back automatically in approximately 15 seconds.
- ▶ **Ejecting all discs:** Press eject button ③.
The DVD changer switches to the first loaded tray and ejects the disc.
- ▶ Take disc out of slot ①.
The DVD changer switches to the next loaded magazine tray and ejects the disc.
- ▶ Repeat last step until magazine is empty.

COMAND audio CD/audio DVD/MP3

Inserting/Ejecting a PCMCIA card

- i** COMAND supports commercially available PCMCIA cards or PCMCIA card adapters with storage media that may not be designed for the temperatures which occur in the vehicle. You should therefore remove the PCMCIA card from the vehicle when not in use since extreme temperatures could damage these devices.



- ① Eject button
② Slot for PCMCIA card

- ▶ **Inserting:** Insert PCMCIA card into slot ②. The side with the contact must point towards the slot.
If the PCMCIA card contains a storage medium with MP3 tracks, COMAND switches to MP3 mode.
- ▶ **Ejecting:** Press eject button ① twice. The PCMCIA card is ejected.
- ▶ Take PCMCIA card out of slot ②.

Submenu overview

- i** The components and operating principles of COMAND can be found on (> page 78).

COMAND audio CD/audio DVD/MP3

CD or DVD-A or MP3	Pause/Stop/Play (audio DVD mode only)	Tracks/ Track List/ Tracks A-Z	Folders (MP3 mode only)	Changer	Sound
Normal Track Sequence	Pausing playback	Showing track list (audio CD mode and audio DVD mode)	Selecting folder	Selecting medium	Treble
Random Tracks	Stopping playback	Displaying alphabetical track listing (MP3 mode only)			Bass
Random folder (MP3 mode only)	Restarting playback				Balance/Fader
Repeat folder (MP3 mode only) Group (DVD-Audio mode only)					3D Sound

COMAND audio CD/audio DVD/MP3

Switching to audio CD, audio DVD or MP3 mode

▶ Load CD/DVD (▶ page 198) or PCMCIA card (▶ page 200).

or

▶ Select Audio → Audio, then CD, DVD-Audio or MP3.

or

▶ Press the **DISC RADIO** shortcut button once or twice.

i The **DISC RADIO** shortcut button takes you directly to the previously set disc mode (audio CD/DVD, MP3-CD/DVD, video DVD or PCMCIA card). The number of times you have to press the shortcut button depends on the previously set mode.

Example display in audio CD mode



- ① Current playback option
- ② Track number
- ③ Disc number
- ④ Disc name (only if saved on the disc)
- ⑤ Track name (only if saved on the disc)
- ⑥ Track time
- ⑦ Graphic time and track display
- ⑧ Sound settings
- ⑨ Medium selection
- ⑩ To call up track listing
- ⑪ Disc type
- ⑫ Playback options

Example display in audio DVD mode



- ① Current playback option
- ② Track number
- ③ Disc number
- ④ Disc name (only if saved on the disc)
- ⑤ Track name (only if saved on the disc)
- ⑥ Track time
- ⑦ Graphic time and track display
- ⑧ Sound settings
- ⑨ Medium selection
- ⑩ To call up track listing
- ⑪ Stop function
- ⑫ Pause (P1ay appears if paused)
- ⑬ Disc type
- ⑭ Playback options

Example display in MP3 mode

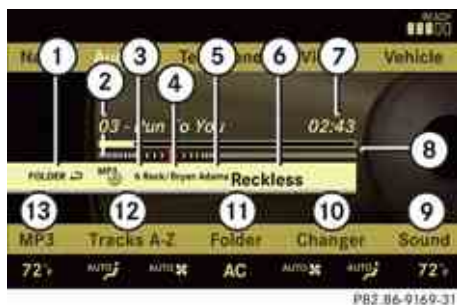



- ① Current playback option
- ② Medium type
- ③ Disc number (not on PCMCIA card)
- ④ Track name
- ⑤ Current folder path
- ⑥ Current folder
- ⑦ Track time
- ⑧ Graphic time and track display
- ⑨ Sound settings
- ⑩ Medium selection
- ⑪ Folder listing
- ⑫ Track listing
- ⑬ Playback options

Stop function

- ❶ This function is only available in audio DVD mode.
- ▶ **Stopping playback:** Select Audio → Audio → DVD-Audio → Stop.
- ▶ **Restarting playback:** Select Audio → Audio → DVD-Audio → Play. Playback starts at the beginning of the DVD.

Pause function

In audio CD, audio DVD and MP3 mode



- ▶ **Pausing playback:** Press  briefly.
- ▶ **Continuing playback:** Press  again briefly.

Only in audio DVD mode

- ▶ **Pausing playback:** Select Audio → Audio → DVD-Audio → Pause. The Pause screen changes to Play.
- ▶ **Continuing playback:** Select Audio → Audio → DVD-Audio → Play. The Play screen changes to Pause.

COMAND audio CD/audio DVD/MP3



Selecting CD/DVD/MP3 media

- ▶ Select Audio → Audio.
 - ▶ Select CD, DVD-Audio or MP3. COMAND begins playback.
 - ▶ **In audio CD, audio DVD and MP3 mode:** Select Changer.
- or
- ▶ **In audio CD and audio DVD mode only:** Press  when the main area is selected. The media list appears. The dot • indicates the current medium.
 - ▶ Select a medium or folder. COMAND changes the medium.
- or
- ▶ Enter a magazine tray number with the telephone keypad using the  -  buttons (▷ page 81).

COMAND audio CD/audio DVD/MP3

Selecting a track

Selecting by skipping to tracks

- ▶ **Skipping forwards or backwards to a track (in CD or DVD mode only):** Rotate  .

i Skipping forwards through the tracks skips to the next track. Skipping backwards through the tracks skips to the beginning of the current track if the track has been playing for more than 8 seconds. If the track has been playing for less than 8 seconds, it skips to the start of the previous track.
If you have switched on the Random Tracks playback option, the order of the tracks is random.





Selecting from the track list

- ▶ Select Audio → Audio.
- ▶ Select CD, DVD-Audio or MP3.

Selecting a track using the COMAND controller



- ▶ Select Tracks, Tracks A-Z or Track list.

or



- ▶ **Only in MP3 mode:** Press  when the main area is selected. The track list of the current folder appears. The dot • indicates the current track.
- ▶ Select a track by rotating   or sliding  .

i In MP3 mode, the list shows all the tracks in alphabetical order.

Selecting a track using the telephone keypad

- ▶ Press  on the telephone keypad (▷ page 81).
- ▶ Enter track number using the  -  buttons.

Fast forward/rewind

- ▶ Select main area.
- ▶ Slide and hold   until desired place is reached.

Selecting a folder

- i** This function is only available in audio MP3 mode.
- ▶ Select Audio → Audio → MP3 → Folder.
- or
- ▶ Press  when main area is selected. The track list of the current folder appears.



- ① Back folder symbol
- ② Current track symbol
- ③ Track symbol

► **Move to the superordinate folder:** Select the folder icon. The display changes to the next folder up in the folder structure on the disc.



- ① Back folder symbol
- ② Current folder symbol
- ③ Folder symbol containing tracks

► **Selecting a folder:** Select desired folder. You will see the tracks in the folder.
 ► Select a track. The track is played and the corresponding folder is now the active folder.

COMAND audio CD/audio DVD/MP3

Setting the audio format

This function lets you choose the audio format that you would like COMAND to play and is only available in DVD-Audio mode.

i The tracks on an audio DVD can be stored in various audio formats. The number of audio formats depends on the audio DVD.

► Select Audio → Audio → DVD-Audio → Group.

i The Group menu item cannot be selected if only one audio format is saved on the DVD.

The list of available audio formats appears. A dot ● indicates the format currently selected.

► **Changing setting:** Slide ↑⊙↓ or rotate ⏪⊙⏩.

► **Exiting menu:** Slide ←⊙→.

COMAND AUX

Playback options

The following options are available:

- Normal Track Sequence
Tracks playback in the order on the disc (e.g. track 1, 2, 3, etc.).
 - Random Tracks
Tracks playback in a random order (e.g. track 3, 8, 5, etc.).
 - Random Folder (in MP3 mode only)
Tracks in the active folder and any subfolders playback in random order.
 - Repeat Folder (in MP3 mode only)
Tracks in the active folder will be repeated until you switch the function off.
- ▶ **Selecting an option:** Select Audio → Audio.
- ▶ Select CD, DVD-Audio or MP3.
The option list appears. A dot ● indicates which option is switched on.
- ▶ Select an option and press .
- The option is switched on. For all options except Normal Track Sequence, you will see a corresponding indicator in the main area.

i The Normal Track Sequence option is automatically activated when you select a

different medium. If an option is activated, it remains activated after COMAND is switched on/off.

COMAND AUX

You can connect an external audio or video source (AUX) to COMAND.

Audio and Video AUX socket

The Audio and Video AUX-jacks to which external audio/video sources can be connected are located in the glove box.



- ① Video AUX jack
- ② Audio AUX jack, left channel
- ③ Audio AUX jack, right channel

Audio AUX

Switching to Audio AUX mode

- ▶ Select **Audio** → **Audio** → **AUX**.
The Audio AUX menu appears. You will hear the medium in the external audio source if it has been connected and switched to play.



- i** Please refer to the corresponding operating instructions for information about how to operate the external audio source.

You can adjust the following settings in Audio AUX mode:

- Volume (▷ page 88)
- Balance and fader (▷ page 89)

- Treble and bass (▷ page 89)
- Surround sound (▷ page 89)

⚠ Warning

Due to the different volumes of the external audio sources, system messages (e.g. navigation announcements) may be much louder. You may need to disable these system messages or adjust the volume of these messages manually.

- i** The volume of external audio sources is extremely variable. It is possible that a device connected as an external audio source will sound quieter or louder in the vehicle or that the usual maximum volume cannot be achieved. On certain devices the volume can be set separately. In this case start at a moderate volume and increase it slowly. In this way you can determine whether the system is capable of playback without distortion, even at high volume.

Video AUX

Automatic picture fade-out

If a video is playing when the vehicle is shifted from park position **P** into neutral position **N**, drive position **D** or reverse gear **R** the picture is faded out automatically and the following message appears in the display: In order not to distract driver, picture is faded out while the vehicle is in motion.

When the vehicle is shifted back into park position **P**, the picture comes on again.

Switching to Video AUX mode

- ▶ Select **Video** → **Video** → **AUX**.
The Video AUX menu appears. You will see the medium in the external audio source if it has been connected and switched to play.

COMAND AUX



i Please refer to the corresponding operating instructions for information about how to operate the external video source.

You can adjust the following settings in Video AUX mode:

- Screen settings (▷ page 208)
- Volume (▷ page 88)
- Balance and fader (▷ page 89)
- Treble and bass (▷ page 89)
- Surround sound (▷ page 89)

Screen settings

Setting brightness, contrast and color

- ▶ Show the menu system, if necessary (▷ page 211).
- ▶ Select Video → AUX → AUX.
The menu appears.
- ▶ **Select a setting:** Slide ↑⊙↓ or turn ⏻⏪.
- ▶ Press ⏻.

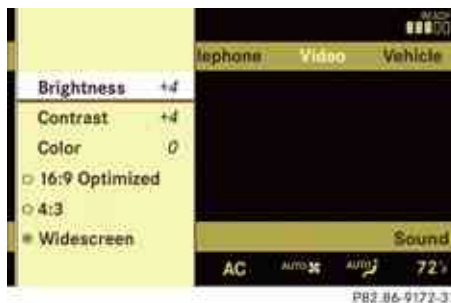

- ▶ **Changing settings:** Slide ↑⊙↓ or turn ⏻⏪ until you reach the desired setting.
- ▶ **Saving settings:** Press ⏻.

Changing the picture format

- ▶ Show the menu system, if necessary (▷ page 211).
- ▶ Select Video → AUX → AUX.
The DVD-V menu appears. The dot • in front of a menu item - 16:9 Optimized, 4:3 or Widescreen indicates the current format.



- ▶ **Changing the format:** Slide ↑⊙↓ or turn ⏻⏪, until you reach the desired setting.
- ▶ **Saving the format:** Press ⏻.

COMAND video DVD

COMAND video DVD

Safety notes

 **Observe Safety notes, see page 195.**

Automatic picture fade-out



If a video DVD is playing when the vehicle is shifted from park position **P** into neutral position **N**, drive position **D** or reverse gear **R** the picture is faded out automatically and the following message appears in the display: In order not to distract driver, picture is faded out while the vehicle is in motion.

When the vehicle is shifted back into park position **P**, the picture comes on again.

Notes about video DVD operation

COMAND can playback commercially available, prerecorded video DVDs that bear the following label. You will usually find the label on the DVD booklet, the inlay, or the DVD itself.



-  Video DVDs differ from recordable DVD-R and DVD-RW discs.
-  There may be playback problems when playing copied DVDs.
There is a large variety of discs, disc-writing software and writers available. This variety means that there is no guarantee that the system will be able to play discs that you have written/copied yourself.

Some DVDs may not comply with the NTSC or PAL TV playback standards. Sound, picture and other playback problems may occur when you play such DVDs.

COMAND can playback video DVDs meeting the following requirements:

- Correct regional code
- NTSC or PAL TV standard

The appropriate information is usually given either on the DVD or the DVD box. The factory setting of COMAND is regional code 1. The setting can be changed at an authorized Mercedes-Benz Center. This will allow you to playback video DVDs with other regional codes, as long as they comply with the NTSC or PAL TV standard.

Notes about DVDs

-  Do not affix stickers or labels to the discs. These could peel away and damage COMAND. COMAND is designed to hold discs which comply with the IEC 60908 standard. You can therefore only use discs with a maximum thickness of 1.3 mm. If you insert thicker discs, e.g. those that contain data on both sides (DVD on one side and audio data on the other), they cannot be ejected and can damage COMAND.

COMAND video DVD

Do not use CDs with a diameter of 8 cm. Attempting to play discs with a diameter of 8 cm or playing such discs with an adapter may cause damage COMAND.

Such damages are not covered by the Mercedes-Benz Limited Warranty.

Only use round discs with a diameter of 12 cm.

Functional limitations

Depending on the DVD, it is possible that certain functions or actions may be temporarily or permanently unavailable. If you try to utilize such functions or carry out such actions, you will see the  symbol in the display.

Inserting or ejecting DVDs

 **Observe Safety notes, see page 198.**

- ▶ Inserting a DVD (▷ page 198).
- or
- ▶ Ejecting a DVD (▷ page 199).

Notes about handling DVDs

For notes about handling DVDs, see (▷ page 198).

Submenu overview of video DVD

DVD-V	Pause/Play	Stop	Changer	Sound
DVD Functions	Pausing playback	Pausing Playback	Selecting medium	Treble
Brightness	Continuing playback	Stopping playback		Bass
Contrast	Restarting playback			Balance/Fader
Color				3D Sound
16:9 Optimized				

DVD-V	Pause/Play	Stop	Changer	Sound
4:3				
Widescreen				

Switching to video DVD mode

- ▶ Insert a DVD (▶ page 198).
- or
- ▶ Select Video → Video → Video DVD.
- or
- ▶ Press the **DISC RADIO** shortcut button once or twice.

i The **DISC RADIO** shortcut button takes you directly to the previously set disc mode (audio CD/DVD, MP3-CD/DVD or video DVD). The number of times you have to press the shortcut button depends on the previously set mode.

Hiding/showing the DVD control menu

- ▶ **Hiding the menu:** Slide ↑⊙↓.
- ▶ **Showing the menu:** Slide ↑⊙↓.
- or
- ▶ Wait for approximately 8 seconds.



- Control menu
- ① Disc type
 - ② Current track
 - ③ Current scene

- ④ Elapsed track time
- ⑤ Show the menu system

Hiding/showing the menu system

- ▶ **Showing the menu:** Press ⊙.
- ▶ **Hiding the menu:** Press ⊙ when the main menu area is selected.



- Menu system
- ① Video DVD options
 - ② Pause



COMAND video DVD

- ③ Stop
- ④ Medium selection
- ⑤ Sound settings

Fast forward/rewind

- ▶ Slide  and hold until you get to the desired scene.

Selecting the DVD medium

- ▶ Select Video → Video → Video DVD.
- ▶ Show the menu system, if necessary (> page 211).
- ▶ Select Changer.
The media list appears. The dot ● indicates the current medium.
- ▶ Select a medium.
COMAND changes the medium.

Stop playback



- ▶ Select Video → Video → Video DVD.
 - ▶ Show the menu system, if necessary (> page 211).
 - ▶ **Stop play:** Select Stop.
In the display, Pause changes to Play.
 - ▶ **Continue playback:** Select Play.
Play is continued from the point at which it was stopped.
 - ▶ **Stop playback:** Select Stop again while playback is stopped.
- or
- ▶ Select Stop twice in quick succession during playback.
 - ▶ **Resume playback:** Select Play.
Playbacks starts again from the beginning.

Pause playback

- ▶ Select Video → Video → Video DVD.
- ▶ Show the menu system, if necessary (> page 211).
- ▶ **Pause playback:** Select Pause.
In the display, Pause changes to Play.
- ▶ **Continue playback:** Select Play.
Play is continued from the point at which it was stopped.

Selecting scene/chapter

Entering scene/chapter using the COMAND controller

- ▶ Make sure that the control menu is shown (> page 211).
- ▶ **Skipping forwards or back:** Slide  or turn .

Entering the scene/chapter using the telephone keypad

- ▶ Press *** +** on the telephone keypad (▷ page 81).
- ▶ Enter scene/chapter using the **1** - **9** **WXYZ** buttons.
COMAND tunes in to the scene/chapter entered.

Selecting film/track

- i** This function is only available if the DVD is comprised of several film/tracks.
- ▶ Select Video → Video → Video DVD.
- ▶ Show the menu system, if necessary (▷ page 211).
- ▶ Select DVD-V → DVD Functions → Title selection.
A selection list appears.
- ▶ Select a film/track.

Screen settings

Setting brightness, contrast and color

- ▶ Select Video → Video → Video DVD.
- ▶ Show the menu system, if necessary (▷ page 211).
- ▶ Select DVD-V → Brightness → Contrast or Color.
- ▶ **Changing settings:** Slide **↑** **⊙** **↓** or turn **⏪** **⊙** **⏩** until you reach the desired setting.
- ▶ **Saving settings:** Press **⏹**.

Changing the picture format

- ▶ Select Video → Video → Video DVD.
- ▶ Show the menu system, if necessary (▷ page 211).
- ▶ Select DVD-V.
The DVD-V menu appears. The dot • in front of a menu item - 16:9 Optimized, 4:3 or Widescreen indicates the current format.
- ▶ **Changing the format:** Slide **↑** **⊙** **↓** or turn **⏪** **⊙** **⏩**, until you reach the desired setting.
- ▶ **Saving the format:** Press **⏹**.

DVD menu

The DVD menu is the menu stored on the DVD itself. It is structured in various ways according to the individual DVD and permits certain actions and settings.

Calling up the DVD menu

- ▶ Select Video → Video → Video DVD.
- ▶ Show the menu system, if necessary (▷ page 211).
- ▶ Select DVD-V → DVD Functions → Menu.
The DVD menu appears.

Selecting menu items in the DVD menu

- ▶ Slide **↑** **⊙** **↓** or **←** **⊙** **→**.
- ▶ **Confirming the selection:** Press **⏹**.
The selection menu appears.

COMAND video DVD



P82.86-5085-31

- ▶ **Reconfirming the selection:** Select Select.
COMAND carries out the action defined by the selected DVD menu item.

i Depending on the DVD, it is possible the menu item **Play** either has no function or has no function in certain parts of the DVD menu.

Stopping the film or skipping to the beginning/end of a scene

- ▶ Select a menu item of your choice from the DVD menu.
The selection menu appears.



P82.86-5086-31

- ① Stop film
- ② Skip to the end of a scene
- ③ Skip to the beginning of a scene

- ▶ **Stopping the film:** Select **Stop**.
- ▶ **Skipping to the end of a scene:** Select **>>>**.
- ▶ **Skipping to the beginning of a scene:** Select **<<<**.

i Depending on the DVD, it is possible the menu items **>>>** and **<<<** either have no function or have no function in certain parts of the DVD menu.

Switching to the next highest DVD menu level

- ▶ Press the **←** back button in the center console.
- or
- ▶ Select the corresponding menu item in the DVD menu.
- or
- ▶ Select a menu item of your choice from the DVD menu.
- ▶ Select the menu item **Go up** in the selection menu.

i Depending on the DVD, it is possible the menu item **Go up** either has no function or has no function in certain parts of the DVD menu.

Back to the film

- ▶ Press the **←** back button until you can see the film.
- or
- ▶ Select the corresponding menu item in the DVD menu.
- or
- ▶ Select a menu item of your choice from the DVD menu.

- ▶ Select the menu item Back (to the film) in the selection menu.

i Depending on the DVD, it is possible the menu item Back (to the film) either has no function or has no function in certain parts of the DVD menu.

Setting the language and audio format

- i** This function is not available for all DVDs. If it is available, you can set the language for the DVD menu and the audio language and/or the audio format. The number of settings you can make is determined by the content of the DVD. It may also be possible to make the settings in the DVD menu (▷ page 213).
- ▶ Select Video → Video → Video DVD.
 - ▶ Show the menu system, if necessary (▷ page 211).
 - ▶ Select DVD-V → DVD Functions.
 - ▶ Select Menu Language or Audio Language.
In both cases a selection list will appear. The dot ● in front of an entry indicates the current language.

- ▶ **Changing the setting:** Slide ↑⊙↓ or turn {⊙}, until you reach the desired setting.
- ▶ **Saving a setting:** Press ⏻.
- ▶ **Exiting the menu:** Slide ←⊙→.

Subtitles and camera angles

- i** This function is not available for all DVDs. The number of settings you can make is determined by the content of the DVD. It may also be possible to make the settings in the DVD menu (▷ page 213).
- ▶ Select Video → Video → Video DVD.
 - ▶ Show the menu system, if necessary (▷ page 211).
 - ▶ Select DVD-V → DVD Functions.
 - ▶ Select Subtitles or Camera angle.
In both cases a selection list will appear. The dot ● in front of an entry indicates the current language.
 - ▶ **Changing the setting:** Slide ↑⊙↓ or turn {⊙}, until you reach the desired setting.
 - ▶ **Saving a setting:** Press ⏻.
 - ▶ **Exiting the menu:** Slide ←⊙→.

Interactive content

- i** DVDs may include interactive content (e. g. a video game). In a video game you can control the play by selecting and initiating actions. The type and number of actions depends on the DVD.
- ▶ **Selecting an action:** Slide ↑⊙↓ or ←⊙→, or turn {⊙}, until you reach the desired setting.
 - ▶ **Initiating an action:** Press ⏻.
A menu appears, the first entry Select is highlighted.
 - ▶ Press ⏻.

COMAND vehicle menu

COMAND vehicle menu

Introduction

In this menu, you can program the following vehicle functions:

Function

Exterior Lighting Delayed Switch-off
(▷ page 216)

Locator Lighting (▷ page 217)

Exterior Mirror Convenience Settings
(▷ page 218)

Automatic Locking (▷ page 218)

Easy Entry/Exit Feature (▷ page 219)

Interior Ambient Light (▷ page 220)

Interior Lighting Delayed Switch-off
(▷ page 220)

Rear-window Sunshade (▷ page 221)

Trunk Opening-height Restriction
(▷ page 222)

Setting night security illumination (Exterior Lighting Delayed Switch-off)

i The components and operating principles of COMAND can be found on (▷ page 78).

Use this function to set whether and how long you would like the exterior lighting to illuminate during darkness after exiting the vehicle and all doors closed.

The exterior lighting automatically goes out after the delayed switch-off time has expired.

You can select:

- 0 sec., the delayed switch-off feature is deactivated
- 15 sec., 30 sec., 45 sec., or 60 sec., the delayed switch-off feature is activated

i You can reactivate this function within 10 minutes by opening a door.

- ▶ Select Vehicle.
The main area is active.
- ▶ **Selecting** Exterior Lighting Delayed Switch-off **menu:** Slide ←○→ or rotate {○}.
▶ **Confirming selection:** Press ⏻.



PB2 86-9174-31

▶ **Selecting length of time:** Slide ↑○↓ or rotate {○}.

▶ **Confirming selection:** Press ⏻.

or

▶ Select Vehicle → Vehicle → Exterior Lighting Delayed Switch-off.

A selection list appears.

The current setting is indicated by a dot •.

COMAND vehicle menu



P82.86-6499-31

- ▶ **Selecting length of time:** Slide ↑⊙↓ or rotate Ⓜ.
- ▶ **Confirming selection:** Press ⊕.

To activate night security illumination:

- ▶ Select delayed switch-off period (see above).
- ▶ Turn the exterior lamp switch to position **A** before turning off the engine.

Locator lighting on/off

i The components and operating principles of COMAND can be found on (▷ page 78).

With the locator lighting feature activated and the exterior lamp switch in position **A** (▷ page 316), the following lamps will switch on during darkness when the vehicle is unlocked from the outside:

- Parking lamps
- Tail lamps
- License plate lamps
- Front fog lamps
- Door entry lamps in the mirror
- Side marker lamps

The locator lighting switches off when the driver's door is opened.

If you do not open a door after unlocking the vehicle with the SmartKey, the lamps will switch off automatically after approximately 40 seconds.

- ▶ Select Vehicle.
The main area is active.
- ▶ **Selecting Locator Lighting function:**
Slide ←⊙→ or rotate Ⓜ.
- ▶ **Confirming selection:** Press ⊕.



P82.86-9175-31

- ▶ **Switching locator lighting on or off:**
Press ⊕.

or

- ▶ Select Vehicle → Vehicle → Locator Lighting.
A checkmark appears when the locator lighting is enabled.

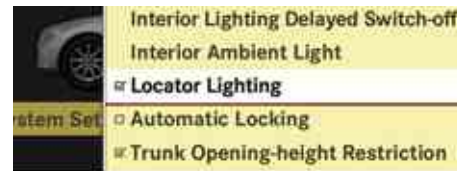

P82.86-6501-31

- ▶ **Confirming selection:** Press ⊕.

COMAND vehicle menu

To activate locator lighting:

- ▶ Make sure the function Locator Lighting is set.
- ▶ Turn the exterior lamp switch to position **A** when exiting the vehicle.

Exterior mirror convenience settings

i The components and operating principles of COMAND can be found on (▷ page 78).

In the Exterior Mirror Convenience Settings menu, you can switch the following exterior rear view mirror functions on or off:

- Exterior rear view mirrors automatically fold in when the vehicle is locked.
 - Exterior rear view mirror on front passenger side automatically tilts downward when the vehicle is reversing.
- ▶ Select **Vehicle**.
The main area is active.
 - ▶ **Selecting** Exterior Mirror Convenience Settings menu: Slide ◀⊙▶ or rotate ⏪⏩.
 - ▶ **Confirming selection:** Press ⏻.



- ▶ **Selecting** Fold in automatically when locking **or** Lower mirror when reversing: Rotate ⏪⏩.
 - ▶ **Confirming selection:** Press ⏻.
 - ▶ Slide ◀⊙▶ to exit.
- or
- ▶ Select **Vehicle** → **Vehicle** → **Exterior mirror Convenience Settings**.
A selection list appears.

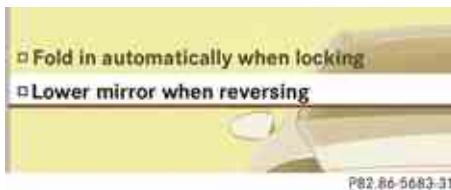

- ▶ **Selecting a function:** Slide ◀⊙▶ or rotate ⏪⏩.

A checkmark appears in the corresponding box when the option has been selected.

- ▶ **Confirming selection:** Press ⏻.
- ▶ Slide ◀⊙▶ to exit.

Automatic locking on/off

i The components and operating principles of COMAND can be found on (▷ page 78).

Use this function to activate or deactivate the automatic central locking (▷ page 295). With the automatic central locking system activated, the vehicle is centrally locked at vehicle speeds of approximately 9 mph (15 km/h).

- ▶ Select **Vehicle**.
The main area is active.
- ▶ **Selecting** Automatic Locking function: Slide ◀⊙▶ or rotate ⏪⏩.

COMAND vehicle menu



► Switching automatic locking on or off:

Press .

or

► Select Vehicle → Vehicle → Automatic Locking.

A checkmark appears when automatic locking is switched on.

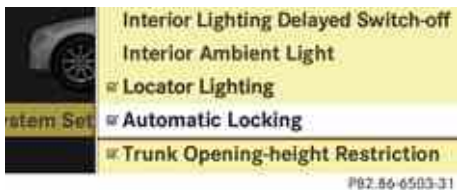

► **Confirming selection:** Press .

► Slide   to exit.

Activating easy-entry/exit feature

i The components and operating principles of COMAND can be found on (► page 78).

Use this function to activate and deactivate the easy-entry/exit feature (► page 306).

The following settings are available for the easy-entry/exit feature:

OFF	The easy-entry/exit feature is deactivated.
Steering Column & Seat	Both the steering column and the driver's seat are moved.

Warning!

You must make sure no one can become trapped or injured by the moving steering wheel and driver's seat when the easy-entry/exit feature is activated.

To stop seat/steering wheel movement, do one of the following:

- Press seat adjustment switch
- Move steering wheel adjustment stalk
- Press one of the memory position buttons or the memory button **M**

Do not leave children unattended in the vehicle, or with access to an unlocked vehicle. Children could open the driver's door and unintentionally activate the easy-entry/exit feature, which could result in an accident and/or serious personal injury.

► Select Vehicle.

The main area is active.

► **Selecting Easy Entry/Exit Feature menu:** Slide   or rotate .



COMAND vehicle menu

▶ **Confirming selection:** Press .

or

▶ Select Vehicle → Vehicle → Easy Entry/Exit Feature.







▶ **Confirming selection:** Press .

A selection list appears.

The current setting is indicated by a dot • .



PB2 86-5657-31

▶ **Selecting a setting:** Slide    or rotate   .

▶ **Confirming selection:** Press .

Setting interior ambient lighting

 The components and operating principles of COMAND can be found on (▷ page 78).

You can adjust the brightness of the interior lighting on a scale of 0 (off) to 5 (bright).

▶ Select Vehicle.

The main area is active.

▶ **Selecting Interior Ambient Light menu:** Slide   or rotate  .

▶ **Confirming selection:** Press .



▶ **Adjusting brightness:** Slide   or rotate  .

▶ **Confirming selection:** Press .

or

▶ Select Vehicle → Vehicle → Interior Ambient Light.



PB2 86-6500-31

▶ **Adjusting brightness:** Slide    or rotate  .

▶ **Confirming selection:** Press .

Setting interior lighting delayed switch-off

 The components and operating principles of COMAND can be found on (▷ page 78).

Use this function to set whether and how long you would like the interior lighting to remain lit during darkness after you have removed the SmartKey from the starter switch.

COMAND vehicle menu

You can select:

- 0 sec., the delayed switch-off feature is deactivated
- 15 sec., 30 sec., 45 sec., or 60 sec., the delayed switch-off feature is activated

▶ **Select Vehicle.**

The main area is active.

▶ **Selecting Interior Lighting Delayed Switch-off menu:** Slide ←⊙→ or rotate Ⓞ.

▶ **Confirming selection:** Press ⊙.

A selection list appears.

The current setting is indicated by a dot •.



▶ **Selecting length of time:** Slide ↑⊙↓ or rotate Ⓞ.

▶ **Confirming selection:** Press ⊙.

or

▶ **Select Vehicle → Vehicle → Interior Lighting Delayed Switch-off.**

A selection list appears.

The current setting is indicated by a dot •.



▶ **Selecting length of time:** Slide ↑⊙↓ or rotate Ⓞ.

▶ **Confirming selection:** Press ⊙.

Extending or retracting rear window sunshade

i The components and operating principles of COMAND can be found on (▷ page 78).

This function is used to extend or retract the rear sunshade.

i You can program this function using the favorite button (▷ page 94).

i At temperatures below -4°F (-20°C), the rear window sunshade is switched off.

▶ **Select Vehicle.**

The main area is active.

▶ **Selecting Rear-window Sunshade function:** Slide ←⊙→ or rotate Ⓞ.

COMAND vehicle menu



P82.86-9181-31

- ▶ **Extending or retracting rear window sunshade:** Press .

or

- ▶ Select Vehicle → Vehicle → Rear-window Sunshade.

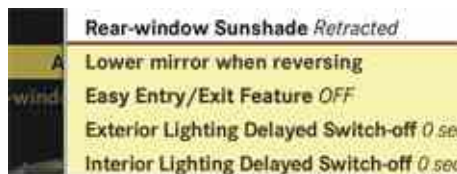

P82.86-6076-31

- ▶ **Confirming selection:** Press .

Warning!

When operating the rear window sunshade, be sure that there is no danger of anyone





being harmed by the extending or retracting procedure.

- ▶ **Reverse the extending or retracting procedure:** Press  again.

Trunk opening-height restriction on/off

- ▶ **Information:** The components and operating principles of COMAND can be found on (▶ page 78).

You can select whether the trunk lid should open fully or only to the height of the roof.

- ▶ **Select Vehicle.**
The main area is active.
- ▶ **Selecting Trunk Opening-height Restriction function:** Slide   or rotate .
- ▶ **Confirming selection:** Press .



P82.86-9182-31

- ▶ **Switching on or off:** Press .

or

- ▶ Select Vehicle → Vehicle → Trunk Opening-height Restriction.
A checkmark appears when the trunk opening-height restriction is switched on.



P82.86-6502-31

- ▶ **Confirming selection:** Press .

COMAND automatic climate control

Introduction

i The components and operating principles of COMAND can be found on (> page 78).

Warning!

Follow the recommended settings for heating and cooling given on the following pages and pages in the “Controls in detail” chapter. Otherwise the windows could fog up, impairing visibility and endangering you and others.

You can operate the climate control via COMAND or via the buttons on the climate control panel (> page 385).

Some of the special climate control functions can only be operated via COMAND.

The following climate control functions can be operated via COMAND:

- Temperature (> page 223)
- Air distribution (> page 224)
- Air volume (> page 224)
- Switching off cooling (AC^{OFF}) (> page 225)
- Central climate control (Mono) (> page 226)

- Footwell temperature (> page 226)
- Air flow from air vents (> page 226)

The climate control menu is called up via the climate control settings.

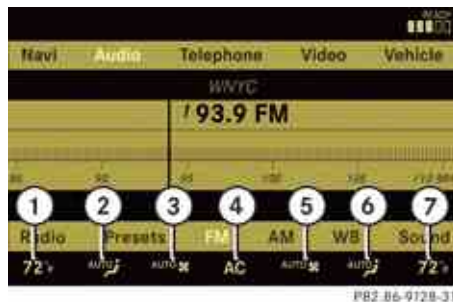

Climate control settings with functions (submenus)

- ① Temperature, driver's side
- ② Air distribution, driver's side
- ③ Air volume, driver's side
- ④ Central menu, climate control
- ⑤ Air volume, passenger side
- ⑥ Air distribution, passenger side
- ⑦ Temperature, passenger side

COMAND automatic climate control

Setting temperature

⚠ Observe Safety notes, see page 387.

Use the temperature controls ▼▲ (> page 385) in the center console or COMAND climate control settings to separately adjust the air temperature on each side of the passenger compartment.

- ▶ Select climate control settings → Temperature, left or right and then press



COMAND automatic climate control

- ▶ **Changing temperature:** Slide $\uparrow \odot \downarrow$ or rotate $\{\odot\}$.
- ▶ **Exiting menu:** Press \odot , back button \leftarrow in the center console (\triangleright page 79) or slide $\leftarrow \odot \rightarrow$.
The setting is saved.

Adjusting air distribution

⚠ Observe Safety notes, see page 387.

You can adjust the air distribution separately for the driver's and front passenger side.

- i** When you change the air distribution, the automatic function of the climate control system is switched off.
- ▶ Select climate control settings \rightarrow Air distribution, driver's side or passenger side.



- ▶ **Changing air distribution:** Rotate $\{\odot\}$.
The symbol for air distribution changes. The direction and size of the arrows represent the air distribution.

or

- ▶ **Switching back to automatic mode:**
Rotate $\{\odot\}$ and select AUTO.
- ▶ **Exiting menu:** Press \odot , back button \leftarrow in the center console (\triangleright page 79) or slide $\leftarrow \odot \rightarrow$.
The setting is saved.

Adjusting air volume

Use rocker switches $\{\odot\}$ (\triangleright page 385) in the center console or COMAND climate control settings to separately adjust the air volume on each side of the passenger compartment.

- i** When you change the air volume, the automatic function of the climate control system is switched off.



- ▶ Select climate control settings \rightarrow Air volume, driver's side or passenger side.



- ▶ **Changing air volume:** Slide $\uparrow \odot \downarrow$ or rotate $\{\odot\}$.

or

- ▶ **Switching back to automatic mode:**
Rotate $\{\odot\}$ and select AUTO.

- ▶ **Exiting menu:** Press , back button  in the center console (▷ page 79) or slide .
- The setting is saved.

Central climate control menu via COMAND

The central climate control menu is in the center of the climate control settings. When the climate control is switched on, you will see AC in the central menu. The following functions can only be operated in the central climate control menu via COMAND:

- Switching off cooling (AC^{OFF}) (▷ page 225)
 - Central climate control (Mono) (▷ page 226)
 - Footwell temperature (▷ page 226)
 - Air flow from air vents (▷ page 226)
- ▶ Select climate control settings → Central menu.

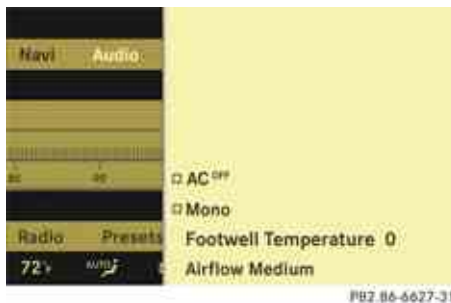

Switching cooling on or off

The cooling function, only operational when the engine is running, cools the vehicle interior down to the selected temperature. The cooling function also dehumidifies the air in the vehicle interior, thus preventing the windows from fogging up.





- ❗ Condensation may drip out from underneath the vehicle. This is normal and not an indication of a malfunction.

Warning!

If you switch off the cooling function, the vehicle will not be cooled when weather conditions are warm. The windows can fog up more quickly. Window fogging may

COMAND automatic climate control

impair visibility and endanger you and others.

- ▶ Select climate control settings → Central climate control menu.
 - ▶ **Selecting AC^{OFF}** : Slide   or rotate .
 - ▶ **Confirming selection:** Press .
- A checkmark appears when the cooling is switched off.
- AC^{OFF} appears in the central menu of the climate control settings.



- ❗ If the air conditioning cannot be activated again, this indicates that the air conditioning is losing refrigerant. The compressor has turned off. Have the air conditioning checked at the nearest authorized Mercedes-Benz Center.

COMAND automatic climate control

Selecting Mono mode

Mono is used to adjust the climate zones for the entire vehicle at the same time. When the Mono function is switched on and you change the climate on the driver's side, these changes will be carried out in the same manner for all climate zones.

- ▶ Select climate control settings → Central climate control menu.
- ▶ **Selecting Mono:** Slide or rotate .
- ▶ **Confirming selection:** Press . A checkmark appears when the function has been selected.

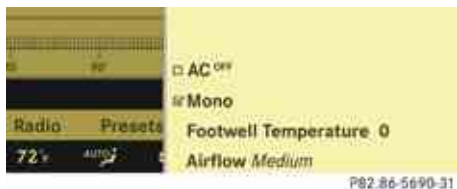

- ▶ **Exiting menu:** Press back button in the center console (▷ page 79) or slide .

The Mono function is automatically switched off when you:

- change a climate control setting for the front passenger side using COMAND
- operate a button from the climate control for the front passenger side
- operate one of the buttons for the rear climate control system

Adjusting footwell temperature

- In automatic mode, this setting optimizes the footwell temperature when outside temperatures are low.

The Footwell Temperature function is used to adjust the temperature difference between the footwell and the rest of the passenger compartment.

The higher the selected value, the higher the temperature in the footwell will be.

- ▶ Select climate control settings → Central climate control menu.
- ▶ **Selecting Footwell Temperature:** Slide or rotate and then press .



P82.86-6664-31

- ▶ **Changing temperature difference:** Slide or rotate .
 - ▶ **Exiting menu:** Press , back button in the center console (▷ page 79) or slide .
- The setting is saved.

Adjusting air flow from air vents

- In automatic mode, this setting optimizes the air flow when outside temperatures are high.

The Airflow setting defines air distribution and air volume in automatic mode:

COMAND seats

- ▶ Focused (default setting, increased air flow)
- ▶ Medium (reduced air flow)
- ▶ Diffuse (minimal air flow)

i When the interior ambient temperature of the vehicle is very hot and the climate control is cooling the interior, the setting for air flow is temporarily overridden.

- ▶ Select climate control settings → Central climate control menu → Airflow. A selection list appears. The current setting is indicated by a dot •.



PBZ 86-5691-31

- ▶ **Changing air flow:** Slide ↑⊙↓ or rotate {⊙}.
- ▶ **Confirming selection:** Press ⊙.

COMAND seats

Operating seats via COMAND

⚠ Observe Safety notes, see page 303.

i The components and operating principles of COMAND can be found on (▷ page 79).

The following seat adjustments can be made via COMAND:

Settings

Lumbar support (CL 550 4MATIC)
(▷ page 228)

Drive-dynamic multicontour seats
(▷ page 229)

Selecting a seat

You must first select the seat for which you would like to make adjustments.

COMAND seats



① Seat menu button

▶ Press button .

The main area is active.

▶ **Switching to the bottom menu line:** Slide

.



▶ **Selecting seat:** Slide or rotate .

▶ **Confirming selection:** Press .

Exiting menu

There are several ways to exit the seat menu.

▶ Press button again.

or

▶ Press any shortcut button.

or

▶ Select another main function from the main menu line.

Lumbar support

(CL 550 4MATIC only)

To support the spine, you can adjust the curvature of the front seat backrests.

▶ Press .

The main area of the COMAND display is active. A scale appears.

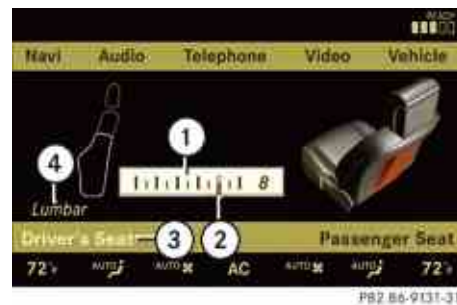

① Scale

② Cursor

③ Current seat

④ Current setting

▶ Select seat (▶ page 227).

▶ **Adjusting lumbar support:** Slide or rotate until desired setting is reached.

▶ **Confirming selection:** Press .

▶ **Switching to the bottom menu line:** Slide .

▶ **Confirming selection:** Press .

i After you have pressed , the seat last adjusted is active.

COMAND seats

Drive-dynamic multicontour seats

i If PRE-SAFE® has been activated, the air pressure in the air chambers (sides of seat cushion and seat backrest) of the drive-dynamic multicontour seats is increased.

Drive-dynamic multicontour seats allow several individual support adjustments and can automatically adjust lateral support to your driving style (▷ page 230).

i Whether adjustments are being made manually or automatically, noises may result from pumping air into or releasing air out of the air chambers.

Multicontour adjustments

To support the spine, you can individually adjust the seat backrest contour of the front seats by regulating the air pressure in the air chambers.

The settings are made on the COMAND display.

You can adjust the following air chambers:

- sides of seat cushion
- sides of seat backrest

- seat backrest curvature in lumbar area
- seat backrest curvature in shoulder area

Adjusting sides of seat cushion

This function is used to adjust the air chambers in the sides of the seat cushion.

- ▶ Select seat (▷ page 227).
- ▶ **Selecting** Seat sides: Slide ←⊙→ or rotate ⊙.
- ▶ **Confirming selection:** Press ⊙. A scale appears.

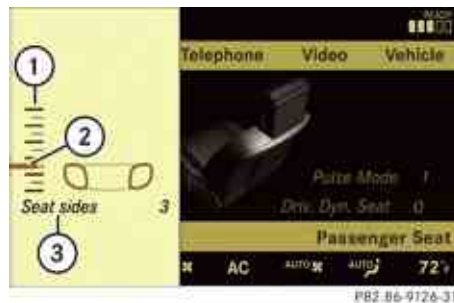

- ① Scale
- ② Cursor
- ③ Current setting

- ▶ Slide ↑⊙↓ or rotate ⊙ until desired setting is reached.
- ▶ **Saving setting:** Press ⊙.

Adjusting seat backrest sides

This function is used to adjust the air chambers in the seat backrest sides.

- ▶ Select seat (▷ page 227).
- ▶ **Selecting** Seatback Sides: Slide ↑⊙↓ or rotate ⊙.
- ▶ **Confirming selection:** Press ⊙. A scale appears.

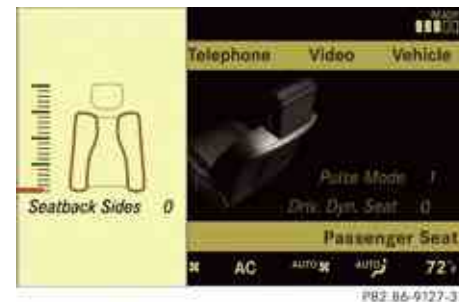

- ▶ Slide ↑⊙↓ or rotate ⊙ until desired setting is reached.
- ▶ **Saving setting:** Press ⊙.

COMAND seats

Adjusting seat backrest curvature in lumbar area

This function is used to adjust the air chambers in the lumbar area of the seat backrest.

- ▶ Select seat (▷ page 227).
- ▶ **Selecting Lumbar:** Slide ←⊙→ or rotate Ⓜ.
- ▶ **Confirming selection:** Press Ⓜ. Cross-hairs appear. You can use them to make two settings:
 - **vertical:** shift the point of greatest curvature upward or downward
 - **horizontal:** adjust the degree of curvature

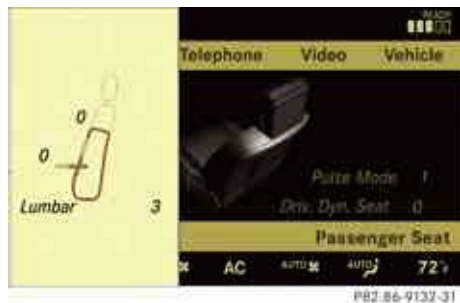

- ▶ Slide ↑⊙↓ or ←⊙→ until desired setting is reached.
- ▶ **Saving setting:** Press Ⓜ.

Adjusting seat backrest curvature in shoulder area

This function is used to adjust the air chambers in the shoulder area of the seat backrest.

- ▶ Select seat (▷ page 227).
- ▶ **Selecting Shoulders:** Slide ←⊙→ or rotate Ⓜ.
- ▶ **Confirming selection:** Press Ⓜ. A scale appears.

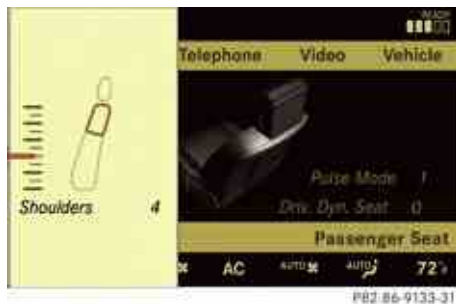

- ▶ Slide ↑⊙↓ or rotate Ⓜ until desired setting is reached.
- ▶ **Saving setting:** Press Ⓜ.

Drive-dynamic function

The drive-dynamic multicontour seat electronically controls the air pressure in the air chambers of the seat backrest side bolsters. This function improves driving comfort and pleasure.

- ▶ Select seat (▷ page 227).
- ▶ **Selecting Driv. Dyn. Seat:** Slide ←⊙→ or rotate Ⓜ.
- ▶ **Confirming selection:** Press Ⓜ. A scale appears. You can choose between:
 - 0: off
 - 1: level 1
 - 2: level 2



PBZ 86-9134-31

- ▶ Slide or rotate until desired setting is reached.
- ▶ **Saving setting:** Press .

Pulse mode

- ▶ Select seat (▷ page 227).
 - ▶ **Selecting Pulse Mode:** Slide or rotate .
 - ▶ **Confirming selection:** Press .
- A list appears. You can choose between different types of massage:



PBZ 86-9125-31

The current setting is indicated by a solid circle.

- ▶ Slide or rotate until desired setting is reached.
 - ▶ **Saving setting:** Press .
- i** Depending on the setting, the massage function runs for about 7 to 10 minutes.

Instrument cluster control system

Instrument cluster control system

Introduction

The control system is activated as soon as the starter switch is in position **2** (▷ page 301).

The control system enables you to call up information about your vehicle and to change vehicle settings.

For example, you can use the control system to find out when your vehicle is next due for maintenance service, to call up statistical data on your vehicle, and much more.

Warning!

A driver's attention to the road and traffic conditions must always be his/her primary focus when driving.

For your safety and the safety of others, selecting features through the multifunction steering wheel should only be done by the driver when traffic and road conditions permit it to be done safely.

Bear in mind that at a speed of just 30 mph (approximately 50 km/h), your vehicle is covering a distance of 44 feet (approximately 14 m) every second.









The control system relays information to the multifunction display.







Instrument cluster control system

Multifunction steering wheel

The displays in the multifunction display and the settings in the control system are controlled by the buttons on the multifunction steering wheel.



①	Multifunction display
②	Press button  to take a call to dial ⁴ to redial ⁴  to end a call to reject an incoming call  to mute
	Press button  to set the volume  to operate the RACETIMER ⁵
③	Press button  to activate the Voice Control System
④	Press button briefly  to cancel the Voice Control System, back, confirm messages
	Press and hold button  to select the standard display

⑤	Press button  to select menus 
	Press button briefly  to select function or scroll through lists  within Audio menu to select previous or next track, scene or stored station within Telephone menu to switch to the phone book and select a name or number
	Press and hold button  within Audio to select previous or next station in station list or wave band  within Telephone menu to start the quick search in the phone book
	Press button  to confirm selection or messages

⁴ Function only available in telephone menu.

⁵ AMG vehicles only.

Depending on the selected menu, pressing the buttons on the multifunction steering wheel will alter what appears in the multifunction display.

The information available in the multifunction display is arranged in menus and accompanying functions. For example, in the Settings menu, you will find functions for making settings to your vehicle. There are functions for calling up information and for making settings to your vehicle.

It is helpful to think of the menus, and the functions within each menu, as being arranged in a circular pattern.

► Press **◀** or **▶** repeatedly to switch menus.

The number of menus available in the system depends on which optional equipment is installed in your vehicle.

► Press button **↔** to return to the next highest menu level.

From a menu's highest level, you will always see the screen from the Trip menu that was last active. When you press **↔** again, you switch to the standard display (▷ page 235).

Instrument cluster control system

Multifunction display



① Main menus

② Text field

Settings, functions as well as any malfunctions appear in the text field.

For more information on menus displayed in the multifunction display, see "Menus" (▷ page 234).

Instrument cluster control system

Menus

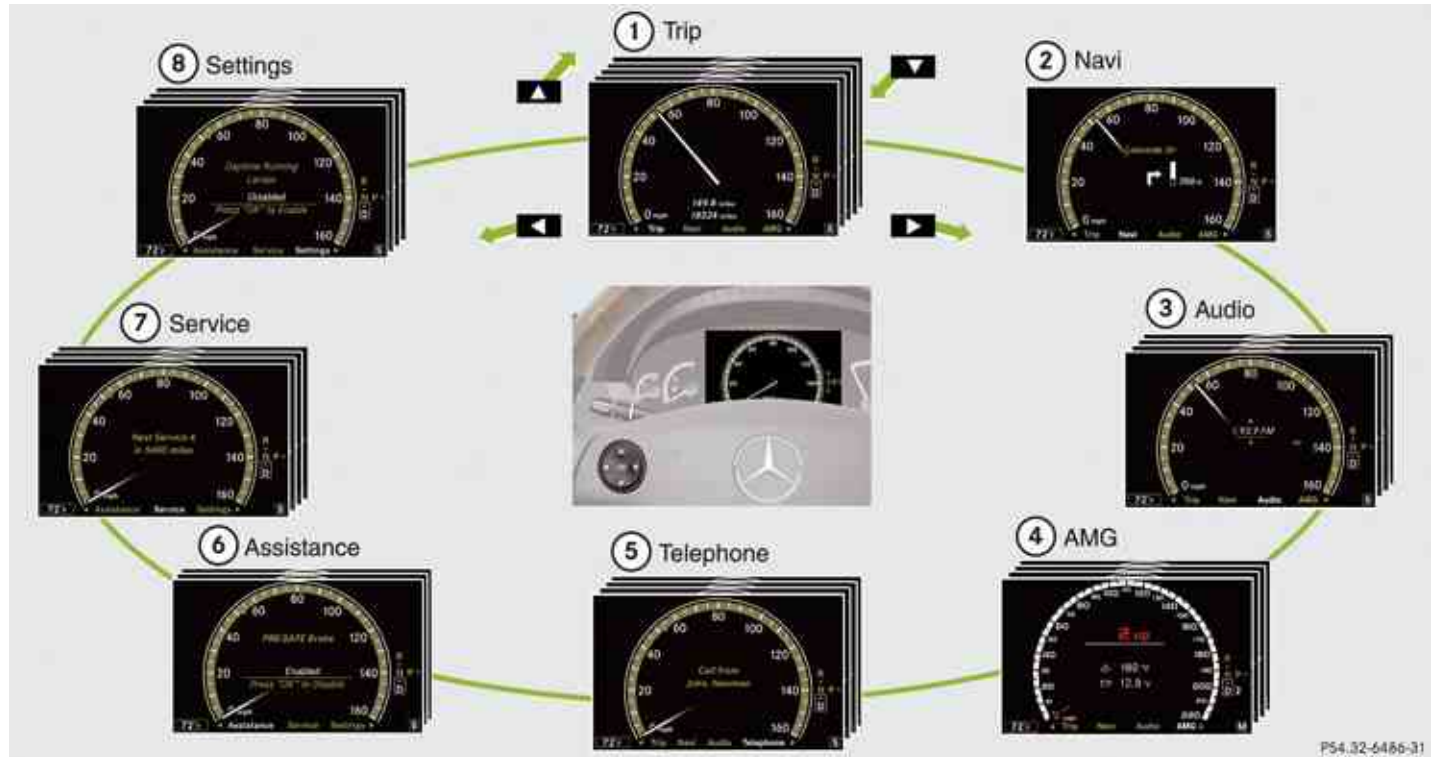

	Function
①	Trip menu (▷ page 235)
②	Navi menu (▷ page 237)
③	Audio menu (▷ page 238)
④	AMG ⁶ menu (▷ page 239)
⑤	Telephone menu (▷ page 242)
⑥	Assistance menu (▷ page 244)
⑦	Service menu (▷ page 245)
⑧	Settings menu (▷ page 246)

Trip menu

In the Trip menu, you can show an additional display for the speedometer and call up or reset your vehicle's statistical data.

The following information is available:

- Standard display (▷ page 235)
- Fuel consumption statistics since start (▷ page 235)
- Fuel consumption statistics since last reset (▷ page 236)

- Resetting values (▷ page 236)
- Distance to empty (▷ page 236)
- Digital Speedometer (▷ page 236)

Standard display

In the standard display, the trip odometer and the main odometer appear in the multifunction display.

- ▶ Press ◀ or ▶ to select the Trip menu.



- ① Main odometer
- ② Trip odometer

Instrument cluster control system

Fuel consumption statistics since start

- ▶ Press ◀ or ▶ to select the Trip menu.
- ▶ Press ▼ or ▲ to select From Start.



- ① Distance driven since start
- ② Time elapsed since start
- ③ Average speed since start
- ④ Average fuel consumption since start

All statistics stored since the last engine start will be reset approximately 4 hours after the SmartKey in the starter switch is turned to position 0 or removed from the starter switch. Resetting will not occur if you turn the SmartKey back to position 1 or 2 within this time period.

⁶ AMG vehicles only.

Instrument cluster control system

Fuel consumption statistics since last reset

- ▶ Press or to select the Trip menu.
- ▶ Press or to select From Reset.



- ① Distance driven since last reset
- ② Time elapsed since last reset
- ③ Average speed since last reset
- ④ Average fuel consumption since last reset

Resetting values

You can reset the values for the following functions:

- Trip odometer
- Fuel consumption statistics since start
- Fuel consumption statistics since last reset

- ▶ Press or to select the Trip menu.
- ▶ Press or to select the function you wish to reset.
- ▶ Press .



Example illustration: Reset trip odometer

- ▶ Press to select Yes.
 - ▶ Press to confirm.
- i** The fuel consumption statistics reset automatically to 0 after 99 999 miles or 9 999 hours, whichever occurs first.

Distance to empty

- ▶ Press or to select the Trip menu.
- ▶ Press or to select Range. The calculated remaining driving range based on the current fuel tank level appears in the multifunction display. If only very little fuel is left in the tank, a vehicle at the fuel pump appears instead of the remaining driving range.

Digital speedometer

- ▶ Press or to select the Trip menu.
- ▶ Press or to select the digital speedometer.



- ① Digital speedometer

Navi menu

The display in the Navi menu depends on whether route guidance is active or not.

- Press ◀ or ▶ to select the Navi menu.

Route guidance not active

The multifunction display shows the direction of travel and the name of the street you are currently driving on, if known by the navigation system.

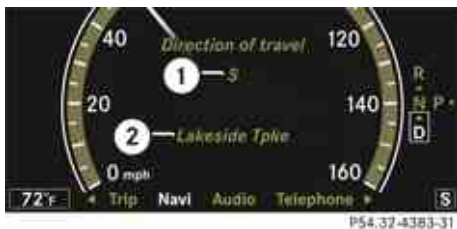

- ① Direction of travel
- ② Street you are currently driving on

Route guidance active

The image in the multifunction display depends on whether you are being notified of a driving maneuver.

No notification of driving maneuver



Example illustration

- ① Distance to destination
- ② Symbol for “follow the course of the road”
- ③ Distance to next driving maneuver
- ④ Street you are currently driving on

Instrument cluster control system

Notification of driving maneuver



Example illustration

- ① Street into which the driving maneuver leads
- ② Symbol for “driving maneuver”
- ③ Distance to driving maneuver and visual distance display

When you are being notified of a driving maneuver, you will see a visual distance display ③ next to the driving maneuver symbol. The visual distance display is reduced from bottom to top the closer you come to the announced driving maneuver.

Navigation status displays in the instrument cluster

While route guidance is active, the following messages may be shown in the multifunction display:

- 🚦

Instrument cluster control system

You have reached your destination.

- Area of dest. reached

You have arrived in the area of your destination. The message appears, for example, for relatively large POIs.

- New Route...

COMAND calculates a new route, e.g. because you have deviated from the calculated route or due to a detour report. Afterward, COMAND continues route guidance.

- Calculating Route

COMAND is calculating a route. Afterward, COMAND starts route guidance.

- Off Map

The vehicle's location is outside of the digital map's range. The vehicle is in an off-map position (▷ page 138).

- Off Mapped Road

The vehicle is either on a road that has not been digitized (▷ page 138) or on the side of a road, e.g. in a parking space.

- No Route

COMAND cannot calculate a route to the selected destination.

- Direction of Dest.

The vehicle has gone off the map during route guidance (▷ page 138).

Audio menu

The functions in the Audio menu operate the audio equipment which you have currently switched on.

The following functions are available:

- Selecting radio station (▷ page 238)
- Operating DVD changer/audio CD/audio DVD/MP3 (▷ page 239)
- Operating video DVD (▷ page 239)

If no audio equipment is currently switched on, the message Audio OFF appears in the multifunction display.

- ▶ **To adjust the volume:** Press **+** or **-** on the multifunction steering wheel.

Selecting radio station

The SIRIUS Satellite Radio is treated as a radio application.

Additional optional satellite radio equipment and a subscription to satellite radio service provider are required for satellite radio operation. Contact an authorized Mercedes-

Benz Center for details and availability for your vehicle.

For more information on satellite radio operation, see "Satellite radio" (▷ page 189).

- ▶ Switch on the COMAND system and select AM/FM radio (▷ page 184) or satellite radio (▷ page 189).





- ▶ Press **◀** or **▶** to select the Audio menu.

The currently tuned station appears in the multifunction display.





Example illustration for FM radio

- ① Station frequency
- ② Wave band setting

- ▶ **Select next or previous stored station:**
Press button  or  briefly to select a stored station.
- ▶ **Select next or previous station in wave band:** Press and hold button  or  to select a station.

You can only change the frequency band and save new stations using the COMAND system, see (▶ page 184) (AM/FM radio) or (▶ page 189) (satellite radio).

Operating DVD changer/audio CD/ audio DVD/MP3

- ▶ Switch on the COMAND system and select CD, DVD-Audio or MP3 (▶ page 195).
- ▶ Press  or  to select the Audio menu.





Example: audio CD

- ① Current track

- ▶ Press  or  to select a track.

- ① When you play a CD or DVD with text, the multifunction display shows the name and number of the track. For MP3s, only the track is shown.

Operating video DVD

- ▶ Switch on the COMAND system and select Video → Video → Video DVD (▶ page 211).
- ▶ Press  or  to select the Audio menu.



- ① Current scene
- ② Disc number

- ▶ Press  or  to select a scene.

Instrument cluster control system

AMG menu

This function is only available in AMG vehicles.

The main screen of the AMG menu shows you

- the gear currently engaged
- the engine oil temperature
- the vehicle supply voltage

- ▶ Press button  or  to select the AMG menu.



- ① Gear indicator
- ② Upshift indicator
- ③ Engine oil temperature indicator
- ④ Vehicle supply voltage indicator

The engine oil temperature will be shown in blue if the engine oil temperature has not yet reached 176°F (80°C). During this time, avoid driving at full engine speed.

▶▶

Instrument cluster control system

If the engine reaches the overspeed range in the manual shift program, you will see **up** next to gear indicator ① as a reminder to upshift.

Use buttons **▼** or **▲** to select the following functions in the AMG menu:

- RACETIMER (▷ page 240)
- Overall analysis (▷ page 241)
- Lap analysis (▷ page 241)

RACETIMER

⚠ Warning!

The RACETIMER feature is only for use on roads and in conditions where high speed driving is permitted. Racing on public roads is prohibited under all circumstances and the driver is and must always remain responsible for following posted speed limits.

The RACETIMER allows you to time and save driving stretches.

- ▶ Press button **◀** or **▶** to select the AMG menu.
- ▶ Press **▲** to select the RACETIMER.

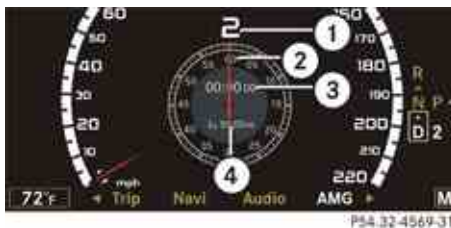

- ① Gear indicator
- ② Seconds display
- ③ RACETIMER
- ④ Lap

You can start the RACETIMER when the engine is running or the starter switch is in position **2** (▷ page 301).

While the RACETIMER is being displayed, you cannot adjust the audio volume using buttons **+** or **-**.

- ▶ **Starting:** Press button **+**.
- ▶ **Displaying intermediate time:** Press button **-** while the timer is running. The intermediate time is shown for 5 seconds.
- ▶ **Stopping:** Press button **+**.

When you stop the vehicle and turn the SmartKey to position **1** (▷ page 301) or, in vehicles with KEYLESS-GO, turn off the engine and do not open the driver's door, the

RACETIMER stops timing. Timing is resumed when you switch the ignition back on or restart the engine and then press button **+**.

When you switch on the Night View Assist (▷ page 380) while the RACETIMER is operating, the RACETIMER will continue to run in the background but cannot be operated with the multifunction steering wheel buttons.

To stop the RACETIMER, switch off the Night View Assist first.

Saving lap time and starting a new lap

You can save up to 16 laps.

- ▶ Press button **-** while the timer is running. The intermediate time will be shown for 5 seconds.
- ▶ Press button **-** within 5 seconds. The intermediate time shown will be saved as a lap time. The RACETIMER begins timing the new lap. The new lap begins to be timed as soon as the intermediate time is called up.



- ① Gear indicator
- ② RACETIMER
- ③ Best lap time

Resetting current lap

- ▶ Press button **+** while the timer is running.
The timer stops.
- ▶ Press button **-**.
The lap time is reset to “0”.

Deleting all laps

It is not possible to delete a single saved lap.

- ▶ Press button **+** while the timer is running.
The timer stops.
- ▶ Press button **-** for at least 3 seconds.

- ▶ Press button **+**.
The timer starts. The saved laps are deleted.

or

- ▶ Press **OK**.
The reset menu appears in the multifunction display.



- ▶ Press **▼** to select Yes and confirm with **OK**.
The saved laps are deleted.

Overall analysis

This function is only available if you have saved at least one lap and have stopped the RACETIMER.

- ▶ Press button **▲** repeatedly until the overall analysis appears in the multifunction display.

Instrument cluster control system

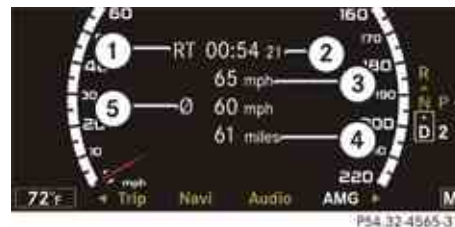

- ① Overall analysis of RACETIMER
- ② Overall driving time
- ③ Maximum speed
- ④ Overall distance driven
- ⑤ Average speed

Lap analysis



This function is only available if you have saved at least two laps and have stopped the RACETIMER.

- ▶ Press button **◀** or **▶** to select the AMG menu.
- ▶ Press button **▲** repeatedly until the lap analysis appears in the multifunction display.

Each lap is shown in its own submenu. The fastest lap is indicated by flashing symbol ①.

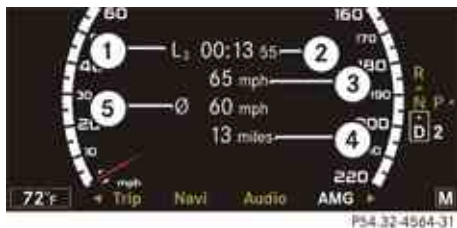
Instrument cluster control system



- ① Lap number
 - ② Lap time
 - ③ Maximum speed during lap
 - ④ Lap length
 - ⑤ Average speed during lap
- ▶ Press button  or  to see other lap analyses.

Telephone menu

Warning!

A driver's attention to the road must always be his/her primary focus when driving. For your safety and the safety of others, we recommend that you pull over to a safe location and stop before placing or taking a telephone call. If you choose to use the telephone while driving, please use the hands-free device and only use the telephone when weather, road and traffic conditions permit.

Some jurisdictions prohibit the driver from using a mobile phone while driving a vehicle.



Bear in mind that at a speed of just 30 mph (approximately 50 km/h), your vehicle is covering a distance of 44 feet (approximately 14 m) every second.

Never operate radio transmitters equipped with a built-in or attached antenna (i.e. without being connected to an external antenna) from inside the vehicle while the engine is running. Doing so could lead to a malfunction of the vehicle's electronic system, possibly resulting in an accident and/or personal injury.

You can use the functions in the **Telephone** menu to operate your telephone, provided it is connected to a hands-free system and switched on.

 Various mobile phone cradles can be installed in the front center armrest, see separate installation instructions for the mobile phone cradle. These mobile phone cradles can be obtained from an authorized Mercedes-Benz Center. For more information on telephone, see (> page 404).

▶ Switch on the telephone and the COMAND system.

▶ Press button  or  to select the Telephone menu.

One of the following messages will appear in the multifunction display:

- Telephone OFF: The telephone is inserted in the mobile phone cradle but it is switched off.
 - ▶ Switch on the telephone.
- No telephone inserted: The telephone is not inserted in the mobile phone cradle.

- ▶ Switch on the telephone.
- ▶ Insert the telephone in the mobile phone cradle.
- Please enter PIN or Enter unlock code: The telephone is inserted in the mobile phone cradle but the PIN or unlock code has not been entered yet.
 - ▶ Enter the PIN or the unlock code with the telephone, the COMAND system or Voice Control. The telephone will then search for a network.
- Ready or Ready (Roaming): The telephone has found a network and is ready for use. You can operate it using the control system.

Answering a call

When your telephone is ready to receive calls, you can answer a call at any time with the ignition on. When you are in the Telephone menu, you will see the following message in the multifunction display:



- ▶ Press button .

The caller's number appears only if it is transmitted.

The caller's name appears only if the number and the name are stored in the phone book.

Ending a call or rejecting an incoming call





- ▶ Press button .

Dialing a number from the phone book







When your telephone is ready to receive calls, you may select and dial a number from the phone book at any time.





- 1 When you insert a Mercedes-Benz approved mobile phone into the cradle, the control system reads in the phone book that is saved on the SIM card or in the phone book of the mobile phone. This can

Instrument cluster control system

take several minutes, depending on how many entries each phone book contains. When you press , , ,  or  during the download of the phone book the message Reading telephone data, please wait... appears in the multifunction display.

When the message: Reading telephone data, please wait... disappears, the phone book has been loaded.

- ▶ Press button  or  to select the Telephone menu.
- ▶ Press button ,  or  to switch to the phone book. The stored names are displayed in ascending alphabetical order.
- ▶ Press button ,  to select the desired entry.

If you press and hold button  or  the system scrolls rapidly through the list of names (quick search). After holding button  or  for a short while the scrolling speed increases. Release the button to stop the quick search. The search stops automatically at the end of the list.

Instrument cluster control system

- ▶ Press button  or **OK**.

If several entries are present for the same name, they are all shown. Select the desired entry and press button  or **OK** again.

The control system dials the selected phone number.

If the connection is successful and this feature is supported by your network provider, the name of the party (if stored in your phone book) you are calling will appear in the multifunction display.



The control system stores the dialed number in the redial memory.



or

- ▶ Press button  if you do not want to make the call.

Redialing

The control system stores the most recently dialed phone numbers. This eliminates the need to search through your entire phone book.

- ▶ Press button  or  to select the Telephone menu.
- ▶ Press button .

- ▶ Press button  or  to select the desired number and/or name.
- ▶ Press button  or **OK**.
The control system dials the selected phone number.





Assistance menu

In the Assistance menu, you can change the settings of your driving systems.

The following functions are available:

- Displaying distance graphic, DISTRONIC Plus (▷ page 353)
- Activating/deactivating PRE-SAFE® Brake (vehicles with DISTRONIC Plus only) (▷ page 244)
- Switching on or off rear view camera automatically (▷ page 245)
- Switching on or off Blind Spot Assist (▷ page 245)

Activating/deactivating PRE-SAFE® Brake (vehicles with DISTRONIC Plus only)

- ▶ Press  or  to select the Assistance menu.
- ▶ Press  or  to select the PRE-SAFE Brake function
- ▶ Press **OK**.



- ① PRE-SAFE® Brake indicator 

- ▶ Press **OK** again if you would like to change the current status.
After the function has been activated, indicator  appears on the left-hand side of the multifunction display.

For more information, see (▷ page 72).

Switching on or off rear view camera automatically

i The image from the rear view camera is shown on the COMAND system display.

- ▶ Press **◀** or **▶** to select the Assistance menu.
- ▶ Press **▼** or **▲** to select the Rearview Camera function
- ▶ Press **OK**.



- ▶ Press **OK** again if you would like to change the current status. The following settings are available:
On When In Reverse: The rear view camera automatically switches on when reverse gear is engaged.
Disabled: The rear view camera is not switched on.

Switching on or off Blind Spot Assist

- ▶ Press **◀** or **▶** to select the Assistance menu.
- ▶ Press **▼** or **▲** to select the Blind Spot Assist function
- ▶ Press **OK**.



- ▶ Press **OK** again if you would like to change the current status.

Instrument cluster control system

Service menu

In the Service menu the following functions are available:

- Calling up messages (▷ page 245)
- Checking tire inflation pressure electronically with the Advanced TPMS (▷ page 438)
- Calling up the maintenance service indicator display (▷ page 461)
- Checking engine oil level (CL 600 and CL 65 AMG) (▷ page 425)

Calling up vehicle malfunction, warning and system status messages stored in memory



Use the vehicle status message memory function to scan malfunction and warning messages that may be stored in the system. Such messages appear in the multifunction display and are based on conditions or system status the vehicle's system has recorded.





The vehicle status message memory function only appears if there are any messages stored.

Instrument cluster control system

Warning!

Malfunction and warning messages are only indicated for certain systems and are intentionally not very detailed. The malfunction and warning messages are simply a reminder with respect to the operation of certain systems. They do not replace the owner's and/or driver's responsibility to maintain the vehicle's operating safety. Have all required maintenance and safety checks performed on the vehicle. Bring the vehicle to an authorized Mercedes-Benz Center to address the malfunction and warning messages.

- ▶ Press  or  to select the Service menu.
If conditions have occurred causing status messages to be recorded, the number of messages appears in the multifunction display: 2 Messages.

- ▶ Press  or  to select the Messages function.
- ▶ Press  to confirm.
For malfunction and warning messages, see “Vehicle status messages in the multifunction display” (▷ page 475).
- ▶ Use  or  to scroll through the messages.







If you turn the SmartKey in the starter switch to position **0** and then back to position **2**, all messages will be deleted from the message memory.



Settings menu

In the Settings menu the following functions are available:

- Setting daytime running lamp mode (USA only) (▷ page 246)
- Showing or hiding additional speedometer (▷ page 247)
- Selecting speedometer display mode (▷ page 247)
- Switching the radar sensors on or off (▷ page 247)

Setting daytime running lamp mode (USA only)

- ▶ Press  or  to select the Settings menu.
- ▶ Press  or  to select the Day Running Lamps function.
- ▶ Press .
- ▶ Press  again if you would like to change the current status.
Depending on the previous status, the daytime running lamps will be switched on or off.

With Daytime Running Lamps mode Enabled selected and the exterior lamp switch at position  or , the low-beam headlamps are switched on when the engine is running.

In low ambient light conditions the following lamps will come on additionally:





- Parking lamps
- Tail lamps
- License plate lamps
- Side marker lamps

For more information on the daytime running lamp mode, see “Lighting” (▷ page 318).





- i** Make sure the light switch is set to  or **A** when you switch off the daytime running lamps while driving at night.

Showing or hiding additional speedometer

You can have an additional digital speedometer shown in the multifunction display. Depending on the setting for the speedometer display mode (▷ page 247), the speed is shown in the unit of kilometers/hour (setting miles) or miles/hour (setting km).

- ▶ Press  or  to select the Settings menu.
- ▶ Press  or  to select the Add. Speedometer function.
- ▶ Press **OK**.
- ▶ Press **OK** again if you would like to change the current status. Depending on the previous status, the additional speedometer will be switched on or off.

Selecting speedometer display mode

- ▶ Press  or  to select the Settings menu.
- ▶ Press  or  to select the Units function.
- ▶ Press **OK**.
- ▶ Press **OK** again if you would like to change the current status. Depending on the previous status, the Display Unit Speed-/Odometer will be switched to miles or km. The additional speedometer (▷ page 247) will be shown in the other unit.

Switching the radar sensors on or off

If your vehicle is equipped with DISTRONIC Plus, BAS Plus, or Park Assist it is equipped with a radar sensor system which you can switch on and off.

When traveling in Canada in a vehicle not registered in Canada, you must switch off the radar sensor system. Canadian law does not permit the use of the radar sensor system for vehicles from outside of Canada. When you switch off the radar sensor system, the following functions are deactivated:

Instrument cluster control system

- BAS Plus (▷ page 66)
- PRE-SAFE® Brake (▷ page 72)
- DISTRONIC Plus (▷ page 350)
- Park Assist (▷ page 369)
- Advanced Parking Guidance (▷ page 373)
- Blind Spot Assist (▷ page 382)

i USA only:

This device has been approved by the FCC as a “Vehicular Radar System”. The radar sensor is intended for use in an automotive radar system only. Removal, tampering, or altering of the device will void any warranties, and is not permitted by the FCC. Do not tamper with, alter, or use in any non-approved way.

Any unauthorized modification to this device could void the user’s authority to operate the equipment.

Voice Control introduction







Canada only:

This device complies with RSS-210 of Industry Canada. Operation is subject to the following two conditions:

1. This device may not cause interference, and
2. this device must accept any interference received, including interference that may cause undesired operation of the device.

Removal, tampering, or altering of the device will void any warranties, and is not permitted. Do not tamper with, alter, or use in any non-approved way.

Any unauthorized modification to this device could void the user's authority to operate the equipment.

- ▶ Press  or  to select the Settings menu.
- ▶ Press  or  to select the Radar Sensors function.
- ▶ Press .
- ▶ Press  again if you would like to change the current status. Depending on the previous status, the radar sensors will be switched on or off.

-  The selected status of the radar sensors remains stored in memory even if the engine is turned off and restarted.

The following message appears in the multifunction display if the radar sensors are switched off and you attempt to activate DISTRONIC Plus, Park Assist or PRE-SAFE® Brake:
Radar Sensors
(See Oper. Manual)
Disabled

Voice Control introduction

Safety notes

Warning!

Only use the Voice Control System when road and traffic conditions permit you to do so. Otherwise you could be involved in an accident in which you or others could be injured.

Warning!

Please devote your attention first and foremost to the traffic situation you are in. While the system permits hands-free phone operation, attention to traffic may be diverted not only by physical operation of a phone, but also by the distraction of a phone conversation while driving. As such, for safety reasons, we encourage the driver to stop the vehicle in a safe place before answering or placing a phone call.

For safety reasons, you should only select a destination when the vehicle is stationary. While the navigation system provides directional assistance, the driver must remain focused on safe driving behavior, especially attention to traffic and street

Voice Control introduction

signs, and should utilize the system's audio cues while driving.

The navigation system does not supply any information on stop signs, yield signs, traffic regulations or traffic safety rules. Their observance always remains in the driver's personal responsibility. DVD maps do not cover all areas nor all routes within an area.

Traffic regulations always have priority over any route recommendations given.

Bear in mind that at a speed of just 30 mph (approximately 50 km/h), your vehicle is covering a distance of 44 feet (approximately 14 m) every second.

Warning!

Navigation announcements are intended to direct you while driving without diverting your attention from the road and driving. Please always use this feature instead of consulting the map display for directions. Consulting the symbols or map display for directions may cause you to divert your attention from driving and increase your risk of an accident.

Warning!

Please do not use the Voice Control System in an emergency, as the tone of your voice may change in a stressful situation. This could cause a delay in completing your phone call in a timely manner. This could distract you in an emergency situation and cause you to be involved in an accident.

General information

The Voice Control System gives you the capability to control the following systems on your vehicle using spoken commands:

- Telephone (▷ page 259)
- Navigation (▷ page 252)
- Address book (▷ page 264)
- Audio (▷ page 267) (AM/FM radio, CD/DVD changer, MP3 player)

You control these systems using spoken commands. Moreover, controls such as the buttons on the multifunction steering wheel (▷ page 250) allow you to keep your hands on the steering wheel.

The command vocabulary consists of approximately 300 ready-to-use phrases. The Voice Control System recognizes commands

and number sequences, irrespective of the speaker. To optimize speech recognition for your voice follow the individualization process (▷ page 287).

You can use the Voice Control System to call up all of COMAND's main menu items, with the exception of the main menus for "Vehicle" and "Navi".

The commands and digit sequences can be spoken without pausing between the individual words. If an unavailable or incorrect command is used, the Voice Control System will prompt you for a new command by asking "Please repeat" or "Please repeat your entry".

In order to provide for a safe and comfortable dialog, the Voice Control System acknowledges important commands.

Voice Control introduction

Spelling

You may not need to spell the entire name (street, intersection, city or point of interest) especially if the name is lengthy. Spelling the first three to five characters of the name should be sufficient for the system to recognize the name provided it is available on the navigation DVD.

The selection appearing on the COMAND display is sorted based on your recognized voice input and a matching algorithm. You can use the commands “Next page” or “Previous page” to scroll up or down in the list.

Use the command “Correction” to start over by again spelling the name.

Speak each character as clearly as you can, especially when they sound very similar (d or e).

Command types

The Voice Control System commands can be categorized as:

- General Commands
These are commands always available to you as soon as the Voice Control System is activated (for example “Help” commands).
- Local Commands
These are commands specific to the currently active system shown in the COMAND display (for example commands to control the CD/DVD changer).

For a complete list of commands (> page 271).

- ❗ During Voice Control System operation visual help windows also appear in the COMAND display (> page 251).

Active System

The active system is the system currently shown in the COMAND display.







If, for example, you listen to the radio while the telephone system is active on the COMAND display, you have to switch to the radio using the command “Radio” before you can operate the radio.

Controls

Operation via the multifunction steering wheel



Voice Control introduction

	Item	
①		Activating the Voice Control System Accepting a call
②		Canceling Voice Control
③		Increasing volume
		Decreasing volume
		Taking a call Dialing Redialing
		Ending a call Rejecting an incoming call

i The Voice Control System can be canceled at any time, even during a dialog. Please note that if the Voice Control System is canceled during a dialog, then the complete procedure is stopped and the Voice Control System is canceled.



Activating the Voice Control System

- ▶ Switch on COMAND (▷ page 79).
- ▶ Press  .
An acoustic signal confirms the activation of the system.
- ▶ Speak a command.

Canceling the Voice Control System

- ▶ Press  .
- or
- ▶ Speak the command “Cancel” (except for speaking voice entries, entering a city or carrying out individualization).
- or
- ▶ Press any COMAND button.

Setting volume level

- ▶ Activate the Voice Control System.
- ▶ Speak a command, for example “Help”.
- ▶ Press  or  . The volume is increased or decreased during voice output.
- or
- ▶ Set volume for voice output using the COMAND volume thumbwheel on the lower

part of the front center console (▷ page 88).

Displays

COMAND Display

In addition to the acoustic help function, a visual help function (▷ page 93) is available on the COMAND display.

Upon activating the Voice Control System, the most important available commands for the currently active system appear on the COMAND display.

When the Voice Control System requires additional information from the user, a selection list is shown on the COMAND display in the address book and navigation system.

Voice Control navigation



① COMAND display

Multifunction display



For example, telephone numbers are shown in the multifunction display while dialing when the main Telephone menu is selected in the instrument cluster control system.



① Multifunction display

Symbols

The following symbols are found in the Voice Control System pages:

-  This symbol stands for commands and voice entries you are speaking.
-  This symbol stands for voice output by the Voice Control System.
-  This symbol indicates that information is available on the COMAND display.

Voice Control navigation

Important notes

Safety notes for using the Voice Control System

 **Observe Safety notes, see page 248.**

Safety notes for using the navigation system

 **Observe Safety notes, see page 95.**

Navigation operation

The Voice Control System allows you to



- enter a state or province
- enter a city
- spell the name of a city
- spell the name of district or center
- spell the name of a street
- spell the name of an intersection
- enter a house number
- enter a complete address

Voice Control navigation

- select one of your last destinations
- enter a POI (point of interest)
- select one of your last destinations
- save a destination
- navigate to a destination stored in the destination memory of the address book
- start route guidance
- display the map
- zoom in or zoom out of the map
- listen to the destination memory
- cancel route guidance
- turn guide instructions on or off

Before you can operate navigation using the Voice Control System, you have to activate the Voice Control System (▷ page 251).

Selecting navigation mode

- ▶ Press .
- ▶ Speak the command “Navigation”.
- ▶ Press .
- ▶ Speak one of the navigation commands.

Navigation commands

- i** You cannot start the route guidance until all necessary address data has been entered.

For a complete list of commands (▷ page 271).







“Help navigation”/“Help”

Use the command “Help navigation” or “Help” to read out an option list of available functions and commands that can be used in conjunction with the navigation system.

“Enter state”, “Enter province”

Use the command “Enter state” or “Enter province” to select a different state or province on the navigation DVD.

Sample dialog:

-  Enter state
-  Please say the name of the state
-  New York
-  The system shows a numbered list of states recognized by the system
-  Please select a line number
-  Number two
- or to accept, say

 Yes

 State accepted

The selected entry is adopted from the list.

“Last states”



Use the command “Last states” to select a state or province from among a number of last selected states or provinces.

Dialog for entering a complete address

“Enter destination”

Use the command “Enter destination” to enter a complete destination address. The system guides you through the dialog. As soon as a valid address has been entered, you can start route guidance or save the destination. For information on spelling (▷ page 257).

Sample dialog:

-  Enter destination
-  Please spell a New York street name
-  B-R-O-A-D-W

Voice Control navigation

 The system displays a numbered list of matching street names on the COMAND display

 Please select a line number

 Number two

 Number two accepted

 Do you want to enter a house number?

 No

 Do you want to enter an intersection?

 No

 Do you want to spell the town's name?

 Yes

 Please spell the town name

 N-E-W-Y-O-R-K

 The system displays a numbered list of matching city names on the COMAND display

 Please select a line number

 Number one

 Number one accepted

 Do you want to start route guidance?

 Yes

 Starting route guidance

The system calculates the route and, upon completing route calculation, starts route guidance.

i You may not need to spell the entire name (street, intersection, city or point of interest) especially if the name is lengthy. Spelling the first three to five characters of the name should be sufficient for the system to recognize the name provided it is available on the navigation DVD.

i The selection appearing on the COMAND display is sorted based on your recognized voice input and a matching algorithm.

You can use the commands “Continue” or “Back” to scroll up or down in the list.

Use the command “Correction” to start over by again spelling the name.

Speak each character as clearly as you can, especially when they sound very similar (d or e).

“Points of interest”

Use the command “Points of interest” to select a point of interest (POI) such as airports, railroad stations, gas stations etc.

Sample dialog:

 Points of interest

 The system shows the following list on the COMAND display:

- current position
- other town/city
- Global POI

 Please select a line number

 Number one

 The system displays a numbered list of available POI categories: Select POI category menu

 Please select a line number

 Number one

 The system displays a numbered list search categories: Find menu

 Please select a line number

 Number one

 The system displays a numbered list of airports sorted by distance



 Please select a line number

 Number one

 Point of interest accepted

 Do you want to start route guidance?

Voice Control navigation

-  Yes
-  Starting route guidance





i Depending on the number of categories and POI's available for a given area, the system may display several lists on each of which you may have to make a selection by speaking the desired line number or you have to spell the name of a POI.

“Next POI”

With the commands

- “Next gas station”
 - “Next parking lot”
 - “Next Mercedes-Benz service”
 - “Next restaurant”
 - “Next hospital”
- you can select POIs in your vicinity.

Sample dialog:

-  Next gas station
-  The system shows a numbered list of gas stations on the COMAND display
-  Please select a line number
-  Number one
-  Number one accepted

-  Do you want to start route guidance?
-  Yes

The system calculates the route and, upon completing route calculation, starts route guidance.

“Last destinations”



Use the command “Last destinations” to select a destination from among a number of destinations last navigated to.







“Save destination”

Use the command “Save destination” to save the current destination in the address book.

- i** The Voice Control System may recognize names even if not saved in your voice. For best possible call-up performance, however, you should speak and save the names you intend to use yourself.
- If an entry is already available in the address book, the system will ask you if you would like to add the address to the available entry.

Sample dialog:

-  Save destination
-  Please say the name

-  John Smith
-  Please repeat the name
-  John Smith
-  Where do you want to save: home or work?
-  Work
-  The destination has been saved

“Navigate to <voice entry>” (address book)

Use the command “Navigate to <voice entry>” to start route guidance by selecting voice entry with a saved destination address from the COMAND address book.

A voice entry may have two different destination addresses associated with it (home or work).

The system confirms your command, calculates the route, and begins route guidance. If only one address is stored, you can use the command “Navigate <voice name>” to select the stored destination address for that name.

If two addresses are stored, you can use the commands

- “Navigate <voice name> home”



Voice Control navigation

or

- “Navigate <voice name> work”
to directly select between home or work address for that name. The system confirms your selection, calculates the route, and begins route guidance.

Sample dialog:



Navigate to John Smith

If more than one address exists for this voice entry, the Voice Control System will prompt you:



Navigate to home or work?



Work



John Smith work

Starting route guidance

“Start route guidance”

Use the command “Start route guidance” to start route guidance after entering a valid destination.

Sample dialog:



Start route guidance



Starting route guidance

Route guidance begins.

“Guidance instructions on”

Use the command “Guidance instructions on” to have the Voice Control System repeat the last guidance instruction. If guidance voice output was previously muted, using this command will deactivate the muting of the voice output.

“Guidance instructions off”

Use the command “Guidance instructions off” to mute the system’s guidance voice output.

“Cancel route guidance”

Use the command “Cancel route guidance” to cancel route guidance.

Sample dialog:



Cancel route guidance



Are you sure you want to cancel route guidance?



Yes

Route guidance is canceled.

or



No



Cancel

The dialog with the Voice Control System is canceled. Route guidance remains active.

“Map”

Use the command “Map” to activate or switch to map display.

“Zoom in”, “Zoom out”

Use these commands to zoom in on map or to zoom out of map to the desired level of map detail.

“Zoom in completely”, “Zoom out completely”

These commands are used to adapt the map display directly to the smallest or largest map scale.

“List destination memory”

Use the command “List destination memory” to have the system read out all destination memory entries and select an entry for route guidance.

Sample dialog:



List destination memory



Voice Control navigation

The system reads out the address book destination memory.

To select a voice entry and adopt address for route guidance:

- ▶ When the system reads the desired entry, press .

If more than one address is available, the system will prompt you:

-  Navigate to home or work?
-  Home

The system reads the selected voice entry and starts route guidance.

To cancel the dialog:

- ▶ Press .

You have canceled the dialog. The system confirms cancellation by saying “Cancel”.

Commands for entering parts of an address







“Enter town”

The “Enter town” command is used to enter any larger town or city in the USA or Canada.

-  If the desired town/city does not appear on the list of towns/cities, the town or city can be entered by using the “Spell town” command.

-  You can scroll through the list by using the “Continue” or “Back” command. Say “Correction” to enter the town or city again.

Sample dialog:

-  Enter town
-  Please spell the name of the town
-  E-A-S-T-O-N
-  The system displays a numbered list of available city names
-  Please select a line number
-  Number one
-  Number one, town accepted







The city selected is adopted for route guidance.

“Spell town”

Use the command “Spell town” to enter a city name by spelling mode and see if it matches an entry available on the navigation DVD.

Speak the characters as a continuous string (five to seven characters). The system then displays a list of cities on the COMAND display from which you can select the desired city.

Sample dialog:

-  Spell town
-  Please spell the town name
-  N-E-W-Y-O-R
-  The system displays a numbered list of available city names
-  Please select a line number
-  Number one
-  Number one, town accepted

The city selected is adopted for route guidance.

-  You can use the commands “Continue” or “Back” to scroll up or down in the list. Use the command “Correction” to start over again by spelling the name of the town.

-  You must also spell foreign towns or cities in English. Please note that the list on the



Voice Control navigation

COMAND display is sorted according to the probability of the voice recognition.







Speak each character as clearly as you can, especially when they sound very similar (d or e).

“District” or “Center”

Use the command “District” or “Center” to spell a city location in the city previously selected.

Speak the characters as a continuous string (five to seven characters). The system then displays a list of available city districts or centers on the COMAND display. Select the desired city center from that list.

Sample dialog:

-  District
-  Please spell the center
-  S-T-A-T-E-N-I-S
-  The system displays a list of available districts if more than one name matches the name of a district for the given city
-  Please select a line number
-  Number one
-  Number one, center accepted







The district selected is adopted for route guidance.

“Street”

Use the command “Street” to spell and select a street for the adopted city. Only street names available on the navigation DVD can be selected.

Speak the characters as a continuous string (five to seven characters). The system then displays a list of available street names on the COMAND display. Select the desired street name from that list.

Sample dialog:

-  Street
-  Please spell the name of the street
-  F-O-R-E-S-T
-  The system displays a numbered list of available street names
-  Please select a line number
-  Number one
-  Number one, street accepted









The street name selected is adopted for route guidance.

“Intersection”, “Cross street”

Use the command “Intersection” or “Cross street” to spell and select an intersection.

Speak the characters as a continuous string (five to seven characters). The system then displays a list of available intersections on the COMAND display. Select the desired intersection from that list.

Sample dialog:







-  Intersection
-  Please spell the first street name
-  F-O-R-E-S-T
-  Please spell the name of the crossing street
-  D-U-D-L-E-Y
-  The system displays a numbered list of available intersections on the COMAND display
-  Please select a line number
-  Number one
-  Intersection accepted

The intersection is adopted for route guidance. If an address at the intersection is recognized, the system asks if it is correct. Say “Yes” or “No”.

“House number”

Use the command “House number” to select a house number for the street previously selected. Speak the house number in single digits.

Sample dialog:

-  House number
-  Please say the house number in single digits
-  Three two
-  Is three two correct?
-  OK
-  House number accepted

The house number is adopted for route guidance.

Voice Control telephone

Safety notes

-  For more information on telephone, see ([▷ page 404](#)) and ([▷ page 151](#)).

Safety notes for using the Voice Control System

-  **Observe Safety notes, see [page 248](#).**

Safety notes for using the telephone

-  **Observe Safety notes, see [page 151](#).**

Telephone operation

The Voice Control System gives you the following capabilities:

- Entering a telephone unlock code.
- Dialing a phone number by speaking the telephone number.
- Storing names and numbers in the COMAND address book.
- Dialing a phone number by speaking the name of an COMAND address book entry.

Voice Control telephone

- Deleting an address book entry from the address book.
- Having the system read out the phone book of the address book entry by entry.
- Managing and accessing an automated answering system/voice mail box.
- Redialing names and numbers.

The Voice Control System detects whether

- your telephone is switched on
- the corresponding mobile network is logged in
- it is possible to dial

If dialing is not possible, the Voice Control System will advise you accordingly.

-  You can continue operating your mobile phone using the telephone keypad or keypad on your phone.

Before you can operate the telephone using the Voice Control System, you have to activate the Voice Control System ([▷ page 251](#)).

Voice Control telephone

Telephone commands

For a complete list of commands, see (> page 271).

“Telephone”

Use the command “Telephone” to activate the telephone main menu. Use this command if you want the digits you are entering to appear on the COMAND display.

“Help telephone”

The Voice Control System features a comprehensive help function.

Use the command “Help telephone” and the Voice Control System will read out an option list of available functions and commands that can be used in conjunction with the telephone (> page 93).

“Enter PIN”

i The PIN (only GSM mobile phones) prompt starts automatically whenever the phone is locked and you wish to use it.

Use the command “Enter PIN” to input the code to unlock your telephone. After speaking the command, you are prompted to enter the code.





Speak the code

- as a continuously spoken string of digits, or
- in digit blocks (three to five digits in each block).

Digits from “Zero” to “Nine” may be used.

After each digit block (separate the digit blocks by using an approximately 0.5 second pause), the Voice Control System repeats the recognized digits and waits until you continue speaking.

Sample dialog:

-  Enter PIN
-  Please say the PIN
-  Zero zero one one
-  Zero zero one one
-  OK

“Dial number”

You can dial a phone number using the command “Dial number”.

Digits from “Zero” to “Nine” may be used.









The phone number must be spoken

- as a continuously spoken string of digits, or
- in digit blocks (three to five digits in each block).

After each digit block (separate the digit blocks by using an approximately 0.5 second pause), the Voice Control System repeats the recognized digits and waits until you continue speaking.

When dialing 1-800 numbers, you may pronounce the first four digits as “One eight hundred” and the system will recognize the spoken entries as “One eight zero zero”. All other numeric entries must be spoken as individual numbers.

Sample dialog:

-  Dial number
-  Please say the number
-  One two three
-  One two three
-  Four five six seven
-  Four five six seven
-  OK
-  Dialing











i You can also dial the telephone number spoken by pressing buttons on the multifunction steering wheel (instead of using the command “OK”): You can dial the telephone number before all numbers are recited in full.

Voice Control telephone

“Confirm”

Using the command “Confirm” will repeat all digits spoken up to that point. Upon repeating the digits, the system will prompt you to continue your input.













Sample dialog:

-  Dial number
-  Please say the number
-  One two three
-  One two three
-  Confirm
-  One two three, please continue
-  Four five six seven
-  Four five six seven
-  OK
-  Dialing

“Correction”

Using the command “Correction” will correct the last entered digit block. After speaking the command, the last digit block is deleted and all previously entered digits are repeated. The system then prompts you to continue your input.





Sample dialog:









-  Dial number
-  Please say the number
-  One two three
-  One two three
-  Four five six seven
-  Five five six seven
-  Correction
-  One two three, please continue
-  Four five six seven
-  Four five six seven
-  OK
-  Dialing

“Delete”

Using the command “Delete” will erase all digits entered. The system then prompts you to start your input again.

Sample dialog:

-  Dial number
-  Please say the number
-  One two three
-  One two three
-  Four five six seven

-  Four five six seven
-  Delete
-  Number deleted. Please enter the number again
-  Four two seven three
-  Four two seven three
-  Three nine one
-  Three nine one
-  OK
-  Dialing

“Redial”

Use the command “Redial” to dial the last dialed number.

“Save name” (COMAND address book)

Use the command “Save name” to create a new entry in your COMAND address book. After using the command, the system will prompt you to enter a phone number. Digits from “Zero” to “Nine” can be entered (▷ page 260).

Speak the telephone number

- as a continuous string



Voice Control telephone

or, with longer phone numbers,

- in digit blocks (three to five digits in each block).















After each digit block (separate the digit blocks by using an approximately 0.5 second pause), the Voice Control System repeats the recognized digits and waits until you continue speaking.

After the command “OK”, you will be prompted up to two times to input the name. When repeating the name, make sure that you pronounce it in the same manner as during the first input. Otherwise the name cannot be saved and the Voice Control System cancels the save procedure.

- The Voice Control System may recognize names even if not saved in your voice. For optimum call-up performance, however, you should speak and save the names you intend to use yourself.

- You can also add a name to an entry by calling up the corresponding menu on COMAND and saying the name twice (▷ page 178).



Sample dialog:

-  Save name
-  Please say the number first
-  One two three
-  One two three
-  Four five six seven
-  Four five six seven
-  OK
-  Please say the name
-  John Smith
-  Please repeat the name
-  John Smith
-  Do you want to save the number in a category?
-  No
-  Name and number saved



“Dial name” (COMAND address book)

Use the command “Dial name” to place a phone call by selecting a name previously saved in your personal address book.

Sample dialog:

-  Dial name
-  Please say the name
-  John Smith

If several telephone numbers exist for the same entry, the Voice Control System will ask for clarification.

-  Do you want to place a work call or a home call?
-  Work
-  John Smith work
Dialing

“Call <voice entry>” (address book)

Use the command “Call <voice entry>” to place a phone call by directly selecting a name previously stored in your address book. One address book entry can have up to three different telephone numbers (mobile phone/car/land line) for both the home and work fields.

If only one telephone number is stored for a given name, you can recall the entry using the command “Call John Smith”.

If several telephone numbers are associated with one entry, you can recall the desired telephone number by using the following commands:

- “Call John Smith home”
- “Call John Smith work”
- “Call John Smith home cell phone”

Voice Control telephone

- “Call John Smith home car”
- “Call John Smith home land line”
- “Call John Smith work cell phone”
- “Call John Smith work car”
- “Call John Smith work land line”

The system confirms your input and the number is dialed.

Sample dialog:

 Call John Smith
If several telephone numbers exist for the same entry, the Voice Control System will ask for clarification.

 Do you want to place a work call or a home call?

 Work

 John Smith work
Dialing

“Delete name” (COMAND address book)

Use the command “Delete name” to delete a name from the COMAND address book.

Sample dialog:

 Delete name

 The name, please

 Smith office

 Smith office: Would you like to delete the voice name?

 Yes

 The voice name is deleted

“List phone book” and dialing a phone number

Use the command “List phone book” to listen to all voice entries in the phone book with a phone number stored, and select an entry and dial that number.

Sample dialog:

 List phone book

The system reads out the complete phone book entry by entry.

Selecting an entry and dialing that number

- ▶ For the desired entry, press  during or immediately after voice output.
If more than one phone number exists for a given entry, the Voice Control System prompts:

 Do you want to place a work call or a home call?

 Home

The system reads out the name of the selected entry and dials the corresponding number.

Canceling the dialog

- ▶ Press .

The system confirms “Cancel”. The dialog is concluded.

Managing automated answering system/voice mail box

Activate the Voice Control System to access and manage your answering machine/voice mail box.

- ▶ Activate the Voice Control System during a phone call (▷ page 251).
An acoustic signal confirms the activation of the system.
- ▶ Speak the required digits (“Zero” to “Nine”).

or

- ▶ Speak the required words “Star” and “Pound”.
- ▶ Speak the final command “OK”.
The system dials the number entered.

Voice Control address book

Voice Control address book

Safety notes

Warning!

Please devote your attention first and foremost to the traffic situation you are in. Before your journey, please familiarize yourself with the address book functions. Only use the Voice Control System when road and traffic conditions permit you to do so. Otherwise you could be involved in an accident in which you or others could be injured.

COMAND address book overview

The Voice Control System address book function gives you the capability to store names and associated phone numbers and address information.

You can store up to 80 speaker-dependent voice entries in the Voice Control System address book.

Using these voice entries, you can dial a phone number stored in address book or start route guidance to an address stored in the address book. Available commands are dependent on the status of the address book.

The address book can be in one of the following status:



- Address book not open
- Address book open

Operation with address book not open (global)

The Voice Control System gives you the following capabilities:

- Storing a name (▷ page 261).
- Dialing a name (▷ page 262).
- Deleting a name (▷ page 263).
- Navigating to an entry (▷ page 255).
- Listing address book (▷ page 265).
- Listing phone book of the address (▷ page 263).
- Listing address book destination memory (▷ page 256).
- Deleting the address book (▷ page 265).
- Opening the address book.

Opening address book

- ▶ Press .
- ▶ Speak the command “Address book”.
- ▶ Press .
- ▶ Speak one of the address book commands described below.

Operation with address book open (local)

In addition to the capabilities listed when the address book is not open, the address book opened allows you to:

- open an entry using the corresponding voice entry
 - open any entry by spelling the name
- ▶ **Opening entry:** Speak the command “Open entry”.

Voice Control address book

Operating and using address book

- ▶ Press .
- ▶ Speak one of the following commands depending on the address book status (open or not open).

Available commands with the address book not open

For a complete list of commands, see (▷ page 271).

“Help address book”

Use the command “Help address book” to have the Voice Control System read out an option list of all available commands for the address book.

“Save name”

For information to “Save name”, see (▷ page 261).

“Dial name”

For information to “Dial name”, see (▷ page 262).







“Call <voice name>”

For information to “Call <voice name>”, see (▷ page 262).

“Delete name” (address book)

Use the command “Delete name” to delete a voice name from your address book.

Sample dialog:

-  Delete name
-  Please say the name
-  John Smith
-  Do you want to delete John Smith?
-  Yes
-  The voice name is deleted

“Navigate to <voice entry>” (address book)

For information to “Navigate to <voice entry>”, see (▷ page 255).



“List address book”

Use the command “List address book” to have the system read out all available address book entries and, if desired, select an entry when it is being read.

Sample dialog:

-  List address book

The system reads out all available address book entries.

- ▶ **Selecting address book entry:** When the system reads the desired entry, press . The entry is selected and shown on the COMAND display.
- ▶ **Canceling the dialog:** Press . You have canceled the dialog. The system reads out “Cancel”.

“List phone book” and dialing a phone number

For information to “List phone book” and dialing a phone number, see (▷ page 263)

“List destination memory”

For information to “List destination memory”, see (▷ page 256).

“Delete address book”

Use the command “Delete address book” to delete all or individual voice names of the address book entries. Only the voice name is



Voice Control address book

deleted; the remaining data in the entry are retained.

“Address book”

Use this command to open the address book.

Available commands with the address book open

“Help address book”

Use the command “Help address book” to have the Voice Control System read out an option list of all available commands for the address book.

“Open <voice name>”

Use the command “Open <voice name>” to open an entry in your address book that has a voice name already assigned to it.





Sample dialog:

-  Open John Smith
-  The entry John Smith appears on the COMAND display

“Select entry”

Use the command “Select entry” to open an entry in your address book.

Sample dialog:

-  Select entry
-  Please say the name
-  John Smith
-  The entry John Smith appears on the COMAND display.





“Spell entry”



Use the command “Spell entry” to open an address book entry by spelling the name.

Speak the name as a continuous string (five to seven characters).

The system will display a list of possible matches on the COMAND display from which you can select the desired entry.

Sample dialog:

-  Spell entry
-  Please spell the name
-  S-M-I-T-H
-  The system displays a numbered list of matching entries on the COMAND display

-  Please select a line number
-  Number two
-  The system opens the entry associated with line number two on the list

i You can use the commands “Continue” or “Back” to scroll up or down the next page. Use the command “Correction” to exit the current selection list and spell the name again.

Voice Control radio

Voice Control radio

Safety notes

 **Warning!**

Please devote your attention first and foremost to the traffic situation you are in. Before your journey, please familiarize yourself with the radio functions.

Only use the Voice Control System when road and traffic conditions permit you to do so. Otherwise you could be involved in an accident in which you or others could be injured.

Radio operation



The Voice Control System gives you the capability to:

- Selecting a station.
- Seeking a station.
- Selecting a specific frequency.
- Saving up to 20 stations in your station list.
- Selecting frequency band (FM or AM).
- Selecting weatherband.
- Switching to satellite radio.

- Deleting station (from station list).
- Listing the station list.
- Deleting the station list.

To operate the radio using the Voice Control System, the Voice Control System must be activated (▷ page 251).

Selecting radio mode

- ▶ Press .
- ▶ Speak the command “Radio”.
- ▶ Press .
- ▶ Speak one of the radio commands. The system switches to the last tuned station in the selected band.

Radio commands

For a complete list of commands (▷ page 271).

“Help Radio”

Use the commands

- “FM”
- “AM”
- “Weatherband”

to select the desired frequency band or switch the radio to the weatherband.

“Sat Radio”

Use this command for switching on the satellite radio.

“Next station” or “Previous station”

The following commands are used to start the station search and to tune in the next station:

- “Next station”
- “Previous station”

Selecting frequency (FM, AM only)

You may, for example, select a frequency in the FM band (87.9 to 107.9 Megahertz) directly using a verbal command such as “Ninety-five five”. The Voice Control System also recognizes the words “frequency”, “point” and “megahertz”. You may for example use the command “Frequency ninety-five point five”.

Sample dialog:

 Ninety-five point five

Voice Control radio

The Voice Control System tunes the radio to frequency FM 95.5.





“Save station” (List saved stations)



Use this command to save the set station (AM and FM only) by name in your personal station list. After using this command, the Voice Control System will prompt you to repeat the name two to four times before it is saved in the station list. When repeating the station name, make sure that you pronounce it in the same manner as during the first input. Otherwise the name cannot be saved and the Voice Control System cancels the save procedure.

i The Voice Control System may recognize names even if not saved in your voice. For optimum performance, however, call up only names you have saved yourself.

i You can freely select the station name, for example “Favorite station”.

Sample dialog:



-  Save station
-  Please say the station name
-  Smooth Jazz
-  Please say the station name again

-  Smooth Jazz
-  The station Smooth Jazz has been saved

“Select station” (List saved stations)

Use the command “Select station” (AM and FM only) to select a saved station name from your station list.

Sample dialog:

-  Select station
-  Please say the station name
-  Smooth Jazz

The Voice Control System tunes to the corresponding frequency.

“Station Smooth Jazz” (List saved stations)

Use this command (AM and FM only) to directly select a saved station name from your station list.

Sample dialog:

-  Station Smooth Jazz

The Voice Control System tunes to the corresponding station.

i If the Voice Control System does not recognize the station name you requested, please refer to the section “List station list”. By following the dialog, you can check and determine if the name is saved in the station list.

“List station list” and select station from list



Use this command to list the entire station list, or to select an entry from the station list.

Sample dialog:

-  List station list

The Voice Control System reads out the entire list.







To select a station:

- ▶ Press , when the system reads the desired station.
- ▶ **Canceling the dialog:** Press . The dialog is concluded. The system confirms “Cancel”.

“Delete station” (List saved stations)

Use the command “Delete station” (AM and FM only) to delete a station from your personal station list.







Sample dialog:

-  Delete station
-  Which station do you want to delete?
-  Smooth Jazz
-  Do you want to delete Smooth Jazz?
-  Yes
-  Station deleted

“Delete station list”

Use this command to delete the complete station list or one or more stations from the station list.

Sample dialog:

-  Delete station list
-  Do you want to delete all voice names from the station list?
-  Yes
-  Are you sure?
-  Yes
-  All voice names have been deleted from the station list

The system deletes the complete station list. The deletion of the station list cannot be undone.

or



-  No

The system starts reading the station list.

When the system reads the station to be deleted:

- ▶ Press  .

The station to be deleted is selected. The name of the selected station is read out once more.

-  Do you want to delete Smooth Jazz?
-  Yes
-  Station deleted

The station is erased and the remaining station entries are read out.

or

-  No

The system continues reading the station list entry by entry.

Voice Control CD/DVD changer/MP3**Voice Control CD/DVD changer/MP3****Safety notes****⚠ Warning!**

Please devote your attention first and foremost to the traffic situation you are in. Before your journey, please familiarize yourself with the audio functions. Only use the Voice Control System when road and traffic conditions permit you to do so. Otherwise you could be involved in an accident in which you or others could be injured.

Operation

The Voice Control System gives you the ability to:

- Selecting a CD/DVD/medium.
- Selecting a track.
- Selecting a folder in MP3 mode.
- Selecting a group in audio-DVD mode.

i The following commands “Next/Previous CD/DVD” and “CD/DVD 1” to “CD/DVD 6”, cause the DVD changer to switch from one slot to another, regardless of the





Voice Control CD/DVD changer/MP3

type of medium found in the selected slot. In your command, you can therefore replace the term “CD/DVD” with “Medium”.

To operate the DVD changer using the Voice Control System, the Voice Control System must be activated (▷ page 251).

Selecting CD mode

- ▶ Press .
- ▶ Speak one of the following commands:
 - “CD”
 - “DVD”
 - “MP3”
- ▶ Press .
- ▶ Speak one of the following commands.

Commands

For a complete list of commands, see (▷ page 271).

“Help CD”, “Help DVD” or “Help MP3”

Use the commands

- “Help CD”
- “Help DVD”
- “Help MP3”

and the Voice Control System will read out a complete list of available commands for the CD, DVD or MP3.

“CD/DVD/Medium 1” to “CD/DVD/Medium 6”

Use commands “CD/DVD/Medium 1” to “CD/DVD/Medium 6” to select one of up to six mediums in your DVD changer.

“Next CD/DVD/Medium”

Use the command “Next CD/DVD/Medium” to select the next available medium in the DVD changer.

“Track 1” to “Track 39”

Use the commands “Track 1” to “Track 39” to select one of up to 39 title numbers of a loaded medium.

“Next track”

Use the command “Next track” to select the next track.

“Previous track” or “Repeat track”

Use the command “Previous track” or “Repeat track” to play again the track you are listening to.

“Group 1” to “Group 9”

The “Group 1” to “Group 9” commands are used to select a group on the inserted audio-DVD.

“Next group”/“Previous group”

The “Next group”/“Previous group” commands are used to select a group on the inserted audio-DVD.

“Memory card”

The “Memory card” command is used to switch from the DVD drive to the PCMCIA card.

“Drive”

The “Drive” command is used to switch from the PCMCIA card to the DVD drive.

Voice Control command list

Chapter “Command list” gives you an overview of all commands available for use to control the Voice Control System. Which commands are available for use depends on the equipment level in your vehicle.

- ❶ Some functions can be operated using several different commands. In the following list, these commands are grouped in one cell. Choose your preferred command from those available.

General commands

- yes
- right
- ok
- cancel
- stop
- quit
- abort
- terminate
- no
- no thank you

Voice Control command list

- address book
- MP3
- CD
- navigation
- route guidance
- audio DVD
- radio
- sat radio
- satellite radio
- telephone
- messages
- SMS
- vehicle
- correction
- wrong
- incorrect

Voice Control command list

- help
- help please
- please help

- help functions
- help devices

- help voice control
- linguatronic help
- general help

- help permanent commands
- help global commands

- letters of the English alphabet

- digits 0 - 9

- continue
- go forward
- next page

- back
- go back
- previous page

- help radio
- help tuner
- radio help
- tuner help

- help telephone
- help phone

- help address book

- help CD
- help disc
- help CD player

- help CD changer

- help audio DVD
- help DVDA
- help DVD audio
- help DVD audio player

- help DVD audio changer

- help navigation
- help nav
- help navi
- help route guidance
- help routing
- help destination guidance

Telephone commands

- telephone (on)
- phone (on)
- telephone off

Voice Control command list

- save
- save PIN
- save PIN code
- save number
- save PIN number
- save telephone number
- save name
- save password
- store PIN
- store PIN code
- store number
- store PIN number
- store telephone number
- store name
- store password

- dial
- dial PIN
- dial number
- dial PIN number
- dial PIN code
- dial phone number
- dial telephone number
- dial password
- dial unlock code
- confirm
- confirm PIN
- confirm number
- confirm PIN number
- confirm PIN code
- confirm phone number
- confirm telephone number
- confirm password
- confirm unlock code

- repeat PIN
- repeat number
- repeat PIN number
- repeat PIN code
- repeat phone number
- repeat telephone number
- repeat password
- repeat unlock code
- enter PIN
- enter PIN code
- enter PIN number
- enter code
- enter unlock code
- list phone book
- read out phone book
- play phone book
- get phone book
- recall phone book
- redial
- redial last number
- redial last phone number

Voice Control command list

- correction
 - wrong PIN
 - wrong number
 - wrong PIN number
 - wrong PIN code
 - wrong phone number
 - wrong telephone number
 - wrong unlock code
 - incorrect PIN
 - incorrect number
 - incorrect PIN number
 - incorrect PIN code
 - incorrect phone number
 - incorrect telephone number
 - incorrect unlock code
-
- delete
 - delete PIN
 - delete number
 - delete PIN number
 - delete PIN code
 - delete phone number

- delete telephone number
- delete unlock code

Navigation commands

- navigation
 - nav
 - navi
 - route guidance
 - routing
 - destination guidance
-
- guidance instructions on
 - switch guidance instruction on
 - switch guidance instructions on
 - switch route guidance instruction on
 - switch route guidance instructions on
 - switch on guidance instruction
 - switch on guidance instructions
 - switch on route guidance instruction
 - switch on route guidance instructions

- guidance instructions off
 - switch guidance instructions off
 - switch route guidance instructions off
 - switch off guidance instructions
 - switch off route guidance instructions
 - mute guidance instructions
 - mute route guidance instructions
-
- house number
 - enter house number
-
- map (on)
 - show map
 - switch on map
-
- zoom in
 - zoom in on map
-
- zoom out
 - zoom out on map
-
- zoom in completely
 - zoom out completely

Voice Control command list

- enter country
- enter another country
- spell country
- spell another country
- change country
- change another country

- intersection
- spell intersection
- spell cross street
- enter intersection
- enter cross street

- last destinations

- last states
- last provinces

- spell town
- spell city
- spell name of town
- spell name of city

- enter town
- enter city
- enter name of town
- enter name of city

- district
- center
- spell district
- spell center
- enter district
- enter center

- points of interest
- enter points of interest
- enter point of interest
- enter POI
- enter POIs

- street
- spell street
- spell name of street
- enter street
- enter name of street

- enter destination
- destination entry
- destination input
- address entry
- address input

- save destination
- save address
- store destination
- store address

Voice Control command list

- start route guidance
- start navigation
- start nav
- start routing
- begin route guidance
- begin navigation
- begin route guidance
- begin routing
- continue route guidance
- continue navigation
- continue nav
- continue routing
- destination guidance on

- cancel route guidance
- cancel navigation
- cancel nav
- cancel routing
- cancel destination guidance
- exit route guidance
- exit navigation
- exit nav
- exit routing
- exit destination guidance
- terminate route guidance
- terminate navigation
- terminate nav
- terminate routing
- terminate destination guidance
- next gas station

- next Mercedes-Benz service
- next workshop
- next MB service
- next MB service point
- next MB service center
- next Mercedes service
- next Mercedes service point
- next Mercedes service center
- next Mercedes-Benz service point
- next Mercedes-Benz service center
- next service point
- next service center
- next hospital
- next parking lot
- next restaurant

Voice Control command list

Address book commands

- address book (on)
- address list (on)
- addresses (on)
- list address book
- read out address book
- get address book
- recall address book
- delete address book
- spell entry
- spell name
- spell heading
- search entry
- search name
- search heading
- open entry
- show entry
- list entry
- select entry
- get entry
- open entry
- open page
- open item
- open name
- open <voice name>
- delete name
- delete
- list destination memory
- read out destination memory
- play destination memory
- get destination memory
- recall destination memory
- <voice name>
- <voice name> car
- <voice name> car phone

- <voice name> land line
- <voice name> phone
- <voice name> telephone
- <voice name> cell phone
- <voice name> mobile phone
- <voice name> cellular phone
- call <voice name>
- call <voice name> work
- call <voice name> office
- call <voice name> business
- call <voice name> company
- <voice name> home
- call <voice name> home
- work
- office
- business
- company
- car
- car phone

Voice Control command list

- land line
- land line phone
- land line telephone
- cell phone
- mobile phone
- cellular phone
- work car (phone)
- office car (phone)
- business car (phone)
- company car (phone)
- car (phone) work
- car (phone) office
- car (phone) business
- car (phone) company
- work land line
- office phone
- land line phone business
- land line telephone company

- work cell phone
- office mobile phone
- business cellular phone
- cell phone company
- home
- home car
- home car phone
- car home
- car phone home
- home land line
- home land line phone
- land line home
- land line phone home
- home cell phone
- home mobile
- cell home
- cell phone home
- mobile home
- mobile phone home
- cellular home
- cellular phone home

- call <voice name> work car
- call <voice name> work land line
- call <voice name> work cell phone
- call <voice name> home car
- call <voice name> land line phone
- call <voice name> cell phone home
- navigate to <voice name>
- drive to <voice name>
- navigate to <voice name> work
- navigate to <voice name> home
- dial name
- dial voice name
- save name
- save voice name
- save number
- save telephone number
- store voice name
- store number
- store telephone number

Voice Control command list

- accept
 - accept PIN
 - accept PIN code
 - accept lock code
 - accept PIN number
 - accept number
 - accept telephone number
 - accept name
 - accept password
 - OK
 - finished
- <1> - <8>
 - use <1> - <8>
 - number <1> - <8>
 - line <1> - <8>

Audio commands

- audio
- audio off

Radio

- radio (on)
- AM
- MW
- FM
- weatherband
- next station
- station search
- going up
- other station
- radio seek
- station <voice entry>
- go to <voice entry>
- <voice entry>
- delete station

- save station
- store station
- select station
- select channel
- list station list
- list saved stations
- read out station list
- play station list
- get station list
- recall station list
- delete station list
- previous station
- last station
- coming down
- station search coming down

Voice Control command list

Example: 95.5 FM

- ninety-five five
- ninety-five five megahertz
- ninety-five point five
- ninety-five point five megahertz
- frequency ninety-five five
- frequency ninety-five point five
- frequency ninety-five five megahertz
- frequency ninety-five point five megahertz

Example: 540 AM

- five-hundred-forty
- five-hundred-forty kilohertz
- frequency five-hundred-forty
- frequency five-hundred-forty kilohertz

Satellite radio

- sat radio
- satellite radio

CD

- CD (on)
- CD player (on)
- CD changer (on)

- next CD
- other CD
- next medium
- other medium

- previous CD
- last CD
- preceding CD
- replay CD
- replay medium
- repeat medium
- last medium
- previous medium

- next track
- other track
- previous track
- last track
- repeat track
- replay track

- track 1-39
- load track 1-39
- load track number 1-39
- select track 1-39
- select track number 1-39

- CD 1-6
- CD number 1-6
- medium 1-6
- medium number 1-6

Voice Control command list

MP3

- MP3 (on)
- MP3 player (on)
- MP3 changer (on)
- next MP3
- other MP3
- next medium
- other medium

- previous MP3
- last MP3
- preceding MP3
- replay MP3
- replay medium
- repeat medium
- last medium
- previous medium

- next directory
- other directory

- next folder
- other folder

- previous directory
- previous folder
- last directory
- last folder
- repeat directory
- repeat folder

- next track
- other track

- previous track
- last track
- repeat track
- replay track

- track 1-39
- load track 1-39
- load track number 1-39
- select track 1-39
- select track number 1-39

- MP3 1-6
- MP3 number 1-6
- medium 1-6
- medium number 1-6
- drive
- memory card

DVD

- audio DVD
- DVDA player (on)
- audio DVD player (on)
- DVD audio player (on)
- DVDA changer (on)
- audio DVD changer (on)
- DVD audio changer (on)
- next DVDA
- other DVDA

Voice Control command list

- next DVD audio
 - other DVD audio
 - next audio DVD
 - other audio DVD
 - next medium
 - other medium
-
- previous DVDA
 - last DVDA
 - preceding DVDA
 - replay DVDA
 - previous DVD audio
 - last DVD audio
 - preceding DVD audio
 - replay DVD audio
 - previous audio DVD
 - last audio DVD
 - preceding audio DVD
 - replay audio DVD

- replay medium
- repeat medium
- last medium
- previous medium

- next directory
- other directory
- next folder
- other folder

- previous directory
- previous folder
- last directory
- last folder
- repeat directory
- repeat folder

- next group
- other group

- previous group
- previous repeat group
- previous replay group
- last group
- last repeat group
- last replay group
- group 1-9
- select group 1-9
- group number 1-9
- select group number 1-9

- next track
- other track

- previous track
- last track
- repeat track
- replay track

- track 1-39
 - load track 1-39
 - load track number 1-39
 - select track 1-39
 - select track number 1-39
-
- DVDA 1-6
 - DVDA number 1-6
 - DVD audio 1-6
 - DVD audio number 1-6
 - audio DVD 1-6
 - audio DVD number 1-6
 - medium 1-6
 - medium number 1-6

Voice Control troubleshooting

Help function

To support the user, the Voice Control System contains an extensive help function.

The help function gives you:

- general hints on how to best use the Voice Control System
- a listing of all available commands

Help commands

“Help voice control”

Using the command “Help voice control” will give you information on how to best use the Voice Control System.

“Help”

In a main menu, help can be accessed at any time by saying the command “Help”. The Voice Control System will then read out the available functions and commands of all systems.

In a submenu, help can also be accessed at any time by saying the command “Help”. The Voice Control System will then read out an option list of all available functions and

Voice Control troubleshooting

commands available in the particular submenu.

You can also use the help function to access help for a specific system. To access help for the phone operation, you would speak the command “Help Telephone”.

If you wish to execute the last command read out:

▶ Press  .

Help window

You can use the help window to view a selection of valid commands on the COMAND display.

The help functions can be switched on or off via COMAND in the System settings menu (▷ page 93).

Voice Control troubleshooting

Entering digits and spelling

Entering digits

- Digits from “Zero” to “Nine” may be used.
- Speaking phone numbers in digit blocks of 3 to 5 digits has proven a very reliable method for the input of phone numbers.

Spelling

- The letters of the English alphabet and the digits 0 - 9 may be used.
- Speak the letters in blocks of 5 - 7 letters at a time.
- Speak each individual letter clearly.

What to do if ...

Problem	Possible cause/consequence	Suggested solution
Voice Control System does not recognize a station list entry.	The voice entries for the station names sound too similar.	<ul style="list-style-type: none">▶ When you create your address book entries, select names with the greatest possible acoustic differences.▶ Speak the command “List station list”. The system reads out the station list entry by entry.▶ Press  when the desired station name is being read out. The station is selected (▷ page 268).

Voice Control troubleshooting

Problem	Possible cause/consequence	Suggested solution
Should interference occur during the process of storing a name, the Voice Control System prompts you to repeat your voice entry a third and fourth time. If the interference continues, the dialog is stopped.	Both voice entries differ.	▶ Pronounce the voice entries both times in the same manner.
Voice Control System does not recognize commands.	You have not operated the system from the driver's seat.	▶ Operate the Voice Control System only by the driver as the microphone is geared to the driver side.
	You have spoken unclearly, too loudly or too quietly.	▶ Speak the commands in a continuous manner using a normal tone.
	A blower is set to the highest setting, vents are pointed at microphones or wind noise is being created through open windows.	▶ Avoid loud disturbances.

Voice Control troubleshooting

Problem	Possible cause/consequence	Suggested solution
Voice Control System does not recognize a address book entry.	The voice entries in the address book sound too similar.	<ul style="list-style-type: none">▶ When you create your address book entries, select names with the greatest possible acoustic differences: If for example you have the names Smith and Schmidt, choose for example “Smith work” or “Schmidt John”.▶ Speak the command “List phone book”. The system reads out the address book entry by entry.▶ Press  when the desired entry is being read out. The entry is selected and the corresponding number is dialed (▷ page 263).

Voice Control individualization

i The individualization can only be performed when the vehicle is stationary. If you drive off, the individualization will be canceled.

After starting the session, the system will guide you through the individualization by means of acoustic instructions.

The individualization is used to adapt the Voice Control System to your own voice and to therefore improve speech recognition. This does not affect the speech recognition of other users.

Individualization consists of two stages:

- Digits
- Commands

You can activate individualization in the COMAND system settings (> page 93). A dialog and screen displays will guide you through the individualization process.

The system can be reset to the factory settings at any time.

i You may wish to complete only a portion of the individualization process.

Completing the digits portion alone may result in an improved recognition rate.

Individualization can be exited at any time. The data trained, however, will only be retained if a given individualization portion is completed and the data is stored when prompted to do so by the system.

Vehicle equipment	290	Driving and parking	328
Locking and unlocking	290	Automatic transmission	335
Starter switch positions	301	Instrument cluster	345
Seats	303	Driving systems	346
Multifunction steering wheel	310	Climate control system	385
Mirrors	311	Rear window defroster	393
Memory function	314	Power tilt/sliding sunroof	394
Lighting	316	Loading and storing	396
Wipers	322	Useful features	401
Power windows	325		

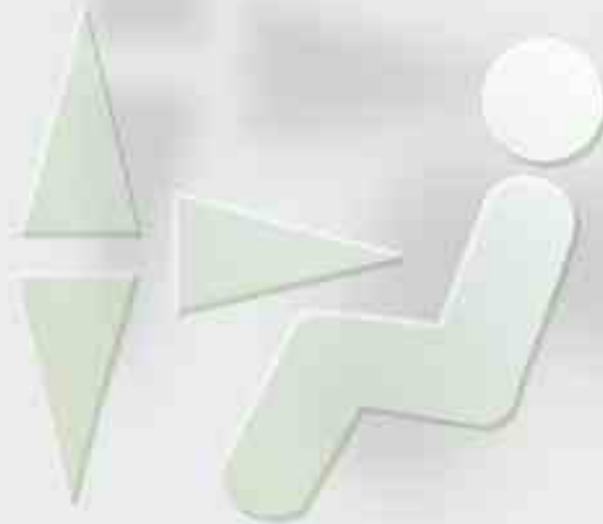

Locking and unlocking

Vehicle equipment

i This Operator's Manual describes all features, standard or optional, potentially available for your vehicle at the time of purchase. Please be aware that your vehicle might not be equipped with all features described in this manual.

Locking and unlocking

Notes

⚠ Observe Safety notes, see page 59.

When unlocking or locking the vehicle with the SmartKey an acoustic signal sounds. The acoustic signal is activated at the factory. If you wish to deactivate the feature, or adjust its signal volume, contact an authorized Mercedes-Benz Center.

When unlocking the vehicle, all turn signal lamps flash once, an acoustic signal sounds once, the locking knobs in the doors move up, and the anti-theft alarm system is disarmed.

When locking the vehicle, all turn signal lamps flash three times, an acoustic signal sounds three times, the locking knobs in the doors move down, and the anti-theft alarm system is armed.

All doors and the trunk must be closed.

! If you cannot lock or unlock the vehicle with the SmartKey, the batteries in the SmartKey are discharged, the SmartKey is malfunctioning, or the vehicle battery is drained.

- Check the batteries in the SmartKey and replace them if necessary.
- Use the mechanical key to unlock the driver's door and the trunk.
- Use the mechanical key to lock the vehicle.
- Have the vehicle battery and the vehicle battery connections checked at an authorized Mercedes-Benz Center.

If the SmartKey is malfunctioning, contact Roadside Assistance or an authorized Mercedes-Benz Center.

SmartKey



Your vehicle comes supplied with two SmartKeys, each with remote control and a removable mechanical key.

The SmartKey centrally locks and unlocks:

- the doors
- the trunk lid
- the fuel filler flap

Locking and unlocking



- ①  Lock button
- ②  Unlock button for trunk lid
- ③  Unlock button
- ④ Battery check lamp

When you open a door, the side windows on that side lowers slightly. Once you close the door, the window moves up again.

! A side window will not work if it is blocked with ice or if the vehicle battery is discharged. If you cannot shut a door, do not force it or you could damage the door or side window. Fix whatever is affecting the window before trying to shut the door.

1 USA only:

This device complies with Part 15 of the FCC Rules. Operation is subject to the following two conditions:

1. This device may not cause harmful interference, and
2. this device must accept any interference received, including interference that may cause undesired operation.

Any unauthorized modification to this device could void the user's authority to operate the equipment.



1 Canada only:

This device complies with RSS-210 of Industry Canada. Operation is subject to the following two conditions:

1. This device may not cause interference, and
2. this device must accept any interference received, including interference that may cause undesired operation of the device.





Any unauthorized modification to this device could void the user's authority to operate the equipment.

Factory setting

- ▶ **Global unlocking:** Press button  .
The vehicle will lock again automatically and rearm the anti-theft alarm system within approximately 40 seconds of unlocking if neither door nor trunk is opened.
- ▶ **Global locking:** Press button  .

Selective setting

If you frequently travel alone, you may wish to reprogramm the SmartKey so that pressing button  only unlocks the driver's door and the fuel filler flap.

- ▶ **Switching on/off:** Press and hold buttons  and  simultaneously for approximately 6 seconds until battery check lamp ④ (> page 291) flashes twice. The SmartKey will then function as follows:
- ▶ **Unlocking driver's door and fuel filler flap:** Press button  once.
- ▶ **Global unlocking:** Press button  .
- ▶ **Global locking:** Press button  .

Locking and unlocking

KEYLESS-GO

Vehicles equipped with KEYLESS-GO come with two SmartKeys with KEYLESS-GO, each with remote control and a removable mechanical key.

The KEYLESS-GO function is integrated into the SmartKey. The validity of the SmartKey is checked every time you grasp an outside door handle.

When the SmartKey is valid, your vehicle unlocks

- the doors
- the fuel filler flap
- the trunk lid

When you open a door, the side windows on that side lowers slightly. Once you close the door, the window moves up again.

! A side window will not work if it is blocked with ice or if the vehicle battery is discharged. If you cannot shut a door, do not force it or you could damage the door or side window. Fix whatever is affecting the window before trying to shut the door.

i USA only:

This device complies with Part 15 of the FCC Rules. Operation is subject to the following two conditions:

1. This device may not cause harmful interference, and
2. this device must accept any interference received, including interference that may cause undesired operation.

Any unauthorized modification to this device could void the user's authority to operate the equipment.

i Canada only:

This device complies with RSS-210 of Industry Canada. Operation is subject to the following two conditions:

1. This device may not cause interference, and
2. this device must accept any interference received, including interference that may cause undesired operation of the device.

Any unauthorized modification to this device could void the user's authority to operate the equipment.

Important notes on using KEYLESS-GO

- You can also use the SmartKey with KEYLESS-GO like a normal SmartKey (> page 290).
- You can combine KEYLESS-GO functions with normal SmartKey functions (e.g. unlocking with KEYLESS-GO and locking with button ).
- Always carry the SmartKey with you.
- Never store the SmartKey together with:
 - Electronic items such as a mobile phone or another SmartKey
 - Metallic objects such as coins or metal foilDoing so could impair the function of the KEYLESS-GO system.
- To lock or unlock the vehicle, the SmartKey must be located outside the vehicle within approximately 3 ft (1 m) of a door or the trunk.
- If the vehicle has been parked for more than 72 hours, you must pull an outside door handle in order to activate the KEYLESS-GO function.
- If the SmartKey is positioned farther away from the vehicle, the system may no longer recognize the SmartKey. The vehicle

Locking and unlocking

Factory setting

- cannot be locked or the engine started via the KEYLESS-GO system.
- If the SmartKey is removed from the vehicle (e.g. if a passenger exits the vehicle with the SmartKey)
 - when pressing the KEYLESS-GO start/stop button or trying to lock the vehicle with the outside door handle the message **Key Not Detected** appears in the multifunction display
 - with the engine running, the message **Key Not Detected** appears in the multifunction display while driving off
- Find the SmartKey or change its present location immediately (e.g. place it on the front passenger seat or insert it in shirt pocket).
- If you have started the engine with the KEYLESS-GO start/stop button, you can turn it off again by
 - pressing the KEYLESS-GO start/stop button
 - inserting the SmartKey into the starter switch when the vehicle is at a standstill and the automatic transmission is in park position **P**
- The vehicle could be inadvertently unlocked if the SmartKey is within 3 ft (1 m) of the vehicle and
 - an outside door handle is splashed with water
 - or
 - you attempt to clean an outside door handle
- Remember that the engine can be started by anyone with a SmartKey that is left inside the vehicle.

Possibility 1 (One SmartKey in the vehicle, one SmartKey outside the vehicle):

If you leave the SmartKey behind when exiting and locking the vehicle, no message appears in the multifunction display.

Possibility 2 (One SmartKey in the vehicle, no SmartKey outside the vehicle):

When exiting and trying to lock the vehicle, the message **Key Detected In Vehicle** appears in the multifunction display. The vehicle will not be locked.

- **Global unlocking:** Pull an outside door handle. The vehicle will lock again automatically and rearm the anti-theft alarm system within approximately 40 seconds if neither door nor trunk is opened.

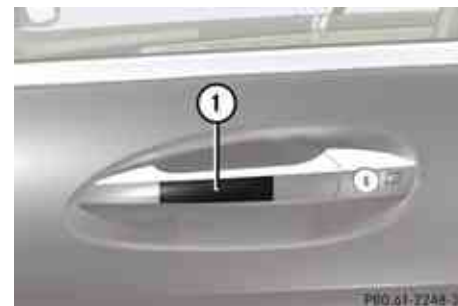



① Outside door handle

- **Global locking:** Touch outside of door handle ①.

Selective setting

If you frequently travel alone, you may wish to reprogram the SmartKey so when you pull the driver's outside door handle, only the driver's door and the fuel filler flap unlock. >>



Locking and unlocking

▶ **Switching on/off:** Press and hold buttons  and  simultaneously for approximately 6 seconds until battery check lamp ④ (▷ page 291) flashes twice.

The SmartKey will then function as follows:

- ▶ **Unlocking driver's door and fuel filler flap:** Pull the driver's outside door handle.
- ▶ **Global unlocking:** Pull the outside door handle on the passenger side.
- ▶ **Global locking:** Touch outside of door handle ①.



Checking SmartKey batteries

▶ Press button  or  on the SmartKey.
Battery check lamp ④ (▷ page 291) comes on briefly to indicate that the SmartKey batteries are in order.

If the battery check lamp does not come on briefly during check, the SmartKey batteries are discharged.

▶ Replace the batteries (▷ page 541).

- i** You can obtain the required batteries at any authorized Mercedes-Benz Center.
- i** If the batteries are checked within signal range of the vehicle, pressing button

 or  will lock or unlock the vehicle accordingly.

Loss of the SmartKey

If you lose your SmartKey or mechanical key, you should do the following:

- ▶ Have the SmartKey deactivated by an authorized Mercedes-Benz Center.
- ▶ Report the loss of the SmartKey or the mechanical key to your car insurance company immediately.
- ▶ Have the mechanical lock replaced if necessary.

Any authorized Mercedes-Benz Center will be glad to supply you with a replacement.

Opening the doors from the inside

You can open a locked door from the inside. Open door only when conditions are safe to do so.



Example illustration driver's door

① Locking knob

② Inside door handle

If the vehicle has previously been locked with the SmartKey or with KEYLESS-GO, opening a door from the inside will trigger the anti-theft alarm system.

To cancel the alarm, see (▷ page 76).

▶ Pull on inside door handle ② on the respective door.

If the door was locked, locking knob ① will move up.

Opening a door causes its window to open slightly. It will fully close when the door is shut.

Automatic central locking

The doors and the trunk lock automatically when the vehicle is set into motion.

You can open a locked door from the inside. Open door only when conditions are safe to do so.

The doors are designed to unlock automatically after an accident if the force of the impact exceeds a preset threshold.

The vehicle locks automatically when the ignition is switched on and the wheels are turning at vehicle speeds of approximately 9 mph (15 km/h) or more. You could therefore lock yourself out when the vehicle is pushed or towed or is on a test stand.

You can deactivate the automatic central locking using the COMAND system (► page 218).

Locking and unlocking from the inside

⚠ Observe Safety notes, see page 59.

You can lock or unlock the vehicle from inside using the central locking switches. This can be useful, for example, if you want to lock the vehicle before starting to drive.

The central locking switches do not lock or unlock the fuel filler flap or the interior storage compartments, such as the glove box.



- ① Central unlocking switch
- ② Central locking switch

Locking and unlocking

- **Locking:** Press central locking switch ②.
If the passenger door is closed, the vehicle locks.
- **Unlocking:** Press central unlocking switch ①.

You can open a locked door from inside at any time. Open door only when conditions are safe to do so.

If the vehicle was previously locked with the central locking switch:

- and the SmartKey is set to factory settings, the complete vehicle is unlocked when a door is opened from the inside
- and the SmartKey is set to selective settings, only the door opened from inside is unlocked

If the vehicle was previously locked centrally with the SmartKey or with KEYLESS-GO, it will not unlock using the central unlocking switch.

Locking and unlocking

Opening the trunk

Warning!

Make sure the trunk is closed when the engine is running and while driving. Among other dangers, deadly carbon monoxide (CO) gases may enter vehicle interior resulting in unconsciousness and death.

You can open the trunk when the vehicle is stationary.

A minimum height clearance of 5.90 ft (1.80 m) is required to open the trunk lid.

 The trunk lid swings open upwards automatically. Always make sure there is sufficient overhead clearance.

Opening the trunk from the outside

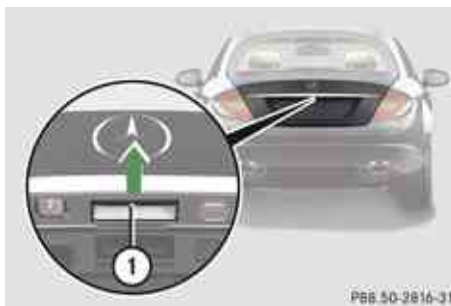

① Handle

▶ Press and hold button  on the SmartKey until the trunk unlocks and begins to open.

or

▶ Pull on handle ①.

In vehicles without KEYLESS-GO: The vehicle must be unlocked.

▶ **Stopping the opening procedure:** Press button  on the SmartKey.

Opening the trunk from the inside



① Remote trunk opening/closing switch

▶ Press and hold switch ① until the trunk begins to open.

▶ **To interrupt the opening procedure:** Press switch ①.

Trunk opening-height restriction

The trunk lid opening height can be limited when transporting goods on a roof rack (e.g. presence of an optional MB sport luggage container). When activated, the trunk opens to approximately the height of the roof edge.

▶ **Activating:** Use the COMAND system (▷ page 222).

Locking and unlocking

Closing the trunk

⚠ Warning!

Make sure the trunk is closed when the engine is running and while driving. Among other dangers, deadly carbon monoxide (CO) gases may enter vehicle interior resulting in unconsciousness and death.

⚠ Warning!

To prevent possible personal injury, always keep hands and fingers away from the trunk opening when closing the trunk lid. Be especially careful when small children are around.

⚠ Observe Safety notes, see page 59.

Do not leave the SmartKey in the open trunk. You may lock yourself out.

If the vehicle was previously centrally locked with the SmartKey or KEYLESS-GO, the trunk lid will lock automatically when closed. All turn signal lamps flash three times to confirm locking.

Vehicles with KEYLESS-GO:

To prevent a possible inadvertent lockout, the trunk lid will open automatically if a SmartKey

with KEYLESS-GO is recognized inside the vehicle or in the trunk.

The vehicle is only locked when the turn signal lamps flash three times. If you are carrying a second SmartKey with KEYLESS-GO with you, you can still lock the vehicle.

Closing the trunk from the outside manually



① Handle

- ▶ Lower trunk lid by pulling firmly on handle ①.
- ▶ Close trunk with hands placed flat on trunk lid.

The power closing assist automatically ensures that the trunk lid is pulled completely close (▷ page 300).

Closing the trunk from the inside automatically

⚠ Warning!

Maintain sight of the area around the rear of the vehicle while operating the trunk lid with the door mounted switch. Monitor the closing procedure carefully to make sure no one is in danger of being injured.

To interrupt the closing procedure, release the door mounted remote trunk opening/closing switch again.

Even with the SmartKey removed from the starter switch or the SmartKey with KEYLESS-GO removed from the vehicle, the remote trunk opening/closing switch can be operated. Therefore, do not leave children unattended in the vehicle, or with access to an unlocked vehicle. A child's unsupervised access to a vehicle could result in an accident and/or serious personal injury.

If the trunk lid comes into contact with an object while closing (e.g. luggage that has been piled too high) in the upper motion



Locking and unlocking

sequence, the closing procedure is stopped and the trunk reopens slightly.



① Remote trunk opening/closing switch

- ▶ Press and hold switch ① until the trunk is closed.

To interrupt the closing procedure:

- ▶ Release switch ①.

Closing the trunk from the outside automatically

Warning!

Monitor the closing procedure carefully to make sure no one is in danger of being injured. To prevent possible personal injury, always keep hands and fingers away from the trunk opening when closing the

trunk lid. Be especially careful when small children are around. To stop the closing procedure, do one of the following:

- Press button  on the SmartKey.
- Press the remote trunk opening/closing switch (on the driver's door).
- Press the trunk closing switch.
- Press the KEYLESS-GO locking/closing switch.
- Pull the trunk lid handle.

Even with the SmartKey removed from the starter switch or the SmartKey with KEYLESS-GO removed from the vehicle, the remote trunk opening/closing switch can be operated. Therefore, do not leave children unattended in the vehicle, or with access to an unlocked vehicle. A child's unsupervised access to a vehicle could result in an accident and/or serious personal injury.



Vehicles without KEYLESS-GO

① Trunk closing switch



Vehicles with KEYLESS-GO

① Trunk closing switch

- ▶ Press switch ① briefly.

Locking and unlocking

If the trunk lid comes into contact with an object while closing (e.g. luggage that has been piled too high) in the upper motion sequence, the closing procedure is stopped and the trunk lid reopens slightly.

Closing the trunk and locking vehicle from outside

You can close the trunk and lock the vehicle simultaneously from the outside using the KEYLESS-GO locking/closing switch.



① KEYLESS-GO locking/closing switch

- ▶ Make sure you have the SmartKey with KEYLESS-GO with you.
 - ▶ Press switch ① briefly.
- With all doors closed:

- The locking knobs in the doors move down.
- The trunk lid starts to close automatically.
- All turn signal lamps flash three times to confirm locking once the trunk has closed completely.
- An acoustic signal sounds three times.
- The anti-theft alarm system is armed.

If the trunk lid comes into contact with an object while closing (e.g. luggage that has been piled too high) in the upper motion sequence, the closing procedure is stopped and the trunk lid reopens slightly.

Trunk lid emergency release

With the emergency release button, the trunk lid can be opened from inside the trunk.



① Emergency release button

- ▶ Briefly press emergency release button ①.
- The trunk lid unlocks and opens.

The emergency release button unlocks and opens the trunk while the vehicle is standing still or in motion.

Illumination of the emergency release button:

- The button flashes for 30 minutes after opening the trunk.
- The button flashes for 60 minutes after closing the trunk.

The emergency release button does not open the trunk, if the vehicle battery is discharged or disconnected.

Locking and unlocking

Valet locking

To deny any unauthorized person access to the trunk, e.g. when you valet park the vehicle, lock it separately with the mechanical key. Leave only the SmartKey less its mechanical key with the vehicle.



1 Neutral position

2 Locked

- ▶ **Valet locking:** Close the trunk.
- ▶ Remove the mechanical key from the SmartKey (> page 540).
- ▶ Insert the mechanical key in the trunk lid lock.
- ▶ Turn the mechanical key clockwise to position 2 and remove the mechanical key in that position to lock the trunk.

The trunk remains locked even when the vehicle is centrally unlocked.

You can only cancel the separate trunk locking mode by means of the mechanical key.

- ▶ **Canceling:** Insert the mechanical key in the trunk lid lock.
- ▶ Turn the mechanical key counterclockwise to neutral position 1 and remove the mechanical key in that position to unlock the trunk.
You can now open the trunk.

Power closing assist for doors and trunk lid

It is not necessary to slam the door or trunk lid closed. An electrical power-assisted mechanism draws doors and trunk lid closed quietly and automatically once door and trunk lid has been latched. When the electrical power-assisted mechanism has stopped, doors and/or trunk can be reopend.

⚠ Warning!

To prevent possible personal injury, always keep hands and fingers away from the door or trunk opening when closing a door or the

trunk lid. Be especially careful when small children are around.

In case of danger, pull the inside or outside door handle, or pull the trunk lid handle.

To prevent personal injury, never actuate the closing assist mechanism by tampering with the door or trunk lid latch.

⚠ Warning!

Only drive with the doors closed.

Otherwise, one or more of the doors could open while the vehicle is in motion, putting you and/or others at risk.

⚠ Warning!

Make sure the trunk is closed when the engine is running and while driving. Among other dangers, deadly carbon monoxide (CO) gases may enter vehicle interior resulting in unconsciousness and death.

- ▶ **Power closing assist for doors:** Press the doors gently past the initial engage position into the lock.
- ▶ **Power closing assist for trunk lid:** Press the trunk lid gently into its lock.

Starter switch positions

SmartKey

⚠ Observe Safety notes, see page 59.



Starter switch

- 0** For removing SmartKey
- 1** Power supply for some electrical consumers, e.g. radio
- 2** Ignition (power supply for all electrical consumers) and driving position
- 3** Starting position

When you switch on the ignition, all lamps (except high-beam headlamp indicator lamp, and turn signal indicator lamps unless activated) in the instrument cluster come on. If a lamp in the instrument cluster fails to come on when the ignition is switched on,

have it checked and replaced if necessary. If a lamp in the instrument cluster remains on after starting the engine or comes on while driving, refer to “Lamps in instrument cluster” (▷ page 527).

! If the SmartKey cannot be turned in the starter switch, the vehicle battery may not be sufficiently charged.

- Check the vehicle battery and charge it if necessary.
- Get a jump start.

To prevent accelerated vehicle battery discharge or a completely discharged vehicle battery, always remove the SmartKey from the starter switch when the engine is not in operation.

KEYLESS-GO

⚠ Observe Safety notes, see page 59.

Vehicles equipped with the KEYLESS-GO feature are supplied with a SmartKey with integrated KEYLESS-GO function and a removable KEYLESS-GO start/stop button. With the KEYLESS-GO start/stop button inserted in the starter switch and the SmartKey present in the vehicle, pressing the KEYLESS-GO start/stop button

- without the brake pedal depressed corresponds to the various starter switch positions (▷ page 301)
- with the brake pedal firmly depressed will start the engine (▷ page 328)

If you wish or should there be the need to insert the SmartKey in the starter switch, the KEYLESS-GO start/stop button can be easily removed by pulling it out of the starter switch.

- i** The KEYLESS-GO start/stop button does not need to be removed from the starter switch when you leave the vehicle. However, always take the SmartKey with you when you leave the vehicle. As long as the SmartKey is in the vehicle, the vehicle’s electrical systems can be switched on or



Starter switch positions

the engine can be started using the KEYLESS-GO start/stop button.

The function of the SmartKey overrides the KEYLESS-GO function.

The SmartKey must be located in the vehicle.



① KEYLESS-GO start/stop button

② Starter switch

▶ Insert KEYLESS-GO start/stop button ① into starter switch ② (if not inserted already).

i When you switch from SmartKey mode back to KEYLESS-GO mode, the system requires 2 seconds of detection time before you can use the KEYLESS-GO button as usual.

▶ Make sure the automatic transmission is in park position **P**.

▶ Do not depress the brake pedal.



KEYLESS-GO start/stop button

③ USA only

④ Canada only

Position 0

Before you press the KEYLESS-GO start/stop button, the vehicle's on-board electronics have status **0** (as with SmartKey removed).

Position 1

▶ Press the KEYLESS-GO start/stop button once.

This supplies power for some electrical consumers, such as radio functions.

i If you now press the KEYLESS-GO start/stop button

- once more, the ignition (position **2**) is switched on
- twice more the power supply is again switched off

Ignition (or position 2)

▶ Press the KEYLESS-GO start/stop button twice.

This supplies power for all electrical consumers.

All lamps (except high-beam headlamp indicator lamp and turn signal indicator lamps unless activated) in the instrument cluster come on. If a lamp in the instrument cluster fails to come on when the ignition is switched on, have it checked and replaced if necessary. If a lamp in the instrument cluster remains on after starting the engine or comes on while driving, refer to "Lamps in instrument cluster" (▶ page 527).

i If you now press the KEYLESS-GO start/stop button once, the power supply is again switched off.

Seats

Safety notes

⚠ Warning!

In order to avoid possible loss of vehicle control, all seat, head restraint, steering wheel, and rear view mirror adjustments, as well as fastening of seat belts, must be done before the vehicle is put into motion.

⚠ Warning!

Do not adjust the driver's seat while driving. Adjusting the seat while driving could cause the driver to lose control of the vehicle.

Never ride in a moving vehicle with the seat backrest in an excessively reclined position as this can be dangerous. You could slide under the seat belt in a collision. If you slide under it, the seat belt would apply force at the abdomen or neck. That could cause serious or fatal injuries. The seat backrest and seat belts provide the best restraint when the wearer is in a position that is as upright as possible and seat belts are properly positioned on the body.

⚠ Warning!

Your seat must be adjusted so that you can correctly fasten your seat belt.

Observe the following points:

- Adjust the seat backrest until your arms are slightly angled when holding the steering wheel.
- Adjust the seat to a comfortable seating position that still allows you to reach the accelerator/brake pedal safely. The position should be as far back as possible with the driver still able to operate the controls properly.
- Adjust the head restraint so that it is as close to the head as possible and the center of the head restraint supports the back of the head at eye level.
- Never place hands under the seat or near any moving parts while a seat is being adjusted.

Failure to do so could result in an accident and/or serious personal injury.

⚠ Warning!

The power seats can be operated at any time. Therefore, do not leave children unattended in the vehicle, or with access to

an unlocked vehicle. A child's unsupervised access to a vehicle could result in an accident and/or serious personal injury.

⚠ Warning!

According to accident statistics, children are safer when properly restrained in the rear seating positions than in the front seating position. Thus, we strongly recommend that children be placed in the rear seats whenever possible. Regardless of seating position, children 12 years old and under must be seated and properly secured in an appropriately sized infant restraint, toddler restraint, or booster seat recommended for the size and weight of the child. For additional information, see "Children in the vehicle".

A child's risk of serious or fatal injuries is significantly increased if the child restraints are not properly secured in the vehicle and/or the child is not properly secured in the child restraint.

⚠ Warning!

For your protection, drive only with properly positioned head restraints.

Adjust the head restraint so that it is as close to the head as possible and the center



Seats

of the head restraint supports the back of the head at eye level. This will reduce the potential for injury to the head and neck in the event of an accident or similar situation.

Do not drive the vehicle without the seat head restraints. Head restraints are intended to help reduce injuries during an accident.

Seat adjustment

You can adjust the lumbar support, multicontour seats for driver and front passenger, as well as drive-dynamic multicontour seats using COMAND (▷ page 227).

! When moving the seats, make sure there are no items in the footwell or behind the seats. Otherwise, you could damage the seats.

Power seats



- ① Head restraint height
- ② Seat height
- ③ Seat cushion tilt
- ④ Seat cushion depth
- ⑤ Seat fore and aft adjustment
- ⑥ Seat backrest tilt

i If PRE-SAFE® has been activated, the front passenger's seat will be moved to a more favorable seat position.

i The memory function (▷ page 314) lets you store the settings for the seat position together with the settings for the steering wheel and the exterior rear view mirrors.

▶ **Seat height:** Press the switch up or down in direction of arrow ②.

▶ **Seat cushion tilt:** Press the switch up or down in direction of arrow ③ until your upper legs are lightly supported.

▶ **Seat cushion depth:** Press the switch forward or backward in direction of arrow ④ until your legs are supported comfortably.

▶ **Seat fore and aft:** Press the switch forward or backward in direction of arrow ⑤.

i When moving the seat fore or aft, the head restraints may readjust automatically.

▶ **Seat backrest tilt:** Press the switch forward or backward in direction of arrow ⑥.

▶ **Head restraint height:** Press the switch up or down in direction of arrow ①.

Adjusting front passenger seat from driver's seat

⚠ Warning!

When adjusting the front passenger seat, make sure the seat, if occupied, is as far from the front passenger front air bag as possible.

Otherwise, the passenger could be seriously or even fatally injured in the event of an accident or braking maneuver.

Make sure no one is caught or injured while the seat is being adjusted.

Even with the SmartKey or SmartKey with KEYLESS-GO removed from the starter switch or the SmartKey with KEYLESS-GO removed from the vehicle, the power seats can be operated. Therefore, do not leave children unattended in the vehicle, or with access to an unlocked vehicle. A child's unsupervised access to a vehicle could result in an accident and/or serious personal injury.

- !** Do not move the front passenger seat completely forward if objects are stored in the parcel net in the front passenger-side footwell. Items in the net may be damaged.

You can adjust the front passenger seat using the seat switches on the driver's side.



① Selector button for front passenger seat

- Press button ①.

When the indicator lamp in button ① is on, you can operate the following features of the front passenger seat:

- seat adjustment
- seat heating/ventilation
- memory function

Folding front seat backrests forward

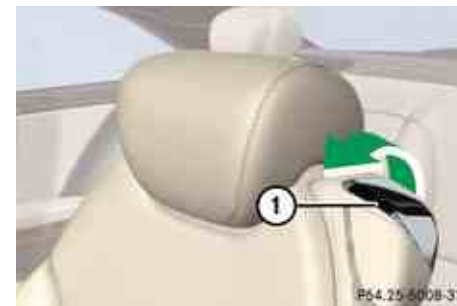

① Release lever

- **Folding seat backrest forward:** Lift release lever ① and fold the seat backrest forward.

The seat will automatically slide forward and the head restraint will move down.

- **Folding seat backrest back:** Fold and press the seat backrest rearward until it engages in driving position. The seat and head restraint return to their previous positions.

⚠ Warning!

Always ensure that no one can become trapped or injured when the seat is moving. In case potential danger exists, the procedure can be interrupted by moving



Seats

the seat adjustment switch in the door control panel or by moving the release lever again.

Warning!

The seat belts provide protection only with the seat backrest locked in place.

Therefore, the seat backrest must be locked in place with the vehicle in motion. Do not drive the vehicle when the seat backrest is not locked in place. If the warning message:

Lock Seat Backrest Front Right

or

Lock Seat Backrest Front Left

is displayed in the multifunction display, then the respective seat backrest is not engaged in its lock. Carefully slow down, and drive with caution to an area which is in a safe distance from the roadway. Always provide sufficient room behind the seat backrest and fold the seat backrest all the way back until it locks in place.

The warning message is no longer displayed as soon as the seat backrest is locked in place. If both seat backrests are locked in place and the warning message is still displayed, have the system checked at

an authorized Mercedes-Benz Center immediately.

 The automatic seat slide is provided with a safety feature.

The automatic process is interrupted if the seat backrest of the sliding seat is pushed against an occupant or object. The seat will slide forward and stop.

Investigate and correct the cause of interruption.

Now use memory button or seat adjustment switch to bring the seat into the desired position.

When folding the seat backrest forward from a reclined position, and then folding it back, the seat backrest stops in a more upright position for the safety of any rear-seat passenger. Adjust the seat backrest until your arms are slightly angled when holding the steering wheel.

Head restraint fore and aft adjustment



- ▶ Adjust the head restraint to the desired position by pushing or pulling on the upper edge of the head restraint cushion.

Easy-entry/exit feature

This feature allows for easier entry into and exit from the vehicle. When entering and exiting the vehicle, the driver's seat is in its maximum rearward position and the steering wheel is in its uppermost position.

The easy-entry/exit feature can be activated or deactivated in the **Vehicle** menu of the COMAND system (▷ page 219).

⚠ Warning!

You must make sure no one can become trapped or injured by the moving steering wheel and driver's seat when the easy-entry/exit feature is activated.

To stop seat/steering wheel movement, do one of the following:

- Press seat adjustment switch
- Move steering wheel adjustment stalk
- Press one of the memory position buttons or the memory button **M**

Do not leave children unattended in the vehicle, or with access to an unlocked vehicle. Children could open the driver's door and unintentionally activate the easy-entry/exit feature, which could result in an accident and/or serious personal injury.

! Do not activate the easy-entry/exit feature if the seat backrest is in an excessively reclined position. Doing so could cause damage to front or rear seats. First move the seat backrest to an upright position.

With the easy-entry/exit feature activated, the steering wheel and driver's seat will return to their last set memory position or a

factory-set maximum forward position when you:

- close the driver's door with the ignition switched on
- insert the SmartKey into the starter switch or press the KEYLESS-GO start/stop button once with the driver's door closed

i For safety reasons, the driver's seat will not return to its last set position with the easy-entry/ exit feature activated if the system recognizes the last set position as an extreme forward position. Instead, the driver's seat will remain at or move to a factory-set maximum forward position. To again fully return the driver's seat to your last set position or to memory position, adjust the seat to the desired position or press and hold the respective memory position button (▷ page 315).

i The last set driver's seat and steering wheel positions are stored when the ignition is switched off and the position is stored in memory.

With the easy-entry/exit feature activated the steering wheel tilts upwards and the driver's seat moves a few inches to the rear when you:

- remove the SmartKey from the starter switch,
or
- open the driver's door with the SmartKey in starter switch position **0** or **1** or the KEYLESS-GO start/stop button in position **1**

i If the current position for the steering wheel is in the uppermost tilt position, the steering wheel will no longer be able to move upward when the easy-entry/exit feature is activated.

If the current seat position falls into a factory-set position range and the system recognizes the current seat position to be rearward enough for easy entry and exit, the driver's seat will not move to the rear when the easy-entry/ exit feature is activated.

The adjustment procedure is briefly interrupted when the engine is started.

⚠ Warning!

Let the system complete the adjustment procedure before setting the vehicle in motion. All driver's seat and steering wheel adjustments must be completed before setting the vehicle in motion. Driving off with the driver's seat/steering wheel still

Seats

adjusting could cause the driver to lose control of the vehicle.

Rear seat head restraints

⚠ Warning!

For safety reasons, always drive with the rear head restraints in the upright position when the rear seats are occupied.

Keep the area around head restraints clear of articles (e.g. clothing) to not obstruct the folding operation of the head restraints.

⚠ Warning!

For your protection, drive only with properly positioned head restraints.

Adjust the head restraint in such a way that it is as close to the head as possible and the center of the head restraint supports the back of the head at eye level. This will reduce the potential for injury to the head and neck in the event of an accident or similar situation.

With a rear seat occupied, make sure to move the respective head restraint up from the lowest non-use position and have the occupant adjust the head restraint properly.

Do not drive the vehicle without the seat head restraints installed when the rear seats are occupied. Head restraints are intended to help reduce injuries during an accident.

⚠ Warning!

Make sure the rear seat head restraints engage when placing them upright manually. Otherwise their protective function cannot be ensured.

The back of the head will not be supported in the event of a collision. That could cause serious or even fatal injuries. Rear seat occupants can be seriously injured or killed.

Folding rear seat head restraints back

The rear seat head restraints can be folded backward for increased visibility.



① Head restraint release switch

- ▶ Switch on the ignition.
- ▶ Press switch ① in the front center console briefly.
The head restraints will fold backward.

Placing rear seat head restraints upright

- ① When fasten a rear seat belt, the respective rear seat head restraint places upright automatically.

- ▶ Switch on the ignition.
- ▶ Press and hold switch ① in the front center console.
The rear seat head restraints will place upright.

Placing rear seat head restraints upright manually



- ▶ Pull the head restraint forward until it locks into position.

Seat ventilation



- ① Seat ventilation button

The blue indicator lamps in the button come on to show which ventilation level you have selected.

- ① The seat ventilation for the driver's seat can be activated using summer opening feature (▶ page 327).

- ▶ Switch on the ignition.
- ▶ **Switching on:** Press button ① repeatedly until the desired ventilation level is set.
- ▶ **Switching off:** Press button ① repeatedly until all indicator lamps go out.

If one or more of the indicator lamps in the seat ventilation button ① are flashing, there is insufficient voltage available since too

many electrical consumers are turned on. The seat ventilation switches off automatically. The seat ventilation will switch back on again automatically as soon as sufficient voltage is available.

Seat heating



- ① Seat heating button

The red indicator lamps in button ① come on to show which heating level you have selected.

The seat heating switches from level **3** (high) to level **2** after approximately 5 minutes.

The seat heating switches from level **2** to level **1** (low) after approximately 10 minutes.

The seat heating automatically switches off from level **1** after approximately 20 minutes.



Multifunction steering wheel

- ▶ Switch on the ignition.
- ▶ **Switching on:** Press button ① repeatedly until the desired heating level is set. One or more red indicator lamps in button ① show the selected heating level.
- ▶ **Switching off:** Press button ① repeatedly until all indicator lamps go out.

If one or more of the indicator lamps in seat heating button ① are flashing, there is insufficient voltage available since too many electrical consumers are turned on. The seat heating switches off automatically.

The seat heating will switch back on again automatically as soon as sufficient voltage is available.

Multifunction steering wheel

Safety notes

⚠ Warning!

Do not adjust the steering wheel while driving. Adjusting the steering wheel while driving could cause the driver to lose control of the vehicle.

The electrical steering wheel adjustment feature can be operated at any time. Therefore, do not leave children unattended in the vehicle, or with access to an unlocked vehicle. A child's unsupervised access to a vehicle could result in an accident and/or serious personal injury.

Make sure

- you can reach the steering wheel with your arms slightly bent at the elbows
- you can move your legs freely
- all displays (including malfunction and indicator lamps) on the instrument cluster are clearly visible

Steering wheel adjustment



- ① Adjusting steering wheel, in or out
- ② Adjusting steering wheel, up or down

- ▶ **Adjusting steering wheel in or out:** Move stalk in direction of arrows ①.
- ▶ **Adjusting steering wheel up or down:** Move stalk in direction of arrows ②.

i The memory function (▷ page 314) lets you store the settings for the steering wheel together with the settings for the seat position and the exterior rear view mirrors.

Heated steering wheel

The steering wheel heating warms up the leather area of the steering wheel.



- ① Switching on
- ② Switching off
- ③ Indicator lamp

► Switch on the ignition.

► **Switching on:** Turn switch at the tip of the stalk in direction of arrow ①. Indicator lamp ③ comes on.

i The steering wheel heating will not switch on, when the temperature of the vehicle interior is above 86°F (30°C).

► **Switching off:** Turn switch at the tip of stalk in direction of arrow ②. Indicator lamp ③ goes out.

i Indicator lamp ③ flashes or goes out in case of power surge or undervoltage or if the steering wheel heating malfunctions.

i The steering wheel heating switches off automatically:

- when you remove the SmartKey from the starter switch
- on vehicles with KEYLESS-GO, when you switch off the ignition and open the driver's door
- when the temperature of the vehicle interior is above 86°F (30°C)
- after approximately 24 minutes

For more information on the steering wheel, see "Multifunction steering wheel" (► page 232).

Mirrors

Notes

Adjust the interior and exterior rear view mirrors before driving so that you have a good view of the road and traffic conditions.

Interior rear view mirror

► Adjust the interior rear view mirror manually.

Exterior rear view mirrors

⚠ Warning!

Exercise care when using the passenger-side exterior rear view mirror. The mirror surface is convex (outwardly curved surface for a wider field of view). Objects in mirror are closer than they appear. Check your interior rear view mirror and glance over your shoulder before changing lanes.

Mirrors

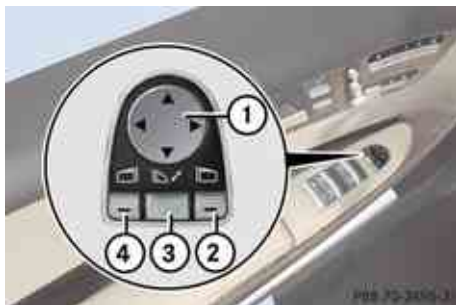

- ① Adjustment button
- ② Passenger-side exterior rear view mirror button
- ③ Button for folding exterior rear view mirrors in and out
- ④ Driver's side exterior rear view mirror button

- ▶ Switch on the ignition.
- ▶ Press button ④ for the driver's side exterior rear view mirror or button ② for the passenger-side exterior rear view mirror.
The indicator lamp in the respective button comes on.
- ▶ Press adjustment button ① up, down, left or right according to the desired setting.

When you press button ① for the first time, the exterior mirror on the driver's side is always selected.

If you do not make adjustments to the selected exterior rear view mirror within 15 seconds, the indicator lamp goes out. You will then have to select the desired exterior rear view mirror again before adjustments can be made. Adjustments can only be made with the indicator lamp for the respective exterior rear view mirror button illuminated.

! If an exterior rear view mirror was forcibly hit from the front, manually snap it back into place.

i At low ambient temperatures, the exterior rear view mirrors will be heated automatically.

Auto-dimming rear view mirrors

The exterior rear view mirror on the driver's side and the interior rear view mirror will respond automatically to glare when the ignition is switched on and incoming light from headlamps falls on the sensor in the interior rear view mirror.

The rear view mirrors will not react if the automatic transmission is set to reverse gear **R** or the interior lighting is switched on.

⚠ Warning!

The auto dimming function does not react if incoming light is not aimed directly at sensors in the interior rear view mirror.

The interior rear view mirror and the exterior rear view mirror on the driver's side do not react, for example, if the rear window sunshade is in raised position.

Light hitting the mirror(s) at certain angles (incident light) could blind you. As a result, you may not be able to observe traffic conditions and could cause an accident.

Power folding exterior rear view mirrors

! Before you drive the vehicle through an automatic car wash, fold in the exterior rear view mirrors. Otherwise they may get damaged.

Folding in and out automatically

When the corresponding function in the COMAND system is activated (▷ page 218):

- The exterior rear view mirrors fold in automatically as soon as the vehicle is locked from the outside.
- The exterior rear view mirrors fold out automatically as soon as the vehicle is unlocked and the driver's or passenger door are subsequently opened.

Folding in and out manually

i The mirrors do not fold out if they were previously folded in manually. Please make sure both mirrors are folded out before driving off.

The exterior rear view mirrors can vibrate if they are not folded out completely.



① Button for folding exterior rear view mirrors in and out

- ▶ **Folding in:** Briefly press button ①. Both exterior rear view mirrors fold in.
- ▶ **Folding out:** Briefly press button ①. Both exterior rear view mirrors fold out.

! If an exterior rear view mirror housing is forcibly pushed forward (hit from the rear), reposition it manually by applying firm pressure until it snaps back into place. If an exterior rear view mirror housing is forcibly pushed rearward (hit from the front), press button ① to fold mirrors in, then press button ① again to fold mirrors out. Do not force mirrors by hand as this may damage the adjustment mechanism.

The mirror housing is then properly positioned and you can adjust the mirror in the usual manner.

Activating exterior rear view mirror parking position

Follow these steps to activate the mirror parking position so that the passenger-side exterior rear view mirror will be turned downward to the stored position.

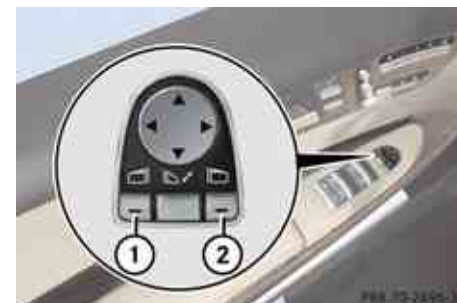

- ① Driver's side exterior rear view mirror button
- ② Passenger-side exterior rear view mirror button

Memory function

- ▶ Make sure you have stored a parking position for the passenger-side exterior rear view mirror (▶ page 315).
- ▶ Make sure the Lower mirror when reversing function in the Exterior Mirror Convenience Settings submenu of the COMAND system is selected.
- ▶ Switch on the ignition.
- ▶ Press button ② for the passenger-side exterior rear view mirror.

i With the automatic transmission in reverse gear **R**, the previously selected exterior rear view mirror is activated.

- ▶ Shift the automatic transmission into reverse gear **R**.
The passenger-side exterior rear view mirror will be turned downward to the stored position.

The exterior rear view mirror returns to its previously stored driving position:

- when you switch off the ignition
- 10 seconds after you have put the gear selector lever out of reverse gear **R**

- immediately once your vehicle exceeds a speed of approximately 6 mph (10 km/h)
- immediately when you press button ① for driver's side exterior rear view mirror.

1 If you adjust the exterior mirrors while they are in the parking position, the new mirror position is stored as a new parking position.

Memory function

Notes

With the memory function you can store up to three different configurations per front seat.

Each memory position button on the driver's side can store all of the following settings:

- Seat position
- Lumbar support (CL 550 4MATIC)
- Multicontour seat: previously saved setting
- Drive-dynamic multicontour seat: activation/deactivation
- Steering wheel position
- Exterior rear view mirrors' position

Warning!

Do not activate the memory function while driving. Activating the memory function while driving could cause the driver to lose control of the vehicle.

Each memory position button on the front passenger side can store all of the following settings:

- Seat position
- Multicontour seat: previously saved setting

Memory function

- Lumbar support (CL 550 4MATIC)
- Drive-dynamic multicontour seat: activation/deactivation



M Memory button
1, 2, 3 Memory position button

Storing positions into memory

- ▶ Adjust the seats.
- ▶ On the driver's side, additionally adjust the steering wheel and exterior rear view mirrors to the desired positions.
- ▶ Press memory button **M**.
- ▶ Release memory button **M** and press memory position button **1**, **2** or **3** within 3 seconds.

When the settings are stored to the selected position, an acknowledgement signal sounds.

Recalling positions from memory

- ▶ Press and hold desired memory position button **1**, **2** or **3** until the seat has completely moved to the stored position. On the driver's side, also wait for the steering wheel and exterior rear view mirrors to move to the stored position.
 - ❗ Releasing the memory position button stops movement to the stored positions immediately.
- The multicontour seat and/or lumbar support (CL 550 4MATIC) will continue to be adjusted.

Storing exterior rear view mirror parking position

For easier parking, you can adjust the passenger-side exterior rear view mirror so that you can see the right rear wheel as soon as you engage reverse gear **R**.

For information on activating the parking position, see (▶ page 313).

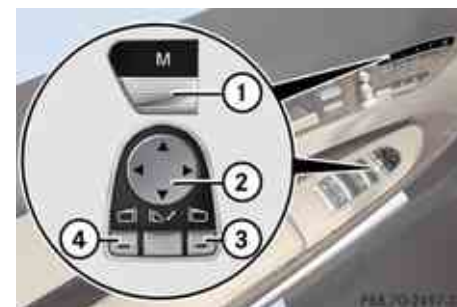

- ① Memory button **M**
 - ② Adjustment button
 - ③ Passenger side exterior rear view mirror button
 - ④ Driver's side exterior rear view mirror button
- ▶ Stop the vehicle.
 - ▶ Switch on the ignition.

Lighting

- ▶ Press button ③.
The passenger-side exterior rear view mirror is selected.
 - ▶ Adjust the passenger-side exterior rear view mirror with adjustment button ② so that you see the rear wheel and the road curb.
 - ▶ Press memory button **M** ①.
 - ▶ Within 3 seconds, press bottom of adjustment button ②.
The parking position is stored if the mirror does not move.
- i** If the mirror does move, repeat the above steps. After the setting is stored, you can move the mirror again.

Lighting

Notes

- i** If you drive in countries where vehicles drive on the other side of the road than the country where the vehicle is registered, you must have the headlamps modified for symmetrical low beams. Relevant information can be obtained at any authorized Mercedes-Benz Center.
- i** The active Bi-Xenon headlamps monitor the vehicle's steering angle and speed, then automatically shift their beams to either side to better follow the curvature of the road ahead, increasing usable illumination over conventional headlamps.

Exterior lamp switch



- 1** Standing lamps, left
- 2** Standing lamps, right
- 3** **0** Off
Daytime running lamp mode
- 4** **A** Automatic headlamp mode
Daytime running lamp mode
- 5** Parking lamps (also tail lamps, license plate lamps, side marker lamps and instrument panel lamps)
- 6** Low-beam headlamps or high-beam headlamps
- 7** Front fog lamps
- 8** Rear fog lamp

- i** The exterior lamps go out automatically when you remove the SmartKey from the

starter switch or open the driver's door with the ignition switched off.

When the parking lamps or the rear fog lamp are switched on and you remove the SmartKey from the starter switch and open the driver's door, an acoustic signal sounds.

In addition, the message Please Switch Off Lights appears in the multifunction display.

Switch off the parking lamps or the rear fog lamp manually.

! Failure to switch off the parking lamps when leaving the vehicle may result in a discharged battery.

Low-beam headlamps

The low-beam headlamps can be switched on and off with the exterior lamp switch.

► Switch on the ignition.

► **Switching on:** Turn the exterior lamp switch to position .

The following lamps come on:

- Low-beam headlamps
- Tail lamps
- Parking lamps

- License plate lamps
- Side marker lamps
- Instrument panel lamps
- Green indicator lamp  in the exterior lamp switch

► **Switching off:** Turn the exterior lamp switch to position .

Automatic headlamp mode

The following lamps come on and go out automatically depending on the brightness of the ambient light:





- Low-beam headlamps
- Tail lamps
- Parking lamps
- License plate lamps
- Side marker lamps

Warning!

If the exterior lamp switch is set to , the headlamps will not automatically come on under foggy conditions.

To minimize risk to you and to others, activate headlamps by turning exterior lamp switch to  when driving or when

traffic and/or ambient lighting conditions require you to do so.

In low ambient lighting conditions, only switch from position  to  with the vehicle at a standstill in a safe location. Switching from  to  will briefly switch off the headlamps. Doing so while driving in low ambient lighting conditions may result in an accident.

The automatic headlamp feature is only an aid to the driver. The driver is responsible for the operation of the vehicle's lights at all times.

► **Switching on:** Turn the exterior lamp switch to position . With the SmartKey in starter switch position 1 or the KEYLESS-GO start/stop button pressed once, the tail and parking lamps, the license plate lamps and the side marker lamps will come on and go out depending on the brightness of the ambient light.



When the engine is running the low-beam headlamps, the tail and parking lamps, the license plate lamps and the side marker lamps will come on and go out depending on the brightness of the ambient light.

Lighting

Canada only: High-beam headlamps are only available with the exterior lamp switch in position .

Daytime running lamp mode

In Canada, the daytime running lamp mode is mandatory and therefore in a constant mode. In the USA, the daytime running lamp mode is deactivated by default. Activate the daytime running lamp mode using the control system, see “Setting daytime running lamp mode (USA only)” (▷ page 246).

- ▶ Turn the exterior lamp switch to position  or .



When the engine is running, the low-beam headlamps come on.

In low ambient lighting conditions, the following lamps will come on additionally:

- Tail lamps
- Parking lamps
- License plate lamps
- Side marker lamps

With the daytime running lamp mode activated and the engine running, you cannot switch off the low-beam headlamps manually.



Canada only

With the exterior lamp switch in position  or , you cannot switch on the high-beam headlamps.

The high-beam flasher is available at all times.



For nighttime driving turn the exterior lamp switch to position  to permit activation of the high-beam headlamps.

When the engine is running, and you



- shift from a driving position to park position **P** with the vehicle at a standstill or the electronic parking brake is engaged, the low-beam headlamps will go out with a delay of 3 minutes
- turn the exterior lamp switch to position , the low-beam headlamps, the tail and parking lamps, the license plate lamps and the side marker lamps come on
- turn the exterior lamp switch to position , the manual headlamp mode has priority over the daytime running lamp mode

The corresponding exterior lamps come on (▷ page 316).



USA only



You can only switch on the high-beam headlamps in low ambient lighting conditions. The high-beam flasher is available at all times. When the engine is running, and you turn the exterior lamp switch to position  or , the manual headlamp mode has priority over the daytime running lamp mode. The corresponding exterior lamps come on (▷ page 316).

Fog lamps

Fog lamps cannot be switched on with the exterior lamp switch in position . To switch on the fog lamps, turn the exterior lamp switch to position  first.





Warning!

In low ambient lighting or foggy conditions, only switch from position  to  with the vehicle at a standstill in a safe location.

Switching from  to  will briefly switch off the headlamps. Doing so while driving in low ambient lighting conditions may result in an accident.

Fog lamps will operate with the parking lamps and/or the low-beam headlamps on. Fog

lamps should only be used in conjunction with low-beam headlamps. Consult your State or Province Motor Vehicle Regulations regarding permissible lamp operation.

- ▶ Switch on the ignition.
- ▶ Turn the exterior lamp switch to position  or  (▷ page 316).
- ▶ **Switching on front fog lamps:** Pull out the exterior lamp switch to first stop. The green indicator lamp  in the exterior lamp switch comes on.
- ▶ **Switching on rear fog lamp:** Pull out the exterior lamp switch to second stop. The rear fog lamp, the front fog lamps and the yellow indicator lamp  in the exterior lamp switch come on.
- ▶ **Switching off front fog lamps/rear fog lamp:** Push in the exterior lamp switch to its stop.

Locator lighting and night security illumination



The locator lighting and night security illumination are described in the COMAND vehicle menu section under “Locator lighting on/off” (▷ page 217) and “Setting night security illumination” (▷ page 216).

Combination switch



- ① High beam
- ② High-beam flasher

High beam

- ▶ Turn the exterior lamp switch to position  (▷ page 316).
- ▶ **Switching on:** Push the combination switch in direction of arrow ①. The high-beam headlamp indicator lamp  in the instrument cluster comes on.
- ▶ **Switching off:** Pull the combination switch in direction of arrow ② to its original position.



High-beam flasher

- ▶ **Switching on:** Pull the combination switch briefly in direction of arrow ②.

Turn signals



- ① Turn signals, right
- ② Turn signals, left

- ▶ Press the combination switch in direction of arrow ① or ②. The corresponding turn signal indicator lamp  or  in the instrument cluster flashes.

The combination switch resets automatically after major steering wheel movements.

- ▶ **i** To signal minor directional changes such as changing lanes, press combination



Lighting

switch only to point of resistance and release. The corresponding turn signal lamps will flash three times.

Hazard warning flasher

The hazard warning flasher can be switched on at all times, even with the SmartKey removed from the starter switch.

The hazard warning flasher comes on automatically when an air bag deploys.

CL 600 and CL 65 AMG, USA only:

The hazard warning flasher comes on automatically when you brake the vehicle strongly at a speed of more than 50 mph (70 km/h) and bring it to a complete stop.



① Hazard warning flasher switch

▶ **Switching on:** Press hazard warning flasher switch ①.

All turn signal lamps are flashing.

① With the hazard warning flasher activated and the combination switch set for either left or right turn, only the respective left or right turn signals will operate when the ignition is switched on.

▶ **Switching off:** Press hazard warning flasher switch ① again.

① If the hazard warning flasher has been activated automatically, press hazard warning flasher switch ① once to switch off.

Headlamp cleaning system

The headlamps will be cleaned with a high-pressure water jet automatically when the engine is running and you have

- switched on the headlamps and
- the windshield wipers have wiped the windshield with washer fluid five times

The counter resets when you switch off the ignition.

For information on filling up the washer reservoir, see “Washer system and headlamp cleaning system” (▷ page 428).

Corner-illuminating lamps

The corner-illuminating lamps improve illumination of the area in the direction into which you are turning.

The corner-illuminating lamps will only operate in low ambient lighting conditions.

If you are driving faster than 43 mph (70 km/h) the corner-illuminating function is not available.

Switching on

- ▶ Make sure the engine is running.
- ▶ Turn the exterior lamp switch to position  or **A** (▷ page 316).

or

- ▶ Activate the daytime running lamp mode (▷ page 318).
- ▶ Switch on the left or right turn signal, depending on whether you are turning left or right.

The respective corner-illuminating lamp comes on. If you have switched on the turn signal for one side but turn the steering

Lighting

wheel in the other direction, the corner-illuminating lamp comes on on the side of the turn signal.

or

- ▶ Turn steering wheel in desired direction. Driving forward: The corner-illuminating lamp on the side of your steering direction comes on.

Driving in reverse: The corner-illuminating lamp opposite to your steering direction comes on.

The corner-illuminating lamps will come on automatically depending on the steering angle, even if you did not switch on either turn signal. If the corner-illuminating lamps came on automatically, they will also go out automatically depending on the steering angle and vehicle speed.

The corner-illuminating lamps temporarily come on on both sides of the vehicle if you turn the steering wheel in one direction and then again in the other direction shortly thereafter.

The corner-illuminating lamp may remain lit for a short time. The corner-illuminating lamp comes on for no more than 20 seconds with the vehicle standing still. It then goes out even if the turn signal is still switched on or if

you have turned the steering wheel to full lock.

Switching off

- ▶ Switch off the left or right turn signal.

or

- ▶ Steer straight ahead. The corner-illuminating lamp goes out.

- i** There may be a brief delay before the corner-illuminating lamps go out.

Interior lighting

- i** Even with the SmartKey being removed from the starter switch you can still use the lighting for the storage compartment, glove box and vanity mirrors, when you open a door or press one of the interior lighting buttons. If a lamp is switched on and you do not lock the vehicle, it will be switched off automatically after 30 minutes.

When you lock the vehicle from the outside, the interior lighting is switched off.

The interior lighting controls are located in the overhead control panel.

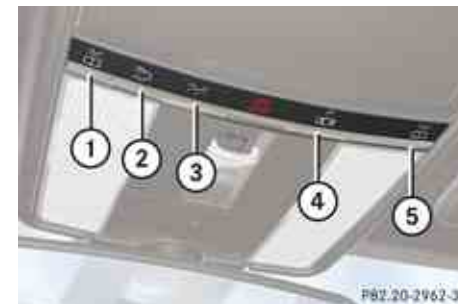

- ① Left front reading lamp on/off
- ② Rear interior lighting on/off
- ③ Front interior lighting on/off
- ④ Automatic control on/off
- ⑤ Right front reading lamp on/off

Automatic control

- ▶ **Activating:** Press button .

The OFF indicator lamp next to the button goes out.

The interior lighting comes on, when you:

Wipers

- unlock the vehicle
- remove the SmartKey from the starter switch
- open a door

▶ **Deactivating:** Press button .

The OFF indicator lamp next to the button comes on.

The interior lighting goes out after a preset time (▷ page 220).

- i** If a door remains open, the interior lamps go out automatically after approximately 5 minutes.

Manual control

▶ **Switching on/off front interior lighting:** Press button .

▶ **Switching on/off rear interior lighting:** Press button .

▶ **Switching on/off front reading lamps:** Press respective button .

- i** The brightness of the ambient lighting is adjusted via COMAND (▷ page 220).

Emergency lighting

The interior lighting is activated automatically if the vehicle is involved in an accident.

▶ **Switching off:** Press hazard warning flasher switch (▷ page 320).

or

▶ Press switch .

or

▶ Unlock the vehicle.

Wipers

Notes

! Do not operate the wipers when the windshield is dry. Dust that accumulates on a windshield might scratch the glass and/or damage the wiper blades when wiping occurs on a dry windshield. If it is necessary to operate the wipers in dry weather conditions, always operate the wipers with washer fluid.

! If the windshield wipers leave smears on the windshield after the car has been driven through an automatic car wash, then wax or other residue is on the windshield. Shortly after washing the car in an automatic car wash, clean the windshield with washer fluid.

Wipers



Combination switch

- ① Switching on windshield wipers
 - ② Single wipe
- Wiping with washer fluid

► Switch on the ignition.

Windshield wipers

Switching on/off

0	Windshield wipers off
...	Slow intermittent wiping Rain sensor operation with low sensitivity.
....	Fast intermittent wiping Rain sensor operation with high sensitivity.
—	Slow continuous wiping
≡	Fast continuous wiping

► Turn the combination switch in direction of arrow ① to the desired position, depending on the intensity of the rain.

i When the windshield wipers are switched on and you brake the vehicle to a stop, the wipers operate more slowly.

Intermittent wiping

Only switch on intermittent wiping under wet weather conditions or in the presence of precipitation.

When you select intermittent wiping, the rain sensor is activated. The rain sensor sets a suitable wiping interval depending on the wetness of the sensor surface automatically.

! Do not leave windshield wipers on an intermittent setting when the vehicle is taken to an automatic car wash or during windshield cleaning. Windshield wipers will operate in the presence of water sprayed on the windshield, and windshield wipers may be damaged as a result.

! If you have set intermittent wiping, dirt on the surface of the rain sensor or optical effects may cause the windshield wipers to wipe in an undesired fashion. This could then damage the windshield wiper blades or scratch the windshield. You should therefore switch off the windshield wipers when weather conditions are dry.

► Turn the combination switch to position **...** or **....**.
After the initial wipe, pauses between wipes are controlled by the rain sensor automatically.

Intermittent wiping is interrupted when the vehicle is at a standstill and a door is opened. This protects persons getting into or out of the vehicle from being sprayed.



Wipers

Intermittent wiping will be continued when all doors are closed and

- the automatic transmission is in drive position **D** or reverse gear **R**
or
- the wiper setting is changed using the combination switch

Single wipe

- ▶ Press the combination switch briefly in direction of arrow ② to the resistance point.
The windshield wipers wipe one time without washer fluid.

Wiping with washer fluid

- ▶ Press the combination switch in direction of arrow ② past the resistance point.
The windshield wipers operate with washer fluid.
- i** To prevent smears on the windshield or noisy/chattering wiper blades, wipe with washer fluid every now and then even when it is raining.

For information on filling up the washer reservoir, see “Washer system and headlamp cleaning system” (▷ page 428).

For information on cleaning the headlamps with washer fluid, see “Headlamp cleaning system” (▷ page 320).

Problems with wipers

! If anything blocks the windshield wipers (leaves, snow, etc.), switch them off immediately.

For safety reasons, stop the vehicle in a safe location, and

- - remove the SmartKey from the starter switch
or
- turn off the engine by pressing the KEYLESS-GO start/stop button and open the driver’s door (with the driver’s door open, starter switch is in position **0**, same as with SmartKey removed from starter switch)
- engage the parking brake
before attempting to remove any blockage.
- Remove blockage.
- Turn the windshield wipers on again.

If the windshield wipers fail to function at all with the combination switch in position

... or **....**,

- set the combination switch to the next higher wiper speed
- have the windshield wipers checked at the nearest authorized Mercedes-Benz Center

Power windows

Power windows

Opening and closing

The windows are opened and closed electrically. The switches for all windows are located on the driver's door. The switches for the respective windows are located on the passenger door and the rear side trim panels.

- i** Operating the rear side windows from the rear is not possible when you activate the override switch (▷ page 63).

Vehicles equipped with the PRE-SAFE® system: If the vehicle is in a critical dynamic driving situation, the front side windows close until only a small gap remains.

⚠ Warning!

When opening or closing the windows, make sure there is no danger of anyone being harmed by the opening/closing procedure.

The door windows are equipped with the express operation and automatic reversal function. If in express operation mode a door window encounters an obstruction that blocks its path, the automatic reversal function will stop the door window and open it slightly.

The door windows operate differently when the switch is pressed and held. See the "Closing when a window is blocked" section in this chapter for details.

The closing of the door windows can be immediately halted by releasing the switch or, if the switch was pulled past the resistance point and released, by either pressing or pulling the respective switch.

The closing of the rear side windows can be immediately halted by releasing the switch.

Activate the override switch when children are riding in the back seats of the vehicle. The children may otherwise injure themselves, e.g. by becoming trapped in the window opening.

- ⚠ Observe Safety notes, see page 59.**

⚠ Warning!

Do not keep any part of your body up against the window pane when opening a window. The downward motion of the pane may pull that part of your body down between the window pane and the door frame and trap it there. If there is a risk of entrapment, release the switch and pull it to close the window.

- i** You can also open or close the windows using the SmartKey, see "Summer opening feature" (▷ page 327) and "Convenience closing feature" (▷ page 327).
- i** After switching off the ignition or removing the SmartKey from the starter switch, you can operate the windows until you open a door. If no door was opened you can operate the windows for up to 5 minutes.



- ① Left door window
- ② Right door window
- ③ Right rear side window
- ④ Left rear side window

Power windows

- ▶ Switch on the ignition.
- ▶ **Opening/Closing:** Press or pull and hold switch ① to ④ to the resistance point. The corresponding window will move downwards or upwards until you release the switch.
- ▶ **Express operation:** Press or pull switch ① or ② past the resistance point and release. The corresponding door window opens or closes completely.
- ▶ **Express opening of rear side windows:** Press switch ③ or ④ past the resistance point and release. The corresponding side window opens completely.
- ▶ **Stopping during express operation:** Press or pull the respective switch again.

Closing when a window is blocked

Warning!

Make sure that nobody can become trapped and be seriously or even fatally injured when closing a window with greater force or without automatic reversal function.

If the upward movement of a window is blocked during the closing procedure, the window will stop and open slightly. However, the door window will exert greater force before reversing than when the door window is closed in express operation. Please exercise caution!

- ▶ Immediately after the window has stopped because it was blocked, pull the respective switch upwards until the window is fully closed.

If the door window is blocked again and opens slightly:

- ▶ Immediately after the window was blocked, pull the respective switch upwards until the window is fully closed.

Warning!

Pressing and holding the switch to close the window immediately after it had been blocked two times will cause the window to close without any reversal function for as long as you hold the switch.

Synchronizing power windows

The windows must be synchronized if they cannot be fully closed (express operation). Each window must be synchronized separately.

- ▶ Close all doors.
- ▶ Switch on the ignition.
- ▶ Pull and hold switch ①, ②, ③ or ④ (▷ page 325) until the respective window is closed. The window opens again slightly.
- ▶ Pull and hold the respective switch once more immediately until the window is completely closed.
- ▶ Hold the respective switch for approximately 1 second. The window is synchronized.



Power windows

Summer opening feature

If the weather is warm, you can ventilate the vehicle before driving off by simultaneously:

- opening the windows
- opening the tilt/sliding sunroof
- switching on the seat ventilation for the driver's seat

The summer opening feature can only be activated via the remote control of the SmartKey. The SmartKey must be in close proximity to the driver's outside door handle.

- ▶ Aim transmitter eye of the SmartKey at the driver's outside door handle.
- ▶ Press and hold button  on the SmartKey until the windows and the tilt/sliding sunroof have reached the desired position.
The vehicle unlocks.
- ▶ Release button  on the SmartKey to interrupt the opening procedure.



Convenience closing feature

When locking the vehicle, you can simultaneously close the windows and the tilt/sliding sunroof.

 **Warning!**

When closing the windows and the tilt/sliding sunroof, make sure there is no danger of anyone being harmed by the closing procedure.

If potential danger exists, proceed as follows:

- Release button  to stop the closing procedure. To open, press and hold button . To continue the closing procedure after making sure that there is no danger of anyone being harmed by the closing procedure, press and hold button .



Vehicles with KEYLESS-GO:

- Release the sensor surface on the outside door handle to stop the closing procedure.
- Immediately pull on the same outside door handle and hold firmly. The windows and the tilt/sliding sunroof will open for

as long as the door handle is held but the door not opened.

With SmartKey

The SmartKey must be in close proximity to the driver's outside door handle.

- ▶ Aim transmitter eye of the SmartKey at the driver's outside door handle.
- ▶ Press and hold button  on the SmartKey until the windows and the tilt/sliding sunroof are completely closed. The vehicle locks.
- ▶ Release button  on the SmartKey to interrupt the closing procedure.

With KEYLESS-GO

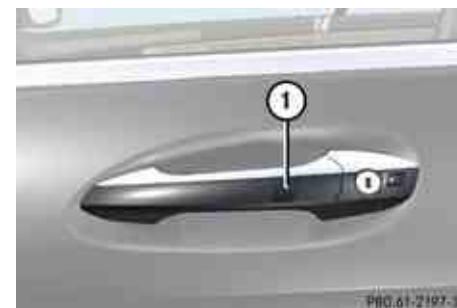

① Sensor surface

Driving and parking

The SmartKey with KEYLESS-GO must be located outside the vehicle within approximately 3 ft (1 m) of a door.

- ▶ Close all doors.
- ▶ Touch and hold sensor surface ① on an outside door handle until the windows and the tilt/sliding sunroof are completely closed.
- ① Make sure you are only touching the sensor surface.
- ▶ Release the sensor surface to interrupt the closing procedure.

Driving and parking

Safety notes

Warning!

Make sure absolutely no objects are obstructing the pedals' range of movement. Keep the driver's footwell clear of all obstacles. If there are any floor mats or carpets in the footwell, make sure the pedals still have sufficient clearance. During sudden driving or braking maneuvers the objects could get caught between the pedals. You could then no longer brake or accelerate. This could lead to accidents and injury.

Warning!

With the engine not running, there is no power assistance for the brake and steering systems. In this case, it is important to keep in mind that a considerably higher degree of effort is necessary to brake and steer the vehicle. Adapt your driving accordingly.

Starting the engine

Warning!

Inhalation of exhaust gas is hazardous to your health. All exhaust gas contains carbon monoxide (CO), and inhaling it can cause unconsciousness and possible death.

Do not run the engine in confined areas (such as a garage) which are not properly ventilated. If you think that exhaust gas fumes are entering the vehicle while driving, have the cause determined and corrected immediately. If you must drive under these conditions, drive only with at least one window fully open at all times.

Automatic transmission



Gearshift pattern for automatic transmission

- ① Button for selecting park position **P**
- P** Park position
- R** Reverse gear
- N** Neutral position
- D** Drive position

For more information on how to operate the gear selector lever, see “Automatic transmission” (> page 335).

- ▶ Make sure the automatic transmission is in park position **P**. The transmission position indicator in the multifunction display should be on P (> page 338).

With SmartKey

- ▶ Do not depress the accelerator pedal.
- ▶ Turn the SmartKey in the starter switch to position **3** (> page 301) and release it. The engine starts automatically.

With KEYLESS-GO

Warning!

As long as the SmartKey is in your vehicle, the vehicle can be started. Therefore, never leave children unattended in the vehicle, as they could otherwise accidentally start the engine.

When leaving the vehicle, always take the SmartKey with you and lock the vehicle. Do not leave children unattended in the vehicle, or with access to an unlocked vehicle. A child's unsupervised access to a vehicle could result in an accident and/or serious personal injury.

You can start your vehicle without the SmartKey in the starter switch using the KEYLESS-GO start/stop button in the starter switch.

The SmartKey must be located in the vehicle.

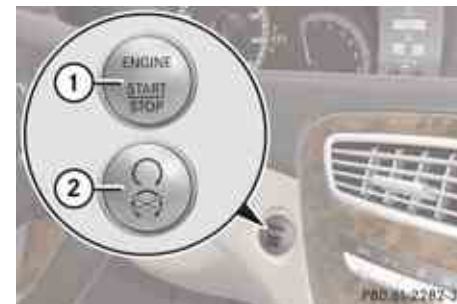

KEYLESS-GO start/stop button

- ① USA only
- ② Canada only

- ▶ Make sure the KEYLESS-GO start/stop button is inserted in the starter switch.
- i** If you wish to start the engine with the SmartKey instead of the KEYLESS-GO function, remove the KEYLESS-GO start/stop button from the starter switch and proceed as described in “With SmartKey” (> page 329).
- ▶ Depress the brake pedal during the starting procedure.
- ▶ Do not depress the accelerator pedal.

Driving and parking

- ▶ Press the KEYLESS-GO start/stop button once.
The engine starts automatically.

Starting difficulties

- ❗ Remember that extended starting attempts can drain the battery.

The engine does not start. You can hear the starter.

There could be a malfunction in the engine electronics or in the fuel supply system.

Carry out the following steps:

- ▶ If you are starting the engine with the SmartKey: Turn the SmartKey in the starter switch to position **0** and repeat the starting procedure.
- ▶ If you are starting the engine with KEYLESS-GO: Close any doors that may be open to allow for better detection of the SmartKey.

or

- ▶ Remove the KEYLESS-GO start/stop button from the starter switch.
- ▶ Start the engine with the SmartKey as radio signals from another source may be interfering with the KEYLESS-GO function.
- ▶ Repeat the starting procedure.

If the engine does not start after several starting attempts:

- ▶ Contact an authorized Mercedes-Benz Center or call Roadside Assistance.

The engine does not start. You cannot hear the starter.

The battery may not be sufficiently charged.

- ▶ Get a jump start (▷ page 554).

If the engine will not start despite a jump start:

- ▶ Contact an authorized Mercedes-Benz Center or call Roadside Assistance.

The starter has been exposed to excessive temperatures.

- ▶ Let the starter cool for about 2 minutes.
- ▶ Repeat the starting procedure.

If the engine does not start after several starting attempts:

- ▶ Contact an authorized Mercedes-Benz Center or call Roadside Assistance.

Driving off

Warning!

On slippery road surfaces, never downshift in order to obtain braking action. This could result in drive wheel slip and reduced vehicle control. Your vehicle's ABS will not prevent this type of loss of control.

- ❗ Do not run cold engine at high engine speeds. Running a cold engine at high engine speeds may shorten the service life of the engine. This is not covered by the Mercedes-Benz Limited Warranty.
CL 63 AMG: At engine temperatures below 68°F (20°C), the engine's maximum speed is restricted in order to protect it from damage. Avoid driving your vehicle at full speed when the engine is cold to prevent premature engine wear and/or diminished comfort.

Driving and parking

! You have forgotten to release the electronic parking brake when driving off if

- an acoustic warning sounds
- the message **Please Release Parking Brake** appears in the multifunction display
- the red indicator lamp for the electronic parking brake **PARK** (USA only) or **(P)** (Canada only) in the instrument cluster flashes

Release the electronic parking brake.

! Avoid spinning of a drive wheel. This may cause serious damage to the drivetrain which is not covered by the Mercedes-Benz Limited Warranty.

! Simultaneously depressing the accelerator pedal and applying the brakes reduces engine performance and causes premature brake and drivetrain wear which is not covered by the Mercedes-Benz Limited Warranty.

i Once the vehicle is in motion, the automatic central locking system engages and the locking knobs in the doors move down.

The automatic door lock feature can be deactivated (▷ page 218).

Automatic transmission

Warning!

It is dangerous to shift the automatic transmission out of park position **P** or neutral position **N** if the engine speed is higher than idle speed. If your foot is not firmly on the brake pedal, the vehicle could accelerate quickly forward or in reverse. You could lose control of the vehicle and hit someone or something. Only shift into gear when the engine is idling normally and when your right foot is firmly on the brake pedal.

! Only shift the automatic transmission into reverse gear **R** or park position **P** when the vehicle is stopped. Otherwise the automatic transmission could be damaged.

- ▶ Depress the brake pedal. The gear selector lever can now be used.
- ▶ Shift the automatic transmission into drive position **D** or reverse gear **R**.

i Shifting the automatic transmission out of park position **P** is only possible with the brake pedal depressed.

Without the brake pedal depressed, the gear selector lever can be moved up or down, but the parking pawl remains engaged, not allowing shifting to occur.

- ▶ Wait for the gear selection process to complete before setting the vehicle in motion.
- ▶ Release the brake pedal.
- ▶ Carefully depress the accelerator pedal. The electronic parking brake releases automatically.

The red indicator lamp **PARK** (USA only) or **(P)** (Canada only) in the instrument cluster goes out.

After a cold start, the automatic transmission shifts at a higher engine revolution. This allows the catalytic converter to reach its operating temperature earlier.

For more information on driving, see “Driving instructions” (▷ page 454).

Driving and parking

Problems while driving

The engine runs erratically and misfires

- An ignition cable may be damaged.
 - The engine electronics may not be operating properly.
 - Unburned gasoline may have entered the catalytic converter and damaged it.
- ▶ Give very little gas.
- ▶ Have the problem checked at an authorized Mercedes-Benz Center as soon as possible.

The coolant temperature is above 248°F (120°C)

The coolant is too hot and is no longer cooling the engine.

- ▶ Stop the vehicle in a safe location as soon as possible.
- ▶ Turn off the engine immediately.
- ▶ Allow the engine and coolant to cool off.
- ▶ Check the coolant level and add coolant if necessary (▷ page 427).

In case of accident

If the vehicle is leaking fuel:

- ▶ Do not start the engine under any circumstances.
- ▶ Exit the vehicle at a safe distance from the roadway.
- ▶ Notify local fire and/or police authorities.

If the extent of the damage cannot be determined:

- ▶ Contact an authorized Mercedes-Benz Center or call Roadside Assistance.

If no damage on major assemblies, fuel system, and engine mount can be determined:

- ▶ Start the engine in the usual manner.

Parking

Warning!

Do not park this vehicle in areas where combustible materials such as grass, hay or leaves can come into contact with the hot exhaust system, as these materials could be ignited and cause a vehicle fire.

To reduce the risk of serious personal injury, or damage to the vehicle or the vehicle drivetrain, as a result of vehicle movement, always do the following before turning off the engine and leaving the vehicle:

- Keep right foot on the brake pedal.
- Engage the electronic parking brake.
- Shift the automatic transmission into park position **P**.
- Slowly release the brake pedal.
- When parked on an incline, always turn the front wheels towards the road curb.
- Turn the SmartKey in the starter switch to position **0** and remove the SmartKey

Driving and parking

from the starter switch, or press the KEYLESS-GO start/stop button.

- Take the SmartKey with you and lock the vehicle when leaving.

Electronic parking brake

Warning!

When leaving the vehicle, always remove the SmartKey from the starter switch, take it with you, and lock the vehicle. Do not leave children unattended in the vehicle, or with access to an unlocked vehicle. Children could release the electronic parking brake and/or shift the automatic transmission out of park position **P**, either of which could result in an accident and/or serious personal injury.



- ① Handle for electronic parking brake

Releasing electronic parking brake manually

- ▶ Make sure the ignition is switched on.
- ▶ Pull handle ①.
The red indicator lamp **PARK** (USA only) or  (Canada only) in the instrument cluster goes out.

Releasing electronic parking brake automatically

Your vehicle's electronic parking brake releases automatically when:

- The engine is running.
- The automatic transmission is in drive position **D** or reverse gear **R**. With the

automatic transmission in reverse gear **R** the trunk lid must be closed.

- The hood is closed.
 - You have fastened your seat belt.
 - You press on the accelerator pedal.
- i** If you have not fastened your seat belt, the following conditions must be met in order for the electronic parking brake to release automatically:
- The driver's door is closed and you shift the automatic transmission out of park position **P**.
 - or
 - The driver's door is closed and you drive faster than 2 mph (3 km/h).

Engaging electronic parking brake manually



- ▶ Press handle ①.
The red indicator lamp **PARK** (USA only) or  (Canada only) in the instrument cluster comes on.
- i** You can also engage the electronic parking brake when the SmartKey is removed from the starter switch.

Driving and parking

Engaging electronic parking brake automatically

Your vehicle's electronic parking brake engages automatically when DISTRONIC Plus (> page 350) brings your vehicle to a standstill, and at least one of the following conditions is met:

- The engine is turned off.
- The driver's door is opened and the seat belt is not inserted in the seat belt buckle.
- The hood lock is released.
- The trunk lid is opened while the automatic transmission is in reverse gear **R**.
- The vehicle is stationary for an extended period of time.

The red indicator lamp  (USA only) or  (Canada only) in the instrument cluster comes on.

- i** In addition to engaging the electronic parking brake, the automatic transmission will shift into park position **P** automatically.



Emergency braking with electronic parking brake

In an emergency situation, you can also brake your vehicle while driving by using the electronic parking brake.

- ▶ While driving, press the handle for the electronic parking brake (> page 333).

- i** Your vehicle will be braked for as long as you press and hold the handle for the electronic parking brake. The longer you keep the handle for the electronic parking brake pressed, the more strongly your vehicle will be braked. This method occurs on all four wheels, not just the rear wheels.

During the braking procedure

- an acoustic warning sounds
- the message **Please Release Parking Brake** appears in the multifunction display
- the red indicator lamp for the electronic parking brake  (USA only) or  (Canada only) in the instrument cluster flashes

Once the vehicle comes to a complete stop, the electronic parking brake will engage automatically.

Turning off the engine

Warning!

Do not turn off the engine before the vehicle has come to a complete stop. With the engine not running, there is no power assistance for the brake and steering systems. In this case, it is important to keep in mind that a considerably higher degree of effort is necessary to brake and steer the vehicle.

- i** If the engine cannot be turned off as described, see “Emergency engine shutdown” (> page 561).
- ▶ Shift the automatic transmission into park position **P**.
- i** When parked on an incline, also turn the front wheels towards the road curb.
- i** Observe instructions if you want the automatic transmission to remain in neutral position **N**, see “Remaining in neutral position **N**” (> page 337).

With SmartKey

- ▶ Turn the SmartKey in the starter switch to position **0**.

Automatic transmission

Automatic transmission

Introduction

For information on driving with an automatic transmission, see “Driving and parking” (▷ page 328).

⚠ Warning!

Make sure absolutely no objects are obstructing the pedals’ range of movement. Keep the driver’s footwell clear of all obstacles. If there are any floor mats or carpets in the footwell, make sure the pedals still have sufficient clearance.

During sudden driving or braking maneuvers the objects could get caught between the pedals. You could then no longer brake or accelerate. This could lead to accidents and injury.

! Allow engine to warm up under low load use. Do not place full load on the engine until the operating temperature has been reached.

Avoid spinning of a drive wheel for an extended period when driving off on slippery road surfaces.

This may cause serious damage to the engine and the drivetrain which is not



- ▶ Remove the SmartKey from the starter switch.

The immobilizer is activated.

If you turn off the engine using the SmartKey, and remove the SmartKey from the starter switch or open a front door, the automatic transmission will shift into park position **P** automatically.

⚠ Warning!

Keep in mind that turning off the engine alone only will shift the automatic transmission into neutral position **N** automatically.

Always shift the automatic transmission into park position **P** before turning off the engine.

Otherwise the vehicle could roll away which could result in an accident and/or serious personal injury.

With KEYLESS-GO

- ▶ Press the KEYLESS-GO start/stop button. With the driver’s door closed, the starter switch is now in position **1**. With the driver’s door opened, the starter switch is set to position **0**, same as the SmartKey removed from the starter switch (▷ page 301).

If you turn off the engine using the KEYLESS-GO start/stop button and open a front door, the automatic transmission will shift into park position **P** automatically.

⚠ Warning!

Keep in mind that turning off the engine alone only will shift the automatic transmission into neutral position **N** automatically.

Always shift the automatic transmission into park position **P** before turning off the engine.

Otherwise the vehicle could roll away which could result in an accident and/or serious personal injury.

- i** In an emergency you can turn off the engine while driving by pressing and holding the KEYLESS-GO start/stop button for approximately 3 seconds.

If you have started the engine with the KEYLESS-GO start/stop button and cannot turn it off as described above:

- ▶ Remove the KEYLESS-GO start/stop button from the starter switch.
- ▶ Insert the SmartKey into the starter switch. The engine turns off. The starter switch is in position **0** (▷ page 301).

Automatic transmission

covered by the Mercedes-Benz Limited Warranty.

- i** During the brief warm-up, transmission upshifting is delayed. This allows the catalytic converter to heat up more quickly to operating temperature.

Gear selector lever



Gearshift pattern for automatic transmission

- 1** Button for selecting park position **P**
- P** Park position
- R** Reverse gear
- N** Neutral position
- D** Drive position

⚠ Warning!

It is dangerous to shift the automatic transmission out of park position **P** or neutral position **N** if the engine speed is higher than idle speed. If your foot is not firmly on the brake pedal, the vehicle could accelerate quickly forward or in reverse. You could lose control of the vehicle and hit someone or something. Only shift into gear when the engine is idling normally and when your right foot is firmly on the brake pedal.

- !** Only shift the automatic transmission into reverse gear **R** or park position **P** when the vehicle is stopped. Otherwise the automatic transmission could be damaged.

- !** The vehicle must be stopped when you shift the automatic transmission

- directly between drive position **D** and reverse gear **R**
- directly between reverse gear **R** and drive position **D**
- directly into park position **P**

Otherwise the automatic transmission could be damaged.

When trying to free a vehicle stuck in mud or snow, see “Rocking the vehicle” (▷ page 339).

- i** Shifting the automatic transmission out of park position **P** is only possible with the brake pedal depressed.

Without the brake pedal depressed, the gear selector lever can be moved up or down, but the parking pawl remains engaged, not allowing shifting to occur.

- i** The gear selector lever always returns to its original position.

The current transmission position **P**, **R**, **N**, or **D** appears in the multifunction display (▷ page 338).

Shifting into park position **P**

- ▶ With the vehicle at a standstill, press button **1** on the gear selector lever to select park position **P**.

SmartKey: When you turn off the engine using the SmartKey, and remove the SmartKey from the starter switch or open a front door, the automatic transmission will shift into park position **P** automatically.

KEYLESS-GO: When you turn off the engine using the KEYLESS-GO start/stop button and

Automatic transmission

open a front door, the automatic transmission will shift into park position **P** automatically.

 **Warning!**

Keep in mind that turning off the engine alone only will shift the automatic transmission into neutral position **N** automatically.

Always shift the automatic transmission into park position **P** before turning off the engine.

Otherwise the vehicle could roll away which could result in an accident and/or serious personal injury.

 Moving the gear selector lever up or down shifts the automatic transmission out of park position **P**.

DISTRONIC Plus:

The automatic transmission will shift into park position **P** automatically when DISTRONIC Plus brings your vehicle to a standstill, and at least one of the following conditions is met:

- The engine is turned off.
- The driver's door is opened and the seat belt is not inserted in the seat belt buckle.
- The hood lock is released.

- The trunk lid is opened while the automatic transmission is in reverse gear **R**.
- The vehicle is stationary for an extended period of time.

In addition to shifting into park position **P**, the electronic parking brake will engage automatically.

Shifting into neutral position **N**

- ▶ With the vehicle at a standstill, depress the brake pedal and move the gear selector lever up or down to the resistance point to select neutral position **N**.

When you turn off the engine, the automatic transmission will shift into neutral position **N** automatically.

SmartKey: Removing the SmartKey from the starter switch or opening a front door after turning off the engine will shift the automatic transmission into park position **P** automatically.

KEYLESS-GO: Opening a front door after turning off the engine will shift the automatic transmission into park position **P** automatically.

Remaining in neutral position **N**

If you want the automatic transmission to remain in neutral position **N**, e.g. when taking the vehicle through an automatic conveyor-type car wash, observe the following instructions:

 **Warning!**

When leaving the SmartKey in the starter switch, do not leave children unattended in the vehicle. It is possible for children to switch on the ignition which could result in unsupervised use of vehicle equipment. Unsupervised use of vehicle equipment could result in an accident and/or serious personal injury.

With SmartKey:

- ▶ Make sure the ignition is switched on.
- ▶ With the vehicle at a standstill, depress the brake pedal and keep it pressed.
- ▶ Shift the automatic transmission into neutral position **N**.
- ▶ Release the brake pedal.
- ▶ If engaged, manually release the electronic parking brake.
- ▶ Switch off the ignition and leave the SmartKey in the starter switch.

Automatic transmission

With KEYLESS-GO:

- ▶ Make sure the ignition is switched on.
- ▶ With the vehicle at a standstill, depress the brake pedal and keep it pressed.
- ▶ Shift the automatic transmission into park position **P**.
- ▶ Release the brake pedal.
- ▶ Remove the KEYLESS-GO start/stop button from the starter switch.
- ▶ Insert the SmartKey into the starter switch.
- ▶ Switch on the ignition.
- ▶ Depress the brake pedal and keep it pressed.
- ▶ Shift the automatic transmission into neutral position **N**.
- ▶ Release the brake pedal.
- ▶ If engaged, manually release the electronic parking brake.
- ▶ Switch off the ignition and leave the SmartKey in the starter switch.

Shifting into reverse gear R

- ▶ With the vehicle at a standstill, depress the brake pedal and move the gear selector lever up past the resistance point to select reverse gear **R**.

Shifting into drive position D

- ▶ With the vehicle at a standstill, depress the brake pedal and move the gear selector lever down past the resistance point to select drive position **D**.

Shifting procedure

The automatic transmission selects individual gears automatically, depending on:

- the selected gear range (▷ page 340)
- the selected program mode:
 - C/S** (▷ page 340)
 - or
 - M** (AMG vehicles only) (▷ page 342)
- the position of the accelerator pedal
- the vehicle speed

With drive position **D** selected, you can influence transmission shifting by:

- limiting the gear range
- extending the gear range
- changing the gears manually (AMG vehicles only)

Transmission positions

The current transmission position appears in the multifunction display.

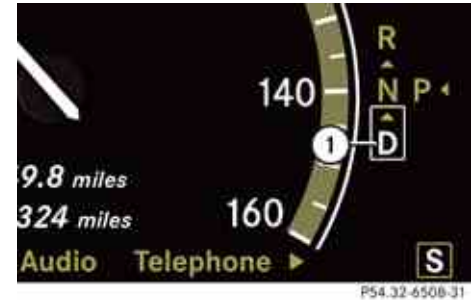

- ① Transmission position indicator

If the current transmission position does not appear in the multifunction display due to a malfunction, for example, make sure that the automatic transmission is in the desired position:

- ▶ Shift the automatic transmission into drive position **D**.
- ▶ Select automatic program mode **S**.
- ▶ Do not limit the gear range.
- ▶ Drive off carefully.

Automatic transmission

	Effect
P	<p>Park position</p> <p>Shift the automatic transmission into park position P only when the vehicle is stopped. The park position is not intended to serve as a brake when the vehicle is parked. Rather, the driver should always engage the electronic parking brake in addition to shifting the automatic transmission into park position P to secure the vehicle.</p> <p>If the vehicle's electrical system is malfunctioning, the automatic transmission could remain locked in park position P.</p> <ul style="list-style-type: none"> ▶ Have the vehicle's electrical system checked at an authorized Mercedes-Benz Center as soon as possible.
R	<p>Reverse gear</p> <p>Shift the automatic transmission into reverse gear R only when the vehicle is stopped.</p>

	Effect
N	<p>Neutral position</p> <p>No power is transmitted from the engine to the drive axle. When the brakes are released, the vehicle can be moved freely (pushed or towed).</p> <p>To avoid damage to the transmission, never shift the automatic transmission into neutral position N while driving.</p> <p>Exception: If the ESP® is deactivated or malfunctioning, shift the automatic transmission into neutral position N if the vehicle is in danger of skidding.</p> <p>! Coasting the vehicle, or driving for any other reason with the automatic transmission in neutral position N can result in transmission damage that is not covered by the Mercedes-Benz Limited Warranty.</p>
D	<p>Drive position</p>

	Effect
	<p>The automatic transmission shifts automatically. All forward gears are available.</p>

Driving tips

Kickdown

Use the kickdown when you want maximum acceleration.

- ▶ Fully depress the accelerator pedal. Depending on the engine speed the automatic transmission shifts into a lower gear.

Canada vehicles and AMG vehicles only:

- ▶ Depress the accelerator pedal past the point of resistance to use the kickdown.

Rocking the vehicle

Rocking the vehicle by shifting the automatic transmission directly between drive position **D** and reverse gear **R** can help free a vehicle stuck in mud or snow. The engine control system of this vehicle electronically limits directly shifting the automatic transmission between drive position **D** and reverse gear **R** to very low speeds, i.e. approximately 5 mph



Automatic transmission

(9 km/h). To shift the automatic transmission directly between drive position **D** and reverse gear **R**, move the gear selector lever past the resistance point up or down.

Working on the vehicle

Warning!

When working on the vehicle, engage the electronic parking brake and shift the automatic transmission into park position **P**. Otherwise the vehicle could roll away which could result in an accident and/or serious personal injury.

Gear ranges

With the automatic transmission in drive position **D** and driving in automatic program mode **C** or **S**, you can limit or extend the gear range, see “One-touch gearshifting” (> page 341).

The current gear range appears in the multifunction display.

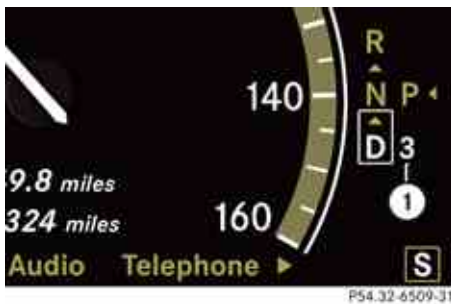

① Gear range indicator

	Effect
3	With this selection you can use the braking effect of the engine.
2	Allows the use of engine's braking power when driving <ul style="list-style-type: none">• on steep downgrades• in mountainous regions• under extreme operating conditions
1	For maximum use of engine's braking effect on very steep or lengthy downgrades.

Automatic shift program

The program mode selector switch is used to adjust

- the shift program
- the suspension tuning of the AIRMATIC or the ABC system
- the engine control

Automatic transmission



Program mode selector switch

C Comfort	For comfort driving
S Sport	For standard driving



Program mode selector switch on AMG vehicles

C Comfort	For standard driving
S Sport	For sporty driving
M Manual	For manual gearshifting (▷ page 342)

The current program mode appears in the multifunction display.

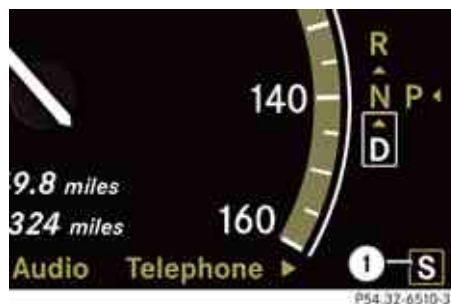

① Program mode indicator

You should only change the program mode when the automatic transmission is in park position **P**.

- ① The last selected automatic program mode (**C** or **S**) is switched on when the engine is restarted.

▶ Press the program mode selector switch repeatedly until the letter of the desired

program mode appears in the multifunction display.

Selecting program mode **C** means:

- The vehicle starts out more gentle, both forward and reverse, except when driving off with full throttle.
- Traction and driving stability are improved on icy roads.
- Upshifts occur earlier even when you give more gas. The engine then operates at lower revolutions and the wheels are less likely to spin.

Selecting program mode **S** means that upshifts occur later.

One-touch gearshifting

With the automatic transmission in drive position **D** and driving in automatic program mode **C** or **S**, you can limit or extend the gear range using the steering wheel gearshift control.

AMG vehicles: For information on using the steering wheel gearshift control in manual program mode **M**, see “Manual shift program” (▷ page 342).



Automatic transmission



Steering wheel gearshift control (example illustration)

- ① Limiting gear range
Downshift (in manual program mode **M**)
- ② Extending gear range
Upshift (in manual program mode **M**)

i You cannot shift with the steering wheel gearshift control when the automatic transmission is in park position **P**, neutral position **N**, or reverse gear **R**.

Limiting gear range

Warning!

On slippery road surfaces, never downshift in order to obtain braking action. This could result in drive wheel slip and reduced

vehicle control. Your vehicle's ABS will not prevent this type of loss of control.

- ▶ Briefly pull left gearshift control ①.
The automatic transmission will shift into the next lower gear as permitted by the shift program. This action simultaneously limits the gear range of the automatic transmission.
- i** To avoid overrevving the engine when downshifting, the automatic transmission will not shift into a lower gear if the engine's maximum speed would be exceeded.

Extending gear range

- ▶ Briefly pull right gearshift control ②.
The automatic transmission will shift into the next higher gear as permitted by the shift program. This action simultaneously extends the gear range of the automatic transmission.
- i** If you press on the accelerator pedal when the engine has reached the revolution limit of the current gear range, the automatic transmission will upshift beyond any gear range limit selected.

Canceling gear range limit

- ▶ Pull and hold right gearshift control ② until the gear range indicator disappears from the multifunction display.
The automatic transmission will shift from the current gear range directly into drive position **D**.

Shifting into optimal gear range

- ▶ Pull and hold left gearshift control ①.
The automatic transmission will select the gear range suited for optimal acceleration and deceleration automatically. This will involve shifting down one or more gears.

Manual shift program

The manual shift program is available on AMG vehicles only.

Manual program mode **M** differs with regard to spontaneity, response time, and shifting smoothness from automatic program mode **S**.

In manual program mode **M**, system-controlled automatic gearshifting is switched off. You need to change the gears by manually upshifting or downshifting using the steering wheel gearshift control.

Automatic transmission



Program mode selector switch

C Comfort	For standard driving
S Sport	For sporty driving
M Manual	For manual gearshifting

The current program mode appears in the multifunction display (▷ page 341).

For information on automatic program mode (**C** or **S**), see “Automatic shift program” (▷ page 340) and “One-touch gearshifting” (▷ page 341).

Activating manual shift program

- ▶ Press the program mode selector switch repeatedly until **M** appears in the multifunction display. The automatic transmission switches to manual program mode **M**. Automatic shifting is switched off. The gear range is not limited.

You can change the gears manually with drive position **D** selected. You can upshift or downshift through the gears in succession.

- i** Manual program mode **M** will not be stored. When the engine is turned off with manual program mode **M** selected, the automatic transmission will go to automatic program mode (**C** or **S**) when the engine is restarted.

Upshifting

- !** In manual program mode **M**, the automatic transmission will not upshift, even if the engine has reached its overrevving range. Shift up into the next gear before the engine has reached its overrevving range. Make absolutely certain that the engine speed does not reach the red marking on the tachometer. Otherwise the engine could be damaged which is not

covered by the Mercedes-Benz Limited Warranty.

- ▶ Briefly pull right gearshift control ② (▷ page 342). The automatic transmission shifts into the next higher gear.

Upshift indicator



- ① Current gear
- ② Upshift indicator

In manual program mode **M**, upshift indicator ② in the multifunction display advises you to upshift before the engine reaches the overspeed range. Thus you can drive at the maximum engine speed for each gear without overrevving the engine.

Automatic transmission

- ▶ Shift the automatic transmission from current gear ① into the next higher gear. The fuel supply will otherwise be interrupted to prevent the engine from overrevving.

Downshifting

Warning!

On slippery road surfaces, never downshift in order to obtain braking action. This could result in drive wheel slip and reduced vehicle control. Your vehicle's ABS will not prevent this type of loss of control.

- ▶ Briefly pull left gearshift control ① (▷ page 342). The automatic transmission shifts into the next lower gear.
- i** For maximum acceleration, pull and hold the left gearshift control. Depending on the engine speed the automatic transmission selects the optimal gear for maximum acceleration.
- i** When you brake or stop, the automatic transmission shifts down into a gear from which you can easily accelerate or take off.

Kickdown

Using the kickdown when driving in manual program mode **M** is not possible.

Deactivating manual shift program

- ▶ Press the program mode selector switch repeatedly until **C** or **S** appears in the multifunction display.

or

- ▶ Restart the engine. The automatic transmission will go to automatic program mode (**C** or **S**).

Manual program mode **M** is not stored.

Emergency operation (limp-home mode)

If vehicle acceleration becomes less responsive or sluggish or the automatic transmission no longer shifts, the automatic transmission is most likely operating in limp-home (emergency operation) mode. In this mode only second gear and reverse gear **R** can be selected.

- ▶ Stop the vehicle in a safe location.
- ▶ Shift the automatic transmission into park position **P**.

- ▶ Turn off the engine.
- ▶ Wait at least 10 seconds before restarting.
- ▶ Restart the engine.
- ▶ Shift the automatic transmission into drive position **D** (for second gear) or reverse gear **R**.
- ▶ Have the automatic transmission checked at an authorized Mercedes-Benz Center as soon as possible.

Instrument cluster

Instrument cluster

Introduction

For a full view illustration of the instrument cluster, see “Instrument cluster” (▷ page 30).

⚠ Warning!

No messages will be displayed if either the instrument cluster or the multifunction display is inoperative.

As a result, you will not be able to see information about your driving conditions, such as speed or outside temperature, warning/indicator lamps, malfunction/warning messages or the failure of any systems. Driving characteristics may be impaired.

If you must continue to drive, please do so with added caution. Contact an authorized Mercedes-Benz Center as soon as possible.

The language setting for the multifunction display can be changed via COMAND (▷ page 94).

Activating the instrument cluster

The instrument cluster is activated when you

- open a door
- switch on the ignition
- switch on the exterior lamps

Adjusting the instrument cluster illumination



① Knob

- ① The instrument cluster illumination is dimmed or brightened automatically to suit ambient light conditions.

The instrument cluster illumination will also be adjusted automatically when you switch on the vehicle's exterior lamps.

- ▶ **To brighten illumination:** Turn knob ① clockwise.
- ▶ **To dim illumination:** Turn knob ① counterclockwise.

Coolant temperature gauge

The coolant temperature gauge is located on the left side in the instrument cluster (▷ page 30).

⚠ Warning!

Driving when your engine is overheated can cause some fluids which may have leaked into the engine compartment to catch fire. You could be seriously burned.

Steam from an overheated engine can cause serious burns which can occur just by opening the engine hood. Stay away from the engine if you see or hear steam coming from it.

Stop the vehicle in a safe location away from other traffic. Turn off the engine, get out of the vehicle and do not stand near the vehicle until the engine has cooled down.

During severe operating conditions, e.g. stop-and-go traffic, the coolant temperature may rise close to 248°F (120°C), i.e. close to the red zone of the temperature gauge.



Driving systems

! Excessive coolant temperature triggers a warning in the multifunction display.

The engine should not be operated with a coolant temperature above 248°F (120°C), i.e. in the red zone of the coolant temperature gauge. Doing so may cause serious engine damage which is not covered by the Mercedes-Benz Limited Warranty.

Tachometer

The red marking on the tachometer (▷ page 30) denotes excessive engine speed.

! Avoid driving at excessive engine speeds, as it may result in serious engine damage that is not covered by the Mercedes-Benz Limited Warranty.

To help protect the engine, the fuel supply is interrupted if the engine is operated within the red marking.

Outside temperature indicator

The outside temperature indicator is on the bottom left-hand side of the instrument cluster (▷ page 30).

⚠ Warning!

The outside temperature indicator is not designed to serve as an ice-warning device and is therefore unsuitable for that purpose.

Indicated temperatures just above the freezing point do not guarantee that the road surface is free of ice. The road may still be icy, especially in wooded areas or on bridges.

Fuel gauge

The fuel gauge is on the left-hand side of the instrument cluster (▷ page 30). Once the fuel level has fallen below the reserve mark, the yellow segment indicator for the fuel reserve comes on.

Driving systems

Introduction

This section describes the following driving systems of your vehicle:

- Cruise control and DISTRONIC Plus
- Hill start assist system
- AIRMATIC
- Active Body Control (ABC)
- All-wheel drive (4MATIC)
- Parktronic system
- Park Assist
- Advanced Parking Guidance
- Rear View Camera
- Night View Assist
- Blind Spot Assist

The ABS, Adaptive Brake, BAS, BAS Plus, EBP, ESP® and PRE-SAFE® Brake driving safety systems are described in the “Safety and security” section (▷ page 65).

Cruise control

The cruise control automatically maintains the speed you set for your vehicle.

The use of the cruise control is recommended for driving at a constant speed for extended periods of time.

The currently set speed or last set speed (“Resume” function) appears in the multifunction display for approximately 5 seconds. The set speed is shown by a triangle in the speedometer and the corresponding speedometer segments from the selected speed to the vehicle maximum speed in the multifunction display are illuminated.

Warning!

The cruise control is a convenience system designed to assist the driver during vehicle operation. The driver is and must always remain responsible for the vehicle’s speed and for safe brake operation.

Only use the cruise control if the road, traffic, and weather conditions make it advisable to travel at a constant speed.

- The use of the cruise control can be dangerous on winding roads or in heavy

traffic because conditions do not allow safe driving at a constant speed.

- The use of the cruise control can be dangerous on slippery roads. Rapid changes in tire traction can result in wheel spin and loss of control.
- Deactivate the cruise control when driving in fog.

The “Resume” function should only be operated if the driver is fully aware of the previously set speed and wishes to resume this particular preset speed.

Warning!

The cruise control brakes automatically so that the set speed is not exceeded. The brake pedal depresses automatically when the cruise control engages the brakes.

Keep the driver’s footwell clear at all times, including the area under the brake pedal. Objects stored in this area may impair pedal movement which could interfere with the braking ability of the cruise control system.

Do not place your foot under the brake pedal – your foot could become caught.

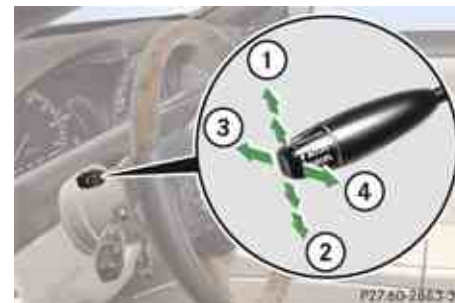

- ① Setting current or higher speed
- ② Setting current or lower speed
- ③ Canceling the cruise control
- ④ Activating the cruise control or resuming to last set speed

Activating cruise control

You can activate the cruise control at a vehicle speed above 20 mph (30 km/h). You cannot activate the cruise control:

- when you brake
- when you have engaged the electronic parking brake

Driving systems

- when the automatic transmission is in park position **P**, reverse gear **R**, or neutral position **N**
- the ESP® is switched off or has switched off due to a malfunction

The vehicle speed displayed in the speedometer can briefly vary from the speed setting for the cruise control system.

Setting current speed

- ▶ Accelerate or decelerate to the desired speed.
- ▶ Briefly lift the cruise control lever in direction of arrow ① or press in direction of arrow ②.
- ▶ Remove your foot from the accelerator pedal.

i On uphill grades, the cruise control may not be able to maintain the set speed. Once the grade eases, the set speed will be resumed.

On downhill grades, the cruise control maintains the set speed by braking with the vehicle's brake system. In addition, on longer downhill grades the automatic transmission will downshift automatically.

Canceling cruise control

- ▶ Depress the brake pedal.
- or
- ▶ Briefly push the cruise control lever in direction of arrow ③.

The last set speed is stored for later use.

The last stored speed is deleted from memory when the engine is turned off.

The cruise control switches off automatically when you depress the brake pedal or you engage the electronic parking brake. In this case, the speedometer segments in the multifunction display will go out.

The cruise control also switches off automatically when

- the vehicle speed falls below 20 mph (30 km/h)
- the ESP® is in operation
- the ESP® is switched off with the ESP® switch
- the ESP® has switched off due to a malfunction
- you shift the automatic transmission into neutral position **N** while driving

The speedometer segments in the multifunction display goes out and an

acoustic warning will sound. Observe additional messages in the multifunction display that may appear.

Depressing the accelerator pedal does not deactivate the cruise control. After a brief acceleration (e.g. for passing), the cruise control will resume the last set speed.

Changing the set speed

Warning!

Keep in mind that it may take a brief moment until the vehicle has made the necessary adjustments.

Increase or decrease the set vehicle speed to a value that the prevailing road conditions and legal speed limits permit. Otherwise, sudden and unexpected acceleration or deceleration of the vehicle could cause an accident and/or serious injury to you and others.

You can increase or decrease the set speed in 1 mph (Canada: 1 km/h) increments or in 5 mph (Canada: 10 km/h) increments.

When you use the cruise control lever to decelerate, the brake system will brake the vehicle automatically if the engine's braking power does not brake the vehicle sufficiently.

Adjustment in 1 mph (Canada: 1 km/h) increments

- i** The set speed value is increased or decreased in 1 mph (Canada: 1 km/h) increments each time you lift or press the cruise control lever up or down to the resistance point.
- ▶ Briefly lift the cruise control lever up to the resistance point in direction of arrow ① to increase or press the cruise control lever down to the resistance point in direction of arrow ② to decrease.
- ▶ Release the cruise control lever. The new speed is set and the vehicle will accelerate or decelerate.

Adjustment in 5 mph (Canada: 10 km/h) increments

- i** The set speed value is increased or decreased in 5 mph (Canada: 10 km/h) increments each time you lift or press the cruise control lever up or down past the resistance point.
- ▶ Briefly lift the cruise control lever up past the resistance point in direction of arrow ① to increase or press the cruise control

lever down past the resistance point in direction of arrow ② to decrease.

- ▶ Release the cruise control lever. The new speed is set and the vehicle will accelerate or decelerate. Keep in mind that it may take a brief moment until the vehicle has reached the set speed.

Resume last stored speed

Warning!

The set speed stored in memory should only be set again if prevailing road conditions and legal speed limits permit. Possible acceleration or deceleration differences arising from returning to the preset speed could cause an accident and/or serious injury to you and others.

- ▶ Briefly pull the cruise control lever in direction of arrow ④.
- If no speed is stored, the current speed is set and stored.
- ▶ Remove your foot from the accelerator pedal.

The last stored speed is deleted from memory when the engine is turned off.

Hill start assist system

Warning!

The hill start assist system is not designed to function as a parking brake and does not prevent the vehicle from moving when parked on an incline.

Always engage the electronic parking brake in addition to shifting the automatic transmission into park position **P**.

On uphill grades with a gradient angle of more than 5°, the hill start assist system maintains the pressure in the brake system for approximately 1 second after you have released the brake pedal. Therefore, you can start off smoothly without the vehicle moving immediately after releasing the brake pedal.

- ▶ Depress the brake pedal.
- ▶ Shift the automatic transmission into drive position **D** or reverse gear **R**.
- ▶ Release the brake pedal.
- ▶ Carefully depress the accelerator pedal.

The hill start assist system is inactive

- when starting off on a level road or downhill grades
- with the automatic transmission in neutral position **N**

Driving systems

- with the electronic parking brake engaged
- if the ESP® has switched off due to a malfunction

DISTRONIC Plus

Safety notes

When activated, the DISTRONIC Plus adaptive cruise control system increases the driving convenience afforded by the cruise control while traveling on expressways and other major roadways.

- If the DISTRONIC Plus distance sensor detects a slower moving vehicle directly ahead, your vehicle speed will be reduced so that you follow that vehicle at your preset following distance.
- If there is no vehicle directly ahead of you, the DISTRONIC Plus will function in the same way as standard cruise control (> page 347).

Warning!

The DISTRONIC Plus requires familiarity with its operational characteristics. We strongly recommend that you review the following information carefully before operating the system.

Warning!

The DISTRONIC Plus is a convenience system. Its speed adjustment reduction capability is intended to make cruise control more effective and usable when traffic speeds vary. It is not however, intended to, nor does it, replace the need for extreme care.

The responsibility for the vehicle's speed, distance to the preceding vehicle and, most importantly, brake operation to ensure a safe stopping distance, always remains with the driver.

The DISTRONIC Plus cannot take street and traffic conditions into account.

Complex driving situations are not always fully recognized by the DISTRONIC Plus. This could result in wrong or missing distance warnings.

Warning!

The DISTRONIC Plus adaptive cruise control is not a substitute for active driving involvement. It does not react to pedestrians or on stationary objects, nor does it recognize or predict the curvature and lane layout or the movement of preceding vehicles. The DISTRONIC Plus

can only apply a maximum of 40% of the vehicle's braking power.

The DISTRONIC Plus may not detect narrow vehicles possibly driving in front of you, such as motorcycles and vehicles driving in an offset formation.

It is the driver's responsibility at all times to be attentive to the road, weather and traffic conditions. Additionally, the driver must provide the steering, braking and other driving inputs necessary to remain in control of the vehicle.

High-frequency sources such as toll stations, speed measuring systems etc. can cause the DISTRONIC Plus system to temporarily cease functioning.

Warning!

The DISTRONIC Plus cannot take road and traffic conditions into account. Only use the DISTRONIC Plus if the road, weather and traffic conditions make it advisable to travel at a constant speed.

Warning!

Use of the DISTRONIC Plus can be dangerous on slippery roads. Rapid

changes in tire traction can result in wheel spin and loss of control.

The DISTRONIC Plus does not function in adverse sight and distance conditions. Do not use the DISTRONIC Plus during conditions of fog, heavy rain, snow or sleet.

Warning!

The DISTRONIC Plus cannot take weather conditions into account. Switch off the DISTRONIC Plus or do not switch it on if:

- roads are slippery or covered with snow or ice. The wheels could lose traction while braking or accelerating, and the vehicle could skid.
- the DISTRONIC Plus system sensor cover is dirty or visibility is diminished due to snow, rain or fog, for example. The distance control system functionality could be impaired.

Always pay attention to surrounding traffic conditions even while the DISTRONIC Plus is switched on. Otherwise, you may not be able to recognize dangerous situations until it is too late. This could cause an accident in which you and/or others could be injured.

Warning!

The “Resume” function should only be operated if the driver is fully aware of the previously set speed and wishes to resume this particular preset speed.

Warning!

Close attention to road and traffic conditions is imperative at all times, regardless of whether or not the DISTRONIC Plus is activated.

Use of the DISTRONIC Plus can be dangerous on winding roads or in heavy traffic because conditions do not allow safe driving at a constant speed.

The DISTRONIC Plus will not react to stationary objects in the roadway (e.g. a stopped vehicle in a traffic jam or a disabled vehicle). The DISTRONIC Plus will also not respond to oncoming vehicles.

Switch off the DISTRONIC Plus:

- when changing from the left to the right lane if vehicles are moving more slowly in the left lane
- when entering a turn lane or highway off ramp
- in complex driving situations, such as in highway construction zones

In these situations, the DISTRONIC Plus will continue to maintain the set speed unless deactivated.

The DISTRONIC Plus is designed and intended only to maintain a set speed and keep a set distance from moving objects in front of it.

The DISTRONIC Plus functions in a speed range of 0 to 120 mph (Canada: 0 to 200 km/h).

Do not use the DISTRONIC Plus if you are driving on a road with steep uphill or downhill slopes.

When traveling in Canada in a vehicle not registered in Canada, you must switch off the radar sensor system (▷ page 247). Canadian law does not permit the use of the radar sensor system for vehicles from outside of Canada. When you switch off the radar sensor



Driving systems

system, the following functions are deactivated:

- DISTRONIC Plus
- BAS Plus (▷ page 66)
- PRE-SAFE® Brake (▷ page 72)
- Park Assist (▷ page 369)
- Advanced Parking Guidance (▷ page 373)
- Blind Spot Assist (▷ page 382)

i Due to its radar-emitting nature DISTRONIC Plus may have an appearance similar to a radar detector to law enforcement officials. You may want to refer to this section of your Operator's Manual when asked.

i USA only:

This device has been approved by the FCC as a "Vehicular Radar System". The radar sensor is intended for use in an automotive radar system only. Removal, tampering, or altering of the device will void any warranties, and is not permitted by the FCC. Do not tamper with, alter, or use in any non-approved way.

Any unauthorized modification to this device could void the user's authority to operate the equipment.

i Canada only:

This device complies with RSS-210 of Industry Canada. Operation is subject to the following two conditions:

1. This device may not cause interference, and
2. this device must accept any interference received, including interference that may cause undesired operation of the device.

Removal, tampering, or altering of the device will void any warranties, and is not permitted. Do not tamper with, alter, or use in any non-approved way.

Any unauthorized modification to this device could void the user's authority to operate the equipment.

DISTRONIC Plus displays in multifunction display



- ① Speed of the vehicle ahead
- ② Set speed
- ③ Distance warning lamp

If the DISTRONIC Plus is activated, the marker ② indicates the set speed.

The vehicle speed displayed on the speedometer can briefly vary from the speed setting on the DISTRONIC Plus system.

If the DISTRONIC Plus detects a vehicle directly ahead, the ring on the speedometer dial comes on between the speed of the vehicle ahead ① and the set speed ②.

If the DISTRONIC Plus calculates that there is a danger of collision, the distance warning

lamp  in the instrument cluster comes on and an intermittent warning sounds.

- Immediately apply the brake to avoid a collision.

Under no circumstances should the driver await the intermittent warning sound before braking. See the following warning note.

The intermittent warning sound ceases and the distance warning lamp  goes out when the necessary distance to the vehicle ahead is again established.

Warning!

An intermittent warning sounds and the distance warning lamp  in the instrument cluster is illuminated if the DISTRONIC Plus system calculates that the distance to the vehicle ahead and your vehicle's current speed indicate that the DISTRONIC Plus will not be capable of slowing the vehicle sufficiently to maintain the preset following distance, which creates a danger of a collision.

Immediately brake the vehicle to increase your distance to the preceding vehicle. The warning sound is intended as a final caution in which you should intercede with your own braking inputs to avoid a potentially

dangerous situation. Do not wait for the operation of the warning signal to intercede with your own braking. This will result in potentially dangerous emergency braking which will not always result in an impact being avoided.

Tailgating increases the risk of an accident.

Warning!

The DISTRONIC Plus brakes your vehicle with a maximum deceleration of 13 ft/s² (4 m/s²). This corresponds to approximately 40% of the maximum deceleration of your vehicle.

You must also apply the brakes yourself to avoid a collision. The DISTRONIC Plus brakes the vehicle in an effort to restore the preset distance or to maintain the set speed. The brake pedal is automatically applied as this happens which results in the brake pedal moving

Keep driver's foot area clear at all times, including the area under the brake pedal. Objects stored in this area may impair pedal movement which could interfere with the braking ability of the DISTRONIC Plus system.

Do not place your foot under the brake pedal – your foot could become caught.

Warning!

If you do not receive visual or acoustic warning signals during a critical traffic situation, DISTRONIC Plus has either not recognized the collision risk, has been deactivated or is malfunctioning.

Remember, whether or not DISTRONIC Plus is operating, it is ultimately always the drivers responsibility to apply the brakes in order to control the vehicle and avoid a collision.

Displaying the distance graphic





In the Assistance menu under Distance Display you see the current settings for DISTRONIC Plus. The Information shown in the multifunction display depends on whether DISTRONIC Plus is activated or deactivated.

For activating or deactivating the DISTRONIC Plus system, see “Activating DISTRONIC Plus” (▷ page 355) or “Deactivating DISTRONIC Plus” (▷ page 359).

The menu overview can be found on (▷ page 234).



Driving systems

- ▶ Press  or  to select the Assistance menu.
- ▶ Press  or  to select the Distance Display function.
- ▶ Press .
The DISTRONIC Plus distance graphic appears and you will see one of the following displays in the multifunction display.

DISTRONIC Plus activated

When the DISTRONIC Plus is activated, you will see the set speed in the multifunction display for approximately 5 seconds. The following display appears in the multifunction display.



- ① DISTRONIC Plus activated
- ② Your vehicle
- ③ Preset distance threshold to the preceding vehicle
- ④ Preceding vehicle, if detected

DISTRONIC Plus deactivated

When the DISTRONIC Plus is deactivated, you will see the standard DISTRONIC Plus display in the multifunction display.



- ① Preceding vehicle, if detected
- ② Actual distance to the preceding vehicle
- ③ Preset distance threshold to the preceding vehicle
- ④ Your vehicle

DISTRONIC Plus lever



- ① Setting current or higher speed
- ② Setting current or lower speed
- ③ Deactivating the DISTRONIC Plus
- ④ Activating the DISTRONIC Plus or resuming to the last set speed
- ⑤ Setting target distance

Activating DISTRONIC Plus

Warning!

When the DISTRONIC Plus is braking, the brake pedal is retracted (i.e. depressed automatically). The pedals' range of motion must not be impeded by any obstacles:

- Do not place any objects in the footwell.
- Make sure that the floor mats and carpets are securely in place.
- Do not rest your foot underneath the brake pedal, as it could otherwise be trapped.

You could otherwise cause an accident and injure yourself and/or others.

Warning!

When the DISTRONIC Plus is switched on, the vehicle can be braked. You should therefore switch off the DISTRONIC Plus if the vehicle must be towed.

You can activate the DISTRONIC Plus when the vehicle speed is above 20 mph (30 km/h).

It is also possible to activate the DISTRONIC Plus when the vehicle speed is below 20 mph (30 km/h) and the DISTRONIC Plus has detected a preceding vehicle.

The maximum vehicle speed you can set is 120 mph (Canada: 200 km/h).

When the DISTRONIC Plus is activated, the set speed is indicated with a marker in the speedometer dial (▷ page 352).

If the DISTRONIC Plus is not activated after the DISTRONIC Plus lever is pulled in direction of arrow ④ (▷ page 355), you will see the message: DISTRONIC PLUS --- mph (Canada: DISTRONIC PLUS --- kmh) in the multifunction display.

In the following cases you cannot activate the DISTRONIC Plus:

- up to 2 minutes after starting the engine
- if the engine is switched off
- if you step on the brake pedal while driving
- the vehicle is secured with the electronic parking brake
- when the automatic transmission is in park position **P**, reverse gear **R**, or neutral position **N**
- if the ESP® is switched off or has switched off due to a malfunction
- if the hood is open

Driving systems

- if the driver's door is open and the driver has not fastened his or her seat belt
- if the radar sensors are switched off (> page 247)

Switching on while driving

- ▶ Tap the DISTRONIC Plus lever up ① or down ② until desired speed is set. The DISTRONIC Plus is switched on.

or

- ▶ Pull the DISTRONIC Plus lever briefly in direction of arrow ④ to call up the last set speed, or if no speed is stored, to set and store the current speed. The DISTRONIC Plus is switched on.

- ▶ Remove your foot from the accelerator pedal.

Your vehicle adapts its speed to the preceding vehicle, observing the set speed as a maximum value.

Below 20 mph (30 km/h), you can only switch on the DISTRONIC Plus if the preceding vehicle has been detected and is shown in the multifunction display. If you no longer see the preceding vehicle in the multifunction display and if it is no longer detected because it has changed lanes, for example, the DISTRONIC Plus switches off and a signal sounds.

If you do not completely remove your foot from the accelerator pedal, the message DISTRONIC PLUS Override appears in the multifunction display. The distance to a slower-driving vehicle will not be set. You will drive at the speed you dictate by pressing the accelerator pedal.

Switching on when approaching a stationary vehicle

If the preceding vehicle is stationary, you can only switch on the DISTRONIC Plus if your vehicle is also at a standstill.

- ▶ Tap the DISTRONIC Plus lever up ① or down ② until desired speed is set. The DISTRONIC Plus is switched on.

or

- ▶ Pull the DISTRONIC Plus lever briefly in direction of arrow ④ to call up the last set speed, or if no speed is stored, to set and store the current speed. The DISTRONIC Plus is switched on.

It is helpful to switch on the DISTRONIC Plus display in the multifunction display (> page 353) since you can only switch on the DISTRONIC Plus below a speed of 20 mph (30 km/h) when a preceding vehicle is detected.

You can adjust the set speed using the DISTRONIC Plus lever and the target distance using the distance setting switch on the DISTRONIC Plus lever (> page 360).

- ❗ If the DISTRONIC Plus is switched off, the PRE-SAFE® Brake (> page 72) will warn of an impending collision if this function has been activated with the instrument cluster control system (> page 244).

Starting off

When the preceding vehicle starts off:

- ▶ Remove your foot from the brake pedal.
- ▶ Pull the DISTRONIC Plus lever briefly in direction of arrow ④.

or

- ▶ Briefly step on the accelerator pedal.

Your vehicle starts off and adapts its speed to the preceding vehicle.

Driving

If there is no preceding vehicle, the DISTRONIC Plus functions like the cruise control (> page 347).

When the DISTRONIC Plus detects that the preceding vehicle is driving more slowly, it

brakes the vehicle in order to keep the distance specified by you.

When the DISTRONIC Plus detects that the preceding vehicle is driving faster, it accelerates the vehicle up to the set speed.

Warning!

When you step on the brake pedal, you switch off the DISTRONIC Plus except when the vehicle is at a standstill. The DISTRONIC Plus will no longer brake your vehicle. You are always responsible for maintaining a distance from other vehicles, observing road speeds and braking well in advance.

Stopping

Warning!

The braking effect of the DISTRONIC Plus is canceled and the vehicle can start to roll if

- the DISTRONIC Plus is switched off using the DISTRONIC Plus lever
- you accelerate
- the DISTRONIC Plus system or the power supply is malfunctioning, e.g. due to battery failure

- the electrical components in the engine compartment or the fuses have been manipulated
- the battery is disconnected

Warning!

Never get out of the vehicle while the DISTRONIC Plus is switched on!

The DISTRONIC Plus must never be operated or switched off by passengers or from outside the vehicle.

The DISTRONIC Plus is not a substitute for the electronic parking brake and may not be used for parking.

When you get out of the vehicle or switch off the engine, deactivate the DISTRONIC Plus and secure the vehicle from rolling away by engaging the electronic parking brake.

When the DISTRONIC Plus detects that the preceding vehicle is stopping, the vehicle brakes until it also stops.

Once the DISTRONIC Plus has stopped the vehicle and it is at a standstill, it remains stationary; the brake pedal does not need to be depressed.

After a short while, the vehicle is secured in place by the electronic parking brake so that the operating brake can be relieved of load.

Depending on the following distance set using the distance setting switch on the DISTRONIC Plus lever (▷ page 360), the vehicle will stop approximately 13.1 ft away from the preceding vehicle.

Setting the current speed

- ▶ Accelerate or decelerate to the desired speed.
- ▶ Briefly lift the DISTRONIC Plus lever in direction of arrow ① or depress in direction of arrow ② (▷ page 355). The current speed is set.
- ▶ Remove your foot from the accelerator pedal.

 If you do not take your foot off of the accelerator pedal and continue to accelerate past the set speed, the following message will appear in the multifunction display:

DISTRONIC PLUS Override

The distance to a slower moving vehicle in front of you will not be set. Your vehicle



Driving systems

speed will then be determined only by the accelerator pedal position.

Setting a higher speed

Warning!

Keep in mind that it may take a brief moment until the vehicle has made the necessary adjustments.

Increase the set vehicle speed to a value that the prevailing road conditions and legal speed limits permit. Otherwise, sudden and unexpected acceleration of the vehicle could cause an accident and/or serious injury to you and others.

You can increase the set speed in 1 mph (Canada: 1 km/h) increments or in 5 mph (Canada: 10 km/h) increments.

Adjustment in 1 mph (Canada: 1 km/h) increments

- ▶ Briefly lift the DISTRONIC Plus lever up to the resistance point in direction of arrow  (▷ page 355).
- ▶ Release the DISTRONIC Plus lever. The vehicle set speed increases in increments of 1 mph (Canada: 1 km/h)

each time you lift the DISTRONIC Plus lever up to the resistance point.

Adjustment in 5 mph (Canada: 10 km/h) increments

- ▶ Briefly lift the DISTRONIC Plus lever up past the resistance point in direction of arrow  (▷ page 355).
- ▶ Release the DISTRONIC Plus lever. The vehicle set speed increases in increments of 5 mph (Canada: 10 km/h) each time you lift the DISTRONIC Plus lever up past the resistance point. The new speed is set and the vehicle will accelerate. Keep in mind that it may take a brief moment until the vehicle has reached the set speed.

Setting a lower speed

Warning!

Keep in mind that it may take a brief moment until the vehicle has made the necessary adjustments.

Decrease the set vehicle speed to a value that the prevailing road conditions and legal speed limits permit. Otherwise, sudden and unexpected deceleration of the vehicle

could cause an accident and/or serious injury to you and others.

- i** When you use the DISTRONIC Plus lever to decelerate, the brake system will automatically brake the vehicle if the engine's braking power does not brake the vehicle sufficiently.

You can reduce the set speed in 1 mph (Canada: 1 km/h) increments or in 5 mph (Canada: 10 km/h) increments.

Adjustment in 1 mph (Canada: 1 km/h) increments

- ▶ Briefly press the DISTRONIC Plus lever down to the resistance point in direction of arrow  (▷ page 355).
- ▶ Release the DISTRONIC Plus lever. The vehicle set speed decreases in increments of 1 mph (Canada: 1 km/h) each time you press the DISTRONIC Plus lever down to the resistance point.

Adjustment in 5 mph (Canada: 10 km/h) increments

- ▶ Briefly press the DISTRONIC Plus lever down past the resistance point in direction of arrow ② (▷ page 355).
- ▶ Release the DISTRONIC Plus lever. The vehicle set speed decreases in increments of 5 mph (Canada: 10 km/h) each time you press the DISTRONIC Plus lever down past the resistance point. The new speed is set and the vehicle will decelerate. Keep in mind that it may take a brief moment until the vehicle has reached the set speed.

Setting stored speed (Resume function)**⚠ Warning!**

The set speed stored in memory should only be set again if prevailing road conditions and legal speed limits permit. Possible acceleration or deceleration differences arising from returning to the preset speed could cause an accident and/or serious injury to you and others.

- ▶ Briefly pull the DISTRONIC Plus lever in direction of arrow ④ (▷ page 355). The DISTRONIC Plus is activated and resumes to the last set speed or, if no speed is stored, it will set and store the current speed.
- ▶ Remove your foot from the accelerator pedal.

Deactivating DISTRONIC Plus

- ▶ Depress the brake pedal.
- or
- ▶ Briefly push the DISTRONIC Plus lever in direction of arrow ③ (▷ page 355). The last set speed is stored for later use.
- The last stored speed is deleted from memory when the engine is turned off. The DISTRONIC Plus switches off automatically when

- the vehicle is secured with the electronic parking brake
- the vehicle speed falls below 20 mph (30 km/h) and no preceding vehicle is detected
- the ESP® is in operation, or switched off with the ESP® switch (▷ page 70), or the ESP® has switched off due to a malfunction

- you shift the automatic transmission into park position **P**, reverse gear **R**, or neutral position **N** while driving
- the radar sensors are switched off (▷ page 247)
- the vehicle rolls backward

The marker for the set speed on the speedometer dial go out, an acoustic signal sounds, and the message DISTRONIC PLUS Off appears in the multifunction display for approximately 5 seconds.

If the vehicle has been stopped by the DISTRONIC Plus and a malfunction occurs in the DISTRONIC Plus system, the message Brake Immediately will appear in the multifunction display. Step on the brake pedal immediately to prevent the vehicle from rolling. The DISTRONIC Plus is then switched off and the message disappears.

⚠ Warning!

The DISTRONIC Plus switches off and releases the brakes when the vehicle decelerates below the minimum speed of 20 mph (30 km/h) by operation of the system unless the DISTRONIC Plus detects a vehicle directly ahead of you. At that time the driver must apply the brakes in order to



Driving systems

reduce vehicle speed further or bring it to a stop.

Depressing the accelerator pedal does not deactivate the DISTRONIC Plus. After a brief acceleration (e.g. for passing), the DISTRONIC Plus will resume the last set speed.

Setting the following distance in DISTRONIC Plus

You can set the specified following distance for the DISTRONIC Plus by varying the time setting between 1.0 and 2.0 seconds. Using this time setting and the current speed of your vehicle, the DISTRONIC Plus calculates and sets the required following distance to the preceding vehicle.

The set distance will be shown in the multifunction display.

⚠ Warning!

It is up to the driver to exercise discretion to select the appropriate setting given road conditions, traffic, driver's preferred driving style and applicable laws and driving recommendations for safe following distance.



- ① Distance setting switch for target distance
 - ② To increase target distance
 - ③ To decrease target distance
- ▶ **Increasing distance:** Turn distance setting switch ① in direction of arrow ②. Increasing the distance setting tells the DISTRONIC Plus to maintain a greater following distance to the preceding vehicle.
- ▶ **Decreasing distance:** Turn distance setting switch ① in direction of arrow ③. Decreasing the distance setting tells the DISTRONIC Plus to maintain a shorter following distance to the preceding vehicle.

Driving with DISTRONIC Plus

This section describes a number of driving situations where special precaution is required on the part of the driver. Be prepared to brake in such situations. Braking will deactivate the DISTRONIC Plus system.

⚠ Warning!

The DISTRONIC Plus works to maintain the speed selected by the driver unless a moving obstacle proceeding directly ahead of it in the same travel direction is detected (e.g. following another vehicle ahead of you at your set distance).

This means that:

- Your vehicle can pass another vehicle after you have changed lanes.
- While in a sharp turn or if the preceding vehicle is in a sharp turn, the DISTRONIC Plus could lose sight of the preceding vehicle. Your vehicle could then accelerate to the previously selected speed.

The DISTRONIC Plus regulates only the distance between your vehicle and those directly ahead of it. It may not register stationary objects in the road, e.g.:

- a stopped vehicle in a traffic jam
- a disabled vehicle
- an oncoming vehicle

The driver must always be alert, observe all traffic and intercede as required by means of steering or braking the vehicle.

Warning!

The DISTRONIC Plus should not be used in snowy or icy road conditions.

The most likely cause for a malfunctioning system is a dirty sensor (located in the hood grille and in the bumper), especially at times of snow and ice or heavy rain.

In such a case, the DISTRONIC Plus will switch off, and the message DISTRONIC PLUS Currently Unavailable See Oper. Manual appears in the multifunction display. For cleaning and care of the sensors, see (▷ page 465).

- i** If the message DISTRONIC PLUS Currently Unavailable See Oper.

Manual disappears during driving and the last speed stored flashes for approximately 5 seconds, the dirt (e.g. slush) has dissolved; the DISTRONIC Plus is available again.

Another cause might be that the radar sensors have been manually switched off in the instrument cluster control system. Please verify that the radar sensors are switched on (▷ page 247).

Turns and bends

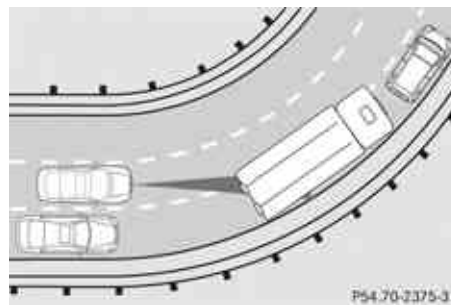

In turns or bends, the DISTRONIC Plus may not detect a preceding vehicle, or it may detect one too soon. This may cause your vehicle to brake late or unexpectedly.

Offset driving

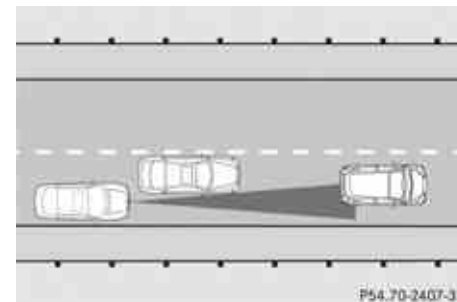

A vehicle traveling in your lane but offset from your direct line of travel may not be detected by the DISTRONIC Plus. There will be insufficient distance to the preceding vehicle.

Lane changing

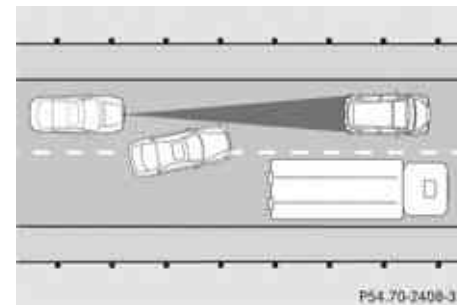

Driving systems

The DISTRONIC Plus has not yet detected the vehicle changing lanes. There will be insufficient distance to the lane-changing vehicle.

Narrow vehicles

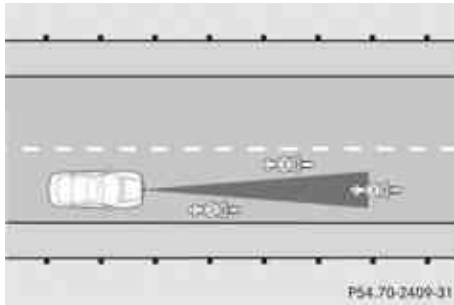

Because of their narrow profile, the vehicles traveling near the outer edges of the lane have not yet been detected by the DISTRONIC Plus. There will be insufficient distance to the preceding vehicles.

Obstacles and stationary vehicles

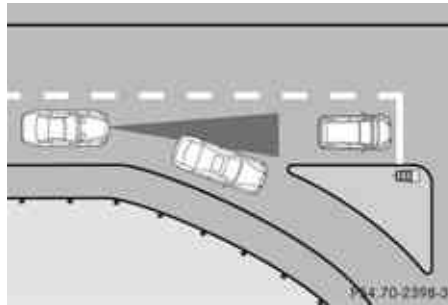

The DISTRONIC Plus does not brake for obstacles or stationary vehicles. If, for example, the vehicle detected in front of you changes lanes to bypass an obstacle or stationary vehicle in front of it, the DISTRONIC Plus will not brake for the obstacle or stationary vehicle.

Cross-traffic

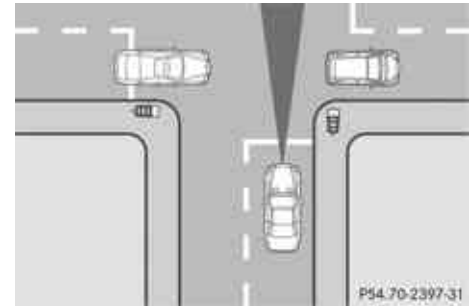

The DISTRONIC Plus may inadvertently detect crossing vehicles. If you switch on the DISTRONIC Plus, for example, at a traffic light with cross traffic, the vehicle may suddenly start to drive off.

AIRMATIC

Introduction

The AIRMATIC consists of two components. The Adaptive Damping System (ADS) (▷ page 363) and the vehicle level control (▷ page 363).

Adaptive Damping System (ADS)

The fine tuning of the damping is dependent on:

- road surface conditions
- your driving style
- vehicle loading
- your personal settings

The program mode selector switch (C/S) (▷ page 34 1) is used to adjust the suspension tuning.

Driving program	Suspension tuning
C Comfort	comfortable (default setting)
S Sport	sporty for dynamic driving

- ▶ Start the engine.
- ▶ Press the program mode selector switch (C/S) (▷ page 34 1) to select the desired driving program.

Vehicle level control

Warning!

To help avoid personal injury, keep hands and feet away from wheel housing area, and stay away from under the vehicle when lowering the vehicle chassis.

Your vehicle automatically adjusts its ride height to increase vehicle safety and to reduce fuel consumption.

You can choose between raised or normal level.

The vehicle chassis ride height is raised or lowered according to the selected level setting and to the vehicle speed. With increasing speed, ride height is reduced by up to approximately 0.8 in (20 mm). With decreasing speed, the ride height is again raised to the selected vehicle level.

 These height adjustment are so small that you may not notice any change.

Select the raised level only when required by current driving conditions. Otherwise, the

handling may be impaired and the fuel consumption may increase.

The following vehicle level settings can be selected when the vehicle is stationary and the engine is running:

Level	
Normal	For driving on normal roads. The indicator lamp is off.
Raised	For driving on rough roads or with snow chains. The indicator lamp is on



- ① Vehicle level control switch
- ② Indicator lamp

Driving systems

- ▶ Start the engine.
- ▶ Briefly press switch ① to change from one level setting to the other.

The message: **Vehicle Rising** appears in the multifunction display when changing from normal level to raised level. Indicator lamp ② is then lit. The message disappears when the vehicle is raised.

- ▶ Press switch ① again to lower the vehicle.

The setting raised is canceled and the vehicle is lowered to the regular level automatically if the vehicle speed is above 75 mph (120 km/h) or if the vehicle speed stays between 50 mph (80 km/h) and 75 mph (120 km/h) for approximately 3 minutes. Indicator lamp ② in switch ① goes out.

If you do not drive in this speed range, the selected vehicle level setting remains stored in memory even if the SmartKey is removed from the starter switch.

Active Body Control (ABC)

The ABC system is an active, computer-controlled system that hydraulically adjusts the suspension at all four wheels in response to various driving situations. It automatically selects the optimum suspension tuning and ride height for your vehicle.

Warning!

When you turn off the engine, the entire vehicle is lowered. You should therefore make sure that no one is near the wheel housing or under the vehicle when you turn off the engine. Otherwise, parts of the individuals body could be trapped.

 When you turn off the engine, the entire vehicle is lowered. When parking, position your vehicle in such a way that it will not scrape against a curb, for example, when it is lowered. Your vehicle could otherwise be damaged.

 CL 63 AMG and CL 65 AMG only:
When you turn off the engine, the entire vehicle is lowered by 0.2 in (5 mm).

Vehicle level control

Warning!

To help avoid personal injury, keep hands and feet away from wheel housing area, and stay away from under the vehicle when lowering the vehicle chassis.

Your vehicle adjusts its ride height automatically to increase vehicle safety and to reduce fuel consumption.

The vehicle chassis ride height is raised or lowered according to the selected level setting and to the vehicle speed. With increasing speed, the ride height is reduced by up to approximately 0.4 in (10 mm). With decreasing speed, the ride height is again raised to the selected vehicle level.

These height adjustments are so small that you may not notice any change.

The following vehicle level settings can be selected when the vehicle is stationary:

Level	
Normal	For driving on normal roads. The indicator lamp is off.
Raised	For driving on rough roads or with snow chains. The indicator lamp is on.

Select the “Raised” level setting only when required by current driving conditions. Otherwise the fuel consumption may increase and/or the handling may be impaired.

i The selected vehicle level setting remains stored in memory, even when the engine is turned off and restarted.



- ① Vehicle level control switch
- ② Indicator lamp

▶ Start the engine.

Selecting a higher level

If indicator lamp ② is off:

- ▶ Press switch ①.
Indicator lamp ② comes on. The vehicle is raised to a higher level.

Selecting a normal level

If indicator lamp ② is on:

- ▶ Press switch ①.
Indicator lamp ② goes out. The vehicle is adjusted to a normal level.

Suspension tuning

The suspension tuning is set according to:

- your driving style
- road surface conditions
- the vehicle loading
- your choice of suspension style

The program mode selector switch (**C/S**) (▷ page 340) or (**S/C/M**) (▷ page 340) is used to adjust the suspension tuning.

Driving program	Suspension tuning
C Comfort	comfortable (default setting)
S Sport	sporty
M Manual	for dynamic driving

- ▶ Start the engine.
- ▶ Select the desired driving program.

Driving systems

All-wheel drive (4MATIC)

⚠ Warning!

If a drive wheel is spinning due to insufficient traction:

- While driving off, apply as little throttle as possible.
- While driving, ease up on the accelerator pedal.
- Adapt your speed and driving style to the prevailing road conditions.

Failure to observe these guidelines could cause the vehicle to skid.

The 4MATIC cannot prevent accidents resulting from excessive speed.

! Do not tow with one axle raised. Doing so could damage the transfer case, which is not covered by the Mercedes-Benz Limited Warranty. All wheels must be on or off the ground. Observe instructions for towing the vehicle with all wheels on the ground.

i In winter operation, the maximum effectiveness of the 4MATIC is only achieved with winter tires (▷ page 452) or snow chains as required.

Parktronic system

The Parktronic system is an electronic parking aid with ultrasonic sensors designed to assist the driver during parking maneuvers. It indicates the relative distance between the vehicle and an obstacle visually and audibly.

The Parktronic system is activated automatically when you

- switch on the ignition and
- release the electronic parking brake or
- start the engine and
- shift the automatic transmission into drive position **D**, reverse gear **R**, or neutral position **N**

The Parktronic system deactivates at speeds above approximately 11 mph (18 km/h). At lower speeds, the Parktronic system switches on again.

The Parktronic system also deactivates when you shift the automatic transmission into park position **P** or engage the electronic parking brake and turn off the engine.

The Parktronic system monitors the surroundings of your vehicle with six sensors in the front bumper and four sensors in the rear bumper.

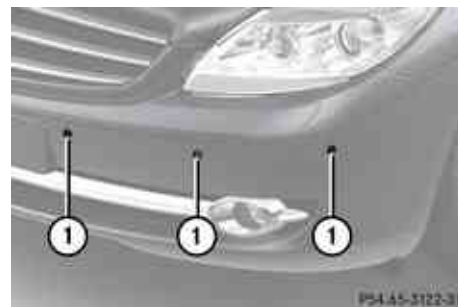

① Sensors in the front bumper (Only visible without DISTRONIC Plus)

To function properly, the sensors must be free of dirt, ice, snow and slush. Clean the sensors regularly, being careful not to scratch or damage the sensors, see “Cleaning the Parktronic system sensors” (▷ page 465).

⚠ Warning!

The Parktronic is a supplemental system. It is not intended to, nor does it replace, the need for extreme care. The responsibility during parking and other critical maneuvers always remains with the driver.

Warning!

Make sure no persons or animals are in or near the area in which you are parking/ maneuvering. Otherwise, they could be injured.

! Special attention must be paid to objects with smooth surfaces or low silhouettes (e.g. trailer couplings, painted posts, elevated crossbars or road curbs). Such objects may not be detected by the system and can damage the vehicle.

During parking maneuvers, pay special attention to objects located above or below the height of the sensors (e.g. street curbs, painted posts, or trailer hitches etc.). The Parktronic system will not detect such objects at close range and damage to your vehicle or the object may result.

! Ultrasonic signals from outside sources (e.g. truck air brakes, car wash, or jackhammers) may impair the operation of the Parktronic system.

Range of the sensors



Front sensors

Center	approx. 40 in (100 cm)
Corners	approx. 24 in (60 cm)

Rear sensors

Center	approx. 48 in (120 cm)
Corners	approx. 32 in (80 cm)

Minimum distance

Center	approx. 8 in (20 cm)
Corners	approx. 6 in (15 cm)

If the Parktronic system detects an obstacle in this range, all the distance warning segments illuminate and you hear a warning signal. If the obstacle is closer than the minimum distance, the actual distance may no longer be indicated by the Parktronic system.

Warning indicators

Visual signals indicate to the driver the relative distance between the sensors and an obstacle.

Driving systems

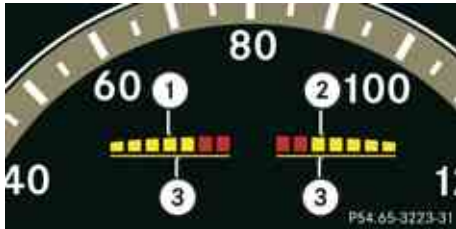

- ① Left side of the vehicle
- ② Right side of the vehicle
- ③ Readiness indicators

Each warning indicator is divided into five yellow and two red distance segments for either side of the vehicle. The Parktronic system is ready to measure when the yellow readiness indicators ③ are illuminated.

The current transmission position determines which warning indicator will be activated.

Current transmission position	Warning indicator
D	Front area activated
R	Front and rear area activated
N	With the electronic parking brake engaged: neither activated With the electronic parking brake released: front and rear area activated

As your vehicle approaches an object, one or more distance segments will illuminate, depending on the distance. When the seventh distance segment illuminates, you have reached the minimum distance.

- **Front area:** An intermittent acoustic warning will sound as the first red distance segment illuminates and a constant acoustic warning lasting a maximum of 2 seconds will sound for the second red distance segment. The signal is canceled

when the automatic transmission is shifted into park position **P**.

- **Rear area:** An intermittent acoustic warning will sound as the first red distance segment illuminates and a constant acoustic warning lasting a maximum of 2 seconds will sound for the second red distance segment. The signal is canceled when the automatic transmission is shifted into drive position **D** or park position **P**.

Switching the Parktronic system on/off

The Parktronic system switches on automatically when the ignition is switched on.



- ① Parktronic switch
- ② Indicator lamp

Driving systems

- ▶ **Switching off Parktronic system:** Press Parktronic switch ①. Indicator lamp ② comes on.
- ▶ **Switching on Parktronic system:** Press Parktronic switch ① again.

Parktronic system malfunction

There is a malfunction in the Parktronic system, if only the red distance segments illuminate and an acoustic warning sounds. The Parktronic system will switch off automatically after 20 seconds and indicator lamp ② in Parktronic switch ① comes on.

- ▶ Have the Parktronic system checked at an authorized Mercedes-Benz Center as soon as possible.

If only the red distance segments illuminate and no acoustic warning sounds, the Parktronic system sensors are dirty (e.g. dirt, ice, snow and slush) or there is an interference from other radio or ultrasonic signals (e.g. truck air brakes, car wash, or jackhammers). The Parktronic system will switch off automatically after 20 seconds and indicator lamp ② in Parktronic switch ① comes on.

- ▶ Switch off the ignition.
- ▶ Clean the Parktronic system sensors (▷ page 465).
- ▶ Switch on the ignition. or
- ▶ Check the Parktronic system operation at another location to rule out interference from outside radio or ultrasonic signals.

Park Assist

Warning!

The Park Assist is a supplemental system. It is not intended to, nor does it replace, the need for extreme care. The responsibility during parking and other critical maneuvers always remains with the driver.

Warning!

Make sure no persons or animals are in the area in which you are maneuvering. You could otherwise injure them.

- ! Special attention must be paid to objects with smooth surfaces or low silhouettes (e.g. trailer couplings, painted posts, elevated crossbars or road curbs). Such

objects may not be detected by the system and can damage the vehicle.

USA only:

This device has been approved by the FCC as a “Vehicular Radar System”. The radar sensor is intended for use in an automotive radar system only. Removal, tampering, or altering of the device will void any warranties, and is not permitted by the FCC. Do not tamper with, alter, or use in any non-approved way.

Any unauthorized modification to this device could void the user’s authority to operate the equipment.

Canada only:

This device complies with RSS-210 of Industry Canada. Operation is subject to the following two conditions:

1. This device may not cause interference, and
2. this device must accept any interference received, including interference that may cause undesired operation of the device.

Removal, tampering, or altering of the device will void any warranties, and is not



Driving systems

permitted. Do not tamper with, alter, or use in any non-approved way.

Any unauthorized modification to this device could void the user's authority to operate the equipment.

When traveling in Canada in a vehicle not registered in Canada, you must switch off the radar sensor system (▷ page 247). Canadian law does not permit the use of the radar sensor system for vehicles from outside of Canada. When you switch off the radar sensor system, the following functions are deactivated:

- Park Assist
- BAS Plus (▷ page 66)
- PRE-SAFE® Brake (▷ page 72)
- DISTRONIC Plus (▷ page 350)
- Advanced Parking Guidance (▷ page 373)
- Blind Spot Assist (▷ page 382)

! The operational function of the Park Assist system can be affected by dirty sensors, especially at times of snow and ice.

Make sure that the area on the bumpers around the sensors is free of dirt, ice and/or slush, otherwise the Park Assist may not function properly.

For cleaning the driving systems sensors, see (▷ page 465).

! High-frequency sources such as toll stations, speed measuring systems, etc. can cause the Park Assist system to malfunction. You can switch off the Park Assist using the Park Assist button or switch off the radar sensors with the instrument cluster control system to prevent possible malfunction.

The Park Assist is an electronic parking aid with radar sensors that helps you while parking. It visually and audibly indicates the relative distance between the vehicle and an obstacle.

The Park Assist is automatically activated when the engine is running and the automatic transmission is in drive position **D**, reverse gear **R** or neutral position **N**.

The Park Assist deactivates at speeds over approximately 10 mph (16 km/h). At lower speeds the Parktronic system turns on again.

The Park Assist is also switched off when you set the automatic transmission into park position **P** or switch off the engine.

While the automatic transmission is in neutral position **N**, the Park Assist is switched off if

you secure the vehicle in place with the electronic parking brake.

The Park Assist monitors the surroundings of your vehicle with four sensors in the front bumper and two sensors in the rear bumper.

Range of the sensors

The sensors of the Park Assist system are integrated in the front and rear bumpers. Make sure that the bumpers are clear of dirt, ice and slush in the area of the sensors, as otherwise, Park Assist may not function properly, see (▷ page 465).



Driving systems

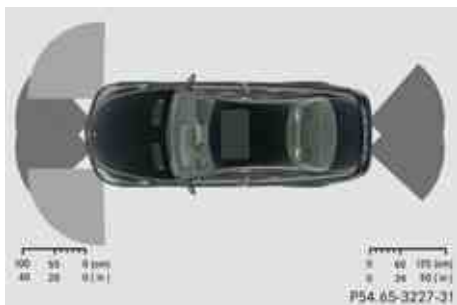

Due to the sensors' broad detection range, it is possible that the Park Assist also detects and issues a warning for obstacles in the ground, e.g. sewer canal covers, rails, bumps in the road or gutters or obstacles moving upward quickly, e.g. rolling garage doors.

Front sensors

Center	approx. 40 in (100 cm)
Corners	approx. 24 in (60 cm)

Rear sensors

Center	approx. 50 in (125 cm)
Corners	approx. 24 in (60 cm)

L While parking, pay particular attention to objects over or underneath the sensors,

e.g. flower boxes, an elevated crossbar or a trailer tow hitch. The Park Assist does not detect such nearby objects. You could otherwise damage the vehicle or the objects.

Warning indicators

Visual signals indicate to the driver the relative distance between the sensors and an obstacle.

The warning indicator for the front area is in the instrument cluster. The warning indicator for the rear area is on the roof liner in the rear.

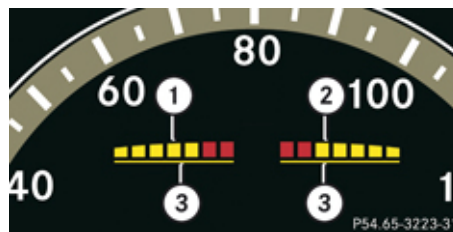

- ① Left side of the vehicle
- ② Right side of the vehicle
- ③ Readiness indicators

Each warning indicator is divided into five yellow and two red distance segments for either side of the vehicle.

If yellow readiness indicators ③ under the distance segments are lit, the Park Assist is ready to measure.

The current transmission position determines which warning indicators will be activated.

Current transmission position	Warning indicator
D	Front area activated
R	Front and rear area activated
N	With the electronic parking brake engaged: neither activated. With the electronic parking brake released: front and rear area activated.
P	Neither activated

As your vehicle approaches an object, one or more distance segments will illuminate, depending on the distance. When the seventh distance segment illuminates, you have reached the minimum distance.



Driving systems

Front area:

As soon as the first red distance segment illuminates, you will hear an intermittent warning tone for approximately 2 seconds. Once the second red distance segment illuminates, you will hear a continuous warning tone. You have reached the minimum distance. The signal is canceled when the automatic transmission is in park position **P** or neutral position **N** with the electronic parking brake engaged.

Rear area:

As soon as the first red distance segment illuminates, you will hear an intermittent warning tone for approximately 2 seconds. Once the second red distance segment illuminates, you will hear a continuous warning tone. You have reached the minimum distance. The signal is canceled when the automatic transmission is in drive position **D**, park position **P**, or neutral position **N** with the electronic parking brake engaged.

- i** During strong rainfall, the warning indicators and warning tones may be triggered, for example, by water splashing into the area of the sensors.

Collision warning

The Park Assist can detect obstacles from a considerable distance. If you drive in reverse towards an obstacle, you will hear a warning tone. You must then brake in order to avoid a collision. The warning tone for a collision will not sound when the vehicle is at a standstill very close to the obstacle. In this case, you will hear a corresponding tone for the warning indicator in the rear area.

- i** During strong rainfall, the collision warning may be triggered, for example, by water splashing into the area of the sensors.

Switching Park Assist system on/off

The Park Assist system can be switched off manually.

The Park Assist button with the indicator lamp is located on the control panel on the right-hand side of the instrument cluster.

- i** When the indicator lamp is on, the Park Assist system is switched off.



① Park Assist button

② Indicator lamp

► **Switching off:** Press button ①. Indicator lamp ② comes on.

► **Switching on:** Press button ① again. Indicator lamp ② goes out.

The Park Assist system is automatically switched on when the ignition and radar sensors (▷ page 247) are switched on.

Advanced Parking Guidance

Warning!

The Advanced Parking Guidance is only an aid and may display parking spaces that are not suitable e.g. due to parking regulations, unsuitable road/ground surfaces, driveways, entrances/exits, etc.

The Advanced Parking Guidance only shows a representation of the parking space in the instrument cluster display as parking space is first initially measured when driving past. Subsequent changes to the parking space are not taken into account, e.g. if the position of the vehicle parked in front of or behind the space changes or objects in the parking space are moved. Moving objects are not shown, e.g. pedestrians or vehicles driving past. The Advanced Parking Guidance does not relieve you of the responsibility to pay attention. If you only rely on the Advanced Parking Guidance, you may cause an accident and injure yourself and others. You are always responsible for safety and must continue to pay attention to your immediate surroundings when parking and maneuvering.

Warning!

Make sure no persons or animals are in the area in which you are maneuvering. You could otherwise injure them.

 Special attention must be paid to objects with smooth surfaces or low silhouettes (e.g. trailer couplings, painted posts, elevated crossbars or road curbs). Such objects may not be detected by the system and can damage the vehicle.

USA only:

This device has been approved by the FCC as a “Vehicular Radar System”. The radar sensor is intended for use in an automotive radar system only. Removal, tampering, or altering of the device will void any warranties, and is not permitted by the FCC. Do not tamper with, alter, or use in any non-approved way.

Any unauthorized modification to this device could void the user’s authority to operate the equipment.

Canada only:

This device complies with RSS-210 of Industry Canada. Operation is subject to the following two conditions:

1. This device may not cause interference, and
2. this device must accept any interference received, including interference that may cause undesired operation of the device.

Removal, tampering, or altering of the device will void any warranties, and is not permitted. Do not tamper with, alter, or use in any non-approved way.

Any unauthorized modification to this device could void the user’s authority to operate the equipment.

 The operation and functionality of the Advanced Parking Guidance can be affected or impaired by dirty sensors, especially at times of snow and ice. Make sure that the area on the bumpers around the sensors is free of dirt, ice and/or slush, otherwise Advanced Parking Guidance may not function properly.

The Advanced Parking Guidance is an electronic parking aid equipped with radar



Driving systems

sensors that scan the area on both sides of vehicle. When suitable parking space is found it is shown in the display and you receive steering instructions for parking in that space.

When traveling in Canada in a vehicle not registered in Canada, you must switch off the radar sensor system (> page 247). Canadian law does not permit the use of the radar sensor system for vehicles from outside of Canada. When you switch off the radar sensor system, the following functions are deactivated:

- Advanced Parking Guidance
- BAS Plus (> page 66)
- PRE-SAFE® Brake (> page 72)
- DISTRONIC Plus (> page 350)
- Park Assist (> page 369)
- Blind Spot Assist (> page 382)

Use the Advanced Parking Guidance for parking spaces that are

- parallel to the direction of travel
- located on straight streets, i.e. not in curves
- on the same level as the street, i.e. not on sidewalks, for example. Flat curbs may

possible not be detected by the Advanced Parking Guidance.

Parking instructions:

- On narrow streets, drive by the parking space as close as possible.
- Parking spaces that are dirty, overgrown or located in front of trailers may not be detected correctly.
- Also observe the Park Assist warning indicator (> page 369) while the Advanced Parking Guidance is active.
- How well your vehicle will be parked after completion of the Advanced Parking Guidance depends on the position and shape of the vehicles parked in front of and behind the parking space as well as the conditions of the immediate surroundings. In certain cases, the Advanced Parking Guidance may guide you too far into the parking space or not far enough. If this is the case, cancel the parking procedure with the Advanced Parking Guidance and correct the vehicle position yourself.

Detecting a parking space

The Advanced Parking Guidance is active when driving forward. The system operates at

a vehicle speed of up to 25 mph (40 km/h) and automatically scans for and measures potential parking spaces on both sides of the vehicle. At a vehicle speed of below 10 mph (16 km/h), you see the white parking space symbol as a system display in the instrument cluster. As soon as the Advanced Parking Guidance has detected a suitable parking space, the parking space symbol changes to blue.



- ① Detected parking spaces on the left
- ② Parking space symbol
- ③ Detected parking spaces on the right

In order to be detected by the Advanced Parking Guidance, a parking space must be:

- closed-in at the rear
- parallel to the direction of travel

- at least 5 ft (1.5 m) wide
- at least 3.5 ft (1.0 m) longer than your vehicle is

A parking space is shown in the display when driving by until you have reached a distance of 50 ft (15 m) from the space. The Advanced Parking Guidance only shows parking spaces on the front-passenger side of the vehicle unless you activate the driver's side (left) turn signal. If you would like to park on the driver's side, the left turn signal must remain on until the reverse gear is engaged.

Parking

The following describes how you can park on the front-passenger side. Parking on the driver's side is performed reversed left to right.

If the Advanced Parking Guidance detects an obstacle behind the vehicle during the parking procedure, you will hear an audible warning. Stop the vehicle immediately. The parking space and the lane flash in the instrument cluster. Only continue driving/parking after you have made sure that this is possible to do in a safe manner. If the Advanced Parking Guidance no longer detects any obstacles, the display in the

instrument cluster stops blinking. You may continue the parking procedure.

Warning!

The Advanced Parking Guidance is only an aid and may not detect all obstacles. At corners or near smooth surfaces, the Advanced Parking Guidance may not detect an object correctly. The Advanced Parking Guidance does not relieve you of the responsibility to pay attention. You are always responsible for safety and must continue to pay attention to your immediate surroundings when parking and maneuvering. Otherwise, you could endanger yourself and others.

- ▶ Bring the vehicle to a standstill as long as the desired parking space is displayed by

the blue parking space symbol in the instrument cluster.

- ▶ Shift the automatic transmission into reverse gear **R**. The message **Check Surroundings Press 'OK' to Confirm** appears in the multifunction display.
- ▶ Press **OK** on the multifunction steering wheel to confirm. The display in the instrument cluster changes to the Advanced Parking Guidance.

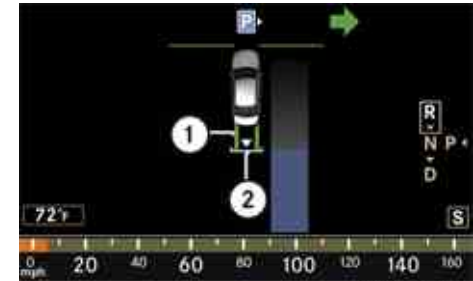

- ① Green lane
- ② White bracket indicates the stopping position

Driving systems

- ▶ Where necessary, depending on the distance to the parking space, back up in a straight line a short distance. This is indicated by a green lane ①.
- ▶ Back up until you hear an audible warning, then stop. The stopping position has been reached, indicated by a white bracket ②.

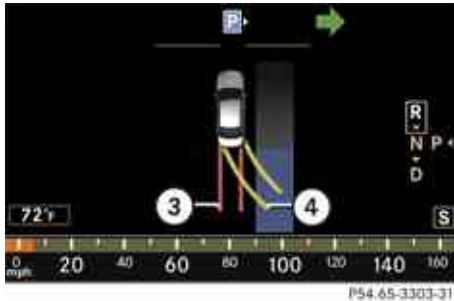

- ③ Red lane indicates the current steering wheel position
- ④ Yellow lane indicates the required steering wheel position
- ▶ When the vehicle is stationary, turn the steering wheel until red lane ③ matches up with yellow lane ④. Lane ④ then turns green. If the parking space is located within the display range, a white bracket with an arrow for the target

position is shown at the end of the green lane.

Driving into the parking space

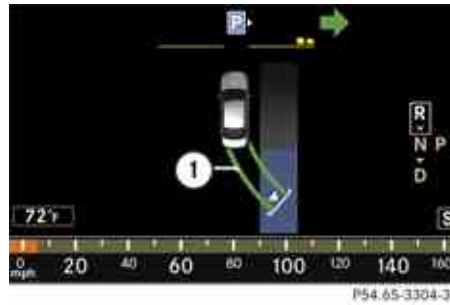

- ① Green lane indicates the correct steering wheel position
- ▶ Maintain the steering wheel position and carefully back up.
- ▶ Stop as soon as you hear the audible warning. The vehicle has reached the position for countersteering.

Countersteering

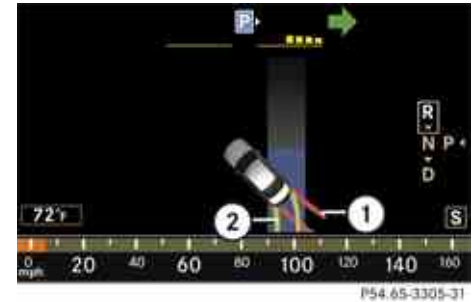

- ① Red lane indicates the current steering wheel position
- ② Yellow lane indicates the required steering wheel position
- ▶ When the vehicle is stationary, turn the steering wheel until red lane ① matches up with yellow lane ②. Lane ② then turns green and a white arrow and a white bracket are shown to indicate the target position.

Reaching end position



① Green lane indicates the correct steering wheel position

- ▶ Maintain the steering wheel position and carefully back up until the end position has been reached.

The message **Parking Guidance Finished** appears in the multifunction display and you will hear an audible warning.

If the distance to the rear is too short, you will also be audibly warned by the Park Assist system (▷ page 369).



End position

Depending on the size of the parking space, the vehicle may be positioned at an angle in the parking space. The Advanced Parking Guidance guides you close to the rear limit of the parking space where possible.

- ▶ Adjust the end position by maneuvering as needed.
- ▶ Observe the Park Assist display (▷ page 369).

Canceling the Advanced Parking Guidance

- ▶ Press the Park Assist button (▷ page 372). The Advanced Parking Guidance is immediately canceled and the Park Assist is deactivated. No message is shown in the multifunction display.

The Advanced Parking Guidance is automatically canceled if guidance into the parking space is no longer possible or if an error occurs.

The parking space symbol disappears and the message **Parking Guidance Canceled** appears in the multifunction display.

Rear view camera

The rear view camera is an electronic and visual parking aid. It shows you the area behind the vehicle on the COMAND system display.

In addition, the rear view camera contains guide lines to help you with driving in reverse. The area behind the vehicle is displayed as a reverse-mirror image similar to the view in a rear view mirror.

Driving systems



① Rear view camera

View through the rear view camera

i The image from the rear view camera is shown mirror-inverted on the COMAND system display.

⚠ Warning!

Please note that objects which do not touch the ground, such as the bumper of a vehicle parked behind you, a trailer hitch, or the back of a truck, may appear to be further away than they actually are. In this case, you should not use the guide lines to judge distance. The use of the guide lines to judge distance increases the risk of impacting the objects.

⚠ Warning!

Make sure no persons or animals are in or near the area in which you are parking/ maneuvering. Otherwise, they could be injured.

⚠ Warning!

The rear view camera is a supplement system. It is not intended to, nor does it replace, the need for extreme care. The responsibility during parking and other driving maneuvers always remains with the driver.

The rear view camera may show obstacles with a distorted perspective, incorrectly or not at all.

Special attention must be paid to objects outside of the camera's field of view such as those located very close to or below the rear bumper, or above the recessed grip of the luggage compartment lid. Such objects may not be detected by the system and can damage the vehicle.

The rear view camera does not warn you about impending collisions with objects. The driver is always responsible for safety and must continue to pay attention to the immediate surroundings while parking or

maneuvering the vehicle. This applies not only to the area behind the vehicle, but also to the area in front of and to the sides of the vehicle. Failure to do so could result in injury to persons and/or damage to the vehicle or other property. We also recommend that the driver uses the Parktronic system, Park Assist, or Advanced Parking Guidance when parking or maneuvering the vehicle.

⚠ Warning!

The rear view camera either will not function or will not function to its full capability if

- the trunk lid is open or not completely closed
- it is raining or snowing heavily, or if there is thick fog
- in a very dark area
- the camera is exposed to a very bright white light (white stripes may appear on the COMAND system display)
- the immediate surroundings are illuminated with fluorescent light (the COMAND system display can flicker)

- there is a sudden change in temperature, e.g. if you drive into a heated garage from the cold (lens condensation)
- the camera lens is dirty or covered
- the rear of your vehicle is damaged

In this case, have the position and setting of the camera checked by a qualified specialist workshop. Mercedes-Benz recommends that you contact a Mercedes-Benz Center for this purpose.

Do not use the rear view camera if the roads are icy, slippery or covered with snow. The vehicle could slip causing the actual vehicle position to deviate from the one shown on the COMAND system display. This may cause injury to you or others, or damage the vehicle or objects.

Mounting tires/rims of other specification than the original equipment tires/rims may impair the function of the rear view camera. Contact an authorized Mercedes-Benz Center.

Warning!

Use of rear view camera can be dangerous if you are color-blind or have impaired color vision.

Only use rear view camera if you can see and distinguish all colored guide lines shown by rear view camera on the COMAND system display.

Switching on rear view camera

- 1 The rear view camera must be activated in the instrument cluster control system in order for it to be switched on.

- ▶ Switch on the ignition.
- ▶ Switch on the COMAND system.
- ▶ Shift into reverse gear **R**.
The COMAND system display will show the area behind the vehicle with guide lines.

Warning!

Please note that objects which do not touch the ground, such as the bumper of a vehicle parked behind you, a trailer hitch, or the back of a truck, may appear to be further away than they actually are. In this case, you should not use the guide lines to judge distance as the use of the guide lines to judge distance increases the risk of impacting the objects.

Even when the object you approach is directly on the ground (and nothing on the

object extends above the ground beyond the object's contours directly touching the ground) and no objects that do not touch the ground, such as the bumper of a vehicle parked behind you, a trailer hitch, or the back of a truck are in the path, do not approach the object on the ground any closer than the red guide line.

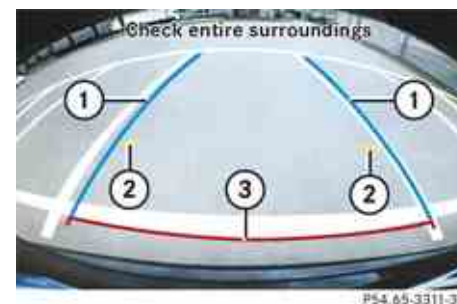

- ① Blue guide lines for vehicle width
- ② Yellow 39 in (1 m) guide line
- ③ Red 10 in (0.25 m) guide line

The red 10 in (0.25 m) guide line ③, the yellow 39 in (1 m) guide line ② correspond to the relevant distance from the rear of the vehicle. The blue guide line for vehicle width ① show the required width for the vehicle.



Driving systems

i If you activate a different function on the driver's COMAND system controls while reverse parking or parallel parking, the image from the rear view camera is interrupted.

To reactivate the rear view camera, take the vehicle out of reverse gear and then re-engage reverse gear again.

Night View Assist

⚠ Warning!

The Night View Assist is only an aid to support you while driving and cannot substitute your careful attention. Do not rely on the display of the Night View Assist; instead, continue to look through the windshield. You are always responsible for safety and must drive in accordance with traffic conditions. Otherwise, you could endanger yourself and others.

If it is foggy, raining or snowing, the clarity of the Night View Assist image on the multifunction display may be diminished.

The Night View Assist illuminates the road with infrared light in addition to the normal headlamps.

A camera at the top of the windshield measures the infrared light and shows a black-and-white image on the multifunction display. The image on the multifunction display corresponds to a road lit up by high-beam headlamps.

⚠ Warning!

The Night View Assist cannot record objects immediately in front of or next to the vehicle. When maneuvering, continue to look through the windshield. Make sure no persons or animals are in the area in which you are maneuvering. You could otherwise injure them.

The Night View Assist image on the multifunction display is not impaired by the headlamps of approaching vehicles or if you cannot switch on the high beams due to oncoming traffic.

As a result, you can better follow the course of the road and detect obstacles earlier on.

i Infrared light is invisible to the human eye and can therefore remain permanently switched on without blinding oncoming traffic.

The camera is at the top of the windshield.



① Night View Assist camera

Switching on or off

You can only switch on the Night View Assist if

- the SmartKey in the starter switch is set to position **2**
- it is dark
- the light switch is set to **A** or  or if the daytime driving lamps are switched on
- the automatic transmission is not in reverse gear **R**



① Night View Assist on or off

▶ Press button ① up or down.

The Night View Assist image appears on the multifunction display.

i The infrared headlamps only come on above a speed of approximately 9 mph (15 km/h). Therefore, when you are at a standstill, you do not have a complete view and cannot check the function of the Night View Assist.

Image on multifunction display

When you switch on the Night View Assist, the dial for the speedometer changes on the multifunction display. The speedometer dial is shown as a bar on the lower edge of the multifunction display. The line for main

menus is no longer available. If you would like to change a setting using the steering wheel buttons, you must first switch off the Night View Assist.

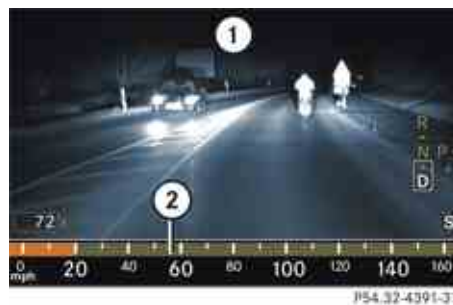

① Night View Assist image

② Speedometer dial

If you change the brightness of the instrument cluster while the Night View Assist is switched on, only the brightness of the multifunction display is changed.

Adjusting instrument cluster illumination



① Knob

▶ Make sure the Night View Assist is switched on.

▶ **Brightening illumination:** Turn knob ① clockwise.

▶ **Dimming illumination:** Turn knob ① counterclockwise.

Dirty or fogged-up windshield

If the windshield in front of the camera is fogged up on the inside or outside or if it is dirty, the Night View Assist image is diminished.



Driving systems

Warning!

Please do not forget that your primary responsibility is to drive the vehicle. A driver's attention to the road must always be his/her primary focus when driving. For your safety and the safety of others, stop before trying to remove window fogging or cleaning the window in front of the Night View Assist camera.

Bear in mind that at a speed of just 30 mph (approximately 50 km/h), your vehicle is covering a distance of 44 feet (approximately 14 m) every second.

- ▶ **Removing condensation:** Check settings of the climate control and change them, if necessary (▷ page 385).
- ▶ Swing the camera cover downward (▷ page 466).
- ▶ **Cleaning inside of windshield:** Use a soft, non-scratching cloth (▷ page 466).

Blind Spot Assist

The Blind Spot Assist uses radar sensors to monitor the area on both sides of your vehicle. It will assist you when you change lanes driving at speeds of above 20 mph (30 km/h). A warning will appear in the exterior rear view mirror as soon as another vehicle is detected in the area being monitored. If you then activate the corresponding turn signals to change lanes, you will see and hear a collision warning. The Blind Spot Assist operates using two sensors in the front bumper and four sensors in the rear bumper.

Warning!

The Blind Spot Assist is only a driving aid and may not detect all vehicles.

The Blind Spot Assist may not be able to detect narrow vehicles such as motorcycles or bicycles, or it may not detect them until it is too late.

The monitoring function may be impaired if your sensors are dirty, subject to heavy spray, or if visibility is poor due to e.g. snow, rain, or fog. This can result in vehicles not being detected or being detected too late.

Blind Spot Assist cannot detect road, traffic and weather conditions.

It is the driver's responsibility at all times to be attentive to road, weather and traffic conditions and to provide the steering, braking and other driving inputs necessary to retain control of the vehicle. Failure to do so could result in recognizing dangers too late, possibly resulting in an accident and serious injury to yourself and others.

In order for the Blind Spot Assist to function, the radar sensors must be switched on and operational.

When traveling in Canada in a vehicle not registered in Canada, you must switch off the radar sensor system (▷ page 247). Canadian law does not permit the use of the radar sensor system for vehicles from outside of Canada. When you switch off the radar sensor system, the following functions are deactivated:

- Blind Spot Assist
- BAS Plus (▷ page 66)
- PRE-SAFE® Brake (▷ page 72)
- DISTRONIC Plus (▷ page 350)
- Park Assist (▷ page 369)
- Advanced Parking Guidance (▷ page 373)

i USA only:

This device has been approved by the FCC as a “Vehicular Radar System”. The radar sensor is intended for use in an automotive radar system only. Removal, tampering, or altering of the device will void any warranties, and is not permitted by the FCC. Do not tamper with, alter, or use in any non-approved way.

Any unauthorized modification to this device could void the user’s authority to operate the equipment.

i Canada only:

This device complies with RSS-210 of Industry Canada. Operation is subject to the following two conditions:

1. This device may not cause interference, and
2. this device must accept any interference received, including interference that may cause undesired operation of the device.

Removal, tampering, or altering of the device will void any warranties, and is not permitted. Do not tamper with, alter, or use in any non-approved way.

Any unauthorized modification to this device could void the user’s authority to operate the equipment.

Sensor monitoring range

The Blind Spot Assist is able to monitor a range up to 10 ft (3 m) to the rear and both sides of the vehicle.

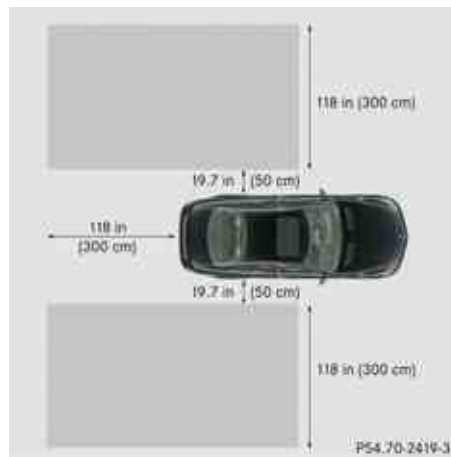
**Warning!**

The Blind Spot Assist monitors certain areas in the immediate vicinity of your vehicle. Vehicles approaching and passing

at speeds that exceed the speed of your vehicle significantly will not be detected. There will be no warning display and no audible warning.

When driving in a very wide lane, the sensors may not be able to cover the entire width of the neighboring lane. Vehicles driving on the outside of the neighboring lane may not be detected.

It is the driver’s responsibility at all times to be attentive to road, weather and traffic conditions and to provide the steering, braking and other driving inputs necessary to retain control of the vehicle. Failure to do so could result in recognizing dangers too late, possibly resulting in an accident and serious injury to yourself and others.

When driving in a very narrow lane, the sensors may detect and display vehicles in the second lane over. This will be the case if there are vehicles driving on the inside edge of their lane.

The Blind Spot Assist sensors are built into the front and rear bumpers. Make sure that the area of the bumpers around the sensors is free of dirt, ice and snow. The radar sensors must not be obstructed, for example, by bicycle carriers or overhanging luggage.



Driving systems

❗ In the event of a significant impact or damage affecting the bumpers, have the radar sensors checked by a qualified specialist workshop such as a Mercedes-Benz Center. Failure to do this can result in Blind Spot Assist not functioning correctly.

Indicator and warning lamps

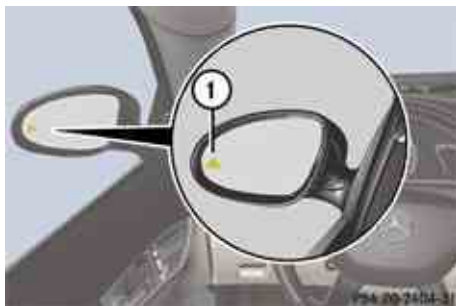

Exterior rear view mirror, driver's side

① Yellow indicator lamp/red warning lamp

- ▶ Make sure that the radar sensors (▷ page 247) and Blind Spot Assist (▷ page 245) are switched on.
- ▶ Switch on the ignition. Red warning lamps ① in the exterior rear view mirrors come on.
- ▶ Start the engine. Yellow indicator lamps ① in the exterior rear view mirrors come on up to a speed of 20 mph (30 km/h).

Above a speed of 20 mph (30 km/h), yellow indicator lamps ① go out and the Blind Spot Assist is active. If the Blind Spot Assist detects a vehicle in its range, red warning lamp ① on the corresponding side of the vehicle comes on.

When you shift the automatic transmission in reverse gear **R**, yellow indicator lamps ① in the exterior rear view mirrors goes out after approximately 3 seconds. The Blind Spot Assist is then not active.

The brightness of indicator lamps/warning lamps ① is controlled automatically depending on the brightness of the ambient light.

⚠ Warning!

The Blind Spot Assist is not active at speeds below approximately 20 mph (30 km/h).

The yellow indicator lamps in the exterior rear view mirrors are illuminated. You will not be alerted to the presence of vehicles in the monitored area at these speeds.

It is the driver's responsibility at all times to be attentive to road, weather and traffic conditions and to provide the steering, braking and other driving inputs necessary to retain control of the vehicle. Failure to do so could result in recognizing dangers too late, possibly resulting in an accident and serious injury to yourself and others.

Collision warning

If a vehicle is detected in the Blind Spot Assist range and you activate the turn signal, a two-tone warning will sound once and red warning lamp ① on the corresponding side of the vehicle will flash.

⚠ Warning!

Do not change lanes or make turns, while red warning lamp ① is flashing. Doing so could result in an accident and serious injury to yourself and others.

- ▶ Remain on the lane that you are currently on until traffic conditions permit to change.

If the turn signal remains on, red warning lamp ① will flash to indicate that vehicles

have been detected. No further audible warnings will sound.

Climate control system

Control panel







P&B.20-4148-31

	Function	Recommendation/Notes	
①	AUTO Air distribution and air volume, driver's side (automatic mode)	i Switches on the automatic mode. The indicator lamp in button AUTO comes on.	(▷ page 388)
②	▼▲ Temperature control, driver's side	i Set the temperature to 72°F (22°C).	(▷ page 388)
③	☪ Manual fan speed adjustment, driver's side		(▷ page 390)



Climate control system

	Function	Recommendation/Notes	
④	 MAX Front defroster	i Keep this setting selected only until the windshield or the side windows are clear again.	(▷ page 391)
⑤	 Air recirculation	i Only use this function for a short time, e.g. in a tunnel. Otherwise, the windows can fog up due to lack of fresh air.	(▷ page 392)
⑥	OFF Climate control on/off	i Switches on the climate control system. The indicator lamp in button OFF goes out.	(▷ page 387)
⑦	REST Residual heat/ventilation	i With the engine turned off, it is possible to continue to heat or ventilate the interior.	(▷ page 392)
⑧	 REAR Rear window defroster	i At very low temperatures, rear window defroster operation is delayed until the vehicle interior has warmed up.	(▷ page 393)
⑨	 Manual fan speed adjustment, passenger side		(▷ page 390)
⑩	 Temperature control, passenger side	i Set the temperature to 72°F (22°C).	(▷ page 388)
⑪	AUTO Air distribution and air volume, passenger side (automatic mode)	i Switches on the automatic mode. The indicator lamp in button AUTO comes on.	(▷ page 388)

Climate control system

Notes on climate control system

i If you have the air distribution and air volume automatically controlled, you can adjust the temperature, footwell temperature and air flow. The following basic settings are recommended:

- Automatic air distribution control (▷ page 388)
- Temperature: 72°F (22°C) (▷ page 388)
- Footwell temperature: 0 (▷ page 226)
- Air flow: focused (▷ page 226)

The climate control system is operational whenever the engine is running. You can operate the climate control system in either the automatic or manual mode. The system cools or heats the interior depending on the selected interior temperature and the current outside temperature.

It can only function optimally when you are driving with the windows and the tilt/sliding sunroof closed.

Nearly all dust particles, pollutants and odors are filtered out before outside air enters the passenger compartment through the air distribution system.

⚠ Warning!

Severe conditions (e.g. strong air pollution) may require replacement of the filter before its scheduled replacement interval. A clogged filter will reduce the air volume to the interior and the windows could fog up, impairing visibility and endangering you and others. Have a clogged filter replaced as soon as possible at an authorized Mercedes-Benz Center.

⚠ Warning!

Follow the recommended settings for heating and cooling given on the following pages and in the “COMAND automatic climate control” section. Otherwise the windows could fog up, impairing visibility and endangering you and others.

- ▶ Keep the air intake grille in front of the windshield free of snow and debris.

Do not obstruct air flow by placing objects on the air flow-through exhaust slots below the rear window.

- i** If the vehicle interior is hot, ventilate the interior before driving off, see “Summer opening feature” (▷ page 327). The climate control will then adjust the interior temperature to the set value much faster.

The following climate control functions can be operated via COMAND:

- Temperature (▷ page 223)
- Air distribution (▷ page 224)
- Air volume (▷ page 224)
- Switching off cooling (AC^{OFF}) (▷ page 225)
- Central climate control (Mono) (▷ page 226)
- Footwell temperature (▷ page 226)
- Air flow from air vents (▷ page 226)

Deactivating the climate control system

⚠ Warning!

When the climate control system is switched off, the outside air supply and circulation are also switched off. Only choose this setting for a short time. Otherwise the windows could fog up, impairing visibility and endangering you and others.

Climate control system

- ▶ **Deactivating:** Press rocker switch **OFF** up or down.

The indicator lamp in the rocker switch comes on. You will see Climate Control OFF in the COMAND display.

- ▶ **Reactivating:** Press rocker switch **OFF** up or down.

The indicator lamp in the rocker switch goes out. You will see the previous settings in the COMAND display.

Air conditioning

The air conditioning is operational while the engine is running and cools the interior air to the temperature set by the operator. In addition, the air conditioning dehumidifies the interior air and helps prevent window fogging.

Warning!

If you switch off the cooling function, the vehicle will not be cooled when weather conditions are warm. The windows can fog up more quickly. Window fogging may impair visibility and endanger you and others.

- ① Condensation may drip out from underneath the vehicle. This is normal and not an indication of a malfunction.

The cooling function can be activated or deactivated via COMAND (▷ page 225).

Automatic mode

Air distribution and air volume can be adjusted automatically by the climate control system. You can also adjust the settings for air distribution and air volume manually.

When operating the climate control system in automatic mode, the interior air temperature, air volume and air distribution are adjusted automatically.

In automatic mode, cooling with dehumidification is switched on. This function can be switched off if necessary.

Warning!

If you switch off the cooling function, the vehicle will not be cooled when weather conditions are warm. The windows can fog up more quickly. Window fogging may impair visibility and endanger you and others.

- ▶ Set the desired temperature (▷ page 388).

- ▶ **Activating:** Press rocker switch **AUTO** up or down.

The indicator lamp in the rocker switch comes on.

- ▶ **Deactivating:** Press rocker switch **AUTO** up or down.

or

- ▶ Press rocker switch  up or down.

or

- ▶ Adjust air volume via COMAND (▷ page 224).

The indicator lamp in rocker switch **AUTO** goes out.

Setting temperature

You can adjust the air temperature for each of the 3 zones separately. You should raise or lower the temperature setting in small increments, preferably starting at 72°F (22°C).

Climate control system



- ▶ **Increasing/decreasing:** Press rocker switches  ② and/or ⑩ up or down or use COMAND (▶ page 223). The climate control system will correspondingly adjust the interior air temperature.

Adjusting air vents

⚠ **Warning!**

When operating the climate control, the air that enters the passenger compartment through the air vents can be very hot or very cold (depending on the set temperature). This may cause burns or frostbite to unprotected skin in the immediate area of the air vents.

Always keep sufficient distance between unprotected parts of the body and the air vents. If necessary, use the air distribution adjustment to direct the air to air vents in the vehicle interior that are not in the immediate area of unprotected skin.

For best possible performance of the climate control:

- ▶ Keep the air intake grille in front of the windshield free of snow, leaves, sticks, and any other debris.
- ▶ Always keep all air vents and grilles in the passenger compartment free from obstruction.

- ① For draft-free ventilation, move the adjustable center and side air vents to the middle position.

Center air vents

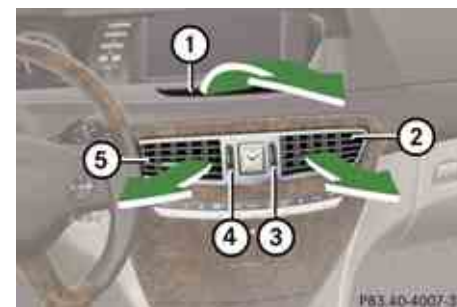

- ① Cockpit air vent, fixed
- ② Right center air vent, adjustable
- ③ Thumbwheel for air volume control for adjustable right center air vent
- ④ Thumbwheel for air volume control for adjustable left center air vent
- ⑤ Left center air vent, adjustable
- ▶ **Opening/closing:** Turn thumbwheels ③ and ④ upward or downward.

Climate control system

Side air vents

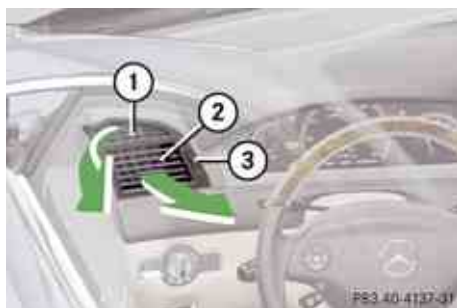

Example illustration driver's side

- ① Left side defroster air vent, fixed
- ② Left side air vent, adjustable
- ③ Thumbwheel for air volume control for adjustable left side air vent

► **Opening/closing:** Turn thumbwheel ③ upward or downward.

Rear center console air vents



- ① Left rear center air vent, adjustable
- ② Right rear center air vent, adjustable
- ③ Thumbwheel for air volume control for right rear center air vent
- ④ Thumbwheel for air volume control for left rear center air vent

► **Opening/closing:** Turn thumbwheel ③ or ④ in the required direction.

Adjusting air distribution

Air distribution in front/rear passenger compartment via COMAND

The air distribution can be adjusted via COMAND (► page 224).

Adjusting air volume

You can adjust the air volume separately on each side if the passenger compartment.

You can adjust the air volume via COMAND (► page 224).

► **Decrease/increase:** Press rocker switches  up or down.

Climate control system

Front defroster

You can use this setting to defrost the windshield, for example if it is iced up.

You can also defog the windshield and the side windows.

- i** Keep this setting selected only until the windshield or the side windows are clear again.

Activating

- ▶ Press rocker switch  up or down. The indicator lamp in the rocker switch comes on.

The climate control switches to the following functions automatically:

- most efficient blower speed and heating power, depending on outside temperature
- air flows onto the windshield and the front side windows
- the air conditioning compressor switches on at outside temperatures above approximately 41°F (5°C) for air-drying

Adjustments



You can adjust the air volume and the temperature when the front defroster is

switched on. The air flow will remain on the windshield and front door windows.

- ▶ Press rocker switch  up or down to increase or decrease air volume to the desired level. The air volume increases/decreases to the next higher/lower blower speed and heating switches to the temperature that was set before the front defroster was switched on.

The indicator lamp in rocker switch  goes out.

or

- ▶ Press rocker switches   ② and ⑩ (▷ page 385) up or down. Heating switches to the temperature that was set before the front defroster was switched on.

The indicator lamp in rocker switch  goes out.

- i** The air conditioning compressor remains on even with the indicator lamp in button  goes out. This helps to prevent windshield from fogging.

Deactivating

- ▶ Press rocker switch  up or down. The indicator lamp in the rocker switch goes out. The previous settings are once again in effect, except air recirculation mode stays off.

Windshield fogged on the outside

- ▶ Switch the windshield wipers on (▷ page 323).
- ▶ Press rocker switch  up or down. The indicator lamp in the rocker switch comes on.

Maximum cooling MAX COOL

MAX COOL is only operational when the engine is running.

MAX COOL is only available in U.S. vehicles.

If  is selected on both the left and right side and there is a high demand for cooling, the display MAXCOOL appears in the COMAND display.

This provides the fastest possible cooling of the vehicle interior (when windows and tilt/



Climate control system

sliding sunroof or tilt/sliding panel are closed).

- i** Maximum cooling MAX COOL is only available when the engine is running.

Air recirculation mode

Switch to air recirculation mode to prevent unpleasant odors from entering the vehicle from the outside (e.g. before driving through a tunnel). This setting cuts off the intake of outside air and recirculates the air in the passenger compartment.

Warning!

Fogged windows impair visibility, endangering you and others. If the windows begin to fog on the inside, switching off the air recirculation mode immediately should clear interior window fogging. If interior window fogging persists, make sure the air conditioning is activated, or press button



- ▶ **Activating:** Press rocker switch  up or down.
The indicator lamp in the rocker switch comes on.

- i** The air recirculation mode is activated automatically at high outside temperatures.

The indicator lamp in rocker switch  is not lit when the air recirculation mode is switched on automatically.

A quantity of outside air is added when the cooling demand is not at maximum.

If the air conditioning has been turned off or the outside temperature is below 41°F (5°C), the air recirculation mode will not switch on automatically.

- ▶ **Deactivating:** Press rocker switch  up or down.
The indicator lamp in the rocker switch goes out.

- i** The manually selected air recirculation mode is deactivated automatically:

- after 5 minutes if the outside temperature is below approximately 41°F (5°C)
- after 5 minutes if the air conditioning is turned off
- after 30 minutes if the outside temperature is above approximately 41°F (5°C)

Residual heat and ventilation

With the engine switched off, it is possible to continue to heat or ventilate the interior for up to 30 minutes. This feature makes use of the residual heat produced by the engine.

- i** If you switch on the residual heat function when outside temperatures are high, only the ventilation will be switched on.
- i** Regardless of the selected air volume, the blower operates at low speed when heating. In case of ventilation the blower operates at higher speed.
- i** How long the system will provide heating depends on the coolant temperature and

Rear window defroster

the selected temperature. The blower will run at low speed regardless of the air distribution control setting.

- ▶ **Activating:** Switch off the ignition.
- ▶ Press rocker switch **REST** up or down. The indicator lamp in the rocker switch comes on.
- ▶ **Deactivating:** Press rocker switch **REST** up or down. The indicator lamp in the rocker switch goes out.

The residual heat is deactivated automatically:



- when the ignition is switched on
- after approximately 30 minutes
- if the battery voltage drops
- if the coolant temperature is too low

Rear window defroster

 **Warning!**

Any accumulation of snow and ice should be removed from the rear window before driving. Visibility could otherwise be impaired, endangering you and others.

The rear window defroster uses a large amount of power. To keep the battery drain to a minimum, switch off the defroster as soon as the rear window is clear. The defroster is switched off automatically after approximately 6 to 17 minutes of operation depending on the outside temperature.

- ▶ Switch on the ignition.
- ▶ **Switching on:** Press button  up or down. The indicator lamp in the button comes on.
- ▶ **Switching off:** Press button  up or down.

! If the rear window defroster switches off too soon and the indicator lamp starts flashing, too many electrical consumers are operating simultaneously and there is insufficient voltage in the battery. The system responds automatically by switching the rear window defroster off.

As soon as the battery has sufficient voltage, the rear window defroster switches back on automatically.

Power tilt/sliding sunroof

Power tilt/sliding sunroof

Opening and closing

Warning!

When opening or closing the tilt/sliding sunroof, make sure there is no danger of anyone being harmed by the opening/closing procedure.

The tilt/sliding sunroof is equipped with the express operation and automatic reversal function. If the movement of the tilt/sliding sunroof is blocked during the closing procedure, the tilt/sliding sunroof will stop and open slightly.

The tilt/sliding sunroof operates differently when the sunroof switch is pressed and held. See the “Closing when the tilt/sliding sunroof is blocked” section for details.

The opening/closing procedure of the tilt/sliding sunroof can be immediately halted by releasing the sunroof switch or, if the sunroof switch was moved past the resistance point and released, by moving the sunroof switch in any direction.

 **Observe Safety notes, see page 59.**

Warning!

The tilt/sliding sunroof is made out of glass. In the event of an accident, the glass may shatter. This may result in an opening in the roof.

In a vehicle rollover, occupants not wearing their seat belts or not wearing them properly may be thrown out of the opening. Such an opening also presents a potential for injury for occupants wearing their seat belts properly as entire body parts or portions of them may protrude from the passenger compartment.

 To avoid damaging the seals, do not transport any objects with sharp edges which can stick out of the tilt/sliding sunroof.

Do not open the tilt/sliding sunroof if there is snow or ice on the roof, as this could result in malfunctions.

If you cannot open or close the tilt/sliding sunroof due to a malfunction contact Roadside Assistance or an authorized Mercedes-Benz Center.

 Please keep in mind that weather conditions can sometimes change rapidly. Make sure to close the tilt/sliding sunroof when leaving the vehicle. If water enters the vehicle interior, vehicle electronics could be damaged which is not covered by the Mercedes-Benz Limited Warranty.

 You can also open or close the tilt/sliding sunroof using the SmartKey or the KEYLESS-GO function, see “Summer opening feature” (> page 327) and “Convenience closing feature” (> page 327).

 After switching off the ignition or removing the SmartKey from the starter switch, you can operate the tilt/sliding sunroof until you open the driver’s or passenger door. If no door was opened you can operate the tilt/sliding sunroof for up to 5 minutes.

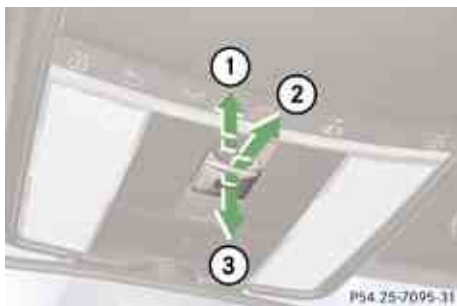

Sunroof switch

- ① Raising
- ② Opening
- ③ Closing

With the sunroof closed or raised, you can slide the sunroof screen forward and back.

- ▶ Switch on the ignition.

Opening

- ▶ **Opening manually:** Press and hold the sunroof switch to the resistance point in direction of arrow ②.
- ▶ Release the sunroof switch when the desired position is reached.
- ▶ **Express operation:** To open the tilt/sliding sunroof completely, press the

sunroof switch past the resistance point in direction of arrow ② and release.

- ▶ **Stopping during express operation:** Move the sunroof switch in any direction.

- ① Express opening is not available when the tilt/sliding sunroof is raised. The tilt/sliding sunroof must be closed first.

- ① When the tilt/sliding sunroof is open, resonance noises may result in addition to the usual wind noises. They are caused by minimal pressure changes in the passenger compartment. To reduce or eliminate these noises, change the position of the tilt/sliding sunroof or open a window slightly.

Raising

- ▶ **Raising manually:** Press and hold the sunroof switch to the resistance point in direction of arrow ①.
- ▶ Release the sunroof switch when the desired position is reached.
- ▶ **Express operation:** To raise the tilt/sliding sunroof completely, press the sunroof switch past the resistance point in direction of arrow ① and release.
- ▶ **Stopping during express operation:** Move the sunroof switch in any direction.

Power tilt/sliding sunroof

- ① Express raising is not available when the tilt/sliding sunroof is open. The tilt/sliding sunroof must be closed first.

Closing

- ▶ **Closing manually:** Pull and hold the sunroof switch to the resistance point in direction of arrow ③.
- ▶ Release the sunroof switch when the desired position is reached.
- ▶ **Express operation:** To close the tilt/sliding sunroof completely, pull the sunroof switch past the resistance point in direction of arrow ③ and release.
- ▶ **Stopping during express operation:** Move the sunroof switch in any direction.

Closing when the tilt/sliding sunroof is blocked

Warning!

Make sure that nobody can become trapped and be seriously or even fatally injured when closing the tilt/sliding sunroof with greater force or without automatic reversal function.

Loading and storing

If the movement of the tilt/sliding sunroof is blocked during the closing procedure (e. g. by ice or pollution), the tilt/sliding sunroof will stop and open slightly. However, the tilt/sliding sunroof will exert greater force before reversing than when the tilt/sliding sunroof is closed in express operation. Please exercise caution!

- ▶ Immediately after the tilt/sliding sunroof has stopped because it was blocked, pull the sunroof switch in direction of arrow ③ until the tilt/sliding sunroof is fully closed.

If the tilt/sliding sunroof is blocked again and opens slightly:

- ▶ Immediately after the tilt/sliding sunroof was blocked, pull the sunroof switch in direction of arrow ③ until the tilt/sliding sunroof is fully closed.

Warning!

Pulling and holding the sunroof switch to close the tilt/sliding sunroof immediately after it had been blocked two times will cause the tilt/sliding sunroof to close without any reversal function for as long as you hold the sunroof switch.

Synchronizing

The tilt/sliding sunroof must be synchronized after a malfunction or if it does not open smoothly.

- ❗ If the tilt/sliding sunroof cannot be closed or synchronized, contact an authorized Mercedes-Benz Center or call Roadside Assistance.
- ▶ Switch on the ignition.
- ▶ Press and hold the sunroof switch in direction of arrow ① (▷ page 395) until the tilt/sliding sunroof is fully raised at the rear.
- ▶ Keep holding the sunroof switch in direction of arrow ① for approximately 1 second.
- ▶ Check the express operation feature (▷ page 395).
If the tilt/sliding sunroof opens and closes completely, the roof is synchronized. Otherwise repeat the above steps.

Loading and storing

Loading instructions

Warning!

Always fasten items being carried as securely as possible using fastening materials appropriate for the weight and size of the load.

In an accident, during hard braking or sudden maneuvers, loose items will be thrown around inside the vehicle and can cause injury to vehicle occupants unless the items are securely fastened in the vehicle.

To help avoid personal injury during a collision or sudden maneuver, exercise care when transporting cargo. Do not pile luggage or cargo higher than the seat backrests.

The trunk is the preferred place to carry objects. Do not place anything on the rear-window shelf.

Never drive vehicle with the trunk open. Deadly carbon monoxide (CO) gases may enter vehicle interior resulting in unconsciousness and death.

Load distribution

The total load weight including vehicle occupants and luggage/cargo should not exceed the total load limit indicated on the corresponding Tire and Loading Information placard located on the driver's door B-pillar (▷ page 432).

The handling characteristics of a fully loaded vehicle depend greatly on the load distribution. It is therefore recommended to load the vehicle accordingly with the heaviest items being placed towards the front of the vehicle.

Please pay attention to and comply with the following instructions when loading the vehicle and transporting cargo:

- Always place items being carried against front or rear seat backrests, and fasten them as securely as possible.
- The heaviest portion of the cargo should always be kept as low as possible against front or rear seat backrests.

Parcel nets

Warning!

The parcel net is intended for storing light-weight items only, such as road maps, mail, etc.

Heavy objects, objects with sharp edges or fragile objects may not be transported in the parcel net. In an accident, during hard braking, or sudden maneuvers, they could be thrown around inside the vehicle and cause injury to vehicle occupants.

The parcel net cannot protect transported goods in the event of an accident.

Parcel nets are located in the front passenger footwell and on the right trunk side wall.

Hooks

A retaining hook can be used to attach cargo items such as bags.



① Tab

② Retaining hook

▶ Pull tab ① of retaining hook ② down.

! Do not use the retaining hook to tie down cargo.

Loading and storing

Storage compartments

Warning!

To help avoid personal injury during a collision or sudden maneuver, exercise care when storing objects in the vehicle. Put luggage or cargo in the trunk if possible.

Do not pile luggage or cargo higher than the seat backrests.

Parcel nets cannot secure hard or heavy objects.

Keep compartment lids closed. This will help to prevent stored objects from being thrown about and injuring vehicle occupants during

- braking
- vehicle maneuvers
- an accident

Glove box

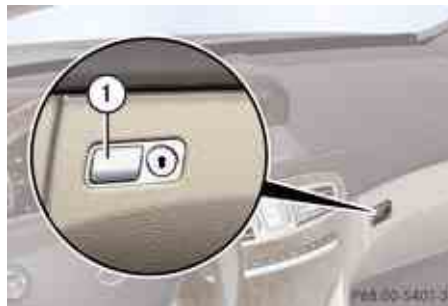

① Glove box lid release

- ▶ **Opening:** Press glove box lid release ①.
- ▶ **Closing:** Push glove box lid up until it engages.

Locking and unlocking the glove box separately

You can lock the glove box separately, e.g. when the vehicle is in the shop for service.

The glove box can only be locked or unlocked with the mechanical key.



① Unlocking glove box

② Locking glove box

Eyeglasses compartment

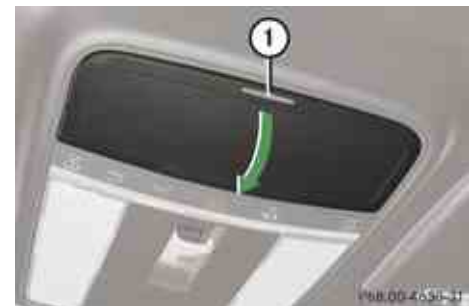

① Eyeglasses compartment mark

Loading and storing

- ▶ **Opening:** Press eyeglasses compartment mark ①.
- ▶ **Closing:** Swing eyeglasses compartment upward until it engages.

Front armrest storage compartments

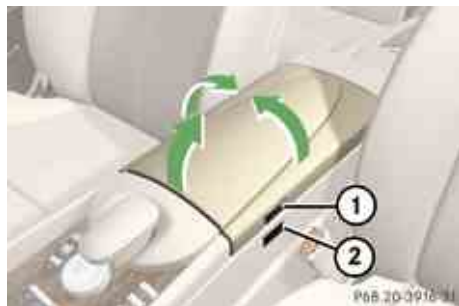

- ① Button for storage tray/telephone compartment
- ② Button for storage compartment
- ▶ **Opening storage tray/telephone compartment:** Press button ① and swing armrest to left or right side.
- ▶ **Opening storage compartment:** Press button ② and swing armrest upward.

Seat storage compartments

Storage compartments are located in the seat base of each front seat.

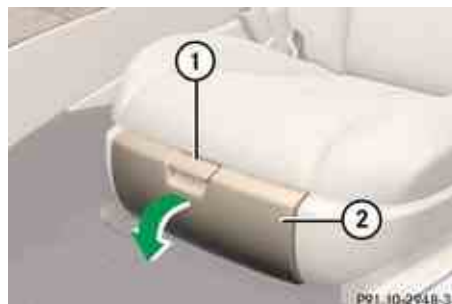

- ① Handle
- ② Storage compartment lid
- ▶ **Opening:** Pull handle ① up.
- ▶ Fold storage compartment lid ② forward.

Rear storage compartments

Armrest with integrated storage compartment

- ⚠ Before storing the armrest in the seat backrest, close the storage compartment cover.

- ⚠ Do not sit on or lean your body weight against the armrest when it is folded down, as you could otherwise damage it.

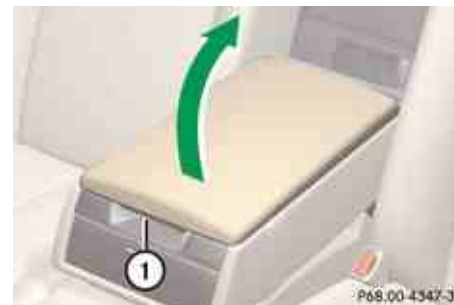

- ① Release catch
- ▶ **Opening:** Pull down the armrest.
- ▶ Pull release catch ① and swing the storage compartment cover upward in direction of arrow.

Loading and storing

Storage compartment between rear seats



① Handle

- ▶ **Opening:** Pull handle ① backward in the direction of arrow.

Rear storage box

- ⚠ Do not sit on or lean your body weight against the armrest when it is folded down, as you could otherwise damage it.

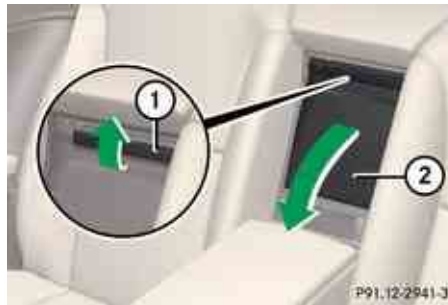

① Handle

② Cover

- ▶ Fold down rear armrest.
- ▶ Pull handle ① upward in direction of arrow.
- ▶ Swing down cover ② in direction of arrow.

Storage spaces under trunk floor

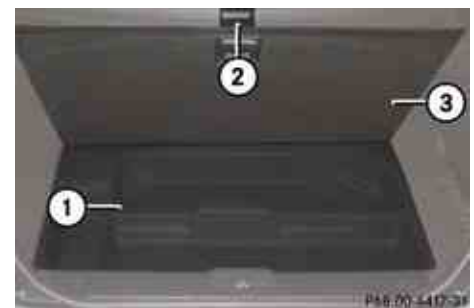

① Storage space

② Cover handle

③ Trunk floor cover

- ▶ Lift up trunk floor cover ③ and engage cover handle ② in upper edge of trunk.

Useful features

Cup holders

⚠ Warning!

In order to help prevent spilling liquids on vehicle occupants and/or vehicle equipment, only use containers that fit into the cup holder. Use lids on open containers and do not fill containers to a height where the contents, especially hot liquids, could spill during braking, vehicle maneuvers, or in an accident. Liquids spilled on vehicle occupants may cause serious personal injury. Liquids spilled on vehicle equipment may cause damage not covered by the Mercedes-Benz Limited Warranty.

When not in use, keep the cup holder closed. An open cup holder may cause injury to you or others when contacted during braking, vehicle maneuvers, or in an accident.

Keep in mind that objects placed in the cup holder may come loose during braking, vehicle maneuvers, or in an accident and be thrown around in the vehicle interior. Objects thrown around in the vehicle interior may cause an accident and/or serious personal injury.

Cup holder in front center console



- ① Chrome label
- ② Handle

- ▶ **Opening:** Press chrome label ①.
- ▶ **Closing:** Fold cover in until it engages.

The front cup holder can be removed for cleaning purposes.

- ▶ **Removing:** Pull cup holder out by pulling handle ② upward in direction of arrow.
- ▶ **Reinstalling:** Press handle ② downward until it engages. While doing so, make sure that the word "Front" is in the proper installation position.

Cup holder in rear armrest



- ① Chrome label

- ▶ **Opening:** Press chrome label ①.
- ▶ **Closing:** Slide cup holder back until it engages.

! Do not sit on or lean your body weight against the armrest when it is folded down, as you could otherwise damage it.

! Close the cup holder before folding the armrest upwards. Otherwise you could damage the cup holder.

Useful features

Sun visors

Warning!

Do not use the vanity mirror while driving. Keep the vanity mirrors in the sun visors closed while vehicle is in motion. Reflected glare can endanger you and others.

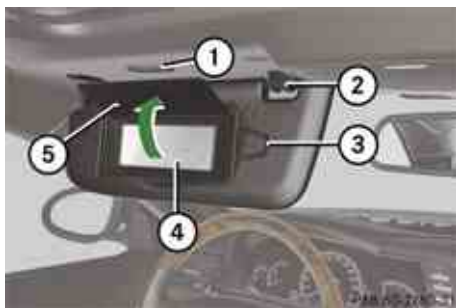

- ① Vanity mirror lamp
- ② Mounting
- ③ Holder, e.g. for gas cards
- ④ Vanity mirror
- ⑤ Vanity mirror cover

Glare through the windshield

- ▶ Flip sun visor down when you experience glare.

Glare through a door window

- ▶ Close vanity mirror cover ⑤ if opened.
- ▶ Disengage sun visor from mounting ②.
- ▶ Pivot sun visor to the side.

Vanity mirror

The mirror lamp only functions when the sun visor is engaged in mounting.

- ▶ Flip sun visor down.
- ▶ Lift up vanity mirror cover ⑤. Vanity mirror lamp ① comes on.

Ashtrays

Warning!

Remove ashtray insert only with vehicle standing still.



- ① Button
- ② Cover plate

- ▶ **Opening:** Press mark on cover plate ② forward.
- ▶ **Removing ashtray insert:** Push button ① to the left. The ashtray is disengaged and slides out a short way.
- ▶ Grab and remove insert from ashtray frame.
- ▶ **Reinstalling ashtray insert:** Push the ashtray insert back into frame until it engages.
- ▶ **Closing:** Briefly press mark on cover plate ② forward.

Cigarette lighter

⚠ **Observe Safety notes, see page 59.**

⚠ **Warning!**

Never touch the heating element or sides of the lighter; they are extremely hot. Hold the knob only.

Make sure any children traveling with you do not injure themselves or start a fire with the hot cigarette lighter.

If the engine is off and the cigarette lighter is being used extensively, the vehicle battery may become discharged.



① Cigarette lighter

- ▶ Switch on the ignition.
- ▶ Open the cover plate (▷ page 402).

- ▶ Push in cigarette lighter ①. Cigarette lighter ① will pop out automatically when hot.
 - ▶ Take out cigarette lighter ①.
 - ▶ Reinsert cigarette lighter ① in its socket after use.
- ❗ The lighter socket can be used to accommodate 12V DC electrical accessories (up to a maximum of 85 W) designed for use with the standard “cigarette lighter” plug type. Keep in mind, however, that connecting accessories to the lighter socket (for example extensive connecting and disconnecting, or using plugs that do not fit properly) can damage the lighter socket. With the socket damaged, the lighter may not function properly any longer.

Power outlet

The power outlet can be used to accommodate 12V DC electrical accessories (e.g. auxiliary lamps, mobile phone chargers) up to a maximum of 15 A (180 W).

If the engine is off and the power outlet is being used extensively, the vehicle battery may become discharged.

- ▶ Switch on the ignition.



① Power outlet

Useful features

Telephone



i Various mobile phone cradles can be installed in the front center armrest, see separate installation instructions for the mobile phone cradle. These mobile phone cradles can be obtained from an authorized Mercedes-Benz Center.

The functions and services available to you while using the mobile phone depend on your service provider and the type of mobile phone you are using. See also separate operating manual for instructions on how to use your mobile phone.

Radio transmitters, such as a portable telephone or a citizens band unit, should only be used inside the vehicle if they are connected to an antenna that is installed on the outside of the vehicle.

The external antenna must be approved by Mercedes-Benz. Please contact an authorized Mercedes-Benz Center for information on the installation of an approved external antenna. Refer to the radio transmitter operation instructions regarding use of an external antenna.

When the mobile phone is inserted in the cradle, you can operate the telephone using the following devices:

- mobile phone keypad
- COMAND telephone keypad (▷ page 81)
- buttons  and  on the multifunction steering wheel (▷ page 232)
- Voice Control System (▷ page 248)
- Bluetooth® headset (▷ page 164)

Please note that these functions are only available with Mercedes-Benz approved mobile phones. Please contact an authorized Mercedes-Benz Center for information on features available for your mobile phone of choice.

The contact plate for the mobile phone cradle is located in the front center armrest.

- ▶ Open telephone compartment (▷ page 399).



① Cover for contact plate

- ▶ Pull cover for contact plate ① in direction of arrow.
You can now access the contact plate.
- ▶ Install a mobile phone cradle, see separate installation instructions for the cradle.

Tele Aid

! In order to activate the Tele Aid system, a subscriber agreement must be completed. To ensure your system is activated and operational, please press the  button to perform the acquaintance call. Failure to complete either of these steps may result in a system that is not activated.

If you have any questions regarding activation, please call the Response Center at 1-800-756-9018 (in the USA) or 1-888-923-8367 (in Canada).

Shortly after the completion of your Tele Aid acquaintance call, you will receive a user ID and password in the mail. You may use this password to access the Tele Aid section in “Owner’s Online” at www.mbUSA.com (USA only). The “My Tele Aid” section will give you access to account information, remote door unlock and more.

The Tele Aid system is available if

- it has been activated and is operational. Activation requires a subscription for

monitoring services, connection and cellular air time.

- vehicle battery power is available.
 - the relevant cellular phone network and GPS signals are available and pass the information on to the Response Center.
- i** Location of the vehicle on a map is only possible if the vehicle is able to receive signals from the GPS satellite network and pass the information on to the Response Center.

The Tele Aid system



(Telematic Alarm Identification on Demand)
The Tele Aid system consists of three types of response:

- Automatic and manual emergency
- Roadside Assistance
- Information

The Tele Aid system is operational providing that the vehicle’s battery is charged, properly connected, not damaged, and cellular and GPS coverage is available. The Tele Aid system utilizes the cellular network for communication and the GPS (Global Positioning System) satellites for vehicle

location. If either of these signals are unavailable, the Tele Aid system may not function and if this occurs, assistance must be summoned by other means.



To adjust the speaker volume during a Tele Aid call do the following:

- ▶ Press button  or  on the multifunction steering wheel.
- or
- ▶ Use the COMAND volume thumbwheel  on the lower part of the front center console (▶ page 88).

System self-test

The system performs a self-test after you have switched on the ignition.

Warning!

If the indicator lamps in the SOS button, in the Roadside Assistance button  and/or in the Information button  do not come on during the system self-test, or if any of these indicators remain illuminated constantly in red and/or the message Tele Aid Not Activated or Tele Aid Inoperative is displayed in the multifunction display after the system self-

Useful features

test, a malfunction in the system has been detected.

If a malfunction is indicated as outlined above, the system may not operate as expected. In case of an emergency, help will have to be summoned by other means.

Have the system checked at the nearest Mercedes-Benz Center or contact the Response Center at 1-800-756-9018 (in the USA) or 1-888-923-8367 (in Canada) as soon as possible.

Emergency calls

I In order to activate the Tele Aid system, a subscriber agreement must be completed. To ensure your system is activated and operational, please press the  button to perform the acquaintance call. Failure to complete either of these steps may result in a system that is not activated.

If you have any questions regarding activation, please call the Response Center at 1-800-756-9018 (in the USA) or 1-888-923-8367 (in Canada).

An emergency call is initiated automatically following an accident in which the Emergency Tensioning Devices (ETDs) or air bags deploy.

An emergency call can also be initiated manually (▷ page 407).

Once the emergency call is in progress, the indicator lamp in the SOS button will begin to flash. The message **Connecting Call** appears in the multifunction display.

Emergency Call Activated appears in the COMAND display and the audio system is muted. When the connection is established, the message **Call Connected** appears in the multifunction display. **Emergency Call Activated** appears in the COMAND display.

All information relevant to the emergency, such as the location of the vehicle (determined by the GPS satellite location system), vehicle model, identification number and color are generated.

i During the emergency call message **Emergency Call Activated** is displayed, operation from audio system or COMAND system is not possible. The climate control can be still adjusted using the switches on the climate control panel.

A voice connection between the Response Center and the occupants of the vehicle will be established automatically soon after the emergency call has been initiated. The Response Center will attempt to determine more precisely the nature of the emergency

provided they can speak to an occupant of the vehicle.

i If no vehicle occupant responds, an ambulance will be sent to the vehicle immediately.

Warning!

If the indicator lamp in the SOS button is flashing continuously and there was no voice connection to the Response Center established, then the Tele Aid system could not initiate an emergency call (e.g. the relevant cellular phone network is not available).

The message **Call Failed** appears in the multifunction display for approximately 10 seconds.

Should this occur, assistance must be summoned by other means.

i During the emergency call the telephone is switched off automatically and must be switched back on to make a call.

i The “911” emergency call system is a public service. Using it without due cause is a criminal offense.

Initiating an emergency call manually

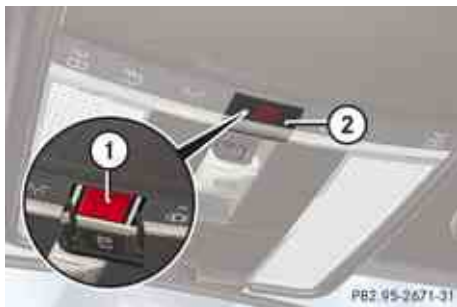

- ① SOS button
- ② Cover

- ▶ Briefly press on cover ② to open.
- ▶ Press SOS button ① briefly.
The indicator lamp in SOS button ① will flash until the emergency call is concluded.
- ▶ Wait for a voice connection to the Response Center.
- ▶ Close cover ② after the emergency call is concluded.

⚠ Warning!



If you feel at any way in jeopardy when in the vehicle (e.g. smoke or fire in the vehicle, vehicle in a dangerous road location), please do not wait for voice contact after you have pressed the emergency button.

Carefully leave the vehicle and move to a safe location. The Response Center will automatically contact local emergency officials with the vehicle's approximate location if they receive an automatic SOS signal and cannot make voice contact with the vehicle occupants.

Roadside Assistance button

- ▶ Open the storage compartment (▶ page 399).



- ① Roadside Assistance button 
- ▶ Press and hold Roadside Assistance button  for longer than 2 seconds.
A call to a Mercedes-Benz Roadside Assistance dispatcher will be initiated. The indicator lamp in the Roadside Assistance

button  will flash while the call is in progress. The message Connecting Call will appear in the multifunction display. Roadside Assistance Activated appears in the COMAND Display. The audio system or the COMAND system is muted.

When the connection is established, the message Call Connected appears in the multifunction display. Roadside Assistance Activated appears in the COMAND display. The Tele Aid system will transmit data generating the vehicle identification number, model, color and location (subject to availability of cellular and GPS signals).

- i** The COMAND system display indicates that a Tele Aid call is in progress. While the call is connected you can change to the navigation menu by pressing the  shortcut button. Spoken commands are not available.



A voice connection between the Roadside Assistance dispatcher and the occupants of the vehicle will be established.

- ▶ Describe the nature of the need for assistance.

Useful features

The Mercedes-Benz Roadside Assistance dispatcher will either dispatch a qualified Mercedes-Benz technician or arrange to tow your vehicle to the nearest authorized Mercedes-Benz Center. For services such as labor and/or towing, charges may apply. Refer to the Roadside Assistance manual for more information.

The following is only available in the USA:
Sign and Drive services: Services such as a jump start, a few gallons of fuel or the replacement of a flat tire with the vehicle spare tire are obtainable at no charge.



i If the indicator lamp in the Roadside Assistance button  is flashing continuously and there was no voice connection to the Response Center established, then the Tele Aid system could not initiate a Roadside Assistance call (e.g. the relevant cellular phone network is not available). The message **Call Failed** appears in the multifunction display. **Call could not be connected!** appears in the COMAND display. Confirm the message pressing  (> page 81).

- ▶ **Terminating calls:** Press button  on the multifunction steering wheel.
- or
- ▶ Press the respective button for ending a telephone call on the telephone keypad.

Information button

- ▶ Open the storage compartment (> page 399).



- 1** Information button 
- ▶ Press and hold Information button  for longer than 2 seconds. A call to the Customer Assistance Center will be initiated. The indicator lamp in the Information button  will flash while the call is in progress. The message **Connecting Call** will appear in the



multifunction display. Information **Call Activated** appears in the COMAND display. The audio system or the COMAND system is muted.

When the connection is established, the message **Call Connected** appears in the multifunction display. Information **Call Activated** appears in the COMAND display. The Tele Aid system will transmit data generating the vehicle identification number, model, color and location (subject to availability of cellular and GPS signals).

i The COMAND system display indicates that a Tele Aid call is in progress. While the call is connected you can change to the navigation menu by pressing the  shortcut button. Spoken commands are not available.

A voice connection between the Customer Assistance Center representative and the occupants of the vehicle will be established. Information regarding the operation of your vehicle, the nearest authorized Mercedes-Benz Center or Mercedes-Benz USA products and services is available to you.

For more details concerning the Tele Aid system, please visit www.mbusa.com (USA only), log in to “Owner’s Online” and visit the “My Tele Aid” section to learn more.

i If the indicator lamp in the Information button  is flashing continuously and there was no voice connection to the Response Center established, then the Tele Aid system could not initiate an Information call (e.g. the relevant cellular phone network is not available). The message **Call Failed** appears in the multifunction display. **Call could not be connected!** appears in the COMAND display. Confirm the message pressing  (> page 81).

► **Terminating calls:** Press button  on the multifunction steering wheel.

or

► Press the respective button for ending a telephone call on the telephone keypad.

Call priority

If other service calls such as a Roadside Assistance call or Information call are active, an emergency call is still possible. In this case, the emergency call will take priority and override all other active calls.

The indicator lamp in the respective button flashes until the call is concluded. Emergency calls can only be terminated by a Response Center or Customer Assistance Center

representative. All other calls can be terminated by pressing button  on the multifunction steering wheel or the respective button for ending a telephone call on the telephone keypad.

i When a Tele Aid call has been initiated, the audio system is muted. The optional mobile phone (if installed) switches off. If you must use this phone, we recommend that you use it only with the vehicle at a standstill in a safe location. Unplug the telephone, switch it on and place the call. The navigation system (if engaged) will continue to run. The multifunction display in the instrument cluster is available for use, but spoken commands are not available.

Destination Download to the COMAND system

i The components and operating principles of the COMAND system can be found on (> page 79).



Destination Download allows you access to a database of over 10 million points of interest (POIs) that can be downloaded to your vehicle's navigation system. If you know the destination, the address can be downloaded,

or can be provided with points of interests near your location.

The Response Center can transmit destination data to the COMAND system during the connection with the Roadside Assistance or Customer Assistance Center. The transmitted data can contain address details for a Mercedes-Benz Center or POIs.

Route guidance

You will be prompted to confirm that route guidance to the entered address is to be started.

► Slide  or rotate  to select Yes menu item and confirm by pressing .

The system calculates the route and subsequently starts the route guidance to the defined address.

i If you select No, you can save the address to your address book.

i The Destination Download feature is available if the relevant mobile phone network is available and data connection is possible.

Useful features

Search and Send

i In order to utilize Search & Send your vehicle must be equipped with Tele Aid, Navigation, and an active Tele Aid subscription.

“Search & Send” is a navigation destination address entry service. A destination address located using Google Maps® or Yahoo Local Maps® website can be delivered via Tele Aid directly to the navigation system in your vehicle.

Specify and Send a Destination Address

i Please refer to any specific instructions provided by either website regarding entering or sending an address. Each website functions differently and is subject to change.

- ▶ Go to **www.maps.google.com** or **www.maps.yahoo.com** and enter a destination address in the address entry field.
- ▶ Depending on which website you are using, click on the appropriate button to send the destination address to your Tele Aid account email address.
- ▶ Enter the email address you specified when you activated your Tele Aid account in the

appropriate field when the “Send” dialog box appears.

- ▶ Click “Send”.

Retrieve Destination Address

- ▶ Press the Tele Aid Information button to begin the download of the destination address to your vehicle’s navigation system.



- i** If you have sent more than one destination address to your vehicle you must make one Information call for each destination address download.
- ▶ Select Yes when the message appears asking if you would like to start navigation. This will open the start navigation screen.



- ▶ Select Start.
- or
- ▶ Select No if you wish to save the downloaded destination address in the From Memory destination list for future use.



i Destination addresses will download in the same order they were sent. If you have multiple Mercedes-Benz vehicles equipped with Tele Aid and active accounts, each destination address sent will be retrievable by all vehicles associated with the e-mail address you specified for your Tele Aid account.

Remote door unlock

In case you have locked your vehicle unintentionally (e.g. SmartKey inside vehicle), and the reserve SmartKey is not available:

- ▶ Contact the Response Center at 1-800-756-9018 (in the USA) or 1-888-923-8367 (in Canada). You will be asked to provide your password.
- ▶ Then return to your vehicle at the time arranged with the Response Center and pull the trunk lid handle for a minimum of 20 seconds until the indicator lamp in the SOS button is flashing. The message *Connecting Call* appears in the multifunction display.

As an alternative, you may unlock the vehicle via Internet in the “My Tele Aid” section of “Owner’s Online”, using your ID and password (USA only).

The Response Center will then unlock your vehicle with the remote door unlocking feature.

i The remote door unlock feature is available if the relevant cellular phone network is available.

The SOS button will flash and the message *Connecting Call* will appear in the multifunction display to indicate receipt of the door unlock command.

Once the vehicle is unlocked, a Response Center specialist will attempt to establish voice contact with the vehicle occupants. If the trunk lid handle was pulled for more than 20 seconds before door unlock authorization was received by the Response Center, you must wait 15 minutes before pulling the trunk lid handle again.

Remote door lock

If you have forgotten to lock your vehicle and are no longer near it, you can have it locked remotely through the Response Center.

The vehicle can be remotely locked within 4 days after the ignition has been switched off.

- ▶ Contact the Response Center at 1-800-756-9018 (in the USA) or 1-888-923-8367 (in Canada). You will be asked to provide your password.

When you are inside your vehicle the next time and switch on the ignition, the message *Tele Aid Doors Locked Remotely* will appear on the multifunction display.

i The remote door lock feature is available if the relevant telephone network is available and data connection is possible.

Automatic Maintenance Call

The CL-Class is equipped with a feature that considerably enhances vehicle care. Just prior to reaching a vehicle maintenance milestone, Tele Aid transmits important vehicle maintenance information that alerts your authorized Mercedes-Benz Center of required service. This is automatic and does not require driver intervention. This feature allows your preferred Mercedes-Benz Center to significantly improve the process of arranging your service appointment and ensures that your vehicle receives the best possible care.

i The Automatic Maintenance Call feature is available if the relevant telephone



Useful features

network is available and data connection is possible.

Stolen Vehicle Recovery services

In the event your vehicle was stolen:

- ▶ Report the incident to the police.
The police will issue a numbered incident report.
- ▶ Pass this number on to the Response Center along with your password.
The Response Center will then attempt to covertly contact the vehicle's Tele Aid system. Once the vehicle is located, the Response Center will contact the local law enforcement and you. The vehicle's location will only be provided to law enforcement.
- ❗ If the anti-theft alarm stays on for more than 30 seconds, a call to the Response Center is initiated automatically by the Tele Aid system provided Tele Aid service was subscribed to and properly activated, and that necessary cellular service and GPS coverage are available. See "Anti-theft alarm system" (▷ page 75).

Garage door opener

The integrated remote control can operate up to three separately controlled devices compatible with HomeLink® or some other systems.

⚠ Warning!

Before programming the integrated remote control to a garage door opener or gate operator, make sure people and objects are out of the way of the device to prevent potential harm or damage. When programming a garage door opener, the door moves up or down. When programming a gate operator, the gate opens or closes.

Do not use the integrated remote control with any garage door opener that lacks safety stop and reverse features as required by U.S. federal safety standards (this includes any garage door opener model manufactured before April 1, 1982). A garage door that cannot detect an object - signaling the door to stop and reverse - does not meet current U.S. federal safety standards.

When programming a garage door opener, park vehicle outside the garage.

Do not run the engine while programming the integrated remote control. Inhalation of exhaust gas is hazardous to your health. All exhaust gas contains carbon monoxide (CO), and inhaling it can cause unconsciousness and possible death.

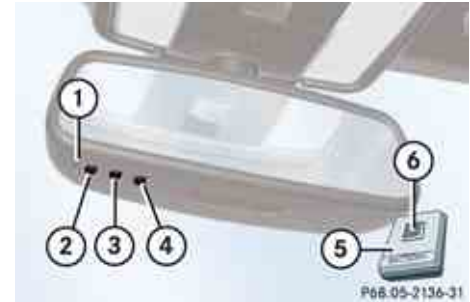

Interior rear view mirror with integrated remote control

- ① Indicator lamp
- ②③④ Signal transmitter button
- ⑤ Hand-held remote control (not part of vehicle equipment)
- ⑥ Hand-held remote control button

Programming the integrated remote control

- ▶ **Step 1:** Switch on the ignition.
- ▶ **Step 2:** If you have previously programmed a signal transmitter button and wish to retain its programming, proceed to step 3.

or

- ▶ If you are programming the integrated remote control for the first time, press and hold the two outer signal transmitter buttons (2) and (4) and release them when indicator lamp (1) begins to flash after approximately 20 seconds.

Do not hold the button for longer than 30 seconds.

This procedure erases any previous settings for all three channels and initializes the memory. If you later wish to program a second and/or third hand-held transmitter to the remaining two signal transmitter buttons, do not repeat this step and begin directly with step 3.

- ▶ **Step 3:** Hold the end of hand-held remote control (5) of the device you wish to train approximately 2 to 12 in (5 to 30 cm) away from the signal transmitter button (2), (3) or (4) to be programmed, while keeping indicator lamp (1) in view.

- ▶ **Step 4:** Using both hands, simultaneously press hand-held remote control button (6) and the desired signal transmitter button (2), (3) or (4). Do not release the buttons until step 5 is completed. Indicator lamp (1) will flash, first slowly and then rapidly.

i Indicator lamp (1) flashes immediately the first time the signal transmitter button is programmed. If this button has already been programmed, the indicator lamp will start flashing after 20 seconds.

- ▶ **Step 5:** After indicator lamp (1) changes from a slow to a rapidly flashing light, release the hand-held remote control button and the signal transmitter button.

▶ **Step 6:** Press and hold the just-trained signal transmitter button (2), (3) or (4) and observe indicator lamp (1). If indicator lamp (1) stays on constantly, programming is complete and your device should activate when the respective signal transmitter button (2), (3) or (4) is pressed and released.

i If indicator lamp (1) flashes rapidly for approximately 2 seconds and then turns to a constant light, continue with

programming steps 8 through 12 as your garage door opener may be equipped with the “rolling code” feature.

- ▶ **Step 7:** To program the remaining two signal transmitter buttons, repeat the steps above starting with step 3.

Rolling code programming

To train a garage door opener (or other rolling code devices) with the rolling code feature, follow these instructions after completing the “Programming” portion (steps 1 through 6) of this text. A second person may make the following training procedures quicker and easier.

- ▶ **Step 8:** Locate the “training” button on the garage door opener motor head unit.

i Exact location and color of the button may vary by garage door opener brand. Depending on manufacturer, the “training” button may also be referred to as “learn” or “smart” button. If there is difficulty locating the transmitting button, refer to the garage door opener Operator’s Manual.

- ▶ **Step 9:** Press the “training” button on the garage door opener motor head unit. The “training light” is activated.



Useful features

You have 30 seconds to initiate the following two steps.

- ▶ **Step 10:** Return to the vehicle and firmly press, hold for 2 seconds and release the programmed signal transmitter button (②, ③ or ④).
 - ▶ **Step 11:** Press, hold for 2 seconds and release same signal transmitter button a second time to complete the training process.
- i** Some garage door openers (or other rolling code equipped devices) may require you to press, hold for 2 seconds and release the same signal transmitter button a third time to complete the training process.
- ▶ **Step 12:** Confirm the garage door operation by pressing the programmed signal transmitter button (②, ③ or ④).
 - ▶ **Step 13:** To program the remaining two signal transmitter buttons, repeat the steps above starting with step 3.

Gate operator/Canadian programming

Canadian radio-frequency laws require transmitter signals to “time-out” (or quit) after several seconds of transmission which may not be long enough for the integrated

signal transmitter to pick up the signal during programming. Similar to this Canadian law, some U.S. gate operators are designed to “time-out” in the same manner.

If you live in Canada or if you are having difficulties programming a gate operator (regardless of where you live) by using the programming procedures, replace step 4 with the following:

- ▶ **Step 4:** Press and hold the signal transmitter button (②, ③ or ④). Do not release this button until it has been successfully trained.
- ▶ While still holding down the signal transmitter button (②, ③ or ④), “cycle” your hand-held remote control button ⑥ as follows: Press and hold button ⑥ for 2 seconds, then release it for 2 seconds, and again press and hold it for 2 seconds. Repeat this sequence on the hand-held remote control until the frequency signal has been learned. Upon successful training, indicator lamp ① will flash slowly and then rapidly after several seconds.
- ▶ Proceed with programming step 5 and step 6 to complete.

- i** Upon completion of programming the integrated remote control, make sure you retain the hand-held remote control that came with the garage door opener, gate operator or other device. You may need it for use in other vehicles, for future programming of an integrated remote control, or simply for continued use as a hand-held remote control to operate the respective device in other situations.

Reprogramming a single signal transmitter button

To program a device using a signal transmitter button previously trained, follow these steps:

- ▶ Switch on the ignition.
- ▶ Press and hold the desired signal transmitter button (②, ③ or ④). Do not release the button. Indicator lamp ① will begin to flash after 20 seconds.
- ▶ Without releasing the signal transmitter button, proceed with programming starting with step 3.

Operation of integrated remote control

- ▶ Switch on the ignition.
- ▶ Select and press the appropriate integrated signal transmitter button (②, ③ or ④) to activate the remote controlled device.
The integrated remote control transmitter continues to send the signal as long as the button is pressed – up to 20 seconds.

Erasing the integrated remote control memory

- ❗ If you sell your vehicle, erase the codes of all three channels.
- ▶ Switch on the ignition.
- ▶ Simultaneously press and hold outer signal transmitter buttons ② and ④, for approximately 20 seconds, until indicator lamp ① flashes rapidly. Do not hold for longer than 30 seconds.
The codes of all three channels are erased.

Programming tips

If you are having difficulty programming the integrated remote control, here are some helpful tips:

- Check the frequency of hand-held remote control ⑤ (typically located on the reverse side of the remote). The integrated remote control is compatible with radio-frequency devices operating between 280-390 MHz.
- Put a new battery in hand-held remote control ⑤. This will increase the likelihood of the hand-held remote control sending a faster and more accurate signal to the integrated remote control.
- While performing step 3, hold hand-held remote control ⑤ at different lengths and angles from the signal transmitter button (②, ③ or ④) you are programming. Attempt varying angles at the distance of 2 to 12 inches (5 to 30 cm) away or the same angle at varying distances.
- If another hand-held remote control is available for the same device, try the programming steps again using that other hand-held remote control. Make sure new

batteries are in the hand-held remote control before beginning the procedure.

- Straighten the antenna wire from the garage door opener assembly. This may help improve transmitting and/or receiving signals.
- ❗ Certain types of garage door openers are incompatible with the integrated remote control. If you should experience further difficulties with programming the integrated remote control, contact an authorized Mercedes-Benz Center, or call the Mercedes-Benz Customer Assistance Center (in the USA) at 1-800-FOR-MERcedes, or Customer Service (in Canada) at 1-800-387-0100.
- ❗ USA only:
This device complies with Part 15 of the FCC Rules. Operation is subject to the following two conditions:
 1. This device may not cause harmful interference, and
 2. this device must accept any interference received, including interference that may cause undesired operation.



Useful features

Any unauthorized modification to this device could void the user's authority to operate the equipment.

i Canada only:

This device complies with RSS-210 of Industry Canada. Operation is subject to the following two conditions:

1. This device may not cause interference, and
2. this device must accept any interference received, including interference that may cause undesired operation of the device.

Any unauthorized modification to this device could void the user's authority to operate the equipment.

Floormats

⚠ Warning!

Whenever you are using floormats, make sure there is enough clearance and that the floormats are securely fastened.

Floormats should always be securely fastened using the fastening equipment. Before driving off, check that the floormats are securely in place and adjust them if necessary. A loose floormat could slip and hinder proper functioning of the pedals.

Do not place several floormats on top of each other as this may impair pedal movement.

- i** To install or remove the floormat more easily, move the driver's seat or front passenger seat as far to the rear as possible.

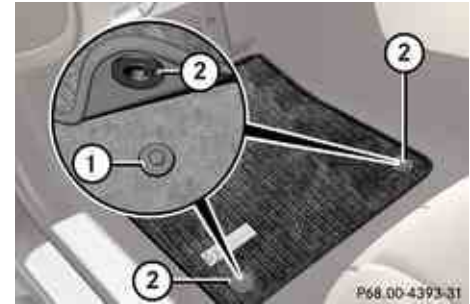

- ① Retainer pin
② Eyelet

- **Removing:** Pull floormat off of retainer pins ①.
- **Installing:** Press floormat eyelets ② onto retainer pins ①.

Infrared reflecting windshield

Infrared reflecting glass reduces the amount of radiated heat entering the vehicle interior through the windows.

The infrared reflecting glass also prevents the transmission of signals through the glass by in-vehicle electronic devices, e.g. electronic toll collection devices.

To allow the use of these devices in the vehicle, infrared transparent areas ① and ③ are placed in the windshield.

You can see them from certain angles when ambient light condition permit.



Vehicles without Night View Assist

- ① Infrared transparent area (located left and right to the cover of the rain light sensor)
- ② Cover of the rain light sensor
- ③ Infrared transparent area



Vehicles with Night View Assist

- ① Infrared transparent area (located left to the cover of the rain light sensor)
- ② Cover of the rain light sensor
- ③ Infrared transparent area

Vehicle equipment 420
The first 1000 miles (1500 km) 420
At the gas station 421
Engine compartment 423
Tires and wheels 429
Winter driving 452
Driving instructions 454
Maintenance 460
Vehicle care 462



The first 1000 miles (1500 km)

Vehicle equipment

i This Operator's Manual describes all features, standard or optional, potentially available for your vehicle at the time of purchase. Please be aware that your vehicle might not be equipped with all features described in this manual.

The first 1000 miles (1500 km)

The more cautiously you treat your vehicle during the break-in period, the more satisfied you will be with its performance later on.

- Drive your vehicle during the first 1000 miles (1500 km) at varying but moderate vehicle and engine speeds.
- During this period, avoid heavy loads (full throttle driving) and excessive engine speeds (no more than $\frac{2}{3}$ of maximum rpm in each gear).
- Select **C** as the preferred shift program (▷ page 340) for the first 1000 miles (1500 km).
- Avoid accelerating by kickdown.
- Do not attempt to slow the vehicle down by shifting to a lower gear using the gear selector lever.
- Select gear ranges **3**, **2** or **1** (▷ page 340) only when driving at moderate speeds (for hill driving).

After 1000 miles (1500 km) you may gradually increase vehicle and engine speeds to the permissible maximum.

! Additional instructions for AMG vehicles:

- During the first 1000 miles (1500 km), do not exceed a speed of 85 mph (140 km/h).
- During this period, avoid engine speeds above 4500 rpm in each gear.
- Shift gears in a timely manner.

All of the above instructions, as may apply to your vehicle type, also apply when driving the first 1000 miles (1500 km) after the engine or the rear differential has been replaced.

i Always obey applicable speed limits.

At the gas station

At the gas station

Refueling

 **Warning!**

Gasoline is highly flammable and poisonous. It burns violently and can cause serious personal injury.

Never allow sparks, flames or smoking materials near gasoline!

Turn off the engine before refueling.

Whenever you are around gasoline, avoid inhaling fumes and any skin or clothing contact. Extinguish all smoking materials.

Direct skin contact with fuels and the inhalation of fuel vapors are damaging your health.

 **Warning!**

Overfilling of the fuel tank may create pressure in the system which could cause a gas discharge. This could cause the gas to spray back out when removing the fuel pump nozzle, which could cause personal injury.

 Never refuel vehicles with gasoline engine with diesel fuel. Even small amounts of diesel fuel will damage the fuel system and

engine. Damage resulting from the use of non-approved fuels or fuel additives or resulting from mixing gasoline with diesel fuel is not covered by the Mercedes-Benz Limited Warranty.

 If you have accidentally filled the tank with incorrect or non-approved fuel, do not switch on the ignition. Otherwise the incorrect or non-approved fuel will get into the fuel lines. The fuel system must be drained completely. Contact an authorized Mercedes-Benz Center to have the fuel system drained completely.

 To prevent damage to the catalytic converters, only use premium unleaded gasoline in this vehicle.

Any noticeable irregularities in engine operation should be repaired promptly. Otherwise, excessive unburned fuel may reach the catalytic converter, causing it to overheat and potentially start a fire.

 Only use premium unleaded gasoline with a minimum Posted Octane Rating of 91 (average of 96 RON/86 MON). Information on gasoline quality can normally be found on the fuel pump. Please

contact gas station personnel in case labels on the pump cannot be found.

For more information on gasoline, see “Premium unleaded gasoline” (▷ page 580), see “Fuel requirements” (▷ page 581), or contact an authorized Mercedes-Benz Center, or visit **www.mbusa.com** (USA only).

The fuel filler flap is located on the right-hand side of the vehicle towards the rear.

Locking/unlocking the vehicle with the SmartKey automatically locks/unlocks the fuel filler flap.

 In case the central locking system does not release the fuel filler flap, or the opening mechanism is clamping, contact Roadside Assistance or an authorized Mercedes-Benz Center.

At the gas station

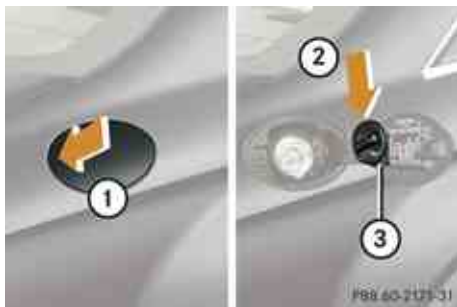

- ① Fuel filler flap
- ② Fuel filler cap
- ③ Holder

▶ Turn off the engine.

i Leaving the engine running and the fuel filler cap open can cause the yellow engine malfunction indicator lamp  to illuminate.

For more information, see also “Practical hints” (▷ page 536).

▶ Remove the SmartKey from the starter switch.

KEYLESS-GO: Open the driver’s door (this puts the starter switch in position **0**, same as with the SmartKey removed from the

starter switch). The driver’s door then can be closed again.

- ▶ **Opening:** Press fuel filler flap ① at the point indicated by the arrow.
- ▶ Turn fuel filler cap ② counterclockwise.
- ▶ Take off fuel filler cap ②.
- ▶ Place fuel filler cap ② in direction of arrow into holder ③.
- ▶ Fully insert filler nozzle unit and refuel.
- ▶ Only fill your tank until the filler nozzle unit cuts out – **do not top off or overfill.**
- ▶ **Closing:** Turn fuel filler cap ② clockwise until it audibly engages.

i Make sure to close the fuel filler flap before locking your vehicle as the flap locking pin prevents closing after you have locked the vehicle.

▶ Close fuel filler flap ①.

Check regularly and before a long trip

For information on quantities and requirements of operating agents, see “Fuels, coolants, lubricants, etc.” (▷ page 577).

Check the following:

- Engine oil level (▷ page 424)
- Tire inflation pressure (▷ page 437)
- Coolant level (▷ page 427)
- Vehicle lighting (▷ page 543)
- Washer system and headlamp cleaning system (▷ page 428)
- Brake fluid (▷ page 456), (▷ page 490), (▷ page 529)

Engine compartment

Engine compartment

Hood

⚠ Warning!

Do not pull the release lever while the vehicle is in motion. Otherwise the hood could be forced open by passing air flow. This could cause the hood to come loose and injure you and/or others.

Opening

⚠ Warning!

If you see flames or smoke coming from the engine compartment, or if the coolant temperature gauge indicates that the engine is overheated, do not open the hood. Move away from vehicle and do not open the hood until the engine has cooled. If necessary, call the fire department.

⚠ Warning!

You could be injured when the hood is open – even when the engine is turned off. Parts of the engine can become very hot. To prevent burns, let the engine cool off completely before touching any components on the vehicle. Comply with all relevant safety precautions.

⚠ Warning!

To help prevent personal injury, stay clear of moving parts when the hood is open and the engine is running.

The radiator fan may continue to run for approximately 30 seconds or may even restart after the engine has been turned off. Stay clear of fan blades.

⚠ Warning!

The engine is equipped with a transistorized ignition system. Because of the high voltage it is dangerous to touch any components (ignition coils, spark plug sockets, diagnostic socket) of the ignition system

- with the engine running
- while starting the engine
- when the ignition is switched on and the engine is turned manually



① Hood lock release lever

- ▶ Pull release lever ①.
The hood is unlocked.

! To avoid damage to the windshield wipers or hood, never open the hood if the wiper arms are folded forward away from the windshield.

Engine compartment



② Handle

- ▶ Push handle ② under the hood upwards.
- ▶ Pull up on the hood and then release it.
The hood will be automatically held open at shoulder height by gas-filled struts.

Closing

⚠ Warning!

When closing the hood, use extreme caution not to catch hands or fingers. Be careful that you do not close the hood on anyone.

Make sure the hood is securely engaged before driving off. Do not continue driving if the hood can no longer engage after an accident, for example. The hood could

otherwise come loose while the vehicle is in motion and injure you and/or others.

- ▶ Let the hood drop from a height of approximately 1 ft (30 cm).
- ▶ Check to make sure the hood is fully closed.

If you can raise the hood at a point above the headlamps, then it is not properly closed. Open it again and let it drop with somewhat greater force.

Engine oil

The amount of oil your engine needs will depend on a number of factors, including driving style. Increased oil consumption can occur when the vehicle is new or the vehicle is driven frequently at higher engine speeds. Engine oil consumption checks should only be made after the vehicle break-in period.

- ❗ Do not use any special lubricant additives, as these may damage the drive assemblies. Using special additives not approved by Mercedes-Benz may cause damage not covered by the Mercedes-Benz Limited Warranty.

For further information contact an authorized Mercedes-Benz Center.

Notes on checking engine oil level

When checking the oil level

- the vehicle must be parked on level ground
- with the engine at operating temperature, the vehicle must have been stationary for at least 5 minutes with the engine turned off
- with the engine not at operating temperature, the vehicle must have been stationary for at least 30 minutes with the engine turned off

Checking engine oil level with the oil dipstick

On the CL 550 4MATIC and CL 63 AMG, you can check the engine oil level with the oil dipstick.

- ▶ Open the hood (▷ page 423).

Engine compartment

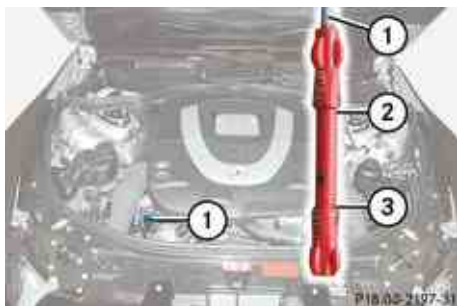

Example illustration CL 550 4MATIC

① Oil dipstick

② Upper (max) mark

③ Lower (min) mark

- ▶ Pull out oil dipstick ①.
- ▶ Wipe oil dipstick ① clean.
- ▶ Fully insert oil dipstick ① into the dipstick guide tube.
- ▶ Pull out oil dipstick ① again after approximately 3 seconds to obtain accurate reading.
The oil level is correct when it is between lower (min) mark ③ and upper (max) mark ② of oil dipstick ①.

i CL 550 4MATIC only:

The filling quantity between the upper and lower marks on the oil dipstick is approximately 2.1 US qt. (2.0 l).

- 1** AMG vehicles only:
The filling quantity between the upper and lower marks on the oil dipstick is approximately 1.6 US qt. (1.5 l).

▶ If necessary, add engine oil.

For more information on engine oil, see “Fuels, coolants, lubricants etc.” (▷ page 577).

For information on messages in the multifunction display concerning engine oil, see the “Practical hints” section (▷ page 516).

Checking engine oil level with the control system

On the CL 600 and CL 65 AMG, you can check the engine oil level with the control system.

- 1** The menu overview can be found on (▷ page 234).
- ▶ Switch on the ignition.
- ▶ Press ◀ or ▶ to select the Service menu.

- ▶ Press ▲ or ▼ to select Engine Oil Level.
- ▶ Press OK.

The following message appears in the multifunction display:

```
Measuring
Engine Oil Level
Accurate Only
When Vehicle Is Level
```

One of the following messages will subsequently appear in the multifunction display:

- Engine Oil Level OK
- Add 1.0 qts. Engine Oil At Next Refueling (Canada: 1.0 l)
- Add 1.5 qts. Engine Oil At Next Refueling (Canada: 1.5 l)
- Add 2.0 qts. Engine Oil At Next Refueling (Canada: 2.0 l)

- 1** If you want to interrupt the checking procedure, press button ↵ on the multifunction steering wheel.

Engine compartment

- ▶ If necessary, add engine oil.

For more information on engine oil, see “Fuels, coolants, lubricants etc.” (> page 577).

Other display messages

If the ignition is not switched on, the following message appears in the multifunction display:

For Engine Oil Level
Ignition Must be On

- ▶ Switch on the ignition.

If you see the message:

Need More Time
to Check
Engine Oil Level

- ▶ If the engine is at operating temperature, wait 5 minutes before repeating check procedure.
- ▶ If the engine is not at operating temperature yet, you must wait 30 minutes before checking oil.

If you see the message:

Engine Oil Level
Not Measurable
With Running Engine

- ▶ Turn off the engine.
- ▶ If the engine is at operating temperature, wait 5 minutes before checking oil.
- ▶ If the engine is not at operating temperature yet, you must wait 30 minutes before checking oil.

If there is excess engine oil with the engine at normal operating temperature, the following message appears in the multifunction display:

Reduce
Engine Oil Level

- ▶ Have excess oil siphoned or drained off. Contact an authorized Mercedes-Benz Center.

! Excess oil must be siphoned or drained off. It could cause damage to the engine and emission control system not covered by the Mercedes-Benz Limited Warranty.

For information on messages in the multifunction display concerning engine oil, see the “Practical hints” section (> page 516).

Adding engine oil

! Only use approved engine oils and oil filters required for vehicles with

Maintenance System. For a listing of approved engine oils and oil filters, contact an authorized Mercedes-Benz Center or visit **www.mbusa.com** (USA only).

Using engine oils and oil filters of specification other than those expressly required for the Maintenance System, or changing of oil and oil filter at change intervals longer than those called for by the Maintenance System will result in engine or emission control system damage not covered by the Mercedes-Benz Limited Warranty.



Example illustration CL 550 4MATIC

- ① Filler cap

Engine compartment



CL 63 AMG

① Filler cap

- ▶ Unscrew filler cap ① from filler neck.
- ▶ Add engine oil as required. Be careful not to overfill with oil.

Be careful not to spill any oil when adding. Avoid environmental damage caused by oil entering the ground or water.

! Excess oil must be siphoned or drained off. It could cause damage to the engine and emission control system not covered by the Mercedes-Benz Limited Warranty.

- ▶ Screw filler cap ① back on filler neck.

For more information on engine oil, see the “Technical data” section (▶ page 577) and (▶ page 579).

Transmission fluid level

The transmission fluid level does not need to be checked. If you notice transmission fluid loss or gearshifting malfunctions, have an authorized Mercedes-Benz Center check the transmission.

Active Body Control (ABC) fluid level

Regular fluid level check is not required. If you notice fluid leaks or malfunction messages in the multifunction display, have an authorized Mercedes-Benz Center check the ABC system.

Coolant level

The engine coolant is a mixture of water and anticorrosion/antifreeze.

When checking the coolant level, the vehicle must be parked on level ground, and the coolant temperature must be below 158°F (70°C).

⚠ Warning!

In order to avoid any potentially serious burns:

- Use extreme caution when opening the hood if there are any signs of steam or coolant leaking from the cooling system, or if the coolant temperature gauge indicates that the coolant is overheated.
- Do not remove pressure cap on coolant reservoir if coolant temperature is above 158°F (70°C). Allow engine to cool down before removing cap. The coolant reservoir contains hot fluid and is under pressure.
- Using a rag, slowly open the cap approximately $\frac{1}{2}$ turn to relieve excess pressure. If opened immediately,

Engine compartment

scalding hot fluid and steam will be blown out under pressure.

- Do not spill antifreeze on hot engine parts. Antifreeze contains ethylene glycol which may burn if it comes into contact with hot engine parts.



CL 550 4MATIC (example illustration)

- ① Cap
- ② Coolant expansion tank
- ③ Marking bar in the expansion tank

- ▶ Using a rag, turn cap ① slowly approximately $1/2$ turn counterclockwise to release any excess pressure.
- ▶ Continue turning cap ① counterclockwise and remove it.

The coolant level is correct if the level

- for cold coolant: reaches marking bar ③ in coolant expansion tank ②
- for warm coolant: is approximately 0.6 in (1.5 cm) higher

- ▶ Add coolant as required.
- ▶ Replace and tighten cap ①.

For more information on coolant, see the “Technical data” section (▶ page 578) and (▶ page 582).

Washer system and headlamp cleaning system

⚠ Warning!

Washer solvent/antifreeze is highly flammable. Do not spill washer solvent/antifreeze on hot engine parts, because it may ignite and burn. You could be seriously burned.

- ❗ Always use washer solvent/antifreeze where temperatures may fall below freezing point. Failure to do so could result in damage to the washer system/fluid reservoir.

- ❗ Only use washer fluid which is suitable for plastic lenses. Improper washer fluid can damage the plastic lenses of the headlamps.

- ❗ Do not use distilled or deionized water in the washer fluid reservoir. Otherwise, the washer fluid level sensor could be damaged.



- ① Cap for washer fluid reservoir

Fluid for the washer system and the headlamp cleaning system is supplied from the washer fluid reservoir.

During all seasons, add MB Windshield Washer Concentrate “MB SummerFit” to water. Premix the washer fluid in a suitable container.

Tires and wheels

- ▶ **Opening washer fluid reservoir:** Pull tab of cap ① upwards.
- ▶ Refill the washer fluid reservoir with MB Windshield Washer Concentrate “MB SummerFit” and water (or commercially available premixed washer solvent/antifreeze, depending on ambient temperatures) (▷ page 583).
- ▶ **Closing washer fluid reservoir:** Press cap ① onto filler hole until it engages.

For more information, see “Washer system and headlamp cleaning system” (▷ page 579).

Tires and wheels

Safety notes

Contact an authorized Mercedes-Benz Center for information on tested and recommended rims and tires for summer and winter operation. They can also offer advice concerning tire service and purchase.

 **Warning!**

Replace rims or tires with the same designation, manufacturer and type as shown on the original part. For further information contact an authorized Mercedes-Benz Center. If incorrectly sized rims and tires are mounted, the wheel brakes or suspension components can be damaged. Also, the correct operating clearance of the wheels and the tires may no longer be correct.

 **Warning!**

Worn, old tires can cause accidents. If the tire tread is worn to minimum tread depth, or if the tires have sustained damage, replace them.

When replacing rims, only use genuine Mercedes-Benz wheel bolts specified for the particular rim type. Failure to do so can

result in the bolts loosening and possibly an accident.

Retreaded tires are not tested or recommended by Mercedes-Benz, since previous damage cannot always be recognized on retreads. The operating safety of the vehicle cannot be assured when such tires are used.

 **Warning!**

If you feel a sudden significant vibration or ride disturbance, or you suspect that possible damage to your vehicle has occurred, you should turn on the hazard warning flashers, carefully slow down, and drive with caution to an area which is a safe distance from the road.

Inspect the tires and the vehicle underbody for possible damage. If the vehicle or tires appear unsafe, have the vehicle towed to the nearest authorized Mercedes-Benz Center or tire dealer for repairs.

 **Warning!**

Do not drive with a flat tire. A flat tire affects the ability to steer or brake the vehicle. You could lose control of the vehicle. Continued driving with a flat tire or driving at high



Tires and wheels

speed with a flat tire will cause excessive heat build-up and possibly a fire.

Important guidelines

- Only use sets of tires and rims of the same type and make.
- Tires must be of the correct size for the rim.
- Break in new tires for approximately 60 miles (100 km) at moderate speeds.
- Regularly check the tires and rims for damage. Dented or bent rims can cause tire inflation pressure loss and damage to the tire beads.
- If vehicle is heavily loaded, check tire inflation pressure and correct as required.
- Do not allow your tires to wear down too far. Adhesion properties on wet roads are sharply reduced at tread depths of less than $\frac{1}{8}$ in (3 mm).
- When replacing individual tires, you should mount new tires on the front wheels first (on vehicles with same-sized wheels all around).

Tire care and maintenance

Warning!

Regularly check the tires for damage. Damaged tires can cause tire inflation pressure loss. As a result, you could lose control of your vehicle.

Worn, old tires can cause accidents. If the tire tread is worn to minimum tread depth, or if the tires have sustained damage, replace them.

Check the tire inflation pressure at least every other week. For more information on checking tire inflation pressure, see “Recommended tire inflation pressure” (> page 435).

Tire inspection

Every time you check the tire inflation pressure, you should also inspect your tires for the following:

- excessive treadwear (> page 430)
- cord or fabric showing through the tire’s rubber
- bumps, bulges, cuts, cracks or splits in the tread or side of the tire

Replace the tire if you find any of the above conditions.

Make sure you also inspect the spare tire periodically for condition and inflation. Spare tires will age and become worn over time even if never used, and thus should be inspected and replaced when necessary.

Life of tire

Warning!

Tires and spare tire should be replaced after 6 years, regardless of the remaining tread.

The service life of a tire is dependent upon varying factors including but not limited to:

- Driving style
- Tire inflation pressure
- Distance driven

Tread depth

Warning!

Although the applicable federal motor vehicle safety laws consider a tire to be worn when the treadwear indicators (TWI) become visible at approximately $\frac{1}{16}$ in

Tires and wheels

(1.6 mm), we recommend that you do not allow your tires to wear down to that level. As tread depth approaches $\frac{1}{8}$ in (3 mm), the adhesion properties on a wet road are sharply reduced.

Depending upon the weather and/or road surface (conditions), the tire traction varies widely.

Do not allow your tires to wear down too far. Adhesion properties on wet roads are sharply reduced at tread depths of less than $\frac{1}{8}$ in (3 mm).

Treadwear indicators (TWI) are required by law. These indicators are located in six places on the tread circumference and become visible at a tread depth of approximately $\frac{1}{16}$ in (1.6 mm), at which point the tire is considered worn and should be replaced. The recommended minimum tire tread depth for summer tires is $\frac{1}{8}$ in (3 mm). The recommended minimum tire tread depth for winter tires is $\frac{1}{6}$ in (4 mm).

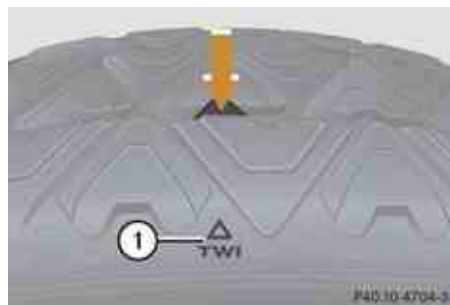

① TWI (Tread Wear Indicator)

The treadwear indicator appears as a solid band across the tread.

Storing tires

- ⚠ Keep unmounted tires in a cool, dry place with as little exposure to light as possible. Protect tires from contact with oil, grease and fuels.

Cleaning tires

- ⚠ Never use a round nozzle to power wash tires. The intense jet of water can result in damage to the tire. Always replace a damaged tire.

Direction of rotation

Unidirectional tires offer added advantages, such as better hydroplaning performance. To benefit, however, you must make sure the tires rotate in the direction specified.

An arrow on the sidewall indicates the intended direction of rotation (spinning) of the tire.

Spare wheels may be mounted against the direction of rotation (spinning) even with a unidirectional tire for temporary use only until the regular drive wheel has been repaired or replaced. Always observe and follow applicable temporary use restrictions and speed limitations indicated on the spare wheel.

Tires and wheels

Loading the vehicle

Two labels on your vehicle show how much weight it may properly carry.

(1) The Tire and Loading Information placard can be found on the driver's door B-pillar. This placard tells you important information about the number of people that can be in the vehicle and the total weight that can be carried in the vehicle. It also contains information on the proper size and recommended tire inflation pressures for the original equipment tires on your vehicle.

(2) The certification label, also found on the driver's door B-pillar. It tells you about the gross weight capacity of your vehicle, called the Gross Vehicle Weight Rating (GVWR). The GVWR includes the weight of the vehicle, all occupants, fuel and cargo. The certification label also tells you about the front and rear axle weight capacity, called the Gross Axle Weight Rating (GAWR).

The GAWR is the total allowable weight that can be carried by a single axle (front or rear). Never exceed the GVWR or GAWR for either the front axle or rear axle.



① Driver's door B-pillar

Following is a discussion on how to work with the information contained on the Tire and Loading Information placard with regards to loading your vehicle.

Tire and Loading Information

⚠ Warning!

Do not overload the tires by exceeding the specified load limit as indicated on the Tire and Loading Information placard on the driver's door B-pillar. Overloading the tires can overheat them, possibly causing a blowout. Overloading the tires can also result in handling or steering problems, or brake failure.

Tire and Loading Information placard

① Data shown on Tire and Loading Information placard example are for illustration purposes only. Load limit data are specific to each vehicle and may vary from data shown in the following illustration. Refer to Tire and Loading Information placard on vehicle for actual data specific to your vehicle.

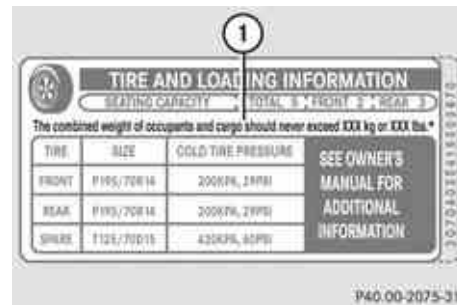

① Load limit information on the Tire and Loading Information placard

The Tire and Loading Information placard showing the load limit information is located on the driver's door B-pillar (▷ page 432).

► Locate the statement "The combined weight of occupants and cargo should never exceed XXX kilograms or XXX lbs."

Tires and wheels

on the Tire and Loading Information placard.

The combined weight of all occupants, cargo/luggage and trailer tongue load (if applicable) should never exceed the weight referenced in that statement.

Seating capacity

The seating capacity gives you important information on the number of occupants that can be in the vehicle. Observe front and rear seating capacity. The Tire and Loading Information placard showing the seating capacity is located on the driver's door B-pillar (▷ page 432).

i Data shown on Tire and Loading Information placard example are for illustration purposes only. Seating capacity data are specific to each vehicle and may vary from data shown in the following illustration. Refer to Tire and Loading Information placard on vehicle for actual data specific to your vehicle.

The image shows a 'TIRE AND LOADING INFORMATION' placard. At the top, it says 'SEATING CAPACITY' with a circled '1' above it. Below that, it says 'TOTAL WEIGHT' and 'GROSS WEIGHT'. The placard contains a table with the following data:

TIRE	SIZE	COLD TIRE PRESSURE
FRONT	P195/70R14	200KPa, 29PSI
REAR	P195/70R14	200KPa, 29PSI
SHOCK	T125/70D15	420KPa, 60PSI

Below the table, it says 'SEE OWNER'S MANUAL FOR ADDITIONAL INFORMATION'. At the bottom right, it says '740-00-2076-31'.

① Seating capacity information on the Tire and Loading Information placard

Steps for determining correct load limit

The following steps have been developed as required of all manufacturers under Title 49, Code of U.S. Federal Regulations, Part 575 pursuant to the “National Traffic and Motor Vehicle Safety Act of 1966”.

- ▶ **Step 1:** Locate the statement “The combined weight of occupants and cargo should never exceed XXX kg or XXX lbs.” on your vehicle’s Tire and Loading Information placard.
- ▶ **Step 2:** Determine the combined weight of the driver and passengers that will be riding in your vehicle.

- ▶ **Step 3:** Subtract the combined weight of the driver and passengers from XXX kilograms or XXX lbs.
- ▶ **Step 4:** The resulting figure equals the available amount of cargo and luggage load capacity. For example, if the “XXX” amount equals 1400 lbs and there will be five 150 lbs passengers in your vehicle, the amount of available cargo and luggage load capacity is 650 lbs (1400 - 750 (5 x 150) = 650 lbs).
- ▶ **Step 5:** Determine the combined weight of luggage and cargo being loaded on the vehicle. That weight may not safely exceed the available cargo and luggage load capacity calculated in step 4.
- ▶ **Step 6 (if applicable):** If your vehicle will be towing a trailer, load from your trailer will be transferred to your vehicle. Consult this manual to determine how this reduces the available cargo and luggage load capacity of your vehicle (▷ page 435).

The following table shows examples on how to calculate total and cargo load capacities with varying seating configurations and number and size of occupants. The following examples use a load limit of 1500 lbs. **This is for illustration purposes only.** Make sure you are using the actual load limit for your



Tires and wheels

vehicle stated on the vehicle's Tire and Loading Information placard (▷ page 433).

Example	Combined weight limit of occupants and cargo from Tire and Loading Information placard	Number of occupants (driver and passengers)	Seating configuration	Occupants weight	Combined weight of all occupants	Available cargo/luggage and trailer tongue weight (total load limit from Tire and Loading Information placard minus combined weight of all occupants)
1	1 500 lbs	5	front: 2 rear: 3	Occupant 1: 150 lbs Occupant 2: 180 lbs Occupant 3: 160 lbs Occupant 4: 140 lbs Occupant 5: 120 lbs	750 lbs	1 500 lbs - 750 lbs = 750 lbs
2	1 500 lbs	3	front: 1 rear: 2	Occupant 1: 200 lbs Occupant 2: 190 lbs Occupant 3: 150 lbs	540 lbs	1 500 lbs - 540 lbs = 960 lbs
3	1 500 lbs	1	front: 1	Occupant 1: 150 lbs	150 lbs	1 500 lbs - 150 lbs = 1 350 lbs

The higher the weight of all occupants, the less cargo and luggage load capacity is available.

For more information, see “Trailer tongue load” (▷ page 435).

Certification label

Even after careful determination of the combined weight of all occupants, cargo and the trailer tongue load (if applicable) (▷ page 435) as to not exceed the permissible load limit, you must make sure your vehicle never exceeds the Gross Vehicle Weight Rating (GVWR) and the Gross Axle Weight Rating (GAWR) for either the front or

rear axle. You can obtain the GVWR and GAWR from the certification label. The certification label can be found on the driver's door B-pillar, see the “Technical data” section (▷ page 565).

Gross Vehicle Weight Rating (GVWR): The total weight of the vehicle, all occupants, all cargo, and the trailer tongue load (if applicable) must never exceed the GVWR.

Tires and wheels

Gross Axle Weight Rating (GAWR): The total allowable weight that can be carried by a single axle (front or rear).

To assure that your vehicle does not exceed the maximum permissible weight limits (GVWR and GAWR for front and rear axle), have the loaded vehicle (including driver, passengers and all cargo and, if applicable, trailer fully loaded) weighed on a suitable commercial scale.

Trailer tongue load

The tongue load of any trailer is an important weight to measure because it affects the load you can carry in your vehicle. If a trailer is towed, the tongue load must be added to the weight of all occupants riding and any cargo you are carrying in the vehicle. The tongue load typically is 10% of the trailer weight and everything loaded in it.

Your Mercedes-Benz has been designed primarily to carry passengers and their cargo. Mercedes-Benz does not recommend trailer towing with your vehicle.

Recommended tire inflation pressure

Warning!

Follow recommended tire inflation pressures.

Do not underinflate tires. Underinflated tires wear excessively and/or unevenly, adversely affect handling and fuel economy, and are more likely to fail from being overheated.

Do not overinflate tires. Overinflated tires can adversely affect handling and ride comfort, wear unevenly, increase stopping distance, and result in sudden deflation (blowout) because they are more likely to become punctured or damaged by road debris, potholes etc.

Do not overload the tires by exceeding the specified load limit as indicated on the Tire and Loading Information placard on the driver's door B-pillar. Overloading the tires can overheat them, possibly causing a blowout. Overloading the tires can also result in handling or steering problems, or brake failure.

Your vehicle is equipped with the Tire and Loading Information placard located on the driver's door B-pillar (▷ page 432).

The tire inflation pressure should be checked regularly and should only be adjusted on cold tires. The tires can be considered cold if the vehicle has been parked for at least 3 hours or driven less than 1 mile (1.6 km).

Follow recommended cold tire inflation pressures listed on Tire and Loading Information placard on the driver's door B-pillar.

Keeping the tires properly inflated provides the best handling, tread life and riding comfort.

In addition to the Tire and Loading Information placard on the driver's door B-pillar, also consult the tire inflation pressure label (if available) on the inside of the filler flap for any additional information pertaining to special driving situations. For more information, see "Important notes on tire inflation pressure" (▷ page 436).

 Data shown on Tire and Loading Information placard example are for illustration purposes only. Tire data are specific to each vehicle and may vary from data shown in the following illustration. Refer to Tire and Loading Information placard on vehicle for actual data specific to your vehicle.

Tires and wheels

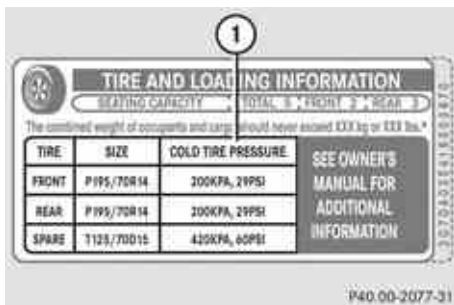

- ① Tire and Loading Information placard with recommended cold tire inflation pressures

The Tire and Loading Information placard lists the recommended cold tire inflation pressures for maximum loaded vehicle weight. The tire inflation pressures listed apply to the tires installed as original equipment.

Important notes on tire inflation pressure

Warning!

If the tire inflation pressure drops repeatedly, check the tires for punctures from foreign objects and/or whether air is

leaking from the valves or from around the rim.

Tire temperature and tire inflation pressure are also increased while driving, depending on the driving speed and the tire load.

If you will be driving your vehicle at high speeds of 100 mph (160 km/h) or higher, where it is legal and conditions allow, consult the tire inflation pressure label on the inside of the fuel filler flap (if available) on how to adjust the cold tire inflation pressure. If you do not adjust the tire inflation pressure, excessive heat can build up and result in sudden tire failure.

If your vehicle is not equipped with the tire inflation pressure label on the inside of the fuel filler flap, contact an authorized Mercedes-Benz Center for proper tire inflation pressure.

- ① Driving comfort may be reduced when the tire inflation pressure is adjusted to the value for speeds above 100 mph (160 km/h) as specified on the tire inflation pressure label located on the inside of the fuel filler flap.

Make sure to readjust the tire inflation pressure for normal driving speeds. You

should wait until the tires are cold before adjusting the tire inflation pressure.

Some vehicles may have supplemental tire inflation pressure information for vehicle loads less than the maximum loaded vehicle condition. If such information is provided, it can be found on the tire inflation pressure label located on the inside of the fuel filler flap.

Tire inflation pressure changes by approximately 1.5 psi (0.1 bar) per 18°F (10°C) of air temperature change. Keep this in mind when checking tire inflation pressure where the temperature is different from the outside temperature.

Potential problems associated with underinflated and overinflated tires

Underinflated tires

Warning!

Follow recommended tire inflation pressures.

Do not underinflate tires. Underinflated tires wear excessively and/or unevenly, adversely affect handling and fuel economy, and are more likely to fail from being overheated.

Tires and wheels

Underinflated tires can

- cause excessive and uneven tire wear
- adversely affect fuel economy
- lead to tire failure from being overheated
- adversely affect handling characteristics

Overinflated tires

Warning!

Follow recommended tire inflation pressures.

Do not overinflate tires. Overinflated tires can adversely affect handling and ride comfort, wear unevenly, increase stopping distance, and result in sudden deflation (blowout) because they are more likely to become punctured or damaged by road debris, potholes etc.

Overinflated tires can

- adversely affect handling characteristics
- cause uneven tire wear
- be more prone to damage from road hazards
- adversely affect ride comfort
- increase stopping distance

Checking tire inflation pressure

Safety notes

Warning!

Follow recommended tire inflation pressures.

Do not underinflate tires. Underinflated tires wear excessively and/or unevenly, adversely affect handling and fuel economy, and are more likely to fail from being overheated.

Do not overinflate tires. Overinflated tires can adversely affect handling and ride comfort, wear unevenly, increase stopping distance, and result in sudden deflation (blowout) because they are more likely to become punctured or damaged by road debris, potholes etc.

Do not overload the tires by exceeding the specified load limit as indicated on the Tire and Loading Information placard on the driver's door B-pillar. Overloading the tires can overheat them, possibly causing a blowout. Overloading the tires can also result in handling or steering problems, or brake failure.

Check the tire inflation pressure at least every other week.

Check and adjust the tire inflation pressure when the tires are cold. The tires can be considered cold if the vehicle has been parked for at least 3 hours or driven less than 1 mile (1.6 km).

If you check the tire inflation pressure when the tires are warm (the vehicle has been driven for several miles or sitting less than 3 hours), the reading will be approximately 4 psi (0.3 bar) higher than the cold reading. This is normal. Do not let air out to match the specified cold tire inflation pressure. Otherwise, the tire will be underinflated.

Checking tire inflation pressure manually

Follow the steps below to achieve correct tire inflation pressure:

- ▶ Remove the cap from the valve on one tire.
- ▶ Firmly press a tire gauge onto the valve.
- ▶ Read the tire inflation pressure on the tire gauge and check against the recommended tire inflation pressure on the Tire and Loading Information placard on the driver's door B-pillar (▷ page 432). If necessary, add air to achieve the recommended tire inflation pressure.
- ▶ If you have overfilled the tire, release tire inflation pressure by pushing the metal



Tires and wheels

stem of the valve with e.g. a tip of a pen. Then recheck the tire inflation pressure with the tire gauge.

- ▶ Install the valve cap.
- ▶ Repeat this procedure for each tire.

Advanced Tire Pressure Monitoring System (Advanced TPMS)

Your vehicle is equipped with the Advanced Tire Pressure Monitoring System (Advanced TPMS). It measures the tire inflation pressure in the vehicle's tires and issue warnings in case of pressure loss in one or more of the tires.

The TPMS is equipped with a combination low tire pressure/ TPMS malfunction telltale (USA) or a low tire pressure telltale (Canada) in the instrument cluster. Depending on how the telltale illuminates, it indicates a low tire pressure condition or a malfunction in the TPMS system itself:

- If the telltale illuminates continuously, one or more of your tires is significantly underinflated. There is no malfunction in the TPMS.
- USA only: If the telltale flashes for 60 seconds and then stays illuminated, the

TPMS system itself is not operating properly.

The TPMS only functions on wheels that are equipped with the proper electronic sensors.

Warning!

The TPMS does not indicate a warning for wrongly selected inflation pressures. Always adjust tire inflation pressure according to the Tire and Loading Information placard or, if available, on the supplemental tire inflation pressure information on the inside of the fuel filler flap.

The TPMS is not able to issue a warning due to a sudden dramatic loss of pressure (e.g. tire blowout caused by a foreign object). In this case bring the vehicle to a halt by carefully applying the brakes and avoiding abrupt steering maneuvers.

Warning!

Each tire, including the spare (if provided), should be checked every other week when cold and inflated to the inflation pressure recommended by the vehicle manufacturer on the Tire and Loading Information placard on the driver's door B-pillar or, if available, the tire inflation pressure label on the inside

of the fuel filler flap. If your vehicle has tires of a different size than the size indicated on the vehicle placard or the tire inflation pressure label, you should determine the proper tire inflation pressure for those tires.

As an added safety feature, your vehicle has been equipped with a tire pressure monitoring system (TPMS) that illuminates a low tire pressure telltale when one or more of your tires are significantly underinflated. Accordingly, when the low tire pressure telltale illuminates, you should stop and check your tires as soon as possible, and inflate them to the proper pressure. Driving on a significantly underinflated tire causes the tire to overheat and can lead to tire failure.

Underinflation also reduces fuel efficiency and tire tread life, and may affect the vehicle's handling and stopping ability. Please note that the TPMS is not a substitute for proper tire maintenance, and it is the driver's responsibility to maintain correct tire pressure, even if underinflation has not reached the level to trigger illumination of the TPMS low tire pressure telltale.

USA only:

Tires and wheels

Your vehicle has also been equipped with a TPMS malfunction indicator to indicate when the system is not operating properly. The TPMS malfunction indicator is combined with the low tire pressure telltale. When the system detects a malfunction, the telltale will flash for approximately 1 minute and then remain continuously illuminated. This sequence will continue upon subsequent vehicle start-ups as long as the malfunction exists. When the malfunction indicator is illuminated, the system may not be able to detect or signal low tire pressure as intended.

TPMS malfunctions may occur for a variety of reasons, including the installation of replacement or alternate tires or wheels on the vehicle that prevent the TPMS from functioning properly. Always check the TPMS malfunction telltale after replacing one or more tires or wheels on your vehicle to ensure that the replacement or alternate tires and wheels allow the TPMS to continue to function properly.

i USA only:

If a condition causing the TPMS to malfunction develops, it may take up to

10 minutes for the system to signal a malfunction using the TPMS telltale flashing and illumination sequence.

The telltale extinguishes after a few minutes driving if the malfunction has been corrected.

Tire pressure inquiries are made using the multifunction display. The current tire inflation pressure for each tire appears in the multifunction display after a few minutes of driving.

- i** Possible differences between the readings of a tire pressure gauge of an air hose, e.g. gas station equipment, and the vehicle's control system can occur. The tire pressure displayed by the control system apply to sea level. In high-altitude locations, the reading on a tire pressure gauge will be higher than the reading issued by the vehicle's control system. Do not reduce the tire inflation pressure under such circumstances.
- ▶ Switch on the ignition.
- ▶ Press button **◀** or **▶** on the multifunction steering wheel to select the Service menu (▶ page 245).

▶ Press button **▲** or **▼** to select Tire Press..

▶ Press button **OK**.

The current inflation pressure for each tire appears in the multifunction display.



When the vehicle has been parked for longer than 20 minutes, the message Tire Pressure Displayed After Driving A Few Minutes appears in the multifunction display.

i With a spare wheel mounted, the system may still indicate the tire inflation pressure of the removed road wheel for some minutes. If this happens, keep in mind that the indicated value where the spare wheel is mounted does not reflect the actual spare tire inflation pressure.

i Operating radio transmission equipment (e.g. wireless headsets, two-way radios) in



Tires and wheels

or near the vehicle could cause the TPMS to malfunction.

i USA only:

This device complies with Part 15 of the FCC Rules. Operation is subject to the following two conditions:

1. This device may not cause harmful interference, and
2. this device must accept any interference received, including interference that may cause undesired.

Any unauthorized modification to this device could void the user's authority to operate the equipment.

i Canada only:

This device complies with RSS-210 of Industry Canada. Operation is subject to the following two conditions:

1. This device may not cause interference, and
2. this device must accept any interference received, including interference that may cause undesired operation of the device.

Any unauthorized modification to this device could void the user's authority to operate the equipment.

Tire inflation pressure warnings

If the system detects a significant loss of tire inflation pressure in one or more than one tire, a message appears in the multifunction display. In addition, an acoustic warning sounds and the low tire pressure telltale in the instrument cluster comes on.



Example illustration

The respective tire and the corresponding tire inflation pressure are indicated in yellow.

Restarting Advanced TPMS

⚠ Warning!

It is the driver's responsibility to set the tire inflation pressure to the recommended cold tire inflation pressure. Underinflated tires affect the ability to steer or brake the

vehicle. You might lose control over the vehicle.

When you restart the TPMS, the system sets new reference values for each tire.





The TPMS must be restarted when you have adjusted the tire inflation pressure to a new level (e.g. because of different load or driving conditions). The TPMS is then recalibrated to the current tire inflation pressures.

i Canada only:

The TPMS usually recognizes tire pressure adjustments and sets new reference values automatically. You can, however, restart the TPMS manually as described.

Restart the TPMS after adjusting the tire inflation pressure to the inflation pressure recommended for the vehicle operating condition. Tire pressure should only be adjusted on cold tires. Observe the recommended tire inflation pressure on the Tire and Loading Information placard on the driver's door B-pillar. Some vehicles may have supplemental tire pressure information for driving at high speeds or for vehicle loads less than the maximum loaded vehicle condition. If such information is provided, it can be found on the inside of the fuel filler flap.

Tires and wheels

- ▶ Using the Tire and Loading Information placard on the driver's door B-pillar (▷ page 432) or, if available, the supplemental tire inflation pressure information on the inside of the fuel filler flap, make sure the tire inflation pressure of all four tires is correct.
- ▶ Switch on the ignition.
- ▶ Press button  or  on the multifunction steering wheel to select the Service menu.
- ▶ Press button  or  on the multifunction steering wheel to select Tire Press..
- ▶ Press button .

The current inflation pressure for each tire appears in the multifunction display or the following message appears in the multifunction display:

Tire Pressure
Displayed After Driving
A Few Minutes
- ▶ Press button .

The following message appears in the multifunction display:

Use Current
Pressures As New
Reference Values

Press 'OK' to Confirm

- ▶ Press button .

The following message appears in the multifunction display:

Tire Pressure Monitor
Reactivated

After driving a few minutes the system verifies that the current tire inflation pressures are within the system's specified range. Afterwards the current tire inflation pressures are accepted as reference values and then monitored.
 - ▶ **If you wish to cancel:** Press button .

▶

or
 - ▶ Press button  to exit the menu screen.
- i** When the wheel positions have been changed, the air pressure of a tire may be displayed for the wrong position temporarily. After driving for a few minutes, the air pressure will be shown for the correct position.
- i** With a spare wheel mounted, the system may still indicate the tire inflation pressure of the removed road wheel for some minutes. If this happens, keep in mind that

the indicated value where the spare wheel is mounted does not reflect the actual spare tire inflation pressure.

Tire labeling

Besides tire name (sales designation) and manufacturer name, a number of markings can be found on a tire.

Following are some explanations for the markings on your vehicle's tires:

Tires and wheels

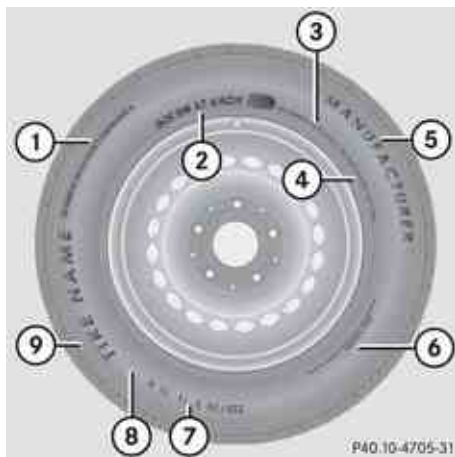

- ① Uniform Tire Quality Grading Standards (▷ page 447)
- ② DOT, Tire Identification Number (▷ page 445)
- ③ Maximum tire load (▷ page 446)
- ④ Maximum tire inflation pressure (▷ page 446)
- ⑤ Manufacturer
- ⑥ Tire ply material (▷ page 448)
- ⑦ Tire size designation, load and speed rating (▷ page 442)
- ⑧ Load identification (▷ page 445)
- ⑨ Tire name

① For illustration purposes only. Actual data on tires are specific to each vehicle and may vary from data shown in above illustration.

For more information, see “Rims and tires” (▷ page 569).

Tire size designation, load and speed rating

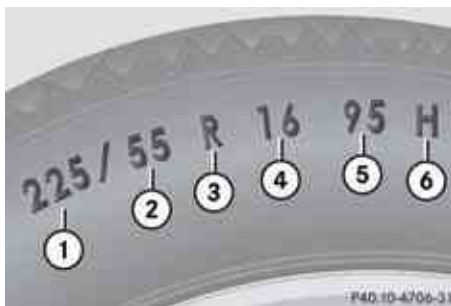

- ① Tire width
- ② Aspect ratio in %
- ③ Radial tire code
- ④ Rim diameter
- ⑤ Tire load rating
- ⑥ Tire speed rating

① For illustration purposes only. Actual data on tires are specific to each vehicle and may vary from data shown in above illustration.

General: Depending on the design standards used, the tire size molded into the sidewall may have no letter or a letter preceding the tire size designation.

No letter preceding the size designation (as illustrated above): Passenger car tire based on European design standards.

Letter “P” preceding the size designation: Passenger car tire based on U.S. design standards.

Letter “LT” preceding the size designation: Light Truck tire based on U.S. design standards.

Letter “T” preceding the size designation: Temporary spare tires which are high pressure compact spares designed for temporary emergency use only.

Tire width

Tire width ① indicates the nominal tire width in millimeters.

Aspect ratio

Aspect ratio ② is the dimensional relationship between tire section height and section width and is expressed in percentage. The aspect ratio is arrived at by dividing section height by section width.

Tire code

Tire code ③ indicates the tire construction type. The “R” stands for radial tire type. Letter “D” means diagonal or bias ply construction; letter “B” means belted-bias ply construction. At the tire manufacturer’s option, any tire with a speed capability above 149 mph (240 km/h) can include a “ZR” in the size designation (for example: 245/40 ZR 18). For additional information, see “Tire speed rating” (▷ page 443).

Rim diameter

Rim diameter ④ is the diameter of the bead seat, not the diameter of the rim edge. The rim diameter is indicated in inches (in).

Tire load rating

Warning!

The tire load rating must always be at least half of the GAWR of your vehicle. Otherwise, tire failure may be the result

which may cause an accident and/or serious injury to you or others.

Always replace rims and tires with the same designation, manufacturer and type as shown on the original part.

Warning!

Do not overload the tires by exceeding the specified load limit as indicated on the Tire and Loading Information placard on the driver’s door B-pillar. Overloading the tires can overheat them, possibly causing a blowout. Overloading the tires can also result in handling or steering problems, or brake failure.

Tire load rating ⑤ is a numerical code associated with the maximum load a tire can support.

For example, a load rating of 91 corresponds to a maximum load of 1356 lb (615 kg) the tire is designed to support. See also “Maximum tire load” (▷ page 446) where the maximum load associated with the load index is indicated in kilograms and lbs.

For additional information on tire load rating, see “Load identification” (▷ page 445).

Tire speed rating

Warning!

Even when permitted by law, never operate a vehicle at speeds greater than the maximum speed rating of the tires.

Exceeding the maximum speed for which tires are rated can lead to sudden tire failure, causing loss of vehicle control and possibly resulting in an accident and/or serious personal injury and possible death, for you and for others.

Regardless of the tire speed rating, local speed limits should be obeyed. Use prudent driving speeds appropriate to prevailing conditions.

Tire speed rating ⑥ indicates the approved maximum speed for the tire.



Summer tires

Index	Speed rating
Q	up to 100 mph (160 km/h)
R	up to 106 mph (170 km/h)
S	up to 112 mph (180 km/h)
T	up to 118 mph (190 km/h)
H	up to 130 mph (210 km/h)



Tires and wheels

Index	Speed rating
V	up to 149 mph (240 km/h)
W	up to 168 mph (270 km/h)
Y	up to 186 mph (300 km/h)
ZR...Y	up to 186 mph (300 km/h)
ZR...(..Y)	above 186 mph (300 km/h)
ZR	above 149 mph (240 km/h)

- At the tire manufacturer's option, any tire with a speed capability above 149 mph (240 km/h) can include a "ZR" in the size designation (for example: 245/40 ZR18). To determine the maximum speed capability of the tire, the service description for the tire must be referred to. The service description is comprised of tire load rating  and tire speed rating .
- If your tire includes "ZR" in the size designation and no service description is given, the tire manufacturer must be consulted for the maximum speed capability.



If a service description is given, the speed capability is limited by the speed symbol in

the service description. Example: 245/40 ZR18 97Y. In this example, "97Y" is the service description. The letter "Y" designates the speed rating and the speed capability of the tire is limited to 186 mph (300 km/h).

- Any tire with a speed capability above 186 mph (300 km/h) must include a "ZR" in the size designation AND the service description must be placed in parenthesis. Example: 275/40 ZR 18 (99Y). The "(Y)" speed rating in parenthesis designates the maximum speed capability of the tire as being above 186 mph (300 km/h). Consult the tire manufacturer for the actual maximum permissible speed of the tire.

All-season and winter tires

Index	Speed rating
Q M+S ⁷	up to 100 mph (160 km/h)
T M+S ⁷	up to 118 mph (190 km/h)
H M+S ⁷	up to 130 mph (210 km/h)
V M+S ⁷	up to 149 mph (240 km/h)

-  Not all M+S rated tires provide special winter performance. Make sure the tires you use show M+S and the mountain/snowflake  marking on the tire sidewall. These tires meet specific snow traction performance requirements of the Rubber Manufacturers Association (RMA) and the Rubber Association of Canada (RAC) and have been designed specifically for use in snow conditions.

An electronic speed limiter prevents your vehicle from exceeding a speed of:

- 130 mph (210 km/h):
 - All models except AMG vehicles
- 155 mph (250 km/h):
 - CL 63 AMG
- 186 mph (300 km/h):
 - CL 63 AMG with increased top speed
 - CL 63 AMG (Performance Package)

The factory equipped tires on your vehicle may have a tire speed rating above the maximum speed permitted by the electronic speed limiter.

Make sure your tires have the required tire speed rating as specified for your vehicle in

⁷ or M+S  for winter tires

Tires and wheels

the “Technical data” section (> page 569), for example when purchasing new tires.

If you are uncertain about the correct reading of the information given on a tire’s sidewall, any authorized Mercedes-Benz Center will be glad to assist you.

Load identification



① Load identification

i For illustration purposes only. Actual data on tires are specific to each vehicle and may vary from data shown in above illustration.

In addition to tire load rating, special load identification ① may be molded into the tire sidewall following the letter designating the tire speed rating ⑥ (> page 442).

- No specification given: absence of any text (like in above example) indicates a standard load (SL) tire.
- XL or Extra Load: designates an extra load (or reinforced) tire.
- Light Load: designates a light load tire.
- C, D, E: designates load range associated with the maximum load a tire can carry at a specified pressure.

DOT, Tire Identification Number (TIN)

U.S. tire regulations require each new tire manufacturer or tire retreader to mold a TIN into or onto a sidewall of each tire produced. The TIN is a unique identifier which facilitates efforts by tire manufacturers to notify purchasers in recall situations or other safety matters concerning tires and gives purchasers the means to easily identify such tires.

The TIN is comprised of “Manufacturer’s identification mark”, “Tire size”, “Tire type code” and “Date of manufacture”.



- ① DOT
- ② Manufacturer’s identification mark
- ③ Tire size
- ④ Tire type code (at the option of the tire manufacturer)
- ⑤ Date of manufacture

i For illustration purposes only. Actual data on tires are specific to each vehicle and may vary from data shown in above illustration.

DOT (Department of Transportation)

Tire branding symbol ① denotes that the tire meets requirements of the U.S. Department of Transportation.

Tires and wheels

Manufacturer's identification mark

Manufacturer's identification mark ② denotes the tire manufacturer.

New tires have a mark with two symbols.

Retreaded tires have a mark with four symbols. For more information on retreaded tires, see (▷ page 429).

Tire size

Code ③ indicates the tire size.

Tire type code

Tire type code ④ may, at the option of the manufacturer, be used as a descriptive code for identifying significant characteristics of the tire.

Date of manufacture

The date of manufacture ⑤ identifies the week and year of manufacture.

The first two figures identify the week, starting with "01" to represent the first full week of the calendar year. The second two figures represent the year.

For example, "3202" represents the 32nd week of 2002.

Maximum tire load

⚠ Warning!

Do not overload the tires by exceeding the specified load limit as indicated on the Tire and Loading Information placard on the driver's door B-pillar. Overloading the tires can overheat them, possibly causing a blowout. Overloading the tires can also result in handling or steering problems, or brake failure.



① Maximum tire load rating

i For illustration purposes only. Actual data on tires are specific to each vehicle and

may vary from data shown in above illustration.

The maximum tire load is the maximum weight the tires are designed to support.

For more information on tire load rating, see (▷ page 443).

For information on calculating total and cargo load capacities, see (▷ page 433).

Maximum tire inflation pressure

⚠ Warning!

Never exceed the maximum tire inflation pressure. Follow recommended tire inflation pressures.

Do not underinflate tires. Underinflated tires wear excessively and/or unevenly, adversely affect handling and fuel economy, and are more likely to fail from being overheated.

Do not overinflate tires. Overinflated tires can adversely affect handling and ride comfort, wear unevenly, increase stopping distance, and result in sudden deflation (blowout) because they are more likely to become punctured or damaged by road debris, potholes etc.

Tires and wheels



① Maximum permissible tire inflation pressure

i For illustration purposes only. Actual data on tires are specific to each vehicle and may vary from data shown in above illustration.

This is the maximum permissible tire inflation pressure for the tire.

Always follow the recommended tire inflation pressure (▷ page 435) for proper tire inflation.

Uniform Tire Quality Grading Standards

The Uniform Tire Quality Grading is a U.S. Government requirement designed to give drivers consistent and reliable information regarding tire performance. Tire manufacturers are required to grade tires based on three performance factors: treadwear, traction, and temperature resistance. Although not a Government of Canada requirement, all tires made for sale in North America have these grades branded on the sidewall.



- ① Treadwear
- ② Traction
- ③ Temperature resistance

i For illustration purposes only. Actual data on tires are specific to each vehicle and may vary from data shown in above illustration.

Quality grades can be found, where applicable, on the tire sidewall between tread shoulder and maximum section width. For example:

Treadwear	Traction	Temperature
200	AA	A

All passenger car tires must conform to federal safety requirements in addition to these grades.

Treadwear

The treadwear grade is a comparative rating based on the wear rate of the tire when tested under controlled conditions on a specified U.S. Government test course. For example, a tire graded 150 would wear one and one-half (1 1/2) times as well on the government course as a tire graded 100.

The relative performance of tires depends upon the actual conditions of their use, however, and may depart significantly from the norm due to variations in driving habits,



Tires and wheels

service practices and differences in road characteristics and climate.

Traction

Warning!

The traction grade assigned to this tire is based on straight-ahead braking traction tests, and does not include acceleration, cornering, hydroplaning, or peak traction characteristics.

The traction grades, from highest to lowest, are AA, A, B, and C. Those grades represent the tire's ability to stop on wet pavement as measured under controlled conditions on specified government test surfaces of asphalt and concrete. A tire marked C may have poor traction performance.

Warning!

If ice has formed on the road, tire traction will be substantially reduced. Under such weather conditions, drive, steer and brake with extreme caution.

The safe speed on a wet, snow covered or icy road is always lower than on a dry road.

You should pay particular attention to the condition of the road whenever the outside temperature is close to the freezing point.

Mercedes-Benz recommends winter tires (▷ page 452) with a minimum tread depth of approximately $\frac{1}{6}$ in (4 mm) on all four wheels for the winter season to ensure normal balanced handling characteristics. On packed snow, they can reduce your stopping distance compared to summer tires. Stopping distance, however, is still considerably greater than when the road is not covered with snow or ice. Exercise appropriate caution.

 **!** Avoid spinning of a drive wheel. This may cause serious damage to the drivetrain which is not covered by the Mercedes-Benz Limited Warranty.

Temperature

Warning!

The temperature grade for this tire is established for a tire that is properly inflated and not overloaded. Excessive speed, underinflation, or excessive loading, either separately or in combination, can cause excessive heat build-up and possible tire failure.

The temperature grades are A (the highest), B, and C, representing the tire's resistance to the generation of heat and its ability to

dissipate heat when tested under controlled conditions on a specified indoor laboratory test wheel. Sustained high temperature can cause the material of the tire to degenerate and reduce tire life, and excessive temperature can lead to sudden tire failure. The grade C corresponds to a level of performance which all passenger car tires must meet under the Federal Motor Vehicle Safety Standard No. 109. Grades B and A represent higher levels of performance on the laboratory test wheel than the minimum required by law.

Tire ply material



- ① Plies in sidewall
- ② Plies under tread

Tires and wheels

i For illustration purposes only. Actual data on tires are specific to each vehicle and may vary from data shown in above illustration.

This marking tells you about the type of cord and number of plies in the sidewall and under the tread.

Tire and loading terminology

Accessory weight

The combined weight (in excess of those standard items which may be replaced) of automatic transmission, power steering, power brakes, power windows, power seats, radio, and heater, to the extent that these items are available as factory-installed equipment (whether installed or not).

Air pressure

The amount of air inside the tire pressing outward on each square inch of the tire. Air pressure is expressed in pounds per square inch (psi), or kilopascal (kPa) or bar.

Aspect ratio

Dimensional relationship between tire section height and section width expressed in percentage.

Bar

Another metric unit for air pressure. There are 14.5038 pounds per square inch (psi) to 1 bar; there are 100 kilopascals (kPa) to 1 bar.

Bead

The tire bead contains steel wires wrapped by steel cords that hold the tire onto the rim.

Cold tire inflation pressure

Tire inflation pressure when your vehicle has been sitting for at least 3 hours or driven no more than 1 mile (1.6 km).

Curb weight

The weight of a motor vehicle with standard equipment including the maximum capacity of fuel, oil, and coolant, and, if so equipped, air conditioning and additional optional equipment, but without passengers and cargo.

DOT (Department of Transportation)

A tire branding symbol which denotes the tire meets requirements of the U.S. Department of Transportation.

GAWR (Gross Axle Weight Rating)

The GAWR is the maximum permissible axle weight. The gross vehicle weight on each axle must never exceed the GAWR for the front and rear axle indicated on the certification label located on the driver's door B-pillar.

GVW (Gross Vehicle Weight)

The GVW comprises the weight of the vehicle including fuel, tools, spare wheel, installed accessories, passengers and cargo and, if applicable, trailer tongue load. The GVW must never exceed the GVWR indicated on the certification label located on the driver's door B-pillar.

GVWR (Gross Vehicle Weight Rating)

This is the maximum permissible vehicle weight of the fully loaded vehicle (weight of the vehicle including all options, passengers, fuel, and cargo and, if applicable, trailer



Tires and wheels

tongue load). It is indicated on certification label located on the driver's door B-pillar.

Kilopascal (kPa)

The metric unit for air pressure. There are 6.9 kPa to 1 psi; another metric unit for air pressure is bar. There are 100 kilopascals (kPa) to 1 bar.

Maximum load rating

The maximum load in kilograms and pounds that can be carried by the tire.

Maximum loaded vehicle weight

The sum of curb weight, accessory weight, total load limit, and production options weight.

Maximum permissible tire inflation pressure

This number is the greatest amount of air pressure that should ever be put in the tire.

Normal occupant weight

The number of occupants the vehicle is designed to seat, multiplied by 68 kilograms (150 lb).

Occupant distribution

The distribution of occupants in a vehicle at their designated seating positions.

Production options weight

The combined weight of those installed regular production options weighing over 5 lbs (2.3 kilograms) in excess of those standard items which they replace, not previously considered in curb weight or accessory weight, including heavy duty brakes, ride levelers, roof rack, heavy duty battery, and special trim.

PSI (Pounds per square inch)

A standard unit of measure for air pressure.

Recommended tire inflation pressure

The recommended tire inflation pressure for normal driving conditions is listed on the Tire and Loading Information placard located on the driver's door B-pillar and provides best

handling, tread life and riding comfort. If so equipped, supplemental information pertaining to special driving situations can be found on the tire inflation pressure label on the inside of the fuel filler flap.

Rim

A metal support for a tire or a tire and tube assembly upon which the tire beads are seated.

Sidewall

The portion of a tire between the tread and the bead.

TIN (Tire Identification Number)

Unique identifier which facilitates efforts by tire manufacturers to notify purchasers in recall situations or other safety matters concerning tires and gives purchasers the means to easily identify such tires. The TIN is comprised of "Manufacturer's identification mark", "Tire size", "Tire type code" and "Date of manufacture".

Tires and wheels

Tire load rating

Numerical code associated with the maximum load a tire can support.

Tire ply composition and material used

This indicates the number of plies or the number of layers of rubber-coated fabric in the tire tread and sidewall. Tire manufacturers also must indicate the ply materials in the tire and sidewall, which include steel, nylon, polyester, and others.

Tire speed rating

Part of tire designation; indicates the speed range for which a tire is approved.

Total load limit

Rated cargo and luggage load plus 68 kilograms (150 lb) times the vehicle's designated seating capacity.

Traction

Force exerted by the vehicle on the road via the tires. The amount of grip provided.

Tread

The portion of a tire that comes into contact with the road.

Treadwear indicators

Narrow bands, sometimes called "wear bars" that show across the tread of a tire when only $\frac{1}{16}$ in (1.6 mm) of tread remains.

Uniform Tire Quality Grading Standards

A tire information system that provides consumers with ratings for a tire's traction, temperature and treadwear. Ratings are determined by tire manufacturers using U.S. government testing procedures. The ratings are molded into the sidewall of the tire.

Vehicle maximum load on the tire

Load on an individual tire that is determined by distributing to each axle its share of the maximum loaded vehicle weight and dividing it by two.

Rotating tires**⚠ Warning!**

Rotate front and rear wheels only if the tires are of the same dimension.

If your vehicle is equipped with mixed-size tires (different tire dimensions front vs. rear), tire rotation is not possible.

⚠ Warning!

Have the tightening torque checked after changing a wheel. The wheels could come loose if they are not tightened to a torque of 110 lb-ft (150 Nm).

Only use genuine Mercedes-Benz wheel bolts specified for your vehicle's rims.

Tire rotation can be performed on vehicles with tires of the same dimension all around. If your vehicle is equipped with tires of the same dimension all around, tires can be rotated, observing a front-to-rear rotation pattern that will maintain the intended rotation (spinning) direction of the tire (▷ page 431).

In some cases, such as when your vehicle is equipped with mixed-size tires (different tire dimension front vs. rear), tire rotation is not possible.



Winter driving

If applicable to your vehicle's tire configuration, tires can be rotated according to the tire manufacturer's recommended intervals in the tire manufacturer's warranty pamphlet located in your vehicle literature portfolio. If none is available, tires should be rotated every 3 000 to 6 000 miles (5 000 to 10 000 km), or sooner if necessary, according to the degree of tire wear. The same rotation (spinning) direction must be maintained.

Rotate tires before the characteristic tire wear pattern becomes visible (shoulder wear on front tires and tread center wear on rear tires).

Thoroughly clean the mounting face of wheels and brake disks, i.e. the inner side of the wheels/tires, during each rotation. Check for and ensure proper tire inflation pressure.

For information on wheel change, see "Flat tire" (> page 547).

Winter driving

General information

Have your vehicle winterized at an authorized Mercedes-Benz Center.

Winter tires

Warning!

Winter tires with a tread depth of less than $\frac{1}{6}$ in (4 mm) must be replaced. They are no longer suitable for winter operation.

Warning!

If you use your spare wheel when winter tires are fitted on the other wheels, be aware that the difference in tire characteristics may very well impair turning stability and that overall driving stability may be reduced. Adapt your driving style accordingly.

Have the spare wheel replaced by regular road wheel with a winter tire at the nearest authorized Mercedes-Benz Center.

Always use winter tires at temperatures below 45°F (7°C) and whenever wintry road conditions prevail. Not all M+S rated tires provide special winter performance. Make

sure the tires you use show the mountain/snowflake  marking on the tire sidewall. These tires meet specific snow traction performance requirements of the Rubber Manufacturers Association (RMA) and the Rubber Association of Canada (RAC) and have been designed specifically for use in snow conditions. Use of winter tires is the only way to achieve the maximum effectiveness of your vehicle's driving safety systems such as the ABS and the ESP® in winter operation.

For safe handling, make sure all mounted winter tires are of the same make and have the same tread design.

For information on winter tires for your vehicle model, see the "Technical data" section (> page 569).

Always observe the speed rating of the winter tires installed on your vehicle. If the maximum speed for which your tires are rated is below the speed rating of your vehicle, you must place a notice to this effect where it will be seen by the driver. Such notices are available at your tire dealer or any authorized Mercedes-Benz Center.

Winter driving

Snow chains

! When driving with snow chains, always select the raised level of the vehicle level control. Other settings may result in damage to your vehicle.

! Some tire sizes do not leave adequate clearance for snow chains. To help avoid serious damage to your vehicle or tires, make sure the use of snow chains is permissible as specified in the “Technical data” section of this Operator’s Manual.

Snow chains should only be driven on snow-covered roads at speeds not to exceed 30 mph (50 km/h). Remove chains as soon as possible when driving on roads without snow.

Observe the following guidelines when using snow chains:

- Use of snow chains is not permissible with all wheel/tire combinations (▷ page 569).
- Use snow chains in pairs and on rear wheels only. Follow the manufacturer’s mounting instructions.

! If snow chains are mounted to the front wheels, they may scrape against the body

or axle components. The tires or the vehicle could be damaged as a result.

- Only use snow chains that are approved by Mercedes-Benz. Any authorized Mercedes-Benz Center will be glad to advise you on this subject.
 - Use of snow chains may be prohibited depending on location. Always check local and state laws before installing snow chains.
 - Do not use snow chains on the spare wheel.
- i** When driving with snow chains, you may wish to switch off the ESP® (▷ page 69) before setting the vehicle in motion. This will improve the vehicle’s traction.

Winter driving instructions

⚠ Warning!

If the vehicle becomes stuck in snow, make sure snow is kept clear of the exhaust pipe and from around the vehicle with the engine running. Otherwise, deadly carbon monoxide (CO) gases may enter vehicle interior resulting in unconsciousness and death.

To assure sufficient fresh air ventilation, open a window slightly on the side of the vehicle not facing the wind.

⚠ Warning!

The outside temperature indicator is not designed to serve as an ice-warning device and is therefore unsuitable for that purpose.

Indicated temperatures just above the freezing point do not guarantee that the road surface is free of ice. The road may still be icy, especially in wooded areas or on bridges.

⚠ Warning!

On slippery road surfaces, never downshift in order to obtain braking action. This could result in drive wheel slip and reduced



Driving instructions

vehicle control. Your vehicle's ABS will not prevent this type of loss of control.

The most important rule for slippery or icy roads is to drive sensibly and to avoid abrupt acceleration, braking and steering maneuvers. Do not use the cruise control or DISTRONIC Plus system under such conditions.

When the vehicle is in danger of skidding, shift the automatic transmission to neutral position **N**. Try to keep the vehicle under control by corrective steering action.

 For information on driving with snow chains, see "Snow chains" (▷ page 453).

Road salts and chemicals can adversely affect braking efficiency. Increased pedal force may become necessary to produce the normal brake effect.

Depressing the brake pedal periodically when traveling at length on salt-strewn roads can bring road-salt-impaired braking efficiency back to normal.

If the vehicle is parked after being driven on salt-treated roads, the braking efficiency should be tested as soon as possible after driving is resumed.

Warning!

Make sure not to endanger any other road users when carrying out these braking maneuvers.

Driving instructions

Drive sensibly – save fuel

To save fuel you should:

- Keep tires at the recommended inflation pressures.
- Remove unnecessary loads.
- Remove roof rack when not in use.
- Allow engine to warm up under low load use.
- Avoid frequent acceleration and deceleration.
- Have all maintenance work performed at the intervals specified in the Maintenance Booklet and as required by the Maintenance system. Contact an authorized Mercedes-Benz Center.

Fuel consumption is also increased by driving in cold weather, in stop-and-go traffic, on short trips and in mountainous areas.

Driving instructions

Drinking and driving

Warning!

Drinking and driving and/or taking drugs and driving are very dangerous combinations. Even a small amount of alcohol or drugs can affect your reflexes, perceptions and judgment.

The possibility of a serious or even fatal accident are greatly increased when you drink or take drugs and drive.

Do not drink or take drugs and drive or allow anyone to drive who has been drinking or taking drugs.

Pedals

Warning!

Make sure absolutely no objects are obstructing the pedals' range of movement. Keep the driver's footwell clear of all obstacles. If there are any floor mats or carpets in the footwell, make sure that the pedals still have sufficient clearance.

During sudden driving or braking maneuvers, the objects could get caught between the pedals. You could then no

longer brake or accelerate. This could lead to accidents and injury.

Power assistance

Warning!

There is no power assistance for the steering and the service brake when the engine is not running.

Steering and braking requires significantly more effort and you could lose control of the vehicle and cause an accident as a result.

Do not turn off the engine while the vehicle is in motion.

Brakes

Downhill grades

 When driving down long and steep grades, relieve the load on the brakes by shifting into a lower gear to use the engine's braking power. This helps prevent overheating of the brakes and reduces wear.

When using the engine's braking power, a drive wheel may not spin for an extended period of time, e.g. on slippery road

surfaces. This may cause serious damage to the drivetrain which is not covered by the Mercedes-Benz Limited Warranty.

Continuous or hard braking

Warning!

Resting your foot on the brake pedal will cause excessive and premature wear of the brake pads.

It can also result in the brakes overheating, thereby significantly reducing their effectiveness. It may not be possible to stop the vehicle in sufficient time to avoid an accident.

After hard braking, it is advisable to drive on for some time, rather than immediately park, so that the air stream will cool down the brakes faster.

Wet roads

Warning!

After driving in heavy rain for some time without applying the brakes or through water deep enough to wet brake components, the first braking action may be somewhat reduced and increased pedal pressure may be necessary to obtain



Driving instructions

expected brake effect. Maintain a safe distance from vehicles in front.

To help prevent brake disk corrosion after driving on wet or salt-covered roads, it is advisable to brake the vehicle with considerable force prior to parking. The heat generated serves to dry the brakes.

Salt-covered roads

Warning!

A layer of salt on the brake discs and the brake linings may cause a delay in the braking effect, resulting in a significantly increased braking distance, which could lead to an accident.

To avoid this danger, you should:

- occasionally brake carefully when you are driving on salt-covered roads, so that any layer of salt that may have built up on the brake discs and the brake linings is removed without putting other road users at risk
- maintain a greater distance to the vehicle ahead and drive with particular care
- carefully apply the brakes at the end of a trip and immediately after commencing a

new trip, so that salt residues are removed from the brake disc

Brake service

 The brake fluid level in the reservoir may be too low if the red brake warning lamp in the instrument cluster comes on while the engine is running and an acoustic warning sounds. Observe additional messages in the multifunction display that may appear. Brake pad wear or a leak in the system may be the reason for low brake fluid in the reservoir.

Have the brake system inspected immediately. Contact an authorized Mercedes-Benz Center.

All checks and service work on the brake system should be carried out by qualified technicians only. Contact an authorized Mercedes-Benz Center.

Only install brake pads and use brake fluid recommended by Mercedes-Benz.

Warning!

If other than recommended brake pads are installed, or other than recommended brake fluid is used, the braking properties of the vehicle can be degraded to an extent

that safe braking is substantially impaired. This could result in an accident.

Vehicles with 4MATIC:

Only conduct operational or performance tests on a two-axle dynamometer. If such tests are necessary, contact an authorized Mercedes-Benz Center. You could otherwise seriously damage the brake system or the transfer case which is not covered by the Mercedes-Benz Limited Warranty.

Vehicles with 4MATIC:

Because the ESP[®] operates automatically, the engine and ignition must be shut off (SmartKey in starter switch position **0** or **1** or KEYLESS-GO start/stop button in position **0** or **1**) when the electronic parking brake is being tested on a brake test dynamometer.

Active braking action through the ESP[®] may otherwise seriously damage the brake system which is not covered by the Mercedes-Benz Limited Warranty.

Vehicles without 4MATIC:

Because the ESP[®] operates automatically, the engine and ignition must be shut off

Driving instructions

(SmartKey in starter switch position **0** or **1** or KEYLESS-GO start/stop button in position **0** or **1**) when the electronic parking brake is being tested on a brake test dynamometer or when the vehicle is being towed with one axle raised.

Active braking action through the ESP® may otherwise seriously damage the brake system which is not covered by the Mercedes-Benz Limited Warranty.

If your brake system is normally only subjected to moderate loads, you should occasionally test the effectiveness of the brakes by applying above-normal braking pressure at higher speeds. This will also enhance the grip of the brake pads.

 **Warning!**

Make sure not to endanger any other road users when carrying out these braking maneuvers.

Refer to the description of the Brake Assist System BAS (▷ page 66) or BAS Plus (▷ page 66).

High-performance brake system

The high-performance brake system is only available on CL 63 AMG and CL 65 AMG.

 **Warning!**

New vehicle brake pads and discs, and replacement brake pads and discs may take several hundred miles of driving until they provide optimum braking efficiency. Until that time, you may need to use increased brake pedal pressure while braking. Please be aware of this and adjust your driving and braking accordingly during this break-in period.

Excessive high-demand braking will cause correspondingly high brake wear. Please be attentive to the brake warning lamp in the instrument cluster and brake condition messages in the multifunction display. Especially for high performance driving, it is important to maintain and have the brake system checked regularly.

The high-performance brake system is designed to operate under the extremely high operating demands required to accommodate the performance capabilities of the vehicle.

The brakes may produce a squeaking-type noise depending on the

- vehicle speed
- brake force applied
- ambient conditions, e.g. temperature and humidity

As with any brake system, the wear of individual brake system components such as brake pads or disks strongly depends on your driving style and the conditions under which you operate the vehicle. Thus, a driving style calling for high-demand braking will cause your vehicle's brakes to wear more quickly.

Driving off

Warm up the engine smoothly. Do not place full load on the engine until the operating temperature has been reached.

 When driving off on a slippery surface, do not allow a drive wheel to spin for an extended period with the ESP® switched off. Doing so may cause serious damage to the drivetrain which is not covered by the Mercedes-Benz Limited Warranty.

 Simultaneously depressing the accelerator pedal and applying the brakes



Driving instructions

reduces engine performance and causes premature brake and drivetrain wear which is not covered by the Mercedes-Benz Limited Warranty.

Hydroplaning

Depending on the depth of the water layer on the road, hydroplaning may occur, even at low speeds and with new tires. In heavy rain or when conditions indicate possible hydroplaning:

- ▶ Reduce vehicle speed.
- ▶ Avoid track grooves in the road.
- ▶ Apply brakes cautiously.

Standing water

! Do not drive through flooded areas. Before driving through water, determine its depth.

If you must drive through standing water, drive slowly to prevent water from entering the passenger compartment or the engine compartment. Water in these areas could cause damage to electrical components or wiring of the engine or transmission, or could result in water being ingested by the engine through the air intake causing severe internal engine damage. Any such damage is not covered by the Mercedes-Benz Limited Warranty.

Driving abroad

If you plan to drive the vehicle outside the U.S. or Canada, you should request dealer network information for your destination from any authorized Mercedes-Benz Center.

Control and operation of radio transmitter

Safety notes

Warning!

Please do not forget that your primary responsibility is to drive the vehicle. A driver's attention to the road must always be his/her primary focus when driving. For your safety and the safety of others, we recommend that you pull over to a safe location and stop before placing or taking a telephone call.

If you choose to use the telephone⁸ while driving, please use the hands-free device and only use the telephone when road, weather and traffic conditions permit. Some jurisdictions prohibit the driver from using a mobile telephone while driving a vehicle.

⁸ Observe all legal requirements.

Driving instructions

Only operate the COMAND⁸ (Cockpit Management and Data System) if road, weather and traffic conditions permit. Otherwise, you may not be able to observe traffic conditions and could endanger yourself and others.

Bear in mind that at a speed of just 30 mph (approximately 50 km/h), your vehicle is covering a distance of 44 feet (approximately 14 m) every second.

Telephones and two-way radios

Warning!

Never operate radio transmitters equipped with a built-in or attached antenna, such as a portable telephone or a citizens band unit, from inside the vehicle while the engine is running. Doing so could lead to a malfunction of the vehicle's electronic system, possibly resulting in an accident and/or serious personal injury. Radio transmitters should only be used inside the vehicle if they are connected to an antenna that is installed on the outside of the vehicle.

Refer to the radio transmitter operation instructions regarding use of an external antenna.

Emission control

Certain systems of the engine serve to keep the toxic components of the exhaust gases within permissible limits required by law.

These systems will function properly only when maintained strictly according to factory specifications. Any adjustments on the engine should, therefore, be carried out only by qualified Mercedes-Benz Center authorized technicians.

Engine adjustments should not be altered in any way. Moreover, the specified service procedures must be carried out regularly according to Mercedes-Benz servicing requirements. For details refer to the Maintenance Booklet.

Warning!

Inhalation of exhaust gas is hazardous to your health. All exhaust gas contains carbon monoxide (CO), and inhaling it can cause unconsciousness and possible death.

Do not run the engine in confined areas (such as a garage) which are not properly ventilated. If you think that exhaust gas fumes are entering the vehicle while driving, have the cause determined and corrected immediately. If you must drive under these conditions, drive only with at least one window fully open at all times.

⁸ Observe all legal requirements.

Maintenance

Maintenance

Notes

The Maintenance System in your vehicle tracks the distance driven and the time elapsed since the last maintenance service, calculates other maintenance service work required, and calls for the next maintenance service accordingly.

We strongly recommend that you have your vehicle serviced at an authorized Mercedes-Benz Center, in accordance with the Maintenance Booklet at the times called for by the maintenance service indicator.

- i** Failure to have the vehicle maintained in accordance with the Maintenance Booklet and maintenance service indicator at the designated times/mileage will result in vehicle damage not covered by the Mercedes-Benz Limited Warranty.

Maintenance service indicator message

The maintenance service indicator message will notify you when the next maintenance service is due.

Starting approximately 1 month before the next maintenance service is due, one of the following messages will appear in the multifunction display while you are driving or when you switch on the ignition (example service A):

Next Service A in XXX miles (km)

Next Service A in XXX days

Service A Due



The maintenance services will be indicated by showing a service type A through type H in the multifunction display. Types A through H are classified based on estimated time needed to perform the maintenance service, ranging:

from Service A
(approximately 1 hour)
to Service H
(approximately 8 hours)

Refer to Maintenance Booklet for a listing of maintenance services and intervals they need to be performed at.

Clearing the maintenance service indicator message

The maintenance service indicator message is cleared automatically

- after approximately 10 seconds when you switch on the ignition
- after approximately 10 seconds when reaching the service threshold while driving
- after approximately 30 seconds, once the suggested maintenance service term has passed

► **Clearing the maintenance service indicator message manually:** Press button  on the multifunction steering wheel.

The standard display appears in the multifunction display.

Maintenance service term exceeded

If you have exceeded the suggested maintenance service term, you will see the following message in the multifunction display:

Service A Exceeded by XXXX miles (km)

Service A Exceeded By XXX days

In addition, a signal sounds when the message appears.

Any authorized Mercedes-Benz Center will reset the maintenance service indicator following a completed maintenance service.



Calling up the maintenance service indicator display



i The menu overview can be found on (▷ page 234).

You can call up the maintenance service indicator display at any time to check when the next maintenance service is due.

▶ Switch on the ignition.

The standard display of the control system appears (▷ page 235).

▶ Press button  or  on the multifunction steering wheel to select the Service menu.

- ▶ Press button  or  to select ASSYST PLUS.
 - ▶ Press button  on the multifunction steering wheel to confirm. The maintenance service indicator display with the maintenance service deadline appears in the multifunction display.
- i** If the battery is disconnected, the days of disconnection will not be included in the count shown by the maintenance service indicator. To arrive at the true maintenance service deadline, you will need to subtract these days from the days shown in the maintenance service indicator message or maintenance service indicator display.

Resetting the maintenance service indicator

In the event that the maintenance service on your vehicle is not carried out at an authorized Mercedes-Benz Center, you can have the maintenance service indicator reset.

The automotive maintenance facility carrying out the maintenance service will find the information for resetting the maintenance service indicator in the maintenance-relevant literature for your vehicle.

Such literature is available from any authorized Mercedes-Benz Center or directly from Mercedes-Benz.

! If the maintenance service indicator was inadvertently reset, have an authorized Mercedes-Benz Center correct it. Only reset if the proper maintenance service has been performed. Resetting the system without performing the proper maintenance service as called for by the maintenance service indicator will result in engine damage and/or other vehicle damage not covered by the Mercedes-Benz Limited Warranty.

Vehicle care

Vehicle care

Cleaning and care of the vehicle

Notes

Regular and proper care will help to maintain the value of your vehicle.

Warning!

Many cleaning products can be hazardous. Some are poisonous, others are flammable. Always follow the instructions on the particular container. Always open your vehicle's doors or windows when cleaning the inside.

Never use fluids or solvents that are not designed for cleaning your vehicle.

Always lock away cleaning products and keep them out of reach of children.

! When cleaning the vehicle, do not use scouring agents. Never apply strong force and only use a soft, wet cloth or sponge. Otherwise you may scratch or damage the surface to be cleaned.

While in operation, even while parked, your vehicle is subjected to varying external influences which, if gone unchecked, can attack the paintwork as well as the vehicle underbody and cause lasting damage.

Such damage is caused not only by extreme and varying climatic conditions, but also by:

- Air pollution
- Road salt
- Tar
- Gravel and stone chipping

To avoid paint damage, you should immediately remove:

- Grease and oil
- Fuel
- Coolant
- Brake fluid
- Bird droppings
- Insects
- Tree resins etc.

Frequent washing reduces and/or eliminates the aggressiveness and potency of the above adverse influences.

More frequent washings are necessary to deal with unfavorable conditions:

- near the ocean
- in industrial areas (smoke, exhaust emissions)
- during winter operation

You should check your vehicle from time to time for stone chipping or other damage. Any damage should be repaired as soon as possible to prevent corrosion.

In doing so, do not neglect the underbody of the vehicle. A prerequisite for a thorough check is a washing of the underbody followed by a thorough inspection. Damaged areas need to be re-undercoated.

Your vehicle has been treated at the factory with a wax-base rustproofing in the body cavities which will last for the lifetime of the vehicle. Post-production treatment is neither necessary nor recommended by Mercedes-Benz because of the possibility of incompatibility between materials used in the production process and others applied later.

We have selected vehicle-care products and compiled recommendations which are specially matched to our vehicles and which always reflect the latest technology. You can obtain Mercedes-Benz approved vehicle-care products at an authorized Mercedes-Benz Center.

Scratches, corrosive deposits, corrosion or damage due to negligent or incorrect care cannot always be removed or repaired with the vehicle-care products recommended

here. In such cases it is best to seek aid at an authorized Mercedes-Benz Center.

The following topics deal with the cleaning and care of your vehicle and give important “how-to” information as well as references to Mercedes-Benz approved vehicle-care products.

Power washer

! Follow the instructions provided by the power washer manufacturer on maintaining a distance between the vehicle and the nozzle of the power washer.

Never use a round nozzle to power-wash tires. The intense jet of water can result in damage to the tire.

Always replace a damaged tire.

Always keep the jet of water moving across the surface. Do not aim directly at electrical parts, electrical connectors, seals, or other rubber parts.

i Vehicles with KEYLESS-GO: If a door handle is hit by a strong jet of water, and a SmartKey is within approximately 3 ft (1 m) of the vehicle, it could be inadvertently locked or unlocked.

Tar stains

Quickly remove tar stains before they dry and become more difficult to remove. A tar remover is recommended.

Paintwork, painted body components

! Affixing stickers, magnets, adhesive tape or similar materials to painted body components may damage the paintwork.

Mercedes-Benz approved Paint Care should be applied when water drops on the paint surface do not “bead up”. This should normally be done every 3 to 5 months, depending on the climate and washing detergent used.

Mercedes-Benz approved Paint Cleaner should be applied if the paint surface shows signs of embedded dirt (i.e. loss of gloss).

Do not apply any of these products or wax if your vehicle is parked in the sun or if the hood is still hot.

► Use the appropriate MB-Touch-Up Stick for quick and provisional repairs of minor paint damage (i.e. chips from stones, vehicle doors, etc.).

Engine cleaning

Prior to cleaning the engine compartment, make sure to protect electrical components and connectors from contact with water and cleaning agents.

Corrosion protection, such as MB Anticorrosion Wax should be applied to the engine compartment after every engine cleaning. Before applying, all control linkage bushings and joints should be lubricated. The poly-V-belt and all pulleys should be protected from any wax.

Vehicle washing

In the winter, thoroughly remove all traces of road salt as soon as possible.

When washing the vehicle underbody, do not forget to clean the inner sides of the wheels.

i Vehicles with KEYLESS-GO: If a door handle is hit by a strong jet of water, and a SmartKey is within approximately 3 ft (1 m) of the vehicle, it could be inadvertently locked or unlocked.

Vehicle care

Hand-wash

- ▶ Do not use hot water or wash your vehicle in direct sunlight.
- ▶ Only use a soft, wet cloth or sponge to clean the vehicle.
- ▶ Only use a mild vehicle wash detergent, such as Mercedes-Benz approved Car Shampoo.
- ▶ Thoroughly spray the vehicle with a diffused jet of water.
- ▶ Do not spray directly towards the ventilation intake.
- ▶ Use plenty of water and rinse the sponge and chamois frequently.
- ▶ Rinse with clean water and thoroughly dry with a chamois.

Do not allow cleaning agents to dry on the finish.

Automatic car wash

You can have your vehicle washed in an automatic car wash from the start. Brushless car washes are preferable.

- ▶ To protect the filter system, activate the air recirculation mode using rocker switch  on the climate control panel.

! Do not clean your vehicle in an automatic touchless car wash which uses caustic spray. Caustic spray will damage the paint or ornamental moldings.

If the vehicle is very dirty, prewash it before running it through the automatic car wash.

! Make sure the combination switch is set to wiper setting **0**. Otherwise, the rain sensor could activate and cause the wipers to move unintentionally. This may lead to vehicle damage.

Due to the width of the vehicle, fold in exterior rear view mirrors prior to running the vehicle through an automatic car wash to prevent damage to the mirrors.

- ▶ **When taking the vehicle through an automatic conveyor-type car wash:** Make sure the automatic transmission remains in neutral position **N**. Observe instructions, see “Remaining in neutral position **N**” (> page 337).

When leaving the automatic car wash, make sure the mirrors are folded out.

After running the vehicle through an automatic car wash, wipe any wax off of the windshield and the wiper blade inserts. This will prevent smears and reduce wiping noise

which can be caused by residual wax on the windshield.

Ornamental moldings

- ▶ For regular cleaning and care of ornamental moldings, use a damp cloth.

! Do not use chrome cleaner on ornamental moldings. Although ornamental moldings may have chrome appearance, they could be made of anodized aluminum that will be damaged when cleaned with chrome cleaner. Instead, use a damp cloth to clean those ornamental moldings.

For very dirty ornamental moldings of which you are sure are chrome-plated, use a chrome cleaner. If in doubt whether an ornamental molding is chrome-plated, contact an authorized Mercedes-Benz Center.

Headlamps, brake lamps, tail lamps, side markers, turn signal lenses

- ▶ Use a mild vehicle wash detergent, such as Mercedes-Benz approved Car Shampoo, with plenty of water.

! Only use window cleaning solutions that are suitable for plastic lamp lenses.

Window cleaning solutions which are not suitable may damage the plastic lamp lenses of the headlamps. Therefore, do not use abrasives, solvents or cleaners that contain solvents.

Cleaning the DISTRONIC Plus/PRE-SAFE® Brake system sensors

The sensors are integrated in the front bumpers and cannot be seen from the outside.

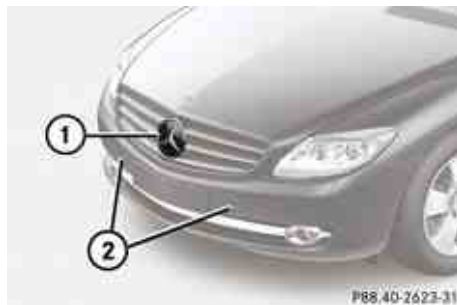

- ① Sensor cover
- ② Bumper area near sensors

- ▶ Switch off the ignition.
- ▶ Only clean sensor cover ① by hand.
- ▶ Use a mild vehicle wash detergent, such as Mercedes-Benz approved Car Shampoo,

with plenty of water and a non-scratching cloth to clean sensor cover ①.

- ▶ Clean a wide area of the bumpers surrounding the sensors ②.
- ▶ Restart the engine after cleaning sensor cover ① and sensors ②.

Cleaning the Parktronic system sensors

Parktronic system sensors are located in the front and rear bumper.

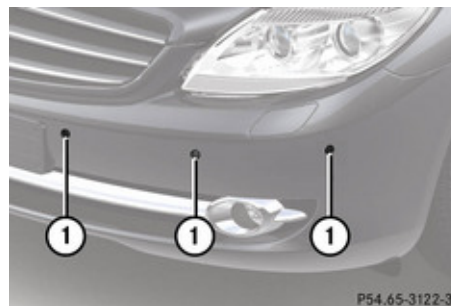

- ① Parktronic system sensors in front bumper (Only visible without DISTRONIC Plus)
- ▶ Only clean sensors ① by hand.
- ▶ Use a mild vehicle wash detergent, such as Mercedes-Benz approved Car Shampoo, with plenty of water and a soft, non-

scratching cloth to clean sensors ① on the bumpers.

- ❗ Applying strong pressure may damage the sensor covers.

Cleaning the driving systems sensors

The sensors are integrated in the front and rear bumpers and cannot be seen from the outside. They work with the following systems:

- BAS Plus
- PRE-SAFE® Brake
- Blind Spot Assist
- Park Assist
- Advanced Parking Guidance

Vehicle care

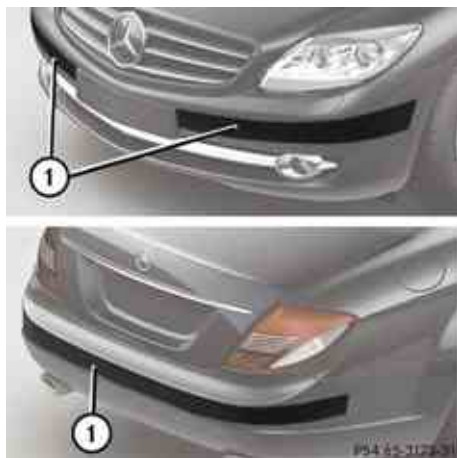

① Bumper area near sensors

- ▶ Switch off the ignition.
- ▶ Use a mild car wash detergent, such as Mercedes-Benz approved Car Shampoo, with plenty of water and a soft, non-scratching cloth to clean the bumper area near sensors.

Cleaning the rear view camera lens

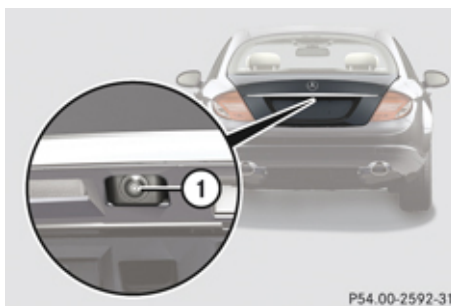

① Camera lens

- ▶ Only use clean water and a soft, non-scratching cloth to clean camera lens ①.

Be careful not to apply wax to camera lens ① when waxing the vehicle. If necessary, remove the wax using the Mercedes-Benz approved Car Shampoo with plenty of water.

- ❗ Do not clean the camera and the area around the camera
 - with a high-pressure cleaner
 - with a dry cloth and strong pressure
 - with aggressive cleaning agents
- You could otherwise damage the camera.

Cleaning the windshield in front of the Night View Assist camera

⚠ Warning!

Please do not forget that your primary responsibility is to drive the vehicle. A driver's attention to the road must always be his/her primary focus when driving. For your safety and the safety of others, stop before trying to remove window fogging or cleaning the window in front of the Night View Assist camera.

Bear in mind that at a speed of just 30 mph (approximately 50 km/h), your vehicle is covering a distance of 44 feet (approximately 14 m) every second.

- ❗ Do not clean the lens of the Night View Assist camera. If the camera lens is dirty, please contact an authorized Mercedes-Benz Center.



① Recessed handles of camera cover

- ▶ Use recessed handles ① to swing camera cover downward.



② Camera

- ▶ Clean inside of windshield in front of camera ② with a soft, non-scratching cloth.

! If you use a windshield cleaning product, make sure that none of the cleaning product comes into contact with the lens of the Night View Assist camera.

- ▶ Use recessed handles ① to swing camera cover up.

Cleaning the windows and the wiper blades

! The windshield wipers must be in a vertical position before folding them away from the windshield. They could otherwise damage the hood.

Never open the hood when the wiper arms are folded forward.

- ▶ Make sure the hood is fully closed.
- ▶ Switch on the ignition.
- ▶ Turn combination switch to wiper setting  (▶ page 323).
- ▶ With wiper arms in vertical position, switch off the ignition.

Warning!

For safety reasons, switch off wipers and remove SmartKey from starter switch (vehicles with KEYLESS-GO: Make sure the vehicle's on-board electronics have status

0) before cleaning the windshield and/or the wiper blades. Otherwise, the wiper motor could suddenly turn on and cause injury.

! Do not pull on the wiper blade inserts. They could tear.

- ▶ Fold the wiper arms forward until they snap into place.
- ▶ Clean the windshield and the wiper blade inserts with a clean cloth and mild detergent solution.
- ▶ Use a soft, clean cloth and a mild window cleaning solution on all outside and inside glass surfaces.
An automotive glass cleaner is recommended.

! Fold the windshield wiper arms back onto the windshield before turning the SmartKey in the starter switch or pressing the KEYLESS-GO start/stop button (vehicles with KEYLESS-GO).

Hold on to the wiper when folding the wiper arm back. If released, the force of the impact from the tensioning spring could crack the windshield.

Vehicle care

! To clean the window interior, do not use a dry cloth, abrasives, solvents or cleaners containing solvents. Do not touch the inside of the front, rear or side windows with hard objects such as an ice scraper or ring. Doing so may damage the windows.

Light alloy wheels

If possible, clean wheels once a week.

▶ Use Mercedes-Benz approved Wheel Care, a soft bristle brush and a strong spray of water for cleaning the light alloy wheels.

! Only use acid-free cleaning materials. Acid may cause corrosion or damage the clear coat.

! The vehicle should not be parked for an extended period of time immediately after it has been cleaned, especially not after the wheel rims have been cleaned with wheel rim cleaner. Wheel rim cleaners can lead to increased corrosion of the brake disks and brake pads. Non-approved wheel cleaners may also damage the wheel paint if the vehicle is not driven after cleaning.

Therefore, the vehicle's brake system should always be warmed-up before it is parked after cleaning. Drive your vehicle for several minutes to allow the brakes to dry.

When applying Mercedes-Benz approved Tire Care and Mercedes-Benz approved Wheel Care products, take care not to spray them on the brake disks.

Plastic and rubber parts

▶ Use a gentle dishwashing detergent or mild detergent for delicate fabrics as a washing solution.

▶ Wipe with a cloth moistened in a lukewarm solution. The surface may temporarily change color. If this is the case, wait for it to dry.

⚠ Warning!

Do not use cleaners or cockpit care sprays containing solvents to clean the cockpit or the steering wheel. Cleaners containing solvents will make the surface porous and vehicle occupants could suffer serious injuries from plastic parts coming loose in the event of air bag deployment.

! Do not use oil, wax or scouring agents. Otherwise you may scratch or damage the surface.

Hard plastic trim items

▶ Use Mercedes-Benz approved Interior Care on a soft, lint-free cloth and apply with light pressure.

COMAND display

! You must switch off the COMAND display and allow it to cool prior to cleaning.

! Do not use any liquids or cleaning agents. These can damage or even destroy the audio display screen.

▶ Use a standard microfiber cloth and apply with light pressure.

Steering wheel

▶ Wipe with a damp cloth and dry thoroughly or clean with Mercedes-Benz approved Leather Care.

Carpets

▶ Use Mercedes-Benz approved Carpet and Fabric Care for cleaning the carpets.

Headliner and shelf below rear window

- ▶ Use a soft bristle brush or a dry-shampoo cleaner in case of excessive dirt.

Seat belts

- ▶ Only use clear, lukewarm water and soap.

! The seat belts must not be treated with chemical cleaning agents. Do not dry the seat belts at temperatures above 176°F (80°C) or in direct sunlight.

Warning!

Do not bleach or dye seat belts as this may severely weaken them. In a crash they may not be able to provide adequate protection.

Upholstery

Using aftermarket seat covers or wearing clothing that have the tendency to give off coloring (e.g. when wet, etc.) may cause the upholstery to become permanently discolored. By lining the seats with a proper intermediate cover, contact-discoloration will be prevented.

Warning!

Only use seat covers which have been tested and approved by Mercedes-Benz for your vehicle model. Using other seat covers may interfere with or prevent the deployment of the side impact air bags. Contact an authorized Mercedes-Benz Center for availability.

Leather upholstery

Please note that leather upholstery is a natural product and is therefore subject to a natural aging process. Leather upholstery may also react to certain ambient influences such as high humidity or high temperature by showing wrinkles for example.

- ▶ Wipe leather upholstery with a damp cloth and dry thoroughly or clean with Mercedes-Benz approved Leather Care.
- !** To avoid damage to leather upholstery:
 - Wipe with light pressure only.
 - Do not clean with abrasive cleaning agents such as scouring milk or powder.
 - Do not soak the leather upholstery.

As leather is a natural product, it could otherwise harden or become porous.

- Exercise particular care when cleaning perforated leather as its underside should not become wet.

Wood trims

- ▶ Only use water and a damp cloth to clean wood trims in your vehicle.

! Do not use solvents like tar remover or wheel cleaner nor polishes or waxes as these may be abrasive.

Chrome-plated exhaust tip

Regular cleaning and care of chrome-plated exhaust tips will help to maintain their shine and the classy appearance.

- ▶ Use Mercedes-Benz approved Chrome Polishing Paste each time the vehicle has been washed, especially during the winter.
- !** Do not use alkaline cleaners such as wheel cleaners as they could cause corrosion.

Vehicle equipment	472
Where will I find ...?	472
Vehicle status messages in the multifunction display	475
What to do if	527
Unlocking/locking manually	539
Replacing SmartKey batteries	541
Replacing bulbs	543
Replacing wiper blades	545
Flat tire	547
Battery	551
Jump starting	554
Towing the vehicle	555
Fuses	558



Where will I find ...?

Vehicle equipment

i This Operator's Manual describes all features, standard or optional, potentially available for your vehicle at the time of purchase. Please be aware that your vehicle might not be equipped with all features described in this manual.

Where will I find ...?

First aid kit

i Check expiration dates and contents for completeness at least once a year and replace missing/expired items.

The first aid kit is located in the trunk on the right side storage pocket, secured by a tensioning strap.



① Tensioning strap

② First aid kit

- ▶ Loosen tensioning strap ①.
First aid kit ② can be removed.

Vehicle tool kit

The vehicle tool kit is located in the space underneath the trunk floor.

The vehicle tool kit includes:

- Alignment bolt
- Collapsible wheel chock
- Fuse chart
- Jack
- Pair of gloves
- Towing eye bolt
- Wheel wrench

- ▶ **Removing:** Open the trunk (▷ page 296).
- ▶ Lift the trunk floor using the floor handle.
- ▶ Engage the floor handle on the upper trunk lip.

! To prevent damage, always disengage the floor handle from the upper trunk lip and lower the trunk floor before closing the trunk.

Where will I find ...?



- ① Collapsible wheel chock
- ② Vehicle tool kit box cover
- ③ Tool bag
- ④ Jack

► Open vehicle tool kit box cover ②.

Collapsible wheel chock

The collapsible wheel chock serves to secure the vehicle, e.g. while changing a wheel.

► Take the collapsible wheel chock from the vehicle tool kit (▷ page 472).



- ① Tilt the plates upward
- ② Fold the lower plate outward
- ③ Insert the plate

- **Setting up:** Tilt both plates upward ①.
- Fold the lower plate outward ②.
- Guide the tabs of the lower plate all the way into the openings of base plate ③.

For information on where to place wheel chocks when changing a wheel, see “Lifting the vehicle” (▷ page 547).

Jack

⚠ Warning!

Only use the jack supplied with your vehicle to lift the vehicle briefly for wheel changes. If you use the jack for any other purpose,

you or others could be injured, as the jack is designed only for the purpose of changing a wheel.

When using the jack, observe the safety notes in the “Mounting the spare wheel” section and the notes on the jack.

► Take the jack from the vehicle tool kit (▷ page 472).

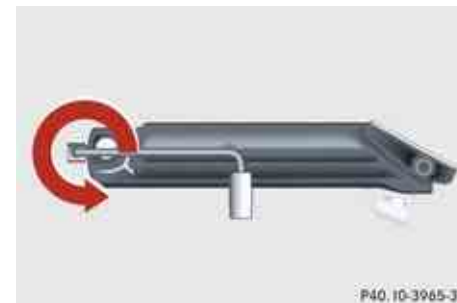

Storage position

► Turn the crank handle in the direction of arrow as far as it will go.

Where will I find ...?

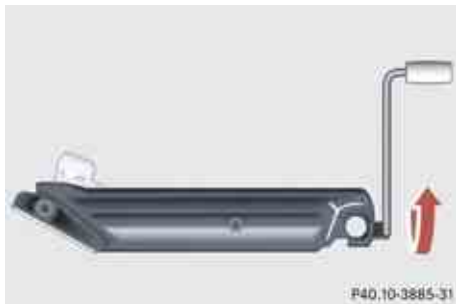

Operational position

- ▶ Turn the crank handle clockwise.

Before placing the jack back into the vehicle tool kit:

- ▶ Fully collapse the jack.
- ▶ Fold in the crank handle (storage position).

Spare wheel

⚠ Observe Safety notes, see page 547.

The spare wheel is located in the space underneath the trunk floor.

- ▶ **Removing:** Open the trunk (▶ page 296).
- ▶ Lift the trunk floor using the floor handle.
- ▶ Engage the floor handle on the upper trunk lip.

! To prevent damage, always disengage the floor handle from the upper trunk lip and lower the trunk floor before closing the trunk.

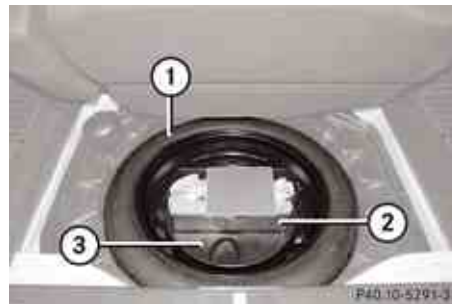

- ① Spare wheel
- ② Vehicle tool kit box
- ③ Spare wheel mounting

- ▶ Remove spare wheel mounting ③ by turning it counterclockwise.

i Vehicle tool kit box ② can only be removed together with spare wheel mounting ③. After removing spare wheel mounting ③, you can disengage vehicle tool kit box ② from spare wheel mounting ③.

- ▶ Remove spare wheel ①.

The spare wheel bolts are located in a container on the spare wheel rim.

- ▶ Take off the spare wheel bolts.

For information on mounting the spare wheel, see “Flat tire” (▶ page 547).

Storing the spare wheel after use

- ▶ Place spare wheel ① into the spare wheel well (▶ page 474).
- ▶ Secure spare wheel ① by turning spare wheel mounting ③ clockwise (▶ page 474).

Vehicle status messages in the multifunction display

Vehicle status messages in the multifunction display



Notes

Warning and malfunction messages appear in the multifunction display located in the instrument cluster.



Certain warning and malfunction messages are accompanied by an audible signal.

Address these messages accordingly and follow the additional instructions given in this Operator's Manual.

High-priority messages are shown in red in the multifunction display. Messages of lower priority are also shown in yellow or white.

Certain messages of high priority cannot be cleared from the multifunction display using  or  on the multifunction steering wheel (▷ page 232).

Other messages of high priority and messages of less immediate priority can be

cleared from the multifunction display using  or . They are then stored in the Vehicle status message memory (▷ page 245). Remember that clearing a message will only make the message disappear. Clearing a message will not correct the condition that caused the message to appear.

Warning!

All categories of messages contain important information which should be taken note of and, where a malfunction is indicated, addressed as soon as possible at an authorized Mercedes-Benz Center.

Failure to repair the condition noted may cause damage not covered by the Mercedes-Benz Limited Warranty, or result in property damage or personal injury.

Warning!

No messages will be displayed if either the instrument cluster or the multifunction display is inoperative.

As a result, you will not be able to see information about your driving conditions, such as speed or outside temperature, warning/indicator lamps, malfunction/warning messages or the failure of any systems. Driving characteristics may be impaired.

If you must continue to drive, please do so with added caution. Contact an authorized Mercedes-Benz Center as soon as possible.

On the pages that follow, you will find a compilation of the most important warning and malfunction messages that may appear in the multifunction display.

For your convenience the messages are divided into text messages (▷ page 476) and symbol messages (▷ page 490).

Vehicle status messages in the multifunction display

Text messages



Safety systems

Display messages	Possible cause/consequence	Possible solution
<p>PRE-SAFE Inoperative See Oper. Manual</p>	<p>The PRE-SAFE® system itself has failed. All other occupant safety systems, such as the air bags, are still available.</p>	<p>► Contact an authorized Mercedes-Benz Center as soon as possible.</p>
<p>PRE-SAFE Function Currently Limited See Oper. Manual</p>	<p>The PRE-SAFE® Brake is switched off and is temporarily unavailable. The PRE-SAFE® Brake is deactivated if:</p> <ul style="list-style-type: none"> • the DISTRONIC Plus cover in the radiator grille is dirty • the area around the sensors in the front or the rear bumper is dirty • its function is impaired as a result of heavy precipitation • the radar sensor system is temporarily inoperative due to electromagnetic interference near television and radio transmitter stations, toll stations, speed measuring systems, etc. • the system is out of the operating temperature range • the battery voltage is insufficient 	<p>The PRE-SAFE® Brake becomes operational again and the message in the multifunction display disappears when:</p> <ul style="list-style-type: none"> • dirt on the radiator grille has fallen off while driving (e.g. slush or snow) • the system recognizes full sensor availability (due to lessening rain or the road surface drying) • the system is within the operating temperature range <p>If the message in the multifunction display does not disappear:</p> <ul style="list-style-type: none"> ► Clean the DISTRONIC Plus cover in the radiator grille (▷ page 465). ► Clean the front and the rear bumper (▷ page 465). ► Restart the vehicle. ► Wait until the battery recovers.

Vehicle status messages in the multifunction display

Display messages	Possible cause/consequence	Possible solution
PRE-SAFE Function Limited See Oper. Manual	The PRE-SAFE® Brake is unavailable due to a malfunction. The BAS Plus may also be unavailable.	▶ Contact an authorized Mercedes-Benz Center as soon as possible.

Vehicle status messages in the multifunction display

Display messages	Possible cause/consequence	Possible solution
<p>Front Passenger Airbag Enabled See Oper. Manual</p>	<p>The front passenger front air bag is activated while driving even though a child, small individual, or object below the system's weight threshold is on the front passenger seat, or the front passenger seat is empty. Objects on the seat or forces acting on the seat may make the system sense supplemental weight.</p>	<ul style="list-style-type: none"> ▶ Stop the vehicle in a safe location as soon as possible. ▶ Engage the electronic parking brake. ▶ Switch off the ignition. ▶ Open the passenger door. ▶ Remove child and child restraint from front passenger seat and properly secure the child in rear seat employing the child restraint if necessary. ▶ Make sure no objects which apply supplemental weight to the seat are present. The system may recognize such supplemental weight and sense that an occupant on the front passenger seat is of a greater weight than actually present. ▶ Keep the seat unoccupied, close the passenger door and switch on the ignition. <p>Monitor the  PASS AIR BAG OFF indicator lamp right of the instrument cluster (▷ page 51) and the multifunction display in the instrument cluster (▷ page 30) for the following:</p> <p>With the seat unoccupied and the ignition switched on,</p> <ul style="list-style-type: none"> • the  PASS AIR BAG OFF indicator lamp right of the instrument cluster should illuminate and remain illuminated, indicating that the OCS

Vehicle status messages in the multifunction display

Display messages	Possible cause/consequence	Possible solution
		<p>(▷ page 48) has deactivated the front passenger front air bag.</p> <ul style="list-style-type: none"> the message Front Passenger Airbag Enabled See Oper. Manual or the message Front Passenger Airbag Disabled See Oper. Manual should not appear in the multifunction display at any time the seat is unoccupied. Wait at least 60 seconds for the system to complete the necessary check cycles and to make sure neither message appears in the multifunction display. <p>If above conditions are met, you can occupy the front passenger seat again. Depending on the front passenger classification sensed by the OCS, the  PASS AIR BAG OFF indicator lamp will remain illuminated or go out.</p> <p>If above conditions are not met, the system is not working properly. Have the system checked as soon as possible at an authorized Mercedes-Benz Center.</p>



 **Warning!**

If the  **PASS AIR BAG OFF** indicator lamp remains out even after performing the

above corrective steps, do not have any children 12 years old and under and other



small individuals use the front passenger seat until the system has been repaired.

Vehicle status messages in the multifunction display

Display messages	Possible cause/consequence	Possible solution
<p>Front Passenger Airbag Disabled See Oper. Manual</p>	<p>The front passenger front air bag is deactivated while driving even though an adult or someone larger than a small individual is occupying the front passenger seat. Forces acting on the seat may make the system sense a decrease in weight.</p>	<ul style="list-style-type: none"> ▶ Stop the vehicle in a safe location as soon as possible. ▶ Engage the electronic parking brake. ▶ Switch off the ignition. ▶ Have the front passenger vacate the seat and exit the vehicle. ▶ Keep the seat unoccupied, close the passenger door and switch on the ignition. <p>Monitor the  PASS AIR BAG OFF indicator lamp right of the instrument cluster (▷ page 51) and the multifunction display in the instrument (▷ page 30) cluster for the following: With the seat unoccupied and the ignition switched on,</p> <ul style="list-style-type: none"> • the  PASS AIR BAG OFF indicator lamp right of the instrument cluster should illuminate and remain illuminated, indicating that the OCS (▷ page 48) has deactivated the front passenger front air bag. • the message Front Passenger Airbag Enabled See Oper. Manual or the message Front Passenger Airbag Disabled See Oper. Manual should not appear in the multifunction display at any time the seat is unoccupied. Wait at least 60 seconds for the system to complete the necessary check

Vehicle status messages in the multifunction display

Display messages	Possible cause/consequence	Possible solution
		<p>cycles and to make sure neither message appears in the multifunction display.</p> <p>If above conditions are met, you can occupy the front passenger seat again. Depending on the front passenger classification sensed by the OCS, the  PASS AIR BAG OFF indicator lamp will remain illuminated or go out.</p> <p>If above conditions are not met, the system is not working properly. Have the system checked as soon as possible at an authorized Mercedes-Benz Center.</p>

 **Warning!**
 If the  **PASS AIR BAG OFF** indicator lamp remains illuminated with an adult occupant

on the front passenger seat even after performing the above corrective steps, do not have any passenger use the front

passenger seat until the system has been repaired.

Driving systems

Display messages	Possible cause/consequence	Possible solution
Cruise Control - - - mph	One of the activation conditions for the cruise control has not been fulfilled. For example, you have attempted to set a speed below 20 mph (30 km/h).	<ul style="list-style-type: none"> ▶ Drive faster than 20 mph (30 km/h), if the situation allows, and set the speed. ▶ Check the activation conditions for the cruise control (▷ page 347).
Cruise Control Inoperative	The cruise control is malfunctioning.	<ul style="list-style-type: none"> ▶ Have the cruise control checked at an authorized Mercedes-Benz Center.



Vehicle status messages in the multifunction display

Display messages	Possible cause/consequence	Possible solution
DISTRONIC PLUS Currently Unavailable See Oper. Manual	<p>The DISTRONIC Plus is switched off and is temporarily unavailable.</p> <p>The DISTRONIC Plus is deactivated if:</p> <ul style="list-style-type: none"> • the DISTRONIC Plus cover in the radiator grille is dirty • its function is impaired as a result of heavy precipitation • the radar sensor system is temporarily inoperative due to electromagnetic interference near television and radio transmitter stations, toll stations, speed measuring systems, etc. • the radar sensors do not sense any other vehicles or objects, i.e. road sign or similar to this, for a long time • the system is out of the operating temperature range • the battery voltage is insufficient 	<ul style="list-style-type: none"> ▶ If necessary, clean the DISTRONIC Plus cover in the radiator grille (▷ page 465). ▶ Restart the vehicle. ▶ Try activating the DISTRONIC Plus again later. ▶ Wait until the system is within the operating temperature range or the battery recovers. <p>The DISTRONIC Plus becomes operational again without the engine being restarted when:</p> <ul style="list-style-type: none"> • dirt on the radiator grille has fallen off while driving (e.g. slush or snow) • the system recognizes full sensor availability (due to lessening rain or the road surface drying) • the message in the multifunction display disappears
DISTRONIC PLUS Inoperative	<p>The DISTRONIC Plus is malfunctioning. The BAS Plus and the PRE-SAFE® Brake are also not available.</p>	<ul style="list-style-type: none"> ▶ Contact an authorized Mercedes-Benz Center as soon as possible.
DISTRONIC PLUS Override	<p>You have accelerated. The DISTRONIC Plus has switched off.</p>	<ul style="list-style-type: none"> ▶ Stop accelerating.

Vehicle status messages in the multifunction display

Display messages	Possible cause/consequence	Possible solution
DISTRONIC PLUS - - - mph	One of the activation conditions for the DISTRONIC Plus has not been fulfilled. For example, you have attempted to set a speed below 20 mph (30 km/h).	<ul style="list-style-type: none"> ▶ Drive faster than 20 mph (30 km/h), if the situation allows, and set the speed. ▶ Check the activation conditions for the DISTRONIC Plus (▷ page 355).
Park Assist Currently Unavailable See Oper. Manual	The Park Assist is deactivated because the area around the sensors in the front or the rear bumper is dirty.	▶ Clean the front and rear bumper (▷ page 465).
	The Park Assist is deactivated because the battery voltage is insufficient.	▶ Have the battery checked at an authorized Mercedes-Benz Center.
	The Park Assist is switched off because the radar sensor system is temporarily inoperative due to electromagnetic interference near television and radio transmitter stations, toll stations, speed measuring systems, etc.	▶ Wait until the message in the multifunction display disappears.
Park Assist Inoperative	The Park Assist is unavailable due to a malfunction.	▶ Contact an authorized Mercedes-Benz Center as soon as possible.



Vehicle status messages in the multifunction display

Display messages		Possible cause/consequence	Possible solution
Blind Spot Assist	Currently Unavailable See Oper. Manual	The Blind Spot Assist is deactivated because the area around the sensors in the front or the rear bumper is dirty.	▶ Clean the front and rear bumper (▷ page 465).
		The Blind Spot Assist is deactivated because the battery voltage is insufficient.	▶ Have the battery checked at an authorized Mercedes-Benz Center.
		The Blind Spot Assist is switched off because the radar sensor system is temporarily inoperative due to electromagnetic interference near television and radio transmitter stations, toll stations, speed measuring systems, etc.	▶ Wait until the message in the multifunction display disappears.
Blind Spot Assist	Inoperative	The Blind Spot Assist is unavailable due to a malfunction.	▶ Contact an authorized Mercedes-Benz Center as soon as possible.

Vehicle status messages in the multifunction display

Display messages	Possible cause/consequence	Possible solution
Parking Guidance Currently Unavailable See Oper. Manual	The Advanced Parking Guidance is deactivated because the area around the sensors in the front or the rear bumper is dirty.	► Clean the front and rear bumper (▷ page 465).
	The Advanced Parking Guidance is deactivated because the battery voltage is insufficient.	► Have the battery checked at an authorized Mercedes-Benz Center.
	The Advanced Parking Guidance is switched off because the radar sensor system is temporarily inoperative due to electromagnetic interference near television and radio transmitter stations, toll stations, speed measuring systems, etc.	► Wait to see if the interference is temporary or do not use Advanced Parking Guidance. Try in a location where the interfering transmission might not be present.
Parking Guidance Canceled	The Advanced Parking Guidance has been canceled because: <ul style="list-style-type: none"> • the vehicle is sliding • the bumper became dirty in the area of the sensors • there has been a malfunction 	► Use the Advanced Parking Guidance again later. If the parking space symbol is not shown in the multifunction display at a speed below 10 mph (16 km/h): ► Clean the bumpers (▷ page 465). or ► Restart the engine. or ► Contact an authorized Mercedes-Benz Center.



Vehicle status messages in the multifunction display

Display messages	Possible cause/consequence	Possible solution
Parking Guidance Finished	Advanced Parking Guidance: The vehicle is in the end position.	The display message disappears automatically.
Radar Sensors Deactivated See Oper. Manual	You have attempted to activate the DISTRONIC Plus, the Park Assist or the PRE-SAFE® Brake even though you have switched off the radar sensors on the vehicle.	<ul style="list-style-type: none"> ▶ Check if the radar sensors may be switched on (▷ page 247). ▶ Switch on the radar sensors using the instrument cluster control system.

Vehicle

Display messages	Possible cause/consequence	Possible solution
Apply Brake to Shift from 'P'	You have attempted to shift the automatic transmission into drive position D , reverse gear R or neutral position N without depressing the brake pedal.	▶ Depress the brake pedal.
Door Open Vehicle Not in Park	You have opened the driver's door and the automatic transmission is still in drive position D , reverse gear R or neutral position N .	▶ Before you leave the vehicle, make sure the automatic transmission is in park position P and the electronic parking brake is engaged.
Only Shift to Position 'P' When Vehicle Is Stationary	You have attempted to shift the automatic transmission into park position P although the vehicle was still in motion.	<ul style="list-style-type: none"> ▶ Stop your vehicle as soon as it is safe to do so. ▶ Shift the automatic transmission to park position P. ▶ Engage the electronic parking brake.

Vehicle status messages in the multifunction display

Display messages	Possible cause/consequence	Possible solution
Shift to P or N to Start Engine	You have attempted to start the engine while the automatic transmission was in reverse gear R or drive position D .	▶ Shift the automatic transmission into park position P or neutral position N .
Auxiliary Battery Malfunction	The backup battery for the automatic transmission is no longer charging.	▶ Contact an authorized Mercedes-Benz Center.
Auxiliary Battery Malfunction	The backup battery for the automatic transmission is discharged. In case of failure of the on-board electrical system, you may not be able change transmission positions.	<ul style="list-style-type: none"> ▶ Stop the vehicle in a safe location or as soon as it is safe to do so. ▶ Engage the electronic parking brake. ▶ Do not drive any further. ▶ Contact an authorized Mercedes-Benz Center or call Roadside Assistance.
Service Required Do Not Shift Gears	The automatic transmission cannot be shifted out of the set position because of a malfunction.	<p>If the automatic transmission is in drive position D:</p> <ul style="list-style-type: none"> ▶ Without shifting the automatic transmission out of drive position D, drive to an authorized Mercedes-Benz Center. <p>If the automatic transmission is set to position neutral position N, reverse gear R or park position P:</p> <ul style="list-style-type: none"> ▶ Do not drive. ▶ Contact an authorized Mercedes-Benz Center.
Next Service X in ... days in ... mls (km)	The specified maintenance service must be carried out within the remaining time range or driving distance (> page 460).	▶ Have the maintenance service carried out at an authorized Mercedes-Benz Center.



Vehicle status messages in the multifunction display

Display messages	Possible cause/consequence	Possible solution
Service X Due	The specified maintenance service must be carried out (▷ page 460).	▶ Have the maintenance service carried out at an authorized Mercedes-Benz Center as soon as possible.
Service X Exceeded by X days by XXX mls (km)	The specified maintenance service term has been exceeded (▷ page 461).	▶ Have the maintenance service carried out at an authorized Mercedes-Benz Center as soon as possible.

! Failure to have the vehicle maintained in accordance with the Maintenance Booklet

and maintenance service indicator at the designated times/mileage will result in

vehicle damage not covered by the Mercedes-Benz Limited Warranty.

Tires

Display messages	Possible cause/consequence	Possible solution
Tire Pressures Displayed After Driving A Few Minutes	The tire inflation pressure is being checked.	▶ Drive the vehicle for a few minutes.
Tire Pressure Monitor Inoperative	The Advanced TPMS or a wheel sensor is malfunctioning.	▶ Have the Advanced TPMS checked at an authorized Mercedes-Benz Center.
Tire Pressure Monitor Inoperative No Wheel Sensors	The Advanced TPMS is deactivated because wheels without proper sensors were installed.	▶ Have the appropriate wheel sensors installed at an authorized Mercedes-Benz Center. As soon as all wheels with sensors have been mounted, the Advanced TPMS is switched back on after driving for several minutes.

Vehicle status messages in the multifunction display

Display messages	Possible cause/consequence	Possible solution
Tire Pressure Monitor Currently Unavailable	The Advanced TPMS is unable to monitor the tire inflation pressure due to: <ul style="list-style-type: none"> • a nearby radio interference source • the on-board voltage is too low • excessive wheel sensor temperatures 	As soon as the causes of the malfunction have been removed, the Advanced TPMS becomes active again automatically after a few minutes driving.

 **Warning!**

Do not drive with a flat tire. A flat tire affects the ability to steer or brake the vehicle. You may lose control of the vehicle. Continued driving with a flat tire will cause excessive heat build-up and possibly a fire.

 **Warning!**

Follow recommended tire inflation pressures.



Do not underinflate tires. Underinflated tires wear excessively and/or unevenly, adversely affect handling and fuel economy, and are more likely to fail from being overheated.

Do not overinflate tires. Overinflated tires can adversely affect handling and ride comfort, wear unevenly, increase stopping distance, and result in sudden deflation (blowout) because they are more likely to become punctured or damaged by road debris, potholes etc.

Vehicle status messages in the multifunction display

Symbol messages

Brake





Display messages	Possible cause/consequence	Possible solution
 <p>(USA only)</p>  <p>(Canada only)</p>	<p>Check Brake Fluid Level</p> <p>There is insufficient brake fluid in the reservoir.</p>	<p>Risk of accident!</p> <ul style="list-style-type: none"> ▶ Stop the vehicle in a safe location or as soon as it is safe to do so. ▶ Engage the electronic parking brake. ▶ Do not drive any further. ▶ Contact an authorized Mercedes-Benz Center or call Roadside Assistance. <p>Do not add brake fluid! This will not solve the problem.</p>

Warning!



Driving with the message **Check Brake Fluid Level** displayed can result in an accident. Have your brake system checked immediately. Do not add brake fluid before checking the brake system. Overfilling the brake fluid reservoir can result in spilling brake fluid on hot engine parts and the brake fluid catching fire. You can be seriously burned.

! If you find that the brake fluid in the brake fluid reservoir has fallen to the minimum mark or below, have the brake system checked for brake pad thickness and leaks.



Vehicle status messages in the multifunction display

Display messages	Possible cause/consequence	Possible solution
<div data-bbox="98 193 252 309">  </div> <p data-bbox="312 193 533 221">Brake Immediately</p> <p data-bbox="98 316 209 344">(USA only)</p> <div data-bbox="98 348 252 456">  </div> <p data-bbox="98 462 240 490">(Canada only)</p>	<p data-bbox="571 193 922 249">A malfunction has occurred while DISTRONIC Plus was switched on.</p>	<ul style="list-style-type: none"> <li data-bbox="1013 193 1514 311">▶ While observing surrounding traffic conditions and when it is safe, immediately depress the brake pedal firmly until the warning message disappears. <li data-bbox="1013 316 1514 372">▶ Secure vehicle from rolling away before getting out of it (▷ page 333).
<div data-bbox="98 512 252 628">  </div> <p data-bbox="312 512 533 602">EBR, ABS, and ESP Inoperative See Oper. Manual</p> <p data-bbox="98 633 209 661">(USA only)</p> <div data-bbox="98 665 252 773">  </div> <p data-bbox="98 779 240 807">(Canada only)</p>	<p data-bbox="571 512 991 658">The brake system is still functioning normally but due to a malfunction, the ABS, the BAS, the BAS Plus, the EBP, the ESP®, the PRE-SAFE® and the PRE-SAFE® Brake are unavailable.</p>	<ul style="list-style-type: none"> <li data-bbox="1013 512 1514 602">▶ Continue driving with added caution. Wheels may lock during hard braking, reducing steering capability. <li data-bbox="1013 608 1514 664">▶ Adjust driving to be consistent with reduced braking responsiveness. <li data-bbox="1013 669 1514 725">▶ Have the system checked at an authorized Mercedes-Benz Center as soon as possible. <p data-bbox="1013 731 1514 787">Failure to follow these instructions increases the risk of an accident.</p>





Vehicle status messages in the multifunction display

Display messages	Possible cause/consequence	Possible solution
<div data-bbox="86 197 237 311">  <p>BRAKE</p> </div> <div data-bbox="86 318 193 344"> <p>(USA only)</p> </div> <div data-bbox="86 348 237 460">  </div> <div data-bbox="86 468 228 495"> <p>(Canada only)</p> </div>	<p>Service See Oper. Manual</p> <p>CL 600 and CL 65 AMG only: The brake system sensors are malfunctioning. The brake system continues to function normally with full brake force boost.</p>	<ul style="list-style-type: none"> ▶ Continue driving with added caution. ▶ Have the system checked at an authorized Mercedes-Benz Center as soon as possible.



Vehicle status messages in the multifunction display

Display messages	Possible cause/consequence	Possible solution
<div data-bbox="100 194 252 309">  </div> <p data-bbox="100 318 209 344">(USA only)</p> <div data-bbox="100 348 252 458">  </div> <p data-bbox="100 467 240 493">(Canada only)</p> <p data-bbox="312 194 517 250">Parking Brake See Oper. Manual</p>	<p data-bbox="571 194 991 306">In addition, the red indicator lamp for the electronic parking brake is either on or off and the yellow warning lamp for the electronic parking brake comes on.</p> <p data-bbox="571 318 887 374">The electronic parking brake is malfunctioning.</p>	<p data-bbox="1013 194 1126 221">To release:</p> <ul data-bbox="1013 232 1501 393" style="list-style-type: none"> ▶ Pull handle of electronic parking brake. or ▶ Drive off carefully. ▶ Contact an authorized Mercedes-Benz Center as soon as possible. <p data-bbox="1013 400 1126 427">To engage:</p> <ul data-bbox="1013 439 1501 554" style="list-style-type: none"> ▶ Switch off ignition and press handle for electronic parking brake for at least 10 seconds, until the warning message in the multifunction display disappears. <p data-bbox="1013 562 1461 589">If the warning message does not disappear:</p> <ul data-bbox="1013 600 1501 810" style="list-style-type: none"> ▶ Shift the automatic transmission to park position P (▷ page 336). ▶ Protect vehicle from rolling away while parked by using a chock from the vehicle tool kit (▷ page 473). ▶ Contact an authorized Mercedes-Benz Center as soon as possible.

Vehicle status messages in the multifunction display





Display messages	Possible cause/consequence	Possible solution
<div data-bbox="86 196 237 311">  </div> <div data-bbox="86 318 193 344">(USA only)</div> <div data-bbox="86 348 237 460">  </div> <div data-bbox="86 467 228 493">(Canada only)</div>	<p>Parking Brake See Oper. Manual</p> <p>In addition, the red indicator lamp for the electronic parking brake flashes. The power supply for the electronic parking brake was malfunctioning or the electronic parking brake was previously mechanically released.</p>	<ul style="list-style-type: none"> ▶ Pull handle of electronic parking brake. or ▶ Drive off carefully. or ▶ Press handle for electronic parking brake until the warning message in the multifunction display disappears.
<div data-bbox="86 512 237 628">  </div> <div data-bbox="86 635 193 661">(USA only)</div> <div data-bbox="86 665 237 777">  </div> <div data-bbox="86 784 228 810">(Canada only)</div>	<p>Parking Brake See Oper. Manual</p> <p>In addition, the red indicator lamp for the electronic parking brake flashes and the yellow warning lamp for the electronic parking brake comes on. The electronic parking brake is malfunctioning.</p>	<ul style="list-style-type: none"> ▶ Switch ignition off and back on again, and engage or release electronic parking brake. or ▶ Drive off carefully. ▶ Contact an authorized Mercedes-Benz Center as soon as possible.

Vehicle status messages in the multifunction display



Display messages	Possible cause/consequence	Possible solution
<div data-bbox="100 194 252 309">  </div> <p data-bbox="312 194 517 250">Parking Brake See Oper. Manual</p> <p data-bbox="100 318 209 342">(USA only)</p> <div data-bbox="100 348 252 458">  </div> <p data-bbox="100 469 240 493">(Canada only)</p>	<p data-bbox="571 194 991 306">When you engage or release the electronic parking brake, the red indicator lamp for the electronic parking brake flashes for approx. 10 seconds. Afterward, it goes out or comes on continuously. The yellow warning lamp for the electronic parking brake comes on.</p> <p data-bbox="571 306 991 490">The electronic parking brake is malfunctioning or overheated for example due to overvoltage or undervoltage.</p>	<ul style="list-style-type: none"> <li data-bbox="1013 194 1225 219">▶ Drive off carefully. <li data-bbox="1013 230 1506 284">▶ Contact an authorized Mercedes-Benz Center as soon as possible. <p data-bbox="1013 295 1465 320">In the event of overvoltage or undervoltage:</p> <ul style="list-style-type: none"> <li data-bbox="1013 331 1506 418">▶ Remove the cause of the overvoltage or undervoltage, e.g. charge the battery or restart the engine. <li data-bbox="1013 430 1481 483">▶ Switch ignition off and back on again, and engage or release electronic parking brake. <p data-bbox="1013 495 1474 544">If the electronic parking brake still cannot be released:</p> <ul style="list-style-type: none"> <li data-bbox="1013 555 1506 609">▶ Contact an authorized Mercedes-Benz Center as soon as possible. <p data-bbox="1013 620 1155 645">If overheated:</p> <ul style="list-style-type: none"> <li data-bbox="1013 656 1465 710">▶ Let vehicle cool down, and do not engage electronic parking brake during this time. <p data-bbox="1013 721 1038 745">or</p> <ul style="list-style-type: none"> <li data-bbox="1013 757 1481 810">▶ Switch ignition off and back on again, and engage or release electronic parking brake.





Vehicle status messages in the multifunction display

Display messages	Possible cause/consequence	Possible solution
<div data-bbox="86 194 237 309">  <p>(USA only)</p> </div> <div data-bbox="86 348 237 462">  <p>(Canada only)</p> </div>	<p>Parking Brake Inoperative</p> <p>When you engage or release the electronic parking brake, the red indicator lamp for the electronic parking brake flashes and goes out after approx. 10 seconds. The yellow warning lamp for the electronic parking brake comes on. The electronic parking brake is malfunctioning.</p>	<ul style="list-style-type: none"> ▶ Switch ignition off and back on again, and engage or release electronic parking brake. <p>If the electronic parking brake cannot be engaged:</p> <ul style="list-style-type: none"> ▶ Shift the automatic transmission to park position P (▷ page 336). ▶ Protect vehicle from rolling away while parked by using a chock from the vehicle tool kit (▷ page 473). ▶ Contact an authorized Mercedes-Benz Center as soon as possible.
<div data-bbox="86 566 237 680">  <p>(USA only)</p> </div> <div data-bbox="86 720 237 834">  <p>(Canada only)</p> </div>	<p>Please Release Parking Brake</p> <p>In addition, the red indicator lamp for the electronic parking brake flashes and an acoustic warning sounds. You are driving with the electronic parking brake engaged, or you are carrying out an emergency brake application with the electronic parking brake (▷ page 333).</p>	<ul style="list-style-type: none"> ▶ Release electronic parking brake. <p>or</p> <ul style="list-style-type: none"> ▶ Drive off carefully. <p>or</p> <ul style="list-style-type: none"> ▶ Release the handle for electronic parking brake.

Vehicle status messages in the multifunction display

Display messages	Possible cause/consequence	Possible solution
<div data-bbox="100 194 252 309">  </div> <p data-bbox="312 194 496 253">Please Release Parking Brake</p> <p data-bbox="100 318 209 342">(USA only)</p> <div data-bbox="100 348 252 458">  </div> <p data-bbox="100 467 240 491">(Canada only)</p>	<p data-bbox="571 194 991 337">In addition, the red indicator lamp for the electronic parking brake flashes, the yellow warning lamp for the electronic parking brake comes on and an acoustic warning sounds.</p> <p data-bbox="571 348 906 430">The electronic parking brake is malfunctioning; braking action is restricted.</p>	<p data-bbox="1013 194 1150 219">While driving:</p> <ul data-bbox="1013 230 1461 286" style="list-style-type: none"> ▶ Release the handle for electronic parking brake. <p data-bbox="1013 297 1222 322">While at a standstill:</p> <ul data-bbox="1013 333 1485 445" style="list-style-type: none"> ▶ Switch off ignition and press handle for electronic parking brake until the warning message disappears from the multifunction display. <p data-bbox="1013 456 1461 481">If the warning message does not disappear:</p> <ul data-bbox="1013 492 1509 705" style="list-style-type: none"> ▶ Shift the automatic transmission to park position P (▷ page 336). ▶ Protect vehicle from rolling away while parked by using a chock from the vehicle tool kit (▷ page 473). ▶ Contact an authorized Mercedes-Benz Center as soon as possible.

Vehicle status messages in the multifunction display



Display messages	Possible cause/consequence	Possible solution
 <p>Turn On the Ignition to Release the Parking Brake</p> <p>(USA only)</p>  <p>(Canada only)</p>	<p>In addition, the red indicator lamp for the electronic parking brake comes on.</p> <p>You have tried to release the electronic parking brake, but the ignition was not switched on.</p>	<p>► Switch on the ignition.</p>
 <p>Check Brake Pad Wear</p>	<p>The brake pads have reached their wear limit.</p>	<p>► Have the brake pads replaced as soon as possible.</p>

! Brake pad thickness must be visually inspected by a qualified technician at the



intervals specified in the Maintenance Booklet.

Vehicle status messages in the multifunction display





Safety systems

Display messages	Possible cause/consequence	Possible solution
 <p>ABS and ESP Inoperative See Oper. Manual</p>	<p>The brake system is still functioning normally but due to a malfunction, the ABS, the BAS, the BAS Plus, the ESP[®], the PRE-SAFE[®] system and the PRE-SAFE[®] Brake are unavailable.</p>	<ul style="list-style-type: none"> ▶ Continue driving with added caution. Wheels may lock during hard braking, reducing steering capability. ▶ Have the system checked at an authorized Mercedes-Benz Center as soon as possible. <p>Failure to follow these instructions increases the risk of an accident.</p>
 <p>ABS and ESP Currently Unavailable See Oper. Manual</p>	<p>The brake system is still functioning normally but due to a malfunction, the ABS, the BAS, the BAS Plus, the ESP[®], the PRE-SAFE[®] system and the PRE-SAFE[®] Brake are unavailable.</p> <p>The self-diagnosis may not be completed yet.</p>	<ul style="list-style-type: none"> ▶ Drive a short distance with added caution at a vehicle speed of above 12 mph (20 km/h). When the message disappears, the ABS and the ESP[®] are available again.
 <p>ABS and ESP Currently Unavailable See Oper. Manual</p>	<p>The brake system still functions normally but due to insufficient power supply, the ABS, the BAS, the BAS Plus, the ESP[®], the PRE-SAFE[®] system and the PRE-SAFE[®] Brake are not available.</p>	<p>When the voltage is above the required value again, the ABS, the BAS, the BAS Plus, the ESP[®] and the PRE-SAFE[®] system are operational again and the message should disappear.</p> <p>If the message does not disappear:</p> <ul style="list-style-type: none"> ▶ Have the alternator and the battery checked.

Vehicle status messages in the multifunction display







Display messages	Possible cause/consequence	Possible solution
 <p data-bbox="300 197 502 253">Inoperative See Oper. Manual</p>	<p data-bbox="555 197 983 320">ESP® as well as the PRE-SAFE® system are switched off due to a malfunction. In addition, the yellow ESP® warning lamp  comes on.</p> <p data-bbox="555 331 973 387">The ABS may not be operational and the following systems are not available:</p> <ul data-bbox="560 398 813 589" style="list-style-type: none"> • BAS and BAS Plus • PRE-SAFE® Brake • DISTRONIC Plus • Cruise control • Hill start assist system 	<ul data-bbox="999 197 1469 286" style="list-style-type: none"> ▶ Continue driving with added caution. ▶ Have the system checked at an authorized Mercedes-Benz Center as soon as possible. <p data-bbox="999 297 1493 353">Failure to follow these instructions increases the risk of an accident.</p>

Vehicle status messages in the multifunction display







Display messages	Possible cause/consequence	Possible solution
 <p>Inoperative See Oper. Manual</p>	<p>CL 600 and CL 65 AMG only: The ESP® as well as the PRE-SAFE® system are switched off due to a malfunction.</p> <p>In addition, the  and BRAKE (USA only) or  (Canada only) warning lamps in the instrument cluster come on.</p> <p>Brake force assistance is impaired and is sustained through an electric substitute function as long as the engine is running. The brake system continues to function normally. You will feel a pulsating effect at the brake pedal while braking.</p> <p>The BAS Plus and the PRE-SAFE® Brake are also not available.</p>	<ul style="list-style-type: none"> ▶ Continue driving with added caution. ▶ Have the system checked at an authorized Mercedes-Benz Center as soon as possible. <p>Failure to follow these instructions increases the risk of an accident.</p>
 <p>Currently Unavailable See Oper. Manual</p>	<p>The ESP® and the PRE-SAFE® system are temporarily unavailable. It is possible that the self-diagnostics have not yet completed.</p> <p>In addition, the yellow ESP® warning lamp  comes on.</p> <p>The brake system still functions normally. The BAS Plus and the PRE-SAFE® Brake are also not available.</p>	<p>Synchronize the ESP®:</p> <ul style="list-style-type: none"> ▶ Drive a short distance with gentle turns at a speed above 12 mph (20 km/h). The message disappears when ESP® is again available.



Vehicle status messages in the multifunction display

Display messages	Possible cause/consequence	Possible solution
 <p>ESP Currently Unavailable See Oper. Manual</p>	<p>The ESP® and the PRE-SAFE® system are switched off due to undervoltage. It is possible that the battery is not charged. The brake system still functions normally. The BAS Plus and the PRE-SAFE® Brake are also not available.</p>	<ul style="list-style-type: none"> ▶ Continue driving with added caution. ▶ Have the system checked at an authorized Mercedes-Benz Center as soon as possible. <p>Failure to follow these instructions increases the risk of an accident.</p>
 <p>ESP Currently Unavailable See Oper. Manual</p>	<p>If the yellow ESP® warning lamp  flashes while driving and this message appears, the Electronic Traction System (ETS/4-ETS) has switched off to prevent overheating of the drive wheel brakes. The BAS Plus and the PRE-SAFE® Brake are also not available.</p>	<p>As soon as the brakes have cooled off, the Electronic Traction System (ETS/4-ETS) switches on again. The message in the multifunction display disappears and the ESP® warning lamp  goes out.</p>
 <p>SOS Tele Aid Inoperative</p>	<p>One or more main functions of the Tele Aid system are malfunctioning.</p>	<ul style="list-style-type: none"> ▶ Have the Tele Aid system checked at an authorized Mercedes-Benz Center.
 <p>SRS Malfunction Service Required</p>	<p>There is a malfunction in the supplemental restraint systems. The air bags or Emergency Tensioning Devices (ETDs) could deploy unexpectedly or fail to activate in an accident.</p>	<ul style="list-style-type: none"> ▶ Drive with added caution to the nearest authorized Mercedes-Benz Center.

Vehicle status messages in the multifunction display

Display messages	Possible cause/consequence	Possible solution
 <p>Front Left SRS Malfunction Service Required</p>	<p>Components of the driver's supplemental restraint system may not work properly.</p>	<p>► Drive with added caution to the nearest authorized Mercedes-Benz Center.</p>
 <p>Front Right SRS Malfunction Service Required</p>	<p>Components of the front passenger's supplemental restraint system may not work properly.</p>	<p>► Drive with added caution to the nearest authorized Mercedes-Benz Center.</p>
 <p>Rear Left SRS Malfunction Service Required</p>	<p>Components of the left rear passenger's supplemental restraint system may not work properly.</p>	<p>► Drive with added caution to the nearest authorized Mercedes-Benz Center.</p>
 <p>Rear Center SRS Malfunction Service Required</p>	<p>Components of the center rear passenger's supplemental restraint system may not work properly.</p>	<p>► Drive with added caution to the nearest authorized Mercedes-Benz Center.</p>
 <p>Rear Right SRS Malfunction Service Required</p>	<p>Components of the right rear passenger's supplemental restraint system may not work properly.</p>	<p>► Drive with added caution to the nearest authorized Mercedes-Benz Center.</p>
 <p>Left Side Curtain Airbag Malfunction Service Required</p>	<p>The left window curtain air bag may not work properly.</p>	<p>► Drive with added caution to the nearest authorized Mercedes-Benz Center.</p>



Vehicle status messages in the multifunction display

Display messages	Possible cause/consequence	Possible solution
 <p>Right Side Curtain Airbag Malfunction Service Required</p>	<p>The right window curtain air bag may not work properly.</p>	<p>► Drive with added caution to the nearest authorized Mercedes-Benz Center.</p>





Warning!

In the event a malfunction of the SRS is indicated as outlined above, the SRS may not be operational.

For your safety, we strongly recommend that you contact an authorized Mercedes-Benz Center immediately to have the system checked. Otherwise the SRS may not be activated when needed in an accident, which could result in serious or fatal injury, or it might deploy unexpectedly and unnecessarily which could also result in injury.





Vehicle status messages in the multifunction display

Driving systems







Display messages		Possible cause/consequence	Possible solution
	Malfunction Stop Vehicle	You have started driving although the vehicle level is still too low. The vehicle is being raised. The ABC message goes out after a few seconds.	<ul style="list-style-type: none"> ▶ Stop your vehicle in a safe location or as soon as it is safe to do so. ▶ Engage the electronic parking brake. ▶ Wait until the message disappears from the multifunction display. You may then drive off.
	Malfunction Stop Vehicle	The vehicle is losing oil. The ABC message is continuously shown.	<ul style="list-style-type: none"> ▶ Stop your vehicle in a safe location or as soon as it is safe to do so. ▶ Engage the electronic parking brake. ▶ Call Roadside Assistance. <p>or</p> <ul style="list-style-type: none"> ▶ Contact an authorized Mercedes-Benz Center.
	Malfunction Stop Vehicle	The ABC is malfunctioning. The ABC message is continuously shown.	<ul style="list-style-type: none"> ▶ Avoid large steering maneuvers. The fenders or tires could otherwise be damaged. Listen for scraping noises. ▶ Do not drive faster than 50 mph (80 km/h). ▶ Contact an authorized Mercedes-Benz Center as soon as possible.
	Malfunction	The capability of the ABC system is restricted. This can impair handling.	<ul style="list-style-type: none"> ▶ Do not drive faster than 50 mph (80 km/h). ▶ Contact an authorized Mercedes-Benz Center as soon as possible.







Vehicle status messages in the multifunction display

Display messages	Possible cause/consequence	Possible solution
 <p>Vehicle Rising Please Wait Briefly</p>	<p>The vehicle's level is too low while at a standstill. The vehicle will be raised.</p>	<ul style="list-style-type: none"> ▶ Wait until the message disappears from the multifunction display.
 <p>STOP, Car Too Low</p>	<p>You have started driving although the vehicle level was too low. The vehicle will be raised.</p>	<ul style="list-style-type: none"> ▶ Stop your vehicle as soon as it is safe to do so. ▶ Engage the electronic parking brake. ▶ Wait until the message disappears from the multifunction display. You may then drive off.
 <p>STOP, Car Too Low</p>	<p>The AIRMATIC is malfunctioning.</p>	<ul style="list-style-type: none"> ▶ Stop and press the vehicle level control switch to select a higher vehicle level (▷ page 363). ▶ Avoid large steering maneuvers. The fenders or tires could otherwise be damaged. Listen for scraping noises. ▶ Do not drive faster than 50 mph (80 km/h). ▶ Contact an authorized Mercedes-Benz Center as soon as possible. <p>There is otherwise danger of an accident.</p>
 <p>Malfunction</p>	<p>The capability of the AIRMATIC system is restricted. This can impair the handling.</p>	<ul style="list-style-type: none"> ▶ Do not drive faster than 50 mph (80 km/h). ▶ Contact an authorized Mercedes-Benz Center as soon as possible.



Vehicle status messages in the multifunction display

Display messages	Possible cause/consequence	Possible solution
 <p>Vehicle Rising Please Wait Briefly</p>	Vehicles with AIRMATIC: The vehicle level is too low.	▶ Wait until the message disappears from the multifunction display.
 <p>Night View Assist Inoperative</p>	Night View Assist is malfunctioning.	▶ Contact an authorized Mercedes-Benz Center as soon as possible.
 <p>Night View Assist Currently Unavailable</p>	The temperature of the camera is too high (▷ page 380).	▶ Wait until the message Night View Assist Available Again appears. In addition you can: ▶ Swing the camera cover down (▷ page 466). ▶ Adjust the air distribution of the climate control so that air flows upward (▷ page 224).
 <p>Night View Assist Lights Must Be Set to AUTO or ON</p>	You have tried to switch on Night View Assist, but the exterior lamp switch is not set to A or  .	▶ Turn the exterior lamp switch to A or  (▷ page 316).
 <p>Night View Assist Not In Reverse Gear</p>	You have tried to switch on Night View Assist while the automatic transmission was in reverse gear R .	▶ Shift the automatic transmission to park position P , neutral position N or drive position D (▷ page 335).



Vehicle status messages in the multifunction display

Display messages	Possible cause/consequence	Possible solution
 <p>Night View Assist Lights ON or AUTO, Not in R Gear</p>	<p>You have tried to switch on Night View Assist, but the light switch is not set to A or .</p> <p>In addition, the automatic transmission is in reverse gear R.</p>	<ul style="list-style-type: none"> ▶ Turn the exterior lamp switch to A or  (▷ page 316). ▶ Shift the automatic transmission to park position P, neutral position N or drive position D (▷ page 335).
 <p>Night View Assist Only When It Is Dark</p>	<p>You have tried to switch on Night View Assist by daylight.</p>	<p>You can only switch on Night View Assist when it is dark.</p>



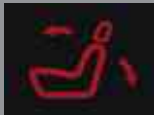

Vehicle

Display messages	Possible cause/consequence	Possible solution
	<p>You are driving with the hood open.</p>	<ul style="list-style-type: none"> ▶ Close the hood (▷ page 424).
	<p>You are driving with the trunk open.</p>	<ul style="list-style-type: none"> ▶ Close the trunk.





Vehicle status messages in the multifunction display

Display messages	Possible cause/consequence	Possible solution
	You are driving with at least one door open. The display symbol shows you which doors are open.	▶ Close all doors.
 Lock Seat Backrest Front Left or Lock Seat Backrest Front Right	The driver or front passenger seat backrest is not engaged. The driver's or front passenger's seat belt can not secure the driver or passenger.	▶ Fold back and push the seat backrest until the seat cushion and seat backrest audibly engage into the driving position.
 Shift to P	You have attempted to turn off the engine with the KEYLESS-GO start/stop button and opened the driver's door with the automatic transmission not shift to park position P .	▶ Shift the automatic transmission to park position P (▷ page 335). or ▶ Close the driver's door.
 Key Not Detected	The SmartKey with KEYLESS-GO is not detected while the engine is running because the SmartKey is not in the vehicle.	▶ Stop the vehicle as soon as it is safe to do so. ▶ Engage the electronic parking brake. ▶ Search for the SmartKey. Otherwise the vehicle cannot be locked centrally nor can the engine be started again after the engine is stopped.





Vehicle status messages in the multifunction display

Display messages	Possible cause/consequence	Possible solution
 <p>Key Not Detected</p>	<p>The SmartKey with KEYLESS-GO is not detected while the engine is running because there is strong radio-frequency interference.</p>	<ul style="list-style-type: none"> ▶ Stop the vehicle as soon as it is safe to do so. ▶ Engage the electronic parking brake. ▶ Remove KEYLESS-GO button from the starter switch (▶ page 302). ▶ Operate the vehicle with the SmartKey in the starter switch.
 <p>Key Not Detected</p>	<p>The SmartKey with KEYLESS-GO is momentarily not detected.</p>	<ul style="list-style-type: none"> ▶ Change the position of the SmartKey in the vehicle. ▶ If necessary, remove KEYLESS-GO button from the starter switch (▶ page 302). ▶ Operate the vehicle with the SmartKey in the starter switch.
 <p>Close Doors to Lock Vehicle</p>	<p>You wanted to lock the vehicle but not all doors were closed.</p>	<ul style="list-style-type: none"> ▶ Close doors and lock vehicle again.
 <p>Don't Forget Your Key</p>	<p>This display appears for a maximum of 60 seconds if the driver's door is opened with the engine turned off and no SmartKey in the starter switch. This message is only a reminder.</p>	<ul style="list-style-type: none"> ▶ Take the SmartKey with you when leaving the vehicle.

Vehicle status messages in the multifunction display

Display messages	Possible cause/consequence	Possible solution
 <p>Take Your Key From Ignition</p>	You have forgotten to remove the SmartKey from the starter switch.	▶ Remove the SmartKey from the starter switch.
 <p>Replace Key Battery</p>	The batteries in the SmartKey with KEYLESS-GO are discharged.	▶ Replace the batteries (▷ page 541).
 <p>Key Detected In Vehicle</p>	A SmartKey with KEYLESS-GO left in the vehicle was recognized while trying to lock the vehicle from the outside.	▶ Take the SmartKey out of the vehicle.
 <p>Key Not Detected</p>	The SmartKey with KEYLESS-GO is momentarily not detected.	<ul style="list-style-type: none"> ▶ Change the position of the SmartKey in the vehicle. ▶ If necessary, remove KEYLESS-GO button from the starter switch (▷ page 302). ▶ Operate the vehicle with the SmartKey in the starter switch.
 <p>Key Being Initialized... Please Wait</p>	The SmartKey with KEYLESS-GO is being initialized in the vehicle.	▶ Wait until the message disappears from the multifunction display.

Vehicle status messages in the multifunction display

Display messages	Possible cause/consequence	Possible solution
 <p>Remove 'Start' Button and Insert Key</p>	<p>The KEYLESS-GO system is malfunctioning.</p>	<ul style="list-style-type: none"> ▶ Remove KEYLESS-GO button from the starter switch (▷ page 302). ▶ Operate the vehicle with the SmartKey in the starter switch.
 <p>Obtain a New Key</p>	<p>The SmartKey with KEYLESS-GO must be replaced.</p>	<ul style="list-style-type: none"> ▶ Contact an authorized Mercedes-Benz Center as soon as possible.
 <p>Key Does Not Belong to Vehicle</p>	<p>The SmartKey or SmartKey with KEYLESS-GO in the starter switch does not belong to the vehicle.</p>	<ul style="list-style-type: none"> ▶ Remove the SmartKey from the starter switch.
 <p>Check Washer Fluid</p>	<p>The water level has dropped to approx. 1.1 US qts (1.0 l).</p>	<ul style="list-style-type: none"> ▶ Add washer fluid (▷ page 428).

Vehicle status messages in the multifunction display

Engine

Display messages	Possible cause/consequence	Possible solution
 <p data-bbox="316 241 517 328">Check Coolant Level See Oper. Manual</p>	<p data-bbox="571 241 858 264">The coolant level is too low.</p>	<ul style="list-style-type: none"> <li data-bbox="1013 241 1305 264">▶ Add coolant (▷ page 427). <li data-bbox="1013 275 1513 357">▶ If you have to add coolant frequently, have the cooling system checked at an authorized Mercedes-Benz Center.

 **Warning!**

Do not spill antifreeze on hot engine parts. Antifreeze contains ethylene glycol which may burn if it comes into contact with hot engine parts. You could be seriously burned.

! Do not ignore the low engine coolant level warning. Extended driving with the message and symbol displayed may cause serious engine damage not covered by the Mercedes-Benz Limited Warranty.

Do not drive without sufficient amount of coolant in the cooling system. The engine will overheat causing major engine damage.

Vehicle status messages in the multifunction display

Display messages	Possible cause/consequence	Possible solution
 <p data-bbox="300 194 494 281">Coolant Low Stop Vehicle Turn Engine Off</p>	<p data-bbox="555 194 786 219">The coolant is too hot.</p>	<ul style="list-style-type: none"> <li data-bbox="999 194 1481 247">▶ Stop the vehicle immediately as soon as it is safe to do so. <li data-bbox="999 258 1353 283">▶ Turn off the engine immediately. <li data-bbox="999 294 1398 319">▶ Engage the electronic parking brake. <li data-bbox="999 330 1490 412">▶ Only start the engine again after the message disappears. You could otherwise damage the engine. <li data-bbox="999 423 1495 476">▶ Observe the coolant temperature gauge in the instrument cluster. <p data-bbox="999 487 1490 568">During severe operation conditions and stop-and-go city traffic, the coolant temperature may rise close to 248°F (120°C).</p>

Warning!

Driving when your engine is overheated can cause some fluids which may have leaked into the engine compartment to catch fire. You could be seriously burned.

Steam from an overheated engine can cause serious burns which can occur just by opening the engine hood. Stay away from the engine if you see or hear steam coming from it.

Stop the vehicle in a safe location away from other traffic. Turn off the engine, get out of the vehicle and do not stand near the vehicle until the engine has cooled down.



! The engine should not be operated with the coolant temperature above 248°F (120°C). Doing so may cause serious damage which is not covered by the Mercedes-Benz Limited Warranty.

Vehicle status messages in the multifunction display



Display messages	Possible cause/consequence	Possible solution
 <p data-bbox="316 194 507 284">Coolant Low Stop Vehicle Turn Engine Off</p>	<p data-bbox="571 194 906 221">The poly-V-belt could be broken.</p>	<ul style="list-style-type: none"> <li data-bbox="1013 194 1497 250">▶ Stop the vehicle immediately as soon as it is safe to do so. <li data-bbox="1013 262 1369 288">▶ Turn off the engine immediately. <li data-bbox="1013 300 1417 327">▶ Engage the electronic parking brake. <li data-bbox="1013 338 1264 365">▶ Check the poly-V-belt. <li data-bbox="1013 376 1508 508">▶ If it is broken: Do not continue to drive. Otherwise the engine will overheat due to an inoperative water pump which may result in damage to the engine. Contact an authorized Mercedes-Benz Center. <li data-bbox="1013 519 1508 651">▶ If it is intact: Do not continue to drive the vehicle with this message displayed. Doing so could result in serious engine damage that is not covered by the Mercedes-Benz Limited Warranty. <li data-bbox="1013 663 1508 719">▶ Observe the coolant temperature gauge in the instrument cluster. <li data-bbox="1013 730 1232 757">▶ Restart the engine. <p data-bbox="1013 768 1508 824">If this message disappears from the multifunction display:</p> <ul style="list-style-type: none"> <li data-bbox="1013 835 1508 891">▶ Drive to the nearest authorized Mercedes-Benz Center immediately. <p data-bbox="1013 902 1508 958">If this message does not disappear from the multifunction display:</p> <ul style="list-style-type: none"> <li data-bbox="1013 969 1305 996">▶ Call Roadside Assistance.



Vehicle status messages in the multifunction display

Display messages	Possible cause/consequence	Possible solution
	<p>The cooling fan for the coolant is malfunctioning.</p>	<ul style="list-style-type: none"> ▶ Observe the coolant temperature gauge in the instrument cluster. If the coolant temperature is below 248°F (120°C), you may continue driving to an authorized Mercedes-Benz Center. ▶ Avoid placing heavy loads on the engine (e.g. by driving uphill) as well as stop-and-go traffic. ▶ Have the fan replaced as soon as possible.
	<p>The battery is no longer charging. Possible causes:</p> <ul style="list-style-type: none"> • alternator malfunctioning • broken poly-V-belt • a malfunction in the electronic system 	<ul style="list-style-type: none"> ▶ Stop immediately in a safe location or as soon as it is safe to do so and check the poly-V-belt. ▶ If it is broken: Do not continue to drive. Otherwise the engine will overheat due to an inoperative water pump which may result in damage to the engine. Contact an authorized Mercedes-Benz Center. ▶ If it is intact: Drive to the nearest authorized Mercedes-Benz Center immediately. Adjust driving to be consistent with reduced braking responsiveness.
 <p>Engine Oil Level Low Stop Vehicle Turn Engine Off</p>	<p>CL 600 and CL 65 AMG only: There is no oil in the engine. There is a danger of engine damage.</p>	<ul style="list-style-type: none"> ▶ Stop the vehicle in a safe location or as soon as it is safe to do so. ▶ Engage the electronic parking brake. ▶ Turn off the engine. ▶ Add engine oil (▷ page 426) and check the engine oil level (▷ page 424).

Vehicle status messages in the multifunction display

Display messages	Possible cause/consequence	Possible solution
 <p>Check Engine Oil Level (Add 1 quart) (USA only)</p>  <p>Check Engine Oil Level (Add 1 Liter) (Canada only)</p>	<p>CL 600 and CL 65 AMG only: The engine oil level is too low.</p>	<ul style="list-style-type: none"> ▶ Add engine oil (▷ page 426) and check the engine oil level (▷ page 424). ▶ If you must add engine oil frequently, have the engine checked for possible leaks.
 <p>Check Engine Oil at Next Refueling</p>	<p>CL 550 4MATIC and CL 63 AMG only: The engine oil level has dropped to approximately the minimum level.</p>	<ul style="list-style-type: none"> ▶ Check the engine oil level (▷ page 424) and add engine oil as required (▷ page 426). ▶ If you must add engine oil frequently, have the engine checked for possible leaks.

When the message Check Engine Oil at Next Refueling (CL 550 4MATIC and CL 63 AMG only) or Check Engine Oil Level (Add 1 quart) (Canada: 1 Liter) (CL 600 and CL 65 AMG) appears while the engine is running and at operating temperature, the engine oil level has dropped to approximately the minimum level.





The message will be stored in the vehicle status message memory after you have cleared it from the multifunction display.

Visually check for oil leaks. If there are no obvious oil leaks, drive to the nearest service station to refill your engine oil to the required level.

For information on approved engine oils contact an authorized Mercedes-Benz Center or visit **www.mbusa.com** (USA only).





! Engine oil level warnings should not be ignored. Extended driving with the symbol displayed could result in serious engine damage that is not covered by the Mercedes-Benz Limited Warranty.

Vehicle status messages in the multifunction display



Display messages	Possible cause/consequence	Possible solution
 <p>Engine Oil Level Cannot Be Measured</p>	<p>CL 600 and CL 65 AMG only: The measuring system is malfunctioning.</p>	<p>▶ Have the measuring system checked at an authorized Mercedes-Benz Center.</p>
 <p>Engine Oil Level Too High</p>	<p>CL 600 and CL 65 AMG only: You have added too much engine oil. There is a risk of damaging the engine or the catalytic converter.</p>	<p>▶ Have oil siphoned or drained off. Observe all legal requirements with respect to its disposal.</p>
 <p>Reserve Fuel</p>	<p>The fuel level has dropped below the reserve mark.</p>	<p>▶ Refuel at the next gas station.</p>
 <p>Gas Cap Loose</p>	<p>A loss of pressure has been detected in the fuel system. The fuel cap may not be closed properly or the fuel system may be leaky.</p>	<p>▶ Check the fuel cap (▷ page 421). ▶ If it is not closed properly: Close the fuel cap. ▶ If it is closed properly: Have the fuel system checked at an authorized Mercedes-Benz Center.</p>

Vehicle status messages in the multifunction display





Lamps

Display messages	Possible cause/consequence	Possible solution
 <p data-bbox="316 239 533 295">Check Center Brake Lamp</p>	<p data-bbox="571 239 986 351">The high mounted brake lamp is malfunctioning. This message will only appear if a critical number of LEDs have stopped working.</p>	<p data-bbox="1013 239 1501 295">► Contact an authorized Mercedes-Benz Center as soon as possible.</p>
 <p data-bbox="316 381 507 527">Check Left Cornering Light or Check Right Cornering Light</p>	<p data-bbox="571 381 986 437">The left or right corner-illuminating lamp is malfunctioning.</p>	<p data-bbox="1013 381 1501 437">► Contact an authorized Mercedes-Benz Center as soon as possible.</p>
 <p data-bbox="316 549 496 695">Check Left Low Beam or Check Right Low Beam</p>	<p data-bbox="571 549 986 605">The left or right low-beam lamp is malfunctioning.</p>	<p data-bbox="1013 549 1501 605">► Contact an authorized Mercedes-Benz Center as soon as possible.</p>
 <p data-bbox="316 717 517 773">Active Headlamps Inoperative</p>	<p data-bbox="571 717 986 740">The active headlamps are malfunctioning.</p>	<p data-bbox="1013 717 1501 773">► Contact an authorized Mercedes-Benz Center as soon as possible.</p>





Vehicle status messages in the multifunction display

Display messages	Possible cause/consequence	Possible solution
 <p data-bbox="300 194 531 253">Auto Lamp Function Inoperative</p>	<p data-bbox="555 194 911 281">The light sensor is malfunctioning. Daytime driving lamps come on automatically.</p>	<ul style="list-style-type: none"> <li data-bbox="997 194 1492 253">▶ Contact an authorized Mercedes-Benz Center as soon as possible. <li data-bbox="997 266 1492 294">To switch off the headlamps (U.S. vehicles only): <li data-bbox="997 308 1492 394">▶ Switch off daytime running lamps in the instrument cluster control system (▷ page 246). <li data-bbox="997 400 1492 456">▶ Switch off the headlamps using the exterior lamp switch (▷ page 316).
 <p data-bbox="300 482 440 692">Check Rear Left Turn Signal or Check Rear Right Turn Signal</p>	<p data-bbox="555 482 981 568">The left or right rear turn signal lamp is malfunctioning. A substitute bulb is being used.</p>	<ul style="list-style-type: none"> <li data-bbox="997 482 1492 538">▶ Contact an authorized Mercedes-Benz Center as soon as possible.
 <p data-bbox="300 712 456 921">Check Left Mirror Turn Signal or Check Right Mirror Turn Signal</p>	<p data-bbox="555 712 981 826">The turn signal in the left or right exterior rear view mirror is malfunctioning. This message will only appear if a critical number of LEDs have stopped working.</p>	<ul style="list-style-type: none"> <li data-bbox="997 712 1492 740">▶ Have the LEDs replaced as soon as possible.



Vehicle status messages in the multifunction display

Display messages	Possible cause/consequence	Possible solution
 <p>Check Front Left Turn Signal or Check Front Right Turn Signal</p>	<p>The left or right front turn signal lamp is malfunctioning.</p>	<p>► Contact an authorized Mercedes-Benz Center as soon as possible.</p>
 <p>Check Left High Beam or Check Right High Beam</p>	<p>The left or right high-beam lamp is malfunctioning.</p>	<p>► Contact an authorized Mercedes-Benz Center as soon as possible.</p>
 <p>Check Left License Plate Lamp or Check Right License Plate Lamp</p>	<p>The left or right license plate lamp is malfunctioning.</p>	<p>► Contact an authorized Mercedes-Benz Center as soon as possible.</p>
 <p>Please Switch Off Lights</p>	<p>You are getting out of the vehicle and the lights are still switched on.</p>	<p>► Turn the exterior lamp switch to 0 or A (► page 316). or ► With the rear fog lamp switched on: Push in the exterior lamp switch to its stop.</p>

Vehicle status messages in the multifunction display



Display messages	Possible cause/consequence	Possible solution
 <p>Check Left Fog Lamp or Check Right Fog Lamp</p>	<p>The left or right front fog lamp is malfunctioning.</p>	<p>► Contact an authorized Mercedes-Benz Center as soon as possible.</p>
 <p>Check Rear Left Fog Lamp</p>	<p>The rear fog lamp is malfunctioning. A substitute bulb is being used.</p>	<p>► Contact an authorized Mercedes-Benz Center as soon as possible.</p>
 <p>Check Front Left Parking Lamp or Check Front Right Parking Lamp</p>	<p>The left or right front parking lamp is malfunctioning. A substitute bulb is being used.</p>	<p>► Contact an authorized Mercedes-Benz Center as soon as possible.</p>
 <p>Check Left Reverse Lamp or Check Right Reverse Lamp</p>	<p>The left or right backup lamp is malfunctioning.</p>	<p>► Contact an authorized Mercedes-Benz Center as soon as possible.</p>

Vehicle status messages in the multifunction display



Display messages	Possible cause/consequence	Possible solution
 <p>Check Front Left Sidemarker Lamp or Check Front Right Sidemarker Lamp</p>	<p>The front left or right side marker lamp is malfunctioning.</p>	<p>► Contact an authorized Mercedes-Benz Center as soon as possible.</p>
 <p>Check Rear Left Sidemarker Lamp or Check Rear Right Sidemarker Lamp</p>	<p>The rear left or right side marker lamp is malfunctioning.</p>	<p>► Contact an authorized Mercedes-Benz Center as soon as possible.</p>
 <p>Check Left Tail and Brake Lamp or Check Right Tail and Brake Lamp</p>	<p>The left or right tail lamp/brake lamp is malfunctioning. This message will only appear if a critical number of LEDs have stopped working. A substitute bulb is being used.</p>	<p>► Contact an authorized Mercedes-Benz Center as soon as possible.</p>

Vehicle status messages in the multifunction display

Tires

Display messages	Possible cause/consequence	Possible solution
 <p data-bbox="300 241 440 294">Caution Tire Defect</p>	<p data-bbox="555 241 938 329">One or more tires are deflating. The respective tire is indicated in the multifunction display.</p>	<ul data-bbox="999 241 1481 395" style="list-style-type: none"> ▶ Carefully bring the vehicle to a halt, avoiding abrupt steering and braking maneuvers. ▶ Engage the electronic parking brake. ▶ If necessary, change the wheel (▷ page 547).
 <p data-bbox="300 493 440 518">Check Tires</p>	<p data-bbox="555 493 954 611">The pressure is too low in one or more tires. The respective tire is indicated in the multifunction display.</p>	<ul data-bbox="999 493 1481 712" style="list-style-type: none"> ▶ Carefully bring the vehicle to a halt, avoiding abrupt steering and braking maneuvers. ▶ Engage the electronic parking brake. ▶ Check and correct tire inflation pressure as required (▷ page 437). ▶ If necessary, change the wheel (▷ page 547).
 <p data-bbox="300 745 491 798">Wheel Sensor(s) Missing</p>	<p data-bbox="555 745 954 986">One or more sensors malfunction (e.g. battery in one or more wheel sensor is empty). One or more wheels without wheel sensors mounted (e.g. spare tire). No pressure value is shown in the multifunction display for the tire in question.</p>	<ul data-bbox="999 745 1490 953" style="list-style-type: none"> ▶ Have the Advanced TPMS checked by an authorized Mercedes-Benz Center. ▶ Have the wheel sensors installed by an authorized Mercedes-Benz Center. The tire pressure for the respective tire is shown in the multifunction display after a few minutes of driving.

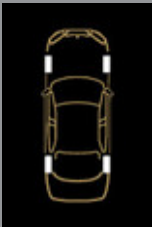
Vehicle status messages in the multifunction display

Display messages	Possible cause/consequence	Possible solution
 <p>Tire Pressure Please Rectify</p>	<p>The pressure is too low in one or more tires.</p> <p>Or the tire pressures of the individual wheels differ too radically from one another.</p>	<ul style="list-style-type: none"> ▶ Check and correct tire inflation pressure as required (▷ page 437).
 <p>Tire Press. Warning Caution Tire Malfunction</p>	<p>One or more tires are deflating.</p>	<ul style="list-style-type: none"> ▶ Carefully bring the vehicle to a halt, avoiding abrupt steering and braking maneuvers. ▶ Engage the electronic parking brake. ▶ If necessary, change the wheel (▷ page 547).
 <p>Check Tire Pressure</p>	<p>The tire pressure is too low in one or more tires.</p>	<ul style="list-style-type: none"> ▶ Carefully bring the vehicle to a halt, avoiding abrupt steering and braking maneuvers. ▶ Engage the electronic parking brake. ▶ Check and correct tire inflation pressure as required (▷ page 437). ▶ If necessary, change the wheel (▷ page 547).

 **Warning!**

Do not drive with a flat tire. A flat tire affects the ability to steer or brake the vehicle. You may lose control of the vehicle. Continued driving with a flat tire will cause excessive heat build-up and possibly a fire.

Vehicle status messages in the multifunction display

 **Warning!**

Follow recommended tire inflation pressures.

Do not underinflate tires. Underinflated tires wear excessively and/or unevenly, adversely affect handling and fuel economy, and are more likely to fail from being overheated.

Do not overinflate tires. Overinflated tires can adversely affect handling and ride comfort, wear unevenly, increase stopping distance, and result in sudden deflation (blowout) because they are more likely to become punctured or damaged by road debris, potholes etc.

What to do if ...**Lamps in instrument cluster****Notes**



If any of the following lamps in the instrument cluster fails to come on during the bulb self-









check when switching on the ignition, have the respective bulb checked and replaced if necessary.

When you switch on the ignition, all lamps (except high-beam headlamp indicator lamp, and turn signal indicator lamps unless activated) in the instrument cluster come on. If a lamp in the instrument cluster fails to come on when the ignition is switched on, have it checked and replaced if necessary.

What to do if ...

Brake

Problem	Possible cause/consequence	Suggested solutions
<p> The yellow ABS indicator lamp comes on while the engine is running.</p>	<p>The ABS has detected a malfunction and switched off. The BAS, ESP[®], EBP and PRE-SAFE[®] are also switched off (see messages in multifunction display).</p> <p>The brake system is still functioning normally but without the systems specified above available.</p> <p>If the ABS control unit is malfunctioning, other systems such as the Parktronic, the DISTRONIC Plus, the navigation system or the automatic transmission may also be malfunctioning.</p>	<ul style="list-style-type: none"> ▶ Continue driving with added caution. Wheels may lock during hard braking, reducing steering capability. ▶ Read and observe messages that may appear in the multifunction display (▷ page 475). ▶ Have the system checked at an authorized Mercedes-Benz Center as soon as possible. <p>Failure to follow these instructions increases the risk of an accident.</p>
<p> The yellow ABS indicator lamp comes on while the engine is running.</p>	<p>The ABS has switched off due to insufficient power supply. The battery might not be charged sufficiently.</p>	<p>When the voltage is above the required value again, the ABS is operational again and the ABS indicator lamp should go out.</p> <ul style="list-style-type: none"> ▶ If the ABS indicator lamp does not go out: Have the alternator and the battery checked.

Problem	Possible cause/consequence	Suggested solutions
  <p>The yellow ABS malfunction indicator lamp and the yellow ESP® warning lamp come on while the engine is running and an acoustic warning sounds.</p>	<p>The brake system is still functioning normally but due to a malfunction, the ABS, the BAS, the EBP, the ESP® and PRE-SAFE® are unavailable.</p>	<ul style="list-style-type: none"> ▶ Continue driving with added caution. Wheels may lock during hard braking, reducing steering capability. ▶ Read and observe messages in the multifunction display (▷ page 475). ▶ Have the system checked at an authorized Mercedes-Benz Center as soon as possible. <p>Failure to follow these instructions increases the risk of an accident.</p>
 (USA only)  (Canada only)   <p>The red brake warning lamp comes on while driving. In addition, the yellow ABS malfunction indicator lamp, and the yellow ESP® warning lamp come on and an acoustic warning sounds.</p>	<p>The Electronic Brake Proportioning (EBP) switched off due to a malfunction.</p> <p>The ABS, the BAS, the ESP® and PRE-SAFE® are also switched off.</p> <p>The brake system continues to function normally, but without electronic support.</p>	<ul style="list-style-type: none"> ▶ Continue driving with added caution. Wheels may lock during hard braking, reducing steering capability. ▶ Read and observe messages that may appear in the multifunction display (▷ page 475). ▶ Have the system checked at an authorized Mercedes-Benz Center as soon as possible. <p>Failure to follow these instructions increases the risk of an accident.</p>
 (USA only)  (Canada only) <p>The red indicator lamp for the electronic parking brake flashes and/or the yellow warning lamp for the electronic parking brake is on.</p>	<p>The electronic parking brake is malfunctioning or defective.</p>	<ul style="list-style-type: none"> ▶ Read and observe messages that may appear in the multifunction display (▷ page 475). ▶ Have the system checked at an authorized Mercedes-Benz Center as soon as possible.

What to do if ...

Problem	Possible cause/consequence	Suggested solutions
<p>BRAKE (USA only)  (Canada only)</p> <p>The red brake warning lamp comes on while the engine is running and an acoustic warning sounds.</p>	<p>There is insufficient brake fluid in the reservoir.</p>	<ul style="list-style-type: none"> ▶ Risk of accident! Do not drive any further. Stop the vehicle in a safe location as soon as it is safe to do so. ▶ Engage the electronic parking brake. ▶ Read and observe messages that may appear in the multifunction display (▷ page 475). ▶ Contact an authorized Mercedes-Benz Center. Do not add brake fluid! This will not solve the problem.



Warning!

Driving with the brake warning lamp illuminated can result in an accident. Have your brake system checked immediately if the brake warning lamp stays on. Do not add brake fluid before checking the brake system.

Overfilling the brake fluid reservoir can result in spilling brake fluid on hot engine parts and the brake fluid catching fire. You can be seriously burned.

! If you find that the brake fluid in the brake fluid reservoir has fallen to the minimum mark or below, have the brake system checked for brake pad thickness and leaks.

Safety systems

Problem	Possible cause/consequence	Suggested solutions
 The red seat belt telltale comes on for a maximum of 6 seconds after starting the engine.	The seat belt telltale reminds you and your passengers to fasten your seat belts before driving off.	<ul style="list-style-type: none"> ▶ Fasten your seat belts. Regardless of whether the seat belts are fastened or not, the seat belt telltale always comes on and remains lit for 6 seconds after starting the engine.
 You hear a warning chime for a maximum of 6 seconds after starting the engine.	You have forgotten to fasten your seat belt.	<ul style="list-style-type: none"> ▶ Fasten your seat belt. The warning chime stops sounding.
 The red seat belt telltale comes on while the vehicle is standing still and the engine is running or during driving.	You and/or your front passenger have forgotten to fasten your seat belts.	<ul style="list-style-type: none"> ▶ Fasten your seat belts. The seat belt telltale goes out.
	There are items placed on the front passenger seat and therefore the system senses the front passenger seat as being occupied.	<ul style="list-style-type: none"> ▶ Remove the items from the front passenger seat and put them in a safe place. The seat belt telltale goes out.

What to do if ...

Problem	Possible cause/consequence	Suggested solutions
 During driving the red seat belt telltale flashes and you additionally hear an intermittent warning chime with increasing intensity.	The vehicle's speed once exceeded 15 mph (25 km/h) and you and/or your front passenger have forgotten to fasten your seat belts.	<ul style="list-style-type: none"> ▶ Fasten your seat belts. The seat belt telltale goes out and the warning chime stops sounding.
	There are items placed on the front passenger seat and therefore the system senses the front passenger seat as being occupied.	<ul style="list-style-type: none"> ▶ Remove the items from the front passenger seat and put them in a safe place. The seat belt telltale goes out and the warning chime stops sounding.



i After 60 seconds with an unfastened seat belt the warning chime stops sounding and the seat belt telltale illuminates continuously. The seat belt telltale will only go out if both, the driver and front passenger's seat belt are fastened, or the vehicle is standing still and a door is opened.

Problem	Possible cause/consequence	Suggested solutions
 The red SRS indicator lamp comes on while driving.	There is a malfunction in the restraint systems. The air bags or Emergency Tensioning Devices (ETDs) could deploy unexpectedly or fail to activate in an accident.	<ul style="list-style-type: none"> ▶ Drive with added caution to the nearest authorized Mercedes-Benz Center.

Warning!

In the event a malfunction of the SRS is indicated as outlined above, the SRS may not be operational.



For your safety, we strongly recommend that you contact an authorized Mercedes-Benz Center immediately to have the system checked. Otherwise the SRS may not be activated when needed in an accident, which could result in serious or fatal injury, or it might deploy unexpectedly and unnecessarily which could also result in injury.

Problem	Possible cause/consequence	Suggested solutions
<p> The yellow ESP® warning lamp comes on while the engine is running.</p>	<p>The ESP® has been switched off. Risk of accident!</p> <p>When the ESP® is switched off it will not stabilize the vehicle if the system recognizes that the vehicle starts to skid or that a wheel is spinning.</p> <p>The cruise control is deactivated and cannot be switched on.</p>	<ul style="list-style-type: none"> ▶ Switch the ESP® back on. Exceptions: (▷ page 70). ▶ If leaving the ESP® switched off, adapt your speed and driving to the prevailing road and weather conditions. ▶ If the ESP® cannot be switched back on: Have the system checked at an authorized Mercedes-Benz Center as soon as possible.
<p> The yellow ESP® warning lamp comes on while the engine is running.</p>	<p>The ESP® is not operational due to a malfunction. Risk of accident!</p> <p>The cruise control is deactivated and cannot be switched on.</p>	<ul style="list-style-type: none"> ▶ Read and observe additional messages that may appear in the multifunction display. ▶ Continue driving with added caution. ▶ Adapt your speed and driving to the prevailing road and weather conditions. ▶ Have the system checked at an authorized Mercedes-Benz Center as soon as possible.

What to do if ...

Problem	Possible cause/consequence	Suggested solutions
 The yellow ESP® warning lamp flashes while driving.	<p>The ESP® or Electronic Traction System (ETS/4-ETS) has come into operation because of detected traction loss in at least one tire.</p> <p>The cruise control and the DISTRONIC Plus are deactivated.</p>	<ul style="list-style-type: none"> ▶ When driving off, apply as little throttle as possible. ▶ While driving, ease up on the accelerator pedal. ▶ Adapt your speed and driving to the prevailing road and weather conditions. ▶ Do not deactivate the ESP®. <p>Exceptions: (▷ page 70).</p> <p>Failure to follow these instructions increases the risk of an accident.</p>

Driving systems



Problem	Possible cause/consequence	Suggested solutions
 PRE-SAFE® Brake: The red distance warning lamp comes on while driving.	<p>You are too close to the vehicle in front of you to maintain selected speed.</p>	<ul style="list-style-type: none"> ▶ Apply the brakes immediately to increase the following distance.
 DISTRONIC Plus or PRE-SAFE® Brake: The red distance warning lamp comes on while driving and an acoustic warning sounds.	<p>You are gaining too rapidly on the vehicle ahead of you or DISTRONIC Plus or PRE-SAFE® Brake has recognized a stationary obstacle on your probable line of travel.</p>	<ul style="list-style-type: none"> ▶ Apply the brakes immediately. ▶ Carefully observe the traffic situation. You may need to brake or maneuver to avoid hitting an obstacle.

Vehicle



Problem	Possible cause/consequence	Suggested solutions
The yellow fuel tank reserve warning lamp in the fuel gauge comes on while driving.	The fuel level has gone below the reserve mark.	▶ Refuel at the next gas station.

What to do if ...

Engine

Problem	Possible cause/consequence	Suggested solutions
 <p>The yellow engine malfunction indicator lamp comes on when the engine is running.</p>	<p>There may be a malfunction in:</p> <ul style="list-style-type: none"> • The fuel management system • The ignition system • The emission control system • Systems which affect emissions <p>Such malfunctions may result in excessive emissions values and may switch the engine to limp-home (emergency operation) mode.</p>	<ul style="list-style-type: none"> ▶ Have the vehicle checked as soon as possible at an authorized Mercedes-Benz Center. ▶  Some states may by law require you to visit a workshop as soon as the engine malfunction indicator lamp comes on. Check local requirements.
 <p>The yellow engine malfunction indicator lamp comes on when the engine is running.</p>	<p>A loss of pressure has been detected in the fuel system. The fuel cap may not be closed properly or the fuel system may be leaky.</p>	<ul style="list-style-type: none"> ▶ Check the fuel cap (▷ page 421). ▶ If it is not closed properly: Close the fuel cap. ▶ If it is closed properly: Have the fuel system checked by an authorized Mercedes-Benz Center.

Tires

Problem	Possible cause/consequence	Suggested solutions
 USA only: Combination low tire pressure telltale/TPMS malfunction telltale for the Advanced TPMS illuminates continuously. Canada only: Low tire pressure telltale for the Advanced TPMS illuminates continuously.	The Advanced TPMS detects a loss of pressure in at least one tire.	<ul style="list-style-type: none"> ▶ Carefully bring the vehicle to a halt, avoiding abrupt steering and braking maneuvers. Observe the traffic situation around you. ▶ Read and observe messages in the multifunction display (> page 475). If the tire inflation pressure in the respective tire(s) has (have) been corrected, the combination low tire pressure/TPMS malfunction telltale goes out after a few minutes of driving.
 USA only: Combination low tire pressure telltale/TPMS malfunction telltale for the Advanced TPMS flashes 60 seconds and then stays illuminated.	There is a malfunction in the Advanced TPMS.	<ul style="list-style-type: none"> ▶ Read and observe messages in the multifunction display (> page 475). ▶ Have the Advanced TPMS checked by an authorized Mercedes-Benz Center. After the malfunction has been remedied, the combination low tire pressure/TPMS malfunction telltale goes out after a few minutes of driving.

 **Warning!**

Each tire, including the spare (if provided), should be checked every other week when cold and inflated to the inflation pressure recommended by the vehicle manufacturer on the Tire and Loading Information placard

on the driver's door B-pillar or, if available, the tire inflation pressure label on the inside of the fuel filler flap. If your vehicle has tires of a different size than the size indicated on the vehicle placard or the tire inflation

pressure label, you should determine the proper tire inflation pressure for those tires. As an added safety feature, your vehicle has been equipped with a tire pressure monitoring system (TPMS) that illuminates a low tire pressure telltale when one or



What to do if ...

more of your tires are significantly underinflated. Accordingly, when the low tire pressure telltale illuminates, you should stop and check your tires as soon as possible, and inflate them to the proper pressure. Driving on a significantly underinflated tire causes the tire to overheat and can lead to tire failure.

Underinflation also reduces fuel efficiency and tire tread life, and may affect the vehicle's handling and stopping ability.

Please note that the TPMS is not a substitute for proper tire maintenance, and it is the driver's responsibility to maintain correct tire pressure, even if underinflation

has not reached the level to trigger illumination of the TPMS low tire pressure telltale.

USA only:

Your vehicle has also been equipped with a TPMS malfunction indicator to indicate when the system is not operating properly. The TPMS malfunction indicator is combined with the low tire pressure telltale. When the system detects a malfunction, the telltale will flash for approximately 1 minute and then remain continuously illuminated. This sequence will continue upon subsequent vehicle

start-ups as long as the malfunction exists. When the malfunction indicator is illuminated, the system may not be able to detect or signal low tire pressure as intended.

TPMS malfunctions may occur for a variety of reasons, including the installation of replacement or alternate tires or wheels on the vehicle that prevent the TPMS from functioning properly. Always check the TPMS malfunction telltale after replacing one or more tires or wheels on your vehicle to ensure that the replacement or alternate tires and wheels allow the TPMS to continue to function properly.

Lamp in center console

Problem	Possible cause/consequence	Suggested solutions
 PASS AIR BAG OFF The front passenger front air bag off indicator lamp illuminates and remains illuminated with the weight of a typical adult or someone larger than a small individual on the front passenger seat.	The system is malfunctioning.	<ul style="list-style-type: none"> ▶ Have the system checked as soon as possible at an authorized Mercedes-Benz Center. ▶ Read and observe messages in the multifunction display and follow corrective steps (▷ page 475).

Unlocking/locking manually

Warning!

If the  **PASS AIR BAG OFF** indicator lamp illuminates and remains illuminated with

the weight of a typical adult or someone larger than a small individual on the front passenger seat, do not have any passenger

use the front passenger seat until the system has been repaired.

Problem	Possible cause/consequence	Suggested solutions
 PASS AIR BAG OFF The front passenger front air bag off indicator lamp does not illuminate and/or does not remain illuminated with the weight of a typical 12-month-old child in a standard child restraint or less on the front passenger seat.	The system is malfunctioning.	<ul style="list-style-type: none"> ▶ Make sure there is nothing between seat cushion and child seat and check installation of the child seat. ▶ Make sure no objects applying supplemental weight onto the seat are present. ▶ If the front passenger front air bag off indicator lamp remains out, have the system checked as soon as possible at an authorized Mercedes-Benz Center. Do not transport a child on the front passenger seat until the system has been repaired. ▶ Read and observe messages in the multifunction display and follow corrective steps (▷ page 475).

Warning!

If the  **PASS AIR BAG OFF** indicator lamp does not illuminate or remains out with the weight of a typical 12-month-old child in a standard child restraint or less on the front passenger seat, do not transport a child on the front passenger seat until the system has been repaired.

Unlocking/locking manually

Unlocking the vehicle

If you cannot unlock the vehicle with the SmartKey or with KEYLESS-GO, unlock the driver's door and the trunk using the mechanical key.

i Unlocking the vehicle with the mechanical key and opening the driver's

door or the trunk will trigger the anti-theft alarm system.

To cancel the alarm, insert the SmartKey in the starter switch.

Unlocking/locking manually

Removing the mechanical key

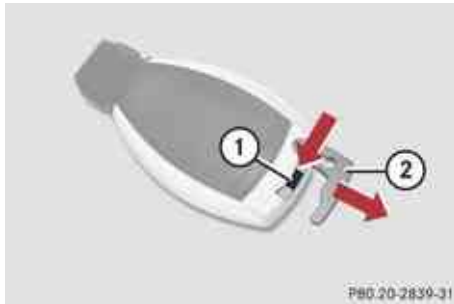

- ① Mechanical key locking tab
- ② Mechanical key

- ▶ Move locking tab ① in direction of arrow.
- ▶ Slide mechanical key ② out of the housing.

Unlocking the driver's door

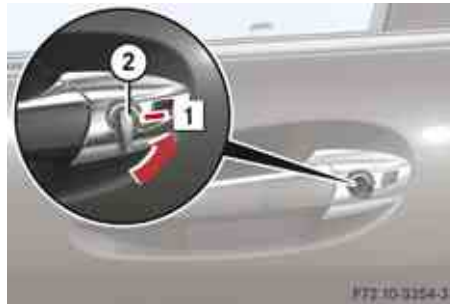

- ① Unlocking
- ② Mechanical key

- ▶ Insert mechanical key ② into the driver's door lock until it stops.
- ▶ Turn mechanical key ② counterclockwise to position ①.
- ▶ Pull the door handle past the resistance point until the locking knob moves up. The driver's door is unlocked.
- ▶ Pull the door handle once more to open the driver's door.
- ▶ Turn mechanical key ② back and remove it from the driver's door lock.

Unlocking the trunk

A minimum height clearance of 5.9 ft (1.8 m) is required to open the trunk lid.



- ① Unlocking
- ② Mechanical key

- ▶ Insert mechanical key ② into the trunk lid lock until it stops.
- ▶ Turn mechanical key ② all the way counterclockwise to position ①.
- ⚠ The trunk lid swings open upwards automatically. Always make sure there is sufficient overhead clearance.
- ▶ Turn mechanical key ② back and remove it from the trunk lid lock.

Locking the vehicle

If you cannot lock the vehicle with the SmartKey or with KEYLESS-GO, lock it as follows:

- ▶ Close the driver's door and the trunk.
- i** If you cannot close the trunk with the remote trunk opening/closing switch, lower the trunk lid manually and close it with hands placed flat on the trunk lid until it is engaged in its lock.
- ▶ Open the passenger door.
- ▶ Press down the locking knob of the driver's door manually.
- ▶ Press down the locking knob of the passenger door.
- !** To prevent inadvertent lockout, make sure to have the SmartKey with you before proceeding with the next step. The next step will lock the vehicle.
- ▶ Exit the vehicle.
- ▶ Lock the trunk with the mechanical key (▷ page 300).
- ▶ Close the passenger door.

- 1** This procedure does not arm the anti-theft alarm system, nor does it lock the fuel filler flap.

Replacing SmartKey batteries

Replacing SmartKey batteries

If the batteries in the SmartKey are discharged, the vehicle can no longer be locked or unlocked. It is recommended to have the batteries replaced at an authorized Mercedes-Benz Center.

⚠ Warning!

Batteries contain poisonous and corrosive substances. Therefore, keep the batteries out of reach of children.

If a battery is swallowed, seek medical help immediately.

⚠ Warning!

SmartKey batteries contain perchlorate material, which may require special handling and regard for the environment. Check with your local government's disposal guidelines. California residents, see www.dtsc.ca.gov/HazardousWaste/Perchlorate/index.cfm.

Batteries contain materials that can harm the environment if disposed of improperly. Recycling of batteries is the preferred method of disposal. Many states/provinces require



Replacing SmartKey batteries

sellers of batteries to accept old batteries for recycling.

When inserting the batteries, make sure they are clean and free of lint.

When replacing batteries, always replace both batteries.

i The required replacement batteries are available at any authorized Mercedes-Benz Center.

Replacement batteries: Lithium, type CR 2025 or equivalent.

▶ Remove the mechanical key from the SmartKey (> page 540).

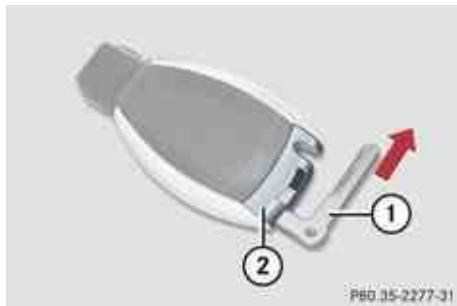

- ① Mechanical key
- ② Battery compartment

- ▶ Insert mechanical key ① into opening.
- ▶ Press mechanical key ① in direction of arrow. Battery compartment ② is unlatched.
- ▶ Pull battery compartment ② out of the SmartKey housing.

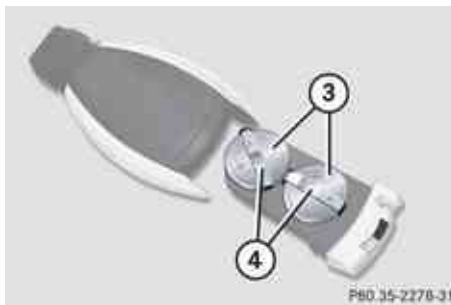

- ③ Batteries
- ④ Contact springs

- ▶ Pull out batteries ③.
- ▶ Insert new batteries ③ under contact springs ④ with the positive terminal (+) side facing up.
- ▶ Return battery compartment ② into SmartKey housing until it locks into place.

- ▶ Slide mechanical key ① back into the SmartKey.
- ▶ Check the operation of the SmartKey as well as the KEYLESS-GO function.

Replacing bulbs

Safety notes

Safe vehicle operation depends on proper exterior lighting and signaling to a large degree.

Correct headlamp adjustment is extremely important. Have headlamps checked and readjusted at regular intervals and when a bulb has been replaced. Contact an authorized Mercedes-Benz Center for headlamp adjustment.

⚠ Warning!

Bulbs and bulb sockets can be very hot. Allow the lamp to cool down before changing a bulb.

Keep bulbs out of reach of children.

Halogen lamps contain pressurized gas. A bulb can explode if you:

- touch or move it when hot
- drop the bulb
- scratch the bulb

Wear eye and hand protection.

Because of high voltage in Xenon lamps, it is dangerous to replace the bulb or repair

the lamp and its components. We recommend that you have such work done by a qualified technician.

⚠ Warning!

The bulbs in the tail lamps cannot be replaced individually. The tail lamp bulbs are under pressure and could explode during an attempt to replace them.

If the tail lamps are malfunctioning, have them replaced at an authorized Mercedes-Benz Center.

- i** If the headlamps or front fog lamps are fogged up on the inside as a result of high humidity, driving the vehicle a distance with the lights on should clear up the fogging.

Bulbs



Replacing bulbs

Front lamps

	Lamp	Type
①	Low- and high-beam lamp ⁹	D1S-35 W
②	High-beam flasher lamp	H11 (55 W)
	IR emitter (for Night View Assist)	H11 (55 W)
③	Additional turn signal lamp	LED
④	Side marker lamp	W 5 W
⑤	Parking and standing lamp	W 5 W
⑥	Turn signal lamp	PY 24 W
⑦	Corner-illuminating lamp	H7 (55 W)
⑧	Front fog lamp	H11 (55 W)

Rear lamps

	Lamp	Type
⑨	High-mounted brake lamp	LED
⑩	Brake lamp, tail lamp, parking and standing lamp	LED
⑪	Turn signal lamp	HiP
⑫	License plate lamps	W 5 W
⑬	Rear fog lamp (driver's side only)	HiP
⑭	Backup lamp	HiP
⑮	Side marker lamp	LED

Notes on bulb replacement

- Only use 12-volt bulbs of the same type and with the specified watt rating.
- Switch the lights off before changing a bulb to prevent short circuits.
- Always use a clean lint-free cloth when handling bulbs.

- Your hands should be dry and free of oil and grease.
- If the newly installed bulb does not come on, contact an authorized Mercedes-Benz Center.

i Mercedes-Benz recommends using Longlife (LL) bulbs.

! Do not replace LEDs and bulbs yourself. You could otherwise damage the LEDs, the bulbs or parts of the vehicle. Only have the LEDs and bulbs replaced at an authorized Mercedes-Benz Center.

Replacing bulbs for front lamps

⚠ Warning!

Do not remove the cover for the Bi-Xenon headlamp. Because of high voltage in Xenon lamps, it is dangerous to replace the bulb or repair the lamp and its components. It is recommended to have such work done by a qualified technician.

i Replacing the bulbs for the front lamps is a technically complex process. Have such

⁹ Vehicles with Bi-Xenon headlamps: Low beam and high beam use the same D1S-35 W lamp. Do not replace the Bi-Xenon bulbs yourself. Contact an authorized Mercedes-Benz Center.

work done by an authorized Mercedes-Benz Center.

Replacing bulbs for rear lamps

Tail lamp unit

The tail lamps are equipped with HiP bulbs and LEDs. Have them replaced at an authorized Mercedes-Benz Center.

Replacing wiper blades

Safety notes

Warning!

For safety reasons, switch off wipers and remove SmartKey from starter switch (vehicles with KEYLESS-GO: Make sure the vehicle's on-board electronics have status **O**) before replacing a wiper blade. Otherwise, the wiper motor could suddenly turn on and cause injury.

Warning!

Wiper blades are components that are subject to wear and tear. Replace the wiper blades twice a year, preferably in the spring and fall. Otherwise the windows will not be properly wiped. As a result, you may not be able to observe surrounding traffic conditions and could cause an accident.

! To avoid damage to the hood the wiper arms should only be folded forward when in the vertical position.

! Never open the hood when a wiper arm is folded forward.

Hold on to the wiper when folding a wiper arm back. If released, the force of the

Replacing wiper blades

impact from the tensioning spring could crack the windshield.

Do not allow a wiper arm to contact the windshield glass without a wiper blade inserted.

Mercedes-Benz recommends that you have this work carried out at an authorized Mercedes-Benz Center.

Placing wiper arms in vertical position



Wiper arms in vertical position

► Make sure the hood is fully closed.

Replacing wiper blades

Vehicles with SmartKey

- ▶ Turn the SmartKey in the starter switch to position **1**.
- ▶ Turn combination switch to wiper setting **—**.
- ▶ With wiper arms in vertical position, turn the SmartKey in the starter switch to position **0**.
- ▶ Remove the SmartKey from the starter switch.

Vehicles with KEYLESS-GO

- ▶ Make sure the vehicle's on-board electronics have status **1**.
- ▶ Turn combination switch to wiper setting **—**.
- ▶ Press KEYLESS-GO start/stop button repeatedly until windshield wipers start.
- ▶ Press KEYLESS-GO start/stop button when the wiper arms are in a vertical position.

Removing wiper blades

- ❗ Do not pull on the wiper blade inserts. They could tear.
- ▶ Fold the wiper arm forward until it snaps into place.



- ① Turning wiper blade
- ② Removing

- ▶ Turn the wiper blade in direction of arrow ①.
- ▶ Slide the wiper blade sideways out of the retainer in the direction of arrow ②.

Installing wiper blades

- ▶ Slide the wiper blade onto wiper arm until it locks in place.
- ▶ Rotate the wiper blade into position parallel to the wiper arm.
- ▶ Fold the wiper arm backward to rest on the windshield. Make sure you hold on to the wiper when folding the wiper arm back.
- ❗ Make sure the wiper blades are properly installed. Improperly installed wiper blades may cause windshield damage.

Flat tire

Safety notes

 **Warning!**

The dimensions of the spare wheel are different from those of the road wheels. As a result, the vehicle handling characteristics change when driving with a spare wheel mounted. Adapt your driving style accordingly.

The spare wheel is for temporary use only. When driving with spare wheel mounted, ensure proper tire inflation pressure and do not exceed a vehicle speed of 50 mph (80 km/h).

Contact the nearest authorized Mercedes-Benz Center as soon as possible to have the spare wheel replaced with a regular road wheel.

Never operate the vehicle with more than one spare wheel mounted.

Do not switch off the ESP® when a spare wheel is mounted.

Preparing the vehicle

- ▶ Park the vehicle in a safe distance from moving traffic on a hard, flat surface when possible.
 - ▶ Turn on the hazard warning flasher.
 - ▶ Turn the steering wheel so that the front wheels are in a straight-ahead position.
 - ▶ Engage the electronic parking brake.
 - ▶ Shift the automatic transmission into park position **P**.
 - ▶ Turn off the engine.
 - ▶ Remove the SmartKey from the starter switch.
- or
- ▶ Vehicles with KEYLESS-GO: Open the driver's door (this puts the starter switch in position **O**, same as with the SmartKey removed from the starter switch). The driver's door can then be closed again. Open doors only when conditions are safe to do so.
 - ▶ Vehicles with KEYLESS-GO: Remove the KEYLESS-GO start/stop button from the starter switch.
 - ▶ Have any passenger exit the vehicle at a safe distance from the roadway. Open

doors only when conditions are safe to do so.

Mounting the spare wheel

Introduction

- ▶ Prepare the vehicle as described (▷ page 547).
- ▶ Take the following out of the vehicle:
 - spare wheel
 - jack
 - vehicle tool kit
 - wheel bolts for spare wheel

For information on where to find the respective items, see “Where will I find ...?” (▷ page 472) and (▷ page 474).

Lifting the vehicle

 **Warning!**

When jacking up the vehicle, only use the jack which has been specifically approved by Mercedes-Benz for your vehicle.

The jack is designed exclusively for jacking up the vehicle at the jack take-up brackets built into both sides of the vehicle. Make



Flat tire

sure the jack arm is fully seated in the jack take-up bracket. The jack must always be vertical when in use, especially on inclines or declines.

The jack is intended only for lifting the vehicle briefly for wheel changes. It is not suited for performing maintenance work under the vehicle. To help avoid personal injury, use the jack only to lift the vehicle during a wheel change.

Never get beneath the vehicle while it is supported by the jack. Keep hands and feet away from the area under the lifted vehicle. Always lower the vehicle onto sufficient capacity jackstands before working under the vehicle.

Always firmly set the parking brake and block the wheels with wheel chocks or other sizeable objects before raising the vehicle with the jack. Do not disengage the parking brake while the vehicle is raised.

Make sure that the ground on which the vehicle is standing and where you place the jack is solid, level and not slippery. If necessary, use a large underlay. On slippery surfaces, such as tiled floors, you should use a non-slip underlay, for example a rubber mat.

Do not use wooden blocks or similar objects to support the jack. Otherwise the jack may not be able to achieve its load-bearing capacity if it is not at its full height. Never start the engine when the vehicle is raised.

Also observe the notes on the jack.

- ▶ Prevent the vehicle from rolling away by blocking wheels with wheel chocks or other sizeable objects.

One wheel chock is included with the vehicle tool kit (▷ page 472). For information on setting up the collapsible wheel chock, see (▷ page 473).

When changing wheel on a level surface:

- ▶ Place the wheel chock in front of and another wheel chock or other sizeable object behind the wheel that is diagonally opposite to the wheel being changed.

Always try lifting the vehicle using the jack on a level surface. However, should circumstances require you to do so on a hill, place the wheel chock and another sizeable object as follows:

- ▶ Place wheel chocks or other sizeable objects on the downhill side blocking both wheels of the axle not being worked on.

⚠ Warning!

Only jack up the vehicle on level ground or on slight inclines/declines. Otherwise, the vehicle could fall off the jack and injure you or others.



① Wheel wrench

- ▶ On wheel to be changed, loosen but do not yet remove the wheel bolts (approximately one full turn with wrench ①).

The jack take-up brackets are located directly behind the front wheel housings and in front of the rear wheel housings.

⚠ Warning!

The jack is designed exclusively for jacking up the vehicle at the jack take-up brackets.

Make sure the jack arm is fully seated in the jack take-up bracket.

If you do not position the jack correctly in the jack take-up bracket, the vehicle can fall off the jack and seriously or fatally injure you or others.

! Do not position the jack on the body of the vehicle, as this may cause damage to the vehicle.



② Take-up bracket

③ Jack

④ Crank

- ▶ Place jack ③ on firm ground.
- ▶ Position jack ③ under take-up bracket ② so that it is always vertical as seen from

the side, even if the vehicle is parked on an incline.

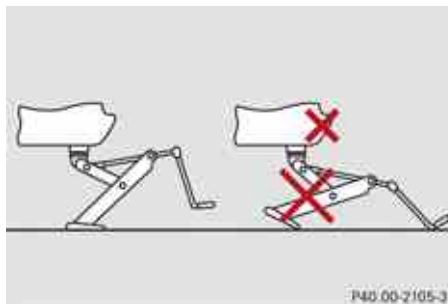

- ▶ Turn crank ④ clockwise until jack ③ is fully seated in take-up bracket ② and the jack base evenly meets the ground.
- ▶ Jack up the vehicle until the wheel is a maximum of 1.2 in (3 cm) from the ground.

Removing the wheel



① Alignment bolt

- ▶ Unscrew uppermost wheel bolt and remove it.
- ▶ Replace this wheel bolt with alignment bolt ① supplied with the vehicle tool kit.
- ▶ Remove the remaining bolts.

! Do not place wheel bolts in sand or dirt. This could result in damage to the wheel bolts and wheel hub threads.

- ▶ Remove the wheel.

Flat tire

Attaching the spare wheel

⚠ Warning!

Always replace wheel bolts that are damaged or rusted.

Never apply oil or grease to wheel bolts.

Damaged wheel hub threads should be repaired immediately. Do not continue to drive under these circumstances! Contact an authorized Mercedes-Benz Center or call Roadside Assistance.

Incorrect wheel bolts or improperly tightened wheel bolts can cause the wheel to come off. This could cause an accident. Be sure to use the correct wheel bolts.

⚠ Warning!

Only use genuine Mercedes-Benz wheel bolts. Other wheel bolts may come loose.

Do not tighten the wheel bolts when the vehicle is raised. Otherwise the vehicle could fall off the jack.

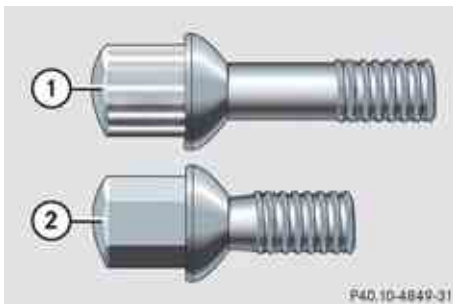

- ① Wheel bolt for light alloy rims
- ② Wheel bolt for Minispare wheel (located in trunk with Minispare wheel)

! Wheel bolts ② must be used when mounting the Minispare wheel. The use of any wheel bolts other than wheel bolts ② for the Minispare wheel will damage the vehicle's brakes.

⚠ Warning!

Make sure to use the original length wheel bolts when remounting the original wheel after it has been repaired.

- ▶ Clean contact surfaces of wheel and wheel hub.

! To avoid paint damage, place wheel flat against hub and hold it there while installing first wheel bolt.



- ▶ Guide the spare wheel onto the alignment bolt and push it on.
- ▶ Insert the wheel bolts and tighten them slightly.
- ▶ Unscrew the alignment bolt.
- ▶ Install last wheel bolt and tighten it slightly.

Lowering the vehicle

- ▶ Lower the vehicle by turning crank counterclockwise until the vehicle is resting fully on its own weight.
- ▶ Remove the jack.

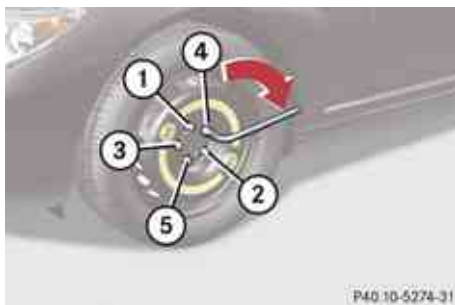

① - ⑤ Wheel bolts

- ▶ Tighten the five wheel bolts evenly, following the diagonal sequence illustrated (① to ⑤), until all bolts are tight. Observe a tightening torque of 110 lb-ft (150 Nm).

Warning!

Have the tightening torque checked after changing a wheel. The wheels could come loose if they are not tightened to a torque of 110 lb-ft (150 Nm).

- ▶ Fully collapse the jack, with handle folded in (storage position), see (▷ page 473).
- ▶ Store the jack and the other vehicle tools in the designated storage space.

For information on storing the spare wheel after it has been replaced by a regular road wheel, see (▷ page 474).

- 1 Do not restart the tire inflation pressure monitor until a full size wheel/tire with functioning sensor has been placed back into service on the vehicle.

Battery

Safety notes

A battery should always be sufficiently charged in order to achieve its rated service life. Refer to Maintenance Booklet for battery maintenance intervals.

If you use your vehicle mostly for short-distance trips, you will need to have the battery charge checked more frequently.

When replacing a battery, always use a battery approved by Mercedes-Benz.

If you do not intend to operate your vehicle for an extended period of time, contact an authorized Mercedes-Benz Center about steps you need to observe.

Warning!

Observe all safety instructions and precautions when handling automotive batteries.



Risk of explosion.



Fire, open flames and smoking are prohibited when handling batteries. Avoid creating sparks.

Battery



Battery acid is caustic. Do not allow it to come into contact with skin, eyes or clothing.

Wear suitable protective clothing, especially gloves, apron and faceguard.

Wear eye protection.

Rinse any acid spills immediately with clear water. Contact a physician if necessary.

Keep children away.

Follow the instructions in this Operator's Manual.



Batteries contain materials that can harm the environment if disposed of improperly. Large 12-volt storage batteries contain lead. Recycling of batteries is the preferred method of disposal. Many states (USA only) or provinces (Canada only) require sellers of batteries to accept old batteries for recycling.

Warning!

Failure to follow these instructions can result in severe injury or death.

Never lean over batteries while connecting. You might get injured.

Battery fluid contains sulfuric acid. Do not allow this fluid to come in contact with eyes, skin or clothing. In case it does, immediately flush affected area with water and seek medical help if necessary.

A battery will also produce hydrogen gas, which is flammable and explosive. Keep flames or sparks away from battery, avoid improper connection of jumper cables, smoking etc.

Warning!

Do not place metal objects on the battery as this could result in a short circuit.

Use leak-proof batteries only to avoid the risk of acid burns in the event of an accident.

Take care that you do not become statically charged, e.g. by wearing synthetic clothing or rubbing against textiles. For this reason, you also should not pull or push the battery over carpets or other synthetic materials.

Never touch the battery first. First touch the outside body of the vehicle in order to release any possible electrostatic charges.

Do not rub the battery with rags or cloths. The battery could explode if touched due to electrostatic charge or due to spark formation.

! The battery is a Valve-Regulated Lead Acid (VRLA) battery, also referred to as “fleece” battery.

Such batteries do not require topping-up of the electrolyte level. VRLA batteries therefore do not have cell caps and the battery cover is non-removable. Do not attempt to open the battery as otherwise the battery will be damaged.

Even though VRLA batteries do not require topping-up of the electrolyte level and cannot be opened to check the electrolyte level, the battery condition must be checked periodically by performing a battery conductance test. Refer to Maintenance Booklet for battery condition testing intervals.

The factory-equipped VRLA battery is leak-proofed. Only use a battery as replacement that has the same security features and is

of identical size, voltage, and capacity as the factory-equipped battery.

! As with any other battery, have the battery disconnect at a qualified workshop or an authorized Mercedes-Benz Center if you do not intend to operate your vehicle for an extended period of time to prevent battery discharge. You may also connect an accessory battery charge unit expressly approved by Mercedes-Benz for your vehicle model to maintain the battery charge. Contact an authorized Mercedes-Benz Center for further information.

The battery, the battery ventilation hose and the lateral plug must always be securely installed when the vehicle is in operation.

! Switch off the engine and switch off the vehicle's internal electrical functions before you disconnect or remove the battery's terminal clamps. You could otherwise destroy electronic assemblies such as the generator.

Remove SmartKey from starter switch (vehicles with KEYLESS-GO: Make sure the vehicle's on-board electronics have status **0**) when you turn off the engine and no longer require any electrical consumers. The vehicle

then uses very little power and the battery is spared.

If the battery is discharged, you must use the mechanical key to unlock the vehicle.

Charging the battery

Warning!

Never charge a battery while still installed in the vehicle unless the accessory battery charge unit approved by Mercedes-Benz is being used. Gases may escape during charging and cause explosions that may result in paint damage, corrosion or personal injury.

An accessory battery charge unit specially adapted for Mercedes-Benz vehicles and tested and approved by Mercedes-Benz is available, permitting the charging of the battery in its installed position. Contact an authorized Mercedes-Benz Center for information and availability.

Charge battery in accordance with the separate instructions for the accessory battery charger.

Have batteries charged at an authorized Mercedes-Benz Center. If you charge the

batteries yourself, follow the operating instructions for your charging device.

Only use a battery charge unit with a maximum charging voltage of 14.8 V.

► Charge battery in accordance with the instructions of the battery charger manufacturer.

Jump starting

Jump starting

Warning!

Failure to follow these directions will cause damage to the electronic components, and can lead to a battery explosion and severe injury or death.

Never lean over batteries while connecting or jump starting. You might get injured.

Battery fluid contains sulfuric acid. Do not allow this fluid to come in contact with eyes, skin or clothing. In case it does, immediately flush affected area with water, and seek medical help if necessary.

A battery will also produce hydrogen gas, which is flammable and explosive. Keep flames or sparks away from battery, avoid improper connection of jumper cables, smoking, etc.

Attempting to jump start a frozen battery can result in it exploding, causing personal injury.

Read all instructions before proceeding.

 Do not tow-start the vehicle. You could otherwise seriously damage the automatic transmission which is not covered by the Mercedes-Benz Limited Warranty.

 Avoid repeated and lengthy starting attempts.

Do not attempt to start the engine using a battery quick-charge unit.

If the engine does not run after several unsuccessful starting attempts, have it checked at the nearest authorized Mercedes-Benz Center.

Excessive unburned fuel generated by repeated failed starting attempts may damage the catalytic converter and may present a fire risk.

Make sure the jumper cables do not have loose or missing insulation.

Make sure the cable clamps do not touch any other metal part while the other end is still attached to a battery.

If the battery is discharged, the engine can be started with jumper cables and the fully charged battery of another vehicle or an equivalent starter pack. Observe the following:

- Access to the battery is not possible on all vehicles. If you cannot access the battery

in your vehicle provide jump start power by an external battery or starter pack.

- Jump starting should only be performed when the engine and catalytic converter are cold.
 - Do not start the engine if the battery is frozen. Let the battery thaw out first.
 - Only jump start from batteries with the same voltage rating (12 V). Jump starting with a more powerful battery could damage the vehicle's electrical system, which will not be covered by the Mercedes-Benz Limited Warranty.
 - Only use jumper cables with sufficient cross-section and insulated terminal clamps.
 - Always make sure the jumper cables are not on or near pulleys, fans or other parts that move when an engine is started or running.
 - Should the battery be drained completely, let the donating power source charge the vehicle for several minutes before reattempting the starting process.
- ▶ Make sure the two vehicles do not touch.
 - ▶ Switch off all electrical consumers.
 - ▶ Engage the electronic parking brake.

Towing the vehicle

- ▶ Make sure the automatic transmission is in park position **P**.
- ▶ Open the hood.

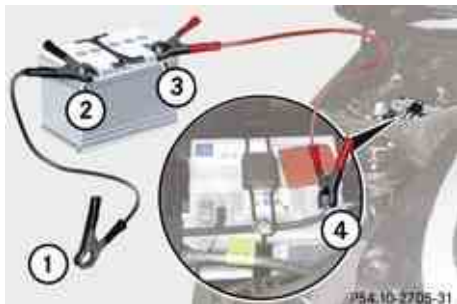

- ① Negative clamp
- ② Negative terminal of charged battery
- ③ Positive terminal of charged battery
- ④ Positive terminal of discharged battery

! Never invert the terminal connections!

- ▶ Connect positive terminals ③ and ④ of the batteries with a jumper cable. Clamp the cable to positive terminal ③ of the charged battery first.
- ▶ Connect negative terminal ② of charged battery with a jumper cable and attach other end of the jumper cable with the

negative clamp ① to a suitable ground point on the vehicle.

- ▶ Get into vehicle and start engine within 30 seconds.

If the starting attempt does not succeed:

- ▶ Turn the SmartKey in starter switch to position **0**.
- ▶ Take out the SmartKey.
- ▶ Turn off engine of donor vehicle, restart it and let it run at idle speed for several minutes.
- ▶ Disconnect the jumper cable during this time.
- ▶ Reconnect jumper cable as described before.
- ▶ Restart engine.

If the starting attempt is succeed:

- ▶ While the engine is running, switch off several electrical consumers such as the blower.
- ▶ Remove the jumper cables first from negative clamp ① from ground point and negative terminal ②, then from positive terminals ④ and ③.
- ▶ Have the battery checked at the nearest authorized Mercedes-Benz Center.

Towing the vehicle

Safety notes

Mercedes-Benz recommends that the vehicle be transported with all wheels off the ground using flatbed or appropriate wheel lift/dolly equipment. This method is preferable to other types of towing.

! To prevent damage during transport, do not tie down vehicle by its chassis or suspension parts.

If circumstances do not permit the recommended towing methods, the vehicle may be towed with all wheels on the ground or front axle raised only so far as necessary to have the vehicle moved to a safe location where the recommended towing methods can be employed.

! Before towing the vehicle observe the following instructions:

- Do not tow-start the vehicle. You could otherwise seriously damage the automatic transmission which is not covered by the Mercedes-Benz Limited Warranty.
- Do not tow with sling-type equipment. Towing with sling-type equipment over

▷▷

Towing the vehicle

bumpy roads will damage radiator and supports.

- Towing of the vehicle should only be done using the properly installed towing eye bolt. Never attach a tow cable, tow rope or tow rod to the vehicle chassis, frame or suspension parts.

i If the battery is disconnected or discharged

- the SmartKey will not turn in the starter switch
- the automatic transmission will remain in park position **P**
- For more information see “Battery” (▷ page 551) or “Jump starting” (▷ page 554).

Installing towing eye bolt

Depending on whether you are towing a vehicle or you are being towed, the towing eye bolt can be screwed into threaded holes which are located behind covers on each bumper.

The towing eye bolt is supplied with the vehicle tool kit, located underneath the trunk floor (▷ page 472).

- ▶ Take the vehicle tool kit out of the trunk.

Removing cover in front bumper

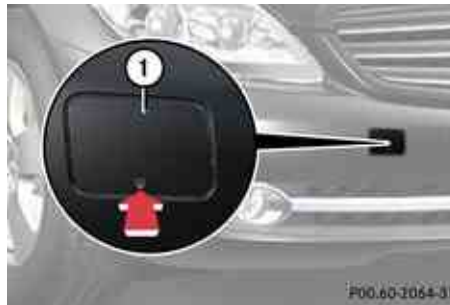

① Cover

- ▶ Press mark on cover ① as indicated by the arrow.
- ▶ Lift cover ① off to reveal the threaded hole for the towing eye bolt.

Removing cover in rear bumper

⚠ Warning!

In order to avoid possible serious burns or injury, use extreme caution when removing the rear cover, because the rear exhaust pipe is extremely hot.



① Cover

Towing the vehicle

- ▶ Press mark on cover ① as indicated by the arrow.
- ▶ Lift cover ① off to reveal the threaded hole for the towing eye bolt.

Fixing towing eye bolt



Example illustration front bumper

- ① Towing eye bolt
- ▶ Take the towing eye bolt and the wheel wrench from the vehicle tool kit.
- ▶ Screw towing eye bolt ① clockwise into threaded hole to its stop.
- ▶ Insert wheel wrench into towing eye and tighten towing eye bolt ① by turning it clockwise.

Removing towing eye bolt

- ▶ Loosen towing eye bolt ① counterclockwise with wheel wrench.
- ▶ Unscrew towing eye bolt ①.
- ▶ **Reinstalling cover:** Fit cover ① (▷ page 556) and snap it into place.
- ▶ Store the towing eye bolt and wheel wrench back into the vehicle tool kit.

Towing with all wheels on the ground

⚠ Warning!

If circumstances require towing the vehicle with all wheels on the ground, always tow with a tow bar if:

- the engine will not run
- there is a malfunction in the brake system
- there is a malfunction in the power supply or in the vehicle's electrical system

This is necessary to adequately control the towed vehicle.

Prior to towing the vehicle with all wheels on the ground, make sure the SmartKey is in starter switch position **2**.

⚠ Warning!

With the engine not running, there is no power assistance for the brake and steering systems. In this case, it is important to keep in mind that a considerably higher degree of effort is necessary to brake and steer the vehicle. Adapt your driving accordingly.

- ▶ Make sure the ignition is switched on.
- ▶ With the vehicle at a standstill, depress the brake pedal and keep it pressed.
- ▶ Shift the automatic transmission into neutral position **N**.
- ▶ Release the brake pedal.
- ▶ If engaged, release the electronic parking brake.
- ▶ Switch on the hazard warning flasher (▷ page 320).

❗ Keep in mind that it is important to have the ignition switched on. Removing the SmartKey from the starter switch or opening a front door with the ignition switched off will automatically shift the automatic transmission into park position **P**.

Fuses

- !** The vehicle may be towed only for distances up to 30 miles (50 km) and at a speed not to exceed 30 mph (50 km/h).
- i** To signal turns while being towed with the hazard warning flasher in use you can activate the combination switch for the left or right turn signal in the usual manner – only the selected turn signal will operate. Upon canceling the turn signal, the hazard warning flasher will operate again.

Towing with front axle raised

When towing the vehicle with the front axle raised, the wheels on the ground have to move freely.

- ▶ Switch off the automatic central locking (▷ page 218).
 - ▶ Switch on the hazard warning flasher (▷ page 320).
 - ▶ Make sure the automatic transmission remains in neutral position **N**. Observe instructions, see “Remaining in neutral position **N**” (▷ page 337).
- !** Vehicles without 4MATIC:
Because the ESP® operates automatically, the engine and ignition must be shut off

(SmartKey in starter switch position **0** or **1** or KEYLESS-GO start/stop button in position **0** or **1**) when the vehicle is being towed with one axle raised.

Active braking action through the ESP® may otherwise seriously damage the brake system which is not covered by the Mercedes-Benz Limited Warranty.

- !** Keep in mind that it is important for the SmartKey to be left in starter switch with the ignition switched off. As soon as the SmartKey is removed from the starter switch the automatic transmission will shift to park position **P**.
- !** The vehicle may be towed only for distances up to 30 miles (50 km) and at a speed not to exceed 30 mph (50 km/h).

Fuses

Introduction

The electrical fuses in your vehicle serve to switch off malfunctioning power circuits.

If a fuse is blown, the components and systems secured by that fuse will stop operating.

⚠ Warning!

Only use fuses approved by Mercedes-Benz with the specified amperage for the system in question and do not attempt to repair or bridge a blown fuse. Using other than approved fuses or using repaired or bridged fuses may cause an overload leading to a fire, and/or cause damage to electrical components and/or systems. Have the cause determined and remedied by an authorized Mercedes-Benz Center.

- !** Switch off the vehicle's internal electrical functions when you are working on the fuses.

A blown fuse must be replaced by an appropriate spare fuse (recognizable by its color or the fuse rating given on the fuse) of the amperage recommended in the fuse chart. Any Mercedes-Benz Center will be glad to advise you on this subject.

i In case of a blown fuse contact Roadside Assistance or an authorized Mercedes-Benz Center.

If a newly inserted fuse blows again, have the cause determined and rectified by an authorized Mercedes-Benz Center.

A fuse chart is located in the trunk with the vehicle tool kit (▷ page 472). The fuse chart explains the fuse allocation and fuse amperages.

Before replacing fuses

- ▶ Engage the electronic parking brake.
- ▶ Make sure the automatic transmission is in park position **P**.

The transmission position indicator in the multifunction display should be on **P**.

- ▶ Switch off all electrical consumers.
- ▶ Turn off the engine.

Fuse box in passenger compartment

! Do not use sharp objects such as a screwdriver to open the fuse box cover in the dashboard. You could damage the fuse box cover or the dashboard.



Fuse box on driver's side

① Fuse box cover

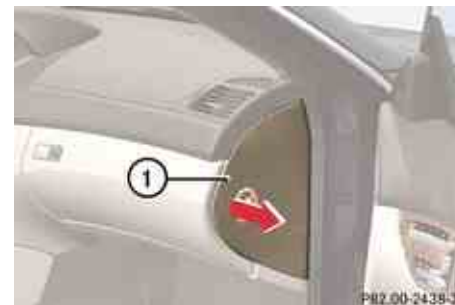

Fuse box on passenger side

① Fuse box cover

- ▶ Open the respective door.
- ▶ Using your hands, pull cover ① in direction of arrow and remove it.
- ▶ **Closing:** Hook cover ① into the opening at the front.

! The fuse box cover must be properly positioned as described to prevent moisture or dirt from entering the fuse box and possibly impairing fuse operation.

Fuses

Fuse box in the rear passenger compartment



① Cover

- ▶ **Opening:** Swing down center armrest.
- ▶ Open cover behind center armrest.
- ▶ Pull cover ① forward in direction of arrow.
- ▶ **Closing:** Press cover ① backward and engage.

❗ Make sure the seal in the cover is not damaged during opening or closing.

Fuse box in engine compartment

The fuse boxes are located in the engine compartment on the driver's and passenger side.

- ▶ Open the hood.

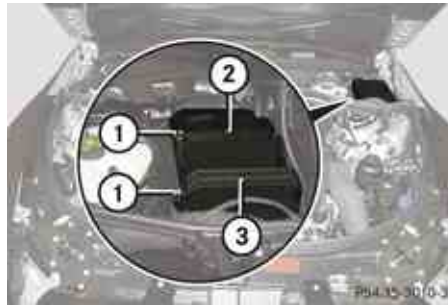

Fuse box on driver's side

- ① 4 screws
- ② Fuse box cover
- ③ Bracket

- ▶ CL 63 AMG: Remove the control box above the fuse box.
- ▶ **Removing cover:** Take the crank from the Operator's Manual pouch.
- ▶ Loosen screws ① with crank.
- ▶ Remove bracket ③.
- ▶ Remove fuse box cover ②.

- ▶ **Installing cover:** Attach fuse box cover ②.
- ▶ Attach bracket ③.
- ▶ Tighten screws ① with crank.

❗ The fuse box cover must be installed properly to prevent moisture and/or dirt from entering the fuse box and possibly impairing fuse operation.



Example illustration fuse box on passenger side

- ① Retaining lugs
- ② Fuse box cover
- ▶ **Removing cover:** Press retaining lugs ①.
- ▶ Remove fuse box cover ②.
- ▶ **Installing cover:** Attach fuse box cover ②.
- ▶ Press fuse box cover ② down.

- ❗ The fuse box cover must be installed properly to prevent moisture and/or dirt from entering the fuse box and possibly impairing fuse operation.
- ▶ Close the hood after checking or replacing fuses.

Emergency engine shutdown

If the engine cannot be turned off as described (▷ page 334), you may use the following emergency procedure.

- ▶ Take the fuse chart from the vehicle tool kit (▷ page 472).
- ▶ Find row “Emergency engine shutdown” in the fuse chart table to identify the fuses that have to be removed as well as their locations.
- ▶ Remove the respective fuses.

Vehicle equipment 564
Parts service 564
Warranty coverage 564
Identification labels 565
Engine 567
Rims and tires 569
Electrical system 574
Main dimensions 575
Weights 576
Fuels, coolants, lubricants etc. 577



Warranty coverage

Vehicle equipment

i This Operator's Manual describes all features, standard or optional, potentially available for your vehicle at the time of purchase. Please be aware that your vehicle might not be equipped with all features described in this manual.

Parts service

All authorized Mercedes-Benz Centers maintain a stock of Genuine Mercedes-Benz Parts required for maintenance and repair work. In addition, strategically located parts distribution centers provide quick and reliable parts service.

More than 300 000 different parts for Mercedes-Benz models are available.

Genuine Mercedes-Benz Parts are subjected to stringent quality inspections. Each part has been specifically developed, manufactured or selected for and adapted to Mercedes-Benz vehicles.

Therefore, Genuine Mercedes-Benz Parts should be installed.

! Do not use non-genuine Mercedes-Benz parts and accessories not authorized by Mercedes-Benz. Doing so could damage the vehicle, which is not covered by the Mercedes-Benz Limited Warranty. Also, it could compromise the vehicle's durability or safety.

Warranty coverage

Your vehicle is covered under the terms of the warranties printed in the Service and Warranty Information booklet.

Your authorized Mercedes-Benz Center will exchange or repair any defective parts originally installed in the vehicle in accordance with the terms of the following warranties:

- New Car Limited Warranty
- Emission System Warranty
- Emission Performance Warranty
- California, Connecticut, Maine, Massachusetts, New York, Pennsylvania, Rhode Island, and Vermont Emission Control Systems Warranty
- State Warranty Enforcement Laws (Lemon Laws)

Replacement parts and accessories are covered by the Mercedes-Benz Parts and Accessories warranties, copies of which are available at any authorized Mercedes-Benz Center.

Identification labels

Loss of Service and Warranty Information booklet

Should you lose your Service and Warranty Information booklet, have an authorized Mercedes-Benz Center arrange for a replacement. It will be mailed to you.

Identification labels

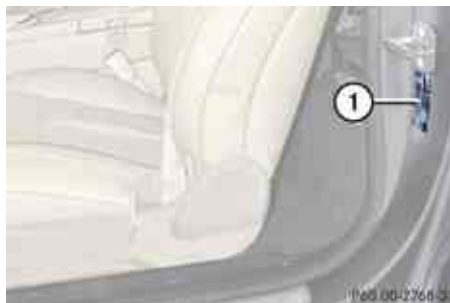

- ① Certification label (on driver's door B-pillar)

The Vehicle Identification Number (VIN) can be found in the following locations:

- on the certification label
- embossed underneath a cover behind the rear center armrest (▷ page 566)
- on the lower edge of the windshield (▷ page 566)



Example certification label (U.S. vehicles)

- ② VIN
- ③ Paintwork code



Example certification label (Canada vehicles)

- ② VIN
- ③ Paintwork code

Identification labels

i Data shown on certification label are for illustration purposes only. These data are specific to each vehicle and may vary from data shown in the illustration. Refer to certification label on vehicle for actual data specific to your vehicle.



Rear center armrest

④ VIN

► Fold down the rear center armrest.

The VIN is embossed underneath a cover behind the rear center armrest.

► Open the cover.

VIN ④ is now visible.

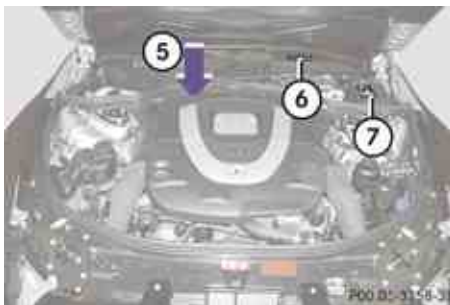

All models except AMG vehicles

⑤ Engine number (engraved on engine)

⑥ VIN (on lower edge of windshield)

⑦ Emission control information label, includes both federal and California certification exhaust emission standards

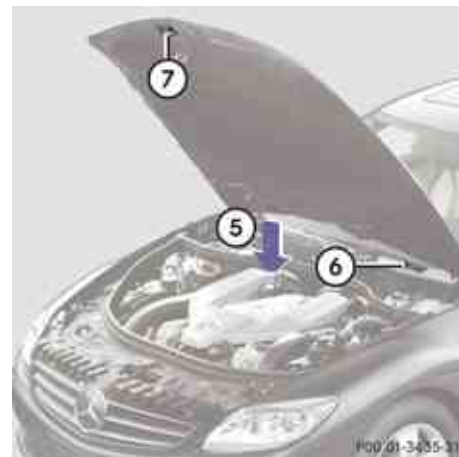

AMG vehicles

⑤ Engine number (engraved on engine)

⑥ VIN (on lower edge of windshield)

⑦ Emission control information label, includes both federal and California certification exhaust emission standards

i When ordering parts, please specify vehicle identification and engine number.

Engine		
Model	CL 550 4MATIC (216.386) ¹⁰	CL 600 (216.376) ¹⁰
Engine	273	275
Mode of operation	4-stroke engine, gasoline injection	4-stroke engine, gasoline injection
No. of cylinders	8	12
Bore	3.86 in (98.00 mm)	3.23 in (82.00 mm)
Stroke	3.56 in (90.50 mm)	3.43 in (87.00 mm)
Total piston displacement	333.3 cu in (5 461 cm ³)	336.4 cu in (5 513 cm ³)
Compression ratio	10.7:1	9:1
Output acc. to SAE J 1349	382 hp/6 000 rpm (285 kW/6 000 rpm) ¹¹	510 hp/5 000 rpm (380 kW/5 000 rpm) ¹¹
Maximum torque acc. to SAE J 1349	391 lb-ft/2 800 rpm - 4 800 rpm (530 Nm/2 800 rpm - 4 800 rpm)	612 lb-ft/1 800 rpm - 3 500 rpm (830 Nm/1 800 rpm - 3 500 rpm)
Maximum engine speed	6 500 rpm	5 950 rpm
Firing order	1-5-4-2-6-3-7-8	1-12-5-8-3-10-6-7-2-11-4-9
Poly-V-belt	2 404 mm	2 370 mm

¹⁰ The quoted data apply only to the standard vehicle. Contact an authorized Mercedes-Benz Center for the corresponding data of all special bodies and special equipment.

¹¹ Premium fuel required. Performance may vary with fuel octane rating.

Engine

Model	CL 63 AMG (216.377) ¹²	CL 65 AMG (216.379) ¹²
Engine	156	275
Mode of operation	4-stroke engine, gasoline injection	4-stroke engine, gasoline injection
No. of cylinders	8	12
Bore	4.02 in (102.20 mm)	3.25 in (82.60 mm)
Stroke	3.72 in (94.60 mm)	3.66 in (93.00 mm)
Total piston displacement	378.8 cu in (6 208 cm ³)	364.9 cu in (5 980 cm ³)
Compression ratio	11.3:1	9:1
Output acc. to SAE J 1349	518 hp/6 800 rpm (386 kW/6 800 rpm) ¹³	603 hp/4 800 rpm - 5 100 rpm (450 kW/4 800 rpm - 5 100 rpm) ¹³
Maximum torque acc. to SAE J 1349	465 lb-ft/5 200 rpm (630 Nm/5 200 rpm)	738 lb-ft/2 000 rpm - 4 000 rpm (1 000 Nm/2 000 rpm - 4 000 rpm)
Maximum engine speed	7 200 rpm	5 950 rpm
Firing order	1-5-4-2-6-3-7-8	1-12-5-8-3-10-6-7-2-11-4-9
Poly-V-belt	2 360 mm	2 370 mm

¹² The quoted data apply only to the standard vehicle. Contact an authorized Mercedes-Benz Center for the corresponding data of all special bodies and special equipment.

¹³ Premium fuel required. Performance may vary with fuel octane rating.

Rims and tires

Notes

! Only use tires which have been tested and approved by Mercedes-Benz. Tires approved by Mercedes-Benz are developed to provide best possible performance in conjunction with the driving safety systems on your vehicle such as the ABS or the ESP®. Tires specially developed for your vehicle and tested and approved by Mercedes-Benz can be identified by finding the following on the tire's sidewall:

- MO = Mercedes-Benz Original equipment tires

Using tires other than those approved by Mercedes-Benz may result in damage that is not covered by the Mercedes-Benz Limited Warranty.

! Using tires other than those approved by Mercedes-Benz can have detrimental effects, such as

- poor handling characteristics
- increased noise
- increased fuel consumption

Moreover, tires and rims not approved by Mercedes-Benz may, under load, exhibit

dimensional variations and different tire deformation characteristics that could cause them to come into contact with the vehicle body or axle parts. Damage to the tires or the vehicle may be the result.



- i** Further information on tires and rims is available at any authorized Mercedes-Benz Center. A placard with the recommended tire inflation pressures is located on the driver's door B-pillar. Some vehicles may have supplemental tire inflation pressure information for driving at high speeds or for vehicle loads less than the maximum loaded vehicle condition. If such information is provided, it can be found on the placard located on the inside of the fuel filler flap. The tire inflation pressure should be checked regularly and should only be adjusted on cold tires. Follow tire manufacturer's maintenance recommendation included with the vehicle.

For information on recommended tire inflation pressure and supplemental tire inflation pressure information for special driving situations, see (▷ page 435).

- i** The following pages also list the approved wheel rim and tire sizes for equipping your vehicles with winter tires. Winter tires are

not available as standard or optional factory equipment, but can be purchased from an authorized Mercedes-Benz Center. Equipping your vehicle with winter tires approved for your vehicle model may require the purchase of two or four wheel rims of the recommended size for use with these winter tires. This depends on vehicle model and the standard or optional factory-equipped wheel rim/tire configuration on your vehicle. For more information contact an authorized Mercedes-Benz Center.



Rims and tires

Same size tires		
Model	CL 550 4MATIC	CL 600 CL 550 4MATIC (Sport Package) CL 600 (Sport Package)
Rims (light alloy)	8.5 J x 18 H2	8.5 J x 18 H2
Wheel offset	1.69 in (43 mm)	1.69 in (43 mm)
All-season tires ^{14,15}	255/45 R18 99H M+S	—
Winter tires ^{14,15,16}	255/45 R18 99V M+S 	255/45 R18 99V M+S 

¹⁴ Radial-ply tires.

¹⁵ For use with snow chains contact an authorized Mercedes-Benz Center.

¹⁶ Not available as factory equipment.

Model	CL 550 4MATIC (AMG Sport Package)	CL 63 AMG CL 63 AMG (Performance Package) CL 65 AMG
Rims (light alloy)	8.5 J x 18 H2	–
Wheel offset	1.69 in (43 mm)	–
Winter tires ^{17,18,19}	255/45 R18 99V M+S 	–
AMG rims (light alloy)	8.5 J x 19 H2	8.5 J x 19 H2
Wheel offset	1.69 in (43 mm)	1.69 in (43 mm)
All-season tires ¹⁷	255/40 R19 100V XL (Extra Load) M+S	–
Winter tires ^{17,18,19}	–	255/40 R19 100V XL (Extra Load) M+S 

¹⁷ Radial-ply tires.

¹⁸ For use with snow chains contact an authorized Mercedes-Benz Center.

¹⁹ Not available as factory equipment.

Rims and tires

Mixed size tires				
	Model	CL 600	CL 600	CL 63 AMG CL 63 AMG (Performance Package) CL 65 AMG
Front axle	Rims (light alloy)	8.5 J x 18 H2	8.5 J x 19 H2	—
	AMG rims (light alloy)	—	—	8.5 J x 20 H2
	Wheel offset	1.69 in (43 mm)	1.69 in (43 mm)	1.69 in (43 mm)
	All-season tires ²⁰	255/45 R18 99H M+S	255/40 R19 100V XL (Extra Load) M+S	255/35 ZR20 XL (Extra Load)
Rear axle	Rims (light alloy)	9.5 J x 18 H2	9.5 J x 19 H2	—
	AMG rims (light alloy)	—	—	9.5 J x 20 H2
	Wheel offset	1.69 in (43 mm)	1.69 in (43 mm)	1.69 in (43 mm)
	All-season tires ^{20,21}	275/45 R18 103H M+S	275/40 R19 101V M+S	275/35 ZR20 XL (Extra Load)

²⁰ Radial-ply tires.

²¹ Must not be used with snow chains.

Spare wheel

! Compare the recommended tire inflation pressure for your vehicle with the tire inflation pressure on the yellow label located on the spare wheel rim.

If the tire inflation pressure on the yellow label on the spare wheel rim differs from the values given in this Operator's Manual, inflate the tire to the recommended tire inflation pressure given on the yellow label on the spare wheel rim.

i Please note that the tire inflation pressure of the spare wheel differs from the tire inflation pressure of the road tires.

Model	All models
Rim	4.5 B x 19 H2
Wheel offset	1.38 in (35 mm)
Minispare tire ²²	T 155/70 R19 113M
Recommended tire inflation pressure	61 psi (4.2 bar)

²² Must not be used with snow chains.

Electrical system

Electrical system

Model		CL 550 4MATIC	CL 600	CL 63 AMG	CL 65 AMG
Alternator		14 V/220 A	14 V/220 A	14 V/220 A	14 V/220 A
Starter motor		12 V/1.7 kW	12 V/2.0 kW	12 V/2.1 kW	12 V/1.7 kW
Starter battery		12 V/35 Ah	12 V/35 Ah	12 V/35 Ah	12 V/35 Ah
Battery for electrical consumers		12 V/95 Ah	12 V/95 Ah	12 V/95 Ah	12 V/95 Ah
Spark plugs	Type	NGK PLKR 7A Bosch Y 7 MPP33	NGK IFR 6Q-G	NGK ILZKAR 7A10	NGK IFR 6Q-G
	Electrode gap	0.031 in (0.8 mm)	0.028 in (0.7 mm)	0.039 in (1.0 mm)	0.028 in (0.7 mm)
	Tightening torque	15 lb-ft - 18 lb-ft (20 Nm - 25 Nm)	15 lb-ft - 22 lb-ft (20 Nm - 30 Nm)	18 lb-ft - 22 lb-ft (25 Nm - 30 Nm)	15 lb-ft - 22 lb-ft (20 Nm - 30 Nm)

Main dimensions

Model	CL 550 4MATIC CL 600	CL 63 AMG CL 65 AMG
Overall vehicle length	199.7 in (5 071 mm)	200.4 in (5 090 mm)
Overall vehicle width, exterior rear view mirrors folded out	84.2 in (2 139 mm)	84.2 in (2 139 mm)
Overall vehicle height (vehicles with 18 in rims)	58.5 in (1 485 mm)	–
Overall vehicle height (vehicles with 19 in rims)	–	56.1 in (1 426 mm)
Overall vehicle height (vehicles with 20 in rims)	–	56.2 in (1 428 mm)
Wheelbase	116.3 in (2 955 mm)	116.3 in (2 955 mm)
Track, front	63.0 in (1 601 mm)	63.0 in (1 601 mm)
Track, rear	63.3 in (1 607 mm)	63.3 in (1 607 mm)
Turning circle	38.1 ft (11.6 m)	38.1 ft (11.6 m)

Weights

Weights

Model	All models
Trunk load	max. 220 lb (100 kg)

Fuels, coolants, lubricants etc.

Capacities

Vehicle components and their respective lubricants must match. Therefore only use products tested and approved by Mercedes-Benz.

For information on tested and approved products, contact an authorized Mercedes-Benz Center or visit www.mbusa.com (USA only).

⚠ Warning!

Comply with all valid regulations with respect to handling, storing, and disposing of service fluids. Otherwise you could endanger persons or the environment. Keep service fluids out of the reach of children.

Fuels, coolants, lubricants etc.

For health reasons, you should prevent service fluids from coming into direct contact with your skin or clothing.

If a service fluid is swallowed, contact a physician immediately.

	Model	Capacity	Fuels, coolants, lubricants, etc.
Engine with oil filter	CL 550 4MATIC	9.0 US qt (8.5 l)	Approved engine oils
	CL 600 CL 65 AMG	9.5 US qt (9.0 l)	
	CL 63 AMG ²³	9.9 US qt (9.35 l)	
Automatic transmission	CL 550 4MATIC	10.4 US qt (9.8 l)	MB Automatic Transmission Fluid
	CL 600	8.1 US qt (7.7 l)	
	CL 63 AMG ²⁴	9.25 US qt (8.75 l)	
	CL 65 AMG	9.2 US qt (8.7 l)	

²³ Engine with oil cooler.

²⁴ Automatic transmission with oil cooler.



Fuels, coolants, lubricants etc.

	Model	Capacity	Fuels, coolants, lubricants, etc.
Rear axle	CL 550 4MATIC	1.9 US qt (1.8 l)	Hypoid gear oil SAE 85 W 90
	CL 600	1.7 US qt (1.6 l)	
	CL 63 AMG	1.3 US qt (1.2 l)	Fuchs Titan EG 5010 D
	CL 65 AMG	1.7 US qt (1.6 l)	
Hydraulic system for active body control (ABC)	All models except 4MATIC	4.2 US qt (4.0 l)	MB ABC Fluid
Power steering	CL 550 4MATIC CL 63 AMG	1.1 US qt (1.0 l)	MB Power Steering Fluid (Chevron Texaco PSF 9109)
	CL 600 CL 65 AMG	1.3 US qt (1.2 l)	
Brake system		0.63 US qt (0.6 l)	MB Brake Fluid (DOT 4+)
Cooling system	CL 550 4MATIC	approx. 12.7 US qt (12.0 l)	MB 325.0 Anticorrosion/Antifreeze
	CL 600	approx. 15.9 US qt (15.0 l)	
	CL 63 AMG	approx. 11.3 US qt (10.7 l)	
	CL 65 AMG	approx. 14.7 US qt (13.9 l)	
Low temperature cooling system	CL 600	approx. 2.8 US qt (2.6 l)	MB 325.0 Anticorrosion/Antifreeze
Fuel tank, including a reserve of		23.8 US gal (90.0 l)	Premium unleaded gasoline (Minimum Posted Octane 91 [Avg. of 96 RON/86 MON])
	All models except AMG vehicles	2.9 US gal (11.0 l)	
	AMG vehicles	3.7 US gal (14.0 l)	

Fuels, coolants, lubricants etc.

	Model	Capacity	Fuels, coolants, lubricants, etc.
Air conditioning system		—	R134a refrigerant and special PAG lubricant oil (never R 12)
Washer system and headlamp cleaning system		6.9 US qt (6.5 l)	MB Windshield Washer Concentrate ²⁵ (▷ page 583) Washer fluid mixing ratio (▷ page 583)

Approved engine oils

Engine oils are specifically tested for their suitability in our engines and durability for our service intervals. Therefore, only use approved engine oils and oil filters required for vehicles with Maintenance System.

For a listing of approved engine oils and oil filters, contact an authorized Mercedes-Benz Center or visit www.mbusa.com (USA only).

! Using engine oils and oil filters of a specification other than those expressly required for the Maintenance System, or changing of oil and oil filter at change intervals longer than those called for by the Maintenance System will result in engine or emission control system damage not

covered by the Mercedes-Benz Limited Warranty.

Please follow Maintenance System recommendations for scheduled oil changes. Failure to do so will result in engine or emission control system damage not covered by the Mercedes-Benz Limited Warranty.

Mercedes-Benz recommends MOBIL OIL. Use the table below to determine the MB sheet number.

Model	Engine type	MB sheet number
CL 550 4MATIC	273	229.5
CL 600	275	229.5

Model	Engine type	MB sheet number
CL 63 AMG	156	229.5 ²⁶
CL 65 AMG	275	229.5

i MB sheet numbers are printed on the outside of oil containers.

²⁵ Mixed with water or commercially available premixed washer solvent/antifreeze.

Fuels, coolants, lubricants etc.

Viscosity grades for engine oils

Using the chart below, select oil viscosity according to the lowest air temperature expected before the next oil change.

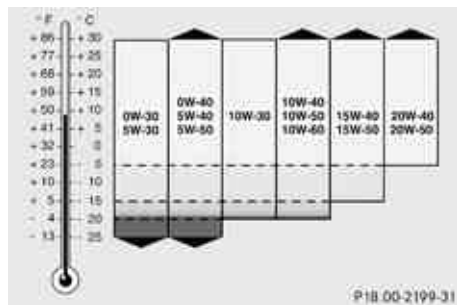

Engine oil additives

! Do not blend oil additives with engine oil. They may damage the engine. Damage or malfunctions resulting from blending oil additives are not covered by the Mercedes-Benz Limited Warranty.

Air conditioning refrigerant

R134a (HFC) refrigerant and special PAG lubricating oil are used in the air conditioning system.

! Never use R 12 (CFC) or mineral-based lubricating oil. Otherwise damage to the system will occur.

Brake fluid

Warning!

During vehicle operation, the boiling point of the brake fluid is continuously reduced through the absorption of moisture from the atmosphere.

Under extremely strenuous operating conditions, this moisture content can lead to the formation of bubbles in the system, thus reducing the system's efficiency.

Therefore, the brake fluid must be replaced regularly. Refer to your vehicle's Maintenance Booklet for replacement interval.

Only brake fluid approved by Mercedes-Benz is recommended. Any authorized Mercedes-

Benz Center will provide you with additional information.

Premium unleaded gasoline

Warning!

Gasoline is highly flammable and poisonous. It burns violently and can cause serious personal injury.

Never allow sparks, flames or smoking materials near gasoline!

Turn off the engine before refueling.

Whenever you are around gasoline, avoid inhaling fumes and any skin or clothing contact. Extinguish all smoking materials.

Direct skin contact with fuels and the inhalation of fuel vapors are damaging your health.

! To maintain the engine's durability and performance, premium unleaded gasoline must be used.

If premium unleaded gasoline is not available and low octane gasoline is used, follow these precautions:

- Have the fuel tank only partially filled with unleaded regular gasoline and fill up

²⁶ Restriction: Only SAE 0W-40/SAE 5W-40 engine oils may be used.

Fuels, coolants, lubricants etc.

with premium unleaded gasoline as soon as possible.

- Avoid full throttle driving and abrupt acceleration.
- Do not exceed an engine speed of 3 000 rpm if the vehicle is loaded with a light load such as two persons and no luggage.
- Do not exceed $\frac{2}{3}$ of maximum accelerator pedal position if the vehicle is fully loaded or operating in mountainous terrain.

Fuel requirements

Only use premium unleaded gasoline. The octane number (posted at the pump) must be 91 min. It is an average of both the Research Octane Number (RON) and the Motor Octane Number (MON): $(RON+MON)/2$. This is also known as the ANTI-KNOCK INDEX.

Reformulated gasolines (RFG) and/or unleaded gasoline containing oxygenates such as ethanol, TAME, ETBE, IPA, IBA, and TBA can be used provided the ratio of any one of these oxygenates to gasoline does not exceed 10%; MTBE must not exceed 15%.

The ratio of methanol to gasoline must not exceed 3% plus additional cosolvents.

Using mixtures of ethanol and methanol is not allowed. Gasohol, which contains 10% ethanol and 90% unleaded gasoline, can be used.

These blends must also meet all other fuel requirements, such as resistance to spark knock, boiling range, vapor pressure, etc.

Gasoline additives

A major concern among engine manufacturers is carbon build-up caused by gasoline. Mercedes-Benz recommends only the use of quality gasoline containing additives that prevent the build-up of carbon deposits.

After an extended period of using fuels without such additives carbon deposits can build up, especially on the intake valves and in the combustion area, leading to engine performance problems such as:

- Warm-up hesitation
- Unstable idle
- Knocking/pinging

- Misfire
- Power loss

In areas where carbon deposits may be encountered due to lack of availability of gasoline which contains these additives, Mercedes-Benz recommends the use of additives approved by us for use on Mercedes-Benz vehicles.

Contact an authorized Mercedes-Benz Center or visit www.mbusa.com (USA only) for a listing of approved product(s). Follow directions on product label.

Do not blend other fuel additives with fuel. This only results in unnecessary cost and may be harmful to the engine operation.

! Damage or malfunction resulting from poor fuel quality or from blending additional fuel additives other than those tested and approved by us for use on Mercedes-Benz vehicles are not covered by the Mercedes-Benz Limited Warranty or by any pre-owned or Extended Limited warranties.

Fuels, coolants, lubricants etc.

Coolants

The engine coolant is a mixture of water and anticorrosion/antifreeze, which provides:

- Corrosion protection
- Freeze protection
- Boiling protection (by increasing the boiling point)

The cooling system was filled at the factory with a coolant providing freeze protection to approximately -35°F (-37°C) and corrosion protection.

! Add premixed coolant solution only. Adding water and MB 325.0 Anticorrosion/Antifreeze separately from each other, could cause engine damage not covered by the Mercedes-Benz Limited Warranty.

If the antifreeze mixture is effective to -35°F (-37°C), the boiling point of the coolant in the pressurized cooling system is reached at approximately 266°F (130°C).

The coolant solution must be used year round to provide the necessary corrosion protection and increase boil-over protection. Refer to the Maintenance Booklet for replacement interval.

Coolant system design and coolant used determine the replacement interval. The

replacement interval published in the Maintenance Booklet is only applicable if MB 325.0 Anticorrosion/Antifreeze solution or other Mercedes-Benz approved products of equal specification are used to renew the coolant concentration or bring it back up to the proper level.

For information on other Mercedes-Benz approved products of equal specification, contact an authorized Mercedes-Benz Center or visit www.mbusa.com (USA only).

To provide important corrosion protection, the solution must be at least 50% anticorrosion/antifreeze (equivalent to freeze protection to approximately -35°F [-37°C]).

If you use a solution that is more than 55% anticorrosion/antifreeze (freeze protection to approximately -49°F [-45°C]), the engine temperature will increase due to the lower heat transfer capability of the solution. Therefore, do not use more than this amount of anticorrosion/antifreeze.

If the coolant level is low, water and MB 325.0 Anticorrosion/Antifreeze should be used to bring it up to the proper level (have cooling system checked for signs of leakage). Please make sure the mixture is in accordance with label instructions.

The water in the cooling system must meet minimum requirements, which are usually satisfied by normal drinking water.

If you are not sure about the water quality, contact an authorized Mercedes-Benz Center.

Anticorrosion/antifreeze

Your vehicle contains a number of aluminum parts. The use of aluminum components in motor vehicle engines necessitates that anticorrosion/antifreeze coolant used in such engines be specifically formulated to protect the aluminum parts. Failure to use such anticorrosion/antifreeze coolant will result in a significantly shortened service life.

Therefore, the following product is strongly recommended for use in your vehicle: MB 325.0 Anticorrosion/Antifreeze agent.

Before the start of the winter season (or once a year in hot southern regions), you should have the anticorrosion/antifreeze concentration checked.

The coolant is also regularly checked each time you bring your vehicle to an authorized Mercedes-Benz Center for service.

Fuels, coolants, lubricants etc.

	Model	Approximate freeze protection	
		-35°F (-37°C)	-49°F (-45°C)
Cooling system	CL 550 4MATIC	6.3 US qt (6.0 l)	7.0 US qt (6.6 l)
	CL 600	7.9 US qt (7.5 l)	8.8 US qt (8.3 l)
	CL 63 AMG	5.7 US qt (5.4 l)	6.2 US qt (5.9 l)
	CL 65 AMG	7.4 US qt (7.0 l)	8.1 US qt (7.7 l)
Low temperature cooling system	CL 600	1.4 US qt (1.3 l)	1.5 US qt (1.4 l)

Washer system and headlamp cleaning system

 **Warning!**

Washer solvent/antifreeze is highly flammable. Do not spill washer solvent/antifreeze on hot engine parts, because it may ignite and burn. You could be seriously burned.

- ▶ Use MB Windshield Washer Concentrate “MB SummerFit”. (1.34 fl oz [40 ml] “MB SummerFit” to 1 gal [4.0 l] solvent)
- ▶ Mix with water for temperatures above freezing point.
- ▶ Mix with commercially available premixed washer solvent/antifreeze for temperatures below freezing point.

Washer fluid mixing ratio

For temperatures above freezing point:
 1 part “MB SummerFit” to 100 parts water
 (1.34 fl oz [40 ml] “MB SummerFit” to 1 gal [4.0 l] water)

For temperatures below freezing point:
 1 part “MB SummerFit” to 100 parts solvent

Service and Literature

Your authorized Mercedes-Benz Center has trained technicians and Genuine Mercedes-Benz Parts to service your vehicle properly. For expert advice and quality service, contact an authorized Mercedes-Benz Center.

If you are interested in obtaining service literature for your vehicle, please contact an authorized Mercedes-Benz Center.

We consider this the best way for you to obtain accurate information for your vehicle.

For further information you can find us on the Mercedes-Benz web-site **www.mbusa.com** (USA only) or **www.mercedes-benz.ca** (Canada only).

Warning!

To help avoid personal injury, be extremely careful when performing any service work or repairs. Improper or incomplete service or the use of incorrect or inappropriate parts or materials may damage the vehicle or its equipment, which may in turn result in personal injury.

If you have any questions about carrying out any type of service, turn to the advice of an authorized Mercedes-Benz Center.

We reserve the right to make changes in design and equipment.

Therefore, information, illustrations and descriptions in this Operator's Manual might differ from your vehicle.

Reprinting, translation and copying, even of excerpts, is not permitted without our prior authorization in writing.

Press time May 26, 2008

GSP/OIS

Printed in U. S. A.



2165843681

Order no. 6515 2274 13 Part no. 216 584 36 81 Edition A 2009