



Operator's Manual
CLK-Class Cabriolet



2 0 9 5 8 4 5 2 9 6

Order No. 6515 1315 13 Part No. 209 584 52 96 USA Edition A, 2007

CLK-Class Cabriolet



Mercedes-Benz

CLK 350

CLK 550

CLK 63 AMG

Our company and staff congratulate you on the purchase of your new Mercedes-Benz.

Your selection of our product is a demonstration of your trust in our company name. Furthermore, it exemplifies your desire to own an automobile that will be as easy as possible to operate and provide years of service.

Your Mercedes-Benz represents the efforts of many skilled engineers and craftsmen. To help assure your driving pleasure, and also the safety of you and your passengers, we ask you to make a small investment of time:

- Please read this manual carefully, then return it to your vehicle where it will be handy for your reference.
- Please follow the recommendations contained in this manual. They are designed to acquaint you with the operation of your Mercedes-Benz.
- Please pay attention to the warnings and cautions contained in this manual. They are designed to help improve the safety of the vehicle operator and occupants.

We extend our best wishes for many miles of safe, pleasurable driving.

Mercedes-Benz USA, LLC
A DaimlerChrysler Company

Introduction	9
Product information	9
Operator's Manual	10
Service and warranty information ..	10
Important notice for California retail buyers and lessees of Mercedes-Benz automobiles	11
Maintenance	12
Roadside Assistance	12
Change of address or ownership....	12
Operating your vehicle outside the USA or Canada	13
Where to find it	14
Symbols	15
Operating safety	16
Proper use of the vehicle	16
Problems with your vehicle	17
Reporting safety defects	18
Reporting safety defects	18
Vehicle data recording	19
Information regarding electronic recording devices	19

At a glance	21
Exterior view	22
Cockpit	24
Instrument cluster	26
Multifunction steering wheel	28
Center console	29
Upper part	29
Lower part	30
Overhead control panel	31
Door control panel	32

Getting started	33
Unlocking	34
Unlocking with the SmartKey	34
Unlocking with KEYLESS-GO*	35
Starter switch positions	36
Adjusting	39
Seats	39
Steering wheel	43
Mirrors	45
Driving	47
Fastening the seat belts	47
Starting the engine	50
Parking brake	52
Driving	53
Switching on headlamps	54
Turn signals	55
Windshield wipers	55
Problems while driving	57
Parking and locking	58
Parking brake	58
Switching off headlamps	59
Turning off the engine	60
Releasing seat belts	61
Locking	61

Safety and Security	63	Controls in detail	97	Memory function	124
Occupant safety	64	Locking and unlocking	98	Storing positions into memory	125
Air bags	65	SmartKey	98	Recalling positions from memory	125
Occupant Classification System	71	SmartKey with KEYLESS-GO*	101	Lighting	126
Seat belts	75	Checking the batteries in the		Exterior lamp switch	126
Active head restraints	80	SmartKey or		Combination switch	130
Roll bars	81	SmartKey with KEYLESS-GO*	107	Corner-illuminating front	
Children in the vehicle	82	Loss of the		fog lamps* (With Bi-Xenon*	
Blocking of rear		SmartKey or		headlamps only)	131
side window operation	86	SmartKey with KEYLESS-GO*	107	Hazard warning flasher	133
Panic alarm	87	Opening the doors		Interior lighting	134
Activating	87	from the inside	108	Door entry lamps	135
Deactivating	87	Opening the trunk	109	Trunk lamp	135
Driving safety systems	88	Closing the trunk	110	Instrument cluster	136
ABS	88	Trunk emergency release	116	Adjusting	
BAS	90	Valet locking	117	instrument cluster illumination	136
ESP®	90	Automatic central locking	117	Coolant temperature indicator	137
Anti-theft systems	95	Locking and unlocking		Resetting trip odometer	137
Immobilizer	95	from the inside	118	Tachometer	138
Anti-theft alarm system	95	Seats	119	Clock	138
		Front seat active head restraints .	119	Outside temperature indicator	138
		Rear seat head restraints	119	Control system	139
		Multicontour seat*	121	Multifunction display	139
		Seat heating*	122	Multifunction steering wheel	140
		Seat ventilation*	123	Menus	142
				Standard display menu	145

AMG menu	145	Good visibility	184	Adjusting air volume	204
AUDIO menu	149	Headlamp cleaning system*	184	Front defroster	204
NAV* menu	151	Rear view mirrors.....	184	Maximum cooling MAXCOOL.....	205
Vehicle status		Sun visors	186	Air recirculation mode	205
message memory menu	152	Rear window defroster.....	187	Charcoal filter	207
Settings menu.....	153	Climate control.....	188	Air conditioning	208
Trip computer menu.....	165	Deactivating the		Residual heat and ventilation*	
TEL menu*	167	climate control system	191	(Canada only).....	209
Automatic transmission.....	170	Operating the climate control		Rear passenger compartment	
Gear selector lever.....	170	system in automatic mode.....	191	adjustable air vents	210
Shifting procedure	171	Setting the temperature.....	192	Audio system.....	211
Gear selector lever positions	172	Adjusting air distribution.....	192	Audio and telephone*, operation..	211
Driving tips.....	174	Adjusting air volume	193	Operating safety	211
Gear ranges	175	Front defroster.....	193	Sound system*	211
Automatic shift program	176	Air recirculation mode	194	Operating and display elements ...	212
Gear selector lever		Air conditioning.....	196	Button and soft key operation	214
one-touch gearshifting	177	Rear passenger compartment		Operation.....	214
Steering wheel gearshift control		adjustable air vents.....	197	Radio operation	218
one-touch gearshifting*	179	Automatic climate control	198	Introduction to satellite radio*	
Manual shift program		Deactivating the automatic		(USA only).....	222
CLK 63 AMG	181	climate control system	201	CD mode.....	227
Emergency operation		Operating the automatic		GSM network phones	234
(Limp-Home Mode)	183	climate control system		TDMA or CDMA network phones ..	241
		in automatic mode	201	Emergency calls “911”	247
		Setting the temperature.....	202		
		Adjusting air distribution.....	203		

Contents

Power windows.....	249	Useful features	276	Operation	299
Opening and closing		Storage compartments	276	The first 1000 miles (1500 km)	300
the windows	249	Center armrest.....	278	Driving instructions	301
Synchronizing power windows	251	Armrest in the		Drive sensibly – save fuel.....	301
Summer opening feature.....	252	rear passenger compartment.....	279	Drinking and driving.....	301
Convenience closing feature	253	Cup holders.....	279	Pedals	301
Opening and closing		Ashtrays.....	280	Power assistance	302
all side windows with		Cigarette lighter	282	Brakes.....	302
the soft top switch	254	Power outlet in the		Driving off	304
Soft top.....	255	rear passenger compartment.....	283	Parking.....	304
Opening and closing		Floor mats*	283	Tires.....	305
the soft top.....	255	Telephone*	284	Hydroplaning.....	306
Opening and closing		Tele Aid	287	Tire traction	306
the soft top with the SmartKey	259	Garage door opener*	293	Tire speed rating.....	307
Luggage cover.....	260			Winter driving instructions.....	308
Wind screen	261			Standing water.....	309
Driving systems	263			Passenger compartment.....	309
Cruise control.....	263			Driving abroad	309
Parktronic system				Control and operation	
(Parking assist)*,				of radio transmitters	309
CLK 63 AMG (USA),				Catalytic converter.....	310
Canada all vehicles.....	267			Emission control	310
Loading.....	271			Coolant temperature.....	311
Ski sack* (Canada only)	271				
Loading instructions.....	275				

At the gas station	312	Maximum tire inflation pressure ...	344	Practical hints	365
Refueling	312	Uniform Tire Quality Grading		What to do if ...?	366
Check regularly		Standards (U.S. vehicles).....	344	Lamps in instrument cluster	366
and before a long trip.....	314	Tire ply material	346	Lamp in center console	376
Engine compartment	315	Tire and loading terminology.....	347	Vehicle status messages	
Hood	315	Rotating tires	350	in the multifunction display	378
Engine oil	317	Winter driving	351	Where will I find...?	404
Transmission fluid level.....	319	Winter tires	351	First aid kit.....	404
Coolant	320	Block heater (Canada only)	352	TIREFIT (CLK 63 AMG only).....	404
Battery	321	Snow chains.....	352	Vehicle tool kit.....	404
Windshield washer system and		Maintenance.....	353	Minispare wheel.....	407
headlamp cleaning system*	322	Maintenance		Spare wheel bolts	409
Tires and wheels.....	323	service indicator message	353	Unlocking/locking in an emergency ..	410
Important guidelines	323	Clearing the maintenance		Unlocking the vehicle	410
Tire care and maintenance.....	324	service indicator message	354	Locking the vehicle.....	411
Direction of rotation.....	326	Maintenance		Manually unlocking	
Loading the vehicle	326	service term exceeded.....	354	the gear selector lever	412
Recommended		Calling up the maintenance		Opening/closing in an emergency	413
tire inflation pressure	331	service indicator display	355	Operating roll bars manually.....	413
Checking tire inflation pressure ...	333	Resetting the maintenance		Soft top emergency operation	415
MOExtended system*	336	service indicator	355	Resetting activated head restraints....	424
Tire labeling.....	337	Vehicle care.....	356	Resetting activated	
Load identification	341	Cleaning and care of vehicle	356	head restraints	424
DOT,					
Tire Identification Number (TIN)...	342				
Maximum tire load	343				

Contents

Replacing SmartKey batteries.....	425	Fuses.....	456	Main dimensions and weights	471
SmartKey / SmartKey with		Mainfuse box		Main dimensions.....	471
KEYLESS-GO*.....	426	in passenger compartment	457	Weights.....	471
Replacing bulbs	427	Fuse box		Fuels, coolants, lubricants, etc.....	472
Bulbs	428	in engine compartment	457	Capacities	472
Replacing bulbs for front lamps....	430	Fuse box		Engine oils	474
Replacing bulbs for rear lamps.....	432	in trunk	458	Engine oil additives	474
Replacing wiper blades	434			Air conditioning refrigerant	474
Removing and				Brake fluid.....	475
installing wiper blades.....	434			Premium unleaded gasoline.....	475
Flat tire	436	Technical data	459	Fuel requirements.....	476
Preparing the vehicle.....	436	Parts service.....	460	Gasoline additives.....	476
Sealing tires with TIREFIT		Warranty coverage.....	461	Coolants	477
(CLK 63 AMG only).....	436	Loss of Service and Warranty		Windshield washer system and	
Mounting the Minispare wheel	441	Information Booklet	461	headlamp cleaning system*	479
MOExtended system*	446	Identification labels	462		
Battery	447	Layout of poly-V-belt drive.....	464		
Disconnecting the battery	448	CLK 350 / CLK 550	464		
Removing the battery	448	CLK 63 AMG	464		
Charging and		Engine.....	465		
reinstalling the battery	449	Rims and tires.....	466		
Reconnecting the battery	449	Same size tires.....	467		
Jump starting	450	Mixed size tires	468		
Towing the vehicle	452	Minispare wheel.....	469		
Towing the vehicle.....	452	Electrical system	470		
Installing towing eye bolt.....	454				
				Index	481

▼ Product information

Please observe the following in your own best interest:

We recommend using Genuine Mercedes-Benz Parts as well as conversion parts and accessories explicitly approved by us for your vehicle model.

We have tested these parts to determine their reliability, safety and special suitability for Mercedes-Benz vehicles.

We are unable to make an assessment for other products and therefore cannot be held responsible for them, even if in individual cases an official approval or authorization by governmental or other agencies should exist. Use of such parts and accessories could adversely affect the safety, performance or reliability of your vehicle. Please do not use them.

Genuine Mercedes-Benz Parts as well as conversion parts and accessories approved by us are available at your authorized Mercedes-Benz Center where you will receive comprehensive information, also on permissible technical modifications, and where proper installation will be performed.

This Operator's Manual contains a great deal of useful information. We urge you to read it carefully and familiarize yourself with the vehicle before driving.

For your own safety and longer service life of the vehicle, we urge you to follow the instructions and warnings contained in this manual. Ignoring them could result in damage to the vehicle or personal injury to you or others. Vehicle damage caused by failure to follow instructions is not covered by the Mercedes-Benz Limited Warranty.

Your vehicle may have some or all of the equipment described in this manual. Therefore, you may find explanations for optional equipment not installed in your vehicle. If you have any questions about the operation of any equipment, your authorized Mercedes-Benz Center will be glad to demonstrate the proper procedures.

We continuously strive to improve our product, and ask for your understanding that we reserve the right to make changes in design and equipment. Therefore, information, illustrations and descriptions in this Operator's Manual might differ from your vehicle.

Optional equipment is also described in this manual, including operating instructions wherever necessary. Since they are special-order items, the descriptions and illustrations herein may vary slightly from the actual equipment of your vehicle.

If there are any equipment details that are not shown or described in this Operator's Manual, your authorized Mercedes-Benz Center will be glad to inform you of correct care and operating procedures. The Operator's Manual and Maintenance Booklet are important documents and should be kept with the vehicle.

Service and warranty information

The Service and Warranty Information Booklet contains detailed information about the warranties covering your Mercedes-Benz, including:

- New Car Limited Warranty
- Emission System Warranty
- Emission Performance Warranty
- California, Maine, Massachusetts, and Vermont Emission Control System Warranty (California, Maine, Massachusetts, and Vermont only)
- State Warranty Enforcement Laws (Lemon Laws)

Important notice for California retail buyers and lessees of Mercedes-Benz automobiles

Under California law you may be entitled to a replacement of your vehicle or a refund of the purchase price or lease price, if Mercedes-Benz USA, LLC and/or its authorized repair or service facilities fail to fix one or more substantial defects or malfunctions in the vehicle that are covered by its express warranty after a reasonable number of repair attempts. During the period of 18 months from original delivery of the vehicle or the accumulation of 18 000 miles (approx. 29 000 km) on the odometer of the vehicle, whichever occurs first, a reasonable number of repair attempts is presumed for a retail buyer or lessee if one or more of the following occurs:

- (1) the same substantial defect or malfunction results in a condition that is likely to cause death or serious bodily injury if the vehicle is driven, that defect or malfunction has been subject to repair two or more times, and you have directly notified Mercedes-Benz USA, LLC in writing of the need for its repair,
- (2) the same substantial defect or malfunction of a less serious nature than category (1) has been subject to repair four or more times and you have directly notified us in writing of the need for its repair, or
- (3) the vehicle is out of service by reason of repair of the same or different substantial defects or malfunctions for a cumulative total of more than 30 calendar days.

Written notification should not be sent to a dealer, it should be addressed to:
Mercedes-Benz USA, LLC
Customer Assistance Center
One Mercedes Drive
Montvale, NJ 07645-0350

Maintenance

The Maintenance Booklet describes all the necessary maintenance work which should be performed at regular intervals.

Always have the Maintenance Booklet with you when you take the vehicle to your authorized Mercedes-Benz Center for service. The service advisor will record each service in the booklet for you.

Roadside Assistance

The Mercedes-Benz Roadside Assistance Program provides factory trained technical help in the event of a breakdown. Calls to the toll-free Roadside Assistance number

1-800-FOR-MERCEdes (in the USA)
1-800-387-0100 (in Canada)

will be answered by Mercedes-Benz Customer Assistance Representatives 24 hours a day, 365 days a year.

For additional information refer to the Mercedes-Benz Roadside Assistance Program Brochure in your vehicle literature portfolio.

Change of address or ownership

If you change your address, be sure to send in the "Change of Address Notice" found in the Service and Warranty Information Booklet, or simply call the Mercedes-Benz Customer Assistance Center (in the USA) at 1-800-FOR-MERCEdes, or Customer Service (in Canada) at 1-800-387-0100. It is in your own interest that we can contact you should the need arise.

If you sell your Mercedes, please leave all literature with the vehicle to make it available to the next operator.

If you bought this vehicle used, be sure to send in the "Notice of Purchase of Used Car" found in the Service and Warranty Information Booklet, or call the Mercedes-Benz Customer Assistance Center (in the USA) at 1-800-FOR-MERCEdes, or Customer Service (in Canada) at 1-800-387-0100.

Operating your vehicle outside the USA or Canada

If you plan to operate your vehicle in foreign countries, please be aware that:

- service facilities or replacement parts may not be readily available,
- unleaded gasoline for vehicles with catalytic converters may not be available; the use of leaded fuels will damage the catalysts,
- gasoline may have a considerably lower octane rating, and improper fuel can cause engine damage.

Certain Mercedes-Benz models are available for delivery in Europe under our European Delivery Program. For details, consult an authorized Mercedes-Benz Center or write to:

In the USA:

Mercedes-Benz USA, LLC
European Delivery Department
One Mercedes Drive
Montvale, NJ 07645-0350

In Canada:

Mercedes-Benz Canada Inc.
European Delivery Department
98 Vanderhoof Avenue
Toronto, Ontario M4G 4C9

Where to find it

This Operator's Manual is designed to provide comprehensive support information for you, the vehicle operator. Each section has its own reference color.

At a glance

Here you will find an overview of all the controls that can be operated from the driver's seat.

Getting started

Here you will find all the information you need for your first drive. You should read this section first if this is your first Mercedes-Benz vehicle or if you are renting or borrowing this vehicle.

Safety and Security

Here you will find descriptions of the safety and security features of your vehicle.

Controls in detail

Here you will find detailed information about the equipment installed in your vehicle. This section expands on the "Getting started" section and also describes technical innovations. If you are already familiar with the basic functions of your vehicle, this section will be of particular interest to you.

Operation

Here you will find all the information you need for the proper operation of your vehicle.

Practical hints

This section provides fast assistance for dealing with problems you may encounter.

Technical data

All important technical data for your vehicle can be found in this section.

Indexes

The table of contents and the index are designed to help you find information quickly and easily.

The following publications are part of your vehicle documentation:

- this Operator's Manual
- the Maintenance Booklet

Separate operating instructions will be provided as required depending on the equipment options installed in your vehicle.

▼ Symbols

Trademarks:

- ESP® is a registered trademark of DaimlerChrysler.
- HomeLink® is a registered trademark of Prince, a Johnson Controls Company.
- SIRIUS and related marks are trademarks of SIRIUS Satellite Radio Inc.

The following symbols are found in this Operator's Manual:

- * Optional equipment is identified with an asterisk. Since standard equipment varies between models, the descriptions and illustrations in this manual may differ slightly from the actual equipment of your vehicle.

Warning!



Warning notices draw your attention to hazards that may endanger your health or life, or the health or life of others.

 *Highlights hazards that may result in damage to your vehicle.*

 *Helpful hints or further information you may find useful.*

- ▶ This symbol points to instructions for you to follow.
- ▶ A number of these symbols appearing in succession indicates a multiple-step procedure.
- ▷ Page This symbol tells you where to look for further information on a topic.
- ▷▷ This continuation symbol marks a procedure which is continued on the next page.
- ▷▷ This continuation symbol marks a warning which is continued on the next page.
- > This symbol is used to indicate cross-references to term definitions.
- Display Words appearing in the multi-function display and Audio display are printed in the type shown here.

Warning!



Work improperly carried out on electronic components and associated software could cause them to cease functioning. Because the vehicle's electronic components are interconnected, any modifications made may produce an undesired effect on other systems. Electronic malfunctions could seriously impair the operating safety of your vehicle.

See an authorized Mercedes-Benz Center for repairs or modifications to electronic components.

Other improper work or modifications on the vehicle could also have a negative impact on the operating safety of the vehicle.

Some safety systems only function while the engine is running. You should therefore never turn off the engine while driving.

Warning!



Heavy blows against the vehicle underbody or tires / wheels, for example when running over an obstacle, road debris or a pothole, may cause serious damage to and impair the operating safety of your vehicle. If you feel a sudden significant vibration or ride disturbance, or you suspect that damage to your vehicle has occurred, you should turn on your hazard warning flashers, carefully slow down, and drive with caution to an area which is a safe distance from the road.

Inspect the vehicle underbody and tires / wheels for possible damage. If the vehicle appears unsafe, have it towed to the nearest authorized Mercedes-Benz Center or other qualified maintenance or repair facility for further inspection or repairs.

Proper use of the vehicle

Proper use of the vehicle requires that you are familiar with the following information and rules:

- the safety precautions in this manual
- the “Technical data” section in this manual
- traffic rules and regulations
- motor vehicle laws and safety standards

Warning!



Various warning labels are attached to your vehicle. These warning labels are intended to make you and others aware of various risks. You should not remove any of these warning labels unless explicitly instructed to do so by information on the label itself. Removal of any of these labels may cause you and others to be unaware of certain risks which may result in an accident and/or personal injury.

▼ Problems with your vehicle

If you should experience a problem with your vehicle, particularly one that you believe may affect its safe operation, we urge you to immediately contact an authorized Mercedes-Benz Center to have the problem diagnosed and corrected if required. If the matter is not handled to your satisfaction, please discuss the problem with the Mercedes-Benz Center management, or if necessary contact us at one of the following addresses:

In the USA:

Customer Assistance Center
Mercedes-Benz USA, LLC
One Mercedes Drive
Montvale, NJ 07645-0350

In Canada:

Customer Relations Department
Mercedes-Benz Canada Inc.
98 Vanderhoof Avenue
Toronto, Ontario M4G 4C9

Reporting safety defects

For the USA only:

The following text is published as required of manufacturers under Title 49, Code of U.S. Federal Regulations, Part 575 pursuant to the “National Traffic and Motor Vehicle Safety Act of 1966”.

Reporting safety defects

If you believe that your vehicle has a defect which could cause a crash or could cause injury or death, you should immediately inform the National Highway Traffic Safety Administration (NHTSA) in addition to notifying Mercedes-Benz USA, LLC.

If NHTSA receives similar complaints, it may open an investigation, and if it finds that a safety defect exists in a group of vehicles, it may order a recall and remedy campaign. However, NHTSA cannot become involved in individual problems between you, your dealer, or Mercedes-Benz USA, LLC.

To contact NHTSA, you may call the Vehicle Safety Hotline toll-free at 1-888-327-4236 (TTY: 1-800-426-9153); go to <http://www.safercar.gov>; or write to: Administrator, NHTSA, 400 Seventh Street, SW., Washington, DC 20590. You can also obtain other information about motor vehicle safety from <http://www.safercar.gov>.

▼ Vehicle data recording

Information regarding electronic recording devices

(Including notice pursuant to California Code § 9951)

Please note that your vehicle is equipped with devices that can record vehicle systems data and, if equipped with the Tele Aid system, may transmit some data in certain accidents.

This information helps, for example, to diagnose vehicle systems after a collision and to continuously improve vehicle safety. DaimlerChrysler may access the information and share it with others

- for safety research or vehicle diagnosis purposes
- with the consent of the vehicle owner or lessee
- in response to an official request by law enforcement or other government agency
- for use in dispute resolution involving DaimlerChrysler, its affiliates or sales/service organization and/or
- as otherwise required or permitted by law.

Please check the Tele Aid subscription service agreement for details regarding the information that may be recorded or transmitted via that system.

Exterior view

Cockpit

Instrument cluster

Multifunction steering wheel

Center console

Overhead control panel

Door control panel



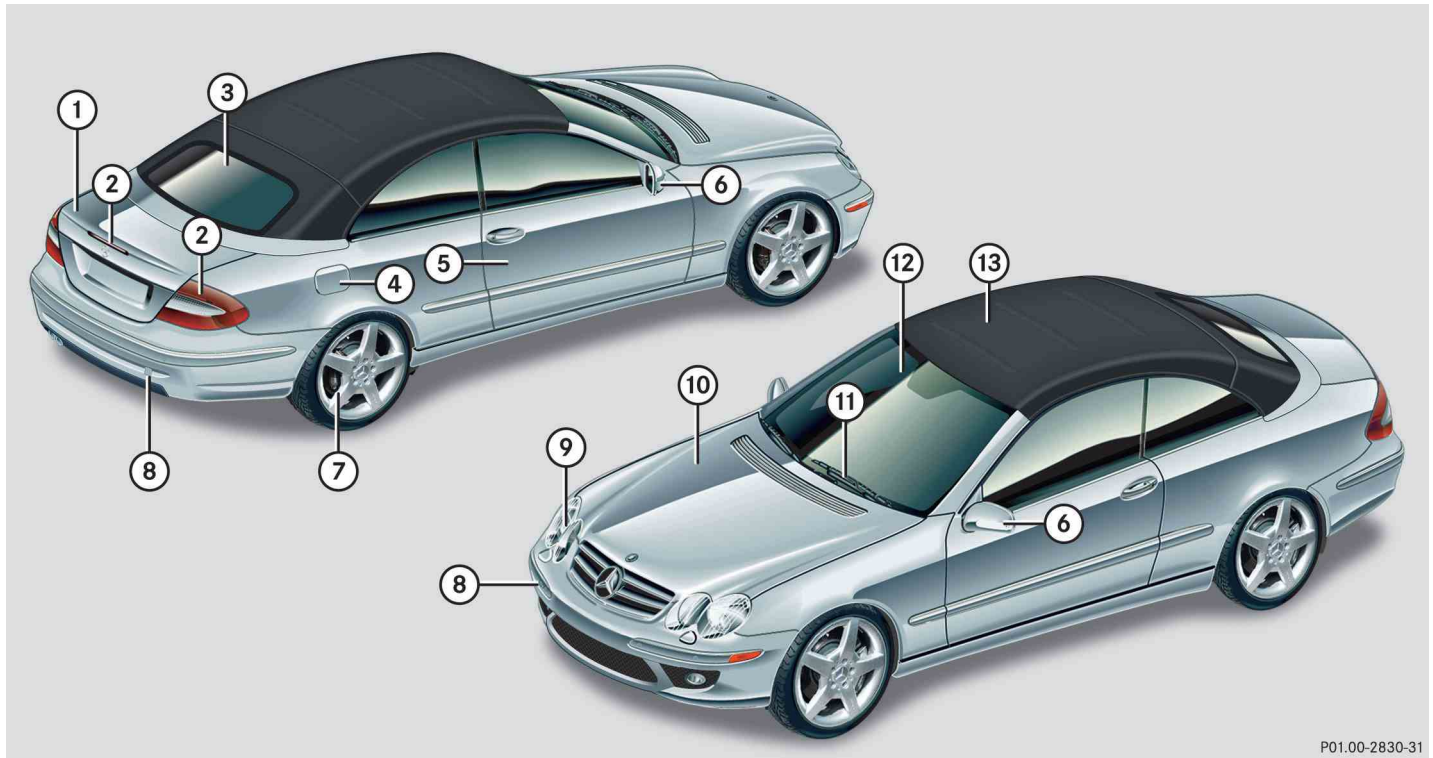

P01.00-2830-31

Item	Page
① Trunk	
Unlocking	34
Opening and closing	109, 110
Minispare wheel	407
Vehicle tool kit	404
② Rear lamps	432
③ Rear window, defrosting	187
④ Fuel filler flap	312
Refueling	312
Gasoline	475
⑤ Doors	
Locking and unlocking	34, 62, 98
Closing	108
Unlocking/locking in an emergency	410

Item	Page
⑥ Exterior rear view mirror	
Adjusting	45
Auto-dimming rear view mirrors	185
⑦ Tires and wheels	323
Checking tire inflation pressure	333
Run Flat Indicator*	334
General information	323
TIREFIT Kit (CLK 63 AMG)	404
Vehicle tool kit	404
Minispare wheel	407
Flat tire	436
⑧ Towing	452
Installing towing eye bolt	454
⑨ Front lamps	430

Item	Page
⑩ Hood, opening	315
Engine oil	317
Coolant	320
Battery	321
⑪ Windshield wipers	55
Wiper blades, replacing	434
Wiper blades, cleaning	362
⑫ Windshield	
Front window, defrosting	189, 199
Cleaning with wiper fluid	56
Cleaning	362
⑬ Soft top	
Opening and closing	255
Opening and closing in an emergency	415
Roll bars	81
Cleaning	359

Cockpit

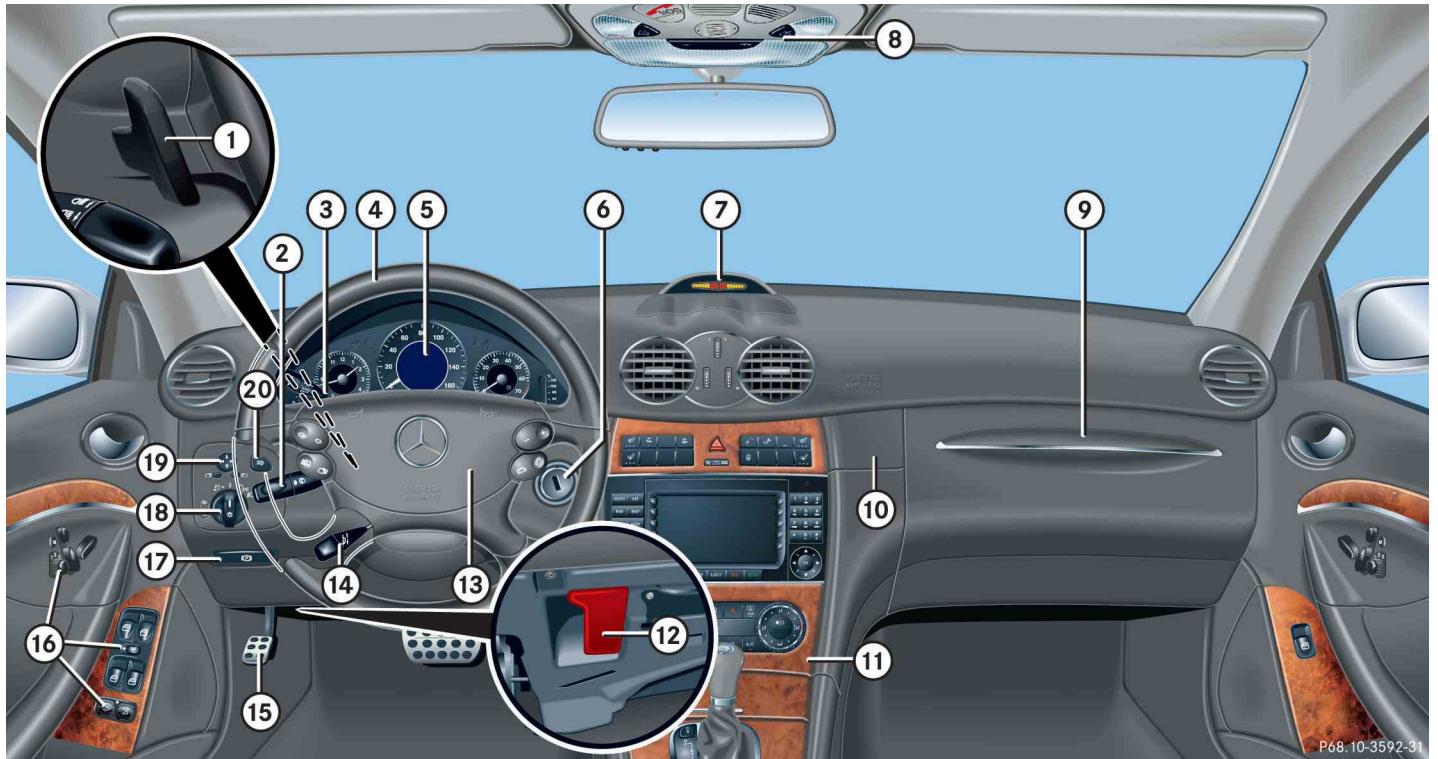

P68.10-3592-31





Item	Page
① Steering wheel gearshift paddles*	179
② Combination switch	
• Turn signals	55
• Windshield wipers	55
• High beam	54
③ Cruise control lever	263
④ Multifunction steering wheel	28, 140
⑤ Instrument cluster	26, 136
⑥ Starter switch	36
⑦ Front Parktronic* warning indicator (CLK 63 AMG (USA), Canada all vehicles)	267
⑧ Overhead control panel	31
⑨ Glove box	276

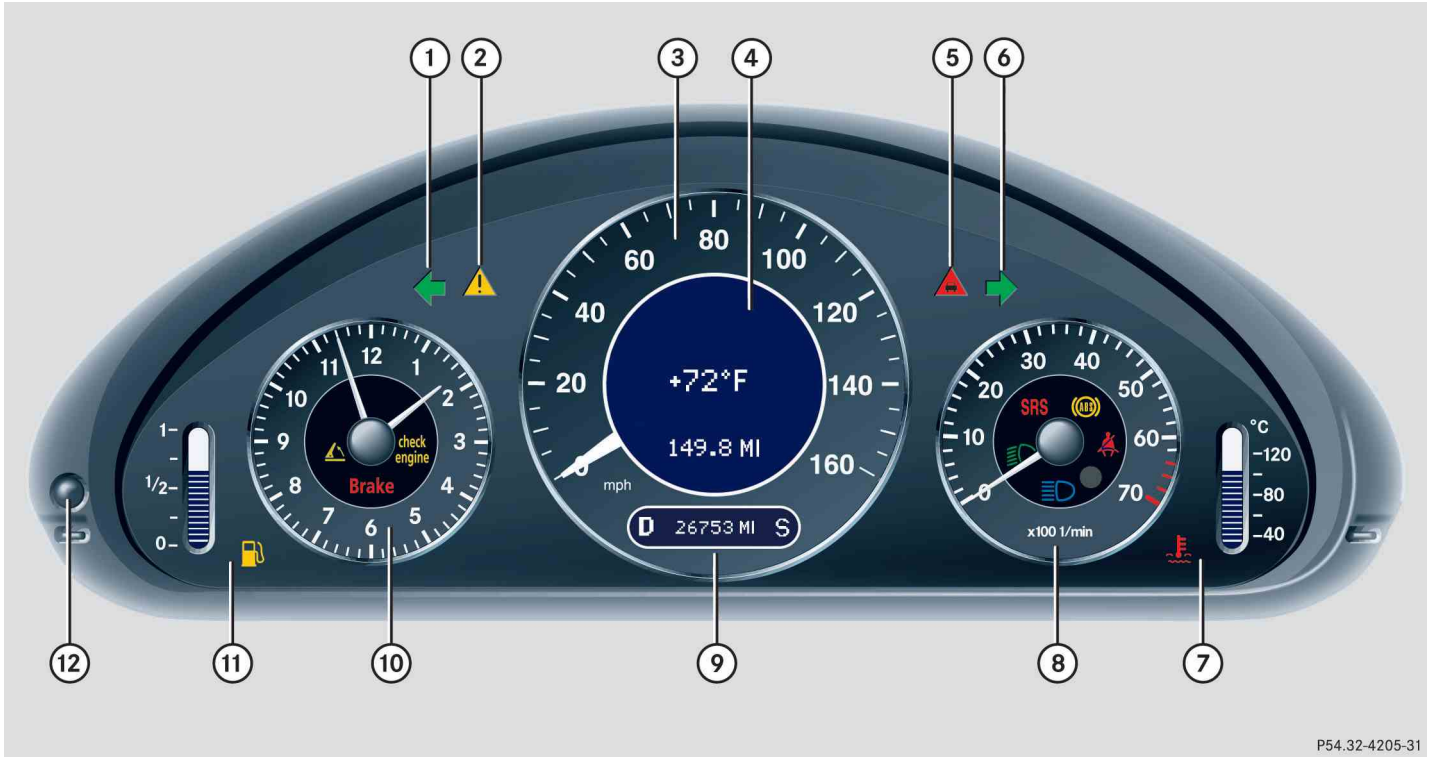



Item	Page
⑩ Depending on vehicle production date:	
Storage box	276
Cup holder	279
⑪ Center console	29, 30
⑫ Hood lock release	316
⑬ Horn	
⑭ Steering wheel adjustment stalk	43
⑮ Parking brake pedal	52
⑯ Door control panel	32
⑰ Parking brake release	52
⑱ Exterior lamp switch	54, 126
⑲ Exterior rear view mirror adjustment	45
⑳ Headlamp washer switch*	184







Instrument cluster



P54.32-4205-31

Item	Page
①  Left turn signal indicator lamp	55
②  ESP® warning lamp	372
③ Speedometer	
④ Multifunction display	139
⑤  Distance warning lamp	
Warning lamp without function. It illuminates with the ignition on. It should go out when the engine is running.	
⑥  Right turn signal indicator lamp	55
⑦ Coolant temperature indicator with:	137
 Coolant temperature warning lamp	371, 391

Item	Page
⑧ Tachometer with:	138
 Supplemental Restraint System (SRS) indicator lamp	64, 375, 375
 Antilock Brake System (ABS) indicator lamp	366
 Seat belt telltale	78, 373
 High beam headlamp indicator lamp	131
 Low beam headlamp indicator lamp	131
⑨ Main odometer with:	
• Gear selector lever position	139
• Program mode	139

Item	Page
⑩ Clock with:	158
 Brake warning lamp, USA only	368
 Brake warning lamp, Canada only	368
 Engine malfunction indicator lamp, USA only	369
 Engine malfunction indicator lamp, Canada only	369
 Roll bar warning lamp	
⑪ Fuel display with:	
 Fuel reserve warning lamp	373
⑫ Reset button for:	
• Resetting trip odometer	136
• Adjusting instrument cluster illumination	136
• Confirming new time settings	158

Multifunction steering wheel

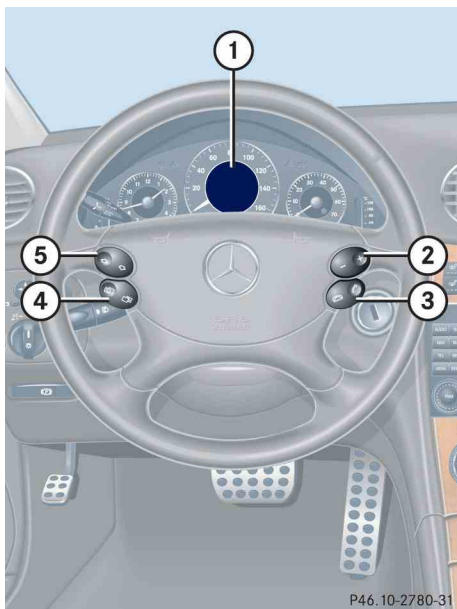

	Item	Page
①	Multifunction display	139
	Operating control system	140
②	Selecting the submenu or setting the volume: Press button	
	up / to increase	
	down / to decrease	
③	Telephone*: Press button	
	to take a call	168
	to dial a call	168
	to end a call	168
	to reject an incoming call	168

	Item	Page
④	Menu systems: Press button	
	for next menu	
	for previous menu	
⑤	Moving within a menu: Press button	
	for next display	
	for previous display	

▼ Center console

Upper part

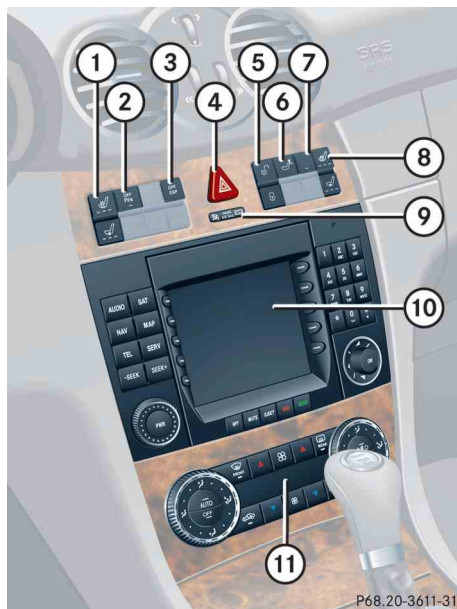

P68.20-3611-31

Item	Page
① Seat heater*, driver's side	122
Seat ventilation*, driver's side	123
② Parktronic system* deactivation switch (CLK 63 AMG (USA), Canada all vehicles)	270
③ ESP® control switch	90
④ Hazard warning flasher switch - switching on/off	133
⑤ Central unlocking switch	118
Central locking switch	118
⑥ Switch for lowering rear seat head restraints	120
⑦ Anti-theft alarm system indicator lamp	95

Item	Page
⑧ Seat heater*, passenger side	122
Seat ventilation*, passenger side	123
⑨ Front passenger front air bag off indicator lamp	74, 376
⑩ Audio system,	149
or	
COMAND* (see separate operating instructions)	
⑪ Climate control	188
Automatic climate control	198
Rear window defroster	187

Center console

Lower part

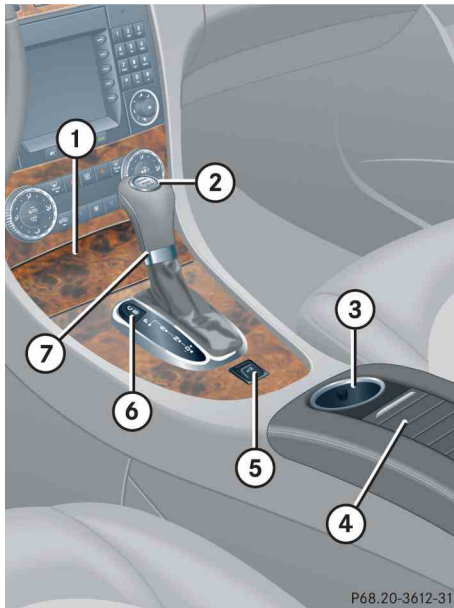

	Item	Page
①	Ashtray	280
	Cigarette lighter	282
②	KEYLESS-GO* start/stop button	37
③	Cup holder	279
④	Storage compartment with cup holder and telephone* compartment in center armrest	278 279
⑤	Soft top switch	256
⑥	Program mode selector switch for automatic transmission	
	• Automatic shift program	176
	• Manual shift program (CLK 63 AMG)	181
⑦	Gear selector lever for automatic transmission	170

▼ Overhead control panel



P82.00-2451-31

	Item	Page
①	Tele Aid (emergency call system) button	287
②	Right reading lamp on/off	135
③	Interior lighting control	134
④	Interior rear view mirror	45, 184
⑤	Garage door opener*	293
⑥	Hands-free microphone for Tele Aid (emergency call system) and telephone*	284
⑦	Left reading lamp on/off	135

Door control panel

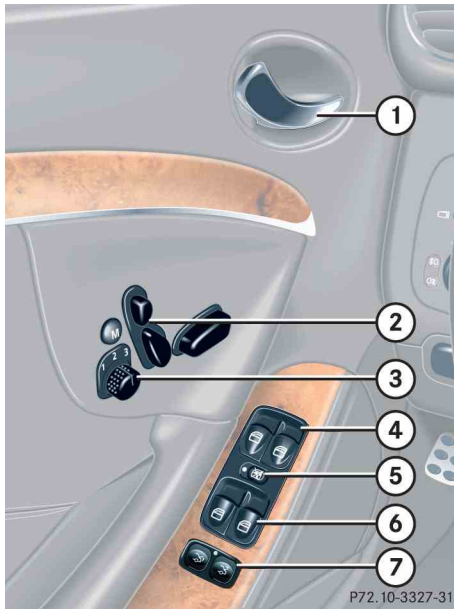

	Item	Page
①	Inside door handle	108
②	Seat adjustment	40, 119
③	Memory function (for storing seat, exterior mirror and steering wheel settings)	124
④	Switches for opening/closing front door windows	249
⑤	Rear window override switch	86
⑥	Switches for opening/closing rear windows	249
⑦	Remote trunk opening switch	109
	Remote trunk opening/closing* switch	110

Unlocking

Adjusting

Driving

Parking and locking

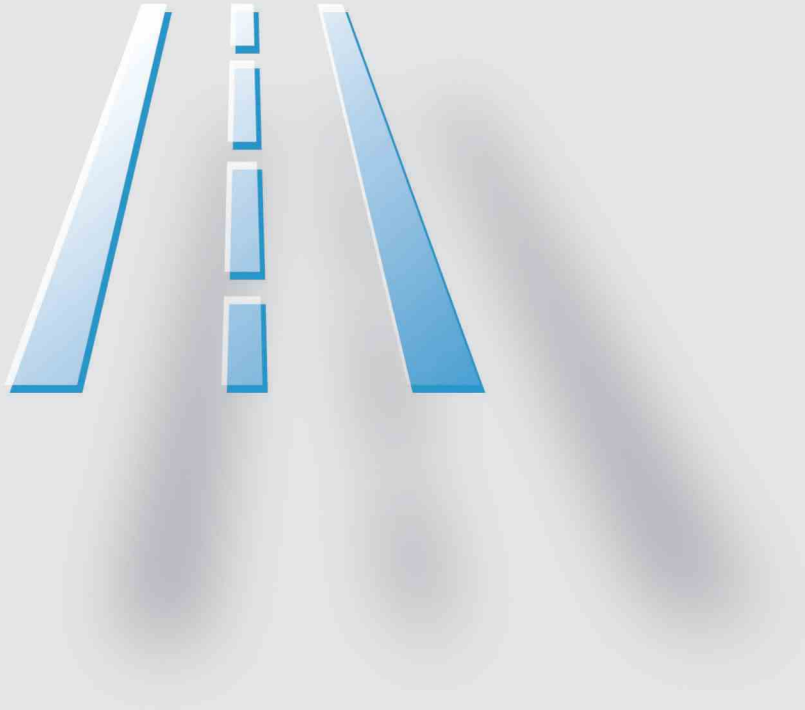

Unlocking





The “Getting started” section provides an overview of the vehicle’s most basic functions. First-time Mercedes-Benz owners should pay special attention to the information given here.

If you are already familiar with the basic functions described here, the “Controls in detail” section will provide you with further information. The corresponding page references are located at the end of each segment.

Unlocking with the SmartKey



SmartKey with remote control

- ①  Lock button
- ②  Opening button for trunk
- ③  Unlock button
- ④  Panic button (▷ page 87)

- ▶ Press unlock button  on the SmartKey.
 - All turn signal lamps flash once.
 - An acoustic signal sounds once. For more information, see “Factory setting” (▷ page 100).
 - The locking knobs in the doors move up.
 - The anti-theft alarm system is disarmed.
- ▶ Enter the vehicle and insert the SmartKey in the starter switch.

Warning!

When leaving the vehicle, always remove the SmartKey from the starter switch, take it with you, and lock the vehicle. Do not leave children unattended in the vehicle, or with access to an unlocked vehicle. A child's unsupervised access to a vehicle could result in an accident and/or serious personal injury.

i *Opening a door causes the windows on that side of the car to open slightly. They will return to the up position when the door is closed.*

For more information, see “SmartKey” (▷ page 98).

Unlocking with KEYLESS-GO*

With the KEYLESS-GO function, you can lock and unlock the vehicle without using the remote control buttons on the SmartKey and start the engine without inserting the SmartKey in the starter switch.

i *To unlock the vehicle, the SmartKey with KEYLESS-GO must be outside the vehicle, no further than approx. 3 feet (1 meter) away from the door to be opened.*

Warning!

When leaving the vehicle, always take the SmartKey with KEYLESS-GO with you, and lock the vehicle. Do not leave children unattended in the vehicle, or with access to an unlocked vehicle. A child's unsupervised access to a vehicle could result in an accident and/or serious personal injury.

- ▶ Pull an outside door handle.
 - All turn signal lamps flash once.
 - An acoustic signal sounds once. For more information, see “Factory setting” (▷ page 100).
 - The locking knobs in the doors move up.
 - The anti-theft alarm system is disarmed.

- ▶ Enter the vehicle.

i *Opening a door causes the windows on that side of the car to open slightly. They will return to the up position when the door is closed.*

For more information, see “SmartKey with KEYLESS-GO*” (▷ page 101).

Unlocking

Starter switch positions

Warning!



When leaving the vehicle, always remove the SmartKey or SmartKey with KEYLESS-GO* from the starter switch, take it with you, and lock the vehicle. Do not leave children unattended in the vehicle, or with access to an unlocked vehicle. A child's unsupervised access to a vehicle could result in an accident and/or serious personal injury.

SmartKey

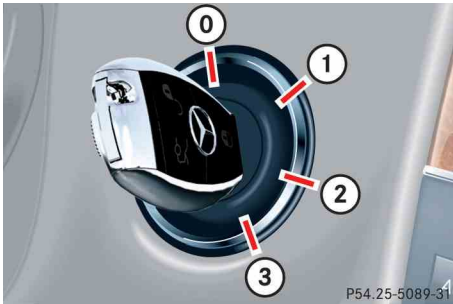

Starter switch

- 0** For removing SmartKey
The steering is locked when the SmartKey is removed from the starter switch.
- 1** Power supply for some electrical consumers, such as seat adjustment
- 2** Ignition (power supply for all electrical consumers) and driving position
All lamps (except low beam headlamp indicator lamp, high beam headlamp indicator lamp, and turn signal indicator lamps unless activated) in the instrument cluster come on when the ignition is switched on, have it checked and replaced if necessary. If a lamp in the instrument cluster remains on after starting the engine or comes on while driving, refer to “Lamps in instrument cluster” (▷ page 366).
- 3** Starting position

i When you switch on the ignition, the indicator and warning lamps (except low beam headlamp indicator lamp, high beam headlamp indicator lamp, and turn signal indicator lamps unless activated) in the instrument cluster come on. The indicator and warning lamps (except low beam headlamp indicator lamp, high beam headlamp indicator lamp, and turn signal indicator lamps if activated) will go out when the engine is running. This indicates that the respective systems are operational.

i The SmartKey can only be removed from the starter switch with the gear selector lever in position **P**.

i If the SmartKey is left in starter switch position **0** for an extended period of time, it can no longer be turned in the switch. In this case, the steering is locked. To unlock, remove SmartKey from starter switch and reinsert.

! If the SmartKey cannot be turned in the starter switch, the battery may not be sufficiently charged.

- Check the battery and charge it if necessary (▷ page 447).
- Get a jump start (▷ page 450).

To prevent accelerated battery discharge or a completely discharged battery, always remove the SmartKey from the starter switch when the engine is not in operation.

For more information, see “SmartKey” (▷ page 98).

For information on starting the engine using the SmartKey, see “Starting with the SmartKey” (▷ page 51).

SmartKey with KEYLESS-GO*

Pressing the KEYLESS-GO start/stop button on the gear selector lever corresponds to turning the SmartKey to the various starter positions.

If you firmly depress the brake pedal during pressing the KEYLESS-GO start/stop button, the engine starts automatically.

You can also use the SmartKey with KEYLESS-GO like a normal SmartKey.

i The function of the SmartKey overrides the KEYLESS-GO function.

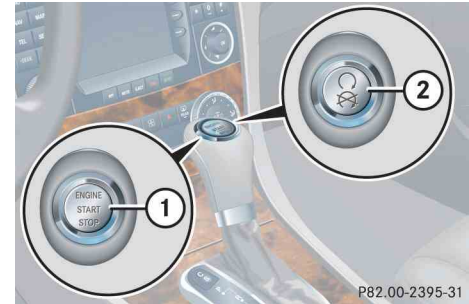

KEYLESS-GO start/stop button

- ① USA only
- ② Canada only

The SmartKey with KEYLESS-GO must be located in the vehicle.

- ▶ Make sure the gear selector lever is set to **P**.
- ▶ Do not depress the brake pedal.

Unlocking

Position 0

Before you press the KEYLESS-GO start/stop button, the vehicle's on-board electronics have status **0** (as with SmartKey removed).

Position 1

- ▶ Press the KEYLESS-GO start/stop button once.

This supplies power for some electrical consumers, such as seat adjustment.

i *If you now press the KEYLESS-GO start/stop button*

- *once again, the ignition (position 2) is switched on.*
- *twice, the power supply is again switched off.*

Ignition (or position 2)

- ▶ Press the KEYLESS-GO start/stop button twice.

This supplies power for all electrical consumers. All the lamps (except low beam headlamp indicator lamp, high beam headlamp indicator lamp, and turn signal indicator lamps unless activated) in the instrument cluster come on. If a lamp in the instrument cluster fails to come on when the ignition is switched on, have it checked and replaced if necessary. If a lamp in the instrument cluster remains on after starting the engine or comes on while driving, refer to “Lamps in instrument cluster”(▷ page 366).

i *If you now press the KEYLESS-GO start/stop button once, the power supply is again switched off.*

i *When you switch on the ignition, the indicator and warning lamps (except low beam headlamp indicator lamp, high beam headlamp indicator lamp, and turn signal indicator lamps unless activated) in the instrument cluster come on. The indicator and warning lamps (except low beam headlamp indicator lamp, high beam headlamp indicator lamp, and turn signal indicator lamps if activated) will go out when the engine is running. This indicates that the respective systems are operational.*

For more information, see “SmartKey with KEYLESS-GO*” (▷ page 101).

For information on starting the engine using the KEYLESS-GO start/stop button, see “Starting with KEYLESS-GO*” (▷ page 51).

▼ Adjusting

Warning!



All seat, head restraint, steering wheel, and rear view mirror adjustments, as well as fastening of seat belts, must be done before the vehicle is put into motion.

Seats

Warning!



Do not adjust the driver's seat while driving. Adjusting the seat while driving could cause the driver to lose control of the vehicle.

Never ride in a moving vehicle with the seat back in an excessively reclined position as this can be dangerous. You could slide under the seat belt in a collision. If you slide under it, the belt would apply force at the abdomen or neck. That could cause serious or fatal injuries. The seat back and seat belts provide the best restraint when the wearer is in a nearly upright position and belts are properly positioned on the body.

Your seat must be adjusted so that you can correctly fasten your seat belt (▷ page 47).

Never place hands under the seat or near any moving parts while a seat is being adjusted.

Warning!



When leaving the vehicle, always remove the SmartKey or SmartKey with KEYLESS-GO* from the starter switch, take it with you, and lock the vehicle.

Even with the SmartKey or SmartKey with KEYLESS-GO* removed from the starter switch, or the SmartKey with KEYLESS-GO* removed from the vehicle, the power seats can be operated when the respective door is open. Therefore, do not leave children unattended in the vehicle, or with access to an unlocked vehicle. Unsupervised use of vehicle equipment may cause an accident and/or serious personal injury.

Warning!



According to accident statistics, children are safer when properly restrained in the rear seating positions than in the front seating position. Thus, we strongly recommend that children be placed in the rear seats whenever possible. Regardless of seating position, children 12 years old and under must be seated and properly secured in an appropriate infant, or toddler restraint, or booster seat recommended for the size and weight of the child. For additional information, see "Children in the vehicle" (▷ page 82).

A child's risk of serious or fatal injuries is significantly increased if the child restraints are not properly secured in the vehicle and/or the child is not properly secured in the child restraint.

Adjusting

Seat adjustment

The seat adjustment switches are located on the respective door.

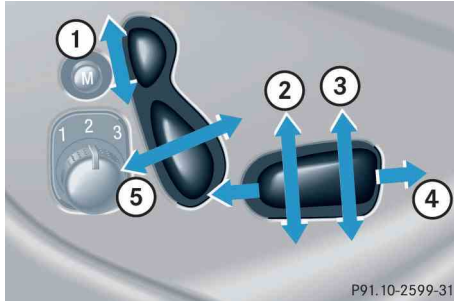

- ① Head restraint height
- ② Seat height
- ③ Seat cushion tilt
- ④ Seat fore and aft adjustment
- ⑤ Backrest tilt

▶ Switch on the ignition (▷ page 36).

or

▶ Open the respective door.

i The memory function (▷ page 124) lets you store the settings for the seat position together with the settings for the steering wheel and the exterior rear view mirrors.

Seat fore and aft adjustment

▶ Press switch forward or backward in direction of arrow ④.

Adjust seat to a comfortable seating position that still allows you to reach the accelerator / brake pedal safely. The position should be as far to the rear as possible, consistent with ability to properly operate controls.

! When moving the seat, make sure there are no items in the footwell or behind the seats. Otherwise you could damage the seats.

Seat height

▶ Press switch up or down in direction of arrow ②.

Seat cushion tilt

▶ Press switch up or down in direction of arrow ③ until your upper legs are lightly supported.

Seat backrest tilt

▶ Press switch forward or backward in direction of arrow ⑤ until your arms are slightly angled when holding the steering wheel.

Head restraint height

▶ Press switch up or down in direction of arrow ①.

Warning!

For your protection, drive only with properly positioned head restraints.

Adjust the head restraint so that it is as close to the head as possible and the center of the head restraint supports the back of the head at eye level. This will reduce the potential for injury to the head and neck in the event of an accident or similar situation.

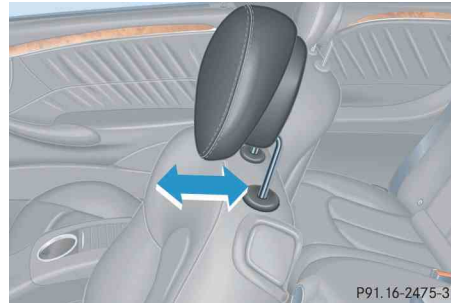
Head restraint adjusting

Manually adjust the head restraint.

- ▶ Push or pull the head restraint cushion to the desired position.

For more information, see “Seats”
(▷ page 119).

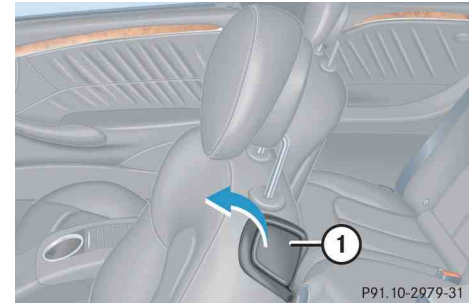
Folding front seat backrests forward

- ① Release lever

Folding backrests forward

- ▶ Pull release lever ① forward and fold the seat backrest forward.

The head restraint will automatically move down.

Adjusting

Folding backrests back

- ▶ Fold and press the backrest rearward until it engages in driving position.

The head restraint returns to its previous position.

i In addition to the front seat backrests, the front seat cushions can also be shifted forward to permit easy access to the rear whenever the seat is located in the rear half of its adjustment range. Pivot backrest forward by pulling the release lever until the seat moves in a combined forward and upward movement.

! When moving the seat, make sure there are no items in the footwell or behind the seats. Otherwise you could damage the seats.

Warning!



The seat belts provide protection only with the backrest locked in place. Therefore, the backrest must be locked in place with the vehicle in motion. Do not drive the vehicle when the backrest is not locked in place.

If the warning message:

Engage
front-passenger
seat

or

Engage
driver's
seat

is displayed in the multifunction display, then the respective backrest is not engaged in its lock. Carefully slow down, and drive with caution to an area which is in a safe distance from the roadway. Always provide sufficient room behind the backrest and fold the backrest all the way back until it locks in place.

The warning message is no longer displayed as soon as the backrest is locked in place. If both backrests are locked in place and the warning message is still displayed, have the system checked at an authorized Mercedes-Benz Center immediately.

When leaving the vehicle, always remove the SmartKey or SmartKey with KEYLESS-GO* from the starter switch, take it with you, and lock the vehicle.

The power seats can also be operated with the driver's or passenger door open. Do not leave children unattended in the vehicle or with access to an unlocked vehicle. Unsupervised use of vehicle equipment may cause an accident and/or serious personal injury.

Never place hands under seat or near any moving parts during a seat adjustment procedure.

For information on additional convenience features permitting easy entry and exit, see "Easy-entry/exit feature" (▷ page 44).

Steering wheel

Warning!



Do not adjust the steering wheel while driving. Adjusting the steering wheel while driving could cause the driver to lose control of the vehicle.

When leaving the vehicle, always remove the SmartKey or SmartKey with KEYLESS-GO* from the starter switch, take it with you, and lock the vehicle.

Even with the SmartKey or SmartKey with KEYLESS-GO* removed from the starter switch, or the SmartKey with KEYLESS-GO* removed from the vehicle, the steering wheel adjustment feature can be operated when the driver's door is open. Therefore, do not leave children unattended in the vehicle, or with access to an unlocked vehicle. Unsupervised use of vehicle equipment may cause an accident and/or serious personal injury.

Steering wheel adjustment

The stalk for steering wheel adjustment is located on the lower left of steering column.

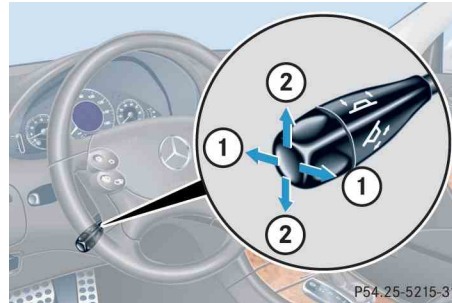

- ① Adjusting steering column, in or out
- ② Adjusting steering column, up or down

► Switch on the ignition (▷ page 36).

or

► Open the driver's door.

Adjusting steering column in or out

► Move stalk forward or back in direction of arrow ① until a comfortable steering wheel position is reached with your arms slightly bent at the elbow.

Adjusting steering column up or down

► Move stalk up or down in direction of arrow ②.

Make sure your legs can move freely and all the displays (including malfunction and indicator lamps) on the instrument cluster are clearly visible.

i *The memory function (▷ page 124) lets you store settings for the steering wheel together with the settings for the exterior rear view mirrors and the seat position.*

Adjusting

Easy-entry/exit feature

This feature allows for easier entry into and exit from the vehicle. When entering and exiting the vehicle, the steering wheel is in its uppermost position.

The easy-entry/exit feature can be activated or deactivated in the Convenience submenu of the control system (▷ page 164).

Warning!



You must make sure that no one can become trapped or injured by the moving steering wheel when the easy-entry/exit feature is activated.

To stop steering wheel movement, do one of the following:

- Move steering wheel adjustment stalk (▷ page 43).
- Press the memory position switch (▷ page 124).

Do not leave children unattended in the vehicle, or with access to an unlocked vehicle. Children could open the driver's door and unintentionally activate the easy-entry/exit feature, which could result in an accident and/or serious personal injury.

With the easy-entry/exit feature activated, the steering wheel will return to its last set position when you:

- close the driver's door with the ignition switched on,
or
- insert the SmartKey into the starter switch or press the KEYLESS-GO* start/stop button (▷ page 37) once with the driver's door closed.

i *The last set steering wheel position is stored when*

- *the ignition is switched off.*
- *the position is stored in memory (▷ page 125).*

With the easy-entry/exit feature activated, the steering wheel tilts upwards when you:

- remove the SmartKey from the starter switch,
or
- open the driver's door with the SmartKey in starter switch position **0** or **1** or the KEYLESS-GO* start/stop button (▷ page 37) in position **1**.

i *If the current position for the steering wheel is in the uppermost tilt position, the steering wheel will no longer be able to move upward when the easy-entry/exit feature is activated.*

The adjustment procedure is briefly interrupted when the engine is started.

Warning!

Let the system complete the adjustment procedure before setting the vehicle in motion. All steering wheel adjustment must be completed before setting the vehicle in motion. Driving off with the steering wheel still adjusting could cause the driver to lose control of the vehicle.

Mirrors

Adjust the interior and exterior rear view mirrors before driving so that you have a good view of the road and traffic conditions.

Warning!

In case of an accident, liquid electrolyte may escape the mirror housing if the mirror glass breaks.

Electrolyte has an irritating effect. Do not allow the liquid to come into contact with eyes, skin, clothing, or respiratory system. In case it does, immediately flush affected area with water, and seek medical help if necessary.

! *Electrolyte drops coming into contact with the vehicle paint finish can only be completely removed while in their liquid state and by applying plenty of water.*

Interior rear view mirror

- ▶ Manually adjust the interior rear view mirror.

For more information, see “Rear view mirrors” (▷ page 184).

Exterior rear view mirrors**Warning!**

Exercise care when using the passenger-side exterior rear view mirror. The mirror surface is convex (outwardly curved surface for a wider field of view). Objects in mirror are closer than they appear. Check your interior rear view mirror or glance over your shoulder before changing lanes.



Adjusting

▷▷ The buttons are located above the exterior lamp switch.



- ① Adjustment button
- ② Passenger-side exterior rear view mirror button
- ③ Driver's side exterior rear view mirror button

- ▶ Switch on the ignition (▷ page 36).
- ▶ Press button ③ for the driver's side exterior rear view mirror or button ② for the passenger-side exterior rear view mirror.
- ▶ Push adjustment button ① up, down, left, or right, according to the desired setting.

! *If an exterior rear view mirror was forcibly pushed forward (hit from the rear) or forcibly pushed rearward (hit from the front), reposition it by applying firm pressure until it snaps into place. The mirror housing is now properly positioned and you can adjust the mirror normally.*

i *The memory function (▷ page 124) lets you store the setting for the exterior rear view mirrors together with the settings for the steering wheel and the driver's seat position.*

i *At low ambient temperatures, the exterior rear view mirrors will be heated automatically.*

For more information, see "Rear view mirrors" (▷ page 184).

▼ Driving

Warning!



Make sure that absolutely no objects are obstructing the pedals' range of movement. Keep the driver's footwell clear of all obstacles. If there are any floor mats or carpets in the footwell, make sure that the pedals still have sufficient clearance.

During sudden driving or braking maneuvers, the objects could get caught between or beneath the pedals. You could then no longer brake or accelerate. This could lead to accidents and injury.

Fastening the seat belts

Warning!



Always fasten your seat belt before driving off. Always make sure your passengers are properly restrained, even those sitting in the rear.

Failure to wear and properly fasten and position your seat belt greatly increases your risk of injuries and their likely severity in an accident. You and your passengers should always wear seat belts.

If you are ever in an accident, your injuries can be considerably more severe without your seat belt properly buckled. Without your seat belt buckled, you are much more likely to hit the interior of the vehicle or be ejected from it. You can be seriously injured or killed.

In the same crash, the possibility of injury or death is lessened if you are wearing your seat belt. The air bags can only provide the protection they were designed to afford if the occupants are using their seat belts (▷ page 64).

Warning!



According to accident statistics, children are safer when properly restrained in the rear seating positions than in the front seating position. Thus, we strongly recommend that children be placed in the rear seats. Regardless of seating position, children 12 years old and under must be seated and properly secured in an appropriate infant or toddler restraint, or booster seat recommended for the size and weight of the child. For additional information, see "Children in the vehicle" (▷ page 82).

A child's risk of serious or fatal injuries is significantly increased if the child restraints are not properly secured in the vehicle and/or the child is not properly secured in the child restraint.

Driving

Warning!



Never let more people ride in the vehicle than there are seat belts available. Be sure everyone riding in the vehicle is correctly restrained with a separate seat belt. Never use a seat belt for more than one person at a time.

Warning!



Never ride in a moving vehicle with the seat backrest in an excessively reclined position as this can be dangerous. You could slide under the seat belt in a collision. If you slide under it, the belt would apply force at the abdomen or neck. This could cause serious or even fatal injuries. The seat backrest and seat belt provide the best restraint when the wearer is in a nearly upright position and the belt is properly positioned on the body.

Warning!



Read and observe the additional warning notices printed in the “Safety and Security” section (▷ page 67).

The seat belt presenter for driver and passenger makes it easier to put on the seat belt.

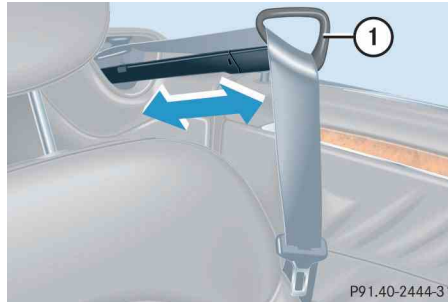

① Seat belt presenter

The seat belt presenter ① slides out when the corresponding door is closed and the ignition is switched on (▷ page 36).

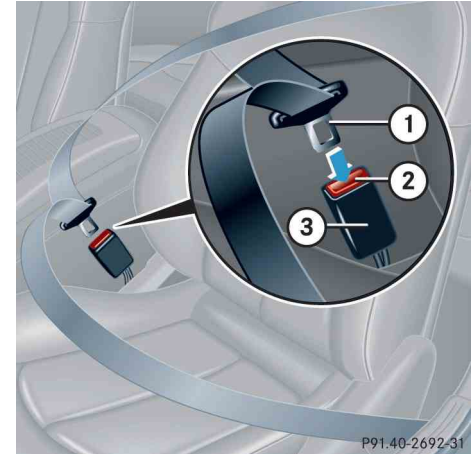

- ① Latch plate
- ② Release button
- ③ Buckle

- ▶ With a smooth motion, pull the belt out of the seat belt presenter.
- ▶ Place the shoulder portion of the belt across the top of your shoulder and the lap portion across your hips.
- ▶ Push latch plate ① into buckle ③ until it clicks.
- ▶ If necessary, tighten the lap portion to a snug fit by pulling shoulder portion up.

Proper use of seat belts

- Do not twist the belt when fastening.
- Adjust seat belt so that the shoulder portion is located as close as possible to the middle of the shoulder (it should not touch the neck). Never pass the shoulder portion of the belt under your arm.
- Position the lap belt as low as possible on your hips (over hip joint) and not across the abdomen.
- Place the seat backrest in a nearly upright position.
- Never use a seat belt for more than one person at a time.
- Do not fasten a seat belt around a person and another object at the same time. When using a seat belt to secure infant or toddler restraints or children in booster seats, always follow the child seat manufacturer's instructions.

- Check your seat belt periodically during travel to make sure that it is properly positioned.
- Make sure that the seat belt is always fitted snugly. Take special care of this when wearing loose clothing.

Warning!



Do not pass belts over sharp edges. They could tear.

Do not allow the belt to get caught in the door or in the seat adjustment mechanism. This could damage the belt.

Never attempt to make modifications to seat belts. This could impair the effectiveness of the belts.

Do not bleach or dye seat belts as this may severely weaken them. In a crash they may not be able to provide adequate protection.

Damaged seat belts or belts that were highly stressed in an accident must be replaced. Contact an authorized Mercedes-Benz Center.

Driving

The seat belt presenter slides back:

- right after you push the latch plate ① into buckle ③ and hear it click.
- after approximately 60 seconds if you do not push latch plate ① into buckle ③.
- if your door is opened.
- if you turn the SmartKey in the starter switch to position **0**.
- if you release a front seat backrest and fold it forward.

Warning!



The seat belt presenter must be retracted while the vehicle is in motion. Only when the seat belt presenter is retracted can the seat belt be properly positioned on the body and protect the occupant as intended.

Starting the engine

Warning!



Inhalation of exhaust gas is hazardous to your health. All exhaust gas contains carbon monoxide (CO), and inhaling it can cause unconsciousness and possible death.

Do not run the engine in confined areas (such as a garage) which are not properly ventilated. If you think that exhaust gas fumes are entering the vehicle while driving, have the cause determined and corrected immediately. If you must drive under these conditions, drive with at least one window fully open.

Automatic transmission

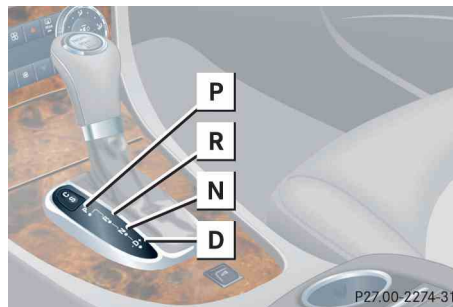

Gearshift pattern for automatic transmission

- P** Park position with gear selector lever lock
- R** Reverse gear
- N** Neutral
- D** Drive position

For more information, see “Automatic transmission” (▷ page 170).

Starting with the SmartKey

- ▶ Make sure the gear selector lever is set to **P**.
- ▶ Do not depress accelerator.
- ▶ Turn the SmartKey in the starter switch to position **3** (▷ page 36) and release it again immediately (“touch-start”).

The engine then starts automatically.

For information on turning off the engine with the SmartKey, see (▷ page 60).

Starting with KEYLESS-GO*

Warning!



As long as the SmartKey with KEYLESS-GO is in your vehicle, the vehicle can be started. Therefore, never leave children unattended in the vehicle, as they could otherwise accidentally start the engine.

When leaving the vehicle, always take the SmartKey with KEYLESS-GO with you and lock the vehicle. Do not leave children unattended in the vehicle, or with access to an unlocked vehicle.

You can start your vehicle without the SmartKey in the starter switch using the KEYLESS-GO start/stop button on the gear selector lever.

The SmartKey with KEYLESS-GO must be located in the vehicle.

- ▶ Make sure the gear selector lever is set to **P**.
- ▶ Do not depress accelerator.

- ▶ Depress the brake pedal during the starting procedure.

The gear selector lever lock is released.

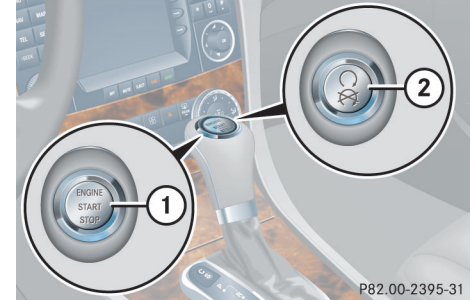

KEYLESS-GO start/stop button

- ① USA only
- ② Canada only

- ▶ Press KEYLESS-GO start/stop button once.

The engine starts if the SmartKey with KEYLESS-GO is in the vehicle.

For information on turning off the engine with KEYLESS-GO, see “Turning off the engine with KEYLESS-GO*” (▷ page 60).

Driving

Starting difficulties

If the SmartKey is left in starter switch position **0** for an extended period of time, it can no longer be turned in the switch. In this case, the steering is locked.

- ▶ To unlock, remove SmartKey from starter switch and reinsert.

If the engine does not start as described, carry out the following steps:

- ▶ If you are starting the engine with the SmartKey, turn SmartKey in starter switch to position **0** and repeat starting procedure.
- ▶ If you are starting the engine with KEYLESS-GO*: Close any doors that may be open to allow for better detection of the SmartKey with KEYLESS-GO*.

Or:

Start the engine with the SmartKey as radio signals from another source may be interfering with the SmartKey with KEYLESS-GO*.

- ▶ Repeat the starting procedure (▷ page 50).

Remember that extended starting attempts can drain the battery.

- ▶ Get a jump start (▷ page 450).

If the engine does not start after several starting attempts, there could be a malfunction in the engine electronics or in the fuel supply system.

- ▶ Notify an authorized Mercedes-Benz Center.

Parking brake

Warning!



When leaving the vehicle, always remove the SmartKey or SmartKey with KEYLESS-GO* from the starter switch, take it with you, and lock the vehicle. Do not leave children unattended in the vehicle, or with access to an unlocked vehicle. Children could release the parking brake, which could result in an accident and/or serious personal injury.

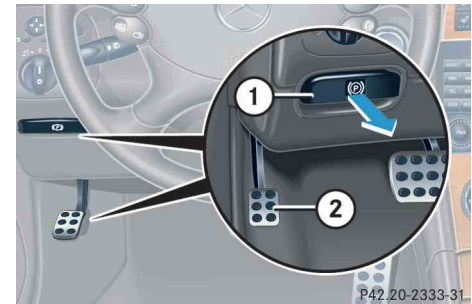



- ① Release handle
- ② Parking brake pedal

- ▶ Release the parking brake by pulling on release handle ①.

The indicator lamp **BRAKE** (USA only) or  (Canada only) in the clock goes out.

Driving

- ▶ Depress the brake pedal.
- ▶ Move gear selector lever to position **D** or **R**.
-  Wait for the gear selection process to complete before setting the vehicle in motion.
- ▶ Release the brake pedal.
- ▶ Carefully depress the accelerator pedal.

 If you hear a warning signal and the message **Release parking brake** appears in the multifunction display when driving off, you have forgotten to release the parking brake.

Release the parking brake (▷ page 52).

 At vehicle speeds of approximately 9 mph (15 km/h), the automatic central locking system engages and the locking knobs drop down.

The automatic door lock feature can be deactivated (▷ page 164).

You can open a locked door from the inside. Open door only when conditions are safe to do so.

 Simultaneously depressing the accelerator pedal and applying the brake reduces engine performance and causes premature brake and drivetrain wear.

After a cold start, the automatic transmission shifts at a higher engine revolution. This allows the catalytic converter to reach its operating temperature earlier.

Warning!



On slippery road surfaces, never downshift in order to obtain braking action. This could result in drive wheel slip and reduced vehicle control. Your vehicle's ABS will not prevent this type of loss of control.

 Place the gear selector lever in position **R** or **P** only when the vehicle is stopped in order to avoid damaging the transmission.

 Do not run cold engine at high engine speeds. Running a cold engine at high engine speeds may shorten the service life of the engine.

CLK 63 AMG:

At low engine temperatures below +68°F (+20°C), the engine's maximum speed is restricted in order to protect it from damage. Avoid driving your vehicle at full speed when the engine is cold to prevent premature engine wear and/or diminished comfort.

Warning!



It is dangerous to shift the gear selector lever out of **P** or **N** if the engine speed is higher than idle speed. If your foot is not firmly on the brake pedal, the vehicle could accelerate quickly forward or in reverse. You could lose control of the vehicle and hit someone or something. Only shift into gear when the engine is idling normally and when your right foot is firmly on the brake pedal.

For more information on driving, see “Driving instructions” (▷ page 301).

Switching on headlamps

Low beam headlamps

The exterior lamp switch is located on the dashboard to the left of the steering wheel.



Exterior lamp switch

- ① Off
- ② Low beam headlamps on
- ▶ Turn the exterior lamp switch to position .

The low beam headlamps and the low beam headlamp indicator lamp  in the instrument cluster comes on (▷ page 26).

High beam

The combination switch is located on the left of the steering column.

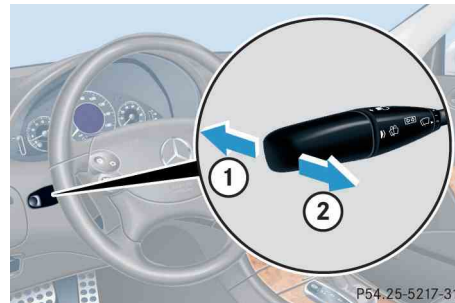

Combination switch

- ① High beam
- ② High beam flasher

- ▶ Push the combination switch in direction of arrow ①.

The high beam headlamps and the high beam headlamp indicator lamp  in the instrument cluster comes on (▷ page 26).

For more information on headlamps, see “Lighting” (▷ page 126).

Turn signals



The combination switch is located on the left of the steering column.



Combination switch

- ① Turn signals, right
- ② Turn signals, left

- ▶ Press the combination switch in direction of arrow ① or ②.

The corresponding turn signal indicator lamp  or  in the instrument cluster flashes (▷ page 26).

The combination switch resets automatically after major steering wheel movements.

- ❗ If the combination switch is pressed to the point of resistance and released, the corresponding turn signals will flash three times.

Windshield wipers

The combination switch is located on the left of the steering column.

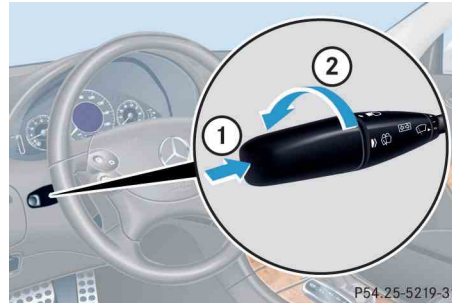

Combination switch

- ① Single wipe
Wiping with windshield washer fluid
- ② Switching on windshield wipers
- ▶ Switch on the ignition (▷ page 36).

- ❗ Do not operate the windshield wipers when the windshield is dry. Dust that accumulates on a windshield might scratch the glass and/or damage the wiper blades when wiping occurs on a dry windshield. If it is necessary to operate the windshield wipers in dry weather conditions, always operate the windshield wipers with windshield washer fluid (▷ page 56).

Switching on windshield wipers

- ▶ Turn the combination switch to the desired position depending on the intensity of the rain.
 - 0 Windshield wipers off
 - I Intermittent wiping
 - II Normal wiper speed
 - III Fast wiper speed

Intermittent wiping

! Do not leave windshield wipers in intermittent setting when the vehicle is taken to an automatic car wash or during windshield cleaning. Windshield wipers will operate in the presence of water sprayed on the windshield, and windshield wipers may be damaged as a result.

! If you have set intermittent wiping, dirt on the surface of the rain sensor or optical effects may cause the windshield wipers to wipe in an undesired fashion. This could then damage the windshield wiper blades or scratch the windows. You should therefore switch off the windshield wipers when weather conditions are dry.

Intermittent wiping interval is dependent on wetness of windshield.

- ▶ Turn the combination switch to position **I**.

After the initial wipe, pauses between wipes are automatically controlled by the rain sensor.

i Intermittent wiping is interrupted when the vehicle is at a standstill and a door is opened. This protects persons getting into or out of the vehicle from being sprayed.

Intermittent wiping will be continued when

- all doors are closed
- and
- the gear selector lever is in position **D** or **R** or
- the wiper setting is changed using the combination switch

Single wipe

- ▶ Press the combination switch briefly in direction of arrow ① (▷ page 55) to the resistance point.

The windshield wipers wipe one time without washer fluid.

Wiping with windshield washer fluid

- ▶ Press the combination switch in direction of arrow ① (▷ page 55) past the resistance point.

The windshield wipers operate with washer fluid.

i To prevent smears on the windshield, or noisy/chattering wiper blades, wipe with windshield washer fluid every now and then even when it is raining.

For information on filling up the washer reservoir, see “Windshield washer system and headlamp cleaning system*” (▷ page 322).

! If anything blocks the windshield wipers (leaves, snow, etc.), switch them off immediately.

- For safety reasons, stop the vehicle in a safe location and,
 - remove SmartKey from starter switch or
 - turn off the engine by pressing the KEYLESS-GO* start/stop button and open the driver's door (with the driver's door open, starter switch is in position **0**, same as with SmartKey removed from starter switch)

before attempting to remove any blockage.

- Remove blockage.
- Turn the windshield wipers on again.

If windshield wipers fail to function at all in combination switch position **I**,

- set the combination switch to the next higher wiper speed
- have the windshield wipers checked at the nearest authorized Mercedes-Benz Center.

Problems while driving

The engine runs erratically and misfires

- An ignition cable may be damaged.
 - The engine electronics may not be operating properly.
 - Unburned gasoline may have entered the catalytic converter and damaged it.
- ▶ Give very little gas.
 - ▶ Have the problem repaired by an authorized Mercedes-Benz Center as soon as possible.

The coolant temperature is above 248°F (120°C)

The coolant is too hot and is no longer cooling the engine.

- ▶ Stop the vehicle in a safe location as soon as possible and turn off the engine. Allow engine and coolant to cool off.

- ▶ Check the coolant level and add coolant if necessary (▷ page 320).

In case of accident

If the vehicle is leaking gasoline:

- ▶ Do not start the engine under any circumstances.
- ▶ Notify local fire and/or police authorities.

If the extent of the damage cannot be determined:

- ▶ Notify an authorized Mercedes-Benz Center.

If no damage can be determined on the

- major assemblies
- fuel system
- engine mount:
- ▶ Start the engine in the usual manner.

Parking and locking

You have now completed your first drive. You have properly stopped and parked your vehicle. End your drive as follows:

Warning!



With the engine not running, there is no power assistance for the brake and steering systems. In this case, it is important to keep in mind that a considerably higher degree of effort is necessary to brake and steer the vehicle.

Warning!



Do not park this vehicle in areas where combustible materials such as grass, hay or leaves can come into contact with the hot exhaust system, as these materials could be ignited and cause a vehicle fire.

To reduce the risk of personal injury, or damage to the vehicle or the vehicle drivetrain, as a result of vehicle movement, always do the following before turning off the engine and leaving the vehicle:

- Keep right foot firmly on brake pedal.
- Firmly depress parking brake pedal.
- Move the gear selector lever to position **P**.
- Slowly release brake pedal.
- When parked on an incline, always turn the front wheels towards the road curb.
- Turn the SmartKey or the SmartKey with KEYLESS-GO* to starter switch position **0** and remove, or press KEYLESS-GO* start/stop button.
- Take the SmartKey or the SmartKey with KEYLESS-GO* with you and lock the vehicle when leaving.

Parking brake

Warning!



Do not engage the parking brake while the vehicle is in motion. Doing so can cause the rear wheels to lock up. You could lose control of the vehicle and cause an accident. In addition, the vehicle's brake lights do not light up when the parking brake is engaged, which could endanger other road users.

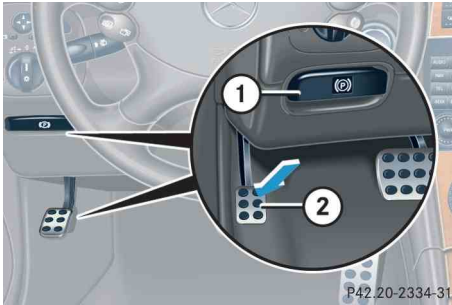

- ① Release handle
- ② Parking brake pedal

- ▶ Step firmly on parking brake pedal ②.

When the engine is running, the warning lamp **BRAKE** (USA only) or **(P)** (Canada only) in the clock will be illuminated.

Warning!



When leaving the vehicle, always remove the SmartKey or SmartKey with KEYLESS-GO* from the starter switch, take it with you, and lock the vehicle. Do not leave children unattended in the vehicle, or with access to an unlocked vehicle. Children could release the parking brake and/or move the gear selector lever from position **P**, either of which could result in an accident and/or serious personal injury.

Position **P** alone may not prevent your vehicle from moving, possibly hitting people or objects. Always set the parking brake in addition to shifting to position **P** (▷ page 172).

When parked on an incline, always turn the front wheels towards the road curb.

Getting out of your vehicle without taking the above measurements to secure it is dangerous.

Switching off headlamps

- ▶ Turn the exterior lamp switch to **0** (▷ page 54).

For more information, see “Lighting” (▷ page 126).

Parking and locking

Turning off the engine

- ▶ Place the gear selector lever in position **P**.
- ▶ Apply the parking brake (▷ page 58).

i Always set the parking brake in addition to shifting to position **P**.

On slopes, turn the front wheels towards the curb.

Turning off the engine with the SmartKey

- ▶ Turn the SmartKey in the starter switch to position **0** (▷ page 36).
- ▶ Remove the SmartKey from the starter switch.
The immobilizer is activated.

i The SmartKey can only be removed from the starter switch with the gear selector lever in position **P**.

Turning off the engine with KEYLESS-GO*

- ▶ Press the KEYLESS-GO start/stop button to shut off the engine.

With the driver's door closed, the starter switch is now in position **1**. With the driver's door opened, the starter switch is set to position **0**, same as SmartKey removed from starter switch (▷ page 36).

i If you hear a warning signal, you have tried to turn off the engine while the gear selector lever was not in **P**.

*In addition, the message **Selector lever in Park** appears in the multifunction display.*

*Place the gear selector lever in **P**.*

Releasing seat belts

- ▶ Press the seat belt release button (▷ page 48).

Allow the retractor to completely rewind the seat belt by guiding the latch plate.

! *Make sure the seat belt retracts fully so that the seat belt and/or latch plate cannot get caught or pinched in the door or in the seat mechanism. This can damage the seat belt and impair the effectiveness of the seat belt, and/or cause damage to the door and/or door trim panel. Such damage is not covered by the Mercedes-Benz Limit Warranty.*

Damaged seat belts must be replaced. Contact an authorized Mercedes-Benz Center.

Locking

Warning!



To prevent possible personal injury, always keep hands and fingers away from the door openings when closing the doors. Be especially careful when small children are around.

Before closing doors, make sure there is no possibility of someone getting caught in a door during closing.

Warning!



When leaving the vehicle, always remove the SmartKey or SmartKey with KEYLESS-GO* from the starter switch, take it with you, and lock the vehicle. Do not leave children unattended in the vehicle, or with access to an unlocked vehicle. A child's unsupervised access to a vehicle could result in an accident and/or serious personal injury.

- ▶ Exit the vehicle, take the SmartKey or the SmartKey with KEYLESS-GO* with you, and close all doors and the trunk lid.

i *If you hear a warning signal you have forgotten to switch off the headlamps before opening the driver's door.*

In addition the message Turn off lamps appears in the multifunction display. Vehicles with KEYLESS-GO, this message is only displayed for approximately 1 second. It is then overwritten by the message, Please do not forget key.*

Switch off the headlamps.

i *Opening a door causes the windows on that side of the car to open slightly. They will return to the up position when the door is closed.*

Parking and locking

Locking with the SmartKey

- ▶ Press lock button  on the SmartKey (▷ page 34).

With the trunk and both doors closed:

- All turn signal lamps flash three times.
- An acoustic signal sounds three times.
For more information, see “Factory setting” (▷ page 100).
- The locking knobs in the doors move down.
- The anti-theft alarm system is armed.

For more information, see “SmartKey” (▷ page 98).

Locking with KEYLESS-GO*

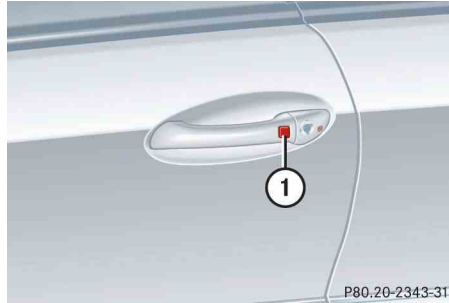

① Lock button

- ▶ Press lock button ① on an outside door handle.

With the trunk and both doors closed:

- All turn signal lamps flash three times.
- An acoustic signal sounds three times.
For more information, see “Factory setting” (▷ page 100).
- The locking knobs in the doors move down.
- The anti-theft alarm system is armed.

For more information, see “SmartKey with KEYLESS-GO*” (▷ page 101).

Occupant safety

Panic alarm

Driving safety systems

Anti-theft systems



Occupant safety

In this section you will learn the most important facts about the restraint system components of the vehicle.

- Seat belts (▷ page 75)
- Child restraints (▷ page 82)
- Lower Anchors and Tethers for Children (LATCH) (▷ page 85)

Additional protection potential provide

- Supplemental Restraint System (SRS) with
 - Air bags (▷ page 65)
 - Air bag control unit (with crash sensors)
 - Emergency tensioning device (ETD) for seat belts (▷ page 79)
- Active head restraint (▷ page 80)
- Roll bars (▷ page 81)

Air bag system components with

- Front passenger front air bag off indicator lamp (▷ page 74)
- Front passenger seat with Occupant Classification System (OCS) (▷ page 71)

Although independent systems, their protective functions work in conjunction with each other.

 For information on infants and children traveling with you in the vehicle and restraint systems for infants and children, see “Children in the vehicle” (▷ page 82).

The SRS system conducts a self-test when the ignition is switched on and in regular intervals while the engine is running. This facilitates detection of system malfunctions. The **SRS** indicator lamp in the instrument cluster comes on when the ignition is switched on and goes out no later than a few seconds after the engine has been started.

The SRS components are in operational readiness if the **SRS** indicator lamp is not lit when the engine is running.

A malfunction in the system has been detected if the **SRS** indicator lamp:

- fails to go out after approximately 4 seconds after the engine was started
- does not come on at all
- comes on after the engine was started or while driving

Warning!



Modifications to or work improperly conducted on restraint systems (such as seat belts and anchors, emergency tensioning devices, seat belt force limiters or air bags) or their wiring, as well as tampering with interconnected electronic systems, can lead to the restraint systems no longer functioning as intended.

Air bags or emergency tensioning devices, for example, could deploy inadvertently or fail to deploy in accidents although the deceleration threshold for air bag deployment is exceeded. Therefore, never modify the restraint systems. Do not tamper with electronic components or their software.

Warning!



In the event that the **SRS** indicator lamp comes on during driving or does not come on at all, the SRS self-check has detected a malfunction. For your safety, we strongly recommend that you visit an authorized Mercedes-Benz Center immediately to have the system checked; otherwise the SRS may not deploy when needed in an accident, which could result in serious or fatal injury, or it might deploy unexpectedly and unnecessarily which could also result in injury.

In addition, improper repair work on the SRS creates a risk of rendering the SRS inoperative or causing unintended air bag deployment. Work on the SRS must therefore only be performed by qualified technicians. Contact an authorized Mercedes-Benz Center.

If it is necessary to modify an air bag system to accommodate a person with disabilities, contact your local authorized Mercedes-Benz Center or call our Customer Assistance Center at 1-800-FOR-MERCEdes (1-800-367-6372) for details.

Air bags

Warning!



Air bags are designed to reduce the potential of injury and fatality in certain frontal impacts (front air bags) or side impacts (head-thorax air bags and rear side impact air bags*). However, no system available today can totally eliminate injuries and fatalities.

The deployment of the air bags temporarily releases a small amount of dust from the air bags. This dust, however, is neither injurious to your health, nor does it indicate a fire in the vehicle. The dust might cause some temporary breathing difficulty for people with asthma or other breathing trouble. To avoid this, you may wish to get out of the vehicle as soon as it is safe to do so. If you have any breathing difficulty but cannot get out of the vehicle after the air bag inflates, then get fresh air by opening a window or door.

Occupant safety

Warning!



To reduce the risk of injury when the front air bags inflate, it is very important for the driver and front passenger to always be in a properly seated position and to wear their respective seat belts.

For maximum protection in the event of a collision always be in normal seated position with your back against the backrest. Fasten your seat belt and make sure that it is properly positioned on your body.

Since the air bag inflates with considerable speed and force, a proper seating and hands on steering wheel position will help to keep you at a safe distance from the air bag. Occupants who are unbelted, out of position or too close to the air bag can be seriously injured or killed by an air bag as it inflates with great force in the blink of an eye:

- Sit properly belted in a nearly upright position with your back against the seat backrest.

- Adjust the driver's seat as far as possible rearward, still permitting proper operation of vehicle controls. The distance from the center of the driver's breastbone to the center of the air bag cover on the steering wheel must be at least 10 in (25 cm) or more. You should be able to accomplish this by a combination of adjustments to the seat and steering wheel. If you have any problems, please see an authorized Mercedes-Benz Center.
- Do not lean your head or chest close to the steering wheel or dashboard.
- Keep hands on the outside of steering wheel rim. Placing hands and arms inside the rim can increase the risk and potential severity of hand/arm injury when driver's front air bag inflates.
- Adjust the front passenger seat as far as possible rearward from the dashboard when the seat is occupied.

- Occupants, especially children, should always sit nearly upright, properly use the seat belts and use an appropriately sized infant or toddler restraint or booster seat recommended for the size and weight of the child.

Failure to follow these instructions can result in severe injuries to you or other occupants.

If you sell your vehicle, it is important that you make the buyer aware of this safety information. Be sure to give the buyer this Operator's Manual.

Warning!

Accident research shows that the safest place for children in an automobile is in the rear seat.

There is a possibility for a head-thorax air bag or rear side impact air bag* related injury if occupants, especially children, are not properly seated or restrained when next to a head-thorax air bag and/or rear side impact air bag* which needs to deploy rapidly in a side impact in order to do its job.

To help avoid the possibility of injury, please follow these guidelines:

- (1) Always sit as upright as possible, properly use the seat belts, and for children 12 years old and under, use an appropriately sized infant or toddler restraint or booster seat recommended for the size and weight of the child.
- (2) Always wear seat belts properly.

i Air bags are designed to deploy only in certain frontal impacts (front air bags), and in side impacts (head-thorax air bags and rear side impact air bags*) which exceed preset thresholds. Only during these events will they provide their supplemental protection.

The driver and passengers should always wear their seat belts. Otherwise it is not possible for the air bags to provide their supplemental protection.

In case of other types of impacts and impacts below air bag deployment thresholds, air bags will not deploy. The driver and passenger will then be protected to the extent possible by a properly fastened seat belt. A properly fastened seat belt is also needed to provide the best possible protection in a rollover.

We caution you not to rely on the presence of the air bags in order to avoid wearing your seat belt.

It is important to your safety and that of your passengers that you replace deployed air bags and repair any malfunctioning air bags to make sure that the vehicle will continue to provide supplemental crash protection for occupants.

Safety guidelines for the seat belt, emergency tensioning device and air bag**Warning!**

- Damaged seat belts or belts that were highly stressed in an accident must be replaced and their anchoring points must also be checked. Only use belts installed or supplied by an authorized Mercedes-Benz Center.
- Air bags and emergency tensioning devices (ETDs) are designed to function on a one-time-only basis. An air bag or ETD that is deployed must be replaced.
- Do not pass belts over sharp edges. They could tear.
- Do not make any modification that could change the effectiveness of the belts.
- Do not bleach or dye seat belts as this may severely weaken them. In a crash they may not be able to provide adequate protection.



Occupant safety



- No modifications of any kind may be made to any components or wiring of the SRS. This includes changing or removing any component or part of the SRS, the installation of additional trim material, seat covers, badges, etc. over the steering wheel hub, front passenger front air bag cover, outboard sides of the front seat backrests, door frame trims, or rear side trim panels, and installation of additional electrical/electronic equipment on or near SRS components and wiring. Keep area between air bags and occupants free from objects (e.g. packages, purses, umbrellas, etc.).
- Air bag system components will be hot after an air bag has inflated. Do not touch.
- Never place your feet on the instrument panel, dashboard, or on the seat. Always keep both feet on the floor in front of the seat.

- In addition, improper repair work on the SRS creates a risk of rendering the SRS inoperative or causing unintended air bag deployment. Work on the SRS must therefore only be performed by qualified technicians. Contact an authorized Mercedes-Benz Center.
- For your protection and the protection of others, when scrapping the air bag unit or emergency tensioning device, our safety instructions must be followed. These instructions are available from your authorized Mercedes-Benz Center.
- Given the considerable deployment speed, required inflation volume, and the textile structure of the air bags, there is the possibility of abrasions or other, potentially more serious injuries resulting from air bag deployment.

Warning!



Only use seat covers which have been tested and approved by Mercedes-Benz for your vehicle model. Using other seat covers may interfere with or prevent the deployment of the head-thorax air bags. Contact your authorized Mercedes-Benz Center for availability.

When you sell your vehicle, we strongly urge you to give notice to the subsequent owner that it is equipped with an SRS by alerting them to the applicable section in the Operator's Manual.

Front air bags



- ① Driver air bag
- ② Passenger air bag

Driver and front passenger front air bags are deployed:

- in the event of certain frontal impacts
- if impact exceeds a preset deployment threshold
- independently of the head-thorax air bag and/or rear side impact air bag*

i The front air bags in this vehicle have been designed to inflate in two stages. This allows the air bag to have different rates of inflation that are based on the rate of relevant vehicle deceleration as assessed by the air bag control unit.

On the front passenger side, the front air bag deployment is additionally influenced by the passenger's weight category as identified by the Occupant Classification System (OCS) (▷ page 71).

The lighter the front passenger side occupant, the higher the vehicle deceleration rate required for the second stage inflation of the air bag.

The air bags will not deploy in impacts which do not exceed the system's deployment thresholds. You will then be protected by the fastened seat belts.

The front passenger front air bag will only be deployed if:

- the system, based on OCS weight sensor readings, senses that the front passenger seat is occupied
- the  indicator lamp in the center console is not lit (▷ page 74)
- the impact exceeds a preset deployment threshold

Occupant safety

Head-thorax air bags

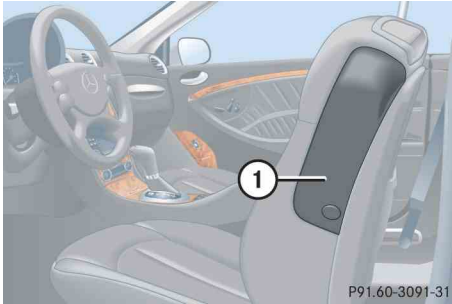

① Head-thorax air bag

The head-thorax air bags ① in the drivers and front passenger seat are deployed:

- on the impacted side of the vehicle
- in impacts exceeding a preset deployment threshold
- independently of the front air bags

The head-thorax air bags ① are not deployed in impacts which do not exceed the system's deployment threshold.

Warning!



Only use seat covers which have been tested and approved by Mercedes-Benz for your vehicle model. Using other seat covers may interfere with or prevent the deployment of the head-thorax air bags. Contact your authorized Mercedes-Benz Center for availability.

Rear side impact air bags*

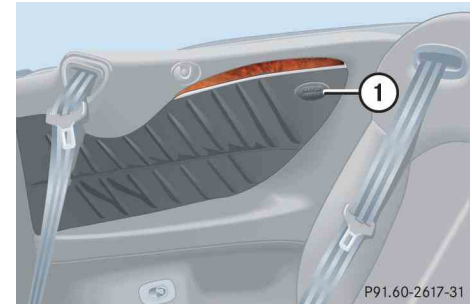

① Rear side impact air bag*

The rear side impact air bags* ① are deployed:

- on the impacted side of the vehicle
- in impacts exceeding a preset deployment threshold
- independently of the front air bags

The rear side impact air bags* ① are not deployed in impacts which do not exceed the system's deployment threshold.

Occupant Classification System

The Occupant Classification System (OCS) automatically turns the front passenger front air bag on or off based on the classified occupant weight category determined by weight sensor readings from the front passenger seat.

i *The system does not deactivate the head-thorax air bag and the emergency tensioning device.*

Occupants must sit properly belted in a position that is as upright as possible with their back against the seat backrest and feet on the floor to be correctly classified. If the occupant's weight is transferred to another object in the vehicle (e.g. by leaning on armrests), the OCS may not be able to properly approximate the occupant's weight category.



i *If your seat, including your trim cover and cushion needs to be serviced in any way, take the vehicle to an authorized Mercedes-Benz Center.*

Only seat accessories approved by Mercedes-Benz may be used.

Both driver and the front passenger should always use the  indicator lamp as an indication of whether or not the front passenger is properly positioned.

Warning!



If the  indicator lamp illuminates when an adult or someone larger than a small individual is in the front passenger seat, have the front passenger re-position himself or herself in the seat until the  indicator lamp goes out.

More information about air bag display messages (▷ page 382).

In the event of a collision, the air bag control unit will not allow front passenger front air bag deployment when the OCS classified the front passenger seat occupant as being up to or less than the weight of a typical 12-month-old child in a standard child restraint or if the front passenger seat is sensed as being empty.

When the OCS senses that the front passenger seat occupant is classified as being up to or less than the weight of a typical 12-month-old child in a standard child restraint, the  indicator lamp will illuminate when the engine is started and







Occupant safety





remain illuminated, indicating that the front passenger front air bag is deactivated.

When the OCS senses that the front passenger seat is classified as being empty, the  indicator lamp will illuminate when the engine is started and remain illuminated, indicating that the front passenger front air bag is deactivated.

When the OCS senses that the front passenger seat occupant is classified as being heavier than the weight of a typical 12-month-old child seated in a standard child restraint or as being a small individual (such as a young teenager or a small adult), the  indicator lamp will illuminate for approximately 6 seconds when the engine is started and then, depending on occupant weight sensor readings from the seat, remain illuminated or go out. With the  indicator lamp illuminated, the front passenger front air bag is deactivated. With the  indicator lamp out, the front passenger front air bag is activated.

When the OCS senses that the front passenger seat occupant is classified as an adult or someone larger than a small individual, the  indicator lamp will illuminate for approximately 6 seconds when the engine is started and then go out, indicating that the front passenger front air bag is activated.

If the  indicator lamp is illuminated, the front passenger front air bag is deactivated and will not be deployed.

If the  indicator lamp is not illuminated, the front passenger front air bag is activated and will be deployed:

- in the event of certain frontal impacts
- if impact exceeds a preset deployment threshold
- independently of the head-thorax air bags and/or rear side impact air bags*.

If the front passenger front air bag is deployed, the rate of inflation will be influenced by:

- the rate of vehicle deceleration as assessed by the air bag control unit
- front passenger's weight category as identified by the Occupant Classification System (OCS).

Warning!







According to accident statistics, children are safer when properly restrained in the rear seating positions than in the front seating position. Thus, we strongly recommend that children be placed in the rear seats whenever possible. Regardless of seating position, children 12 years old and under must be seated and properly secured in an appropriate infant or child restraint recommended for the size and weight of the child.

The infant or child restraint must be properly secured with the vehicle's seat belt, or seat belt and lower anchors, fully in accordance with the child seat manufacturer's instructions.

Children can be killed or seriously injured by an inflating air bag. Note the following important information when circumstances require you to place a child in the front passenger seat:

- Your vehicle is equipped with air bag technology designed to turn off the front passenger front air bag in your vehicle when the system senses the weight of a typical 12-month-old child or less along with the weight of a standard appropriate child restraint on the front passenger seat.

- A child in a rear-facing child restraint on the front passenger seat will be seriously injured or even killed if the front passenger front air bag inflates in a collision which could occur under some circumstances, even with the air bag technology installed in your vehicle. The only means to completely eliminate this risk is to never place a child in a rear-facing child restraint in the front seat. We therefore strongly recommend that you always place a child in a rear-facing child restraint in the back seat.
- If you must install a rear-facing child restraint on the front passenger seat because circumstances require you to do so, make sure that the  indicator lamp is illuminated, indicating that the front passenger front air bag is deactivated. Should the  indicator lamp not illuminate or go out while the restraint is installed, please check installation. Periodically check the  indicator lamp while driving to make sure the  indicator lamp is illuminated.

If the  indicator lamp goes out or remains out, do not transport a child on the front passenger seat until the system has been repaired. A child in a rear-facing child restraint on the front passenger seat will be seriously injured or even killed if the front passenger front air bag inflates.



- If you have to place a child in a forward-facing child restraint on the front passenger seat, move the seat as far back as possible, use the proper child restraint recommended for the age, size and weight of the child, and secure child restraint with the vehicle's seat belt according to the child seat manufacturer's instructions. For children larger than the typical 12-month-old child, the front passenger front air bag may or may not be activated (> page 72).

Occupant safety

i Deployment of the driver front air bag does not mean that the front passenger front air bag also should have deployed.



The Occupant Classification System (▷ page 71) may have determined:

- that the seat was empty or occupied by the weight up to or less than that of a typical 12-month-old child seated in a standard child restraint – both instances where the system suppresses deployment of the front passenger front air bag even though the impact met the criteria and was of sufficient severity to deploy the driver front air bag.
- that the seat was occupied by a small individual (such as a young teenager or a small adult) or a child weighing more than the weight of a typical 12-month-old child in a standard child restraint – instances where the system may suppress deployment of the front passenger front air bag even though the impact met the criteria and was of sufficient severity to deploy the driver front air bag.

The   indicator lamp is located in the center console.





① Front passenger front air bag off indicator lamp

The   indicator lamp ① will be illuminated, except with the SmartKey removed from the starter switch or with the starter switch in position 0.

Warning!





If the **SRS** indicator lamp and the   indicator lamp are lit at the same time, there is a malfunction in the Occupant Classification System. The front passenger front air bag will be deactivated in this case.

In order to ensure proper operation of the air bag system and OCS:

- Have the system checked as soon as possible by qualified technicians. Contact an authorized Mercedes-Benz Center.
- Sit properly belted in a nearly upright position with your back against the seat backrest.
- Do not lean on the armrests or lift yourself from the seat by using the handle over the door as this may cause the OCS to be unable to correctly approximate the occupant weight category.

- Only have the seat repaired or replaced by an authorized Mercedes-Benz Center.
- Read and observe all warnings in this chapter.

Self-test Occupant Classification System

After turning the SmartKey in the starter switch to position **1** or **2** or pressing the KEYLESS-GO* start/stop button once or twice, the  indicator lamp located in the center console illuminates. If an adult occupant is properly sitting on the front passenger seat and the system senses the occupant as being an adult, the  indicator lamp will illuminate and go out after approximately 6 seconds.

If the seat is not occupied and the system senses the front passenger seat as being empty, the  indicator lamp will illuminate and not go out.

Warning!



If the  indicator lamp should not illuminate, the system is not functioning. You must see an authorized Mercedes-Benz Center before seating any child on the front passenger seat.

More information can be found in the “Practical hints” section (▷ page 376).

Warning!



Never place anything between seat cushion and child seat (e.g. pillow), since it reduces the effectiveness of the Occupant Classification System. The bottom of the child seat must make full contact with the passenger seat cushion. An incorrectly mounted child seat could cause injuries to the child in case of an accident, instead of increasing protection for the child.

Follow the manufacturer’s instructions for installation of child seats.

Seat belts

The use of seat belts and infant and child restraint systems is required by law in all 50 states, the District of Columbia, the U.S. territories and all Canadian provinces.

Even where this is not the case, all vehicle occupants should have their seat belts fastened whenever the vehicle is in motion.

For more information, see “Fastening the seat belts” (▷ page 47).

 For information on infants and children traveling with you in the vehicle and restraint systems for infants and children, see “Children in the vehicle” (▷ page 82).

Occupant safety

Warning!



Always fasten your seat belt before driving off. Always make sure all of your passengers are properly restrained, including those sitting in the rear.

Failure to wear and properly fasten and position your seat belt greatly increases your risk of injuries and their likely severity in an accident. You and your passengers should always wear seat belts.

If you are ever in an accident, your injuries can be considerably more severe without your seat belt properly buckled. Without your seat belt buckled, you are much more likely to hit the interior of the vehicle or be ejected from it. You can be seriously injured or killed.

In the same crash, the possibility of injury or death is lessened if you are properly wearing your seat belt. Air bags can only protect as they are designed if the occupants are properly wearing their seat belts.

Warning!



Never ride in a moving vehicle with the seat backrest in an excessively reclined position as this can be dangerous. You could slide under the seat belt in a collision. If you slide under it, the belt would apply force at the abdomen or neck. That could cause serious or even fatal injuries. The seat backrest and seat belt provide the best restraint when the wearer is in a nearly upright position and the belt is properly positioned on the body.

Warning!



Never let more people ride in the vehicle than there are seat belts available. Make sure everyone riding in the vehicle is correctly restrained with a separate seat belt. Never use a seat belt for more than one person at a time.

Warning!



Damaged seat belts or belts that were highly stressed in an accident must be replaced and their anchoring points must also be checked.

Only use seat belts which have been approved by Mercedes-Benz.

Do not make any modifications to the seat belts. This can lead to unintended activation of the ETDs or to their failure to activate when necessary.

Do not bleach or dye seat belts as this may severely weaken them. In a crash they may not be able to provide adequate protection.

Have all work carried out only by qualified technicians. Contact an authorized Mercedes-Benz Center.

Warning!**USE SEAT BELTS PROPERLY**

- Seat belts can only work when used properly. Never wear seat belts in any other way than as described in this section, as that could result in serious injuries in case of an accident.
- Each occupant should wear their seat belt at all times, because seat belts help reduce the likelihood of and potential severity of injuries in accidents, including rollovers. The integrated restraint system includes SRS (driver air bag, front passenger front air bag, head-thorax air bags and rear side impact air bags*), ETD (seat belt emergency tensioning device), and front seat knee bolsters. The system is designed to enhance the protection offered to properly belted occupants in certain frontal (front air bags and ETD) and side (head-thorax air bags and rear side impact air bags* and ETD) impacts which exceed preset deployment thresholds.

- Never wear the shoulder belt under your arm, against your neck or off your shoulder. In a frontal crash, your body would move too far forward. That would increase the chance of head and neck injuries. The belt would also apply too much force to the ribs or abdomen, which could severely injure internal organs such as your liver or spleen.
- Never wear belts over rigid or breakable objects in or on your clothing, such as eyeglasses, pens, keys etc., as these might cause injuries.
- Position the lap belt as low as possible on your hips and not across the abdomen. If the belt is positioned across your abdomen, it could cause serious injuries in a crash.
- Never use a seat belt for more than one person at a time. Do not fasten a seat belt around a person and another person or other objects.

- Belts should not be worn twisted. In a crash, you wouldn't have the full width of the belt to distribute impact forces. The twisted belt against your body could cause injuries.
- Pregnant women should also always use a lap-shoulder belt. The lap belt portion should be positioned as low as possible on the hips to avoid any possible pressure on the abdomen.
- Never place your feet on the instrument panel, dashboard, or on the seat. Always keep both feet on the floor in front of the seat.
- When using a seat belt to secure infant or toddler restraints or children in booster seats, always follow the child seat manufacturer's instructions.

Occupant safety

Enhanced seat belt reminder system

When the engine is started, the seat belt telltale  will always illuminate for 6 seconds to remind you and your passengers to fasten your seat belts.

If the driver's seat belt is not fastened when the engine is started, an additional warning chime will also sound for a maximum of 6 seconds or until the driver's seat belt is fastened.

If after these 6 seconds the driver's or the front passenger's seat belt (with the front passenger seat occupied) is not fastened with both doors closed,

- the seat belt telltale  remains illuminated for as long as either the driver's or front passenger's seat belt is not fastened.

- and if the vehicle speed once exceeds 15 mph (25 km/h), the seat belt telltale  starts flashing and a warning chime sounds with increasing intensity for a maximum of 60 seconds or until the driver's and the front passenger's seat belt are fastened.

If you and/or your passenger release the seat belt during driving, the seat belt telltale  starts flashing and a warning chime sounds as described before.

If the driver's or the front passenger's seat belt remains unfastened after 60 seconds, the warning chime stops sounding, the seat belt telltale  stops flashing but continues to be illuminated.

After a vehicle standstill the warning chime is reactivated and the seat belt telltale  is flashing again if the vehicle speed once exceeds 15 mph (25 km/h).

The seat belt telltale  will only go out if both the driver's and the front passenger's seat belt (with the front passenger seat occupied) are fastened, or the vehicle is standing still and a door is opened.

For more information, see "Practical hints" (▷ page 373).

Emergency tensioning device (ETD), seat belt force limiter

The seat belts are equipped with emergency tensioning devices and belt force limiters.

The ETD is designed to activate in the following cases:

- in frontal or rear-end impacts exceeding the system deployment threshold
- if the restraint systems are operational and functioning correctly, see **SRS** indicator lamp (▷ page 64)

! *The ETDs for the front seats will only activate if the front seat belts are fastened (latch plate properly inserted into buckle).*

The ETDs for the rear seats will activate with or without the respective seat belts fastened.

When activated, emergency tensioning devices remove slack from the belts. Belt force limiters reduce the force exerted by the seat belts on occupants during a crash.

Warning!



An emergency tensioning device (ETD) that was activated must be replaced.

When disposing of the emergency tensioning device, our safety instructions must be followed. These are available at your authorized Mercedes-Benz Center.

Automatic comfort-fit feature seat belt

An automatic comfort-fit feature for front seats reduces the retracting force of the seat belts when they are in normal use.

Occupant safety

Active head restraints

The active front seat head restraints are intended to offer the driver and front passenger increased protection from whiplash type injuries in rear-end collisions. In the event of a rear-end collision exceeding the systems' deployment threshold, the active head restraints on the driver's and front passenger's seats are designed to move forward in the direction of travel, providing the head with increased support earlier on in the collision sequence. The active head restraints activate whether the seat is occupied or not.

Warning!



For your protection, drive only with properly positioned head restraints.

Adjust the head restraint so that it is as close to the head as possible and the center of the head restraint supports the back of the head at eye level. This will reduce the

potential for injury to the head and neck in the event of an accident or similar situation.

Do not drive the vehicle without the seat head restraints. Head restraints are intended to help reduce injuries during an accident.

Warning!



Only use seat or head restraint covers which have been tested and approved by Mercedes-Benz for your vehicle model. Using other seat or head restraint covers may interfere with or prevent the activation of the active head restraints. Contact an authorized Mercedes-Benz Center for availability.

Do not attach any objects (e.g. hangers) to the head restraint posts. Otherwise, the active head restraints may not be able to function properly or offer the intended degree of protection in the event of an accident.

You cannot remove the active head restraint on the driver's and front passenger's seat.

For removal of the active head restraints we recommend that you contact an authorized Mercedes-Benz Center.

For information on head restraint adjustment, see "Seats" (▷ page 39).

For information on resetting the activated active head restraints, see "Resetting activated head restraints" (▷ page 424).

Roll bars

Warning!



Make sure nothing is blocking the roll bars' path of motion. Otherwise someone could be injured when the roll bars are raised. The head restraints should therefore always be in the raised position when the rear seat is occupied (▷ page 120).

The roll bars are integrated into the rear head restraints.

The roll bars raise automatically in an accident or in a critical driving situation.

i *When the roll bars are raised automatically, you will hear a ratcheting sound and the rear head restraints will also rise.*

You can manually lower the roll bars again when the soft top is open (▷ page 414). With the soft top closed, contact an authorized Mercedes-Benz Center to have the roll bars lowered. Do not attempt to lower the roll bars manually with the soft top

closed. Lowering the roll bars manually with the soft top closed may impair the function of the roll bars.

i *You cannot lower the rear head restraints with the rear head restraint lowering switch (▷ page 120) when the roll bars are in the raised position.*

Also, you cannot operate the soft top using the soft top switch when the roll bars are in the raised position.

- *If the soft top is open, you can manually lower the roll bars (▷ page 414).*
- *If the soft top is closed, contact an authorized Mercedes-Benz Center to have the roll bars lowered.*

Warning!



If the yellow roll bar warning lamp  in the clock does not go out after starting the engine, or if it comes on while driving, then the roll bar system is not operating properly and may not activate in an accident. In this case, raise the roll bars manually before continuing to drive (▷ page 413).

For safety reasons, drive only with the roll bars raised until the malfunction is repaired. Have your vehicle checked at an authorized Mercedes-Benz Center.

Occupant safety

Children in the vehicle

If an infant or child is traveling with you in the vehicle:

- ▶ Secure the child using an infant or child restraint appropriate to the age and size of the child.
- ▶ Make sure that the infant or child is properly secured at all times while the vehicle is in motion.

Warning!



Do not leave children unattended in the vehicle, even if they are secured in a child restraint system. The children could

- injure themselves on parts of the vehicle
- be seriously or fatally injured through excessive exposure to extreme heat or cold

If children open a door, they could

- injure other persons
- get out of the car and injure themselves or be injured by oncoming traffic

Do not expose the child restraint system to direct sunlight. The child restraint system's metal parts, for example, could become very hot, and the child could be burned on these parts.

Do not carry heavy or hard objects in the passenger compartment or trunk unless they are firmly secured in place. For more information, see “Loading” (▷ page 271), and see “Useful features” (▷ page 276) in the “Controls in detail” chapter.

Unsecured or improperly positioned cargo increases a child's risk of injury in the event of

- strong braking maneuvers
- sudden changes of direction
- an accident

Infant and child restraint systems

We recommend all infants and children be properly restrained at all times while the vehicle is in motion.

All lap-shoulder belts except the driver's seat belt have special seat belt retractors for secure fastening of child restraints.

To fasten a child restraint, follow child restraint instructions for mounting. Then pull the shoulder belt out completely and let it retract. During seat belt retraction, a ratcheting sound can be heard to indicate that the special seat belt retractor is activated. The belt is now locked. Push down on child restraint to take up any slack.

To deactivate, release seat belt buckle and let seat belt retract completely. The seat belt can again be used in the usual manner.

Warning!

Never release the seat belt buckle while the vehicle is in motion, since the special seat belt retractor will be deactivated.

i For information on LATCH-type child seat anchors (▷ page 85).

! The use of infant or child restraints is required by law in all 50 states, the District of Columbia, the U.S. territories, and all Canadian provinces.

Infants and small children should be seated in an appropriate infant or child restraint system properly secured in accordance with the manufacturer's instructions for the child restraint, that complies with U.S. Federal Motor Vehicle Safety Standards 213 and 225 and Canadian Motor Vehicle Safety Standards 213 and 210.2.

! A statement by the child restraint manufacturer of compliance with these standards can be found on the instruction label on the restraint and in the instruction manual provided with the restraint.

When using any infant, or toddler restraint, or booster seat, be sure to carefully read and follow all manufacturer's instructions for installation and use.

Please read and observe warning labels affixed to the inside of the vehicle and to infant or child restraints.

Warning!

According to accident statistics, children are safer when properly restrained in the rear seating positions than in the front seating position. Thus, we strongly recommend that children be placed in the rear seats whenever possible. Regardless of seating position, children 12 years old and under must be seated and properly secured in an appropriate infant or child restraint recommended for the size and weight of the child.

The infant or child restraint must be properly secured with the vehicle's seat belt or seat belt and lower anchors, fully in accordance with the child seat manufacturer's instructions.

Always sit nearly upright, properly use the seat belts and use an appropriately sized infant or toddler restraint or booster seat recommended for the size and weight of the child.





Children can be killed or seriously injured by an inflating air bag. Note the following important information when circumstances require you to place a child in the front passenger seat:

- Your vehicle is equipped with air bag technology designed to turn off the front passenger front air bag in your vehicle when the OCS senses the weight of a typical 12-month-old child or less along with the weight of a standard appropriate child restraint on the front passenger seat.



Occupant safety



- A child in a rear-facing child restraint on the front passenger seat will be seriously injured or even killed if the front passenger front air bag inflates in a collision which could occur under some circumstances, even with the air bag technology installed in your vehicle. The only means to completely eliminate this risk is to never place a child in a rear-facing child restraint in the front seat. We therefore strongly recommend that you always place a child in a rear-facing child restraint in the back seat.
- If you must install a rear-facing child restraint on the front passenger seat because circumstances require you to do so, make sure that the  indicator lamp is illuminated, indicating that the front passenger front air bag is deactivated. Should the  indicator lamp not illuminate or go out while the restraint is installed, please check installation. Periodically check the  indicator lamp while driving to make sure the  indicator lamp is illuminated. If the  indicator lamp goes out

or remains out, do not transport a child on the front passenger seat until the system has been repaired. A child in a rear-facing child restraint on the front passenger seat will be seriously injured or even killed if the front passenger front air bag inflates.

- If you have to place a child in a forward-facing child restraint on the front passenger seat, move the seat as far back as possible, use the proper child restraint recommended for the age, size and weight of the child, and secure child restraint with the vehicle's seat belt according to the child seat manufacturer's instructions. For children larger than the typical 12-month-old child, the front passenger front air bag may or may not be activated (▷ page 72).

Warning!



Infants and small children should never share a seat belt with another occupant. During an accident, they could be crushed between the occupant and seat belt.

A child's risk of serious or fatal injuries is significantly increased if the child restraints are not properly secured in the vehicle and/or the child is not properly secured in the child restraint.

Children too big for a toddler restraint must ride in seats using regular seat belts. Position shoulder belt across chest and shoulder, not face or neck. A booster seat may be necessary to achieve proper belt positioning for children over 41 lbs until they reach a height where a lap/shoulder belt fits properly without a booster.

When the child restraint is not in use, remove it from the vehicle or secure it with the seat belt to prevent the child restraint from becoming a projectile in the event of an accident.

Do not leave children unattended in the vehicle, even if the children are secured in a child restraint system. Unsupervised children in a child restraint system may use vehicle equipment and may cause an accident and/or serious personal injury.

Child seat anchors – LATCH-type

This vehicle is equipped with two LATCH (Lower Anchors and Tethers for Children) type anchors (at each of the rear seats) for the installation of a LATCH-type child seat with matching mounting fittings.

i Your cabriolet does not have and is not required to have anchorage rings for a child seat's top tether strap in the rear seating positions. Child seats can be used with the seat belt, or lower anchor system and seat belt, fully in accordance with the child seat manufacturer's instructions.

i The child seat must be firmly attached in the right and left side anchor ② (▷ page 85).

Warning!



Children too big for a toddler restraint must ride in seats using regular seat belts. Position shoulder belt across chest and shoulder, not face or neck.

A booster seat may be necessary to achieve proper belt positioning for children over 41 lbs until they reach a height where a lap/shoulder belt fits properly without a booster.

Install child seat according to manufacturer's instructions.

The child seat must be firmly attached to the right and left side anchor.

An incorrectly mounted child seat may come loose during an accident which could result in serious injury or death to the child.

Damaged or impact damaged child seats or child seat anchor fittings must be replaced.

Do not leave children unattended in the vehicle, even if the children are secured in a child restraint system.

i Non-LATCH-type child seats may also be used and can be installed using the vehicle's seat belt system (▷ page 75). Install child seat according to the manufacturer's instructions.

LATCH-type anchors

The LATCH-type anchors are located between the seat cushion and the backrest.

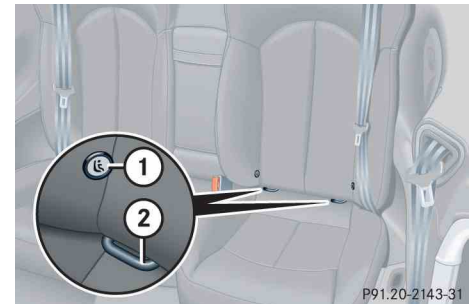

- ① Indicates the position of the anchors
- ② Anchors

▶ Install child seat according to the manufacturer's instructions.

Occupant safety

Blocking of rear side window operation

You can block the rear side window operation (for instance when you have children riding in the rear passenger compartment).

The override switch is located on the door control panel of the driver's door.



- ① Deactivating override switch
- ② Activating override switch
- ③ Override switch

Warning!



Activate the override switch when children are riding in the back seats of the vehicle. The children may otherwise injure themselves, e.g. by becoming trapped in the window opening.

When leaving the vehicle, always remove the SmartKey or SmartKey with KEYLESS-GO* from the starter switch, take it with you, and lock the vehicle. Do not leave children unattended in the vehicle, or with access to an unlocked vehicle. A child's unsupervised access to a vehicle could result in an accident and/or serious personal injury.

Activating override switch

- ▶ Slide override switch ③ to the right in direction ②.

The rear side windows can no longer be operated using the respective switch located in the rear trim panels.

i Operation of the rear side windows with the switches located on the door control panel of the driver's door is still possible.

Deactivating override switch

- ▶ Slide override switch ③ to the left in direction ①.

The rear side windows can be operated using the respective switch located in the rear trim panels.

For more information, see "Power windows" (▷ page 249).

▼ Panic alarm



① **PANIC** button

i USA only:

This device complies with Part 15 of the FCC Rules. Operation is subject to the following two conditions:

- (1) This device may not cause harmful interference, and*
- (2) this device must accept any interference received, including interference that may cause undesired operation.*

Any unauthorized modification to this device could void the user's authority to operate the equipment.

i Canada only:

This device complies with RSS-210 of Industry Canada. Operation is subject to the following two conditions:

- (1) This device may not cause interference, and*
- (2) this device must accept any interference received, including interference that may cause undesired operation of the device.*

Any unauthorized modification to this device could void the user's authority to operate the equipment.

Activating

- ▶ Press and hold button **PANIC** for at least 1 second.

An audible alarm and flashing exterior lamps will operate briefly.

Deactivating

- ▶ Press button **PANIC** again.

or

- ▶ Insert the SmartKey or the SmartKey with KEYLESS-GO* in starter switch.

or

- ▶ Press the KEYLESS-GO* start/stop button (▷ page 37).

The SmartKey with KEYLESS-GO* must be inside the vehicle.

Driving safety systems

In this section you will find information on the following driving safety systems:

- ABS (Antilock Brake System)
- BAS (Brake Assist System)
- ESP® (Electronic Stability Program)

Warning!



The following factors increase the risk of accidents:

- Excessive speed, especially in turns
- Wet and slippery road surfaces
- Following another vehicle too closely

The ABS, BAS, and ESP® cannot reduce this risk.

Always adjust your driving style to the prevailing road and weather conditions.

i *In winter operation, the maximum effectiveness of the ABS, the BAS, and the ESP® is only achieved with winter tires (▷ page 351) or snow chains as required.*

ABS

Warning!



Do not pump the brake pedal. Use firm, steady brake pedal pressure instead. Pumping the brake pedal defeats the purpose of the ABS and significantly reduces braking effectiveness.

The Antilock Brake System (ABS) regulates the brake pressure so that the wheels do not lock during braking. This allows you to maintain the ability to steer your vehicle.

The ABS is functional above a speed of approximately 5 mph (8 km/h) independent of road surface conditions.

On slippery road surfaces, the ABS will respond even to light brake pressure.

The  indicator lamp in the instrument cluster (▷ page 26) comes on when you switch on the ignition. It goes out when the engine is running.

Braking

At the instant one of the wheels is about to lock up, a slight pulsation can be felt in the brake pedal, indicating that the ABS is in the regulating mode.

- ▶ Keep firm and steady pressure on the brake pedal while experiencing the pulsation.

Continuous, steady brake pedal pressure yields the advantages provided by the ABS, namely braking power and the ability to steer the vehicle.

The pulsating brake pedal can be an indication of hazardous road conditions and functions as a reminder to take extra care while driving.

Emergency brake maneuver

- ▶ Keep continuous full pressure on the brake pedal.

Warning!



When the ABS is malfunctioning, the BAS and the ESP[®] are also switched off. The basic driving and braking functions are still available

When the ABS is malfunctioning, the wheels may lock during hard braking, reducing steering capability and extending the braking distance.

Warning!



The ABS cannot prevent the natural laws of physics from acting on the vehicle, nor can it increase braking or steering efficiency beyond that afforded by the condition of the vehicle brakes and tires or the traction available on the road surface. The ABS cannot prevent accidents, including those resulting from excessive speed in turns, following another vehicle too closely, or hydroplaning. Only a safe, attentive, and skillful driver can prevent accidents. The capabilities of an ABS equipped vehicle must never be exploited in a reckless or dangerous manner which could jeopardize the user's safety or the safety of others.

For more information, see "Practical hints" (▷ page 365).

Driving safety systems

BAS

The Brake Assist System (BAS) operates in emergency situations. If you apply the brakes very quickly, the BAS automatically provides full brake boost, thereby potentially reducing the braking distance.

- ▶ Apply continuous full braking pressure until the emergency braking situation is over.

The ABS will prevent the wheels from locking.

When you release the brake pedal, the brakes function again as normal. The BAS is then deactivated.

Warning!



If the BAS is malfunctioning, the brake system is still functioning normally, but without the additional brake boost available that BAS would normally provide in an emergency braking maneuver. Therefore, the braking distance may increase.

Warning!





The BAS cannot prevent the natural laws of physics from acting on the vehicle, nor can it increase braking efficiency beyond that afforded by the condition of the vehicle brakes and tires or the traction. The BAS cannot prevent accidents, including those resulting from excessive speed in turns, following another vehicle too closely, or hydroplaning. Only a safe, attentive, and skillful driver can prevent accidents. The capabilities of a BAS equipped vehicle must never be exploited in a reckless or dangerous manner which could jeopardize the user's safety or the safety of others.

ESP®

The Electronic Stability Program (ESP®) is operational as soon as the engine is running and monitors the vehicle's traction (force of adhesive friction between the tires and the road surface) and handling.

The ESP® recognizes when a wheel is spinning or if the vehicle starts to skid. By applying the brakes to the appropriate wheel and by limiting the engine output, the ESP® works to stabilize the vehicle. The ESP® is especially useful while driving off and on wet or slippery road surfaces. The ESP® also stabilizes the vehicle during braking and steering maneuvers.

The ESP® warning lamp  in the instrument cluster flashes when the ESP® is engaged.

The ESP® warning lamp  in the instrument cluster comes on when you switch on the ignition. It goes out when the engine is running.

Warning!

Never switch off the ESP[®] when you see the ESP[®] warning lamp  flashing in the instrument cluster. In this case, proceed as follows:

- While driving off, apply as little throttle as possible.
- While driving, ease upon the accelerator.
- Adapt your speed and driving style to the prevailing road conditions.

Failure to observe these guidelines could cause the vehicle to skid.

The ESP[®] cannot prevent accidents resulting from excessive speed.

Warning!

The ESP[®] cannot prevent the natural laws of physics from acting on the vehicle, nor can it increase the traction afforded by the existing road and tire conditions. The ESP[®] cannot prevent accidents, including those resulting from excessive speed in turns or hydroplaning. Only a safe, attentive, and skillful driver can prevent accidents. The capabilities of an ESP[®] equipped vehicle must never be exploited in a reckless or dangerous manner which could jeopardize the user's safety or the safety of others.

! Because the ESP[®] operates automatically, the engine must be turned off (SmartKey in starter switch position **0** or **1** or KEYLESS-GO* start/stop button in position **0** or **1**) when

- the parking brake is being tested on a brake test dynamometer
- the vehicle is being towed with the front axle raised

Active braking action through the ESP[®] may otherwise seriously damage the brake system.

i The ESP[®] will only function properly if you use wheels of the recommended tire size (▷ page 466).

For more information, see the "Practical hints" section (▷ page 372) and (▷ page 380).

Driving safety systems

Electronic traction system

The electronic traction system is a component of ESP®.

The electronic traction system improves the vehicle's ability to utilize available traction, especially under slippery road conditions by applying the brakes to a spinning wheel.

Except CLK 63 AMG:

When you switch off the ESP®, the electronic traction system is still enabled.

Warning!



If you are driving too fast, the electronic traction system cannot reduce the risk of an accident.

The electronic traction system cannot prevent the natural laws of physics from acting on the vehicle.

Switching off the ESP®

Switching off the ESP® (except CLK 63 AMG)

Warning!



The ESP® should not be switched off during normal driving other than in the circumstances described below. Disabling of the system will reduce vehicle stability in standard driving maneuvers.

Do not switch off the ESP® when a spare wheel is mounted.

To improve the vehicle's traction, switch off the ESP® in driving situations where it would be advantageous to have the drive wheels spin and thus cut into surfaces for better grip such as:

- when driving with snow chains
- in deep snow
- in sand or gravel

! Switch on the ESP® immediately if the aforementioned circumstances do not apply anymore.

When you switch off the ESP®

- the ESP® does not stabilize the vehicle
- the engine output is not limited, which allows the drive wheels to spin and thus cut into surfaces for better grip
- the traction control will still apply the brakes to a spinning wheel
- the ESP® continues to operate when you are braking
- you cannot activate the cruise control
- the cruise control switches off if currently activated

i When the ESP® is switched off and one or more drive wheels are spinning, the ESP® warning lamp  in the instrument cluster flashes. However, the ESP® will then not stabilize the vehicle.

The ESP® switch is located on the center console.



① ESP® switch

- ▶ With the engine running, press ESP® switch ① until the ESP® warning lamp  in the instrument cluster comes on.

The ESP® is switched off.

Warning!



When the ESP® warning lamp  is illuminated continuously, the ESP® is switched off or is not operational due to a malfunction. Vehicle stability in standard driving maneuvers reduces.

Adapt your speed and driving to the prevailing road conditions and to the non-operating status of the ESP®.

! *Avoid spinning of a drive wheel for an extended period with the ESP® switched off. This may cause serious damage to the drivetrain which is not covered by the Mercedes-Benz Limited Warranty.*

Switching off the ESP® (CLK 63 AMG only)

Warning!



The ESP® should not be switched off during normal driving. Disabling of the system will result in the following:

- no restriction to engine torque
- no differential brake support
- loss of system supported traction control

“ESP® Off” is designed for driving on closed tracks when the vehicle’s natural oversteer and understeer characteristics are desired and requires a highly skilled and experienced driver able to handle these critical driving situations.

You could lose control of your vehicle and cause an accident.

Please be aware of these limits when you switch off the ESP®.

Driving safety systems

When you switch off the ESP®

- the ESP® does not stabilize the vehicle
- the engine output is not limited, which allows the drive wheels to spin and thus cut into surfaces for better grip
- the traction control is not available
- the ESP® operates while you are braking
- you cannot activate the cruise control
- the cruise control switches off if currently activated

i When the ESP® is switched off and one or more drive wheels are spinning, the ESP® warning lamp  in the instrument cluster flashes. However, the ESP® will then not stabilize the vehicle.

The ESP® switch is located on the center console.



① ESP® switch

- ▶ With the engine running, press ESP® switch ① until the ESP® warning lamp  in the instrument cluster comes on.

The ESP® is switched off.

Warning!



When the ESP® warning lamp  is illuminated continuously, the ESP® is switched off or is not operational due to a malfunction. Vehicle stability in standard driving maneuvers reduces.

Adapt your speed and driving to the prevailing road conditions and to the non-operating status of the ESP®.

! Avoid spinning of a drive wheel for an extended period with the ESP® switched off. This may cause serious damage to the drivetrain which is not covered by the Mercedes-Benz Limited Warranty.

Switching on the ESP®

- ▶ Press ESP® switch ① until the ESP® warning lamp  in the instrument cluster goes out.

You are now again in normal driving mode with ESP® switched on.

▼ Anti-theft systems

Immobilizer

The immobilizer prevents unauthorized persons from starting your vehicle.

Activating

With the SmartKey

- ▶ Remove the SmartKey from the starter switch.

*With KEYLESS-GO**

- ▶ Turn off the engine by means of the start/stop button (▷ page 37) on the gear selector lever.
- ▶ Open the driver's door.

Deactivating

With the SmartKey

- ▶ Insert the SmartKey in the starter switch.

*With KEYLESS-GO**

- ▶ Switch on the ignition (▷ page 38).

i *Starting the engine will also deactivate the immobilizer.*

In case the engine cannot be started (yet the vehicle's battery is charged), the system is not operational. Contact an authorized Mercedes-Benz Center or call 1-800-FOR-MERCEdes (in the USA), or 1-800-387-0100 (in Canada).

Anti-theft alarm system

Once the alarm system has been armed, a visual and audible alarm is triggered when someone opens

- a door
- the trunk
- the hood.

The alarm will stay on even if the activating element (e.g. a door) is immediately closed.

The alarm system will also be triggered when

- the vehicle is opened with the mechanical key.
- someone opens a door from the inside.
- someone opens the trunk with the emergency release button.

i *If the alarm stays on for more than 30 seconds, a call to the Response Center is initiated automatically by the Tele Aid system (▷ page 287) provided Tele Aid service was subscribed to and properly activated, and that necessary cellular service and GPS coverage are available.*

Anti-theft systems

Arming the alarm system

The indicator lamp is in the center console.



① Indicator lamp

- ▶ Lock the vehicle with the SmartKey or KEYLESS-GO*.

The turn signal lamps flash three times, and an acoustic signal sounds three times, to indicate that the alarm system is armed.

Indicator lamp ① begins to flash after approximately 30 seconds after arming the alarm system.

i If the turn signal lamps do not flash three times, and the acoustic signal do not sounds three times (if equipped and feature activated), one of the following elements may not be properly closed:

- a door
- the trunk

Close the respective element and lock the vehicle again.

Disarming the alarm system



- ▶ Unlock the vehicle with the SmartKey or KEYLESS-GO*.

The turn signal lamps flash once, and an acoustic signal sounds once, to indicate that the alarm system is disarmed.

i The alarm system will rearm automatically after approximately 40 seconds if neither a door nor the trunk lid was opened.

Canceling the alarm

With the SmartKey

- ▶ Press the  or  button on the SmartKey.

or

- ▶ Insert the SmartKey in the starter switch.

With KEYLESS-GO*

- ▶ Pull an outside door handle.

The SmartKey with KEYLESS-GO must be within 3 ft (1 m) of the vehicle.

or

- ▶ Press the KEYLESS-GO start/stop button (▷ page 38).

The SmartKey with KEYLESS-GO must be inside the vehicle.

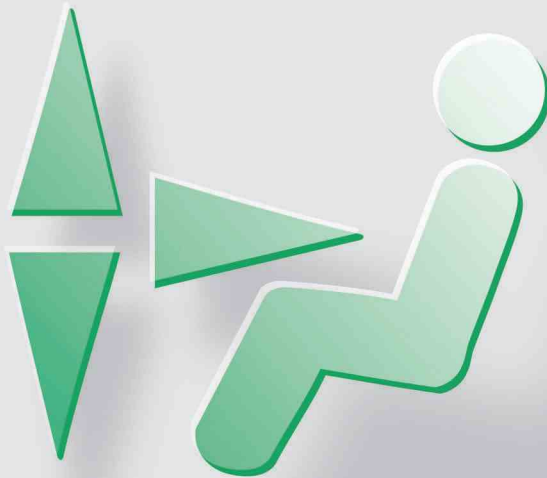

Locking and unlocking

Seats

Memory function

Lighting

Instrument cluster

Control system

Automatic transmission

Good visibility

Climate control

Automatic climate control

Audio system

Power windows

Soft top

Driving systems

Loading

Useful features

Locking and unlocking

In the “Controls in detail” section you will find detailed information on how to operate the equipment installed in your vehicle. If you are already familiar with the basic functions of your vehicle, this section will be of particular interest to you.

To quickly familiarize yourself with the basic functions of the vehicle, refer to the “Getting started” section of this manual. The corresponding page numbers are given at the beginning of each segment.

For more information on locking and unlocking, see “Getting started” (▷ page 34) and (▷ page 58).

SmartKey

Your vehicle comes supplied with two SmartKeys, each with remote control and a removable mechanical key.

The locking tabs for the mechanical key portion of the two SmartKeys are a different color to help distinguish each SmartKey unit.

The SmartKey provides an extended operating range. To prevent theft, however, it is advisable to only unlock the vehicle when you are in close proximity to it.

The SmartKey centrally locks and unlocks:

- the doors
- the glove box
- the trunk
- the fuel filler flap



P80.35-2282-31

SmartKey with remote control

- ① Lock button
- ② Opening button for trunk (▷ page 107)
- ③ Mechanical key locking tab
- ④ Unlock button
- ⑤ Battery check lamp
- ⑥ PANIC Panic button (▷ page 87)

! To prevent possible malfunction, avoid exposing the SmartKey to high levels of electromagnetic radiation.

Warning!

When leaving the vehicle, always remove the SmartKey from the starter switch, take it with you, and lock the vehicle. Do not leave children unattended in the vehicle, or with access to an unlocked vehicle. It is possible for children to open a locked door from the inside, which could result in an accident and/or serious personal injury.

i When you open a door, the side window on that side lowers slightly. Once you close the door, the window moves up again.

! The side windows will not open or close if the battery is discharged or the windows are covered with ice. As a result, you may no longer be able to properly close the door. Do not attempt to force the door shut. Doing so may damage the door or the side window. Correct the condition that prevents the windows from operating before attempting to close the door.

i USA only:
This device complies with Part 15 of the FCC Rules. Operation is subject to the following two conditions:

- (1) This device may not cause harmful interference, and
- (2) this device must accept any interference received, including interference that may cause undesired operation.

Any unauthorized modification to this device could void the user's authority to operate the equipment.

i Canada only:
This device complies with RSS-210 of Industry Canada. Operation is subject to the following two conditions:

- (1) This device may not cause interference, and
- (2) this device must accept any interference received, including interference that may cause undesired operation of the device.

Any unauthorized modification to this device could void the user's authority to operate the equipment.

i You can also open and close the windows (▷ page 252) and the soft top (▷ page 259) using the SmartKey.

! If you can no longer lock or unlock the vehicle with the SmartKey, then the batteries in the SmartKey are discharged, the SmartKey is malfunctioning or the vehicle battery is drained.

- Check the batteries in the SmartKey (▷ page 107) and replace them if necessary (▷ page 425).
- Use the mechanical key to unlock the driver's door (▷ page 410) and the trunk (▷ page 411).
- Use the mechanical key to lock the driver's door (▷ page 411) and the trunk (▷ page 117).
- Have the vehicle battery and the battery connections checked (▷ page 447).

If the SmartKey is malfunctioning, contact Roadside Assistance or an authorized Mercedes-Benz Center.

Locking and unlocking

Factory setting

i When unlocking or locking the vehicle with the SmartKey an acoustic signal sounds. The acoustic signal is activated at the factory. If you wish to deactivate the feature, or adjust its signal volume, contact an authorized Mercedes-Benz Center.

Global unlocking

- ▶ Press button .
- All turn signal lamps flash once.
- An acoustic signal sounds once.
- The locking knobs in the doors move up.
- The anti-theft alarm system is disarmed.

The vehicle will lock again automatically and rearm the anti-theft alarm system within approximately 40 seconds of unlocking if:

- neither door nor trunk is opened
- the SmartKey is not inserted in the starter switch

- the central locking switch is not activated

Global locking



- ▶ Press button .

With the trunk and both doors closed:

- All turn signal lamps flash three times.
- An acoustic signal sounds three times.
- The locking knobs in the doors move down.
- The anti-theft alarm system is armed.

Selective setting

If you frequently travel alone, you may wish to reprogram the SmartKey so that pressing button  only unlocks the driver's door and the fuel filler flap.

- ▶ Press and hold buttons  and  simultaneously for about 5 seconds until battery check lamp  (▷ page 98) flashes twice.

The SmartKey will then function as follows:

Unlocking driver's door and fuel filler flap

- ▶ Press button  once.
- All turn signal lamps flash once.
- An acoustic signal sounds once.
- The locking knob in the driver's door moves up.
- The anti-theft alarm system is disarmed.

Global unlocking

- ▶ Press button  twice.
- All turn signal lamps flash once.
- An acoustic signal sounds once.

- The locking knobs in the doors move up.
- The anti-theft alarm system is disarmed.



Global locking

- ▶ Press button .

With the trunk and both doors closed:

- All turn signal lamps flash three times.
- An acoustic signal sounds three times.
- The locking knobs in the doors move down.
- The anti-theft alarm system is armed.

Restoring to factory setting

- ▶ Press and hold buttons  and  simultaneously for about 5 seconds until battery check lamp  (▷ page 98) flashes twice.

Unlocking and opening the trunk

You can unlock and open the trunk separately.

A minimum height clearance of 5.41 ft (1.65 m) is required to open the trunk lid.

- ▶ Press and hold button  until trunk unlocks and begins to open.

 *The trunk lid swings open upwards automatically. Always make sure there is sufficient overhead clearance.*

Vehicles with trunk opening/closing system: To stop the opening procedure, press button . The trunk lid stops moving.*

 *If the trunk does not open, it is still locked separately (▷ page 117).*

The trunk can also be opened from its inside in an emergency, see “Trunk emergency release” (▷ page 116).

SmartKey with KEYLESS-GO*

Vehicles equipped with KEYLESS-GO come with two SmartKeys with KEYLESS-GO, each with remote control and a removable mechanical key.

The locking tabs for the mechanical key portion of the two SmartKeys with KEYLESS-GO are a different color to help distinguish each SmartKey with KEYLESS-GO unit.

The KEYLESS-GO function is integrated into the SmartKey. On these vehicles, the validity of the SmartKey with KEYLESS-GO is checked every time you pull an outside door handle.

If the SmartKey with KEYLESS-GO is valid, your vehicle unlocks

- the doors
- the glove box
- the trunk
- the fuel filler flap

Locking and unlocking

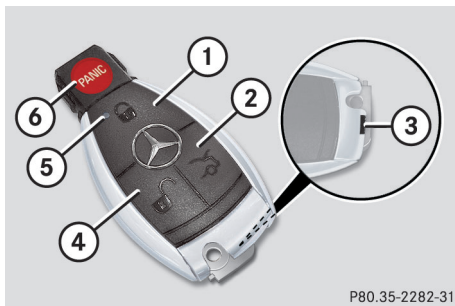

SmartKey with KEYLESS-GO

- ① Lock button
- ② Opening button for trunk
(▷ page 107)
- ③ Mechanical key locking tab
- ④ Unlock button
- ⑤ Battery check lamp
- ⑥ PANIC Panic button (▷ page 87)

! To prevent possible malfunction, avoid exposing the SmartKey with KEYLESS-GO to high levels of electromagnetic radiation.

i When the passenger outside door handle is pulled, the vehicle is centrally unlocked.

Warning!



When leaving the vehicle, always take the SmartKey with KEYLESS-GO* with you, and lock the vehicle. Do not leave children unattended in the vehicle, or with access to an unlocked vehicle. A child's unsupervised access to a vehicle could result in an accident and/or serious personal injury.

i When you open a door, the side window on that side lowers slightly. Once you close the door, the window moves up again.

! The side windows will not open or close if the battery is discharged or the windows are covered with ice. As a result, you may no longer be able to properly close the door. Do not attempt to force the door shut. Doing so may damage the door or the side window. Correct the condition that prevents the windows from operating before attempting to close the door.

i USA only:

This device complies with Part 15 of the FCC Rules. Operation is subject to the following two conditions:

- (1) This device may not cause harmful interference, and
- (2) this device must accept any interference received, including interference that may cause undesired operation.

Any unauthorized modification to this device could void the user's authority to operate the equipment.

i Canada only:

This device complies with RSS-210 of Industry Canada. Operation is subject to the following two conditions:

- (1) This device may not cause interference, and
- (2) this device must accept any interference received, including interference that may cause undesired operation of the device.

Any unauthorized modification to this device could void the user's authority to operate the equipment.

i You can also open and close the windows (▷ page 252) and the soft top (▷ page 259) using the SmartKey with KEYLESS-GO*.

! If you can no longer lock or unlock the vehicle with the SmartKey with KEYLESS-GO, then the batteries in the SmartKey with KEYLESS-GO are discharged, the SmartKey with KEYLESS-GO is malfunctioning or the vehicle battery is drained.

- Check the batteries in the SmartKey with KEYLESS-GO (▷ page 107) and replace them if necessary (▷ page 425).
- Use the mechanical key to unlock the driver's door (▷ page 410) and the trunk (▷ page 411).
- Use the mechanical key to lock the driver's door (▷ page 411) and the trunk (▷ page 117).
- Have the vehicle battery and the battery connections checked (▷ page 447).

If the SmartKey with KEYLESS-GO is malfunctioning, contact an authorized Mercedes-Benz Center.

Important notes on using KEYLESS-GO*

- You can also use the SmartKey with KEYLESS-GO like a normal SmartKey (▷ page 98).
- You can combine KEYLESS-GO functions with normal SmartKey functions (e.g. unlocking with KEYLESS-GO and locking with the  button).
- Always carry the SmartKey with KEYLESS-GO with you.
- Never store the SmartKey with KEYLESS-GO together with:
 - Electronic items such as a cellular phone or another SmartKey with KEYLESS-GO.
 - Metallic objects such as coins or metal foil.

Doing so could impair the function of the KEYLESS-GO system.

- To lock or unlock the vehicle, the SmartKey with KEYLESS-GO must be located outside the vehicle within approximately 3 ft (1 m) of the door to be opened or the trunk lid.
- In order to start the engine with the SmartKey with KEYLESS-GO:
 - The SmartKey with KEYLESS-GO must be located in the vehicle.
 - All doors must be closed.
 - The brake pedal must be firmly depressed. Do not depress the accelerator.
- If the SmartKey with KEYLESS-GO is positioned farther away from the vehicle, the system may no longer recognize the SmartKey with KEYLESS-GO. The vehicle then cannot be locked or the engine started via the KEYLESS-GO system.
- If the SmartKey with KEYLESS-GO is removed from the vehicle (e.g. if passenger exits the vehicle with the SmartKey with KEYLESS-GO)

Locking and unlocking

- with the starter switch position 1, the message:
Key not detected
appears in the multifunction display
- with the engine running, the message:
Key not detected
appears in the multifunction display while driving off.

Find the SmartKey with KEYLESS-GO or change its present location immediately (e.g. place it on the front passenger seat or insert it in shirt pocket).

- If you have started the engine with the KEYLESS-GO start/stop button (▷ page 37), you can turn it off again with:
 - the KEYLESS-GO start/stop button
 - the SmartKey inserted in the starter switch, when the gear selector lever is in position **P**

- Remember that the engine can be started by anyone with a SmartKey with KEYLESS-GO that is left inside the vehicle.

Possibility 1:

(One SmartKey with KEYLESS-GO in the vehicle, one SmartKey with KEYLESS-GO outside the vehicle):
If you leave the SmartKey with KEYLESS-GO behind when exiting and locking the vehicle, no message appears in the multifunction display.

Possibility 2:

(One SmartKey with KEYLESS-GO in the vehicle, no SmartKey with KEYLESS-GO outside the vehicle):
When exiting and trying to lock the vehicle, the message
Key detected in vehicle
will appear in the multifunction display.
The vehicle will not be locked.

Factory setting

i When unlocking or locking the vehicle with the SmartKey with KEYLESS-GO an acoustic signal sounds. The acoustic signal is activated at the factory. If you wish to deactivate the feature, or adjust its signal volume, contact an authorized Mercedes-Benz Center.

Global unlocking

- ▶ Pull an outside door handle (SmartKey with KEYLESS-GO must be near this door).
 - All turn signal lamps flash once.
 - An acoustic signal sounds once.
 - The locking knobs in the doors move up.
 - The anti-theft alarm system is disarmed.

i If the vehicle has been parked for a longer period of time, you must pull an outside door handle in order to activate the KEYLESS-GO function.

The vehicle will lock again automatically and rearm the anti-theft alarm system within approximately 40 seconds of unlocking if:

- neither door nor trunk is opened.
- the central locking switch is not activated.

i *The vehicle could inadvertently be unlocked if the SmartKey with KEYLESS-GO is within 3 ft (1 m) of the vehicle and:*

- *an outside door handle is splashed with water, or*
- *you attempt to clean an outside door handle.*

Global locking

- ▶ Press the lock button on an outside door handle (▷ page 62) or the trunk lid (▷ page 106).



With the trunk and both doors closed:

- All turn signal lamps flash three times.
- An acoustic signal sounds three times.

- The locking knobs in the doors move down.
- The anti-theft alarm system is armed.

Selective setting

If you frequently travel alone, you may wish to reprogram the SmartKey with KEYLESS-GO so when you, pull the driver's door handle only the driver's door and the fuel filler flap unlocks.

- ▶ Press and hold buttons  and  simultaneously for about 5 seconds until battery check lamp ⑤ (▷ page 102) flashes twice.

The SmartKey with KEYLESS-GO will then function as follows:

Unlocking driver's door and fuel filler flap

- ▶ Pull the driver's outside door handle.
 - All turn signal lamps flash once.
 - An acoustic signal sounds once.
 - The locking knob in the driver's door move up.
 - The anti-theft alarm system is disarmed.

Global unlocking

- ▶ Pull the outside door handle on the passenger side.
 - All turn signal lamps flash once.
 - An acoustic signal sounds once.
 - The locking knobs in the doors move up.
 - The anti-theft alarm system is disarmed.

Locking and unlocking

Global locking



- ▶ Press the lock button on an outside door handle.

With the trunk and both doors closed:

- All turn signal lamps flash three times.
- An acoustic signal sounds three times.
- The locking knobs in the doors move down.
- The anti-theft alarm system is armed.

i You can also lock the vehicle using the KEYLESS-GO lock button on the trunk lid (▷ page 106) or, vehicles with trunk opening/closing system*, KEYLESS-GO locking/closing switch (▷ page 114).

Restoring to factory setting

- ▶ Press and hold buttons  and  simultaneously for about 5 seconds until Battery check lamp  (▷ page 102) flashes twice.

Global locking using the KEYLESS-GO lock button on the trunk lid

Depending on vehicle production date your vehicle may be equipped with the KEYLESS-GO lock button on trunk lid.

i To prevent a possible inadvertent lockout, the trunk will open automatically if a SmartKey with KEYLESS-GO* is recognized inside the vehicle or in the trunk.

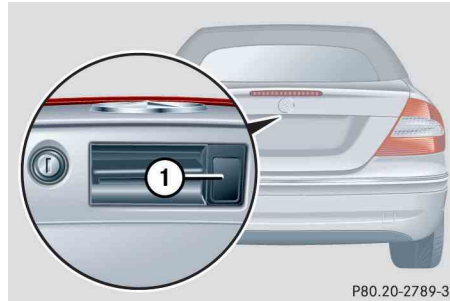

 Lock button

- ▶ Press lock button  on the trunk lid.

With the trunk and all doors closed, all turn signal lamps flash three times. The locking knobs in the doors move down. The anti-theft alarm system is armed.

i You can also lock the vehicle using the lock button on an outside door handle (▷ page 62) or, vehicles with trunk opening/closing system*, KEYLESS-GO locking/closing switch (▷ page 114).

Unlocking and opening the trunk

You can unlock and open the trunk separately.

A minimum height clearance of 5.41 ft (1.65 m) is required to open the trunk lid.

- ▶ Press and hold button  until trunk unlocks and begins to open.

! *The trunk lid swings open upwards automatically. Always make sure there is sufficient overhead clearance.*

Vehicles with trunk opening/closing system: To stop the opening procedure, press button . The trunk lid stops moving.*

i *If the trunk does not open, it is still locked separately (▷ page 117).*

The trunk can also be opened from its inside in an emergency, see “Trunk emergency release” (▷ page 116).

Checking the batteries in the SmartKey or SmartKey with KEYLESS-GO*



- ▶ Press button  or .

The battery check lamp (▷ page 98) or (▷ page 102) comes on briefly to indicate that the SmartKey or SmartKey with KEYLESS-GO batteries are in order.

! *If the battery check lamp does not come on briefly during check, the SmartKey or SmartKey with KEYLESS-GO batteries are discharged.*

Replace the batteries (▷ page 425).

You can obtain the required batteries at any authorized Mercedes-Benz Center.

i *If the batteries are checked within signal range of the vehicle, pressing the  or  button will lock or unlock the vehicle accordingly.*

Loss of the SmartKey or SmartKey with KEYLESS-GO*

If you lose your SmartKey, SmartKey with KEYLESS-GO, or mechanical key, you should do the following:

- ▶ Have the SmartKey or SmartKey with KEYLESS-GO deactivated by an authorized Mercedes-Benz Center.
- ▶ Report the loss of the SmartKey, SmartKey with KEYLESS-GO, or the mechanical key immediately to your car insurance company.
- ▶ Have the mechanical lock replaced if necessary.

Your authorized Mercedes-Benz Center will be glad to supply you with a replacement.

Locking and unlocking

Opening the doors from the inside

You can open a locked door from the inside. Open doors only when conditions are safe to do so.

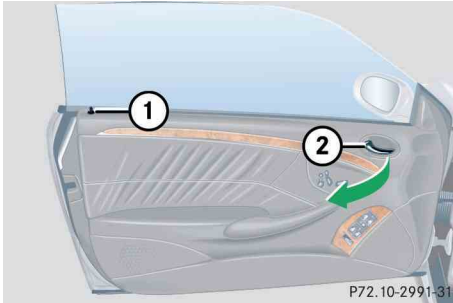



- ① Locking knob
- ② Inside door handle

i If the vehicle has previously been locked with the SmartKey or KEYLESS-GO*, opening a door from the inside will trigger the anti-theft alarm system.

To cancel the alarm, do one of the following:

With the SmartKey

- Insert the SmartKey in the starter switch.
- Press button  or  on the SmartKey.

With KEYLESS-GO*:

- Press the KEYLESS-GO* start/stop button (▷ page 37).

The SmartKey with KEYLESS-GO* must be inside the vehicle.

- Pull an outside door handle.

The SmartKey with KEYLESS-GO* must be within 3 ft (1 m) of the vehicle.

- ▶ Pull on door handle ②.

If door was locked, locking knob ① will move up.

i If you hear a warning signal you have forgotten to switch off the headlamps before opening the driver's door.

In addition the message Turn off lamps appears in the multifunction display. Vehicles with KEYLESS-GO*, this message is only displayed for approximately 1 second. It is then overwritten by the message, Please do not forget key.

Switch off the headlamps.

i If you open a door, the side windows on that side of the vehicle will lower slightly. The windows close again when you close the door.

Opening the trunk

Warning!



Only drive with the trunk closed as, among other dangers such as blocked visibility, exhaust fumes may enter the vehicle interior.

You can open the trunk if the vehicle is stationary.

A minimum height clearance of 5.41 ft (1.65 m) is required to open the trunk lid.

! *The trunk lid swings open upwards automatically. Always make sure there is sufficient overhead clearance.*

Opening the trunk from outside

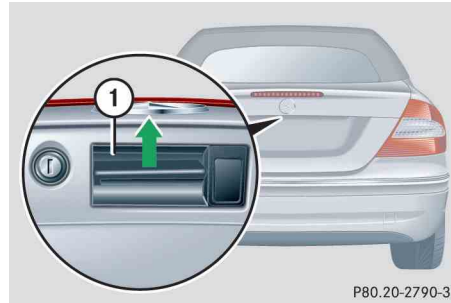

① Handle

- ▶ Press and hold button  on the SmartKey or SmartKey with KEYLESS-GO* until trunk unlocks and begins to open.

or

- ▶ Pull on handle ①.

In vehicles without KEYLESS-GO*:
The vehicle must be unlocked.

i *If the trunk does not open, it is still locked separately (▷ page 117).*

! *Vehicles with trunk opening/closing system*: To stop the opening procedure, press button  on the SmartKey or SmartKey with KEYLESS-GO*.*

i *The trunk can also be opened from its inside in an emergency, see “Trunk emergency release” (▷ page 116).*

Opening the trunk from the inside



Vehicles without trunk opening/closing system*

- ① Remote trunk opening switch

Locking and unlocking



Vehicles with trunk opening/closing system*

- ① Remote trunk opening switch*
 - ② Remote trunk closing switch*
- ▶ Press remote trunk opening switch ① until the trunk begins to open.
- The trunk opens. The indicator lamp comes on and remains lit until the trunk is closed.

i If the trunk does not open, it is still locked separately (▷ page 117).

! Vehicles with trunk opening/closing system*: To stop the opening procedure, press switch ① or ②.

i The trunk can also be opened using button  on the SmartKey or SmartKey with KEYLESS-GO* or from its inside in an emergency, see “Trunk emergency release” (▷ page 116).

Closing the trunk

Closing the trunk from the inside automatically*

In vehicles with trunk opening/closing system* you can close the trunk from the inside using the remote trunk closing* switch.

- ▶ Press the remote trunk closing* switch ② (▷ page 110) until the indicator lamp in the switch goes out and the trunk lid is closed.

To interrupt the closing procedure:

- ▶ Release remote trunk closing* switch ②.

i You can also close the trunk by hand (▷ page 111).

Warning!

Maintain sight of trunk area while operating the door mounted remote trunk closing* switch. Monitor the closing procedure carefully to ensure that no one is in danger of being injured.

To interrupt the closing procedure, release the door mounted remote trunk closing switch.

Even with the SmartKey or the SmartKey with KEYLESS-GO* removed from the starter switch or the SmartKey with KEYLESS-GO* removed from the vehicle, the remote trunk opening/closing* switch can be operated. Therefore, do not leave children unattended in the vehicle, or with access to an unlocked vehicle. Unsupervised use of vehicle equipment may cause an accident and/or serious personal injury.

Warning!

Only drive with the trunk closed as, among other dangers such as blocked visibility, exhaust fumes may enter the vehicle interior.

If the trunk lid comes into contact with an object while closing (e.g. luggage that has been piled too high), in the sequence, the upper motion the closing procedure is stopped and the trunk reopens slightly.

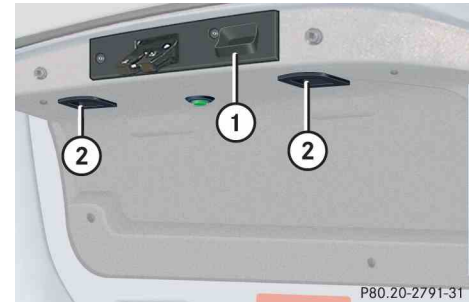
Closing the trunk from the outside manually

- ① Handle
- ② Handles

- ▶ Lower trunk lid by pulling firmly on handle ① or handles ②.
- ▶ Close trunk from the outside with hands placed flat on the trunk lid.

Locking and unlocking

Warning!



To prevent possible personal injury, always keep hands and fingers away from the trunk lid opening when closing the trunk. Be especially careful when small children are around.

When leaving the vehicle, always remove the SmartKey or SmartKey with KEYLESS-GO* from the starter switch, take it with you, and lock the vehicle. Do not leave children unattended in the vehicle, or with access to an unlocked vehicle. It is possible for children to open a locked door from the inside, which could result in an accident and/or serious personal injury.

Warning!



Only drive with the trunk closed as, among other dangers such as blocked visibility, exhaust fumes may enter the vehicle interior.

i Do not place the SmartKey in the open trunk. You may lock yourself out.

Vehicles with KEYLESS-GO:
To prevent a possible inadvertent lockout, the trunk lid will open automatically if a SmartKey with KEYLESS-GO* is recognized inside the vehicle or in the trunk.*

i If the vehicle was previously centrally locked, the trunk will lock automatically after closing it (▷ page 110). All turn signal lamps flash three times, and an acoustic signal sounds three times, to confirm locking.

Closing the trunk from outside (vehicles without KEYLESS-GO*)

In vehicle with trunk opening/closing system* you can close the trunk separately

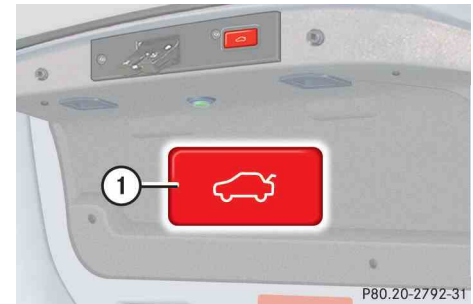

① Trunk closing switch

▶ Press trunk closing switch ① briefly.
The trunk closes.

i You can also close the trunk by hand (▷ page 111).

If the trunk lid comes into contact with an object while closing (e.g. luggage that has been piled too high), the closing procedure is stopped and the trunk reopens slightly.

Warning!



Monitor the closing procedure carefully to ensure that no one is in danger of being injured. To prevent possible personal injury, always keep hands and fingers away from the trunk opening when closing the trunk. Be especially careful when small children are around. To stop the closing procedure, do one of the following:

- press trunk closing switch ①
- press the  button on the SmartKey
- press the remote trunk opening or closing switch (on driver's door)

Even with the SmartKey removed from the starter switch, the trunk closing switch can be operated. Therefore, do not leave children unattended in the vehicle, or with access to an unlocked vehicle.

Unsupervised use of vehicle equipment may cause an accident and/or serious personal injury.

Warning!



Only drive with the trunk closed as, among other dangers such as blocked visibility, exhaust fumes may enter the vehicle interior.

i Do not place the SmartKey in the open trunk. You may lock yourself out.

i If the vehicle was previously centrally locked, the trunk will lock automatically after closing it (▷ page 110). All turn signal lamps flash three times, and an acoustic signal sounds three times, to confirm locking.

Closing the trunk from the outside (vehicles with KEYLESS-GO*)

In vehicles with trunk opening/closing system* you can close the trunk separately.

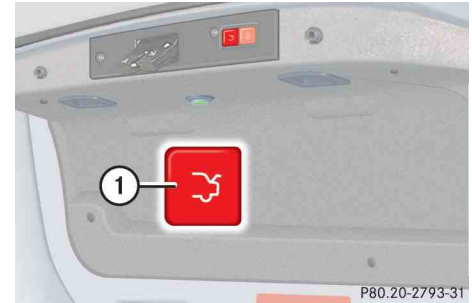

① Trunk closing switch

- ▶ Make sure you have the SmartKey with KEYLESS-GO with you.
- ▶ Press trunk closing switch ① briefly. The trunk closes.

i You can also close the trunk by hand (▷ page 111).

If the trunk lid comes into contact with an object while closing (e.g. luggage that has been piled too high), the closing procedure is stopped and the trunk reopens slightly.

Locking and unlocking

i To prevent a possible inadvertent lockout, the trunk will open automatically if a SmartKey with KEYLESS-GO* is recognized inside the vehicle or in the trunk.

Warning!



Monitor the closing procedure carefully to ensure that no one is in danger of being injured. To prevent possible personal injury, always keep hands and fingers away from the trunk opening when closing the trunk. Be especially careful when small children are around. To stop the closing procedure, do one of the following:

- press trunk closing switch ①
- press KEYLESS-GO locking/closing switch
- press the remote trunk opening or closing switch (on driver's door)
- press the  button on the SmartKey with KEYLESS-GO

Even with the SmartKey with KEYLESS-GO removed from the vehicle, the trunk closing switch can be operated. Therefore, do not leave children unattended in the vehicle, or with access to an unlocked vehicle. Unsupervised use of vehicle equipment may cause an accident and/or serious personal injury.

Warning!



Only drive with the trunk closed as, among other dangers such as blocked visibility, exhaust fumes may enter the vehicle interior.

i If the vehicle was previously centrally locked, the trunk will lock automatically after closing it (▷ page 110). All turn signal lamps flash three times, and an acoustic signal sounds three times, to confirm locking.

Closing the trunk and locking the vehicle from the outside (vehicles with KEYLESS-GO*)

In vehicles with trunk opening/closing system* and KEYLESS-GO, you can close the trunk lid and lock the vehicle simultaneously.

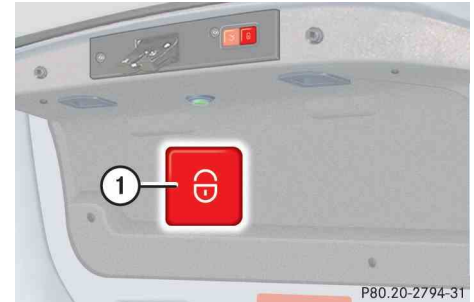

- ① KEYLESS-GO locking/closing switch
- ▶ Make sure you have the SmartKey with KEYLESS-GO with you.
- ▶ Press switch ① briefly.

With all doors closed, the locking knobs in the doors move down and the trunk starts to close automatically. All turn signal lamps flash three times to confirm locking once the trunk has closed completely. The anti-theft alarm system is armed.

 You can also close the trunk by hand (▷ page 111).

If the trunk lid comes into contact with an object while closing (e.g. luggage that has been piled too high), the closing procedure is stopped and the trunk reopens slightly.

 To prevent a possible inadvertent lockout, the trunk will open automatically if a SmartKey with KEYLESS-GO is recognized inside the vehicle or in the trunk.

Warning!



Monitor the closing procedure carefully to ensure that no one is in danger of being injured. To prevent possible personal injury, always keep hands and fingers away from the trunk opening when closing the trunk. Be especially careful when small children are around. To stop the closing procedure, do one of the following:

- press KEYLESS-GO locking/closing switch ①
- press trunk closing switch
- press the  button on the SmartKey with KEYLESS-GO
- press the remote trunk opening or closing switch (on driver's door)

Even with the SmartKey with KEYLESS-GO removed from the vehicle, the trunk closing switch can be operated. Therefore, do not leave children unattended in the vehicle, or with access to an unlocked vehicle. Unsupervised use of vehicle equipment may cause an accident and/or serious personal injury.

Warning!



Only drive with the trunk closed as, among other dangers such as blocked visibility, exhaust fumes may enter the vehicle interior.

Locking and unlocking

Trunk emergency release

With the emergency release button, the trunk can be opened from inside the trunk.

The emergency release button is located on the inside of the trunk lid.



① Emergency release button

- ▶ Briefly press emergency release button ①.

The trunk unlocks and opens slightly.

- ▶ Push up the trunk lid to fully open.

i The emergency release button unlocks and opens the trunk while the vehicle is standing still or in motion.

Illumination of the emergency release button:



- The button will flash for 30 minutes after opening the trunk.
- The button will flash for 60 minutes after closing the trunk.

i The emergency release button does not open the trunk if the vehicle battery is discharged or disconnected.

i If the trunk does not open, it is still locked separately (▷ page 117).

i If the vehicle has previously been locked using the SmartKey or KEYLESS-GO*, opening the trunk from the inside using the emergency release button will trigger the anti-theft alarm system.

To cancel the alarm, do one of the following:

- Insert the SmartKey in the starter switch.
- Press button  or  on the SmartKey.

In vehicles with KEYLESS-GO*:

- Pull an outside door handle.

The SmartKey with KEYLESS-GO* must be within 3 ft (1 m) of the vehicle.

- Press the KEYLESS-GO* start/stop button (▷ page 37).

The SmartKey with KEYLESS-GO* must be inside the vehicle.

Valet locking

i To deny any unauthorized person access to the trunk, e.g. when you valet park the vehicle, lock it separately with the mechanical key. Leave only the SmartKey or SmartKey with KEYLESS-GO* less its mechanical key with the vehicle.

The lock is located next to the handle above the rear license plate recess.

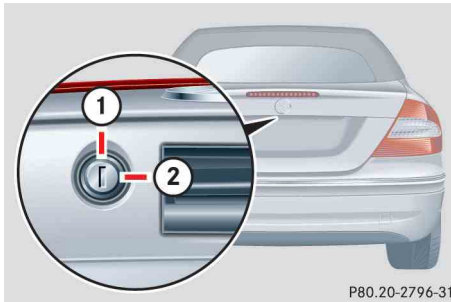

P80.20-2796-31

- ① Neutral position
- ② Locked

- ▶ Close the trunk (▷ page 110).
- ▶ Pull the mechanical key out of the SmartKey (▷ page 410).

- ▶ Insert the mechanical key in the trunk lid lock.
- ▶ Turn the mechanical key clockwise to position ② and remove the mechanical key in that position to lock the trunk.

The trunk remains locked even when the vehicle is centrally unlocked.

i You can only cancel the separate trunk locking mode by means of the mechanical key.

- ▶ Insert the mechanical key in the trunk lid lock.
- ▶ Turn the mechanical key counterclockwise to neutral position ① and remove the mechanical key in that position to unlock the trunk.

You can now open the trunk (▷ page 109).

Automatic central locking

The doors and the trunk automatically lock when the ignition is switched on and the wheels are turning at vehicle speeds of approximately 9 mph (15 km/h) or more.

You can open a locked door from the inside. Open door only when conditions are safe to do so.

i The doors unlock automatically after an accident if the force of the impact exceeds a preset threshold.

To prevent the vehicle door locks from locking, deactivate the automatic central locking when the vehicle

- is pushed or towed
- is on a test stand

You can deactivate the automatic locking mode using the control system, see “Setting automatic locking” (▷ page 164).

Locking and unlocking

Locking and unlocking from the inside

You can lock or unlock the doors and the trunk from inside using the central locking or unlocking switch. This can be useful, for example, if you want to lock the vehicle before starting to drive.

You cannot lock or unlock the fuel filler flap with the central locking or unlocking switch.

Warning!



When leaving the vehicle, always remove the SmartKey or SmartKey with KEYLESS-GO* from the starter switch, take it with you, and lock the vehicle. Do not leave children unattended in the vehicle, or with access to an unlocked vehicle. A child's unsupervised access to a vehicle could result in an accident and/or serious personal injury.

The switches are located in the center console.

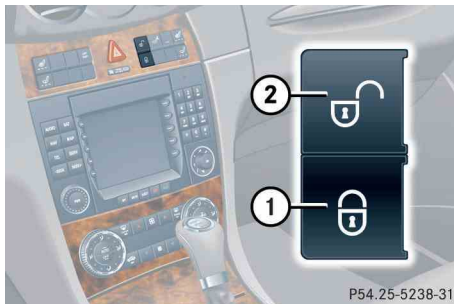

- ① Central locking switch
- ② Central unlocking switch

i You can open a locked door from the inside. Open door only when conditions are safe to do so.

If the vehicle was previously centrally locked with the SmartKey or the SmartKey with KEYLESS-GO*, it will not unlock using the central unlocking switch ②.

If the vehicle was previously locked with the central locking switch ①

- while in the selective remote control mode, only the door opened from inside is unlocked.
- while in the global remote control mode, the complete vehicle is unlocked when a door is opened from the inside.

Locking

- ▶ Press central locking switch ①.

If both doors are closed, the vehicle locks.

Unlocking

- ▶ Press central unlocking switch ②.

The vehicle unlocks.

▼ Seats

For information on seat adjustment, see “Adjusting” (▷ page 39).

Front seat active head restraints

Warning!



For your protection, drive only with properly positioned head restraints.

Adjust the head restraint so that it is as close to the head as possible and the center of the head restraint supports the back of the head at eye level. This will reduce the potential for injury to the head and neck in the event of an accident or similar situation.

You cannot remove the active head restraints on the driver’s and front passenger’s seat.

For removal of the active head restraints we recommend that you contact an authorized Mercedes-Benz Center.

For information on head restraint adjustment, see “Seats” (▷ page 39).

For information on active head restraints, see “Active head restraints” (▷ page 80).

Rear seat head restraints

Warning!



For safety reasons, always drive with the rear head restraints in the raised position when the rear seats are occupied.

Keep the area around head restraints clear of articles (e.g. clothing) to not obstruct the lowering/raising operation of the head restraints.

Raising rear head restraints

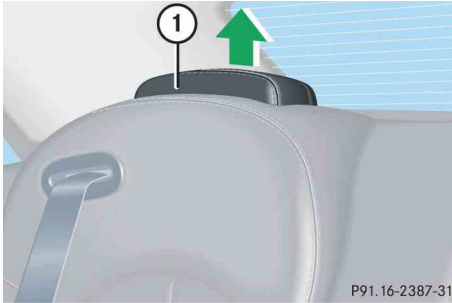

- ① Rear seat head restraint
- ▶ Pull head restraint ① to its highest position.

Lowering rear head restraints with switch in the center console



- ① Rear head restraint lowering switch
- ▶ Switch on the ignition (▷ page 36).
- ▶ Push the rear head restraints lowering switch ①.

The rear head restraints are lowered.

i The rear head restraints cannot be lowered using the switch ① when the roll bars have been released. The roll bars need to be lowered before the rear head restraints can be operated again using switch ①.

- If the roll bars have released and the soft top is closed, contact an authorized Mercedes-Benz Center to have the roll bars lowered. Do not attempt to lower the roll bars manually with the soft top closed. Lowering the roll bars manually with the soft top closed may impair the function of the roll bars.
- If the roll bars have released and the soft top is open, you can lower the roll bars manually (▷ page 414) or contact an authorized Mercedes-Benz Center to have the roll bars lowered.

Multicontour seat*

The multicontour seat has a movable seat cushion and inflatable air cushions built into the backrest to provide additional lumbar and side support.

The seat cushion movement, backrest cushion height and curvature can be continuously varied with switches on the side of the seat after switching on ignition.

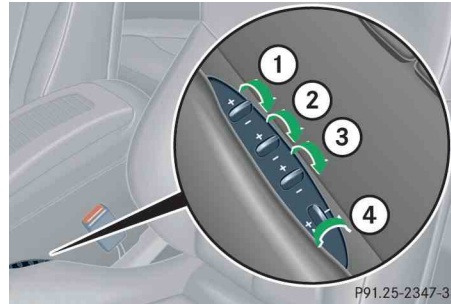

- ① Seat cushion depth
 - ② Backrest bottom
 - ③ Backrest center
 - ④ Side bolster adjustment
- ▶ Switch on the ignition (▷ page 38).

Seat cushion depth

- ▶ Adjust the seat cushion depth to the length of your upper leg using switch ①.

Backrest contour

- ▶ Adjust the contour of the backrest to the desired position using switches ② and ③.

Backrest side bolsters

- ▶ Adjust the backrest side bolsters so that they provide good lateral support using switch ④.

i If, after a period of time, the seat no longer provides the desired contour, then repeat the adjustment procedure.

Seats

Seat heating*

Both switches for the front seats are located in the center console.



① Seat heating switch

The red indicator lamps on the switch ① show which heating level you have selected.

Level	
3	Three indicator lamps on (highest level). After approximately five minutes, seat heating is automatically switched to level 2.
2	Two indicator lamps on. After approximately ten minutes, seat heating is automatically switched to level 1.
1	One indicator lamp on (lowest level). After approximately 20 minutes, seat heating is automatically switched off.
off	No indicator lamp on.

- ▶ Switch on the ignition (▷ page 36).

Switching on seat heating

- ▶ Press seat heating switch ① once.
Three red indicator lamps in the switch come on.
- ▶ Continue pressing seat heating switch ① until desired seat heating level is reached.

Switching off seat heating

- ▶ Press seat heating switch ① repeatedly until all red indicator lamps go out.

i If one or more of the indicator lamps on the seat heater switch ① are flashing, there is insufficient voltage due to too many electrical consumers being switched on. The seat heating switches off automatically.

The seat heating will switch back on again automatically as soon as sufficient voltage is available.

Seat ventilation*

Both switches for the front seats are located in the center console.



① Seat ventilation switch

The blue indicator lamps in the switch ① show which ventilation level you have selected:

Level	
3	Three indicator lamps on
2	Two indicator lamps on
1	One indicator lamp on
off	No indicator lamp on

- ▶ Switch on the ignition (▷ page 36).
All lamps in the instrument cluster come on.

Switching on seat ventilation

- ▶ Press seat ventilation switch ①.
Three blue indicator lamps come on.
- ▶ Press seat ventilation switch ① repeatedly until the desired seat ventilation level is reached.

i The seat ventilation for the driver's seat is automatically set to the highest level if activated via summer opening feature (▷ page 252).

Switching off seat ventilation

- ▶ Press seat ventilation switch ① repeatedly until all blue indicator lamps go out.

i If one or more of the indicator lamps on the seat ventilation switch ① are flashing, there is insufficient voltage due to too many electrical consumers being switched on. The seat ventilation switches off automatically.

The seat ventilation will switch back on again automatically as soon as sufficient voltage is available.

Memory function

Prior to operating the vehicle, the driver should check and adjust the seat height, seat position fore and aft, and seat backrest angle if necessary, to ensure adequate control, reach and comfort. The head restraint should also be adjusted for proper height. See also the section on air bags (▷ page 65) for proper seat positioning.

In addition, adjust the steering wheel to ensure adequate control, reach, operation and comfort. Both the interior and exterior rear view mirrors should be adjusted for adequate rear vision.

Fasten seat belts. Infants and small children should be seated in a properly secured restraint system that complies with U.S. Federal Motor Vehicle Safety Standards 213 and 225 and Canadian Motor Vehicle Safety Standards 213 and 210.2.

The following settings are stored when using the buttons on the driver's door:

- Driver's seat, backrest and head restraint position
- Steering wheel position
- Exterior rear view mirror position

Warning!



Do not activate the memory function while driving. Activating the memory function while driving could cause the driver to lose control of the vehicle.

The following settings are stored when using the buttons on the passenger door:

- Front passenger seat, backrest and head restraint position

The memory button and memory position switch are located on the door.

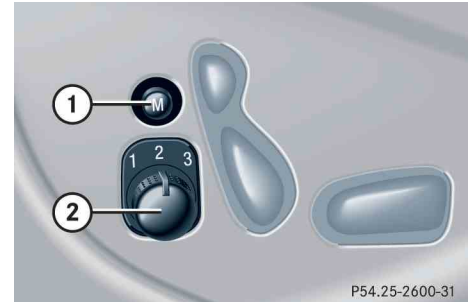

- ① Memory button
- ② Memory position switch

▶ Switch on the ignition (▷ page 36).

or

▶ Open the respective door and insert the SmartKey in the starter switch.

Storing positions into memory

- ▶ Adjust the seats, steering wheel and exterior rear view mirrors to the desired position (▷ page 39).
- ▶ Turn memory position switch ② to the desired memory position.
- ▶ Press memory button ①.
- ▶ Release memory button ① and press memory position switch ② within 3 seconds.

All settings are stored to the selected position.

Recalling positions from memory

! Do not operate the seats using the memory button if the seat backrest is in an excessively reclined position. Doing so could cause damage to front or rear seats.

First move the seat backrest to an upright position.

- ▶ Turn memory position switch ② to the desired memory position.
- ▶ Press and hold memory position switch ② until the seat, steering wheel and exterior rear view mirrors have completely moved to the stored positions.

i Releasing the memory position switch stops movement to the stored positions immediately.

Lighting

For information on how to switch on the headlamps and use the turn signals, see “Switching on headlamps” (▷ page 54) and “Turn signals” (▷ page 55).

i If you drive in countries where vehicles drive on the other side of the road than the country where the vehicle is registered, you must have the headlamps modified for symmetrical low beams. Relevant information can be obtained at an authorized Mercedes-Benz Center.

i Vehicles equipped with active Bi-Xenon* headlamps:

The active Bi-Xenon headlamps monitor your steering angle and driving speed, then automatically shift their beams to either side to better follow the curvature of the road ahead, increasing usable illumination over conventional headlamps.

Exterior lamp switch



Exterior lamp switch

- 0** Off
Daytime running lamp mode
(▷ page 128)
- AUTO** Automatic headlamp mode
Daytime running lamp mode
(▷ page 128)
- ☀** Parking lamps (also tail lamps,
license plate lamps, side marker
lamps, instrument panel lamps)

☀ Low beam headlamps or high beam headlamps when the combination switch is pushed forward. The tail lamps, license plate lamps, side marker lamps, parking lamps and instrument panel lamps also come on.

P ← Standing lamps, right (turn left one stop)

→ P Standing lamps, left (turn left two stops)

☁ Indicator lamp for front fog lamps

☁ Indicator lamp for rear fog lamp

i If you hear a warning signal you have forgotten to switch off the headlamps before opening the driver's door.

In addition the message Turn off lamps appears in the multifunction display. Vehicles with KEYLESS-GO*, this message is only displayed for approximately 1 second. It is then overwritten by the message, Please do not forget key.

Switch off the headlamps

Manual headlamp mode

The low beam headlamps and the parking lamps can be switched on and off with the exterior lamp switch.

- ▶ Turn the exterior lamp switch to position .

Automatic headlamp mode

The following lamps switch on and off automatically depending on the brightness of the ambient light:

- Low beam headlamps
- Tail and parking lamps
- License plate lamps
- Side marker lamps



Warning!



If the exterior lamp switch is set to **AUTO**,

- the headlamps may switch off unexpectedly when the system senses bright ambient light, for example light from oncoming traffic.
- the headlamps will not be automatically switched on under foggy conditions.

To minimize risk to you and to others, activate headlamps by turning exterior lamp switch to  when driving or when traffic and/or ambient lighting conditions require you to do so.

In low ambient lighting conditions, only switch from position **AUTO** to  with the vehicle at a standstill in a safe location. Switching from **AUTO** to  will briefly switch off the headlamps. Doing so while driving in low ambient lighting conditions may result in an accident.

The automatic headlamp feature is only an aid to the driver. The driver is responsible for the operation of the vehicle's lights at all times.

- ▶ Turn the exterior lamp switch to position **AUTO**.

With the SmartKey in starter switch position **1** or the KEYLESS-GO* start/stop button pressed once, only the parking lamps and the side marker lamps will switch on and off automatically.

When the engine is running, the low beam headlamps, the tail and parking lamps, the license plate lamps, and the side marker lamps will switch on and off automatically.

 *USA only:*

With the automatic headlamp mode activated you can switch on the high beam headlamps in low ambient lighting conditions.

Lighting

Daytime running lamp mode

- ▶ Turn the exterior lamp switch to position **0** or **AUTO**.

When the engine is running, the low beam headlamps are switched on.

In low ambient light conditions, the following lamps will switch on additionally:

- Tail and parking lamps
- License plate lamps
- Side marker lamps

i *With the daytime running lamp mode activated and the engine running, you cannot switch off the low beam headlamps manually.*

Canada only

The daytime running lamp mode is mandatory and therefore in a constant mode.



i *With the exterior lamp switch in position **0** or **AUTO**, you cannot switch on the high beam headlamps.*

The high beam flasher is available at all times.

For nighttime driving turn the exterior lamp switch to position  to permit activation of the high beam headlamps.

When the engine is running, and you shift from a driving position to position **N** or **P**, the low beam headlamps will switch off with a three-minute delay.

When the engine is running, and you

- turn the exterior lamp switch to position , the parking lamps and the side marker lamps switch on additionally.
- turn the exterior lamp switch to position , the manual headlamp mode has priority over the daytime running lamp mode.

The corresponding exterior lamps switch on (▷ page 126).



USA only

By default, the daytime running lamp mode is deactivated. Activate the daytime running lamp mode using the control system, see “Setting daytime running lamp mode (USA only)” (▷ page 160).

i *With the daytime running lamp mode activated and the exterior lamp switch in position **0**, you cannot switch on the high beam headlamps.*

The high beam flasher is available at all times.

*For nighttime driving turn the exterior lamp switch to position  or **AUTO** to permit activation of the high beam headlamps.*



When the engine is running, and you turn the exterior lamp switch to position  or , the manual headlamp mode has priority over the daytime running lamp mode.

The corresponding exterior lamps switch on (▷ page 126).

Locator lighting and night security illumination

The locator lighting and the night security illumination are described in the “Control system” section, see “Setting locator lighting” (▷ page 161) and “Setting night security illumination” (▷ page 162).

Fog lamps**Warning!**

In low ambient lighting or foggy conditions, only switch from position **AUTO** to  with the vehicle at a standstill in a safe location. Switching from **AUTO** to  will briefly switch off the headlamps. Doing so while driving in low ambient lighting conditions may result in an accident.



i *Fog lamps will operate with the parking lamps and/or the low beam headlamps on. Fog lamps should only be used in conjunction with low beam headlamps. Consult your State or Province Motor Vehicle Regulations regarding permissible lamp operation.*

i *Fog lamps cannot be switched on with the exterior lamp switch in position **AUTO**. To switch on the fog lamps, turn the exterior lamp switch to position  first.*



Lighting



Front fog lamps

- ▶ Switch on the low beam headlamps  (▷ page 54).
- ▶ Pull out the exterior lamp switch to first stop.
The front fog lamps switch on.
The green indicator lamp  in the exterior lamp switch comes on (▷ page 126).
- ▶ Push in the exterior lamp switch.
The front fog lamps switch off.
The green indicator lamp  in the exterior lamp switch goes out.

Rear fog lamp (driver's side only)

- ▶ Switch on the low beam headlamps  (▷ page 54).
- ▶ Pull out the exterior lamp switch to second stop.
The front fog lamps and the rear fog lamp switch on.
The yellow indicator lamp  in the exterior lamp switch comes on (▷ page 126).
- ▶ Push in the exterior lamp switch to first stop.
The rear fog lamp switches off.
The yellow indicator lamp  in the exterior lamp switch goes out.
The front fog lamps remain lit.

Combination switch

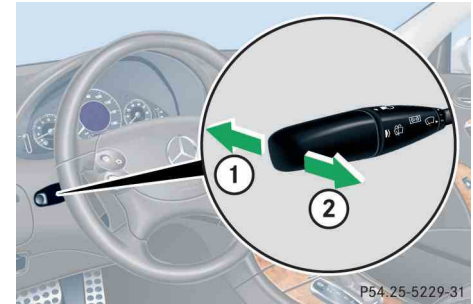

Combination switch

- ① High beam
- ② High beam flasher

High beam

- ▶ Turn the exterior lamp switch to position  (▷ page 126).
- ▶ Push the combination switch in direction of arrow ① to switch on the high beam.

The high beam headlamp indicator lamp  in the instrument cluster comes on (▷ page 26).

- ▶ Pull the combination switch in direction of arrow ② to its original position to switch off the high beam.

The high beam headlamp indicator lamp  in the instrument cluster goes out.

High beam flasher

- ▶ Pull the combination switch briefly in direction of arrow ②.

Corner-illuminating front fog lamps* (With Bi-Xenon* headlamps only)

The corner-illuminating front fog lamps improve illumination of the area in the direction into which you are turning.

The corner-illuminating front fog lamps will operate with the engine running and with

- the exterior lamp switch in position  (▷ page 126)
or
- the exterior lamp switch in position **AUTO** (▷ page 126)
or
- the daytime running lamp mode activated (▷ page 128)

i *With the automatic headlamp mode activated: The corner-illuminating front fog lamps will only come on in low ambient lighting conditions.*

i *If you are driving faster than 25 mph (40 km/h) or have the front fog lamps switched on, the corner-illuminating front fog lamps function is not available.*

Driving forward

Switching on corner-illuminating front fog lamps

- ▶ Switch on the left or right turn signal (▷ page 55), depending on whether you are turning left or right.

The respective front fog lamp comes on and illuminates the area in the direction into which you are turning.

or

- ▶ Turning steering wheel in desired direction.

The front fog lamp on the side of your steering direction comes on. ▷▷

Lighting

- ▷▷ **i** *If you have switched on the turn signal for one side but turn the steering wheel in the opposite direction, the corner-illuminating front fog lamp comes on for the side indicated by the turn signal.*

The corner-illuminating front fog lamp remains lit for a maximum of three minutes. Afterward, it goes out even if the turn signal is still switched on.

- i** *The corner-illuminating front fog lamps temporarily come on, on both sides of the vehicle if you turn the steering wheel in one direction and then again in the other direction shortly thereafter.*

- i** *The corner-illuminating front fog lamps will come on automatically depending on the steering angle, even if you did not switch on either turn signal.*

If the corner-illuminating front fog lamps came on automatically, they will also go out automatically depending on the steering angle.

Switching off corner-illuminating front fog lamps

The combination switch for the turn signal resets automatically after major steering wheel movements. This will switch off the corner-illuminating front fog lamps if they were activated by switching on the left or right turn signal.

If the turn signal should stay on after making the turn, the turn signal and corner-illuminating front fog lamps can be switched off by returning the combination switch to its original position.

- i** *There may be a brief delay before the corner-illuminating front fog lamps switch off.*

Driving in reverse

Switching on corner-illuminating front fog lamps

- ▶ Place the gear selector lever in position **R**.

The corner-illuminating front fog lamp opposite to your steering direction comes on.

Switching off corner-illuminating front fog lamps

- ▶ Place the gear selector lever out of position **R**.

The respective front fog lamp goes out.

Hazard warning flasher

The hazard warning flasher can be switched on at all times, even with the SmartKey removed from the starter switch or with the SmartKey with KEYLESS-GO* removed from the vehicle.

The hazard warning flasher switches on automatically when an air bag deploys.

The hazard warning flasher switch is located on the center console.



P54.25-5242-31

① Hazard warning flasher switch

Switching on hazard warning flasher

- ▶ Press hazard warning flasher switch ①.

All turn signal lamps are flashing.

i With the hazard warning flasher activated and the combination switch set for either left or right turn, only the respective left or right turn signals will operate when the ignition is switched on (> page 38).

Switching off hazard warning flasher

- ▶ Press hazard warning flasher switch ① again.

i If the hazard warning flasher has been activated automatically, press hazard warning flasher switch ① once to switch it off.

Lighting

Interior lighting

The controls are located in the overhead control panel.



- ① Left front reading lamp on/off
- ② Rocker switch for automatic control system
- ③ Right front reading lamp on/off

! An interior lamp switched on manually does not go out automatically.

Leaving an interior lamp switch in the ON position for extended periods of time with the engine turned off could result in a discharged battery.

Deactivating automatic control

i The interior lighting is factory-set to automatic mode.

- ▶ Press the  symbol on rocker switch ②.

The interior lighting remains switched off in darkness, even when you

- unlock the vehicle
- remove the SmartKey from the starter switch
- open a door
- open the trunk

Activating automatic control

- ▶ Press rocker switch ② to center position.

The interior lighting switch on in darkness, when you

- unlock the vehicle
- remove the SmartKey from the starter switch
- open a door
- open the trunk

The interior lighting switches off after approximately 10 seconds, see “Setting interior lighting delayed shut-off” (▷ page 163).

i If a door remains open, the interior lighting switches off automatically after approximately 5 minutes.

Manual control



Switching front interior lighting on and off

- ▶ Press the  symbol on rocker switch ②.

The front interior lighting comes on.

- ▶ Press rocker switch ② to center position to activate the automatic control.

Switching front reading lamps on and off

- ▶ Press the left or right button  to switch on the desired front reading lamp.
- ▶ Press the left or right button  again to switch off the respective front reading lamp.

Door entry lamps

For better orientation in the dark, the corresponding door entry lamps will switch on in darkness when you open a door and the automatic control is activated.

The door entry lamps will switch off when the corresponding door is closed.

i *If you turn the SmartKey in the starter switch to position 0 and switch off the headlamps, the door entry lamps will remain lit for approximately 5 minutes.*

Trunk lamp

The trunk lamp switches on if the trunk is opened.

If the trunk lid remains open, the trunk lamp switches off automatically after approximately 10 minutes.

Instrument cluster

For a full view illustration of the instrument cluster, see “Instrument cluster” (▷ page 26).

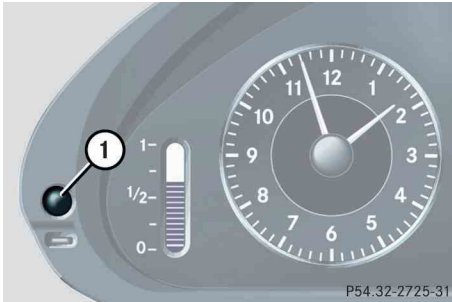

① Reset button

The instrument cluster is activated when you

- open a door
- switch on the ignition (▷ page 38)
- press reset button ①
- switch on the exterior lamps

You can change the instrument cluster settings in the Instrument cluster submenu of the control system (▷ page 156).

Warning!



No messages will be displayed if either the instrument cluster or the multifunction display is inoperative.

As a result, you will not be able to see information about your driving conditions, such as speed or outside temperature, warning/indicator lamps, malfunction/warning messages or the failure of any systems. Driving characteristics may be impaired.

If you must continue to drive, please do so with added caution. Visit an authorized Mercedes-Benz Center as soon as possible.

Adjusting instrument cluster illumination

Use the reset button ① to adjust the illumination brightness for the instrument cluster.

i *The instrument cluster illumination is dimmed or brightened automatically to suit ambient light conditions.*

The instrument cluster illumination will also be adjusted automatically when you switch on the vehicle's exterior lamps.

To brighten illumination

- ▶ Turn reset button ① clockwise.

The instrument cluster illumination will brighten.

To dim illumination

- ▶ Turn reset button ① counterclockwise.

The instrument cluster illumination will dim.

Coolant temperature indicator

The coolant temperature indicator is on the right side in the instrument cluster (▷ page 26).

Warning!



- Driving when your engine is overheated can cause some fluids which may have leaked into the engine compartment to catch fire. You could be seriously burned.
- Steam from an overheated engine can cause serious burns which can occur just by opening the hood. Stay away from the engine if you see or hear steam coming from it.



Stop the vehicle in a safe location away from other traffic. Turn off the engine, get out of the vehicle and do not stand near the vehicle until the engine has cooled down.

! Excessive coolant temperature triggers a warning in the multifunction display (▷ page 391) and the red coolant warning lamp in the instrument cluster comes on (▷ page 371).

The engine should not be operated with the coolant temperature above 248 °F (120 °C). Doing so may cause serious engine damage which is not covered by the Mercedes-Benz Limited Warranty.

i During severe operating conditions, e.g. stop-and-go traffic, the coolant temperature may rise close to 248 °F (120 °C).

Resetting trip odometer

- ▶ Make sure you are viewing the standard display in the multifunction display (▷ page 145).
- ▶ If it is not displayed, press button  or  on the multifunction steering wheel repeatedly until the standard display appears (▷ page 140).
- ▶ Press and hold the reset button on the instrument cluster (▷ page 136) until the trip odometer is reset.

Tachometer

The red marking on the tachometer (▷ page 26) denotes excessive engine speed.

! *Avoid driving at excessive engine speeds, as it may result in serious engine damage that is not covered by the Mercedes-Benz Limited Warranty.*

To help protect the engine, the fuel supply is interrupted if the engine is operated within the red marking.

Clock

In vehicles with Audio 20, the clock can be set via the control system (▷ page 158).

i *Vehicles with COMAND*:
For information on setting the time in COMAND, refer to the separate COMAND operating instructions.*

Outside temperature indicator

Warning!



The outside temperature indicator is not designed to serve as an ice-warning device and is therefore unsuitable for that purpose.

Indicated temperatures just above the freezing point do not guarantee that the road surface is free of ice. The road may still be icy, especially in wooded areas or on bridges.

The outside temperature is indicated in the multifunction display (▷ page 139).

The temperature sensor is located in the front bumper area. Due to its location, the sensor can be affected by road or engine heat during idling or slow driving. This means that the accuracy of the displayed temperature can only be verified by comparison to a thermometer placed next to the sensor, not by comparison to external displays (e.g. bank signs etc.).

When moving the vehicle into colder ambient temperatures (e.g. when leaving your garage), you will notice a delay before the lower temperature is displayed.

A delay also occurs when ambient temperatures rise. This prevents inaccurate temperature indications caused by heat radiated from the engine during idling or slow driving.

▼ Control system

The control system is activated as soon as the SmartKey in the starter switch is turned to position **1** or as soon as the KEYLESS-GO* start/stop button is in position **1**. The control system enables you to

- call up information about your vehicle
- change vehicle settings

For example, you can use the control system to find out when your vehicle is next due for service, to set the language for messages in the instrument cluster display, and much more.

i *The displays for the audio systems (radio, CD player etc.) will appear in English, regardless of the language selected.*

Warning!



A driver's attention to the road and traffic conditions must always be his/her primary focus when driving.

For your safety and the safety of others, selecting features through the multifunction steering wheel should only be done by the driver when traffic and road conditions permit it to be done safely.

Bear in mind that at a speed of just 30 mph (approximately 50 km/h), your vehicle is covering a distance of 44 feet (approximately 14 m) every second.

The control system relays information to the multifunction display.

Multifunction display



- ① Outside temperature
- ② Trip odometer
- ③ Current shift program mode
- ④ Main odometer
- ⑤ Current gear selector lever position/gear range

For more information on menus displayed in the multifunction display, see “Menus” (▷ page 142).

Control system

Multifunction steering wheel

The displays in the multifunction display and the settings in the control system are controlled by the buttons on the multifunction steering wheel (> page 28).

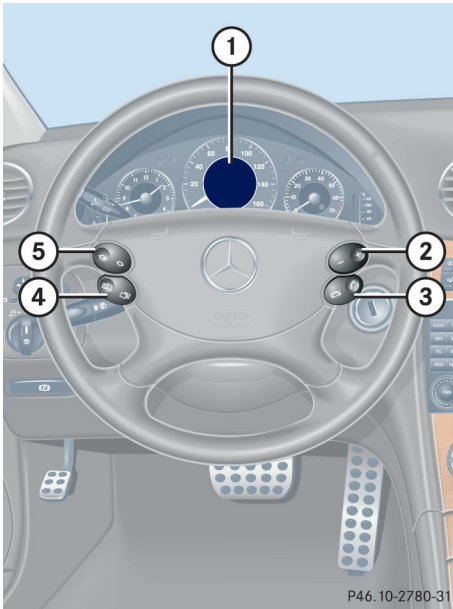

① Multifunction display

Operating the control system

② Selecting the submenu or setting the volume:

Press button

+ up / to increase

- down / to decrease

③ Telephone*:

Press button

 to take a call
to dial
to redial

 to end a call
to reject an incoming call

④ Menu systems:

Press button

 for next menu

 for previous menu

⑤ Moving within a menu:

Press button

 for next display





 for previous display

Depending on the selected menu (▷ page 142), pressing the buttons on the multifunction steering wheel will alter what is shown in the multifunction display.

The information available in the multifunction display is arranged in menus, each containing a number of functions or submenus.

The individual functions are then found within the relevant menu (radio or CD operations under *Audio*, for example). These functions serve to call up relevant information or to customize the settings for your vehicle.

It is helpful to think of the menus, and the functions within each menu, as being arranged in a circular pattern.

- If you press button  or  repeatedly, you will pass through each menu one after the other.
- If you press button  or  repeatedly, you will pass through each function display, one after the other, in the current menu.

In the *Settings* menu, instead of functions you will find a number of submenus for calling up and changing settings. For instructions on using these submenus, see “Submenus in the *Settings* menu” (▷ page 154).

The number of menus available in the system depends on which optional equipment is installed in your vehicle.

The menus are described on the following pages.

Control system

Menus

This is what you will see when you scroll through the menus.

The table on the next page provides an overview of the individual menus.

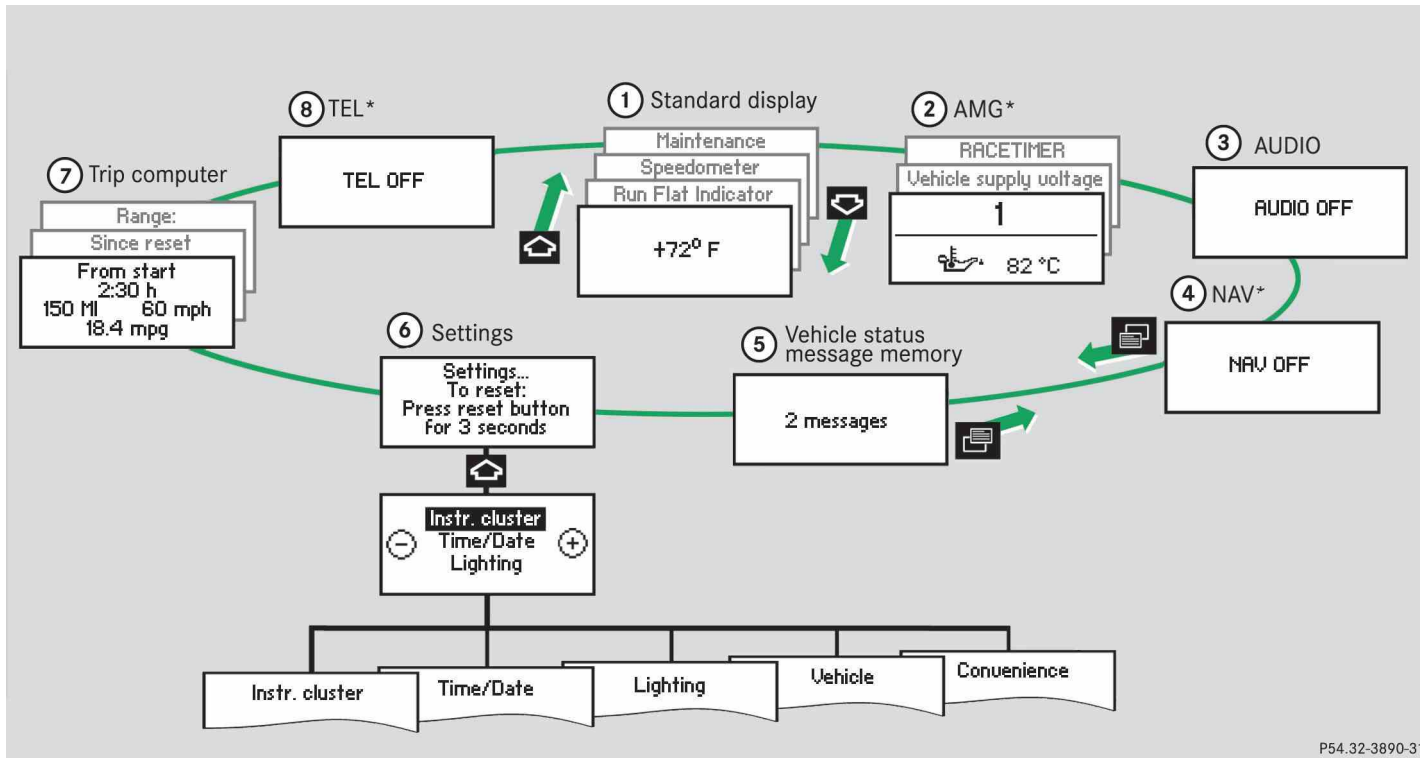

Menus, submenus and functions

	Menu ①	Menu ②	Menu ③	Menu ④
	Standard display (▷ page 145)	AMG¹ (▷ page 145)	AUDIO (▷ page 149)	NAV* (▷ page 151)
Commands/submenus	Run Flat Indicator*	Engine oil temperature	Selecting radio station	Show route guidance instructions, current direction traveled
	Digital speedometer	Vehicle supply voltage	Selecting satellite radio station* (USA only)	
	Call up maintenance service display	RACETIMER Overall analysis Lap analysis	Operating CD player	

¹ AMG vehicles only

Table continued on next page.

Control system

	Menu ⑤ Vehicle status message memory ¹ (▷ page 152)	Menu ⑥ Settings (▷ page 153)	Menu ⑦ Trip computer (▷ page 165)	Menu ⑧ TEL* (▷ page 167)
Commands/submenus	Calling up vehicle malfunction, warning and system status messages stored in memory	Reset to factory settings	Fuel consumption statistics after start	Load phone book
		Instrument cluster submenu	Fuel consumption statistics since the last reset	Search for name in phone book
		Time/Date submenu	Call up range	
		Lighting submenu		
		Vehicle submenu Convenience submenu		

¹ The vehicle status message memory menu is only displayed if there is a message stored.

i *The headings used in the menus table are designed to facilitate navigation within the system and are not necessarily identical to those shown in the control system displays.*

The first function displayed in each menu will automatically show you which part of the system you are in.



Standard display menu



In the standard display, the outside temperature and the trip odometer are shown in the multifunction display.

i You can have the digital speedometer displayed instead of the outside temperature in the standard display. You can select the setting in the submenu Instr. cluster via the function Basic display (▷ page 157).



- ① Outside temperature
- ② Trip odometer



If you see another display, press button  or  repeatedly until the standard display appears.

- ▶ Press button  or  to select the functions in the standard display menu.

The following functions are available:

Function	Page
Run Flat Indicator	334
Call up digital speedometer	145
Call up maintenance service display	355

Display digital speedometer

- ▶ Press button  or  until the digital speedometer appears in the multifunction display.

The current vehicle speed is shown in the multifunction display and the status line appears.





- ① Digital Speedometer
- ② Status line with outside temperature
- ③ Trip odometer

i You can have the digital speedometer displayed instead of the outside temperature in the status line. You can select the setting in the submenu Instr. cluster via the function Status line display (▷ page 157).

AMG menu

i This function is only available in AMG vehicles.

The main screen of the AMG menu shows you the gear currently engaged as well as the engine oil temperature.

- ▶ Press button  or  repeatedly until the AMG menu appears in the multifunction display.

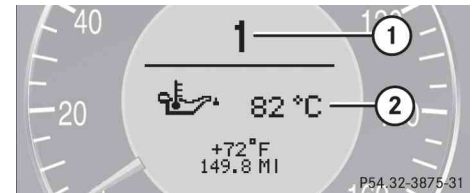



- ① Gear indicator
- ② Engine oil temperature



Control system



▷▷ **i** The engine oil temperature symbol flashes if the engine oil temperature has not yet reached 176°F (80°C). During this time, avoid driving at full engine speed.

- ▶ Press button  or  to select the following functions in the AMG menu:

Function	Page
Vehicle supply voltage	149
RACETIMER	149
Overall analysis	150
Lap analysis	150

i If the engine reaches the overspeed range in the manual shift program, the menu will be shown in red. In addition, you will see **UP** next to gear indicator ① as a reminder to upshift.

Vehicle supply voltage

- ▶ Press button  or  repeatedly until the AMG menu appears in the multifunction display.
- ▶ Press button  repeatedly until you see the vehicle supply voltage.



- ① Gear indicator
- ② Vehicle supply voltage



RACETIMER

Warning!



The RACETIMER feature is only for use on roads and in conditions where high speed driving is permitted. Racing on public roads is prohibited under all circumstances and the driver is and must always remain responsible for following posted speed limits.

The RACETIMER allows you to time and save driving stretches in hours, minutes and seconds.

- ▶ Press button  or  repeatedly until the AMG menu appears in the multifunction display.
- ▶ Press button  repeatedly until you see the RACETIMER.

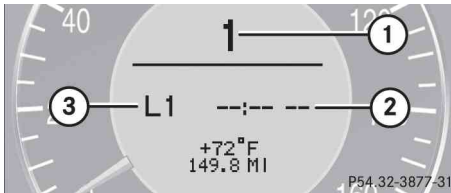

- ① Gear indicator
- ② RACETIMER
- ③ Lap

i You can start the RACETIMER when the engine is running or the starter switch is in position 2 (▷ page 36).

i While the RACETIMER is being displayed, you can not adjust the volume using button **+** or **-**.

Starting the RACETIMER

- ▶ Press button **+**.

The timer starts.

Displaying intermediate time

- ▶ Press button **-** while the timer is running.

The intermediate time is shown for 5 seconds.

Stopping the RACETIMER

- ▶ Press button **+**.

The timer stops.

i When you stop the vehicle and turn the SmartKey to position 1 (▷ page 36) or, in vehicles with KEYLESS-GO⁺, turn off the engine and do not open the driver's door, the RACETIMER stops timing. Timing is resumed when you switch the ignition back on (▷ page 36) or restart the engine (▷ page 50) and then press the **+** button.

Saving lap time and starting a new lap

i You can save up to 9 laps.

- ▶ Press button **-** while the timer is running.

The intermediate time is shown for 5 seconds.

- ▶ Press button **-** within the next 5 seconds.

The intermediate time shown will be saved as a lap time.

The RACETIMER begins timing the new lap. The new lap begins to be timed as soon as the intermediate time is called up.



Control system

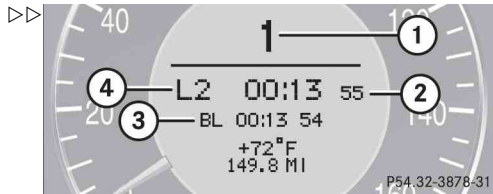

- ① Gear indicator
- ② RACETIMER
- ③ Best lap time
- ④ Lap number

Resetting current lap

- ▶ Press button **+** while the timer is running.

The timer stops.

- ▶ Press button **-**.

The lap time is reset to "0".

Deleting all laps

- ❗ *It is not possible to delete a single saved lap.*

- ▶ Press button **+** while the timer is running.

The timer stops.

- ▶ Press the reset button twice (▷ page 136).

- ▶ Press button **+**.

The timer starts. The saved laps are deleted.

- ❗ *When you turn off the engine, the RACETIMER will be reset to "0" after 30 seconds. All laps are deleted.*

Overall analysis

- ❗ *These functions are only available if you have saved at least one lap and have stopped the RACETIMER.*

- ▶ Press button **☰** or **☷** repeatedly until the AMG menu appears in the multifunction display.

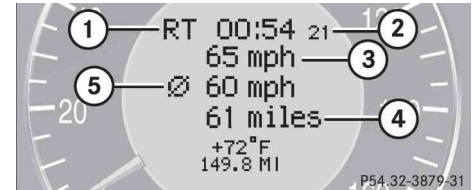

- ▶ Press button **⬆** repeatedly until you see the overall analysis.



- ① Overall analysis of RACETIMER
- ② Overall driving time
- ③ Maximum speed
- ④ Overall distance driven
- ⑤ Average speed



Lap analysis

i These functions are only available if you have saved at least two laps and have stopped the RACETIMER.

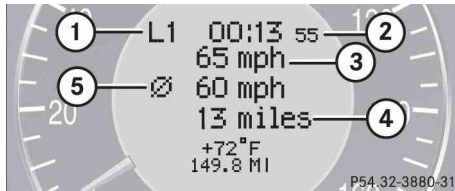
- ▶ Press button  or  repeatedly until the AMG menu appears in the multifunction display.
- ▶ Press button  repeatedly until you see the lap analysis.



- ① Lap number
- ② Lap time
- ③ Maximum speed
- ④ Lap length
- ⑤ Average speed during lap

- ▶ Press button  or  to see other lap analysis.

i Each lap is shown in its own submenu. The fastest lap is indicated by flashing symbol ①.

AUDIO menu



The functions in the Audio menu operate the audio equipment which you currently have turned on.

If no audio equipment is currently turned on, the message AUDIO OFF appears in the multifunction display.

The following functions are available:



Function	Page
Selecting radio station	149
Selecting satellite radio station* (USA only)	149
Operating CD player	150

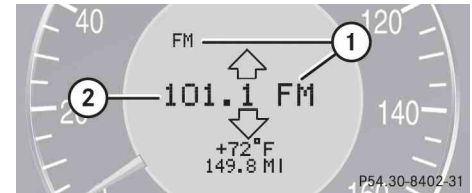

Selecting radio station

- ▶ Turn on the radio (▷ page 214) and select radio. Vehicles with COMAND*: Refer to separate operating instructions.
- ▶ Press button  or  repeatedly until the currently tuned station appears in the multifunction display.



- ① Waveband setting
- ② Station frequency

- ▶ Press button  or  repeatedly until the desired station or the desired stored station is found.

The station search depends on the selected setting in the Vehicle submenu of the control system (▷ page 163). Pressing button  or  will either start a frequency scan or select the next stored radio station.

i You can only store new stations using the corresponding feature on the radio (▷ page 220).

Vehicles with COMAND*: Refer to separate operating instructions.

You can also operate the radio in the usual manner.

Control system

Selecting satellite radio station* (USA only)

The satellite radio is treated as a radio application.

- ▶ Select satellite radio with the corresponding soft key (SAT) in the radio menu.



- ① SAT mode and preset number
 - ② Setting for station selection using memory
 - ③ Channel name or number
- ▶ Press button or repeatedly until the desired channel is found.

i For more information on satellite radio operation, see “Introduction to satellite radio* (USA only)” (▷ page 222).

Vehicles with COMAND*:
Refer to separate operating instructions.

Operating the CD player

i The COMAND* system and the CD changer* can play audio CDs as well as CDs with MP3 files.

Selecting CD track

- ▶ Turn on the radio and select CD (▷ page 227) or CD changer* (▷ page 231). Vehicles with COMAND*: Refer to separate operating instructions.
- ▶ Press button or repeatedly until the settings for the CD currently being played appear in the multifunction display.

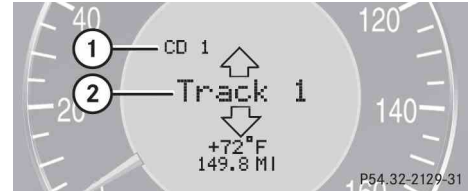

- ① Current CD (with additional number from 1 to 6 when running from CD changer*)
 - ② Current track
- ▶ Press button or repeatedly until the desired track is selected.



i To select a CD from the CD changer* magazine, press a number on the audio system or the COMAND* system key pad located in the center console.

For more information on CD operation, see “CD mode” (▷ page 227) and for the CD changer*, see “CD changer*” (▷ page 231).

Selecting CD MP3-track (vehicles with COMAND* and/or CD changer*)

- ▶ Turn on the radio and select the CD changer* (▷ page 231) or turn on COMAND* and select CD or CD changer*. Vehicles with COMAND*: Refer to separate operating instructions.

i A CD with MP3 files insert in the CD changer* is handled by the audio/COMAND* system like an audio CD. Information contained on the CD with MP3 files will not shown in the multifunction display or in the audio/COMAND* display.

- ▶ Press button  or  repeatedly until the settings for the CD currently being played appear in the multifunction display.

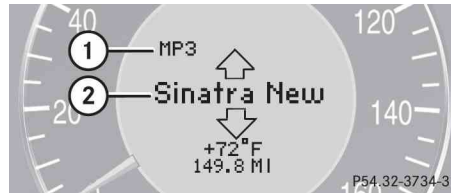

- ① MP3 mode (vehicles with COMAND*)
- ② Current track

- ▶ Press button  or  repeatedly until the desired track is selected.



i Level of information displayed will vary depending on the information contained on the CD with MP3 files insert in the single CD player of the COMAND* system.

To select a CD from the CD changer* magazine, press a number on the audio system or the COMAND* system key pad located in the center console.

For more information on MP3, see “MP3 notes” (▷ page 228), and for operating, see “MP3 playback” (▷ page 229)

NAV* menu

The NAV menu contains the functions needed to operate your navigation system.

- ▶ Press button  or  repeatedly until the message NAV appears in the multifunction display.
 - If COMAND* is switched off, the message Nav off appears in the multifunction display.
 - With COMAND* switched on but route guidance not activated, the direction of travel and, if available, the name of the street currently traveled on appear in the multifunction display.
 - With COMAND* switched on and route guidance activated, the direction of travel and maneuver instructions appear in the multifunction display.

Please refer to the COMAND* manual for instructions on how to activate the route guidance system*.

Control system

Vehicle status message memory menu



Use the vehicle status message memory menu to scan malfunction and warning messages that may be stored in the system. Such messages appear in the multifunction display and are based on conditions or system status the vehicle's system has recorded.

The vehicle status message memory menu only appears if there are any messages stored.

Warning!



Malfunction and warning messages are only indicated for certain systems and are intentionally not very detailed. The malfunction and warning messages are simply a reminder with respect to the operation of certain systems and do not replace the owner's and/or driver's responsibility to maintain the vehicle's operating safety by having all required maintenance and safety checks performed on the vehicle and by bringing the vehicle to an authorized Mercedes-Benz Center to address the malfunction and warning messages (▷ page 378).

- ▶ Press button  or  repeatedly until the vehicle status message memory appears in the multifunction display.

If the vehicle status message memory menu does not appear, then there are no messages stored.

Vehicle status messages have been recorded

If conditions have occurred causing status messages to be recorded, the number of messages appears in the multifunction display:



- ① Number of messages

- ▶ Press button  or .

The stored messages will now be displayed in the order in which they have occurred.



For malfunction and warning messages, see “Vehicle status messages in the multifunction display” (▷ page 378).

Should the vehicle's system record any conditions while driving, the number of messages will reappear in the multifunction display when the SmartKey in the starter switch is turned to position **0** or removed from the starter switch. With KEYLESS-GO*, turn off the engine by pressing the KEYLESS-GO* start/stop button and open the driver's door.

i The vehicle status message memory will be cleared when you switch on the ignition (▷ page 36). You will then only see high-priority messages in the multifunction display (▷ page 378).

Settings menu

In the Settings menu there are two functions:

- The function **Reset to factory settings?**, with which you can reset all the settings to the original factory settings.
 - A collection of submenus with which you can make individual settings for your vehicle.
- ▶ Press button  or  repeatedly until the Settings menu appears in the multifunction display.



Resetting all settings

You can reset all the functions of all submenus to the factory settings.

- ▶ Press the reset button in the instrument cluster (▷ page 136) for approximately 3 seconds.

The request to press the reset button once more to confirm appears in the multifunction display.



- ▶ Press the reset button once more.

The functions of all the submenus will reset to factory settings.

Control system

i *The settings you have changed will not be reset unless you confirm the action by pressing the reset button a second time. After approximately five seconds, the Settings... menu reappears in the multifunction display.*

For safety reasons, the following function is not reset while driving:

- the Headlamp mode function in the Lighting submenu.

Submenus in the Settings menu



- ▶ Press button .



The collection of the submenus appears in the multifunction display.





- ▶ Press button .

The selection marker moves to the next submenu.

The submenus are arranged by hierarchy. Scroll down with button , scroll up with button .

With the selection marker on the desired submenu, use button  to access the individual functions within that submenu. Once within the submenu, you can use button  to move to the next function or button  to move to the previous function within that submenu.

The settings themselves are made with button  or .

Resetting the functions of a submenu

For each submenu you can reset all the functions to the factory settings.

- ▶ Move to a function in the submenu.
- ▶ Press the reset button (▷ page 136) in the instrument cluster for approximately three seconds.

The request to press the reset button once more to confirm appears in the multifunction display.

- ▶ Press the reset button once more.

All functions of the submenu will reset to factory settings.

i *The settings you have changed will not be reset unless you confirm the action by pressing the reset button a second time. After approximately five seconds, the Settings menu reappears in the multifunction display.*

The table below shows what settings can be changed within the various menus.

Detailed instructions on making individual settings can be found on the following pages.

INSTRUMENT CLUSTER (▷ page 156)	TIME/DATE (▷ page 158)	LIGHTING (▷ page 160)	VEHICLE (▷ page 164)	CONVENIENCE (▷ page 164)
Selecting speedometer display mode	Setting time (hours)	Setting daytime running lamp mode (USA only)	Selecting audio search function	Activate easy-entry/exit feature
Selecting language	Setting time (minutes)	Setting locator lighting	Setting automatic locking	
Selecting display (speed display or outside temperature) for the status line	Setting the date (month)	Setting night security illumination		
Selecting display (speed display or outside temperature) for standard display	Setting the date (day)	Setting interior lighting delayed shut-off		
	Setting the date (year)			

Control system

Instrument cluster submenu

Access the Instr. cluster submenu via the Settings menu. Use the Instr. cluster submenu to change the instrument cluster display settings.

The following functions are available:

Function	Page
Selecting speedometer display mode	156
Selecting language	156
Selecting display (speed display or outside temperature) for the status line	157
Selecting display (speed display or outside temperature) for standard display	157

Selecting speedometer display mode

- ▶ Move the selection marker with button **+** or **-** to the Instr. cluster submenu.
- ▶ Press button **▲** or **▼** repeatedly until the message Display unit Speed-/odometer appears in the multifunction display.

The selection marker is on the current setting.

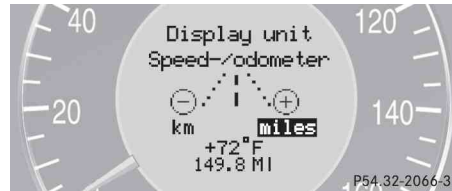

- ▶ Press button **+** or **-** to set speedometer unit to km or miles.

Selecting language

- ▶ Move the selection marker with button **+** or **-** to the Instr. cluster submenu.
- ▶ Press button **▲** or **▼** repeatedly until the message Language appears in the multifunction display.

The selection marker is on the current setting.



- ▶ Press button **+** or **-** to select the language to be used for the multifunction display messages.

Available languages:

- German
- English
- French
- Italian
- Spanish
- Dutch
- Danish
- Swedish
- Portuguese
- Turkish
- Russian (Canada only)

Selecting display (speed display or outside temperature) for the status line

- ▶ Move the selection marker with button **+** or **-** to the Instr. cluster submenu.
- ▶ Press button **▲** or **▼** repeatedly until the message Status line display appears in the multifunction display.

The selection marker is on the current setting.

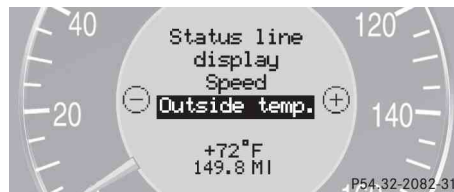

- ▶ Press button **+** or **-** to select the desired setting.

i You will see the status line when you have called up a different display from the standard display.

Selecting display (speed display or outside temperature) for standard display

- ▶ Move the selection marker with button **+** or **-** to the Instr. cluster submenu.
- ▶ Press button **▲** or **▼** repeatedly until the message Basic display appears in the multifunction display.

The selection marker is on the current setting.



- ▶ Press button **+** or **-** to select the display mode shown in the basic display.

Control system

Time/Date submenu

Access the Time/Date submenu via the Settings menu. Use the Time/Date submenu to change the instrument cluster display settings.

The following functions are available:

Function	Page
Setting the time (hours)	158
Setting the time (minutes)	158
Setting the date (month)	159
Setting the date (day)	159
Setting the date (year)	160

i The Time/Date submenu is not shown in vehicles with COMAND*.

Setting time (hours)

This function can only be seen in vehicles with audio system.

i Vehicles with COMAND*: For information on setting the time in COMAND, refer to the separate COMAND operating instructions.

- ▶ Move the selection marker with button **+** or **-** to the Time/Date submenu.
- ▶ Press button **↶** or **↷** repeatedly until the message **Clock, hours** Confirm by press. R appears in the multifunction display.

The selection marker is on the hour setting.

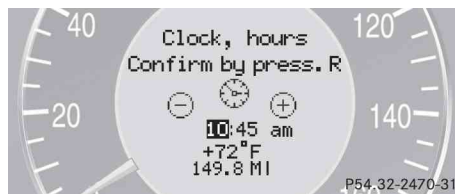

- ▶ Press button **+** or **-** to set the hour.

- ▶ Press the reset button in the instrument cluster (▷ page 136) to confirm. The hour is set and stored.

Setting time (minutes)

This function can only be seen in vehicles with audio system.

i Vehicles with COMAND*: For information on setting the time in COMAND, refer to the separate COMAND operating instructions.

- ▶ Move the selection marker with button **+** or **-** to the Time/Date submenu.
- ▶ Press button **↶** or **↷** repeatedly until the message **Clock, minutes** Confirm by press. R appears in the multifunction display.

The selection marker is on the minutes setting.



- ▶ Press button **+** or **-** to set the minutes.
- ▶ Press the reset button in the instrument cluster (▷ page 136) to confirm. The minutes are set and stored.

Setting the date (month)

This function can only be seen in vehicles with audio system.

i Vehicles with COMAND*:

For information on setting the date in COMAND, refer to the separate COMAND operating instructions.

- ▶ Move the selection marker with button **+** or **-** to the Time/Date submenu.

- ▶ Press button **↶** or **↷** repeatedly until the message Set date month appears in the multifunction display.

The selection marker is on the month setting.

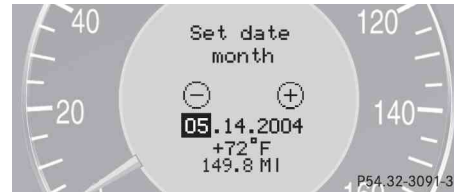

- ▶ Press button **+** or **-** to set the month.

Setting the date (day)

This function can only be seen in vehicles with audio system.

i Vehicles with COMAND*:

For information on setting the date in COMAND, refer to the separate COMAND operating instructions.

- ▶ Move the selection marker with button **+** or **-** to the Time/Date submenu.

- ▶ Press button **↶** or **↷** repeatedly until the message Set date day appears in the multifunction display.

The selection marker is on the day setting.



- ▶ Press button **+** or **-** to set the day.

Control system

Setting the date (year)

This function can only be seen in vehicles with audio system.

i Vehicles with COMAND*:
For information on setting the date in COMAND, refer to the separate COMAND operating instructions.

- ▶ Move the selection marker with button **+** or **-** to the Time/Date submenu.
- ▶ Press button **↕** or **↓** repeatedly until the message **Set date year** appears in the multifunction display.

The selection marker is on the year setting.



- ▶ Press button **+** or **-** to set the year.

Lighting submenu

Access the Lighting submenu via the Settings menu. Use the Lighting submenu to change the lamp and lighting settings on your vehicle.

The following functions are available:

Function	Page
Setting daytime running lamp mode (USA only)	160
Setting locator lighting	161
Setting night security illumination	162
Setting interior lighting delayed shut-off	163

Setting daytime running lamp mode (USA only)

i This function is not available in countries where the daytime running lamp mode is mandatory and therefore in a constant mode.

- ▶ Move the selection marker with button **+** or **-** to the Lighting submenu.
- ▶ Press button **↕** or **↓** repeatedly until the message **Headlamp mode** appears in the multifunction display.

The selection marker is on the current setting.



- ▶ Press button **+** or **-** to select manual operation (Manual) or daytime running lamp mode (Constant) activated.

With daytime running lamp mode activated and the exterior lamp switch in position **0** or **AUTO** the low beam headlamps are switched on when the engine is running.

In low ambient light conditions the following lamps will switch on additionally:

- Parking lamps
- Tail lamps
- License plate lamps
- Side marker lamps

For more information on the daytime running lamp mode, see “Lighting” (▷ page 126).

i For safety reasons, resetting the Lighting submenu to factory settings (▷ page 154) while driving will not deactivate the daytime running lamp mode.

The following message appears in the multifunction display:

Lighting - Cannot be completely reset to factory settings while driving.

Setting locator lighting

With the locator lighting feature activated and the exterior lamp switch in position **AUTO**, the following lamps will switch on during darkness when the vehicle is unlocked using button **U** on the SmartKey or SmartKey with KEYLESS-GO*:

- Parking lamps
- Tail lamps
- License plate lamps
- Side marker lamps
- Front fog lamps

The locator lighting switches off when the driver’s door is opened.

If you do not open a door after unlocking the vehicle with the SmartKey, the lamps will switch off automatically after approximately 40 seconds.

- ▶ Move the selection marker with button **+** or **-** to the Lighting submenu.

- ▶ Press button **▲** or **▼** repeatedly until the message Surround lighting function appears in the multifunction display.

The selection marker is on the current setting.



- ▶ Press button **+** or **-** to switch the locator lighting function On or Off
- ▶ Turn the exterior lamp switch to position **AUTO** when exiting the vehicle.

The locator lighting feature is activated.

Control system

Setting night security illumination (Headlamps delayed shut-off feature)

Use this function to set whether you would like the exterior lamps to remain on for 15 seconds during darkness after exiting the vehicle and closing all doors.

With the headlamps delayed shut-off feature activated and the exterior lamp switch in position **AUTO** before the engine is turned off, the following lamps will switch on when the engine is turned off:

- Parking lamps
- Tail lamps
- License plate lamps
- Side marker lamps
- Front fog lamps

If after turning off the engine you do not open a door or do not close an opened door, the lamps will automatically switch off after 60 seconds.

- ▶ Move the selection marker with button **+** or **-** to the Lighting submenu.
- ▶ Press button **↶** or **↷** repeatedly until the message Headlamps delayed shut-off appears in the multifunction display.

The selection marker is on the current setting.



- ▶ Press button **+** or **-** to switch the headlamps delayed shut-off feature On or Off.
- ▶ Turn the exterior lamp switch to position **AUTO** before turning off the engine.

The headlamps delayed shut-off feature is activated.

You can temporarily deactivate the headlamp delayed shut-off feature:

- ▶ Before exiting the vehicle, turn the SmartKey in the starter switch to position **0**.
- ▶ Then turn it to position **2** and back to **0**.

The headlamp delayed shut-off feature is deactivated. It will reactivate as soon as you reinsert the SmartKey in the starter switch.

Vehicles with KEYLESS-GO*:

- ▶ Press the KEYLESS-GO start/stop button on the gear selector lever (▷ page 38).

Setting interior lighting delayed shut-off

Use this function to set whether you would like the interior lighting to remain on for 10 seconds during darkness after you have removed the SmartKey from the starter switch.

- ▶ Move the selection marker with button **+** or **-** to the Lighting submenu.
- ▶ Press button **▲** or **▼** repeatedly until the message Interior lamp delayed shut-off appears in the multifunction display.

The selection marker is on the current setting.



- ▶ Press button **+** or **-** to switch the interior lighting delayed shut-off feature On or Off.

Vehicle submenu

Access the Vehicle submenu via the Settings menu. Use the Vehicle submenu to make general vehicle settings.

The following function is available:

Function	Page
Selecting audio search function	163
Setting automatic locking	164

Selecting audio search function

Use of the Audio Search function to select a radio station (▷ page 149) will enable you to start a frequency scan (Freq.) or select a radio station stored in memory (Memory).

- ▶ Move the selection marker with button **+** or **-** to the Vehicle submenu.
- ▶ Press button **▲** or **▼** repeatedly until the message Audio Search function appears in the multifunction display.

The selection marker is on the current setting.



- ▶ Press button **+** or **-** to set the audio search function to Freq. or Memory.

To select a radio station, see “Selecting radio station” (▷ page 149).

Control system

Setting automatic locking

Use this function to activate or deactivate the automatic central locking. With the automatic central locking system activated, the vehicle is centrally locked at vehicle speeds of approximately 9 mph (15 km/h).

- ▶ Move the selection marker with button **+** or **-** to the Vehicle submenu.
- ▶ Press button **▲** or **▼** repeatedly until the message Automatic door lock appears in the multifunction display.

The selection marker is on the current setting.



- ▶ Press button **+** or **-** to switch the automatic central locking On or Off.

Convenience submenu

Access the Convenience submenu via the Settings menu. Use the Convenience submenu to change the settings for the easy-entry/exit convenience feature.

Function	Page
Activating easy-entry/exit feature	164

Activating easy-entry/exit feature

Use this function to activate and deactivate the easy-entry/exit feature (▷ page 44).

Warning!



You must make sure no one can become trapped or injured by the moving steering wheel when the easy-entry/exit feature is activated.

To stop steering wheel movement, do one of the following:

- Move steering wheel adjustment stalk (▷ page 43).
- Press the memory position switch (▷ page 124).

Do not leave children unattended in the vehicle, or with access to an unlocked vehicle. Children could open the driver's door and unintentionally activate the easy-entry/exit feature, which could result in an accident and/or serious personal injury.

- ▶ Move the selection marker with button **+** or **-** to the Convenience submenu.
- ▶ Press button **↶** or **↷** repeatedly until the message **Easy-entry function** appears in the multifunction display.

The selection marker is on the current setting.



- ▶ Press button **+** or **-** to switch the easy-entry/exit feature On or Off.

Trip computer menu

Use the trip computer menu to call up statistical data on your vehicle.

The following information is available:

Function	Page
Fuel consumption statistics from start	165
Fuel consumption statistics since last reset	166
Call up range (distance to empty)	166

Fuel consumption statistics from start

- ▶ Press button **☰** or **☷** repeatedly until the first function of the trip computer menu appears in the multifunction display.
- ▶ Press button **↶** or **↷** repeatedly until the message **From start** appears in the multifunction display.

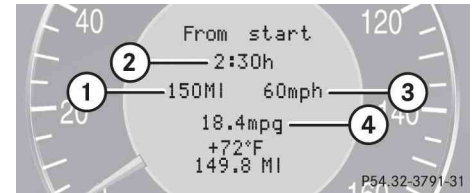





- ① Distance driven from start
- ② Time elapsed from start
- ③ Average speed from start
- ④ Average fuel consumption from start

i All statistics stored from the last engine start will be reset approximately four hours after the SmartKey in the starter switch is turned to position **0** or removed from the starter switch.

Resetting will not occur if you turn the SmartKey back to position **1** or **2** within this time period.

Control system



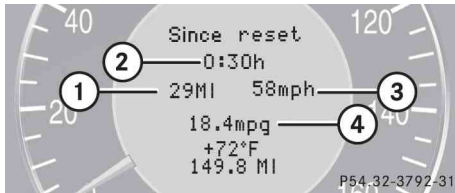

Fuel consumption since last reset

- ▶ Press button  or  repeatedly until the first function of the trip computer menu appears in the multifunction display.
- ▶ Press button  or  repeatedly until the message **Since reset** appears in the multifunction display.







- ① Distance driven since last reset
- ② Time elapsed since last reset
- ③ Average speed since last reset
- ④ Average fuel consumption since last reset

Resetting fuel consumption statistics

- ▶ Press button  or  repeatedly until the first function of the trip computer menu appears in the multifunction display.
- ▶ Press button  or  repeatedly until the reading that you want to reset appears in the multifunction display.
- ▶ Press and hold the reset button in the instrument cluster (▶ page 136) until the value is reset to 0.

Distance to empty

- ▶ Switch on the ignition (▶ page 38).
- ▶ Press button  or  repeatedly until the first function of the trip computer menu appears in the multifunction display.
- ▶ Press button  or  repeatedly until the message **Range:** appears in the multifunction display.

The calculated remaining driving range based on the current fuel tank level appears in the multifunction display. If the remaining fuel in the tank is sufficiently low, a fuel pump is shown instead of the range.



TEL menu*

Warning!



A driver's attention to the road must always be his/her primary focus when driving. For your safety and the safety of others, we recommend that you pull over to a safe location and stop before placing or taking a telephone call. If you choose to use the telephone while driving, please use the hands-free device and only use the telephone when weather, road and traffic conditions permit.

Some jurisdictions prohibit the driver from using a cellular telephone while driving a vehicle.

Bear in mind that at a speed of just 30 mph (approximately 50 km/h), your vehicle is covering a distance of 44 feet (approximately 14 m) every second.

Never operate radio transmitters equipped with a built-in or attached antenna (i.e. without being connected to an external antenna) from inside the vehicle while the engine is running. Doing so could lead to a malfunction of the vehicle's electronic system, possibly resulting in an accident and /or personal injury.

You can use the functions in the TEL menu to operate your telephone, provided it is connected to a hands-free system and switched on.

- ▶ Switch on the telephone and Audio or COMAND*.
- ▶ Press button  or  on the steering wheel repeatedly until the message TEL appears in the multifunction display.

Which messages will appear in the multifunction display depends on whether your telephone is switched on or off:

- If the telephone is off, the message TEL Off appears in the multifunction display.

- If the telephone is on:

The telephone will then search for a network. During this time the multifunction display is empty.

As soon as the telephone has found a network, the message READY appears in the multifunction display.



This standby message indicates that your telephone is ready for use and you can operate it using the control system.

Control system

Answering a call

When your telephone is ready to receive calls, you can answer a call at any time. In the multifunction display you will see the message, or if available, the caller ID (name and number):



- ▶ Press button .





You have answered the call. The duration of the call appears in the multifunction display.

Ending a call or rejecting an incoming call

- ▶ Press button .



Dialing a number from the phone book

If your telephone is ready to receive calls, you may select and dial a number from the phone book at any time.

- ▶ Press button  or  repeatedly until the message TEL appears in the multifunction display.
- ▶ Press button  or .

The control system reads the phone book which is stored in the telephone. This may take several minutes. The message *Please wait* appears in the multifunction display.



When the message *Please wait* disappears, the phone book has been loaded.

- ▶ Press button  or  repeatedly until the desired name appears in the multifunction display.

The stored names are displayed in ascending or descending alphabetical order.



- ① Name from the phone book

 If you press and hold button  or  for longer than one second, the system scrolls rapidly through the list of names until you release the button again.

Cancel the quick search mode by pressing .

- ▶ Press button .

The system dials the selected phone number.



- If the connection is successful and this feature is supported by your network provider, the name of the party you are calling (if stored in your phone book) and the duration of the call will appear in the multifunction display.



- If no connection is made, the control system stores the dialed number in the redial memory.



Redialing



The control system stores the most recently dialed phone numbers. This eliminates the need to search through your entire phone book.

- ▶ Press button  or  repeatedly until the message TEL appears in the multifunction display.

- ▶ Press button .

The first number in the redial memory appears in the multifunction display.

- ▶ Press button  or  repeatedly until the desired name appears in the multifunction display.

 If you do not want to use the telephone, press button .

- ▶ Press button .

The control system dials the selected phone number.

Automatic transmission

For more information on driving with an automatic transmission, see “Automatic transmission” (▷ page 50).

Your vehicle’s transmission adapts its gear shifting process to your individual driving style by continually adjusting the shift points up or down. These shift point adjustments are performed based on current operating and driving conditions.

If the operating conditions change, the automatic transmission reacts by adjusting its shift program.

i During the brief warm-up, transmission upshifting is delayed. This allows the catalytic converter to heat up more quickly to operating temperature.

Warning!



Make sure that absolutely no objects are obstructing the pedals’ range of movement. Keep the driver’s footwell clear of all obstacles. If there are any floor mats or carpets in the footwell, make sure that the pedals still have sufficient clearance.

During sudden driving or braking maneuvers the objects could get caught between or beneath the pedals. You could then no longer brake or accelerate. This could lead to accidents and injury.

Gear selector lever

The gear selector lever is located on the lower part of the center console.

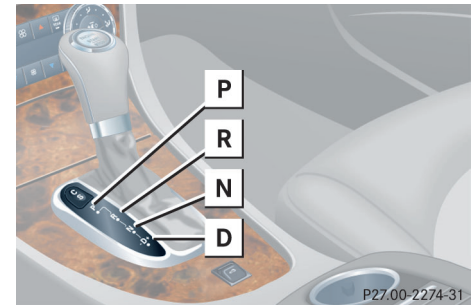

Gearshift pattern for automatic transmission

- P** Park position
- R** Reverse gear
- N** Neutral
- D** Drive position

i The current gear selector lever position **P**, **R**, **N** or **D** appears in the multifunction display (▷ page 172).

Warning!

It is dangerous to shift the gear selector lever out of park position **P** or neutral position **N** if the engine speed is higher than idle speed. If your foot is not firmly on the brake pedal, the vehicle could accelerate quickly forward or reverse. You could lose control of the vehicle and hit someone or something. Only shift into gear when the engine is idling normally and when your right foot is firmly on the brake pedal.

An additional indication of the current gear selector lever position can be found on the cover of the shifting-gate.

The indicators come on when you activate a switch (e.g. unlocking the vehicle or opening a door) and go out after approximately 15 minutes.

Shifting procedure

The automatic transmission selects individual gears automatically, depending on:

- gear selector lever position **D** (▷ page 172) with gear ranges (▷ page 175)
- the selected program mode: **(C/S)** (▷ page 176)
or
(M/C/S) (CLK 63 AMG only) (▷ page 181)
- the position of the accelerator pedal (▷ page 174)
- the vehicle speed

! Allow engine to warm up under low load use. Do not place full load on the engine until the operating temperature has been reached.

Shift into reverse gear **R** or park position **P** only when the vehicle is stopped.

Avoid spinning of a drive wheel when driving off on slippery road surfaces. This may cause serious damage to the drivetrain which is not covered by the Mercedes-Benz Limited Warranty.

When the gear selector lever is in drive position **D**, you can influence transmission shifting by:

- limiting the gear range
- changing gears manually

Automatic transmission

Gear selector lever positions

The current gear selector lever position appears in the multifunction display.



① Current gear selector lever position

Effect

P Park position

Gear selector lever position when the vehicle is parked. Place gear selector lever in park position **P** only when vehicle is stopped. The park position is not intended to serve as a brake when the vehicle is parked.

Rather, the driver should always set the parking brake in addition to placing the gear selector lever in park position **P** to secure the vehicle.

Effect

The SmartKey can only be removed from the starter switch with the gear selector lever in park position **P**. With the SmartKey removed, the gear selector lever is locked in park position **P**.

If the vehicle's electrical system is malfunctioning, the gear selector lever could remain locked in park position **P** (▷ page 412).

R Reverse gear

Place gear selector lever in position **R** only when vehicle is stopped.

	Effect
N	<p>Neutral</p> <p>No power is transmitted from the engine to the drive axle. When the brakes are released, the vehicle can be moved freely (pushed or towed).</p> <p>To avoid damage to the transmission, never engage neutral position N while driving.</p> <p>If the ESP[®] is deactivated or malfunctioning: Move gear selector lever to neutral position N only if the vehicle is in danger of skidding, e.g. on icy roads.</p>
D	<p>Drive</p> <p>The transmission shifts automatically. All forward gears are available.</p>

! *Coasting the vehicle, or driving for any other reason with gear selector lever in neutral position **N** can result in transmission damage that is not covered by the Mercedes-Benz Limited Warranty.*

Warning!

Position **P** alone is not intended to or capable of preventing your vehicle from moving, possibly hitting people or objects. Always set the parking brake in addition to shifting to park position **P** (▷ page 52).

When parked on an incline, turn the front wheels towards the road curb.

Do not park this vehicle in areas where combustible materials such as grass, hay or leaves can come into contact with the hot exhaust system, as these materials could be ignited and cause a vehicle fire.

Warning!

When leaving the vehicle, always remove the SmartKey or SmartKey with KEYLESS-GO* from the starter switch, take it with you, and lock the vehicle. Do not leave children unattended in the vehicle, or with access to an unlocked vehicle. Children could move the gear selector lever from park position **P**, which could result in an accident and/or serious personal injury.

Getting out of your vehicle without taking the above measurements to secure it is dangerous.

Automatic transmission

Driving tips

Accelerator position

Your driving style influences the transmission's shifting behavior:

Less throttle	Earlier upshifting
More throttle	Later upshifting

Kickdown

Use kickdown when you want maximum acceleration.

- ▶ Press the accelerator past the point of resistance.
Depending on the engine speed the transmission shifts into a lower gear.
- ▶ Ease on the accelerator when you have reached the desired speed.
The transmission shifts up again.

Stopping

When you stop briefly, e.g. at traffic lights:

- ▶ Leave the transmission in gear.
- ▶ Hold the vehicle with the brake.

When you stop for a longer period of time with the engine idling and/or on a hill:

- ▶ Set the parking brake.
- ▶ Move the gear selector lever to park position **P**.

Maneuvering

When you maneuver in tight areas, e.g. when pulling into a parking space:

- ▶ Control the vehicle speed by gradually releasing the brakes.
- ▶ Accelerate gently.
- ▶ Never abruptly step on the accelerator.

Working on the vehicle

Warning!



When working on the vehicle, set the parking brake and move gear selector lever to park position **P**. Otherwise the vehicle could roll away.

Gear ranges

With the gear selector lever in drive position **D** and driving in program mode **C** or **S** (▷ page 176), you can select a gear range for the automatic transmission to operate within.

Gear selector lever (▷ page 177):

You can limit the gear range by pressing the gear selector lever to the left (**D-**), and reverse the gear range limit by pressing the gear selector lever to the right (**D+**).

Steering wheel gearshift control* (▷ page 179):

You can limit the gear range by pulling the left gearshift paddle on the steering wheel gearshift control, and reverse the gear range limit by pulling the right gearshift paddle on the steering wheel gearshift control.

The selected gear range appears in the multifunction display.



① Current gear range

Effect	
6	The transmission shifts through sixth gear only.
5	The transmission shifts through fifth gear only.
4	The transmission shifts through fourth gear only.

Effect	
3	The transmission shifts through third gear only. With this selection you can use the braking effect of the engine.
2	The transmission shifts through second gear only. Allows the use of engine's braking power when driving <ul style="list-style-type: none"> • on steep downgrades • in mountainous regions • under extreme operating conditions
1	The transmission operates in first gear only. For maximum use of engine's braking effect on very steep or lengthy downgrades.

Automatic transmission

Automatic shift program

The program mode selector switch is located on the lower part of the center console.



Program mode selector switch

- C** Comfort For comfort driving
- S** Sport For standard driving



Program mode selector switch (CLK 63 AMG only)

- M** Manual For manual gear shifting (▷ page 181)
- C** Comfort For standard driving
- S** Sport For sporty driving

The selected program mode appears in the multifunction display.



- ① Selected program mode (comfort, sport, or manual (CLK 63 AMG only))

! Never change the program mode when the gear selector lever is out of park position **P**. This could result in a change of driving characteristics for which you may not be prepared.

i The last selected program mode (**C** or **S**) is switched on when the engine is restarted.

- ▶ Press program mode selector switch repeatedly until the letter of the desired program mode appears in the multifunction display.

Select **C** for comfort driving (CLK 63 AMG: for standard driving):

- The vehicle starts out in second gear (both forward and reverse) for gentler starts. This does not apply if full throttle is applied or gear range **1** is selected.
- Traction and driving stability are improved on icy roads.
- Upshifts occur earlier even when you give more gas. The engine then operates at lower rpms and the wheels are less likely to spin.

Select **S** for standard driving (CLK 63 AMG: for sporty driving):

- The vehicle starts out in first gear.
- Upshifts occur later.

Gear selector lever one-touch gearshifting

With the gear selector lever in drive position **D** and driving in program mode **C** or **S**, you can limit or extend the gear range.

If your vehicle is equipped with manual shift program **M**, you can use the gear selector lever to manually shift the gears.

i For information on using the gear selector lever in program mode **M**, see “Manual shift program CLK 63 AMG” (▷ page 181).

! Allow engine to warm up under low load use. Do not place full load on the engine until the operating temperature has been reached.

Shift into reverse gear **R** or park position **P** only when the vehicle is stopped.

Avoid spinning of a drive wheel when driving off on slippery road surfaces. This may cause serious damage to the drivetrain which is not covered by the Mercedes-Benz Limited Warranty.

The following instructions describe operation of the gear selector lever when driving in the automatic program mode **C** or **S**.

Limiting gear range

Warning!



On slippery road surfaces, never downshift in order to obtain braking action. This could result in drive wheel slip and reduced vehicle control. Your vehicle's ABS will not prevent this type of loss of control.

- ▶ Briefly press the gear selector lever to the left in the **D**- direction.

The transmission will shift to the next lower gear as permitted by the shift program. This action simultaneously limits the gear range of the transmission (▷ page 175).

i To avoid overrevving the engine when downshifting, the transmission will not shift to a lower gear if the engine's max. speed would be exceeded.

Automatic transmission

Extending gear range

- ▶ Briefly press the gear selector lever to the right in the **D+** direction.

The transmission will shift to the next higher gear as permitted by the shift program. This action simultaneously extends the gear range of the transmission.

i *If you press on the accelerator when the engine has reached its rpm limit, the transmission will upshift beyond any gear range limit selected.*

Canceling gear range limit

- ▶ Press and hold the gear selector lever in the **D+** direction until **D** reappears in the multifunction display (▷ page 172).

The transmission will shift from the current gear range directly to gear range **D**.

Shifting into optimal gear range

- ▶ Press and hold the gear selector lever in the **D-** direction.

The transmission will automatically select the gear range suited for optimal acceleration and deceleration. This will involve shifting down one or more gears.

Steering wheel gearshift control one-touch gearshifting*

With the gear selector lever in drive position **D** and driving in program mode **C** or **S**, you can limit or extend the gear range.

If your vehicle is equipped with manual shift program **M**, you can use the steering wheel gearshift control to manually shift the gears.

i For information on using the steering wheel gearshift control in program mode **M**, see “Manual shift program CLK 63 AMG” (▷ page 181).

! Allow engine to warm up under low load use. Do not place full load on the engine until the operating temperature has been reached.

Shift into reverse gear **R** or park position **P** only when the vehicle is stopped.

Avoid spinning of a drive wheel when driving off on slippery road surfaces. This may cause serious damage to the drivetrain which is not covered by the Mercedes-Benz Limited Warranty.



Gearshift paddles (example illustration CLK 550)

- ① Left shift paddle: limiting gear range or downshift (in program mode **M**)
- ② Right shift paddle: extending gear range or upshift (in program mode **M**)

i You cannot shift with the steering wheel gearshift paddles when the gear selector lever is in position **P**, **N** or **R**.

The following instructions describe operation of the steering wheel gearshift control when driving in the automatic program mode **C** or **S**.

Automatic transmission

Limiting gear range

Warning!



On slippery road surfaces, never downshift in order to obtain braking action. This could result in drive wheel slip and reduced vehicle control. Your vehicle's ABS will not prevent this type of loss of control.

- ▶ Briefly pull left shift paddle ①.

The transmission will shift to the next lower gear as permitted by the shift program. This action simultaneously limits the gear range of the transmission (▷ page 175).

i *To avoid overrevving the engine when downshifting, the transmission will not shift to a lower gear if the engine's max. speed would be exceeded.*

Extending gear range

- ▶ Briefly pull right shift paddle ②.

The transmission will shift to the next higher gear as permitted by the shift program. This action simultaneously extends the gear range of the transmission.

i *If you press on the accelerator when the engine has reached its rpm limit, the transmission will upshift beyond any gear range limit selected.*

Canceling gear range limit

- ▶ Pull and hold right shift paddle ② until **D** reappears in the multifunction display (▷ page 172).

The transmission will shift from the current gear range directly to gear range **D**.

Shifting into optimal gear range

- ▶ Pull and hold left shift paddle ①.

The transmission will automatically select the gear range suited for optimal acceleration and deceleration. This will involve shifting down one or more gears.

Manual shift program CLK 63 AMG

In addition to the automatic shift program **C** or **S**, your vehicle is equipped with the manual shift program **M**.

In the manual program mode **M**, system-controlled automatic gearshifting is switched off and you need to change the gears by manually upshifting or downshifting using the steering wheel gearshift paddles (▷ page 179) or the gear selector lever.

! Allow engine to warm up under low load use. Do not place full load on the engine until the operating temperature has been reached.

Shift into reverse gear **R** or park position **P** only when the vehicle is stopped.

Avoid spinning of a drive wheel when driving off on slippery road surfaces. This may cause serious damage to the drivetrain which is not covered by the Mercedes-Benz Limited Warranty.

The program mode selector switch is located on the lower part of the center console.



Program mode selector switch

M Manual	For manual gear shifting
C Comfort	For standard driving
S Sport	For sporty driving

The selected program mode appears in the multifunction display (▷ page 176).

i For information on automatic program modes **C** or **S**, see “Automatic shift program” (▷ page 176), “Gear selector lever one-touch gearshifting” (▷ page 177), and “Steering wheel gearshift control one-touch gearshifting*” (▷ page 179).

Automatic transmission

Activating manual shift program

- ▶ Press program mode selector switch repeatedly until the **M** for manual program mode **M** appears in the multifunction display.

The transmission switches to the manual program mode **M**. Automatic shifting is switched off. The gear range is not limited.

You can change the gears manually when the gear selector lever is in drive position **D**. You can upshift or downshift through the gears in succession.

i *The manual program mode **M** will not be stored. When the engine is turned off with the manual program mode **M** selected, the transmission will go to the automatic program mode (**C** or **S**) when the engine is restarted.*

Upshifting

! *In the manual program mode **M**, the transmission will not upshift, even if the engine has reached its overrevving range. Shift up to the next gear before the engine has reached its overrevving range. Make absolutely certain that the engine speed does not reach the red marking on the tachometer (▷ page 26). Otherwise the engine could be damaged which is not covered by the Mercedes-Benz Limited Warranty.*

- ▶ Briefly press the gear selector lever to the right in the **D+** direction.

or

- ▶ Briefly pull right shift paddle ② (▷ page 179).

The transmission shifts to the next higher gear.

If, instead of the manual program mode symbol **M**, the **^** symbol appears in the multifunction display (▷ page 176), shift to the next higher gear. The fuel supply will otherwise be interrupted to prevent the engine from overrevving.

If you have selected the AMG menu in the control system and you are driving in the manual program mode **M**, upshift indicator ② in the multifunction display advises you to upshift before the engine reaches the overspeed range. Thus you can drive at the maximum engine speed for each gear without overrevving the engine.

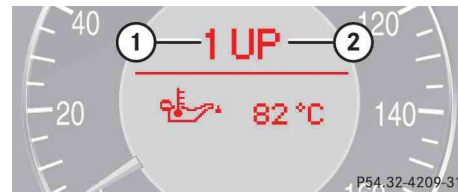

- ① Gear indicator
- ② Upshift indicator

- ▶ Shift to the next higher gear.

The fuel supply will otherwise be interrupted to prevent the engine from overrevving.

Downshifting

Warning!



On slippery road surfaces, never downshift in order to obtain braking action. This could result in drive wheel slip and reduced vehicle control. Your vehicle's ABS will not prevent this type of loss of control.

- ▶ Briefly press the gear selector lever to the left in the **D**- direction.

or

- ▶ Briefly pull left shift paddle ① (▷ page 179).

The transmission shifts to the next lower gear.

i When you brake or stop, the transmission shifts down to a gear from which you can easily accelerate or take off.

Kickdown

Using the kickdown when driving in the manual program mode **M** is not possible.

Deactivating manual shift program

- ▶ Press the program mode selector switch (▷ page 181) repeatedly until **C** or **S** appears in the multifunction display.

or

- ▶ Restart the engine.

The transmission will go to the automatic program mode (**C** or **S**).

The manual program mode **M** is not stored.

Emergency operation (Limp-Home Mode)

If vehicle acceleration becomes less responsive or sluggish or the transmission no longer shifts, the transmission is most likely operating in limp-home (emergency operation) mode. In this mode only second gear and reverse gear can be selected.

- ▶ Stop the vehicle in a safe location.
- ▶ Move the gear selector lever to park position **P**.
- ▶ Turn off the engine.
- ▶ Wait at least 10 seconds before restarting.
- ▶ Restart the engine.
- ▶ Move the gear selector lever to position **D** (for second gear) or position **R**.
- ▶ Have the transmission checked at an authorized Mercedes-Benz Center as soon as possible.

Good visibility

For information on the windshield wipers, see “Windshield wipers” (▷ page 55).

Headlamp cleaning system*

The button is located on the left side of the dashboard.



① Headlamp washer button

- ▶ Switch on the ignition (▷ page 38).
- ▶ Press button ①.

The headlamps are cleaned with a high-pressure water jet.

i The headlamps will automatically be cleaned when you have

- switched on the headlamps and
- operated the windshield wipers with windshield washer fluid fifteen times

When you switch off the ignition, the counter resets.

For information on filling up the washer reservoir, see “Windshield washer system and headlamp cleaning system**” (▷ page 479).

Rear view mirrors

For more information on setting the rear view mirrors, see “Mirrors” (▷ page 45).

Interior rear view mirror, antiglare position

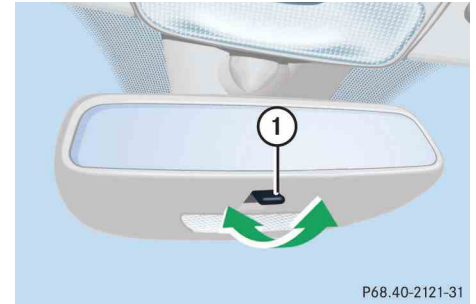

① Lever

- ▶ Tilt the mirror to the antiglare position by moving lever ① towards the windshield.

The interior rear view mirror is dimmed.

Auto-dimming rear view mirrors*

The reflection brightness of the exterior rear view mirror on the driver's side and the interior rear view mirror will respond automatically to glare when

- the ignition is switched on, and
- incoming light from headlamps falls on the sensor in the interior rear view mirror.

The rear view mirror will not react if

- reverse gear **R** is engaged
- the interior lighting is turned on

Warning!

The auto-dimming function does not react if incoming light is not aimed directly at sensors in the interior rear view mirror.

The interior rear view mirror and the exterior rear view mirror on the driver's side do not react, for example, if the wind screen is installed.

Light hitting the mirror(s) at certain angles (incident light) could blind you. As a result, you may not be able to observe traffic conditions and could cause an accident.

Warning!

In case of an accident, liquid electrolyte may escape from the mirror housing if the mirror glass breaks.

Electrolyte has an irritating effect. Do not allow the liquid to come into contact with eyes, skin, clothing, or respiratory system. In case it does, immediately flush affected area with water, and seek medical help if necessary.

! *Electrolyte drops coming into contact with the vehicle paint finish can be completely removed only while in the liquid state and by applying plenty of water.*

Warning!

Exercise care when using the passenger-side exterior rear view mirror. The mirror surface is convex (outwardly curved surface for a wider field of view). Objects in mirror are closer than they appear. Check your interior rear view mirror or glance over your shoulder before changing lanes.

Good visibility

Sun visors

The sun visors protect you from sun glare while driving.

Warning!



Do not use the vanity mirror while driving.

Keep the vanity mirrors in the sun visors closed while vehicle is in motion. Reflected glare can endanger you and others.

- ▶ Swing sun visor ④ down when you experience glare.

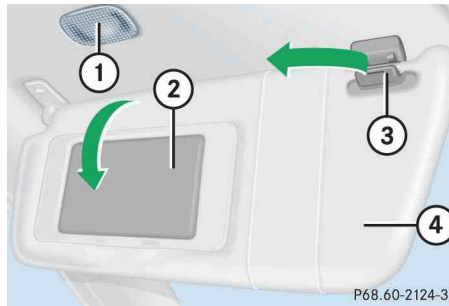

P68.60-2124-31

- ① Vanity mirror lamp
- ② Vanity mirror cover
- ③ Mounting
- ④ Sun visor

- ▶ To use the illuminated vanity mirror, lift up mirror cover ②.

i If sun visor ④ is disengaged from mounting ③ with vanity mirror cover ② open, vanity mirror lamp ① will switch off.

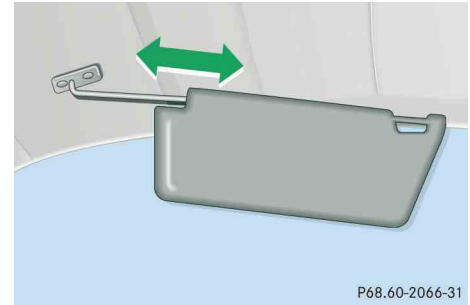

P68.60-2066-31

If sunlight enters through a side window:

- ▶ disengage sun visor from mounting ③.
- ▶ pivot sun visor to the side.

The sun visors are extendable.

- ▶ Adjust the sun visors by pushing or pulling in the direction of the arrows.

! Close vanity mirror cover ② (if open) before you disengage the sun visor ④ from mounting ③ and pivot it to the side.

Rear window defroster

The rear window defroster uses a large amount of power. To keep the battery drain to a minimum, switch off the defroster as soon as the rear window is clear. The defroster is automatically deactivated after approximately 6 to 17 minutes of operation depending on the outside temperature.



- ▶ Switch on the ignition (▷ page 36).

Warning!



Any accumulation of snow and ice should be removed from the rear window before driving. Visibility could otherwise be impaired, endangering you and others.

Activating

- ▶ Press button  or  in the climate control panel (▷ page 189) or automatic climate control panel (▷ page 199).

The indicator lamp on the button comes on.

Deactivating

- ▶ Press button  or  again.

The indicator lamp on the button goes out.

! *If the rear window defroster switches off too soon and the indicator lamp starts flashing, this means that too many electrical consumers are operating simultaneously and there is insufficient voltage in the battery. The system responds automatically by deactivating the rear window defroster.*

As soon as the battery has sufficient voltage, the rear window defroster automatically switches on again.

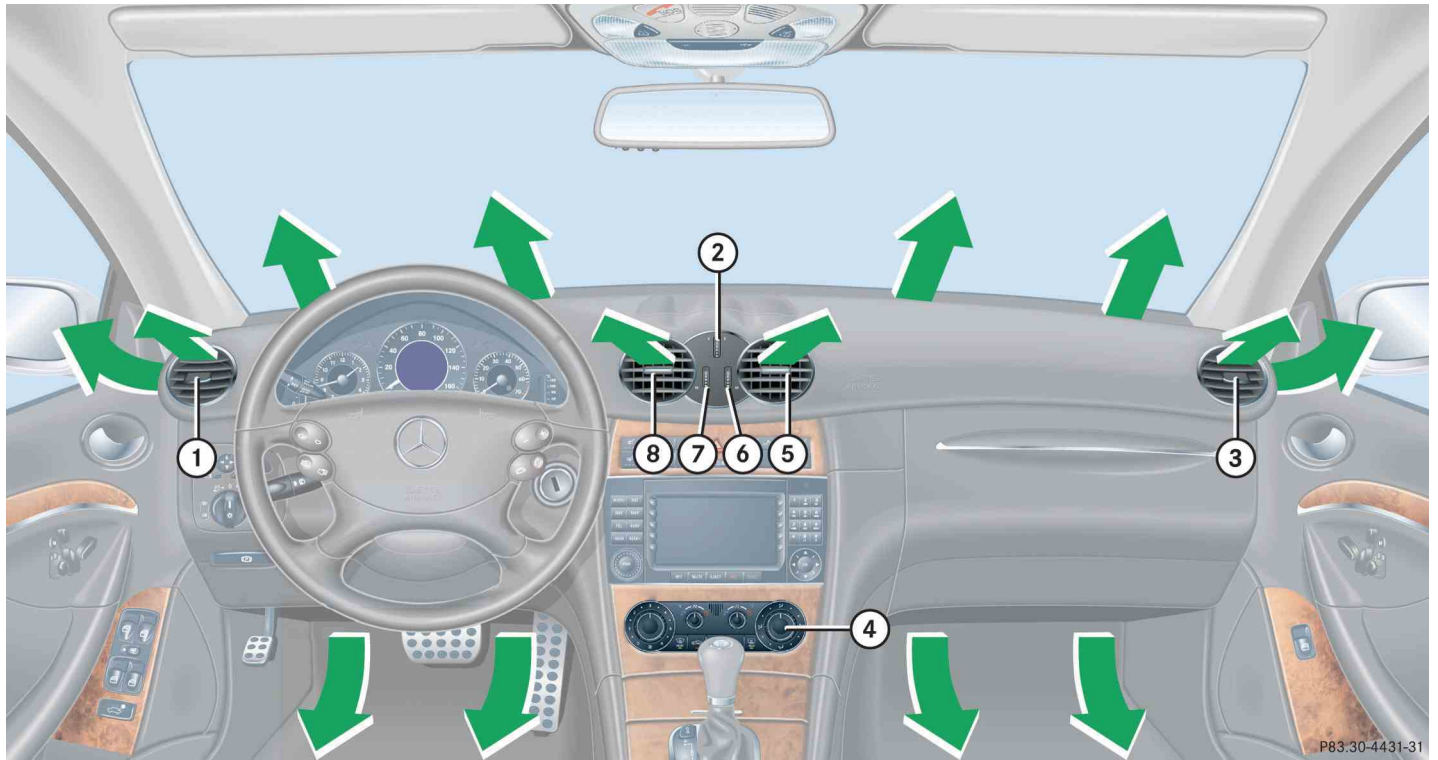

P83.30-4431-31

CLK 350 standard equipped with climate control for Canada, for USA depending on vehicle production date.

Item
① Left side air vent, adjustable
② Thumbwheel for air volume control for center air vents
③ Right side air vent, adjustable
④ Climate control panel
⑤ Right center air vent, adjustable
⑥ Thumbwheel for air volume control for right side center air vent
⑦ Thumbwheel for air volume control for left side center air vent
⑧ Left center air vent, adjustable

i For draft-free ventilation, move the sliders for the side air vents and center air vents to the middle position.

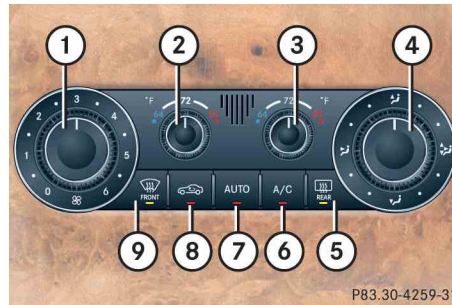

USA only (depending on vehicle production date)

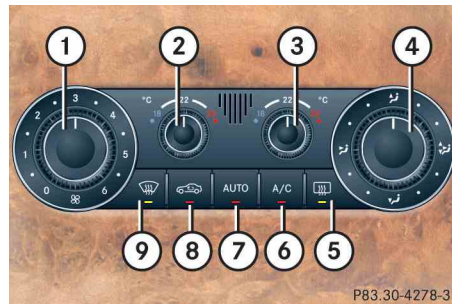

Canada only

Item
① Air volume control
② Left side temperature control
③ Right side temperature control
④ Air distribution control
⑤ Rear window defroster
⑥ AC cooling on/off
⑦ Air distribution and air volume (automatic mode)
⑧ Air recirculation
⑨ Front defroster

Climate control

The climate control is operational whenever the engine is running. You can operate the climate control system in either the automatic or manual mode. The system cools or heats the interior depending on the selected interior temperature and the current outside temperature.

Warning!



When operating the climate control, the air that enters the passenger compartment through the air vents can be very hot or very cold (depending on the set temperature). This may cause burns or frostbite on unprotected skin in the immediate area of the air vents. Always keep sufficient distance between unprotected parts of the body and the air vents. If necessary, use the air distribution control (> page 189) to direct the air to air vents in the vehicle interior that are not in the immediate area of unprotected skin.

Nearly all dust particles, pollutants and odors are filtered out before outside air enters the passenger compartment through the air distribution system.

The air conditioning will not engage (no cooling) if the **A/C** mode is deactivated (> page 196).

Warning!



Follow the recommended settings for heating and cooling given on the following pages. Otherwise the windows could fog up, impairing visibility and endangering you and others.

i Severe conditions (e.g. strong air pollution) may require replacement of the filter before its scheduled interval. A clogged filter will reduce the air volume to the interior.

If the vehicle interior is hot, ventilate the interior before driving off, see “Summer opening feature” (> page 252). The climate control will then adjust the interior temperature to the set value much faster.

Keep the air intake grille in front of the windshield free of snow and debris.

Do not obstruct air flow by placing objects on the air flow-through exhaust slots below the rear window.

Deactivating the climate control system

Warning!



When the climate control is switched off, the outside air supply and circulation are also switched off. Only choose this setting for a short time. Otherwise the windows could fog up, impairing visibility and endangering you and others.

Deactivating

- ▶ Set air volume control ① (▷ page 189) to position **0**.

Reactivating

- ▶ Make sure the ignition is switched on.
- ▶ Set air volume control ① (▷ page 189) to any speed.

The previous settings are once again in effect.

Operating the climate control system in automatic mode

i When operating the climate control system in automatic mode, you will only rarely need to adjust the temperature, air volume and air distribution.

*In automatic mode, the dehumidify function is switched on when the system is cooling. If necessary, this function can be switched off by pushing the **A/C** button.*

Activating

- ▶ Press button **AUTO** (▷ page 189) while the engine is running.

The indicator lamp on the button comes on. The air volume and air distribution are adjusted automatically.

- ▶ Use temperature controls ② and ③ (▷ page 189) to separately adjust the air temperature on each side of the passenger compartment.

The temperature of the vehicle interior is adjusted automatically.

Deactivating

- ▶ Press button **AUTO** (▷ page 189) again.

The indicator lamp on the button goes out. The automatic operation of air volume and air distribution switches off.

Climate control

Setting the temperature

Use temperature controls ② and ③ (▷ page 189) to separately adjust the air temperature on each side of the passenger compartment. You should raise or lower the temperature setting in small increments, preferably starting at 72°F (22°C). The climate control will adjust to the set temperature as fast as possible.

Increasing

- ▶ Turn temperature control ② and/or ③ (▷ page 189) slightly clockwise.

The climate control system will correspondingly adjust the interior air temperature.

i *If you turn the temperature control fully clockwise for one side of the vehicle, you are increasing the temperature for the other side of the vehicle as well.*

Decreasing





- ▶ Turn temperature control ② and/or ③ (▷ page 189) slightly counterclockwise.

The climate control system will correspondingly adjust the interior air temperature.

i *If you turn the temperature control fully counterclockwise for one side of the vehicle, you are decreasing the temperature for the other side of the vehicle as well.*

Adjusting air distribution

Use air distribution control ④ (▷ page 189) to adjust the air distribution. The following symbols are located on the controls:

Symbol	Function
	Directs air through the center, side and rear passenger compartment air vents
	Directs air to the windshield and the side defroster vents
	Directs air into the entire vehicle interior
	Directs air to the footwells

- ▶ Press button **AUTO** (▷ page 189).

The indicator lamp on the button goes out. The automatic air distribution is switched off. The air distribution is controlled according to the selected control setting.

- ▶ Turn air distribution control ④ (▷ page 189) to the desired symbol.

Opening center and side air vents

- ▶ Turn thumbwheels ②, ⑥ and ⑦ (▷ page 188) upward.

The side air vents ① and ③ and center air vents ⑤ and ⑧ are open.

Closing center and side air vents

- ▶ Turn thumbwheels ②, ⑥ and ⑦ (▷ page 188) downward.

The side air vents ① and ③ and center air vents ⑤ and ⑧ are closed.

Adjusting air volume

Six blower speeds are available.

- ▶ Press button **AUTO** (▷ page 189).

The indicator lamp on the button goes out. The automatic air volume control is switched off. The air volume is controlled according to the currently selected control setting.



- ▶ Use the air volume control ① (▷ page 189) to adjust the air volume.

Front defroster

You can use this setting to defrost the windshield, for example if it is iced up. You can also defog the windshield and the side windows.

i *Keep this setting selected only until the windshield or the side windows are clear again.*

Activating

- ▶ Press button  or  (▷ page 189).

The indicator lamp on the button comes on.



The air conditioning switches automatically to the following functions:

- cooling on to dehumidify
- maximum blowing and heating power
- air flows onto the windshield and the front side windows
- the air recirculation mode is switched off

Climate control

i If you have switched on the defrost function using the  or  button, you cannot make any other settings.

Deactivating

▶ Press button  or  (> page 189) again.

The indicator lamp on the button goes out. Defrosting is turned off.

The previous settings are once again in effect.

i The cooling remains switched on.

Windshield fogged on the outside

i Keep this setting selected only until the windshield is clear again.

▶ Switch the windshield wipers on (> page 55).

If the automatic mode of the climate control is switched off:



▶ Turn air distribution control ④ to  or  (> page 189).

Air recirculation mode

Switch to air recirculation mode to prevent unpleasant odors from entering the vehicle from the outside (e.g. before driving through a tunnel). This setting cuts off the intake of outside air and recirculates the air in the passenger compartment.

Warning!



Fogged windows impair visibility, endangering you and others. If the windows begin to fog on the inside, switching off the air recirculation mode immediately should clear interior window fogging. If interior window fogging persists, make sure the air conditioning (> page 196) is activated, or press button  or .

Activating

▶ Press button  (> page 189).

The indicator lamp on the button comes on.

i The air recirculation mode is activated automatically at high outside temperatures.

The indicator lamp on button  is not lit when the air recirculation mode is automatically switched on.

A quantity of outside air is added after approximately 30 minutes.

Deactivating

- ▶ Press button  (> page 189).

The indicator lamp on the button goes out.

i *The air recirculation mode is deactivated automatically:*

- *after 5 minutes if the outside temperature is below approximately 41 °F (5 °C)*
- *after 5 minutes if the air conditioning is turned off*
- *after 30 minutes if the outside temperature is above approximately 41 °F (5 °C)*

Air recirculation mode with convenience closing or opening feature

Warning!



Never operate the side windows if there is the possibility of anyone being harmed by the closing procedure.

When using the air recirculation mode with convenience closing feature, should the upward movement of a window be blocked by some obstructions including but not limited to arms, hands, fingers. etc., the automatic reversal feature will not operate.



In the event that the procedure causes potential danger, the closing of the side windows can be immediately halted by releasing the  button or by pressing or pulling the respective window switch.

Convenience closing

- ▶ Press and hold button  (> page 189) until the windows are closed or have reached the desired position. The indicator lamp on the button comes on. The air recirculation mode is activated.

Convenience opening

- ▶ Press and hold button  (> page 189) until the windows have return to their previous position or they have reached the desired position. The indicator lamp on the button goes out. The air recirculation mode is deactivated.

i *A side window will only return to its previous position if it has not been moved to another position using the respective side window switch after it was closed with button . A side window that was moved will remain in its current position if button  is used to re-open the remaining side windows.*

Climate control

Air conditioning

The cooling function, is only operational when the engine is running, cools the vehicle interior down to the selected temperature. The cooling function also dehumidifies the air in the vehicle interior, thus preventing the windows from fogging up.

 *Condensation may drip out from underneath the vehicle. This is normal and not an indication of a malfunction.*

Warning!



If you turn off the cooling function, the vehicle will not be cooled when weather conditions are warm. The windows can fog up more quickly. Window fogging may impair visibility and endanger you and others.

Deactivating

It is possible to deactivate the air conditioning (cooling) function of the climate control system. The air in the vehicle will then no longer be cooled or dehumidified.

- ▶ Press button  (▷ page 189).

The indicator lamp on the button goes out.

The cooling function switches off after a short delay.

Activating

Moist air can fog up the windows. You can dehumidify the air with the air conditioning.

- ▶ Press button  (▷ page 189) again.

The indicator lamp on the button comes on.

The air conditioning uses the refrigerant R134a. This refrigerant is free of CFCs which are harmful to the ozone layer.

 *If the air conditioning cannot be turned on again, this indicates that the air conditioning is losing refrigerant. The compressor has turned itself off.*

Have the air conditioning checked at the nearest authorized Mercedes-Benz Center.

Rear passenger compartment adjustable air vents

The air conditioning for the rear passenger compartment is controlled via the climate control panel (> page 189).

i The temperature at the center air vents ② and ③ for the rear passenger compartment (> page 197) is the same as at the dashboard center air vents.

The air vents for the rear passenger compartment are located in the rear center console.

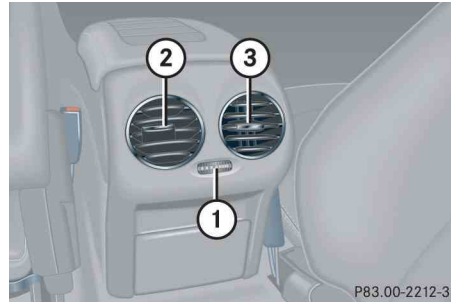

- ① Thumbwheel for air volume control for center air vents
- ② Left center air vent
- ③ Right center air vent

Adjusting air distribution

- ▶ Push the slide for the left center vent ② or right center vent ③ to the left, right, up or down.

The air flow is directed in the corresponding direction.

i For draft-free ventilation, move the slider for the center air vents ② and ③ upward.

Adjusting air volume

- ▶ Turn thumbwheel ① to the left or right.

The air volume is increased or decreased.

Automatic climate control

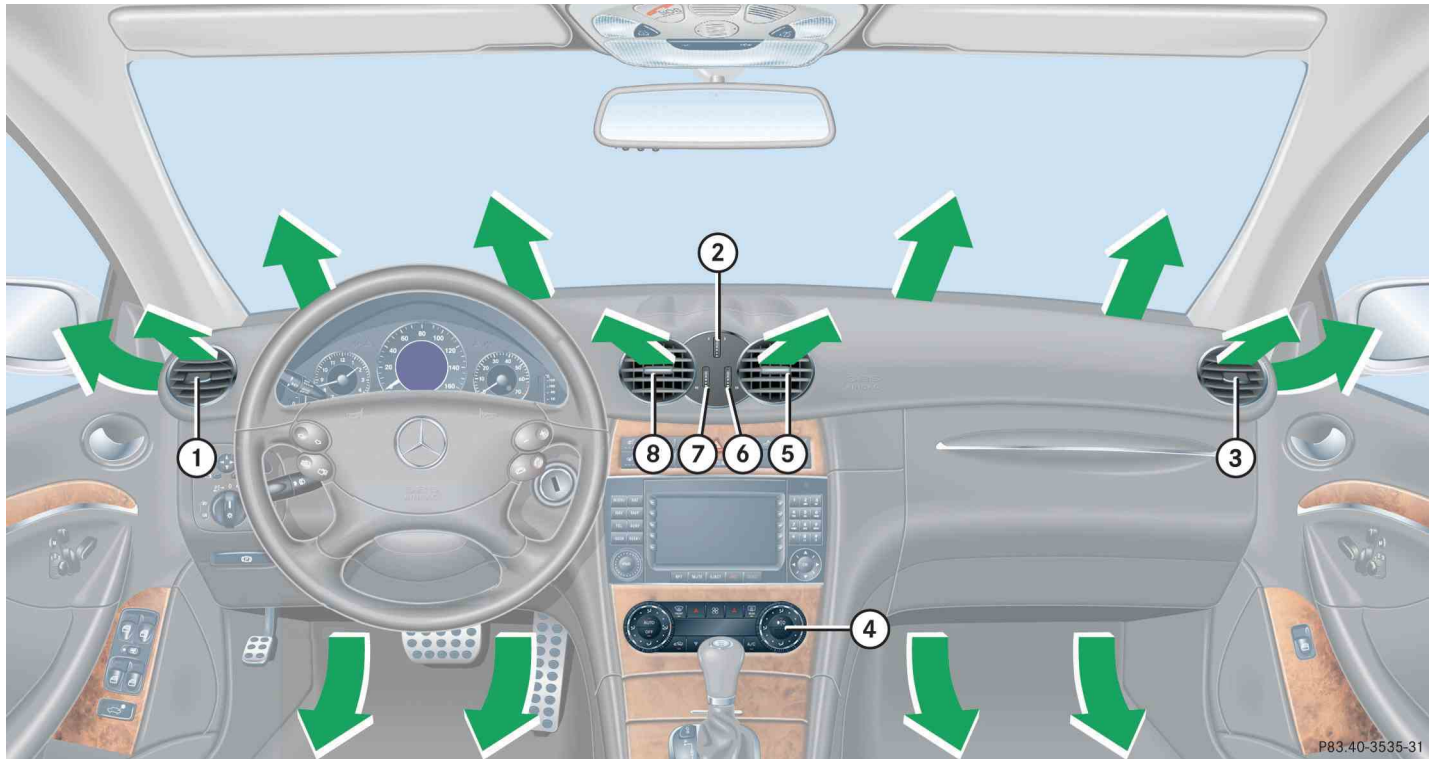

P83.40-3535-31

CLK 350 USA standard equipped with automatic climate control, depending on vehicle production date.
CLK 550 / CLK 63 AMG standard equipped with automatic climate control.

Automatic climate control

Item
① Left side air vent, adjustable
② Thumbwheel for air volume control for center air vents
③ Right side air vent, adjustable
④ Automatic climate control panel
⑤ Right center air vent, adjustable
⑥ Thumbwheel for air volume control for right side center air vent
⑦ Thumbwheel for air volume control for left side center air vent
⑧ Left center air vent, adjustable

i For draft-free ventilation, move the sliders for the center air vents and side air vents to the middle position.

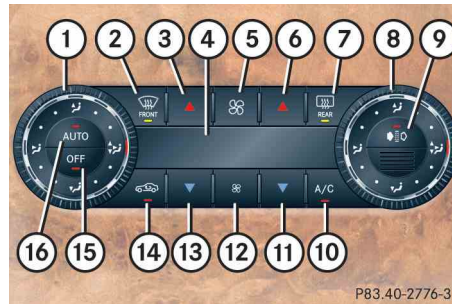

USA only



Canada only

Item
① Left side air distribution control
② Front defroster

Item
③ Temperature control, left, raising
④ Display
⑤ Air volume control, raising
⑥ Temperature control, right, raising
⑦ Rear window defroster
⑧ Right side air distribution control
⑨ Charcoal filter
⑩ AC cooling on/off Residual heat/ventilation (Canada only)
⑪ Temperature control, right, lowering
⑫ Air volume control, lowering
⑬ Temperature control, left, lowering
⑭ Air recirculation
⑮ Automatic climate control on/off (complete system)
⑯ Air distribution and air volume (automatic mode)

Automatic climate control

The automatic climate control is operational whenever the engine is running. You can operate the automatic climate control system in either the automatic or manual mode. The system cools or heats the interior depending on the selected interior temperature and the current outside temperature.

Warning!



When operating the automatic climate control, the air that enters the passenger compartment through the air vents can be very hot or very cold (depending on the set temperature). This may cause burns or frostbite on unprotected skin in the immediate area of the air vents. Always keep sufficient distance between unprotected parts of the body and the air vents. If necessary, use the air distribution controls (▷ page 199) to direct the air to air vents in the vehicle interior that are not in the immediate area of unprotected skin.

Nearly all dust particles, pollutants and odors are filtered out before outside air enters the passenger compartment through the air distribution system.

The air conditioning will not engage (no cooling) if the **A/C** mode is deactivated (▷ page 208).

Warning!



Follow the recommended settings for heating and cooling given on the following pages. Otherwise the windows could fog up, impairing visibility and endangering you and others.

i Severe conditions (e.g. strong air pollution) may require replacement of the filter before its scheduled interval. A clogged filter will reduce the air volume to the interior.

If the vehicle interior is hot, ventilate the interior before driving off, see “Summer opening feature” (▷ page 252). The automatic climate control will then adjust the interior temperature to the set value much faster.

Keep the air intake grille in front of the windshield free of snow and debris.

Do not obstruct air flow by placing objects on the air flow-through exhaust slots below the rear window.

Automatic climate control

Deactivating the automatic climate control system

Warning!



When the automatic climate control is switched off, the outside air supply and circulation are also switched off. Only choose this setting for a short time. Otherwise the windows could fog up, impairing visibility and endangering you and others.

Deactivating

- ▶ Press button **OFF** (▷ page 199).
The indicator lamp on the button comes on.

Reactivating

- ▶ Make sure the ignition is switched on.
- ▶ Press button **OFF** (▷ page 199).
The indicator lamp on the button goes out. The previous settings are once again in effect.

Operating the automatic climate control system in automatic mode

i When operating the climate control system in automatic mode, you will only rarely need to adjust the temperature, air volume and air distribution.

*In automatic mode, the dehumidify function is switched on when the system is cooling. If necessary, this function can be switched off by pushing the button **A/C** or **A/C BEST** (▷ page 199).*

i You can switch the automatic climate control system on and off for each side of the passenger compartment as desired.

Activating

- ▶ Press button **AUTO** (▷ page 199) while the engine is running.
The indicator lamp on the button comes on. The air volume and air distribution are adjusted automatically.

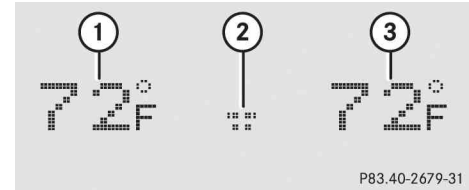

P83.40-2679-31

- ① Temperature, left
- ② Blower speed
- ③ Temperature, right

- ▶ Use temperature controls ③ and ⑬ or ⑥ and ⑪ (▷ page 199) to separately adjust the air temperature on each side of the passenger compartment.

The temperature of the vehicle interior is adjusted automatically.

Deactivating

- ▶ Press button **AUTO** (▷ page 199) again.
The indicator lamp on the button goes out. The automatic operation of air volume and air distribution switches off.

Automatic climate control

Setting the temperature

Use temperature controls ③ and ⑬ for the left side or ⑥ and ⑪ for the right side (▷ page 199) to separately adjust the air temperature on each side of the passenger compartment. You should raise or lower the temperature setting in small increments, preferably starting at 72°F (22°C). The automatic climate control will adjust to the set temperature as fast as possible.

Increasing

- ▶ Press and hold temperature button ③ and/or ⑥ (▷ page 199) until the desired temperature appears in the display ④ (▷ page 199).

The automatic climate control system will correspondingly adjust the interior air temperature.

i *If you increase the temperature for one side of the vehicle to the highest adjustable value then you will see the message HI in the display. This also increases the temperature for the other side of the vehicle.*

Decreasing





- ▶ Press and hold temperature button ⑪ and/or ⑬ (▷ page 199) until the desired temperature appears in the display ④ (▷ page 199).

The automatic climate control system will correspondingly adjust the interior air temperature.

i *If you decrease the temperature for one side of the vehicle to the lowest adjustable value then you will see the message LO in the display. This also decreases the temperature for the other side of the vehicle.*

Adjusting air distribution

Use the air distribution controls ① and ⑧ (▷ page 199) to separately adjust the air distribution on each side of the passenger compartment. The following symbols are located on the controls:

Symbol	Function
	Directs air to the windshield and the side defroster vents
	Directs air into the entire vehicle interior
	Directs air to the footwells
	Directs air through the center, side and rear passenger compartment air vents

- ▶ Turn air distribution control ① or ⑧ (▷ page 199) to the desired symbol.

The indicator lamp on the button **AUTO** goes out.

The automatic air distribution is switched off. The air distribution is controlled according to the selected control setting.

- i** You can also turn the air distribution control to a position between two symbols.

Opening center and side air vents

- ▶ Turn thumbwheels ②, ⑥ and ⑦ (▷ page 198) upward.

The center air vents ⑤ and ⑧ and side air vents ① and ③ (▷ page 198) are open.



Closing center and side air vents

- ▶ Turn thumbwheels ②, ⑥ and ⑦ (▷ page 198) downward.



The center air vents ⑤ and ⑧ and side air vents ① and ③ (▷ page 198) are closed.

Automatic climate control

Adjusting air volume

Use button **AUTO** (▷ page 199) for automatic mode or air volume controls  or  (▷ page 199) to adjust air volume manually.

Seven blower speeds are available.

- ▶ Press button  to decrease or  (▷ page 199) to increase air volume to the desired level.

The indicator lamp on the button **AUTO** goes out.



The automatic air distribution remains switched on.

Front defroster

You can use this setting to defrost the windshield, for example if it is iced up. You can also defog the windshield and the side windows.

i *Keep this setting selected only until the windshield or the side windows are clear again.*

Activating

- ▶ Press button  or  (▷ page 199).

The indicator lamp on the button comes on.

The air conditioning switches automatically to the following functions:

- cooling on to dehumidify
- maximum blowing and heating power
- air flows onto the windshield and the front side windows
- the air recirculation mode is switched off

i *If you have switched on the defrost function using the  or  button, you cannot make any other settings.*

Deactivating

- ▶ Press button  or  (▷ page 199) again.

The indicator lamp on the button goes out.

The previous settings are once again in effect.

i *The cooling remains switched on.*

Windshield fogged on the outside

i *Keep this setting selected only until the windshield is clear again.*

- ▶ Switch the windshield wipers on (▷ page 55).

If the automatic mode of the automatic climate control is switched off:

- ▶ Turn air distribution control ① or ⑧ to  or  (▷ page 199).

Maximum cooling MAXCOOL

If the left and right air distribution controls as well as the airflow volume control are set to **AUTO** (> page 199) and there is a high need for cooling, the display “MAXCOOL” appears.



This provides the fastest possible cooling of the vehicle interior (when side windows and soft top are closed).

Air recirculation mode

Switch to air recirculation mode to prevent unpleasant odors from entering the vehicle from the outside (e.g. before driving through a tunnel). This setting cuts off the intake of outside air and recirculates the air in the passenger compartment.

Warning!



Fogged windows impair visibility, endangering you and others. If the windows begin to fog on the inside, switching off the air recirculation mode immediately should clear interior window fogging. If interior window fogging persists, make sure the air conditioning (> page 208) is activated, or press button  or .

Activating

▶ Press button  (> page 199).

The indicator lamp on the button comes on.

i *The air recirculation mode is activated automatically at high outside temperatures.*

The indicator lamp on button  is not lit when the air recirculation mode is automatically switched on.

A quantity of outside air is added after approximately 30 minutes.

Automatic climate control

Deactivating

- ▶ Press button  (> page 199).

The indicator lamp on the button goes out.

i *The air recirculation mode is deactivated automatically:*

- *after 5 minutes if the outside temperature is below approximately 41 °F (5 °C)*
- *after 5 minutes if the air conditioning is turned off*
- *after 30 minutes if the outside temperature is above approximately 41 °F (5 °C)*

Air recirculation mode with convenience closing or opening feature

Warning!



Never operate the side windows and the tilt/sliding sunroof* if there is the possibility of anyone being harmed by the closing procedure.

When using the air recirculation mode with convenience closing feature, should the upward movement of a window be blocked by some obstructions including but not limited to arms, hands, fingers. etc., the automatic reversal feature will not operate.



In the event that the procedure causes potential danger, the closing of the side windows can be immediately halted by releasing the  button or by pressing or pulling the respective window switch.

Convenience closing

- ▶ Press and hold button  (> page 199) until the windows are closed or have reached the desired position. The indicator lamp on the button comes on. The air recirculation mode is activated.

Convenience opening

- ▶ Press and hold button  (> page 199) until the windows have return to their previous position or they have reached the desired position. The indicator lamp on the button goes out. The air recirculation mode is deactivated.

i *A side window will only return to its previous position if it has not been moved to another position using the respective side window switch after it was closed with button . A side window that was moved will remain in its current position if button  is used to re-open the remaining side windows.*

Charcoal filter

An activated charcoal filter markedly reduces bad odors and removes pollutants from air entering the passenger compartment. The charcoal filter can be activated or deactivated.

The system switches automatically to the air recirculation mode, if the

- charcoal filter is switched on.
- carbon monoxide (CO) or nitrogen oxide (NO_x) concentration of the outside air increases beyond a predetermined level.

i *The automatic air recirculation mode does not function if the **A/C** (indicator lamp on button  or **A/C RESET** not lit) mode is deactivated, or if the outside temperature has fallen below 41 °F (5 °C).*

Activating

- ▶ Press button  (▷ page 199).
The indicator lamp on the button comes on.

i *If you press and hold button , the side windows will close.*

i *The activated charcoal filter should be switched off when windows fog up on the inside, or if the passenger compartment needs to be quickly heated or cooled down.*

Warning!



Never operate the side windows if there is the possibility of anyone being harmed by the closing procedure.

When using the charcoal filter with convenience closing feature, should the upward movement of a window be blocked by some obstructions including but not limited to arms, hands, fingers. etc., the automatic reversal feature will not operate.



In the event that the procedure causes potential danger, the closing of the side windows can be immediately halted by releasing the  button or by pressing or pulling the respective window switch.

Deactivating

- ▶ Press button  (▷ page 199).

The indicator lamp on the button goes out.

i *If you press and hold button , the side windows will return to their previous position.*

A side window will only return to its previous position if it has not been moved to another position using the respective side window switch after it was closed with button . A side window that was moved will remain in its current position if button  is used to re-open the remaining side windows.

Automatic climate control

Air conditioning

The cooling function, only operational when the engine is running, cools the vehicle interior down to the selected temperature. The cooling function also dehumidifies the air in the vehicle interior, thus preventing the windows from fogging up.

 *Condensation may drip out from underneath the vehicle. This is normal and not an indication of a malfunction.*



Warning!



If you turn off the cooling function, the vehicle will not be cooled when weather conditions are warm. The windows can fog up more quickly. Window fogging may impair visibility and endanger you and others.

Deactivating

It is possible to deactivate the air conditioning (cooling) function of the automatic climate control system. The air in the vehicle will then no longer be cooled or dehumidified.



- ▶ Press button  or  (▷ page 199).

The indicator lamp on the button goes out.

The cooling function switches off after a short delay.

Activating

Moist air can fog up the windows. You can dehumidify the air with the air conditioning.

- ▶ Press button  or  (▷ page 199) again.

The indicator lamp on the button comes on.

The air conditioning uses the refrigerant R134a. This refrigerant is free of CFCs which are harmful to the ozone layer.

 *If the air conditioning cannot be turned on again, this indicates that the air conditioning is losing refrigerant. The compressor has turned itself off.*

Have the air conditioning checked at the nearest authorized Mercedes-Benz Center.

Residual heat and ventilation* (Canada only)

With the engine switched off, it is possible to continue to heat or ventilate the interior for up to 30 minutes. This feature makes use of the residual heat produced by the engine.

 *How long the system will provide heating depends on*

- *the coolant temperature*
- *the temperature set by the operator*

The blower will run at speed setting 1 regardless of the air distribution control setting.

Activating

▶ Switch off the ignition (▷ page 38).

▶ Press button  (▷ page 199).

The indicator lamp on the button comes on.

Deactivating

▶ Press button  (▷ page 199).

The indicator lamp on the button goes out.

The residual heat is automatically turned off:

- when the ignition is switched on
- after about 30 minutes
- if the battery voltage drops

Automatic climate control

Rear passenger compartment adjustable air vents

The air conditioning for the rear passenger compartment is controlled via the automatic climate control panel (▷ page 199).

i The temperature at the center air vents ② and ③ for the rear passenger compartment (▷ page 210) is the same as at the dashboard center air vents.

The air vents for the rear passenger compartment are located in the rear center console.

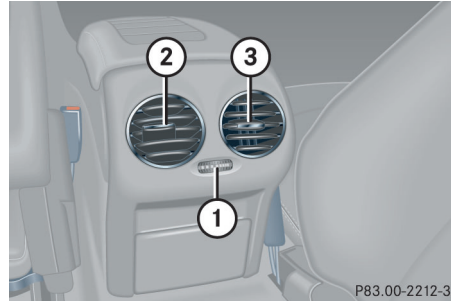

- ① Thumbwheel for air volume control for center air vents
- ② Left center air vent
- ③ Right center air vent

Adjusting air distribution

- ▶ Push the slide for the left center vent ② or right center vent ③ to the left, right, up or down.

The air flow is directed in the corresponding direction.

i For draft-free ventilation, move the slider for the center air vents ② and ③ upward.

Adjusting air volume

- ▶ Turn thumbwheel ① to the left or right.

The air volume is increased or decreased.

▼ Audio system

Audio and telephone*, operation

These instructions are intended to help you become familiar with your Mercedes-Benz audio system. They contain useful tips and a detailed description of the user functions.

Warning!



In order to avoid distraction which could lead to an accident, the driver should enter system settings with the vehicle at a standstill and operate the system only when road and traffic conditions permit. Always pay full attention to traffic conditions first before operating system controls while driving.

Bear in mind that at a speed of just 30 mph (approximately 50 km/h), your car is covering a distance of 44 feet (approximately 14 m) every second.

Operating safety

Warning!



Any alterations made to electronic components can cause malfunctions.

The radio, amplifier, CD changer*, satellite radio*, and telephone* are interconnected. When one of the components is not operational or has not been removed/replaced properly, the function of other components may be impaired.

This condition might seriously impair the operating safety of your vehicle.

We recommend that you have any service work on electronic components carried out by an authorized Mercedes-Benz Center.

Sound system*

Your vehicle is equipped with a sound system. The subwoofer is located between the rear seats.



P82.62-2446-31

! Make sure no objects fall into the openings of the subwoofer between the rear seats.

If necessary, contact an authorized Mercedes-Benz Center to remove any objects which may have fallen into the openings.

Operating and display elements

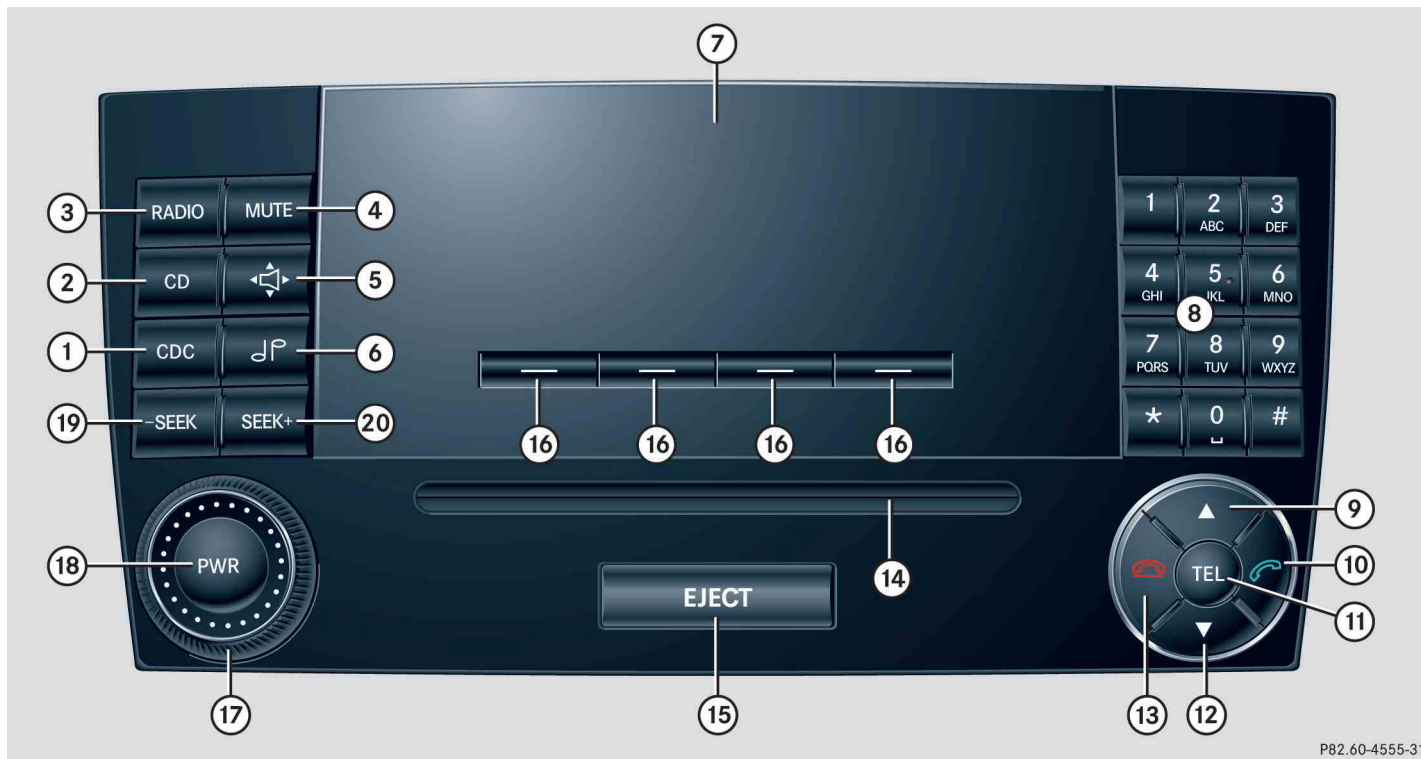

P82.60-4555-31

Item	Page
① CD changer mode selector	227
AUX mode selector	217
② Single CD mode selector	230
③ Radio mode selector	
④ Mute function (radio)	221
Pause (CD)	234
⑤ Volume distribution	216
⑥ Sound settings	215
⑦ Display	
⑧ Alphanumeric keypad	

Item	Page
⑨ Speed dialing memory (telephone) in descending order	
⑩ Accepting a call (telephone)	239
⑪ Telephone mode selector	234
⑫ Speed dialing memory (telephone) in ascending order	236
⑬ Terminating a call (telephone)	240
⑭ CD slot	
⑮ CD ejection	230

Item	Page
⑯ Soft keys	214
⑰ Volume	214
⑱ Switching on/off	214
⑲ Manual tuning / seek tuning (radio)	219
Track search, reverse (CD)	233
⑳ Manual tuning / seek tuning (radio)	219
Track search, fast forward (CD)	233

Audio system

Button and soft key operation

In these instructions, the alphanumeric keypad (right side of radio panel) and the function buttons (left side of radio panel) are referred to as “buttons”. The four keys below the display panel are referred to as “soft keys”.

! Do not press directly in the display face. Otherwise, the display will be damaged.

Operation

Switching the unit on/off

Switching on

- ▶ Turn the SmartKey in the starter switch to position **1** or **2**.
- ▶ If the audio system was on as you removed the SmartKey from the starter switch, the audio system will automatically come back on as you turn the SmartKey to position **1** or **2**.

or

- ▶ Press  button.

i If the radio is switched on without the key in the starter switch, it will automatically switch off again after approx. 30 minutes.

If your vehicle is equipped with a telephone, the display may prompt you to enter your PIN (GSM network) or code (TDMA or CDMA network).

Switching off

- ▶ Remove SmartKey from starter switch.

or

- ▶ Press  button.

i Should excessively high temperatures occur while the audio system is being operated, the display will dim. If temperatures continue to rise, HIGH TEMP will appear in the display, after which the audio system will be switched off for a cooling-down period.

Adjusting the volume

- ▶ Turn rotary control of  button.

The volume will increase or decrease depending on the direction turned.

i If your vehicle equipment includes a Mercedes-Benz specified mobile phone*, you can adjust its volume separately from the volume of the audio system while the telephone is being used.

Adjusting sound functions

The bass and treble functions are called up by pressing the  button.

Settings for bass and treble are stored separately for the AM and FM wavebands, weather band, CD mode and telephone mode.

Bass

- ▶ Press  button repeatedly until BASS appears in the display.



- ▶ Press + or - soft key to increase or decrease tone level accordingly.

or

- ▶ Press RES soft key briefly to reset bass tones to their center level.

The radio switches back to the standard radio menu eight seconds after the last soft key is pressed.

Adjusting treble

- ▶ Press  button repeatedly until TREBLE appears in the display.



- ▶ Press + or - soft key to increase or decrease tone level accordingly.

or

- ▶ Press RES soft key briefly to reset treble tones to their center level.

The radio switches back to the standard radio menu eight seconds after the last soft key is pressed.

Sound system*

You can either program the sound settings manually (▷ page 215) or choose settings via preset sound characteristics.

You can select from among the following settings:

- STANDARD: conventional stereo sound.
- SURROUND: the sound is set for better three-dimensional acoustic characteristics.
- SPEECH: the sound is optimized for the spoken word.

- ▶ Press  button repeatedly until STANDARD, SURROUND or SPEECH appears in the display.

- ▶ Press <<< or >>> soft key repeatedly until the desired sound setting has been reached.

The sound is set accordingly.

or

- ▶ Press RES soft key briefly.



Audio system

▷▷ The sound setting is reset depending on the sound source activated.

- Radio mode: STANDARD
- CD/AUX mode: SURROUND
- Telephone: SPEECH

The radio switches back to the standard radio menu eight seconds after the last soft key is pressed.

Returning sound functions to factory settings

▶ Press  button to call up settings menu in the display.



▶ Press RES soft key briefly; the respective sound function is reset to its center level.

or

▶ Press and hold RES soft key until RESET appears in the display.

The sound settings for bass and treble are returned to their center level and the volume is set to a predefined level.

Vehicles with sound system*:

The sound setting is reset depending on the sound source activated.

- Radio mode: STANDARD
- CD/AUX mode: SURROUND
- Telephone: SPEECH

The radio switches back to the standard radio menu four seconds after the last soft key is pressed.



Adjusting volume distribution

Call up fader and balance functions by pressing the  button.

Fader

▶ Press  button repeatedly until FADER appears in the display.



▶ Press  or  soft key.

The volume is distributed accordingly between the front and rear of the vehicle.

or

▶ Press RES soft key briefly.

The fader is reset to its center level.

The radio switches back to the standard radio menu eight seconds after the last soft key is pressed.

Adjusting balance

- ▶ Press  button repeatedly until BALANCE appears in the display.



- ▶ Press <<< or >>> soft key.
The volume is distributed between the left and right sides of the vehicle.
- or
- ▶ Press RES soft key briefly.
The balance is reset to its center level.
The radio switches back to the standard radio menu eight seconds after the last button is pressed.

Returning volume distribution to factory settings

- ▶ Press  button to call up settings menu in the display.



- ▶ Press RES soft key briefly; the respective volume distribution is reset to its center (flat) level.
- or
- ▶ Press and hold RES soft key until RESET appears in the display.
The volume distribution settings for fader and balance are set to their center level.
The radio switches back to the standard radio menu four seconds after the last soft key is pressed.

Telephone* muting

If your vehicle equipment includes a Mercedes-Benz specified mobile phone*, you can adjust its volume separately from the volume of the audio system while the telephone is being used.

Connecting an external audio source (AUX) to the radio*

An optional dealer-installed cinch-connector* for connecting an external audio source may become available for your vehicle model. Feature description is based on preliminary information at time of printing. Contact an authorized Mercedes-Benz Center for availability.

You can adjust the volume (▷ page 214), the sound settings (▷ page 215) and the volume distribution (▷ page 216) for the AUX input.

Audio system

Calling up AUX mode

- ▶ Press and hold **CDC** button until AUX appears in the display.

Canceling AUX mode

- ▶ Press any audio source button.

Radio operation

Selecting radio mode

- ▶ Press **RADIO** button.

Calling up wavebands

You can choose from among the FM, AM and WB wavebands.

Weather band (▷ page 221).

i *FM waveband:* 87.7.....107.9 MHz

AM waveband: 530.....1710 kHz

Calling up wavebands for radios without SAT*

- ▶ Press FM or AM soft key to switch between FM and AM.

The FM and AM wavebands are called up one after another.

or

- ▶ Press WB soft key.

The weather band menu is called up.

The waveband currently selected appears in the upper left-hand corner of the display.

Calling up wavebands for radios with SAT*

- ▶ Press FM, AM or WB soft key repeatedly until desired waveband has been selected.

The FM, AM and WB wavebands are called up one after another.

The waveband currently selected appears in the upper left-hand corner of the display.

Selecting a station

The following options are available for selecting a station:

- Direct frequency input (▷ page 219)
- Manual tuning (▷ page 219)
- Automatic seek tuning (▷ page 219)
- Scan search (▷ page 219)
- Station memory (▷ page 220)
- Automatic station memory (Autostore) (▷ page 220)

The station search proceeds in the following frequency increments:

- 200 kHz in FM range
- 10 kHz in AM range

Direct frequency input

- ▶ Select desired waveband.



P82.60-4454-31

- ▶ Press ***** button.
- ▶ Enter desired frequency with buttons **1** to **0**.

i You can only enter frequencies within the respective waveband.

If a button is not pressed within four seconds, the radio will return to the last station tuned.

Manual tuning

- ▶ Select desired waveband.
- ▶ Press **SEEK+** or **-SEEK** button for approx. three seconds.
- ▶ Press button repeatedly until desired frequency has been reached.

Step-by-step station tuning takes place in ascending or descending order. Each time the button is pressed, the radio tunes further by 0.2 MHz. During manual tuning, the radio is muted.

Automatic seek tuning

- ▶ Select desired waveband.
 - ▶ Press **SEEK+** or **-SEEK** button briefly.
- The radio will tune to the next highest or next lowest receivable frequency.

i If no station is received after two consecutive scans of the complete frequency range, then the scan stops at the frequency from which it began.

Scan search

- Starting scan search
 - ▶ Select desired waveband.



P82.60-4459-31

- ▶ Press **SC** soft key.

SC will appear in the display. The radio briefly tunes in all receivable stations on the waveband selected.

- Ending scan search
 - ▶ Press **SC** soft key or **SEEK+** or **-SEEK**.

The station last played will be selected and SC disappears from the display.

Audio system

Station memory

You can store ten AM and ten FM stations in the memory.

- Storing stations
 - ▶ Tune in desired station.
 - ▶ Press and hold desired station button **1** to **0** until a brief signal tone is heard.

The frequency is stored on the selected station button.
- Calling up stations
 - ▶ Press desired station button **1** to **0** briefly.

Autostore – automatic station memory

The Autostore memory function provides an additional memory level. The station memory for manually stored stations is not overwritten.

- Calling up Autostore memory level and storing stations



- ▶ Press AS soft key briefly.

The radio switches to the Autostore memory level. AS and SEARCH appear in the display and the radio finds the ten stations with the strongest signals. These stations are stored on the station buttons **1** to **0** in order of signal strength.
- Calling up stations
 - ▶ Press desired station button **1** to **0**.
- Leaving the Autostore memory level
 - ▶ Press FM or AM soft key briefly.

Interrupting radio mode

The radio mode is interrupted by an incoming call on the telephone* (▷ page 239).

- Mute on
 - ▶ Press **MUTE** button.

The radio mode is interrupted and MUTED appears in the display.
- Mute off
 - ▶ Press **MUTE** button.

The radio mode is again active.

Weather band



- ▶ Press WB soft key.

The weather band station last received is tuned in.

Selecting a weather band station directly

- ▶ Select desired weather band station with buttons **1** to **7** **PRESET**.
- If a station cannot be tuned in, a search is automatically started.

Search

- ▶ Press **SEEK+** or **SEEK-** button to tune in the next receivable weather band station.

i *If no weather band station is received after three consecutive scans of the complete frequency range, then the scan stops at the channel with which it began and NO WB FOUND appears in the display.*

If this happens, switch back to standard radio mode.

Scan search

- Starting scan search
 - ▶ Press SC soft key.

SC will appear in the display. The radio briefly tunes in all receivable weather band stations.
- Ending scan search
 - ▶ Press SC soft key or **SEEK+** or **SEEK-**.

The weather band station last played will be selected and SC disappears from the display.

Audio system

Introduction to satellite radio* (USA only)

SIRIUS satellite radio provides 100 channels of digital-quality radio, among others music, sports, news, and entertainment, free of commercials. SIRIUS satellite radio uses a fleet of high-power satellites to broadcast 24 hours per day, coast to coast, in the contiguous U.S.

This diverse, satellite-delivered programming is available for a monthly subscription fee.

For more information and service availability call the SIRIUS Service Center (▷ page 226), or contact www.siriusradio.com

i *Additional satellite radio equipment and a subscription to a satellite radio service provider are required for the satellite radio operation described here.*

Contact an authorized Mercedes-Benz Center for details and availability for your vehicle.

Note that categories and channels shown in illustrations are dependent on programming content delivered by the service provider. Programming content is subject to change. Therefore, channels and categories shown in illustrations and descriptions contained in this manual may differ from the channels and categories delivered by the service provider.

i *Satellite radio service may be unavailable or interrupted from time to time for a variety of reasons, such as environmental or topographic conditions and other things beyond the service provider's or our control. Service might also not be available in certain places (e.g., in tunnels, parking garages, or within or next to buildings) or near other technologies.*

Program categories

The channels are categorized. Categories allow you to tune to stations broadcasting a certain type of program (category mode) (▷ page 225).

Calling up the SAT main menu

- ▶ Press SAT soft key.

SAT is displayed in the upper left-hand corner of the display.

Prior to activation of the satellite radio service (▷ page 223).

After activation of satellite radio service (▷ page 223).

Prior to activation of the satellite radio service



The telephone number of the SIRIUS Service Center (888-539-7474) is displayed.

- ▶ Press ESN soft key.

The twelve-digit electronic serial number (ESN) of the SAT tuner* installed in your vehicle is displayed.

This information is required to call the SIRIUS Service Center for an activation request.

i Credit card information may also be required for your application.

The activation process takes approximately five to ten minutes after calling the SIRIUS Service Center.

After activation of the satellite radio service

The satellite radio main menu appears. The radio station selected last is audible, provided it can be received.

i The system will tune to a default station if no station had been selected previously.



The first channel 001 is called up and the PTY system changes to All categories.

If no station can be received, ACQUIRING appears in the display.

If the Satellite radio service is not activated, ACQUIRING will also appear in the radio display and NO SAT will appear in the multifunction display.

Audio system

Selecting a station

The following options are available:

- Selecting a station using the selected category (▷ page 225).
- Tuning via station presets (▷ page 224).
- Tuning via scan search (▷ page 225).
- Tuning via manual channel input (▷ page 224).
- Tuning via the program category list (▷ page 225).

Tuning via station presets

Ten satellite radio station presets are available.

You can access the presets via number keys.

Accessing via number keys

- ▶ Enter number of preset you wish to select, e.g. **1**.

The radio plays the station stored under this number and the PTY function changes to the category corresponding to the station.

Tuning via manual channel input



Example: tuning in channel 16

- ▶ Press *** ***.

Input line appears in the main radio menu.

- ▶ Use number keys to enter desired channel within eight seconds, e.g. **1** **6**.

The system tunes to channel 16.

The station you have selected begins to play.

i You can only enter available channel numbers.

Tuning via the program category list

The category list contains all currently receivable categories of programs. It is arranged alphabetically.

- Selecting a category.
 - ▶ Press **PTY** soft key.



The current **PTY** category of the station is displayed.

- ▶ Press **<<<** or **>>>** soft key.
This switches between the individual categories.

When changing the category, the channel selected last in the new category becomes audible.

The system will automatically switch to a station of the selected category if the currently selected station is not of the selected category. Otherwise, the currently selected station remains tuned.

- Tuning a station within the selected category.

The channels identified for the currently selected category are arranged numerically. Only one entry is visible at a time.

- ▶ Press **SEEK+** or **-SEEK** button briefly.

The next station within the category is started.

or

- ▶ Press and hold **SEEK+** or **-SEEK** button for approx. three seconds until desired station has been reached.

Tuning via scan search

Scan search is characterized as follows:

- Scan search plays a channel for approx. eight seconds and then skips to the next channel within the current category.
- Scan search can be terminated manually.

- ▶ Press **SC** soft key.

The search starts. **SC** appears in the display.

- ▶ Press **SC** soft key again.

The search stops.

Audio system

Obtaining additional text information

Additional text information (artist, title) related to the current channel can be displayed.

- ▶ Press INF soft key.

The title being played is displayed.

- ▶ Press INF soft key again.

The name of the artist performing the title being played is displayed.

i *If a button is not pressed within four seconds, the radio will return to the standard display.*

Storing stations

- ▶ Tune in desired station.
- ▶ Press and hold desired station button **1** to **0** until a brief signal tone is heard.

The frequency is stored on the selected station button.

The radio saves the current station at the memory preset selected. The memory preset selected appears in the status line, e.g. S3.

i *There are ten presets available.*

An existing entry is overwritten in the memory list when a new entry is given.

Calling up the ESN information menu

- ▶ Press INF soft key.
- ▶ Press ESN soft key.

The twelve-digit electronic serial number (ESN) of the SAT tuner* installed in your vehicle is displayed.

- ▶ Press RET soft key to exit the menu.

CD mode

Safety precautions

Warning!



The single CD player and the CD changer* are Class 1 laser products. There is a danger of invisible laser radiation if the housing is opened or damaged.

Do not open the housing. The single CD player and the CD changer* do not contain any parts that can be serviced by the user. For safety reasons, have any necessary service work performed only by qualified personnel.

Warning!



In order to avoid distraction which could lead to an accident, the driver should insert CDs with the vehicle at a standstill and operate the audio system only if permitted by road, weather and traffic conditions.

Bear in mind that at a speed of just 30 mph (approximately 50 km/h), your car covers a distance of 44 feet (approximately 14 m) every second.

General notes

The system may not be able to play audio CDs with copy protection.

Playing copied CDs may cause malfunctions during playback.

! *If you affix stickers to the CDs, they can become warped due to the heat that develops in the CD drive or CD changer*.*

In certain situations, the CDs can then no longer be ejected and cause damage to the drive. Such damage is not covered by the Mercedes-Benz Limited Warranty.

! *Your CD drive or CD changer* has been designed to play CDs which correspond to the EN 60908 standard. You can therefore only use CDs with a maximum thickness of 1.3 mm.*

If you insert thicker data carriers, e.g. ones that have data on both sides (one side with DVD data, the other side with audio data), they cannot be ejected and will damage the drive.

Do not use CDs with an eight cm diameter, not even with a CD adapter. Attempting to play CDs with an eight cm diameter or playing such CDs with an adapter may cause damage to the CD drive. Such damage is not covered by the Mercedes-Benz Limited Warranty.

Should excessively high or low temperatures occur while in CD changer mode*, CD TEMP will appear in the display, and the CD will be muted until the temperature has reached an acceptable level for the system to continue operation.

The single CD player play audio CDs, the CD changer* can play audio CDs as well as CDs with MP3 files.

Audio system

Tips on handling CDs

- Handle CDs carefully to prevent interference during playback.
- Avoid scratches, fingerprints and dust on the CDs.
- Do not write on CDs or apply any labels or other material to them.
- Clean CDs from time to time with a commercially available cleaning cloth. Never wipe the CD in a circular motion; instead, wipe it in a straight line starting in the center and moving outward. Do not use solvents, anti-static sprays, etc. for cleaning.
- Replace the CD in its case after use.
- Protect CDs from heat and direct sunlight.

MP3 notes

The CD changer* can play audio CDs as well as CDs with MP3 files.

Information on MP3 data carriers

i *CD media, CD burning software and CD writers are available in great variety. Due to this variety, it cannot be guaranteed that the CD changer will be able to play every user-written CD.*

The burning process can lead to data errors and aging of the medium may result in data loss. Therefore, the CD changer may be restricted in its ability to play MP3 data carriers; it may play them with reduced sound quality, or it may not be able to play them at all.

Problems may be encountered during playback of user-written CDs with a storage capacity of more than 700 MB. These CDs do not meet valid standards as of this printing.

Compatible MP3 data carriers

The CD changer can read the following data carriers in MP3 mode:

- CD-DA
- CD-R
- CD-RW

Compatible file systems and compression methods

Use Romeo or Joliet. Depending on file format used, up to 128 characters are possible

The following compression methods are compatible:

- MP3
- WMA
- WAV

Compatible bit and sampling rates

Fixed and variable bit rates of up to 320 kBit/s are possible.

The following table lists possible sampling rates:

MPEG1 Audio Layer 3	44.1 kHz, 48 kHz, 32 kHz
MPEG2 Audio Layer 3	22.5 kHz, 24 kHz, 16 kHz
MPEG 2.5 Audio Layer 3	11.025 kHz, 12 kHz, 8 kHz
WMA	32 kHz, 44.1 kHz, 48 kHz

i Only use MP3 tracks with a bite rate of 128 kBit/s or higher and with the specified sampling rates.

The use of rates other than those specified may lead to noticeably inferior sound quality.

Information on copyright

The music tracks that you create for use in MP3 mode or that you play in MP3 mode are subject to copyright laws under applicable international and national regulations.

In many countries, the reproduction of copyrighted materials is not permitted, even if only for personal use, without the express prior consent of the copyright holder.

Please check the current copyright laws for your country and comply with them.

These restrictions do not apply, for example, to your own compositions and recordings, or for recordings for which authorization has been obtained from the copyright holder.

MP3 playback

You can play an CD with MP3 files on the CD changer* as you would play any standard audio CD. All of the functions described for the CD changer also apply for the playback of CDs with MP3 files. Keep in mind that the single CD player in the audio system unit is not able to read CDs with MP3 files.

The first 99 tracks on the CD, including tracks in subdirectories, are recognized and played. Any additional tracks will not be played.

i Due to the branched data structure, playback of the first track may be delayed slightly.

Audio system

Operating the single CD player in the audio system unit

Loading a CD

The single CD player in the audio system unit has capacity for one CD. The CD slot for loading the drive is located underneath the soft keys.

i Keep in mind that the single CD player in the audio system unit is not able to play CDs with MP3 files.

- ▶ Make sure the system is switched on.
- ▶ Insert CD into CD slot. The label side of the CD must face upwards.

The system automatically pulls the CD into the CD slot. The audio CD begins to play.

! If a CD is already loaded, it must be ejected before inserting a new CD. Inserting a second CD in the slot with another CD still loaded will cause damage to the CD drive not covered by the Mercedes-Benz Limited Warranty.

i If a CD has been inserted incorrectly or cannot be read, **WRONG CD ERROR** will appear in the display.

Ejecting a CD

- ▶ Make sure the system is switched on.
- ▶ Press **EJECT** button.

The system ejects the CD. **NO CD** will appear in the display.

- ▶ Remove CD from slot.

i If you do not take the CD out of the CD slot within approx. 15 seconds, the system automatically pulls the CD back in and plays it.

If a CD is pulled back in, press the **EJECT** button for five seconds; the CD will then be ejected.

Operational readiness of CD changer*

If a CD changer has been installed in the vehicle, it can be operated from the front control panel of the audio system. A loaded magazine must be installed to play CDs.

The CD changer is located in the glove box.

Loading/unloading the CD magazine

i The CD changer* may not be able to play audio CDs with copy protection.

- ▶ Slide changer door to the right and press **▲** button.
- ▶ Magazine will be ejected.

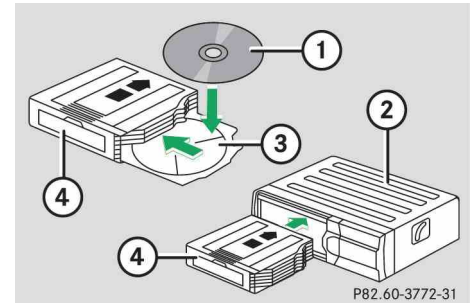

- ① CD
- ② CD changer
- ③ CD tray
- ④ CD magazine

- ▶ Remove magazine ④ and pull CD tray ③ fully out.
- ▶ Place CD ① in recess of tray, label side up.

- ▶ Push tray into magazine in direction of arrow.

i *Improperly inserted or unreadable CDs will not be played.*

- ▶ Push magazine into CD changer ② in direction of arrow and close sliding door.

Playing CDs

Single CD player in the audio unit

- ▶ Press **CD** button.

CD 0 will appear in the upper left-hand corner of the display.

The CD will resume playback at the point where it was switched off.

CD changer*

- ▶ Press **CDC** button.

CD and the selected magazine slot number appear in the upper left-hand corner of the display.

If you have not removed a CD since the last time the CD audio source was activated, the last CD listened to will begin to play at the point where it was switched off.

After the last track on a CD has finished, the next CD is automatically played.

Playing tracks

You have the following options:

- Audio system with CD changer*: selecting CDs
- Direct track entry
- Track skip forward/reverse
- Fast forward/reverse
- Scan
- Random tracks
- Repeat track

Audio system

Selecting CDs in the audio unit with CD changer*



- ▶ You can select from among the inserted CDs with buttons **0** to **6**.
0 = CD player in the audio unit
1 to **6** = CDs in the CD changer*

The magazine slot number of the selected CD appears next to CD in the display, and the number of the currently played track appears next to TRACK.

i If there is no CD in the selected magazine slot, NO CD appears in the display with the corresponding slot number.

Direct track entry



You can make a direct selection from among the tracks on a CD.

- ▶ Press ***** button.
- ▶ Enter track number using buttons **1** to **0**.

The number of the track being played appears next to TRACK in the display.

You can only enter available track numbers.

Skipping tracks forward/backward

- Skipping tracks forward
 - ▶ Press **SEEK+** button briefly.
The next track will be played.
- Skipping tracks backward
 - ▶ Press **SEEK-** button briefly.

If the track has been playing for more than ten seconds, the unit skips back to the beginning of the track currently playing. If less than ten seconds have been played, the unit skips back to the beginning of the previous track.

Pressing the **SEEK-** or **SEEK+** button repeatedly will result in multiple tracks being skipped.

Fast forward/reverse

- Fast forward
 - ▶ Press and hold **SEEK+** button until desired point has been reached.
- Reverse
 - ▶ Press and hold **-SEEK** button until desired point has been reached.

i *The track number and the relative time of the track is shown in the display during the search.*

Scan

- Starting scan
 - ▶ Press **SC** soft key.
SC will appear in the display.
Each track on the current CD will be played for approx. eight seconds in ascending order.
- Ending scan
 - ▶ Press **SC** soft key or **-SEEK** or **SEEK+**.

Random play

The random function (RDM) plays the tracks of the current CD in random order.

i *When you start the RDM function, the RPT function is automatically switched off.*

- Switching on random
 - ▶ Press RDM soft key.
RDM appears in the display. A randomly selected track is played.
- Switching off random
 - ▶ Press RDM soft key again.

Repeat

The track being played is repeated until the repeat function is switched off.

i *When you start the RPT function, the RDM function is automatically switched off.*

- Switching on repeat
 - ▶ Press RPT soft key.
RPT appears in the display.
- Switching off repeat
 - ▶ Press RPT soft key again.

Audio system

Pause function

The CD changer* mode is interrupted by an incoming call on the telephone* (▷ page 239).

- Switching on pause function



- ▶ Press **MUTE** button.

The CD changer* mode is interrupted and **PAUSE** appears in the display.

- Switching off pause function

- ▶ Press **MUTE** button.

The CD changer* mode is active again.

Track and time display



- ▶ Press **T** soft key.

The number of the track being played and the elapsed playing time appear in the display.

- ▶ Press **T** soft key again.

The total number of tracks and the total playing time of the CD appear in the display.

- ▶ Press **T** soft key.

The standard CD playback menu appears in the display.

GSM network phones

Warning!



Please do not forget that your primary responsibility is to drive the vehicle. A driver's attention to the road must always be his/her primary focus when driving. For your safety and the safety of others, we recommend that you pull over to a safe location and stop before placing or taking a telephone call.

If you choose to use the telephone¹ while driving, please use the hands-free device and only use the telephone when road, weather and traffic conditions permit. Some jurisdictions prohibit the driver from using a cellular telephone while driving a vehicle.

Bear in mind that at a speed of just 30 mph (approximately 50 km/h), your vehicle is covering a distance of 44 feet (approximately 14 m) every second.

¹ Observe all legal requirements.

Using your Mercedes-Benz specified mobile phone*, a number of functions and operating steps can be performed and displayed in the audio system display.

Further operating instructions not covered here can be found in the operating instructions for the multifunction steering wheel and the cellular telephone*.

If your audio system is set up for telephone operation, the  symbol will appear in the display.

When you insert your Mercedes-Benz specified mobile phone* into the telephone cradle, you will be prompted to enter your PIN for 30 seconds (▷ page 235). This display disappears when you press any button.

When your mobile phone is inserted into the telephone cradle, you will see the reception strength in the upper right-hand corner of the display.

Switching on the telephone

Switching on the telephone

- ▶ Press **TEL** button.

If the telephone was previously switched off, PROCESSING appears in the display and you will then be prompted to enter your PIN.

Switching off the telephone

- ▶ Press **TEL** button for approx. three seconds.

PROCESSING appears in the display until the telephone is off. Afterward, PHONE OFF appears in the display.

PIN entry



- ▶ Enter PIN number using buttons **1** to **0**.
- ▶ If necessary, correct number entered with the CLR soft key. Press soft key briefly to delete the last digit entered; press soft key and hold to delete the complete number.
- ▶ Press OK soft key after entering correct PIN.
- ▶ READY or ROAMING will appear in the display.

Audio system

i If the PIN is entered incorrectly three times, **NEED PUK** will appear in the display. Enter **PUK** via your telephone. Please refer to the separate telephone operating instructions for more information.

Adjusting the volume

- ▶ Turn rotary control of  button during a telephone call.

The volume will increase or decrease depending on the direction turned.

i The volume can be adjusted separately for telephone mode and audio mode.



Adjusting sound

- ▶ Adjust sound during a telephone call. Sound adjustment (> page 215).

Placing a call

Entering a telephone number and starting the dialing process



- ▶ Enter desired telephone number using buttons  to .

The number can have up to 32 digits, but only twelve of these are visible in the display.

- ▶ If necessary, correct number entered with the **CLR** soft key. Press soft key briefly to delete the last digit entered; press soft key and hold to delete the complete number.

- ▶ After correct telephone number has been entered, press .

i If the telephone number has been saved together with a name in the telephone book, the name will appear in the display.

Phone book

The numbers stored in the phone book of the telephone can be called up either by name or number.

In addition, incoming calls are stored in the phone book.

i This is only possible, however, when the call information transmitted includes the number of the person calling. If the telephone number is not transmitted, **NO NUMBER** will be stored in the phone book.

Searching and calling up telephone book entries by name.

You can access your mobile phone's phone book using the audio system. You can access both the main entries and the sub-entries of your phone book.



- ▶ Press MEM soft key or press or .
- ▶ Press desired numerical key to .

The stored entries are selected according to the alphabetical order of the initial letters (e.g. for S-Smith, press button four times).

or

- ▶ Press and hold button or .

The system jumps from one initial letter to the next in ascending or descending order.

- ▶ Press and hold button or until desired initial letter has been reached.

or

- ▶ Press button or repeatedly until desired entry has been reached.

The stored entries are selected in alphabetical order with the sub-entries.

Several sub-entries can be stored for each main entry (name). These entries are marked by a corresponding abbreviation that appears in the upper left-hand corner of the display. The following abbreviations for sub-entries are possible:





*CEL = Mobile phone
 HOM = Home
 WOR = Work
 FAX = Fax
 PAG = Pager
 TEL = Main*











Audio system

- ▷▷ ▶ When you have selected a number, press  button.
The call will be made.
- Viewing the telephone number of a telephone book entry
 - ▶ Search for desired entry.
 - ▶ Press NUM soft key.
The telephone number of the phone book entry appears in the display.
- Returning calls received



- ▶ Press MEM soft key or press  or .
- ▶ Press RCV soft key (received calls).
The number of received calls and then the call last received appear briefly in the display.
- ▶ Select desired telephone number with button  or .
- ▶ When you have selected a number, press  button.
The call will be made.

- Speed dial
If you have stored telephone numbers as speed dial numbers in your telephone, you can also enter these with buttons  to  on the radio head unit.
 - ▶ Press desired button  to  briefly.
 - ▶ Press  button.
The call will be made.
- Turbo dial
If you have stored telephone numbers as turbo dial numbers in your telephone, you can also enter these with buttons  to  on the radio head unit.
 - ▶ Press desired button  to  until the call is made.

Redial

If the number you have dialed is busy, you can again place calls to the last ten telephone numbers dialed using the redial function.

i If you have activated the automatic redial function on your telephone, the number of the person being called is automatically redialed after a short waiting period if there is a busy signal. Refer to the separate operating instructions for the mobile phone.

- Manual redial



- ▶ Press  button.

The telephone number last dialed will appear in the display.

- ▶ Select desired telephone number with button  or .

The letter L and the number of the memory position appears in the left-hand corner of the display. The numbers are stored in the order of the calls made.

- ▶ When you have selected a number, press  button.

The call will be made.

Accepting an incoming call

If the telephone is active in the background (reception symbol is visible in the display), the audio source is muted when an incoming call is received. A ringing tone can be heard and the caller's telephone number, or the name under which the telephone number has been saved in the phone book, appears in the display. If the caller's number is not transmitted with the call, CALL will appear in the display.

- ▶ Press  button.

The call is accepted.

Audio system

Muting a call

It is possible to mute a call; the caller is then no longer able to hear you.

- Mute on
 - ▶ Press MUT soft key.
 - ▶ MIC MUTE will appear in the display.
- Mute off
 - ▶ Press MUT soft key again.

Terminating a call

- ▶ Press  button.

The current call is terminated and the muted audio source becomes active again.

Talking with two callers at the same time

If you wish to receive or place another call during an already active call, you can accept or place the second call and switch between the callers or combine them into one call. Note that the features described here are depending on availability from your mobile phone service provider.

- Placing/accepting a second call
 - ▶ Place new call by entering telephone number manually.
 - ▶ Press  button.

You are connected to the second caller; the first caller is kept on hold.



or

- ▶ Press  button to accept a second call.





 *You will be notified of the second call acoustically, but you will not see this in the display.*

You are connected with the second caller; the first caller is kept on hold.

- Switching between calls

- ▶ Press  and  buttons.

This switches between the calls. The non-active call is kept on hold.

- Terminating a call
 - ▶ Press  button.
The current call is terminated. You are again connected with the caller previously placed on hold.
- Combining two calls
 - ▶ Press  and  buttons.
The calls are combined into one call.
- Terminating a combined call
 - ▶ Press  button.
The connection to both callers is terminated.

TDMA or CDMA network phones

Warning!



Please do not forget that your primary responsibility is to drive the vehicle. A driver's attention to the road must always be his/her primary focus when driving. For your safety and the safety of others, we recommend that you pull over to a safe location and stop before placing or taking a telephone call.

If you choose to use the telephone¹ while driving, please use the hands-free device and only use the telephone when road, weather and traffic conditions permit. Some jurisdictions prohibit the driver from using a cellular telephone while driving a vehicle.

Bear in mind that at a speed of just 30 mph (approximately 50 km/h), your vehicle is covering a distance of 44 feet (approximately 14 m) every second.

¹ Observe all legal requirements.

Using your Mercedes-Benz specified mobile phone*, a number of functions and operating steps can be performed and displayed in the audio system display.

Further operating instructions not covered here can be found in the operating instructions for the multifunction steering wheel and the mobile phone*.

If your audio system is set up for telephone operation, the  symbol will appear in the display.

When you insert your Mercedes-Benz specified mobile phone* into the telephone cradle, you will be prompted to enter your PIN for 30 seconds (▷ page 235). This display disappears when you press any button.

When your mobile phone is inserted into the telephone cradle, you will see the reception strength in the upper right-hand corner of the display.

Audio system

Switching on the telephone

Switching on the telephone

- ▶ Press **TEL** button.

If you have programmed an unlock code for the telephone, you must now enter the code.



P82.60-4469-31

- ▶ Enter code using buttons **1** to **0**.
- ▶ If necessary, correct number entered with the CLR soft key. Press soft key briefly to delete the last digit entered; press soft key and hold to delete the complete number.

- ▶ Press OK soft key after entering correct code.

The telephone is unlocked. If you have entered an incorrect code, you must enter the correct code.

Switching off the telephone

- ▶ Press **TEL** button for approx. three seconds.

PROCESSING appears in the display until the telephone is off. Afterward, PHONE OFF appears in the display.

Adjusting the volume

- ▶ Turn rotary control of  button during a telephone call.

The volume will increase or decrease depending on the direction turned.

 *The volume can be adjusted separately for telephone mode and audio mode.*

Adjusting sound

- ▶ Adjust sound during a telephone call. Sound adjustment (> page 215).

Placing a call

Entering a telephone number and starting the dialing process



P82.60-4558-31

- ▶ Enter desired telephone number using buttons **1** to **0**.

The number can have up to 32 digits, but only twelve of these are visible in the display.

- ▶ If necessary, correct number entered with the CLR soft key. Press soft key briefly to delete the last digit entered; press soft key and hold to delete the complete number.
- ▶ After correct telephone number has been entered, press  button.

i If the telephone number has been saved together with a name in the phone book, the name will appear in the display.

Phone book

The numbers stored in the phone book of the mobile phone can be called up either by name or number.





In addition, incoming calls are stored in the phone book.

i This is only possible, however, when the call information transmitted includes the number of the person calling. If the telephone number is not transmitted, NO NUMBER will be stored in the phone book.

- Searching and calling up phone book entries by name.



You can access your mobile phone's phone book with the audio system. You can access both the main entries and the sub-entries of your phone book.





- ▶ Press MEM soft key or press  or .
- ▶ Press desired numerical key  to .

The stored entries are selected according to the alphabetical order of the initial letters (e.g. for S-Smith, press button  four times).

or

- ▶ Press and hold button  or .



The system jumps from one initial letter to the next in ascending or descending order.

- ▶ Press and hold button  or  until desired initial letter has been reached.

or



Audio system

- ▷▷ ▶ Press button  or  repeatedly until desired entry has been reached.

The stored entries are selected in alphabetical order with the sub-entries.

 Several sub-entries can be stored for each main entry (name). These entries are marked by a corresponding abbreviation that appears in the upper left-hand corner of the display. The following abbreviations for sub-entries are possible:

CEL = Mobile phone

HOM = Home

WOR = Work





FAX = Fax

PAG = Pager

TEL = Main

- ▶ When you have selected a number, press  button.
The call will be made.
- Viewing the telephone number of a phone book entry
 - ▶ Search for desired entry.
 - ▶ Press NUM soft key.The telephone number of the phone book entry appears in the display.
- Returning calls received



- ▶ Press MEM soft key or press  or .
- ▶ Press RCV soft key (received calls).
The number of received calls and then the call last received appear briefly in the display.
- ▶ Select desired telephone number with button  or .
- The letter R and the number of the memory position appear in the upper left-hand corner of the display. The numbers are stored in the order of the calls received.
- ▶ When you have selected a number, press  button.
The call will be made.

- Speed dial

If you have stored telephone numbers as speed dial numbers in your telephone, you can also enter these with buttons **1** to **0** on the radio unit.

- ▶ Press desired button **1** to **0** briefly.
- ▶ Press  button.
The call will be made.

- Turbo dial

If you have stored telephone numbers as turbo dial numbers in your telephone, you can also enter these with buttons **1** to **0** on the radio unit.

- ▶ Press desired button **1** to **0** until the call is made.

Redial

If the number you have dialed is busy, you can again place calls to the last ten telephone numbers dialed using the redial function.

 *If you have activated the automatic redial function on your mobile phone, the number of the person being called is automatically redialed after a short waiting period if there is a busy signal.*

Refer to the separate operating instructions for the mobile phone.

- Manual redial



- ▶ Press  button.

The telephone number last dialed will appear in the display.

- ▶ Select desired telephone number with button  or .

The letter L and the number of the memory position appears in the left-hand corner of the display. The numbers are stored in the order of the calls made.

- ▶ When you have selected a number, press  button.

The call will be made.

Audio system

Accepting an incoming call

If the telephone is active in the background (reception symbol is visible in the display), the audio source is muted when an incoming call is received. A ringing tone can be heard and the caller's telephone number, or the name under which the telephone number has been saved in the telephone book, appears in the display. If the caller's number is not relayed, CALL will appear in the display.

- ▶ Press  button.

The call is accepted.

Muting a call

It is possible to mute a call; the caller is then no longer able to hear you.

- Mute on
 - ▶ Press MUT soft key.
 - ▶ MIC MUTE will appear in the display.
- Mute off
 - ▶ Press MUT soft key again.

Terminating a call

- ▶ Press  button.

The current call is terminated and the muted audio source becomes active again.



Accepting a second incoming call

If you receive another call during an already active call, you can accept the second call and switch between the two.

- Accepting a second call
 - ▶ Place new call by entering telephone number manually.

 *You will be notified of the second call acoustically, but you will not see this in the display.*

You are connected to the second caller; the first caller is kept on hold.

- Switching between calls
 - ▶ Press  button.
This switches between the calls. The non-active call is kept on hold.
- Terminating a call
 - ▶ Press  button.
The current call is terminated. The connection to the caller previously kept on hold is also interrupted; however, reconnection is indicated by an acoustic signal.

Placing a second call

If you wish to place another call during an already active call, you can place the second call and switch between the callers or combine them into one call. Note that this feature is dependent on availability from your mobile phone service provider.

- Placing a second call
 - ▶ Place a new call by entering telephone number manually.

- ▶ Press  button.

You are connected to the second caller; the first caller is kept on hold.

- Terminating a call

- ▶ Press  button.

The current call is terminated. The connection to the caller previously kept on hold is also interrupted; however, reconnection is indicated by an acoustic signal.

- Combining two calls

- ▶ Press  button.

The calls are combined into one call.

- Terminating a combined call

- ▶ Press  button.

The connection to both callers is terminated.

Emergency calls “911”

The following describes how to dial a “911” emergency call using the audio system head unit when a Mercedes-Benz specified mobile phone* is inserted in the phone cradle*. Unless otherwise specified, the descriptions refer to the audio system head unit.

Consult the separate telephone operating instructions that came with your mobile phone* for information on how to place a “911” emergency call on the mobile phone*.

Warning!



The “911” emergency call system is a public service. Using it without due cause is a criminal offense.

The following conditions must be met for a “911” emergency call:

- Telephone must be switched on.
- The corresponding mobile communications network must be available.

 *Emergency calls may not be possible with all telephone networks or if certain network services and/or telephone functions are active. Check with your local service providers.*

If you cannot make an emergency call, you will have to initiate rescue measures yourself.

GSM network phones

Placing a “911” emergency call using audio head unit with the phone locked

- ▶ Press  button to switch to telephone operation.

PIN? appears in the audio display.

- ▶ Enter 911 using the number keypad on the audio head unit.



Audio system

- ▷▷ Press OK soft key or  button for dialing to begin.

DIALING appears in the audio display while the telephone establishes the connection.

- ▶ Wait until the emergency call center answers, then describe the emergency.

Placing a “911” emergency call using audio head unit with the phone unlocked

- ▶ Press **TEL** button to switch to telephone operation.
- ▶ Enter 911 using the number keypad on the audio head unit.
- ▶ Press  button for dialing to begin.

DIALING appears in the audio display while the telephone establishes the connection.

- ▶ Wait until the emergency call center answers, then describe the emergency.

 *If no SIM card is in the mobile phone, NO SERVICE appears in the audio display. In that case, you only can make an emergency call on the mobile phone itself, without the use of the head unit.*

TDMA/CDMA network phones

Placing a “911” emergency call using audio head unit with the phone locked

- ▶ Press **TEL** button to switch to telephone operation.
- CODE? appears in the audio display.
- ▶ Enter 911 using the number keypad on the audio head unit.
 - ▶ Press OK soft key or  button for dialing to begin.

DIALING appears in the audio display while the telephone establishes the connection.

- ▶ Wait until the emergency call center answers, then describe the emergency.

Placing a “911” emergency call using audio head unit with the phone unlocked

- ▶ Press **TEL** button to switch to telephone operation.
- ▶ Enter 911 using the number keypad on the audio head unit.
- ▶ Press  button for dialing to begin.

DIALING appears in the audio display while the telephone establishes the connection.

- ▶ Wait until the emergency call center answers, then describe the emergency.

▼ Power windows

Opening and closing the windows

The side windows are opened and closed electrically. The switches for all the side windows are on the driver's door. The switches for the respective windows are on the front passenger door and the rear side trim panels.



- ① Left front window
 - ② Right front window
 - ③ Right rear window
 - ④ Left rear window
 - ⑤ Rear window override switch
- (▷ page 86)

Warning!





When closing the windows, make sure there is no danger of anyone being harmed by the closing procedure.

The closing of the door windows can be immediately halted by releasing the switch or, if switch was pulled past the resistance point and released, by either pressing or pulling the respective switch.

The closing of the rear side windows can be immediately halted by releasing the switch.

The door windows are equipped with the express-close and automatic reversal function. If a door window encounters an obstruction that blocks its path in a circumstance where you pulled the switch past the resistance point and released it to close the window, the automatic reversal function will stop the window and open it slightly.

If a door window encounters an obstruction that blocks its path in a circumstance where you are closing the window by pulling and holding the switch, by pressing and holding the switch, by pressing and holding the lock button (vehicles with KEYLESS-GO*) on an outside door handle, by operating the soft top switch, or by pressing and holding button  on the SmartKey, by pressing and holding button  or  on the climate control panel, the automatic reversal function will not operate.



When leaving the vehicle, always remove the SmartKey or SmartKey with KEYLESS-GO* from the starter switch, take it with you, and lock the vehicle. Do not leave children unattended in the vehicle, or with access to an unlocked vehicle. A child's unsupervised access to a vehicle could result in an accident and/or serious personal injury.

Power windows

i You can also open or close the windows using the:

- Soft top switch (▷ page 254).
- SmartKey (summer opening/convenience feature) (▷ page 252).

Depending on current position, the windows may also open or close when:

- the air recirculation button  in the control panel of the climate control (▷ page 189) or automatic climate control (▷ page 199) is pressed and held or
- the charcoal filter button  in the control panel of the automatic climate control (▷ page 199) is pressed and held.

i Operating the rear side windows from the rear is not possible if you activate the override switch (▷ page 86).

i With the SmartKey in starter switch position **0** or removed from the starter switch, the power windows can be operated:

- until you open the driver's or passenger's door.
- for at least five minutes.

- ▶ Switch on the ignition (▷ page 36).

Opening the windows

- ▶ Press switch ① to ④ to the resistance point.

The corresponding window will move downwards until you release the switch.

Closing the windows

- ▶ Pull switch ① to ④ to the resistance point.

The corresponding window will move upwards until you release the switch.

Warning!



If you pull and hold the switch up when closing the window, and upward movement of the window is blocked by some obstruction including but not limited to arms, hands, fingers, etc., the automatic reversal will not operate.

Fully opening the door windows (Express-open)

- ▶ Press switch ① or ② past the resistance point and release.

The corresponding window opens completely.

Fully closing the door windows (Express-close)

- ▶ Pull switch ① or ② past the resistance point and release.

The corresponding window closes completely.

! *If the upward movement of a door window is blocked during the closing procedure, the door window will stop and open slightly.*

Remove the obstruction, pull the switch again past the resistance point and release.

If the door window still does not close when there is no obstruction, then pull the switch and hold it. The door window will then close without the obstruction sensor function.

Warning!



Driver's door only:

If within five seconds you again pull the switch past the resistance point and release, the automatic reversal will not function.

Stopping windows during Express-operation

- ▶ Press or pull the respective power window switch again.

Synchronizing power windows

The power windows must be resynchronized each time

- after the battery has been disconnected.
- if the power windows cannot be fully opened (Express-open) or closed (Express-close).

- ▶ Switch on the ignition (▷ page 38).
- ▶ Pull the power window switches until the side windows are closed.
- ▶ Hold the switches for approximately one second.

The power windows are synchronized.



Power windows

Summer opening feature

Warning!



Never operate the windows or soft top if there is the possibility of anyone being harmed by the opening or closing procedure.



In the event that the procedure causes potential danger, the procedure can be immediately halted by releasing the button on the SmartKey. To reverse direction of movement, press  for opening or  for closing.

If the weather is warm, you can ventilate the vehicle before driving off by simultaneously:

- opening the side windows
- opening the soft top
- turning on the seat ventilation* for the driver's seat

 *The seat ventilation* for the driver's seat is automatically set to the highest level if activated via summer opening feature.*



- ▶ Aim transmitter eye of the SmartKey or SmartKey with KEYLESS-GO* at the driver's outside door handle. The SmartKey or SmartKey with KEYLESS-GO* must be in close proximity to the driver's outside door handle.
- ▶ Press and hold button  after unlocking the vehicle.
The windows and soft top begin to open after approximately one second. The message **Top in operation** appears in the multifunction display.
- ▶ Release the  button to interrupt procedure.

Make sure the soft top is fully opened.

Convenience closing feature



Warning!



When closing the side windows and the soft top, make sure that there is no danger of anyone being harmed by the closing procedure.

The windows will not automatically re-open if blocked during convenience closing.

If potential danger exists, proceed as follows:

- Release button  to stop the closing procedure. To open, press and hold button . To continue the closing procedure after making sure that there is no danger of anyone being harmed by the closing procedure, press and hold button .

Vehicles with KEYLESS-GO*:

- Release the lock button (▷ page 62) on exterior door handle to stop the closing procedure.

- Immediately pull on the same outside door handle and hold firmly. The side windows and the soft top will open for as long as the door handle is held but the door is not opened.

When you lock the vehicle, you can close the windows and soft top simultaneously.

- ▶ Aim transmitter eye of the SmartKey or SmartKey with KEYLESS-GO* at the driver's outside door handle (▷ page 252). The SmartKey or SmartKey with KEYLESS-GO* must be in close proximity to the driver's outside door handle.
- ▶ Press and hold button  until the windows and soft top are completely closed.

The windows and soft top begin to close after approximately one second. The message *Top in operation* appears in the multifunction display.

- ▶ Release button  to interrupt procedure.

Vehicles with KEYLESS-GO*:

- ▶ Press and hold the lock button on an outside door handle (▷ page 62) until the side windows are completely closed.
- ▶ Release the lock button on the outside door handle to interrupt procedure.

Make sure all side windows and the soft top are properly closed before leaving the vehicle.

Power windows

Opening and closing all side windows with the soft top switch

The soft top switch is located in the center console.

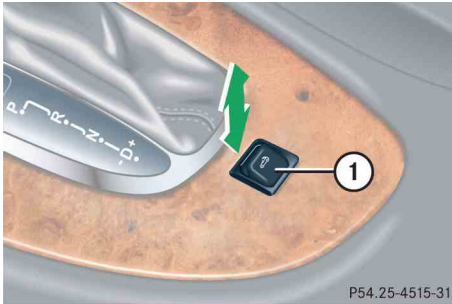

① Soft top switch

As an alternate method to using the power window switches, all side windows can be opened or closed using the soft top switch ①.

Warning!



Never operate the windows if there is the possibility of anyone being harmed by the opening or closing procedure.

In case the procedure causes potential danger, the procedure can be immediately halted by releasing the soft top switch. To open the windows again, press the soft top switch twice. Press the switch briefly the first time. Then press the switch a second time and hold it until the side windows have reached the desired position.

- ▶ Switch on the ignition.

Opening

- ▶ Press soft top switch ① twice. Press the switch briefly the first time. Then press the switch a second time and hold it until the side windows have reached the desired position.

Closing

- ▶ Pull soft top switch ① twice. Pull the switch briefly the first time. Then pull the switch a second time and hold it until the side windows have reached the desired position.

▼ Soft top

Opening and closing the soft top

For safety reasons, the soft top can only be opened and closed when the vehicle is standing still.

Warning!



Before operating the switch for the soft top, make sure no persons can be injured by the moving parts (roll bars, soft top frame, and soft top compartment cover).

Hands must never be placed near the roll bar, soft top frame, upper windshield area, shelf behind roll bar, or soft top storage compartment while the soft top is being raised or lowered. Serious personal injury may occur.

If potential danger exists, release the soft top switch. This immediately interrupts the raising or lowering procedure. You then can operate the soft top switch to raise or lower the soft top away from the danger zone.

Warning!



When leaving the vehicle, always remove the SmartKey or SmartKey with KEYLESS-GO* from the starter switch, take it with you, and lock the vehicle. Do not leave children unattended in the vehicle, or with access to an unlocked vehicle. A child's unsupervised access to a vehicle could result in an accident and/or serious personal injury.

! *Never sit or place heavy objects on the rear shelf. Doing so could cause damage to the soft top and the rear shelf.*

! *When opening and closing the soft top, make sure:*

- *there is sufficient clearance for the soft top to move up*
- *the luggage cover is engaged in place (▷ page 260)*
- *the trunk is only loaded to the height of the luggage cover*
- *the luggage/cargo does not push the closed luggage cover up*
- *the trunk lid is closed*
- *nothing is placed on the soft top compartment cover*
- *the outside temperature is above +5°F (-15°C)*

Otherwise the soft top and other parts of the vehicle could be damaged.

Soft top

Opening the soft top

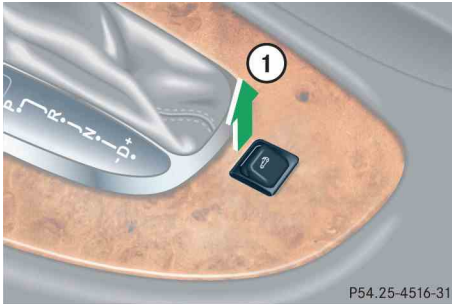

P54.25-4516-31

① Soft top, opening

Before pulling on the soft top switch, you must make sure:

- the parking brake is engaged (▷ page 52)
- the luggage cover is latched, see “Latch luggage cover” (▷ page 260)
- the trunk lid is closed
- the ignition is switched on (▷ page 38)

i The soft top cannot be opened using the soft top switch when the roll bars have been re-leased. The roll bars need to be lowered before the soft top can be operated again using the soft top switch. If the roll bars have released and the soft top is closed, contact an authorized Mercedes-Benz Center to have the roll bars lowered. Do not attempt to lower the roll bars manually with the soft top closed. Lowering the roll bars manually with the soft top closed may impair the function of the roll bars (▷ page 413).

If the roll bars have released and the soft top is open, you can lower the roll bars manually (▷ page 414) or contact an authorized Mercedes-Benz Center to have the roll bars lowered.

- ▶ Pull up on the soft top switch as indicated by the arrow ① until the soft top is completely lowered into its trunk storage compartment.

During the opening procedure the multifunction display shows the message Top in operation.

If you continuously pull on the soft top switch, the windows will close.

However, the windows can also be closed/opened later on, for more information see “Opening and closing all side windows with the soft top switch” (▷ page 254), or see “Opening and closing the windows” (▷ page 249).

i For safety reasons, the soft top cannot be opened while driving.

Make sure the soft top is dry before you open it. Otherwise water may enter the trunk interior.

! To prevent mildew, the soft top must be dry before lowering it into the storage compartment.

Do not lower a frozen soft top until thawed and dry. Lowering a frozen soft top may result in damage not covered by the Mercedes-Benz Limited Warranty.

Warning!



Do not place anything on the soft top compartment cover.

The soft top compartment cover must never be used by any persons as a seat bench.

Raising of the roll bars could result in serious personal injury.

Closing the soft top

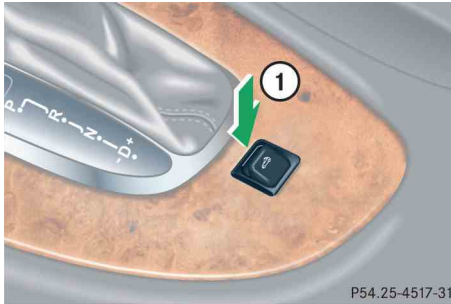

P54.25-4517-31

① Soft top, closing

Before pressing the soft top switch, you must make sure:

- the parking brake is engaged (▷ page 52)
- the trunk lid is closed
- the ignition is switched on (▷ page 38)

- ▶ Press the soft top switch as indicated by the arrow ① until the soft top is completely closed and locked.

During the closing procedure the multifunction display shows the message Top in operation.

If you continuously press on the soft top switch the windows will close.

However, the windows can also be closed/opened later on, for more information see “Opening and closing all side windows with the soft top switch” (▷ page 254) or see “Opening and closing the windows” (▷ page 249).

- ⓘ *For safety reasons, the soft top cannot be closed while driving.*

- ⓘ *The soft top cannot be closed using the soft top switch when the roll bars have been released. The roll bars need to be lowered before the soft top can be operated again using the soft top switch. If the roll bars have released and the soft top is open, you can lower the roll bars manually (▷ page 414) or contact an authorized Mercedes-Benz Center to have the roll bars lowered.*

Warning!



To prevent possible accidents, drive the vehicle only with the soft top either completely closed and locked, or fully lowered into its storage compartment.

If the soft top does not completely open or close, a warning sounds. In the multifunction display you will see , and the message Top being opened appears. After about 15 seconds the roof hydraulics lose pressure.

Properly lock the soft top (▷ page 258) before continuing to drive.

Soft top

Locking the soft top after raising/lowering

Warning!



The soft top is not fully closed and locked or not fully opened if:

- the message *Top in operation* is shown in the multifunction display
- a warning sounds for 10 seconds when starting to drive

To prevent possible accidents, drive the vehicle only with the soft top either completely closed and locked, or fully lowered into its storage compartment.

If the soft top is not properly locked, lock it as described below.

Unlocked status noticed when stopped

- ▶ Switch on the ignition (▷ page 38).
- ▶ To lock the soft top in its fully closed position, press soft top switch.

or:

- ▶ To lock the soft top in its fully opened position, pull up on the soft top switch.

Unlocked status noticed while driving

Warning!



Stop the vehicle in a safe location or as soon as it is safe to do so and lock the soft top before continuing to drive. You could otherwise endanger yourself and others.

- ▶ Stop the vehicle.
- ▶ Leave the ignition switched on.
- ▶ To lock the soft top in its fully closed position, press soft top switch.

or:

- ▶ To lock the soft top in its fully opened position, pull up on the soft top switch.

Warning!



If the soft top does not completely open or close, the roof hydraulics will lose pressure and the soft top will lower

- after approximately seven minutes when the ignition is switched on.
- after approximately 15 seconds when the ignition is switched off.

Shortly before the soft top is lowered, a warning will sound. In the multifunction display you will see , and the message *Top being opened* appears.

- Properly lock the soft top (▷ page 258) before continuing to drive.

Opening and closing the soft top with the SmartKey



The windows will also be opened or closed when you operate the soft top with the SmartKey.

Warning!



Before operating the soft top, make sure no persons can be injured by the moving parts (roll bar, soft top frame, and soft top compartment cover) due to negligence.

Hands must never be placed near the roll bar, soft top frame, upper windshield area, shelf behind roll bar, or soft top storage compartment while the soft top is being raised or lowered. Serious personal injury may occur.

If potential dangers exist, release the respective button on the SmartKey. This immediately interrupts the raising or lowering procedure. You then can operate  to lower or  to raise the soft top away from the danger zone.

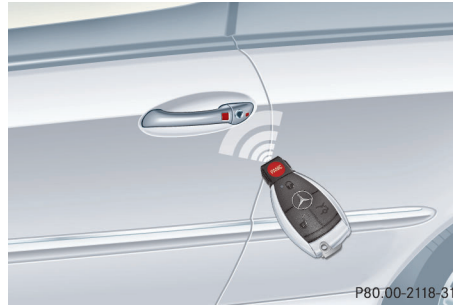

- ▶ Aim transmitter eye of the SmartKey or SmartKey with KEYLESS-GO* at the driver's outside door handle. The SmartKey or SmartKey with KEYLESS-GO* must be in close proximity to the driver's outside door handle.

Opening (Summer opening feature)

- ▶ Press and hold button  until the soft top is completely open.

The windows and soft top begin to open after approximately one second.

During the opening procedure the multifunction display shows the message Top in operation.

- ▶ Release transmit button  to interrupt procedure.

Make sure the soft top is fully opened.

Closing (Convenience feature)

- ▶ Press and hold button  until the soft top is completely closed.

The windows and soft top begin to close after approximately one second.

During the closing procedure the multifunction display shows the message Top in operation.

- ▶ Release transmit button  to interrupt procedure.

Soft top

Make sure all side windows and the soft top are properly closed before leaving the vehicle.

Warning!



If the soft top does not completely open or close, a warning sounds and the soft top switch flashes. In the multifunction display you will see , and the message Top being opened appears. After about 15 seconds the roof hydraulics lose pressure.

Properly lock the soft top (▷ page 258) before continuing to drive.

Luggage cover

The luggage cover is located in the trunk.

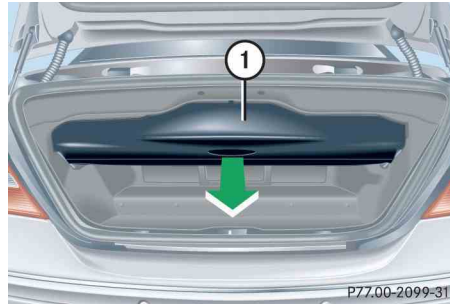

① Luggage cover

- ▶ Open the trunk

Latch luggage cover

- ▶ Pull luggage cover ① out in direction of arrow until it engages in place.

Folding back luggage cover

- ▶ Press luggage cover ① in direction of rear seat.

! To prevent damage to the soft top or luggage/cargo when lowering the roof:

- load trunk only to the height of the luggage cover
- do not permit luggage/cargo to push up the closed luggage cover
- do not place anything on the shelf behind the roll bars
- do not place anything on the soft top compartment cover

! Never place anything behind the side nets when the luggage cover has been folded back. You could forget about objects placed there, which could result in damage when operating the soft top.

Wind screen

Warning!



The wind screen can restrict the driver's vision to the rear of the vehicle. To prevent a possible accident when visibility is limited (e.g. in darkness), the upper part of the wind screen should be folded back.

The wind screen deflects drafts away from the driver and passenger when the soft top is lowered. It is stored in a separate storage bag in the trunk.

Installing

- ▶ Remove the wind screen from its storage bag.

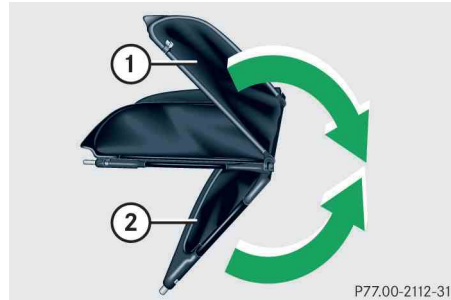

- ① Upper section
- ② Lower section
- ▶ Fold sections ① and ② together.

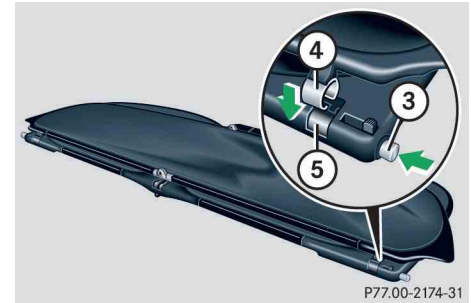

- ③ Catch
- ④ Retainer claw
- ⑤ Snap fastener

- ▶ Press retainer claw ④ on upper section into snap fastener ⑤ of lower section. ▷▷

Soft top

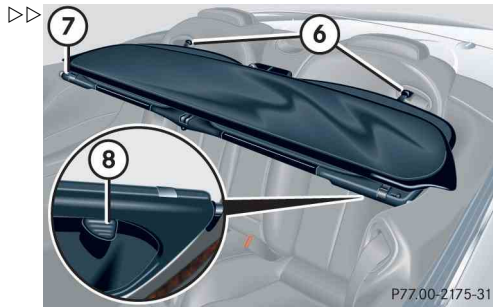

- ⑥ Retaining lugs
- ⑦ Mounting fixture on right side
- ⑧ Catch

- ▶ Fold retaining lugs ⑥ out.
- ▶ Slide pre-assembled wind screen into mounting fixture on right side ⑦ using retaining pin on right side. Simultaneously, retaining lugs ⑥ should slide into seat belt passage in rear bench seat.

- ▶ Pull catch ⑧ back and guide left retaining pin into mounting fixture on left side.
- ▶ Fold upper section of wind screen up toward head restraints until it stops.

Warning!



Check for secure locking by pulling up on the wind screen.

To prevent personal injury, remove wind screen if rear seats are to be occupied by passengers.

Removing

- ▶ Fold upper section of wind screen back down.
- ▶ Pull catch ⑧ back and pull wind screen out toward front of vehicle. Be careful not to damage interior trim with guide tabs.
- ▶ Fold retaining lugs ⑥ back.



- ⑨ Catch

- ▶ Press catch ⑨ and fold upper and lower sections back.
- ▶ Place the wind screen back into the bag.

▼ Driving systems

The driving systems of your vehicle are described on the following pages:

- Cruise control, with which the vehicle can maintain a preset speed.
- Parktronic* (CLK 63 AMG (USA), Canada all vehicles), which serves as a parking assistant.

For information on the BAS, ABS, and ESP®, see “Driving safety systems” (▷ page 88).

Cruise control

Cruise control automatically maintains the speed you set for your vehicle.

Use of cruise control is recommended for driving at a constant speed for extended periods of time.

You can set or resume cruise control at any speed over 20 mph (30 km/h).

The cruise control function is operated by means of the cruise control lever.

The cruise control lever is the uppermost lever on the left-hand side of the steering column (▷ page 24).

Warning!



Cruise control is a convenience system designed to assist the driver during vehicle operation. The driver is and must always remain responsible for the vehicle's speed and for safe brake operation.

Only use cruise control if the road, traffic and weather conditions make it advisable to travel at a steady speed.

- The use of cruise control can be dangerous on winding roads or in heavy traffic because conditions do not allow safe driving at a steady speed.
- The use of cruise control can be dangerous on slippery roads. Rapid changes in tire traction can result in wheel spin and loss of control.
- Deactivate cruise control when driving in fog.

The “Resume” function should only be operated if the driver is fully aware of the previously set speed and wishes to resume this particular preset speed.

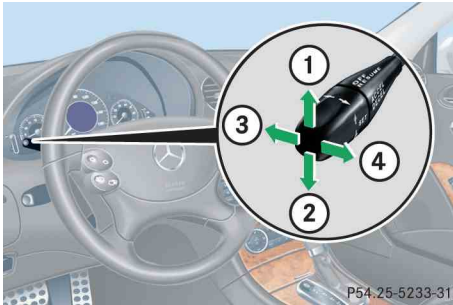

- ① Set current or higher speed
- ② Set current or lower speed
- ③ Cancel cruise control
- ④ Resume to last set speed

Warning!



Cruise control brakes automatically so that the set speed is not exceeded. The brake pedal depresses when the cruise control engages the brakes.

Keep driver's foot area clear at all times, including the area under the brake pedal. Objects stored in this area may impair pedal movement which could interfere with the braking ability of the cruise control system.

Do not place your foot under the brake pedal - your foot could become caught.

Keep in mind that cruise control is a convenience system designed to assist the driver during vehicle operation. The driver is and must always remain responsible for the vehicle's speed and for safe brake operation.

Setting current speed

- ▶ Accelerate or decelerate to the desired speed.
- ▶ Briefly lift ① or depress ② the cruise control lever (> page 264).

The current speed is set.

- ▶ Remove your foot from the accelerator pedal.

Cruise control is activated.

The selected speed appears in the multi-function display for approximately five seconds, and the corresponding speedometer segments from the selected speed to the vehicle maximum speed are illuminated.

i *On uphill or downhill grades, cruise control may not be able to maintain the set speed. Once the grade eases, the set speed will be resumed.*

On downhill grades, the cruise control will hold the set speed with braking from the vehicle's brake system.

In addition, on longer downhill grades the automatic transmission will automatically downshift.

Canceling cruise control

There are several ways to cancel cruise control:

- ▶ Step on the brake pedal.

Cruise control is canceled. The last speed set is stored for later use.

or

- ▶ Briefly push the cruise control lever to position ③.

Cruise control is canceled. The last speed set is stored for later use.

i *The last stored speed is canceled when you turn off the engine.*

i *Cruise control automatically switched off, if*

- *you step on the brake pedal.*
- *you press the parking brake pedal.*

In this case the segments in the multifunction display (▷ page 264) go out and no warning sounds.

- *the vehicle speed is below 20 mph (30 km/h).*
- *ESP® is in operation or switched off with the ESP® switch (▷ page 92).*
- *you move the gear selector lever to position N while driving.*

The segments in the multifunction display (▷ page 264) go out, and an acoustic warning sounds.

! *Moving gear selector lever to position N while driving also cancels cruise control. However, the gear selector lever should not be moved to position N while driving except to coast when the vehicle is in danger of skidding (e.g. on icy roads).*

i *Depressing the accelerator pedal does not deactivate cruise control. After brief acceleration (e.g. for passing), cruise control will resume the last speed set.*

Setting a higher speed

- ▶ Lift the cruise control lever in direction of arrow ① (▷ page 264) and hold it up until the desired speed is reached.
- ▶ Release the cruise control lever.
The new speed is set.

Driving systems

Setting a lower speed

- ▶ Depress the cruise control lever in direction of arrow ② (▷ page 264) and hold it down until the desired speed is reached.
- ▶ Release the cruise control lever.

The new speed is set.

i *When you use the cruise control lever to decelerate, the brake system will automatically brake the vehicle if the engine's braking power does not brake the vehicle sufficiently.*

Fine adjustment in 1 mph (Canada: 1 km/h) increments

Faster

- ▶ Briefly tip the cruise control lever in direction of arrow ① (▷ page 264).

Slower

- ▶ Briefly tip the cruise control lever in direction of arrow ② (▷ page 264).

Setting to last stored speed ("Resume" function)

Warning!



The speed stored in memory should only be set again if prevailing road conditions permit. Possible acceleration or deceleration differences arising from returning to the preset speed could cause an accident and/or serious injury to you and others.

- ▶ Briefly push cruise control lever to position ④ (▷ page 264).
The cruise control resumes the last set speed.
- ▶ Remove your foot from the accelerator pedal.

The selected speed appears in the multi-function display for approximately five seconds, and the corresponding speedometer segments from the selected speed to the vehicle maximum speed are illuminated (▷ page 264).

Parktronic system (Parking assist)*, CLK 63 AMG (USA), Canada all vehicles

Warning!



Parktronic is a supplemental system. It is not intended to, nor does it replace, the need for extreme care. The responsibility during parking and other critical maneuvers always rests with the driver.

Special attention must be paid to objects with smooth surfaces or low silhouettes (e.g. trailer couplings, painted posts or road curbs). Such objects may not be detected by the system and can damage the vehicle.

The operational function of the Parktronic system can be affected by dirty sensors, especially at times of snow and ice, see "Cleaning the Parktronic system* sensors (CLK 63 AMG (USA), Canada all vehicles)" (▷ page 361).

Interference caused by other ultrasonic signals (e.g. working jackhammers, car wash, or the air brakes of trucks) can cause the system to send erratic indications, and should be taken into consideration.

Warning!



Make sure no persons or animals are in the area in which you are maneuvering. You could otherwise injure them.

The Parktronic system is an electronic aid designed to assist the driver during parking maneuvers. It visually and audibly indicates the relative distance between the vehicle and an obstacle.

The Parktronic system is automatically activated when you switch on the ignition (▷ page 36) and placed the gear selector lever in position **D**, **R**, or **N**.

The Parktronic system deactivates at speeds over approximately 11 mph (18 km/h). At lower speeds the Parktronic system turns on again.

The Parktronic system also deactivates when you place the gear selector lever in position **P**.

The Parktronic system monitors the surroundings of your vehicle with six sensors in the front bumper and four sensors in the rear bumper.

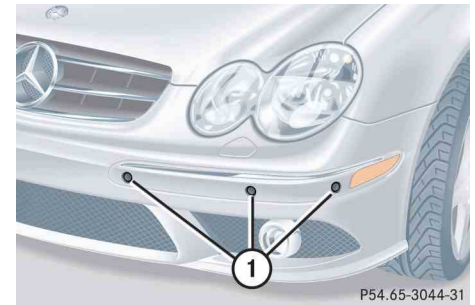

P54.65-3044-31

① Sensors in the front bumper

Driving systems

Range of the sensors

To function properly, the sensors must be free of dirt, ice, snow and slush. Clean the sensors regularly, being careful not to scratch or damage the sensors, see “Cleaning the Parktronic system* sensors (CLK 63 AMG (USA), Canada all vehicles)” (▷ page 36 1).

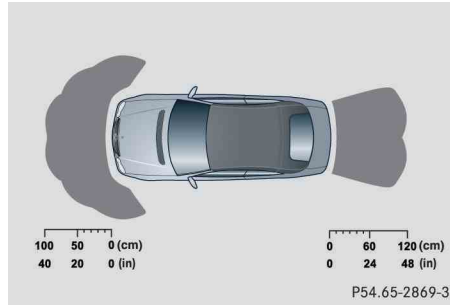
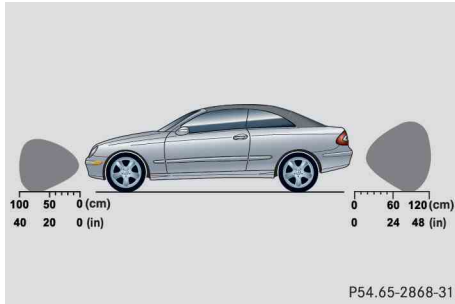

Front sensors

Center	approx. 40 in (100 cm)
Corners	approx. 24 in (60 cm)

Rear sensors

Center	approx. 48 in (120 cm)
Corners	approx. 32 in (80 cm)

! During parking maneuvers, pay special attention to objects located above or below the height of the sensors (e.g. planters or trailer hitches). The Parktronic system will not detect such objects at close range and damage to your vehicle or the object may result.

Ultrasonic signals from outside sources (e.g. truck air brakes, car wash, or jackhammers) may impair the operation of the Parktronic system.

Minimum distance

Center	approx. 8 in (20 cm)
Corners	approx. 6 in (15 cm)

If the system detects an obstacle in this range, all the distance warning segments illuminate and you hear a warning signal. If the obstacle is closer than the minimum distance, the actual distance may no longer be indicated by the system.

Warning indicators

Visual signals indicate to the driver the relative distance between the sensors and an obstacle. The warning indicator for the front area is located above the center air vents in the dashboard. The warning indicator for the rear area is integrated between the rear backrests.

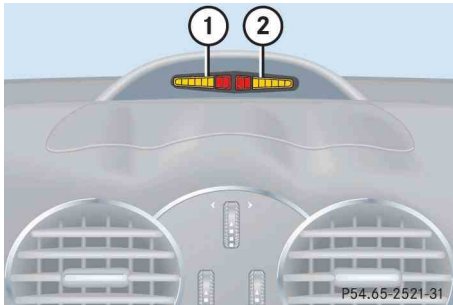

- ① Left side of the vehicle
- ② Right side of the vehicle

Each warning indicator is divided into six yellow and two red distance segments for either side of the vehicle. The Parktronic system is ready when the border around the indicator is illuminated.

The position of the gear selector lever determines which warning indicators will be activated.

Gear selector lever position	Warning indicator
D	Front area activated
R or N	Front and rear area activated
P	Neither activated

As your vehicle approaches an object, one or more distance segments will illuminate, depending on the distance. When the eighth distance segment illuminates, you have reached the minimum distance.

- **Front area:** An intermittent acoustic warning will sound as the first red distance segment illuminates and a constant acoustic warning lasting a maximum of two seconds will sound for the second red distance segment. The signal is canceled when the gear selector lever is placed in position **P**.
- **Rear area:** An intermittent acoustic warning will sound as the first red distance segment illuminates and a constant acoustic warning lasting a maximum of two seconds will sound for the second red distance segment. The signal is canceled when the gear selector lever is placed in position **D** or **P**.

Driving systems

Switching the Parktronic system on/off

The Parktronic system can be switched off manually.

The Parktronic switch is located in the upper part of the center console.



P54.25-5243-31

- ① Parktronic switch
- ② Indicator lamp

Switching off the Parktronic system

- ▶ Press Parktronic switch ①.
- Indicator lamp ② comes on.

Switching on the Parktronic system

- ▶ Press Parktronic switch ① again.
- Indicator lamp ② goes out.

i The Parktronic system is automatically switched on when the ignition is switched on (▷ page 36).

Parktronic system malfunction

If only the red distance segments illuminate and a acoustic warning sounds, there is a malfunction in the Parktronic system. The Parktronic system will automatically switch off after 20 seconds and the indicator lamp in the Parktronic switch comes on.

- ▶ Have the Parktronic system checked by an authorized Mercedes-Benz Center as soon as possible.

If only the red distance segments illuminate and no acoustic warning sounds, the Parktronic system sensors are dirty or there is an interference from other radio or ultrasonic signals. The Parktronic system will automatically switch off after 20 seconds and the indicator lamp in the Parktronic switch comes on.

- ▶ Switch off the ignition (▷ page 36).
 - ▶ Clean the Parktronic system sensors (▷ page 36 1).
 - ▶ Switch on the ignition.
- or
- ▶ Check the Parktronic system operation at another location to rule out interference from outside radio or ultrasonic signals.

▼ **Loading**

Ski sack* (Canada only)

Unfolding and loading

- ▶ Close soft top completely (▷ page 257).
- ▶ Open the trunk.

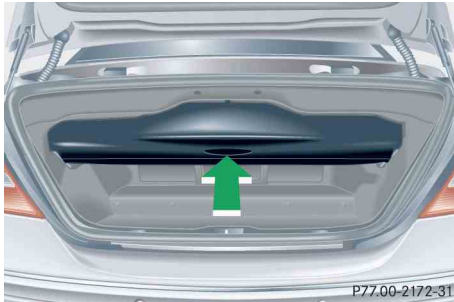

- ▶ Fold luggage cover back in direction of the arrow.

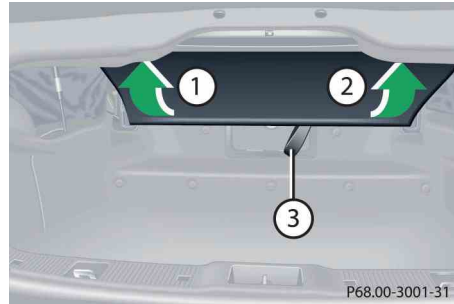

- ① Left hinge
- ② Right hinge
- ③ Pull strap

- ▶ Pull ski sack roller blind upward using pull strap ③.
- ▶ Manually fold left ① and right hinges ② of ski sack roller blind all the way up.

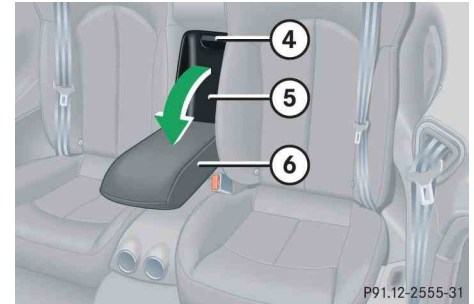

- ④ Handle
- ⑤ Cover
- ⑥ Armrest

- ▶ Fold armrest ⑥ down (arrow).
- ▶ Pull handle ④ and swing cover ⑤ down.



Loading



P91.12-2556-31

- ⑦ Hook and loop fastener
- ▶ Unfasten hook and loop fastener ⑦.
- ▶ Pull ski sack into passenger compartment and unfold.

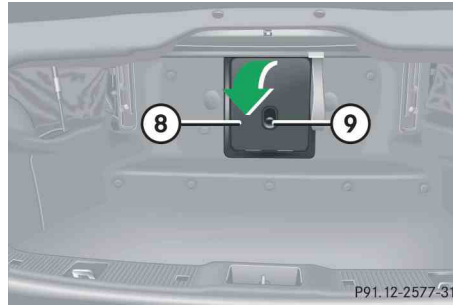

P91.12-2577-31

- ⑧ Flap
- ⑨ Catch
- ▶ Pull down catch ⑨.
- ▶ Open the flap ⑧ downwards in the direction of the arrow.



P91.12-2557-31

- ▶ From trunk, slide skis into ski sack.

Warning!



The ski sack is designed for up to two pairs of skis. Do not load the ski sack with other objects.

Always fasten the ski sack securely. In an accident, an unfastened ski sack can cause injury to vehicle occupants.



⑩ Strap

- ▶ Tighten strap ⑩ by pulling at the loose end (arrow) until the skis in the ski sack are tightly secured.

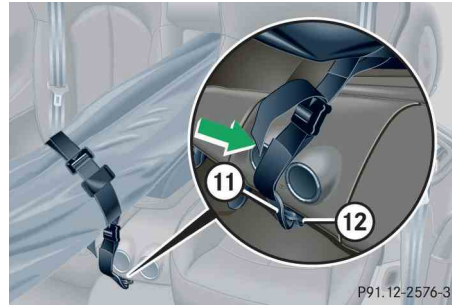

⑪ Hook

⑫ Eye

- ▶ Connect hook ⑪ to eye ⑫ located on center tunnel in front of rear seat bench.
- ▶ Tighten strap by pulling at the loose end (arrow).

Unloading and folding

- ▶ Loosen both straps.
- ▶ Disconnect hook ⑪ from eye ⑫.
- ▶ Unload skis.
- ▶ Close flap ⑧ in trunk.
- ▶ Fold and flatten ski sack lengthwise.
- ▶ Place folded ski sack inside recess of backrest.
- ▶ Fasten hook and loop fastener.



- ▶ Close ski sack compartment cover.

Loading

Closing ski sack roller blind

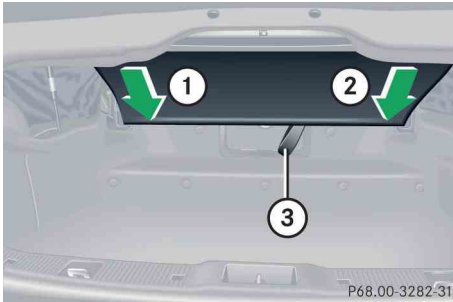

- ① Left hinge
- ② Right hinge
- ③ Pull strap

- ▶ Pull ski sack roller blind downward using pull strap ③.
- ▶ Manually fold left ① and right hinges ② of ski sack roller blind all the way down.

- ▶ To snap ski sack roller blind into place, press left and right hinges where the word PRESS can be seen.
- ▶ Fold luggage cover back and close it securely (▷ page 260).

Removing the ski sack

For ski sack removal, we recommend that you contact an authorized Mercedes-Benz Center.

Warning!



Never drive vehicle with trunk open while the ski sack is removed. Deadly carbon monoxide (CO) gases may enter vehicle interior, resulting in unconsciousness and death.

i To prevent unauthorized persons from access to the trunk, always close the flap.

Loading instructions

The total load weight including vehicle occupants and luggage/cargo should not exceed the load limit indicated on the corresponding placard located on the driver's door B-pillar (▷ page 326).

The handling characteristics of a fully loaded vehicle depend greatly on the load distribution. It is therefore recommended to load the heaviest items being placed towards the front of the vehicle.

Always place items being carried against rear seat backrests, and fasten them as securely as possible.

The heaviest portion of the cargo should always be kept as low as possible since it influences the handling characteristics of the vehicle.

! *To prevent damage to the soft top or luggage/cargo when lowering the roof:*

- *load trunk only to the height of the luggage cover*
- *do not permit luggage/cargo to push up the closed luggage cover*
- *do not place anything on the shelf behind the roll bar*
- *do not place anything on the soft top compartment cover*

Warning!



Always fasten items being carried as securely as possible using fastening materials appropriate for the weight and size of the load.

In an accident, during hard braking or sudden maneuvers, loose items will be thrown around inside the vehicle and can cause injury to vehicle occupants unless the items are securely fastened in the vehicle.

To help avoid personal injury during a collision or sudden maneuver, exercise care when transporting cargo. Put luggage or cargo in the trunk if possible.

Never drive vehicle with trunk open. Deadly carbon monoxide (CO) gases may enter vehicle interior resulting in unconsciousness and death.

Useful features

Storage compartments

Warning!



Do not store any flammable substances inside the vehicle or in the trunk. Otherwise the flammable substances could ignite and start a fire inside the vehicle.

To help avoid personal injury during a collision or sudden maneuver, exercise care when storing objects in the vehicle. Put luggage or cargo in the trunk if possible. Do not pile luggage or cargo higher than the seat backs.

Parcel nets cannot secure hard or heavy objects.

Keep compartment lids closed. This will help to prevent stored objects from being thrown about and injuring vehicle occupants during an accident.

Glove box

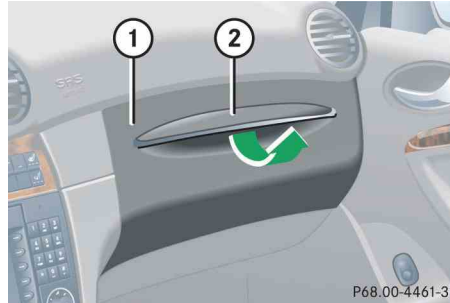

- ① Glove box lid
- ② Glove box lid release

Opening the glove box

- ▶ Pull glove box lid release ②.

The glove box lid ① opens downward.

Closing the glove box

- ▶ Push glove box lid ① up to close.

i *Audio system/COMAND* with CD changer*: The CD changer* is located in the glove box.*

Storage compartment in the dashboard

Depending on your vehicle's production date, your vehicle is equipped with either a cup holder (▷ page 280) or a storage compartment.

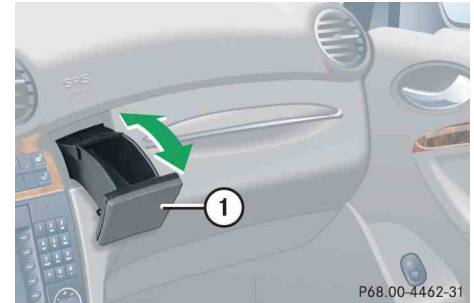

- ① Cover

Opening storage box

- ▶ Push cover ①.

The storage box opens automatically.

Closing storage box

- ▶ Push the storage box back until it engages.

Ruffled storage bags



Storage bags are located on the rear side of the front seats.

Warning!



The ruffled storage bag is intended for storing light-weight items only.

Heavy objects, objects with sharp edges or fragile objects may not be transported in the ruffled storage bag. In an accident, during hard braking, or sudden maneuvers, they could be thrown around inside the vehicle and cause injury to vehicle occupants.

The ruffled storage bag cannot protect transported goods in the event of an accident.

Parcel net in front passenger footwell

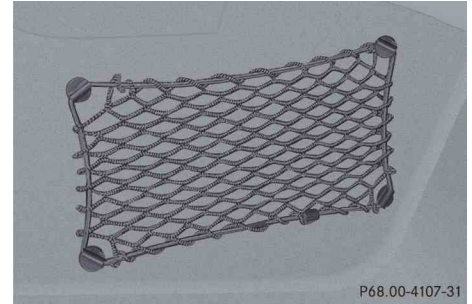

A small convenience parcel net is located in the front passenger footwell. It is for small and light items, such as road maps, mail, etc.

Useful features

Warning!



The parcel net is intended for storing light-weight items only.

Heavy objects, objects with sharp edges or fragile objects may not be transported in the parcel net. In an accident, during hard braking, or sudden maneuvers, they could be thrown around inside the vehicle and cause injury to vehicle occupants.



The parcel net cannot protect transported goods in the event of an accident.

Center armrest

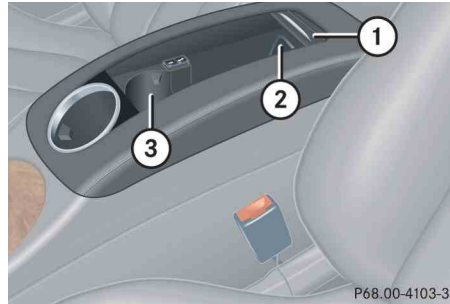
The compartment in the center armrest contains a cup holder and the telephone* compartment.



- ① Cover
- ② Telephone* compartment
- ③ Cup holder

i The Roadside Assistance button  (▷ page 290) and the Information button  (▷ page 291) are located below the cover ①.

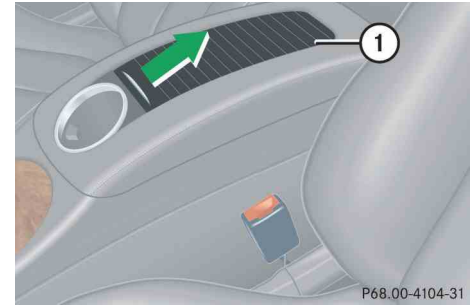

- ① Cover

Opening compartment

- ▶ Slide cover ① in direction of arrow.

Closing compartment

- ▶ Slide cover ① back.

Opening telephone compartment

- ▶ Slide cover ① in direction of arrow and open it fully.

Closing telephone compartment

- ▶ Slide cover ① back.

Armrest in the rear passenger compartment



P68.00-3701-31

- ▶ Pull the top of the armrest out and fold it down.

! Do not sit on or lean your full body weight against the armrest when it is folded down, as you could otherwise damage it.

Cup holders

Warning!



In order to help prevent spilling liquids on vehicle occupants and/or vehicle equipment, only use containers that fit into the cup holder. Use lids on open containers and do not fill containers to a height where the contents, especially hot liquids, could spill during braking, vehicle maneuvers, or in an accident. Liquids spilled on vehicle occupants may cause serious personal injury. Liquids spilled on vehicle equipment may cause damage not covered by the Mercedes-Benz Limited Warranty.

When not in use, keep the cup holder closed. An open cup holder may cause injury to you and others when contacted during braking, vehicle maneuvers, or in an accident.

Keep in mind that objects placed in cup holder may come loose during braking, vehicle maneuvers, or in an accident and be thrown around in the vehicle interior. Objects thrown around in the vehicle interior may cause an accident and/or serious personal injury.

Cup holder in the center armrest

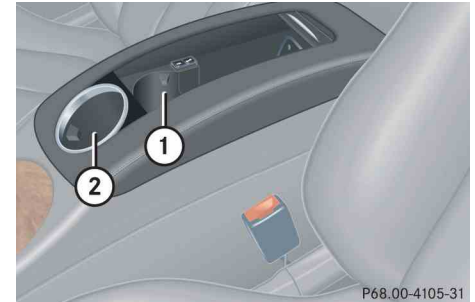

P68.00-4105-31

- ① Cup holder in compartment
(▶ page 278)
- ② Cup holder

Useful features

Cup holder in the dashboard

Depending on your vehicle's production date, your vehicle is equipped with either a storage compartment (▷ page 276) or a cup holder.



- ① Cover

Opening cup holder

- ▶ Push cover ①.
The cup holder opens automatically.

Closing cup holder

- ▶ Push the cup holder back until it engages.

Ashtrays

Center console ashtray



- ① Cover plate
- ② Sliding button
- ③ Ashtray insert

Opening ashtray

- ▶ Briefly press the bottom of cover plate ①.
The cover plate opens automatically.

Removing ashtray insert

Warning!



Remove front ashtray only with vehicle standing still. Set the parking brake to secure vehicle from movement. Move the gear selector lever to position **N** and turn off the engine.

- ▶ Secure vehicle from movement by setting the parking brake.
- ▶ Move the gear selector lever to position **N**.
Now you have more room to take out the insert.
- ▶ Push sliding button ② to the right.
The ashtray is disengaged and slides a short way in direction of arrow ③.
- ▶ Remove the ashtray insert.

Reinstalling the ashtray insert

- ▶ Push the ashtray insert ③ down into the retainer until it engages.
- ▶ Push down cover plate ① to close ashtray.

The cover plate engages.

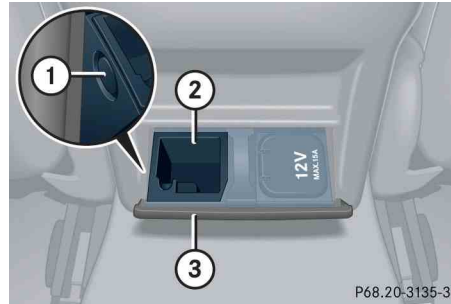
Rear seat ashtray

- ① Button
- ② Ashtray insert
- ③ Cover

Opening ashtray

- ▶ Pull at top of cover ③.

Removing ashtray insert

- ▶ Push button ① to disengage ashtray insert ② and remove it.

Reinstalling ashtray insert

- ▶ Push the ashtray insert ② down into the retainer until it engages.
- ▶ Push at top of cover ③ to close ashtray.

Useful features

Cigarette lighter

Warning!



Never touch the heating element or sides of the cigarette lighter; they are extremely hot. Hold the knob only.

Make sure that any children traveling with you do not injure themselves or start a fire with the hot cigarette lighter.

When leaving the vehicle, always remove the SmartKey or SmartKey with KEYLESS-GO* from the starter switch, take it with you, and lock the vehicle. Do not leave children unattended in the vehicle, or with access to an unlocked vehicle. A child's unsupervised access to a vehicle could result in an accident and/or serious personal injury.

- ▶ Switch on the ignition (▷ page 38).



- ① Cover
- ② Cigarette lighter

- ▶ Briefly press the bottom of cover plate ①.
The cover plate opens automatically.
- ▶ Push in cigarette lighter ②.
The cigarette lighter will pop out automatically when hot.
- ▶ Push down cover plate ① to close ashtray.
The cover plate engages.

! The lighter socket can accommodate 12V DC electrical accessories (up to a maximum of 85 W) designed for use with the standard “cigarette lighter” plug type. Keep in mind, however, that connecting accessories to the lighter socket (for example extensive connecting and disconnecting, or using plugs that do not fit properly) can damage the lighter socket. With the socket damaged, the lighter may no longer be able to be placed in the heating (pushed-in) position, or the lighter may pop out too early with the lighter not hot enough.

To help avoid damaging the cigarette lighter socket, we recommend connecting 12V DC electrical accessories designed for use with the standard “cigarette lighter” plug type to the 12V power outlet (▷ page 283) in your vehicle whenever possible.

Power outlet in the rear passenger compartment

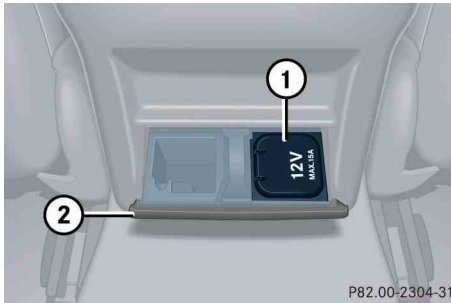

- ① Power outlet
- ② Cover
- ▶ Switch on the ignition (▷ page 38).
- ▶ Pull at top of cover ②.
- ▶ Flip cover ① to the left and insert electrical plug (cigarette lighter type).

i The power outlet can be used to accommodate electrical consumers (e.g. air pump, auxiliary lamps) up to a maximum of 180 W.

Floormats*

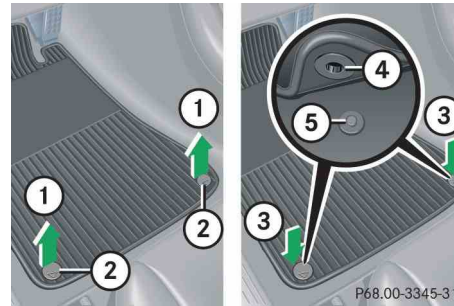

Removing

- ▶ Pull floormats off of retainer pins ② in direction of arrow ①.
- ▶ Remove the floormats.

Installing

- ▶ Lay down the floormat.
- ▶ Press the floormat eyelets ④ onto retainer pins ⑤ in direction of arrow ③.

Warning!



Whenever you are using floormats, make sure there is enough clearance and that the floormats are securely fastened.

Floormats should always be securely fastened using eyelets ④ and retainer pins ⑤.

Before driving off, check that the floormats are securely in place and adjust them if necessary. A loose floormat could slip and hinder proper functioning of the pedals.

Telephone*

Warning!



Never operate radio transmitters equipped with a built-in or attached antenna (i.e. without being connected to an external antenna) from inside the vehicle while the engine is running. Doing so could lead to a malfunction of the vehicle's electronic system, possibly resulting in an accident and/or serious personal injury.

Radio transmitters, such as a portable telephone or a citizens band unit, should only be used inside the vehicle if they are connected to an antenna that is installed on the outside of the vehicle.

The external antenna must be approved by Mercedes-Benz. Please contact an authorized Mercedes-Benz Center for information on the installation of an approved external antenna. Refer to the radio transmitter operation instructions regarding use of an external antenna.

Warning!



Please do not forget that your primary responsibility is to drive the vehicle. A driver's attention to the road must always be his/her primary focus when driving. For your safety and the safety of others, we recommend that you pull over to a safe location and stop before placing or taking a telephone call.

If you choose to use the telephone¹ while driving, please use the hands-free device and only use the telephone when road, weather and traffic conditions permit. Some jurisdictions prohibit the driver from using a mobile telephone while driving a vehicle.

Only operate the COMAND*¹ if road, weather and traffic conditions permit.



Bear in mind that at a speed of just 30 mph (approximately 50 km/h), your vehicle is covering a distance of 44 feet (approximately 14 m) every second.

¹ Observe all legal requirements.

 Various mobile phone cradles can be installed in the front center armrest, see separate installation instructions for the mobile phone cradle. These mobile phone cradles can be obtained from an authorized Mercedes-Benz Center.

The functions and services available to you while using the mobile phone depend on your service provider and the type of mobile phone you are using. See also separate operating manual for instructions on how to use your mobile phone.

When the mobile phone is inserted in the cradle, you can operate the telephone using the following devices:

- mobile phone keypad
- COMAND* (see separate operating instructions)
- buttons  and  on the multifunction steering wheel (▷ page 140)
- audio system (▷ page 234)

Please note that these functions are only available with Mercedes-Benz approved mobile phones. Please contact an authorized Mercedes-Benz Center for information on features available for your mobile phone of choice.

The cradle is located in the front center armrest.

- ▶ Open telephone compartment (▷ page 278).

Inserting mobile phone in mobile phone cradle

Once the mobile phone has been inserted in the mobile phone cradle, you have to use the hands-free device to respond during phone calls.

! Do not try to remove the mobile phone along with the cradle. You could otherwise damage the mobile phone cradle.

- ▶ If applicable, remove the cover for the external antenna connection from the back of the mobile phone and store it in a safe place. Be sure to comply with the mobile phone's operating instructions as well.



Example illustration

- ① Insert the mobile phone
 - ② Connector contact
 - ③ Mobile phone cradle
- ▶ Slide the lower end of the mobile phone into connector contact ② on cradle ③.

- ▶ Push the top of the mobile phone in direction of arrow ①, until the lug on the mobile phone release button engages.

The mobile phone is connected to the network via the external antenna.

The mobile phone is linked to the hands-free device and the multifunction steering wheel.

The battery is charged depending on its charge status and the position of the SmartKey in the starter switch. The charge procedure will be indicated in the mobile phone's display.

You can place or receive phone calls. You can control other functions of the mobile phone via the control system (▷ page 167), audio system (▷ page 234), COMAND* (see separate operating instructions).

i When you take the SmartKey or SmartKey with KEYLESS-GO* out of the starter switch, the mobile phone remains switched on for approx. 10 minutes. If you place or receive a call during this time, the mobile phone switches off 10 minutes after the call has been completed.

Useful features

Removing mobile phone from mobile phone cradle



Example illustration

- ① Release catch for mobile phone
- ② Mobile phone cradle

i When using a flip-style mobile phone, open flip top before removing from the cradle while a call is connected. Otherwise, the call will be disconnected.

- ▶ Press release catch in direction of arrow ① and take mobile phone out of mobile phone cradle ②.

Changing mobile phone cradle

If you require a different cradle for your mobile phone, remove the present cradle before installing a new one.

Removing an existing mobile phone cradle



Example illustration

- ① To release the mobile phone cradle
 - ② To remove the mobile phone cradle
 - ③ Mobile phone cradle
- ▶ Press release button in direction of arrow ① and take mobile phone cradle ③ out in direction of arrow ②.

Installing a different mobile phone cradle

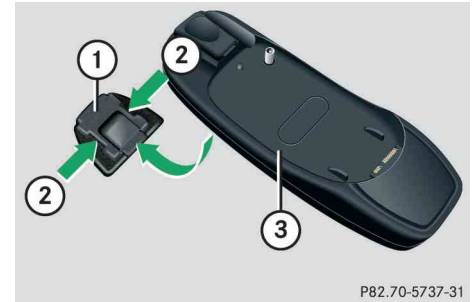

Example illustration

- ① Contact plate
 - ② Recesses
 - ③ Mobile phone cradle
- ▶ Insert mobile phone cradle ③ into recesses ② of contact plate ①.
 - ▶ Push mobile phone cradle ③ forward until it engages.

Tele Aid

! *The initial activation of the Tele Aid system may only be performed by completing the subscriber agreement and placing an acquaintance call using the  button. Failure to complete either of these steps will result in a system that is not activated.*

If you have any questions regarding activation, please call the Response Center at 1-800-756-9018 (in the USA) or 1-888-923-8367 (in Canada).



The Tele Aid system



(Telematic Alarm Identification on Demand)

The Tele Aid system consists of three types of response:



- automatic and manual emergency
- roadside assistance and
- information

The Tele Aid system is operational providing that the vehicle's battery is charged, properly connected, not damaged and cellular and GPS coverage is available.

The speaker volume of a Tele Aid call can be adjusted when using the volume control on the multifunction steering wheel. To raise, press button  and to lower, press button . The volume can also be adjusted using the volume knob on your audio system or COMAND* head unit.

- ▶ To activate, press the SOS button, the Roadside Assistance button  or the Information button , depending on the type of response required.



i *The SOS button is located in the overhead control panel (▷ page 31).*

The Roadside Assistance button  and the Information button  are located in the center armrest compartment below the cover (▷ page 278).

Shortly after the completion of your Tele Aid acquaintance call, you will receive a user ID and password. By visiting www.mbusa.com and selecting "Tele Aid" (USA only), you will have access to account information, remote door unlock and more.

i *The Tele Aid system utilizes the cellular network for communication and the GPS (Global Positioning System) satellites for vehicle location. If either of these signals is unavailable, the Tele Aid system may not function and if this occurs, assistance must be summoned by other means.*

System self-check

Initially, after switching on the ignition, malfunctions are detected and indicated (the indicator lamps in the SOS button, the Roadside Assistance button  and the Information button  stay on longer than ten seconds or do not come on). The message Tele Aid inoperative appears in the multifunction display.

Warning!



If the indicator lamps in the SOS button, in the Roadside Assistance button and/or in the Information button remain illuminated constantly in red and/or message *Tele Aid inoperative* is displayed in the multifunction display after the system self-check, a malfunction in the system has been detected.

If a malfunction is indicated as outlined above, the system may not operate as expected. Have the system checked at the nearest Mercedes-Benz Center as soon as possible.

Emergency calls

An emergency call is initiated automatically following an accident in which the emergency tensioning devices (ETDs) or air bags deploy.

An emergency call can also be initiated manually by opening the cover next to the interior rear view mirror labeled SOS, then briefly pressing the button located under the cover. See (▷ page 289) for instructions on initiating an emergency call manually.

Once the emergency call is in progress, the indicator lamp in the SOS button will begin to flash. The message *Connecting call* appears in the multifunction display and the audio system is muted. When the connection is established, the message *Call connected* appears in the multifunction display. All information relevant to the emergency, such as the location of the vehicle (determined by the GPS satellite location system), vehicle model, identification number and color are generated.

A voice connection between the Response Center and the occupants of the vehicle will be established automatically soon after the emergency call has been initiated. The Response Center will attempt to determine more precisely the nature of the emergency provided they can speak to an occupant of the vehicle.

The Tele Aid system is available if:

- it has been activated and is operational. Activation requires a subscription for monitoring services, connection and cellular air time
- the relevant cellular phone network and GPS signals are available and pass the information on to the Response Center

i *Location of the vehicle on a map is only possible if the vehicle is able to receive signals from the GPS satellite network and pass the information on to the Response Center.*

Warning!

If the indicator lamp in the SOS button is flashing continuously and there was no voice connection to the Response Center established, then the Tele Aid system could not initiate an emergency call (e.g. the relevant cellular phone network is not available). The message *Call failed* appears in the multifunction display for approximately ten seconds.

Should this occur, assistance must be summoned by other means.

Initiating an emergency call manually

- ① Cover
- ② SOS button

- ▶ Briefly press on cover ①.
The cover will open.
- ▶ Press SOS button ② briefly.
The indicator lamp in SOS button ② will flash until the emergency call is concluded.

- ▶ Wait for a voice connection to the Response Center.
- ▶ Close cover ① after the emergency call is concluded.

Warning!

If you feel at any way in jeopardy when in the vehicle (e.g. smoke or fire in the vehicle, vehicle in a dangerous road location), please do not wait for voice contact after you have pressed the emergency button. Carefully leave the vehicle and move to a safe location. The Response Center will automatically contact local emergency officials with the vehicle's approximate location if they receive an automatic SOS signal and cannot make voice contact with the vehicle occupants.

Useful features

Roadside Assistance button

The Roadside Assistance button  is located below the center armrest cover.

- ▶ Press and hold the  button (for longer than two seconds).

A call to a Mercedes-Benz Roadside Assistance dispatcher will be initiated. The  button will flash while the call is in progress. The message `Connecting call` will appear in the multifunction display and the audio system is muted.

When the connection is established, the message `Call connected` appears in the multifunction display. The Tele Aid system will transmit data generating the vehicle identification number, model, color and location (subject to availability of cellular and GPS signals).



A voice connection between the Roadside Assistance dispatcher and the occupants of the vehicle will be established.

- ▶ Describe the nature of the need for assistance.

The Mercedes-Benz Roadside Assistance dispatcher will either dispatch a qualified Mercedes-Benz technician or arrange to tow your vehicle to the nearest authorized Mercedes-Benz Center. For services such as labor and/or towing, charges may apply. Refer to the Roadside Assistance manual for more information.

The following is only available in the USA:

- Sign and Drive services: Services such as jump start, a few gallons of fuel or the replacement of a flat tire with the vehicle spare tire are obtainable.

 *The indicator lamp on the Roadside Assistance button  remains illuminated in red for approximately ten seconds during the system self-check after switching on the ignition (together with the SOS button and the Information button .*

See system self-check (▷ page 287) when the indicator lamp does not come on in red or stays on longer than approximately ten seconds.

If the indicator lamp on the Roadside Assistance button  is flashing continuously and there was no voice connection to the Response Center established, then the Tele Aid system could not initiate a Roadside Assistance call (e.g. the relevant cellular phone network is not available). The message `Call failed` appears in the multifunction display.

Roadside Assistance calls can be terminated using the  button on the multifunction steering wheel or the respective button for ending a telephone call on the audio system or the COMAND headunit.*

Information button 

The Information button  is located below the center armrest cover.

- ▶ Press and hold the  button (for longer than two seconds).



A call to the Customer Assistance Center will be initiated. The  button will flash while the call is in progress. The message **Connecting call** will appear in the multifunction display and the audio system is muted.

When the connection is established, the message **Call connected** appears in the multifunction display. The Tele Aid system will transmit data generating the vehicle identification number, model, color and location (subject to availability of cellular and GPS signals).

A voice connection between the Customer Assistance Center representative and the occupants of the vehicle will be established. Information regarding the operation of your vehicle, the nearest

Mercedes-Benz Center or Mercedes-Benz USA products and services is available to you.

For more details concerning the Tele Aid system, please visit www.mbusa.com and use your ID and password (sent to you separately) to learn more (USA only).

 *The indicator lamp on the Information button  remains illuminated in red for approximately ten seconds during the system self-check after switching on ignition (together with the SOS button and the Roadside Assistance button ).*

See System self-check (▷ page 287) when the indicator lamp does not come on in red or stays on longer than approximately ten seconds.

*If the indicator lamp on the Information button  is flashing continuously and there was no voice connection to the Response Center established, then the Tele Aid system could not initiate an Information call (e.g. the relevant cellular phone network is not available). The message **Call failed** appears in the multifunction display.*

Information calls can be terminated using the  button on the multifunction steering wheel or the respective button for ending a telephone call on the audio system or the COMAND headunit.*

 *If the indicator lamps do not start flashing after pressing one of the buttons or remain illuminated (in red) at any time, the Tele Aid system has detected a malfunction or the service is not currently active, and may not initiate a call. Visit an Mercedes-Benz Center and have the system checked or contact the Response Center at 1-800-756-9018 (in the USA) or 1-888-923-8367 (in Canada) as soon as possible.*

Useful features

Call priority

If other service calls such as a Roadside Assistance call or Information call are active, an Emergency call is still possible. In this case, the Emergency call will take priority and override all other active calls.

i The indicator lamp in the respective button flashes until the call is concluded. Calls can only be terminated by a Response Center or Customer Assistance Center representative except Roadside Assistance and Information calls, which can also be terminated by pressing button  on the multifunction steering wheel or the respective button for ending a telephone call on the audio system or the COMAND* head unit.

! If the indicator lamp continues to flash or the system does not reset, contact the Response Center at 1-800-756-9018 (in the USA), or 1-888-923-8367 (in Canada), or Mercedes-Benz Customer Assistance at 1-800-FOR-MERCEDES (1-800-367-6372) in the USA, or Customer Service at 1-800-387-0100 in Canada.

i When a Tele Aid call has been initiated, the audio system or the COMAND* system audio is muted and the selected mode (radio or CD) pauses. The optional cellular phone (if installed) switches off. If you must use this phone, the vehicle must be parked. Disconnect the coiled cord and place the call. The COMAND* navigation system (if engaged) will continue to run. The display in the instrument cluster is available for use, and spoken commands are only available by pressing the RPT button on the COMAND* head-unit. A pop-up window will appear in the COMAND* display to indicate that a Tele Aid call is in progress.

Remote door unlock

In case you have locked your vehicle unintentionally (e.g. SmartKey inside vehicle), and the reserve SmartKey is not handy:

▶ Contact the Mercedes-Benz Response Center at 1-800-756-9018 (in the USA) or 1-888-923-8367 (in Canada).

You will be asked to provide your password which you provided when you completed the subscriber agreement.

▶ Then return to your vehicle and pull the trunk recessed handle for a minimum of 20 seconds until the SOS button is flashing.

The message **Connecting call** appears in the multifunction display.

As an alternative, you may unlock the vehicle via Internet using the ID and password sent to you shortly after the completion of your acquaintance call.

The Response Center will then unlock your vehicle with the remote door unlocking feature.

i The remote door unlock feature is available if the relevant cellular phone network is available.

The SOS button will flash and the message Connecting call will appear in the multifunction display to indicate receipt of the door unlock command.

Once the vehicle is unlocked, a Response Center specialist will attempt to establish voice contact with the vehicle occupants.

If the trunk recessed handle was pulled for more than 20 seconds before door unlock authorization was received by the Response Center, you must wait 15 minutes before pulling the trunk recessed handle again.

Stolen Vehicle Recovery services

In the event your vehicle was stolen:

- ▶ Report the incident to the police.
The police will issue a numbered incident report.
- ▶ Pass this number on to the Mercedes-Benz Response Center along with your password issued to you when you subscribed to the service.

The Response Center will then attempt to covertly contact the vehicle's Tele Aid system. Once the vehicle is located, the Response Center will contact the local law enforcement and you. The vehicle's location will only be provided to law enforcement.

i When the anti-theft alarm stays on for more than 30 seconds, a call is initiated automatically to the Response Center, see "Anti-theft alarm system" (▷ page 95).

Garage door opener*

The integrated remote control is capable of operating up to three separately controlled devices. It provides a convenient way to replace up to three hand-held remote controls used to operate devices such as garage door openers, gate openers, or other devices compatible with HomeLink® or some other systems.

Before the integrated remote control can be used, it must be programmed to the garage door opener, gate operator or other device you wish to operate. See the following instructions for programming information.

Useful features

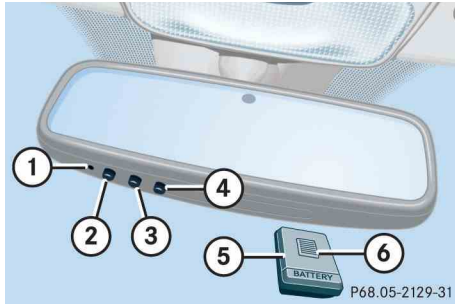

Interior rear view mirror with integrated remote control

- ① Indicator lamp
- ② ③ ④ Signal transmitter button

Needed for programming (not part of vehicle equipment):

- ⑤ Hand-held remote control of garage door opener, gate operator or other device
- ⑥ Hand-held remote control button

Warning!



Before programming the integrated remote control to a garage door opener or gate operator, make sure people and objects are out of the way of the device to prevent potential harm or damage. When programming a garage door opener, the door moves up or down. When programming a gate operator, the gate opens or closes.

Do not use the integrated remote control with any garage door opener that lacks safety stop and reverse features as required by U.S. federal safety standards (this includes any garage door opener model manufactured before April 1, 1982). A garage door that cannot detect an object – signaling the door to stop and reverse – does not meet current U.S. federal safety standards.

When programming a garage door opener, park outside the garage.

Do not run the engine while programming the integrated remote control. Inhalation of exhaust gas is hazardous to your health. All exhaust gas contains carbon monoxide (CO), and inhaling it can cause unconsciousness and possible death.

Programming the integrated remote control

Step 1:

- ▶ Switch on the ignition (▷ page 38).

Step 2:

- ▶ If you have previously programmed a signal transmitter button and wish to retain its programming, proceed to step 3.

If you are programming the integrated remote control for the first time, press and hold the two outer signal transmitter buttons ② and ④ and release them only when indicator lamp ① be-

gins to flash after approximately 20 seconds (do not hold the button for longer than 30 seconds). This procedure erases any previous settings for all three channels and initializes the memory.

If you later wish to program a second and/or third hand-held transmitter to the remaining two signal transmitter buttons, do not repeat this step and begin directly with step 3.

Step 3:

- ▶ Hold the end of hand-held remote control ⑤ of the device you wish to train approximately 2 to 5 in (5 to 12 cm) away from the signal transmitter button (②, ③ or ④) to be programmed, while keeping indicator lamp ① in view.

Step 4:

- ▶ Using both hands, simultaneously press hand-held remote control button ⑥ and the desired signal trans-

mitter button (②, ③ or ④). Do not release the buttons until step 5 is completed.

Indicator lamp ① will flash, first slowly and then rapidly.

i Indicator lamp ① flashes immediately the first time the signal transmitter button is programmed. If this button has already been programmed, the indicator lamp will only start flashing after 20 seconds.

Step 5:

- ▶ After indicator lamp ① changes from a slow to a rapidly flashing light, release the hand-held remote control button and the signal transmitter button.

Step 6:

- ▶ Press and hold the just-trained signal transmitter button (②, ③ or ④) and observe indicator lamp ①.

If indicator lamp ① stays on constantly, programming is complete and your device should activate when the respective signal transmitter button (②, ③ or ④) is pressed and released.

i If indicator lamp ① flashes rapidly for about 2 seconds and then turns to a constant light, continue with programming steps 8 through 12 as your garage door opener may be equipped with the “rolling code” feature.

Step 7:

- ▶ To program the remaining two signal transmitter buttons, repeat the steps above starting with step 3.

Useful features

Rolling code programming

To train a garage door opener (or other rolling code devices) with the rolling code feature, follow these instructions after completing the “Programming” portion (steps 1 through 6) of this text. (A second person may make the following training procedures quicker and easier.)

Step 8:

- ▶ Locate “training” button on the garage door opener motor head unit.

Exact location and color of the button may vary by garage door opener brand. Depending on manufacturer, the “training” button may also be referred to as “learn” or “smart” button. If there is difficulty locating the transmitting button, refer to the garage door opener Operator’s Manual.

Step 9:

- ▶ Press the “training” button on the garage door opener motor head unit.

The “training light” is activated.

You have 30 seconds to initiate the following step.

Step 10:

- ▶ Return to the vehicle and firmly press, hold for 2 seconds and release the programmed signal transmitter button (②, ③ or ④).

Step 11:

- ▶ Press, hold for 2 seconds and release same signal transmitter button a second time to complete the training process.

i *Some garage door openers (or other rolling code equipped devices) may require you to press, hold for 2 seconds and release the same signal transmitter button a third time to complete the training process.*

Step 12:

- ▶ Confirm the garage door operation by pressing the programmed signal transmitter button (②, ③ or ④).

Step 13:

- ▶ To program the remaining two signal transmitter buttons, repeat the steps above starting with step 3.

Gate operator/Canadian programming

Canadian radio-frequency laws require transmitter signals to “time-out” (or quit) after several seconds of transmission which may not be long enough for the integrated signal transmitter to pick up the signal during programming. Similar to this Canadian law, some U.S. gate operators are designed to “time-out” in the same manner.

If you live in Canada or if you are having difficulties programming a gate operator (regardless of where you live) by using the programming procedures, replace step 4 with the following:

Step 4:

- ▶ Press and hold the signal transmitter button (②, ③ or ④). Do not release this button until it has been successfully trained.
- ▶ While still holding down the signal transmitter button (②, ③ or ④), “cycle” your hand-held remote control button ⑥ as follows: Press and hold button ⑥ for 2 seconds, then release it for 2 seconds, and again press and hold it for 2 seconds. Repeat this sequence on the hand-held remote control until the frequency signal has been learned. Upon successful training, indicator lamp ① will flash slowly and then rapidly after several seconds.
- ▶ Proceed with programming step 5 and step 6 to complete.

i Upon completion of programming the integrated remote control, make sure you retain the hand-held remote control that came with the garage door opener, gate operator or other device. You may need it for use in other vehicles, for future programming of an integrated remote control, or simply for continued use as a hand-held remote control to operate the respective device in other situations.

Reprogramming a single signal transmitter button

To program a device using a signal transmitter button previously trained, follow these steps:

- ▶ Switch on the ignition (▷ page 38).
- ▶ Press and hold the desired signal transmitter button (②, ③ or ④). Do not release the button.
- ▶ Indicator lamp ① will begin to flash after 20 seconds. Without releasing the signal transmitter button, proceed with programming starting with step 3.

Operation of integrated remote control

- ▶ Switch on the ignition (▷ page 38).
- ▶ Select and press the appropriate integrated signal transmitter button (②, ③ or ④) to activate the remote controlled device.

The integrated remote control transmitter continues to send the signal as long as the button is pressed – up to 20 seconds.

Erasing the integrated remote control memory

- ▶ Switch on the ignition (▷ page 38).
- ▶ Simultaneously press and hold outer signal transmitter buttons ② and ④, for approximately 20 seconds, until indicator lamp ① flashes rapidly. Do not hold for longer than 30 seconds.

The codes of all three channels are erased.

i If you sell your vehicle, erase the codes of all three channels.

Useful features

Programming tips

If you are having difficulty programming the integrated remote control, here are some helpful tips:

- Check the frequency of hand-held remote control ⑤ (typically located on the reverse side of the remote). The integrated remote control is compatible with radio-frequency devices operating between 280-390 MHz.
- Put a new battery in hand-held remote control ⑤. This will increase the likelihood of the hand-held remote control sending a faster and more accurate signal to the integrated remote control.
- While performing step 3, hold hand-held remote control ⑤ at different lengths and angles from the signal transmitter button (②, ③ or ④) you are programming. Attempt varying angles at the distance of 2 to 5 inches (5 to 12 cm) away or the same angle at varying distances.

- If another hand-held remote control is available for the same device, try the programming steps again using that other hand-held remote control. Make sure new batteries are in the hand-held remote control before beginning the procedure.
- Straighten the antenna wire from the garage door opener assembly. This may help improve transmitting and/or receiving signals.

i Certain types of garage door openers are incompatible with the integrated remote control. If you should experience further difficulties with programming the integrated remote control, contact an authorized Mercedes-Benz Center, or call Mercedes-Benz Customer Assistance Center (in the USA only) at 1-800-FOR-MERCEdes, or Customer Service (in Canada) at 1-800-387-0100.

i USA only:

This device complies with Part 15 of the FCC Rules. Operation is subject to the following two conditions:

- (1) *This device may not cause harmful interference, and*
- (2) *this device must accept any interference received, including interference that may cause undesired operation.*

Any unauthorized modification to this device could void the user's authority to operate the equipment.

i Canada only:

This device complies with RSS-210 of Industry Canada. Operation is subject to the following two conditions:

- (1) *This device may not cause interference, and*
- (2) *this device must accept any interference received, including interference that may cause undesired operation of the device.*

Any unauthorized modification to this device could void the user's authority to operate the equipment.

The first 1000 miles (1500 km)

Driving instructions

At the gas station

Engine compartment

Tires and wheels

Winter driving

Maintenance

Vehicle care



The first 1 000 miles (1 500 km)

In the “Operation” section you will find detailed information on operating, maintaining and caring for your vehicle.

The more cautiously you treat your vehicle during the break-in period, the more satisfied you will be with its performance later on.

- Drive your vehicle during the first 1 000 miles (1 500 km) at varying but moderate vehicle and engine speeds.
- During this period, avoid heavy loads (full throttle driving) and excessive engine speeds (no more than $\frac{2}{3}$ of maximum rpm in each gear).
- Shift gears in a timely manner.
- Avoid accelerating by kickdown.
- Do not attempt to slow the vehicle down by shifting to a lower gear using the gear selector lever.
- Select positions **3**, **2** or **1** only when driving at moderate speeds (for hill driving).
- Select mode **C** as the preferred shift program (▷ page 176) for the first 1 000 miles (1 500 km).

After 1 000 miles (1 500 km), you may gradually increase vehicle and engine speeds to the permissible maximum.

Additional instructions for AMG vehicles:

- *During the first 1 000 miles (1 500 km), do not exceed a speed of 85 mph (140 km/h).*
- *During this period, avoid engine speeds above 4500 rpm in each gear.*
- *Shift gears at the correct time.*

All of the above instructions, as may apply to your vehicle type, also apply when driving the first 1 000 miles (1 500 km) after the engine or the rear differential has been replaced.

 *Always obey applicable speed limits.*

▼ Driving instructions

Drive sensibly – save fuel

Fuel consumption, to a great extent, depends on driving habits and operating conditions.

To save fuel you should:

- Keep tires at the recommended tire inflation pressures.
- Remove unnecessary loads.
- Allow engine to warm up under low load use.
- Avoid frequent acceleration and deceleration.
- Have all maintenance work performed at the intervals specified in the Maintenance Booklet and as required by the Maintenance System (U.S. vehicles) or FSS (Canada vehicles). Contact an authorized Mercedes-Benz Center.

Fuel consumption is also increased by driving in cold weather, in stop-and-go traffic, on short trips and in hilly area.

Drinking and driving

Warning!



Drinking and driving and/or taking drugs and driving are very dangerous combinations. Even a small amount of alcohol or drugs can affect your reflexes, perceptions and judgment.

The possibility of a serious or even fatal accident are greatly increased when you drink or take drugs and drive.

Do not drink or take drugs and drive or allow anyone to drive who has been drinking or taking drugs.

Pedals

Warning!



Make sure that absolutely no objects are obstructing the pedals' range of movement. Keep the driver's footwell clear of all obstacles. If there are any floor mats or carpets in the footwell, make sure that the pedals still have sufficient clearance.

During sudden driving or braking maneuvers, the objects could get caught between or beneath the pedals. You could then no longer brake or accelerate. This could lead to accidents and injury.

Driving instructions

Power assistance

Warning!



With the engine not running, there is no power assistance for the brake and steering systems. In this case, it is important to keep in mind that a considerably higher degree of effort is necessary to brake and steer the vehicle.

Brakes

Warning!



After driving in heavy rain for some time without applying the brakes or through water deep enough to wet brake components, the first braking action may be somewhat reduced and increased pedal pressure may be necessary to obtain expected braking effect. Maintain a safe distance from vehicles in front.

Resting your foot on the brake pedal will cause excessive and premature wear of the brake pads.

It can also result in the brakes overheating, thereby significantly reducing their effectiveness. It may not be possible to stop the vehicle in sufficient time to avoid an accident.

! Because the ESP[®] operates automatically, the engine must be shut off when

- the parking brake is being tested on a brake test dynamometer
- the vehicle is being towed with the front axle raised

Active braking action through the ESP[®] may otherwise seriously damage the brake system.

To help prevent brake disk corrosion after driving on wet road surfaces (particularly salted roads), it is advisable to brake the vehicle with considerable force prior to parking. The heat generated serves to dry the brakes.

If your brake system is normally only subject to moderate loads, you should occasionally test the effectiveness of the brakes by applying above-normal braking pressure at higher speeds. This will also enhance the grip of the brake pads.

Warning!

Make sure not to endanger any other road users when carrying out these braking maneuvers.

Refer to the description of the Brake Assist System (BAS) (▷ page 90).

Brake pad wear or a leak in the system may be the reason for low brake fluid level in the reservoir.

The brake fluid level in the reservoir may be too low if the brake warning lamp in the instrument cluster comes on and an acoustic warning sounds although the parking brake is released (▷ page 368). Observe additional messages in the multi-function display that may appear (▷ page 389).

Have the brake system inspected immediately. Contact an authorized Mercedes-Benz Center.

All checks and service work on the brake system should be carried out by qualified technicians only. Contact an authorized Mercedes-Benz Center.

Only install brake pads and brake fluid recommended by Mercedes-Benz.

Warning!

If other than recommended brake pads are installed, or other than recommended brake fluid is used, the braking properties of the vehicle can be degraded to an extent that safe braking is substantially impaired. This could result in an accident.

! *When driving down long and steep grades, relieve the load on the brakes by shifting into a lower gear to use the engine's braking power. This helps prevent overheating of the brakes and reduces brake pad wear.*

After hard braking, it is advisable to drive on for some time, rather than immediately park, so that the air stream can cool down the brakes faster.

High-performance brake system (CLK 63 AMG only)

The high-performance brake system is designed to operate under the extremely high operating demands required to accommodate the performance capabilities of the vehicle. The brakes may produce a squeaking-type noise depending on the

- vehicle speed
- brake force applied
- ambient conditions, e.g. temperature and humidity

As with any brake system, the wear of individual brake system components such as brake pads or discs strongly depends on your driving style and the conditions under which you operate the vehicle. Thus, a driving style calling for high demand braking will cause your vehicle's brakes to wear more quickly.

Driving instructions

Warning!



New vehicle brake pads and discs, and replacement brake pads and discs may take several hundred miles of driving until they provide optimum braking efficiency. Until that time, you may need to use increased brake pedal pressure while braking. Please be aware of this and adjust your driving and braking accordingly during this break-in period.

Excessive high demand braking will cause correspondingly high brake wear. Please be attentive to the brake warning lamp in the instrument cluster and brake condition messages in the multifunction display. Especially for high performance driving, it is important to maintain and have the brake system checked regularly.

Driving off

Apply the brakes to test them briefly after driving off. Perform this procedure only when the road is clear of other traffic.

Warm up the engine gradually. Do not place full load on the engine until the operating temperature has been reached.

! *When starting off on a slippery surface, do not allow a drive wheel to spin for an extended period with the ESP[®] switched off. Doing so may cause serious damage to the drivetrain which is not covered by the Mercedes-Benz Limited Warranty.*

! *Simultaneously depressing the accelerator pedal and applying the brake reduces engine performance and causes premature brake wear and drivetrain wear.*

Parking

Warning!



Do not park this vehicle in areas where combustible materials such as grass, hay or leaves can come into contact with the hot exhaust system, as these materials could be ignited and cause a vehicle fire.

To reduce the risk of personal injury, or damage to the vehicle or the vehicle drivetrain, as a result of vehicle movement, always do the following before turning off the engine and leaving the vehicle:

- Keep right foot firmly on brake pedal.
- Firmly depress parking brake pedal.
- Move the gear selector lever to position **P**.
- Slowly release brake pedal.
- When parked on an incline, always turn the front wheels towards the road curb.

- Turn the SmartKey or the SmartKey with KEYLESS-GO* to starter switch position **0** and remove, or press KEYLESS-GO* start/stop button.
- Take the SmartKey or the SmartKey with KEYLESS-GO* with you and lock the vehicle when leaving.

Tires

Warning!



If you feel a sudden significant vibration or ride disturbance, or you suspect that possible damage to your vehicle has occurred, you should turn on the hazard warning flashers, carefully slow down, and drive with caution to an area which is a safe distance from the road.

Inspect the tires and the vehicle underbody for possible damage. If the vehicle or tires appear unsafe, have the vehicle towed to the nearest Mercedes-Benz Center or tire dealer for repairs.

Treadwear indicators (TWI) are required by law. These indicators are located in six places on the tread circumference and become visible at a tread depth of approximately $\frac{1}{16}$ in (1.6 mm), at which point the tire is considered worn and should be replaced.

The treadwear indicator appears as a solid band across the tread.

Warning!



Although the applicable federal motor vehicle safety laws consider a tire to be worn when the treadwear indicators (TWI) become visible at approximately $\frac{1}{16}$ in (1.6 mm), we recommend that you do not allow your tires to wear down to that level. As tread depth approaches $\frac{1}{8}$ in (3 mm), the adhesion properties on a wet road are sharply reduced.

Depending upon the weather and/or road surface (conditions), the tire traction varies widely.

Specified tire inflation pressures must be maintained. This applies particularly if the tires are subject to extreme operating conditions (e.g. high speeds, heavy loads, high ambient temperatures).

Driving instructions

Warning!



Do not drive with a flat tire. A flat tire affects the ability to steer or brake the vehicle. You may lose control of the vehicle. Continued driving with a flat tire or driving at high speed with a flat tire will cause excessive heat build-up and possibly a fire.

For more information, see “Tires and wheels” (▷ page 323).

Hydroplaning

Depending on the depth of the water layer on the road, hydroplaning may occur, even at low speeds and with new tires. Reduce vehicle speed, avoid track grooves in the road and apply brakes cautiously in the rain.

Tire traction

The safe speed on a wet, snow covered or icy road is always lower than on a dry road.

You should pay particular attention to the condition of the road whenever the outside temperatures are close to the freezing point.

Warning!



If ice has formed on the road, tire traction will be substantially reduced. Under such weather conditions, drive, steer and brake with extreme caution.

Mercedes-Benz recommends winter tires (▷ page 351) with a minimum tread depth of approximately $\frac{1}{6}$ in (4 mm) on all four wheels for the winter season to ensure normal balanced handling characteristics. On packed snow, they can reduce your stopping distance compared to summer tires. Stopping distance, however, is still considerably greater than when the road is not covered with snow or ice. Exercise appropriate caution.

! *Avoid spinning of a drive wheel. This may cause serious damage to the drivetrain which is not covered by the Mercedes-Benz Limited Warranty.*

Tire speed rating

Regardless of the tire speed rating, local speed limits should be obeyed. Use prudent driving speeds appropriate to prevailing conditions.

Warning!



Even when permitted by law, never operate a vehicle at speeds greater than the maximum speed rating of the tires.

Exceeding the maximum speed for which tires are rated can lead to sudden tire failure, causing loss of vehicle control and possibly resulting in an accident and/or personal injury and possible death, for you and for others.

An electronic speed limiter prevents your vehicle from exceeding a speed of

- CLK 350, CLK 550:
130 mph (210 km/h)
- CLK 63 AMG:
155 mph (250 km/h)
- CLK 63 AMG with increased top speed*:
174 mph (280 km/h)

The factory equipped tires on your vehicle may have a tire speed rating above the maximum speed permitted by the electronic speed limiter.

Make sure your tires have the required tire speed rating as specified for your vehicle in the "Technical data" section (▷ page 466), for example when purchasing new tires.

For information on how to identify the tire speed rating on a tire's sidewall, see "Tire size designation, load and speed rating" (▷ page 337).

If you are uncertain about the correct reading of the information given on a tire's sidewall, any authorized Mercedes-Benz Center will be glad to assist you.

 For information on tire speed rating for winter tires, see "Winter tires" (▷ page 351).

For additional general information on tire speed markings on the sidewall, see "Tire speed rating" (▷ page 337).

Driving instructions

Winter driving instructions

The most important rule for slippery or icy roads is to drive sensibly and to avoid abrupt acceleration, braking and steering maneuvers. Do not use the cruise control system under such conditions.

When the vehicle is in danger of skidding, move gear selector lever to position **N**. Try to keep the vehicle under control by corrective steering action.

 For information on driving with snow chains, see “Snow chains” (▷ page 352).

Warning!



On slippery road surfaces, never downshift in order to obtain braking action. This could result in drive wheel slip and reduced vehicle control. Your vehicle’s ABS will not prevent this type of control loss.

Road salts and chemicals can adversely affect braking efficiency. Increased pedal force may become necessary to produce the normal braking effect.

Depressing the brake pedal periodically when traveling at length on salt-strewn roads can bring road-salt-impaired braking efficiency back to normal.

If the vehicle is parked after being driven on salt-treated roads, the braking efficiency should be tested as soon as possible after driving is resumed.

Warning!



Make sure not to endanger any other road users when carrying out these braking maneuvers.

Warning!



If the vehicle becomes stuck in snow, make sure snow is kept clear of the exhaust pipe and from around the vehicle with the engine running. Otherwise, deadly carbon monoxide (CO) gases may enter vehicle interior resulting in unconsciousness and death.

To assure sufficient fresh air ventilation, open a window slightly on the side of the vehicle not facing the wind.

Warning!



The outside temperature indicator is not designed to serve as an ice-warning device and is therefore unsuitable for that purpose. Indicated temperatures just above the freezing point do not guarantee that the road surface is free of ice.

For more information, see “Winter driving” (▷ page 351).

Standing water

! Do not drive through flooded areas or water of unknown depth. Before driving through water, determine its depth. Never accelerate before driving into water. The bow wave could force water into the engine and auxiliary equipment, thus damaging them.

If you must drive through standing water, drive slowly to prevent water from entering the passenger compartment or the engine compartment. Water in these areas could cause damage to electrical components or wiring of the engine or transmission, or could result in water being ingested by the engine through the air intake, causing severe internal engine damage. Any such damage is not covered by the Mercedes-Benz Limited Warranty.

Passenger compartment

Warning!



Always fasten items being carried as securely as possible.

In an accident, during hard braking or sudden maneuvers, loose items will be thrown around inside the vehicle, and cause injury to vehicle occupants unless the items are securely fastened in the vehicle.

The trunk is the preferred place to carry objects.

Driving abroad

Abroad, there is an extensive Mercedes-Benz service network at your disposal. If you plan to drive into areas which are not listed in the index of your Mercedes-Benz Center directory, you should request pertinent information from an authorized Mercedes-Benz Center.

Control and operation of radio transmitters

COMAND*, radio and telephone*

Warning!



Please do not forget that your primary responsibility is to drive the vehicle safely. Only operate the COMAND (Cockpit Management and Data System), radio or telephone¹ if road, weather and traffic conditions permit.

Bear in mind that at a speed of just 30 mph (approximately 50 km/h), your vehicle is covering a distance of 44 feet (approximately 14 m) every second.

¹ Observe all legal requirements.

Driving instructions

Telephones* and two-way radios

Warning!



Never operate radio transmitters equipped with a built-in or attached antenna (i.e. without being connected to an external antenna) from inside the vehicle while the engine is running. Doing so could lead to a malfunction of the vehicle's electronic system, possibly resulting in an accident and/or serious personal injury.

Radio transmitters, such as a portable telephone or a citizens band unit should only be used inside the vehicle if they are connected to an antenna that is installed on the outside of the vehicle.

Refer to the radio transmitter operation instructions regarding use of an external antenna.

Catalytic converter

Your Mercedes-Benz is equipped with monolithic-type catalytic converters, an important element in conjunction with the oxygen sensors to achieve substantial control of the pollutants in the exhaust emissions. Keep your vehicle in proper operating condition by following our recommended maintenance instructions as outlined in your Maintenance Booklet.

! *To prevent damage to the catalytic converters, only use premium unleaded gasoline in this vehicle.*

Any noticeable irregularities in engine operation should be repaired promptly. Otherwise, excessive unburned fuel may reach the catalytic converter, causing it to overheat and potentially start a fire.

Warning!



As with any vehicle, do not idle, park or operate this vehicle in areas where combustible materials such as grass, hay, or leaves can come into contact with the hot exhaust system, as these materials could be ignited and cause a vehicle fire.

Emission control

Certain systems of the engine serve to keep the toxic components of the exhaust gases within permissible limits required by law.

These systems, of course, will function properly only when maintained strictly according to factory specifications. Any adjustments to the engine should therefore be carried out only by qualified Mercedes-Benz Center authorized technicians.

Engine adjustments should not be altered in any way. Moreover, the specified service jobs must be carried out regularly according to Mercedes-Benz servicing requirements. For details refer to the Maintenance Booklet.

Warning!

Inhalation of exhaust gas is hazardous to your health. All exhaust gas contains carbon monoxide (CO), and inhaling it can cause unconsciousness and lead to death.

Do not run the engine in confined areas (such as a garage) which are not properly ventilated. If you think that exhaust gas fumes are entering the vehicle while driving, have the cause determined and corrected immediately. If you must drive under these conditions, drive with at least one window fully open at all times.

Coolant temperature

During severe operating conditions and stop-and-go city traffic, the coolant temperature may rise close to approximately 248°F (120°C).

The engine should not be operated with the coolant temperature over 248°F (120°C). Doing so may cause serious engine damage which is not covered by the Mercedes-Benz Limited Warranty.

Warning!

- Driving when your engine is overheated can cause some fluids, which may have leaked into the engine compartment, to catch fire. You could be seriously burned.
- Steam from an overheated engine can cause serious burns which can occur just by opening the hood. Stay away from the engine if you see or hear steam coming from it.

Turn off the engine, get out of the vehicle and do not stand near the vehicle until the engine has cooled down.

At the gas station

Refueling

Warning!



Gasoline is highly flammable and poisonous. It burns violently and can cause serious personal injury.

Never allow sparks, flame or smoking materials near gasoline!

Turn off the engine before refueling

Whenever you are around gasoline, avoid inhaling fumes and skin or clothing contact, extinguish all smoking materials.

Direct skin contact with fuels and the inhalation of fuel vapors can damage to your health.

The fuel filler flap is located on the right-hand side of the vehicle towards the rear. Locking/unlocking the vehicle with the SmartKey or the SmartKey with KEYLESS-GO* automatically locks/unlocks the fuel filler flap.

i In cases where the central locking system is not releasing the fuel filler flap, or the opening mechanism is clamping, notify Roadside Assistance or an authorized Mercedes-Benz Center.

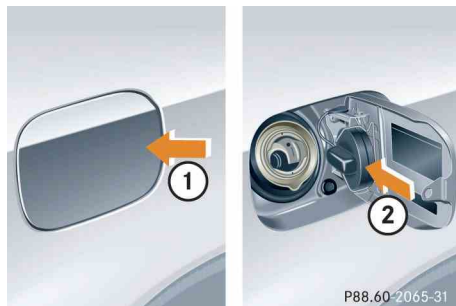

- ① To open the fuel filler flap
- ② To insert the fuel filler cap

- ▶ Turn the engine off
 - by turning the SmartKey to position **0**. Remove the SmartKey from the starter switch.
 - by pressing the KEYLESS-GO* start/stop button. Open the driver's door (with driver's door open, starter switch is now in position **0**, same as with SmartKey removed from starter switch).
- ▶ Open the fuel filler flap by pushing at the point indicated by the arrow ①. The fuel filler flap springs open.
- ▶ Turn fuel cap counterclockwise and hold on to it until possible pressure is released.

- ▶ Take off cap and set it in direction of arrow ② in the recess on the fuel filler flap.

To prevent fuel vapors from escaping into open air, fully insert filler nozzle unit.

- ▶ Only fill your tank until the filler nozzle unit cuts out – **do not top up or overfill.**

Warning!



Overfilling of the fuel tank may create pressure in the system which could cause a gas discharge. This could cause the gas to spray back out when removing the fuel pump nozzle, which could cause personal injury.

- ▶ Replace fuel cap by turning it clockwise until it audibly engages.



i Make sure to close the fuel filler flap before locking your vehicle as the flap locking pin prevents closing after you have locked the vehicle.

- ▶ Close fuel filler flap.

i Only use premium unleaded gasoline with a minimum Posted Octane Rating of 91 (average of 96 RON/86 MON).

Information on gasoline quality can normally be found on the fuel pump.

For more information on gasoline, see “Premium unleaded gasoline” (▷ page 475) or the Factory Approved Service Products pamphlet.

i Leaving the engine running and the fuel cap open can cause the  malfunction indicator lamp (USA only) or the  malfunction indicator lamp (Canada only) to illuminate.

More information can be found in the “Practical hints” section (▷ page 369).

At the gas station

Check regularly and before a long trip

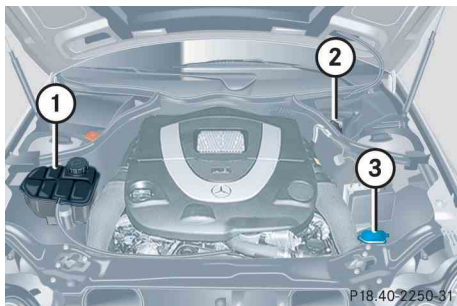

Engine compartment (CLK 550, example)

- 1 Coolant level
- 2 Brake fluid (fuse box cover removed)
- 3 Windshield washer and headlamp cleaning system*

i Opening the hood, see (▷ page 315).

Coolant

For normal replenishing, use water (potable water quality). For more information, see “Coolant” (▷ page 320) and see “Fuels, coolants, lubricants, etc.” (▷ page 472).

Brake fluid

Removing fuse box cover (▷ page 457).

! *If you find that the brake fluid in the brake fluid reservoir has fallen to the minimum mark or below, have the brake system checked for brake pad thickness and leaks immediately. Notify an authorized Mercedes-Benz Center immediately. Do not add brake fluid as this will not solve the problem. For more information, see also “Practical hints” (▷ page 368).*

Windshield washer and headlamp cleaning system*

For more information on filling up the washer reservoir, see “Windshield washer system and headlamp cleaning system*” (▷ page 322).

Engine oil level

For more information on engine oil, see “Engine oil” (▷ page 317).

Vehicle lighting

Check function and cleanliness. For more information on replacing light bulbs, see “Replacing bulbs” (▷ page 427).

For more information, see “Exterior lamp switch” (▷ page 54).

Tire inflation pressure

For more information, see “Recommended tire inflation pressure” (▷ page 331).

▼ Engine compartment

Hood

Warning!



Do not pull the release lever while the vehicle is in motion. Otherwise the hood could be forced open by passing air flow.

This could cause the hood to come loose and injure you and/or others.

Opening

Warning!



If you see flames or smoke coming from the engine compartment, or if the coolant temperature indicator indicates that the engine is overheated, do not open the hood. Move away from vehicle and do not open the hood until the engine has cooled. If necessary, call the fire department.

Warning!



You could be injured when the hood is open - even when the engine is turned off.

Parts of the engine can become very hot. To prevent burns, only touch owner serviceable components described in the Operator's Manual and comply with all relevant safety precautions.

Warning!



To help prevent personal injury, stay clear of moving parts when the hood is open and the engine is running.

The radiator fan may continue to run for approximately 30 seconds or even restart after the engine has been turned off. Stay clear of fan blades.

Warning!



The engine is equipped with a transistorized ignition system. Because of the high voltage it is dangerous to touch any components (ignition coils, spark plug sockets, diagnostic socket) of the ignition system

- with the engine running
- while starting the engine
- if ignition is "on" and the engine is turned manually

Engine compartment

The hood lock release lever is located to the left of the steering wheel under the dashboard.

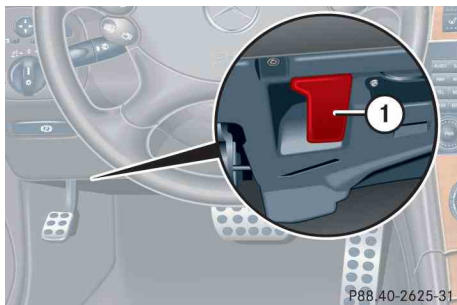

- ① Hood lock release lever
- ▶ Pull lever ① downwards.
The hood is unlocked.

! To avoid damage to the windshield wipers or hood, never open the hood if the wiper arms are folded forward away from the windshield.

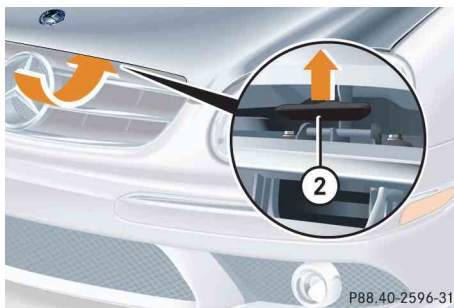

- ② Lever for opening the hood
- ▶ Push lever ② on the hood upwards.
- ▶ Pull up on the hood and then release it.
The hood will be automatically held open at shoulder height by gas-filled struts.

Closing

Warning!



When closing the hood, use extreme caution not to catch hands or fingers.

Be careful that you do not close the hood on anyone.

Make sure that the hood is securely engaged before driving off. Do not continue driving if the hood can no longer engage after an accident, for example. The hood could otherwise come loose while the vehicle is in motion and injure you and/or others.

- ▶ Let the hood drop from a height of approximately 1 ft (30 cm).
The hood will lock audibly.
- ▶ Check to make sure the hood is fully closed.

If you can raise the hood at a point above the headlamps, then it is not properly closed. Open it again and let it drop with somewhat greater force.

Engine oil

The amount of oil your engine needs will depend on a number of factors, including driving style. Higher oil consumption can occur when

- the vehicle is new
- the vehicle is driven frequently at higher engine speeds

Engine oil consumption checks should only be made after the vehicle break-in period.

i *Do not use any special lubricant additives, as these may damage the drive assemblies. Using special additives not approved by Mercedes-Benz may cause damage not covered by the Mercedes-Benz Limited Warranty. More information on this subject is available at any Mercedes-Benz Center.*

Checking engine oil level

When checking the oil level

- the vehicle must be parked on level ground.
- with the engine at operating temperature, the vehicle must have been stationary for at least 5 minutes with the engine turned off.
- with the engine not at operating temperature yet, the vehicle must have been stationary for at least 30 minutes with the engine turned off.

Engine compartment

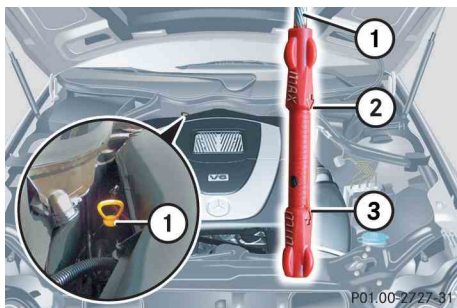

CLK 350 / CLK 550

- ① Oil dipstick
- ② Upper (max) mark
- ③ Lower (min) mark

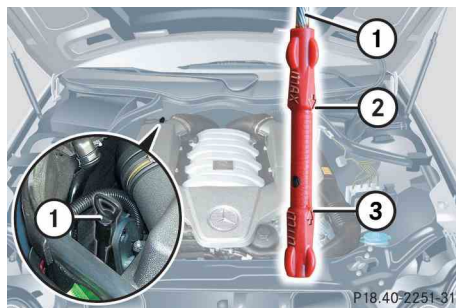

CLK 63 AMG

- ① Oil dipstick
- ② Upper (max) mark
- ③ Lower (min) mark

To check the engine oil level with the oil dipstick, do the following:

- ▶ Open the hood (▷ page 315).
- ▶ Pull out oil dipstick ①.
- ▶ Wipe oil dipstick ① clean.
- ▶ Fully insert oil dipstick ① into the dipstick guide tube.

- ▶ Pull out oil dipstick ① again after approximately 3 seconds to obtain accurate reading.

The oil level is correct when it is between the lower (min) mark ③ and upper (max) mark ② of oil dipstick ①.

i CLK 350:

The filling quantity between the upper and lower marks on the oil dipstick is approximately 2.1 US qt. (2.0 l).

CLK 550 / CLK 63 AMG:

The filling quantity between the upper and lower marks on the oil dipstick is approximately 1.6 US qt. (1.5 l).

- ▶ If necessary, add engine oil.

For adding engine oil, see “Adding engine oil” (▷ page 319).

For more information on engine oil, see “Fuels, coolants, lubricants, etc.” (▷ page 472).

For more information on messages in the multifunction display concerning engine oil, see the “Practical hints” section (▷ page 394).

Adding engine oil

! Only use approved engine oils and oil filters required for vehicles with Maintenance System (U.S. vehicles) or FSS (Canada vehicles). For a listing of approved engine oils and oil filters, refer to the Factory Approved Service Products pamphlet in your vehicle literature portfolio, or contact an authorized Mercedes-Benz Center.

Using engine oils and oil filters of specification other than those expressly required for the Maintenance System (U.S. vehicles) or FSS (Canada vehicles), or changing of oil and oil filter at change intervals longer than those called for by the Maintenance System (U.S. vehicles) or FSS (Canada vehicles) will result in engine or emission control system damage not covered by the Mercedes-Benz Limited Warranty.



CLK 350 / CLK 550

① Filler cap



CLK 63 AMG

① Filler cap

- ▶ Unscrew filler cap ① from filler neck.
- ▶ Add engine oil as required. Be careful not to overfill with oil.

Be careful not to spill any oil when adding. Avoid environmental damage caused by oil entering the ground or water.

! Excess oil must be siphoned or drained off. It could cause damage to the engine and emission control system not covered by the Mercedes-Benz Limited Warranty.

- ▶ Screw filler cap ① back on filler neck.

More information on engine oil can be found in the “Technical data” section (▷ page 472) and (▷ page 474).

Transmission fluid level

The transmission fluid level does not need to be checked. If you notice transmission fluid loss or gear shifting malfunctions, have an authorized Mercedes-Benz Center check the automatic transmission.

Engine compartment

Coolant

The engine coolant is a mixture of water and anticorrosion/antifreeze. To check the coolant level, the vehicle must be parked on level ground and the engine must be cool.

The coolant expansion tank is located on the passenger side of the engine compartment.

Warning!



In order to avoid any potentially serious burns:

- Use extreme caution when opening the hood if there are any signs of steam or coolant leaking from the cooling system, or if the coolant temperature indicator indicates that the coolant is overheated.
- Do not remove pressure cap on coolant reservoir if the coolant temperature is above 158°F (70°C). Allow the coolant to cool down before removing cap.

The coolant reservoir contains hot fluid and is under pressure.

- Using a rag, slowly open the cap approximately $1/2$ turn to relieve excess pressure. If opened immediately, scalding hot fluid and steam will be blown out under pressure.
- Do not spill antifreeze on hot engine parts. Antifreeze contains ethylene glycol which may burn if it comes into contact with hot engine parts.

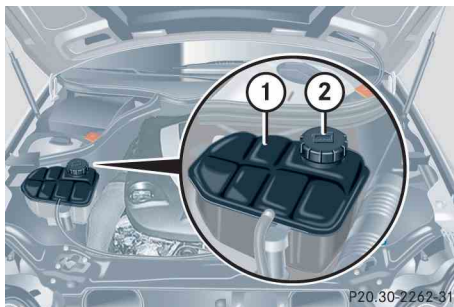

- ① Coolant expansion tank
- ② Cap

- ▶ Using a rag, turn cap ② slowly approximately one half turn counter-clockwise to release any excess pressure.
- ▶ Continue turning the cap ② counter-clockwise and remove it.

The coolant level is correct if the level

- for cold coolant: reaches the marking (plastic bridge) inside the reservoir
 - for warm coolant: is approx. 0.6 in (1.5 cm) higher
- ▶ Add coolant as required.
 - ▶ Replace and tighten cap ②.

More information on coolant can be found in the “Technical data” section (▷ page 477).

Battery

Your vehicle's battery is located in the engine compartment on the right-hand side (> page 447).

The battery should always be sufficiently charged in order to achieve its rated service life. Refer to Maintenance Booklet for battery maintenance intervals.

If you use your vehicle mostly for short-distance trips, you will need to have the battery charge checked more frequently.

When replacing the battery, always use batteries approved by Mercedes-Benz.

If you do not intend to operate your vehicle for an extended period of time, consult an authorized Mercedes-Benz Center about steps you need to observe.

Warning!



Observe all safety instructions and precautions when handling automotive batteries.



Risk of explosion.



Fire, open flames and smoking are prohibited when handling batteries. Avoid creating sparks.



Battery acid is caustic. Do not allow it to come into contact with skin, eyes or clothing.

Wear suitable protective clothing, especially gloves, apron and faceguard.



Wear eye protection.

Rinse any acid spills immediately with clear water. Contact a physician if necessary.



Keep children away.



Follow the instructions in this Operator's Manual.

Batteries contain materials that can harm the environment if disposed of improperly. Recycling of batteries is the preferred method of disposal. Many states require sellers of batteries to accept old batteries for recycling.

Engine compartment

Windshield washer system and headlamp cleaning system*

The windshield washer reservoir is located in the engine compartment.

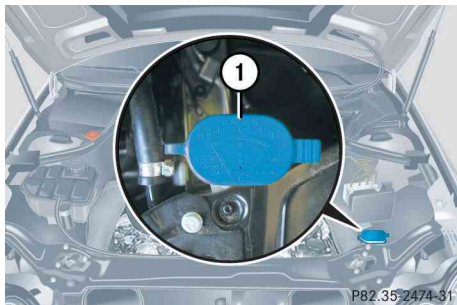

① Washer fluid reservoir cap

Fluid for the windshield washer system and the headlamp cleaning system is supplied from the windshield washer reservoir. It has a capacity of approx. 6.4 US qt (6 l).

During all seasons, add MB Windshield Washer Concentrate “MB SummerFit” to water. Premix the windshield washer fluid in a suitable container.

Warning!



Washer solvent/antifreeze is highly flammable. Do not spill washer solvent/antifreeze on hot engine parts, because it may ignite and burn. You could be seriously burned.

- ▶ Refill the reservoir with MB Windshield Washer Concentrate “MB SummerFit” and water (or commercially available premixed windshield washer solvent / antifreeze, depending on ambient temperatures).

! Always use washer solvent/antifreeze where temperatures may fall below the freezing point. Failure to do so could result in damage to the washer system/reservoir.

! Only use washer fluid which is suitable for plastic lenses. Improper washer fluid can damage the plastic lenses of the headlamps.

For more information, see “Windshield washer system and headlamp cleaning system*” (▷ page 479).

▼ Tires and wheels

See an authorized Mercedes-Benz Center for information on tested and recommended rims and tires for summer and winter operation. They can also offer advice concerning tire service and purchase.

Warning!



Replace rims or tires with the same designation, manufacturer and type as shown on the original part. See an authorized Mercedes-Benz Center for further information. If incorrectly sized rims and tires are mounted:

- The wheel brakes or suspension components can be damaged.
- The operating clearance of the wheels and the tires may no longer be correct.

Warning!



Worn, old tires can cause accidents. If the tire tread is badly worn, or if the tires have sustained damage, replace them.

When replacing rims, only use Genuine Mercedes-Benz wheel bolts specified for the particular rim type. Failure to do so can result in the bolts loosening and possibly an accident.

Retreaded tires are not tested or recommended by Mercedes-Benz, since previous damage cannot always be recognized on re-treads. The operating safety of the vehicle cannot be assured when such tires are used.

Important guidelines

- Only use sets of tires and rims of the same type and make.
- Tires must be of the correct size for the rim.
- Break in new tires for approximately 60 miles (100 km) at moderate speeds.
- Regularly check the tires and rims for damage. Dented or bent rims can cause tire inflation pressure loss and damage to the tire beads.
- If vehicle is heavily loaded, check tire inflation pressure and correct as required.
- Do not allow your tires to wear down too far. Adhesion properties on wet roads are sharply reduced at tread depths under $\frac{1}{8}$ in (3 mm).
- When replacing individual tires, you should mount new tires on the front wheels first (on vehicles with same-sized wheels all around).

Tires and wheels

Tire care and maintenance

Warning!



Regularly check the tires for damage. Damaged tires can cause tire inflation pressure loss. As a result, you could lose control of your vehicle.

Worn, old tires can cause accidents. If the tire tread is badly worn, or if the tires have sustained damage, replace them.

Regularly check your tire inflation pressure at least once a month. For more information on checking tire inflation pressure see “Recommended tire inflation pressure” (▷ page 331).

Tire inspection

Every time you check your tire inflation pressure, you should also inspect your tires for the following:

- excessive treadwear (▷ page 325)
- cord or fabric showing through the tire’s rubber
- bumps, bulges, cuts, cracks or splits in the tread or side of the tire

Replace the tire if you find any of the above conditions.

Make sure you also inspect the spare tire periodically for condition and inflation. Spare tires will age and become worn over time even if never used, and thus should be inspected and replaced when necessary.

Life of tire

The service life of a tire is dependent upon varying factors including but not limited to:

- Driving style
- Tire inflation pressure
- Distance driven

Warning!



Tires and spare tire should be replaced after six years, regardless of the remaining tread.

Tread depth

Do not allow your tires to wear down too far. Adhesion properties on wet roads are sharply reduced at tread depths under $\frac{1}{8}$ in (3 mm).

Treadwear indicators (TWI) are required by law. These indicators are located in six places on the tread circumference and become visible at a tread depth of approximately $\frac{1}{16}$ in (1.6 mm), at which point the tire is considered worn and should be replaced.

Recommended minimum tire tread depth:

- Summer tires $\frac{1}{8}$ in (3 mm)
- Winter tires $\frac{1}{6}$ in (4 mm)

Warning!



Although the applicable federal motor safety laws consider a tire to be worn when the treadwear indicators (TWI) become visible at approximately $\frac{1}{16}$ in (1.6 mm), we recommend that you do not allow your tires

to wear down to that level. As tread depth approaches $\frac{1}{8}$ in (3 mm), the adhesion properties on a wet road are sharply reduced.

Depending upon the weather and/or road surface (conditions), the tire traction varies widely.

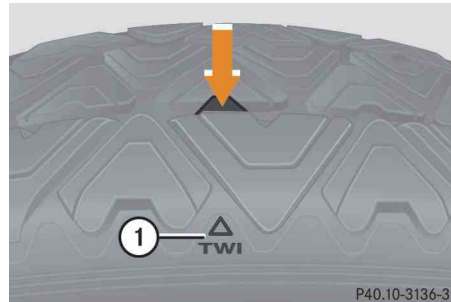

① TWI (Tread Wear Indicator)

The treadwear indicator appears as a solid band across the tread.

Storing tires

! Keep unmounted tires in a cool, dry place with as little exposure to light as possible. Protect tires from contact with oil, grease and gasoline.

Cleaning tires

! Never use a round nozzle to power wash tires. The intense jet of water can result in damage to the tire.

Always replace a damaged tire.

Tires and wheels

Direction of rotation

Unidirectional tires offer added advantages, such as better hydroplaning performance. To benefit, however, you must make sure the tires rotate in the direction specified.

An arrow on the sidewall indicates the intended direction of rotation (spinning) of the tire.

i *Spare wheels may be mounted against the direction of rotation (spinning) even with a unidirectional tire for temporary use only until the regular drive wheel has been repaired or replaced. Always observe and follow applicable temporary use restrictions and speed limitations indicated on the spare wheel.*

Loading the vehicle

A label on your vehicle shows how much weight it may properly carry.

- The Tire and Loading Information placard can be found on the driver's door B-pillar. This placard tells you important information about the number of people that can be in the vehicle and the total weight that can be carried in the vehicle. It also contains information on the proper size and recommended tire inflation pressures for the original equipment tires on your vehicle.
- The certification label found on the driver's door B-pillar tells you about the gross weight capacity of your vehicle, called the Gross Vehicle Weight Rating (GVWR). The GVWR includes the weight of the vehicle, all occupants, fuel and cargo. The certification label also tells you about

the front and rear axle weight capacity, called the Gross Axle Weight Rating (GAWR). The GAWR is the total allowable weight that can be carried by a single axle (front or rear). Never exceed the GVWR or GAWR for either the front axle or rear axle.



① Driver's door B-pillar

Following is a discussion on how to work with the information contained on the placard with regards to loading your vehicle.

Tire and Loading Information

Warning!



Do not overload the tires by exceeding the specified load limit as indicated on the placard on the driver’s door B-pillar. Overloading the tires can overheat them, possibly causing a blowout. Overloading the tires can also result in handling or steering problems, or brake failure.

Your vehicle is equipped with a Tire and Loading Information placard.

i Data shown on placard example are for illustration purposes only. Load limit data is specific to each vehicle and may vary from data shown in the illustration below. Refer to placard on vehicle for actual data specific to your vehicle.

Placard

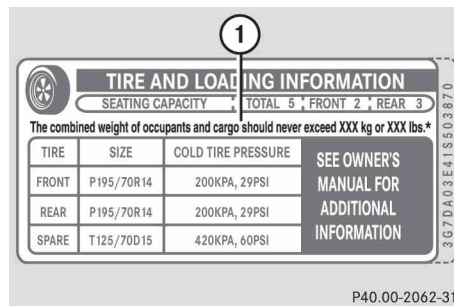

- ① Load limit information on the Tire and Loading Information placard

The placard showing the load limit information is located on the driver’s door B-pillar. Locate the statement “The combined weight of occupants and cargo should never exceed XXX kilograms or XXX lbs.” on this placard. The combined weight of all occupants, cargo / luggage and trailer tongue load (if applicable) should never exceed the weight referenced in that statement.

Seating capacity

The seating capacity gives you important information on the number of occupants that can be in the vehicle. Observe front and rear seating capacity. The placard showing the seating capacity is located on the driver’s door B-pillar (▷ page 326).

i Data shown on placard example are for illustration purposes only. Seating data is specific to each vehicle and may vary from data shown in the illustration below. Refer to placard on vehicle for actual data specific to your vehicle.

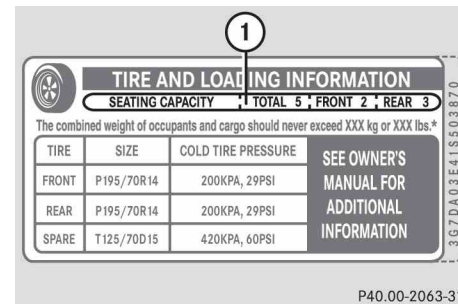

- ① Seating capacity information on the Tire and Loading Information placard.

Tires and wheels

Steps for determining correct load limit

The following steps have been developed as required of all manufacturers under Title 49, Code of U.S. Federal Regulations, Part 575 pursuant to the “National Traffic and Motor Vehicle Safety Act of 1966”.

Step 1

- ▶ Locate the statement “The combined weight of occupants and cargo should never exceed XXX kg or XXX lbs.” on your vehicle’s placard.

Step 2

- ▶ Determine the combined weight of the driver and passengers that will be riding in your vehicle.

Step 3

- ▶ Subtract the combined weight of the driver and passengers from XXX kilograms or XXX lbs.

Step 4

- ▶ The resulting figure equals the available amount of cargo and luggage load capacity. For example, if the “XXX” amount equals 1400 lbs and there will be five 150 lbs passengers in your vehicle, the amount of available cargo and luggage load capacity is 650 lbs. $(1400 - 750 (5 \times 150) = 650 \text{ lbs})$

Step 5

- ▶ Determine the combined weight of luggage and cargo being loaded on the vehicle. That weight may not safely exceed the available cargo and luggage load capacity calculated in step 4.

Step 6 (if applicable)

- ▶ If your vehicle will be towing a trailer, load from your trailer will be transferred to your vehicle. Consult this manual to determine how this reduces the available cargo and luggage load capacity of your vehicle (▷ page 330).

The following table shows examples on how to calculate total and cargo load capacities with varying seating configurations and number and size of occupants. The following examples use a load limit of 1500 lbs. **This is for illustration purposes only.** Make sure you are using the actual load limit for your vehicle stated on the vehicle’s placard (▷ page 327).

Example	Combined weight limit of occupants and cargo from placard	Number of occupants (driver and passengers)	Seating configuration	Occupants weight	Combined weight of all occupants	Available cargo/luggage and trailer tongue weight (total load limit from placard minus combined weight of all occupants)
1	1500 lbs	4	front: 2 rear: 2	Occupant 1: 150 lbs Occupant 2: 180 lbs Occupant 3: 160 lbs Occupant 4: 140 lbs	630 lbs	1500 lbs - 630 lbs = 870 lbs
2	1500 lbs	3	front: 1 rear: 2	Occupant 1: 200 lbs Occupant 2: 190 lbs Occupant 3: 150 lbs	540 lbs	1500 lbs - 540 lbs = 960 lbs
3	1500 lbs	1	front:1	Occupant 1: 150 lbs	150 lbs	1500 lbs - 150 lbs = 1350 lbs

The higher the weight of all occupants, the less cargo and luggage load capacity is available.

For more information, see “Trailer tongue load” (> page 330).

Tires and wheels

Certification label

Even after careful determination of the combined weight of all occupants, cargo and the trailer tongue load (if applicable) (▷ page 330) as to not exceed the permissible load limit, you must make sure that your vehicle never exceeds the Gross Vehicle Weight Rating (GVWR) and the Gross Axle Weight Rating (GAWR) for either the front or rear axle. You can obtain the GVWR and GAWR from the certification label. The certification label can be found on the driver's door B-pillar, see "Technical data" (▷ page 462).

Gross Vehicle Weight Rating (GVWR): The total weight of the vehicle, all occupants, all cargo, and the trailer tongue load (▷ page 330) must never exceed the GVWR.

Gross Axle Weight Rating (GAWR): The total allowable weight that can be carried by a single axle (front or rear).

To assure that your vehicle does not exceed the maximum permissible weight limits (GVWR and GAWR for front and rear axle), have the loaded vehicle (including driver, passengers and all cargo and, if applicable, trailer fully loaded) weighed on a suitable commercial scale.

Trailer tongue load

The tongue load of any trailer is an important weight to measure because it affects the load you can carry in your vehicle. If a trailer is towed, the tongue load must be added to the weight of all occupants riding and any cargo you are carrying in the vehicle. The tongue load typically is ten percent of the trailer weight and everything loaded in it.

Your Mercedes-Benz has been designed primarily to carry passengers and their cargo. Mercedes-Benz does not recommend trailer towing with your vehicle.

Recommended tire inflation pressure

Warning!



Follow recommended tire inflation pressures.

Do not underinflate tires. Underinflated tires wear excessively and / or unevenly, adversely affect handling and fuel economy, and are more likely to fail from being overheated.

Do not overinflate tires. Overinflated tires can adversely affect handling and ride comfort, wear unevenly, increase stopping distance, and result in sudden deflation (blowout) because they are more likely to become punctured or damaged by road debris, potholes etc.

Your vehicle is equipped with a Tire and Loading Information placard located on the driver's door B-pillar (▷ page 326).

The tire inflation pressure should be checked regularly and should only be adjusted on cold tires. The tires can be considered cold if the vehicle has been parked for at least three hours or driven less than one mile (1.6 km).

Follow recommended cold tire inflation pressures listed on placard.

Keeping the tires properly inflated provides the best handling, tread life and riding comfort.

In addition to the tire placard on the driver's door B-pillar, also consult the fuel filler flap for any additional information pertaining to special driving situations. For more information, see "Important notes on tire inflation pressure" (▷ page 332).

i Data shown on placard example are for illustration purposes only. Tire data is specific to each vehicle and may vary from data shown in the illustration below. Refer to placard on vehicle for actual data specific to your vehicle.

Placard

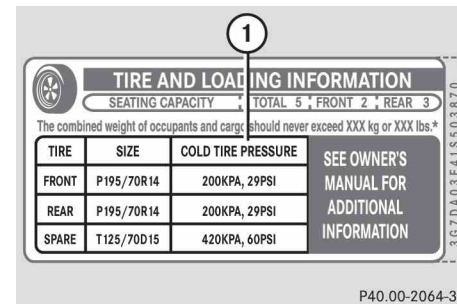

① Tire and Loading Information placard with recommended cold tire inflation pressures

The placard lists the recommended cold tire inflation pressures for maximum loaded vehicle weight. The tire inflation pressures listed apply to the tires installed as original equipment.

Tires and wheels

Important notes on tire inflation pressure

Warning!



If the tire inflation pressure repeatedly drops:

- Check the tires for punctures from foreign objects.
- Check to see whether air is leaking from the valves or from around the rim.

Tire temperature and tire inflation pressure are also increased while driving, depending on the driving speed and the tire load.

If you will be driving your vehicle at high speeds of 100 mph (160 km/h) or higher, where it is legal and conditions allow, consult the placard on the inside of the fuel filler flap on how to adjust the cold tire inflation pressure. If you do not adjust the tire inflation pressure, excessive heat can build up and result in sudden tire failure. Be sure to readjust the tire inflation pressure for normal driving speeds. You should wait until the tires are cold before adjusting the tire inflation pressure.

i *Driving comfort may be reduced when the tire inflation pressure is adjusted to the value for speeds above 100 mph (160 km/h) as specified on the placard located on the inside of the fuel filler flap.*

Some vehicles may have supplemental tire pressure information for vehicle loads less than the maximum loaded vehicle condition. If such information is provided, it can be found on the placard located on the inside of the fuel filler flap.

Tire inflation pressure changes by approximately 1.5 psi (0.1 bar) per 18°F (10°C) of air temperature change. Keep this in mind when checking tire inflation pressure where the temperature is different from the outside temperature.

Checking tire inflation pressure

Regularly check your tire inflation pressure at least once a month.

Check and adjust the tire inflation pressure when the tires are cold. The tires can be considered cold if the vehicle has been parked for at least three hours or driven less than one mile (1.6 km).

If you check the tire inflation pressure when the tires are warm (the vehicle has been driven for several miles or sitting less than three hours), the reading will be approximately 4 psi (0.3 bar) higher than the cold reading. This is normal. Do not let air out to match the specified cold tire inflation pressure. Otherwise, the tire will be underinflated.

Warning!



Follow recommended tire inflation pressures.

Do not underinflate tires. Underinflated tires wear excessively and /or unevenly, adversely affect handling and fuel economy, and are more likely to fail from being overheated.

Do not overinflate tires. Overinflated tires can adversely affect handling and ride comfort, wear unevenly, increase stopping distance, and result in sudden deflation (blowout) because they are more likely to become punctured or damaged by road debris, potholes etc.

Do not overload the tires by exceeding the specified load limit as indicated on the placard on the driver's door B-pillar. Overloading the tires can overheat them, possibly causing a blowout.

Checking tire inflation pressure manually

Follow the steps below to achieve correct tire inflation pressure:

- ▶ Remove the cap from the valve on one tire.
- ▶ Firmly press a tire gauge onto the valve.
- ▶ Read tire inflation pressure on tire gauge and check against the recommended tire inflation pressure on the placard on the driver's door B-pillar (▷ page 331). If necessary, add air to achieve the recommended tire inflation pressure.

i *If you have overfilled the tire, release tire inflation pressure by pushing the metal stem of the valve with e.g. a tip of a pen. Then recheck the tire inflation pressure with the tire gauge.*

- ▶ Install the valve cap.
- ▶ Repeat this procedure for each tire.

Tires and wheels

Run Flat Indicator*

U.S. vehicles: The Run Flat Indicator is only available in conjunction with the MOExtended system* (▷ page 336).

While the vehicle is being driven, the Run Flat Indicator monitors the set tire inflation pressures by evaluating each wheel's rotational speed. This allows the system to detect a significant loss of pressure in a tire. If a wheel's rotational speed changes due to falling tire inflation pressure, you will see a corresponding warning message in the multifunction display.

The Run Flat Indicator may function in a restricted manner or with a delay if:

- snow chains are mounted to the vehicle
- in presence of ice and snow
- you are driving on a loose surface (e.g. sand or gravel)
- you are driving in a very sporty manner (involving rapid acceleration or high speeds in curves)

- you are driving with very heavy cargo loaded

Warning!



When the multifunction display shows the message **Tire pressure Check tires**, one or more of your tires is significantly under-inflated. You should stop and check your tires as soon as possible, and inflate them to the proper tire inflation pressure as indicated on the vehicle's tire information placard. Driving on a significantly under-inflated tire causes the tire to overheat and can lead to tire failure. Under-inflation also reduces fuel efficiency and tire tread life, and may affect the vehicle's handling and stopping ability. Each tire, including the spare, should be checked monthly when cold and set to the recommended tire inflation pressure as specified in the vehicle placard.

 *The recommended tire inflation pressures for your vehicle can be found on the tire placard located on the driver's door B-pillar (▷ page 326). The tire inflation pressures are not listed in the Operator's Manual.*

Warning!



The Run Flat Indicator does not provide a warning for wrongly selected tire inflation pressures. Always adjust tire inflation pressure according to the placard on the driver's door B-pillar or fuel filler flap.

The Run Flat Indicator does not replace regular checks of the tire inflation pressures since a gradual pressure loss in more than one tires cannot be detected by the Run Flat Indicator.

The Run Flat Indicator is not able to issue a warning due to a sudden dramatic loss of tire inflation pressure (e.g. tire blowout caused by a foreign object). In this case bring the vehicle to a halt by carefully applying the brakes and avoiding abrupt steering maneuvers.

Reactivating the Run Flat Indicator

The tire inflation pressure monitor must be reactivated in the following situations:

- If you have changed the tire inflation pressure
 - If you have replaced the wheels or tires
 - If you have installed new wheels or tires
- Using the tire placard on the driver's door B-pillar or, if available, the inside of the fuel filler flap, make sure the tire inflation pressure of all four tires is correct.



Warning!

The Run Flat Indicator can only warn you in a reliable manner if you have set the correct tire inflation pressures for each tire.

If an incorrect tire inflation pressure was set, the system will monitor the pressure according to the incorrect value.

- Switch on the ignition (▷ page 36).

Make sure the standard display menu appears in the multifunction display (▷ page 145).

- Press button  or  repeatedly until the following message appears in the multifunction display:



- Press the reset button in the instrument cluster (▷ page 136).

The following message will appear in the multifunction display:

```
Restart
Run Flat Indicator?
Cancel
Yes
```

If you wish to confirm activation:

- Press button .

The following message will appear in the multifunction display:

```
Run Flat Indicator
restarted
```

After a certain “learning phase”, the Run Flat Indicator checks the set pressure values for all four tires.

If you wish to cancel activation:

- Press button .

or

- Wait until the message
Restart
Run Flat Indicator?
Cancel
Yes
disappears.

Tires and wheels

Potential problems associated with underinflated and overinflated tires

Underinflated tires

Underinflated tires can:

- cause excessive and uneven tire wear
- adversely affect fuel economy
- lead to tire failure from being overheated
- adversely affect handling characteristics

Warning!



Follow recommended tire inflation pressures.

Do not underinflate tires. Underinflated tires wear excessively and / or unevenly, adversely affect handling and fuel economy, and are more likely to fail from being overheated.

Overinflated tires

Overinflated tires can:

- adversely affect handling characteristics
- cause uneven tire wear
- be more prone to damage from road hazards
- adversely affect ride comfort
- increase stopping distance

Warning!



Follow recommended tire inflation pressures.

Do not overinflate tires. Overinflated tires can adversely affect handling and ride comfort, wear unevenly, increase stopping distance, and result in sudden deflation (blowout) because they are more likely to become punctured or damaged by road debris, potholes etc.

MOExtended system*

The *MOExtended* system allows you to continue driving your vehicle even if there is a total loss of pressure in one or more tires.

You may only use the *MOExtended* system in conjunction with the Run Flat Indicator* (▷ page 334).

For information on driving in case of pressure loss in one or more tires (emergency mode), see the “Practical hints” section (▷ page 446).

Tire labeling

Besides tire name (sales designation) and manufacturer name, a number of markings can be found on a tire.

Following are some explanations for the markings on your vehicle's tires:

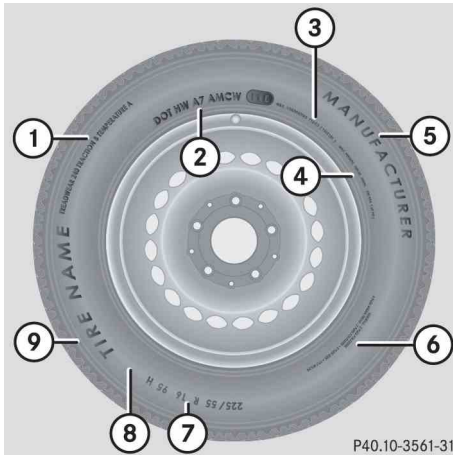

- ① Uniform Quality Grading Standards (▷ page 344)
- ② DOT, Tire Identification Number (TIN) (▷ page 342)
- ③ Maximum tire load (▷ page 343)
- ④ Maximum tire inflation pressure (▷ page 344)
- ⑤ Manufacturer
- ⑥ Tire ply material (▷ page 346)
- ⑦ Tire size designation, load and speed rating (▷ page 337)
- ⑧ Load identification (▷ page 341)
- ⑨ Tire name

i For illustration purposes only. Actual data on tires are specific to each vehicle and may vary from data shown in above illustration.

For more information, see “Rims and tires” (▷ page 466).

Tire size designation, load and speed rating

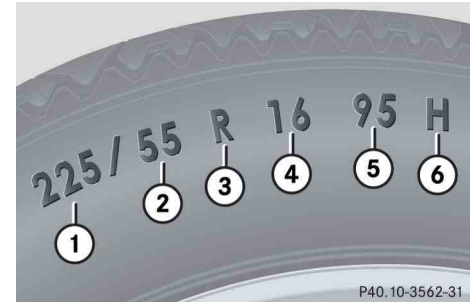

- ① Tire width
- ② Aspect ratio in %
- ③ Radial tire code
- ④ Rim diameter
- ⑤ Tire load rating
- ⑥ Tire speed rating

i For illustration purposes only. Actual data on tires are specific to each vehicle and may vary from data shown in above illustration.

Tires and wheels

General:

Depending on the design standards used, the tire size molded into the sidewall may have no letter or a letter preceding the tire size designation.

No letter preceding the size designation (as illustrated above): Passenger car tire based on European design standards.

Letter “P” preceding the size designation: Passenger car tire based on U.S. design standards.

Letter “LT” preceding the size designation: Light Truck tire based on U.S. design standards.

Letter “T” preceding the size designation: Temporary spare tires which are high pressure compact spares designed for temporary emergency use only.

Tire width

The tire width ① (▷ page 337) indicates the nominal tire width in mm.

Aspect ratio

The aspect ratio ② (▷ page 337) is the dimensional relationship between tire section height and section width and is expressed in percentage. The aspect ratio is arrived at by dividing section height by section width.

Tire code

The tire code ③ (▷ page 337) indicates the tire construction type. The “R” stands for radial tire type. Letter “D” means diagonal or bias ply construction; letter “B” means belted-bias ply construction.

At the tire manufacturer’s option, any tire with a speed capability above 149 mph (240 km/h) can include a “ZR” in the size designation (for example: 245/40 ZR 18). For additional information, see “Tire speed rating” (▷ page 339).

Rim diameter

The rim diameter ④ (▷ page 337) is the diameter of the bead seat, not the diameter of the rim edge. Rim diameter is indicated in inches (in).

Tire load rating

The tire load rating ⑤ (▷ page 337) is a numerical code associated with the maximum load a tire can support.

For example, a load rating of 91 corresponds to a maximum load of 1356 lbs (615 kg) the tire is designed to support. See also “Maximum tire load” (▷ page 343) where the maximum load associated with the load index is indicated in kilograms and lbs.

Warning!

The tire load rating must always be at least half of the GAWR (▷ page 347) of your vehicle. Otherwise, tire failure may be the result which may cause an accident and/or serious personal injury to you or others.

Always replace rims and tires with the same designation, manufacturer and type as shown on the original part.

Warning!

Do not overload the tires by exceeding the specified load limit as indicated on the placard located on the driver's door B-pillar. Overloading the tires can overheat them, possibly causing a blowout. Overloading the tires can also result in handling or steering problems, or brake failure.

For additional information on tire load rating, see "Load identification" (▷ page 341).

i *Tire load rating ⑤ (▷ page 337) and Tire speed rating ⑥ (▷ page 337) are also referred to as "service description".*

Tire speed rating

The tire speed rating ⑥ (▷ page 337) indicates the approved maximum speed for the tire.

Warning!

Even when permitted by law, never operate a vehicle at speeds greater than the maximum speed rating of the tires.

Exceeding the maximum speed for which tires are rated can lead to sudden tire failure, causing loss of vehicle control and possibly resulting in an accident and/or personal injury and possible death, for you and for others.

i *Tire load rating ⑤ (▷ page 337) and Tire speed rating ⑥ (▷ page 337) are also referred to as "service description".*

Tires and wheels

Summer tires

Index	Speed rating
Q	up to 100 mph (160 km/h)
R	up to 106 mph (170 km/h)
S	up to 112 mph (180 km/h)
T	up to 118 mph (190 km/h)
H	up to 130 mph (210 km/h)
V	up to 149 mph (240 km/h)
W	up to 168 mph (270 km/h)
Y	up to 186 mph (300 km/h)
(Y)	above 186 mph (300 km/h)
ZR	above 149 mph (240 km/h)

- At the tire manufacturer's option, any tire with a speed capability above 149 mph (240 km/h) can include a "ZR" in the size designation (for example: 245/40 ZR18). To determine the maximum speed capability of the tire, the service description for the tire must be referred to. The service description is comprised of the tire load rating ⑤ (▷ page 337) and the tire speed rating ⑥ (▷ page 337).

If your tire includes "ZR" in the size designation and no service description ⑤ and ⑥ (▷ page 337) is given, the tire manufacturer must be consulted for the maximum speed capability.

If a service description ⑤ and ⑥ (▷ page 337) is given, the speed capability is limited by the speed symbol in the service description.

Example: 245/40 ZR18 97Y.

In this example, "97Y" is the service description. The letter "Y" designates

the speed rating and the speed capability of the tire is limited to 186 mph (300 km/h).

- Any tire with a speed capability above 186 mph (300 km/h) must include a "ZR" in the size designation AND the service description must be placed in parenthesis. Example: 275/40 ZR 18 (99Y). The "(Y)" speed rating in parenthesis designates the maximum speed capability of the tire as being above 186 mph (300 km/h). Consult the tire manufacturer for the actual maximum permissible speed of the tire.

All-season and winter tires

Index	Speed rating
Q M+S ¹	up to 100 mph (160 km/h)
T M+S ¹	up to 118 mph (190 km/h)
H M+S ¹	up to 130 mph (210 km/h)
V M+S ¹	up to 149 mph (240 km/h)

¹ or M+S  for winter tires

i Not all M+S rated tires provide special winter performance. Make sure the tires you use show M+S and the mountain/snowflake  marking on the tire sidewall. These tires meet specific snow traction performance requirements of the Rubber Manufacturers Association (RMA) and the Rubber Association of Canada (RAC) and have been designed specifically for use in snow conditions.

Load identification



① Load identification

i For illustration purposes only. Actual data on tires are specific to each vehicle and may vary from data shown in above illustration.

In addition to tire load rating, special load information may be molded into the tire sidewall following the letter designating the tire speed rating **⑥** (▷ page 337).

No specification given: absence of any text (like in above example) indicates a standard load (SL) tire.

XL or Extra Load: designates an extra load (or reinforced) tire.

Light Load: designates a light load tire.

C, D, E: designates load range associated with the maximum load a tire can carry at a specified pressure.

Tires and wheels

DOT, Tire Identification Number (TIN)

U.S. tire regulations require each new tire manufacturer or tire retreader to mold a TIN into or onto a sidewall of each tire produced.

The TIN is a unique identifier which facilitates efforts by tire manufacturers to notify purchasers in recall situations or other safety matters concerning tires and gives purchasers the means to easily identify such tires.

The TIN is comprised of “Manufacturer’s identification mark”, “Tire size”, “Tire type code” and “Date of manufacture”.

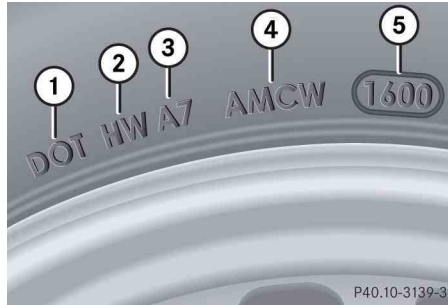

- ① DOT
- ② Manufacturer’s identification mark
- ③ Tire size
- ④ Tire type code (at the option of the tire manufacturer)
- ⑤ Date of manufacture

i For illustration purposes only. Actual data on tires are specific to each vehicle and may vary from data shown in above illustration.

DOT (Department of Transportation)

A tire branding symbol ① (▷ page 342) which denotes the tire meets requirements of the U.S. Department of Transportation.

Manufacturer’s identification mark

The manufacturer’s identification mark ② (▷ page 342) denotes the tire manufacturer.

New tires have a mark with two symbols.

Retreaded tires have a mark with four symbols. For more information on retreaded tires, see (▷ page 323).

Tire size

The code ③ (▷ page 342) indicates the tire size.

Tire type code

The code ④ (▷ page 342) may, at the option of the manufacturer, be used as a descriptive code for identifying significant characteristics of the tire.

Date of manufacture

The date of manufacture ⑤ (▷ page 342) identifies the week and year of manufacture.

The first two figures identify the week, starting with “01” to represent the first full week of the calendar year. The second two figures represent the year.

For example, “3202” represents the 32nd week of 2002.

Maximum tire load

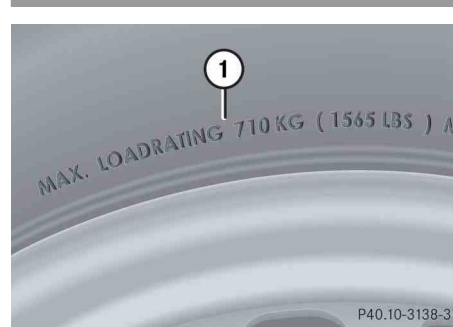

① Maximum tire load rating

i For illustration purposes only. Actual data on tires are specific to each vehicle and may vary from data shown in above illustration.

The maximum tire load is the maximum weight the tires are designed to support.

Warning!



Do not overload the tires by exceeding the specified load limit as indicated on the placard located on the driver’s door B-pillar. Overloading the tires can overheat them, possibly causing a blowout. Overloading the tires can also result in handling or steering problems, or brake failure.

For more information on tire load rating (▷ page 338).

For information on calculating total and cargo load capacities (▷ page 328).

Tires and wheels

Maximum tire inflation pressure

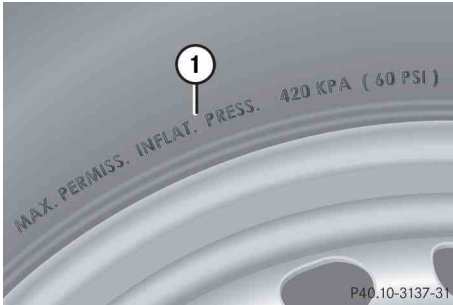

- ① Maximum permissible tire inflation pressure

i For illustration purposes only. Actual data on tires are specific to each vehicle and may vary from data shown in above illustration.

This is the maximum permissible tire inflation pressure for the tire.

Always follow the recommended tire inflation pressure (▷ page 331) for proper tire inflation.

Warning!



Never exceed the max. tire inflation pressure. Follow recommended tire inflation pressures.

Do not underinflate tires. Underinflated tires wear excessively and / or unevenly, adversely affect handling and fuel economy, and are more likely to fail from being overheated.

Do not overinflate tires. Overinflated tires can adversely affect handling and ride comfort, wear unevenly, increase stopping distance, and result in sudden deflation (blowout) because they are more likely to become punctured or damaged by road debris, potholes etc.

Uniform Tire Quality Grading Standards (U.S. vehicles)

Tire manufacturers are required to grade tires based on three performance factors: treadwear, traction and temperature resistance.

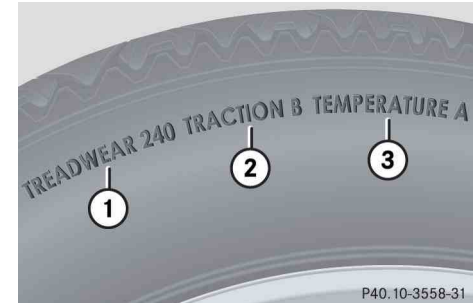

- ① Treadwear
- ② Traction
- ③ Temperature resistance

i For illustration purposes only. Actual data on tires are specific to each vehicle and may vary from data shown in above illustration.

Quality grades can be found, where applicable, on the tire sidewall between tread shoulder and maximum section width. For example:

Treadwear	Traction	Temperature
200	AA	A

All passenger car tires must conform to federal safety requirements in addition to these grades.

Treadwear

The treadwear grade is a comparative rating based on the wear rate of the tire when tested under controlled conditions on a specified government test course. For example, a tire graded 150 would wear one and one-half ($1\frac{1}{2}$) times as well on the government course as a tire graded 100. The relative performance of tires depends upon the actual conditions of their use, however, and may depart significantly from the norm due to variations in driving habits, service practices and differences in road characteristics and climate.

Traction

The traction grades, from highest to lowest, are AA, A, B, and C. Those grades represent the tire's ability to stop on wet pavement as measured under controlled conditions on specified government test surfaces of asphalt and concrete. A tire marked C may have poor traction performance.

Warning!



The traction grade assigned to this tire is based on straight-ahead braking traction tests, and does not include acceleration, cornering, hydroplaning, or peak traction characteristics.

Tires and wheels

Temperature

The temperature grades are A (the highest), B, and C, representing the tire's resistance to the generation of heat and its ability to dissipate heat when tested under controlled conditions on a specified indoor laboratory test wheel. Sustained high temperature can cause the material of the tire to degenerate and reduce tire life, and excessive temperature can lead to sudden tire failure. The grade C corresponds to a level of performance which all passenger car tires must meet under the Federal Motor Vehicle Safety Standard No. 109. Grades B and A represent higher levels of performance on the laboratory test wheel than the minimum required by law.

Warning!



The temperature grade for this tire is established for a tire that is properly inflated and not overloaded. Excessive speed, underinflation, or excessive loading, either separately or in combination, can cause excessive heat build-up and possible tire failure.

Tire ply material



- ① Plies in sidewall
- ② Plies under tread

i For illustration purposes only. Actual data on tires are specific to each vehicle and may vary from data shown in above illustration.

This marking tells you about the type of cord and number of plies in the sidewall and under the tread.

Tire and loading terminology

Accessory weight

The combined weight (in excess of those standard items which may be replaced) of automatic transmission, power steering, power brakes, power windows, power seats, radio, and heater, to the extent that these items are available as factory-installed equipment (whether installed or not).

Air pressure

The amount of air inside the tire pressing outward on each square inch of the tire. Air pressure is expressed in pounds per square inch (psi), or kilopascal (kPa) or bars.

Aspect ratio

Dimensional relationship between tire section height and section width expressed in percentage.

Bar

Another metric unit for air pressure. There are 14.5038 pounds per square inch (psi) to 1 bar; there are 100 kilopascals (kPa) to 1 bar.

Bead

The tire bead contains steel wires wrapped by steel cords that hold the tire onto the rim.

Cold tire inflation pressure

Tire inflation pressure when your vehicle has been sitting for at least 3 hours or driven no more than 1 mile (1.6 km).

Curb weight

The weight of a motor vehicle with standard equipment including the maximum capacity of fuel, oil, and coolant, and, if so equipped, air conditioning and additional optional equipment, but without passengers and cargo.

DOT (Department of Transportation)

A tire branding symbol which denotes the tire meets requirements of the U.S. Department of Transportation.

GAWR (Gross Axle Weight Rating)

The GAWR is the maximum permissible axle weight. The gross vehicle weight on each axle must never exceed the GAWR for the front and rear axle indicated on the certification label located on the driver's door B-pillar.

GVW (Gross Vehicle Weight)

The GVW comprises the weight of the vehicle including fuel, tools, spare wheel, installed accessories, passengers and cargo and, if applicable, trailer tongue load. The GVW must never exceed the GVWR indicated on the certification label located on the driver's door B-pillar.

Tires and wheels

GVWR (Gross Vehicle Weight Rating)

This is the maximum permissible vehicle weight of the fully loaded vehicle (weight of the vehicle including all options, passengers, fuel, and cargo and, if applicable, trailer tongue load). It is indicated on certification label located on the driver's door B-pillar.

Kilopascal (kPa)

The metric unit for air pressure. There are 6.9 kPa to 1 psi; another metric unit for air pressure is bars. There are 100 kilopascals (kPa) to 1 bar.

Maximum load rating

The maximum load in kilograms and pounds that can be carried by the tire.

Maximum loaded vehicle weight

The sum of curb weight, accessory weight, total load weight, and production options weight.

Maximum tire inflation pressure

This number is the greatest amount of air pressure that should ever be put in the tire under normal driving conditions.

Normal occupant weight

The number of occupants the vehicle is designed to seat, multiplied by 68 kilograms (150 lbs).

Occupant distribution

The distribution of occupants in a vehicle at their designated seating positions.

Production options weight

The combined weight of those installed regular production options weighing over 5 lbs (2.3 kilograms) in excess of those standard items which they replace, not previously considered in curb weight or accessory weight, including heavy duty brakes, ride levelers, roof rack, heavy duty battery, and special trim.

PSI (Pounds per square inch)

A standard unit of measure for air pressure -> bar, kilopascal (kPa).

Recommended tire inflation pressure

Recommended tire inflation pressure listed on placard located on driver's door B-pillar for normal driving conditions. Provides best handling, tread life and riding comfort.

Rim

A metal support for a tire or a tire and tube assembly upon which the tire beads are seated.

Sidewall

The portion of a tire between the tread and the bead.

TIN (Tire Identification Number)

Unique identifier which facilitates efforts by tire manufacturers to notify purchasers in recall situations or other safety matters concerning tires and gives purchases the means to easily identify such tires. The TIN is comprised of “Manufacturer’s identification mark”, “Tire size”, “Tire type code” and “Date of manufacture”.

Tire load rating

Numerical code associated with the maximum load a tire can support.

Tire ply composition and material used

This indicates the number of plies or the number of layers of rubber-coated fabric in the tire tread and sidewall. Tire manufacturers also must indicate the ply materials in the tire and sidewall, which include steel, nylon, polyester, and others.

Tire speed rating

Part of tire designation; indicates the speed range for which a tire is approved.

Traction

Force exerted by the vehicle on the road via the tires. The amount of grip provided.

Tread

The portion of a tire that comes into contact with the road.

Treadwear indicators

Narrow bands, sometimes called “wear bars” that show across the tread of a tire when only $\frac{1}{16}$ in (1.6 mm) of tread remains.

Uniform Tire Quality Grading Standards

A tire information system that provides consumers with ratings for a tire's traction, temperature and treadwear. Ratings are determined by tire manufacturers using government testing procedures. The ratings are molded into the sidewall of the tire.

Vehicle maximum load on the tire

Load on an individual tire that is determined by distributing to each axle its share of the maximum loaded vehicle weight and dividing it by two.

Tires and wheels

Rotating tires

Warning!



Rotate front and rear wheels only if the tires are of the same dimension.

If your vehicle is equipped with mixed-size tires (different tire dimensions front vs. rear), tire rotation is not possible.

Tire rotation can be performed on vehicles with tires of the same dimension all around. If your vehicle is equipped with tires of the same dimension all around, tires can be rotated, observing a front-to-rear rotation pattern that will maintain the intended rotation (spinning) direction of the tire (▷ page 326).

In some cases, such as when your vehicle is equipped with mixed-size tires (different tire dimension front vs. rear), tire rotation is not possible.

If applicable to your vehicle's tire configuration, tires can be rotated according to the tire manufacturer's recommended intervals in the tire manufacturer's warranty pamphlet located in your vehicle literature portfolio. If none is available, tires should be rotated every 3000 to 6000 miles (5000 to 10000 km), or sooner if necessary, according to the degree of tire wear. The same rotation (spinning) direction must be maintained (▷ page 326).

Rotate tires before the characteristic tire wear pattern becomes visible (shoulder wear on front tires and tread center wear on rear tires).

Thoroughly clean the mounting face of wheels and brake disks, i.e. the inner side of the wheels/tires, during each rotation. Check for and ensure proper tire inflation pressure.

Warning!



Have the tightening torque checked after changing a wheel. Wheels could become loose if not tightened with a torque of 80 lb-ft (110 Nm).

Only use Genuine Mercedes-Benz wheel bolts specified for your vehicle's rims.

For information on wheel change, see the "Practical hints" section (▷ page 404) and (▷ page 436).

▼ Winter driving

Before the onset of winter, have your vehicle winterized at an authorized Mercedes-Benz Center. This service includes:

- Check of anticorrosion and antifreeze concentration.
- Addition of cleaning concentrate to the water of the windshield and headlamp cleaning system. Add MB Concentrate “MB SummerFit” to a premixed windshield washer solvent / antifreeze which is formulated for temperatures below freezing point (▷ page 479).
- Battery test. Battery capacity drops with decreasing ambient temperature. A well charged battery helps to make sure that the engine can be started even at low ambient temperatures.
- Tire change.

Winter tires

Always use winter tires at temperatures below 45°F (7°C) and whenever wintry road conditions prevail. Not all M+S rated tires provide special winter performance. Make sure the tires you use show the mountain/snowflake  marking on the tire sidewall. These tires meet specific snow traction performance requirements of the Rubber Manufacturers Association (RMA) and The Rubber Association of Canada (RAC) and have been designed specifically for use in snow conditions. Use of winter tires is the only way to achieve the maximum effectiveness of the ABS and the ESP® in winter operation.

For safe handling, make sure that all mounted winter tires are of the same make and have the same tread design.

Warning!



Winter tires with a tread depth under $\frac{1}{6}$ in (4 mm) must be replaced. They are no longer suitable for winter operation.

Always observe the speed rating of the winter tires installed on your vehicle. If the maximum speed for which your tires are rated is below the speed rating of your vehicle, you must place a notice to this effect where it will be seen by the driver. Such notices are available at your tire dealer or any authorized Mercedes-Benz Center.

Warning!



If you use your spare tire when winter tires are fitted on the other wheels, be aware that the difference in tire characteristics may very well impair turning stability and that overall driving stability may be reduced.

Adapt your driving style accordingly.

Have the spare tire replaced with a winter tire at the nearest authorized Mercedes-Benz Center.

Block heater (Canada only)

The engine is equipped with a block heater.

The electrical cable may be installed at an authorized Mercedes-Benz Center.

Snow chains

! Some tire sizes do not leave adequate clearance for snow chains. To help avoid serious damage to your vehicle or tires, make sure that the use of snow chains is permissible as specified in the "Technical data" section of this Operator's Manual, see "Rims and tires" (▷ page 466).

Snow chains should only be driven on snow-covered roads at speeds not higher than 30 mph (50 km/h). Remove chains as soon as possible when driving on roads without snow.

Please observe the following guidelines when using snow chains:

- Using snow chains is not permissible with all wheel/tire combinations (▷ page 466).
- Use snow chains in pairs and on rear wheels only. Follow the manufacturer's mounting instructions.

! If snow chains are mounted to the front wheels, they may scrape against the body or axle components. The tires or the vehicle could be damaged as a result.

- Only use snow chains that are approved by Mercedes-Benz. Any authorized Mercedes-Benz Center will be glad to advise you on this subject.
- Use of snow chains may be prohibited depending on location. Always check local and state laws before installing snow chains.
- Do not use snow chains on the spare wheel (▷ page 469).

i When driving with snow chains, you may wish to deactivate the ESP® (▷ page 92) before setting the vehicle in motion. This will improve the vehicle's traction.

CLK 63 AMG:

Do not switch off the ESP® when driving in snow or with snow chains mounted.

▼ Maintenance

We strongly recommend that you have your vehicle serviced by an authorized Mercedes-Benz Center, in accordance with the Maintenance Booklet at the times called for by the maintenance service indicator.

Failure to have the vehicle maintained in accordance with the Maintenance Booklet and maintenance service indicator at the designated times/mileage will result in vehicle damage not covered by the Mercedes-Benz Limited Warranty.

Maintenance service indicator message

The maintenance service indicator message will notify you when your next maintenance service is due.

Starting approximately 1 month before your next maintenance service is due, one of the following messages will appear in the multifunction display while you are driving or when you switch on the ignition (example service A):

Service A in XXXXX miles (km)

Service A in XXX days

Service A due now

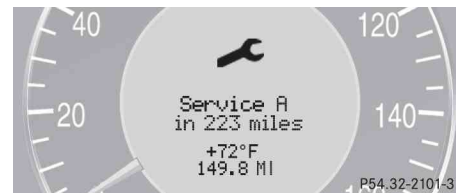

The type of maintenance service due is indicated in the multifunction display:



Basic service (A)



Extended service (B)

i *Vehicles equipped with Maintenance System (U.S. vehicles. Canada vehicles, depending on vehicle production date):*

The Maintenance System in your vehicle tracks distance driven and the time elapsed since your last maintenance service and calculates other maintenance service work required.

i Vehicles equipped with FSS (Flexible Service System) only (Canada vehicles, depending on vehicle production date):

- FSS evaluates engine temperature, oil level, vehicle speed, engine speed, distance driven and the time elapsed since your last service and calculates other maintenance service work required.
- The interval between maintenance services depends on your driving habits. A gentle driving style, moderate engine speeds and the avoidance of short-distance trips will lengthen the interval between services.

Clearing the maintenance service indicator message

The maintenance service indicator message is automatically cleared after approximately 30 seconds when you switch on the ignition or when reaching the maintenance service threshold while driving.

You can also clear it yourself.

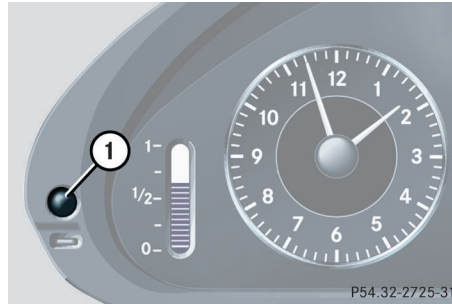

① Reset button

- ▶ Press reset button ① on the instrument cluster.

The maintenance service indicator message is cleared and the standard display appears in the multifunction display (▷ page 145).

Maintenance service term exceeded

If you have exceeded the suggested maintenance service term, you will see the following message in the multifunction display:







Service A exceeded by XXXXX miles (km)
Service A exceeded by XXX days

In addition, a signal sounds when the message appears.

Any authorized Mercedes-Benz Center will reset the maintenance service indicator following a completed maintenance service.

Calling up the maintenance service indicator display

You can call up the maintenance service indicator display at any time to check when the next maintenance service is due.

- ▶ Switch on the ignition (▷ page 38).
- ▶ Press button  or  on the multifunction steering wheel repeatedly until the standard display appears in the multifunction display (▷ page 145).
- ▶ Press button  or  until the maintenance service indicator display with the service symbol  or  and the service deadline appears in the multifunction display.

i *If the battery is disconnected, the days of disconnection will not be included in the count shown by the maintenance service indicator. To arrive at the true maintenance service deadline, you will need to subtract these days from the days shown in the maintenance service indicator message or maintenance service indicator display.*

Do not confuse the maintenance service indicator with the engine oil level indicator .

Resetting the maintenance service indicator

In the event that the maintenance service on your vehicle is not carried out by an authorized Mercedes-Benz Center, you can have the maintenance service indicator reset. The automotive maintenance facility carrying out the maintenance service will find the information for resetting the maintenance service indicator in the maintenance-relevant information for your vehicle. Such information is available from either your authorized Mercedes-Benz Center or directly from Mercedes-Benz.

i *If the maintenance service indicator was inadvertently reset, have an authorized Mercedes-Benz Center correct it.*

Only reset if the proper maintenance service has been performed. Resetting the system without performing the proper service as called for by the maintenance service indicator will result in engine damage and/or other vehicle damage not covered by the Mercedes-Benz Limited Warranty.

Cleaning and care of vehicle

Regular and proper care will help to maintain the value of your vehicle. The best way to protect your vehicle from harmful environmental influences is to wash it and use protective treatments regularly.

Warning!



Many cleaning products can be hazardous. Some are poisonous, others are flammable. Always follow the instructions on the particular container. Always open your vehicle's doors or windows when cleaning the inside.

Never use fluids or solvents that are not designed for cleaning your vehicle.

Always lock away cleaning products and keep them out of reach of children.

While in operation, even while parked, your vehicle is subject to varying external influences which, if gone unchecked, can attack the paintwork as well as the vehicle underbody and cause lasting damage.

Such damage is caused not only by extreme and varying climatic conditions, but also by:

- Air pollution
- Road salt
- Tar
- Gravel and stone chipping

To avoid paint damage, you should immediately remove:

- Grease and oil
- Fuel
- Coolant
- Brake fluid
- Bird droppings
- Insects
- Tree resins, etc.

Frequent washing reduces and / or eliminates the aggressiveness and potency of the above adverse influences.

More frequent washings are necessary to deal with unfavorable conditions:

- near the ocean
- in industrial areas (smoke, exhaust emissions)
- during winter operation

You should check your vehicle from time to time for stone chipping or other damage. Any damage should be repaired as soon as possible to prevent corrosion.

In doing so, do not neglect the underbody of the vehicle. A prerequisite for a thorough check is a washing of the underbody followed by a thorough inspection. Damaged areas need to be re-undercoated.

Your vehicle has been treated at the factory with a wax-base rustproofing in the body cavities which will last for the lifetime of the vehicle. Post-production treatment

is neither necessary nor recommended by Mercedes-Benz because of the possibility of incompatibility between materials used in the production process and others applied later.

We have selected car-care products and compiled recommendations which are specially matched to our vehicles and which always reflect the latest technology. You can obtain Mercedes-Benz approved car-care products at an authorized Mercedes-Benz Center.

Scratches, corrosive deposits, corrosion or damage due to negligent or incorrect care cannot always be removed or repaired with the car-care products recommended here. In such cases it is best to seek aid at an authorized Mercedes-Benz Center.

The following topics deal with the cleaning and care of your vehicle and give important “how-to” information as well as references to Mercedes-Benz approved car-care products.

Power washer

! Follow the instructions provided by the power washer manufacturer on maintaining a distance between the vehicle and the nozzle of the power washer.

Never use a round nozzle to power-wash tires. The intense jet of water can result in damage to the tire.

Always replace a damaged tire.

Always keep the jet of water moving across the surface. Do not aim directly at electrical parts, electrical connectors, seals, or other rubber parts.

i Vehicles with KEYLESS-GO*: *If a door handle is hit by a strong jet of water, and a SmartKey with KEYLESS-GO* is in close proximity, i.e. within approximately 3 ft (approximately 1 m), the vehicle could be inadvertently locked or unlocked.*

Tar stains

Quickly remove tar stains before they dry and become more difficult to remove. A tar remover is recommended.

Paintwork, painted body components

! Affixing stickers, magnets, adhesive tape or similar materials to painted body components may damage the paintwork.

Mercedes-Benz approved Paint Care should be applied when water drops on the paint surface do not “bead up”. This should normally be done every 3 to 5 months, depending on the climate and washing detergent used.

Mercedes-Benz approved Paint Cleaner should be applied if the paint surface shows signs of embedded dirt (i.e. loss of gloss).

Do not apply any of these products or wax if your vehicle is parked in the sun or if the hood is still hot.

- ▶ Use the appropriate MB-Touch-Up Stick for quick and provisional repairs of minor paint damage (i.e. chips from stones, vehicle doors, etc.).

Vehicle care

Engine cleaning

Prior to cleaning the engine compartment, make sure to protect electrical components and connectors from contact with water and cleaning agents.

Corrosion protection, such as MB Anticorrosion Wax, should be applied to the engine compartment after every engine cleaning. Before applying, all control linkage bushings and joints should be lubricated. The poly-V-belt and all pulleys should be protected from any wax.

Vehicle washing

In the winter, thoroughly remove all traces of road salt as soon as possible.

When washing the vehicle underbody, do not forget to clean the inner sides of the wheels.

i *Vehicles with KEYLESS-GO*:*
If a door handle is hit by a strong jet of water, and a SmartKey with KEYLESS-GO is in close proximity, i.e. within approximately 3 ft (approximately 1 m), the vehicle could be inadvertently locked or unlocked.*

Hand-wash

Do not use hot water or wash your vehicle in direct sunlight.

- ▶ Only use a mild car wash detergent, such as Mercedes-Benz approved Car Shampoo.
- ▶ Thoroughly spray the vehicle with a diffused jet of water.

Direct only a very weak spray towards the ventilation intake.

- ▶ Use plenty of water and rinse the sponge and chamois frequently.
- ▶ Rinse with clean water and thoroughly dry with a chamois.

Do not allow cleaning agents to dry on the finish.

! *Do not use scouring agents on these parts. Never apply strong force and only use a soft, non-scratching cloth when cleaning the vehicle. Do not attempt to wipe the surface with a dry cloth or sponge.*

Otherwise you may scratch or damage the paint.

Automatic car wash

You can have your car washed in an automatic car wash from the start. Automatic car washes without brushes are preferable.

- ▶ To protect the filter system, switch the climate control or automatic climate control to air recirculation mode, see “Air recirculation” (▷ page 189) for climate control or (▷ page 199) for automatic climate control.

! *Do not clean your vehicle in an automatic touchless car wash which uses caustic spray. Otherwise the caustic spray will damage the soft top, paint, or ornamental moldings.*

If the vehicle is very dirty, prewash it before running it through the automatic car wash.

! Make sure that the windshield wiper switch is set to **0** (▷ page 55). Otherwise, e.g. the rain sensor could activate and cause the wipers to move unintentionally. This may lead to vehicle damage.

Due to the width of the vehicle, fold in exterior rear view mirrors prior to running the vehicle through an automatic car wash to prevent damage to the mirrors.

i After running the vehicle through an automatic car wash, wipe any wax off of the windshield (▷ page 362). This will prevent smears and reduce wiping noise which can be caused by residual wax on the windshield.

When leaving the car wash, make sure that the mirrors are folded out. Otherwise they may vibrate.

Soft top

Frequent cleaning reduces the dirt-repellent effect of the soft top.

Intensive cleaning with Mercedes-Benz car-care products for convertible soft tops can help to restore the dirt-repellent effect. Contact an authorized Mercedes-Benz Center for detailed information.

Light colored soft tops should be cleaned frequently to prevent spots and dirt from setting in, which could stain and discolor the soft top material permanently.

Incorrect cleaning and care, as well as ageing, can cause the soft-top seams to leak. Have the soft-top seams sealed at a Mercedes-Benz Center.

i If the soft top is kept in the storage compartment for a lengthy period, raise it and air out with the windows open about every 4 months.

Place a suitable cover over the soft top if you are leaving the vehicle parked in the open for an extended period of time.

! Remove bird droppings immediately. The organic acid damages the material and causes the soft top to leak.

Never use a power washer to clean the soft top, as you may damage the soft top material.

Do not use sharp-edged instruments for the removal of ice and snow.

Never use hot-wax when you run the vehicle through an automatic car wash, as you may damage the soft top material.

i Depending on the operation mode of the car wash, there is the possibility of water drops entering the vehicle's interior. This is not an indication of a defect or malfunction in the soft top.

Clean soft top with soft top raised and locked. Lower the soft top into the storage compartment only if the soft top is completely dry.

Dry cleaning:

▶ Brush the dry top with a soft-bristled brush.

Brush top always from front to rear.

Vehicle care

Wet cleaning:

- ▶ Brush the top with a soft-bristled brush.

Wash with clear water or with a mild detergent and an ample supply of lukewarm water by wiping with a soft-bristled brush or sponge from front to rear. Then rinse thoroughly with clear water.

Wash the top only when heavily soiled.

If only parts of the top have been washed, wet the entire top and allow it to air-dry before lowering it into the storage compartment.

i *In general, regular spraying or cleaning with clear water is sufficient to keep the soft top clean.*

For cleaning soft top or wind screen never use:

- gasoline
- thinner
- tar and stain removers
- glass cleaner
- similar organic solvents

They will cause damage which is not covered by the Mercedes-Benz Limited Warranty.

Ornamental moldings

For regular cleaning and care of ornamental moldings, use a damp cloth.

! *Do not use chrome cleaner on ornamental moldings. Although ornamental moldings may have chrome appearance, they could be made of anodized aluminum that will be damaged when cleaned with chrome cleaner. Instead, use a damp cloth to clean those ornamental moldings.*

For very dirty ornamental moldings of which you are sure are chrome-plated, use a chrome cleaner. If in doubt whether an ornamental molding is chrome-plated, contact an authorized Mercedes-Benz Center.

Headlamps, tail lamps, side markers, turn signal lenses

- ▶ Use a mild car wash detergent, such as Mercedes-Benz approved Car Shampoo, with plenty of water.

! Only use window cleaning solutions that are suitable for plastic lamp lenses. Window cleaning solutions which are not suitable may damage the plastic lamp lenses of the headlamps. Therefore, do not use abrasives, solvents or cleaners that contain solvents.

Never apply strong force and only use a soft, non-scratching cloth when cleaning the lenses. Do not attempt to wipe dirty lenses with a dry cloth or sponge.

Otherwise you may scratch or damage the lens surface.

Cleaning the Parktronic system* sensors (CLK 63 AMG (USA), Canada all vehicles)

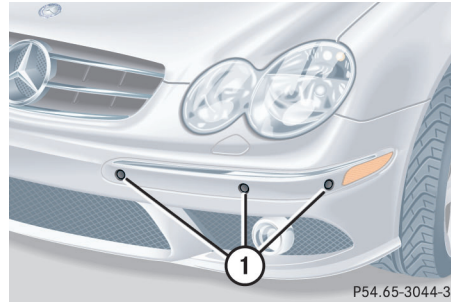

- ① Parktronic system* sensors in front bumper
- ▶ Use a mild car wash detergent, such as Mercedes-Benz approved Car Shampoo, with plenty of water and a soft, non-scratching cloth to clean sensors ① on the bumpers.

! Do not apply strong pressure to the sensor covers. Applying strong pressure may damage the sensor covers.

Follow the instructions provided by the power washer manufacturer on maintaining a distance between the vehicle and the nozzle of the power washer.

! To prevent scratches, never apply strong force and only use a soft, non-scratching cloth when cleaning the sensors. Do not attempt to wipe dirty sensors with a dry cloth or sponge.

Vehicle care

Cleaning the windows and the wiper blades

! *Never open the hood when the wiper arms are folded forward.*

- ▶ Make sure the hood is fully closed.
- ▶ Make sure the vehicle's on-board electronics have status **0** (▶ page 36).

Warning!



For safety reasons, switch off wipers and remove SmartKey from starter switch (vehicles with KEYLESS-GO*: Make sure the vehicle's on-board electronics have status **0**) before cleaning the windshield and/or the wiper blades. Otherwise, the wiper motor could suddenly turn on and cause injury.

- ▶ Fold the wiper arms forward until they snap into place.

! *Do not pull on the wiper blade inserts. They could tear.*

- ▶ Clean the wiper blade inserts with a clean cloth and detergent solution.
- ▶ Use a soft, clean cloth and a mild window cleaning solution on all outside and inside glass surfaces.

An automotive glass cleaner is recommended.

! *Fold the windshield wiper arms back onto the windshield before turning the SmartKey in the starter switch or pressing the KEYLESS-GO start/stop button (vehicles with KEYLESS-GO*). Hold on to the wiper when folding the wiper arm back. If released, the force of the impact from the tensioning spring could crack the windshield.*

! *To clean the window interior, do not use a dry cloth, abrasives, solvents or cleaners containing solvents. Do not touch the inside of the front, rear or side windows with hard objects such as an ice scraper or ring. Doing so may damage the windows.*

Light alloy wheels

If possible, clean wheels once a week.

- ▶ Use Mercedes-Benz approved Wheel Care, a soft bristle brush and a strong spray of water for cleaning the light alloy wheels.

! *Only use acid-free cleaning materials. Acid may cause corrosion or damage the clear coat.*

! *The vehicle should not be parked for an extended period of time immediately after it has been cleaned, especially not after the wheel rims have been cleaned with wheel rim cleaner. Wheel rim cleaners can lead to increased corrosion of the brake disks and brake pads. Non-approved wheel cleaners may also damage the wheel paint if the car is not driven after cleaning. Therefore, the vehicle's brake system should always be warmed-up before it is parked after cleaning. To do so, please drive your vehicle for several minutes to allow the brakes to dry.*

When applying Mercedes-Benz approved Tire Care and Mercedes-Benz approved Wheel Care products, take care not to spray them on the brake disks.

Plastic and rubber parts

- ▶ Use a gentle dishwashing detergent or mild detergent for delicate fabrics as a washing solution.
- ▶ Wipe with a cloth moistened in a lukewarm solution.

The surface may temporarily change color. If this is the case, wait for it to dry.

Warning!



Do not use cleaners or cockpit care sprays containing solvents to clean the cockpit or the steering wheel. Cleaners containing solvents will make the surface porous and vehicle occupants could suffer serious injuries from plastic parts coming loose in the event of air bag deployment.

! Do not use oil, wax or scouring agents on these parts.

Never apply strong force and only use a soft, non-scratching cloth when cleaning the surface. Do not attempt to wipe the surface with a dry cloth or sponge.

Otherwise you may scratch or damage the surface.

Hard plastic trim items

- ▶ Use Mercedes-Benz approved Interior Care, a soft, lint-free cloth and apply with light pressure.

! *Never apply strong force and only use a soft, non-scratching cloth when cleaning the surface. Do not attempt to wipe the surface with a dry cloth or sponge.*

Otherwise you may scratch or damage the surface.

Steering wheel and gear selector lever

- ▶ Wipe with a damp cloth and dry thoroughly or clean with Mercedes-Benz approved Leather Care.

Carpets

- ▶ Use Mercedes-Benz approved Carpet and Fabric Care for cleaning the carpets.

Headliner and shelf below rear window

- ▶ Use a soft bristle brush or a dry-shampoo cleaner in case of excessive dirt.

Vehicle care

Seat belts

- ▶ Only use clear, lukewarm water and soap.

! *The seat belts must not be treated with chemical cleaning agents. Do not dry the seat belts at temperatures above 176 °F (80 °C) or in direct sunlight.*

Warning!



Do not bleach or dye seat belts as this may severely weaken them. In a crash they may not be able to provide adequate protection.

Upholstery

Using aftermarket seat covers or wearing clothing that have the tendency to give off coloring (e.g. when wet, etc.) may cause the upholstery to become permanently discolored. By lining the seats with a proper intermediate cover, contact-discoloration will be prevented.

Warning!



Only use seat or head restraint covers which have been tested and approved by Mercedes-Benz for your vehicle model. Using other seat or head restraint covers may interfere with or prevent the activation of the active head restraints. Contact an authorized Mercedes-Benz Center for availability.

Leather upholstery

Please note that leather upholstery is a natural product and is therefore subject to a natural aging process. Leather upholstery may also react to certain ambient influences such as high humidity or high temperature by showing wrinkles for example.

- ▶ Wipe leather upholstery with a damp cloth and dry thoroughly or clean with Mercedes-Benz approved Leather Care.

! *Wipe with light pressure to avoid damage to the upholstery.*

Exercise particular care when cleaning perforated leather as its underside should not become wet.

Wood trims

- ▶ Dampen cloth using water and use damp cloth to clean wood trims in your vehicle.

! *Do not use solvents like tar remover or wheel cleaner nor polishes or waxes as these may be abrasive.*

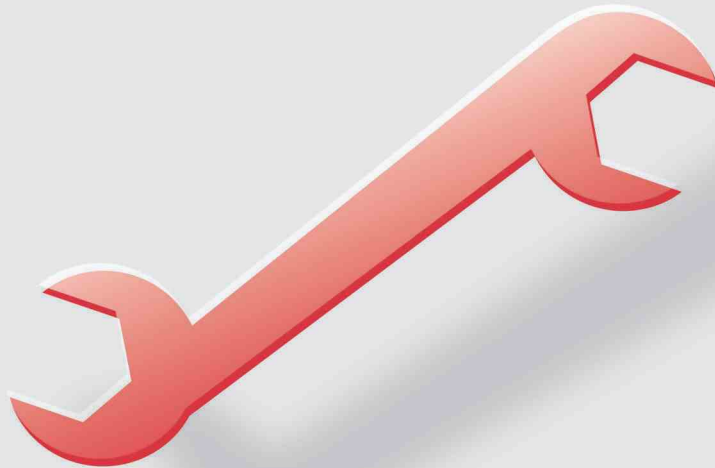

What to do if ...?

Where will I find...?

Unlocking/locking in an emergency

Opening/closing in an emergency

Resetting activated head restraints

Replacing SmartKey batteries

Replacing bulbs

Replacing wiper blades

Flat tire

Battery

Jump starting

Towing the vehicle

Fuses

What to do if ...?

Lamps in instrument cluster

General information:

If any of the following bulbs in the instrument cluster fails to come on during the

bulb self-check when switching on the ignition, have the respective bulb checked and replaced if necessary.

Problem	Possible cause/consequence	Suggested solution
 <p>The yellow ABS indicator lamp comes on while the engine is running.</p>	<p>The ABS has detected a malfunction and has switched off. The BAS and the ESP® are also switched off (see messages in the multifunction display).</p> <p>The brake system is still functioning normally but without the systems specified above.</p> <p>If the ABS control unit is malfunctioning, other systems such as the navigation system* or the automatic transmission may also be malfunctioning.</p> <p>The charging voltage has fallen below 10 volts. The ABS has switched off.</p> <p>The battery might not be charged sufficiently.</p>	<ul style="list-style-type: none"> ▶ Continue driving with added caution. Wheels will lock during hard braking, reducing steering capability. ▶ Read and observe messages in the multifunction display (▷ page 378). ▶ Have the system checked at an authorized Mercedes-Benz Center as soon as possible. <p>Failure to follow these instructions increases the risk of an accident.</p> <ul style="list-style-type: none"> ▶ Switch off electrical consumers that are currently not needed, e.g. seat heating*. ▶ If necessary, have the generator and battery checked. <p>When the voltage is above this value again, the ABS is operational again.</p>

Problem	Possible cause/consequence	Suggested solution
 <p>The yellow ABS indicator lamp comes on while the engine is running.</p>	<p>The ABS is temporarily not available. The ESP® and the BAS are also unavailable.</p> <p>The system's self-diagnosis may not be completed yet.</p> <p>The brake system is still functioning normally but without the systems specified above.</p>	<ul style="list-style-type: none"> ▶ Drive a short distance with added caution at a vehicle speed of above 12 mph (20 km/h). When the ABS indicator lamp goes out, the ABS, the ESP®, and the BAS are available again. <p>If the ABS indicator lamp does not go out:</p> <ul style="list-style-type: none"> ▶ Continue driving with added caution. ▶ Have the system checked at an authorized Mercedes-Benz Center as soon as possible. <p>Failure to follow these instructions increases the risk of an accident.</p>

What to do if ...?

Problem		Possible cause/consequence	Suggested solution
BRAKE 	(USA only)	The red brake warning lamp comes on while driving and you hear a warning sound.	▶ Release the parking brake (▷ page 52).
	(Canada only)	The red brake warning lamp comes on while driving.	



Warning!



Driving with the brake warning lamp illuminated can result in an accident. Have your brake system checked immediately if the brake warning lamp stays on. Do not add brake fluid before checking the brake system.



Overfilling the brake fluid reservoir can result in spilling brake fluid on hot engine parts and the brake fluid catching fire. You could be seriously burned.



! *If you find that the brake fluid in the brake fluid reservoir has fallen to the minimum mark or below, have the brake system checked for brake pad thickness and leaks.*

Problem		Possible cause/consequence	Suggested solution
 (USA only)	The yellow engine malfunction indicator lamp comes on while driving.	There is a malfunction in: <ul style="list-style-type: none"> • The fuel management system • The ignition system • The emission control system • Systems which affect emissions Such malfunctions may result in excessive emissions values and may switch the engine to its Limp-Home Mode (emergency operation).	► Have the vehicle checked as soon as possible by an authorized Mercedes-Benz Center. An on-board diagnostic connector is used by the service station to link the vehicle to the shop diagnostics system. It allows the accurate identification of system malfunctions through the readout of diagnostic trouble codes. It is located in the front left area of the footwell next to the parking brake pedal.
 (Canada only)			

 *In some states you may be required by law to have the vehicle serviced immediately as soon as the engine malfunction indicator lamp comes on. Check local requirements.*

What to do if ...?

Problem		Possible cause/consequence	Suggested solution
 (USA only)	The yellow engine malfunction indicator lamp comes on while driving.	A loss of pressure has been detected in the fuel system. The fuel cap may not be closed properly or the fuel system may be leaky.	<ul style="list-style-type: none"> ▶ Check the fuel cap (▷ page 312).
 (Canada only)			<p>If it is not closed properly:</p> <ul style="list-style-type: none"> ▶ Close the fuel cap. <p>If it is closed properly:</p> <ul style="list-style-type: none"> ▶ Have the fuel system checked by an authorized Mercedes-Benz Center.
		Your fuel tank is empty.	<ul style="list-style-type: none"> ▶ After refuelling, start, turn off, and restart the engine three or four times in succession. <p>The Limp-Home Mode is canceled. You do not need to have your vehicle checked.</p>

Problem	Possible cause/consequence	Suggested solution
 <p>The red coolant warning lamp comes on when the engine is running.</p>	There is insufficient coolant in the reservoir.	▶ Add coolant to prevent engine from overheating (▷ page 320).
	If this warning lamp comes on frequently, there is a leak in the cooling system.	▶ Have the cooling system checked.
	If the coolant level is correct, the electric radiator fan may be broken.	▶ If the coolant temperature is below 257 °F (125 °C), you can continue driving to the nearest authorized Mercedes-Benz Center. ▶ Avoid high engine loads (e.g. driving uphill) and stop-and-go driving.
 <p>The red coolant warning lamp comes on while driving and you hear a warning sound.</p>	The coolant temperature has exceeded 257 °F (125 °C).	▶ Stop as soon as possible and allow the engine and coolant to cool down.

Warning!









Driving when your engine is overheated can cause some fluids which may have leaked into the engine compartment to catch fire. You could be seriously burned.

Steam from an overheated engine can cause serious burns which can occur just by opening the hood. Stay away from the engine if you see or hear steam coming from it.



Turn off the engine, get out of the vehicle and do not stand near the vehicle until the engine has cooled down.

What to do if ...?

Problem	Possible cause/consequence	Suggested solution
<p> The yellow ESP® warning lamp comes on while the engine is running.</p>	<p>The ESP® has been switched off with the ESP® switch or has been switched off due to a malfunction.</p> <p>Risk of accident!</p> <p>When the ESP® is switched off it will not stabilize the vehicle if the system recognizes that the vehicle starts to skid or that a wheel is spinning.</p> <p>The cruise control is deactivated and cannot be switched on.</p>	<ul style="list-style-type: none"> ▶ Switch the ESP® back on (▷ page 94). Exceptions: (▷ page 92). ▶ If leaving the ESP® switched off, adapt your speed and driving to the prevailing road, weather and traffic conditions. <p>If the ESP® cannot be switched on:</p> <ul style="list-style-type: none"> ▶ Continue driving with added caution. ▶ Observe additional messages that may appear in the multifunction display (▷ page 380). ▶ Have the system checked at an authorized Mercedes-Benz Center as soon as possible.
<p> The yellow ESP® warning lamp flashes while driving.</p>	<p>The ESP® or traction control has come into operation because of detected traction loss in at least one tire.</p> <p>The cruise control is deactivated</p>	<ul style="list-style-type: none"> ▶ When driving off, apply as little throttle as possible. ▶ While driving, ease up on the accelerator. ▶ Adapt your speed and driving to the prevailing road, weather and traffic conditions. ▶ Do not deactivate the ESP®. Exceptions: (▷ page 92). <p>Failure to follow these instructions increases the risk of an accident.</p>

Problem	Possible cause/consequence	Suggested solution
 The yellow fuel tank reserve warning lamp comes on while driving.	The fuel level has gone below the reserve mark.	<ul style="list-style-type: none"> ▶ Refuel at the next gas station (▷ page 312).
 The yellow roll bar warning lamp comes on or flickers when the engine is running.	The roll bar system is malfunctioning.	<ul style="list-style-type: none"> ▶ Release the roll bars manually. ▶ Have the system checked at an authorized Mercedes-Benz Center as soon as possible.
 The red seat belt telltale comes on for a maximum of 6 seconds after starting the engine.	The seat belt telltale reminds you and your passengers to fasten your seat belts before driving off.	<ul style="list-style-type: none"> ▶ Fasten your seat belts. <p>Regardless of whether the seat belts are fastened or not, the seat belt telltale always comes on and remains lit for 6 seconds after starting the engine.</p>
 You hear a warning chime for a maximum of 6 seconds after starting the engine.	You have forgotten to fasten your seat belt.	<ul style="list-style-type: none"> ▶ Fasten your seat belt. <p>The warning chime stops sounding.</p>

What to do if ...?

Problem	Possible cause/consequence	Suggested solution
 The red seat belt telltale comes on while the vehicle is standing still and the engine is running or during driving.	You and/or your front passenger have forgotten to fasten your seat belts.	<ul style="list-style-type: none"> ▶ Fasten your seat belts. <p>The seat belt telltale goes out.</p>
	There are items placed on the front passenger seat and therefore the system senses the front passenger seat as being occupied.	<ul style="list-style-type: none"> ▶ Remove the items from the front passenger seat and put them in a safe place. <p>The seat belt telltale goes out.</p>
 During driving the red seat belt telltale flashes and you additionally hear an intermittent warning chime with increasing intensity.	The vehicle's speed once exceeded 15 mph (25 km/h) and you and/or your front passenger have forgotten to fasten your seat belts.	<ul style="list-style-type: none"> ▶ Fasten your seat belts. <p>The seat belt telltale goes out and the warning chime stops sounding.</p>
	There are items placed on the front passenger seat and therefore the system senses the front passenger seat as being occupied.	<ul style="list-style-type: none"> ▶ Remove the items from the front passenger seat and put them in a safe place. <p>The seat belt telltale goes out and the warning chime stops sounding.</p>

i After 60 seconds with an unfastened seat belt the warning chime stops sounding and the seat belt telltale illuminates continuously. The seat belt telltale will only go out if both,

the driver's and the front passenger's seat belt are fastened, or the vehicle is standing still and a door is opened.

Problem	Possible cause/consequence	Suggested solution
<p>SRS The red SRS indicator lamp comes on while driving.</p>	<p>There is a malfunction in the restraint systems. The air bags or emergency tensioning devices (ETDs) could deploy unexpectedly or fail to deploy in an accident.</p>	<p>► Drive with added caution to the nearest authorized Mercedes-Benz Center.</p>

Warning!



In the event a malfunction of the SRS is indicated as outlined above, the SRS may not be operational. For your safety, we strongly recommend that you visit an authorized Mercedes-Benz Center immediately to have the system checked; otherwise the SRS may not be deployed when needed in an accident, which could result in serious or fatal injury, or it might deploy unexpectedly and unnecessarily which could also result in an accident and / or injury to you or to others.

What to do if ...?



Lamp in center console

Problem	Possible cause/consequence	Suggested solution
 The front passenger front air bag off indicator lamp illuminates and remains illuminated with the weight of a typical adult or someone larger than a small individual on the front passenger seat.	The system is malfunctioning.	<ul style="list-style-type: none">▶ Have the system checked as soon as possible by an authorized Mercedes-Benz Center.▶ Read and observe messages in the multifunction display and follow corrective steps (▷ page 382).

Warning!





If the  indicator lamp illuminates and remains illuminated with the weight of a typical adult or someone larger than a small individual on the front passenger seat, do not have any passenger use the front passenger seat until the system has been repaired.

Problem	Possible cause/consequence	Suggested solution
  <p>The front passenger front air bag off indicator lamp does not illuminate and/or does not remain illuminated with the weight of a typical 12-month-old child in a standard child restraint or less on the front passenger seat.</p>	<p>The system is malfunctioning.</p>	<ul style="list-style-type: none"> ▶ Make sure that there is nothing between seat cushion and child seat and check installation of the child seat. ▶ Make sure that no objects applying supplemental weight onto the seat are present. ▶ If the front passenger front air bag off indicator lamp remains out, have the system checked as soon as possible by an authorized Mercedes-Benz Center. Do not transport a child on the front passenger seat until the system has been repaired. ▶ Read and observe messages in the multifunction display and follow corrective steps (▷ page 382).

Warning!



If the   indicator lamp does not illuminate or remains out with the

weight of a typical 12-month-old child in a standard child restraint or less on the front passenger seat, do not transport a child on the front passenger seat until the system has been repaired.

What to do if ...?

Vehicle status messages in the multifunction display





Warning and malfunction messages appear in the multifunction display located in the instrument cluster.





Certain warning and malfunction messages are accompanied by an audible signal.

Address these messages accordingly and follow the additional instructions given in this Operator's Manual.

Selecting the vehicle status message memory menu in the control system (▷ page 152) displays both cleared and uncleared messages.

High-priority messages appear in the multifunction display in red color.

Certain messages of high priority cannot be cleared from the multifunction display using the reset button (▷ page 136) or button , , , or  on the steering wheel.

Other messages of high priority and messages of less immediate priority can be cleared from the multifunction display using the reset button (▷ page 136) or button , , , or  on the steering wheel. They are then stored in the vehicle status message memory (▷ page 152). Remember that clearing a message will only make the message disappear. Clearing a message will not correct the condition that caused the message to appear.

Warning!



All categories of messages contain important information which should be taken note of and, where a malfunction is indicated, addressed as soon as possible at an authorized Mercedes-Benz Center.

Failure to repair condition noted may cause damage not covered by the Mercedes-Benz Limited Warranty, or result in property damage or personal injury.

Warning!

No messages will be displayed if either the instrument cluster or the multifunction display is inoperative.

As a result, you will not be able to see information about your driving conditions, such as speed or outside temperature, warning/indicator lamps, malfunction/warning messages or the failure of any systems. Driving characteristics may be impaired.

If you must continue to drive, please do so with added caution. Visit an authorized Mercedes-Benz Center as soon as possible.

On the pages that follow, you will find a compilation of the most important warning and malfunction messages that may appear in the display.

For your convenience the messages are divided into two sections:

- Text messages (> page 380)
- Symbol messages (> page 388)

i *Switching on the ignition causes all instrument cluster lamps (except low beam headlamp indicator lamp, high beam headlamp indicator lamp, and turn signal indicator lamps unless activated) as well as the multifunction display to come on. Make sure the lamps and the multifunction display are in working order before starting your journey.*

What to do if ...?







Text messages

Display message	Possible cause/consequence	Possible solution
<p>ABS</p> <p>ABS, ESP inoperative See Operator's Man.</p>	<p>The ABS and ESP® are not available due to a malfunction.</p> <p>The BAS is also deactivated.</p> <p>The brake system is still functioning normally but without but without the systems specified above.</p>	<ul style="list-style-type: none"> ▶ Continue driving with added caution. Wheels will lock during hard braking, reducing steering capability. ▶ Have the system checked at an authorized Mercedes-Benz Center as soon as possible. <p>Failure to follow these instructions increases the risk of an accident.</p>
<p>Cruise control and SPEEDTRONIC</p> <p>inoperative</p>	<p>Cruise control is malfunctioning.</p>	<p>Have the cruise control checked by an authorized Mercedes-Benz Center.</p>
<p>ESP</p> <p>inoperative See Operator's Man.</p>	<p>The ESP® has switched off due to a malfunction.</p> <p>The ABS and the BAS might not be operational.</p> <p>The brake system is still functioning normally but without the systems specified above.</p>	<ul style="list-style-type: none"> ▶ Continue driving with added caution. ▶ Contact an authorized Mercedes-Benz Center as soon as possible. <p>Failure to follow these instructions increases the risk of an accident.</p>

Display message	Possible cause/consequence	Possible solution
<p>ESP unavailable See Operator's Man.</p>	<p>The ESP® is temporarily not available. The system's self-diagnosis may not be completed yet. The ABS and the BAS might not be operational. The brake system is still functioning normally but without the systems specified above.</p> <p>The charging voltage has fallen below 10 volts. The ESP® has switched off. The BAS may be switched off, too. The battery may not be charged. The battery or the generator may be malfunctioning. The ABS might not be operational. The brake system is still functioning normally but without the systems specified above.</p>	<p>▶ Drive a short distance with added caution at a vehicle speed of above 12 mph (20 km/h). When the message disappears, the ESP® is available again.</p> <p>If the message does not disappear:</p> <p>▶ Continue driving with added caution. ▶ Have the system checked at an authorized Mercedes-Benz Center as soon as possible.</p> <p>Failure to follow these instructions increases the risk of an accident.</p> <p>▶ Continue driving with added caution. When the voltage is above this value again, the ESP® is operational again. ▶ Have the system checked at an authorized Mercedes-Benz Center as soon as possible.</p>



What to do if ...?

Display message	Possible cause/consequence	Possible solution
Front passenger airbag enabled See Operator's Manual	Front passenger front air bag is activated while driving even though a child, small individual, or object below the system's weight threshold is on the front passenger seat, or the front passenger seat is empty. Objects on the seat or forces acting on the seat may make the system sense supplemental weight.	Stop the vehicle in a safe location as soon as possible and check the front passenger seat for the following: <ul style="list-style-type: none">▶ Switch off the ignition (▷ page 36).▶ Remove child and child restraint from front passenger seat and properly secure the child in rear seat employing the child restraint if necessary.▶ Make sure that no objects applying supplemental weight onto the seat are present. The system may recognize such supplemental weight and sense that an occupant on the front passenger seat is of a greater weight than actually present.▶ Keep the seat unoccupied, close the front passenger door and switch on the ignition (▷ page 36). (Continued on next page)

Display message	Possible cause/ consequence	Possible solution
		<p>Monitor the   indicator lamp on the center console (▷ page 29) and the multifunction display in the instrument cluster (▷ page 26) for the following:</p> <p>With the seat unoccupied and the ignition turned on,</p> <ul style="list-style-type: none"> the   indicator lamp on the center console should illuminate and remain illuminated, indicating that the OCS (▷ page 71) has deactivated the air bag. the message Front passenger airbag enabled See Operator's Manual or the message Front passenger airbag disabled See Operator's Manual should not appear in the multifunction display at any time the seat is unoccupied. Wait at last 60 seconds for the system to complete the necessary check cycles and to make sure neither message appears in the multifunction display. <p>If above conditions are met, you can occupy the front passenger seat again. Depending on the front passenger classification sensed by the OCS (▷ page 71), the   indicator lamp will remain illuminated or go out.</p> <p>If above conditions are not met, the system is not working properly. Have the system checked as soon as possible by an authorized Mercedes-Benz Center.</p>

Warning!





If the   indicator lamp remains

out even after performing the above corrective steps, do not have any children 12 years old and under and other small individuals

use the front passenger seat until the system has been repaired.

What to do if ...?

Display message	Possible cause/consequence	Possible solution
Front passenger airbag disabled See Operator's Manual	Front passenger front air bag is deactivated while driving even though an adult or someone larger than a small individual is occupying the front passenger seat. Forces acting on the seat may make the system sense a decrease in weight.	Stop the vehicle in a safe location as soon as possible and check the front passenger seat for the following: <ul style="list-style-type: none">▶ Switch off the ignition (▷ page 36).▶ Have the front passenger vacate the seat and exit the vehicle.▶ Keep the seat unoccupied, close the front passenger door and switch on the ignition (▷ page 36). (Continued on next page)

Display message	Possible cause/ consequence	Possible solution
		<p>Monitor the  indicator lamp on the center console (▷ page 29) and the multifunction display in the instrument cluster (▷ page 26) for the following:</p> <p>With the seat unoccupied and the ignition turned on,</p> <ul style="list-style-type: none"> the  indicator lamp on the center console should illuminate and remain illuminated, indicating that the OCS (▷ page 71) has deactivated the air bag. the message Front passenger airbag enabled See Operator's Manual or the message Front passenger airbag disabled See Operator's Manual should not appear in the multifunction display at any time the seat is unoccupied. Wait at last 60 seconds for the system to complete the necessary check cycles and to make sure neither message appears in the multifunction display. <p>If above conditions are met, you can occupy the front passenger seat again. Depending on the front passenger classification sensed by the OCS (▷ page 71), the  indicator lamp will remain illuminated or go out.</p> <p>If above conditions are not met, the system is not working properly. Have the system checked as soon as possible by an authorized Mercedes-Benz Center.</p>

Warning!



If the  indicator lamp remains

illuminated with an adult occupant on the front passenger seat even after performing the above corrective steps, do not have any

passenger use the front passenger seat until the system has been repaired.

What to do if ...?

Display message	Possible cause/consequence	Possible solution
<p>P</p> <p>Selector lever in Park</p>	<p>You have turned off the engine with the KEYLESS-GO* start/stop button in gear selector lever position N and opened the driver's door.</p> <p>or</p> <p>You have attempted to switch off the engine with the KEYLESS-GO* start/stop button while the gear selector lever was in position R or D.</p>	<p>▶ Place the gear selector lever in position P.</p>
<p>Please shift to N or P</p>	<p>You have attempted to start the engine with the KEYLESS-GO* start/stop button while the gear selector lever was in position R or D.</p>	<p>▶ Place the gear selector lever in position P or N.</p>
<p>Please engage roll-over bar</p>	<p>The roll bars are malfunctioning.</p>	<p>▶ Have the system checked at an authorized Mercedes-Benz Center as soon as possible.</p>
<p>Please release roll-over bar</p>	<p>The roll bars are malfunctioning.</p>	<p>▶ Operate the roll bars manually (▷ page 413).</p> <p>▶ Have the system checked at an authorized Mercedes-Benz Center as soon as possible.</p>

Display message	Possible cause/consequence	Possible solution
Run Flat Indicator inactive	Run Flat Indicator* is malfunctioning or has been switched off due to an error.	▶ Have the Run Flat Indicator* checked by an authorized Mercedes-Benz Center.
Check tires Then reactivate Run Flat Indicator	There was a warning message about a loss in the tire inflation pressure and the Run Flat Indicator* has not been reactivated yet.	▶ Make sure that the correct tire inflation pressure is set for each tire. ▶ Then reactivate the Run Flat Indicator*.
Tire pressure Check tires	The Run Flat Indicator* indicates that the pressure is too low in one or more tires.	▶ Carefully bring the vehicle to a halt, avoiding abrupt steering and braking maneuvers. Observe the traffic situation around you. ▶ Check and adjust tire inflation pressure as required (▷ page 333). ▶ If necessary, change the wheel (▷ page 436). ▶ Reactivate the Run Flat Indicator* after adjusting the tire inflation pressure values (▷ page 335).

Warning!







Do not drive with a flat tire. A flat tire affects the ability to steer or brake the vehicle.

You may lose control of the vehicle. Continued driving with a flat tire will cause excessive heat build-up and possibly a fire.

What to do if ...?

Symbol messages

Display symbol	Display message	Possible cause/consequence	Possible solution
		<p>The battery is no longer charging. Possible causes:</p> <ul style="list-style-type: none"> • broken poly-V-belt • alternator malfunctioning 	<p>▶ Stop immediately in a safe location or as soon as it is safe to do so and check the poly-V-belt.</p> <p>If it is broken:</p> <p>▶ Do not continue to drive. Otherwise the engine will overheat due to an inoperative water pump which may result in damage to the engine. Notify an authorized Mercedes-Benz Center.</p> <p>If it is intact:</p> <p>▶ Drive immediately to the nearest authorized Mercedes-Benz Center.</p>
	Low voltage Charge battery	The battery has insufficient voltage.	▶ Start the engine (▷ page 50).
	Low voltage Switch off consumers	The battery has insufficient voltage.	▶ Turn off unnecessary electrical consumers.

Display symbol	Display message	Possible cause/consequence	Possible solution
	Brakepad wear	The brake pads have reached their wear limit.	▶ Have the brake pads replaced as soon as possible.
 (USA only)  (Canada only)	Release parking brake	You are driving with the parking brake set.	▶ Release the parking brake (▷ page 52).
	Check brake fluid level	There is insufficient brake fluid in the reservoir.	▶ Risk of accident! Stop the vehicle in a safe location as soon as possible and notify an authorized Mercedes-Benz Center. Do not add brake fluid! This will not solve the problem.

Warning!





Driving with the message **Check brake fluid level** displayed can result in an accident. Have your brake system checked immediately. Do not add brake fluid before checking the brake system. Overfilling the brake fluid reservoir can result in spilling brake fluid on hot engine parts and the brake fluid catching fire. You could be seriously burned.

! *If you find that the brake fluid in the brake fluid reservoir has fallen to the minimum mark or below, have the brake system checked for brake pad thickness and leaks.*

! *Brake pad thickness must be visually checked by a qualified technician at the intervals specified in the Maintenance Booklet.*

What to do if ...?

Display symbol	Display message	Possible cause/consequence	Possible solution
	Visit workshop	There may be a malfunction in the <ul style="list-style-type: none"> • fuel injection system • ignition system • exhaust system • fuel system 	<ul style="list-style-type: none"> ▶ Have the measuring system checked by an authorized Mercedes-Benz Center.
	Top up coolant See Operator's Manual	The coolant level is too low.	<ul style="list-style-type: none"> ▶ Add coolant (▷ page 320). ▶ If you have to add coolant frequently, have the cooling system checked by an authorized Mercedes-Benz Center.

Warning!



Do not spill antifreeze on hot engine parts. Antifreeze contains ethylene glycol which may burn if it comes into contact with hot engine parts. You could be seriously burned.

! Do not ignore the low engine coolant level warning. Extended driving with the message and symbol displayed may cause serious engine damage not covered by the Mercedes-Benz Limited Warranty.

Do not drive without sufficient amount of coolant in the cooling system. The engine will overheat, causing major engine damage.

Display symbol	Display message	Possible cause/consequence	Possible solution
	Coolant Stop, turn engine off	The coolant is too hot. Among other possible causes, the poly-V-belt could be broken.	<ul style="list-style-type: none"> ▶ Stop the vehicle in a safe location or as soon as it is safe to do so. ▶ Apply the parking brake (▷ page 58). ▶ Turn off the engine. ▶ Check the poly-V-belt. <p>If it is broken:</p> <ul style="list-style-type: none"> ▶ Do not continue to drive. Otherwise the engine will overheat due to an in-operative water pump which may result in damage to the engine. Contact an authorized Mercedes-Benz Center. <p>If it is intact:</p> <ul style="list-style-type: none"> ▶ Wait for the message to disappear before restarting the engine. <p>Doing otherwise could result in serious engine damage that is not covered by the Mercedes-Benz Limited Warranty.</p> <p>(Continued on next page)</p>

What to do if ...?

Display symbol	Display message	Possible cause/consequence	Possible solution
			<ul style="list-style-type: none"> ▶ Observe the coolant temperature indicator in the instrument cluster (▷ page 26). <p>If the temperature rises again:</p> <ul style="list-style-type: none"> ▶ Contact an authorized Mercedes-Benz Center immediately.
		The cooling fan for the coolant is malfunctioning.	<p>Observe the coolant temperature indicator in the instrument cluster (▷ page 26).</p> <ul style="list-style-type: none"> ▶ Have the fan replaced as soon as possible.

Warning!





Driving when your engine is overheated can cause some fluids which may have leaked into the engine compartment to catch fire. You could be seriously burned.

Steam from an overheated engine can cause serious burns which can occur just by opening the hood. Stay away from the engine if you see or hear steam coming from it.

Turn off the engine, get out of the vehicle and do not stand near the vehicle until the engine has cooled down.

During severe operating conditions and stop-and-go city traffic, the coolant temperature may rise close to 248°F (120°C).

! *The engine should not be operated with the coolant temperature above 248°F (120°C). Doing so may cause serious engine damage which is not covered by the Mercedes-Benz Limited Warranty.*

Display symbol	Display message	Possible cause/consequence	Possible solution
	Gas cap is open	A loss of pressure has been detected in the fuel system. The fuel cap may not be closed properly or the fuel system may be leaky.	<ul style="list-style-type: none"> ▶ Check the fuel cap (▷ page 312). If it is not closed properly: <ul style="list-style-type: none"> ▶ Close the fuel cap. If it is closed properly: <ul style="list-style-type: none"> ▶ Have the fuel system checked by an authorized Mercedes-Benz Center.
		Certain electronic systems are unable to relay information to the control system. The following systems may have failed: <ul style="list-style-type: none"> • Coolant temperature display • Tachometer • Cruise control display 	<ul style="list-style-type: none"> ▶ Have the electronic systems checked by an authorized Mercedes-Benz Center.

What to do if ...?



Display symbol	Display message	Possible cause/consequence	Possible solution
	Check oil level at next refueling	The engine oil level has dropped to a critical level.	<ul style="list-style-type: none"> ▶ Check the engine oil level (▷ page 317) and add oil as required (▷ page 319). ▶ If you must add engine oil frequently, have the engine checked for possible leaks.

When the message Check oil at next refueling appears while the engine is running and at operating temperature, the engine oil level has dropped to approximately the minimum level.



When this occurs, the warning will first come on intermittently and then stay on if the oil level drops further.

Visually check for oil leaks. If no obvious oil leaks are noted, drive to the nearest service station where the engine oil should be topped to the required level with an approved oil specified in the Factory Approved Service Products pamphlet.

! *The engine oil level warnings should not be ignored. Extended driving with the symbol displayed could result in serious engine damage that is not covered by the Mercedes-Benz Limited Warranty.*

Display symbol	Display message	Possible cause/consequence	Possible solution
	Reserve fuel	The fuel level has dropped below the reserve mark.	▶ Refuel at the next gas station (▷ page 312).
	Remove key	You have forgotten to remove the SmartKey.	▶ Remove the SmartKey from the starter switch.
	Replace key	No additional code available for SmartKey or SmartKey with KEYLESS-GO*.	▶ Contact an authorized Mercedes-Benz Center as soon as possible.
	Change key batteries	The SmartKey with KEYLESS-GO* batteries are discharged.	▶ Change the batteries (▷ page 425).
	Key not detected	<p>The SmartKey with KEYLESS-GO* is not recognized while the engine is running because</p> <ul style="list-style-type: none"> • the SmartKey is not in the vehicle • there is strong radio-frequency interference 	<p>▶ Stop the vehicle as soon as it is safe to do so.</p> <p>▶ Apply the parking brake (▷ page 58).</p> <p>▶ Search for the SmartKey.</p> <p>Otherwise the vehicle cannot be centrally locked nor can the engine be started again after the engine has been stopped.</p>
		The SmartKey with KEYLESS-GO* is momentarily not recognized.	<p>▶ Change the position of the SmartKey in the vehicle.</p> <p>▶ Operate the vehicle with the SmartKey in the starter switch if necessary.</p>

What to do if ...?

Display symbol	Display message	Possible cause/consequence	Possible solution
	Keyless Go Check system	The KEYLESS-GO* system is malfunctioning.	▶ Contact an authorized Mercedes-Benz Center as soon as possible.
	Key detected in vehicle	A SmartKey with KEYLESS-GO* left in the vehicle was recognized while locking the vehicle from the outside.	▶ Take the SmartKey out of the vehicle.
	Please do not forget key	This display appears (for a maximum of 60 seconds) if the driver's door is opened with the engine shut off and no SmartKey in the starter switch. Message is only a reminder.	▶ Insert SmartKey in the starter switch. ▶ Take the SmartKey with KEYLESS-GO* with you when leaving the vehicle.
	Active headlamps inoperative	The Bi-Xenon cornering lamps system is malfunctioning.	▶ Contact an authorized Mercedes-Benz Center as soon as possible.
	Active headlamps Auxiliary bulb on	The active headlamps are malfunctioning. Another light is being used.	▶ Contact an authorized Mercedes-Benz Center as soon as possible.
	AUTO-Light inoperative	The light sensor is malfunctioning. The headlamps switch on automatically.	▶ In the control system, set lamp operation to manual mode (▷ page 160). ▶ Switch on headlamps using the exterior lamp switch. ▶ Contact an authorized Mercedes-Benz Center as soon as possible.

Display symbol	Display message	Possible cause/consequence	Possible solution
	3rd brake lamp	The high mounted brake lamp is malfunctioning.	▶ Contact an authorized Mercedes-Benz Center as soon as possible.
	Brake lamp left side	The left brake lamp is malfunctioning.	▶ Replace the bulb as soon as possible (▷ page 432).
	Brake lamp right side	The right brake lamp is malfunctioning.	▶ Replace the bulb as soon as possible (▷ page 432).
	Front foglamp left side	The left front fog lamp is malfunctioning.	▶ Contact an authorized Mercedes-Benz Center as soon as possible.
	Front foglamp right side	The right front fog lamp is malfunctioning.	▶ Contact an authorized Mercedes-Benz Center as soon as possible.
	Front left turn signal	The left front turn signal lamp is malfunctioning.	▶ Replace the bulb as soon as possible (▷ page 431).
	Front right turn signal	The right front turn signal lamp is malfunctioning.	▶ Replace the bulb as soon as possible (▷ page 431).
	High beam left side	The left high beam lamp is malfunctioning.	▶ Replace the bulb as soon as possible (▷ page 430).
	High beam right side	The right high beam lamp is malfunctioning.	▶ Replace the bulb as soon as possible (▷ page 430).



What to do if ...?

Display symbol	Display message	Possible cause/consequence	Possible solution
	License plate lamp left side	The left license plate lamp is malfunctioning.	▶ Replace the bulb as soon as possible (▷ page 433).
	License plate lamp right side	The right license plate lamp is malfunctioning.	▶ Replace the bulb as soon as possible (▷ page 433).
	Low beam left side	The left low beam lamp is malfunctioning.	Halogen headlamp: ▶ Replace the bulb as soon as possible (▷ page 430). Bi-Xenon* headlamp: ▶ Contact an authorized Mercedes-Benz Center as soon as possible.
	Low beam right side	The right low beam lamp is malfunctioning.	Halogen headlamp: ▶ Replace the bulb as soon as possible (▷ page 430). Bi-Xenon* headlamp: ▶ Contact an authorized Mercedes-Benz Center as soon as possible.
	Parking lamp front left	The left front parking lamp is malfunctioning.	▶ Replace the bulb as soon as possible (▷ page 431).
	Parking lamp front right	The right front parking lamp is malfunctioning.	▶ Replace the bulb as soon as possible (▷ page 431).

Display symbol	Display message	Possible cause/consequence	Possible solution
	Rear foglamp Substitute bulb on	The foglamp is malfunctioning. A back-up bulb is being used.	► Replace the bulb as soon as possible (▷ page 432).
	Reverse lamp left side	The left backup lamp is malfunctioning.	► Replace the bulb as soon as possible (▷ page 432).
	Reverse lamp right side	The right backup lamp is malfunctioning.	► Replace the bulb as soon as possible (▷ page 432).
	Side marker lamp front left	The front left side marker lamp is malfunctioning.	► Contact an authorized Mercedes-Benz Center as soon as possible.
	Side marker lamp front right	The front right side marker lamp is malfunctioning.	► Contact an authorized Mercedes-Benz Center as soon as possible.
	Tail lamp left Substitute bulb on	The left tail lamp is malfunctioning. A back-up bulb is being used.	► Replace the bulb as soon as possible (▷ page 432).
	Tail lamp right Substitute bulb on	The right tail lamp is malfunctioning. A back-up bulb is being used.	► Replace the bulb as soon as possible (▷ page 432).
	Turn off lamps	You have removed the SmartKey from the starter switch, opened the driver's door and left the headlamps on or removed the SmartKey with KEYLESS-GO* from the vehicle and left the headlamps on.	► Switch off the headlamps.

What to do if ...?

Display symbol	Display message	Possible cause/consequence	Possible solution
	Turn signal, left mirror	The turn signal in the left exterior rear view mirror is malfunctioning. This message will only appear if a critical number of LEDs have stopped working.	▶ Contact an authorized Mercedes-Benz Center as soon as possible.
	Turn signal, right mirror	The turn signal in the right exterior rear view mirror is malfunctioning. This message will only appear if a critical number of LEDs have stopped working.	▶ Contact an authorized Mercedes-Benz Center as soon as possible.
	Turn signal rear left Substitute bulb on	The left rear turn signal lamp is malfunctioning. A back-up bulb is being used.	▶ Replace the bulb as soon as possible (▷ page 432).
	Turn signal rear right Substitute bulb on	The right rear turn signal lamp is malfunctioning. A back-up bulb is being used.	▶ Replace the bulb as soon as possible (▷ page 432).

Display symbol	Display message	Possible cause/consequence	Possible solution
	Engage driver's seat	The driver seat backrest is not engaged.	Fold back and push the seat backrest until the seat cushion and seat backrest audibly engage into the driving position.
	Engage front-passenger seat	The passenger seat backrest is not engaged.	Fold back and push the seat backrest until the seat cushion and seat backrest audibly engage into the driving position.
	Tele Aid malfunction Drive to workshop	One or more main functions of the Tele Aid system are malfunctioning.	<ul style="list-style-type: none"> ▶ Have the Tele Aid system checked by an authorized Mercedes-Benz Center.
	Restraint system malfunction Visit workshop	The system is malfunctioning.	<ul style="list-style-type: none"> ▶ Drive with added caution to the nearest authorized Mercedes-Benz Center.

Warning!





In the event a malfunction of the SRS is indicated as outlined above, the SRS may not be operational.

For your safety, we strongly recommend that you visit an authorized Mercedes-Benz

Center immediately to have the system checked; otherwise the SRS may not be deploy when needed in an accident, which could result in serious or fatal injury, or it might deploy unexpectedly and unnecessarily which could also result in injury.

What to do if ...?

Display symbol	Display message	Possible cause/consequence	Possible solution
	Open/close top completely	The soft top is not properly locked.	▶ Lock the soft top again (▷ page 258).
	Top being opened	The soft top is not completely open or closed. The hydraulics are losing pressure.	▶ Open or close the soft top all the way.
	Top locked because vehicle is moving	You have attempted to open or close the soft top while driving.	▶ Pull over to the side of the road and repeat soft top operation while the vehicle is stationary.
	Steering oil Visit workshop	The steering gear oil level is too low. There is a danger of steering gear damage.	▶ Have the system checked by an authorized Mercedes-Benz Center.





Warning!



If the level of steering gear oil in reservoir is too low, the steering power assistance could fail. Much greater effort will then be needed to turn the steering wheel.

Do not add steering oil without checking the steering system.

Do not drive the vehicle. Have the system checked at an authorized Mercedes-Benz Center as soon as possible.

Display symbol	Display message	Possible cause/consequence	Possible solution
	Function Unavailable	This display appears if button  or  on the multifunction steering wheel is pressed and the vehicle is not equipped with a telephone.	
	Please close skibag	This message will appear when the soft top is operated with the ski sack roller blind in its upward position.	▶ Pull the ski sack roller blind downward and secure it (▷ page 274).
	Please close trunk partition	This message will appear when the soft top is operated with the luggage cover open.	▶ Fold down and latch luggage cover (▷ page 260).
	To up Washer fluid	The fluid level has dropped to about $\frac{1}{3}$ of total reservoir capacity.	▶ Add washer fluid (▷ page 322).

Where will I find...?

First aid kit

The first aid kit is located in the trunk on the right side secured by a hook and loop fastener.



- 1 First aid kit
- 2 Hook and loop fastener

- ▶ Loosen hook and loop fastener ②.
- ▶ Remove first aid kit ①.

i Check expiration dates and contents for completeness at least once a year and replace missing/expired items.

TIREFIT (CLK 63 AMG only)

The TIREFIT kit is located under the trunk floor.

- ▶ Lift the trunk floor and engage the handle in the upper edge of trunk.

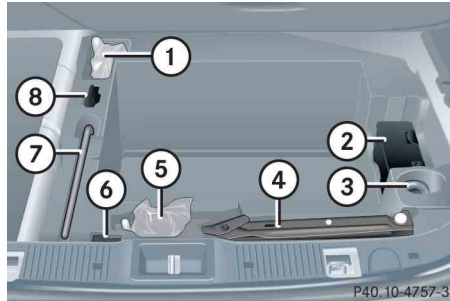

- 1 Straps for soft top emergency operation, a pair of gloves
- 2 Electric air pump
- 3 Towing eye bolt
- 4 Vehicle jack
- 5 TIREFIT kit
- 6 Fuse extractor
- 7 Wheel wrench
- 8 Collapsible wheel chock

Vehicle tool kit

The vehicle tool kit is stored in the compartment underneath the trunk floor.

The following is included:

- Towing eye bolt
- Wheel wrench
- Alignment bolt
- Vehicle jack
- Collapsible wheel chock
- Spare fuses
- Fuse extractor
- Straps for soft top emergency operation
- A pair of gloves

The spare wheel bolts are fixed at the Minispare wheel.

i Hex wrench:

You will find the hex wrench for manually operating the roll bars (▷ page 413) or the soft top (▷ page 415) at the lower edge of the storage well casing.

Removing the vehicle tool kit

- ▶ Lift up trunk floor cover and engage trunk floor handle in upper edge of trunk.

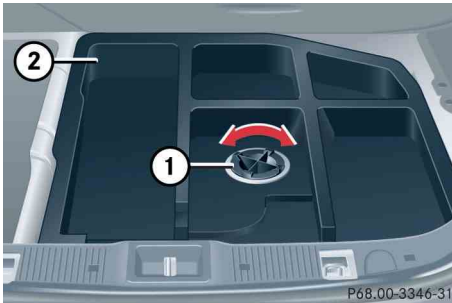

- ① Retaining screw
- ② Storage well casing

- ▶ Loosen retaining screw ① in the middle of storage well casing ② by turning it counterclockwise.

- ▶ Remove storage well casing ②.



- ③ Arrow
- ④ Minispare wheel
- ⑤ Vehicle tool kit storage well casing
- ⑥ Vehicle tool kit

- ▶ Remove vehicle tool kit ⑥.

Storing the vehicle tool kit

- ▶ Place vehicle tool kit ⑥ in vehicle tool kit storage well casing ⑤.
- ▶ Place storage well casing ② over the vehicle tool kit storage well casing ⑤ and turn retaining screw ① clockwise as far as it will go to secure the Minispare wheel.

i Arrow ③ on vehicle tool kit storage well casing ⑤ must point in the direction of travel. Otherwise you cannot place the storage well casing ② on top and secure the Minispare wheel with retaining screw ①.

- ▶ Disengage trunk floor handle in upper edge of trunk and lower trunk floor cover.

! To prevent damage, always disengage trunk floor handle from upper edge of trunk and lower trunk floor before closing the trunk.

Where will I find...?

Vehicle jack

Warning!



The jack is designed exclusively for jacking up the vehicle at the jack take-up brackets built into both sides of the vehicle. To help avoid personal injury, use the jack only to lift the vehicle during a wheel change. Never get beneath the vehicle while it is supported by the jack. Keep hands and feet away from the area under the lifted vehicle. Always firmly set parking brake and block wheels before raising vehicle with jack.

Do not disengage parking brake while the vehicle is raised. Be certain that the jack is always vertical (plumb line) when in use, especially on hills. Always try to use the jack on a level surface. Make sure the jack arm is fully seated in the jack take-up bracket. Always lower the vehicle onto sufficient capacity jackstands before working under the vehicle.

The vehicle jack is located in the storage compartment underneath the trunk floor.

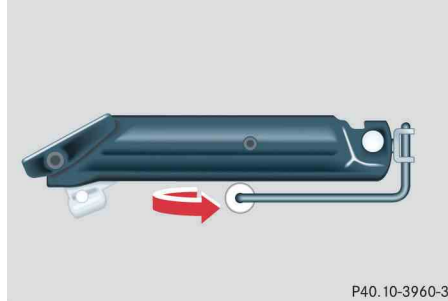

P40.10-3960-31

Storage position

- ▶ Remove vehicle jack from its compartment.
- ▶ Turn crank handle in direction of arrow as far as it will go.

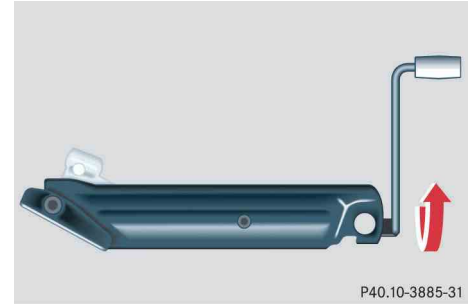

P40.10-3885-31

Operational position

- ▶ Turn crank handle clockwise.

Before storing the vehicle jack in its compartment:

- It should be fully collapsed
- The handle must be folded in (storage position)

Setting up the collapsible wheel chock

The collapsible wheel chock serves to additionally secure the vehicle, e.g. while changing the wheel.

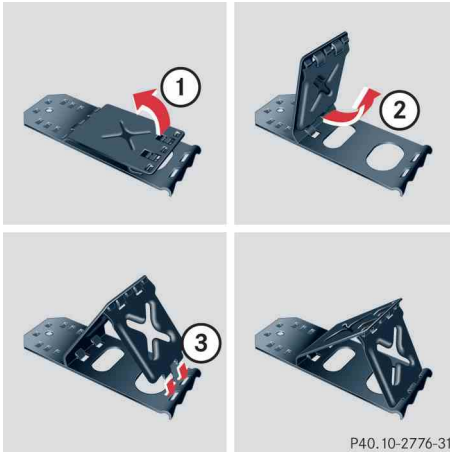

- ① Tilt the plate upward
- ② Fold the lower plate outward
- ③ Insert the plate

- ▶ Tilt both plates upward ①.
- ▶ Fold the lower plate outward ②.
- ▶ Guide the tabs of the lower plate all the way into the openings of the base plate ③.

For information on where to place wheel chocks when changing a wheel, see “Lifting the vehicle” (▷ page 441).

Minispare wheel

The Minispare wheel is located in the storage compartment underneath the trunk floor.

Removing the Minispare wheel

- ▶ Lift up trunk floor cover and engage trunk floor handle in upper edge of trunk.
- ▶ Loosen the retaining screw in the middle of storage well casing by turning it counterclockwise (▷ page 405).
- ▶ Remove the storage well casing (▷ page 405).



Where will I find...?

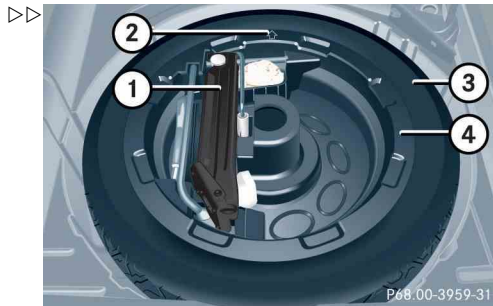

- ① Vehicle tool kit
Wheel wrench
Jack
 - ② Arrow
 - ③ Minispare wheel, Wheel bolts for
Minispare wheel
 - ④ Vehicle tool kit storage well casing
- ▶ Remove vehicle tool kit storage well casing ④.
 - ▶ Remove Minispare wheel ③.

Storing the Minispare wheel

- ▶ Place Minispare wheel ③ in wheel well.
- ▶ Place vehicle tool kit storage well casing ④ over the Minispare wheel.

Make sure arrow ② on vehicle tool kit storage well casing ④ points in the direction of travel.

- ▶ Place storage well casing (▷ page 405) over the vehicle tool kit storage well casing ④ and turn the retaining screw (▷ page 405) clockwise as far it will go to secure the Minispare wheel.

i Arrow ② on vehicle tool kit storage well casing ④ must point in the direction of travel. Otherwise you cannot place the storage well casing (▷ page 405) on top and secure the Minispare wheel with the retaining screw (▷ page 405).

- ▶ Disengage trunk floor handle in upper edge of trunk and lower trunk floor cover.

! To prevent damage, always disengage trunk floor handle from upper edge of trunk and lower trunk floor before closing the trunk.

Warning!



The dimensions of the Minispare wheel are different from those of the road wheels. As a result, the vehicle handling characteristics change when driving with a Minispare wheel mounted.

The Minispare wheel should only be used temporarily, and should be replaced with a regular road wheel as quickly as possible.

Do not switch off the ESP® when a Minispare wheel is mounted.

In case of a flat tire, you may temporarily use the Minispare wheel when observing the following restrictions:

- Do not exceed a vehicle speed of 50 mph (80 km/h).
- Drive to the nearest tire repair facility to have the flat tire repaired or replaced as appropriate.
- Do not operate vehicle with more than one Minispare wheel mounted.

For more information, see “Rims and tires” (▷ page 466).

Spare wheel bolts

The spare wheel bolts are fixed at the Minispare wheel.

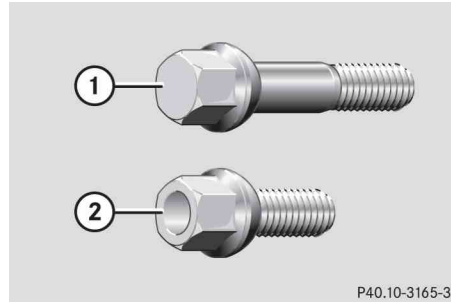

- ① Wheel bolt for light alloy rims
- ② Wheel bolt for Minispare wheel (located in trunk with spare wheel)

! Wheel bolts ② must be used when mounting the Minispare wheel. The use of any wheel bolts other than wheel bolts ② for the Minispare wheel will physically damage the vehicle's brakes.

Warning!



Make sure to use the original length wheel bolts when remounting the original wheel after it has been repaired.



Unlocking/locking in an emergency

Unlocking the vehicle

If you are unable to unlock the vehicle with the SmartKey or KEYLESS-GO*, open the driver's door and the trunk using the mechanical key.

i *Unlocking and opening the driver's door and/or the trunk with the mechanical key will trigger the anti-theft alarm system.*

To cancel the alarm, do one of the following:

- ▶ Press button  or  on the SmartKey.
- ▶ Insert the SmartKey in the starter switch.
Vehicles with KEYLESS-GO:*
- ▶ Pull the outside door handle.
- ▶ Press the KEYLESS-GO* start/stop button (▷ page 37).

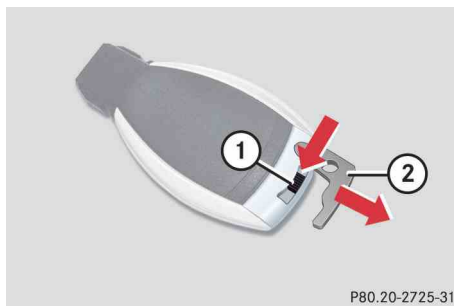

- ① Mechanical key locking tab
- ② Mechanical key

- ▶ Move locking tab ① in direction of arrow.
- ▶ Slide mechanical key ② out of the housing.

Unlocking the driver's door

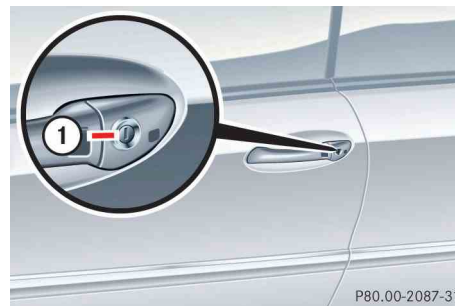

① Unlocking

- ▶ Insert the mechanical key into the driver's door lock until it stops.
- ▶ Turn the mechanical key counterclockwise to position ① until the locking knob moves up.
The driver's door is unlocked.
- ▶ Pull the door handle to open the driver's door.

Unlocking/locking in an emergency

Unlocking the trunk

A minimum height clearance of 5.41 ft (1.65 m) is required to open the trunk lid.

The trunk lid lock is located next to the handle above the rear license plate recess.

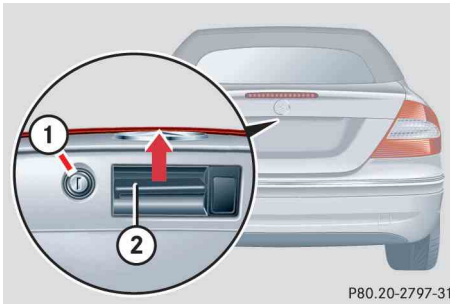

P80.20-2797-31

- ① Unlocking in an emergency
- ② Handle

- ▶ Insert the mechanical key into the trunk lid lock until it stops.
- ▶ Turn the mechanical key counterclockwise to position ① and hold it in this position.

- ▶ Pull the trunk lid handle ② and lift the trunk lid.

The trunk opens.

- ▶ **!** *The trunk lid swings open upwards automatically. Always make sure there is sufficient overhead clearance.*
- ▶ Turn the mechanical key back and remove it from the trunk lid lock.

Locking the vehicle

If you cannot lock the vehicle with the SmartKey or SmartKey with KEYLESS-GO*, do the following:

- ▶ Close the passenger door and the trunk.
- ▶ Press the central locking switch in the center console (▷ page 118).
- ▶ Check to see whether the locking knob on the passenger door has moved down.
- ▶ If necessary, push it down manually.
- ▶ Remove the mechanical key out of the SmartKey (▷ page 410).
- ▶ Check whether the trunk is locked.
- ▶ If necessary, lock the trunk with the mechanical key (▷ page 117).

Except for the driver's door, the vehicle should now be locked. ▷▷

Unlocking/locking in an emergency

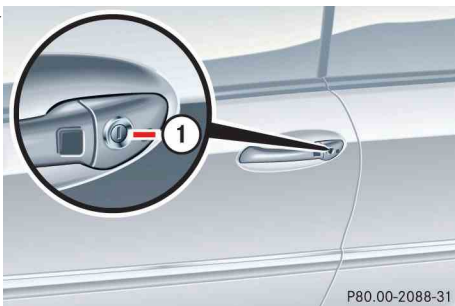

P80.00-2088-31

① Locking

- ▶ Insert the mechanical key into the driver's door lock until it stops.
- ▶ Turn the mechanical key clockwise to position ①.

The driver's door is locked.

i This procedure does not arm the anti-theft alarm system, nor does it lock the fuel filler flap.

Manually unlocking the gear selector lever

In case of power failure, the gear selector lever can be manually unlocked, e.g. to tow the vehicle.

i The gear selector lever is locked again when moving it to position **P**.

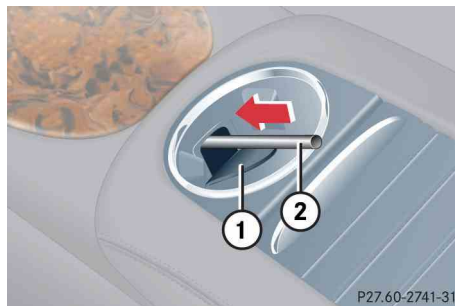

P27.60-2741-31

- ① Tab
- ② Tool

- ▶ Pull the tab ① of the covering back in direction of the center armrest compartment.
- ▶ Insert a tool ② (e.g. flat blade screwdriver) into the opening.
- ▶ Perform the following two steps simultaneously:
 - ▶ Push tool ② down- and forward in the direction of the arrow.
 - ▶ Move gear selector lever from position **P**.
- ▶ Remove the tool ② from the opening.
- ▶ Push the tab ① of the covering back.

Opening/closing in an emergency

▼ Opening/closing in an emergency

Operating roll bars manually

Releasing roll bars manually

If the roll bar system is malfunctioning, you can release the roll bars manually.

Warning!



If the yellow roll bar warning lamp  in the clock does not go out after starting the engine, or if it comes on while driving, then the roll bar system is not operating properly and may not activate in an accident. In this case, raise the roll bars manually before continuing to drive.

For safety reasons drive only with the roll bars raised until the malfunction is repaired. Have your vehicle checked at an authorized Mercedes-Benz Center.

▶ Close the soft top (▷ page 257).

i *With the roll bars released, the soft top cannot be operated using the soft top switch and the rear head restraints cannot be lowered using the rear head restraint lowering switch.*

▶ Open the trunk (▷ page 109).

▶ Fold back the luggage cover (▷ page 260).

▶ Take hex wrench out of its storage location in the storage well casing (▷ page 405).



P77.00-2177-31

① Perforation

▶ Push hex wrench through perforation ① in trim of rear wall in trunk.

Warning!



Make sure no one is located in the roll bar's path of motion while the next steps are being carried out.

When the roll bar is manually released, the rear head restraints and the roll bar underneath shoot up almost instantaneously.



Opening/closing in an emergency

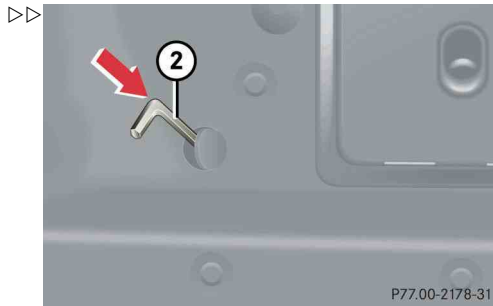

② Hex wrench

- ▶ Insert long side of hex wrench ② into opening.
- ▶ Using hex wrench ②, press release catch down in direction of arrow.

The roll bar extends with a loud sound.

- ▶ Repeat this step for the second roll bar.

Have the systems checked at an authorized Mercedes-Benz Center as soon as possible.

Lowering roll bars manually

With the soft top open, you can lower the roll bars manually after they have been released.

i With the roll bars released, the soft top cannot be operated using the soft top switch and the rear head restraints cannot be lowered using the rear head restraint lowering switch.

Warning!



Never lower the roll bars manually unless the soft top is open. Otherwise, the roll bars function could be impaired, no longer reducing your risk of injury in an optimal manner.

Contact an authorized Mercedes-Benz Center to have the roll bar lowered when the soft top is closed.

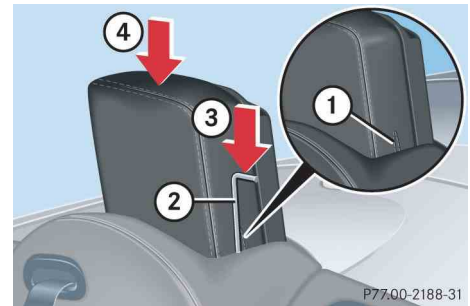

- ① Orientation seam
- ② Hex wrench
- ③ Press wrench down
- ④ Press head restraint down

- ▶ Take hex wrench out of its storage location in the storage well casing (▷ page 405).
- ▶ Align hex wrench so that its long side is parallel to orientation seam ① and insert hex wrench ② into gap on left side of respective head restraint.

Opening/closing in an emergency

- ▶ Press hex wrench down firmly in direction of arrow ③ and hold.
- ▶ Press head restraint down in direction of arrow ④.
- ▶ Pull hex wrench ② out and take weight off head restraint.
- ▶ Repeat this procedure on roll bar for second head restraint.

Soft top emergency operation

If the soft top cannot be automatically closed, check the following:

- Is the luggage cover engaged in place (▷ page 260)?
- Have the roll bars been released? If so, lower the roll bars manually (▷ page 414).
- Is the trunk lid closed (▷ page 110)?
- Is there sufficient on-board voltage? Start the engine if necessary.

These messages will also appear in the multifunction display (▷ page 402).

If automatic operation still does not function properly, you can close the soft top manually.

This procedure should be performed with great care by two persons.

! *Manually closing the soft top is a complicated and technically demanding procedure. Close the soft top manually in emergency cases only. Otherwise, visit an authorized Mercedes-Benz Center. Please read the instructions fully before beginning operation and only undertake it with another person and if you feel fully capable of performing the tasks involved.*

Warning!



- It is important that a second person helps you. Otherwise, you could become trapped or injured.
- Remove any wristwatches or jewelry such as rings or bracelets. Otherwise, they could get caught in the vehicle mechanism, causing personal injury to yourself or damage to the vehicle.
- Always use the grips provided as indicated. Otherwise you could injure yourself.

▶ Engage parking brake.

▶ Lower the side windows.



Opening/closing in an emergency

- ▶▶▶ Lower rear head restraints
(▷ page 120).

i *If the rear head restraints cannot be lowered using the rear head restraint lowering switch, the roll bars may have been released. For more information, see “Operating roll bars manually” (▷ page 413).*

- ▶ For safety reasons, remove SmartKey from starter switch.
- ▶ Open the trunk.
- ▶ Remove the trunk floor cover.
- ▶ Take the two straps for soft top emergency operation out of vehicle tool kit (▷ page 404).
- ▶ Take hex wrench out of its storage location in the storage well casing (▷ page 405).
- ▶ Open the left side trim panel in the trunk.

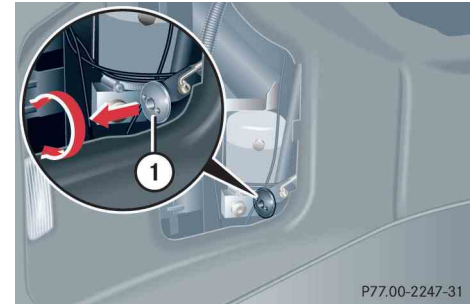

P77.00-2247-31

① Locking mechanism

- ▶ Pull locking mechanism ① out until it stops and rotate it approx. one-quarter of a turn.
- ▶ Make sure the locking mechanism does not retract again. If this happens, pull the locking mechanism out again and rotate it approx. one-quarter of a turn.

Opening/closing in an emergency

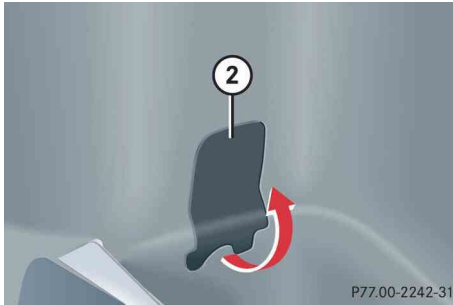

② Trim

- ▶ Fold the right-hand side of the trunk floor away.
- ▶ Detach trim ② along the perforation.

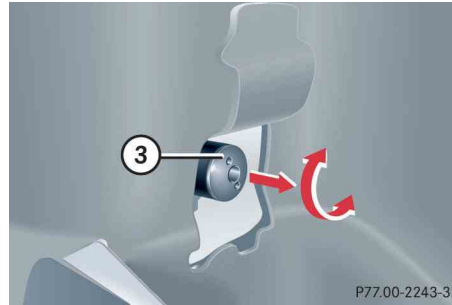

③ Locking mechanism

- ▶ Pull locking mechanism ③ out until it stops and rotate it approx. one-quarter of a turn.
- ▶ Make sure the locking mechanism does not retract again. If this happens, pull the locking mechanism out again and rotate it approx. one-quarter of a turn.

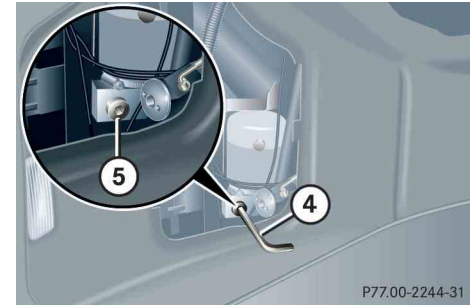

④ Hex wrench

⑤ Screw of hydraulic pump

- ▶ Insert hex wrench ④ into screw ⑤.
- ▶ Turn hydraulic pump screw ⑤ counter-clockwise one revolution with hex wrench ④.

! Do not operate the soft top switch with screw ⑤ in the opened position, otherwise the hydraulic pump could be damaged.



Opening/closing in an emergency

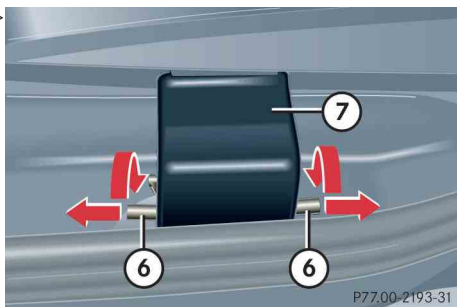

⑥ Lever

⑦ Soft top storage compartment hinge

The soft top storage compartment hinges are located on the left and right of the space between the soft top compartment cover and the trunk seal.

- ▶ Pull the two levers ⑥ apart and fold levers ⑥ of soft top storage compartment hinge ⑦ forward on both sides over the detent position.

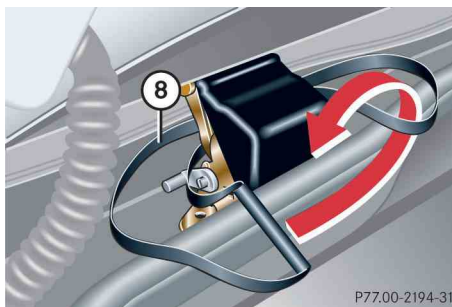

⑧ Strap

- ▶ Pull strap ⑧, supplied in vehicle tool kit, behind soft top storage compartment through hinge ⑦.
- ▶ Bring strap together in front of hinge.
- ▶ Pull the side with the handle through the loop on the opposite side.



- ▶ Pull strap between soft top storage compartment hinge and soft top compartment.
- ▶ Secure second strap to second hinge in the same manner.

! Do not pull the straps when the trunk is open.

Opening/closing in an emergency



- ▶ Place both straps on soft top compartment cover.
- ▶ Take hex wrench out of trunk.
- ▶ Close trunk lid.

You will only have access to the trunk again when the emergency operation has been completed.

i Do not place the SmartKey in the open trunk. You may lock yourself out.

Vehicles with KEYLESS-GO*: To prevent a possible inadvertent lockout, the trunk lid will open automatically if a SmartKey with KEYLESS-GO* is recognized in the area of the rear shelf or inside the trunk.

! The trunk lid must remain closed during the next steps in the procedure. Otherwise the trunk lid and the soft top compartment cover may come into contact with one another and be damaged.

Warning!



At this point, the remaining procedure needs to be done by two people. Otherwise you could be injured.

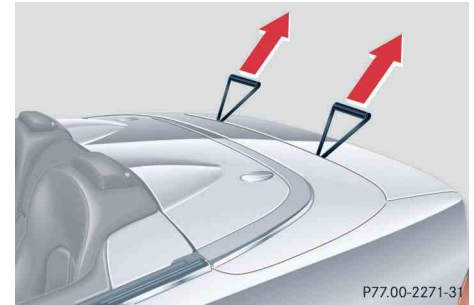

- ▶ You and your assistant should each take one of the straps by the handle.
- ▶ With a strong, simultaneous tug on the loops, pull soft top compartment cover upward and out to the rear.



Opening/closing in an emergency



⑨ Soft top compartment cover

- ▶ One person should stand on the left side of the vehicle and the other on the right side.

Warning!



In the next step, you and your assistant should each take hold of the soft top compartment cover as shown in the illustration. Both of you should use your free hand to support yourselves on the edge of the trunk lid as shown in the illustration.

If either you or your helper assume a different position, one or both of you could be trapped or injured.

- ▶ Pulling the cover back in one smooth motion, lift soft top compartment cover ⑨ into a vertical position until it stops.

! *Make sure the soft top storage compartment hinges do not fold down during this procedure. Otherwise your vehicle could be damaged.*



⑩ Edge of soft top

- ▶ From left and right sides, reach into soft top compartment underneath edge of soft top ⑩.

Warning!



Do not place your hands near the upper windshield area, trunk lid, or between soft top roof panels and hinges while the soft top is being raised and locked. Serious personal injury may occur.

Opening/closing in an emergency



⑪ Windshield frame

- ▶ Lift soft top out of soft top compartment and pull it forward to windshield frame ⑪.

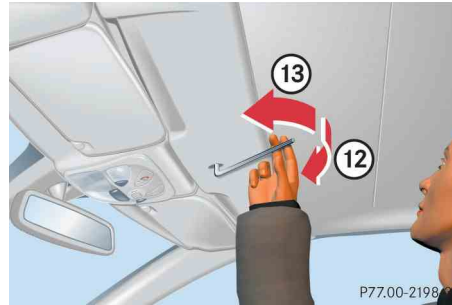

⑫ Opening

⑬ Locking

- ▶ Take off protective cap on the inner side of the soft top.
- ▶ Insert hex wrench into soft top locking mechanism screw.
- ▶ Turn the soft top locking mechanism screw with hex wrench clockwise in direction of arrow ⑫ as far as it will go.
The clasp will open and the soft top will engage audibly.

- ▶ Turn the soft top locking mechanism screw with hex wrench counterclockwise in direction of arrow ⑬ as far as it will go.

The clasp will close and the soft top is now locked onto the windshield frame.

! Make sure you turn the hex wrench counterclockwise as far as it will go. Otherwise the soft top may not lock properly.



Opening/closing in an emergency

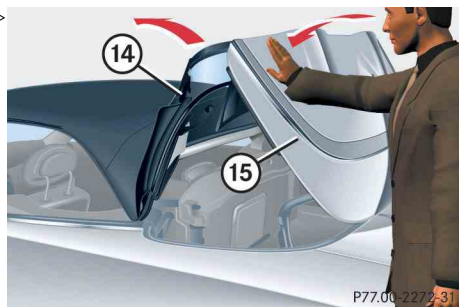

⑭ Material tensioning frame

⑮ Soft top compartment cover

- ▶ Lift material tensioning frame ⑭ into a vertical position.
- ▶ Lower soft top compartment cover ⑮.

! Make sure the soft top compartment cover ⑮ does not collide or make contact with the material tensioning frame ⑭.

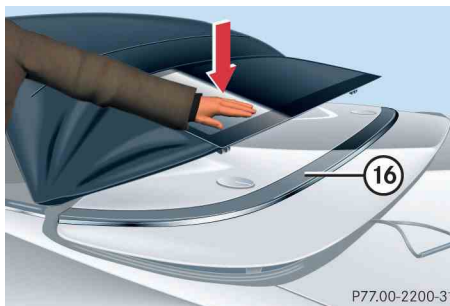

⑯ Soft top base

- ▶ With the palm of your hand, press the window in material tensioning frame ⑭ until it is positioned on the soft top compartment cover ⑮.



- ▶ You and your assistant should press soft top compartment cover ⑮ forward and down with the palms of your hands until it snaps into place in the guide. Place your hands on the areas indicated by the arrows.

At the same time, gently press material tensioning frame ⑭ down with the palms of your hands.

Opening/closing in an emergency

Warning!



Position hands as indicated by arrows so that when you press soft top compartment cover ⑮ forward and lower material tensioning frame ⑭, your hands cannot become trapped.

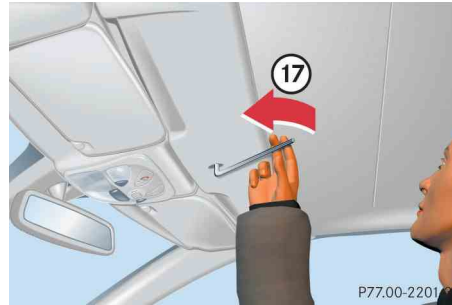

⑰ Locking

- ▶ Insert hex wrench into soft top locking mechanism screw.
- ▶ Turn the soft top locking mechanism screw with hex wrench counterclockwise in direction of arrow ⑰ as far as it will go.

The soft top is locked onto the windshield frame.

! Make sure you turn the hex wrench counterclockwise as far as it will go. Otherwise the soft top may not lock properly.

- ▶ Have the soft top operation checked at an authorized Mercedes-Benz Center as soon as possible.

! If, after completing the soft top emergency operation, the trunk cannot be opened using the remote trunk lid release switch in the driver's door, the  button on the SmartKey, or the trunk lid release handle in the license plate recess, press the soft top compartment cover down again as described above.

Do not open the trunk with the emergency key, as this could otherwise damage the trunk lid and the soft top compartment cover.

Resetting activated head restraints

Resetting activated head restraints

If the active head restraints have been triggered in a rear-end collision, the active head restraints must be reset. Otherwise, the active head restraints cannot offer any additional protection in the event of another rear-end collision.

You can tell that the head restraints have been triggered when they have been moved forward and cannot be adjusted.

i For your convenience, we recommend that you have this work carried out by an authorized Mercedes-Benz Center.

You will find the reset tool for manually operating the active head restraints in the Mercedes-Benz vehicle literature pouch.

Warning!



For safety reasons, have the active head restraints checked by an authorized Mercedes-Benz Center after a rear-end collision.

Warning!



When pushing back the head restraint cushion, take care that your fingers do not become caught between the head restraint cushion and the cover. Failing to do so may lead to injury.

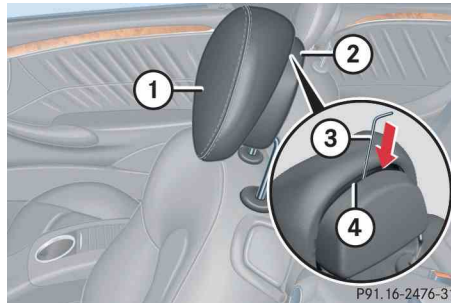

- ① Head restraint cushion
- ② Head restraint cover
- ③ Reset tool
- ④ Hole

- ▶ Take the reset tool ③ out of the Mercedes-Benz vehicle literature pouch.

- ▶ Guide reset tool ③ into the hole ④ between the rear head restraint cover ② and the head restraint cushion ①.

! Be careful not to damage upholstery.

- ▶ Press the reset tool ③ downward until you hear the active head restraint release mechanism audibly engage.
- ▶ Pull out reset tool ③.
- ▶ Firmly press the head restraint cushion ① back toward the rear head restraint cover ② until it engages.
- ▶ Repeat this procedure on the active head restraint for the second seat.
- ▶ After resetting the active head restraints store the reset tool ③ in the Mercedes-Benz vehicle literature pouch.

For information on active head restraints, see “Active head restraints” (▷ page 80).

For information on head restraint adjustment, see “Seats” (▷ page 39).

Replacing SmartKey batteries

▼ Replacing SmartKey batteries

If the batteries in the SmartKey or the SmartKey with KEYLESS-GO* are discharged, the vehicle can no longer be locked or unlocked. It is recommended to have the batteries replaced at an authorized Mercedes-Benz Center.

Warning!

Keep the batteries out of reach of children.

If a battery is swallowed, seek medical help immediately.

Batteries contain materials that can harm the environment if disposed of improperly. Recycling of batteries is the preferred method of disposal. Many states require sellers of batteries to accept old batteries for recycling.

i When inserting the batteries, make sure they are clean and free of lint.

i When changing batteries, always replace both batteries.

The required replacement batteries are available at any Mercedes-Benz Center.

Replacing SmartKey batteries

SmartKey / SmartKey with KEYLESS-GO*

Replacement batteries: Lithium, type CR 2025 or equivalent.

- ▶ Remove the mechanical key from the SmartKey or SmartKey with KEYLESS-GO* (▷ page 410).

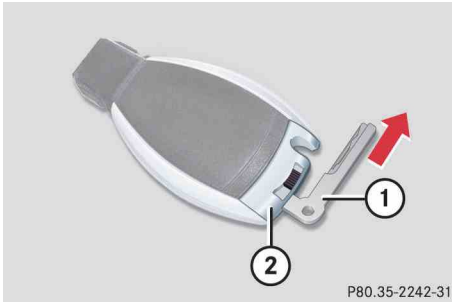

- ① Mechanical key
- ② Battery compartment

- ▶ Insert mechanical key ① into the opening.

- ▶ Press mechanical key ① in direction of arrow.

The battery compartment ② is unlatched.

- ▶ Pull battery compartment ② out of the housing.

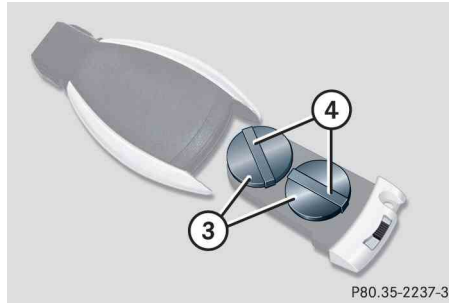

- ③ Batteries
- ④ Contact spring

- ▶ Remove the batteries ③.

- ▶ Using a lint-free cloth, insert new batteries ③ under the contact springs ④ with the positive terminal (+) side facing up.

- ▶ Return battery compartment ② into housing until it locks into place.

- ▶ Slide mechanical key ① back into the SmartKey.

- ▶ Check the operation of the SmartKey.

▼ Replacing bulbs

Safe vehicle operation depends on proper exterior lighting and signaling. It is therefore essential that all bulbs and lamp assemblies are in good working order at all times.

Correct headlamp adjustment is extremely important. Have headlamps checked and readjusted at regular intervals and when a bulb has been replaced. See an authorized Mercedes-Benz Center for headlamp adjustment.

i *If the headlamps or front fog lamps are fogged up on the inside as a result of high humidity, driving the vehicle a distance with the lights on should clear up the fogging.*

i *Back-up bulbs will be brought into use when lamps malfunction. Read and observe the messages in the multifunction display (▷ page 397).*

Replacing bulbs

Bulbs

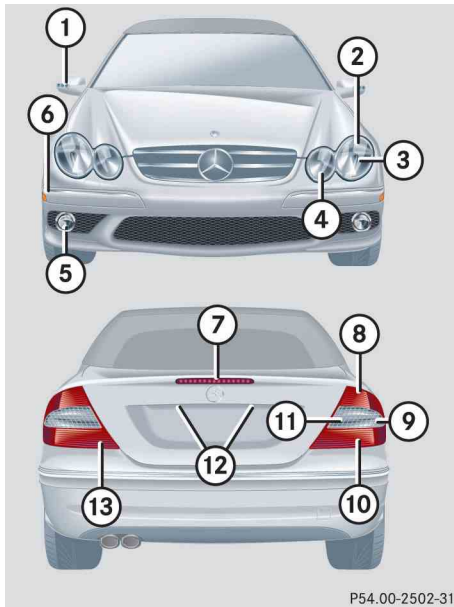

Front lamps

	Lamp	Type
①	Additional turn signal lamp	LED
②	Turn signal lamp	1156 NA
③	Halogen headlamp: Low beam	H7 (55 W)
	Bi-Xenon* headlamp: Low and high beam ¹	D2S-35 W
④	Halogen headlamp: High beam/high beam flasher	H7 (55 W)
	Bi-Xenon* headlamp: High beam flasher	H7 (55 W)
	Parking and standing lamp	W 5 W
⑤	Front fog lamp	HB4 (51 W)
	Corner-illuminating front fog lamp*	H7 (55 W)
⑥	Side marker lamp	W 5 W

¹ Vehicles with Bi-Xenon headlamps* do not replace the Bi-Xenon bulbs yourself.

Rear lamps

	Lamp	Type
⑦	High mounted brake lamp	LED
⑧	Brake lamp	P 21 W
⑨	Turn signal lamp	P 21 W
⑩	Tail, parking and stand- ing lamp, side marker	P 21/4 W W 5 W
⑪	Backup lamp	P 21 W
⑫	License plate lamps	C 5 W
⑬	Rear fog lamp (driver's side only)	P 21/4 W

Warning!

Keep bulbs out of reach of children.

Bulbs and bulb sockets can be very hot. Allow the lamp to cool down before changing a bulb.

Halogen lamps contain pressurized gas. A bulb can explode if you:

- touch or move it when hot
- drop the bulb
- scratch the bulb

Wear eye and hand protection.

Because of high voltage in Xenon lamps, it is dangerous to replace the bulb or repair the lamp and its components. We recommend that you have such work done by a qualified technician.

Notes on bulb replacement

- Only use 12 volt bulbs of the same type and with the specified watt rating.
- Switch lights off before changing a bulb to prevent short circuits.
- Always use a clean lint-free cloth when handling bulbs.
- Your hands should be dry and free of oil and grease.
- If the newly installed bulb does not come on, visit an authorized Mercedes-Benz Center.

Have the LEDs and bulbs for the following lamps replaced by an authorized Mercedes-Benz Center.

- Additional turn signal lamps in the exterior rear view mirrors
- High mounted brake lamp
- Bi-Xenon* lamps
- Front fog lamps
- Front side marker lamps

! Do not replace the LEDs yourself. You could otherwise damage the LEDs or parts of the vehicle. Only have the LEDs replaced by an authorized Mercedes-Benz Center.

Replacing bulbs

Replacing bulbs for front lamps

Before you start to replace a bulb for a front lamp, do the following first:

- ▶ Turn the exterior lamp switch to position **0** (▷ page 126).
- ▶ Open the hood (▷ page 315).

Front lamps halogen-type

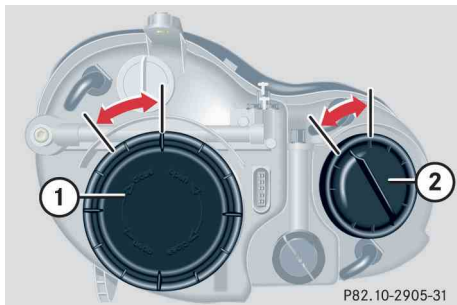

- ① Housing cover for low beam headlamp
- ② Housing cover for high beam headlamp, parking and standing lamp

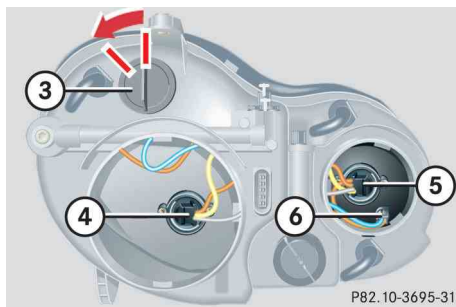

- ③ Bulb socket for turn signal lamp bulb
- ④ Bulb holder of low beam bulb
- ⑤ Bulb holder of high beam bulb
- ⑥ Bulb socket for parking and standing lamp bulb

Low beam bulb

- ▶ Turn housing cover ① counterclockwise and remove it.
- ▶ Turn bulb holder ④ with the bulb counterclockwise and remove it.
- ▶ Pull the bulb at its socket out of bulb holder ④.

- ▶ Insert the new bulb so that its socket locates in the recess of bulb holder ④ and is level to it.
- ▶ Reinsert bulb holder ④ with the bulb in the lamp and turn clockwise.
- ▶ Align housing cover ① and turn it clockwise.

High beam bulb

- ▶ Turn housing cover ② counterclockwise and remove it.
- ▶ Turn bulb holder ⑤ with the bulb counterclockwise and remove it.
- ▶ Pull the bulb at its socket out of bulb holder ⑤.
- ▶ Insert the new bulb so that its socket locates in the recess of bulb holder ⑤ and is level to it.
- ▶ Reinsert bulb holder ⑤ with the bulb in the lamp and turn clockwise.
- ▶ Align housing cover ② and turn it clockwise.

Front turn signal lamp bulb

- ▶ Turn bulb socket ③ counterclockwise and remove it.
- ▶ Press gently onto the bulb and turn counterclockwise out of bulb socket ③.
- ▶ Press the new bulb gently into bulb socket ③ and turn clockwise until it engages.
- ▶ Place bulb socket ③ back into the lamp and turn it clockwise.

Parking and standing lamp bulb

- ▶ Turn housing cover ② counterclockwise and remove it.
- ▶ Pull out bulb socket ⑥ with the bulb.
- ▶ Pull the bulb out of the bulb socket ⑥.
- ▶ Press the new bulb into bulb socket ⑥.
- ▶ Press bulb socket ⑥ back into the lamp.
- ▶ Align housing cover ② and turn it clockwise.

Front lamps Bi-Xenon*-type

Warning!



Do not remove the cover ③ for the Bi-Xenon* headlamp. Because of high voltage in Xenon lamps, it is dangerous to replace the bulb or repair the lamp and its components. We recommend that you have such work done by a qualified technician.

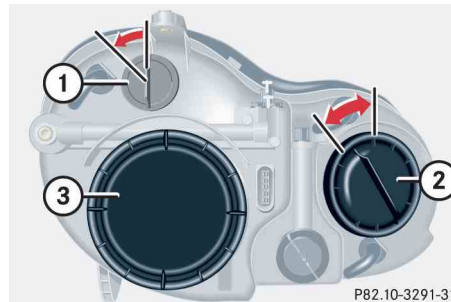

- ① Bulb socket for turn signal lamp
- ② Housing cover for high beam flasher, parking and standing lamp
- ③ Housing cover for Bi-Xenon* headlamp

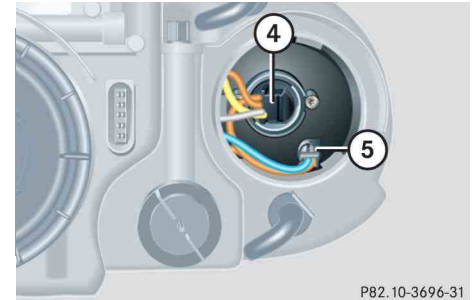

P82.10-3696-31

- ④ Bulb holder for high beam flasher bulb
- ⑤ Bulb socket for parking and standing lamp bulb

High beam bulb for high beam flasher

- ▶ Turn housing cover ② counterclockwise and remove it.
- ▶ Turn bulb holder ④ with the bulb counterclockwise and remove it.
- ▶ Pull the bulb at its socket out of bulb holder ④.
- ▶ Insert the new bulb so that its socket locates in the recess of bulb holder ④ and is level to it.



Replacing bulbs

- ▷▷ Reinsert bulb holder ④ with the bulb in the lamp and turn clockwise.
- ▶ Align housing cover ② and turn it clockwise.

Front turn signal lamp bulb

- ▶ Turn bulb socket ① counterclockwise and remove it.
- ▶ Press gently onto the bulb and turn counterclockwise out of bulb socket ①.
- ▶ Press the new bulb gently into bulb socket ① and turn clockwise until it engages.
- ▶ Place bulb socket ① back into the lamp and turn it clockwise.

Parking and standing lamp bulb

- ▶ Turn housing cover ② counterclockwise and remove it.
- ▶ Pull out bulb socket ⑤ with the bulb.
- ▶ Pull the bulb out of the bulb socket ⑤.

- ▶ Press the new bulb into bulb socket ⑤.
- ▶ Press bulb socket ⑤ back into the lamp.
- ▶ Align housing cover ② and turn it clockwise.

Additional turn signal lamps

The additional turn signal lamps in the exterior rear view mirrors have LEDs.

If a malfunction occurs or LEDs fail to function, the entire turn signal unit must be replaced. Have the additional turn signal unit replaced by an authorized Mercedes-Benz Center.

Front side marker lamp

Since replacing the side marker lamp bulbs is a technically highly demanding process, we recommend you have the side marker lamp bulbs replaced by an authorized Mercedes-Benz Center.

Replacing bulbs for rear lamps

Before you start to replace a bulb for a rear lamp, do the following first:

- ▶ Turn the exterior lamp switch to position **0** (▷ page 126).

Tail lamp unit

- ▶ Open trunk lid.
- ▶ Swing the trim panel covering the corresponding rear lights to the side.

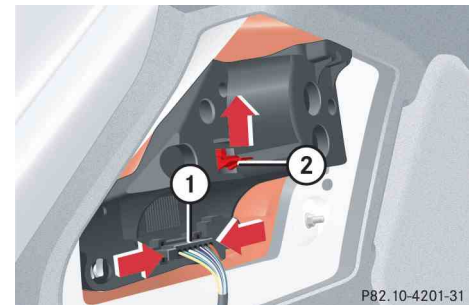

- ① Connector
- ② Tab

- ▶ Disconnect electrical connector ①.

- ▶ Pull tab ② in the direction of the arrow.
- ▶ Remove the bulb carrier.

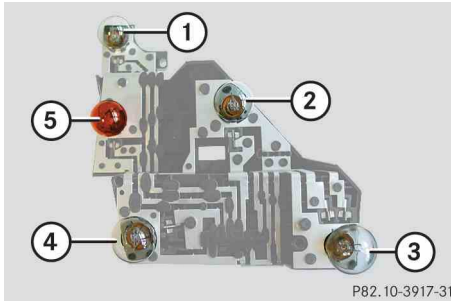

- ① Brake lamp
 - ② Backup lamp
 - ③ Rear fog lamp (driver's side)/tail lamp
 - ④ Tail lamp, parking and standing lamp, side marker lamp
 - ⑤ Turn signal lamp
- ▶ Press gently onto the respective bulb and turn counterclockwise out of its bulb socket.
 - ▶ Press the new bulb gently into its bulb socket and turn clockwise until it engages.

- ▶ Reinstall the bulb carrier.
Let tab ② (> page 432) engage.
- ▶ Connect the electrical connector ① (> page 432) until it engage.
- ▶ Reinstall trim panel.

License plate lamp

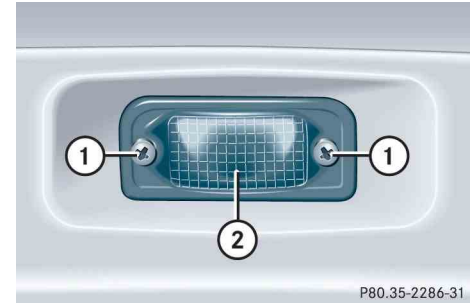

- ① Screws
 - ② License plate lamp
- ▶ Loosen both screws ①.
 - ▶ Remove the license plate lamp ②.
 - ▶ Replace the tubular lamp.
 - ▶ Reinstall the license plate lamp ②.
 - ▶ Retighten the screws ①.

Replacing wiper blades

Removing and installing wiper blades

Warning!



For safety reasons, switch off wipers and remove SmartKey from starter switch (vehicles with KEYLESS-GO*: make sure the vehicle's on-board electronics have status 0) before replacing a wiper blade. Otherwise, the wiper motor could suddenly turn on and cause injury.

Warning!



Wiper blades are components that are subject to wear and tear. Change the wiper blades twice a year, preferably in the spring and fall. Otherwise the windows will not be properly wiped. As a result, you may not be able to observe surrounding traffic conditions and could cause an accident.

! Never open the hood when the wiper arms are folded forward.

For your convenience, we recommend that you have this work carried out by an authorized Mercedes-Benz Center.

- ▶ Remove SmartKey from starter switch (vehicles with KEYLESS-GO*: make sure the vehicle's on board electronics have status 0).

Removing wiper blades

! Do not pull on the wiper blade inserts. They could tear.

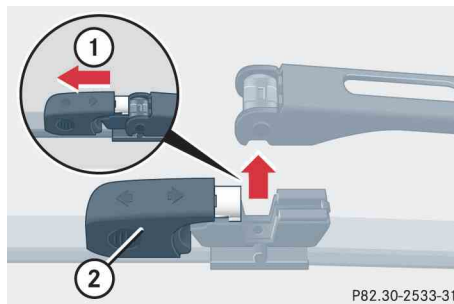

P82.30-2533-31

- ① Unlocking
- ② Tab

- ▶ Pull the tab ② in the direction of arrow ①.

The wiper blade is unlocked.

- ▶ Lift up the wiper arm as far as you need to remove the wiper blade.

! Hold on to the wiper arm. If released, the force of the impact from the tensioning spring could crack the windshield.

- ▶ Carefully fold the wiper arm back to rest on the windshield.

Installing wiper blades

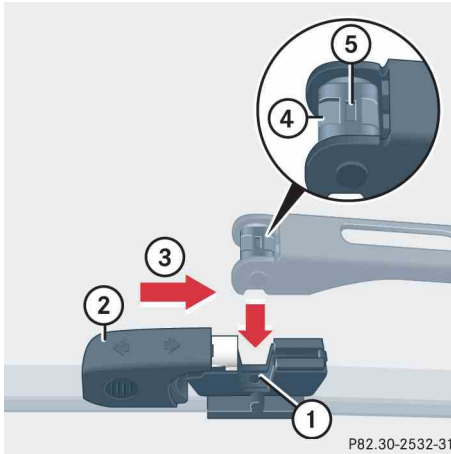

P82.30-2532-31

- ① Recess
- ② Tab
- ③ Locking
- ④ Taper piece
- ⑤ Square recess

- ▶ Lift up the wiper arm as far as you need to position the wiper blade under the wiper arm and hold it.

! Hold on to the wiper arm. If released, the force of the impact from the tensioning spring could crack the windshield.

- ▶ Carefully fold the wiper arm back and make sure that the taper piece ④ slides into the recess ① at the wiper blade.

! Make certain that the square recess ⑤ on the taper piece ④ is on the top, otherwise the taper piece ④ cannot slide into the recess ① at the wiper blade. If the square recess ⑤ is not at the top turn the taper piece ④ around to bring the square recess ⑤ to the top.

- ▶ Slide the tab ② back in the direction of arrow ③ until it audibly engages.

The wiper blade is locked.

! Make certain that the wiper blades are properly installed. Improperly installed wiper blades may cause windshield damage.

Flat tire

The CLK 63 AMG is equipped with a TIREFIT kit

Preparing the vehicle

- ▶ Park the vehicle in a safe distance from moving traffic on a hard, flat surface when possible.
- ▶ Turn on the hazard warning flashers (▷ page 133).
- ▶ Turn the steering wheel so that the front wheels are in a straight ahead position.
- ▶ Set the parking brake (▷ page 58).
- ▶ Move the gear selector lever to **P**.

Vehicles with SmartKey:

- ▶ Turn off the engine (▷ page 60).
- ▶ Remove the SmartKey from the starter switch.

Vehicles with SmartKey with KEYLESS-GO*:

- ▶ Turn off the engine by pressing the KEYLESS-GO* start/stop button on the gear selector lever once (▷ page 60).
 - ▶ Open the driver's door (this puts the ignition in position **0** (▷ page 38), same as with the SmartKey removed from the starter switch). The driver's door then can be closed again.
-  *Open door only when conditions are safe to do so.*
- ▶ Have any passenger exit the vehicle at a safe distance from the roadway.

Sealing tires with TIREFIT (CLK 63 AMG only)

Warning!



Keep TIREFIT away from sparks, open flame or heat source.

Do not smoke.

Small tire punctures, particularly those in the tread, can be sealed with TIREFIT. TIREFIT can be used in ambient temperatures down to -4°F (-20°C).

Warning!



TIREFIT is a limited repair device. TIREFIT cannot be used for cuts or punctures larger than approximately 0.16 in (4 mm) and tire damage caused by driving with extremely low tire inflation pressure, or on a flat tire, or a damaged wheel.

Do not drive the vehicle under such circumstances.

Contact your nearest Mercedes-Benz Center for assistance or call Roadside Assistance.

- ▶ Foreign objects (e.g. screws or nails) should not be removed from the tire.
- ▶ Take TIREFIT, the sticker, and the electric air pump out of the trunk (▷ page 404).
- ▶ Attach the sticker (supplied with the TIREFIT kit) where it will be easily seen by the driver on the instrument cluster.

Warning!



Take care not to allow the contents of TIREFIT to come in contact with hair, eyes or clothing. TIREFIT is harmful if inhaled, swallowed or absorbed through the skin - causes skin, eye and respiratory irritation.

Any contact with eyes or skin should be flushed immediately with plenty of water.

If clothing comes in contact with TIREFIT, change clothing as soon as possible.

In case of allergic reaction or rash, consult a physician immediately.

Warning!



Keep TIREFIT out of reach of children. If swallowed, rinse mouth immediately with plenty of water and drink plenty of water.

Do not induce vomiting!

Consult a physician immediately.

Keep away from open flame or heat source.

i If sealant has leaked out, let it dry. You can then peel it off.

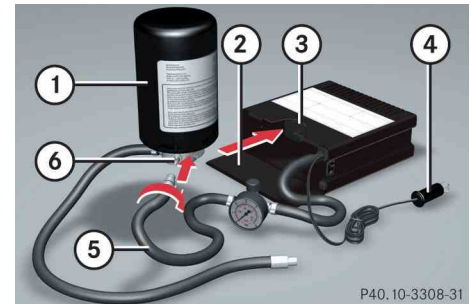

P40.10-3308-31

- ① TIREFIT container
- ② Flap
- ③ Notch
- ④ Electrical plug
- ⑤ Air hose
- ⑥ Flange

- ▶ Open flap ② on the electric air pump.
- ▶ Pull electrical plug ④ and air hose ⑤ out of the pump housing.



Flat tire

- ▷▷ Screw the air pump's air hose ⑤ onto flange ⑥ of the TIREFIT container.
- ▶ Stick TIREFIT container ① upside down into notch ③ of the electric air pump.

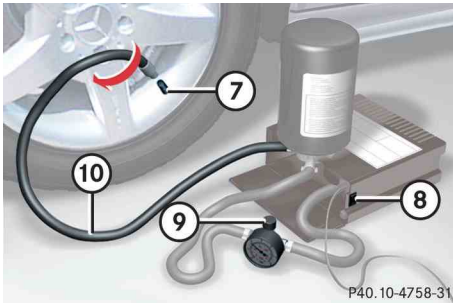

- ⑦ Tire valve
- ⑧ Electric air pump switch
- ⑨ Air hose with pressure gauge and vent screw
- ⑩ Filler hose

Warning!



Observe safety instructions on air pump label.

- ▶ Unscrew the valve cap from tire valve ⑦.
- ▶ Screw filler hose ⑩ onto tire valve ⑦.
- ▶ Insert electrical plug ④ into vehicle cigarette lighter socket (▷ page 282) or the power outlet in the rear passenger compartment (▷ page 283).
- ▶ Turn the SmartKey in the starter switch to position 1 (▷ page 36).

Vehicles with KEYLESS-GO*:

- ▶ Press the KEYLESS-GO* start/stop button (▷ page 37) on the gear selector lever once. Do not depress brake pedal.
 - ▶ Press I on electric air pump switch ⑧.
- The electric air pump should now switch on and inflate the tire.

! Do not operate the electric air pump longer than 6 minutes without interruption. Otherwise it may overheat.

After 5 minutes, the pressure gauge must display at least 26 psi (1.8 bar). The air hose can become hot during inflation. Please exercise appropriate caution.

- ▶ If this tire inflation pressure is not attained:
 - ▶ Turn off the electric air pump, detach the filler hose from the tire valve, and drive vehicle back and forth very slowly approximately 30 ft (10 m).

This serves to better distribute the TIREFIT sealant material inside the tire.

- ▶ Unscrew the air pump's air hose ⑤ from flange ⑥ of the TIREFIT container.
- ▶ Screw air hose ⑤ onto tire valve ⑦.
- ▶ Inflate the tire again.

Warning!

If a tire inflation pressure of 26 psi (1.8 bar) is not attained, tire is too severely damaged for TIREFIT to provide a reliable tire repair.

In this case, TIREFIT cannot properly seal the tire.

Do not drive the vehicle.

Contact the nearest Mercedes-Benz Center or call Roadside Assistance.

- ▶ After attaining a tire inflation pressure of 26 psi (1.8 bar), press **0** on electric air pump switch **(8)**.

The electric air pump should now be switched off.

- ▶ Turn the SmartKey in the starter switch to position **0** (▷ page 36).

Vehicles with KEYLESS-GO*:

- ▶ Press the KEYLESS-GO* start/stop button (▷ page 37) on the gear selector lever twice. Do not depress brake pedal.
- ▶ Detach the electric air pump.
 - The air hose may still be hot. Please exercise appropriate caution.
- ▶ Place the electrical air pump back in the trunk.
- ▶ Close the trunk lid.
- ▶ Drive away immediately.

The TIREFIT sealant will distribute itself evenly inside the tire.

Warning!

Do not exceed vehicle speed of 50 mph (80 km/h). A TIREFIT repair is not designed to operate at higher speeds.

The sticker supplied with the TIREFIT kit must be attached on the instrument cluster where it will be easily seen by the driver.

Vehicle handling characteristics may change. Adapt your driving accordingly.

- ▶ After driving the vehicle for an initial 10 minutes, check the tire inflation pressure using pressure gauge **(9)** on the air pump. ▷▷

Flat tire



Warning!



If tire inflation pressure has fallen below 20 psi (1.3 bar) do not continue to drive the vehicle.

Park your vehicle safely away from the roadway and contact the nearest authorized Mercedes-Benz Center or Roadside Assistance.

Have the damaged tire replaced.

- ▶ If tire inflation pressure is at least 20 psi (1.3 bar), inflate tire to correct pressure (see placard on the driver's door B-pillar), and drive to nearest qualified workshop, e.g. an authorized Mercedes-Benz Center, to have the damaged tire replaced.

Recommended duration of use:
300 miles (500 km) at
50 mph (80 km/h) with the recommended tire inflation pressure.

Warning!



Follow recommend inflation pressures.

Do not overinflate tires. Overinflating tires can result in sudden deflation (blowout) because they are more likely to become punctured or damaged by road debris, potholes, etc.

Do not underinflate tires. Underinflated tires wear unevenly, adversely affect handling and fuel economy, and are more likely to fail from being overheated.

Do not overload the tires by exceeding the specified vehicle capacity weight (as indicated by the label on the pillar in the driver's door opening). Overloading the tires can overheat them, possibly causing a blowout.

- ▶ Visit an authorized Mercedes-Benz Center as soon as possible to obtain a new TIREFIT kit.
- ▶ Bring used TIREFIT materials to an authorized Mercedes-Benz Center for proper disposal.
- ▶ Replace your TIREFIT container every 4 years. Replacement containers are available at any authorized Mercedes-Benz Center.

Mounting the Minispare wheel

Warning!



The dimensions of the Minispare wheel are different from those of the road wheels. As a result, the vehicle handling characteristics change when driving with a Minispare wheel mounted. Adapt your driving style accordingly.

The spare wheel is for temporary use only. When driving with spare wheel mounted, ensure proper tire inflation pressure and do not exceed a vehicle speed of 50 mph (80 km/h).

Drive to the nearest Mercedes-Benz Center as soon as possible to have the spare wheel replaced with a regular road wheel.

Never operate the vehicle with more than one Minispare wheel mounted.

Do not switch off the ESP[®] when a Minispare wheel is mounted.

Preparing the vehicle

Prepare the vehicle as described on (▷ page 436).

- ▶ Take the wheel wrench, alignment bolt, collapsible wheel chock, and the jack out of the trunk (▷ page 407).
- ▶ Take the Minispare wheel and wheel bolts out of the trunk (▷ page 407).

Lifting the vehicle

- ▶ Prevent the vehicle from rolling away by blocking wheels with wheel chocks or other sizeable objects.

One wheel chock is included with the vehicle tool kit (▷ page 404).

When changing wheel on a level surface:

- ▶ Place the wheel chock in front of and another sizeable object behind the wheel that is diagonally opposite to the wheel being changed.

Always try lifting the vehicle using the jack on a level surface. However, should circumstances require you to do so on a hill, place the wheel chock and the other sizeable object as follows:

- ▶ Place the wheel chock and another sizeable object on the downhill side blocking both wheels of the axle not being worked on.

Flat tire

Warning!



The jack is designed exclusively for jacking up the vehicle at the jack take-up brackets built into both sides of the vehicle. To help avoid personal injury, use the jack only to lift the vehicle during a wheel change. Never get beneath the vehicle while it is supported by the jack. Keep hands and feet away from the area under the lifted vehicle. Always firmly set parking brake and block wheels before raising vehicle with jack.

Do not disengage parking brake while the vehicle is raised. Be certain that the jack is always vertical (plumb line) when in use, especially on hills. Always try to use the jack on a level surface. Make sure the jack arm is fully seated in the jack take-up bracket. Always lower the vehicle onto sufficient capacity jackstands before working under the vehicle.

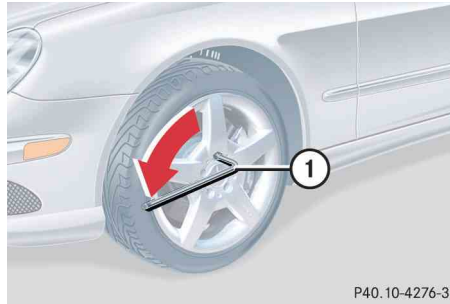

① Wheel wrench

- ▶ On wheel to be changed, loosen but do not yet remove the wheel bolts (approximately one full turn with wrench ①).

The jack take-up brackets are located directly behind the front wheel housings and in front of the rear wheel housings.

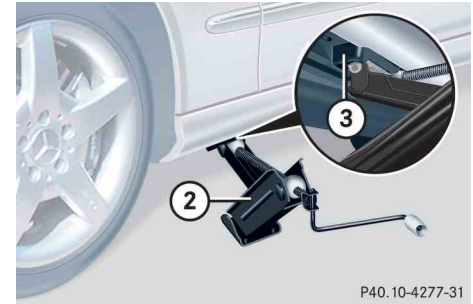

② Jack

③ Take-up bracket

- ▶ Place jack ② on firm ground.
- ▶ Position jack ② under take-up bracket ③ so that it is always vertical (plumb-line) as seen from the side, even if the vehicle is parked on an incline.

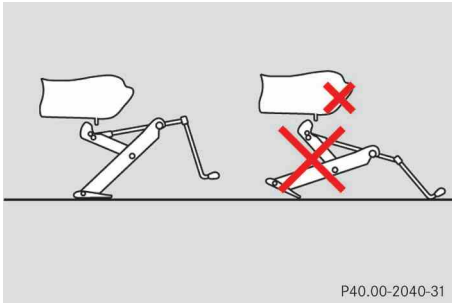

P40.00-2040-31

- ▶ Jack up the vehicle until the wheel is a maximum of 1.2 in (3 cm) from the ground. Never start engine while vehicle is raised.

Warning!



The jack is intended only for lifting the vehicle briefly for wheel changes. It is not suited for performing maintenance work under the vehicle.

- Never start the engine when the vehicle is raised.
- Never lie down under the raised vehicle.

Removing the wheel



P40.10-4278-31

① Alignment bolt

- ▶ Unscrew upper-most wheel bolt and remove.
- ▶ Replace this wheel bolt with alignment bolt ① supplied in the tool kit.
- ▶ Remove the remaining bolts.

! Do not place wheel bolts in sand or dirt. This could result in damage to the bolt and wheel hub threads.

- ▶ Remove the wheel.

Flat tire

Mounting the spare wheel

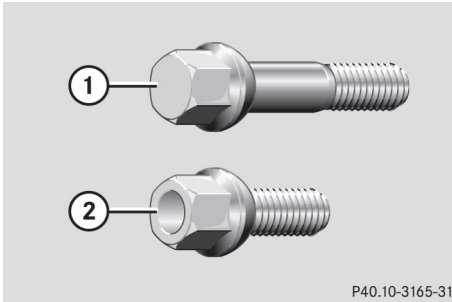

- ① Wheel bolt for light alloy rims
- ② Wheel bolt for Minispare wheel (located in trunk with Minispare wheel)

! Wheel bolts ② must be used when mounting the Minispare wheel. The use of any wheel bolts other than wheel bolts ② for the Minispare wheel will physically damage the vehicle's brakes.

- ▶ Clean contact surfaces of wheel and wheel hub.

! To avoid paint damage, place wheel flat against hub and hold it there while installing first wheel bolt.

Warning!



Always replace wheel bolts that are damaged or rusted.

Never apply oil or grease to wheel bolts.

Damaged wheel hub threads should be repaired immediately. Do not continue to drive under these circumstances! Contact an authorized Mercedes-Benz Center or call Roadside Assistance.

Incorrect wheel bolts or improperly tightened wheel bolts can cause the wheel to come off. This could cause an accident. Make sure to use the correct wheel bolts.



- ① Alignment bolt

- ▶ Guide the spare wheel onto the alignment bolt and push it on.
- ▶ Insert wheel bolts and tighten them slightly.

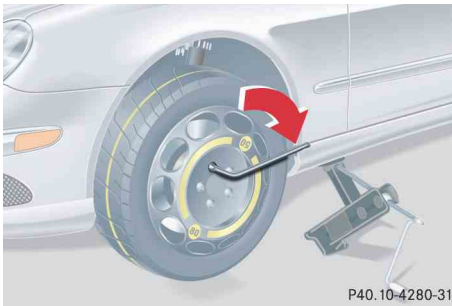

P40.10-4280-31

- ▶ Unscrew the alignment bolt, install last wheel bolt and tighten slightly.

Warning!



Only use Genuine equipment Mercedes-Benz wheel bolts. Other wheel bolts may come loose.

Do not tighten the wheel bolts when the vehicle is raised. Otherwise the vehicle could fall off the jack.

Lowering the vehicle

- ▶ Lower vehicle by turning crank counterclockwise until the full weight of the vehicle is resting on the ground.
- ▶ Remove the jack.

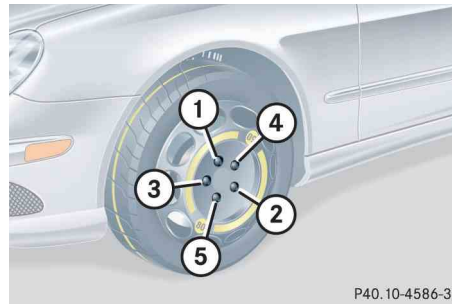

P40.10-4586-31

① - ⑤ Wheel bolts

- ▶ Tighten the five wheel bolts evenly, following the diagonal sequence illustrated (① to ⑤), until all bolts are tight. Observe a tightening torque of 80 lb-ft (110 Nm).

Warning!



Have the tightening torque checked after changing a wheel. The wheels could come loose if they are not tightened to a torque of 80 lb-ft (110 Nm).

Before storing the jack, it should be fully collapsed, with handle folded in (storage position) (▷ page 406).

- ▶ Store the jack and the other vehicle tools in the trunk.

Flat tire

MOExtended system*

The MOExtended system allows you to continue driving your vehicle even if there is a total loss of pressure in one or more tires.

You may only use the MOExtended system in conjunction with the Run Flat Indicator*.

! *The maximum distance in emergency mode depends on the vehicle's load. It is 30 miles (50 km) if the vehicle is partially loaded and 18 miles (30 km) if the vehicle is fully loaded.*

The point at which the maximum driving distance begins in emergency mode is when the warning message appears in the multifunction display indicating that there is a loss of tire inflation pressure.

Do not exceed the maximum speed of 50 mph (80 km/h).

Warning!



In emergency mode, your vehicle's driving characteristics are diminished in such situations as:

- driving around curves
- while braking
- while accelerating rapidly

Therefore, your driving style must be adapted accordingly. Avoid abrupt steering and driving maneuvers, as well as driving over obstacles (road curbs, potholes, or off-road areas). This is especially important if the vehicle is heavily loaded.

The emergency driving distance that can be achieved greatly depends on the demands placed on the vehicle. Depending on speed, load, driving maneuvers, road conditions,

outside temperature, etc., the distance can be significantly shorter or, if the vehicle is driven cautiously, somewhat longer.

Do not continue driving in emergency mode if

- you notice knocking sounds
- the vehicle starts to shake
- smoke develops and you smell rubber
- ESP® is intervening continuously
- you notice tears on the tire sidewalls

After driving in emergency mode, you must have the rims inspected by an authorized Mercedes-Benz Center to check if they are suitable for further use. The failed tire must be replaced in any case.

i *When replacing individual or all tires on the vehicle, make sure only matching tires marked with "MOExtended" are mounted in the size specified for your vehicle (▷ page 466).*

▼ **Battery**

The battery is located in the engine compartment on the right hand side.

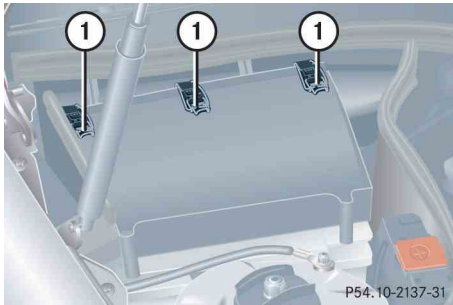

① Clamps

Removing filter box:

- ▶ Release clamps ①.
- ▶ Remove filter box.

Installing filter box:

- ▶ Insert filter box properly.
- ▶ Secure it with clamps ①.

Warning!



Failure to follow these instructions can result in severe injury or death.

Observe all safety instructions and precautions when handling automotive batteries (▷ page 321).

Never lean over batteries while connecting, you might get injured.

Battery fluid contains sulfuric acid. Do not allow this fluid to come in contact with eyes, skin or clothing. In case it does, immediately flush affected area with water and seek medical help if necessary.

A battery will also produce hydrogen gas, which is flammable and explosive. Keep flames or sparks away from battery, avoid improper connection of jumper cables, smoking etc.

! Never loosen or detach battery terminal clamps while the engine is running or the SmartKey is in the starter switch. Otherwise the alternator and other electronic components could be severely damaged.

Have the battery checked regularly by an authorized Mercedes-Benz Center.

Refer to Maintenance Booklet for maintenance intervals or contact an authorized Mercedes-Benz Center for further information.

Warning!



Do not place metal objects on the battery as this could result in a short circuit.

Use leak-proof battery only to avoid the risk of acid burns in the event of an accident.

Battery

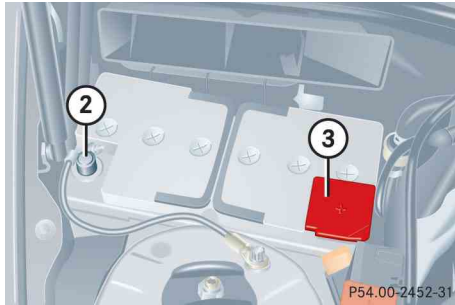

- ② Negative terminal
- ③ Positive terminal cover

Disconnecting the battery

Warning!



With a disconnected battery

- you will no longer be able to turn the SmartKey in the starter switch and pressing the KEYLESS-GO* start/stop button on the gear selector lever will have no effect
- the gear selector lever will remain locked in position **P**

! Always disconnect the battery in the order described below. Otherwise the vehicle's electronics can be damaged.

- ▶ Apply the parking brake (▷ page 59).
- ▶ Make sure gear selector lever is set to position **P** (▷ page 172).
- ▶ Turn off all electrical consumers.
- ▶ Remove SmartKey from starter switch.

Vehicles with KEYLESS-GO*:

- ▶ Press the start / stop button until the engine shuts off.
- ▶ Open the driver's door.
- ▶ Open the hood (▷ page 315).
- ▶ Remove the filter box (▷ page 447).
- ▶ Read and observe safety instructions and precautions (▷ page 447).
- ▶ Disconnect the battery negative lead from negative terminal ②.
- ▶ Remove cover ③ from the positive terminal.
- ▶ Disconnect the battery positive lead.

Removing the battery

- ▶ Remove the screw securing the battery.
- ▶ Remove the battery support and bracket.
- ▶ Pull out the ventilation hose from the battery (depending on battery arrangement in your vehicle model, the ventilation hose is located either on the left or right side of the battery).
- ▶ Take out the battery.

Charging and reinstalling the battery

Warning!



Never charge a battery while still installed in the vehicle unless the accessory battery charge unit approved by Mercedes-Benz is being used. Gases may escape during charging and cause explosions that may result in paint damage, corrosion or personal injury.

An accessory battery charge unit specially adapted for Mercedes-Benz vehicles and tested and approved by Mercedes-Benz is available, permitting the charging of the battery in its installed position. Contact an authorized Mercedes-Benz Center for information and availability. Charge battery in accordance with the separate instructions for the accessory battery charger.

- ▶ Charge battery in accordance with the instructions of the battery charger manufacturer.

- ▶ Reinstall the charged battery. Follow the previously described steps in reverse order.

! *The battery, its filler caps and the ventilation hose must always be securely installed when the vehicle is in operation.*

Reconnecting the battery

! *Always connect the battery in the order described below. Otherwise the vehicle's electronics can be damaged.*

- ▶ Turn off all electrical consumers.
 - ▶ Remove SmartKey from starter switch.
- Vehicles with KEYLESS-GO*:
- ▶ Open the driver's door.

! *Never invert the terminal connections!*

- ▶ Connect the battery positive lead and fasten its cover ③ (▷ page 448).
- ▶ Connect the battery negative lead ② (▷ page 448).
- ▶ Reinstall the filter box (▷ page 447).

i *The following procedures must be carried out following any interruption of battery power (e.g. due to reconnecting):*

- Set the clock (▷ page 158). Vehicles with COMAND*: see COMAND operator's manual.
- Synchronize the side windows (▷ page 251).

Batteries contain materials that can harm the environment if disposed of improperly. Large 12-volt storage batteries contain lead. Recycling of batteries is the preferred method of disposal. Many states require sellers of batteries to accept old batteries for recycling.

Jump starting

Warning!



Failure to follow these directions will cause damage to the electronic components, and can lead to a battery explosion and severe injury or death.

Never lean over batteries while connecting or jump starting, you might get injured.

Battery fluid contains sulfuric acid. Do not allow this fluid to come in contact with eyes, skin or clothing. In case it does, immediately flush affected area with water, and seek medical help if necessary.

A battery will also produce hydrogen gas, which is flammable and very explosive. Keep flames or sparks away from battery, avoid improper connection of jumper cables, smoking, etc.

Attempting to jump start a frozen battery can result in it exploding, causing personal injury.

Read all instructions before proceeding.

! Do not tow-start the vehicle.

! Avoid repeated and lengthy starting attempts.

Do not attempt to start the engine using a battery quick charge unit.

If the engine does not run after several unsuccessful starting attempts, have it checked at the nearest authorized Mercedes-Benz Center.

Excessive unburned fuel generated by repeated failed starting attempts may damage the catalytic converter and may present a fire risk.

Make sure the jumper cables do not have loose or missing insulation.

Make sure the cable clamps do not touch any other metal part while the other end is still attached to a battery.

If the battery is discharged, the engine can be started with jumper cables and the battery of another vehicle. Observe the following:

- Jump starting should only be performed when the engine and catalytic converter are cold.

- Do not start the engine if the battery is frozen. Let the battery thaw out first.
- Only jump start from batteries with the same voltage rating (12 V). Jump starting with a higher voltage battery could damage the vehicle's electrical system, which will not be covered by the Mercedes-Benz Limited Warranty.
- Only use jumper cables with sufficient cross-section and insulated terminal clamps.
- Always make sure the jumper cables are not on or near pulleys, fans or other parts that move when an engine is started or running.

Warning!



Keep flames or sparks away from battery. Do not smoke.

Observe all safety instructions and precautions when handling automotive batteries (▷ page 321).

The battery is located on the right side of the engine compartment. For jump starting, use the terminals in front of the battery.

- ▶ Make sure the two vehicles do not touch.
- ▶ Turn off all electrical consumers.
- ▶ Apply the parking brake (▷ page 59).
- ▶ Make sure the gear selector lever is set to position **P** (▷ page 172).
- ▶ Open the hood (▷ page 315).
- ▶ Flip up cover from positive under hood terminal ② in front of the filter box (▷ page 448).

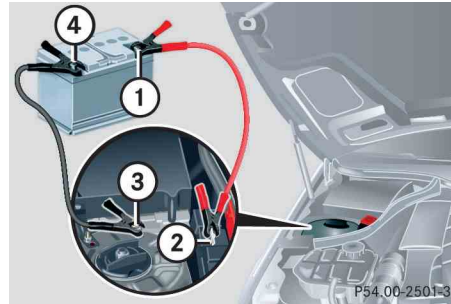

- ① Positive terminal of charged battery
- ② Positive under hood terminal in front of discharged battery
- ③ Negative under hood terminal in front of discharged battery
- ④ Negative terminal of charged battery

! Never invert the terminal connections.

- ▶ Connect the positive terminal ① of the charged battery with the positive under hood terminal ② in front of the filter box with the jumper cable. Clamp cable to charged battery ① first.
- ▶ Start engine of the vehicle with the charged battery and run at idle speed.

- ▶ Connect the negative terminal ④ of the charged battery with the negative under hood terminal ③ in front of the filter box with the second jumper cable. Clamp the cable to the negative terminal ④ of the charged battery first.
- ▶ Start the engine of the disabled vehicle.

You can now turn on the electrical consumers. Do not switch on the headlamps under any circumstances.

- ▶ Remove the jumper cables first from the negative terminals ③ and ④ and then from the positive terminals ② and ①.

You can now switch on the headlamps.

- ▶ Have the battery checked at the nearest authorized Mercedes-Benz Center.

Towing the vehicle

Towing the vehicle

Mercedes-Benz recommends that the vehicle be transported with all wheels off the ground using flatbed or appropriate wheel lift/dolly equipment.

! Do not tow-start the vehicle.

! Use flatbed or wheel lift/dolly equipment with SmartKey in starter switch turned to position **0**.

Do not tow with sling-type equipment. Towing with sling-type equipment over bumpy roads will damage radiator and supports.

To prevent damage during transport, do not tie down vehicle by its chassis or suspension parts.

Switch off the automatic central locking (▷ page 164).

When circumstances do not permit the recommended towing methods, the vehicle may be towed with all wheels on the ground or front wheels raised only so far as necessary to have the vehicle moved to a safe location where the recommended towing methods can be employed.

! If the vehicle is towed with the front axle raised, the gear selector lever must be in position **N** and the engine must be shut off (SmartKey in starter switch position **0** or **1**). Otherwise, the ESP® will immediately be engaged and will apply the rear wheel brakes.

When towing the vehicle with all wheels on the ground, the gear selector lever must be in position **N** and the SmartKey must be in starter switch position **2**.

When towing the vehicle with all wheels on the ground or the front axle raised, the vehicle may be towed only for distances up to 30 miles (50 km) and at a speed not to exceed 30 mph (50 km/h).

Warning!



If circumstances require towing the vehicle with all wheels on the ground, always tow with a tow bar if:

- the engine will not run
- there is a malfunction in the power supply or in the vehicle's electrical system

as that will be necessary to adequately control the towed vehicle.

Prior to towing the vehicle with all wheels on the ground, make certain that the SmartKey is in starter switch position **2**.

If the SmartKey is left in starter switch position **0** for an extended period of time, it can no longer be turned in the switch. In this case, the steering is locked. To unlock, remove SmartKey from starter switch and reinsert.

Warning!

With the engine not running, there is no power assistance for the brake and steering systems. In this case, it is important to keep in mind that a considerably higher degree of effort is necessary to brake and steer the vehicle. Adapt your driving accordingly.

i To signal turns while being towed with the hazard warning flasher in use, switch on the ignition and activate the combination switch for the left or right turn signal in the usual manner – only the selected turn signal will operate.

Upon canceling the turn signal, the hazard warning flasher will operate again.

! When towing the vehicle with all wheels on the ground, please note the following:

With the automatic central locking activated and the SmartKey in starter switch position 2, or KEYLESS-GO start/stop button in position 2, the vehicle doors lock if the left front wheel as well as the right rear wheel are turning at vehicle speeds of approx. 9 mph (15 km/h) or more.*

To prevent the vehicle door locks from locking, deactivate the automatic central locking (▷ page 164).

Towing of the vehicle should only be done using the properly installed towing eye bolt. Never attach tow cable, tow rope or tow rod to the vehicle chassis, frame or suspension parts.

- i** If the battery is disconnected or discharged
- the SmartKey will not turn in the starter switch. For more information, see “Battery” (▷ page 447) and “Jump starting” (▷ page 450).
 - the gear selector lever will remain locked in position P. For information on manually unlocking the transmission gear selector lever, see (▷ page 412).

Towing the vehicle

Installing towing eye bolt

Towing eye bolt CLK 350

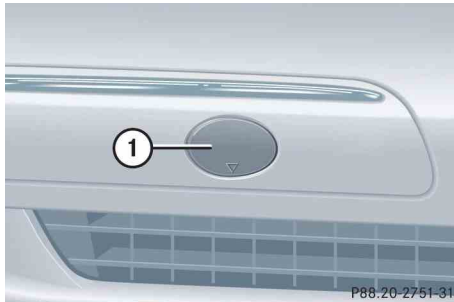

- ① Cover on right side of front bumper

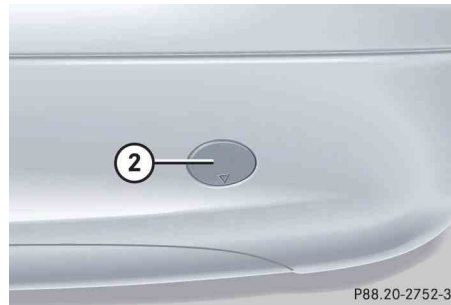

- ② Cover on right side of rear bumper

To remove cover:

- ▶ Press mark on cover ① or ②.
- ▶ Lift cover off to reveal the threaded hole for towing eye bolt.

The towing eye bolt is supplied with the tool kit (located in the compartment underneath the trunk floor).

- ▶ Screw towing eye bolt in to its stop and tighten with lug wrench.

To reinstall cover:

- ▶ Fit cover ① or ② and snap into place.

Towing eye bolt CLK 550/CLK 63 AMG

Towing eye bolt in front bumper

The cover for the threaded bore in the front bumper is identical to the cover on the CLK 350.

To remove and to reinstall cover, see “Towing eye bolt CLK 350” (▷ page 454).

Towing eye bolt in rear bumper

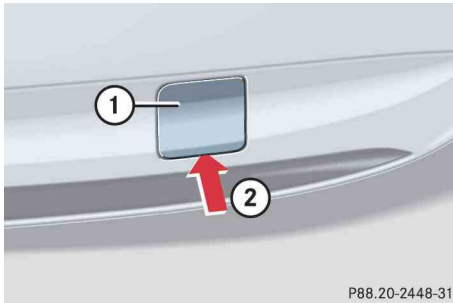

- ① Cover on right side of rear bumper
- ② Recess in the cover

To remove cover ①:

- ▶ Insert flat, blunt object as a lever in recess ② on the edge of cover ①.
- ▶ Loosen cover ① from the bumper using lever, to reveal the threaded hole for towing eye bolt.

The towing eye bolt is supplied with the tool kit (located in the compartment underneath the trunk floor).

- ▶ Screw towing eye bolt in to its stop and tighten with lug wrench.

To reinstall cover ①:

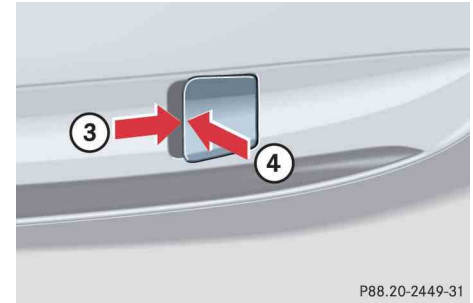

- ▶ Hook right-hand side of the cover ① into opening.
- ▶ Slide cover ① as far as it will go in the direction of the arrow ③.
- ▶ Gently press left-hand side of cover ① in direction of the arrow ④.

The hooks on the left-hand side engage.

i When closing the cover ①, make sure the cover's check strap does not get caught.

Fuses

The electrical fuses in your vehicle serve to switch off malfunctioning power circuits.

If a fuse is blown, the components and systems secured by that fuse will stop operating.

Warning!



Only use fuses approved by Mercedes-Benz with the specified amperage for the system in question and do not attempt to repair or bridge a blown fuse. Using other than approved fuses or using repaired or bridged fuses may cause an overload leading to a fire, and/or cause damage to electrical components and/or systems. Have the cause determined and remedied by an authorized Mercedes-Benz Center

i A blown fuse must be replaced by an appropriate spare fuse (recognizable by its color or the fuse rating given on the fuse) of the amperage recommended in the fuse chart. Any Mercedes-Benz Center will be glad to advise you on this subject.

If a newly inserted fuse blows again, have the cause determined and rectified by an authorized Mercedes-Benz Center.

The following aids are available to help you replace fuses.

- Fuse chart

The fuse chart is located in the main fuse box in the passenger compartment (▷ page 457). The fuse chart explains the fuse allocation and fuse amperages.

- Spare fuses

Spare fuses are located in the vehicle tool kit in the spare wheel well (▷ page 404).

- Fuse extractor

The fuse extractor is located in the trunk underneath the trunk floor cover (▷ page 405), or CLK 63 AMG (▷ page 404).

The electrical fuses are located in different fuse boxes:

- in the passenger compartment on the driver's side (▷ page 457)
- on the driver's side of the engine compartment (▷ page 457)
- in the trunk (▷ page 458)

Before replacing fuses:

- ▶ Apply the parking brake (▷ page 59).
- ▶ Make sure the gear selector lever is set to position **P** (▷ page 172).
- ▶ Turn off all electrical consumers.
- ▶ Turn off the engine (▷ page 60).
- ▶ Remove the SmartKey from the starter switch.

Vehicles with KEYLESS-GO*:

- ▶ Open the driver's door.

Mainfuse box in passenger compartment

The main fuse box is located in the passenger compartment on the driver's side of the cockpit.



① Main fuse box cover

! Do not use sharp objects such as a screw driver to open the fuse box cover ① in the cockpit, as this could damage it.

Opening fuse box

- ▶ Open the driver's door.
- ▶ Insert flat, blunt object as a lever into the edge of the fuse box cover ① at the position indicated by the arrow.
- ▶ Loosen fuse box cover ① from cockpit using lever.
- ▶ Using your hands, remove fuse box cover ① rearward.

Closing fuse box

- ▶ Attach fuse box cover ① in the front.
- ▶ Fold fuse box cover ① in until it engages.

Fuse box in engine compartment

The fuse box is located in the engine compartment on the driver's side.

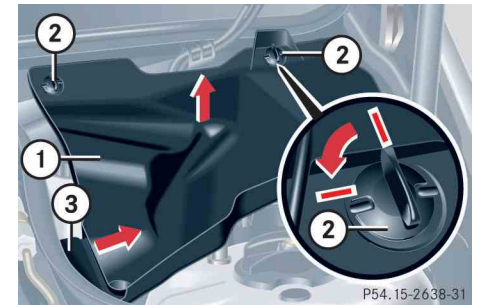

- ① Cover
- ② Screw
- ③ Retainer

Removing cover

- ▶ Twist screws ② 90° counterclockwise.
- ▶ Lift the rear of cover ①.
- ▶ Slide out retainer ③ and remove cover ① by pulling towards front.

Fuses

Opening fuse box

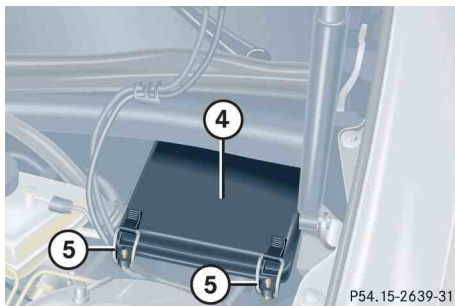

P54.15-2639-31

④ Fuse box cover

⑤ Clamps

- ▶ With a dry cloth, remove any moisture from the fuse box.
- ▶ Release clamps ⑤.
- ▶ Remove fuse box cover ④.

Closing fuse box

- ▶ Make sure that the sealing rubber is properly positioned.
- ▶ Press fuse box cover ④ down and secure with clamps ⑤.

! The fuse box cover ④ must be properly positioned as described to prevent moisture or dirt from entering the fuse box and possibly impairing fuse operation.

Installing cover

- ▶ Insert cover ① sideways into retainer ③.
- ▶ Twist screws ② 90° clockwise.

Fuse box in trunk

The fuse box is located in the trunk behind the left-hand trim panel.

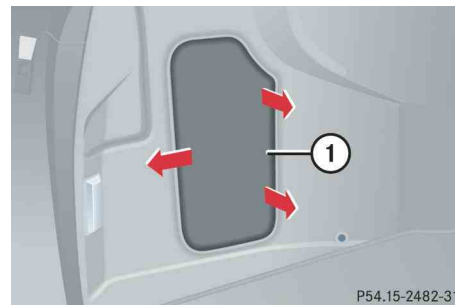

P54.15-2482-31

① Trim panel

Opening fuse box

- ▶ To open, pull trim panel ① in the direction of the rear light and outward.

Closing fuse box

- ▶ Press trim panel ① back into place.

Parts service

Warranty coverage

Identification labels

Layout of poly-V-belt drive

Engine

Rims and tires

Electrical system

Main dimensions and weights

Fuels, coolants, lubricants, etc.

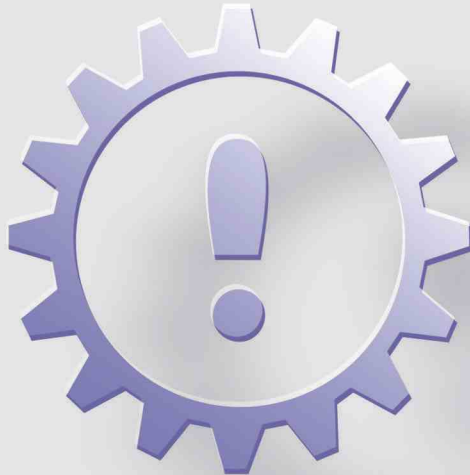

The “Technical data” section provides the necessary technical data for your vehicle.

All authorized Mercedes-Benz Centers maintain a stock of Genuine Mercedes-Benz parts required for maintenance and repair work. In addition, strategically located parts distribution centers provide quick and reliable parts service.

More than 300 000 different parts for Mercedes-Benz models are available.

Genuine Mercedes-Benz parts are subjected to stringent quality inspections. Each part has been specifically developed, manufactured or selected for and adapted to Mercedes-Benz vehicles.

Therefore, Genuine Mercedes-Benz parts should be installed.

! *The use of non-genuine Mercedes-Benz parts and accessories not authorized by Mercedes-Benz could damage the vehicle, which is not covered by the Mercedes-Benz Limited Warranty, or could compromise the vehicle's durability or safety.*

▼ Warranty coverage

Your vehicle is covered under the terms of the warranties printed in the Service and Warranty Information booklet. Your authorized Mercedes-Benz Center will exchange or repair any defective parts originally installed in the vehicle in accordance with the terms of the following warranties:

- New Vehicle Limited Warranty
- Emission System Warranty
- Emission Performance Warranty
- California, Maine, Massachusetts, and Vermont Emission Control Systems Warranty

Replacement parts and accessories are covered by the Mercedes-Benz Parts and Accessories warranties, copies of which are available at any Mercedes-Benz Center.

Loss of Service and Warranty Information Booklet

Should you lose your Service and Warranty Information booklet, have an authorized Mercedes-Benz Center arrange for a replacement. It will be mailed to you.

Identification labels



P60.00-2754-31

① Certification label (on driver's B-pillar)

The Vehicle Identification Number (VIN) can be found in the following locations:

- on the certification label.
- embossed underneath the carpet in front of the passenger seat (▷ page 463).
- on the lower edge of the windshield (▷ page 463).

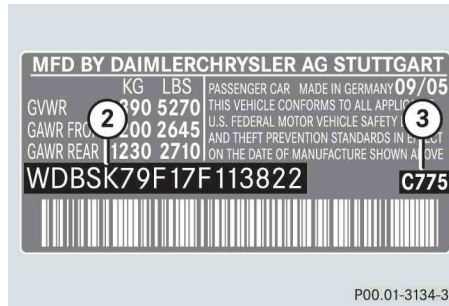

P00.01-3134-31

Example certification label (U.S. vehicles)

- ② VIN
- ③ Paintwork code



P00.01-3271-31

Example certification label (Canada vehicles)

- ② VIN
- ③ Paintwork code

i Data shown on certification label are for illustration purpose only. These data are specific to each vehicle and may vary from data shown in the illustration. Refer to certification label on vehicle for actual data specific to your vehicle.

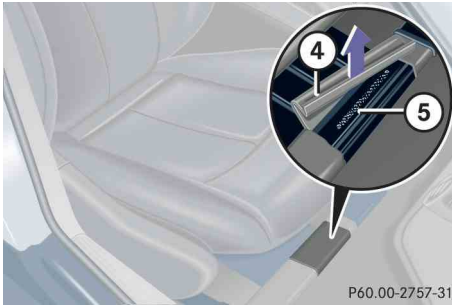

- ④ Carpet
- ⑤ VIN

- ▶ Move the passenger seat to the rear as far as possible.
- ▶ Fold carpet ④ in direction of arrow.
VIN ⑤ is visible.

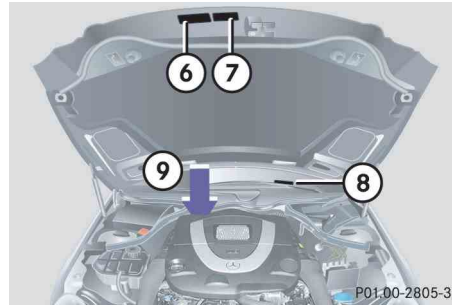

- ⑥ Emission control information label, includes both federal and California certification exhaust emission standards
- ⑦ Vacuum line routing diagram label
- ⑧ VIN (lower edge of windshield)
- ⑨ Engine number (engraved on engine)

i When ordering parts, please specify vehicle identification and engine numbers.

Layout of poly-V-belt drive

CLK 350 / CLK 550

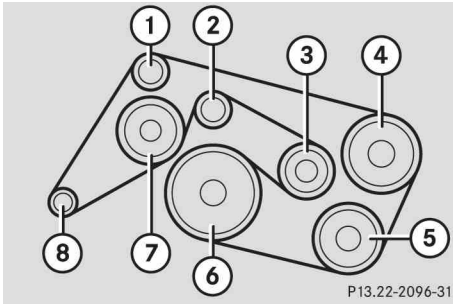

- ① Idler pulley
- ② Idler pulley
- ③ Automatic belt tensioner
- ④ Power steering pump
- ⑤ Air conditioning compressor
- ⑥ Crankshaft
- ⑦ Coolant pump
- ⑧ Generator (alternator)

CLK 63 AMG

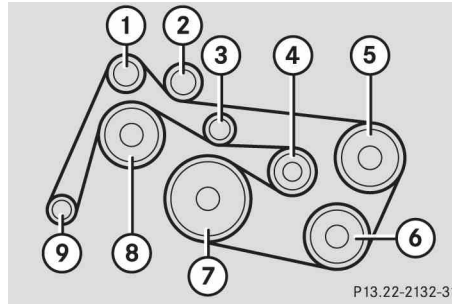

- ① Idler pulley
- ② Idler pulley
- ③ Idler pulley
- ④ Automatic belt tensioner
- ⑤ Power steering pump
- ⑥ Air conditioning compressor
- ⑦ Crankshaft
- ⑧ Coolant pump
- ⑨ Generator (alternator)

▼ Engine

Model	CLK 350 (209.456) ¹	CLK 550 (209.472) ¹	CLK 63 AMG (209.477) ¹
Engine	272	273	156
Mode of operation	4-stroke engine, gasoline injection	4-stroke engine, gasoline injection	4-stroke engine, gasoline injection
No. of cylinders	6	8	8
Bore	3.66 in (92.90 mm)	3.85 in (98.00 mm)	4.02 in (102.20 mm)
Stroke	3.39 in (86.00 mm)	3.56 in (90.50 mm)	3.72 in (94.60 mm)
Total piston displacement	213.5 cu in (3498 cm ³)	333.25 cu in (5461 cm ³)	378.8 cu in (6208 cm ³)
Compression ratio	10.5:1	10.5:1	11.3:1
Output acc. to SAE J 1349	268 hp / 6 000 rpm ² (200 kW / 6 000 rpm)	382 hp / 6 000 rpm ² (285 kW / 6 000 rpm)	475 hp / 6 800 rpm ² (354 kW / 6 800 rpm)
Maximum torque acc. to SAE J 1349	258 lb-ft / 2 400 - 5 000 rpm (350 Nm / 2 400 - 5 000 rpm)	391 lb-ft / 2 800 - 4 800 rpm (530 Nm / 2 800 - 4 800 rpm)	465 lb-ft / 5 000 rpm (630 Nm / 5 000 rpm)
Maximum engine speed	6 300 rpm	6 500 rpm	7 200 rpm
Firing order	1-4-3-6-2-5	1-5-4-2-6-3-7-8	1-5-4-2-6-3-7-8
Poly-V-belt	2404 mm	2380 mm	2369 mm

¹ The quoted data apply only to the standard vehicle. See an authorized Mercedes-Benz Center for the corresponding data of all special bodies and special equipment.

² Premium fuel required. Performance may vary with fuel octane rating.

Rims and tires

! Only use tires which have been tested and approved by Mercedes-Benz. Tires approved by Mercedes-Benz are developed to provide best possible performance in conjunction with the driving safety systems on your vehicle such as ABS or ESP®. Tires specially developed for your vehicle and tested and approved by Mercedes-Benz can be identified by finding the following on the tire's sidewall:

- MO = Mercedes-Benz Original equipment tires

AMG vehicles:

Does not apply to all approved tires on AMG vehicles. For information on tested and approved tires for AMG vehicles, contact an authorized Mercedes-Benz Center.

- MOE = Mercedes-Benz Original Extended (tires with limited run-flat characteristics) original equipment tires. Using tires other than those approved by Mercedes-Benz may result in damage that is not covered by the Mercedes-Benz Limited Warranty.

i For information on driving with MOExtended tires, see "MOExtended system*" (▷ page 336).

! Using tires other than those approved by Mercedes-Benz can have detrimental effects, such as

- poor handling characteristics
- increased noise
- increased fuel consumption

Moreover, tires and rims not approved by Mercedes-Benz may, under load, exhibit dimensional variations and different tire deformation characteristics that could cause them to come into contact with the vehicle body or axle parts. Damage to the tires or the vehicle may be the result.





i Further information on tires and rims is available at any authorized Mercedes-Benz Center. A placard with the recommended tire inflation pressures is located on the driver's door B-pillar. Some vehicles may have supplemental tire inflation pressure information for driving at high speeds (▷ page 332) or for vehicle loads less than the maximum loaded vehicle condition (▷ page 331).

If such information is provided, it can be found on the placard located on the inside of the fuel filler flap. The tire inflation pressure should be checked regularly and should only be adjusted on cold tires. Follow tire manufacturer's maintenance recommendation included with vehicle.

i The following pages also list the approved wheel rim and tire sizes for equipping your vehicles with winter tires. Winter tires are not available as standard or optional factory equipment, but can be purchased from an authorized Mercedes-Benz Center.

Depending on vehicle model and the standard or optional factory-equipped wheel rim/tire configuration on your vehicle (Appearance Package, Sport Package etc.), equipping your vehicle with winter tires approved for your vehicle model may also require the purchase of two or four wheel rims of the recommended size for use with these winter tires. See an authorized Mercedes-Benz Center for more information.

Same size tires

Model	CLK 350	CLK 550
Rims (light alloy)	7.5 J x 17 H2	7.5 J x 17 H2
Wheel offset	1.42 in (36 mm)	1.45 in (37 mm)
Winter tires ^{1,3}	225/45 R17 91 H M+S 	225/45 R17 91 H M+S 
Winter tires ^{1,2,3}	225/45 R17 91 H M+S  MOExtended	225/45 R17 91 H M+S  MOExtended

¹ Radial-ply tires

² Must be used in conjunction with Run Flat Indicator* only.

³ Not available as factory equipment.

Model	CLK 63 AMG
Rims (light alloy)	8 J x 18 H2
Wheel offset	1.34 in (34 mm)
Winter tires ^{1,2,3}	225/40 R18 92 V XL (Extra Load) M+S 

¹ Radial-ply tires

² Not available as factory equipment.

³ For use with snow chains contact an authorized Mercedes-Benz Center.

Rims and tires

Mixed size tires

Model	CLK 350	CLK 550	CLK 63 AMG
Front axle:			
Rims (light alloy)	7.5 J x 17 H2	7.5 J x 17 H2	8 J x 18 H2
Wheel offset	1.42 in (36 mm)	1.46 in (37 mm)	1.34 in (34 mm)
Summer tires¹	225/45 R17 91W	225/45 ZR17 91W	225/40 ZR18 92Y XL (Extra Load)
Summer tires^{*1,2}	225/45 R17 91W MOExtended	225/45 R17 91W MOExtended	-
Rear axle:			
Rims (light alloy)	8.5 J x 17 H2	8.5 J x 17 H2	8.5 J x 18 H2
Wheel offset	1.18 in (30 mm)	1.18 in (30 mm)	1.18 in (30 mm)
Summer tires^{1,3}	245/40 R17 91W	245/40 ZR17 91W	255/35 ZR18 94Y XL (Extra Load)
Summer tires^{*1,2,3}	245/40 R17 91W MOExtended	245/40 R17 91W MOExtended	-

¹ Radial-ply tires

² Must be used in conjunction with Run Flat Indicator* only.

³ Must not be used with snow chains.

Minispare wheel

Model	All Models (except CLK 63 AMG)
Rim	3.5 B x 17 H2
Wheel offset	0.67 in (17 mm)
Tire¹	T 125/80 R 17 99M

¹ Must not be used with snow chains.

! Please compare the recommended tire inflation pressure for your vehicle with the tire inflation pressure on the yellow label located on the spare wheel rim.

If the tire inflation pressure on the yellow label on the spare wheel rim differs from the values given in this Operator's Manual, inflate the spare wheel tire to the recommended tire inflation pressure given on the yellow label on the spare wheel rim.

i Please note that the tire inflation pressure of the Minispare tire differs from the tire inflation pressure of the road tires.

Make sure the Minispare tire is inflated to approximately 61 psi (4.2 bar).

i The CLK 63 AMG does not have a spare wheel. The CLK 63 AMG is equipped with TIREFIT, see "Sealing tires with TIREFIT (CLK 63 AMG only)" (▷ page 436).

Electrical system

Model	CLK 350	CLK 550	CLK 63 AMG
Generator (alternator)	14 V/150 A	14 V/180 A	14 V/180 A
Starter motor	14 V/1.4 KW	14 V/1.7 KW	14 V/2.2 KW
Battery	12 V/100 Ah	12 V/100 Ah	12 V/100 Ah
Spark plugs	Bosch Platin Y 7 MPP 33 NGK PLKR 6A	Bosch F8 DPP 332 NGK PFR 5R-11	NGK T 20036N
Electrode gap	0.031 in (0.80 mm)	0.039 in (1.00 mm)	0.039 in (1.0 mm)
Tightening torque	15 - 22 lb-ft (20 - 30 Nm)	18.5 - 22 lb-ft (25 - 30 Nm)	14.75 - 18.5 lb-ft (20 - 25 Nm)

Main dimensions and weights

▼ Main dimensions and weights

Main dimensions

Model	CLK 350	CLK 550	CLK 63 AMG
Overall vehicle length	183.3 in (4 657 mm)	183.3 in (4 657 mm)	183.3 in (4 657 mm)
Overall vehicle width (exterior rear view mirrors folded out)	78.4 in (1 991 mm)	78.4 in (1 991 mm)	78.4 in (1 991 mm)
Overall vehicle height	55.6 in (1 413 mm)	55.4 in (1 408 mm)	55.3 in (1 405 mm)
Overall vehicle height when opening/closing soft top	80.2 in (2 038 mm)	81.0 in (2 057 mm)	80.6 in (2 047 mm)
Wheelbase	106.9 in (2 715 mm)	106.9 in (2 715 mm)	106.9 in (2 715 mm)
Track, front	58.8 in (1 493 mm)	58.9 in (1 497 mm)	58.9 in (1 495 mm)
Track, rear	58.0 in (1 474 mm)	58.2 in (1 478 mm)	58.0 in (1 474 mm)

Weights

Trunk load max.	220 lbs (100 kg)
-----------------	------------------

Fuels, coolants, lubricants, etc.

Capacities

Vehicle components and their respective lubricants must match. Therefore only use products tested and approved by Mercedes-Benz.

Please refer to the Factory Approved Service Products pamphlet, or inquire at your Mercedes-Benz Center.

Warning!



Comply with all valid regulations with respect to handling, storing, and disposing of service fluids. Otherwise you could endanger persons or the environment.

Keep service fluids out of the reach of children.

For health reasons, you should prevent service fluids from coming into direct contact with your eyes or any open wounds.

If a service fluid is swallowed, contact a physician immediately.

	Model	Capacity	Fuels, coolants, lubricants, etc.
Engine with oil filter	CLK 350	8.5 US qt (8.0 l)	Approved engine oils
	CLK 550	9.0 US qt (8.5 l)	
	CLK 63 AMG	9.0 US qt (8.8 l)	
Automatic transmission	CLK 350	9.0 US qt (8.5 l)	MB Automatic Transmission Fluid
	CLK 550	9.5 US qt (9.0 l)	
	CLK 63 AMG	9.3 US qt (8.5 l)	
Rear axle	CLK 350	1.16 US qt (1.1 l)	Hypoid gear oil SAE 85 W 90
	CLK 550	1.27 US qt (1.2 l)	
	CLK 63 AMG	1.27 US qt (1.2 l)	Fuchs Titan EG 5010D

Fuels, coolants, lubricants, etc.

	Model	Capacity	Fuels, coolants, lubricants, etc.
Power steering	CLK 350 CLK 550 CLK 63 AMG	approx. 1.1 US qt (1.0 l) approx. 1.1 US qt (1.0 l) approx. 1.3 US qt (1.2 l)	MB Power Steering Fluid (Pentosin CHF 11S)
Front wheel hubs	CLK 350 CLK 550 CLK 63 AMG	approx. 3.0 oz (85 g) each approx. 3.0 oz (85 g) each approx. 2.5 oz (70 g) each	High temperature roller bearing grease
Brake system		0.64 US qt (0.6 l)	MB Brake Fluid (DOT 4+)
Cooling system	CLK 350 CLK 550 CLK 63 AMG	approx. 7.8 US qt (7.4 l) approx. 9.7 US qt (9.2 l) approx. 11.5 US qt (10.9 l)	MB 325.0 Anticorrosion/Antifreeze Agent
Fuel tank including a reserve of	CLK 350 CLK 550 CLK 63 AMG	16.35 US gal (62.0 l) 2.11 US gal (8.0 l) 2.11 US gal (8.0 l) 3.17 US gal (12.0 l)	Premium unleaded gasoline: Minimum Posted Octane 91 (Avg. of 96 RON / 86 MON)
Air conditioning system			R-134a refrigerant and special PAG lubricant oil (never R-12)
Windshield washer and headlamp cleaning system*		6.4 US qt (6.0 l)	MB Windshield Washer Concentrate ¹

¹ Use MB Windshield Washer Concentrate “MB SummerFit” and water for temperatures above freezing point or MB Windshield Washer Concentrate “MB SummerFit” and commercially available premixed windshield washer solvent / antifreeze for temperatures below freezing point. Follow suggested mixing ratios (▷ page 479).

Fuels, coolants, lubricants, etc.

Engine oils

Engine oils are specifically tested for their suitability in our engines and durability for our service intervals. Therefore, only use approved engine oils and oil filters required for vehicles with Maintenance System (U.S. vehicles) or FSS (Canada vehicles). For a listing of approved engine oils and oil filters, refer to the Factory Approved Service Products pamphlet, or contact an authorized Mercedes-Benz Center.

! *Using engine oils and oil filters of specification other than those expressly required for the Maintenance System (U.S. vehicles. Canada vehicles, depending on vehicle production date) or FSS (Canada vehicles, depending on vehicle production date), or changing of oil and oil filter at change intervals longer than those called for by the Maintenance System (U.S. vehicles. Canada vehicles, depending on vehicle production date) or FSS (Canada vehicles, depending on vehicle production date) will result in engine or emission control system damage not covered by the Mercedes-Benz Limited Warranty.*

Please follow Maintenance System (U.S. vehicles. Canada vehicles, depending on vehicle production date) or FSS (Canada vehicles, depending on vehicle production date) recommendations for scheduled oil changes. Failure to do so will result in engine or emission control system damage not covered by the Mercedes-Benz Limited Warranty.

Engine oil additives

Do not blend oil additives with engine oil. They may damage the engine.

Damage or malfunctions resulting from blending oil additives are not covered by the Mercedes-Benz Limited Warranty.

Air conditioning refrigerant

R-134a (HFC) refrigerant and special PAG lubricating oil are used in the air conditioning system.

Never use R-12 (CFC) or mineral-based lubricating oil. Otherwise damage to the system will occur.

Brake fluid

During vehicle operation, the boiling point of the brake fluid is continuously reduced through the absorption of moisture from the atmosphere.

Warning!



Under extremely strenuous operating conditions, this moisture content can lead to the formation of bubbles in the system, thus reducing the system's efficiency.

Therefore, the brake fluid must be replaced regularly. Refer to your vehicle's Maintenance Booklet for replacement interval.

Only brake fluid approved by Mercedes-Benz is recommended. An authorized Mercedes-Benz Center will provide you with additional information.

Premium unleaded gasoline

Warning!



Gasoline is highly flammable and poisonous. It burns violently and can cause serious personal injury.

Never allow sparks, flame or smoking materials near gasoline!

Turn off the engine before refueling

Whenever you are around gasoline, avoid inhaling fumes and skin or clothing contact, extinguish all smoking materials.

Direct skin contact with fuels and the inhalation of fuel vapors can be damaging to your health.

! To maintain the engine's durability and performance, premium unleaded gasoline must be used. If premium unleaded is not available and low octane fuel is used, follow these precautions:

- Have the fuel tank only partially filled with unleaded regular and fill up with premium unleaded as soon as possible.
- Avoid full throttle driving and abrupt acceleration.
- Do not exceed an engine speed of 3000 rpm if the vehicle is loaded with a light load such as two persons and no luggage.
- Do not exceed $\frac{2}{3}$ of maximum accelerator pedal position if the vehicle is fully loaded or operating in mountainous terrain.

Fuels, coolants, lubricants, etc.

Fuel requirements

Only use premium unleaded fuel:

- The octane number (posted at the pump) must be 91 min. It is an average of both the Research (R) octane number and the Motor (M) octane number: $(R+M) / 2$. This is also known as the ANTI-KNOCK INDEX.

Unleaded gasoline containing oxygenates such as ethanol, IPA, IBA and TBA can be used provided the ratio of any one of these oxygenates to gasoline does not exceed 10%; MTBE not to exceed 15%.

The ratio of methanol to gasoline must not exceed 3% plus additional cosolvents.

Using mixtures of ethanol and methanol is not allowed. Gasohol, which contains 10% ethanol and 90% unleaded gasoline, can be used.

These blends must also meet all other fuel requirements, such as resistance to spark knock, boiling range, vapor pressure, etc.

Gasoline additives

A major concern among engine manufacturers is carbon build-up caused by gasoline. Mercedes-Benz recommends only the use of quality gasoline containing additives that prevent the build-up of carbon deposits.

After an extended period of using fuels without such additives, carbon deposits can build up especially on the intake valves and in the combustion area, leading to engine performance problems such as:

- Warm-up hesitation
- Unstable idle
- Knocking/pinging
- Misfire
- Power loss

In areas where carbon deposits may be encountered due to lack of availability of gasolines which contain these additives, Mercedes-Benz recommends the use of additives approved by us for use on

Mercedes-Benz vehicles. Refer to Factory Approved Service Products pamphlet for a listing of approved product(s). Follow directions on product label.

Do not blend other fuel additives with fuel. This only results in unnecessary cost and may be harmful to the engine operation.

Damage or malfunction resulting from poor fuel quality or from blending additional fuel additives other than those tested and approved by us for use on Mercedes-Benz vehicles listed in the Factory Approved Service Products pamphlet are not covered by the Mercedes-Benz Limited Warranty.

Coolants

The engine coolant is a mixture of water and anticorrosion / antifreeze, which provides:

- Corrosion protection
- Freeze protection
- Boiling protection (by increasing the boiling point)

The cooling system was filled at the factory with a coolant providing freeze protection to approximately -22°F (-30°C) and corrosion protection.

! *Add premixed coolant solution only. Adding water and MB 325.0 Anticorrosion/Antifreeze separately from each other, could cause engine damage not covered by the Mercedes-Benz Limited Warranty*

If the antifreeze mixture is effective to -22°F (-30°C), the boiling point of the coolant in the pressurized cooling system is reached at approx. 266°F (130°C).

The coolant solution must be used year-round to provide the necessary corrosion protection and increase boil-over protection. Refer to Maintenance Booklet for replacement interval.

Coolant system design and coolant used determine the replacement interval. The replacement interval published in the Maintenance Booklet is only applicable if MB 325.0 Anticorrosion/Antifreeze solution or other Mercedes-Benz approved products of equal specification (see Factory Approved Service Products pamphlet) are used to renew the coolant concentration or bring it back up to the proper level.

To provide important corrosion protection, the solution must be at least 45% anticorrosion/antifreeze (equivalent to freeze protection to approx. -22°F [-30°C]). If you use a solution that is more than 55% anticorrosion/antifreeze (freeze protection to approx. -49°F [-45°C]), the engine temperature will increase due to the lower heat

transfer capability of the solution. Therefore, do not use more than this amount of anticorrosion/antifreeze.

If the coolant level is low, water and MB Anticorrosion/Antifreeze should be used to bring it up to the proper level (have cooling system checked for signs of leakage). Please make sure the mixture is in accordance with label instructions.

The water in the cooling system must meet minimum requirements, which are usually satisfied by normal drinking water. If you are not sure about the water quality, consult an authorized Mercedes-Benz Center.

Fuels, coolants, lubricants, etc.

Anticorrosion/antifreeze

Your vehicle contains a number of aluminum parts. The use of aluminum components in motor vehicle engines necessitates that anticorrosion/antifreeze coolant used in such engines be specifically formulated to protect the aluminum parts. (Failure to use such anticorrosion/antifreeze coolant will result in a significantly shortened service life.)

Therefore, the following product is strongly recommended for use in your vehicle:
Mercedes-Benz 325.0 Anticorrosion/Antifreeze agent.

Before the start of the winter season (or once a year in hot southern regions), you should have the anticorrosion/antifreeze concentration checked. The coolant is also regularly checked each time you bring your vehicle to an authorized Mercedes-Benz Center for service.

Anticorrosion/antifreeze quantity

Model	Approx. freeze protection	
	-35°F (-37°C)	-49°F (-45°C)
CLK 350	3.9 US qt (3.7 l)	4.3 US qt (4.1 l)
CLK 550	4.9 US qt (4.6 l)	5.3 US qt (5.1 l)
CLK 63 AMG	5.8 US qt (5.5 l)	6.3 US qt (6.0 l)

Windshield washer system and headlamp cleaning system*

Both the windshield washer and headlamp cleaning system are supplied from the windshield washer fluid reservoir.

The washer fluid reservoir has a capacity of approx. 6.4 US qt (6.0 l).

- ▶ Refill the reservoir with MB Windshield Washer Concentrate “MB SummerFit” and water (or concentrate and commercially available premixed windshield washer solvent / antifreeze, depending on ambient temperatures).

Warning!



Washer solvent/antifreeze is highly flammable. Do not spill washer solvent/antifreeze on hot engine parts, because it may ignite and burn. You could be seriously burned.

Windshield and headlamp washer fluid mixing ratio

For temperatures above freezing point, use MB Windshield Washer Concentrate “MB SummerFit” and water:

- 1 part “MB SummerFit” to 100 parts water
(1.34 fl oz [40 ml] “MB SummerFit” to 1 gallon [4.0 l] water)

For temperatures below freezing point, use MB Windshield Washer Concentrate “MB SummerFit” and commercially available premixed windshield washer solvent / antifreeze:

- 1 part “MB SummerFit” to 100 parts solvent
(1.34 fl oz [40 ml] “MB SummerFit” to 1 gallon [4.0 l] solvent)

- A**
- ABS 27, 88
 - Malfunction indicator lamp 366
 - Messages in display 380
 - Accelerator position,
 - automatic transmission 174
 - Accessory weight 347
 - Accident 57
 - Active head restraints 80
 - Resetting 424
 - Air bags 65
 - Children 82
 - Front passenger front
 - air bag off indicator lamp 74
 - Front, Driver 69
 - Front, Passenger 69
 - Head-thorax 70
 - Occupant Classification System (OCS) 71
 - Rear side-impact* 70
 - Safety guidelines 67
 - Air conditioning refrigerant 474
 - Air conditioning system see
 - Climate control system
 - Air conditioning, Cooling 196, 208
 - Air distribution 192, 203
 - Air pressure see
 - Tires, Inflation pressure
 - Air recirculation mode 194, 205
 - Air vents 197, 210
 - Air volume 192, 204
 - Alarm system see Anti-theft systems
 - Alignment bolt (vehicle tool kit) 404, 443
 - AMG menu (CLK 63 AMG only) 145
 - Lap analysis 149
 - Overall analysis 148
 - RACETIMER 149
 - Vehicle supply voltage 146
 - Anticorrosion/antifreeze 477, 478
 - Antiglare, Rear view mirror 184, 185
 - Antilock Brake System see ABS
 - Anti-theft alarm
 - system indicator lamp 29
 - Anti-theft systems 95
 - Anti-theft alarm system 95
 - Immobilizer 95
 - Aquaplaning see Hydroplaning
 - Armrest 278, 279
 - Ashtrays 280
 - Aspect ratio 347
 - ATF 319
 - AUDIO menu 149
 - CD player (CD, MP3-CD) 150
 - Radio station 149
 - Radio station (satellite*) 150
 - Search function 163
 - Audio system 211
 - Button and soft key operation 214
 - CD changer* 230
 - CD operation 227
 - Emergency calls "911" 247
 - MP3 228
 - Operating and display elements 212
 - Operating audio system 211
 - Operating safety 211
 - Radio operation 218
 - Sound system* 211, 215
 - Switching on/off 214
 - Telephone* operation 211, 234
 - Auto-dimming, Rear view mirror 185
 - Automatic central locking,
 - Control system 117, 164
 - Automatic climate control see
 - Climate control system
 - Automatic headlamp mode see Headlamps
 - Automatic lighting control,
 - Interior lighting 134

- Automatic locking when driving 117
- Automatic shift program 176
- Automatic transmission
 - Accelerator position 174
 - Automatic shift program 176
 - Emergency operation (limp-home mode) 183
 - Gear ranges 175
 - Gear selector lever 50, 170
 - Gear selector lever control one-touch gearshifting 177
 - Gear selector lever positions 172
 - Gear shifting malfunctions 183
 - Kickdown 174
 - Kickdown, manual shift program 183
 - Manual shift program
 - CLK 63 AMG 181
 - Program mode selector switch 176
 - Shifting procedure 171
 - Starting engine 50
 - Steering wheel gearshift control one-touch gearshifting* 179
 - Transmission fluid level 319
- Automatic Transmission Fluid see ATF
- B**
- Backrest
 - Seat, Multicontour* 121
 - Seat, Power 40
- Backup lamps
 - Messages in display 399
 - Replacing bulbs 427, 428
- Bar 347
- BAS 90
- Batteries, SmartKey
 - Changing 426
 - Checking battery condition 107
- Batteries, SmartKey with KEYLESS-GO*
 - Checking battery condition 107
- Battery, Vehicle 321, 447
 - Charging 449
 - Connecting 449
 - Disconnecting 448
 - Installing 449
 - Jump starting 450
 - Messages in display 388
 - Removing 448
- Bead 347
- Beverage holder see Cup holder
- Block heater (Canada only) 352
- Bolts, Spare wheel 409
- Brake fluid 475
 - Checking 314
 - Messages in display 389
- Brake lamp
 - Cleaning lenses 361
 - High mounted 428
 - Replacing bulbs 428
- Brake pads
 - Messages in display 389
- Brakes 302
 - High-performance brake system (CLK 63 AMG only) 303
 - Warning lamp 368
- Break-in period 300
- Bulbs, replacing see Replacing bulbs

- C**
- California retail buyers and lessees,
 - Important notice for 11
 - Call priority (Tele Aid) 292
 - Can holder see Cup holder
 - Capacities and
 - recommended fuels/lubricants 472
 - Cargo area see Trunk
 - Carpets, cleaning 363
 - Catalytic converter 310
 - CD changer* 227
 - MP3 228
 - CD player 227
 - Control system 150
 - Center console 29
 - Lower part 30
 - Upper part 29
 - Central locking
 - Automatic 117, 164
 - Locking/unlocking from inside 118
 - Central locking switch 118
 - Certification label 462
 - Certification label, examples 462
 - Charcoal filter 207
 - Children in the vehicle 82
 - Air bags 82
 - Blocking rear
 - side window operation 86
 - Front passenger front
 - air bag off indicator lamp 74
 - Infant and
 - child restraint systems 75, 82
 - LATCH-type child seat anchors 85
 - Occupant Classification System (OCS) 71
 - Cigarette lighter 282
 - Climate control see Climate control system
 - Climate control system
 - Air conditioning refrigerant 474
 - Air conditioning, Cooling 196, 208
 - Air distribution 192, 203
 - Air recirculation mode 194, 205
 - Air vents 197, 210
 - Air volume 192, 193, 204
 - Charcoal filter 207
 - Control panel,
 - Automatic climate control 199
 - Control panel, Climate control 189
 - Deactivating/Reactivating 191, 201
 - Defogging 204
 - Defrosting 204
 - Defrosting, Rear window 187
 - Front defroster 193
 - MAXCOOL 205
 - Residual engine heat
 - and ventilation* (REST*) 209
 - Temperature 192, 202
 - Clock 27, 138, 158
 - Setting time 158
 - Cockpit 24
 - Cold tire inflation pressure 347
 - Collapsible wheel chock 404, 407
 - COMAND* see separate COMAND operating instructions
 - Combination switch 54, 130
 - Control system 139
 - Functions 143
 - Multifunction display 139
 - Multifunction steering wheel 140
 - Resetting to factory default 153

- Control system menus 142, 143
 - AMG 145
 - AUDIO 149
 - NAV* 151
 - Settings 153
 - Settings, Submenus 154
 - Standard display 145
 - Submenus 141
 - TEL* 167
 - Trip computer 165
 - Vehicle status message memory 152
- Control system submenus 141, 143, 155
 - Convenience 164
 - Instrument cluster 156
 - Lighting 160
 - Time/Date 158
 - Vehicle 163
- Coolant 320, 477
 - Adding 320
 - Anticorrosion/antifreeze
 - mixing ratio and quantity 477
 - Capacities 472
 - Checking coolant level 320
 - Messages in display 390–392
 - Temperature 311
 - Temperature indicator 137
 - Warning lamp 371
- Coolants 477
- Corner-illuminating front fog lamps* 131
 - Replacing bulbs 428, 429
- Cruise control 263
 - Canceling 265
 - Cruise control lever 263
 - Current speed 264
 - Fine adjustment 266
 - Higher speed 265
 - Last stored speed
 - ("Resume" function) 266
 - Slower speed 266
- Cup holder 279
- Curb weight 347
- D**
 - Date 158
 - Date, Setting 159, 160
 - Daytime running lamp mode 128
 - Setting 160, 161
 - Deep water see Standing water
 - Defogging
 - Windshield 194, 204
 - Defrosting, Front 193, 204
 - Defrosting, Rear 187
 - Delayed shut-off
 - Exterior lamps 162
 - Interior lighting 163
 - Department of Transportation see DOT
 - Difficulties
 - With starting 52
 - Digital speedometer 145
 - Dimensions, Vehicle 471
 - Direction of rotation (tires) 326
 - Displays
 - Digital speedometer 145
 - Lap analysis 149
 - Maintenance service indicator 353
 - Messages in display 378
 - Multifunction display 139
 - Outside temperature 138

Overall analysis 148
 RACETIMER 146
 Symbol messages 388–403
 Text messages 380–386
 Vehicle status message memory 152
 Vehicle status messages see
 Multifunction display messages
 Vehicle supply voltage 146
 Distance to empty (Range),
 Trip computer 165, 166
 Door
 Control panel 32
 Entry lamps 135
 Handle 108
 Handle (inside) 32
 Locking/unlocking,
 KEYLESS-GO* 35, 62, 104
 Locking/unlocking,
 SmartKey 34, 62, 100
 Opening from inside/outside 108
 Remote door unlock (Tele Aid) 292
 Unlocking, Mechanical key 410
 DOT 347
 Drinking and driving 301

Driving
 Abroad 309
 Hydroplaning 306
 In winter 308
 Instructions 47, 301
 Problems 57
 Safety systems 88
 Systems 263
 Through standing water 309
 Driving off 304
 Driving safety systems
 ABS 88
 BAS 90
 Electronic traction system 92
 ESP® 90
 Driving systems
 Cruise control 263
 Parktronic system*
 (CLK 63 AMG (USA),
 Canada all vehicles) 267
 Driving tips 174
 Accelerator position 174
 Kickdown 174

E

Easy-entry/exit feature 44, 164
 Electrical fuses see Fuses
 Electrical outlet 283
 Electrical system, Technical data 470
 Electronic Stability Program see ESP®
 Emergency call system* 287
 Emergency calls
 911 calls 247
 Tele Aid calls 288, 289
 Emergency operation
 (Limp-Home Mode) 183
 Emergency operations
 Active head restraints, Resetting 424
 Center console,
 Indicator lamps 376–377
 Gear selector lever, Unlocking 412
 Instrument cluster,
 Indicator lamps 366–375
 Remote door unlock 292
 Roll bars, Lowering 414
 Roll bars, Releasing 413
 Soft top, Closing 415–423
 Trunk lid, Releasing from inside 116
 Trunk lid, Unlocking 411
 Unlocking/locking the vehicle 410

- Emergency tensioning device see ETD
 - Emergency, In case of
 - Battery, Jump starting 290, 450
 - First aid kit 404
 - Flat tire, Changing 436
 - Fuses 456
 - Hazard warning flasher 133
 - Roadside Assistance 12
 - Towing the vehicle 452
 - Emission control 310
 - Emission control information label 463
 - Emission control vacuum line
 - routing diagram label 463
 - Emission system warranties 10
 - Engine
 - Belt layout 464
 - Block heater (Canada only) 352
 - Break-in recommendations 300
 - Cleaning 358
 - Compartment 315
 - Malfunction
 - indicator lamp 27, 369, 370
 - Maximum engine speed 465
 - Messages in display 390
 - Number 463
 - Starting 50
 - Starting difficulties 52
 - Starting with KEYLESS-GO* 51
 - Starting with SmartKey 51
 - Technical data 465
 - Turning off 60
 - Turning off with KEYLESS-GO* 60
 - Turning off with SmartKey 60
 - Engine coolant see Coolant
 - Engine oil 317, 474
 - Adding 319, 474
 - Additives 474
 - Changing 319, 474
 - Checking level (Dipstick) 317
 - Consumption 317
 - Filler cap 319
 - Filler neck 319
 - Engine oil level 314
 - ESP® 27, 90
 - Messages in display 380–381
 - Warning lamp 372
 - ETD 79
 - Safety guidelines 67
 - Exterior rear view mirrors 45, 184
 - Exterior view 22
- F**
- Filler cap, Engine oil 319
 - Filler neck, Engine oil 319
 - First aid kit 404
 - Flat tire 436
 - Jacking up the vehicle 441
 - Lowering the vehicle 445
 - Minispare wheel 407
 - Mounting the spare wheel 441
 - Preparing the vehicle 436
 - TIREFIT (CLK 63 AMG only) 404
 - TIREFIT kit* 436
 - Flexible Service System see FSS (Canada vehicles)
 - Floor mats* 283
 - Fluids
 - Brake fluid 314, 475
 - Engine coolant 320, 477
 - Engine oil 317, 474
 - Transmission fluid 319
 - Windshield washer and headlamp cleaning* system 322, 479
 - Fog lamps 130, 428
 - Messages in display 397
 - Replacing bulbs 428
 - Front air bags 69

Front lamps see Headlamps
 Front passenger front air bag 65, 69
 Messages in display 382–385
 Front passenger front
 air bag off indicator lamp 29, 74, 376
 FSS (Canada vehicles) 353
 Fuel 313, 472
 Additives 476
 Automatic transmission fluid 472
 Brake fluid 473
 Capacities 472
 Capacities, Fuel tank 473
 Engine coolant 473
 Engine oil 472
 Filling the tank 312
 Fuel display 27
 Fuel filler flap and cap 312
 Fuel filler flap and cap, Multifunction
 display messages 393
 Fuel reserve warning lamp 373
 Power steering fluid 473
 Premium unleaded
 gasoline 313, 473, 475
 Requirements, Octane rating 476
 Technical data 472

Fuel cap
 Message in display 370
 Fuel consumption statistics
 From start 165
 Resetting 166
 Since last reset 166
 Fuel filler flap 312
 Locking/unlocking 312
 Opening 312
 Fuel reserve warning lamp 27
 Fuel tank
 Capacity 473
 Filler flap 312
 Message in display 395
 Fuel, Premium unleaded
 gasoline 313, 475, 476
 Fuels, coolants, lubricants etc.
 Capacities 472
 Fuses 456
 Fuse box (main)
 in passenger compartment 457
 Fuse box
 in engine compartment 457
 Fuse box
 in trunk 458
 Replacing 456

G

Garage door opener 31, 293
 Gasoline see Fuel
 GAWR 347
 Gear range
 Automatic transmission 175
 Limiting 175
 Shifting into optimal 178, 180
 Gear selector lever 30, 50, 170
 Cleaning 363
 Gearshift pattern 170
 Lock 51
 Message in display 386
 Position 171, 172
 Position indicator 27, 139
 Shifting procedure 171
 Unlocking in an emergency 412
 Gear selector lever one-touch gearshifting
 Automatic transmission 177
 Global locking/unlocking see
 Key, SmartKey or KEYLESS-GO*
 Glove box 25, 276
 Gloves 404
 Good visibility 184
 Gross Axle Weight Rating see GAWR
 Gross Vehicle Weight Rating see GVWR

Gross Vehicle Weight see GVW

GVW 347

GVWR 348

H

Halogen headlamp see Headlamps

Hands-free microphone 31

Hard plastic trim items, cleaning 363

Hazard warning flasher 133

Head restraints 40, 119

Active head restraints 80

Front seat 119

Power seat, Adjusting 40

Rear seat 119

Rear seat, Lowering 120

Rear seat, Raising 120

Headlamp cleaning

system* 184, 322, 479

Headlamp delayed shut-off see

Delayed shut-off, Exterior lamps

Headlamps

Automatic headlamp mode 127

Bi-Xenon* 431

Cleaning lenses 361

Daytime running lamp mode 128

Halogen 430

High beam see High beam flasher

High beam see High beam headlamps

Light sensor 396

Locator lighting 129

Low beam see Low beam headlamps

Manual headlamp mode 127

Messages in display 397–400

Night security illumination 129

Replacing bulbs 430, 432

Switch 54, 126

Headliner and shelf below rear window,

Cleaning and care of 363

Head-thorax air bag 70

Heated seats* 122

High beam flasher 54, 131

Replacing bulbs

(Bi-Xenon*) 428, 431

Replacing bulbs

(Halogen) 428, 430

High beam headlamps 54, 131

Indicator lamp 27

Messages in display 397

Replacing bulbs

(Bi-Xenon*) 428, 429

Replacing bulbs

(Halogen) 428, 430

Replacing bulbs for high beam flasher

(Bi-Xenon*) 431

Switching on 54, 131

High mounted brake lamp 428

Hood 315

Horn 25

HVAC see Climate control system

Hydroplaning 306

I

- Identification labels 462
- Identification number,
 - Vehicle (VIN) 462, 463
- Ignition
 - with KEYLESS-GO* 38
 - with SmartKey 36
- Immobilizer 95
- Indicator lamps see
 - Lamps, indicator and warning
- Infant and child restraint systems see
 - Children in the vehicle 82
- Inflation pressure see
 - Tires, Inflation pressure
- Inside door handle 32, 108
- Instrument cluster 26, 136
 - Illumination brightness 136
 - Lamps in 366–375
 - Messages in display see
 - Multifunction display messages
 - Multifunction display 139
- Instrument lighting see
 - Instrument cluster, Illumination brightness
- Instrument panel see Instrument cluster
- Instruments and controls see Cockpit

- Interior lighting 134
 - Delayed shut-off 163
- Interior rear view mirror 45, 184
 - Antiglare position 184
 - Auto-dimming 185
- Interior storage spaces see
 - Storage compartments

J

- Jack 406
- Jacking up the vehicle 441
- Jump starting 450

K

- Key, Mechanical 410
- Key, SmartKey 98
 - Batteries 107
 - Battery check lamp 100, 105
 - Changing batteries 426
 - Factory setting 100, 101
 - Ignition 36
 - Locking/unlocking 34, 62, 98
 - Locking/unlocking,
 - Global setting 100
 - Locking/unlocking,
 - Selective setting 100
 - Loss of 107
 - Message in display 395, 396
 - Opening and closing
 - the power windows 252
 - Opening and closing
 - the soft top 259
 - Positions in starter switch 36
 - Remote control 98
 - SmartKey with KEYLESS-GO* 101
 - Starting the engine 51
 - Steering wheel lock 36
 - Turning off the engine 60
 - Unlocking/opening trunk lid 101

KEYLESS-GO* 101

- Batteries in SmartKey 107
 - Battery check lamp, SmartKey 105
 - Factory setting 104, 106
 - Ignition 38
 - Important notes 103
 - Lock button 62
 - Locking/unlocking 35, 62, 101
 - Locking/unlocking,
 - Global setting 104, 105
 - Locking/unlocking,
 - Global with lock button on trunk lid 106
 - Locking/unlocking,
 - Selective setting 105, 106
 - Loss of key 107
 - Messages in display 395, 396
 - Remote control 101
 - Start/stop button 37
 - Starting the engine 51
 - Turning off the engine 60
 - Unlocking/opening trunk lid 107
- Kickdown 174
 - Kilopascal 348

L

- Labels 462
 - Certification 462
 - Emission control information 463
 - Vacuum line routing diagram 463
- Lamp sensor see Light sensor
- Lamps, exterior 427
 - Light sensor 396
 - Messages in display 397–400
- Lamps, indicator and warning
 - ABS 27, 366
 - Battery (SmartKey) 100, 105
 - Brakes 27, 368
 - Center console 376–377
 - CHECK ENGINE 369, 370
 - Coolant 371
 - Coolant temperature 27, 137
 - Distance warning 27
 - Engine diagnostics 369, 370
 - Engine malfunction 27, 369, 370
 - ESP® 27, 372
 - Fog lamps 130
 - Front passenger front air bag off 69
 - Front passenger front
 - air bag off indicator lamp 376
 - Fuel reserve 27, 373
 - High beam headlamp 27
 - Instrument cluster 366–375
 - Low beam headlamp 27
 - Parktronic system*
 - (CLK 63 AMG (USA), Canada all vehicles)
 - warning indicators 269
 - Roll bar 373
 - Seat belt telltale 27, 78
 - SRS 27, 65, 375
 - Turn signals 27
- Language, Setting 156
- LATCH-type child seat anchors see
 - Children in the vehicle
- License plate lamps
 - Messages in display 398
 - Replacing bulbs 428, 433
- Light alloy wheels, cleaning 362
- Light sensor
 - Messages in display 396
- Lighter see Cigarette lighter
- Lighting, Exterior and interior 126
- Limp-home mode 183
- Loading
 - Ski sack* (Canada only) 271
- Loading see Vehicle loading

Loading the vehicle 326
 Locator lighting 129, 161
 Lock buttons
 Door handle (KEYLESS-GO*) 62, 105
 Trunk lid (KEYLESS-GO*) 106
 Locking 62
 Loss of keys 107
 Loss of Service and
 Warranty Information Booklet 461
 Low beam headlamps
 Indicator lamp 27
 Messages in display 398
 Replacing bulbs (Bi-Xenon*) 428
 Replacing bulbs (Halogen) 428, 430
 Switching on 54
 Lubricants 472
 Luggage cover 260
 Folding back 271

M

Maintenance 12, 353
 Calling up service indicator 355
 Clearing service indicator 354
 Maintenance System 353
 Resetting service indicator 355
 Service indicator 353
 Service term exceeded 354
 Maintenance system 353
 Manual headlamp mode see Headlamps
 Manual shift program
 Deactivating 183
 Manual shift program CLK 63 AMG 181
 MAXCOOL maximum cooling 205
 Maximum load rating, Tires 348
 Maximum loaded vehicle weight,
 Tire inflation pressure 348
 Maximum tire inflation pressure 348
 Mechanical key 410
 Memory function see Seats, Power
 Menus see Control system menus
 Microphone, Hands-free 31
 Minispare wheel see Spare wheel

Mirrors

 Adjusting 45
 Antiglare position 184
 Auto-dimming 185
 Exterior rear view mirrors 45
 Interior rear view mirror 45
 Mobile phone see Telephone*
 MOE tires* see *MOExtended system**
 MOE* see *MOExtended system**
*MOExtended system** 446
 *MOExtended tires** 466
 MON 313
 MP3 228
 Multicontour seat* see
 Seats, Multicontour*
 Multifunction display 139
 Changing settings see
 Control system menus and
 Control system submenus
 Selecting language 156
 Symbol messages 388–403
 Text messages 380–386

Multifunction display messages 378

- ABS 380
- Battery 388
- Brake fluid 389
- Brake pads 389
- Check engine 390
- Coolant 390–392
- Engine 390
- Engine coolant 390–392
- ESP® 380
- Fog lamps 397
- Front passenger
 - front air bag 382–385
- Fuel cap 393
- Fuel reserve tank 395
- Gear selector lever 386
- Headlamps 397–400
- Key, SmartKey 395
- KEYLESS-GO* 395
- Lamps 397
- Lamps, exterior 397–400
- License plate lamp 398
- Light sensor 396
- Parking brake 389
- Parking lamps 398
- Roll bars 386

- Soft top 402
- SRS 401
- Steering gear oil 402
- Tele Aid 401
- Telephone* 403
- Turn signals 397
- Windshield washer fluid 403
- Multifunction steering wheel 28, 140
 - Button operation 140

N

- Navigation system* 151
 - See separate
 - COMAND* operating instructions
- Net, Parcel 277
- Neutral gear position,
 - Automatic transmission 170, 172
- New vehicle break-in 300
- Night security illumination 129
- Normal occupant weight 348
- Number, paintwork code 462
- Number, vehicle identification (VIN) 462, 463

O

- Occupant Classification System see OCS
- Occupant distribution 348
- Occupant safety 64
 - Active head restraints 80
 - Air bags 65
 - Children and air bags 82
 - Children in the vehicle 82
 - ETD 79
 - Fastening the seat belts 47
 - Front air bags 69
 - Front passenger front
 - air bag off indicator lamp 74, 376
 - Head-thorax air bags 70
 - Infant and child restraint systems 82
 - LATCH-type child seat anchors 85
 - OCS 71
 - Rear side-impact air bags* 70
 - Roll bars 81
 - Safety guidelines,
 - Seat belts, Air bag, ETD 67
 - Seat belts 47, 75
 - SRS 64

- OCS 71
 - Self-test 75
- Odometer 27
- Oil level see Engine oil, checking level
- Oil see Engine oil
- One-touch gearshifting
 - Gear selector lever 177
 - Steering wheel gearshift control* 179
- Operating safety 211
- Operating the vehicle
 - outside the USA or Canada 13
- Ornamental moldings, cleaning 360
- Outside temperature see Displays
- Overdue maintenance service 354
- Overhead control panel 31

- P**
- Paintwork code 462
- Paintwork, Cleaning 357
- Panic alarm 87
- Parcel net
 - Front passenger footwell 277
- Parking 58, 304
 - Over combustible materials 58, 304
- Parking assist* see Parktronic system*
 - (CLK 63 AMG (USA), Canada all vehicles)
- Parking brake 52, 58
 - Message in display 389
 - Warning sounds 53
- Parking lamps 126
 - Message in display 398
 - Replacing bulbs 428, 431, 432
- Parktronic 270
- Parktronic system*
 - (CLK 63 AMG (USA), Canada all vehicles) 267
 - Cleaning system sensors 361
 - Malfunction 270
 - Range of the sensors 268
 - Switching on/off 270

- Warning indicators 269
- Warning sounds 269, 270
- Parts service 460
- PASS AIR BAG OFF indicator lamp see Front passenger front air bag off indicator lamp
- Passenger compartment 309
 - Electrical outlet 283
 - Interior lighting 134
 - Interior rear view mirror 45
 - Main fuse box 457
 - Parcel net in
 - front passenger footwell 277
 - Storage bags, rear side of the front seats 277
- Passenger safety see Occupant safety
- Pedals 301
- Phone see Telephone
- Plastic parts, cleaning 363
- Poly-V-belt drive
 - Layout 464
- Positions (Memory function) see Seats, Power
- Power assistance 302
- Power seat see Seats, Power
- Power washer 357

- Power windows 249
 - Cleaning 362
 - Convenience closing feature 253
 - Express opening/closing 250, 251
 - Opening with soft top switch 254
 - Operating 249
 - Rear side windows,
 - Blocking operation 86
 - Summer opening feature 252
 - Synchronizing 251
 - Practical hints 365
 - Premium unleaded gasoline 475
 - Problems
 - While driving 57
 - With vehicle 17
 - Product information 9
 - Production options weight 348
 - Program mode see
 - Automatic transmission,
 - Automatic shift program
 - Program mode selector switch
 - Automatic shift program 176
 - PSI 348
 - Push-start see Tow-start
-
- R**
 - RACETIMER (CLK 63 AMG only) 146
 - Radio
 - Operation 218
 - Search function 163
 - Selecting stations 149
 - Selecting stations (satellite*) 150
 - Radio transmitters 309
 - Range (distance to empty) 166
 - Reading lamp 31, 135
 - Rear fog lamp see Fog lamps
 - Rear lamps see Tail lamps
 - Rear seat ashtray see Ashtrays
 - Rear seat head restraints see
 - Head restraints
 - Rear side windows
 - Blocking operation 86
 - Rear side-impact air bags* 70
 - Rear view mirrors see Mirrors
 - Rear window defroster 187
 - Recommended
 - engine oils and oil filter 474
 - Recommended
 - tire inflation pressure 348
 - Recovery services,
 - Stolen vehicle (Tele Aid) 293
 - Refrigerant, Air conditioning 474
 - Refueling 312
 - Regular checks 314
 - Reminder, Seat belt see Seat belts, Telltale
 - Remote control
 - SmartKey 98, 102
 - SmartKey with KEYLESS-GO* 101
 - Remote door unlock (Tele Aid) 292
 - Removing
 - Ski sack* (Canada only) 274
 - Replacing bulbs 427
 - Additional turn signals 428, 429
 - Backup lamps 428
 - Brake lamps 428
 - Corner-illuminating
 - front fog lamps* 428, 429
 - Fog lamps 428
 - Headlamp bulbs 430
 - Headlamps 428
 - High beam flasher
 - (Bi-Xenon*) 428, 431
 - High beam flasher
 - (Halogen) 428, 430
 - High beam headlamps
 - (Bi-Xenon*) 428, 431

- High beam headlamps
 - (Halogen) 428, 430
- High mounted brake lamp 429
- License plate lamps 428, 433
- Low beam headlamps
 - (Bi-Xenon*) 428, 431
- Low beam headlamps
 - (Halogen) 428, 430
- Parking lamps 428, 431, 432
- Side marker lamps 428
- Standing lamps 428, 431, 432
- Tail lamps 428, 432
- Turn signal lamps 428
- Turn signal lamps (Bi-Xenon*) 432
- Turn signal lamps (Halogen) 431
- Reporting safety defects 18
- Reset button, In
 - instrument cluster 27, 136, 153, 154
- Residual heat and ventilation* see REST*
- REST* 209
- Restraint system see
 - Children in the vehicle
- Reverse gear position,
 - Automatic transmission 170, 172
- Rims 348, 466
- Roadside Assistance 12, 290
- Roll bar 81
 - Messages in display 386
 - Operating manually 413
 - Warning lamp 373
- RON 313
- Rubber parts, cleaning 363
- Run Flat Indicator (Canada only) 334
- S**
- Safety
 - Driving safety systems 88
 - Occupant 64
 - Reporting defects 18
- Safety belts see Seat belts
- Satellite radio* 222
- Seat belts 75
 - Automatic comfort-fit feature 79
 - Cleaning 364
 - ETD 79
 - Fastening 47
 - Force limiter 79
 - Proper use of 49, 77
 - Safety guidelines 67
 - Telltale 27, 78
- Seating capacity 327
- Seats, Multicontour* 121
 - Backrest contour 121
 - Backrest side bolsters 121
 - Cushion depth 121
- Seats, Power 39, 119
 - Active head restraints 80
 - Adjustment 40
 - Easy entry/exit feature 44
 - Heating* 122
 - Memory function 124
 - Ventilation* 123
- Selector lever see Gear selector lever
- Self-test
 - OCS 75
 - Tele Aid 287
- Service and Warranty Booklet
 - Loss of 461
- Service and warranty information 10
- Service intervals see
 - Maintenance, Service indicator
- Service life, Tires 324
- Service see Maintenance
- Service System see
 - Maintenance service system (U.S. vehicles) or
 - FSS (Canada vehicles)

- Service, Parts 460
- Settings
 - Control system menus 142
 - Control system submenus 143
 - Date 159, 160
 - Factory, KEYLESS-GO* 104
 - Factory, SmartKey 100
 - Global, KEYLESS-GO* 104
 - Global, SmartKey 100
 - Individual vehicle 153
 - Memory function 124
 - Menus and submenus 141
 - Resetting all, Control system 153
 - Selective, KEYLESS-GO* 105
 - Selective, SmartKey 100
 - Time 158
- Shelf below rear window, Cleaning 363
- Shift program mode,
 - Automatic transmission 176
- Shifting
 - Gear selector lever 50
- Shifting,
 - Automatic transmission 53, 170
- Side marker lamps
 - Cleaning lenses 361
 - Messages in display 399
 - Replacing bulbs 428
- Side windows see Power windows
- Sidewall 348
- Ski sack* (Canada only) 271
 - Removing 274
 - Ski sack roller blind 271, 274
 - Unfolding and loading 271
 - Unloading and folding 273
- SmartKey see Key, SmartKey 98
- SmartKey with KEYLESS-GO* see KEYLESS-GO*
- Snow chains 352
- Snow tires 351
- Soft top 255
 - Cleaning 359
 - Emergency operations 415–423
 - Locking after raising/lowering 258
 - Luggage cover 260
 - Messages in display 402
 - Opening/closing 255
 - Opening/closing,
 - SmartKey 259
 - Opening/closing,
 - Soft top switch 256, 257
 - Wind screen 261
- Soft top switch 254, 256
- Sound system* 211, 215
- Spare fuses 404, 456
- Spare parts service see Parts service
- Spare wheel 407
 - Bolts 404, 409
 - Mounting 441
 - Sizes 469
- Speedometer 27, 156
- SRS 65, 77
 - Indicator lamp 27, 65, 375
- Standard display, Selecting display 157
- Standing lamps 126
 - Replacing bulbs 428, 431, 432
- Standing water, Driving through 309
- Starter switch 25, 36
 - Positions 36
- Starting difficulties, Engine 52
- Starting, Engine 50
- Status line, Selecting display 157
- Steering column 43
- Steering gear oil
 - Message in display 402

- Steering wheel 43
 - Buttons 28
 - Cleaning 363
 - Lock 52
 - Steering wheel gearshift control
 - one-touch gearshifting*
 - Automatic transmission 179
 - Stolen Vehicle Recovery services 293
 - Storage box 276
 - Storage compartments 276
 - Armrest, Front 278
 - Armrest, Rear 279
 - Cup holder 279
 - Glove box 276
 - Parcel net 277
 - Storage bags 277
 - Storage box 276
 - Telephone* 278
 - Storing
 - Tires 325
 - Submenus see
 - Control system submenus 141
 - Sun visors 186
 - Symbols used
 - in this operator's manual 15
- T**
- Tachometer 27, 138
 - Overspeed range 138
 - Tail lamps
 - Cleaning lenses 361
 - Messages in display 399
 - Replacing bulbs 428, 432
 - Tar stains 357
 - Technical data
 - Air conditioning refrigerant 474
 - Brake fluid 475
 - Capacities fuels, coolants, lubricants etc. 472, 473
 - Coolant 473, 477
 - Electrical system 470
 - Engine 465
 - Engine oil 474
 - Engine oil additives 474
 - Fuel capacity 473
 - Fuel requirements 476
 - Gasoline additives 476
 - Lubricants 472
 - Premium unleaded gasoline 475
 - Rims and tires 466
 - Tires, Mixed size 468
 - Tires, Same size 467
 - Tires, Spare wheel sizes 469
 - Vehicle dimensions 471
 - Weights 471
 - Windshield washer and headlamp
 - cleaning* system 473, 479
- Tele Aid 31, 287
- Call priority 292
 - Emergency calls 288
 - Hands-free microphone 31
 - Information 291
 - Initiating an
 - emergency call manually 289
 - Messages in display 401
 - Remote door unlock 292
 - Roadside Assistance 290
 - SOS button 289
 - Stolen Vehicle
 - Recovery services 293
 - System self-check 287
 - Tele Aid System 287

- Telephone* 28, 167, 284
 - Answering/ending a call 168
 - Changing mobile phone cradle 286
 - Compartment 278
 - Hands-free microphone 31
 - Inserting in cradle 285
 - Installing a different
 - mobile phone cradle 286
 - Messages in display 403
 - Operation 167, 234
 - Phone book* 168
 - Redialing 169
 - Removing from cradle 286
 - TEL menu* 167
- Temperature
 - Interior temperature 192, 202
- Tightening torque, Wheel bolts 445
- Time 158
- Time, Setting 158
- TIN 349
- Tire and Loading Information
 - Placard 327
 - Terminology 347
- Tire inflation pressure 438
 - Checking 331
- Tire inflation pressure see
 - the placard on the fuel filler flap
- TIREFIT (CLK 63 AMG only) 404
- TIREFIT*
 - Instructions for use 436
- Tires 323, 466
 - Air pressure 347
 - Care and maintenance 324
 - Chains 352
 - Cleaning 325
 - Direction of rotation, Spinning 326
 - Driving instructions 305
 - Important notes,
 - Tire inflation pressure 332
 - Inflation pressure 314, 331, 333
 - Inflation pressure,
 - Information placard 331
 - Inspection 324
 - Load rating 349
 - MO*Extended* system* 446
 - MO*Extended** 336, 466
 - Ply composition
 - and material used 349
 - Problems under-/overinflated 336
 - Retreads 323
 - Rims and tires 466
- Rotation 350
- Run Flat Indicator 334
- Service life 324
- Sizes 467
- Snow 351
- Spare wheel 407, 441, 469
- Speed rating 307, 339, 349
- Storing 325
- Temperature 346
- Terminology 347
- Tire Identification Number see TIN
- TIREFIT (CLK 63 AMG only) 404
- Traction 306, 349
- Tread 349
- Tread depth 325, 351
- Treadwear indicators 349
- Wear pattern 350
- Winter 351
- Tools 404
- Top tether
 - Children in the vehicle 85
- Towing eye bolt 454
 - CLK 550, CLK 63 AMG 455
- Towing the vehicle 452
- Tow-start 450, 452
- Traction 92, 306, 349

Transmission see Automatic transmission
 Traveling abroad 309
 Tread 349
 Tread depth 325, 351
 Treadwear indicators 349
 Trip computer 165
 Trip odometer 137
 Trunk
 Closing from inside 110
 Fuse box 458
 Lamp 135
 Lid 109
 Lock button, KEYLESS-GO* 106
 Luggage cover 260
 Opening 109
 Opening from inside 109
 Trunk lid 110
 Trunk lid emergency release 116
 Unlocking in an emergency 411
 Unlocking/opening,
 KEYLESS-GO* 107
 Unlocking/opening,
 SmartKey 101
 Valet locking 117

Turn signal lamps
 Cleaning lenses 361
 Messages in display 397
 Replacing bulbs (Bi-Xenon*) 432
 Replacing bulbs (Halogen) 431
 Turn signals 55
 Additional in mirrors 428
 Bulbs 428
 Bulbs (Bi-Xenon*) 432
 Bulbs (Halogen) 431
 Cleaning lenses 361
 Indicator lamps 27
 Turning off engine 60

U

Uniform Tire Quality Grading
 Standards 349
 Units, Settings
 Speedometer 156
 Unleaded gasoline, Premium 475
 Upholstery, Cleaning 364
 Useful features 276

V

Vacuum line routing diagram label 463
 Vehicle
 Battery 321, 447
 Break-in period 300
 Care 356
 Control system, Settings menu 153
 Dimensions 471
 Jump starting 450
 Locking/unlocking,
 KEYLESS-GO* 35, 62, 101
 Locking/unlocking,
 SmartKey 34, 62, 98
 Lowering 445
 Modifications and alterations,
 Operating safety 16
 Towing 452
 Unlocking/locking
 in an emergency 410, 411
 Washing 358
 Weights 471
 Vehicle identification number see VIN
 Vehicle jack 406, 442
 Vehicle lighting 126, 314

- Vehicle loading
 - Instructions 275, 326
 - Load limit 326
 - Terminology 347
 - Vehicle maximum load on the tire 349
 - Vehicle recovery services,
 - Stolen (Tele Aid) 293
 - Vehicle status message memory 152
 - Vehicle status messages 378
 - Vehicle system settings,
 - Control system 139
 - Vehicle tool kit 404
 - Vehicle washing 358
 - VIN 462
- W**
- Warning indicators
 - Parktronic system*
 - (CLK 63 AMG (USA),
Canada all vehicles) 269
 - Warning sounds
 - Driver's or passenger's seat belt 78
 - Parking brake 53
 - Parktronic system*
 - (CLK 63 AMG (USA),
Canada all vehicles) 269, 270
 - Seat belt telltale 374
 - Warranty coverage 10, 461
 - Washer fluid see Windshield washer fluid
 - Washer reservoir level 473
 - Washing the vehicle 358
 - Wear pattern, Tires 350
 - Weights, Vehicle 471
 - Wheel
 - Bolts 409
 - Change 441
 - Collapsible wheel chock 407
 - Removing 443
 - Spare 407
 - Tightening torque 445
 - TIREFIT (CLK 63 AMG only) 404
 - Wrench 442
 - Wheels, Sizes 467
 - Wheels, Tires and 323
 - Wind screen 261
 - Windows see Power windows
 - Windshield
 - Cleaning 56, 362
 - Defogging 194, 204
 - Windshield washer fluid 322, 479
 - Message in display 403
 - Mixing ratio 479
 - Refilling 322
 - Reservoir level 473
 - Wiping 56
 - Windshield washer system 473, 479
 - Windshield wipers 55
 - Cleaning wiper blades 362
 - Replacing wiper blades 434
 - Winter driving 351
 - Block heater (Canada only) 352
 - Snow chains 352
 - Tires 351
 - Winter driving instructions 308
 - Winter tires 351
 - Wood trims, cleaning 364

Service and Literature

Your authorized Mercedes-Benz Center has trained technicians and original Mercedes-Benz parts to service your vehicle properly. For expert advice and quality service, contact an authorized Mercedes-Benz Center.

If you are interested in obtaining service literature for your vehicle, please contact an authorized Mercedes-Benz Center. We consider this the best way for you to obtain accurate information for your vehicle.

For further information you can find us on the Mercedes-Benz web-site www.mbusa.com or www.mercedes-benz.ca.

Warning!



To help avoid personal injury, be extremely careful when performing any service work or repairs. Improper or incomplete service or the use of incorrect or inappropriate parts or materials may damage the vehicle or its equipment, which may in turn result in personal injury.

If you have questions about carrying out any type of service, turn to the advice of an authorized Mercedes-Benz Center.

We reserve the right to make changes in design and equipment. Therefore, information, illustrations and descriptions in this Operator's Manual might differ from your vehicle. Reprinting, translation and copying, even of excerpts, is not permitted without our prior authorization in writing.

Press time May 9, 2006

GSP/TIP

Printed in Germany

