



2515841381

Order No. 6515 1803 13 Part No. 251 584 13 81 USA Edition B, 2006

Operator's Manual R-Class



Operator's Manual
R-Class



Mercedes-Benz

R 350

R 500

Our company and staff congratulate you on the purchase of your new Mercedes-Benz.

Your selection of our product is a demonstration of your trust in our company name. Furthermore, it exemplifies your desire to own an automobile that will be as easy as possible to operate and provide years of service.

Your Mercedes-Benz represents the efforts of many skilled engineers and craftsmen. To help assure your driving pleasure, and also the safety of you and your passengers, we ask you to make a small investment of time:

- Please read this manual carefully, then return it to your vehicle where it will be handy for your reference.
- Please follow the recommendations contained in this manual. They are designed to acquaint you with the operation of your Mercedes-Benz.
- Please pay attention to the warnings and cautions contained in this manual. They are designed to help improve the safety of the vehicle operator and occupants.

We extend our best wishes for many miles of safe, pleasurable driving.

Mercedes-Benz USA, LLC
A DaimlerChrysler Company

Introduction	9
Product information	9
Operator's Manual	10
Service and warranty information ..	10
Important notice for California retail buyers and lessees of Mercedes-Benz automobiles	11
Maintenance	12
Roadside Assistance	12
Change of address or ownership....	13
Operating your vehicle outside the USA or Canada.....	13
Where to find it.....	14
Symbols.....	15
Operating safety	16
Proper use of the vehicle	16
Problems with your vehicle.....	17
Reporting safety defects.....	18
Reporting safety defects	18
Vehicle data recording.....	19
Information regarding electronic recording devices.....	19

At a glance	21
Cockpit.....	22
Instrument cluster	24
Multifunction steering wheel	28
Center console	29
Upper part	29
Lower part	30
Overhead control panel	31
Storage compartments.....	32
Door control panel.....	34

Getting started	35
Unlocking	36
Unlocking with the SmartKey	36
Unlocking with Keyless-Go*	37
Starter switch positions.....	38
Adjusting.....	42
Seats	42
Steering wheel.....	45
Mirrors.....	47
Driving.....	50
Fastening the seat belts	50
Starting the engine	53
Parking brake	56
Driving	56
Switching on headlamps.....	58
Turn signals	58
Windshield wipers.....	59
Rear window wiper/washer	61
Problems while driving.....	62
Parking and locking.....	64
Parking brake	65
Switching off headlamps.....	65
Turning off the engine.....	66
Releasing seat belts.....	67
Locking.....	67

Safety and Security	69
Occupant safety	70
Air bags	71
Seat belts	77
Preventive occupant safety* (PRE-SAFE®)	81
Children in the vehicle	82
Blocking of rear door window operation	93
Panic alarm	95
Activating	96
Deactivating	96
Driving safety systems	97
ABS	97
BAS	99
ESP®	99
EBP	102
4-ETS	102
Anti-theft systems	104
Immobilizer	104
Anti-theft alarm system	104
Tow-away alarm	106

Controls in detail	109
Locking and unlocking	110
SmartKey	110
SmartKey with KEYLESS-GO*	114
Opening the doors from the inside	121
Opening the tailgate	122
Closing the tailgate	124
Automatic central locking	130
Locking and unlocking from the inside	131
Seats	132
Easy-entry/exit feature*	132
Lumbar support	136
Multicontour seat*	136
Rear seats	137
Seat heating*	141
Memory function*	144
Storing positions into memory	145
Recalling positions from memory	145
Storing exterior rear view mirror parking position	146
Lighting	147
Exterior lamp switch	147
Combination switch	151

Corner-illuminating front fog lamps*	152
Hazard warning flasher	153
Interior lighting	154
Door entry lamps	157
Cargo compartment lamp	157
Instrument cluster	158
Instrument cluster illumination	158
Trip odometer	159
Tachometer	159
Outside temperature indicator	159
Control system	161
Multifunction display	161
Multifunction steering wheel	162
Menus	164
Standard display menu	168
AUDIO menu	170
NAV* menu	172
AIRMATIC* /Compass menu	172
Vehicle status message memory menu	173
Settings menu	174
Vehicle configuration	191
Trip computer menu	192
TEL menu*	194

Automatic transmission.....	197	Setting the temperature.....	222	Power windows	248
Gear selector lever.....	197	Adjusting air distribution.....	222	Opening and closing	248
Shifting procedure	199	Adjusting air volume	222	Synchronizing the door windows ..	251
Transmission positions.....	200	Front defroster.....	223	Summer opening feature	251
Gear ranges	202	Air recirculation mode	224	Convenience closing feature.....	252
Driving tips.....	203	Air conditioning.....	226	Power tilt/sliding sunroof*	255
Automatic shift program	204	Residual heat and ventilation.....	227	Opening and closing	255
Steering wheel gearshift control ..	205	Rear climate control	228	Synchronizing	258
Emergency operation		3-zone automatic climate control*	230	Panorama roof with power	
(Limp Home Mode)	207	Deactivating the climate control		tilt/sliding panel*	259
Good visibility	208	system	234	Roller sunblinds for the	
Headlamp cleaning system*	208	Operating the climate control		panorama roof with power	
Rear view mirrors.....	208	system in automatic mode.....	235	tilt/sliding panel	259
Power folding exterior rear view		Setting the temperature.....	236	Opening and closing the	
mirrors*	211	Adjusting air distribution.....	236	panorama roof with power	
Sun visors	212	Adjusting air volume	237	tilt/sliding panel	260
Rear door window sunshade*	214	Front defroster.....	238	Synchronizing the panorama roof	
Third-row sunshade*	214	Maximum cooling MAX COOL	239	with power tilt/sliding panel.....	262
Rear window defroster	215	Air recirculation mode	239	Driving systems.....	264
Climate control.....	216	Air conditioning.....	241	Cruise control	264
Deactivating the climate control		Using driver-side settings for all		AIRMATIC*	269
system	220	temperature zones.....	242	Parktronic* (Parking assist)	274
Operating the climate control		Residual heat and ventilation.....	243		
system in automatic mode.....	221	Rear automatic climate control.....	244		

Contents

Loading.....	279		
Roof rack*.....	279		
Loading instructions.....	280		
Cargo tie-down rings.....	281		
Hooks.....	282		
Expanding cargo compartment	283		
Cargo compartment cover blind* .	288		
Partition net*.....	290		
Useful features.....	294		
Storage compartments.....	294		
Parcel nets.....	298		
Cup holders.....	299		
Ashtrays*.....	302		
Cigarette lighter*.....	305		
Power outlets.....	306		
Rear center console*.....	308		
Telephone*.....	310		
Tele Aid*.....	311		
Garage door opener*.....	320		
Compass.....	327		
Floormats*.....	328		
Infrared reflecting windshield*.....	328		
Operation	329		
The first 1000 miles (1500 km).....	330		
Driving instructions.....	331		
Drive sensibly – save fuel.....	331		
Drinking and driving.....	331		
Pedals.....	331		
Power assistance.....	331		
Brakes.....	332		
Driving off.....	333		
Parking.....	334		
Tires.....	334		
Hydroplaning.....	335		
Tire traction.....	335		
Tire speed rating.....	336		
Winter driving instructions.....	337		
Standing water.....	338		
Passenger compartment.....	338		
Driving abroad.....	339		
Control and operation of radio transmitters.....	339		
Catalytic converter.....	340		
Emission control.....	340		
Coolant temperature.....	341		
		At the gas station.....	342
		Refueling.....	342
		Check regularly and before a long trip.....	343
		Engine compartment.....	345
		Hood.....	345
		Engine oil.....	346
		Transmission fluid level.....	350
		Coolant level.....	351
		Windshield/rear window washer system and headlamp cleaning system*.....	352
		Tires and wheels.....	353
		Important guidelines.....	353
		Tire care and maintenance.....	354
		Direction of rotation.....	356
		Loading the vehicle.....	356
		Recommended tire inflation pressure.....	363
		Checking tire inflation pressure... ..	365
		Tire labeling.....	375
		Load identification.....	380
		DOT, Tire Identification Number (TIN).....	380
		Maximum tire load.....	382
		Maximum tire inflation pressure ..	382

Uniform Tire Quality Grading Standards (U.S. vehicles)	383		
Tire ply material	385		
Tire and loading terminology	385		
Rotating tires	388		
Winter driving	390		
Winter tires	390		
Block heater (Canada only)	391		
Snow chains	391		
Maintenance	392		
Clearing the maintenance service indicator	393		
Maintenance service term exceeded	393		
Calling up the maintenance service indicator	393		
Resetting the maintenance service indicator	394		
Vehicle care	395		
Cleaning and care of the vehicle ..	395		
		Practical hints	403
		What to do if	404
		Lamps in instrument cluster	404
		Lamp in center console	414
		Vehicle status messages in the multifunction display	416
		Where will I find ...?	454
		First aid kit	454
		Vehicle tool kit	454
		Spare wheel	457
		Unlocking / locking in an emergency ..	459
		Unlocking the vehicle	459
		Locking the vehicle	460
		Fuel filler flap	461
		Opening / closing in an emergency	462
		Power tilt/sliding sunroof*	462
		Replacing SmartKey batteries	463
		SmartKey	463
		SmartKey with KEYLESS-GO*	464
		Replacing bulbs	465
		Bulbs	465
		Replacing bulbs for front lamps	468
		Replacing bulbs for rear lamps	472
		Replacing wiper blades	475
		Front wiper blades	475
		Rear wiper blade	476
		Flat tire	478
		Preparing the vehicle	478
		Mounting the spare wheel	479
		Battery	487
		Disconnecting, removing, reinstalling and reconnecting the battery	489
		Charging the battery	495
		Jump starting	496
		Towing the vehicle	499
		Installing towing eye bolts	501
		Stranded vehicle	502
		Fuses	503
		Main fuse box	504
		Fuse box in cargo compartment ...	504
		Fuse box in passenger compartment	505

Contents

Technical data	507	Fuels, coolants, lubricants, etc.	521	Technical terms	529
Parts service	508	Capacities	521		
Warranty coverage.....	509	Engine oils.....	523		
Loss of Service and Warranty		Engine oil additives	523	Index	535
Information Booklet.....	509	Air conditioning refrigerant	523		
Identification labels.....	510	Brake fluid.....	523		
Layout of poly-V-belt drive	512	Premium unleaded gasoline	524		
Engine.....	513	Fuel requirements	524		
Rims and tires.....	514	Gasoline additives	525		
Same size tires.....	516	Coolants.....	525		
Spare wheel (collapsible tire)	517	Windshield washer and headlamp			
Electrical system.....	518	cleaning* system	528		
Main Dimensions	519				
Weights.....	520				

▼ Product information

Please observe the following in your own best interest:

We recommend using Genuine Mercedes-Benz Parts as well as conversion parts and accessories explicitly approved by us for your vehicle model.

We have tested these parts to determine their reliability, safety and special suitability for Mercedes-Benz vehicles.

We are unable to make an assessment for other products and therefore cannot be held responsible for them, even if in individual cases an official approval or authorization by governmental or other agencies should exist. Use of such parts and accessories could adversely affect the safety, performance or reliability of your vehicle. Please do not use them.

Genuine Mercedes-Benz Parts as well as conversion parts and accessories approved by us are available at your authorized Mercedes-Benz Light Truck Center where you will receive comprehensive information, also on permissible technical modifications, and where proper installation will be performed.

Operator's Manual

This Operator's Manual contains a great deal of useful information. We urge you to read it carefully and familiarize yourself with the vehicle before driving.

For your own safety and longer service life of the vehicle, we urge you to follow the instructions and warnings contained in this manual. Ignoring them could result in damage to the vehicle or personal injury to you or others. Vehicle damage caused by failure to follow instructions is not covered by the Mercedes-Benz Limited Warranty.

Your vehicle may have some or all of the equipment described in this manual. Therefore, you may find explanations for optional equipment not installed in your vehicle. If you have any questions about the operation of any equipment, your authorized Mercedes-Benz Light Truck Center will be glad to demonstrate the proper procedures.

We continuously strive to improve our product, and ask for your understanding that we reserve the right to make changes in design and equipment. Therefore, information, illustrations and descriptions in this Operator's Manual might differ from your vehicle.

Optional equipment is also described in this manual, including operating instructions wherever necessary. Since they are special-order items, the descriptions and illustrations herein may vary slightly from the actual equipment of your vehicle.

If there are any equipment details that are not shown or described in this Operator's Manual, your authorized Mercedes-Benz Light Truck Center will be glad to inform you of correct care and operating procedures.

The Operator's Manual and Maintenance Booklet are important documents and should be kept with the vehicle.

Service and warranty information

The Service and Warranty Information Booklet contains detailed information about the warranties covering your Mercedes-Benz, including:

- New Light Truck Limited Warranty,
- Emission System Warranty,
- Emission Performance Warranty,
- California, Maine, Massachusetts, and Vermont Emission Control System Warranty (California, Maine, Massachusetts, and Vermont only),
- State Warranty Enforcement Laws (Lemon Laws).

Important notice for California retail buyers and lessees of Mercedes-Benz automobiles

Under California law you may be entitled to a replacement of your vehicle or a refund of the purchase price or lease price, if Mercedes-Benz USA, LLC and / or its authorized repair or service facilities fail to fix one or more substantial defects or malfunctions in the vehicle that are covered by its express warranty after a reasonable number of repair attempts. During the period of 18 months from original delivery of the vehicle or the accumulation of 18 000 miles (approx. 29 000 km) on the odometer of the vehicle, whichever occurs first, a reasonable number of repair attempts is presumed for a retail buyer or lessee if one or more of the following occurs:

- (1) the same substantial defect or malfunction results in a condition that is likely to cause death or serious bodily injury if the vehicle is driven, that defect or malfunction has been subject to repair two or more times, and you have directly notified Mercedes-Benz USA, LLC in writing of the need for its repair,
- (2) the same substantial defect or malfunction of a less serious nature than category (1) has been subject to repair four or more times and you have directly notified us in writing of the need for its repair, or
- (3) the vehicle is out of service by reason of repair of the same or different substantial defects or malfunctions for a cumulative total of more than 30 calendar days.

Written notification should be sent to us, not a dealer, at Mercedes-Benz USA, LLC, Customer Assistance Center, One Mercedes Drive, Montvale, NJ 07645-0350.

Maintenance

The Maintenance Booklet describes all the necessary maintenance work which should be performed at regular intervals.

Always have the Maintenance Booklet with you when you take the vehicle to your authorized Mercedes-Benz Light Truck Center for service. The service advisor will record each service in the booklet for you.

Roadside Assistance

The Mercedes-Benz Roadside Assistance Program provides factory-trained technical help in the event of a breakdown. Calls to the toll-free Roadside Assistance number

1-800-FOR-MERCEdes (in the USA)
1-800-387-0100 (in Canada)

will be answered by Mercedes-Benz Customer Assistance Representatives 24 hours a day, 365 days a year.

Roadside Assistance will be provided in accordance with standard program guidelines which include providing service to the vehicle up to a reasonable distance from a paved roadway. We will make every effort to assist in a breakdown situation, however, the accessibility of your vehicle will be determined by our authorized Mercedes-Benz Light Truck Center technician or the tow service provider on a case-by-case basis and may be a factor in our ability to respond.

Additional charges may be applicable for a breakdown location determined not to be a reasonably accessible roadside location as determined by our authorized technician and tow service provider.

For additional information refer to the Mercedes-Benz Roadside Assistance Program brochure in your vehicle literature portfolio.

Change of address or ownership

If you change your address, be sure to send in the “Change of Address Notice” found in the Service and Warranty Information Booklet, or simply call the Mercedes-Benz Customer Assistance Center (in the USA) at 1-800-FOR-MERCEdes, or Customer Service (in Canada) at 1-800-387-0100. It is in your own interest that we can contact you should the need arise.

If you sell your Mercedes, please leave all literature with the vehicle to make it available to the next operator.

If you bought this vehicle used, be sure to send in the “Notice of Purchase of Used Truck” found in the Service and Warranty Information Booklet, or call the Mercedes-Benz Customer Assistance Center (in the USA) at 1-800-FOR-MERCEdes, or Customer Service (in Canada) at 1-800-387-0100.

Operating your vehicle outside the USA or Canada

If you plan to operate your vehicle in foreign countries, please be aware that:

- service facilities or replacement parts may not be readily available,
- unleaded gasoline for vehicles with catalytic converters may not be available; the use of leaded fuels will damage the catalyts,
- gasoline may have a considerably lower octane rating, and improper fuel can cause engine damage.

Where to find it

Where to find it

This Operator's Manual is designed to provide comprehensive support information for you, the vehicle operator. Each section has its own reference color.

At a glance

Here you will find an overview of all the controls that can be operated from the driver's seat.

Getting started

Here you will find all the information you need for your first drive. You should read this section first if this is your first Mercedes-Benz vehicle or if you are renting or borrowing this vehicle.

Safety and Security

Here you will find descriptions of the safety and security features of your vehicle.

Controls in detail

Here you will find detailed information about the equipment installed on your vehicle. This section expands on the "Getting started" section and also describes technical innovations. If you are already familiar with the basic functions of your vehicle, this section will be of particular interest to you.

Operation

Here you will find all the information you need for the proper operation of your vehicle.

Practical hints

This section provides fast assistance for dealing with problems you may encounter.

Technical data

All important technical data for your vehicle can be found in this section.

Indexes

The glossary provides explanations of the most important technical terms.

The table of contents and the index are designed to help you find information quickly and easily.

The following publications are part of your vehicle documentation:

- this Operator's Manual
- the Maintenance Booklet

Separate operating instructions will be provided as required depending on the equipment options installed in your vehicle.

Symbols

Trademarks:

- ESP® and PRE-SAFE® are registered trademarks of DaimlerChrysler.
- HomeLink® is a registered trademark of Prince, a Johnson Controls Company.

The following symbols are found in this Operator's Manual:

- * Optional equipment is identified with an asterisk. Since standard equipment varies between models, the descriptions and illustrations in this manual may differ slightly from the actual equipment of your vehicle.

Warning!



Warning notices draw your attention to hazards that may endanger your health or life, or the health or life of others.



Highlights hazards that may result in damage to your vehicle.



Helpful hints or further information you may find useful.

- ▶ This symbol points to instructions for you to follow.
- ▶ A number of these symbols appearing in succession indicates a multiple-step procedure.
 - ▷ Page This symbol tells you where to look for further information on a topic.
 - ▷▷ This continuation symbol marks an interrupted procedure which will be continued on the next page.
 - > In the glossary of technical terms, this symbol is used to indicate cross-references to term definitions.
- Display Words appearing in the multi-function display are printed in the type shown here.

Warning!



Work improperly carried out on electronic components and associated software could cause them to cease functioning. Because the vehicle's electronic components are interconnected, any modifications made may produce an undesired effect on other systems. Electronic malfunctions could seriously impair the operating safety of your vehicle.

See an authorized Mercedes-Benz Light Truck Center for repairs or modifications to electronic components.

Other improper work or modifications on the vehicle could also have a negative impact on the operating safety of the vehicle.

Some safety systems only function while the engine is running. You should therefore never turn off the engine while driving.

Warning!



Heavy blows against the vehicle underbody or tires / wheels, for example when running over an obstacle, road debris or a pothole, may cause serious damage and impair the operating safety of your vehicle. If you feel a sudden significant vibration or ride disturbance, or you suspect that damage to your vehicle has occurred, you should turn on your hazard warning flashers, carefully slow down, and drive with caution to an area which is a safe distance from the road.

Inspect the vehicle underbody and tires / wheels for possible damage. If the vehicle appears unsafe, have it towed to the nearest authorized Mercedes-Benz Light Truck Center or other qualified maintenance or repair facility for further inspection or repairs.

Proper use of the vehicle

Proper use of the vehicle requires that you are familiar with the following information and rules:

- the safety precautions in this manual
- the “Technical data” section in this manual
- traffic rules and regulations
- motor vehicle laws and safety standards

Warning!



Various warning labels are attached to your vehicle. These warning labels are intended to make you and others aware of various risks. You should not remove any of these warning labels unless explicitly instructed to do so by information on the label itself. Removal of any of these labels may cause you and others to be unaware of certain risks which may result in an accident and / or personal injury.

▼ Problems with your vehicle

If you should experience a problem with your vehicle, particularly one that you believe may affect its safe operation, we urge you to immediately contact an authorized Mercedes-Benz Light Truck Center to have the problem diagnosed and corrected if required. If the matter is not handled to your satisfaction, please discuss the problem with the Mercedes-Benz Light Truck Center management, or if necessary contact us at one of the following addresses:

In the USA:

Customer Assistance Center
Mercedes-Benz USA, LLC
One Mercedes Drive
Montvale, NJ 07645-0350

In Canada:

Customer Relations Department
Mercedes-Benz Canada, Inc.
98 Vanderhoof Avenue
Toronto, Ontario, M4G 4C9

Reporting safety defects

For the USA only:

The following text is published as required of manufacturers under Title 49, Code of U.S. Federal Regulations, Part 575 pursuant to the “National Traffic and Motor Vehicle Safety Act of 1966”.

Reporting safety defects

If you believe that your vehicle has a defect which could cause a crash or could cause injury or death, you should immediately inform the National Highway Traffic Safety Administration (NHTSA) in addition to notifying Mercedes-Benz USA, LLC.

If NHTSA receives similar complaints, it may open an investigation, and if it finds that a safety defect exists in a group of vehicles, it may order a recall and remedy campaign. However, NHTSA cannot become involved in individual problems between you, your dealer, or Mercedes-Benz USA, LLC.

To contact NHTSA, you may either call the Auto Safety Hotline toll-free at 1-888-327-4236 (or 366-0123 in Washington, D.C. area) or write to: NHTSA, U.S. Department of Transportation, Washington, D.C. 20590. You can also obtain other information about motor vehicle safety from the Hotline.

▼ Vehicle data recording

Information regarding electronic recording devices

(Including notice pursuant to California Code § 9951)

Please note that your vehicle is equipped with devices that can record vehicle systems data and, if equipped with the Tele Aid* system, may transmit some data in certain accidents.

This information helps, for example, to diagnose vehicle systems after a collision and to continuously improve vehicle safety. DaimlerChrysler may access the information and share it with others

- for safety research or vehicle diagnosis purposes
- with the consent of the vehicle owner or lessee
- in response to an official request by law enforcement or other government agency
- for use in dispute resolution involving DaimlerChrysler, its affiliates or sales / service organization and / or
- as otherwise required or permitted by law.

Please check the Tele Aid* subscription service agreement for details regarding the information that may be recorded or transmitted via that system.

At a glance

Cockpit

Instrument cluster

Multifunction steering wheel

Center console

Overhead control panel

Storage compartments

Door control panel







Item	Page
① Cruise control lever	265
② Instrument cluster	24
③ Multifunction steering wheel	28
④ Horn	
⑤ Steering wheel gearshift buttons	206
⑥ Gear selector lever for automatic transmission	53
⑦ Front Parktronic* warning indicators	276
⑧ Overhead control panel	31
⑨ Glove box release	294
Glove box lock	295





Item	Page
⑩ Glove box	294
⑪ Electrical outlet	307
⑫ Center console	29
⑬ Starter switch	38
⑭ Steering wheel adjustment, manual	45
⑮ Steering wheel adjustment, electrical*	46
⑯ Hood lock release	345
⑰ Parking brake pedal	65
⑱ Remote tailgate switch	123



Item	Page
⑲ Parking brake release	56
⑳ Headlamp washer switch*	208
㉑ Exterior lamp switch	147
㉒ Door control panel	34
㉓ Combination switch	
• Turn signals	58
• Windshield wipers	59
• High beam	58
• Rear window wiper	61



P54.32-3435-31

	Item	Page
①	 Left turn signal indicator lamp	
②	To dim instrument cluster illumination	158
③	Reset button	158
④	To brighten instrument cluster illumination	158
⑤	 Right turn signal indicator lamp	
⑥	Clock	





	Item	Page
⑦	Speedometer with:	
	 Antilock Brake System (ABS) indicator lamp	404
	 Brake warning lamp, USA only	405
	 Brake warning lamp, Canada only	405
	 Electronic Stability Program (ESP®) warning lamp	409

	Item	Page
	 Variable speed limiter indicator lamp ¹	
	 Distance warning lamp ¹	
	 Combination low tire pressure/TPMS malfunction telltale*	412

¹ Warning lamp without function. It illuminates when the ignition is on. It should go out when the engine is running.



P54.32-3436-31





Item	Page
⑧ Multifunction display with:	
Trip odometer	159
Main odometer	161
⑨ Tachometer with:	
 Seat belt telltale	77, 410
 Supplemental Restraint System (SRS) indicator lamp	70, 411
 Engine malfunction indicator lamp, USA only	407
 Engine malfunction indicator lamp, Canada only	407
 High beam headlamp indicator	151





Item	Page
⑩ Fuel gauge with:	
Fuel tank reserve warning lamp	409
 Fuel filler flap indicator: The fuel filler flap is located on the rear right-hand side	342
⑪ Multifunction display with:	
Outside temperature display or Digital speedometer (depending on selected setting in the control system)	161
Gear position indicator	161
Gear range indicator	179
Selected program mode indicator	199

Multifunction steering wheel



P46.10-2578-31

Item	Page
① Multifunction display	161
Operating the control system	162
② Telephone* Press button	
 to take a call	
 to end a call	
③ Selecting the submenu or setting the volume: Press button	
 up / to increase	
 down / to decrease	

Item	Page
④ Moving within a menu: Press button	
 for next display	
 for previous display	
⑤ Menu systems: Press button	
 for next menu	
 for previous menu	

▼ Center console

Upper part



P68.20-3450-31

Item	Page
① Modular COMAND System, see separate operating instructions	
② Climate control 3-zone automatic climate control*	216 230
③ Seat heating*, front passenger side	141
④ Vehicle level control switch*	272
⑤ Program mode selector switch for automatic transmission	204

Item	Page
⑥ Front passenger front air bag indicator lamp	89, 414
⑦ Hazard warning flasher	153
⑧ Alarm system indicator lamp	105
⑨ Parking assist (Parktronic system)* deactivation switch	277
⑩ Electronic Stability Program (ESP®) switch	101
⑪ Adaptive damping system (ADS)* switch	269
⑫ Seat heating*, driver's side	141

Center console

Lower part

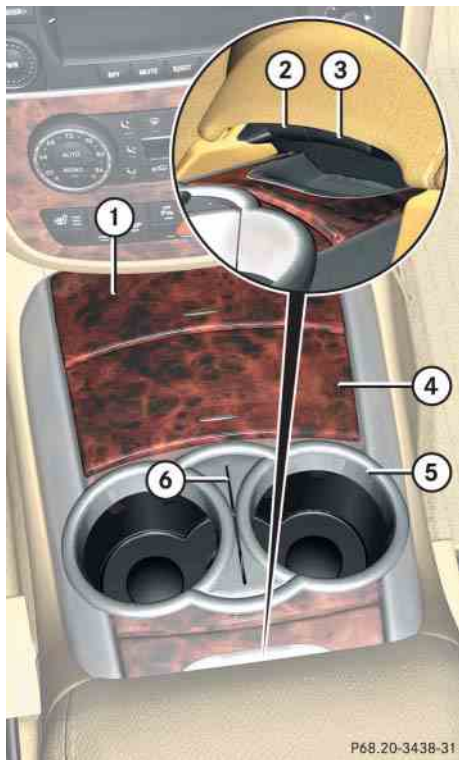

	Item	Page
①	Storage compartment	296
②	Armrest storage tray release	296
③	Armrest storage compartment release	296
④	Storage compartment Ashtray with cigarette lighter*	296 303
⑤	Cup holder	299
⑥	Card, ticket holder Bottle opener	300 300

Overhead control panel

▼ Overhead control panel

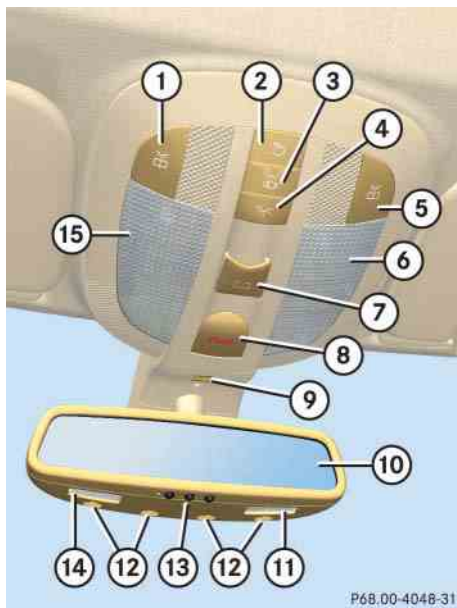

Item	Page
① Left reading lamp on/off	154
② Rear interior lighting on/off	154
③ Automatic interior lighting	154
④ Front interior lighting on/off	154
⑤ Right reading lamp on/off	154
⑥ Front right interior lamp lens	154
⑦ Tilt/sliding sunroof* switch	255
Tilt/sliding panel* switch	259
⑧ Tele Aid* (emergency call system) button	314
⑨ Vehicles without telephone* installed: Hands-free microphone for TeleAid* (emergency call system)	311

Item	Page
⑩ Interior rear view mirror	208
⑪ Reading lamp, front passenger side	154
⑫ Vehicles with telephone* installed: Hands-free microphone for TeleAid* (emergency call system) and telephone*	311
⑬ Garage door opener*	320
⑭ Reading lamp, driver's side	154
⑮ Front left interior lamp lens	154

Storage compartments

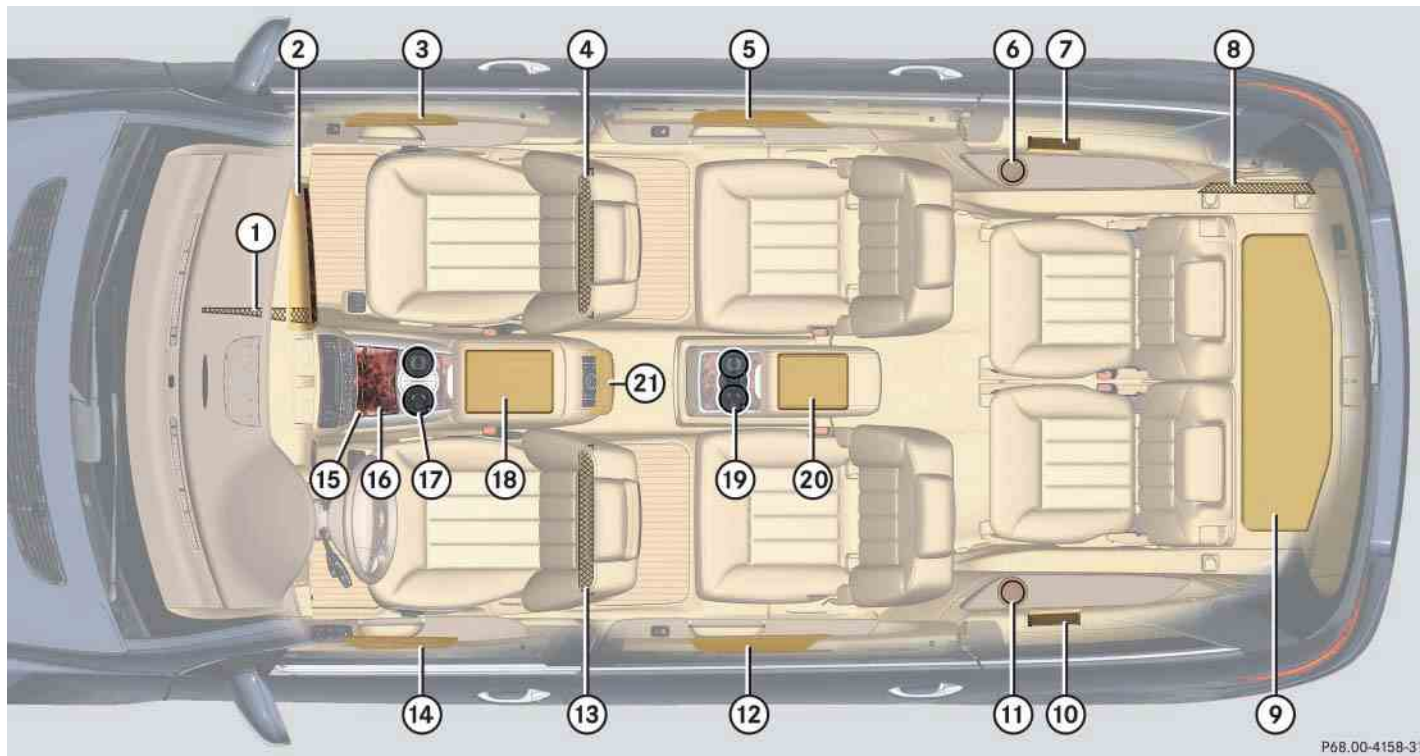

Item	Page
① Parcel net in front passenger footwell	298
② Glove box/CD-changer*	294
③ Door pocket	
④ Parcel net on front passenger seat backrest	298
⑤ Door pocket	
⑥ Cup holder	302
⑦ Third-row storage compartment	298
⑧ Parcel net in cargo compartment	299
⑨ First aid kit, vehicle tool kit, spare wheel	454
⑩ Third-row storage compartment	298
⑪ Cup holder	302

Item	Page
⑫ Door pocket	
⑬ Parcel net on driver's seat backrest	298
⑭ Door pocket	
⑮ Storage compartment in center console	296
⑯ Storage compartment in center console Ashtray*	296
⑰ Cupholders	303
⑱ Front armrest storage compartments	298
⑲ Cup holders*	296
⑳ Rear armrest storage compartment*	302
㉑ Cup holders	297
Rear storage compartment	301
Rear seat ashtray*	297
	304

Door control panel

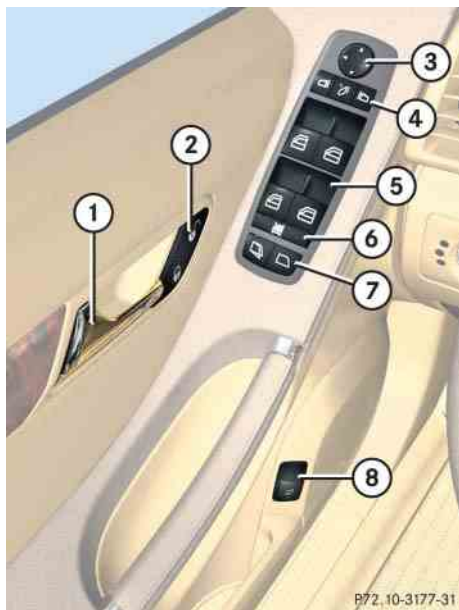

	Item	Page
①	Door handle	121
②	Central locking/unlocking switch	131
③	Exterior rear view mirror adjustment	48
④	Selection buttons for exterior/rear view mirror adjustment	48
	Power-folding exterior rear view mirrors*	211
⑤	Switches for opening/closing front and rear door windows	248
⑥	Rear side window override switch	94
⑦	Hinged quarter window switch*	250
⑧	Remote tailgate release switch, Tailgate opening system*	123, 124

Unlocking

Adjusting

Driving

Parking and locking

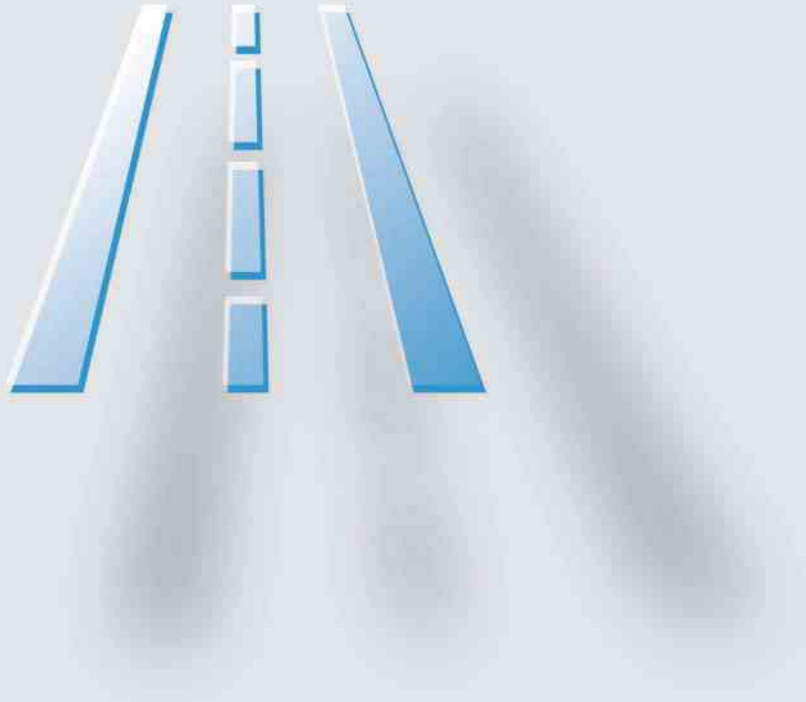

Unlocking





The “Getting started” section provides an overview of the vehicle’s most basic functions. First-time Mercedes-Benz owners should pay special attention to the information given here.

If you are already familiar with the basic functions described here, the “Controls in detail” section will provide you with further information. The corresponding page references are located at the end of each segment.

Unlocking with the SmartKey



SmartKey

- ①  Lock button
- ②  Unlock button* for tailgate
- ③  Unlock button
- ④  PANIC Panic button (▷ page 95)

Warning!



When leaving the vehicle, always remove the SmartKey from the starter switch, take it with you, and lock the vehicle. Do not leave children unattended in the vehicle, or with access to an unlocked vehicle. Unsupervised use of vehicle equipment may cause an accident and / or serious personal injury.

- ▶ Press unlock button  on the SmartKey.

All turn signal lamps flash once. The vehicle unlocks. The locking knobs in the doors move up. The anti-theft alarm system is disarmed. The locator lighting comes on if the feature is enabled in the control system (▷ page 183).

- ▶ Enter the vehicle and insert the SmartKey in the starter switch.





For more information, see “Locking and unlocking” (▷ page 110).

Unlocking with Keyless-Go*

With the KEYLESS-GO function, you can lock or unlock the vehicle without using the remote control buttons on the SmartKey and start the engine without inserting the SmartKey into the starter switch.



SmartKey with KEYLESS-GO*

- ①  Lock button
- ②  Unlock button* for tailgate
- ③  Unlock button
- ④  PANIC button (▷ page 95)



To unlock the vehicle, the SmartKey with KEYLESS-GO must be outside the vehicle, no further than approximately 3 feet (1 meter) away from the respective door.

Warning!



When leaving the vehicle, always take the SmartKey with KEYLESS-GO* with you, and lock the vehicle. Do not leave children unattended in the vehicle, or with access to an unlocked vehicle. Unsupervised use of vehicle equipment may cause an accident and / or serious personal injury.

- ▶ Grasp an outside door handle or the tailgate handle.

All turn signal lamps flash once. The vehicle unlocks. The locking knobs in the doors move up. The anti-theft alarm system is disarmed. The locator lighting comes on if the feature is enabled in the control system (▷ page 183).



If the vehicle has been parked for more than 72 hours, you must pull an outside door handle in order to activate the KEYLESS-GO function.

- ▶ Enter the vehicle.

For more information, see “SmartKey with KEYLESS-GO*” (▷ page 114).

Starter switch positions

Warning!



When leaving the vehicle, always remove the SmartKey or SmartKey with KEYLESS-GO* from the starter switch, take it with you and lock the vehicle. Do not leave children unattended in the vehicle, or with access to an unlocked vehicle. Unsupervised use of vehicle equipment may cause an accident and / or serious personal injury.

SmartKey



Starter switch

- 0** For removing SmartKey
 - 1** Power supply for some electrical consumers, such as seat adjustment
 - 2** Ignition (power supply for all electrical consumers) and driving position
- All lamps (except high beam headlamp indicator lamp and turn signal indicator lamps unless activated) in the instrument cluster come on. If a lamp in the instrument cluster fails to come on when the ignition is switched on, have it checked and replaced if necessary. If a lamp in the instrument cluster re-

mains on after starting the engine or comes on while driving, refer to “Lamps in instrument cluster” (▷ page 404).

3 Starting position



When you switch on the ignition, the indicator and warning lamps (except high beam headlamp indicator lamp and turn signal indicator lamps unless activated) in the instrument cluster come on. The indicator and warning lamps (except high beam headlamp indicator lamp and turn signal indicator lamps if activated) will go out when the engine is running. This indicates that the respective systems are operational.



When the SmartKey is removed from the starter switch and the automatic transmission is in a position other than **P**, the automatic transmission automatically shifts to **P**.



If the SmartKey cannot be turned in the starter switch, the battery may not be sufficiently charged.

- Check the battery and charge it if necessary (▷ page 487).
- Get a jump start (▷ page 496).

To prevent accelerated battery discharge or a completely discharged battery, always remove the SmartKey from the starter switch when the engine is not in operation.

SmartKey with KEYLESS-GO*

Vehicles equipped with the KEYLESS-GO feature are supplied with a SmartKey with integrated KEYLESS-GO function and a removable KEYLESS-GO start/stop button.

With the KEYLESS-GO start/stop button inserted and the SmartKey with KEYLESS-GO present in the vehicle, pressing the KEYLESS-GO start/stop button

- without the brake pedal depressed corresponds to the various starter switch positions (▷ page 40)
- with the brake pedal firmly depressed will start the engine (▷ page 54)

If you wish or should there be a need to insert the SmartKey with KEYLESS-GO in the starter switch, the KEYLESS-GO start/stop button can be easily removed by pulling it out of the starter switch.



The KEYLESS-GO start/stop button does not need to be removed from the starter switch when you leave the vehicle. However, always take the SmartKey with KEYLESS-GO with you when you leave the vehicle. As long as the SmartKey with KEYLESS-GO is in the vehicle, the vehicle's electrical systems can be switched on or the engine can be started using the KEYLESS-GO start/stop button.

Unlocking

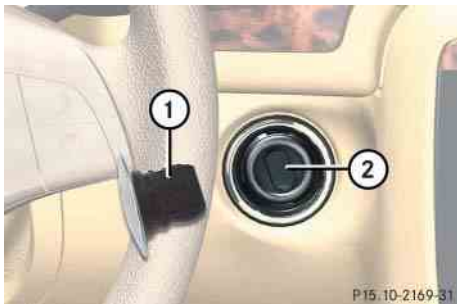

- ① KEYLESS-GO start/stop button
- ② Starter switch

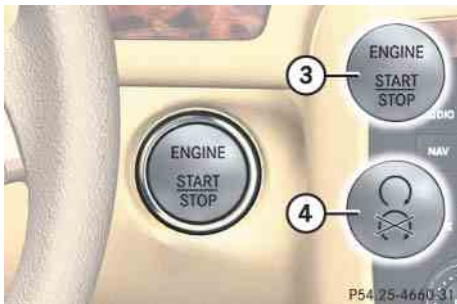

KEYLESS-GO start/stop button

- ③ USA only
- ④ Canada only

The SmartKey with KEYLESS-GO must be located in the vehicle.

- ▶ Insert KEYLESS-GO start/stop button ① into starter switch ② (if not inserted already).
- ▶ Make sure the automatic transmission is set to **P**.
- ▶ Do not depress the brake pedal.

Position 0

Before you press the KEYLESS-GO start/stop button, the vehicle's on-board electronics have status **0** (as with SmartKey removed).

Position 1

- ▶ Press the KEYLESS-GO start/stop button once.

This supplies power for some electrical consumers, such as seat adjustment.



If you now press the KEYLESS-GO start/stop button

- once more, the ignition (position **2**) is switched on
- twice more, the power supply is again switched off

Ignition (or Position 2)

- ▶ Press the KEYLESS-GO start/stop button twice.

This supplies power for all electrical consumers.

All lamps (except high beam headlamp indicator lamp and turn signal indicator lamps unless activated) in the instrument cluster come on. If a lamp in the instrument cluster fails to come on when the ignition is switched on, have it checked and replaced if necessary. If a lamp in the instrument cluster remains on after starting the engine or comes on while driving, refer to "Lamps in instrument cluster" (▶ page 404).



If you now press the KEYLESS-GO start / stop button once more, the power supply is again switched off.



When you switch on the ignition, the indicator and warning lamps (except high beam headlamp indicator lamp and turn signal indicator lamps unless activated) in the instrument cluster come on. The indicator and warning lamps (except high beam headlamp indicator lamp, and turn signal indicator lamps if activated) will go out when the engine is running. This indicates that the respective systems are operational.

For information on starting the engine using the KEYLESS-GO start / stop button, see “Starting with KEYLESS-GO*” (▷ page 54).

For more information on KEYLESS-GO, see “SmartKey with KEYLESS-GO*” (▷ page 114).

Adjusting

Warning!



All seat, head restraint, steering wheel, and rear view mirror adjustments, as well as fastening of seat belts, must be done before the vehicle is put into motion.

Seats

Warning!



Do not adjust the driver's seat while driving. Adjusting the seat while driving could cause the driver to lose control of the vehicle.

Never ride in a moving vehicle with the seat back in an excessively reclined position as this can be dangerous. You could slide under the seat belt in a collision. If you slide under it, the belt would apply force at the abdomen or neck. That could cause serious or fatal injuries. The seat backrest and seat belts provide the best restraint when the wearer is in a nearly upright position and belts are properly positioned on the body.

Your seat must be adjusted so that you can correctly fasten your seat belt (▷ page 50).

Never place hands under the seat or near any moving parts while a seat is being adjusted.

Warning!



When leaving the vehicle, always remove the SmartKey or SmartKey with KEYLESS-GO* from the starter switch, take it with you, and lock the vehicle.

Even with the SmartKey or the SmartKey with KEYLESS-GO* removed from the starter switch or the SmartKey with KEYLESS-GO* removed from the vehicle, the power seats can be operated when the respective door is open.

Therefore, do not leave children unattended in the vehicle, or with access to an unlocked vehicle. Unsupervised use of vehicle equipment may cause an accident and/or serious personal injury.

Warning!



According to accident statistics, children are safer when properly restrained in the rear seating positions than in the front seating position. Thus, we strongly recommend that children be placed in the rear seats whenever possible. Regardless of seating position, children 12 years old and under must be seated and properly secured in an appropriate infant or toddler restraint, or booster seat recommended for the size and weight of the child. For additional information, see “Children in the vehicle” (▷ page 82).

A child's risk of serious or fatal injuries is significantly increased if the child restraints are not properly secured in the vehicle and the child is not properly secured in the child restraint.

Seat adjustment

The seat adjustment switch is located on the entry side of each front seat base.

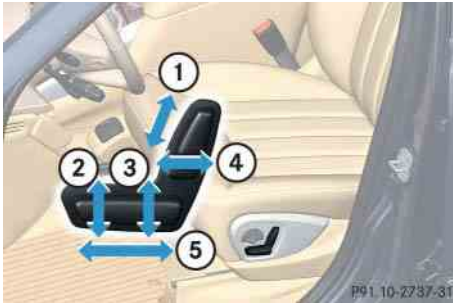

- ① Head restraint height*
- ② Seat cushion tilt
- ③ Seat height
- ④ Backrest tilt
- ⑤ Seat fore and aft adjustment

- ▶ Switch on the ignition (▷ page 38).

or

- ▶ Open the respective door (vehicles with memory function*).

The seat can be adjusted with the respective door opened.

or

- ▶ Open a front door (vehicles without memory function*).

The seat can be adjusted within 3 minutes after either front door has been opened.



When adjusting the seat backrest tilt and head restraint height, make sure the sun visor is folded up (▷ page 212). If the head restraint is in the uppermost position, it could hit and damage the sun visor.



The memory function* (▷ page 144) lets you store the settings for the seat position together with the settings for the steering wheel column and the exterior rear view mirrors.

Seat fore and aft adjustment

- ▶ Press the switch forward or backward in direction of arrow ⑤.

Adjust the seat to a comfortable seating position that still allows you to reach the accelerator/brake pedal safely. The position should be as far to the rear as possible, consistent with ability to properly operate controls.



When moving the seat, make sure there are no items in the footwell or behind the seat. Otherwise you could damage the seat.

Adjusting

Seat height

- ▶ Press the switch up or down in the direction of arrow ③.

Seat cushion tilt

- ▶ Press the switch up or down in direction of arrow ② until your upper legs are lightly supported.

Seat backrest tilt

- ▶ Press the switch forward or backward in direction of arrow ④ until your arms are slightly angled when holding the steering wheel.

Head restraint height

Warning!



For your protection, drive only with properly positioned head restraints.

Adjust head restraint so that the center of the head restraint supports the back of the head at eye level. This will reduce the potential for injury to the head and neck in the event of an accident or similar situation.

Do not drive the vehicle without the seat head restraints. Head restraints are intended to help reduce injuries during an accident.



Do not attempt to remove front seat head restraints. They can only be removed by qualified technicians. We recommend that you have this work carried out by an authorized Mercedes-Benz Light Truck Center.

Vehicles with memory function*:

- ▶ Press switch (▷ page 43) up or down in direction of arrow ①.

Vehicles without memory function*:

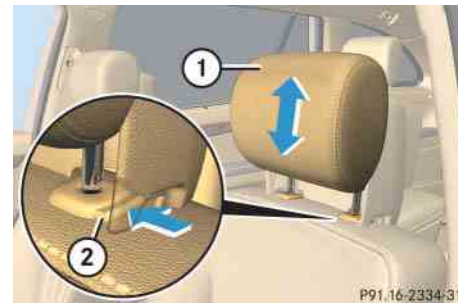

- ① Head restraint
- ② Release button

Raising:

- ▶ Manually adjust the height of head restraint ① by pulling it upward.

If head restraint ① is fully retracted, push release button ② in direction of arrow and pull head restraint ① upward.

Lowering:

- ▶ To lower head restraint ①, push release button ② in direction of arrow and press down on head restraint ①.

Head restraint tilt

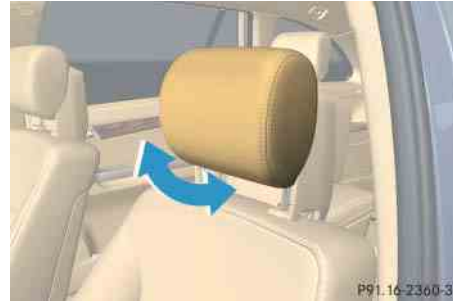

Manually adjust the angle of the head restraint.

- ▶ Push or pull on the lower edge of the head restraint cushion.



Adjust the head restraint in such a way that it is as close to the head as possible.

For more information, see “Seats”
(▷ page 132).

Steering wheel

Steering wheel adjustment, manual

Warning!



Only adjust the steering wheel with the vehicle at a standstill and make sure the steering wheel is securely locked in place before driving off.

Driving without the steering wheel adjustment locked may cause an unexpected steering wheel movement which could cause the driver to lose control of the vehicle. Make sure the steering wheel is securely locked by trying to move it up and down, and in and out before driving off.

Adjusting

The handle for steering wheel adjustment is located on the lower left of the steering column.



- ▶ To unlock the steering column, pull handle out to its stop limit.
- ▶ Move steering wheel to the desired position.

Make sure your legs can move freely and that all displays (including malfunction and indicator lamps) on the instrument cluster are clearly visible.

- ▶ Push handle back to its original position to relock the steering column.

The steering column is locked into position again.

- ▶ Make sure the steering column is securely locked by trying to move the steering wheel up and down as well as in and out before driving off.

Steering wheel adjustment, electrical*

Warning!



Do not adjust the steering wheel while driving. Adjusting the steering wheel while driving could cause the driver to lose control of the vehicle.

When leaving the vehicle, always remove the SmartKey or SmartKey with KEYLESS-GO* from the starter switch, take it with you, and lock the vehicle.

Even with the SmartKey or SmartKey with KEYLESS-GO* removed from the starter switch or the SmartKey with KEYLESS-GO* removed from the vehicle, the steering wheel adjustment feature can be operated when the driver's door is open. Therefore, do not leave children unattended in the vehicle, or with access to an unlocked vehicle. Unsupervised use of vehicle equipment may cause an accident and/or serious personal injury.

The stalk for steering wheel adjustment is located on the lower left of the steering column.



- ① Adjusting steering column, in or out
- ② Adjusting steering column, up or down

▶ Switch on the ignition (▷ page 38).

or

▶ Open the driver's door.

Adjusting steering column in or out

- ▶ Move stalk forward or back in direction of arrow ① until a comfortable steering wheel position is reached with your arms slightly bent at the elbow.

Adjusting steering column up or down

- ▶ Move stalk up or down in direction of arrow ②.

Make sure your legs can move freely and that all displays (including malfunction and indicator lamps) on the instrument cluster are clearly visible.



The memory function (▷ page 144) lets you store the settings for the steering wheel column together with the settings for seat positions and the exterior rear view mirrors.

Mirrors

Adjust the interior and exterior rear view mirrors before driving so that you have a good view of the road and traffic conditions.

Warning!



In case of an accident, liquid electrolyte may escape the mirror housing if the mirror glass breaks.

Electrolyte has an irritating effect. Do not allow the liquid to come into contact with eyes, skin, clothing, or respiratory system. In case it does, immediately flush affected area with water, and seek medical help if necessary.



Electrolyte drops coming into contact with the vehicle paint finish can only be completely removed while in their liquid state and by applying plenty of water.

Adjusting

Interior rear view mirror

- ▶ Manually adjust the interior rear view mirror.

For more information, see “Rear view mirrors” (▷ page 208).

Exterior rear view mirrors

Warning!



Exercise care when using the passenger-side exterior rear view mirror. The mirror surface is convex (outwardly curved surface for a wider field of view). Objects in mirror are closer than they appear. Check your interior rear view mirror or glance over your shoulder before changing lanes.

The buttons are located on the driver's door.



- ① Driver's side exterior rear view mirror button
 - ② Adjustment button
 - ③ Passenger-side exterior rear view mirror button
- ▶ Switch on the ignition (▷ page 38).

- ▶ Press button ① for the driver's side exterior rear view mirror or button ③ for the passenger-side exterior rear view mirror.

The indicator lamp on the respective button comes on for approximately 15 seconds.



If you do not make adjustments to the selected exterior rear view mirror within 15 seconds, the indicator lamp goes out. You will then have to select the desired exterior rear view mirror again before any adjustments can be made. Adjustments can only be made with the indicator lamp for the respective exterior rear view mirror button illuminated.

- ▶ Push adjustment button ② up, down, left, or right according to the desired setting.



If an exterior rear view mirror was forcibly pushed forward (hit from the rear) or forcibly pushed rearward (hit from the front), reposition it by applying firm pressure until it snaps into place. The mirror housing is then properly positioned and you can adjust the mirror in the usual manner.



Vehicles with power folding exterior rear view mirrors*:

If an exterior rear view mirror housing is forcibly pushed forward (hit from the rear) or forcibly pushed rearward (hit from the front) press button ① to fold mirrors in, then press button ① again to fold mirrors out. Do not force mirrors by hand as this may damage the adjustment mechanism.

The mirror housing is then properly positioned and you can adjust the mirror in the usual manner.



The memory function* (▷ page 144) lets you store the settings for the exterior rear view mirrors together with the setting for the steering wheel column and the seat positions.

At low ambient temperatures, the exterior rear view mirrors will be heated automatically.

For more information, see “Rear view mirrors” (▷ page 208) and “Storing exterior rear view mirror parking position” (▷ page 146).

Warning!



Do not lay any objects in the driver's footwell. Be careful that floor mats or carpets in the driver's footwell have sufficient clearance for the pedals.

During sudden driving or braking maneuvers, the objects could get caught between the pedals. You could then no longer brake or accelerate.

Fastening the seat belts

Warning!



Always fasten your seat belt before driving off. Always make sure your passengers are properly restrained, even those sitting in the rear and pregnant women.

Failure to wear and properly fasten and position your seat belt greatly increases your risk of injuries and their likely severity in an accident. You and your passengers should always wear seat belts.

If you are ever in an accident, your injuries can be considerably more severe without your seat belt properly buckled. Without your seat belt buckled, you are much more likely to hit the interior of the vehicle or be ejected from it. You can be seriously injured or killed.

In the same crash, the possibility of injury or death is lessened if you are wearing your seat belt. The airbags can only provide the protection they were designed to afford if the occupants are using their seat belts (▷ page 77).

Warning!



According to accident statistics, children are safer when properly restrained in the rear seating positions than in the front seating position. Thus, we strongly recommend that children be placed in the rear seats. Regardless of seating position, children 12 years old and under must be seated and properly secured in an appropriate infant or toddler restraint, or booster seat recommended for the size and weight of the child. For additional information, see "Children in the vehicle" (▷ page 82).

A child's risk of serious or fatal injuries is significantly increased if the child restraints are not properly secured in the vehicle and the child is not properly secured in the child restraint.

Warning!

Never ride in a moving vehicle with the seat backrest in an excessively reclined position as this can be dangerous. You could slide under the seat belt in a collision. If you slide under it, the belt would apply force at the abdomen or neck. That could cause serious or even fatal injuries. The seat backrest and seat belt provide the best restraint when the wearer is in a nearly upright position and the belt is properly positioned on the body.

Warning!

Never let more people ride in the vehicle than there are seat belts available. Make sure everyone riding in the vehicle is correctly restrained with a separate seat belt. Never use a seat belt for more than one person at a time.

Warning!

Read and observe the additional warning notices printed in the “Safety and Security” section (▷ page 74) and (▷ page 77).



- ① Seat belt outlet
- ② Latch plate
- ③ Buckle
- ④ Release button

Driving

- ▶ With a smooth motion, pull the belt out of seat belt outlet ①.
- ▶ Place the shoulder portion of the belt across the top of your shoulder and the lap portion across your hips.
- ▶ Push latch plate ② into buckle ③ (▷ page 51) until it clicks.
- ▶ If necessary, tighten the lap portion to a snug fit by pulling shoulder portion up.

Seat belt height adjustment

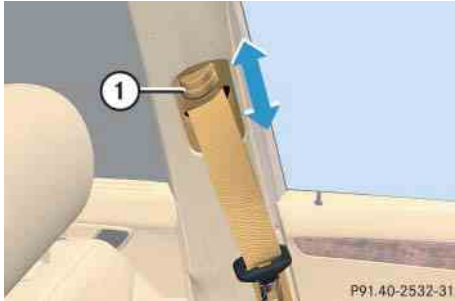

① Release button

- ▶ Press release button ① and move the seat belt height adjuster upward or downward.

Proper use of seat belts

- Do not twist the belt when fastening.
- Adjust seat belt so that the shoulder portion is located as close as possible to the middle of the shoulder (it should not touch the neck). Never pass the shoulder portion of the belt under your arm. For this purpose, you can adjust the height of the belt outlet (▷ page 52).
- Position the lap belt as low as possible on your hips (over hip joint) and not across the abdomen.
- Place the seat backrest in a nearly upright position.
- Never use a seat belt for more than one person at a time.
- Do not fasten a seat belt around a person and another object at the same time. When using a seat belt to secure infant or toddler restraints or children in booster seats, always follow the child seat manufacturer's instructions.
- Check your seat belt periodically during travel to make sure that it is properly positioned.
- Make sure the seat belt is always fitted snugly. Take special care of this when wearing loose clothing.

Warning!

Do not pass belts over sharp edges. They could tear.

Do not allow the belt to get caught in the door or in the seat adjustment mechanism. This could damage the belt.

Never attempt to make modifications to seat belts. This could impair the effectiveness of the belts.

Do not bleach or dye seat belts as this may severely weaken them. In a crash, they may not be able to provide adequate protection.

Damaged seat belts or belts that were highly stressed in an accident must be replaced. Contact an authorized Mercedes-Benz Light Truck Center.

Starting the engine**Warning!**

Inhalation of exhaust gas is hazardous to your health. All exhaust gas contains carbon monoxide, and inhaling it can cause unconsciousness and possible death.

Do not run the engine in confined areas (such as a garage) which are not properly ventilated. If you think that exhaust gas fumes are entering the vehicle while driving, have the cause determined and corrected immediately. If you must drive under these conditions, drive only with at least one window fully open.

Automatic transmission**Gearshift pattern for automatic transmission**

- P** Park position
- R** Reverse gear
- N** Neutral
- D** Drive position

For more information on how to operate the gear selector lever, see “Automatic transmission” (▷ page 197).

Starting with the SmartKey

- ▶ Make sure the automatic transmission is set to **P**.

The gear position indicator in the multi-function display should be on **P**.

- ▶ Do not depress the accelerator.
- ▶ Turn the SmartKey in the starter switch to position **3** (▷ page 38) and hold until the engine starts.



You can also use the “touch-start” function. Turn the SmartKey to position **3** and release it again immediately. The engine then starts automatically.

For information on turning off the engine with the SmartKey, see “Turning off the engine” (▷ page 66).

Starting with KEYLESS-GO*

Warning!



As long as the SmartKey with KEYLESS-GO is in your vehicle, the vehicle can be started. Therefore, never leave children unattended in the vehicle, as they could otherwise accidentally start the engine.

When leaving the vehicle, always take the SmartKey with KEYLESS-GO with you and lock the vehicle. Do not leave children unattended in the vehicle, or with access to an unlocked vehicle.

You can start your vehicle without the SmartKey in the starter switch using the KEYLESS-GO start/stop button in the starter switch.

The SmartKey with KEYLESS-GO must be located in the vehicle.

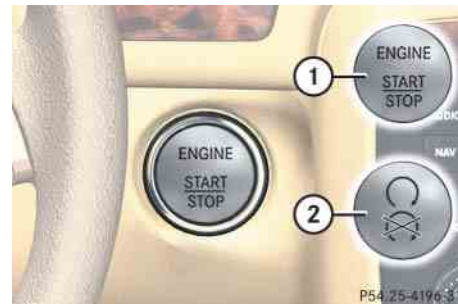

KEYLESS-GO start/stop button

- ① USA only
- ② Canada only

- ▶ Make sure KEYLESS-GO start/stop button ① is inserted in the starter switch (▷ page 40).
- ▶ Make sure the automatic transmission is set to **P**.
The gear position indicator in the multi-function display should be on **P**.
- ▶ Depress the brake pedal during the starting procedure.
- ▶ Do not depress the accelerator.

- ▶ Press KEYLESS-GO start / stop button  once.

The engine starts if the SmartKey with KEYLESS-GO is in the vehicle.



If you wish to start the vehicle using the SmartKey instead of the KEYLESS-GO feature, remove the KEYLESS-GO start/stop button from the starter switch (▷ page 40).

For information on turning off the engine with KEYLESS-GO, see “Turning off with KEYLESS-GO*” (▷ page 66).

Starting difficulties

If the engine does not start as described, carry out the following steps:

- ▶ If you are starting the engine with the SmartKey, turn SmartKey in starter switch to position **0** and repeat starting procedure.
 - ▶ If you are starting the engine with KEYLESS-GO*: Close any doors that may be open to allow for better detection of the SmartKey with KEYLESS-GO.
- Or:
- ▶ Remove KEYLESS-GO start / stop button from starter switch.

- ▶ Start the engine with the SmartKey as radio signals from another source may be interfering with the SmartKey with KEYLESS-GO*.
- ▶ Repeat the starting procedure (▷ page 54). Remember that extended starting attempts can drain the battery.
- ▶ Get a jump start (▷ page 496).

If the engine does not start after several starting attempts, there could be a malfunction in the engine electronics or in the fuel supply system.

- ▶ Notify an authorized Mercedes-Benz Light Truck Center.

Parking brake



- ① Parking brake pedal
- ② Release handle

Warning!



When leaving the vehicle, always remove the SmartKey or SmartKey with KEYLESS-GO* from the starter switch, take it with you and lock the vehicle. Do not leave children unattended in the vehicle, or with access to an unlocked vehicle. Children could release the parking brake, which could result in an accident and/or serious injury.

- ▶ Release the parking brake by pulling on release handle ②.

The warning lamp **BRAKE** (USA only) or **Ⓟ** (Canada only) in the instrument cluster goes out.

Driving

- ▶ Depress the brake pedal.
The gear selector lever can now be used.
- ▶ Shift automatic transmission to **D** or **R** (▷ page 198).



Wait for the gear selection process to complete before setting the vehicle in motion.



Shifting from gear position **P** to position **R**, **N**, or **D** is only possible with the brake pedal depressed. Without the brake pedal depressed, the gear selector lever can be moved, but the parking pawl remains engaged, not allowing shifting to occur.

- ▶ Release the brake pedal.

- ▶ Carefully depress the accelerator pedal.

Once the vehicle is in motion, the automatic central locking system engages and the locking knobs drop down.



The automatic door lock feature can be deactivated (▷ page 188).



You can open a locked door from the inside. Open door only when conditions are safe to do so.



If you hear a warning signal and the message **Release parking brake** appears in the multifunction display when driving off, you have forgotten to release the parking brake.

Release the parking brake.

After a cold start, the automatic transmission shifts at a higher engine revolution. This allows the catalytic converter to reach its operating temperature earlier.

Warning!



On slippery road surfaces, never downshift in order to obtain braking action. This could result in drive wheel slip and reduced vehicle control. Your vehicle's ABS will not prevent this type of loss of control.

Warning!



It is dangerous to shift the gear selector lever out of **P** or **N** if the engine speed is higher than idle speed. If your foot is not firmly on the brake pedal, the vehicle could accelerate quickly forward or in reverse. You could lose control of the vehicle and hit someone or something. Only shift into gear when the engine is idling normally and when your right foot is firmly on the brake pedal.



Shift the automatic transmission to position **P** or **R** only when the vehicle is stopped in order to avoid damaging the transmission.



Do not run cold engine at high engine speeds. Running a cold engine at high engine speeds may shorten the service life of the engine.



Simultaneously depressing the accelerator pedal and applying the brake reduces engine performance and causes premature brake and drivetrain wear.

For more information, see “Driving instructions” (▷ page 331).

Driving

Switching on headlamps

For more information on headlamps, see “Lighting” (▷ page 147).

Low beam headlamps

The exterior lamp switch is located on the dashboard to the left of the steering wheel.



Exterior lamp switch

- ① Off
- ② Low beam headlamps on

- ▶ Turn the exterior lamp switch to position .

The low beam headlamps come on.

High beam

The combination switch is located on the left of the steering column.



Combination switch

- ① High beam
- ② High beam flasher

- ▶ Push the combination switch in direction of arrow ①.

The high beam headlamp indicator lamp  in the instrument cluster comes on (▷ page 24).

For more information on headlamps, see “Combination switch” (▷ page 151).

Turn signals



The combination switch is located on the left of the steering column.



Combination switch

- ① Turn signals, right
- ② Turn signals, left

- ▶ Press combination switch in direction of arrow ① or ②.

The corresponding turn signal indicator lamp  or  in the instrument cluster flashes.

The combination switch resets automatically after major steering wheel movement.



To signal minor directional changes, move combination switch to point of resistance and release. The corresponding turn signal flashes three times.

Windshield wipers

The combination switch is located on the left of the steering column.



Combination switch

- ① Single wipe
Wiping with windshield washer fluid
- ② Switching on windshield wipers
- ▶ Switch on the ignition (> page 38).



Do not operate the windshield wipers when the windshield is dry. Dust that accumulates on a windshield might scratch the glass and/or damage the wiper blades when wiping occurs on a dry windshield. If it is necessary to operate the windshield wipers in dry weather conditions, always operate the windshield wipers with windshield washer fluid (> page 60).

Switching on windshield wipers

- ▶ Turn the combination switch to the desired position depending on the intensity of the rain.
 - 0 Windshield wipers off
 - I Intermittent wiping
 - II Normal wiper speed
 - III Fast wiper speed

Intermittent wiping



Do not leave windshield wipers in intermittent setting when the vehicle is taken to an automatic car wash or during windshield cleaning. Wipers will operate in the presence of water sprayed on the windshield, and windshield wipers may be damaged as a result.

Intermittent wiping interval is dependent on wetness of windshield.

- ▶ Set the wiper switch to position **I**.

After the initial wipe, pauses between wipes are automatically controlled by the rain sensor.



Intermittent wiping is interrupted when the vehicle is at a standstill and a front door is opened.

Intermittent wiping will be continued when

- all doors are closed
- and
- the automatic transmission is set to position **D** or **R**
- or
- the wiper setting is changed using the combination switch

Single wipe

- ▶ Press the combination switch briefly in direction of arrow ① to the resistance point.

The windshield wipers wipe one time without washer fluid.

Wiping with windshield washer fluid

- ▶ Press the combination switch in direction of arrow ① past the resistance point.

The windshield wipers operate with washer fluid.



To prevent smears on the windshield, wipe with windshield washer fluid every now and then even when it is raining.

For information on filling up the washer reservoir, see “Windshield/rear window washer system*” (▷ page 352).



If anything blocks the windshield wipers (leaves, snow, etc.), switch them off immediately.

- For safety reasons, stop the vehicle in a safe location and
 - remove the SmartKey from the starter switch

or

- turn off the engine by pressing the KEYLESS-GO* start/stop button and open the driver's door (with the driver's door open, starter switch is in position **0**, same as with SmartKey removed from starter switch)

before attempting to remove any blockage.

- Remove blockage.
- Turn the windshield wipers on again.

If the windshield wipers fail to function at all in combination switch position **I**,

- set the combination switch to the next higher wiper speed
- have the windshield wipers checked at the nearest authorized Mercedes-Benz Light Truck Center

Rear window wiper/washer

The combination switch is located on the left of the steering column.



Combination switch

- ① Rear window wiper switch
- ② Wiping rear window with washer fluid
- ③ Intermittent wiper
- ④ Rear window wiper off
- ⑤ Wiping rear window with washer fluid

Driving

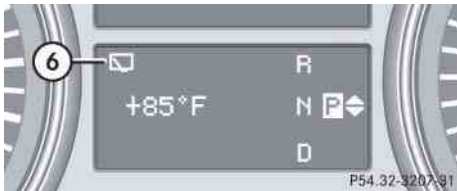

⑥ Rear window wiper indicator

- ▶ Switch on the ignition (▷ page 38).



The rear window wiper engages automatically when the automatic transmission is shifted to position **R** with the windshield wipers switched on.

Activating intermittent wipe

- ▶ Turn rear window wiper switch ① to position ③ (▷ page 61).

In the lower multifunction display you will see symbol ⑥, indicating that the rear window wiper is activated.

Deactivating intermittent wipe

- ▶ Turn rear window wiper switch ① to position ④ (▷ page 61).

Symbol ⑥ for the rear window wiper is cleared from the lower multifunction display, indicating that the rear window wiper is deactivated.

Wiping with windshield washer fluid

- ▶ Turn rear window wiper switch ① to position ② or ⑤ (▷ page 61).
The wiper operates with washer fluid.
- ▶ Hold rear window wiper switch ① in position ② or ⑤ (▷ page 61) until the rear window is clean.

For information on filling up the washer reservoir, see “Windshield / rear window washer system and headlamp cleaning system*” (▷ page 352).

Problems while driving

The engine runs erratically and misfires

- An ignition cable may be damaged.
 - The engine electronics may not be operating properly.
 - Unburned gasoline may have entered the catalytic converter and damaged it.
- ▶ Give very little gas.
 - ▶ Have the problem repaired by an authorized Mercedes-Benz Light Truck Center as soon as possible.

The coolant temperature is above 248°F (120°C)

The coolant is too hot and is no longer cooling the engine.

- ▶ Stop the vehicle as soon as possible in a safe location and turn off the engine. Allow engine and coolant to cool.
- ▶ Check the coolant level and add coolant if necessary (▷ page 351).

In case of accident

If the vehicle is leaking fuel:

- ▶ Do not start the engine under any circumstances.
- ▶ Notify local fire and/or police authorities.

If the extent of the damage cannot be determined:

- ▶ Notify an authorized Mercedes-Benz Light Truck Center.

If no damage can be determined on the

- major assemblies
 - fuel system
 - engine mount:
- ▶ Start the engine in the usual manner.

Parking and locking

You have now completed your first drive. You have properly stopped and parked your vehicle. End your drive as follows.

Warning!



With the engine not running, there is no power assistance for the brake and the steering system. In this case, it is important to keep in mind that a considerably higher degree of effort is necessary to brake and steer the vehicle.

Warning!



Do not park this vehicle in areas where combustible materials such as grass, hay or leaves can come into contact with the hot exhaust system, as these materials could be ignited and cause a vehicle fire.

To reduce the risk of personal injury as a result of vehicle movement, before turning off the engine and leaving the vehicle always:

- Keep right foot on brake pedal.
- Firmly depress parking brake pedal.
- Shift the automatic transmission to position **P**.
- Slowly release brake pedal.
- When parked on an incline, turn front wheel towards the road curb.

- Turn the SmartKey in the starter switch to position **0** and remove the SmartKey from the starter switch, or press the start / stop button (vehicles with KEYLESS-GO*).
- Take the SmartKey or the SmartKey with KEYLESS-GO* and lock vehicle when leaving.

Parking brake

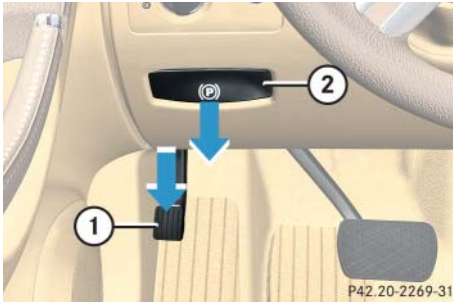

- ① Parking brake pedal
- ② Release handle

- ▶ Step firmly on parking brake pedal ①.

When the engine is running, the warning lamp **BRAKE** (USA only) or **(P)** (Canada only) in the instrument cluster comes on.

Warning!



When leaving the vehicle, always remove the SmartKey or SmartKey with KEYLESS-GO* from the starter switch, take it with you and lock the vehicle. Do not leave children unattended in the vehicle, or with access to an unlocked vehicle. Children could release the parking brake and/or shift the automatic transmission out of position **P**, either of which could result in an accident and/or serious personal injury.

Warning!



Getting out of your vehicle with the automatic transmission not fully engaged in position **P** is dangerous. Also, when parked on an incline, position **P** alone may not prevent your vehicle from moving, possibly hitting people or objects.

Always set the parking brake in addition to shifting to position **P** (▷ page 199).

When parked on an incline, also turn front wheel towards the road curb.

Switching off headlamps

- ▶ Turn the exterior lamp switch to **0**.

For more information, see “Lighting” (▷ page 147).

Parking and locking

Turning off the engine

- ▶ Shift the automatic transmission to position **P** (▷ page 199).
- ▶ Apply the parking brake (▷ page 65).



Always set the parking brake in addition to shifting to position **P** (▷ page 199).

When parked on an incline, also turn front wheel towards the road curb.

Turning off with the SmartKey

- ▶ Turn the SmartKey in the starter switch to position **0** (▷ page 38).
- ▶ Remove the SmartKey from the starter switch.

The immobilizer is activated.



If you turn off the engine using the SmartKey and remove the SmartKey from the starter switch with the transmission in a position other than **P**, the transmission will automatically shift to **P**.

Keep in mind that turning off the engine with the SmartKey alone will not automatically shift the transmission to **P**. Only when the SmartKey is removed from the starter switch will the transmission automatically shift to **P**.

Turning off with KEYLESS-GO*

- ▶ Press the KEYLESS-GO start / stop button (▷ page 40) to turn off the engine.

With the driver's door closed, the starter switch is now in position **1**. With the driver's door opened, the starter switch is set to position **0**, same as SmartKey removed from starter switch (▷ page 38).



If you turn off the engine using the KEYLESS-GO start/stop button and open the driver's door with the transmission in a position other than **P**, the transmission will automatically shift to **P**.

Keep in mind that turning off the engine with the KEYLESS-GO start/stop button alone will not automatically shift the transmission to **P**. Only when the driver's door is opened will the transmission automatically shift to **P**.

Releasing seat belts

- ▶ Press the seat belt release button (▷ page 51).

Allow the retractor to completely re-wind the seat belt by guiding the latch plate.



Make sure the seat belt retracts fully so that the seat belt and/or latch plate cannot get caught or pinched in the door or in the seat mechanism. This can damage the seat belt and impair the effectiveness of the seat belt, and/or cause damage to the door and/or door trim panel. Such damage is not covered by the Mercedes-Benz Limited Warranty.

Damaged seat belts must be replaced. Contact an authorized Mercedes-Benz Light Truck Center.

Locking

Warning!



To prevent possible personal injury, always keep hands and fingers away from the door openings when closing the doors. Be especially careful when small children are around.

Before closing doors, make sure there is no possibility of someone getting caught in a door during closing.

Warning!



When leaving the vehicle, always remove the SmartKey from the starter switch, take the SmartKey with KEYLESS-GO* with you, and lock your vehicle. Do not leave children unattended in the vehicle, or with access to an unlocked vehicle. Unsupervised use of vehicle equipment may cause an accident and/or serious personal injury.



A warning sounds and the message **Switch off lights** appears in the multifunction display if the vehicle's exterior lamps are not switched off

- with the SmartKey removed from the starter switch and the driver's door open
- with the engine turned off using the KEYLESS-GO* start/stop button and the driver's door open (same as SmartKey removed from starter switch)

Switch off the exterior lamps.

- ▶ Exit the vehicle and close all doors and the tailgate.

Parking and locking

Locking with the SmartKey

- ▶ Press lock button  on the SmartKey (▷ page 36).

With the tailgate and all doors closed, the turn signal lamps flash three times. The locking knobs on the doors move down. The anti-theft alarm system is armed.

For more information, see “Locking and unlocking” (▷ page 110).

Locking with KEYLESS-GO*

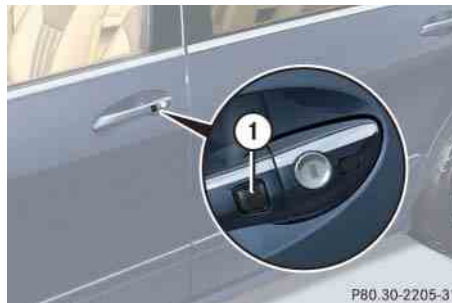

- ① Lock button on the outside door handle

- ▶ Press lock button ① on an outside door handle or on the tailgate (▷ page 120).

With the tailgate and all doors closed, the turn signal lamps flash three times. The locking knobs on the doors move down. The anti-theft alarm system is armed.

For more information, see “Locking and unlocking” (▷ page 110).

Safety and Security

Occupant safety

Panic alarm

Driving safety systems

Anti-theft systems



Occupant safety

In this section you will learn the most important facts about the restraint systems of the vehicle.

The restraint systems are

- Seat belts (▷ page 77)
- Child restraints (▷ page 90)
- Lower anchors and tethers for children (LATCH) (▷ page 92)

Supplemental Restraint System (SRS) with

- Air bags (▷ page 71)
- Air bag control unit (with crash sensors)
- Emergency tensioning device (ETD) for seat belts (▷ page 80)

Advanced air bag system components with

- Front passenger air bag off indicator lamp (▷ page 89)
- Front passenger seat with Occupant Classification System (OCS) (▷ page 85)

As independent systems, their protective functions work in conjunction with each other.



For information on infants and children traveling with you in the vehicle and restraint systems for infants and children, see “Children in the vehicle” (▷ page 82).

The SRS system conducts a self-test when the ignition is switched on and in regular intervals while the engine is running. This facilitates early detection of malfunctions. The **SRS** indicator lamp in the instrument cluster (▷ page 24) comes on when the ignition is switched on and goes out no later than a few seconds after the engine was started.

The SRS components are in operational readiness if the **SRS** indicator lamp is not lit when the engine is running.

A malfunction in the system has been detected if the **SRS** indicator lamp:

- fails to go out no later than approximately 4 seconds after the engine was started
- does not come on at all
- comes on after the engine was started or while driving

Air bags

Warning!



In the event that the **SRS** indicator lamp comes on during driving or does not come at all, the SRS self-check has detected a malfunction. For your safety, we strongly recommend that you visit an authorized Mercedes-Benz Light Truck Center immediately to have the system checked; otherwise the SRS may not deploy when needed in an accident, which could result in serious or fatal injury, or it might deploy unexpectedly and unnecessarily which could also result in injury.

In addition, improper work on the SRS creates a risk of rendering the SRS inoperative or causing unintended air bag deployment. Work on the SRS must therefore only be performed by qualified technicians. Contact an authorized Mercedes-Benz Light Truck Center.

If it is necessary to modify an air bag system to accommodate a person with disabilities, contact a local authorized Mercedes-Benz Light Truck Center or call our Customer Assistance Center at 1-800-FOR-MERCEdes (1-800-367-6372) for details.

Warning!



Air bags are designed to reduce the potential of injury and fatality in certain frontal impacts (front air bags), side impacts (side impact air bags and head protection window curtain air bags) or rollovers (head protection window curtain air bags). However, no system available today can totally eliminate injuries and fatalities.

The activation of the air bags temporarily releases a small amount of dust from the air bags. This dust, however, is neither injurious to your health, nor does it indicate a fire in the vehicle. The dust might cause some temporary breathing difficulty for people with asthma or other breathing trouble. To avoid this, you may wish to get out of the vehicle as soon as it is safe to do so. If you have any breathing difficulty but cannot get out of the vehicle after the air bag inflates, then get fresh air by opening a window or door.

Occupant safety

Warning!



To reduce the risk of injury when the front air bags inflate, it is very important for the driver and front passenger to always be in a properly seated position and to wear their respective seat belt.

For maximum protection in the event of a collision always be in normal seated position with your back against the seat backrest. Fasten your seat belt and make sure it is properly positioned on your body (> page 50).

Since the air bag inflates with considerable speed and force, a proper seating and hands on steering wheel position will help to keep you at a safe distance from the air bag. Occupants who are unbelted, out of position or too close to the air bag can be seriously injured or killed by an air bag as it inflates with great force in the blink of an eye:

- Sit properly belted in a nearly upright position with your back against the seat backrest.

- Adjust the driver seat as far as possible rearward, still permitting proper operation of vehicle controls. The distance from the center of the driver's breastbone to the center of the air bag cover on the steering wheel must be at least 10 inches (25 cm) or more. You should be able to accomplish this by a combination of adjustments to the seat and steering wheel. If you have any problems, please see an authorized Mercedes-Benz Light Truck Center.
- Do not lean your head or chest close to the steering wheel or dashboard.
- Keep hands on the outside of steering wheel rim. Placing hands and arms inside the rim can increase the risk and potential severity of hand / arm injury when driver's front air bag inflates.
- Adjust the front passenger seat as far as possible rearward from the dashboard when the seat is occupied.

- Occupants, especially children, should never place their bodies or lean their heads in the area of the door where the side impact air bag inflates. This could result in serious injuries or death should the air bag be triggered. Always sit nearly upright, properly use the seat belts and use an appropriately sized infant or toddler restraint or booster seat recommended for the size and weight of the child.

Failure to follow these instructions can result in severe injuries to you or other occupants.

If you sell your vehicle, it is important that you make the buyer aware of this safety information. Be sure to give the buyer this Operator's Manual.

Warning!

Accident research shows that the safest place for children in an automobile is in the rear seat.

It should be noted that with respect to both, front side impact air bags or the rear side impact air bags*, there is a possibility for a side impact air bag related injury if occupants, especially children, are not properly seated or restrained when next to a side impact air bag which needs to deploy rapidly in a side impact in order to do its job.

To help avoid the possibility of injury, please follow these guidelines:

- (1) Occupants, especially children, should never place their bodies or lean their heads in the area of the door where the side impact air bag inflates. This could result in serious injuries or death should the side impact air bag be activated.

- (2) Always sit nearly upright, properly use the seat belts and for children 12 years old and under, use an appropriately sized infant or toddler restraint or booster seat recommended for the size and weight of the child.

- (3) Always wear seat belts properly.

If you believe that, even with the use of these guidelines, it would be safer for your rear seat occupants to have the rear seat mounted side impact air bags deactivated, then deactivation can be accomplished upon your written request to do so at an authorized Mercedes-Benz Light Truck Center at an additional cost.

Please contact your local authorized Mercedes-Benz Light Truck Center or call our Customer Assistance Center at 1-800-FOR-MERCEdes (1-800-367-6372) for details.



Air bags are designed to activate only in certain frontal impacts (front air bags), side impacts (side impact and head protection window curtain air bags) which exceed preset thresholds, and in certain rollovers (head protection window curtain air bags). Only during these events will they provide their supplemental protection.

The driver and passengers should always wear their seat belts. Otherwise it is not possible for air bags to provide their supplemental protection.

In case of other types of impacts and impacts below air bag deployment thresholds, air bags will not deploy. The driver and passenger will then be protected to the extent possible by a properly fastened seat belt. A properly fastened seat belt is also needed to provide the best possible protection in a rollover.

Occupant safety

We caution you not to rely on the presence of the air bags in order to avoid wearing your seat belt.

It is important to your safety and that of your passengers that you replace deployed air bags and repair any malfunctioning air bags to make sure the vehicle will continue to provide supplemental crash protection for occupants.

Safety guidelines for the seat belt, emergency tensioning device and air bag

Warning!



- Damaged seat belts or belts that were highly stressed in an accident must be replaced and their anchoring points must also be checked. Use only belts installed or supplied by an authorized Mercedes-Benz Light Truck Center.
- Air bags and pyrotechnic emergency tensioning devices (ETDs) are designed to function on a one-time-only basis. An air bag or ETD that is deployed must be replaced. PRE-SAFE®* has electrically operated reversible pre-tensioners in addition to the pyrotechnic ETDs.
- Do not pass belts over sharp edges. They could tear.
- Do not make any modification that could change the effectiveness of the belts.

- Do not bleach or dye seat belts as this may severely weaken them. In a crash they may not be able to provide adequate protection.
- No modifications of any kind may be made to any components or wiring of the SRS. This includes changing or removing any component or part of the SRS, the installation of additional trim material, badges, etc. over the steering wheel hub, front passenger front air bag cover, outboard sides of the front seat backrests, door trim panels, or door frame trims, and installation of additional electrical / electronic equipment on or near SRS components and wiring. Keep area between air bags and occupants free from objects (e.g. packages, purses, umbrellas, etc.).
- Do not hang items such as coat hangers from the coat hooks or handles over the door. These items may turn into projectiles and cause head and other injuries when curtain air bag is deployed.
- Air bag system components will be hot after an air bag has inflated. Do not touch.

Front air bags



- ① Driver air bag
- ② Passenger air bag

Driver and front passenger air bags are deployed:

- in the event of certain frontal impacts
- if impact exceeds a preset deployment threshold
- independently of the side impact air bags

- Never place your feet on the instrument panel, dashboard, or on the seat. Always keep both feet on the floor in front of the seat.
- In addition, improper repair work on the SRS creates a risk of rendering the SRS inoperative or causing unintended air bag deployment. Work on the SRS must therefore only be performed by qualified technicians. Contact an authorized Mercedes-Benz Light Truck Center.
- For your protection and the protection of others, when scrapping the air bag unit or emergency tensioning device, our safety instructions must be followed. These instructions are available from your authorized Mercedes-Benz Light Truck Center.
- Given the considerable deployment speed, required inflation volume, and the textile structure of the air bags, there is the possibility of abrasions or other more significant injuries resulting from air bag deployment.

Warning!



Only use seat covers which have been tested and approved by Mercedes-Benz for your vehicle model. Using other seat covers may interfere with or prevent the deployment of the front side impact air bags or the rear side impact air bags*. Contact your authorized Mercedes-Benz Light Truck Center for availability.

When you sell your vehicle we strongly urge you to give notice to the subsequent owner that it is equipped with an SRS by alerting them to the applicable section in the Operator's Manual.

Occupant safety



The front air bags in this vehicle have been designed to inflate in two stages. This allows the air bag to have different rates of inflation that are based on the rate of relevant vehicle deceleration as assessed by the air bag control unit.

On the front passenger-side, the front air bag deployment is additionally influenced by the passenger's weight category as identified by the Occupant Classification System (OCS) (> page 85).

The lighter the front passenger side occupant, the higher the vehicle deceleration rate required for the second stage inflation of the air bag.

The air bags will not deploy in impacts which do not exceed the system's deployment thresholds. You will then be protected by the fastened seat belts.

The passenger front air bag will only be deployed if:

- the system, based on OCS weight sensor readings, senses that the front passenger seat is occupied
- the  **PASS AIR BAG OFF** indicator lamp in the center console is not lit (> page 89)
- the impact exceeds a preset deployment threshold

Side impact air bags, window curtain air bags

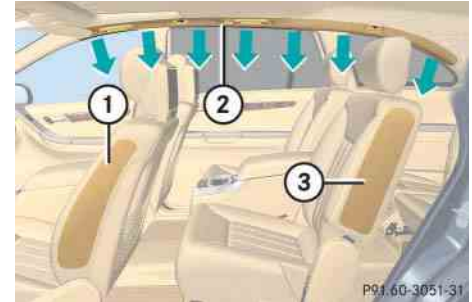

- ① Front side impact air bag
- ② Window curtain air bag
- ③ Rear side impact air bag*

The side impact air bags and window curtain air bags are deployed:

- on the impacted side of the vehicle
- in impacts exceeding a preset deployment threshold
- independently of the front air bags

In addition, the window curtain air bags ② are deployed in certain vehicle rollovers.



The front passenger side impact air bag will not deploy if the OCS senses that the front passenger seat is empty and the front passenger seat belt is not fastened (latch plate is not inserted into the buckle). With an empty front passenger seat and the seat belt fastened (latch plate properly inserted into buckle) the front passenger side impact air bag will deploy independently of the empty seat.

The side impact air bags and window curtain air bags are not deployed in impacts which do not exceed the system's deployment threshold.



Seat belts

When the engine is started, the seat belt telltale  illuminates for a maximum of 6 seconds and a warning chime sounds to remind you and your passengers to fasten your seat belts.

If after these 6 seconds, the driver's or the front passenger's seat belt (with the front passenger seat occupied) are not fastened with all doors closed,

- and the vehicle speed does not exceed 15 mph (25 km/h), the seat belt telltale  remains illuminated for as long as either the driver's or front passenger's seat belt is not fastened
- and the vehicle speed exceeds 15 mph (25 km/h), the seat belt telltale  starts flashing and a warning chime sounds with increasing intensity until both the driver's and front passenger's seat belt are fastened, or for a maximum of 60 seconds from the time the vehicle speed

exceeded 15 mph (25 km/h) if either the driver's or front passenger's seat belt remains unfastened.

If the driver's or front passenger's seat belt remains unfastened after 60 seconds, the seat belt telltale  stops flashing and the warning chime stops sounding. The seat belt telltale  then continues to be illuminated for as long as either the driver's or front passenger's seat belt are not fastened.

The seat belt telltale  will only go out if both the driver's and the front passenger's seat belt (with the front passenger seat occupied) are fastened, or the vehicle is standing still and a front door is opened.

For more information, see "Practical hints" (> page 410).

Occupant safety

Always wear your seat belt. All vehicle occupants always need to have their seat belts fastened and wear them properly.

In addition, applicable motor vehicle safety laws require you to wear seat belts. Even where this is not the case, we strongly recommend that all vehicle occupants have their seat belts fastened and wear them properly.

For more information, see “Fastening the seat belts” (▷ page 50).



For information on infants and children traveling with you in the vehicle and restraint systems for infants and children, see “Children in the vehicle” (▷ page 82).

Warning!



Always fasten your seat belt before driving off. Always make sure all of your passengers are properly restrained, even those sitting in the rear and pregnant women.

Failure to wear and properly fasten and position your seat belt greatly increases your risk of injuries and their likely severity in an accident. You and your passengers should always wear seat belts.

If you are ever in an accident, your injuries can be considerably more severe without your seat belt properly buckled. Without your seat belt buckled, you are much more likely to hit the interior of the vehicle or be ejected from it. You can be seriously injured or killed.

In the same crash, the possibility of injury or death is lessened if you are properly wearing your seat belt. Air bags can only protect as they are designed if the occupants are properly wearing their seat belts.

Warning!



Never ride in a moving vehicle with the seat backrest in an excessively reclined position as this can be dangerous. You could slide under the seat belt in a collision. If you slide under it, the belt would apply force at the abdomen or neck. That could cause serious or even fatal injuries. The seat backrest and seat belt provide the best restraint when the wearer is in a nearly upright position and the belt is properly positioned on the body.

Warning!



Never let more people ride in the vehicle than there are seat belts available. Make sure everyone riding in the vehicle is correctly restrained with a separate seat belt. Never use a seat belt for more than one person at a time.

Warning!

Damaged seat belts or belts that were highly stressed in an accident must be replaced and their anchoring points must also be checked.

Only use seat belts which have been approved by Mercedes-Benz.

Do not make any modifications to the seat belts. This can lead to unintended activation of the ETDs or to failure.

Do not bleach or dye seat belts as this may severely weaken them. In a crash they may not be able to provide adequate protection.

Have all work carried out only by qualified technicians. Contact an authorized Mercedes-Benz Light Truck Center.

Warning!**USE SEAT BELTS PROPERLY**

- Seat belts can only work when used properly. Never wear seat belts in any other way than as described in this section, as that could result in serious injuries in case of an accident.
- Each occupant should wear their seat belt at all times, because seat belts help reduce the likelihood of and potential severity of injuries in accidents, including rollovers. The integrated restraint system includes SRS (driver air bag, passenger front air bag, side impact air bags, head protection window curtain air bags for side windows) and ETD (seat belt emergency tensioning device). The system is designed to enhance the protection offered to properly belted occupants in certain frontal (front air bags and ETD) and side (side impact, window curtain air bags and ETD) impacts which exceed preset deployment thresholds and in certain rollovers (window curtain air bags and ETD).

- Never wear the shoulder belt under your arm, against your neck or off your shoulder. In a frontal crash, your body would move too far forward. That would increase the chance of head and neck injuries. The belt would also apply too much force to the ribs or abdomen, which could severely injure internal organs such as your liver or spleen.
- Never wear belts over rigid or breakable objects in or on your clothing, such as eyeglasses, pens, SmartKeys, etc., as these might cause injuries.
- Position the lap belt as low as possible on your hips and not across the abdomen. If the belt is positioned across your abdomen, it could cause serious injuries in a crash.
- Never use a seat belt for more than one person at time. Do not fasten a seat belt around a person and another person or other objects.



Occupant safety



- Belts should not be worn twisted. In a crash, you would not have the full width of the belt to distribute impact forces. The twisted belt against your body could cause injuries.
- Pregnant women should also use a lap-shoulder belt. The lap belt portion should be positioned as low as possible on the hips to avoid any possible pressure on the abdomen.
- Never place your feet on the instrument panel, dashboard or on the seat. Always keep both feet on the floor in front of the seat.
- When using a seat belt to secure infant or toddler restraints or children in booster seats, always follow the child seat manufacturer's instructions.

Emergency tensioning device (ETD), seat belt force limiter

The seat belts for the front and rear seats are equipped with emergency tensioning devices and belt force limiters.

The ETD is designed to activate in the following cases:

- in frontal or rear-end impacts exceeding a preset severity level
- in certain vehicle rollovers
- if the restraint systems are operational and functioning correctly, see **SRS** indicator lamp (▷ page 411)



The ETDs for the front seats will only activate if the respective front seat belt is fastened (latch plate properly inserted into buckle).

The ETDs for the rear seats will activate with or without the respective seat belt fastened.

In an impact, emergency tensioning devices remove slack from the belts in such a way that the seat belts fit more snugly against the body. Belt force limiters reduce the force exerted by the seat belts on occupants during a crash.

Warning!



A pyrotechnic emergency tensioning device (ETD) that was activated must be replaced.

When disposing of the pyrotechnic emergency tensioning device, our safety instructions must be followed. These are available at your authorized Mercedes-Benz Light Truck Center.

PRE-SAFE®* has electrically operated reversible pre-tensioners that do not require replacement after activation.

Preventive occupant safety* (PRE-SAFE®)

Warning!



The PRE-SAFE® system is intended to reduce the effects of an accident on properly seat-belted vehicle occupants. Despite having the PRE-SAFE® system in your vehicle, the possibility of injuries occurring as a result of an accident cannot be totally eliminated. Therefore you should always drive carefully and adjust your driving to the prevailing road, weather, and traffic conditions.

Your vehicle automatically takes preventive measures to better protect the occupants in the following hazardous situations:

- You execute an emergency braking maneuver and the Brake Assist System (> page 99) is activated.
- The PRE-SAFE® system detects a critical driving dynamics situation.

In such cases, the following systems are automatically activated:

- The front seat belts are pre-tensioned electrically.
- Vehicles with front passenger seat memory function*:
If the OCS senses that the front passenger seat is occupied and the seat is in an unfavorable position, it will be adjusted to a better position.
- Vehicles with tilt/sliding sunroof*:
The tilt/sliding sunroof closes if the vehicle is in a severe skid or is spinning.



If the closing procedure of the tilt/sliding sunroof* is blocked, the tilt/sliding sunroof* will stop and open slightly.



The PRE-SAFE® system is activated in the previously described circumstances only at speeds exceeding 22 mph (35 km/h).

When the driving dynamic situation has passed without an accident occurring, the pre-tensioning on the seat belts is deactivated.

You can then adjust the seats and the tilt/sliding sunroof* to their previous position.

If the seat belts do not release:

- ▶ Adjust the backrest or seat slightly to the rear until the seat belt tension is diminished.

The locking mechanism releases.

Occupant safety

Children in the vehicle

If an infant or child is traveling with you in the vehicle:

- Secure the child using an infant or child restraint appropriate to the age and size of the child.
- Make sure the infant or child is properly secured at all times while the vehicle is in motion.

Infant and child restraint seats and information on choosing an appropriate restraint system can be obtained at any authorized Mercedes-Benz Light Truck Center.

Infant and child restraint systems

We recommend all infants and children be properly restrained at all times while the vehicle is in motion.

All lap-shoulder belts except the driver's seat belt have special seat belt retractors for secure fastening of child restraints.

To fasten a child restraint, follow child restraint instructions for mounting. Then pull the shoulder belt out completely and let it retract. During seat belt retraction, a ratcheting sound can be heard to indicate that the special seat belt retractor is activated. The belt is now locked. Push down on child restraint to take up any slack.

To deactivate, release seat belt buckle and let seat belt retract completely. To deactivate the special seat belt retractor for the front passenger seat, the front passenger seat must be in the most backward position. The seat belt can again be used in the usual manner.



For information on child seats with mounting fittings for tether anchorages, see “Installation of infant and child restraint system” (▷ page 90).

For information on LATCH-type child seat mounts, see “Child seat anchors – LATCH type” (▷ page 92).

The use of infant or child restraints is required by law in all 50 states, the District of Columbia, the U.S. territories and all Canadian provinces.

Infants and small children should be seated in an appropriate infant or child restraint system properly secured by a lap / shoulder belt or, if so equipped, a child restraint lower anchorage system that complies with U.S. Federal Motor Vehicle Safety Standards 213 and 225 and Canadian Motor Vehicle Safety Standard 213 and 210.2.

Warning!

Never release the seat belt buckle while the vehicle is in motion, since the special seat belt retractor will be deactivated.

A statement by the child restraint manufacturer of compliance with this standard can be found on the instruction label on the restraint and in the instruction manual provided with the restraint.

When using any infant or child restraint system, make sure to carefully read and follow all manufacturer's instructions for installation and use.

Please read and observe warning labels affixed to inside of vehicle and to infant or child restraints.

Warning!

According to accident statistics, children are safer when properly restrained in the rear seating positions than in the front seating position. Thus, we strongly recommend that children be placed in the rear seats whenever possible. Regardless of seating position, children 12 years old and under must be seated and properly secured in an appropriate infant or child restraint recommended for the size and weight of the child.

The infant or child restraint must be properly secured with the vehicle's seat belt, the seat belt and top tether strap, or lower anchors and top tether strap, fully in accordance with the child seat manufacturer's instructions.





Children can be killed or seriously injured by an inflating air bag. Note the following important information when circumstances require you to place a child in the front passenger seat:

- Your vehicle is equipped with air bag technology designed to turn off the front passenger front air bag in your vehicle when the OCS senses the weight of a typical 12-month-old child or less along with the weight of a standard appropriate child restraint on the front passenger seat.
- A child in a rear-facing child restraint on the front passenger seat will be seriously injured or even killed if the front passenger front air bag inflates in a collision which could occur under some circumstances, even with the air bag technology installed in your vehicle. The only means to completely eliminate this risk is to never place a child in a rear-facing child restraint in the front seat. We therefore strongly recommend that you always place a child in a rear-facing child restraint in the back seat.



Occupant safety



- If you must install a rear-facing child restraint on the front passenger seat because circumstances require you to do so, make sure that the  **PASS AIR BAG OFF** indicator lamp is illuminated, indicating that the front passenger front air bag is deactivated. Should the  **PASS AIR BAG OFF** indicator lamp not illuminate or go out while the restraint is installed, please check installation. Periodically check the  **PASS AIR BAG OFF** indicator lamp while driving to make sure the lamp is illuminated. If the  **PASS AIR BAG OFF** indicator lamp goes out or remains out, do not transport a child on the front passenger seat until the system has been repaired. A child in a rear-facing child restraint on the front passenger seat will be seriously injured or even killed if the front passenger front air bag inflates.

- If you have to place a child in a forward-facing child restraint on the front passenger seat, move the seat as far back as possible, use the proper child restraint recommended for the age, size and weight of the child, and secure child restraint with the vehicle's seat belt according to the child seat manufacturer's instructions. For children larger than the typical 12-month-old child, the front passenger front air bag may or may not be activated (▷ page 85).

Warning!



Infants and small children should never share a seat belt with another occupant. During an accident, they could be crushed between the occupant and seat belt.

A child's risk of serious or fatal injuries is significantly increased if the child restraints are not properly secured in the vehicle and/or the child is not properly secured in the child restraint.

Children too big for a toddler restraint must ride in seats using regular seat belts. Position shoulder belt across chest and shoulder, not face or neck. A booster seat may be necessary to achieve proper belt positioning for children from 41 lbs until they reach a height where a lap/shoulder belt fits properly without a booster.

When the child restraint is not in use, remove it from the vehicle or secure it with the seat belt to prevent the child restraint from becoming a projectile in the event of an accident.

Do not leave children unattended in the vehicle, even if the children are secured in a child restraint system. Unsupervised children in a child restraint system may use vehicle equipment and may cause an accident and / or serious personal injury.

Occupant Classification System

The Occupant Classification System (OCS) automatically turns the front passenger front air bag on or off based on the classified occupant weight category determined by weight sensor readings from the front passenger seat.



The system does not deactivate the front passenger side impact air bag, the window curtain air bag, and the emergency tensioning device.

Occupants must sit properly belted in a nearly upright position with their back against the seat backrest and feet on the floor to be correctly classified. If the occupant's weight is transferred to another object in the vehicle (e.g. by leaning on armrests), the OCS may not be able to properly approximate the occupant's weight category.

Furthermore, the occupant weight may appear to increase or decrease due to objects hanging on the seat, other passengers pushing on the seat, objects lodged underneath the seat or stuffed between seat and middle console or between seat and door or due to objects applying pressure on the back of the seat. Always make sure the seat has clearance in all directions at all times.



If your seat, including your trim cover and cushion needs to be serviced in any way, take the vehicle to an authorized Mercedes-Benz Light Truck Center.

Only seat accessories approved by Mercedes-Benz may be used.

Both, driver and the front passenger should always use the  **PASS AIR BAG OFF** indicator lamp as an indication of whether or not the front passenger is properly positioned.

Occupant safety

Warning!





If the  **PASS AIR BAG OFF** indicator lamp illuminates when an adult or someone larger than a small individual is in the front passenger seat, have the front passenger reposition himself or herself in the seat until the



 **PASS AIR BAG OFF** indicator lamp goes out, or check whether objects are caught under or around the seat.

More information about air bag display messages (▷ page 423).

In the event of a collision, the air bag control unit will not allow front passenger front air bag deployment when the OCS classified the front passenger seat occupant as being up to or less than the weight of a typical 12-month-old child in a standard child restraint or if the front passenger seat is sensed as being empty.

When the OCS senses that the front passenger seat occupant is classified as being up to or less than the weight of a typical 12-month-old child in a standard child restraint, the  **PASS AIR BAG OFF** indicator lamp will illuminate when the engine is started and remain illuminated, indicating that the front passenger front air bag is deactivated.

When the OCS senses that the front passenger seat is classified as being empty, the  **PASS AIR BAG OFF** indicator lamp will illuminate when the engine is started and remain illuminated, indicating that the front passenger front air bag is deactivated.

When the OCS senses that the front passenger seat occupant is classified as being heavier than the weight of a typical 12-month-old child seated in a standard child restraint or as being a small individual (such as a young teenager or a small adult), the  **PASS AIR BAG OFF** indicator lamp will illuminate for approximately 6 seconds when the engine is started and then, depending on occupant weight sensor readings from the seat, remain illuminated or go out. With the  **PASS AIR BAG OFF** indicator lamp illuminated, the front passenger front air bag is deactivated. With the  **PASS AIR BAG OFF** indicator lamp out, the front passenger front air bag is activated.

When the OCS senses that the front passenger seat occupant is classified as an adult or someone larger than a small individual, the  **PASS AIR BAG OFF** indicator lamp will illuminate for approximately 6 seconds when the engine is started and then go out, indicating that the front passenger front air bag is activated.

If the  **PASS AIR BAG OFF** indicator lamp is illuminated, the front passenger front air bag is deactivated and will not be deployed.

If the  **PASS AIR BAG** indicator lamp is not illuminated, the front passenger front air bag is activated and will be deployed:

- in the event of certain frontal impacts
- if impact exceeds a preset deployment threshold
- independently of the side impact air bags.

If the front passenger front air bag is deployed, the rate of inflation will be influenced by

- the rate of relevant vehicle deceleration as assessed by the air bag control unit
- the front passenger's weight category as identified by the Occupant Classification System (OCS)

Warning!



According to accident statistics, children are safer when properly restrained in the rear seating positions than in the front seating position. Thus, we strongly recommend that children be placed in the rear seats whenever possible. Regardless of seating position, children 12 years old and under must be seated and properly secured in an appropriate infant or child restraint recommended for the size and weight of the child.

The infant or child restraint must be properly secured with the vehicle's seat belt, the seat belt and top tether strap, or lower anchors and top tether strap, fully in accordance with the child seat manufacturer's instructions.





Children can be killed or seriously injured by an inflating air bag. Note the following important information when circumstances require you to place a child in the front passenger seat:

- Your vehicle is equipped with air bag technology designed to turn off the front passenger front air bag in your vehicle when the system senses the weight of a typical 12-month-old child or less along with the weight of a standard appropriate child restraint on the front passenger seat.
- A child in a rear-facing child restraint on the front passenger seat will be seriously injured or even killed if the front passenger front air bag inflates in a collision which could occur under some circumstances, even with the air bag technology. The only means to completely eliminate this risk is to never place a child in a rear-facing child restraint in the front seat. We therefore strongly recommend that you always place a child in a rear-facing child restraint in the back seat.



Occupant safety



- If you must install a rear-facing child restraint on the front passenger seat because circumstances require you to do so, make sure that the  indicator lamp is illuminated, indicating that the front passenger front air bag is deactivated. Should the  indicator lamp not illuminate or go out while the restraint is installed, please check installation. Periodically check the  indicator lamp while driving to make sure the  indicator lamp is illuminated. If the  indicator lamp goes out or remains out, do not transport a child on the front passenger seat until the system has been repaired. A child in a rear-facing child restraint on the front passenger seat will be seriously injured or even killed if the front passenger front air bag inflates.

- If you have to place a child in a forward-facing child restraint on the front passenger seat, move the seat as far back as possible, use the proper child restraint recommended for the age, size and weight of the child, and secure child restraint with the vehicle's seat belt according to the child seat manufacturer's instructions. For children larger than the typical 12-month-old child, the front passenger air bag may or may not be activated (▷ page 85).



Deployment of the driver front air bag does not mean that the front passenger front air bag also should have deployed.

The Occupant Classification System (▷ page 85) may have determined:

- that the seat was empty or occupied by the weight up to or less than that of a typical 12-month-old child seated in a standard child restraint – both instances where the system suppresses deployment of the front passenger front air bag even though the impact met the criteria and was of sufficient severity to deploy the driver front air bag
- that the seat was occupied by a small individual (such as a young teenager or a small adult) or a child weighing more than the weight of a typical 12-month-old child in a standard child restraint – instances where the system may suppress deployment of the front passenger front air bag even though the impact met the criteria and was of sufficient severity to deploy the driver front air bag

The  **PASS AIR BAG OFF** indicator lamp is located in the center console.



①  **PASS AIR BAG OFF** indicator lamp

The  **PASS AIR BAG OFF** indicator lamp ① will be illuminated, except with the SmartKey removed from the starter switch or with the starter switch in position **0** (▷ page 38).

Warning!



If the **SRS** indicator lamp and the  **PASS AIR BAG OFF** indicator lamp are lit at the same time, there is a malfunction in the Occupant Classification System. The front passenger front air bag will be deactivated in this case. Have the system checked as soon as possible by qualified technicians. Contact an authorized Mercedes-Benz Light Truck Center.



In order to ensure proper operation of the air bag system and OCS:

- Do not place more than 4.4 lbs (2 kg) into the parcel net on the back of the front passenger seat. Otherwise, the OCS may not be able to properly approximate the occupant weight category.
- Do not place objects under and/or around the front passenger seat.

- Do not hang anything from or attach any items to the seats.
- Do not stuff objects such as books between the middle console and the front passenger seat.
- Do not move the front passenger seat backwards against stiff objects.
- Sit properly belted in a nearly upright position with your back against the seat backrest.
- Do not lean on the armrests or lift yourself from the seat by using the handle over the door as this may cause the OCS to be unable to correctly approximate the occupant weight category.
- Only have the seat repaired or replaced by an authorized Mercedes-Benz Light Truck Center.
- Read and observe all warnings in this chapter.

Occupant safety

Self-test Occupant Classification System

After turning the SmartKey in the starter switch to position **1** or **2** or pressing the KEYLESS-GO* start / stop button once or twice, the  **PASS AIR BAG OFF** indicator lamp (▷ page 89) located in the center console illuminates. If an adult occupant is properly sitting on the front passenger seat and the system senses the occupant as being an adult, the  **PASS AIR BAG OFF** indicator lamp will illuminate and go out after approximately 6 seconds.

If the seat is not occupied and the system senses the front passenger seat as being empty, the  **PASS AIR BAG OFF** indicator lamp will illuminate and not go out.

Warning!



If the  **PASS AIR BAG OFF** indicator lamp should not illuminate, the system is not functioning. You must see an authorized Mercedes-Benz Light Truck Center before seating any child on the front passenger seat.

For more information, see the “Practical hints” section (▷ page 414).

Warning!



Never place anything between seat cushion and child seat (e.g. pillow), since it reduces the effectiveness of the Occupant Classification System. The bottom of the child seat must make full contact with the passenger seat cushion. An incorrectly mounted child seat could cause injuries to the child in case of an accident, instead of increasing protection for the child.

Follow the manufacturer’s instructions for installation of child seats.

Installation of infant and child restraint system

This vehicle is equipped with tether anchorages for a top tether strap at each of the rear seat backrests.

- ▶ Remove anchorage ring cover **1** from seat backrest of the seat on which a child seat is to be installed.

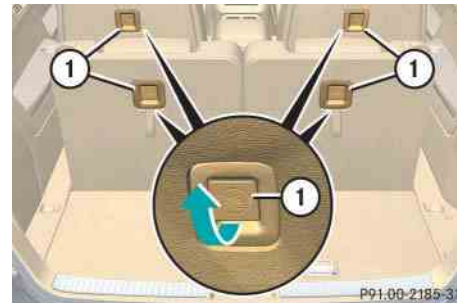

- 1** Anchorage ring cover

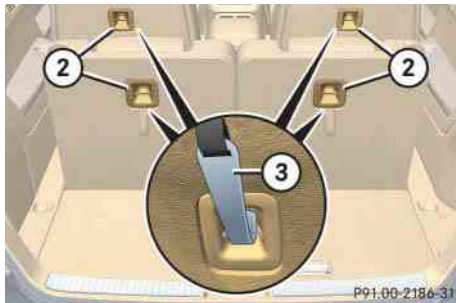

② Anchorage rings

③ Hook

- ▶ Guide top tether strap between head restraint and top of seat backrest.

Head restraint must be installed and positioned such that the top tether strap can pass freely between the head restraint and top of seat backrest.

i

When installing a child seat and top tether on a rear seat if a cargo compartment cover blind* or a partition net* is in place behind that rear seat, make sure the top tether strap is positioned between the seat backrest and the cargo compartment cover blind* or partition net* in order for the child seat to be properly secured.

- ▶ Make sure the tether strap is not twisted.



② Anchorage ring

③ Hook

- ▶ Securely fasten hook ③, which is part of the tether strap, to anchorage ring ②.

Warning!



When installing a child seat on a third-row seat, do not fasten hook ③ to the strap below anchorage ring ②. Otherwise, the child seat will not be securely fastened. A child's risk of serious or fatal injuries is significantly increased if the child seat is not properly secured in the vehicle.

i

For safety, make sure the hook has attached to the ring beyond the safety catch, as illustrated.



Occupant safety



Warning!



Always lock backrest in its upright position when rear seat bench is occupied by passengers, or the expanded cargo area is not in use. Check for secure locking by pushing and pulling on the backrest.

Once the top tether anchorage hook is attached, the child restraint itself can be secured. Tighten the top tether strap according to the child restraint manufacturer's instructions.

Child seat anchors – LATCH type

This vehicle is equipped with two LATCH (Lower Anchors and Tethers for Children) type anchors (at each of the rear seats) for the installation of a LATCH child seat with matching mounting fittings.

The LATCH anchors on the second-row seats are covered with an upholstery blend.

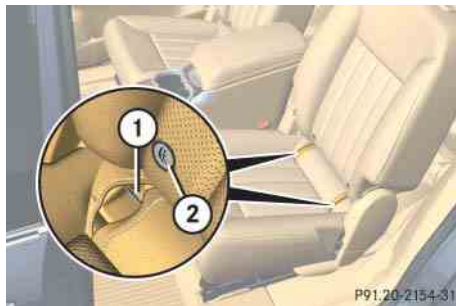

- ① Anchors second-row seats
- ② Indicates the position of the anchors

- ▶ Remove anchorage ring covers ③ from seat on which a child seat is to be installed.

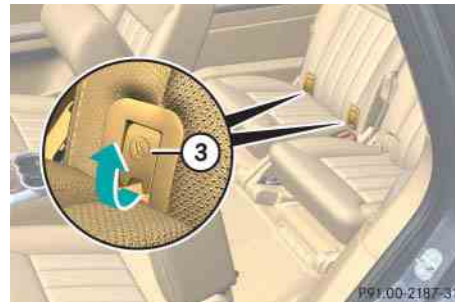

- ③ Anchorage ring covers, third-row seats

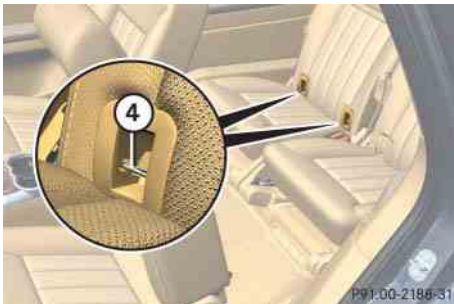

④ Anchors third-row seats

- ▶ Install a LATCH type child seat according to the manufacturer's instructions.



Non-LATCH type child seats may also be used and can be installed using the vehicle's seat belt system. Install child seat according to the manufacturer's instructions.

Warning!



Children too big for a toddler restraint must ride in seats using regular seat belts. Position shoulder belt across chest and shoulder, not face or neck. A booster seat may be necessary to achieve proper belt positioning for children from 41 lbs until they reach a height where a lap /shoulder belt fits properly without a booster.

Install child seat according to manufacturer's instructions.

The child seat must be firmly attached in the right and left side anchors ①.

An incorrectly mounted child seat may come loose during an accident which could result in serious injury or death to the child.

Damaged or impact damaged child seats or child seat mounting fittings must be replaced.

Do not leave children unattended in the vehicle, even if the children are secured in a child restraint system.

Blocking of rear door window operation

With the override switch you can disable the rear side window switches in the rear door panels.

Warning!



Activate the override switch when children are riding in the back seats of the vehicle. The children may otherwise injure themselves, e.g. by becoming trapped in the window opening.

When leaving the vehicle, always remove the SmartKey or SmartKey with KEYLESS-GO* from the starter switch, take it with you, and lock the vehicle. Do not leave children unattended in the vehicle, or with access to an unlocked vehicle. Unsupervised use of vehicle equipment may cause an accident and/or serious personal injury.

Occupant safety

The override switch is located on the driver's door control panel.



① Override switch

For more information on power windows, see “Power windows” (▷ page 248).

Disabling

- ▶ Press override switch ① until it engages.

The switch engages in the recessed position.

The rear door windows can no longer be operated using the switches located in the rear doors.



Operating the rear door windows using the switches located on the door control panel of the driver's door is still possible.

Enabling

- ▶ Press override switch ① once more.

The switch disengages from its recessed position back to its original position.

The rear door windows can again be operated using the switches located in the rear doors.

▼ Panic alarm

An audible alarm and flashing exterior lamps will operate for approximately 2¹/₂ minutes.



SmartKey

① **PANIC** button



SmartKey with KEYLESS-GO*

① **PANIC** button



USA only:

This device complies with Part 15 of the FCC Rules. Operation is subject to the following two conditions:

- (1) This device may not cause harmful interference, and

- (2) this device must accept any interference received, including interference that may cause undesired operation.

Any unauthorized modification to this device could void the user's authority to operate the equipment.



Canada only:

This device complies with RSS-210 of Industry Canada. Operation is subject to the following two conditions:

- (1) This device may not cause interference, and
- (2) this device must accept any interference received, including interference that may cause undesired operation of the device.

Any unauthorized modification to this device could void the user's authority to operate the equipment.

Panic alarm

Activating

- ▶ Press and hold button ① for at least 1 second.

Deactivating

- ▶ Press button ① again.

or

- ▶ Insert SmartKey or the SmartKey with KEYLESS-GO* in starter switch.

or

- ▶ Press the KEYLESS-GO* start/stop button (▷ page 40).

The SmartKey with KEYLESS-GO* must be in the vehicle.

▼ Driving safety systems

In this section you will find information on the following driving safety systems:

- ABS (Antilock Brake System)
- BAS (Brake Assist System)
- ESP® (Electronic Stability Program)
- EBP (Electronic Brake Proportioning)
- 4-ETS (Electronic Traction System)

Warning!



The following factors increase the risk of accidents:

- Excessive speed, especially in turns
- Wet and slippery road surfaces
- Following another vehicle too closely

The ABS, BAS, ESP® and 4-ETS cannot reduce this risk.

Always adjust your driving style to the prevailing road and weather conditions.



In winter operation, the maximum effectiveness of the ABS, the BAS, the ESP®, the EBP, and the 4-ETS is only achieved with winter tires (▷ page 390) or snow chains as required.

ABS

Warning!



Do not pump the brake pedal. Use firm, steady brake pedal pressure instead. Pumping the brake pedal defeats the purpose of the ABS and significantly reduces braking effectiveness.

The Antilock Brake System (ABS) regulates the brake pressure so that the wheels do not lock during braking. This allows you to maintain the ability to steer your vehicle.

The ABS is functional above a speed of approximately 5 mph (8 km/h) independent of road surface conditions.

On slippery road surfaces, the ABS will respond even to light brake pressure.

The  indicator lamp in the instrument cluster (▷ page 24) comes on when you switch on the ignition. It goes out when the engine is running.

Driving safety systems

Braking

At the instant one of the wheels is about to lock up, a slight pulsation can be felt in the brake pedal, indicating that the ABS is in the regulating mode.

- ▶ Keep firm and steady pressure on the brake pedal while experiencing the pulsation.

Continuous, steady brake pedal pressure yields the advantages provided by the ABS, namely braking power and ability to steer the vehicle.

The pulsating brake pedal can be an indication of hazardous road conditions and functions as a reminder to take extra care while driving.

Emergency brake maneuver

- ▶ Keep continuous full pressure on the brake pedal.

Warning!



When the ABS is malfunctioning, the BAS, the ESP[®], and the 4-ETS are also switched off. The basic driving and braking functions are still available

When the ABS is malfunctioning, the wheels may lock during hard braking, reducing steering capability and extending the braking distance.

Warning!



The ABS cannot prevent the natural laws of physics from acting on the vehicle, nor can it increase braking or steering efficiency beyond that afforded by the condition of the vehicle brakes and tires or the traction afforded. The ABS cannot prevent accidents, including those resulting from excessive speed in turns, following another vehicle too closely, or hydroplaning. Only a safe, attentive, and skillful driver can prevent accidents. The capabilities of an ABS equipped vehicle must never be exploited in a reckless or dangerous manner which could jeopardize the user's safety or the safety of others.

For more information, see the “Practical Hints” section (> page 404).

BAS

The Brake Assist System (BAS) operates in emergency situations. If you apply the brakes very quickly, the BAS automatically provides full brake boost, thereby potentially reducing braking distance. Apply continuous full braking pressure until the emergency braking situation is over. The ABS will prevent the wheels from locking.

When you release the brake pedal, the brakes function again as normal. The BAS is then deactivated.

Warning!



If the BAS is malfunctioning, the brake system is still functioning, but without the additional brake boost available that BAS would normally provide in an emergency braking maneuver. Therefore, the braking distance may increase.

Warning!





The BAS cannot prevent the natural laws of physics from acting on the vehicle, nor can it increase braking efficiency beyond that afforded by the condition of the vehicle brakes and tires or the traction afforded. The BAS cannot prevent accidents, including those resulting from excessive speed in turns, following another vehicle too closely, or hydroplaning. Only a safe, attentive, and skillful driver can prevent accidents. The capabilities of a BAS equipped vehicle must never be exploited in a reckless or dangerous manner which could jeopardize the user's safety or the safety of others.

ESP®

The Electronic Stability Program (ESP®) is operational as soon as the engine is running and monitors the vehicle's traction (force of adhesive friction between the tires and the road surface) and handling.

The ESP® recognizes when a wheel is spinning or if the vehicle starts to skid. By applying brakes to the appropriate wheel and by limiting engine output, the ESP® helps stabilize the vehicle. The ESP® is especially useful while driving off and on wet or slippery road surfaces. The ESP® also stabilizes the vehicle during braking maneuvers.

The ESP® warning lamp  in the instrument cluster (▷ page 24) flashes when the ESP® is engaged.

The ESP® warning lamp  in the instrument cluster comes on when you switch on the ignition. It goes out when the engine is running.

Driving safety systems

Warning!



Never switch off the ESP[®] when you see the ESP[®] warning lamp  flashing in the instrument cluster. In this case, proceed as follows:

- While driving off, apply as little throttle as possible.
- While driving, ease up on the accelerator.
- Adapt your speed and driving style to the prevailing road conditions.

Failure to observe these guidelines could cause the vehicle to skid.

The ESP[®] cannot prevent accidents resulting from excessive speed.

Warning!



The ESP[®] cannot prevent the natural laws of physics from acting on the vehicle, nor can it increase the traction afforded. The ESP[®] cannot prevent accidents, including those resulting from excessive speed in turns, following another vehicle too closely, or hydroplaning. Only a safe, attentive, and skillful driver can prevent accidents. The capabilities of an ESP[®] equipped vehicle must never be exploited in a reckless or dangerous manner which could jeopardize the user's safety or the safety of others.



The ESP[®] will only function properly if you use wheels of the recommended tire size (▷ page 514).



Because of the ESP's[®] automatic operation, the engine and ignition must be shut off (SmartKey in starter switch position **0** or **1** or KEYLESS-GO* start / stop button* in position **0** or **1**) when

- the parking brake is being tested on a brake test dynamometer
- the vehicle is being towed with the front or rear axle raised

Active braking action through the ESP[®] may otherwise seriously damage the brake system.

Operational tests with the engine running can only be conducted on a two-axle dynamometer.

For more information, see the "Practical hints" section (▷ page 409).

Switching off the ESP®

Warning!



The ESP® should not be switched off during normal driving other than in the circumstances described below. Disabling of the system will reduce vehicle stability in standard driving maneuvers.

To improve the vehicle's traction, turn off the ESP® in driving situations where it would be advantageous to have the drive wheels spin and thus cut into surfaces for better grip such as:

- starting out on slippery surfaces and in deep snow in conjunction with snow chains
- in sand or gravel



Turn the ESP® on immediately if the aforementioned circumstances do not apply anymore.

When you switch off the ESP®

- the ESP® does not stabilize the vehicle
- the engine output is not limited, which allows the drive wheels to spin and thus cut into surfaces for better grip
- the 4-ETS will still brake a spinning wheel
- the ESP® continues to operate when you are braking



When the ESP® is switched off and one or more drive wheels are spinning, the ESP® warning lamp  in the instrument cluster flashes. However, the ESP® will then not stabilize the vehicle.

The ESP® switch is located on the upper part of the center console.



① ESP® switch

- ▶ Press ESP® switch ① until the ESP® warning lamp  in the instrument cluster comes on.

The ESP® is deactivated.

Warning!



When the ESP® warning lamp  is illuminated continuously, the ESP® is switched off.

Adapt your speed and driving to the prevailing road conditions and to the non-operating status of the ESP®.



Avoid spinning of a drive wheel for an extended period of time with the ESP® switched off. This may cause serious damage to the drivetrain which is not covered by the Mercedes-Benz Limited Warranty.

Switching on the ESP®

- ▶ Press ESP® switch .

The ESP® warning lamp  in the instrument cluster goes out.

You are now again in normal driving mode with the ESP® switched on.

For more information, see the “Practical hints” section (▷ page 404).

EBP

The EBP enhances braking effectiveness by allowing the rear brakes to supply a greater proportion of the braking effort without a loss of vehicle stability.

4-ETS

The 4-Electronic Traction System (4-ETS) improves the vehicle's ability to utilize available traction, especially under slippery road conditions. The brakes are applied to the spinning wheel and power is transferred to the wheel(s) with traction.

The ESP® warning lamp  in the instrument cluster starts to flash at any vehicle speed, as soon as a tire loses traction and the wheel begins to spin.

Warning!

When you see the ESP® warning lamp  flashing in the instrument cluster, then proceed as follows:

- While driving off, apply as little throttle as possible.
- While driving, ease up on the accelerator.
- Adapt your speed and driving style to the prevailing road conditions.

Failure to observe these guidelines could cause the vehicle to skid.

The 4-ETS cannot prevent accidents resulting from excessive speed.



Because of the ESP's® automatic operation, the engine must be shut off (SmartKey in starter switch position **0** or **1**) when the parking brake is being tested on a brake test dynamometer.

Active braking action through ESP® may otherwise seriously damage the brake system.

Operational tests with the engine running can only be conducted on a two-axle dynamometer.



If the yellow ESP® warning lamp  comes on while driving, the 4-ETS is being switched off temporarily to prevent overheating of the drive wheel brakes. In addition, the message **ESP unavailable** See Operator's Manual appears in the multifunction display.

For more information, see the “Practical hints” section (▷ page 404) and (▷ page 416).

Anti-theft systems

Immobilizer

The immobilizer prevents unauthorized persons from starting your vehicle.

Activating

With the SmartKey

- ▶ Remove the SmartKey from the starter switch.

*With KEYLESS-GO**

- ▶ Press the KEYLESS-GO start / stop button (▷ page 40) once.
The engine is turned off.
- ▶ Open the driver's door.

Deactivating

With the SmartKey

- Turn the SmartKey in the starter switch to position **2** (▷ page 38).

*With KEYLESS-GO**

- Switch on the ignition (▷ page 38).



Starting the engine will also deactivate the immobilizer.

In case the engine cannot be started (yet the vehicle's battery is charged), the system is not operational. Contact an authorized Mercedes-Benz Light Truck Center or call 1-800-FOR-MERCEdes (in the USA), or 1-800-387-0100 (in Canada).

Anti-theft alarm system

Once the alarm system has been armed, a visual and audible alarm is triggered when someone opens

- a door
- the tailgate
- the hood

The alarm will stay on, even if the activating element (a door, for example) is immediately closed.

The alarm system will also be triggered when

- the vehicle is raised, see “Tow-away alarm” (▷ page 106)
- the vehicle is opened with the mechanical key, see “Unlocking the vehicle” (▷ page 459)
- a door is opened from the inside, see “Opening the doors from the inside” (▷ page 121)



If the alarm stays on for more than 30 seconds, a call to the Response Center is initiated automatically by the Tele Aid* system (▷ page 311) provided Tele Aid* service was subscribed to and properly activated, and that necessary cellular service and GPS coverage are available.

Arming the alarm system

The alarm system is armed after you have locked the vehicle with the SmartKey or SmartKey with KEYLESS-GO*.

The alarm system indicator lamp is located to the lower left of the hazard warning flasher.



① Alarm system indicator lamp

- ▶ Make sure all doors and the tailgate are closed.
- ▶ Lock the vehicle (▷ page 67).

The turn signal lamps flash three times to indicate that the vehicle is locked.

The alarm system is armed within approximately 10 seconds. Alarm system indicator lamp ① flashes.



If the turn signal lamps do not flash three times, one of the following elements may not be properly closed:

- a door
- the tailgate

Close the respective element and lock the vehicle again.

Anti-theft systems

Disarming the alarm system

- ▶ Unlock the vehicle (▷ page 36).

The turn signal lamps flash once to indicate that the vehicle is disarmed.



The alarm system will rearm automatically again after approximately 40 seconds if neither a door nor the tailgate is opened.



Canceling the alarm

To cancel the alarm:

With the SmartKey

- ▶ Insert the SmartKey in the starter switch.

or

- ▶ Press the  or  button on the SmartKey.

*With KEYLESS-GO**

- ▶ Grasp an outside door handle.

The SmartKey with KEYLESS-GO must be within 3 ft (1 m) of the vehicle.

or

- ▶ Press the KEYLESS-GO start/stop button (▷ page 40).

The SmartKey with KEYLESS-GO must be inside the vehicle.

Tow-away alarm

Once the tow-away alarm is armed, a visual and audible alarm will be triggered when someone attempts to raise the vehicle.



The tow-away protection alarm is triggered, for example, if the vehicle is lifted on one side.

If the alarm stays on for more than 30 seconds, a call to the Response Center is initiated automatically by the Tele Aid* system (▷ page 311) provided Tele Aid* service was subscribed to and properly activated, and that necessary cellular service and GPS coverage are available.

Arming the tow-away alarm

- ▶ Make sure all doors and the tailgate are closed.

- ▶ Lock your vehicle.

The tow-away alarm is automatically armed after about 10 seconds.

Disarming the tow-away alarm

- ▶ Unlock your vehicle.



When you unlock your vehicle, the tow-away protection disarms automatically.

The tow-away alarm remains disarmed until you lock your vehicle again.

Switching off the tow-away alarm



The tow-away alarm feature can be set to default enabled (on) or disabled (off) using the control system (▷ page 191).

To prevent triggering the tow-away alarm feature, switch off the tow-away alarm before towing the vehicle, or when parking on a surface subject to movement, such as a ferry or auto train.

If the tow-away alarm is set to default enabled (on) in the control system and you wish to retain the default setting, you can switch off the tow-away alarm temporarily on a one-time basis as follows:

- ▶ Switch off the ignition (▷ page 38).

With the tow-away alarm set to default enabled (on) in the control system, the following message appears in the multifunction display.



- ▶ If you now wish to deactivate the tow-away alarm on a one-time basis, press button **+** or **-** on the multifunction steering wheel.

The tow-away alarm is switched off. The following message appears in the multifunction display.



Anti-theft systems

- ▷▷ Exit and lock the vehicle (▷ page 67).

The alarm system is armed independently of whether the tow-alarm is switched on or off.



The tow-away alarm is switched off on a one-time basis only. It will be armed automatically the next time you lock the vehicle.

If you have disabled the tow-away alarm feature in the control system (▷ page 191), you can switch on the tow-away alarm on a one-time basis as described above.



Canceling tow-away alarm

To cancel the alarm after it has been triggered:

With the SmartKey

- ▶ Insert the SmartKey in the starter switch.

or

- ▶ Press the  or  button on the SmartKey.

*With KEYLESS-GO**

- ▶ Grasp an outside door handle.

The SmartKey with KEYLESS-GO must be within 3 ft (1 m) of the vehicle.

or

- ▶ Press the KEYLESS-GO start/stop button (▷ page 40).

The SmartKey with KEYLESS-GO must be inside the vehicle.

Locking and unlocking

Seats

Memory function*

Lighting

Instrument cluster

Control system

Automatic transmission

Good visibility

Climate control

3-zone automatic climate control*

Power windows

Power tilt/sliding sunroof*

Panorama roof with power tilt/sliding panel*

Driving systems

Loading

Useful features

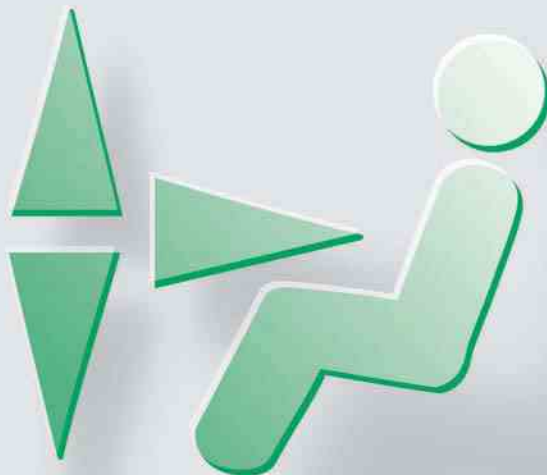

Locking and unlocking

In the “Controls in detail” section you will find detailed information on how to operate the equipment installed in your vehicle. If you are already familiar with the basic functions of your vehicle, this section will be of particular interest to you.

To quickly familiarize yourself with the basic functions of the vehicle, refer to the “Getting started” section of this manual. The corresponding page numbers are given at the beginning of each segment.

For more information on locking and unlocking, see the “Getting started” section (▷ page 36) and (▷ page 67).

SmartKey

Your vehicle comes supplied with two SmartKeys, each with remote control and a removable mechanical key.

The locking tabs for the mechanical key portion of the two SmartKeys are a different color to help distinguish each SmartKey unit.





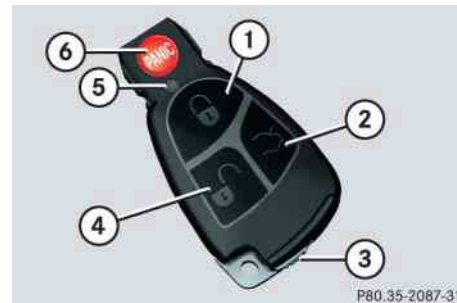

The SmartKey provides an extended operating range. To prevent theft, however, it is advisable to only unlock the vehicle when you are in close proximity to it.

The SmartKey centrally locks and unlocks:

- the doors
- the tailgate
- the fuel filler flap



SmartKey with remote control

- ①  Lock button
- ②  Unlock button* for tailgate
- ③  Locking tab for mechanical key
- ④  Unlock button
- ⑤  Battery check lamp
- ⑥  PANIC (▷ page 95)

Warning!

When leaving the vehicle, always remove the SmartKey from the starter switch, take it with you and lock the vehicle. Do not leave children unattended in the vehicle, or with access to an unlocked vehicle. It is possible for children to open a locked door from the inside, which could result in an accident and/or serious personal injury.



To prevent possible malfunction, avoid exposing the SmartKey to high levels of electromagnetic radiation.



USA only:

This device complies with Part 15 of the FCC Rules. Operation is subject to the following two conditions:

- (1) This device may not cause harmful interference, and
- (2) this device must accept any interference received, including interference that may cause undesired operation.

Any unauthorized modification to this device could void the user's authority to operate the equipment.



Canada only:

This device complies with RSS-210 of Industry Canada. Operation is subject to the following two conditions:

- (1) This device may not cause interference, and
- (2) this device must accept any interference received, including interference that may cause undesired operation of the device.

Any unauthorized modification to this device could void the user's authority to operate the equipment.



You can also open and close the power windows (▷ page 248) and tilt/sliding sunroof* (▷ page 255), or the tilt/sliding panel* (▷ page 259) using the SmartKey.

Locking and unlocking

Factory setting

Global unlocking

- ▶ Press button .

All turn signal lamps flash once. The locking knobs in the doors move up. The anti-theft alarm system is disarmed.

The vehicle will lock again automatically and reactivate the anti-theft alarm system within approximately 40 seconds of unlocking if

- neither door nor tailgate is opened
- the SmartKey is not inserted in the starter switch
- the central locking switch is not activated



Global locking

- ▶ Press button .

With the tailgate and all doors closed, the turn signal lamps flash three times. The locking knobs on the doors move down. The anti-theft alarm system is armed.

Selective setting

If you frequently travel alone, you may wish to reprogram the SmartKey so that pressing  only unlocks the driver's door and the fuel filler flap.

- ▶ Press and hold buttons  and  simultaneously for about 5 seconds until battery check lamp  (▷ page 110) flashes twice.

The SmartKey will then function as follows:

Unlocking driver's door and fuel filler flap

- ▶ Press button  once.

All turn signal lamps flash once. The locking knob in the driver's door moves up. The anti-theft alarm system is disarmed.

Global unlocking

- ▶ Press button  twice.



All turn signal lamps flash once. The locking knobs in the doors move up. The anti-theft alarm system is disarmed.

Global locking

- ▶ Press button .

With the tailgate and all doors closed, the turn signal lamps flash three times. The locking knobs on the doors move down. The anti-theft alarm system is armed.

Restoring to factory setting

- ▶ Press and hold buttons  and  simultaneously for about 6 seconds until battery check lamp  (> page 110) flashes twice.



If you cannot lock or unlock the vehicle with the SmartKey, then either the batteries in the SmartKey are discharged, the SmartKey is malfunctioning, or the vehicle battery is drained.

- Check the batteries in the SmartKey and replace them if necessary (> page 463).
- Use the mechanical key to unlock the driver's door (> page 459).
- Lock the vehicle as described in the "Practical hints" section (> page 460).
- Have the vehicle battery and the vehicle battery connections checked (> page 487).

If the SmartKey is malfunctioning, contact an authorized Mercedes-Benz Light Truck Center.

Checking the batteries

- ▶ Press button  or .

Battery check lamp  (> page 110) comes on briefly to indicate that the SmartKey batteries are in order.





If battery check lamp  does not come on briefly during check, the SmartKey batteries are discharged.

Replace the batteries (> page 463).

You can obtain the required batteries at any authorized Mercedes-Benz Light Truck Center.



If the batteries are checked within signal range of the vehicle, pressing the button  or  will lock or unlock the vehicle accordingly.

Locking and unlocking

Unlocking and opening the tailgate

You can unlock and open the tailgate separately.

A minimum height clearance of 7.2 ft (2.20 m) is required to open the tailgate.

- ▶ Press and hold button  on the SmartKey until the tailgate unlocks and begins to open.



The tailgate swings open upwards automatically. Always make sure there is sufficient overhead clearance.

Vehicles with tailgate opening/closing system*:

To stop the opening procedure, press button  on the SmartKey. The tailgate stops moving.



If the vehicle was previously centrally locked with the SmartKey, the tailgate will lock automatically when closed. The turn signals will flash three times to confirm locking.

Loss of SmartKey or mechanical key

If you lose a SmartKey or mechanical key, you should do the following:

- ▶ Have the SmartKey deactivated by an authorized Mercedes-Benz Light Truck Center.
- ▶ Report the loss of the SmartKey or the mechanical key immediately to your car insurance company.
- ▶ If necessary, have the mechanical lock replaced.

Your authorized Mercedes-Benz Light Truck Center will be glad to supply you with a replacement.

SmartKey with KEYLESS-GO*

Vehicles equipped with KEYLESS-GO come with two SmartKeys with KEYLESS-GO, each with remote control and a removable mechanical key.

The locking tabs for the mechanical key portion of the two SmartKeys with KEYLESS-GO are a different color to help distinguish each SmartKey with KEYLESS-GO unit.

The function of the SmartKey overrules the KEYLESS-GO function.





The KEYLESS-GO function is integrated into the SmartKey. On these vehicles, the validity of the SmartKey with KEYLESS-GO is checked when you grasp an outside door handle.

If the SmartKey with KEYLESS-GO is valid, your vehicle unlocks

- the doors
- the tailgate
- the fuel filler flap



SmartKey with KEYLESS-GO*

- ①  Lock button
- ②  Unlock button* for tailgate
- ③ Mechanical key locking tab
- ④  Unlock button
- ⑤ Battery check lamp
- ⑥  Panic button (▷ page 95)

Warning!



When leaving the vehicle, always take the SmartKey with KEYLESS-GO* with you and lock the vehicle. Do not leave children unattended in the vehicle, or with access to an unlocked vehicle. Unsupervised use of vehicle equipment may cause an accident and/or serious personal injury.



To prevent possible malfunction, avoid exposing the SmartKey with KEYLESS-GO to high levels of electromagnetic radiation.



USA only:

This device complies with Part 15 of the FCC Rules. Operation is subject to the following two conditions:

- (1) This device may not cause harmful interference, and
- (2) this device must accept any interference received, including interference that may cause undesired operation.

Any unauthorized modification to this device could void the user's authority to operate the equipment.

Locking and unlocking



Canada only:

This device complies with RSS-210 of Industry Canada. Operation is subject to the following two conditions:

- (1) This device may not cause interference, and
- (2) this device must accept any interference received, including interference that may cause undesired operation of the device.

Any unauthorized modification to this device could void the user's authority to operate the equipment.



You can also open and close the power windows (▷ page 248) and tilt/sliding sunroof* (▷ page 255), or the tilt/sliding panel* (▷ page 259) using the SmartKey with KEYLESS-GO.

Important notes on using KEYLESS-GO*

- You can also use the SmartKey with KEYLESS-GO like a normal SmartKey (▷ page 110).
- You can combine KEYLESS-GO functions with normal SmartKey functions (e.g. unlocking with KEYLESS-GO and locking with the  button).
- Always carry the SmartKey with KEYLESS-GO with you.
- Never store the SmartKey with KEYLESS-GO together with
 - electronic items such as a cellular phone or another SmartKey with KEYLESS-GO
 - metallic objects such as coins or metal foil

Doing so could impair the function of the KEYLESS-GO system.

- To lock or unlock the vehicle, the SmartKey with KEYLESS-GO must be located outside the vehicle within approximately 3 ft (1 m) of the respective door or the tailgate.
- In order to start the engine with the SmartKey with KEYLESS-GO:
 - The SmartKey with KEYLESS-GO must be located in the vehicle.
 - All doors must be closed.
 - The brake pedal must be firmly depressed. Do not depress the accelerator.

- If the SmartKey with KEYLESS-GO is positioned farther away from the vehicle, the system may no longer recognize the SmartKey with KEYLESS-GO. The vehicle then cannot be locked or the engine started via the KEYLESS-GO system.
- If the SmartKey with KEYLESS-GO is removed from the vehicle while starter switch position **1** (e.g. if a passenger exits the vehicle with the SmartKey with KEYLESS-GO), the message *Key not detected* will appear in the multifunction display while driving off.
Find the SmartKey with KEYLESS-GO or change its present location immediately (e.g. place it on the front passenger seat or insert it in shirt pocket).
- If the SmartKey with KEYLESS-GO is removed from the vehicle with the engine running (e.g. if a passenger exits the vehicle with the SmartKey with KEYLESS-GO), the message *Key not detected* will appear in the multifunction display while driving off.
Find the SmartKey with KEYLESS-GO or change its present location immediately (e.g. place it on the front passenger seat or insert it in shirt pocket).
- Remember that the engine can be started by anyone with a SmartKey with KEYLESS-GO that is left inside the vehicle.
Possibility 1: (One SmartKey with KEYLESS-GO in the vehicle, one SmartKey with KEYLESS-GO outside the vehicle):
If you leave the SmartKey with KEYLESS-GO behind when exiting and locking the vehicle, no message appears in the multifunction display.

Possibility 2: (One SmartKey with KEYLESS-GO in the vehicle, no SmartKey with KEYLESS-GO outside the vehicle):
When exiting and trying to lock the vehicle, the message *Key detected in vehicle* will appear in the multifunction display. The vehicle will not be locked.

Locking and unlocking

Factory setting

Global unlocking

- ▶ Grasp an outside door handle.

All turn signal lamps flash once. The locking knobs in the doors move up. The anti-theft alarm system is disarmed.



If the vehicle has been parked for more than 72 hours, you must pull an outside door handle in order to activate the KEYLESS-GO function.

The vehicle will lock again automatically and reactivate the anti-theft alarm system within approximately 40 seconds of unlocking if

- neither door nor tailgate is opened
- the central locking switch is not activated



The vehicle could be inadvertently unlocked if the SmartKey with KEYLESS-GO is within 3 ft (1 m) of the vehicle and

- an outside door handle is splashed with water
or
- you attempt to clean the outside door handle



Global locking

- ▶ Press the lock button at an outside door handle (▷ page 68) or the tailgate (▷ page 120).

With the tailgate and all doors closed, the turn signal lamps flash three times. The locking knobs on the doors move down. The anti-theft alarm system is armed.

Selective setting

If you frequently travel alone, you may wish to reprogram the SmartKey with KEYLESS-GO so when you grasp the driver's door handle only the driver's door and the fuel filler flap unlocks.

- ▶ Press and hold buttons  and  simultaneously for about 6 seconds until battery check lamp (5) (▷ page 115) flashes twice.

The SmartKey with KEYLESS-GO will then function as follows:

Unlocking driver's door and fuel filler flap

- ▶ Grasp the driver's outside door handle.
All turn signal lamps flash once. The locking knob in the driver's door moves up. The anti-theft alarm system is disarmed.

Global unlocking

- ▶ Grasp any outside door handle other than the driver's outside door handle.



All turn signal lamps flash once. The locking knobs in the doors move up. The anti-theft alarm system is disarmed.

Global locking

- ▶ Press the lock button on an outside door handle (▷ page 68) or the tailgate (▷ page 120).

All turn signal lamps flash three times. The locking knobs in the doors move down. The anti-theft alarm system is armed.

Restoring to factory setting

- ▶ Press and hold buttons  and  simultaneously for about 6 seconds until battery check lamp  (▷ page 115) flashes twice.



If you can no longer lock or unlock the vehicle with the SmartKey with KEYLESS-GO, then the battery in the SmartKey is discharged, the SmartKey with KEYLESS-GO is malfunctioning or the vehicle battery is drained.

- Check the battery in the SmartKey with KEYLESS-GO (▷ page 119) and replace it if necessary (▷ page 463).
- Use the mechanical key to unlock the driver' door (▷ page 459).
- Lock the vehicle as described in the "Practical hints" section (▷ page 460).
- Have the vehicle battery and the vehicle battery connections checked (▷ page 487).

If the SmartKey with KEYLESS-GO is malfunctioning, contact an authorized Mercedes-Benz Light Truck Center.

Checking the battery

- ▶ Press button  or .

Battery check lamp  (▷ page 115) comes on briefly to indicate that the SmartKey with KEYLESS-GO battery is in order.





If battery check lamp  (▷ page 115) does not come on briefly during check, the SmartKey with KEYLESS-GO battery is discharged.

Replace the battery (▷ page 463).

You can obtain the required battery at any authorized Mercedes-Benz Light Truck Center.



If the battery is checked within signal range of the vehicle, pressing the button  or  will lock or unlock the vehicle accordingly.

Locking and unlocking

Unlocking and opening the tailgate

You can unlock and open the tailgate separately.

A minimum height clearance of 7.2 ft (2.20 m) is required to open the tailgate.

The handle is located above the rear license plate recess.



- ▶ Pull on the handle.
- or
- ▶ Press and hold button  on the SmartKey with KEYLESS-GO until the tailgate unlocks and opens.



The tailgate swings open upwards automatically. Always make sure there is sufficient overhead clearance.

Vehicles with tailgate opening/closing system*:

To stop the opening procedure, press button  on the SmartKey. The tailgate stops moving.



If the vehicle was previously centrally locked with the SmartKey or KEYLESS-GO, the tailgate will lock automatically when closed (▷ page 124). The turn signals will flash three times to confirm locking.

Locking the vehicle



- ① Lock button at tailgate
 - ▶ Press lock button on tailgate ①.
 - or
 - ▶ Press the lock button on an outside door handle (▷ page 68).
 - or
 - ▶ Vehicles with tailgate opening/closing system*: Press the KEYLESS-GO locking/closing switch in the tailgate (▷ page 129).
- The vehicle locks. The turn signals flash three times to confirm locking.

Loss of the SmartKey with KEYLESS-GO

If you lose your SmartKey with KEYLESS-GO or mechanical key, you should do the following:

- ▶ Have the SmartKey with KEYLESS-GO deactivated by an authorized Mercedes-Benz Light Truck Center.
- ▶ Report the loss of the SmartKey with KEYLESS-GO or the mechanical key immediately to your car insurance company.
- ▶ Have the mechanical lock replaced if necessary.

Your authorized Mercedes-Benz Light Truck Center will be glad to supply you with a replacement.

Opening the doors from the inside

You can open a locked door from the inside. Open door only when conditions are safe to do so.

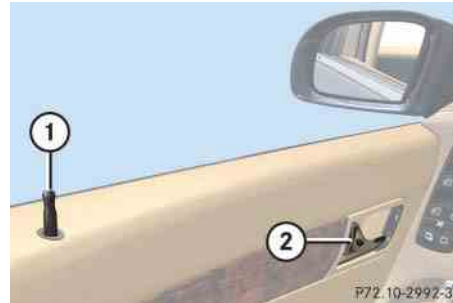

- ① Locking knob
- ② Inside door handle

Front doors

- ▶ Pull on inside door handle ② on the respective front door to open door.

If the door was locked, locking knob ① will move up.

Rear doors

- ▶ Pull up locking knob ① on the respective rear door to unlock door.
- ▶ Pull on inside door handle ② on the respective rear door to open door.



Locking and unlocking



If the vehicle has previously been locked from the outside with the SmartKey or KEYLESS-GO*, opening a door from the inside will trigger the anti-theft alarm system.

To cancel the alarm, do one of the following:

With the SmartKey

- Insert the SmartKey in the starter switch.
- Press the  or  button on the SmartKey.

With KEYLESS-GO*

- Grasp an outside door handle.
- Press the KEYLESS-GO start/stop button (▷ page 40).

The SmartKey with KEYLESS-GO must be inside the vehicle.

Opening the tailgate

Opening the tailgate from the outside

A minimum height clearance of 7.2 ft (2.20 m) is required to open the tailgate.

The handle is located above the rear license plate recess.



P72.20-2411-31

Vehicles without KEYLESS-GO*:
The vehicle must be unlocked (▷ page 37).

- ▶ Pull on the handle.
The tailgate opens slightly.
- ▶ Pull tailgate upwards to open.



Vehicles with tailgate opening/closing system*:

To stop the opening procedure, press button  on the SmartKey. The tailgate stops moving.

The tailgate swings open upwards automatically. Always make sure there is sufficient overhead clearance.



If the vehicle was previously centrally locked, the tailgate will lock automatically after closing it (▷ page 124). The turn signals will flash three times to confirm locking.

The tailgate can also be opened using the SmartKey (▷ page 114).

Opening the tailgate from the inside manually

You can unlock the tailgate from the third-row seats and then open it manually.

The handle is located on the right of the tailgate's window trim.

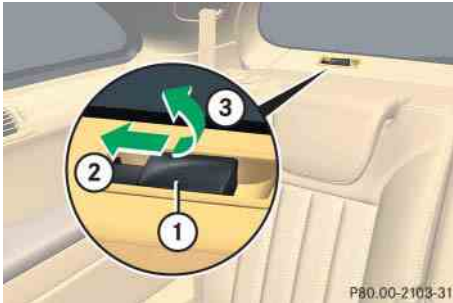

- ① Handle
- ② Push
- ③ Lift

- ▶ Push handle ① in direction of arrow ② and hold it there.

- ▶ Lift handle ① in direction of arrow ③. The tailgate is released and can be opened manually.



Vehicles with tailgate opening/closing system*:
If you do not open the tailgate within a few seconds, the tailgate lock will automatically engage again.

Opening the tailgate from the inside electrically*

You can open the tailgate from the inside if the vehicle is stationary.

A minimum height clearance of 7.2 ft (2.20 m) is required to open the tailgate.

The switch is located on the door control panel.



- ① Remote tailgate switch with indicator lamp
- ▶ Pull remote tailgate switch ① until tailgate begins to open.

The tailgate opens. The indicator lamp in the remote tailgate switch comes on and remains lit until the tailgate is closed. While the tailgate is opening, an acoustic signal sounds.



Locking and unlocking



Warning!



Maintain sight of the area around the rear of the vehicle while operating the tailgate with the door-mounted remote tailgate switch or with the  button on the SmartKey or SmartKey with KEYLESS-GO*. Monitor the opening procedure carefully to make sure no one is in danger of being injured.

To interrupt the opening procedure, press or pull the door-mounted remote tailgate switch or press the  button on the SmartKey or SmartKey with KEYLESS-GO*.



The tailgate swings open upwards automatically. Always make sure there is sufficient overhead clearance. To stop the opening procedure, press or pull remote tailgate switch ①. The tailgate stops moving.



The tailgate can also be opened using the  button on the SmartKey or SmartKey with KEYLESS-GO* (▷ page 114).

Limiting opening height of tailgate*

Vehicles with tailgate opening/closing system*:

The tailgate opening height can be limited when transporting goods on a roof rack* (e.g. presence of an MB sport luggage container*). When activated, the tailgate opens to approximately 6.4 ft (1.95 m).

- ▶ Activate the limiting opening height of tailgate using the control system (▷ page 189).

Closing the tailgate

Closing the tailgate from the inside electrically*

In vehicles with tailgate opening/closing system* you can close the tailgate from the inside using the remote tailgate switch.

- ▶ Press remote tailgate switch ① (▷ page 123) until tailgate begins to close.

The tailgate closes. The indicator lamp in the remote tailgate switch goes out. While the tailgate is closing an acoustic signal sounds.

To interrupt the closing procedure:

- ▶ Press or pull remote tailgate switch ① (▷ page 123).

Warning!

Maintain sight of the area around the rear of the vehicle while operating the tailgate with the door mounted switch. Monitor the closing procedure carefully to make sure no one is in danger of being injured.

To interrupt the closing procedure, press or pull the door mounted remote tailgate switch.

Even with the SmartKey or the SmartKey with KEYLESS-GO* removed from the starter switch or the SmartKey with KEYLESS-GO* removed from the vehicle, the remote tailgate switch can be operated. Therefore, do not leave children unattended in the vehicle, or with access to an unlocked vehicle. Unsupervised use of vehicle equipment may cause an accident and/or serious personal injury.

Warning!

Only drive with the tailgate closed as, among other dangers such as blocked visibility, exhaust fumes may enter the vehicle interior.

If the tailgate comes into contact with an object while closing (e.g. luggage that has been piled too high) the closing procedure is stopped and the tailgate reopens.

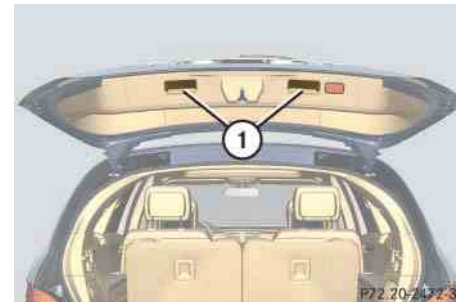
Closing the tailgate from the outside manually

① Handle

- ▶ Lower tailgate by pulling firmly on handle ①.
- ▶ Close tailgate with hands placed flat on it.



Locking and unlocking



Warning!



To prevent possible personal injury, always keep hands and fingers away from the cargo compartment opening when closing the tailgate. Be especially careful when small children are around.

When leaving the vehicle, always remove the SmartKey or SmartKey with KEYLESS-GO* from the starter switch, take it with you, and lock the vehicle. Do not leave children unattended in the vehicle, or with access to an unlocked vehicle. Unsupervised use of vehicle equipment may cause an accident and/or serious personal injury.

Warning!



Only drive with the tailgate closed as, among other dangers such as blocked visibility, exhaust fumes may enter the vehicle interior.



To prevent an inadvertent lockout, do not place the SmartKey in the cargo compartment.

Vehicles with KEYLESS-GO*:

To prevent a possible inadvertent lockout, the tailgate will open automatically if a SmartKey with KEYLESS-GO is recognized inside the vehicle.



If the vehicle was previously centrally locked with the SmartKey or KEYLESS-GO, the tailgate will lock automatically after closing it. The turn signals flash three times to confirm locking.

Closing the tailgate from the outside (vehicles without KEYLESS-GO*)

In vehicles with tailgate opening/closing system* you can close the tailgate separately from the outside using the tailgate closing switch or the  button on the SmartKey.

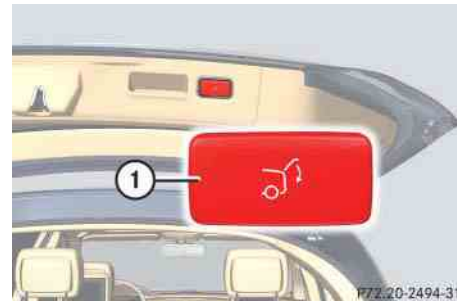

① Tailgate closing switch

- ▶ Press tailgate closing switch ① briefly. The tailgate closes.



You can also close the tailgate manually (▷ page 125).

If the tailgate comes into contact with an object while closing (e.g. luggage that has been piled too high), the closing procedure is stopped and the tailgate reopens slightly.

Warning!



Monitor the closing procedure carefully to make sure no one is in danger of being injured. To prevent possible personal injury, always keep hands and fingers away from the cargo compartment opening when closing the tailgate. Be especially careful when small children are around. To stop the closing procedure, do one of the following:

- Press the tailgate closing switch ①.
- Press the  button on the SmartKey.
- Press or pull the remote tailgate switch (on the driver's door).

Even with the SmartKey removed from the starter switch, the tailgate closing switch can be operated. Therefore, do not leave children unattended in the vehicle, or with access to an unlocked vehicle. Unsupervised use of vehicle equipment may cause an accident and/or serious personal injury.

Warning!



Only drive with the tailgate closed as, among other dangers such as blocked visibility, exhaust fumes may enter the vehicle interior.



Do not place the SmartKey in the open cargo compartment. You may lock yourself out.



If the vehicle was previously centrally locked, the tailgate will lock automatically after closing it. The turn signals will flash three times to confirm locking.

Locking and unlocking

Closing the tailgate from the outside (vehicles with KEYLESS-GO*)

In vehicles with tailgate opening/closing system* you can close the tailgate separately from the outside using the tailgate closing switch or the  button on the SmartKey.

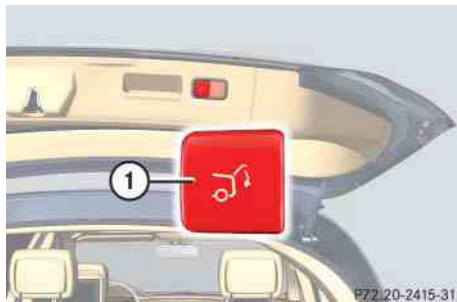

① Tailgate closing switch

- ▶ Make sure you have the SmartKey with KEYLESS-GO* with you.
- ▶ Press tailgate closing switch ① briefly.
The tailgate closes.



You can also close the tailgate manually (▷ page 125).

If the tailgate comes into contact with an object while closing (e.g. luggage that has been piled too high), the closing procedure is stopped and the tailgate reopens slightly.



To prevent a possible inadvertent lock-out, the tailgate will open automatically if a SmartKey with KEYLESS-GO* is recognized inside the vehicle.

Warning!



Monitor the closing procedure carefully to make sure no one is in danger of being injured. To prevent possible personal injury, always keep hands and fingers away from the cargo compartment opening when closing the tailgate. Be especially careful when small children are around. To stop the closing procedure, do one of the following:

- Press the tailgate closing switch ①.
- Press the KEYLESS-GO locking/closing switch.
- Press the  button on the SmartKey with KEYLESS-GO.
- Press or pull the remote tailgate switch (on the driver's door).

Even with the SmartKey with KEYLESS-GO* removed from the vehicle, the tailgate closing switch can be operated. Therefore, do not leave children unattended in the vehicle, or with access to an unlocked vehicle. Unsupervised use of vehicle equipment may cause an accident and/or serious personal injury.

Warning!



Only drive with the tailgate closed as, among other dangers such as blocked visibility, exhaust fumes may enter the vehicle interior.



If the vehicle was previously centrally locked, the tailgate will lock automatically after closing it. The turn signals will flash three times to confirm locking.

Closing the tailgate and locking the vehicle from the outside (vehicles with KEYLESS-GO*)

In vehicles with tailgate opening/closing system* and KEYLESS-GO*, you can close the tailgate and lock the vehicle simultaneously from the outside using the KEYLESS-GO* locking/closing switch or the  button on the SmartKey.

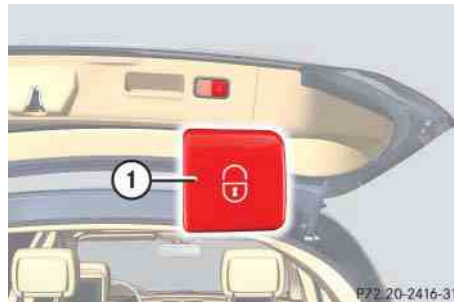

- ① KEYLESS-GO* locking/closing switch
- ▶ Make sure you have the SmartKey with KEYLESS-GO* with you.

- ▶ Press switch ① briefly.

The vehicle is locked and the tailgate closes automatically. The turn signals flash three times to confirm locking. The locking knobs in the doors move down. The anti-theft alarm system is armed.



You can also close the tailgate manually (▷ page 125).

If the tailgate comes into contact with an object while closing (e.g. luggage that has been piled too high), the closing procedure is stopped and the tailgate reopens slightly.



To prevent a possible inadvertent lock-out, the tailgate will open automatically if a SmartKey with KEYLESS-GO* is recognized inside the vehicle.

Locking and unlocking

Warning!



Monitor the closing procedure carefully to make sure no one is in danger of being injured. To prevent possible personal injury, always keep hands and fingers away from the cargo compartment opening when closing the tailgate. Be especially careful when small children are around. To stop the closing procedure, do one of the following:

- Press the tailgate closing switch ①.
- Press the KEYLESS-GO locking/closing switch*.
- Press the  button on the SmartKey with KEYLESS-GO*.
- Press or pull the remote tailgate switch (on the driver's door).

Even with the SmartKey with KEYLESS-GO* removed from the vehicle, the tailgate closing switch can be operated. Therefore, do not leave children unattended in the vehicle, or with access to an unlocked vehicle. Unsupervised use of vehicle equipment may cause an accident and/or serious personal injury.

Warning!



Only drive with the tailgate closed as, among other dangers such as blocked visibility, exhaust fumes may enter the vehicle interior.

Automatic central locking

The doors and the tailgate lock automatically when the ignition is switched on and the wheels are turning at vehicle speeds of approximately 9 mph (15 km/h) or more.

You can open a locked door from the inside. Open door only when conditions are safe to do so.



The doors unlock automatically after an accident if the force of the impact exceeds a preset threshold.

The vehicle automatically locks when the ignition is switched on and the wheels are turning at vehicle speeds of approximately 9 mph (15 km/h) or more. You could therefore lock yourself out when the vehicle

- is pushed or towed
- is on a test stand
- during a wheel change

For information on towing the vehicle, see “Towing the vehicle” (> page 499).

You can deactivate the automatic locking mode using the control system (> page 188).

Locking and unlocking from the inside

You can lock or unlock the doors and the tailgate from inside using the central locking or unlocking switch. This can be useful, for example, if you want to lock the vehicle before starting to drive.

The fuel filler flap cannot be locked or unlocked with the central locking or unlocking switch.

Warning!



When leaving the vehicle, always remove the SmartKey or SmartKey with KEYLESS-GO* from the starter switch, take it with you, and lock the vehicle. Do not leave children unattended in the vehicle, or with access to an unlocked vehicle. Unsupervised use of vehicle equipment may cause an accident and/or serious personal injury.

The switches are located in the front-door control panels.



- ① Central unlocking switch
- ② Central locking switch

Locking

- ▶ Press central locking switch ②.

If all doors and the tailgate are closed, the vehicle locks.

Unlocking

- ▶ Press central unlocking switch ①.
The vehicle unlocks.



You can open a locked door from the inside. Open door only when conditions are safe to do so.

If the vehicle was previously centrally locked with the SmartKey or the SmartKey with KEYLESS-GO*, it will not unlock using the central unlocking switch ①.

If the vehicle was previously locked with the central locking switch ②:

- While in the selective remote control mode, only the front door opened from the inside is unlocked.
- While in the global remote control mode, the vehicle is unlocked completely when a front door is opened from the inside.



With the passenger-side door opened, you cannot lock the vehicle with the central locking switch.

Seats

For information on seat adjustment, see the “Getting started” section (▷ page 43).

For more information on seats, see “Loading” (▷ page 279).

Easy-entry/exit feature*

Easy-entry/exit feature for driver's seat

This feature allows for easier entry into and exit from the vehicle.

The easy-entry/exit feature can be activated or deactivated in the Convenience submenu of the control system (▷ page 189).

Warning!



You must make sure no one can become trapped or injured by the moving steering wheel and driver's seat when the easy-entry/exit feature is activated.

To cancel seat/steering wheel movement, do one of the following:

- Press seat adjustment switch (▷ page 43).
- Move steering column stalk* (▷ page 46).
- Press memory button **M*** (▷ page 145).

Do not leave children unattended in the vehicle, or with access to an unlocked vehicle. Children could open the driver's door and unintentionally activate the easy-entry/exit feature, which could result in an accident and/or serious personal injury.



Do not activate the easy-entry/exit feature if the seat backrest is in an excessively reclined position. Doing so could cause damage to the driver's seat or left rear seat.

Move the seat backrest to an upright position first.

When exiting the vehicle, with the easy-entry/exit feature activated and depending on your selection, the steering wheel tilts upwards and/or the driver's seat moves a few inches to the rear when you

- remove the SmartKey from the starter switch
- or
- open the driver's door with the SmartKey in starter switch position **0** or **1** (▷ page 38) or the KEYLESS-GO* start/stop button in position **1** (▷ page 40)



If the current position for the steering wheel is in the uppermost tilt position, the steering wheel will no longer be able to move upward when the easy-entry/exit feature is activated.

If the current seat position falls into a factory-set position range and the system recognizes the current seat position to be rearward enough for easy entry and exit, the driver's seat will not move to the rear when the easy-entry/exit feature is activated.

When entering the vehicle, with the easy-entry/exit feature activated, the steering wheel or, depending on your selection, the steering wheel and driver's seat will return to their last set memory position or a factory-set maximum forward position when you

- close the driver's door with the ignition switched on
- insert the SmartKey into the starter switch or press the KEYLESS-GO* start/stop button (▷ page 40) once with the driver's door closed



For safety reasons, the driver's seat will not return to its last set position with the easy-entry/exit feature activated if the system recognizes the last set position as an extreme forward position. Instead, the driver's seat will remain at or move to a factory-set maximum forward position. To again fully return the driver's seat to your last set position or to memory position, adjust the seat to the desired position or press and hold the respective memory position button (▷ page 145).



Vehicles with memory function*:
The steering wheel and seat position is stored into memory when you

- switch off the ignition (▷ page 38)
- allocate the current position steering wheel and seat position to a certain memory position button (▷ page 145)

Seats

Easy-entry/exit feature for third-row seats

This feature allows for easier access to and exit from the vehicle's third-row seats.

Warning!



To help avoid personal injury, the second-row seat backrests must be properly locked either in the upright position or, when using the expanded cargo compartment, in the fully folded position while the vehicle is in motion.

Easy-entry feature for third-row seats

The releases for the easy-entry feature are located on the entry side and the back of each second-row seat.



① Easy-entry lever

- ▶ Pull and hold easy-entry lever ① in direction of arrow at resistance point.

The seat backrest folds down.

- ▶ Push the seat forward as far as it will go.

You should now have sufficient space to access the vehicle's third-row seat.



Easy-entry/exit position

For information on how to fold down the second-row seats completely, see "Folding second-row seats" (▶ page 285).

Easy-exit feature for third-row seats

The easy-exit strap is located on the rear of the second-row seat base.

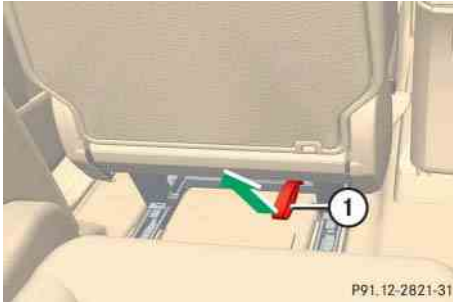

① Easy-exit strap

- ▶ To exit the vehicle when seated on a third-row seat, pull up and hold easy-exit strap ①.

The second-row seat backrest folds down.

- ▶ Push second-row seat forward as far as it will go.

For information on how to fold down the second-row seats completely, see “Folding second-row seats” (> page 285).

Returning seats to their original position

Warning



Make sure all seats are properly locked in position before driving off. Do not drive with seats not properly locked.

Never ride in a moving vehicle with the seat not properly locked as this can be dangerous. The seat could move forward and the seat backrest could fold. You could slide under the seat belt during braking, vehicle maneuvers, or in an accident. If you slide under it, the belt would apply force at the abdomen or neck. That could cause serious or even fatal injuries.

The seat backrest and seat belt provide the best restraint when the wearer is in a nearly upright position and the belt is properly positioned on the body.

The second-row seats have red markings on the seat base that indicate when a second-row seat is not properly locked.

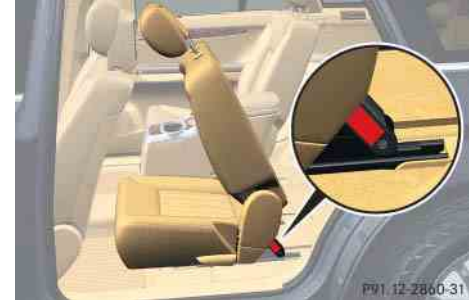

- ▶ When the red marking on the seat base is visible, push seat backrest back until the seat audibly engages.

With the seat properly locked in position, you will not see the red marking on the seat base.

Seats

Lumbar support

The curvature of the driver's seat can be adjusted to help enhance lower back support and seating comfort.

The lever for lumbar support adjustment is located on the right hand side of the driver's seat backrest.



① Adjustment lever

- ▶ Move adjustment lever ① in direction of arrows until you have reached a comfortable seating position.

Multicontour seat*

The multicontour seat has an extendable seat cushion and inflatable air chambers built into the backrest to provide additional lumbar and side support.

The seat cushion depth, seat backrest cushion-height and curvature can be continuously varied with switches on the inside of each front seat base after the ignition is switched on (▷ page 38).



- ① Seat cushion depth
- ② Backrest side bolsters
- ③ Backrest center
- ④ Backrest bottom

- ▶ Switch on the ignition (▷ page 38).

Seat cushion depth

- ▶ Adjust the seat cushion depth to the length of your upper leg with switch ①.

Backrest contour

- ▶ Adjust the contour of the seat backrest to the desired position with switch **+** or **-**.
- ▶ Move the seat backrest support to the bottom with button ④ or to the center with button ③.

Backrest side bolsters

- ▶ Adjust the side bolsters so that they provide good lateral support with switch ②.

Rear seats

Warning!



According to accident statistics, children are safer when properly restrained in the rear seating positions than in the front seating position. Thus, we strongly recommend that children be placed in the rear seats. Regardless of seating position, children 12 years old and under must be seated and properly secured in an appropriate infant or toddler restraint, or booster seat recommended for the size and weight of the child. For additional information, see “Children in the vehicle” (▷ page 82).

A child’s risk of serious or fatal injuries is significantly increased if the child restraints are not properly secured in the vehicle and the child is not properly secured in the child restraint.

Rear seat adjustment

Warning!



Never ride in a moving vehicle with the seat backrest in an excessively reclined position as this can be dangerous. You could slide under the seat belt in a collision. If you slide under it, the belt would apply force at the abdomen or neck. That could cause serious or fatal injuries. The seat backrest and seat belts provide the best restraint when the wearer is in a nearly upright position and belts are properly positioned on the body.

Your seat must be adjusted so that you can correctly fasten your seat belt (▷ page 50).

Never place hands under the seat or near any moving parts while a seat is being adjusted.

Fore and aft adjustment (second-row seats only)

The handles for adjusting the seats are located on the front of each seat base.



① Adjustment handle

- ▶ Pull up handle ① in direction of arrow and hold it there.
- ▶ Move seat to the desired position.
- ▶ Release handle ①.

The seat must audibly engage.

Seats

Seat backrest tilt (second-row seats)

The handles for adjusting the seats are located on the rear of each seat base.

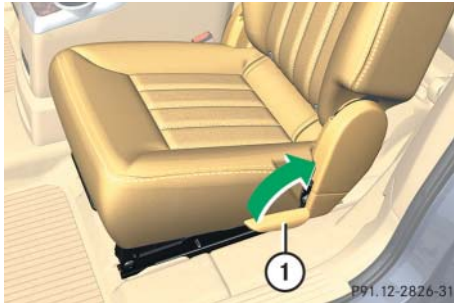

① Adjustment handle

- ▶ While seated, pull handle ① in direction of arrow to resistance point and hold it there.

- ▶ To move seat backrest back, lean lightly against backrest.
- ▶ To move seat backrest forward, lean forward with handle ① pulled and held at resistance point.

The seat backrest will move forward against your back.

- ▶ Release handle ① when the seat backrest has reached the desired position.

To make sure the seat backrest has engaged, lean firmly against the backrest.

Seat backrest tilt (third-row seats)

The handles for adjusting the seats are located on the outer side of each seat backrest.

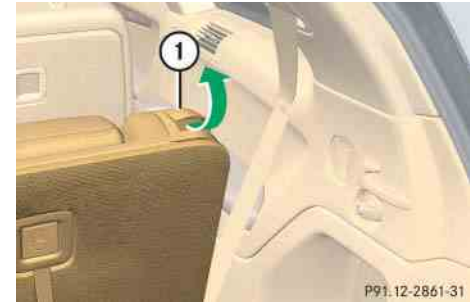

① Adjustment handle

- ▶ While seated, pull handle ① in direction of arrow and hold it there.

- ▶ To move seat backrest back, lean lightly against backrest.
- ▶ To move seat backrest forward, lean forward with handle ① pulled.

The seat backrest will move forward against your back.

- ▶ Release handle ① when the seat backrest has reached the desired position.

To make sure the seat backrest has engaged, lean firmly against the backrest.

Head restraint height

Warning!



For your protection, drive only with properly positioned head restraints.

Adjust head restraint so that the center of the head restraint supports the back of the head at eye level. This will reduce the potential for injury to the head and neck in the event of an accident or similar situation.

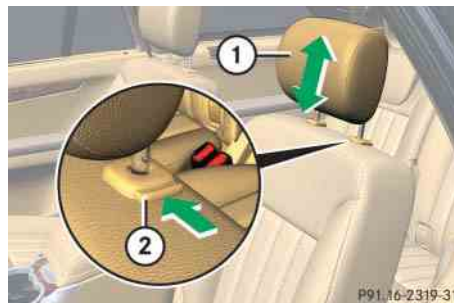

Second-row seat head restraint

- ① Head restraint
- ② Release button

Raising:

- ▶ Manually adjust the height of head restraint ① by pulling it upward to the desired position.

Lowering:

- ▶ To lower head restraint ①, push release button ② and press down on head restraint ①.



The third-row seat head restraints are adjusted in the same manner.



The tilt of the second-row head restraints is adjusted in the same manner as the front-seat head restraints, see “Head restraint tilt” (▶ page 45).

The tilt of the third-row head restraints cannot be adjusted.

Head restraints

Warning!



For your protection, drive only with properly positioned head restraints.

Adjust head restraint so that the center of the head restraint supports the back of the head at eye level. This will reduce the potential for injury to the head and neck in the event of an accident or similar situation.

Do not drive the vehicle without the seat head restraints installed when the rear seats are occupied. Head restraints are intended to help reduce injuries during an accident.

Removing head restraints



Seat position for head restraint removal

- ▶ When removing the head restraint of a second-row seat, adjust the seat to the rear as far as possible (▷ page 137) and fold the seat backrest (▷ page 134) forward.

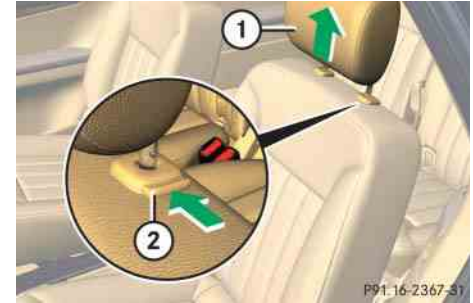

- ① Head restraint
- ② Release button

- ▶ To remove head restraint ①, pull head restraint ① to its highest position.
- ▶ Push release button ② and pull out head restraint.

Installing head restraints

- ▶ Insert head restraint ① into openings on the seat backrest.



On the second-row seats, the guide bar with the detent must be on the left.

- ▶ Push head restraint ① down until it audibly engages.
- ▶ Push release button ② and adjust head restraint ① to the desired position (▷ page 139).

Armrests

The second-row seat armrests can be folded up, when loading for example, and adjusted.

Folding up

- ▶ Move the armrest into a vertical position until it engages.

Adjusting

- ▶ With the armrest folded up, disengage the armrest by pushing it towards the rear slightly.
- ▶ Fold the armrest down to the lowest and then to the desired position until it engages.
- ▶ To readjust the armrest to a higher position, move armrest up to the desired position until it engages.



If you wish to readjust the armrest to a lower position, you must first fold up the armrest again and repeat the steps above.

Seat heating*

Front-seat heating

The switches for front-seat heating are located in the center console. The red indicator lamps in the switch come on to show which heating level you have selected.

Warning!



The seat heating switches off automatically. However, should a malfunction occur and the automatic switch-off function fail, the seat cushion and seat backrest can become very hot. This may cause burns.

Always be aware of the selected heating level for all seats equipped with seat heating. Vehicle occupants, especially occupants who suffer from spinal cord injuries or spinal cord disorders, may not notice that the seat heating is switched on and/or if the seat heating does not switch off as intended. To reduce the risk of burns and personal injury, take notice of whether and how the seat heaters are operational and switch off manually if necessary.

Level	
off	No indicator lamps on.
1	One indicator lamp on. The seat heating automatically switches off after approximately 20 minutes.
2	Two indicator lamps on. The seat heating automatically switches to level 1 after approximately 10 minutes.
3	Three indicator lamps on. The seat heating automatically switches to level 2 after approximately 5 minutes.



- ① Seat heating switch, front seats
- ② Indicator lamps

► Switch on the ignition (► page 38).

Switching on

- Press switch ①.
Three red indicator lamps ② in the switch come on.
- Continue pressing switch ① until desired seat heating level is reached.

Switching off

- ▶ Press switch ① repeatedly until all indicator lamps ② go out.



If one or more of the indicator lamps ② on seat heating switch ① are flashing, there is insufficient voltage due to too many electrical consumers being switched on. The seat heating switches off automatically.

The seat heating will switch back on again automatically as soon as sufficient voltage is available.

Second-row seat heating

The switches for the second-row seats are located in the rear center console.



- ① Seat heating switch
- ② Indicator lamps

- ▶ Operate the seat heating for the second-row seats as described in “Front-seat heating” (▷ page 141).

Memory function*

Prior to operating the vehicle, the driver should check and adjust the seat height, seat position fore and aft, and seat backrest angle if necessary, to ensure adequate control, reach and comfort. The head restraint should also be adjusted for proper height. See also the section on air bags (▷ page 71) for proper seat positioning.

In addition, adjust the steering wheel to ensure adequate control, reach, operation and comfort. Both the interior and exterior rear view mirrors should be adjusted for adequate rear vision.

Fasten seat belts. Infants and small children should be seated in a properly secured restraint system that complies with U.S. Federal Motor Vehicle Safety Standard 213 and 225 and Canadian Motor Vehicle Safety Standards 213 and 210.2.

With the memory function you can store up to three different settings for each front seat.

The following settings are saved for each stored position on the entry side of the driver's seat:

- Driver's seat, head restraint height and backrest position
- Steering wheel position
- Driver's side exterior rear view mirror position
- Passenger-side exterior rear view mirror position

The following are saved for each stored position on the entry side of the front passenger seat:

- Front passenger seat, head restraint height and backrest position

Warning!



Do not activate the memory function while driving. Activating the memory function while driving could cause the driver to lose control of the vehicle.

The memory button and stored position buttons are located on the entry side of each front seat base.



M Memory button

1, 2, 3 Stored positions

- ▶ Switch on the ignition (▷ page 38).

or

- ▶ Open the respective door.

Storing positions into memory

- ▶ Adjust the seats, steering wheel and exterior rear view mirrors to the desired position (▷ page 42).
- ▶ Press memory button **M**.
- ▶ Release memory button **M** and press stored position **1**, **2** or **3** within 3 seconds.

All settings are stored to the selected position.

Recalling positions from memory



Do not operate the power seats using memory button **M** if the seat backrest is in an excessively reclined position. Doing so could cause damage to front or rear seats.

First move seat backrest to an upright position.

- ▶ Press and hold memory position button **1**, **2** or **3** until the seat, steering wheel and exterior rear view mirrors have fully moved to the stored positions.



Releasing the memory position button stops movement to the stored positions immediately.

Memory function*

Storing exterior rear view mirror parking position

For easier parking, you can adjust the passenger-side exterior rear view mirror so that you can see the right rear wheel as soon as you engage reverse gear **R**.

You can switch the parking position feature on and off in the control system.

For information on activating the parking position feature, see “Setting parking position for exterior rear view mirror*” (> page 190).



- ① Adjustment button
- ② Passenger-side exterior rear view mirror
- M** Memory button

- ▶ Stop the vehicle in a safe location.
- ▶ Switch on the ignition (> page 38).
- ▶ Press button ② on the door control panel.

The passenger-side exterior rear view mirror is selected. The indicator lamp on button ② comes on.

- ▶ Adjust the passenger-side exterior rear view mirror with button ① so that you see the rear wheel and the road curb.
- ▶ Press memory button **M**.
- ▶ Within 3 seconds, press adjustment button ① once more.

The parking position is stored if the mirror does not move.



If the mirror does move, repeat the above steps. After the setting is stored, you can move the mirror again.

▼ Lighting

For information on how to switch on the headlamps and use the turn signals, see “Switching on headlamps” (▷ page 58) and “Turn signals” (▷ page 58).



If you drive in countries where vehicles drive on the other side of the road than the country in which the vehicle is registered, you must have the headlamps modified for symmetrical low beams. Relevant information can be obtained at any authorized Mercedes-Benz Light Truck Center.



Vehicles equipped with active Bi-Xenon* headlamps:
The active Bi-Xenon* headlamps monitor the vehicles steering angle, then automatically shift their beams to either side to better follow the curvature of the road ahead, increasing usable illumination over conventional headlamps.

Exterior lamp switch

The exterior lamp switch is located on the dashboard to the left of the steering wheel.



- 0** Off
Daytime running lamp mode (▷ page 149)
- AUTO** Automatic headlamp mode
Daytime running lamp mode (▷ page 148)
- ▷D00<** Parking lamps (also tail lamps, license plate lamps, side marker lamps, instrument panel lamps)
- ▷D** Low beam headlamps (or high beam headlamps when the combination switch is pushed forward) and parking lamps
- P<→** Standing lamps, right (turn left one stop)
- ←P<** Standing lamps, left (turn left two stops)
- ▷D** Indicator lamp for front fog lamps*
- 0#** Indicator lamp for rear fog lamp

Lighting



With the SmartKey removed from the starter switch and the driver's door open, a warning sounds if the parking lamps or low beam headlamps are switched on.

The message *Switch off lights* appears in the multifunction display.



With the daytime running lamp mode activated and the engine running, the low beam headlamps cannot be switched off manually.

For information on how to activate the daytime running lamp mode, see “Daytime running lamp mode” (▷ page 149).

Manual headlamp mode

The low beam headlamps and the parking lamps can be switched on and off with the exterior lamp switch.

Automatic headlamp mode

The following lamps switch on and off automatically depending on the brightness of the ambient light:

- Low beam headlamps
- Tail and parking lamps
- License plate lamps
- Side marker lamps

Warning!



If the exterior lamp switch is set to **AUTO**,

- the headlamps may switch off unexpectedly when the system senses bright ambient light, for example light from oncoming traffic
- the headlamps will not be automatically switched on under foggy conditions

To minimize risk to you and to others, activate headlamps by turning exterior lamp switch to when driving or when traffic and/or ambient lighting conditions require you to do so.

In low ambient lighting conditions, only switch from position **AUTO** to with the vehicle at a standstill in a safe location. Switching from **AUTO** to will briefly switch off the headlamps. Doing so while driving in low ambient lighting conditions may result in an accident.

The automatic headlamp feature is only an aid to the driver. The driver is responsible for the operation of the vehicle's lights at all times.

- ▶ Turn the exterior lamp switch to position **AUTO**.

With the starter switch in position **1** (▷ page 38), only the parking lamps will switch on and off automatically.

When the engine is running, the low beam headlamps, the tail and parking lamps, the license plate lamps, and the side marker lamps will switch on and off automatically.

Daytime running lamp mode

- ▶ Turn the exterior lamp switch to position **0** or **AUTO**.

When the engine is running, the low beam headlamps are switched on.

In low ambient light conditions, the following lamps will switch on additionally:

- Tail and parking lamps
- License plate lamps
- Side marker lamps

For nighttime driving you should turn the exterior lamp switch to position  to permit activation of the high beam headlamps.



With the daytime running lamp mode activated and the exterior lamp switch in position **0**, the high beam headlamps cannot be switched on.



The high beam flasher is available at all times.

Canada only

The daytime running lamp mode is mandatory and therefore in a constant mode.

When the engine is running and you shift from a driving position to position **N** or **P**, the low beam headlamps will switch off with a three-minute delay.

When the engine is running and you



- turn the exterior lamp switch to position , the parking lamps switch on additionally
- turn the exterior lamp switch to position , the manual headlamp mode has priority over the daytime running lamp mode

The corresponding exterior lamps switch on (▷ page 58).

Lighting

USA only

By default, the daytime running lamp mode is deactivated. Activate the daytime running lamp mode using the control system, see “Setting daytime running lamp mode (USA only)” (▷ page 182).

When the engine is running, and you turn the exterior lamp switch to position  or , the manual headlamp mode has priority over the daytime running lamp mode.

The corresponding exterior lamps switch on (▷ page 58).



Locator lighting and night security illumination

The locator lighting and the night security illumination are described in the “Control system” section, see “Setting locator lighting” (▷ page 183) and “Setting night security illumination” (▷ page 184).

Fog lamps

Warning!



In low ambient lighting or foggy conditions, only switch from position **AUTO** to  with the vehicle at a standstill in a safe location. Switching from **AUTO** to  will briefly switch off the headlamps. Doing so while driving in low ambient lighting conditions may result in an accident.



Fog lamps will operate with the parking lamps and/or the low beam headlamps on. Fog lamps should only be used in conjunction with low beam headlamps. Consult your State or Province Motor Vehicle Regulations regarding permissible lamp operation.



Fog lamps cannot be switched on with the exterior lamp switch in position **AUTO**. For switching on the fog lamps, turn the exterior lamp switch to position  first.

Front fog lamps*

- ▶ Switch on the low beam headlamps (▷ page 58).



- ▶ Pull out the exterior lamp switch to first stop.

The front fog lamps switch on.

The green indicator lamp  in the exterior lamp switch comes on (▷ page 147).

- ▶ Push in the exterior lamp switch.

The front fog lamps switch off.

The green indicator lamp  in the exterior lamp switch goes out.

Rear fog lamp (driver's side only)

- ▶ Pull out the exterior lamp switch to second stop.

The rear fog lamp switches on.

The yellow indicator lamp  in the exterior lamp switch comes on (▷ page 147).



If so equipped, the front fog lamps* will also switch on.

- ▶ Push in the exterior lamp switch to first stop.

The rear fog lamp switches off.

The yellow indicator lamp  in the exterior lamp switch goes out.

The front fog lamps* remain lit.

Combination switch

The combination switch is located on the left of the steering column.



- ① High beam
- ② High beam flasher

High beam

- ▶ Turn the exterior lamp switch to position  or **AUTO** (▷ page 147). ▷▷

Lighting

- ▷▷ Push the combination switch in direction of arrow ① to switch on the high beam.

The high beam headlamp indicator lamp  in the instrument cluster comes on (▷ page 24).

- ▶ Pull the combination switch in direction of arrow ② to its original position to switch off the high beam.

The high beam headlamp indicator lamp  in the instrument cluster goes out.

High beam flasher

- ▶ Pull the combination switch briefly in direction of arrow ②.

Corner-illuminating front fog lamps*

The corner-illuminating front fog lamps improve illumination of the road into which you are turning.

The corner-illuminating front fog lamps will operate with the engine running and with

- the exterior lamp switch in position  (▷ page 147)
or
- the exterior lamp switch in position **AUTO** (▷ page 147)
or
- the daytime running lamp mode activated (▷ page 149)



Corner-illuminating front fog lamps will only come on in low ambient lighting conditions.

The corner-illuminating front fog lamps function is not available at a vehicle speed above 25 mph (40 km/h).

Driving forward

Switching on corner-illuminating front fog lamps

- ▶ Depending on whether you are turning left or right, switch on the left or right turn signal (▷ page 58).

The respective front fog lamp comes on and illuminates the road onto which you are turning.



The corner-illuminating front fog lamps will come on automatically depending on the steering angle, even if you did not switch on either turn signal. If the corner-illuminating front fog lamps came on automatically, they will also go out automatically depending on the steering angle.

Switching off corner-illuminating front fog lamps

The combination switch for the turn signal resets automatically after major steering wheel movements. This will switch off the corner-illuminating front fog lamps if they were activated by switching on the left or right turn signal.

If the turn signal should stay on after making the turn, the turn signal and corner-illuminating front fog lamps can be switched off by returning the combination switch to its original position.

Driving rearward

Switching on corner-illuminating front fog lamps

- ▶ Shift the automatic transmission to reverse gear **R** (▷ page 198).

The inverse front fog lamp comes on automatically depending on the steering direction and steering angle.

Switching off corner-illuminating front fog lamps

- ▶ Shift the automatic transmission to a gear other than reverse gear **R** (▷ page 197).

The respective front fog lamp goes out.

Hazard warning flasher

The hazard warning flasher can be switched on at all times, even with the SmartKey removed from the starter switch.

The hazard warning flasher switches on automatically when an air bag deploys.

The hazard warning flasher switch is located on the upper part of the center console.



① Hazard warning flasher switch

Lighting

Switching on hazard warning flasher

- ▶ Press hazard warning flasher switch ①.

All turn signals are flashing.



With the hazard warning flasher activated and the combination switch set for either left or right turn, only the respective turn signals will operate when the ignition is switched on.

Switching off hazard warning flasher

- ▶ Press hazard warning flasher switch ① again.



If the hazard warning flasher has been activated automatically, press hazard warning flasher switch ① once to switch it off.

Interior lighting

The controls for interior lighting are located in the overhead control panel.



The interior lighting is factory-set to automatic mode (▷ page 155).

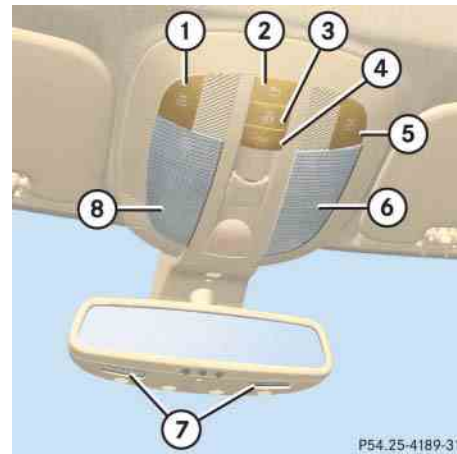

- ① Front left reading lamp, on/off
- ② Rear interior lighting, on/off
- ③ Automatic interior lighting
- ④ Front interior lighting, on/off
- ⑤ Front right reading lamp, on/off
- ⑥ Front right interior lamp lens
- ⑦ Reading lamps
- ⑧ Front left interior lamp lens

Deactivating automatic control

- ▶ Press switch ③.

The interior lighting and the locator lighting (▷ page 183) remain switched off even when you

- unlock the vehicle
- open a door
- open the tailgate
- remove the SmartKey from the starter switch

Activating automatic control

- ▶ Press switch ③.

The interior lighting and the locator lighting (▷ page 183) come on when you

- unlock the vehicle
- open a door
- open the tailgate
- remove the SmartKey from the starter switch

The interior lamps go out following an adjustable time delay (▷ page 185).



If a door remains open, the interior lamps switch off automatically after approximately 5 minutes when the SmartKey is removed or in starter switch position **0**.

An interior lamp switched on manually does not go out automatically.

Manual control

Switching front interior lighting on and off

- ▶ Press button ④.

The lamps in the front passenger compartment come on.

- ▶ Press button ④ once more.

The lamps in the front passenger compartment go out.

Switching rear interior lighting on and off

- ▶ Press button ②.

The lamps in the rear passenger compartment come on.

- ▶ Press button ② once more.

The lamps in the rear passenger compartment go out.

Lighting

Switching front reading lamps on and off

- ▶ Press button ① or ⑤.

The corresponding front reading lamp comes on.

- ▶ Press button ① or ⑤ again.

The corresponding reading lamp goes out.

Switching second-row reading lamps on and off

The second row reading lamps are located above the side windows.

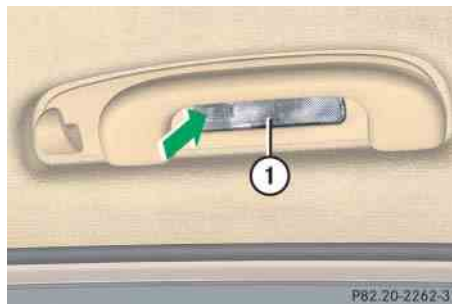

① Second-row reading lamp

- ▶ Press on reading lamp ① in direction of arrow.

The reading lamp comes on.

- ▶ Press on reading lamp ① in direction of arrow once more.

The reading lamp goes out.

Switching third-row reading lamps* on and off

The switches for the third-row reading lamps are located in the rear overhead control panel.

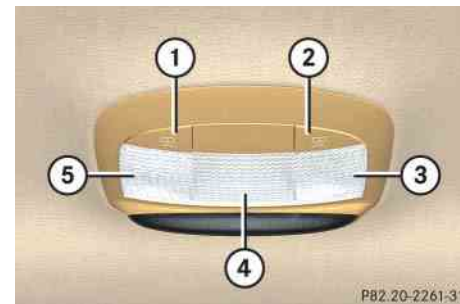

- ① Rear right reading lamp, on/off
- ② Rear left reading lamp, on/off
- ③ Rear left reading lamp lens
- ④ Rear interior lamp lens
- ⑤ Rear right reading lamp lens

- ▶ Press button ① or ②.

The corresponding reading lamp comes on.

- ▶ Press button ① or ② once more.

The corresponding reading lamp goes out.



The rear interior lighting is switched on and off using the button on the front overhead control panel (> page 154).

Door entry lamps

The corresponding door entry lamp comes on if a door is opened and if the interior lighting is switched to automatic mode.

The entry lamp goes out automatically when the door is closed.



If you turn the SmartKey in the starter switch to position **0** or remove the SmartKey from the starter switch, the door entry lamps will remain lit for approximately 5 minutes.

Cargo compartment lamp

The cargo compartment lamp comes on when the tailgate is opened.

If you leave the tailgate open for an extended period of time, the cargo compartment lamp will switch off automatically after approximately 10 minutes.

Instrument cluster

For a full view illustration of the instrument cluster, see “Instrument cluster” (▷ page 24).

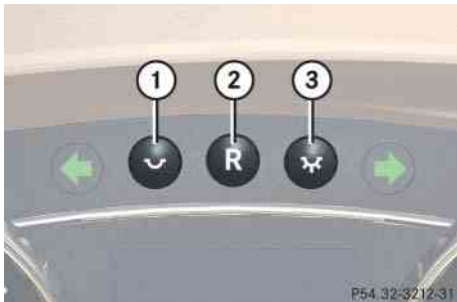

- ① Dimming instrument cluster illumination
- ② Reset button
- ③ Brightening instrument cluster illumination

The instrument cluster is activated when you

- open a door
- switch on the ignition (▷ page 38)
- press reset button ②
- switch on the exterior lamps (▷ page 147)

You can modify the instrument cluster settings in the instrument cluster submenu of the control system (▷ page 178).

Warning!



If the instrument cluster or the multifunction display, or both, are inoperative or malfunctioning, warning messages will not be relayed when potential danger exists. This may cause you and others to be unaware of certain risks, which may result in an accident and/or personal injury.

Contact the nearest authorized Mercedes-Benz Light Truck Center as soon as possible.

Instrument cluster illumination

Use button ① or ③ to adjust the illumination brightness for the instrument cluster.



The instrument cluster illumination is dimmed or brightened automatically to suit ambient light conditions.

The instrument cluster illumination will also be adjusted automatically when you switch on the vehicle's exterior lamps.

To brighten illumination



- ▶ Press and hold button ③ until the desired level of illumination is reached.

To dim illumination

- ▶ Press and hold button ① until the desired level of illumination is reached.

Trip odometer

Make sure you are viewing the trip odometer display (▷ page 161).

- ▶ If it is not displayed, press button  or  on the multifunction steering wheel (▷ page 162) repeatedly until the trip odometer appears in the multifunction display.
- ▶ Press and hold reset button ② (▷ page 158) until the trip odometer is reset.

Tachometer

The red marking on the tachometer (▷ page 24) denotes excessive engine speed.



Avoid driving at excessive engine speeds, as it may result in serious engine damage that is not covered by the Mercedes-Benz Limited Warranty.

To help protect the engine, the fuel supply is interrupted if the engine is operated within the red marking.

Outside temperature indicator

Warning!



The outside temperature indicator is not designed to serve as an ice-warning device and is therefore unsuitable for that purpose.

Indicated temperatures just above the freezing point do not guarantee that the road surface is free of ice. The road may still be icy, especially in wooded areas or on bridges.

The outside temperature is indicated in the multifunction display (▷ page 161).

The temperature sensor is located in the front bumper area. Due to its location, the sensor can be affected by road or engine heat during idling or slow driving. This means that the accuracy of the displayed temperature can only be verified by comparison to a thermometer placed next to the sensor, not by comparison to external displays (e.g. bank signs etc.).

When moving the vehicle into colder ambient temperatures (e.g. when leaving your garage), you will notice a delay before the lower temperature is displayed.

A delay also occurs when ambient temperatures rise. This prevents inaccurate temperature indications caused by heat radiated from the engine during idling or slow driving.

▼ Control system

The control system is activated as soon as the SmartKey in the starter switch is turned to position **1** (▷ page 38) or as soon as the KEYLESS-GO start/stop button* is in position **1** (▷ page 39). The control system enables you to

- call up information about your vehicle
- change vehicle settings

For example, you can use the control system to find out when your vehicle is next due for maintenance service, to set the language for messages in the instrument cluster display, and much more.



The displays for the audio systems (radio, CD player) will appear in English, regardless of the language selected.

Warning!



A driver's attention to the road and traffic conditions must always be his/her primary focus when driving.

For your safety and the safety of others, selecting features through the multifunction steering wheel should only be done by the driver when traffic and road conditions permit it to be done safely.

Bear in mind that at a speed of just 30 mph (approximately 50 km/h), your vehicle is covering a distance of 44 feet (approximately 14 m) every second.

The control system relays information to the multifunction display.

Multifunction display

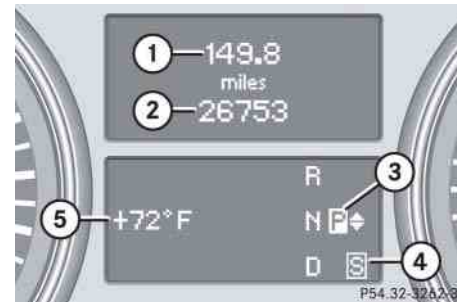

- ① Trip odometer
- ② Main odometer
- ③ Gear position indicator
- ④ Current transmission program mode
- ⑤ Status indicator (outside temperature or digital speedometer)

For more information on menus displayed in the multifunction display, see “Menus” (▷ page 164).

Control system

Multifunction steering wheel

The displays in the multifunction display and the settings in the control system are controlled by the buttons on the multifunction steering wheel.

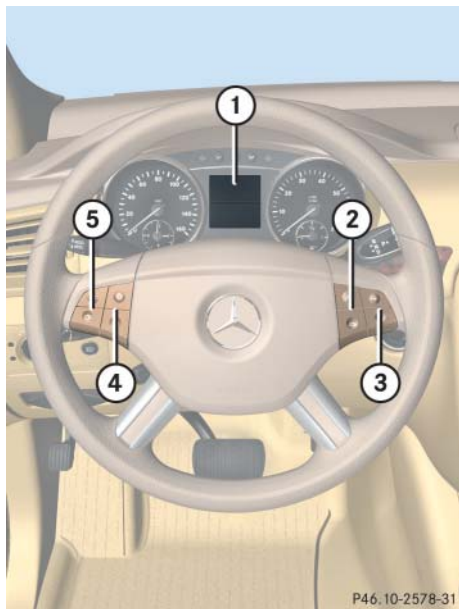

① Multifunction display

Operating the control system

② Telephone*:

Press button

 to take a call

 to end a call

③ Selecting the submenu or setting the volume:

Press button

 up/to increase

 down/to decrease

④ Moving within a menu:

Press button

 for next display

 for previous display

⑤ Menu systems:

Press button

 for next menu





 for previous menu

Pressing any of the buttons, except for the telephone buttons, on the multifunction steering wheel will alter what is shown in the multifunction display.

The information available in the multifunction display is arranged in menus, each containing a number of functions or sub-menus.

The individual functions are then found within the relevant menu (radio or CD operations under AUDIO, for example). These functions serve to call up relevant information or to customize the settings for your vehicle.

It is helpful to think of the menus, and the functions within each menu, as being arranged in a circular pattern.

- If you press button  or  repeatedly, you will pass through each menu one after the other.
- If you press button  or  repeatedly, you will pass through each function display, one after the other, in the current menu.

In the *Settings* menu, instead of functions, you will find a number of submenus for calling up and changing settings. For instructions on using these submenus, see “Settings menu” (▷ page 174).

The number of menus available in the system depends on which optional equipment is installed in your vehicle.

The menus are described on the following pages.

Control system

Menus

This is what you will see when you scroll through the menus ① to ⑤.

The table on the next page provides an overview of the individual menus.

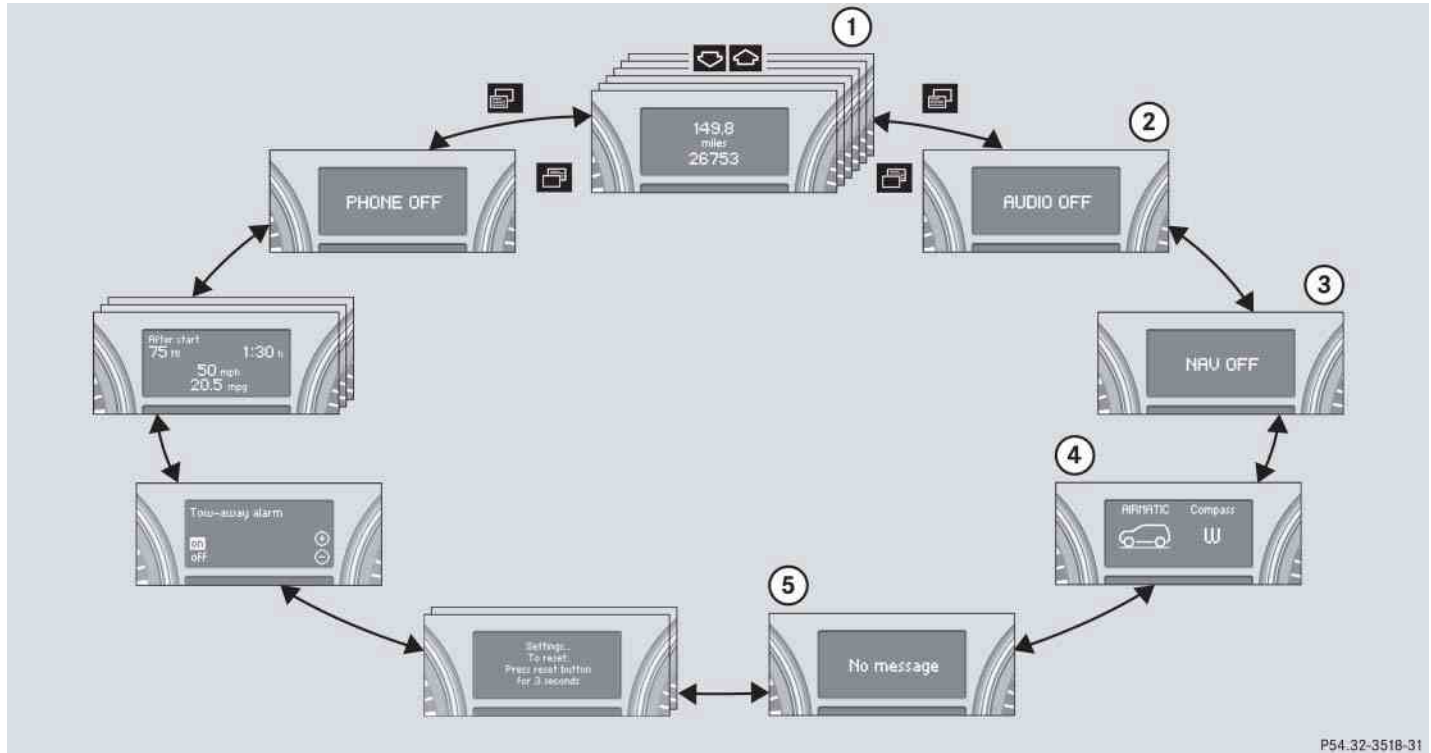

P54-32-351B-31

Menus, submenus and functions

	Menu ① Standard display	Menu ② AUDIO	Menu ③ NAV*	Menu ④ Airmatic/ Compass	Menu ⑤ Vehicle status message memory
	(▷ page 168)	(▷ page 170)	(▷ page 172)	(▷ page 172)	(▷ page 173)
Commands/submenus	Trip- and main odometer	Selecting radio station	Show route guidance instructions, current direction traveled	Airmatic*	Calling up vehicle malfunction, warning and system status messages stored in memory
	Checking tire inflation pressure*	Selecting satellite radio station* (USA only)		Compass	
	Checking coolant temperature	Operating CD player			
	Calling up digital speedometer or outside temperature				
	Calling up maintenance service indicator				
	Checking engine oil level				



The headings used in the menus table are designed to facilitate navigation within the system and are not necessarily identical to those shown in the

control system displays. The first function displayed in each menu will automatically show you which part of the system you are in.

Control system

This is what you will see when you scroll through the menus ⑥ to ⑨.

The table on the next page provides an overview of the individual menus.

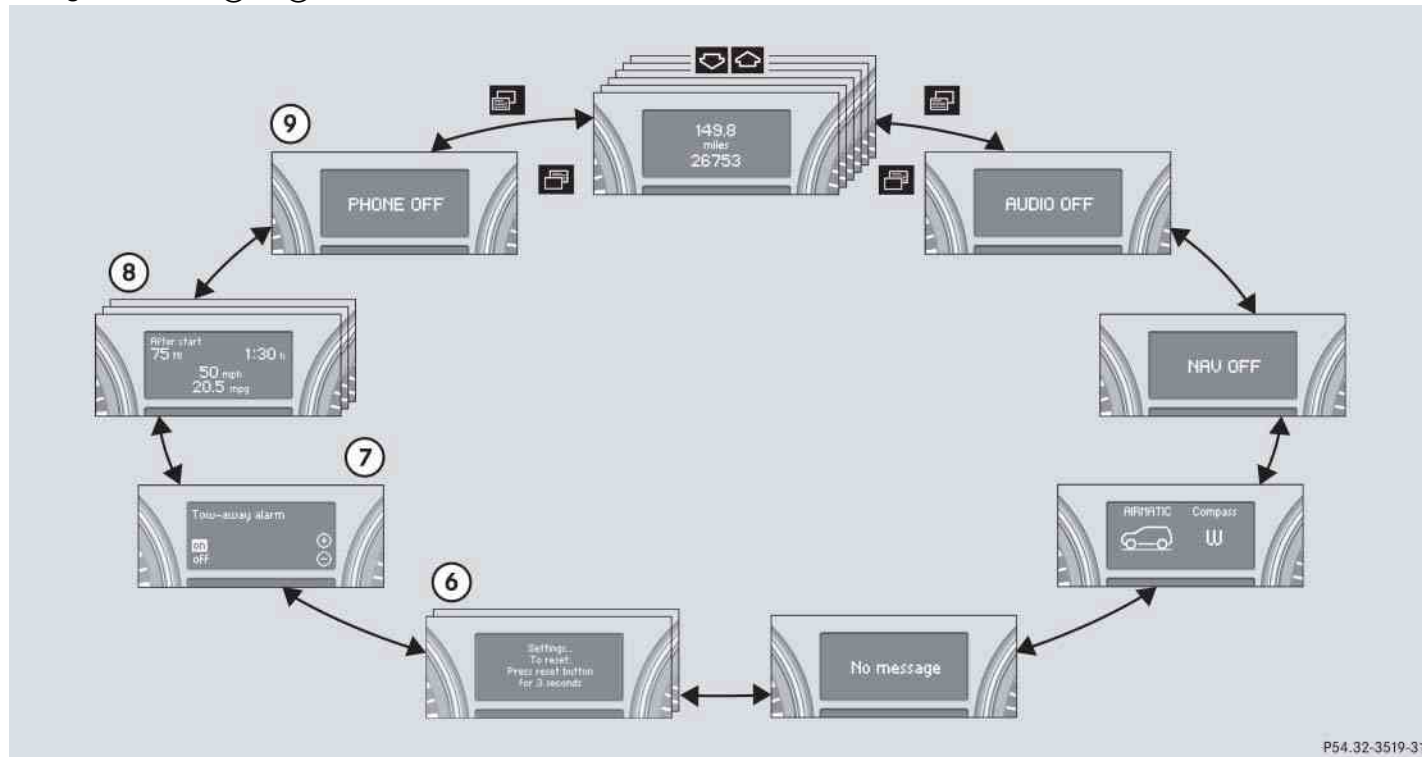

P54.32-3519-31

Menus, submenus and functions

	Menu ⑥ Settings (▷ page 174)	Menu ⑦ Vehicle configuration (▷ page 191)	Menu ⑧ Trip computer (▷ page 192)	Menu ⑨ Telephone* (▷ page 194)
Commands/submenus	Resetting to factory settings	Tow-away alarm on/off	Fuel consumption statistics after start	Loading phone book
	Instrument cluster submenu		Fuel consumption statistics since the last reset	Searching for name in phone book
	Time/Date submenu		Calling up range (distance to empty)	
	Lighting submenu			
	Vehicle submenu			
	Convenience submenu			



The headings used in the menus table are designed to facilitate navigation within the system and are not necessarily identical to those shown in the control system displays.

The first function displayed in each menu will automatically show you which part of the system you are in.



Control system



Standard display menu

In the standard display, the main odometer and the trip odometer appear in the multi-function display.



- ① Trip odometer
- ② Main odometer

If you see another display, press button  or  repeatedly until the standard display appears.

You can select the functions in the standard display menu with button  or .

The following functions are available:

Function	Page
Checking tire inflation pressure*	371
Checking coolant temperature	168
Calling up digital speedometer or outside temperature	169
Calling up maintenance service indicator	393
Checking engine oil level (R 500 only)	347



Checking coolant temperature

Warning!



- Driving when your engine is badly overheated can cause some fluids which may have leaked into the engine compartment to catch fire. You could be seriously burned.
- Steam from an overheated engine can cause serious burns and can occur just by opening the hood. Stay away from the engine if you see or hear steam coming from it.

Turn off the engine, get out of the vehicle and do not stand near the vehicle until the engine has cooled down.

- ▶ Press button  or  repeatedly until the coolant temperature appears in the multifunction display.

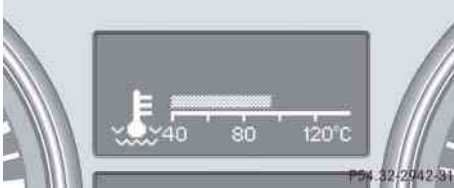



The engine should not be operated with a coolant temperature above 248°F (120°C). Doing so may cause serious engine damage which is not covered by the Mercedes-Benz Limited Warranty.



During severe operating conditions, e.g. stop-and-go city traffic, the coolant temperature may rise close to 248°F (120°C).

Excessive coolant temperature triggers a warning message in the multifunction display (▷ page 434).

Calling up digital speedometer or outside temperature

- ▶ Press button  or  repeatedly until the digital speedometer or the outside temperature appears in the multifunction display.



Digital speedometer



Outside temperature



You can select whether the digital speedometer or the outside temperature is to be displayed.

You can change the setting in the submenu Instr. cluster via the function Status line display, see “Selecting display (digital speedometer or outside temperature) for status indicator” (▷ page 179).

Control system

AUDIO menu



The functions in the **AUDIO** menu operate the audio equipment which you currently have turned on.

If no audio equipment is currently turned on, the message **AUDIO OFF** appears in the multifunction display.



The following functions are available:

Function	Page
Selecting radio station	170
Selecting satellite radio station* (USA only)	171
Operating CD player	171

Selecting radio station

- ▶ Turn on the Modular COMAND System and select radio. Refer to separate Modular COMAND System operating instructions.
- ▶ Press button  or  repeatedly until the currently tuned station appears in the multifunction display.



- ① Waveband setting
- ② Station frequency
- ▶ Press button  or  repeatedly until the desired station is found.





You can only store new stations using the corresponding feature on the radio. Refer to separate Modular COMAND System operating instructions. You can also operate the radio in the usual manner.

Selecting satellite radio station* (USA only)

The satellite radio is treated as a radio application.

- ▶ Select satellite radio with the corresponding soft key on the Modular COMAND System.



- ① SAT mode
 - ② Channel name or number
- ▶ Press button  or  repeatedly until the desired channel is found.





Feature description is based on preliminary information available at time of printing.



Additional optional satellite radio equipment and a subscription to satellite radio service provider are required for satellite radio operation. At time of printing, no date for the availability of optional equipment required for satellite radio operation had been set. Contact an authorized Mercedes-Benz Light Truck Center for details and availability for your vehicle.

For more information, refer to separate Modular COMAND System operating instructions.

Operating the CD player

- ▶ Turn on the Modular COMAND System and select CD. Refer to separate Modular COMAND System operating instructions.
- ▶ Press button  or  repeatedly until the settings for the CD currently being played appear in the multifunction display.



- ① Current CD (for CD changer*)
 - ② Current track
- ▶ Press button  or  repeatedly until the desired track is selected. >>



Control system



To select a CD from the magazine, press a number on the Modular COMAND System key pad located in the center console.

NAV* menu

The NAV menu contains the functions needed to operate your navigation system.

- ▶ Press button  or  repeatedly until the message NAV appears in the multifunction display.



The message shown in the multifunction display depends on the status of the navigation system:

- With the Modular COMAND System switched off, the message NAV OFF appears in the multifunction display.
- With the Modular COMAND System switched on but route guidance not activated, the direction of travel and, if applicable, the name of the street currently traveled on appear in the multifunction display.
- With the Modular COMAND System switched on and route guidance activated, the direction of travel and maneuver instructions appear in the multifunction display.

Please refer to the Modular COMAND System manual for instructions on how to activate the route guidance system.

AIRMATIC*/Compass menu

The AIRMATIC/Compass menu displays the Airmatic messages and the direction into which you are currently driving.

- ▶ Press button  or  repeatedly until the AIRMATIC/Compass menu appears in the multifunction display.



For information on AIRMATIC*, see “AIRMATIC*” (▷ page 269).

For information on the compass, see “Vehicle submenu” (▷ page 186) and “Compass” (▷ page 327).



Vehicle status message memory menu

Use the vehicle status message memory menu to scan malfunction and warning messages that may be stored in the system. Such messages appear in the multifunction display and are based on conditions or system status the vehicle's system has recorded.

Warning!



Malfunction and warning messages are only indicated for certain systems and are intentionally not very detailed. The malfunction and warning messages are simply a reminder with respect to the operation of certain systems and do not replace the owner's and/or driver's responsibility to maintain the vehicle's operating safety by having all required maintenance and safety checks performed on the vehicle and by bringing the vehicle to an authorized Mercedes-Benz Light Truck Center to address the malfunction and warning messages (▷ page 416).

- ▶ Press button  or  repeatedly until the vehicle status message memory appears in the multifunction display.

No vehicle status messages

If no conditions have been recorded in memory, the message in the multifunction display is: No message.

Vehicle status messages have been recorded

If conditions have occurred causing status messages to be recorded, the number of messages appears in the multifunction display:

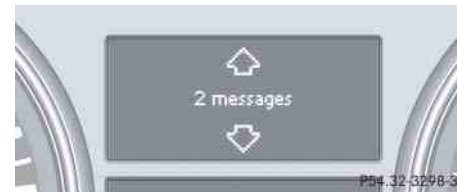

- ▶ Press button  or .

The stored messages will now be displayed in order in which they have occurred. For malfunctions and warning messages, see “Vehicle status messages in the multifunction display” (▷ page 416).



After you have scrolled through all recorded status messages, the first recorded message appears again.

Control system

Should the vehicle's system record any conditions while driving, the number of messages will reappear in the multifunction display



- when the SmartKey in the starter switch is turned to position **0** or removed from the starter switch
or
- when you turn off the engine by pressing the KEYLESS-GO* start/stop button (▷ page 66) in the starter switch once and open the driver's door (this puts the starter switch in position **0**, same as with the SmartKey removed from the starter switch)



The vehicle status message memory will be cleared when you turn the SmartKey in the starter switch to position **1** or **2**, or when you press the KEYLESS-GO* start/stop button once or twice without depressing the brake pedal. You will then only see high priority messages in the multifunction display (▷ page 416).

Settings menu

In the Settings menu there are two functions:

- The function *Reset to factory settings?*, with which you can reset all the settings to the original factory settings.
 - A collection of submenus with which you can make individual settings for your vehicle.
- ▶ Press button  or  repeatedly until the Settings menu appears in the multifunction display.



The following settings and submenus are available in the Settings menu:

Function	Page
Resetting all settings	175
Submenus in the Settings menu	176
Resetting the functions of a submenu	176
Instrument cluster submenu	178
Time/date submenu	180
Lighting submenu	182
Vehicle submenu	186
Convenience submenu	189

Resetting all settings

You can reset all the functions of all submenus to the factory settings.

- ▶ Press the reset button in the instrument cluster (▷ page 158) for approximately 3 seconds.

The request to press the reset button once more to confirm appears in the multifunction display.



- ▶ Press the reset button once more.

The functions of all the submenus will reset to factory settings.



The settings you have changed will not be reset unless you confirm the action by pressing the reset button a second time.

After approximately 5 seconds, the Settings menu reappears in the multifunction display (▷ page 174).



For safety reasons, the function Light circuit headlamp mode in the Lighting submenu cannot be reset while driving.

The following message appears in the multifunction display:

Lighting
Cannot be completely reset
to factory settings while driving

Control system

Submenus in the Settings menu



- ▶ Press button .



The collection of the submenus appears in the multifunction display.





- ▶ Press button .

The selection marker moves to the next submenu.

The submenus are arranged by hierarchy. Scroll down with button , scroll up with button .

With the selection marker on the desired submenu, use the  button to access the individual functions within that submenu. Once within that submenu, you can use the  button to move to the next function or the  button to move to the previous function within that submenu.

The settings themselves are made with button  or .

Resetting the functions of a submenu

You can reset all the functions for each submenu to the factory settings.

- ▶ Move to a function in the submenu.
- ▶ Press the reset button in the instrument cluster (▷ page 158) for approximately 3 seconds.

The request to press the reset button once more to confirm appears in the multifunction display.

- ▶ Press the reset button once more.

All functions of the submenu will reset to factory settings.



The settings you have changed will not be reset unless you confirm the action by pressing the reset button a second time.

After approximately 5 seconds, the Settings menu reappears in the multifunction display (▷ page 174).



For safety reasons, the function Lamp circuit headlamp (▷ page 182) in the Lighting submenu cannot be reset while driving.

The following message appears in the multifunction display:

Lighting
Cannot be completely reset
to factory settings while driving

The table below shows what settings can be changed within the various menus. Detailed instructions on making individual settings can be found on the following pages.

INSTRUMENT CLUSTER	TIME/DATE	LIGHTING	VEHICLE	CONVENIENCE
Selecting speedometer display mode	Setting the time (hours)	Setting daytime running lamp mode (USA only)	Calling up the compass	Activating easy-entry/exit feature*
Selecting language	Setting the time (minutes)	Setting locator lighting	Compass adjustment	Setting parking position for exterior rear view mirror
Selecting display (digital speedometer or outside temperature) for status indicator	Setting the date (month)	Setting night security illumination	Compass calibration	Setting fold-in function for exterior rear view mirrors
	Setting the date (day)	Setting interior lighting delayed shut-off	Setting which display to appear with ignition switched off	
	Setting the date (year)		Setting automatic locking Limiting opening height of tailgate*	

Control system

Instrument cluster submenu

Access the Instr. cluster submenu via the Settings menu. Use the Instr. cluster submenu to change the instrument cluster display settings.

The following functions are available:

Function	Page
Selecting speedometer display mode	178
Selecting language	178
Selecting display (digital speedometer or outside temperature) for status indicator	179

Selecting speedometer display mode

- ▶ Move the selection marker with button **+** or **-** to the Instr. cluster submenu.
- ▶ Press button **↶** or **↷** repeatedly until the message **Display unit** appears in the multifunction display.

The selection marker is on the current setting.



- ▶ Press button **+** or **-** to set speedometer unit to km or miles.

Selecting language

- ▶ Move the selection marker with button **+** or **-** to the Instr. cluster submenu.
- ▶ Press button **↶** or **↷** repeatedly until the message **Language** appears in the multifunction display.

The selection marker is on the current setting.

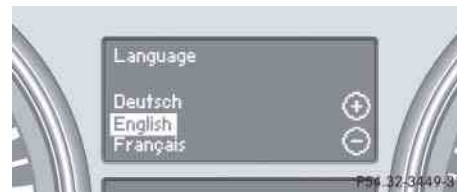

- ▶ Press button **+** or **-** to select the language to be used for the multifunction display messages.

Available languages:

- German (Deutsch)
- English (English)
- French (Français)
- Italian (Italiano)
- Spanish (Español)

Selecting display (digital speedometer or outside temperature) for status indicator

- ▶ Move the selection marker with button **+** or **-** to the Instr. cluster submenu.
- ▶ Press button **↶** or **↷** repeatedly until the message *Status line display* appears in the multifunction display.

The selection marker is on the current setting.

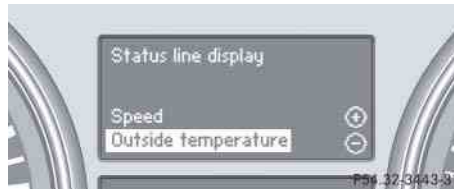

- ▶ Press button **+** or **-** to select the desired setting.

The selected display is then shown continuously in the status indicator (lower display).

The other display now appears in the menu of the standard display (▷ page 169):

- Digital speedometer
- or
- Outside temperature

Control system

Time/Date submenu

Access the Time/Date submenu via the Settings menu. Use the Time/Date submenu to change the time and date settings.

The following functions are available:

Function	Page
Setting the time (hours)	180
Setting the time (minutes)	180
Setting the date (month)	181
Setting the date (day)	181
Setting the date (year)	181



If your vehicle is equipped with the Modular COMAND System and navigation module*, see separate COMAND operating instructions for information on how to set the date and time.

Setting the time (hours)

This function is not available if your vehicle is equipped with the Modular COMAND System and navigation module*.

- ▶ Move the selection marker with button **+** or **-** to the Time/Date submenu.
- ▶ Press button **▲** or **▼** repeatedly until the message **Set clock hours** appears in the multifunction display.

The selection marker is on the hour setting.

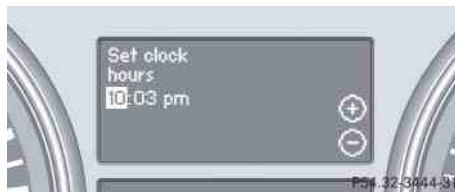

- ▶ Press button **+** or **-** to set the hour.

Setting the time (minutes)

This function is not available if your vehicle is equipped with the Modular COMAND System and navigation module*.

- ▶ Move the selection marker with button **+** or **-** to the Time/Date submenu.
- ▶ Press button **▲** or **▼** repeatedly until the message **Set clock minutes** appears in the multifunction display.

The selection marker is on the minute setting.

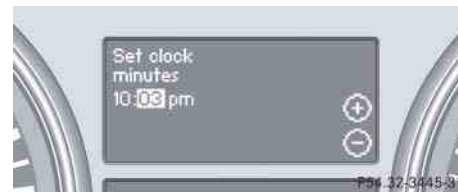

- ▶ Press button **+** or **-** to set the minutes.

Setting the date (month)

This function is not available if your vehicle is equipped with the Modular COMAND System and navigation module*.

- ▶ Move the selection marker with button **+** or **-** to the Time/Date submenu.
- ▶ Press button **↶** or **↷** repeatedly until the message **Set date month** appears in the multifunction display.

The selection marker is on the month setting.

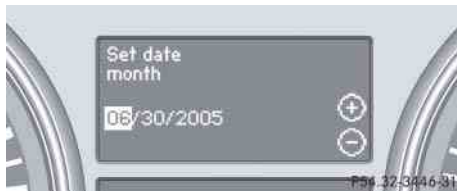

- ▶ Press button **+** or **-** to set the month.

Setting the date (day)

This function is not available if your vehicle is equipped with the Modular COMAND System and navigation module*.

- ▶ Move the selection marker with button **+** or **-** to the Time/Date submenu.
- ▶ Press button **↶** or **↷** repeatedly until the message **Set date day** appears in the multifunction display.

The selection marker is on the day setting.

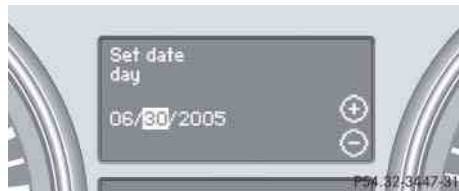

- ▶ Press button **+** or **-** to set the day.

Setting the date (year)

This function is not available if your vehicle is equipped with the Modular COMAND System and navigation module*.

- ▶ Move the selection marker with button **+** or **-** to the Time/Date submenu.
- ▶ Press button **↶** or **↷** repeatedly until the message **Set date year** appears in the multifunction display.

The selection marker is on the year setting.



- ▶ Press button **+** or **-** to set the year.

Control system

Lighting submenu

Access the Lighting submenu via the Settings menu. Use the Lighting submenu to change the lamp and lighting settings on your vehicle.

The following functions are available:

Function	Page
Setting daytime running lamp mode (USA only)	182
Setting locator lighting	183
Setting night security illumination	184
Setting interior lighting delayed shut-off	185

Setting daytime running lamp mode (USA only)



This function is not available in countries where the daytime running lamp mode is mandatory and therefore in a constant mode.

- ▶ Move the selection marker with button **+** or **-** to the Lighting submenu.
- ▶ Press button **↶** or **↷** repeatedly until the message **Lamp circuit headlamp** appears in the multifunction display.

The selection marker is on the current setting.



- ▶ Press button **+** or **-** to select manual operation (**manual**) or daytime running lamp mode (**constant**).

With daytime running lamp mode activated and the exterior lamp switch at position **0** or **AUTO**, the low beam headlamps are switched on when the engine is running.

In low ambient light conditions the following lamps will switch on additionally:

- Parking lamps
- Tail lamps
- License plate lamps
- Side marker lamps

For more information on the daytime running lamp mode, see “Lighting” (▷ page 147).



For safety reasons, resetting the Lighting submenu to factory settings while driving (▷ page 176) will not deactivate the daytime running lamp mode.

The following message appears in the multifunction display:

Lighting

Cannot be completely reset to factory settings while driving

Setting locator lighting

With the locator lighting feature activated, the exterior lamp switch in position **AUTO** (▷ page 148) and the interior lighting in automatic mode (▷ page 155), the following lamps will switch on during darkness when the vehicle is unlocked with the SmartKey:

- Parking lamps
- Tail lamps
- License plate lamps
- Side marker lamps
- Corner-illuminating front fog lamps*

The locator lighting switches off when the driver’s door is opened.

If you do not open a door after unlocking the vehicle with the SmartKey, the lamps will switch off automatically after approximately 40 seconds.

- ▶ Move the selection marker with button **+** or **-** to the Lighting submenu.
- ▶ Press button **↶** or **↷** repeatedly until the message Function Surround lighting appears in the multifunction display.

The selection marker is on the current setting.



- ▶ Press button **+** or **-** to switch the locator lighting function to on.
- ▶ Turn the exterior lamp switch to position **AUTO** (▷ page 147) when exiting the vehicle.

The locator lighting feature is activated.

Control system

Setting night security illumination (Headlamps delayed shut-off)

Use this function to set whether and for how long you would like the exterior lamps to remain on during darkness after exiting the vehicle and the doors closed.

With the delayed shut-off feature activated and the exterior lamp switch in position **AUTO** before the engine is turned off, the following lamps will switch on when the engine is turned off:

- Parking lamps
- Tail lamps
- License plate lamps
- Side marker lamps
- Front fog lamps*

If after turning off the engine you do not open a door, the lamps will switch off automatically after 60 seconds.

- ▶ Move the selection marker with button **+** or **-** to the Lighting submenu.
- ▶ Press button **↶** or **↷** repeatedly until the message **Headlmp. delayed shut-off** appears in the multifunction display.
The selection marker is on the current setting.



- ▶ Press button **+** or **-** to select the desired lamp-on period.

You can select:

- 0 sec., the delayed shut-off feature is deactivated.
- 15 sec., 30 sec., 45 sec. or 60 sec., select the desired lamp-on period.
- ▶ Turn the exterior lamp switch to position **AUTO** (▷ page 147) before turning off the engine.

The headlamps delayed shut-off feature is activated.

You can temporarily deactivate the delayed shut-off feature:

- ▶ Before leaving the vehicle, turn the SmartKey in the starter switch to position **0**.
- ▶ Then turn it to position **2** and back to **0**.

The delayed shut-off feature is deactivated. It will reactivate as soon as you reinsert the SmartKey in the starter switch.

Setting interior lighting delayed shut-off

Use this function to set whether and for how long you would like the interior lighting to remain on after you have removed the SmartKey from the starter switch.

- ▶ Move the selection marker with button **+** or **-** to the Lighting submenu.
- ▶ Press button **▲** or **▼** repeatedly until the message Int. light. delayed shut-off appears in the multifunction display.

The selection marker is on the current setting.

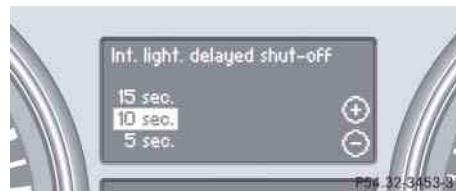

- ▶ Press button **+** or **-** to select the desired lamp-on time period.

You can select:

- 0 sec., the interior lighting delayed shut-off feature is deactivated.
- 5 sec., 10 sec., 15 sec., or 20 sec., select the desired lamp-on period.

The interior lighting delayed shut-off feature is activated.

Control system

Vehicle submenu

Access the **Vehicle** submenu via the **Settings** menu. Use the **Vehicle** submenu to make general vehicle settings.

The following functions are available:

Function	Page
Compass adjustment	186
Compass calibration	187
Setting which display to appear with ignition switched off	188
Setting automatic locking	188
Limiting opening height of tailgate*	189

Compass adjustment

This function is not available if your vehicle is equipped with the Modular COMAND system with navigation module*.

Determine your location on the basis of the following zone maps.

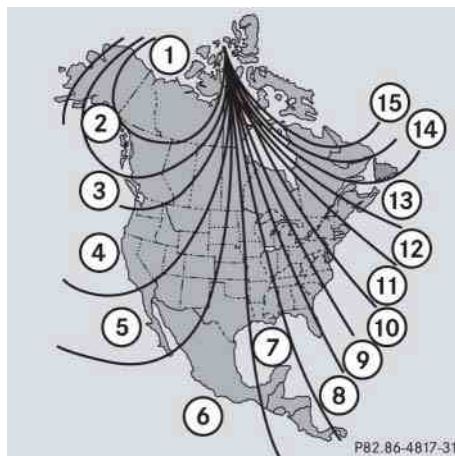

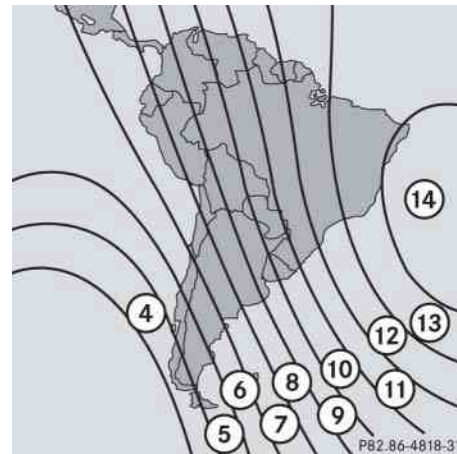

Zone map North America



Zone map South America

- ▶ Press button **+** or **-** to move the selection marker to the **Vehicle** submenu.

- ▶ Press button  or  repeatedly until the message **Compass Adjustment** appears in the multifunction display.

The selection marker is on the current setting.

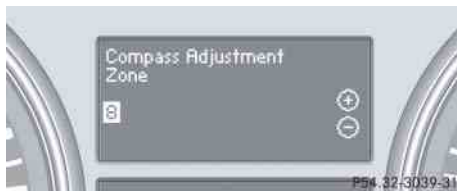



- ▶ Press button  or  to set the respective compass zone.



For information on how to select the proper geographic zone, see “Compass” (▷ page 327).

Compass calibration

This function is not available if your vehicle is equipped with the Modular COMAND system with navigation module*.

In order to calibrate the compass properly, mind the following:

- Calibrate the compass in open terrain. Nearby buildings, bridges, power lines and large antenna masts, for example, could impair compass calibration.
- Switch off electrical consumers (e.g. climate control, windshield wipers, or rear window defroster).
- Close all doors and the tailgate.
- ▶ Start the engine (▷ page 53).
- ▶ Press button  or  to move the selection marker to the **Vehicle** submenu.

- ▶ Press button  or  repeatedly until the message **Compass Calibration** appears in the multifunction display.

The selection marker is on setting **off**.

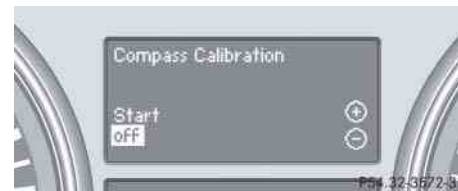

- ▶ Press button  or  to set the selection marker to **Start**.

The following message appears in the multifunction display:

Compass Calibration Active
Please drive in a full circle ▷▷

Control system

- ▷▷ Drive a full circle at a vehicle speed of between 3 mph and 6 mph (5 km/h and 10 km/h).

When calibration was successful, the following message appears in the multifunction display:

Compass Calibration
Completed Successfully



If the message **Compass Calibration Completed Successfully** does not appear in the multifunction display, drive another full circle.

If calibration does not succeed within 3 minutes, the message **Compass Calibration** appears in the multifunction display again. Calibrating the compass has failed due to outside influences.

Repeat compass calibration in a different location.

Setting which display to appear with ignition switched off

This function lets you determine which display you would like to appear in the multifunction display when you switch off the ignition.

- ▶ Move the selection marker with button **+** or **-** to the **Vehicle** submenu.
- ▶ Press button **▲** or **▼** repeatedly until the message **Display when ignition is switched off** appears in the multifunction display.

The selection marker is on the current setting.



- ▶ Press button **+** or **-** to select the desired setting.

Setting automatic locking

Use this function to activate or deactivate the automatic central locking. With the automatic central locking system activated, the vehicle is centrally locked at vehicle speeds of approximately 9 mph (15 km/h).

- ▶ Move the selection marker with button **+** or **-** to the **Vehicle** submenu.
- ▶ Press button **▲** or **▼** repeatedly until the message **Automatic door lock** appears in the multifunction display.

The selection marker is on the current setting.

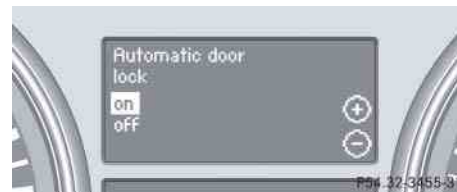

- ▶ Press button **+** or **-** to switch the automatic central locking on or off.

Limiting opening height of tailgate*

Use this function to activate or deactivate the limiting opening height of the tailgate.

- ▶ Move the selection marker with button **+** or **-** to the Vehicle submenu.
- ▶ Press button **↕** or **↘** repeatedly until the message **Opening limiter Tailgate** appears in the multifunction display.

The selection marker is on the current setting.

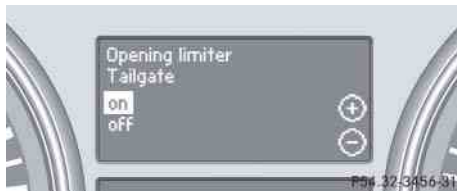

- ▶ Press button **+** or **-** to switch the limiting opening height of the tailgate on or off.

Convenience submenu

Access the Convenience submenu via the Settings menu. Use the Convenience submenu to change the settings for a number of convenience features.

The following functions are available:

Function	Page
Activating easy-entry/exit feature*	189
Setting parking position for exterior rear view mirror*	190
Setting fold-in function for exterior rear view mirrors	191

Activating easy-entry/exit feature*

Use this function to activate and deactivate the easy-entry/exit feature (▷ page 132).

Warning!



You must make sure no one can become trapped or injured by the moving steering wheel and driver's seat when the easy-entry/exit feature is activated.

To cancel seat/steering wheel movement, do one of the following:

- Press seat adjustment switch (▷ page 43).
- Move steering column stalk* (▷ page 46).
- Press memory button* (▷ page 145).



Control system

▷▷ Do not leave children unattended in the vehicle, or with access to an unlocked vehicle. Children could open the driver's door and unintentionally activate the easy-entry/exit feature, which could result in an accident and/or serious personal injury.

- ▶ Move the selection marker with button **+** or **-** to the Convenience submenu.
- ▶ Press button **↕** or **↕** repeatedly until the message **Func. Easy-entry** feature appears in the multifunction display.

The selection marker is on the current setting.



- ▶ Press button **+** or **-** to change the easy-entry/exit setting.

The following settings are available for the easy-entry/exit feature:

off	The easy-entry/exit feature is deactivated.
Steering col.	Only the steering column is moved.
Steer. col.+seat	Both the steering column and the driver's seat are moved.

Setting parking position for exterior rear view mirror*

Use this function to select whether the passenger-side exterior rear view mirror should be turned downward during parking maneuvers when reverse **R** is engaged. For additional information, see "Activating exterior rear view mirror parking position*" (▷ page 210).

- ▶ Move the selection marker with button **+** or **-** to the Convenience submenu.
- ▶ Press button **↕** or **↕** repeatedly until the message **Mirror adjustment parking aid** appears in the multifunction display.

The selection marker is on the current setting.

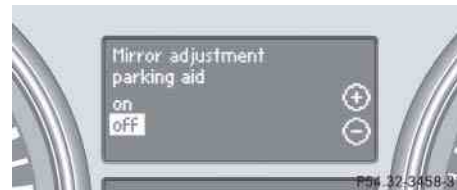

- ▶ Press button **+** or **-** to switch the function on or off.

Setting fold-in function for exterior rear view mirrors*

Using this function, you can set the exterior rear view mirrors to be automatically folded in when you lock your vehicle.



With this function set to on and the exterior rear view mirrors folded in using the button on the door control panel (▷ page 211), the exterior rear view mirrors will not fold out when you switch on the ignition. You will then have to fold out the exterior rear view mirrors using the button on the door control panel (▷ page 211).

- ▶ Move the selection marker with button **+** or **-** to the Convenience submenu.
- ▶ Press button **↶** or **↷** repeatedly until the message Fold in mirrors when locking appears in the multifunction display.

The selection marker is on the current setting.



- ▶ Press button **+** or **-** to switch the function on or off.

Vehicle configuration

In the Vehicle configuration menu you can determine whether the tow-away alarm is to be enabled or disabled. With this function set to on, the tow-away alarm is armed when you lock your vehicle. With this function set to off, the tow-away alarm is not armed automatically when you lock your vehicle. You will then have to switch on the tow-away alarm manually (▷ page 107).

- ▶ Press button **☰** or **☷** repeatedly until the Vehicle configuration menu appears in the multifunction display.



- ▶ Press button **+** or **-** to switch the tow-away alarm on or off.

Control system

Trip computer menu

Use the trip computer menu to call up statistical data on your vehicle.

The following information is available:

Function	Page
Fuel consumption statistics after start	192
Fuel consumption statistics since last reset	193
Calling up range (distance to empty)	193



When you enter the trip computer menu, you will always see the fuel consumption statistics after start first.

Fuel consumption statistics after start

- ▶ Press button or repeatedly until the message *After start* appears in the multifunction display.



- ① Distance driven since start
- ② Time elapsed since start
- ③ Average speed since start
- ④ Average fuel consumption since start







All statistics stored since the last engine start will be reset approximately 4 hours after the SmartKey in the starter switch is turned to position **0** or removed from the starter switch.

Resetting will not occur if you turn the SmartKey back to position **1** or **2** within this time period.

Resetting fuel consumption statistics

- ▶ Press button or repeatedly until the message *After start* appears in the multifunction display.
- ▶ Press and hold the reset button in the instrument cluster (▶ page 158) until the value is reset to 0.





Fuel consumption statistics since last reset

- ▶ Press button  or  repeatedly until the message *After start* appears in the multifunction display.
- ▶ Press button  or  repeatedly until the message *After reset* appears in the multifunction display.



- ① Distance driven since last reset
- ② Time elapsed since last reset
- ③ Average speed since last reset
- ④ Average fuel consumption since last reset

Resetting fuel consumption statistics manually





- ▶ Press button  or  repeatedly until the message *After start* appears in the multifunction display.
- ▶ Press button  or  repeatedly until the message *After reset* appears in the multifunction display.
- ▶ Press and hold the reset button in the instrument cluster (▶ page 158) until the value is reset to 0.

Resetting fuel consumption statistics automatically

The fuel consumption statistics reset automatically to 0 when either of the following values is exceeded:

- distance covered: 100 000 miles
- time elapsed: 10 000 hours

Calling up range (distance to empty)

- ▶ Press button  or  repeatedly until the message *After start* appears in the multifunction display.
- ▶ Press button  or  repeatedly until the message *Range:* appears in the multifunction display.

The calculated range based on the current fuel tank level appears in the multifunction display.



Control system

TEL menu*

Warning!





A driver's attention to the road must always be his/her primary focus when driving. For your safety and the safety of others, we recommend that you pull over to a safe location and stop before placing or taking a telephone call. If you choose to use the telephone while driving, please use the hands-free device and only use the telephone when weather, road and traffic conditions permit.

Some jurisdictions prohibit the driver from using a cellular telephone while driving a vehicle.

Bear in mind that at a speed of just 30 mph (approximately 50 km/h), your vehicle is covering a distance of 44 feet (approximately 14 m) every second.

Never operate radio transmitters equipped with a built-in or attached antenna (i.e. without being connected to an external antenna) from inside the vehicle while the engine is running. Doing so could lead to a malfunction of the vehicle's electronic system, possibly resulting in an accident and/or personal injury.

You can use the functions in the TEL menu to operate your telephone, provided it is connected to a hands-free system and switched on.

- ▶ Switch on the telephone and Modular COMAND System.
- ▶ Press button  or  on the multifunction steering wheel repeatedly until the message TEL appears in the multifunction display.

Which messages will appear in the multifunction display depends on whether your telephone is switched on or off:

- If the telephone is off, the message PHONE OFF appears in the multifunction display.
- If the telephone is on:

The telephone will then search for a network. During this time the multifunction display is empty.

As soon as the telephone has found a network, the message READY appears in the multifunction display.

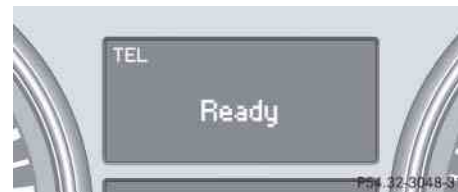

This standby message indicates that your telephone is ready for use and you can operate it using the control system.

Answering a call

When your telephone is ready to receive calls, you can answer a call at any time. In the multifunction display you will then see the message:



- ▶ Press button .

You have answered the call. The duration of the call appears in the multifunction display.



If you do not wish to accept a call, press button .



Ending a call

- ▶ Press button .

You have ended the call. The standby message appears in the multifunction display.

Dialing a number from the phone book



If your telephone is ready to receive calls, you may select and dial a number from the phone book at any time.

- ▶ Press button  or  repeatedly until the message TEL appears in the multifunction display.

- ▶ Press button  or .

The control system reads the phone book which is stored in the telephone. This may take up to 30 seconds. The message *Please wait* appears in the multifunction display.

When the message *Please wait* disappears, the phone book has been loaded.



- ▶ Press button  or  repeatedly until the desired name appears in the multifunction display.

The stored names are displayed in ascending or descending alphabetical order.



- ① Name from the phone book



If you press and hold  or  for longer than 1 second, the system scrolls rapidly through the list of names until you release the button again.

Cancel the quick search mode by pressing button .



Control system

▷▷ Press button .

The system dials the selected phone number.



- If the connection is successful, the name of the party you called and the duration of the call will appear in the multifunction display.



- If no connection is made, the control system stores the dialed number in the redial memory.



Redialing

The control system stores the most recently dialed phone numbers. This eliminates the need to search through your entire phone book.

▶ Press button  or  repeatedly until the message TEL appears in the multifunction display.

▶ Press button .

The first number in the redial memory appears in the multifunction display.

▶ Press button  or  repeatedly until the desired name appears in the multifunction display.

▶ Press button .

The control system dials the selected phone number.

▼ Automatic transmission

For information on driving with an automatic transmission see “Automatic transmission” (▷ page 53).

Your vehicle’s transmission adapts its gear shifting process to your individual driving style by continually adjusting the shift points up or down. These shift point adjustments are performed based on current operating and driving conditions.

If the operating conditions change, the automatic transmission reacts by adjusting its shift program.



During the brief warm-up, transmission upshifting is delayed. This allows the catalytic converter to heat up more quickly to operating temperature.

Gear selector lever

The gear selector lever is located on the right of the steering column.



Gearshift pattern for automatic transmission

- P** Park position
- R** Reverse gear
- N** Neutral
- D** Drive position

Shifting from P to N

Warning!



It is dangerous to shift the automatic transmission out of park position **P** or neutral position **N** if the engine speed is higher than idle speed. If your foot is not firmly on the brake pedal, the vehicle could accelerate quickly forward or reverse. You could lose control of the vehicle and hit someone or something. Only shift into gear when the engine is idling normally and when your right foot is firmly on the brake pedal.

Moving the gear selector lever up or down shifts the automatic transmission out of park position **P**:

- ▶ Depress the brake pedal and keep it pressed.
- ▶ Move gear selector lever up or down to resistance point to select neutral position **N**.

Automatic transmission

Shifting from N to R or from N to D

- ▶ With the vehicle at a standstill, depress the brake pedal and keep it pressed.
- ▶ Move gear selector lever up past the resistance point to select reverse gear **R**.

or

- ▶ Move gear selector down up past the resistance point to select drive position **D**.



The gear selector lever returns to its original position.

- ▶ Release the parking brake (▷ page 56).
- ▶ Release the brake pedal.
- ▶ Carefully depress the accelerator pedal to drive off when it is safe to do so.

Shifting from P to R

- ▶ With the vehicle at a standstill, depress the brake pedal and keep it pressed.
- ▶ Move gear selector lever up past the resistance point to select reverse gear **R**.



The gear selector lever returns to its original position.

- ▶ Release the parking brake (▷ page 56).
- ▶ Release the brake pedal.
- ▶ Carefully depress the accelerator pedal to drive off when it is safe to do so.

Shifting from P to D

- ▶ With the vehicle at a standstill, depress the brake pedal and keep it pressed.
- ▶ Move gear selector lever down past the resistance point to select drive position **D**.



The gear selector lever returns to its original position.

- ▶ Release the parking brake (▷ page 56).
- ▶ Release the brake pedal.
- ▶ Carefully depress the accelerator pedal to drive off when it is safe to do so.

Shifting from D, R, or N to P

If you want to select park position **P** with the transmission being in drive position **D**, reverse gear **R** or neutral position **N**:

- ▶ With the vehicle at a standstill, depress the brake pedal and keep it pressed.
- ▶ Step firmly on parking brake pedal (> page 65).
- ▶ Press button on gear selector lever in direction of arrow (> page 197) to select park position **P**.
- ▶ Release the brake pedal.



Shift the automatic transmission directly from position **D** to **R**, from **R** to **D** or directly to **P** only when the vehicle is stopped. Otherwise the automatic transmission could be damaged.

When trying to free a vehicle stuck in mud or snow, see “Rocking the vehicle” (> page 204).

Shifting from D or R to N

If you want to select neutral position **N** with the transmission being in drive position **D** or reverse gear **R**:

- ▶ With the vehicle at a standstill, depress the brake pedal and keep it pressed.
- ▶ Step firmly on parking brake pedal (> page 65).



When the vehicle needs to be moved with the engine switched off and the transmission set to **N** (> page 200), e.g. in an automatic car wash, do not depress the parking brake pedal.

- ▶ Move gear selector lever up to resistance point when in drive position **D** or down to resistance point when in reverse gear **R** to select neutral position **N**.
- ▶ Release the brake pedal.

Shifting procedure

The automatic transmission selects individual gears automatically, depending on:

- drive position **D** (> page 200) with gear ranges (> page 202)
- the selected program mode (**C/S**) (> page 204)
- the position of the accelerator pedal (> page 203)
- the vehicle speed

The current gear range/transmission position and program mode (C/S) appear in the multifunction display.



- ① Current transmission position

Automatic transmission



Allow engine to warm up under low load use. Do not place full load on the engine until the operating temperature has been reached.

Shift into reverse gear **R** or park position **P** only when the vehicle is stopped.

Avoid spinning of a drive wheel for an extended period when driving off on slippery road surfaces. This may cause serious damage to the drivetrain which is not covered by the Mercedes-Benz Limited Warranty.

With drive position **D** selected, you can use the steering wheel gearshift control buttons (▷ page 206) to influence transmission shifting by:

- limiting the gear range
- changing gears manually

Transmission positions

Effect



Park position

Shift into park position **P** only when vehicle is stopped. The park position is not intended to serve as a brake when the vehicle is parked. Rather, the driver should always set the parking brake in addition to shifting into park position **P** to secure the vehicle.

If the vehicle's electrical system is malfunctioning, the automatic transmission could remain locked in park position **P**.

- ▶ Have the vehicle checked as soon as possible by an authorized Mercedes-Benz Light Truck Center.



SmartKey:

If you turn off the engine using the SmartKey and remove the SmartKey from the starter switch, the transmission will shift to park position **P** automatically. Keep in mind that turning off the engine with the SmartKey alone will not automatically shift the transmission to **P**. Only when the SmartKey is removed from the starter switch, will the transmission automatically shift to **P**.

KEYLESS-GO*:

If you turn off the engine using the KEYLESS-GO start/stop button and open the driver's door, the transmission will shift to park position **P** automatically. Keep in mind that turning off the engine using the KEYLESS-GO start/stop button alone will not automatically shift the transmission to **P**. Only when the driver's door is opened, will the transmission automatically shift to **P**.

Even though this is possible, make it a practice to always shift into park position **P** before turning off the engine and remove the SmartKey from the starter switch, or when using KEYLESS-GO*, before turning off the engine with the start/stop button and opening the driver's door.



If you want the gear position to remain in **N** (for example when the vehicle is pulled through a car wash)

- do not remove the SmartKey from the starter switch
- or, when using KEYLESS-GO*
- do not turn off the engine using the KEYLESS-GO start/stop button* and open the driver's door

Otherwise, the transmission will shift to **P** and lock the wheels, preventing the vehicle from being pulled through a car wash.

	Effect
R	<p>Reverse gear</p> <p>Shift into reverse gear R only when the vehicle is stopped.</p>
N	<p>Neutral</p> <p>No power is transmitted from the engine to the drive axle. When the brakes are released, the vehicle can be moved freely (pushed or towed).</p> <p>To avoid damage to the transmission, never shift into neutral position N while driving.</p> <p>If the ESP® is deactivated or malfunctioning: Shift into neutral position N only if the vehicle is in danger of skidding, e.g. on icy roads.</p>
D	<p>Drive</p> <p>The transmission shifts automatically. All forward gears are available.</p>



Coasting the vehicle, or driving for any other reason in neutral position **N** can result in transmission damage that is not covered by the Mercedes-Benz Limited Warranty.

Warning!



Getting out of your vehicle without shifting into park position **P** is dangerous. Also, park position **P** alone is not intended to or capable of preventing your vehicle from moving, possibly hitting people or objects.

Always set the parking brake in addition to shifting to park position **P** (▷ page 65).

When parked on an incline, turn the front wheels towards the road curb.

Do not park this vehicle in areas where combustible materials such as grass, hay or leaves can come into contact with the hot exhaust system, as these materials could be ignited and cause a vehicle fire.

Warning!



When leaving the vehicle, always remove the SmartKey or SmartKey with KEYLESS-GO* from the starter switch, take it with you, and lock the vehicle. Do not leave children unattended in the vehicle, or with access to an unlocked vehicle. Children could shift the automatic transmission out of park position **P**, which could result in an accident and/or serious personal injury.

Gear ranges

With the automatic transmission in drive position **D**, you can select a gear range for the automatic transmission to operate within.

You can limit the gear range by pressing the respective downshift button on the steering wheel gearshift control, and reverse the gear range limit by pressing the respective upshift button on the steering wheel gearshift control.



① Current gear range

The selected gear range appears in the multifunction display (▷ page 199). If you press on the accelerator when the engine has reached its rpm limit, the transmission will upshift beyond any gear range limit selected.

Effect

6	The transmission shifts through sixth gear only.
5	The transmission shifts through fifth gear only.
4	The transmission shifts through fourth gear only.
3	The transmission shifts through third gear only. With this selection you can use the braking effect of the engine.

	Effect
2	<p>The transmission shifts through second gear only.</p> <p>Allows the use of engine's braking power when driving:</p> <ul style="list-style-type: none"> • on steep downgrades • in mountainous regions • under extreme operating conditions
1	<p>The transmission operates in first gear only.</p> <p>For maximum use of engine's braking effect on very steep or lengthy downgrades.</p>

Driving tips

Accelerator position

Your driving style influences the transmission's shifting behavior:

Less throttle Earlier upshifting
 More throttle Later upshifting

Kickdown

Use kickdown when you want maximum acceleration.

- ▶ Press the accelerator past the point of resistance.
 The transmission shifts into a lower gear.
- ▶ Ease on the accelerator when you have reached the desired speed.
 The transmission shifts up again.

Stopping

When you stop briefly, e.g. at traffic lights:

- ▶ Leave the transmission in gear.
- ▶ Hold the vehicle with the brake.

When you stop for a longer period of time with the engine idling and/or on a hill:

- ▶ Set the parking brake.
- ▶ Shift into park position **P**.

Maneuvering

When you maneuver in tight areas, e.g. when pulling into a parking space:

- ▶ Control the vehicle speed by gradually releasing the brakes.
- ▶ Accelerate gently.
- ▶ Never abruptly step on the accelerator.

Automatic transmission

Rocking the vehicle

Rocking the vehicle by shifting between **D** and **R** can help free a vehicle stuck in mud or snow. The engine control system of this vehicle electronically limits shifting between **D** and **R** to very low speeds (i.e. approx. 2 mph). To shift between **D** and **R**, move the gear selector lever past the resistance point up or down.

Hill start assist system

On uphill grades, the hill start assist system maintains the pressure in the brake system for approximately 1 second after you have released the brake pedal. Therefore, you can start off smoothly without the vehicle moving immediately after releasing the brake pedal.

The hill start assist system is inactive

- when driving downhill
- with the transmission in neutral position **N**
- with the parking brake set

Warning!



The hill start assist system is not designed to function as a parking brake and does not prevent the vehicle from moving when parked on an incline.

Always set the parking brake in addition to shifting to park position **P**.



If the ESP® has switched off due to a malfunction, the hill start assist system is also unavailable.

Working on the vehicle

Warning!



When working on the vehicle, set the parking brake and shift to park position **P**. Otherwise the vehicle could roll away.

Automatic shift program

The program mode selector switch is located on the upper part of the center console.



Program mode selector switch

- | | |
|------------------|----------------------|
| C Comfort | For comfort driving |
| S Sport | For standard driving |

The current gear range/transmission position (▷ page 199) and the selected program mode (C/S) are indicated in the multifunction display.



① Current program mode



Never change the program mode when the automatic transmission is out of park position **P**. This could result in a change of driving characteristics for which you may not be prepared.



The last selected program mode (**C** or **S**) is switched on when the engine is restarted.

► Press program mode selector switch repeatedly until the letter of the desired program mode appears in the multifunction display.

Select **C** for comfort driving:

- The vehicle starts out in second gear (both forward and reverse) for gentler starts. This does not apply if full throttle is applied or gear range **1** is selected.
- Traction and driving stability are improved on icy roads.
- Upshifts occur earlier even when you give more gas. The engine then operates at lower rpms and the wheels are less likely to spin.

Steering wheel gearshift control

With drive position **D** selected, you can use the steering wheel gearshift control buttons to manually shift the gears. When doing so, you are also limiting or extending the gear range.



To avoid overrevving the engine when downshifting with steering wheel gearshift buttons, the transmission will not shift to a lower gear if the engine's max. speed would be exceeded.

Automatic transmission



Allow engine to warm up under low load use. Do not place full load on the engine until the operating temperature has been reached.

Shift into reverse gear **R** or park position **P** only when the vehicle is stopped.

Avoid spinning of a drive wheel for an extended period when driving off on slippery road surfaces. This may cause serious damage to the drivetrain which is not covered by the Mercedes-Benz Limited Warranty.

The steering wheel gearshift buttons are located to the left and right of the steering wheel.

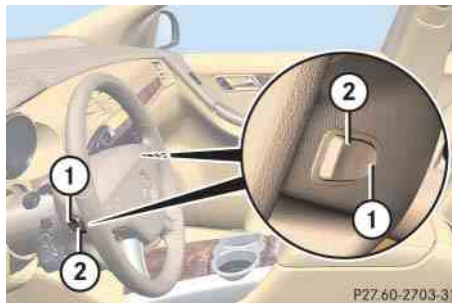

- ① Button, inside: downshift
- ② Button, outside: upshift



You cannot shift with the steering wheel gearshift buttons when the transmission is in position **P**, **N** or **R**.

Downshifting

Warning!



On slippery road surfaces, never downshift in order to obtain braking action. This could result in drive wheel slip and reduced vehicle control. Your vehicle's ABS will not prevent this type of loss of control.

- ▶ Briefly press the inside ① of one of the buttons on the steering wheel.

The transmission will shift to the next lower gear as permitted by the shift program. This action simultaneously limits the gear range of the transmission (▷ page 202).

Upshifting

- ▶ Briefly press the outside ② of one of the buttons on the steering wheel.

The transmission will shift to the next higher gear as permitted by the shift program. This action simultaneously extends the gear range of the transmission.

Canceling gear range limit

- ▶ Press and hold the outside ② of one of the buttons on the steering wheel until **D** reappears in the multifunction display.

The transmission will shift from the current gear range directly to gear range **D**.

Shifting into optimal gear range

- ▶ Press and hold the inside ① of one of the buttons on the steering wheel.

The transmission will automatically select the gear range suited for optimal acceleration and deceleration. This will involve shifting down one or more gears.

Emergency operation (Limp Home Mode)

If vehicle acceleration becomes less responsive or sluggish or the transmission no longer shifts, the transmission is most likely operating in limp home (emergency operation) mode. In this mode only second gear and reverse gear can be selected.

- ▶ Stop the vehicle in a safe location.
- ▶ Shift to park position **P**.
- ▶ Turn off the engine.
- ▶ Wait at least 10 seconds before restarting.
- ▶ Restart the engine.
- ▶ Shift to drive position **D** (for second gear) or reverse gear **R**.
- ▶ Have the transmission checked at an authorized Mercedes-Benz Light Truck Center as soon as possible.

Good visibility

For information on the windshield wipers, see “Windshield wipers” (▷ page 59).

Headlamp cleaning system*

The button is located on the left side of the dashboard.



① Headlamp washer button

- ▶ Switch on the ignition (▷ page 38).
- ▶ Press button ①.

The headlamps are cleaned with a high-pressure water jet.



The headlamps will automatically be cleaned when you have

- switched on the headlamps and
- operated the windshield wipers with windshield washer fluid fifteen times

When you switch off the ignition, the counter resets.

For information on filling up the washer reservoir, see “Windshield / rear window washer system and headlamp cleaning system*” (▷ page 352).

Rear view mirrors

For more information on setting the rear view mirrors, see “Mirrors” (▷ page 47).

Interior rear view mirror, antiglare position

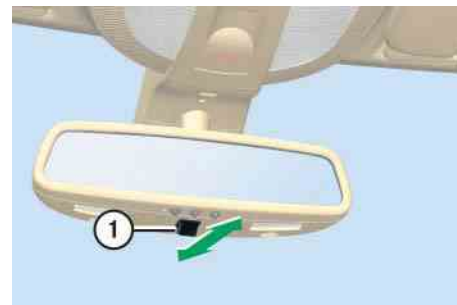

① Lever

- ▶ Tilt the mirror to the antiglare night position by moving lever ① towards the windshield.

The interior rear view mirror is dimmed.

Auto-dimming rear view mirrors*

The reflection brightness of the exterior rear view mirror on the driver's side and the interior rear view mirror will respond automatically to glare when

- the ignition is switched on
- incoming light from headlamps falls on the sensor in the interior rear view mirror

The rear view mirror will not react if

- reverse gear **R** is engaged
- the interior light is turned on

Warning!

The auto-dimming function does not react if incoming light is not aimed directly at sensors in the interior rear view mirror.

The interior rear view mirror and the exterior rear view mirror on the driver's side do not react, for example, when transporting cargo which covers the rear window.

Glare can endanger you and others.

Warning!

In case of an accident liquid electrolyte may escape from the mirror housing if the mirror glass breaks.

Electrolyte has an irritating effect. Do not allow the liquid to come into contact with eyes, skin, clothing, or respiratory system. In case it does, immediately flush affected area with water, and seek medical help if necessary.



Electrolyte drops coming into contact with the vehicle paint finish can be completely removed only while in the liquid state and by applying plenty of water.

Warning!

Exercise care when using the passenger-side exterior rear view mirror. The mirror surface is convex (outwardly curved surface for a wider field of view). Objects in mirror are closer than they appear. Check your interior rear view mirror or glance over your shoulder before changing lanes.

Good visibility

Activating exterior rear view mirror parking position*

Follow these steps to activate the exterior rear view mirror parking position, so that the passenger-side exterior rear view mirror will be turned downward to the stored position.

- ▶ Make sure that you have stored a parking position for the passenger-side exterior rear view mirror (▷ page 146).
- ▶ Make sure the Mirror adjustment parking aid function in the Convenience submenu of the control system is set to on (▷ page 190).
- ▶ Start the engine (▷ page 53).



With the automatic transmission in reverse gear **R**, the previously selected rear view mirror is activated. The indicator lamp in the respective button comes on.



- ① Driver's side exterior rear view mirror button
- ② Passenger-side exterior rear view mirror button
- ▶ Set the automatic transmission in reverse gear **R**.

The passenger-side exterior rear view mirror turns downward to the stored position (▷ page 146) if the passenger-side exterior rear view mirror is selected.

The indicator lamp in button ② should come on when you select reverse gear **R**.

- ▶ If the passenger-side exterior rear view mirror is not selected, press button ②.

The exterior rear view mirror returns to its previous stored driving position:

- when you switch off the ignition
- 10 seconds after you have put the automatic transmission out of reverse gear **R**

Approximately 15 seconds later, the indicator lamp in button ② goes out.

- immediately once your vehicle exceeds a speed of approximately 6 mph (10 km/h)
- immediately when you press button ① for driver's side exterior rear view mirror



With the automatic transmission in reverse gear **R**, you can deactivate the exterior rear mirror parking position by pressing button ① or activate it by pressing button ②. The indicator lamp of the selected button is on.

Power folding exterior rear view mirrors*



Before you drive the vehicle through an automatic car wash, fold the exterior rear view mirrors in. Otherwise they may get damaged.

Folding the exterior rear view mirrors in and out automatically

When the corresponding function in the control system is activated (▷ page 191):

- The exterior rear view mirrors automatically fold in as soon as the vehicle is locked from the outside.
- The exterior rear view mirrors automatically fold out as soon as the vehicle is unlocked and the driver's or front passenger door are subsequently opened.

Synchronizing exterior rear view mirrors

The power folding rear view mirrors may have to be synchronized after the vehicle battery has been disconnected or discharged. If the exterior rear view mirrors do not fold properly upon locking or unlocking the vehicle although the corresponding function in the control system is activated (▷ page 191), do the following:

- ▶ Fold each exterior rear view mirror in completely (▷ page 212).
- ▶ Fold each exterior rear view mirror out completely (▷ page 212).

When the exterior rear view mirrors fold properly upon locking the vehicle, the exterior mirrors are synchronized. Otherwise repeat the above steps.

Folding the exterior rear view mirrors in and out manually



The exterior rear view mirrors can vibrate if they are not folded out completely.

The button is located on the door control panel.



- ① Button for folding exterior rear view mirrors in and out
- ▶ Switch on the ignition (▷ page 38).

Good visibility

Folding in

- ▶ Briefly press button ①.
Both exterior rear view mirrors fold in.



If you are driving at more than approximately 30 mph (47 km/h), you will not be able to fold the exterior mirrors in.

Folding out

- ▶ Briefly press button ① again.
Both exterior rear view mirrors fold out.



If an exterior rear view mirror housing is forcibly pushed forward (hit from the rear) or forcibly pushed rearward (hit from the front) press button ① to fold mirrors in, then press button ① again to fold mirrors out. Do not force mirrors by hand as this may damage the adjustment mechanism.

The mirror housing is then properly positioned and you can adjust the mirror in the usual manner.

Sun visors

The sun visors protect you from sun glare while driving.

Warning!



Do not use the vanity mirror while driving.

Keep the mirrors in the sun visors closed while vehicle is in motion. Reflected glare can endanger you and others.

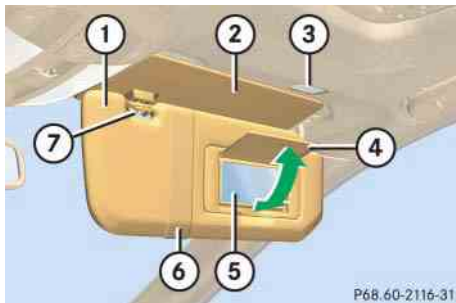

P68.60-2116-31

- ① Sun visor
- ② Additional sun visor*
- ③ Mirror lamp
- ④ Vanity mirror cover
- ⑤ Vanity mirror
- ⑥ Holder for gas cards
- ⑦ Mounting

Glare through the windshield

- ▶ Swing sun visor ① down.
- ▶ Make sure sun visor ① is properly engaged in mounting ⑦.
- ▶ When you do not experience glare anymore, swing sun visor ① up.

Vanity mirror

- ▶ Swing sun visor ① down.
- ▶ Flip up cover ④ to access vanity mirror ⑤.
- Vanity mirror lamp ③ comes on.
- ▶ After using vanity mirror ⑤, flip down cover ④.
- ▶ Swing sun visor ① up.

Glare through a side window

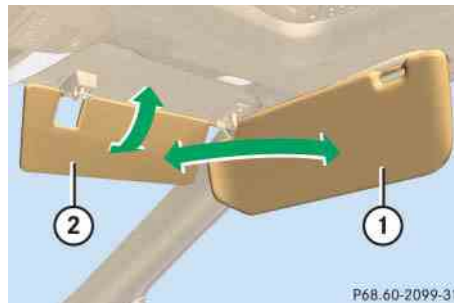

P68.60-2099-31

- ① Sun visor
- ② Additional sun visor*

- ▶ Swing sun visor ① down.
- ▶ Disengage sun visor ① from mounting ⑦ (▷ page 213).
- ▶ Pivot sun visor ① to the side.



To avoid damage to vanity mirror cover ④ (▷ page 213), make sure it is closed before pivoting sun visor ① to the side.

- ▶ Adjust sun visor ① by pushing or pulling in the direction of the arrows.
- ▶ Swing down additional sun visor* ② down when you experience additional glare through the windshield.

Good visibility

Rear door window sunshade*

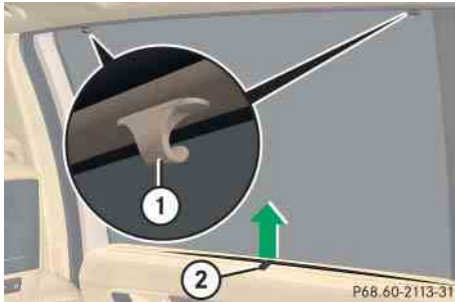

- ① Holder
- ② Tab

- ▶ To raise sunshade, pull on tab ② and engage it in holder ①.
- ▶ To lower sunshade, disengage tab ② from holder ① and guide retraction.



Always guide the sunshade. Do not let it snap back abruptly, as the retractor could be damaged.



With the sunshade raised and the respective door window open, the sunshade could disengage and snap back when driving at high vehicle speeds, e.g. on highways, and damage the retractor. You should therefore always either close the door window or lower the sunshade when driving at high speed.

Third-row sunshade*

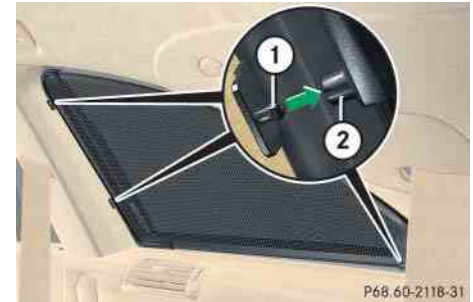

- ① Clip
- ② Mounting

- ▶ Insert clips ① into mountings ②.
- ▶ Press on clips ① to engage in mountings ②.

Rear window defroster

The rear window defroster uses a large amount of power. To keep battery drain to a minimum, switch off the defroster as soon as the rear window is clear. The defroster is automatically deactivated after approximately 6 to 17 minutes of operation depending on the outside temperature.

Activating

- ▶ Switch on the ignition (▷ page 38).
- ▶ Press button  on the climate control panel (▷ page 218) or the automatic climate control* panel (▷ page 232).

The indicator lamp on the button comes on.

Deactivating

- ▶ Press button  again.

The indicator lamp on the button goes out.

Warning!



Any accumulation of snow and ice should be removed from the rear window before driving. Visibility could otherwise be impaired, endangering you and others.



If the rear window defroster switches off too soon and the indicator lamp starts flashing, too many electrical consumers are operating simultaneously and there is insufficient voltage in the battery. The system responds automatically by switching the rear window defroster off.

As soon as the battery has sufficient voltage, the rear window defroster switches back on automatically.

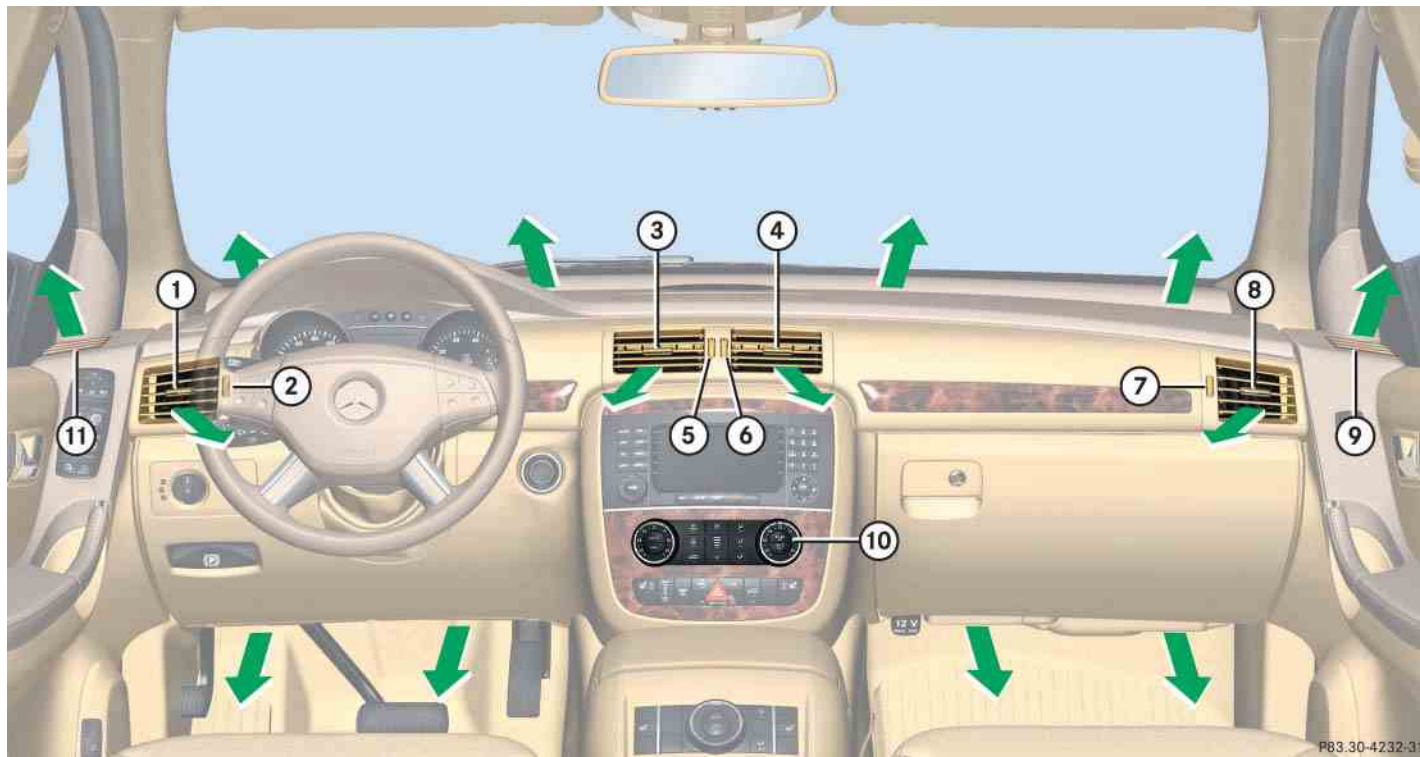

- ① Side air vent, adjustable
- ② Thumbwheel for air volume control for left side and door air vent
- ③ Left center air vent, adjustable
- ④ Right center air vent, adjustable
- ⑤ Thumbwheel for air volume control for left center air vent
- ⑥ Thumbwheel for air volume control for right center air vent
- ⑦ Thumbwheel for air volume control for right side and door air vent
- ⑧ Side air vent, adjustable
- ⑨ Door air vent, fixed
- ⑩ Climate control panel
- ⑪ Door air vent, fixed







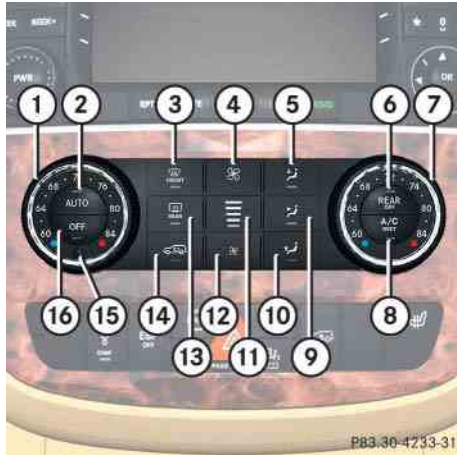

For draft-free ventilation, move the sliders for the center vents ③ and ④ to the middle position.

Climate control



PB3-30-4233-31

- | | | |
|---|-------------------------------------------------------------------------------------------------|--|
| ① | Temperature control, left | |
| ② | Air distribution and air volume (automatic, manual) | |
| ③ | Front defroster | |
| |  USA only | |
| |  Canada only | |
| ④ | Increasing air volume | |
| ⑤ | Air distribution (directs air through the windshield and side air vents) | |
| ⑥ | Rear air conditioning on/off | |
| |  USA only | |
| |  Canada only | |
| ⑦ | Temperature control, right | |
| ⑧ | AC cooling on/off (A/C)
Residual heat/ventilation (REST) | |
| ⑨ | Air distribution (directs air through center and side air vents) | |
| ⑩ | Air distribution (directs air through the footwells and side vents) | |
| ⑪ | Air volume display | |
| ⑫ | Decreasing air volume | |
| ⑬ | Rear window defroster | |
| |  USA only | |
| |  Canada only | |
| ⑭ | Air recirculation | |
| ⑮ | Interior temperature sensor | |
| ⑯ | Climate control on/off | |

The climate control is operational whenever the engine is running. You can operate the climate control system in either the automatic or manual mode. The system cools or heats the interior depending on the selected interior temperature and the current outside temperature.

Warning!

When operating the climate control, the air that enters the passenger compartment through the air vents can be very hot or very cold (depending on the set temperature). This may cause burns or frostbite to unprotected skin in the immediate area of the air vents.

Always keep sufficient distance between unprotected parts of the body and the air vents. If necessary, use the air distribution controls (> page 218) to direct the air to air vents in the vehicle interior that are not in the immediate area of unprotected skin.

Nearly all dust particles, pollutants and odors are filtered out before outside air enters the passenger compartment through the air distribution system.

The air conditioning will not engage (no cooling) if the **A/C** mode is deactivated (> page 227).

Warning!

Follow the recommended settings for heating and cooling given on the following pages. Otherwise the windows could fog up, impairing visibility and endangering you and others.



Severe conditions (e.g. strong air pollution) may require replacement of the filter before its scheduled interval. A clogged filter will reduce the air volume to the interior.

If the vehicle interior is hot, ventilate the interior before driving off, see “Summer opening feature” (> page 251). The climate control will then adjust the interior temperature to the set value much faster.

Keep the air intake grille in front of the windshield free of snow and debris.

Climate control

Deactivating the climate control system

Deactivating

- ▶ Press button **OFF** (▷ page 218).



When the air conditioning is switched off, the outside air supply and circulation are also switched off. Only choose this setting for a short time. Otherwise the windows could fog up.

Reactivating

- ▶ Press button **AUTO** (▷ page 218).



You can also press button **OFF** (▷ page 218) on the climate control panel.

If you press button **FRONT** (▷ page 218) to reactivate the climate control system, the defrosting mode is activated.

Deactivating rear climate control

You can switch on and off the rear climate control using the climate control panel in the front.

Deactivating

- ▶ Press button **REAR OFF** on the front climate control panel (▷ page 218).

The indicator lamp on the button comes on.

Reactivating

- ▶ Press button **REAR OFF** on the front climate control panel (▷ page 218).

The indicator lamp on the button goes out. The rear climate control is adjusted automatically.



You can also switch on and off the rear climate control by pressing the respective button on the rear climate control panel (▷ page 229).

For more information on rear climate control, see “Rear climate control” (▷ page 228).

Operating the climate control system in automatic mode



When operating the climate control system in automatic mode, you will only rarely need to adjust the temperature, air volume and air distribution.

In automatic mode, cooling with dehumidify is switched on. This function can be switched off if necessary (▷ page 227).

Activating

- ▶ Press button **AUTO** (▷ page 218) while the engine is running.

The indicator lamp on the button comes on. The air volume and air distribution are adjusted automatically.



- ▶ Use temperature controls ① and ⑦ (▷ page 218) to separately adjust the air temperature on each side of the passenger compartment.

The interior air temperature is adjusted automatically.



The settings for the passenger side are also used for the rear passenger compartment.

Deactivating

- ▶ Press button  or  (▷ page 218).

The indicator lamp on the **AUTO** button goes out. The automatic operation of air volume switches off. The selected blower speed is shown in the air volume display ⑪ (▷ page 218).

or

- ▶ Press air distribution button ⑤, ⑨, or ⑩ (▷ page 218).

The indicator lamp on the button **AUTO** goes out. The automatic operation of air distribution switches off.

Climate control

Setting the temperature

Use temperature controls ① and ⑦ (▷ page 218) to separately adjust the air temperature on each side of the passenger compartment. You should raise or lower the temperature setting in small increments, preferably starting at 72°F (22°C). The climate control will adjust to the set temperature as fast as possible.

Increasing

- ▶ Turn temperature control ① and/or ⑦ (▷ page 218) slightly clockwise.

The climate control system will correspondingly adjust the interior air temperature.

Decreasing



- ▶ Turn temperature control ① and/or ⑦ (▷ page 218) slightly counterclockwise.

The climate control system will correspondingly adjust the interior air temperature.

Adjusting air distribution

Press air distribution button ⑤, ⑨, or ⑩ (▷ page 218) to adjust the air distribution.

The following symbols are found on the buttons:



Symbol	Function
	Directs air through the center and side air vents
	Directs air to the windshield and side air vents
	Directs air to the footwells and side air vents

- ▶ Press the desired air distribution button ⑤, ⑨, or ⑩ (▷ page 218).

The indicator lamp on the button **AUTO** goes out.

Adjusting air volume

Five blower speeds are available.

- ▶ Press button  to decrease or button  to increase air volume (▷ page 218) to the desired level.

The indicator lamp on button **AUTO** (▷ page 218) goes out. The automatic operation of air volume switches off. The selected blower speed is shown in the air volume display ⑪ (▷ page 218).

Adjusting air volume for the center and side air vents

Opening the center air vents

- ▶ Turn thumbwheels ⑤ and ⑥ (▷ page 216) upward.

The corresponding center air vents on the left and right are open.

Closing the center air vents

- ▶ Turn thumbwheels ⑤ and ⑥ (▷ page 216) downward.

The corresponding center air vents on the left and right are closed.

Opening the side air vents

- ▶ Turn thumbwheels ② and ⑦ (▷ page 216) upward.

The corresponding side air vents on the left and right are open.

Closing the side air vents

- ▶ Turn thumbwheels ② and ⑦ (▷ page 216) downward.

The corresponding side air vents on the left and right are closed.

Front defroster

You can use this setting to defrost the windshield, for example if it is iced up. You can also use it to defog the windshield and side windows.



Keep this setting selected only until the windshield or the side windows are clear again.

Activating

- ▶ Press button  (▷ page 218).

The indicator lamp on the button comes on.

The climate control switches to the following functions automatically:

- maximum blower speed and heating power
- air flows onto the windshield and the front side windows (side air vents must be open)
- the air conditioning compressor switches on at outside temperatures above approximately 41°F (5°C) for air-drying

Deactivating

- ▶ Press button  (▷ page 218) once more.

The indicator lamp on the button goes out. Defrosting is turned off.

The previous settings are in effect again. The air conditioning compressor remains switched on.



To switch off, you can also press button **OFF** or **AUTO** (▷ page 218).

Climate control

Windshield fogged on the outside



Keep this setting selected only until the windshield is clear again.



- ▶ Switch the windshield wipers on (▷ page 59).
- ▶ Press button  (▷ page 218).

The indicator lamp on the button comes on.

The climate control switches automatically to the following functions:

- maximum blower speed and heating power
- air flows onto the windshield and the front side windows (side air vents must be open)
- the air conditioning compressor switches on at outside temperatures above approximately 41°F (5°C) for air-drying

If the automatic air distribution is switched off:

- ▶ Press air distribution button  or  (▷ page 218).

Air recirculation mode

Switch to air recirculation mode to prevent unpleasant odors from entering the vehicle from the outside (e.g. before driving through a tunnel). This setting cuts off the intake of outside air and recirculates the air in the passenger compartment.

Warning!



Fogged windows impair visibility, endangering you and others. If the windows begin to fog on the inside, switching off the air recirculation mode immediately should clear interior window fogging. If interior window fogging persists, make sure the air conditioning (▷ page 226) is activated, or press button .

Activating

- ▶ Press button  (▷ page 218).

The indicator lamp on the button comes on.



The air recirculation mode is activated automatically at high outside temperatures.

The indicator lamp on button  is not lit when the air recirculation mode is switched on automatically.

A quantity of outside air is added after approximately 30 minutes.

If you have turned off the air conditioning (▷ page 226) or the outside temperature is below 41°F (5°C), the air recirculation mode will not switch on automatically.

Warning!



Never operate the windows and tilt/sliding sunroof* or tilt/sliding panel* if there is the possibility of anyone being harmed by the opening or closing procedure.

In case the procedure causes potential danger:

Vehicles with or without tilt/sliding sunroof*: The closing of the windows can be immediately halted by pressing or pulling the respective window switch. The closing of the tilt/sliding sunroof* can be immediately halted by moving the switch for the tilt/sliding sunroof* in any direction.

The closing of the windows and the tilt/sliding sunroof* can be reversed by again pressing and holding the  button.

Vehicles with panorama roof*: The closing of the windows and tilt/sliding panel* can be immediately halted by releasing the  button.



If you press and hold button , the windows and the tilt/sliding sunroof* or tilt/sliding panel* will close.



To cool the interior as fast as possible, the climate control automatically switches to air recirculation. The indicator lamp on button  is not lit when the air recirculation mode has been switched on automatically.

Climate control

Deactivating

- ▶ Press button .

The indicator lamp on the button goes out.





The air recirculation mode is deactivated automatically

- after 5 minutes if the outside temperature is below approximately 41°F (5°C)
- after 5 minutes if the air conditioning and air-drying is turned off
- after 30 minutes if the outside temperature is above approximately 41°F (5°C)



Press and hold button  for approximately 2 seconds. The windows, and/or the tilt/sliding sunroof*, (or tilt/sliding panel*) will return to their previous position. You can release

button  once the opening procedure has begun. The windows and/or the tilt/sliding sunroof* (or tilt/sliding panel*) continue opening until they have reached their previous position.

A window or the tilt/sliding sunroof* (or tilt/sliding panel*) will only return to its previous position if it has not been moved to another position using the respective window switch or tilt/sliding sunroof* (or tilt/sliding panel*) switch after it was closed with button .

A window or the tilt/sliding sunroof (or tilt/sliding panel*) that was moved will remain in its current position if button  is used to re-open the remaining windows or tilt sliding sunroof* (or tilt/sliding panel*).

Air conditioning

The air conditioning is operational while the engine is running and cools the interior air to the temperature set by the operator. In addition, the air conditioning dehumidifies the interior air at outside temperatures above 41°F (5°C) and helps prevent window fogging.



Condensation may drip out from underneath the vehicle. This is normal and not an indication of a malfunction.

Warning!



If you turn off the cooling function, the vehicle will not be cooled when weather conditions are warm. The windows can fog up more quickly. Window fogging may impair visibility and endanger you and others.

Deactivating

It is possible to deactivate the air conditioning (cooling) function of the climate control system. The air in the vehicle will then no longer be cooled or dehumidified.

- ▶ Press button  (▷ page 218).

The indicator lamp on the button goes out.

Activating

Moist air can fog up the windows. You can dehumidify the air with the air conditioning.

- ▶ Press button  (▷ page 218) again.

The indicator lamp on the button comes on.

The air conditioning uses the refrigerant R134a. This refrigerant is free of CFCs which are harmful to the ozone layer.



If the air conditioning cannot be turned on again, this indicates that the air conditioning is losing refrigerant. The compressor has turned off.

Have the air conditioning checked at the nearest authorized Mercedes-Benz Light Truck Center.

Residual heat and ventilation

With the engine switched off, it is possible to continue to heat or ventilate the interior for up to 30 minutes. This feature makes use of the residual heat produced by the engine.



How long the system will provide heating depends on

- the coolant temperature
- the battery voltage

Regardless of the temperature and air volume set on the climate control panel, an interior temperature is aimed at by 72°F (22°C) and the blower runs on low speed to protect the vehicle battery.

Climate control

Activating

- ▶ Switch off the ignition (▷ page 38).
- ▶ Press button **A/C REST** (▷ page 218).

The indicator lamp on button comes on.

Deactivating

- ▶ Press button **A/C REST** (▷ page 218) again.

The indicator lamp on the button goes out.



The residual heat is automatically turned off:

- when the ignition is switched on
- after about 30 minutes
- if the coolant temperature is too low
- if the battery voltage drops

Rear climate control

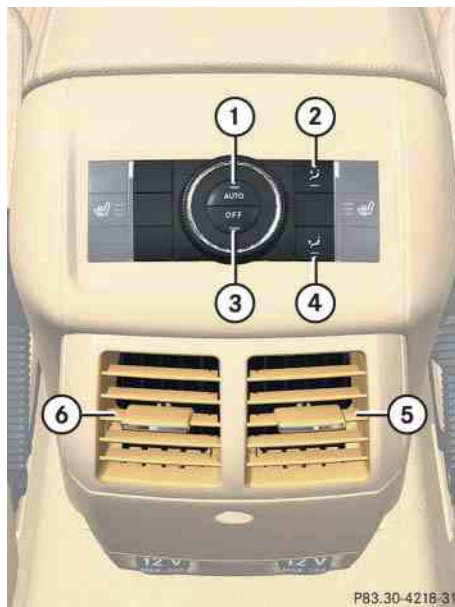

Rear climate control panel

- ① Rear climate control on (automatic mode)
- ② Air distribution (directs air through the center air vents)
- ③ Rear air conditioning off
- ④ Air distribution (directs air through the footwells and side air vents)
- ⑤ Right rear center air vent, adjustable
- ⑥ Left rear center air vent, adjustable

Activating rear climate control



The climate control must be switched on (▷ page 220).

- ▶ Press button **AUTO**.

The indicator lamp on the button comes on. The air volume and air distribution are adjusted automatically.



The temperature is adjusted according to the settings for the front passenger side made on the front climate control panel (▷ page 222).

Deactivating rear climate control

- ▶ Press button **OFF**.

The indicator lamp on the button goes out.

The cooling function switches off after a short delay.



Switch off the rear automatic climate control for improved cooling or heating output in the front passenger compartment.

You can also switch off the rear automatic climate control from the front passenger compartment (▷ page 220).

Adjusting air distribution

Use the air distribution controls ② or ④ to adjust the air distribution for the rear passenger compartment.

The symbols on the controls represent the following functions:

Symbol	Function
	Directs air to the center air vents
	Directs air to the footwells and the side air vents

Adjusting manually

- ▶ Press the desired air distribution control ② or ④.

The indicator lamp in the **AUTO** button goes out.

Adjusting automatically

- ▶ Press button **AUTO**.

The indicator lamp in the button comes on. The air distribution is adjusted automatically.

Adjusting air volume

The air volume for the rear zone corresponds to the air volume settings for the front passenger side. You can switch off the air supply for the rear zone.

You can switch off the supplied amount of air volume.

- ▶ Press button **OFF**.

3-zone automatic climate control*

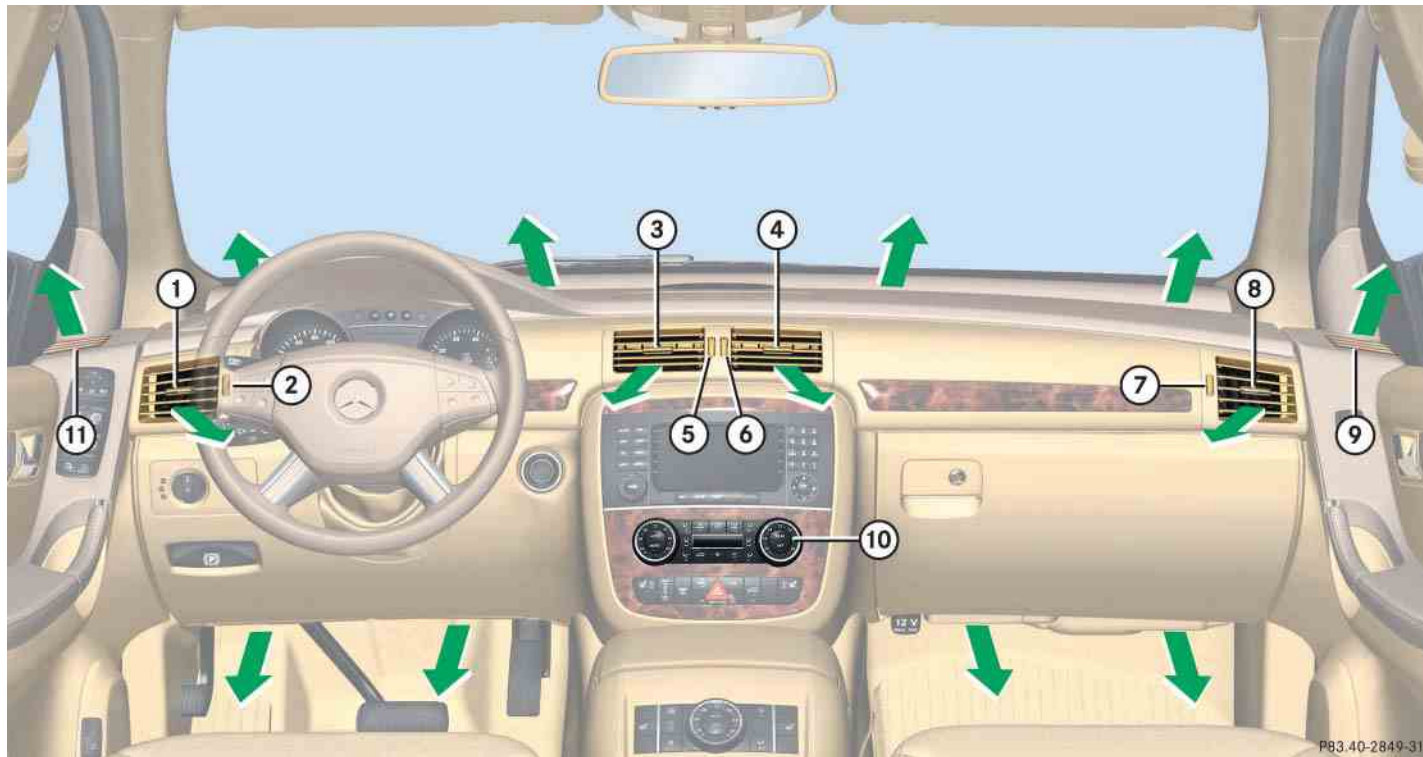

- | | |
|---|-------------------------------------------------------------|
| ① | Side air vent, adjustable |
| ② | Thumbwheel for air volume control for left side air vent |
| ③ | Left center air vent, adjustable |
| ④ | Right center air vent, adjustable |
| ⑤ | Thumbwheel for air volume control for left center air vent |
| ⑥ | Thumbwheel for air volume control for right center air vent |
| ⑦ | Thumbwheel for air volume control for right side air vent |
| ⑧ | Side air vent, adjustable |
| ⑨ | Front passenger door air vent, fixed |
| ⑩ | Climate control panel |
| ⑪ | Driver's door air vent, fixed |



For draft-free ventilation, move the sliders for the center air vents ③ and ④ to the middle position.

3-zone automatic climate control*

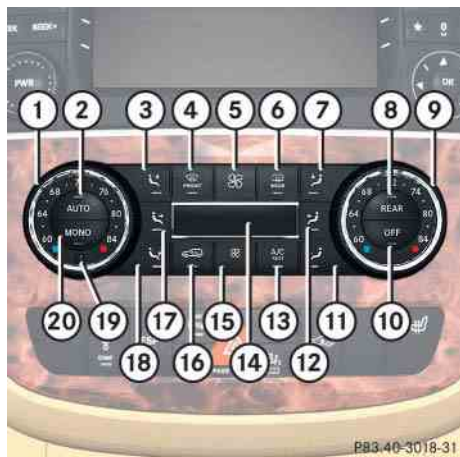

① Temperature control, driver's side

② Air distribution and air volume (automatic, manual)

③ Air distribution, driver's side

④ Front defroster

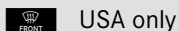

USA only

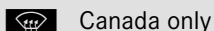

Canada only

⑤ Increasing air volume

⑥ Rear window defroster



USA only



Canada only

⑦ Air distribution, passenger side

⑧ Rear climate control



USA only



Canada only

⑨ Temperature control, passenger side

⑩ Automatic climate control on/off

⑪ Air distribution, passenger side

⑫ Air distribution, passenger side

⑬ AC cooling on/off
Residual heat/ventilation

⑭ Display

⑮ Decreasing air volume

⑯ Air recirculation

⑰ Air distribution, driver's side

⑱ Air distribution, driver's side

⑲ Interior temperature sensor

⑳ Adopting driver's side settings for all zones

3-zone automatic climate control*

Warning!

When operating the automatic climate control, the air that enters the passenger compartment through the air vents can be very hot or very cold (depending on the set temperature). This may cause burns or frostbite to unprotected skin in the immediate area of the air vents.

Always keep sufficient distance between unprotected parts of the body and the air vents. If necessary, use the air distribution controls (> page 232) to direct the air to air vents in the vehicle interior that are not in the immediate area of unprotected skin.

The automatic climate control is a 3-zone intelligent climate control system. Your vehicle interior is divided into 3 zones.

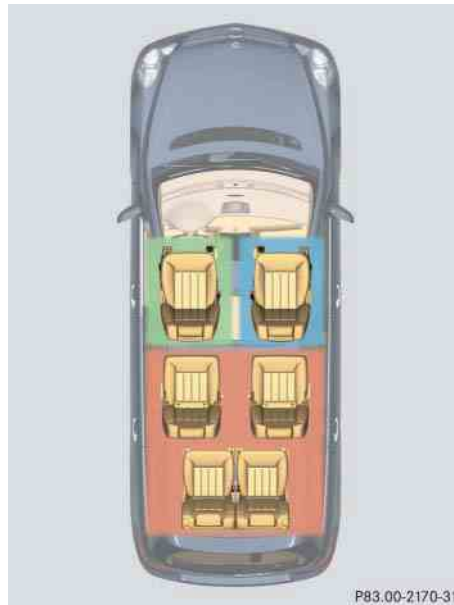

P83.00-2170-31

With the help of a sun sensor, the climate control determines the relation of the sun to the vehicle and automatically adjusts the inside temperature for each individual zone.

The automatic climate control is operational whenever the engine is running. It cools the vehicle's interior according to the angle and intensity of the sun's rays, the outside temperature and the selected temperature. You can operate the automatic climate control in either the automatic or manual mode.

Nearly all dust particles, pollutants and odors are filtered out before outside air enters the passenger compartment through the air distribution system.

The air conditioning will not engage (no cooling) if the **A/C** mode is deactivated (> page 242).

3-zone automatic climate control*

Warning!



Follow the recommended settings for heating and cooling given on the following pages. Otherwise the windows could fog up, impairing visibility and endangering you and others.



Severe conditions (e.g. strong air pollution) may require replacement of the filter before its scheduled interval. A clogged filter will reduce the air volume to the interior.

If the vehicle interior is hot, ventilate the interior before driving off, see “Summer opening feature” (▷ page 251). The automatic climate control will then adjust the interior temperature to the set value much faster.

Keep the air intake grille in front of the windshield free of snow and debris.

Deactivating the climate control system

Deactivating

- ▶ Press button **OFF** (▷ page 232) until the display is cleared.

Warning!



When the automatic climate control is switched off, the outside air supply and circulation are also switched off. Only choose this setting for a short time. Otherwise the windows could fog up, impairing visibility and endangering you and others.

Reactivating

- ▶ Press button **AUTO** (▷ page 232).



You can also press button **OFF** (▷ page 232) on the automatic climate control panel.

If you press button **FRONT** (▷ page 232) to reactivate the automatic climate control system, the defrosting mode is activated.

3-zone automatic climate control*

Deactivating the rear automatic climate control

You can switch on and off the rear automatic climate control with the automatic climate control panel in the front.

Deactivating

- ▶ Press button **REAR** (▷ page 232).

The indicator lamp on the button comes on.

In display ⑭ (▷ page 232), you will see the **REAR** symbol followed by **MODE** for approximately 3 seconds.

- ▶ Press button **OFF** (▷ page 232).

In display ⑭ (▷ page 232), you will see the **REAR** symbol followed by **OFF**.

The rear automatic climate control is switched off.

Reactivating

- ▶ Press button **REAR** (▷ page 232).

The indicator lamp on button **REAR** comes on.

In display ⑭ (▷ page 232), you will see the **REAR** symbol followed by **ON** and **MODE**. The **MODE** display is cleared and the indicator lamp on button **REAR** goes out after approximately 3 seconds.

The rear automatic climate control switches on.



You can switch on and off the rear automatic climate control by pressing the respective button on the rear climate control panel (▷ page 244).

For more information on rear air conditioning, see “Rear automatic climate control” (▷ page 244).

Operating the climate control system in automatic mode

You can switch the automatic climate control system on and off separately for each zone as needed.



When operating the climate control system in automatic mode, you will only rarely need to adjust the temperature, air volume and air distribution.

In automatic mode, cooling with dehumidify is switched on. This function can be switched off if necessary.

Activating

- ▶ Press button **AUTO** (▷ page 232) while the engine is running.

AUTO appears in the display of control panel ⑭ (▷ page 232). Air volume and air distribution are controlled separately for each zone.





3-zone automatic climate control*



- ▷▷ Use temperature controls ① and ⑨ (▷ page 232) to separately adjust the air temperature on each side of the passenger compartment.

The temperature of the interior is adjusted automatically.

Deactivating

- ▶ Press one button of the air distribution (▷ page 232) or press button  or  (▷ page 232).

The AUTO display disappears in the display ⑭ (▷ page 232).

Depending on which button you press – the air distribution button or the air volume button  or  – automatic control of either the air distribution or air volume is switched off.

Setting the temperature

Use temperature controls ① and ⑨ (▷ page 232) to separately adjust the air temperature on each side of the passenger compartment. You should raise or lower the temperature setting in small increments, preferably starting at 72°F (22°C). The automatic climate control will adjust to the set temperature as fast as possible.

Increasing

- ▶ Turn temperature control ① and/or ⑨ slightly clockwise.

The automatic climate control system will correspondingly adjust the interior air temperature.

Decreasing







- ▶ Turn temperature control ① and/or ⑨ slightly counterclockwise.

The automatic climate control system will correspondingly adjust the interior air temperature.

Adjusting air distribution

Use the air distribution buttons ③, ⑰, or ⑱ for the driver's side, or ⑦, ⑪, or ⑫ (▷ page 232) for the passenger side to separately adjust the air distribution on each side of the passenger compartment.

The following symbols are found on the buttons:

Symbol		Function
Driver's side	Passenger side	
		Directs air to the windshield and side air vents
		Directs air through the center, side and rear passenger compartment air vents
		Directs air to the footwells and side air vents

- ▶ Press the desired air distribution button (▷ page 232).

The indicator lamp on the button goes out.

Adjusting the air distribution for the center and side air vents

Opening the center air vents

- ▶ Turn thumbwheels ⑤ and ⑥ (▷ page 230) upward.

The corresponding center air vents on the left and right are open.

Closing the center air vents

- ▶ Turn thumbwheels ⑤ and ⑥ (▷ page 230) downward.

The corresponding center air vents on the left and right are closed.

Opening the side air vents

- ▶ Turn thumbwheels ② and ⑦ (▷ page 230) downward.

The corresponding side air vents on the left and right are open.



Closing the side air vents

- ▶ Turn thumbwheels ② and ⑦ (▷ page 230) downward.

The corresponding side air vents on the left and right are closed.

Adjusting air volume

Five blower speeds are available.

- ▶ Press button  to decrease or button  to increase air volume (▷ page 232) to the desired level.

The indicator lamp on button **AUTO** goes out.

The AUTO display disappears in the display ⑭ (▷ page 232) and the automatic mode is switched off. The selected blower speed appears in the display ⑭ (▷ page 232).

3-zone automatic climate control*

Front defroster

You can use this setting to defrost the windshield, such as when it is iced up. You can also use it to defog the windshield and side windows.



Keep this setting selected only until the windshield or the side windows are clear again.

When the defrost setting has been selected, only the rear window defroster can be switched on. No other settings are possible.

Activating

- ▶ Press button  (▷ page 232).

The indicator lamp on the button comes on.

The air conditioning switches to the following functions automatically:

- maximum blower speed and heating power
- air flows onto the windshield and the front side windows (side air vents must be open)
- the air conditioning compressor switches on at outside temperatures above approximately 41°F (5°C) for air-drying

Deactivating

- ▶ Press button  (▷ page 232).

The indicator lamp on the button goes out. Defrosting is turned off.

The previous settings are once again in effect.



To switch off, you can also press button **OFF** or **AUTO** (▷ page 232).

Windshield fogged on the outside





Keep this setting selected only until the windshield is clear again.

- ▶ Switch the windshield wipers on (▷ page 59).
- ▶ Press button **AUTO** (▷ page 232).

AUTO appears in the display of control panel  (▷ page 232). Air volume and air distribution are controlled separately for each zone.

If the automatic air distribution and air volume are switched off:

- ▶ Press buttons  and  (▷ page 232).

3-zone automatic climate control*

Maximum cooling MAX COOL

If the air distribution control as well as the airflow volume control are set to **AUTO** and there is a high need for cooling, the MAX COOL function is activated. “MAX COOL” appears in the front and rear display.

This provides the fastest possible cooling of the vehicle interior (when windows and tilt/sliding sunroof* or tilt/sliding panel* are closed).

Air recirculation mode

Switch to air recirculation mode to prevent unpleasant odors from entering the vehicle from the outside (e.g. before driving through a tunnel). This setting cuts off the intake of outside air and recirculates the air in the passenger compartment.

Warning!

Fogged windows impair visibility, endangering you and others. If the windows begin to fog on the inside, switching off the air recirculation mode immediately should clear interior window fogging. If interior window fogging persists, make sure the air conditioning (> page 241) is activated, or press button .

Activating

- ▶ Press button  (> page 232).

The indicator lamp on the  button comes on.



The air recirculation mode is activated automatically at high outside temperatures.

The indicator lamp on button  is not lit when the air recirculation mode is automatically switched on.

A quantity of outside air is added after approximately 30 minutes.

If you have turned off the air conditioning (> page 241) or the outside temperature is below 41°F (5°C), the air recirculation mode will not switch on automatically.

3-zone automatic climate control*

Warning!



Never operate the windows and tilt/sliding sunroof* or tilt/sliding panel* if there is the possibility of anyone being harmed by the opening or closing procedure.

In case the procedure causes potential danger:

Vehicles with or without tilt/sliding sunroof*: The closing of the windows can be immediately halted by pressing or pulling the respective window switch. The closing of the tilt/sliding sunroof* can be immediately halted by moving the switch for the tilt/sliding sunroof* in any direction.

The closing of the windows and the tilt/sliding sunroof* can be reversed by again pressing and holding the  button.

Vehicles with panorama roof*: The closing of the windows and tilt/sliding panel* can be immediately halted by releasing the  button.



If you press and hold button , the windows and the tilt/sliding sunroof* or tilt/sliding panel* will close.



To cool the interior as fast as possible, the automatic climate control automatically switches to air recirculation. The indicator lamp on button  is not lit when the system switches to air recirculation automatically.

Deactivating

▶ Press button  (▷ page 232).

The indicator lamp on the  button goes out.





The air recirculation mode is deactivated automatically

- after five minutes if the outside temperature is below approximately 41°F (5°C)
- after five minutes if the air conditioning and air-drying is turned off
- after 30 minutes if the outside temperature is above approximately 41°F (5°C)

3-zone automatic climate control*



Press and hold button  for approximately 2 seconds. The windows, and/or the tilt/sliding sunroof*, (or tilt/sliding panel*) will return to their previous position. You can release button  once the opening procedure has begun. The windows and/or the tilt/sliding sunroof* (or tilt/sliding panel*) continue opening until they have reached their previous position.

A window or the tilt/sliding sunroof* (or tilt/sliding panel*) will only return to its previous position if it has not been moved to another position using the respective window switch or tilt/sliding sunroof* (or tilt/sliding panel*) switch after it was closed with button .

A window or the tilt/sliding sunroof (or tilt/sliding panel*) that was moved will remain in its current position if button  is used to re-open the remaining windows or tilt sliding sunroof* (or tilt/sliding panel*).

At outside temperatures above 79°F (26°C) the system will not automatically switch back to outside air. A quantity of outside air is added after approximately 30 minutes.

Air conditioning

The cooling function, only operational when the engine is running, cools the vehicle down to the selected interior temperature. The cooling function also dehumidifies the air in the vehicle interior, thereby preventing the windows from fogging up.



Condensation may drip out from underneath the vehicle. This is normal and not an indication of a malfunction.

Warning!



If you turn off the cooling function, the vehicle will not be cooled when weather conditions are warm. The windows can fog up more quickly. Window fogging may impair visibility and endanger you and others.

3-zone automatic climate control*

Deactivating

It is possible to deactivate the air conditioning (cooling) function of the automatic climate control system. The air in the vehicle will then no longer be cooled or dehumidified.

- ▶ Press button  (> page 232).

The indicator lamp on the button goes out. The cooling function switches off after a short delay.

Activating

Moist air can fog up the windows. You can dehumidify the air with the air conditioning.

- ▶ Press button  again.

The indicator lamp on the button comes on.

The air conditioning uses the refrigerant R-134a. This refrigerant is free of CFCs which are harmful to the ozone layer.



If the air conditioning cannot be turned on again, this indicates that the air conditioning is losing refrigerant. The compressor has turned off.

Have the air conditioning checked at the nearest authorized Mercedes-Benz Light Truck Center.

Using driver-side settings for all temperature zones

You can use the settings of the driver's side, such as temperature, air volume and air distribution, for all temperature zones. These settings only need to be made once and the climate control system will automatically regulate the settings for all temperature zones quickly and comfortably.

Activating

- ▶ Adjust the temperature, air volume and air distribution (> page 232).
- ▶ Press button  (> page 232).

The indicator lamp on the button comes on.

The driver-side settings are used for all temperature zones.

Deactivating

- ▶ Press button  (▷ page 232) again.

The indicator lamp on the button goes out.



If you manually set the temperature, air volume or air distribution for the passenger side or the rear passenger compartment when the **MONO** setting is active, the **MONO** setting will be switched off.

Residual heat and ventilation

With the engine switched off, it is possible to continue to heat or ventilate the interior for up to 30 minutes. This feature makes use of the residual heat produced by the engine.



How long the system will provide heating depends on

- the coolant temperature
- the battery voltage

Regardless of the temperature and air volume set on the automatic climate control panel, an interior temperature is aimed at by 72°F (22°C) and the blower runs on low speed to protect the vehicle battery.

Activating

- ▶ Switch off the ignition (▷ page 38).
- ▶ Press button  (▷ page 232).

The indicator lamp on the button comes on.

Deactivating

- ▶ Press button .

The indicator lamp on the button goes out.



The residual heat is automatically turned off:

- when the ignition is switched on
- after about 30 minutes
- if the coolant temperature is too low
- if the battery voltage drops

3-zone automatic climate control*

Rear automatic climate control

The control panel is located in the rear center console.

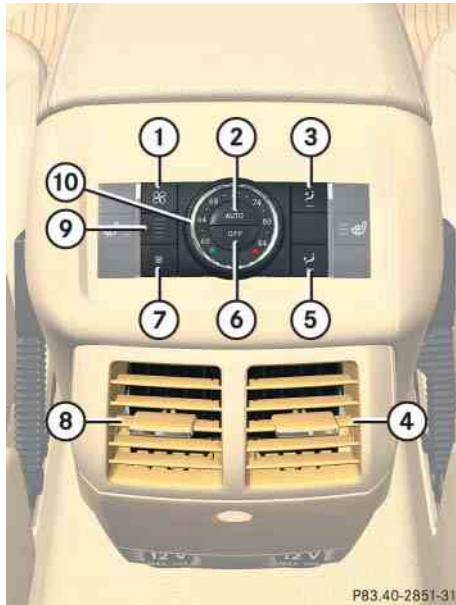

Rear automatic climate control panel

- | | |
|---|-------------------------------------------------------------------------|
| ① | Increase air volume |
| ② | Air distribution and air volume (automatic, manual) |
| ③ | Air distribution (directs air through the side air vents) |
| ④ | Right rear center air vent, adjustable |
| ⑤ | Air distribution (directs air through the footwells and side air vents) |
| ⑥ | Rear automatic climate control on/off |
| ⑦ | Decrease air volume |
| ⑧ | Left rear center air vent, adjustable |
| ⑨ | Indicator lamps for air volume settings |
| ⑩ | Temperature control |

Activating rear air conditioning



The climate control must be switched on (▷ page 234).

- ▶ Press button **AUTO**.

The indicator lamp on the button comes on. The temperature, air volume, and air distribution are adjusted automatically.

Deactivating rear air conditioning

- ▶ Press button **OFF**.

The indicator lamp on the button goes out.

The cooling function switches off after a short delay.

3-zone automatic climate control*



Switch off the rear automatic climate control for improved cooling or heating output in the front passenger compartment.

You can also switch off the rear automatic climate control from the front passenger compartment (> page 235).

Adjusting air distribution

Use the air distribution controls ③ or ⑤ to adjust the air distribution for the rear passenger compartment.

The symbols on the controls represent the following functions:

Symbol	Function
	Directs air to the center air vents
	Directs air to the footwells and the side air vents

Adjusting manually

- ▶ Press the desired air distribution control.

The indicator lamp on button **AUTO** goes out.

Adjusting automatically

- ▶ Press button **AUTO**.

The indicator lamp on the button comes on. The air distribution is adjusted automatically.

Setting the temperature

Use temperature control ⑩ (> page 244) to separately adjust the air temperature of the rear passenger compartment.

You should raise or lower the temperature setting in small increments, preferably starting at 72°F (22°C). The automatic climate control will adjust to the set temperature as fast as possible.



The rear automatic climate control will not cool the air when the air conditioning is switched off (> page 242).

3-zone automatic climate control*

Increasing the temperature

- ▶ Turn temperature control ⑩ (▷ page 244) slightly clockwise.

The rear automatic climate control will correspondingly adjust the interior air temperature for the rear passenger compartment.

Decreasing the temperature

- ▶ Turn temperature control ⑩ (▷ page 244) slightly counterclockwise.

The rear automatic climate control will correspondingly adjust the interior air temperature for the rear passenger compartment.

Setting the temperature from the front automatic climate control panel

You can adjust the temperature for the rear automatic climate control from the front panel.

- ▶ Make sure the front automatic climate control is switched on (▷ page 234).
- ▶ Press button **REAR** (▷ page 232).

The indicator lamp on button **REAR** comes on.

In display ⑭ (▷ page 232), you will see the **REAR** symbol followed by MODE.

- ▶ Set the desired temperature for the rear passenger compartment using temperature control ⑨ (▷ page 232).

After approximately 3 seconds after the last adjustment, the display switches back to its standard display and the indicator lamp on button **REAR** goes out.



You can also press the **REAR** button once more to switch back to the standard display.

Adjusting air volume

Adjusting manually

Five blower speeds are available.

- ▶ Press button to decrease or button to increase air volume to the desired level.

The indicator lamp on the **AUTO** button goes out. The selected blower speed is shown by the indicator lamps for air volume settings ⑨ (▷ page 244).

Adjusting automatically

- ▶ Press button **AUTO**.

The indicator lamp on the button comes on. The air volume is adjusted automatically.

3-zone automatic climate control*

B-pillar air vents

Air vents are located in both B-pillars.

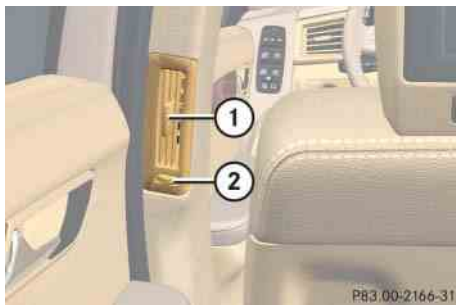

- ① Air vent, adjustable
- ② Thumbwheel for air volume control

Adjusting air volume

- ▶ Turn thumbwheel ② to the left to increase the air volume.

or

- ▶ Turn thumbwheel ② to the right to decrease the air volume.

Adjusting air distribution

- ▶ Move air vent slider ① to the left, right, up, or down to direct the air in the desired direction.

Air vents in third-row side trim

Air vents are located in the left and right side trim below the hinged quarter windows.



- ① Defrost air vent for hinged quarter window, fixed
- ② Air vent, adjustable
- ③ Thumbwheel for air volume control

Adjusting air volume

- ▶ Turn thumbwheel ③ downwards to increase the air volume.

or

- ▶ Turn thumbwheel ③ upwards to decrease the air volume.

Adjusting air distribution

- ▶ Move air vent slider ② to the left, right, up, or down

The air is directed in the desired direction.

Power windows

Opening and closing

The door windows and the hinged quarter windows are opened and closed electrically. The switches for all door windows and the hinge quarter windows are located on the driver's door control panel (▷ page 34). The switches for the respective door windows are located on the control panels of the front passenger door and the rear doors. The hinged quarter windows can be operated from the driver's seat only.

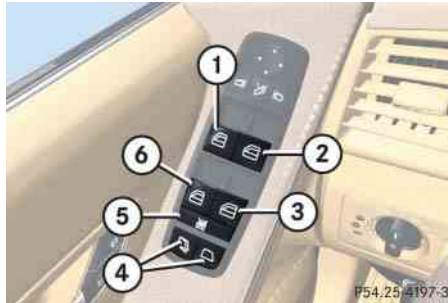

- ① Left front door window
 - ② Right front door window
 - ③ Right rear door window
 - ④ Hinged quarter windows
 - ⑤ Override switch (▷ page 93)
 - ⑥ Left rear door window
- Switch on the ignition (▷ page 38).

Warning!



When closing the windows, make sure that there is no danger of anyone being harmed by the closing procedure.

Activate the override switch (▷ page 93) when children are riding in the back seats of the vehicle. The children may otherwise injure themselves, e.g. by becoming trapped in the window opening.

The closing of a door window can be immediately halted by releasing the switch or, if switch was pulled past the resistance point and released, by either pressing or pulling the respective switch.

If a door window encounters an obstruction that blocks its path in a circumstance where you pulled the switch past the resistance point and released it to close the door window, the automatic reversal function will stop the door window and open it slightly.

If a door window encounters an obstruction that blocks its path in a circumstance where you are closing a door window by pulling and holding the switch, or by pressing and holding button  on the SmartKey, by pressing and holding the lock button (vehicles with KEYLESS-GO*) on the door handle, the automatic reversal function will not operate.

When leaving the vehicle, always remove the SmartKey or SmartKey with KEYLESS-GO* from starter switch, take it with you, and lock the vehicle. Do not leave children unattended in the vehicle, or with access to an unlocked vehicle. Unsupervised use of vehicle equipment can cause an accident and / or serious personal injury.



You can also open or close the windows using the SmartKey, see “Summer opening feature” (▷ page 251) and “Convenience closing feature” (▷ page 252).

Depending on the current position, the power windows may also open or close when the air recirculation button  on the control panel of the climate control (▷ page 218) or automatic climate control (▷ page 232) is pressed and held.



With the SmartKey in starter switch position **0** or removed from the starter switch, the windows can be operated

- until you open the driver’s or front passenger door
- for at least 5 minutes

Opening the door windows

- ▶ Press switch ①, ②, ③, or ⑥ (▷ page 248) to the resistance point.

The corresponding door window moves downwards until you release the switch.

Closing the door windows

- ▶ Pull switch ①, ②, ③, or ⑥ (▷ page 248) to the resistance point.

The corresponding door window moves upwards until you release the switch.

Warning!



If you pull and hold the switch up when closing the door window, and upward movement of the door window is blocked by some obstruction including but not limited to arms, hands, fingers, etc., the automatic reversal will not operate.

Power windows

Fully opening the door windows (Express-open)

- ▶ Press switch ①, ②, ③, or ⑥ (▷ page 248) past the resistance point and release.

The corresponding door window opens completely.

Fully closing the door windows (Express-close)

- ▶ Pull switch ①, ②, ③, or ⑥ (▷ page 248) past the resistance point and release.

The corresponding door window closes completely.

Warning!



Driver's door only:

If within 5 seconds switch is again pulled past the resistance point and released, the automatic reversal will not function.

If the upward movement of a door window is blocked during the closing procedure, the door window will stop and open slightly.

- ▶ Remove the obstruction.
- ▶ Pull the respective power window switch past the resistance point again and release.



If the door window still does not close when there is no obstruction, pull and hold the respective power window switch. The door window will then close without the obstruction sensor function.

Stopping door windows during Express-operation

- ▶ Press or pull the respective door window switch again.

Hinged quarter windows

The switches for opening and closing the hinged quarter windows are located on the door control panel of the driver's door (▷ page 34).



- ① Hinged quarter windows: opening
- ② Hinged quarter windows: closing

Opening

- ▶ Press and release switch ①.

To stop the hinged quarter window:

- ▶ Press and release switch ① once more.

Closing

- ▶ Press and release switch ②.

To stop the hinged quarter window:

- ▶ Press and release switch ② once more.



When the obstruction sensor detects the hinged quarter window is blocked during the closing process, it will stop and open slightly.

Synchronizing the door windows

The door windows must be resynchronized

- after the battery was disconnected
- if the door windows cannot be fully opened (Express-open) or closed (Express-close)



Each door window must be resynchronized separately.

- ▶ Close all doors.
- ▶ Switch on the ignition (▷ page 38).
- ▶ Pull and hold door window switch ①, ②, ③, or ⑥ (▷ page 248).

Once a door window is closed completely, hold the respective switch for approximately 3 seconds.

The door window is synchronized.

Summer opening feature

If the weather is warm, you can ventilate the vehicle before driving off by simultaneously

- opening the door windows
- opening the hinged quarter windows
- opening the tilt/sliding sunroof* (or tilt/sliding panel*)





- ▶ Aim transmitter eye of the SmartKey or SmartKey with KEYLESS-GO* at the driver's outside door handle.

The SmartKey or SmartKey with KEYLESS-GO* must be in close proximity to the driver's outside door handle.



Power windows

Vehicles without tilt/sliding panel

- ▶ Press and hold button  on the SmartKey or SmartKey with KEYLESS-GO* until the windows and the tilt/sliding sunroof* have reached the desired position.
- ▶ Release button  on the SmartKey or SmartKey with KEYLESS-GO* to interrupt the opening procedure.

Vehicles with tilt/sliding panel*

If roller sunblinds are closed:



- ▶ Press and hold button  on the SmartKey or SmartKey with KEYLESS-GO*.
The windows and roller sunblinds begin to open after approximately 1 second.
- ▶ Release button  on the SmartKey or SmartKey with KEYLESS-GO* to interrupt the opening procedure.

- ▶ With the windows and roller sunblinds fully opened, press and hold button  on the SmartKey or SmartKey with KEYLESS-GO* once more.

The tilt/sliding panel opens.

- ▶ Release button  on the SmartKey or SmartKey with KEYLESS-GO* to interrupt the opening procedure.

If roller sunblinds are open:

- ▶ Press and hold button  on the SmartKey or SmartKey with KEYLESS-GO*.
The windows and the tilt/sliding panel begin to open after approximately 1 second.
- ▶ Release button  on the SmartKey or SmartKey with KEYLESS-GO* to interrupt the opening procedure.

Convenience closing feature



When locking the vehicle, you can close the windows and the tilt/sliding sunroof* (or tilt/sliding panel*) simultaneously.

Warning!



When closing the windows and the tilt/sliding sunroof* (or tilt/sliding panel*), make sure that there is no danger of anyone being harmed by the closing procedure.

If potential danger exists, proceed as follows:

- Release button  to stop the closing procedure. To open, press and hold button . To continue the closing procedure after making sure that there is no danger of anyone being harmed by the closing procedure, press and hold button .



Vehicles with KEYLESS-GO*

- Release the lock button (▷ page 68) on the driver's outside door handle to stop the closing procedure.
- Pull on the driver's outside door handle and hold firmly. The windows and the tilt/sliding sunroof* (or tilt/sliding panel*) will open for as long as the door handle is held but the door not opened.

Vehicles without tilt/sliding panel

- ▶ Aim transmitter eye of the SmartKey or SmartKey with KEYLESS-GO* at the driver's outside door handle (▷ page 251).

The SmartKey or SmartKey with KEYLESS-GO* must be in close proximity to the driver's door handle.

- ▶ Press and hold button  on the SmartKey or SmartKey with KEYLESS-GO* until the windows and the tilt/sliding sunroof* are completely closed.
- ▶ Release button  on the SmartKey or SmartKey with KEYLESS-GO* to interrupt the closing procedure.

Vehicles with KEYLESS-GO*:



- ▶ Press and hold the lock button on an outside door handle (▷ page 68) until the windows and the tilt/sliding sunroof* are completely closed.
- ▶ Release the lock button on the outside door handle to interrupt the closing procedure.

Vehicles with tilt/sliding panel*

If tilt/sliding panel is closed:

- ▶ Aim transmitter eye of the SmartKey or SmartKey with KEYLESS-GO* at the driver's outside door handle (▷ page 251).

The SmartKey or SmartKey with KEYLESS-GO* must be in close proximity to the driver's door handle.



- ▶ Press and hold button  on the SmartKey or SmartKey with KEYLESS-GO* until the windows and the roller sunblinds are completely closed.
- ▶ Release button  on the SmartKey or SmartKey with KEYLESS-GO* to interrupt the closing procedure. ▷▷

Power windows

▷▷ Vehicles with KEYLESS-GO*:

- ▶ Press and hold the lock button on an outside door handle (▷ page 68) until the windows and the roller sunblinds are completely closed.
- ▶ Release the lock button on the outside door handle to interrupt the closing procedure.

If tilt/sliding panel is open:

- ▶ Aim transmitter eye of the SmartKey or SmartKey with KEYLESS-GO* at the driver's outside door handle (▷ page 251).
The SmartKey or SmartKey with KEYLESS-GO* must be in close proximity to the driver's door handle.
- ▶ Press and hold button  on the SmartKey or SmartKey with KEYLESS-GO* until the windows and the tilt/sliding panel* are completely closed.
- ▶ Release button  on the SmartKey or SmartKey with KEYLESS-GO* to interrupt the closing procedure.
- ▶ With the windows and the tilt/sliding panel completely closed, press and hold button  on the SmartKey or SmartKey with KEYLESS-GO* once more.

The roller sunblinds close.

Vehicles with KEYLESS-GO*:

- ▶ Press and hold the lock button on an outside door handle (▷ page 68) until the windows and the tilt/sliding panel* are completely closed.
- ▶ Release the lock button on the outside door handle to interrupt the closing procedure.
- ▶ With the windows and the tilt/sliding panel completely closed, press and hold the lock button on an outside door handle (▷ page 68) once more.

The roller sunblinds close.

Power tilt/sliding sunroof*

▼ Power tilt/sliding sunroof*

Opening and closing

The tilt/sliding sunroof is opened and closed electrically. The switch for the tilt/sliding sunroof is located on the overhead control panel.



Sunroof switch

- ① Push back to slide sunroof open
- ② Push forward to slide sunroof closed
- ③ Push up to raise sunroof at rear
- ④ Pull down to lower sunroof at rear

With the sunroof closed or tilted open, a screen can be slid into the roof opening to guard against sun rays. When sliding the sunroof open, the screen will also retract.



Power tilt/sliding sunroof*

Warning!



When closing the tilt/sliding sunroof, make sure that there is no danger of anyone being harmed by the closing procedure.

If the tilt/sliding sunroof encounters an obstruction that blocks its path in a circumstance where you are closing the tilt/sliding sunroof by moving the tilt/sliding sunroof switch past the resistance point, or by pressing and holding button  on the SmartKey, by pressing and holding the lock button (vehicles with KEYLESS-GO*) on the door handle, the automatic reversal function will not operate.

The opening/closing procedure of the tilt/sliding sunroof can be immediately halted by releasing the switch or, if the switch was moved past the resistance point and released, by moving the switch in any direction.

The tilt/sliding sunroof is made out of glass. In the event of an accident, the glass may shatter. This may result in an opening in the roof.

In a vehicle rollover, occupants not wearing their seat belts or not wearing them properly may be thrown out of the opening. Such an opening also presents a potential for injury for occupants wearing their seat belts properly as entire body parts or portions of them may protrude from the passenger compartment.

When leaving the vehicle, always remove the SmartKey or SmartKey with KEYLESS-GO* from the starter switch, take it with you, and lock your vehicle. Do not leave children unattended in the vehicle, or with access to an unlocked vehicle. Unsupervised use of vehicle equipment can cause an accident and/or serious personal injury.



To avoid damaging the seals, do not transport any objects with sharp edges which can stick out of the tilt/sliding sunroof.

Do not open the tilt/sliding sunroof if there is snow or ice on the roof, as this could result in malfunctions.

The tilt/sliding sunroof can be opened or closed manually should an electrical malfunction occur (▷ page 462).



You can also open or close the tilt/sliding sunroof using the SmartKey or the KEYLESS-GO* function, see “Summer opening feature” (▷ page 251) and “Convenience closing feature” (▷ page 252).



Depending on the current position, the tilt/sliding sunroofs may also open or close when the air recirculation button  on the control panel of the climate control (▷ page 218) or automatic climate control (▷ page 232) is pressed and held.

- ▶ Switch on the ignition (▷ page 38).

Opening and closing

- ▶ To open, close, raise, or lower the tilt/sliding sunroof, move the sunroof switch to the resistance point in the required direction of arrows ① to ④ (▷ page 255).
- ▶ Release the sunroof switch when the tilt/sliding sunroof has reached the desired position.

Fully opening (Express-open) and closing (Express-close)

- ▶ To fully open or close the tilt/sliding sunroof, move the switch past the resistance point in the required direction ① or ② (▷ page 255) and release.

The tilt/sliding sunroof opens or closes completely.

Stopping the power tilt/sliding sunroof during Express-open

- ▶ Move the sunroof switch in any direction.

The movement of the tilt/sliding sunroof stops.



If the movement of the tilt/sliding sunroof is blocked during the closing procedure, the tilt/sliding sunroof will stop and reopen slightly.

Warning!



If the tilt/sliding sunroof encounters an obstruction that blocks its path in a circumstance where you are closing the tilt/sliding sunroof by moving the tilt/sliding sunroof switch past the resistance point, or by pressing and holding button  on the SmartKey, by pressing and holding the lock button (vehicles with KEYLESS-GO*) on the door handle, the automatic reversal function will not operate.

The opening/closing procedure of the tilt/sliding sunroof can be immediately halted by releasing the switch or, if the switch was moved past the resistance point and released, by moving the switch in any direction.

Power tilt/sliding sunroof*

Synchronizing

The tilt/sliding sunroof must be synchronized

- after the battery has been disconnected or discharged
 - after the tilt/sliding sunroof has been closed manually (▷ page 462)
 - after a malfunction
 - if the tilt/sliding sunroof does not open smoothly
- ▶ Remove the fuse securing the tilt/sliding sunroof from the fuse box (▷ page 503).



For information on which fuse box contains the fuse for the power tilt/sliding sunroof, see the fuse chart provided with the vehicle tool kit (▷ page 455).

- ▶ Reinsert the fuse in the main box.
- ▶ Switch on the ignition (▷ page 38).
- ▶ Press and hold the sunroof switch in the direction of arrow ③ (▷ page 255) until the tilt/sliding sunroof is fully raised at the rear.
- ▶ Hold the sunroof switch in the direction of arrow ③ for approximately 1 second.
- ▶ Open the tilt/sliding sunroof using the Express-open feature (▷ page 257).

If the tilt/sliding sunroof opens completely, it is synchronized.

If the tilt/sliding sunroof does not open completely:

- ▶ Repeat the above steps.

Panorama roof with power tilt/sliding panel*

▼ Panorama roof with power tilt/sliding panel*

Roller sunblinds for the panorama roof with power tilt/sliding panel

The tilt/sliding panel and the front and rear roller sunblinds are opened and closed electrically. The switch for the tilt/sliding panel and the roller sunblinds is located on the overhead control panel.

The roller sunblinds only operate with the tilt/sliding panel closed. The front and rear roller sunblind cannot be operated individually.

**Roof panel switch**

- ① Open roller sunblinds
- ② Close roller sunblinds

- ▶ Switch on the ignition (▷ page 38).
- ▶ To open or close the roller sunblinds, move the roof panel switch to the resistance point in the required direction of arrow ① or ②.

Release the roof panel switch when the roller sunblinds have reached the desired position.

Warning!

When closing the roller sunblinds, make sure that no one is in danger of being injured by the closing procedure. The closing of the roller sunblinds can be immediately halted by releasing the switch.

Fully opening the roller sunblinds (Express-open)

- ▶ Move the roof panel switch past the resistance point in direction of arrow ① and release.

The roller sunblinds opens completely.

Stopping the roller sunblinds during Express-operation

- ▶ Move the roof panel switch in any direction.

Panorama roof with power tilt/sliding panel*

Opening and closing the panorama roof with power tilt/sliding panel

The tilt/sliding panel is opened and closed electrically. The switch for the tilt/sliding panel is on the overhead control panel.

The tilt/sliding panel only operates with the roller sunblinds opened.



Roof panel switch

- ① Push back to slide roof panel open
- ② Push forward to slide roof panel closed
- ③ Push up to raise roof panel
- ④ Pull down to lower roof panel

Warning!



When opening or closing the tilt/sliding panel, make sure that there is no danger of anyone being harmed by the opening or closing procedure.

The opening procedure of the tilt/sliding panel can be immediately halted by releasing the switch or, if the switch was moved past the resistance point and released, by moving the switch in any direction.

The closing procedure of the tilt/sliding panel can be immediately halted by releasing the switch.

The panorama roof with power tilt/sliding panel is made out of glass. In the event of an accident, the glass may shatter. This may result in an opening in the roof.

Panorama roof with power tilt/sliding panel*

In a vehicle rollover, occupants not wearing their seat belts or not wearing them properly may be thrown out of the opening. Such an opening also presents a potential for injury for occupants wearing their seat belts properly as entire body parts or portions of them may protrude from the passenger compartment.

When leaving the vehicle, always remove the SmartKey or the SmartKey with KEYLESS-GO* from the starter switch, take it with you, and lock the vehicle. Do not leave children unattended in the vehicle, or with access to an unlocked vehicle. Unsupervised use of vehicle equipment can cause an accident and/or serious personal injury.



To avoid damaging the seals, do not transport any objects with sharp edges which can stick out of the tilt/sliding panel.

Do not open the tilt/sliding panel if there is snow or ice on the roof, as this could result in malfunctions.



You can also open or close the tilt/sliding panel using the SmartKey or the KEYLESS-GO* function, see “Summer opening feature” (▷ page 251) and “Convenience closing feature” (▷ page 252).



The tilt/sliding panel may also open when using the air recirculation button  on the control panel of the climate control (▷ page 218) or automatic climate control (▷ page 232).

- ▶ Switch on the ignition (▷ page 38).

Opening

- ▶ Pull and hold the roof panel switch to resistance point in direction of arrow ① (▷ page 260).

Release the roof panel switch when the tilt/sliding panel has reached the desired position.

Closing

- ▶ Press and hold the roof panel switch in direction of arrow ② (▷ page 260).

Release the roof panel switch when the tilt/sliding panel has reached the desired position.

Panorama roof with power tilt/sliding panel*

Raising

You can raise the tilt/sliding panel at the rear for better ventilation of the vehicle interior.

- ▶ Press and hold the roof panel switch in direction of arrow ③ (▷ page 260).

Release the roof panel switch when the tilt/sliding panel has reached the desired position.

Lowering

- ▶ Pull and hold the roof panel switch in direction of arrow ④ (▷ page 260) until the tilt/sliding panel has lowered and closed completely.

Fully opening (Express-open) the panorama roof with tilt/sliding panel

- ▶ Pull the roof panel switch past the resistance point in direction of arrow ① (▷ page 260) and release.

The tilt/sliding panel opens completely.

Stopping the panorama roof with tilt/sliding panel during Express-open

- ▶ Move the roof panel switch in any direction.

The tilt/sliding panel will stop in its current position.

Synchronizing the panorama roof with power tilt/sliding panel

The tilt/sliding panel and its roller sunblinds must be synchronized

- after the battery has been disconnected or discharged
- after a malfunction
- if the tilt/sliding panel does not open smoothly



Do not attempt to open or close the tilt/sliding panel before the tilt/sliding panel is properly synchronized. The tilt/sliding panel could otherwise lock-up in the open position.

If the tilt/sliding panel cannot be closed or synchronized, see an authorized Mercedes-Benz Light Truck Center or call Roadside Assistance (▷ page 315).

Panorama roof with power tilt/sliding panel*

- ▶ Switch off the ignition (▷ page 38) and remove the SmartKey from the starter switch.

Vehicles with KEYLESS-GO*:

- ▶ Switch off the ignition (▷ page 39).
- ▶ Open the driver's door (this puts the starter switch in position **0**, same as with the SmartKey removed from the starter switch). The driver's door then can be closed again.
- ▶ Remove the fuse securing the tilt/sliding panel from the fuse box (▷ page 504).



For information on which fuse box contains the fuse for the power tilt/sliding panel, see the fuse chart provided with the vehicle tool kit (▷ page 455).

- ▶ Reinsert the fuse in the fuse box.
 - ▶ Switch on the ignition (▷ page 38).
 - ▶ Push and hold the roof panel switch in direction of arrow ② (▷ page 260) until the roller sunblinds are fully closed.
 - ▶ Keep holding the roof panel switch in direction of arrow ② (▷ page 260) for approximately 1 second.
 - ▶ Pull and hold the roof panel switch in direction of arrow ① (▷ page 260) until the roller sunblinds are fully opened.
 - ▶ Keep holding the roof panel switch in direction of arrow ① (▷ page 260) for approximately 1 second.
 - ▶ Press and hold the roof panel switch in direction of arrow ③ (▷ page 260) until the tilt/sliding panel is fully raised at the rear.
 - ▶ Push and hold the roof panel switch in direction of arrow ② (▷ page 260) until the tilt/sliding panel is fully closed.
 - ▶ Keep holding the roof panel switch in direction of arrow ② (▷ page 260) for approximately 1 second.
 - ▶ Open the tilt/sliding panel using the Express-open feature (▷ page 262).
If the tilt/sliding panel opens completely, the roof is synchronized.
- If the tilt/sliding sunroof does not open completely:
- ▶ Repeat the above steps.

Driving systems

The driving systems of your vehicle are described on the following pages:

- Cruise control, with which the vehicle can maintain a preset speed.
- Airmatic* adjusts the vehicle suspension characteristics automatically and controls the vehicle level.
- Parktronic*, which serves as a parking assistant.

For information on the BAS, ABS, EBP, 4-ETS and ESP® driving systems, see “Driving safety systems” (▷ page 97).

Cruise control

The cruise control automatically maintains the speed you set for your vehicle.

The use of cruise control is recommended for driving at a constant speed for extended periods of time. You can set or resume cruise control at any speed above 20 mph (30 km/h).

The cruise control function is operated by means of the cruise control lever.

The cruise control lever is the uppermost lever on the left-hand side of the steering column (▷ page 22).

Warning!



The cruise control is a convenience system designed to assist the driver during vehicle operation. The driver is and must always remain responsible for the vehicle's speed and for safe brake operation.

Only use the cruise control if the road, traffic and weather conditions make it advisable to travel at a steady speed.

- The use of cruise control can be dangerous on winding roads or in heavy traffic because conditions do not allow safe driving at a steady speed.
- The use of cruise control can be dangerous on slippery roads. Rapid changes in tire traction can result in wheel spin and loss of control.
- Deactivate the cruise control when driving in fog.

The “Resume” function should only be operated if the driver is fully aware of the previously set speed and wishes to resume this particular preset speed.

Warning!

The cruise control brakes automatically so that the set speed is not exceeded. The brake pedal is depressed automatically to do this.

Keep in mind that the cruise control is a convenience system designed to assist the driver during vehicle operation. The driver is and must always remain responsible for the vehicle's speed and for safe brake operation.

Keep driver's foot area clear at all times, including the area under the brake pedal. Objects stored in this area may impair pedal movement which could interfere with the braking ability of the cruise control system.

Do not place your foot under the brake pedal - your foot could become caught.

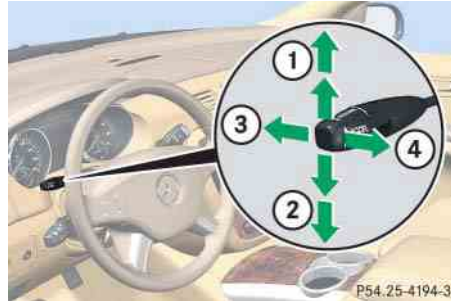

- ① Setting current or higher speed
Adjustment in 1 mph or 5 mph increments (Canada: 1 km/h or 10 km/h)
- ② Setting current or lower speed
Adjustment in 1 mph or 5 mph increments (Canada: 1 km/h or 10 km/h)
- ③ Canceling cruise control
- ④ Resuming to last set speed

Setting current speed

- ▶ Accelerate or decelerate to the desired speed.
- ▶ Briefly lift ① or depress ② the cruise control lever.

The current speed is set.

- ▶ Remove your foot from the accelerator pedal.

The cruise control is activated.

The last set speed appears in the multi-function display for approximately 5 seconds.



On uphill grades, the cruise control may not be able to maintain the set speed. Once the grade eases, the set speed will be resumed.

On downhill grades, the cruise control maintains the set speed with active braking action. In addition, on longer downhill grades the automatic transmission will automatically downshift.

Driving systems

Canceling cruise control

There are several ways to cancel the cruise control:

- ▶ Step on the brake pedal.

The cruise control is canceled. The last speed set is stored for later use.

or

- ▶ Briefly push the cruise control lever in direction of arrow ③ (▷ page 265).

The cruise control is canceled. The last speed set is stored for later use.



The last stored speed is canceled when you turn off the engine.



The cruise control switches off automatically when

- you step on the brake pedal
- you depress the parking brake pedal

The cruise control also switches off automatically when

- the vehicle speed is below 20 mph (30 km/h)
- the ESP® is in operation or switched off with the ESP® switch (▷ page 101)
- you set the automatic transmission to **N** while driving

An acoustic warning sounds and the message *Cruise control off* appears in the multifunction display.



Setting the automatic transmission to **N** while driving cancels the cruise control. However, the automatic transmission should not be set to **N** while driving except to coast when the vehicle is in danger of skidding (e.g. on icy roads).



Depressing the accelerator pedal does not deactivate the cruise control. After brief acceleration (e.g. for passing), the cruise control will resume the last speed set.

Setting a higher speed

You can increase the speed in two stages.

Adjustment in 1 mph (Canada: 1 km/h) increments



The set value is increased in 1 mph (Canada: 1 km/h) increments each time you lift the cruise control lever to the resistance point.

- ▶ Lift the cruise control lever to the resistance point in direction of arrow ① (▷ page 265) and hold it up until the desired speed is reached.

- ▶ Release the cruise control lever.

The new speed is set.

Adjustment in 5 mph (Canada: 10 km/h) increments

Warning!



You can increase the vehicle speed in 5 mph (Canada 10 km/h) increments. When using this feature, keep in mind that it may take a brief moment until the vehicle has reached the set speed.

Increase the vehicle speed to a value that the prevailing road conditions permit. Otherwise, sudden and unexpected acceleration of the vehicle could cause an accident and/or serious injury to you and others.



The set value is increased in 5 mph (Canada: 10 km/h) increments each time you lift the cruise control lever past the resistance point.

- ▶ Briefly lift the cruise control lever past the resistance point in direction of arrow ① (▷ page 265).

The vehicle speed increases in increments of 5 mph (Canada: 10 km/h).



The new speed is set and the vehicle will accelerate. Keep in mind that it may take a brief moment until the vehicle has reached the set speed.

Setting a lower speed

You can reduce the speed in two stages.



When you use the cruise control lever to decelerate, the brake system will automatically brake the vehicle if the engine's braking power does not brake the vehicle sufficiently.

Driving systems

Adjustment in 1 mph (Canada: 1 km/h) increments



The set value is decreased in 1 mph (Canada: 1 km/h) increments each time you press the cruise control lever down to the resistance point.

- ▶ Press the cruise control lever down to the resistance point in direction of arrow ② (▷ page 265) and hold it down until the desired speed is reached.
- ▶ Release the cruise control lever.

The new speed is set.

Adjustment in 5 mph (Canada: 10 km/h) increments

Warning!



You can decrease the vehicle speed in 5 mph (Canada 10 km/h) increments. When using this feature, keep in mind that it may take a brief moment until the vehicle has reached the set speed.

Decelerate the vehicle speed to a value that the prevailing road conditions permit. Otherwise, sudden and unexpected deceleration of the vehicle could cause an accident and/or serious injury to you and others.



The set value is decreased in 5 mph (Canada: 10 km/h) increments each time you press the cruise control lever down past the resistance point.

- ▶ Briefly press the cruise control lever down past the resistance point in direction of arrow ②.

The vehicle speed decreases in increments of 5 mph (Canada: 10 km/h).



The new speed is set and the vehicle will decelerate. Keep in mind that it may take a brief moment until the vehicle has reached the set speed.

Setting to last stored speed ("Resume" function)

Warning!



The speed stored in memory should only be set again if prevailing road conditions permit. Possible acceleration or deceleration differences arising from returning to the pre-set speed could cause an accident and/or serious injury to you and others.

- ▶ Briefly pull the cruise control lever in direction of arrow ④ (▷ page 265).

The cruise control resumes the last set speed.

- ▶ Remove your foot from the accelerator pedal.

The last set speed appears in the multi-function display for approximately 5 seconds.

AIRMATIC*

AIRMATIC lets you set a suspension tuning and automatically optimizes your vehicle's damping behavior and regulates the vehicle level. The system consists of two components:

- Suspension tuning:
Adaptive Damping System (ADS)*
(▷ page 269)
- Vehicle level control* (▷ page 270)

Adaptive Damping System (ADS)*

The fine tuning of the damping is dependent on:

- road surface conditions
- your driving style
- your personal settings

The ADS switch is located on the upper part of the center console.



- ① ADS switch
- ② Indicator lamp for SPORT setting
- ③ Indicator lamp for COMF setting

Driving systems

The following settings are available:

- **AUTO** (for normal driving situations)
Indicator lamps ② and ③ are off.
- **SPORT** (for sporty driving)
Indicator lamp ② comes on.
- **COMF** (for comfort driving)
Indicator lamp ③ comes on.
- ▶ Start the engine (▷ page 53).
- ▶ Press ADS switch ① repeatedly until the desired suspension tuning is reached.



The setting is stored when you turn off the engine.

Vehicle level control*

The vehicle level control automatically regulates the ride height to

- reduce fuel consumption
- improve driving safety



Changes to the vehicle level should be made while the vehicle is moving. The vehicle will then reach the set level as fast as possible.

The vehicle begins adjusting to the set vehicle level as soon as the doors or tailgate are

- unlocked
- or
- opened or closed with the vehicle unlocked

For major changes in vehicle level, the engine must be running.

Warning!



Make sure that no one is near the wheel housing or under the vehicle when you lower the vehicle while it is standing still. Limbs could become wedged into or under the vehicle.

For safety reasons, the vehicle can only be lowered with all doors and the tailgate closed. Lowering is interrupted if a door or the tailgate is opened and will continue after the door is closed again.

Warning!



Adapt your speed and driving to possible changed driving behavior of the vehicle after changing the vehicle level. The ESP® cannot prevent accidents, including those resulting from excessive speed. The ESP® cannot prevent the natural laws of physics from acting on the vehicle.



Keep in mind that in rough or uneven roads, adjusting the vehicle to a lower level may cause the vehicle underbody to come in contact with the road and result in damage to the vehicle underbody. Always make sure the vehicle has sufficient ground clearance before adjusting it to a lower level.



Before jacking up the vehicle with equipment that lifts one or more of the wheels completely off the ground, remove the SmartKey from the starter switch.



Please also note the information in the section on towing (▷ page 499).



The activation threshold is defined by the set suspension tuning (▷ page 269).



The high-speed level is not available when towing a trailer.

Basic settings

There are two setting from which to choose:

- Raised level, for driving on rough roads
- Highway level, for driving on paved roads in fair or better condition



The third available level is the highspeed level that is set automatically.

Compared to the highway level, the vehicle level changes by

- + 1.97 in (+ 50 mm) in raised level
- +/- 0 in (+ 0 mm) in highway level
- - 0.78 in (- 20 mm) in highspeed level

The vehicle lowers to highspeed level automatically when

- the vehicles speed exceeds 70 mph (112 km/h)
- the vehicles speed is between 60 mph (96 km/h) and 70 mph (112 km/h) for longer than 20 seconds



Obey local speed limits. Use prudent driving speeds appropriate to prevailing conditions.

Driving systems

Raised level

Only choose the raised level when the road conditions permit. Otherwise:

- Fuel consumption may increase.
- Handling characteristics of the vehicle may be unfavorable.



You can select the raised level at vehicle speeds of up to 25 mph (40 km/h). At a higher vehicle speed, the message  Level selection not permitted appears in the multifunction display.

- ▶ Start the engine (▷ page 53).

The switch is located on the upper part of the center console.



- ① Vehicle level control switch
- ② Indicator lamp

If indicator lamp ② is off:

- ▶ Press switch ①.



Indicator lamp ② flashes. The vehicle adjusts to the raised level.

The following message appears in the multifunction display while the level is being set:



When the raised level is reached, indicator lamp ② comes on continuously and the following message appears in the multifunction display:



The messages can be cleared by pressing button  or  on the multifunction steering wheel.

Highway level

- ▶ Close all doors and the tailgate.
- ▶ Start the engine (▷ page 53).

The switch is located on the upper part of the center console.



- ① Vehicle level control switch
- ② Indicator lamp



Keep in mind that in rough or uneven roads, adjusting the vehicle to a lower level may cause the vehicle underbody to come in contact with the road and result in damage to the vehicle underbody. Always make sure the vehicle has sufficient ground clearance before adjusting it to a lower level.

If indicator lamp ② is on:

- ▶ Press switch ① (▷ page 272).

Indicator lamp ② flashes. The vehicle adjusts to the highway level.

The following message appears in the multifunction display while the level is being set:

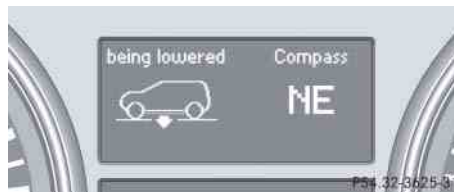

When the highway level is reached, indicator lamp ② goes out and the following message appears in the multifunction display:



The messages can be cleared by pressing button **+** or **-** on the multifunction steering wheel.



The vehicle level is set to highway level automatically when the vehicle speed is exceeding 25 mph (40 km/h).

Parktronic* (Parking assist)

Warning!



Parktronic is a supplemental system. It is not intended to, nor does it replace, the need for extreme care. The responsibility during parking and other critical maneuvers always rests with the driver.

Special attention must be paid to objects with smooth surfaces or low silhouettes (e.g. trailer couplings, painted posts, or road curbs). Such objects may not be detected by the system and can damage the vehicle.

The operational function of the Parktronic system can be affected by dirty sensors, especially at times of snow and ice. See “Cleaning the Parktronic system sensors” (▷ page 399).

Interference caused by other ultrasonic signals (e.g. working jackhammers, car wash, or the air brakes of trucks) can cause the system to send erratic indications, and should be taken into consideration.

Warning!



Make sure no persons or animals are in the area in which you are maneuvering. Otherwise you run the risk of causing injury.

The Parktronic system is an electronic aid designed to assist the driver during parking maneuvers. It visually and audibly indicates the relative distance between the vehicle and an obstacle.

The Parktronic system is automatically activated when you switch on the ignition, release the parking brake, and set the automatic transmission to position **D**, **R**, or **N**.

The Parktronic system deactivates at vehicle speeds exceeding approximately 11 mph (18 km/h). At lower vehicle speeds, the Parktronic system turns on again.

The Parktronic system also deactivates when you set the automatic transmission to position **P** or depress the parking brake pedal.

The Parktronic system monitors the surroundings of your vehicle with six sensors in the front bumper and four sensors in the rear bumper.

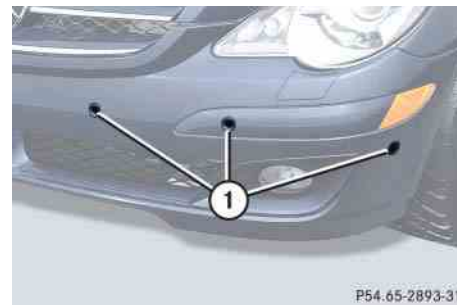

① Sensors in the front bumper

Range of the sensors

To function properly, the sensors must be free of dirt, ice, snow and slush. Clean the sensors regularly, being careful not to scratch or damaging the sensors, see “Cleaning the Parktronic* system sensors” (▷ page 399).

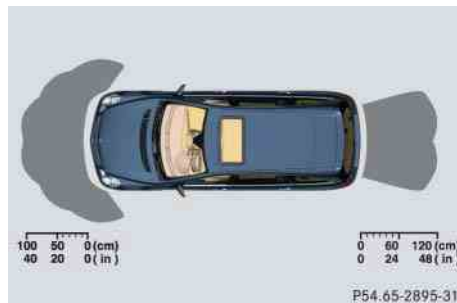
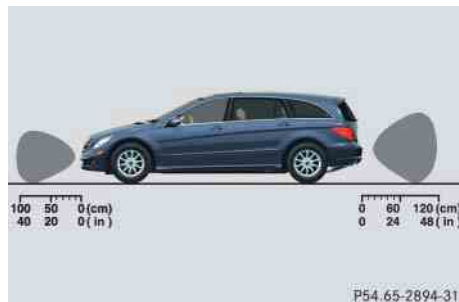

Front sensors

Center	approx. 40 in (100 cm)
Corners	approx. 24 in (60 cm)

Rear sensors

Center	approx. 48 in (120 cm)
Corners	approx. 32 in (80 cm)



During parking maneuvers, pay special attention to objects located above or below the height of the sensors (e.g. planters or trailer hitches). The Parktronic system will not detect such objects at close range and damage to your vehicle or the object may result.

Ultrasonic signals from outside sources (e.g. working jackhammers, car wash or the air brakes of trucks) may impair the operation of the Parktronic system.

Driving systems

Minimum distance

Center	approx. 8 in (20 cm)
Corners	approx. 6 in (15 cm)

If the system detects an obstacle in this range, all the distance warning segments illuminate and you hear a warning signal. If the obstacle is closer than the minimum distance, the actual distance may no longer be indicated by the system.

Warning indicators

Visual signals indicate to the driver the relative distance between the sensors and an obstacle. The warning indicator for the front area is located above the center air vents in the dashboard. The warning indicator for the rear area is located in the rear passenger compartment under the roof.

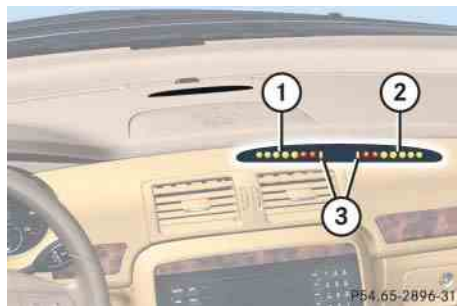

Front area warning indicator

- ① Left side of the vehicle
- ② Right side of the vehicle
- ③ Readiness indicators

Each warning indicator is divided into five yellow and two red distance segments for either side of the vehicle. The Parktronic system is ready when the yellow readiness indicators ③ are illuminated.

The current transmission position determines which warning indicator will be activated.

Transmission position	Warning indicator
D	Front area activated
R or N	Front and rear area activated
P	Neither activated

As your vehicle approaches an object, one or more distance segments will illuminate, depending on the distance. When the seventh distance segment illuminates, you have reached the minimum distance.

- **Front area:** An intermittent acoustic warning will sound as the first red distance segment illuminates and a constant acoustic warning lasting a maximum of 2 seconds will sound for the second red distance segment. The signal is canceled when the automatic transmission is set to position **P** or the parking brake is set.
- **Rear area:** An intermittent acoustic warning will sound as the first red distance segment illuminates and a constant acoustic warning lasting a maximum of 2 seconds will sound for the second red distance segment. The signal is canceled when the automatic transmission is set to position **D**, **P**, or the parking brake is set.

Switching the Parktronic system on/off

You can switch off the Parktronic system manually.

The Parktronic switch is located in the upper part of the center console.



- ① Parktronic switch
- ② Indicator lamp

Switching off the Parktronic system

- ▶ Press Parktronic switch ①.
- Indicator lamp ② comes on.

Switching on the Parktronic system

- ▶ Press Parktronic switch ① once more.
- Indicator lamp ② goes out.



The Parktronic system switches on automatically when you switch on the ignition (▷ page 38).

Driving systems

Parktronic system malfunction

If only the red distance segments illuminate and an acoustic warning sounds, there is a malfunction in the Parktronic system. The Parktronic system will automatically switch off after 20 seconds and the indicator lamp in the Parktronic switch comes on.

- ▶ Have the Parktronic system checked by an authorized Mercedes-Benz Light Truck Center as soon as possible.

If only the red distance segments illuminate and no acoustic warning sounds, the Parktronic system sensors are dirty (e.g. slush, snow or ice) or there is an interference from other radio or ultrasonic signals (e.g. working jackhammers, car wash or the air brakes of trucks). The Parktronic system will automatically switch off after 20 seconds and the indicator lamp in the Parktronic switch comes on.

- ▶ Switch off the ignition (▷ page 38).
 - ▶ Clean the Parktronic system sensors (▷ page 399).
 - ▶ Switch on the ignition (▷ page 38).
- or
- ▶ Check the Parktronic system operation at another location to rule out interference from outside radio or ultrasonic signals.

▼ Loading

Roof rack*

Warning!



Only use the roof rack when the basic carrier bars have been completely mounted. The left and right rails are only stabilized by means of the basic carriers being mounted.

Follow the manufacturer's installation instructions. Otherwise, an improperly attached roof rack system or its load could become detached from the vehicle.

Do not exceed the maximum roof load of 220 lb (100 kg).

Take into consideration that when the roof rack is loaded, the handling characteristics are different from those when operating the vehicles without the roof rack loaded.



Use only those roof racks approved by Mercedes-Benz for your vehicle model. Follow manufacturer's installation instructions. The vehicle could otherwise be damaged.

When loading the roof rack, make sure

- the tilt/sliding sunroof* (or tilt/sliding panel*) can be completely raised at the rear
- the tilt/sliding panel and the tailgate can be completely opened

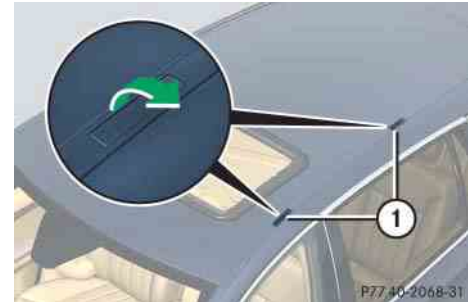

① Trim cover

- ▶ Flip roof trim covers ① open.
- ▶ Attach the roof rack to the attachment points under roof trim covers ①.

Follow roof rack manufacturer's installation instructions.

For further information, inquire at your Mercedes-Benz Light Truck Center.

Loading

Loading instructions

Warning!



Always fasten items being carried as securely as possible using cargo tie-down rings and fastening materials appropriate for the weight and size of the load.

In an accident, during hard braking or sudden maneuvers, loose items will be thrown around inside the vehicle, and can cause injury to vehicle occupants unless the items are securely fastened in the vehicle.

To help avoid personal injury during a collision or sudden maneuver, always use partition net when transporting cargo.

Never drive vehicle with the tailgate open. Deadly carbon monoxide (CO) gases may enter vehicle interior resulting in unconsciousness and death.

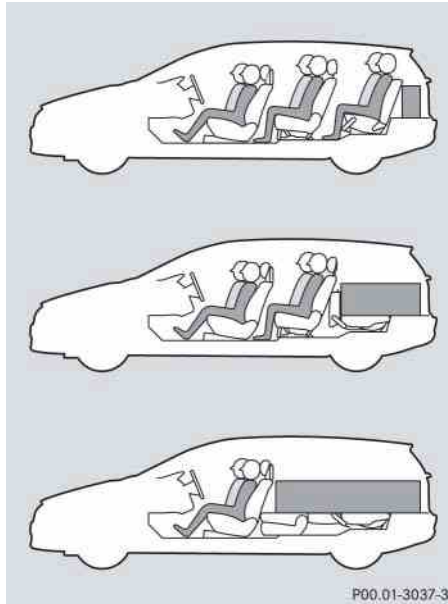

The gross vehicle weight which is the weight of the vehicle including fuel, tools, spare wheel, installed accessories, passengers, and luggage/cargo must never exceed the load limit and the Gross Vehicle Weight Rating (GVWR) for your vehicle as specified on the placard(s) located on the driver's door B-pillar (▷ page 510). In addition, the load must be distributed in such a way so that the weight on each axle never exceeds the Gross Axle Weight Rating (GAWR) for the front and rear axle. The GVWR and GAWR for your vehicle are indicated on the certification label which can be found on the driver's door B-pillar (▷ page 510).

For more information, see "Tire and Load Information" (▷ page 357).

The handling characteristics of a fully loaded vehicle depend greatly on the load distribution. It is therefore recommended to load the vehicle according to the illustrations shown, with the heaviest items being placed towards the front of the vehicle.

Please pay attention to and comply with the following instructions when loading the vehicle and transporting cargo:

- Always place items being carried against front or rear seat backrests, and fasten them as securely as possible.
- The heaviest portion of the cargo should always be kept as low as possible against front or rear seat backrests.



The cargo compartment is the preferred place to carry objects. The expanded cargo compartment (> page 283) should only be used for items which do not fit in the cargo compartment alone.

Cargo tie-down rings

Your vehicle is equipped with eight cargo tie-down rings.

Carefully secure cargo by applying even load on all rings with rope of sufficient strength to hold down the cargo.



While the partition net* (> page 290) will help protect you from smaller objects, it cannot prevent the movement of large, heavier objects into the passenger compartment in an accident. Such items must be properly secured using the cargo tie-down rings in the cargo compartment floor.

Cargo compartment

Four cargo tie-down rings are located in the cargo compartment.

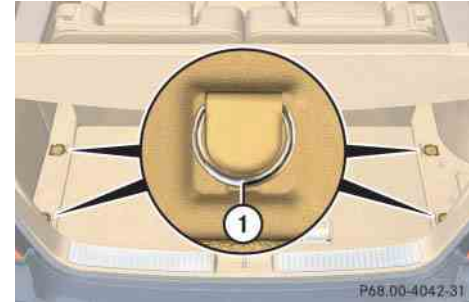

① Cargo tie-down ring

Loading

Second seat-row

Two cargo tie-down rings are located in the footwell behind the driver's and passenger seat.

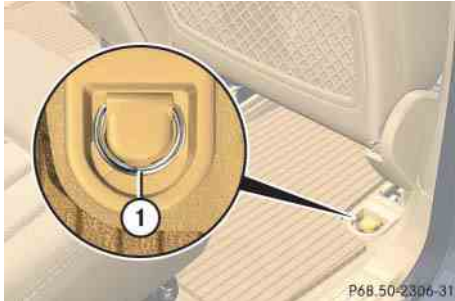

① Cargo tie-down ring

Third seat-row

Two cargo tie-down rings are located in the footwell behind the second-row seats.

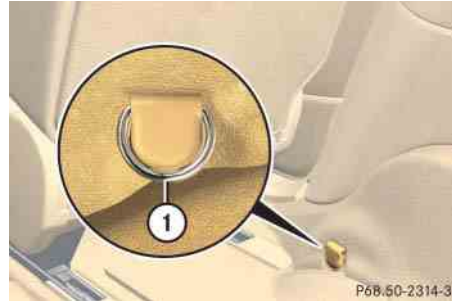

① Cargo tie-down ring

Hooks

Two hooks are located on the rear compartment trim panels, one on each side.

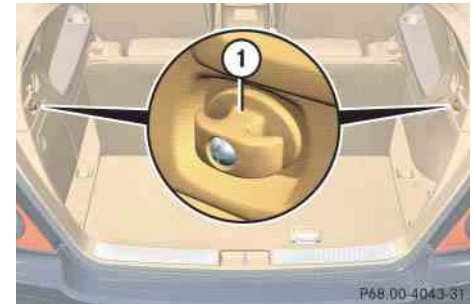

① Hook

Use the hooks to secure light weight items only. The maximum permissible weight per hook is 9 lbs (4 kg).

Expanding cargo compartment

You can separately fold each seat of the rear passenger compartment to expand the cargo compartment.

Warning!



When expanding the cargo compartment, always fully fold the corresponding seats and always use the partition net (▷ page 290) when transporting cargo.

Unless you are transporting cargo, the backrests must remain properly locked in the upright position.

In an accident, during hard braking or sudden maneuvers, loose items will be thrown around inside the vehicle, and can cause injury to vehicle occupants unless the items are securely fastened in the vehicle.

Always use the cargo tie down rings (▷ page 281).

Warning!



Never drive vehicle with the tailgate open. Deadly carbon monoxide (CO) gases may enter vehicle interior resulting in unconsciousness and death.



When the second-row seats are folded forward, the front seats may not be moved to the rearmost position. Otherwise you could damage the front and second-row seats.

Expanding cargo compartment in part

Folding third-row seats

- ▶ Push in the head restraints of the third-row seats all the way (▷ page 139).

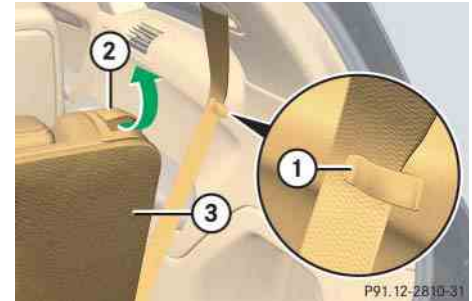

- ① Seat belt holder
- ② Release handle
- ③ Seat backrest

- ▶ Remove cargo compartment cover blind* (▷ page 288), if so equipped.
- ▶ Place seat belt in seat belt holder ①. ▷▷

Loading

- ▷▷ Pull release handle ② on seat backrest ③ in direction of arrow.

Seat backrest ③ is released.

- ▶ Move seat backrest ③ slightly forward.

Seat cushion ④ is released and folds forward automatically.

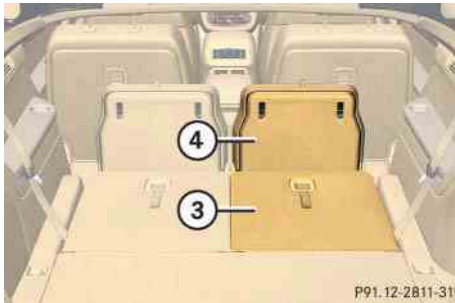

- ③ Seat backrest
- ④ Seat cushion

- ▶ Fold seat backrest ③ to a horizontal position.

Expanding cargo compartment fully

Warning



Folded second-row seats are intended to serve as cargo compartment expansion in conjunction with folded third-row seats only. Do not fold the second-row seats and allow third-row seat occupants to use folded second-row seats as a footrest while driving. Third-row seat occupants must, like all vehicle occupants, keep both feet on the floor in front of their seat. Otherwise, occupants could slide under the seat belt in a collision. If occupants slide under it, the belt would apply force at the abdomen or neck. That could cause serious or even fatal injuries.

Do not fold the second-row seats and allow third-row seat occupants to use folded second-row seats as a table while driving. Objects placed on folded second-row seats may come loose during braking, vehicle maneuvers, or an accident and be thrown around in the vehicle interior. Objects thrown around in the vehicle interior may cause an accident and/or serious personal injury.



When folding the seats, it is important that you fold the second-row seats first, and then fold the third-row seats.

Folding second-row seats



When the second-row seats are folded forward, the front seats may not be moved to the rearmost position. Otherwise you could damage the front and second-row seats.

- ▶ Move the seat to be folded to its rearmost position (▷ page 137).
- ▶ Remove the rear center console*, if so equipped (▷ page 308).



The rear center console* can remain installed, if installed in the most forward position (▷ page 309). However, the cargo compartment floor will then not be an even plane.

- ▶ Remove the head restraint from the second-row seat (▷ page 140).



- ▶ Place the head restraint on the seat cushion.
The guide bars must be facing forward.
- ▶ Push the head restraint against the seat backrest in direction of the arrow.



- ① Seat backrest
- ② Seat cushion
- ③ Release lever



Make sure to remove the head restraint from the seat backrest and place it on the seat cushion as described before folding the seat. Otherwise, the seat or head restraint may be damaged.



Loading

- ▷▷ Pull release lever ③ past the resistance point in direction of arrow as far as it will go.

Seat backrest ① is released.

- ▶ Fold seat backrest ① forward until it fully rests on seat cushion ② in a horizontal position.
- ▶ Push down on folded seat backrest ① until it engages in position.

Folding third-row seats

- ▶ Push in the head restraints of the third-row seats all the way (▷ page 139).

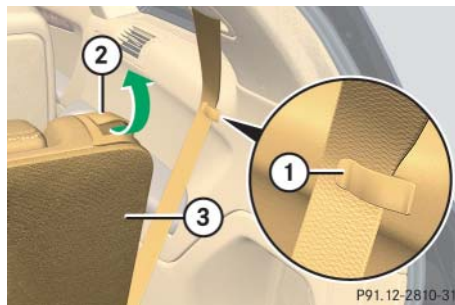

- ① Seat belt holder
- ② Release handle
- ③ Seat backrest

- ▶ Place seat belt in seat belt holder ①.

- ▶ Remove cargo compartment cover blind* (▷ page 288), if so equipped.
- ▶ Pull release handle ① on seat backrest ② in direction of arrow.
Seat backrest ② is released.
- ▶ Slowly move seat backrest ② forward.
Seat cushion ⑦ is released and folds forward automatically.

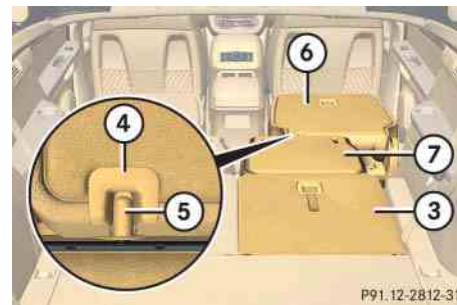

- ③ Seat backrest (third-row seat)
- ④ Recess (on second-row seat)
- ⑤ Guide pin
- ⑥ Seat backrest (second-row seat)
- ⑦ Seat cushion (third-row seat)

- ▶ Fold seat cushion ⑦ to a horizontal position.

Guide pin ⑤ must engage in recess ④ of seat backrest ⑥.



The second-row seats must be in their rearmost position (▷ page 137).

- ▶ Fold seat backrest ③ to a horizontal position.

Returning seats to their original position

- ▶ Carry out the steps described on (▷ page 283) to (▷ page 286) in reverse order.
- ▶ Make sure all seats are properly locked in position.

Warning



Make sure all seats are properly locked in position before driving off. Do not drive with seats not properly locked.

Never ride in a moving vehicle with the seat not properly locked as this can be dangerous. The seat could move forward and the seat backrest could fold. You could slide under the seat belt during braking, vehicle maneuvers, or in an accident. If you slide under it, the belt would apply force at the abdomen or neck. That could cause serious or even fatal injuries.

The seat backrest and seat belt provide the best restraint when the wearer is in a nearly upright position and the belt is properly positioned on the body.

The second-row seats have red markings on the seat base that indicate when a second-row seat is not properly locked.

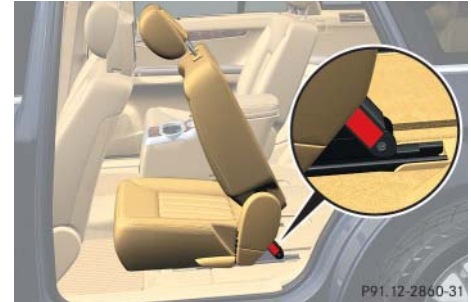

- ▶ When the red marking on a seat base is visible, push seat backrest back until the seat audibly engages.

With the seat properly locked in position, you will not see the red marking on the seat base.

Loading

Cargo compartment cover blind*

The cargo compartment cover blind can be installed behind the third-row seats or the second-row seats.



With the cargo compartment cover blind installed, do not pile luggage higher than the lower edges of the rear side windows.



The cargo compartment cover blind has two extensions which are connected to the cargo compartment cover blind by cords.

The cargo compartment cover blind must be extended for installation behind the second-row seats (▷ page 288).

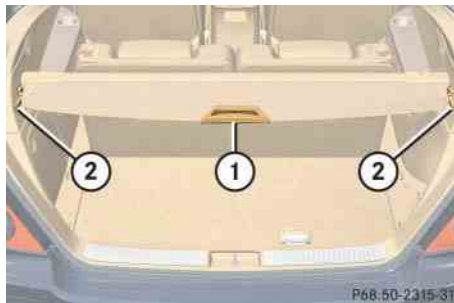

Blind installed behind third-row seats

- ① Handle
- ② Mount

Rolling out blind

- ▶ Pull blind on handle ① across the cargo compartment.
- ▶ Guide blind into mounts ② and release.

Rolling up blind

- ▶ Disengage blind and guide retraction by its handle ①.

Removing blind

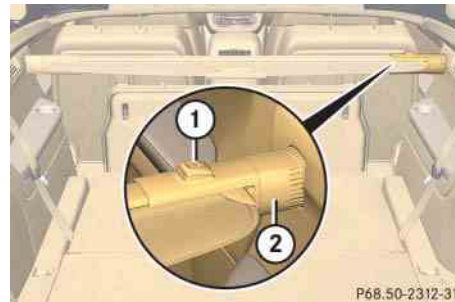

Blind installed behind second-row seats

- ① Release button
- ② Blind

- ▶ Roll the blind up.
- ▶ Push release button ①.
- ▶ Pull blind ② to the left against the spring pressure until the spring in the blind audibly engages.
- ▶ Remove the blind.

Installing blind

- ▶ For installation behind second-row seats, install the blind extensions (▷ page 289).



For installation behind third-row seats, the blind extensions must not be installed. Otherwise, the blind could be damaged.

- ▶ Remove the covers from the mounts in side rim.
- ▶ Place left side of blind ② in left mount.
- ▶ Position right side of blind ② over right mount.
- ▶ Press release button ① and guide blind ② into mount.

Extending blind



The cargo compartment cover blind has two extensions which are connected to the cargo compartment cover blind by cords.

The cargo compartment cover blind must be extended for installation behind the second-row seats.

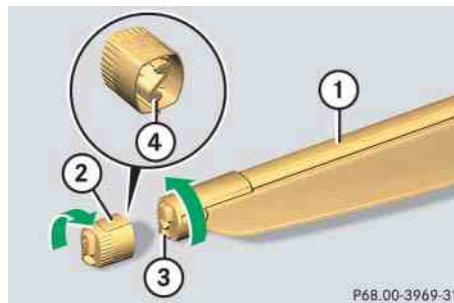

- ① Blind
- ② Extension
- ③ Guidings
- ④ Guide pins

- ▶ Position extension ② over blind ①.
- ▶ Guide pins ④ must point directly at guidings ③.
- ▶ Turn extension ② and blind ① in opposite directions as indicated by the arrows.
- ▶ Guide pins ④ must engage in guidings ③.

When not in use, you can attach the cover blind extensions to the cover blind.

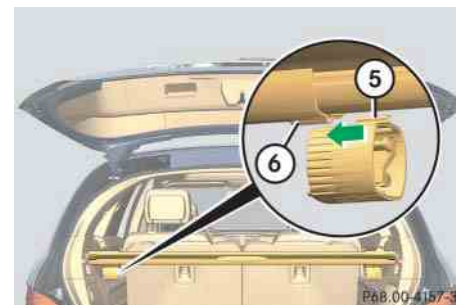

- ⑤ Extension guide rail
- ⑥ Mounting



Loading

- ▷▷ With the cargo compartment cover installed behind third-row seats, insert extension guide rail ⑤ into mounting ⑥.
- ▶ Push extension into mounting ⑥ as far as it will go.

Partition net*

Warning!



Make sure the partition net is properly engaged top and bottom position and the tightening belts are securely fastened.

Never use a damaged partition net.

To help avoid personal injury from smaller objects being thrown around in the occupant compartment during a collision or sudden maneuver, always use partition net when transporting cargo.

The partition net cannot prevent the movement of large, heavier objects into the passenger compartment in an accident. Such items must be properly secured using the cargo tie-down rings in the cargo compartment floor (▷ page 281).

Passenger use of seats behind installed partition net is restricted because of the footwell being taken up by the net.

Use of the partition net is a particularly important safety factor when the vehicle is loaded higher than the top of the seat backrests with smaller objects.

The partition net can be installed in two locations:



① Holder in B-pillar

② Holder in C-pillar

- With the cargo compartment expanded in part (▷ page 283), use holders above C-pillars ② and the cargo tie-down rings in the third-row footwell (▷ page 282).

- With the cargo compartment fully expanded (▷ page 284), use holders above B-pillars ① and the cargo tie-down rings in the second-row footwell (▷ page 282).
- ▶ Open the zipper on the partition net package.
- ▶ Roll out the partition net.
- ▶ Unfold the partition net.

The partition net bar must audibly engage.

Engaging partition net

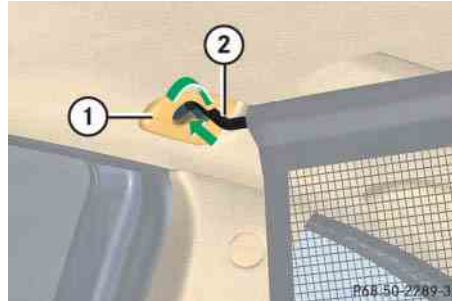

- ① Holder
- ② Mounting hook
- ▶ One after the other, engage mounting hooks ② in holder ①.
- ▶ Push mounting hooks ② forward into holder ①.

Tightening partition net in second row

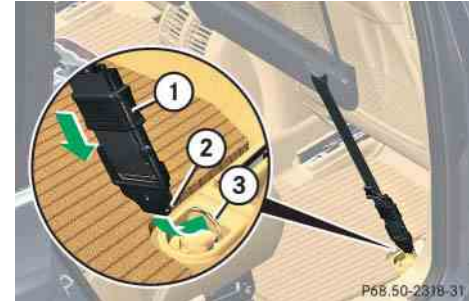

- ① Tensioner
- ② Hook
- ③ Tie-down ring
- ▶ Guide hook ② towards tie-down ring ③.
- ▶ Pull tensioner ① down in direction of arrow towards tie-down ring ③.
- ▶ Insert hook ② in tie-down ring ③.
- ▶ Release tensioner ①.

Loading

Removing partition net

- ▶ Release tensioning of the strap by pulling tensioner ① down.
- ▶ Disengage hook ② from tie-down ring ③.
- ▶ Remove mounting hooks ② from holder ①, see “Engaging partition net” (> page 291).
- ▶ Roll up the partition net.
- ▶ Press the red button on the partition net bar.
- ▶ Fold partition net bar.
- ▶ Roll up the partition net.
- ▶ Close zipper on partition net package.

Tightening partition net in third row

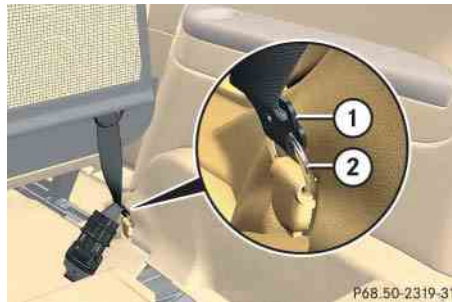

- ① Hook
- ② Tie-down ring

- ▶ Insert hook ① in tie-down ring ②.

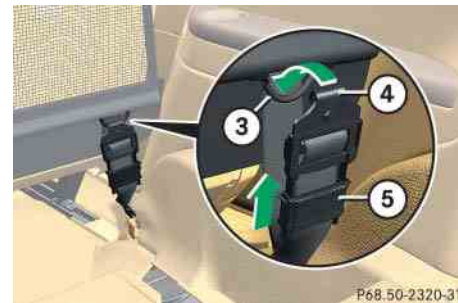

- ③ Partition net ring
- ④ Tensioner hook
- ⑤ Tensioner

- ▶ Pull tensioner ⑤ up in direction of arrow towards partition net ring ③.
- ▶ Insert tensioner hook ④ in partition net ring ③ located at lower edge of the partition net.
- ▶ Release tensioner ①.

Removing partition net

- ▶ Release tensioning of the strap by pulling tensioner ⑤ up.
- ▶ Disengage tensioner hook ④ from partition net ring ③.
- ▶ Disengage hook ① from tie-down ring ②.
- ▶ Remove mounting hooks ② from holder ①, see “Engaging partition net” (▷ page 291).
- ▶ Roll up the partition net.
- ▶ Press the red button on the partition net bar.
- ▶ Fold partition net bar.
- ▶ Roll up the partition net.
- ▶ Close zipper on partition net package.

Useful features

Storage compartments

Warning!



To help avoid personal injury during a collision or sudden maneuver, exercise care when storing objects in the vehicle. Put luggage or cargo in the cargo compartment if possible. Do not pile luggage or cargo higher than the seat backs.

Always use partition net* when transporting cargo. Partition net* cannot secure hard or heavy objects.

Parcel nets cannot secure hard or heavy objects.

Keep compartment lids closed. This will help to prevent stored objects from being thrown about and injuring vehicle occupants during

- braking
- vehicle maneuvers
- an accident

Glove box/CD-changer*



Depending on vehicle equipment, a CD-changer* and an AUX-socket are located in the glove box.



- ① Glove box lid release
- ② Glove box lid

Opening the glove box

- ▶ Pull lid release ① in direction of arrow.
Glove box lid ② opens downward.

Closing the glove box

- ▶ Push glove box lid up to close.

Releasing CD-changer*

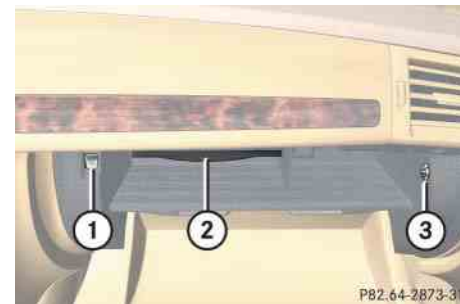

- ① Release button
- ② CD-changer
- ③ AUX-socket

- ▶ Open the glove box.
- ▶ Press release button ①.

CD-changer ② is released and swings down automatically.

For information on CD-changer operation, see separate Modular COMAND System operating instructions.

Closing CD-changer*

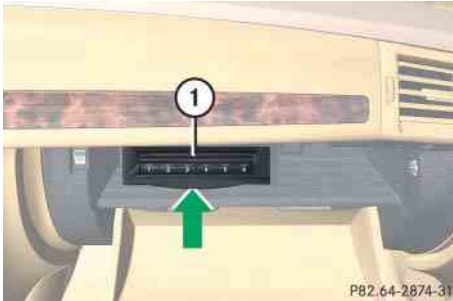

① CD-changer

- ▶ Gently push CD-changer ① up in direction of arrow until it engages.

For information on CD-changer operation, see separate Modular COMAND System operating instructions.

Locking and unlocking the glove box separately

You can lock the glove box separately, e.g. when the vehicle is in the shop for service.

- ▶ Take the mechanical key out of the SmartKey or SmartKey with KEYLESS-GO* (▷ page 459).

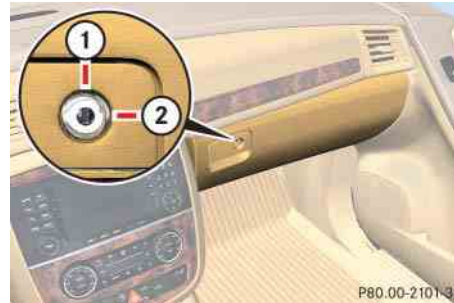

- ① Unlocking glove box
- ② Locking glove box

- ▶ Insert mechanical key into glove box lock.
- ▶ Turn mechanical key to position ②.
- ▶ Turn mechanical key to position ① to unlock the glove box.



The separate locking status of the glove box can be canceled by means of the mechanical key only.

Useful features

Storage compartment in front center console

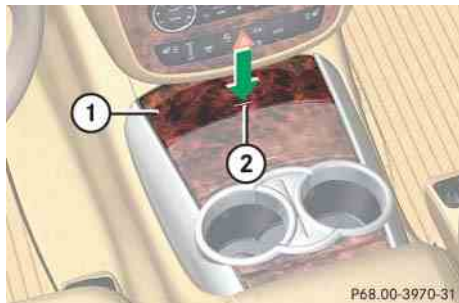

- ① Cover
- ② Chrome label

- ▶ Tab lightly on chrome label ② of cover ①.

Cover ① swings open.

Additional storage compartment in front center console

A storage compartment is located in front of the armrest in the front center console. The storage compartment also contains a power outlet (▷ page 306).

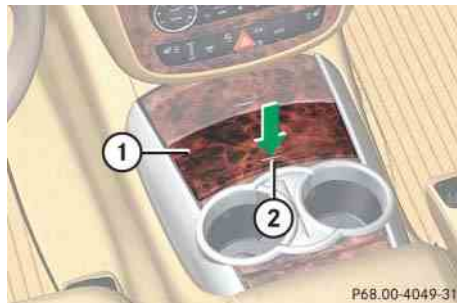

- ① Cover
- ② Chrome label

- ▶ Tab lightly on chrome label ② of cover ①.

Cover ① swings open.



If your vehicle is equipped with a smoking package*, the storage compartment contains an ashtray with cigarette lighter (▷ page 303) instead.

Front armrest storage compartments

Two storage compartments are located below the armrest. Both can be opened separately.

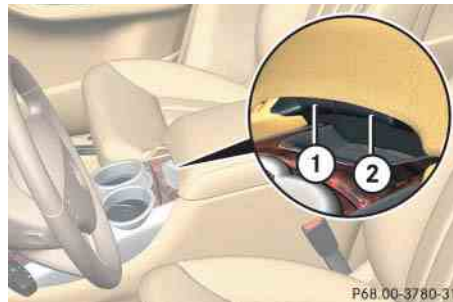

- ① Button to open storage tray
- ② Button to open storage compartment



- ③ Storage tray
- ④ Coinholders

Opening the storage tray

- ▶ Press button ① and lift up armrest.
Two coin holders ④ are located in front of storage tray ③.

Opening the storage compartment

- ▶ Press button ② and lift up armrest.

Rear armrest storage compartment*

A storage compartment is located in the armrest of the rear center console* between the second-row seats.



- ▶ Press button under armrest and lift up armrest.

Rear storage compartment

A storage compartment is located in front of the second-row seats.

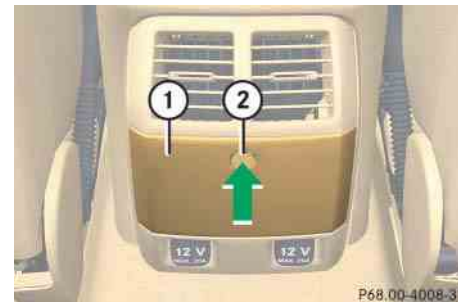

- ① Storage compartment cover
- ② Release button

- ▶ Press release button ① on storage compartment cover ②.

The storage compartment cover opens automatically.



If your vehicle is equipped with a smoking package*, the storage compartment contains an ashtray (> page 304).

Useful features

Third-row storage compartment

Storage compartments are located on the side trims of the third-row seats.

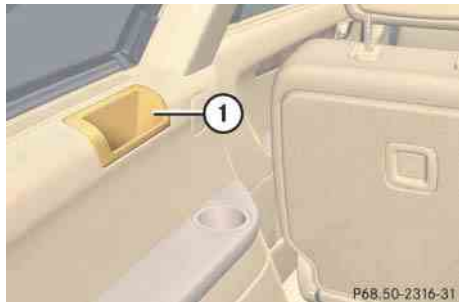

① Storage compartment



If your vehicle is equipped with a 3-zone automatic climate control*, the storage compartment is replaced by adjustable air vents (▷ page 247).

Parcel nets

Warning!



Do not place objects with a combined weight of more than 4.4 lbs (2 kg) into the parcel net on the back of the front passenger seat. Otherwise, the Occupant Classification System OCS (▷ page 85) may not be able to properly approximate the occupant weight category.

Parcel nets are intended for storing light-weight items only.

Heavy objects, objects with sharp edges, or fragile objects may not be transported in the parcel nets. In an accident, during hard braking, or sudden maneuvers, they could be thrown around inside the vehicle and cause injury to vehicle occupants.

Parcel nets cannot protect transported goods in the event of an accident.

Parcel net in front passenger footwell

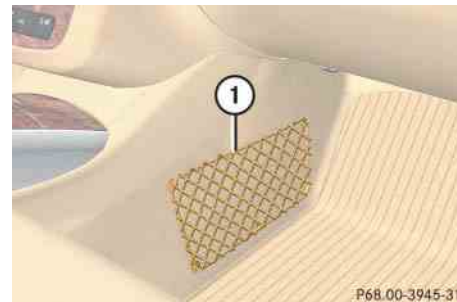

① Parcel net

Parcel nets on front seat backrests



① Parcel net

Parcel net in cargo compartment

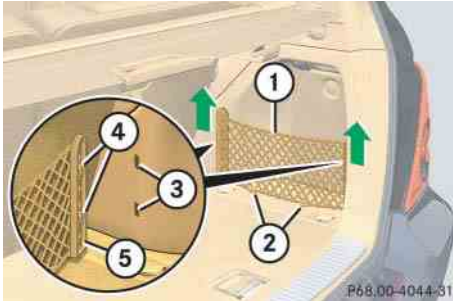

- ① Parcel net
- ② Clips
- ③ Mounting openings
- ④ Mounting lug
- ⑤ Rail

- ▶ Take parcel net ① out of lower clips ②.
- ▶ Push rails ⑤ up slightly in direction of arrows.
- ▶ Pull mounting lugs ④ out of mounting openings ③.
- ▶ Install parcel net ① in reverse order.

Cup holders

Warning!



In order to help prevent spilling liquids on vehicle occupants and/or vehicle equipment, only use containers that fit into the cup holder. Use lids on open containers and do not fill containers to a height where the contents, especially hot liquids, could spill during braking, vehicle maneuvers, or an accident. Liquids spilled on vehicle occupants may cause serious personal injury. Liquids spilled on vehicle equipment may cause damage not covered by the Mercedes-Benz Limited Warranty.

When not in use, keep cup holders closed. An open cup holder may cause injury to you or others when contacted during braking, vehicle maneuvers, or in an accident.

Keep in mind that objects placed in a cup holder may come loose during braking, vehicle maneuvers, or an accident and be thrown around in the vehicle interior. Objects thrown around in the vehicle interior may cause an accident and/or serious personal injury.

Cup holders in front center console

A cupholder and a card/ticket holder with bottle opener are located in the front center console.



- ① Cup holders

Useful features

Card/ticket holder with bottle opener

A card/ticket holder and a bottle opener are located in the cup holder of the front center console.

Cards and tickets can be inserted into the slot in the middle. The card/ticket holder is removable and has a bottle opener underneath.

Removing



① Card/ticket holder with bottle opener

- ▶ Lift card/ticket holder ① at the rear and take it out.

The bottle opener is located underneath the card/ticket holder and has openers for crown caps and screw caps.

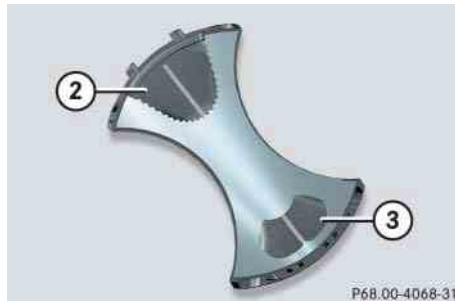

- ② Opener for screw caps
- ③ Opener for crown caps



With the card/ticket holder, you can also take the rubber inlet from the cupholder for cleaning.

Reinserting

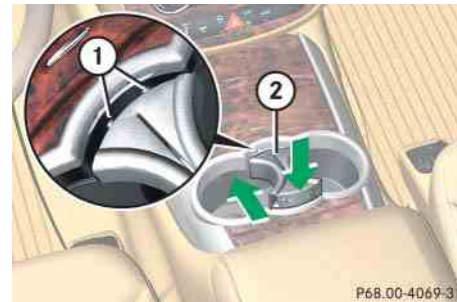

- ① Tabs
- ② Card/ticket holder

- ▶ Guide tabs ① into openings.
- ▶ Guide rear of card/ticket holder ② into the cupholder.

Cup holder in front of second-row seats

A cupholder is located in front of the second-row seats.



Vehicles with rear center console* (▷ page 308) are not equipped with cupholders in front of the second-row seats.

Opening cup holder

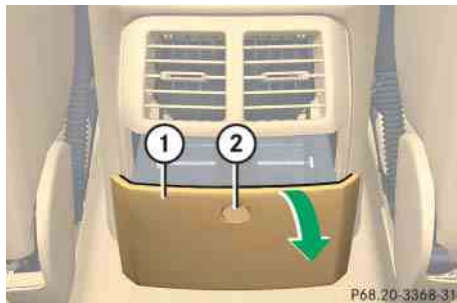

- ① Storage compartment cover
- ② Release button

- ▶ Press release button ② on storage compartment cover ①.
- Storage compartment cover ① opens automatically.
- ▶ Press storage compartment cover ② down in direction of arrow as far as it will go.

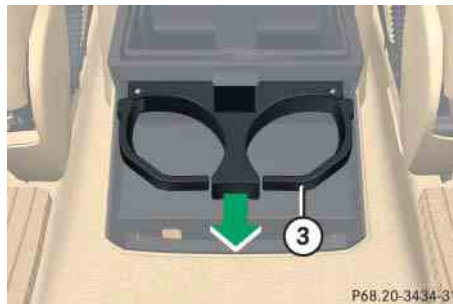

- ③ Cup holder
- ▶ Pull out cup holder ③ in direction of arrow as far as it will go.

Closing cup holder

- ▶ Push cup holder in until it engages.
- ▶ Close storage compartment cover.



Close the cup holder when not in use and before folding the second-row seats.

Useful features

Cupholders in rear center console*

Cupholders are located on the rear center console* between the second-row seats.



① Cup holders

Cupholders in third-row side trim

Cupholders are located in the side trims of the third-row seats.

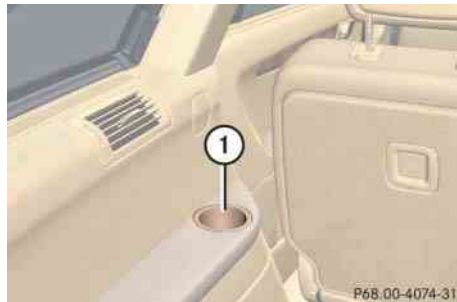

① Cup holder

Ashtrays*

Your vehicle is equipped with an ashtray and a cigarette lighter (▷ page 305) located in the front center console and an ashtray located in front of the second-row seats (▷ page 304).



If your vehicle is not equipped with a smoking package*, it has a storage compartment (▷ page 296) with a power outlet (▷ page 306) instead.

Ashtray in the front center console

Opening the ashtray

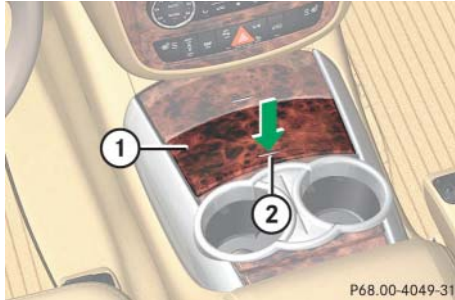

- ① Cover
- ② Chrome label

- ▶ Tab lightly on chrome label ② of cover ①.

Cover ① swings open.

Removing ashtray insert

Warning!



Remove ashtray only with vehicle standing still. Set the parking brake to secure vehicle from movement. Set automatic transmission to **P**. With the automatic transmission set to **P**, turn off the engine.



- ① Cover plate
- ② Ashtray insert

- ▶ Grip ashtray insert ② on the sides and pull it out upwards.

Reinstalling ashtray insert

- ▶ Insert ashtray insert ② and push down until the ball catch engages.
- ▶ Close ashtray cover plate ①.

Useful features

Rear seat ashtray (second row)



Vehicles with rear center console* (▷ page 308) are not equipped with an ashtray in front of the second-row seats.



Close the ashtray when not in use and before folding the second-row seats.

Opening the ashtray

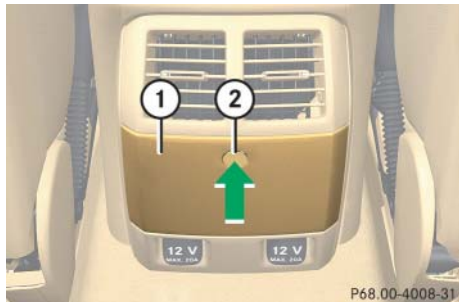

- ① Ashtray cover
- ② Release button

- ▶ Press release button ① on ashtray cover ②.

The ashtray cover opens automatically.

Removing ashtray insert

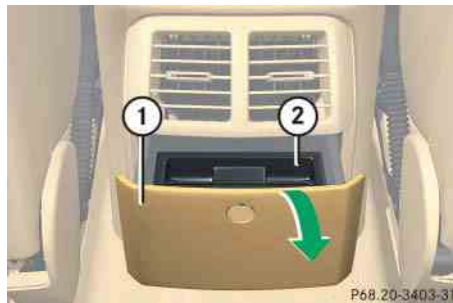

- ① Ashtray cover
- ② Ashtray insert

- ▶ Open ashtray cover ①.
- ▶ Press ashtray cover ② down in direction of arrow as far as it will go.

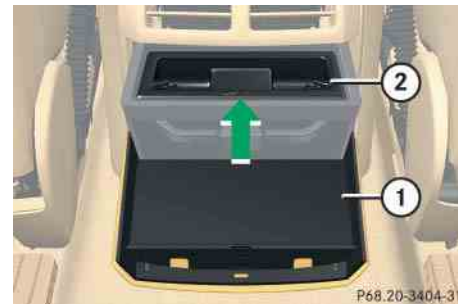

- ① Ashtray cover
- ② Ashtray insert

- ▶ Push on ashtray insert ② and pull it out upwards.

Reinstalling ashtray insert

- ▶ Insert ashtray insert ② into opening.
- ▶ Push down ashtray insert ② until it engages.
- ▶ Close ashtray cover ①.

Cigarette lighter*

Warning!

Never touch the heating element or sides of the cigarette lighter; they are extremely hot. Hold the knob only.

When leaving the vehicle always remove the SmartKey or SmartKey with KEYLESS-GO* from the starter switch, take it with you, and lock the vehicle. Do not leave children unattended in the vehicle, or with access to an unlocked vehicle. Unsupervised use of vehicle equipment may cause an accident and/or serious personal injury.

- ▶ Switch on the ignition (▷ page 38).



① Cover plate

② Cigarette lighter

- ▶ Open cover plate ① (▷ page 302).
- ▶ Push in cigarette lighter ② (▷ page 303).

The cigarette lighter will pop out automatically when hot.



The lighter socket can accommodate 12V DC electrical accessories (up to a maximum of 85 W) designed for use with the standard “cigarette lighter” plug type. Keep in mind, however, that connecting accessories to the lighter socket (for example extensive connecting and disconnecting, or using plugs that do not fit properly) can damage the lighter socket. With the socket damaged, the lighter may no longer be able to be placed in the heating (pushed-in) position, or the lighter may pop out too early with the lighter not hot enough.

To help avoid damaging the cigarette lighter socket, we recommend connecting 12V DC electrical accessories designed for use with the standard “cigarette lighter” plug type to the 12V power outlets (▷ page 306) in your vehicle whenever possible.

Useful features



The cigarette lighter is not designed for use with the electric air pump (▷ page 483). Use a power outlet (▷ page 306) for electric air pump operation.



If the engine is off, and the cigarette lighter is being used extensively, the vehicle battery may become discharged.

Power outlets



If you use all power outlets in the vehicle, make sure that the maximum current drawn does not exceed 55 A.



The power outlets can be used to accommodate electrical consumers (e.g. air pump, auxiliary lamps) up to a maximum of 240 W.

If the engine is off, and the outlets are being used extensively, the vehicle battery may become discharged.

Power outlets are located

- in the additional storage compartment in front center console (▷ page 306)
- in the front passenger footwell (▷ page 307)
- in the second-row footwell (▷ page 307)
- on the right-hand side of the cargo compartment (▷ page 307)

Power outlet in front center console



① Cover plate

② Power outlet cover

- ▶ Open cover plate ① (▷ page 296).
- ▶ Switch on the ignition (▷ page 38).
- ▶ Pull out cover ② and insert electrical plug (cigarette lighter type).



If your vehicle is equipped with a smoking package*, the storage compartment contains an ashtray with cigarette lighter (▷ page 303) instead.

Power outlet in front passenger footwell



- ▶ Switch on the ignition (▷ page 38).
- ▶ Flip up cover and insert electrical plug (cigarette lighter type).

Power outlets in second-row footwell



- ▶ Switch on the ignition (▷ page 38).
- ▶ Flip up cover and insert electrical plug (cigarette lighter type).

Power outlet in cargo compartment



- ▶ Switch on the ignition (▷ page 38).
- ▶ Flip up cover and insert electrical plug (cigarette lighter type).

Useful features

Rear center console*

The rear center console is located between the second-row seats.

The rear center console contains:

- Storage compartment (▷ page 297)
- Cupholder (▷ page 302)
- DVD-player* (see separate COMAND operating instructions)



When fully expanding the cargo compartment, the rear center console has to be removed from the vehicle in order for the cargo compartment floor to be an even plane (▷ page 284).

Removing

Warning!



Remove all containers that may be stored in the cupholders of the rear center console. Otherwise liquids could spill on vehicle occupants and/or vehicle equipment. Hot liquids spilled on vehicle occupants may cause serious personal injury. Liquids spilled on vehicle equipment may cause damage not covered by the Mercedes-Benz Limited Warranty.



To prevent damage to the rear center console and/or its components, make sure the storage compartment (▷ page 297) and the DVD-console lid* (see separate COMAND operating instructions) are closed before removing the rear center console.



Remove all items from the storage compartment (▷ page 297) of the rear center console to reduce the weight of the rear center console.

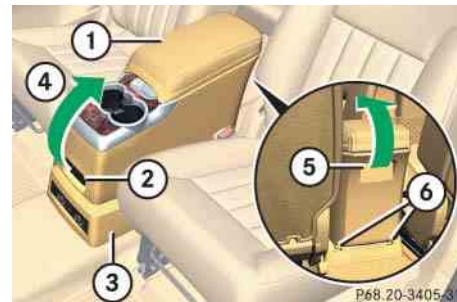

- ① Rear center console
- ② Release handle
- ③ Rear center console base
- ④ Folding back
- ⑤ Handle
- ⑥ Anchorage points

- ▶ Pull release handle ②.

The front part of center console ① is released from base ③.

- ▶ Lift center console ① in direction of arrow ④ and hold it there.
- ▶ While holding center console ① up, grip handle ⑤.
- ▶ Lift center console ① at rear handle ⑤ to release the center console from anchorage points ⑥.
- ▶ Take center console ① out of the vehicle.



Rear center console base ③ cannot be removed.

Installing

Warning!



The rear center console must be properly installed on the center console base. Driving with the rear center console not properly installed on the rear center console base may cause the rear center console to come loose and be thrown around in the vehicle interior, causing injury to vehicle occupants during

- braking
- vehicle maneuvers
- an accident

You can install the rear center console in two different positions. In the most forward position (position 1) you can expand the cargo compartment fully (▷ page 284) without removing the rear center console. However, for the storage compartment and the cupholders in the rear center console to be illuminated, the rear center console must be installed in the most rearward position (position 0).

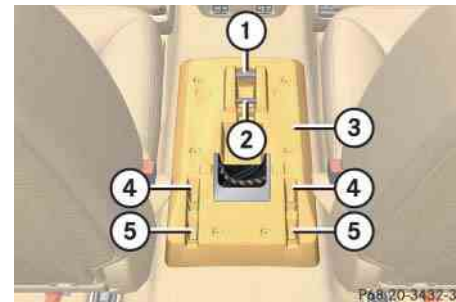

- ① Latch (position 1)
- ② Latch (position 0)
- ③ Rear center console base
- ④ Anchorage point (position 1)
- ⑤ Anchorage point (position 0)



Useful features

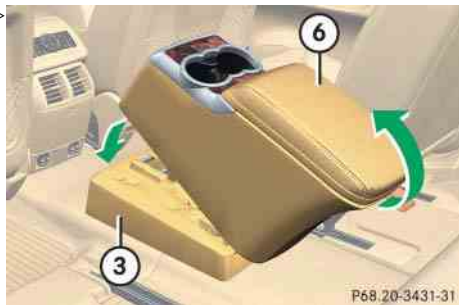

③ Rear center console base

⑥ Rear center console

- ▶ Position center console ⑥ above base ③.
- ▶ Insert the tabs at rear of center console ⑥ into anchorage points ④ or ⑤ on base ③.
- ▶ Guide front of center console ⑥ down towards base ③.

Center console ⑥ must rest on base ③.

- ▶ Press down on front of center console ⑥ until it audibly engages in latch ① or ②.

Telephone*

Warning!



Never operate radio transmitters equipped with a built-in or attached antenna (i.e. without being connected to an external antenna) from inside the vehicle while the engine is running. Doing so could lead to a malfunction of the vehicle's electronic system, possibly resulting in an accident and/or serious personal injury.

Radio transmitters, such as a portable telephone or a citizens band unit, should only be used inside the vehicle if they are connected to an antenna that is installed on the outside of the vehicle.

The external antenna must be approved by Mercedes-Benz. Please contact an authorized Mercedes-Benz Light Truck Center for information on the installation of an approved external antenna. Refer to the radio transmitter operation instructions regarding use of an external antenna.

Warning!





Please do not forget that your primary responsibility is to drive the vehicle. A driver's attention to the road must always be his / her primary focus when driving. For your safety and the safety of others, we recommend that you pull over to a safe location and stop before placing or taking a telephone call.

If you choose to use the telephone¹ while driving, please use the hands-free device and only use the telephone when road, weather and traffic conditions permit. Some jurisdictions prohibit the driver from using a cellular telephone while driving a vehicle.

Only operate the Modular COMAND System¹ if road, weather and traffic conditions permit.

Bear in mind that at a speed of just 30 mph (approximately 50 km / h), your vehicle is covering a distance of 44 feet (approximately 14 m) every second.

¹ Observe all legal requirements

You can take and place telephone calls using the  and  buttons on the steering wheel. To carry out other telephone functions, use the control system (▷ page 194).

See separate instruction manual for information on how to operate the telephone.

Tele Aid*



The initial activation of the Tele Aid system may only be performed by completing the subscriber agreement and placing an acquaintance call using the  button. Failure to complete either of these steps will result in a system that is not activated.

If you have any questions regarding activation, please call the Response Center at 1-800-756-9018 (in the USA) or 1-888-923-8367 (in Canada).

Shortly after the completion of your Tele Aid acquaintance call, you will receive a user ID and password. By visiting www.mbusa.com and selecting “Tele Aid” (USA only), you will have access to account information, remote door unlock and more.

The Tele Aid system

(Telematic Alarm Identification on Demand)

The Tele Aid system consists of three types of response:



- automatic and manual emergency
- roadside assistance
- information

The Tele Aid system is operational providing that the vehicle’s battery is charged, properly connected, not damaged and cellular and GPS coverage is available.

The speaker volume of a Tele Aid call can be adjusted when using the volume control on the Modular COMAND System or on the multifunction steering wheel. To raise, turn the rotary volume control on Modular COMAND System clockwise or press button  on the multifunction steering wheel. To lower, turn the rotary volume control on Modular COMAND System con-



Useful features

Control counterclockwise or press button  on the multifunction steering wheel.

- ▶ To activate, press the SOS button, the Roadside Assistance button  or the Information button , depending on the type of response required.



The SOS button is located in the overhead control panel.

The Roadside Assistance button  and the Information button  are located below the center armrest cover.





The Tele Aid system utilizes the cellular network for communication and the GPS (Global Positioning System) satellites for vehicle location. If either of these signals are unavailable, the Tele Aid system may not function and if this occurs, assistance must be summoned by other means.



When a Tele Aid call has been initiated, the Modular COMAND System audio is muted and the selected mode (radio, CD etc.) pauses. The optional cellular phone (if installed) inserted in cradle switches off. If you must use this phone, we recommend that you use it only with the vehicle at a standstill in a safe location. Remove the phone from the cradle and place the call. The navigation* system (if engaged) will continue to run. The display in the instrument cluster is available for use, and spoken commands are only available by pressing the RPT button on the Modular COMAND System. A pop-up window will appear in the Modular COMAND System display to indicate that a Tele Aid call is in progress. After the Tele Aid call has ended, the optional cellular phone inserted in the cradle switches on again. A PIN entry might be necessary.

System self-check

Initially, after switching on the ignition, malfunctions are detected and indicated (the indicator lamps in the SOS button, the Roadside Assistance button  and the Information button  stay on longer than 10 seconds or do not come on). The message Malfunction. Drive to workshop appears in the multifunction display.

Warning!

If the indicator lamps on the SOS button, on the Roadside Assistance button, and/or on the Information button remain illuminated continuously in red and/or the message *Malfunction. Drive to workshop* is displayed in the multifunction display after the system self-check, a malfunction in the system has been detected.

If a malfunction is indicated as outlined above, the system may not operate as expected. Have the system checked at the nearest Mercedes-Benz Light Truck Center as soon as possible.

Emergency calls

An emergency call is initiated automatically following an accident in which the emergency tensioning devices (ETDs) or air bags deploy.

An emergency call can also be initiated manually by opening the cover next to the interior rear view mirror labeled SOS, then briefly pressing the button located under the cover. See (▷ page 314) for instructions on initiating an emergency call manually.

Once the emergency call is in progress, the indicator lamp on the SOS button will begin to flash. The message *Connecting Call* appears in the multifunction display. When the connection is established, the message *Call connected* appears in the multifunction display. All information relevant to the emergency, such as the location of the vehicle (determined by the GPS satellite location system), vehicle model, identification number and color are generated.

A voice connection between the Response Center and the occupants of the vehicle will be established automatically soon after the emergency call has been initiated. The Response Center will attempt to determine more precisely the nature of the accident provided they can speak to an occupant of the vehicle.

Useful features

The Tele Aid system is available if

- it has been activated and is operational. Activation requires a subscription for monitoring services, connection and cellular air time
- vehicle battery power is available
- the relevant cellular phone network and GPS signals are available and pass the information on to the response center



Location of the vehicle on a map is only possible if the vehicle is able to receive signals from the GPS satellite network and pass the information on to the Response Center.

Warning!



If the indicator lamp in the SOS button is flashing continuously and there was no voice connection to the Response Center established, then the Tele Aid system could not initiate an emergency call (e.g. the relevant cellular phone network is not available). The message *Call failed* appears in the multifunction display for approximately 10 seconds.

Should this occur, assistance must be summoned by other means.

Initiating an emergency call manually

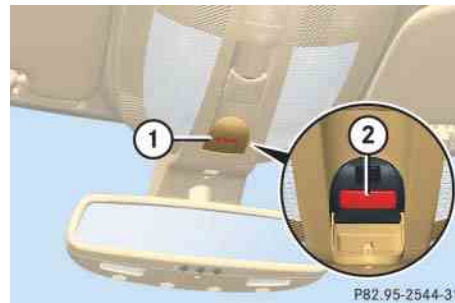

① Cover

② SOS button

- ▶ Briefly press on cover ①.

The cover opens.

- ▶ Press SOS button ② briefly.

The indicator lamp in SOS button ② will flash until the emergency call is concluded.

- ▶ Wait for a voice connection to the Response Center.
- ▶ Close cover ① after the emergency call is concluded.

Warning!

If you feel at any way in jeopardy when in the vehicle (e.g. smoke or fire in the vehicle, vehicle in a dangerous road location), please do not wait for voice contact after you have pressed the emergency button. Carefully leave the vehicle and move to a safe location. The Response Center will automatically contact local emergency officials with the vehicle's approximate location if they receive an automatic SOS signal and cannot make voice contact with the vehicle occupants.

Roadside Assistance button

The Roadside Assistance button is located below the center armrest cover.



① Roadside Assistance button

- ▶ Open the storage tray (▷ page 296).
- ▶ Press and hold button ① (for longer than 2 seconds).

A call to a Mercedes-Benz Roadside Assistance dispatcher will be initiated. The button will flash while the call is in progress. The message `Connecting call` will appear in the multifunction display.

When the connection is established, the message `Call connected` appears in the multifunction display. The Tele Aid system will transmit data generating the vehicle identification number, model, color and location (subject to availability of cellular and GPS signals).



While the call is connected you can change to the navigation menu by pressing NAV button on the Modular COMAND System unit.

A voice connection between the Roadside Assistance dispatcher and the occupants of the vehicle will be established.

- ▶ Describe the nature of the need for assistance.



Useful features

The Mercedes-Benz Roadside Assistance dispatcher will either dispatch a qualified Mercedes-Benz technician or arrange to tow your vehicle to the nearest Mercedes-Benz Light Truck Center. For services such as labor and/or towing, charges may apply. Refer to the Roadside Assistance Manual for more information.

These programs are only available in the USA:

- Sign and Drive services: Services such as jump start, a few gallons of fuel or the replacement of a flat tire with the vehicle spare tire are obtainable.



The indicator lamp on the Roadside Assistance button  remains illuminated in red for approximately 10 seconds during the system self-check after switching on the ignition (together with the SOS button and the Information button ).

See system self-check (▷ page 312) if the indicator lamp does not come on in red or stays on longer than approximately 10 seconds.

If the indicator lamp on the Roadside Assistance button  is flashing continuously and there was no voice connection to the Response Center established, then the Tele Aid system could not initiate a Roadside Assistance call (e.g. the relevant cellular phone network was not available). The message *Call failed* appears in the multifunction display.

Roadside Assistance calls can be terminated using the  button on the multifunction steering wheel or the END Button on the Modular COMAND System.

Information button 

The Information button  is located below the center armrest cover.

**① Information button** 

- ▶ Open the storage tray (▷ page 296).
- ▶ Press and hold button ① (for longer than 2 seconds).

A call to the Customer Assistance Center will be initiated. The button will flash while the call is in progress. The message *Connecting call* will appear in the multifunction display.

When the connection is established, the message *Call connected* appears in the multifunction display. The Tele Aid system will transmit data generating the vehicle identification number, model, color and location (subject to availability of cellular and GPS signals).



i

While the call is connected, you can change to the navigation menu by pressing NAV button on the Modular COMAND System.

A voice connection between the Customer Assistance Center representative and the occupants of the vehicle will be established. Information regarding the operation of your vehicle, the nearest Mercedes-Benz Light Truck Center or Mercedes-Benz USA products and services is available to you.

For more details concerning the Tele Aid system, please visit www.mbusa.com and use your ID and password (sent to you separately) to learn more (USA only).

i

The indicator lamp in the Information button  remains illuminated in red for approximately 10 seconds during the system self-check after switching on the ignition (together with the SOS button and the Roadside Assistance button ).

See system self-check (▷ page 312) if the indicator lamp does not come on in red or stays on longer than approximately 10 seconds.

If the indicator lamp in the Information button  is flashing continuously and there was no voice connection to the Response Center established, then the Tele Aid system could not initiate an Information call (e.g. the relevant cellular phone network is not available). The message *Call failed* appears in the multifunction display.

Useful features

Information calls can be terminated using the  button on the multifunction steering wheel or the END Button on the Modular COMAND System.



If the indicator lamps do not start flashing after pressing one of the buttons or remain illuminated (in red) at any time, the Tele Aid system has detected a malfunction or the service is not currently active, and may not initiate a call. Visit your authorized Mercedes-Benz Light Truck Center and have the system checked or contact the Response Center at 1-800-756-9018 (in the USA) or 1-888-923-8367 (in Canada) as soon as possible.

Call priority

If other service calls such as a Roadside Assistance call or Information call are active, an Emergency call is still possible. In this case, the Emergency call will take priority and override all other active calls.



The indicator lamp in the respective button flashes until the call is concluded. Emergency calls can only be terminated by a Response Center or Customer Assistance Center representative, whereas Roadside Assistance and Information calls can also be terminated by pressing button  on the multifunction steering wheel or using the END button on the Modular COMAND System.



If the indicator lamp continues to flash or the system does not reset, contact the Response Center at 1-800-756-9018 (in the USA) or 1-888-923-8367 (in Canada), or Mercedes-Benz Customer Assistance at 1-800-FOR-MERCEdes (1-800-367-6372) in the USA or Customer Service at 1-800-387-0100 in Canada.

Remote door unlock

In case you have locked your vehicle unintentionally (e.g. SmartKey inside vehicle), and the reserve SmartKey is not handy:

- ▶ Contact the Mercedes-Benz Response Center at 1-800-756-9018 (in the USA) or 1-888-923-8367 (in Canada).

You will be asked to provide your password which you provided when you completed the subscriber agreement.

- ▶ Then return to your vehicle at the time arranged with the Response Center and pull the tailgate recessed handle for minimum of 20 seconds until the SOS button is flashing.

The message *Connecting call* appears in the multifunction display.

As an alternative, you may unlock the vehicle via Internet using the ID and password sent to you shortly after the completion of your acquaintance call.

The Response Center will then unlock your vehicle with the remote door unlocking feature.



The remote door unlock feature is available if the relevant cellular phone network is available.

The SOS button will flash and the message *Connecting call* will appear in the multifunction display to indicate receipt of the door unlock command.

Once the vehicle is unlocked, a Response Center specialist may attempt to establish voice contact with the vehicle occupants.

If the tailgate recessed handle was pulled for more than 20 seconds before door unlock authorization was received by the Response Center, you must wait 15 minutes before pulling the tailgate recessed handle again.

Stolen Vehicle Recovery services

In the event your vehicle was stolen:

- ▶ Report the incident to the police.

The police will issue a numbered incident report.

- ▶ Pass this number on to the Mercedes-Benz Response Center along with your password issued to you when you subscribed to the service.

The Response Center will then attempt to covertly contact the vehicle's Tele Aid system. Once the vehicle is located, the Response Center will contact the local law enforcement and you. The vehicle's location will only be provided to law enforcement.



When the anti-theft alarm or the tow-away alarm stays on for more than 30 seconds, a call is initiated automatically to the Response Center. See anti-theft alarm system (▷ page 104) and tow-away alarm (▷ page 106).

Garage door opener*

The integrated remote control is capable of operating up to three separately controlled devices. It provides a convenient way to replace up to three hand-held remote controls used to operate devices such as garage door openers, gate openers, or other devices compatible with HomeLink® or some other systems.

Before the integrated remote control can be used, it must be programmed to the garage door opener, gate operator or other device you wish to operate. See the following instructions for programming information.

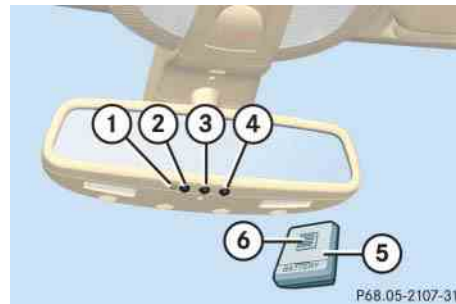

Interior rear view mirror with integrated remote control

- ① Indicator lamp
- ② ③ ④ Signal transmitter button

Needed for programming (not part of vehicle equipment):

- ⑤ Hand-held remote control of garage door opener, gate operator or other device
- ⑥ Hand-held remote control button

Warning!

Before programming the integrated remote control to a garage door opener or gate operator, make sure people and objects are out of the way of the device to prevent potential harm or damage. When programming a garage door opener, the door moves up or down. When programming a gate operator, the gate opens or closes.

Do not use the integrated remote control with any garage door opener that lacks safety stop and reverse features as required by U.S. federal safety standards (this includes any garage door opener model manufactured before April 1, 1982).

A garage door that cannot detect an object – signaling the door to stop and reverse – does not meet current U.S. federal safety standards.

When programming a garage door opener, it is advised to park outside the garage.

Do not run the engine while programming the integrated remote control. Inhalation of exhaust gas is hazardous to your health. All exhaust gas contains carbon monoxide, and inhaling it can cause unconsciousness and possible death.

Programming the integrated remote control

Step 1:

- ▶ Switch on the ignition (▷ page 38).

Step 2:

- ▶ If you have previously programmed an signal transmitter button and wish to retain its programming, proceed to step 3.

If you are programming the integrated remote control for the first time, press and hold the two outer signal transmitter buttons ② and ④ and release them only when the indicator lamp ① begins to flash after approximately 20 seconds (do not hold the button for longer than 30 seconds). This procedure erases any previous settings for all three channels and initializes the memory.

If you later wish to program a second and/or third hand-held transmitter to the remaining two signal transmitter buttons, do not repeat this step and begin directly with step 3. ▷▷

Useful features

▷▷ Step 3:

- ▶ Hold the end of the hand-held remote control ⑤ of the device you wish to train approximately 2 to 5 in (5 to 12 cm) away from the signal transmitter button (②, ③ or ④) to be programmed, while keeping the indicator lamp ① in view.

Step 4:

- ▶ Using both hands, simultaneously press the hand-held remote control button ⑥ and the desired signal transmitter button (②, ③ or ④). Do not release the buttons until step 5 is completed.

The indicator lamp ① will flash, first slowly and then rapidly.



The indicator lamp ① flashes immediately the first time the signal transmitter button is programmed. If this button has already been programmed, the indicator lamp will only start flashing after 20 seconds.

Step 5:

- ▶ After the indicator lamp ① changes from a slow to a rapidly flashing light, release the hand-held remote control button and the signal transmitter button.

Step 6:

- ▶ Press and hold the just-trained signal transmitter button (②, ③ or ④) and observe the indicator lamp ①.

If the indicator lamp ① stays on constantly, programming is complete and your device should activate when the respective signal transmitter button (②, ③ or ④) is pressed and released.



If the indicator lamp ① flashes rapidly for about 2 seconds and then turns to a constant light, continue with programming steps 8 through 12 as your garage door opener may be equipped with the “rolling code” feature.

Step 7:

- ▶ To program the remaining two signal transmitter buttons, repeat the steps above starting with step 3.

Rolling code programming

To train a garage door opener (or other rolling code devices) with the rolling code feature, follow these instructions after completing the “Programming” portion (steps 1 through 6) of this text. (A second person may make the following training procedures quicker and easier.)

Step 8:

- ▶ Locate “training” button on the garage door opener motor head unit.

Exact location and color of the button may vary by garage door opener brand. Depending on manufacturer, the “training” button may also be referred to as “learn” or “smart” button. If there is difficulty locating the transmitting button, refer to the garage door opener operator’s manual.

Step 9:

- ▶ Press the “training” button on the garage door opener motor head unit.

The “training light” is activated.

You have 30 seconds to initiate the following two steps.

Step 10:

- ▶ Return to the vehicle and firmly press, hold for 2 seconds and release the programmed signal transmitter button (②, ③ or ④).

Step 11:

- ▶ Press, hold for 2 seconds and release same signal transmitter button a second time to complete the training process.



Some garage door openers (or other rolling code equipped devices) may require you to press, hold for 2 seconds and release the same signal transmitter button a third time to complete the training process.

Step 12:

- ▶ Confirm the garage door operation by pressing the programmed signal transmitter button (②, ③ or ④).

Step 13:

- ▶ To program the remaining two signal transmitter buttons, repeat the steps above starting with step 3.

Useful features

Gate operator/Canadian programming

Canadian radio-frequency laws require transmitter signals to “time-out” (or quit) after several seconds of transmission which may not be long enough for the integrated signal transmitter to pick up the signal during programming. Similar to this Canadian law, some U.S. gate operators are designed to “time-out” in the same manner.

If you live in Canada or if you are having difficulties programming a gate operator (regardless of where you live) by using the programming procedures, replace step 4 with the following:

Step 4:

- ▶ Press and hold the signal transmitter button (②, ③ or ④). Do not release this button until it has been successfully trained.
- ▶ While still holding down the signal transmitter button (②, ③ or ④), “cycle” your hand-held remote control button ⑥ as follows: Press and hold button ⑥ for 2 seconds, then release it for 2 seconds, and again press and hold it for 2 seconds. Repeat this sequence on the hand-held remote control until the frequency signal has been learned. Upon successful training, the indicator lamp ① will flash slowly and then rapidly after several seconds.
- ▶ Proceed with programming step 5 and step 6 to complete.



Upon completion of programming the integrated remote control, make sure you retain the hand-held remote control that came with the garage door opener, gate operator or other device. You may need it for use in other vehicles, for future programming of an integrated remote control, or simply for continued use as a hand-held remote control to operate the respective device in other situations.

Reprogramming a single signal transmitter button

To program a device using a signal transmitter button previously trained, follow these steps:

- ▶ Switch on the ignition (▷ page 38).
- ▶ Press and hold the desired signal transmitter button (②, ③ or ④). Do not release the button.
- ▶ The indicator lamp ① will begin to flash after 20 seconds. Without releasing the signal transmitter button, proceed with programming starting with step 3.

Operation of integrated remote control

- ▶ Switch on the ignition (▷ page 38).
- ▶ Select and press the appropriate integrated signal transmitter button (②, ③ or ④) to activate the remote controlled device.

The integrated remote control transmitter continues to send the signal as long as the button is pressed – up to 20 seconds.

Erasing the integrated remote control memory

- ▶ Switch on the ignition (▷ page 38).
- ▶ Simultaneously press and hold down the outer signal transmitter buttons ② and ④, for approximately 20 seconds, until the indicator lamp ① flashes rapidly. Do not hold for longer than 30 seconds.

The codes of all three channels are erased.



If you sell your vehicle, erase the codes of all three channels.

Useful features

Programming tips

If you are having difficulty programming the integrated remote control, here are some helpful tips:

- Check the frequency of the hand-held remote control ⑤ (typically located on the reverse side of the remote). The integrated remote control is compatible with radio-frequency devices operating between 288-399 MHz.
- Put a new battery in the hand-held remote control ⑤. This will increase the likelihood of the hand-held remote control sending a faster and more accurate signal to the integrated remote control.
- While performing step 3, hold the hand-held remote control ⑤ at different lengths and angles from the signal transmitter button (②, ③ or ④) you are programming. Attempt varying angles at the distance of 2 to 5 inches (5 to 12 cm) away or the same angle at varying distances.

- If another hand-held remote control is available for the same device, try the programming steps again using that other hand-held remote control. Make sure new batteries are in the hand-held remote control before beginning the procedure.
- Straighten the antenna wire from the garage door opener assembly. This may help improve transmitting and/or receiving signals.



Certain types of garage door openers are incompatible with the integrated remote control. If you should experience further difficulties with programming the integrated remote control, contact an authorized Mercedes-Benz Light Truck Center, or call Mercedes-Benz Customer Assistance Center (in the USA only) at 1-800-FOR-MERCEdes, or Customer Service (in Canada) at 1-800-387-0100.



USA only:

This device complies with Part 15 of the FCC Rules. Operation is subject to the following two conditions:

- (1) This device may not cause harmful interference, and
- (2) this device must accept any interference received, including interference that may cause undesired operation.

Any unauthorized modification to this device could void the user's authority to operate the equipment.



Canada only:



This device complies with RSS-210 of Industry Canada. Operation is subject to the following two conditions:

- (1) This device may not cause interference, and
- (2) this device must accept any interference received, including interference that may cause undesired operation of the device.

Any unauthorized modification to this device could void the user's authority to operate the equipment.

Compass

Calling up the compass

- ▶ Press button  or  repeatedly until the AIRMATIC/Compass menu appears in the multifunction display.

The compass displays the direction into which the vehicle is currently traveling: N, NE, E, SE, S, SW, W or NW.



Example for compass display on vehicles equipped with AIRMATIC*



If your vehicle is not equipped with AIRMATIC*, the multifunction display will show the compass only.



The presence of buildings, bridges, power lines and large antenna masts can influence the displayed values. Metallic or magnetic objects in or on the vehicle can influence the accuracy of the compass.

To make sure the display is correct, the compass must be set to the proper geographic zone (▷ page 186). It may also be necessary to calibrate the compass (▷ page 187).



If the compass is not calibrated or its function is impaired by outside influences, the message **Compass - - -** appears in the multifunction display.

Floormats*

Warning!



Whenever you are using floormats, make sure there is enough clearance and that the floormats are securely fastened.

Floormats should always be securely fastened using eyelets ② and retainer pins ①.

Before driving off, check that the floormats are securely in place and adjust them if necessary. A loose floormat could slip and hinder proper function of the pedals.



To install or remove the floormats more easily, move the driver's seat or front passenger seat as far to the rear as possible (▷ page 43).

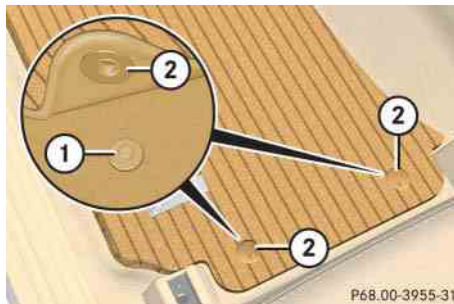

- ① Retainer pin
- ② Eyelet

Removing

- ▶ Pull floormat off of retainer pins ①.
- ▶ Remove the floormat.

Installing

- ▶ Lay down the floormat in the respective footwell.
- ▶ Press floormat eyelets ② onto retainer pins ①.

Infrared reflecting windshield*



① Infrared transparent areas

Your vehicle is equipped with infrared reflecting glass, which reduces the amount of radiated heat entering the vehicle interior or through the windows.

The infrared reflecting glass also prevents the transmission of signals through the glass by in-vehicle electronic devices (e.g. electronic toll collection devices).

To allow the use of these devices in the vehicle, infrared transparent areas are placed in the windshield.

The first 1000 miles (1500 km)

Driving instructions

At the gas station

Engine compartment

Tires and wheels

Winter driving

Maintenance

Vehicle care



The first 1000 miles (1500 km)

In the “Operation” section you will find detailed information on operating, maintaining and caring for your vehicle.

The more cautiously you treat your vehicle during the break-in period, the more satisfied you will be with its performance later on.

- Drive your vehicle during the first 1000 miles (1500 km) at varying but moderate vehicle and engine speeds.
- During this period, avoid heavy loads (full throttle driving) and excessive engine speeds (no more than $\frac{2}{3}$ of maximum rpm in each gear).
- Shift gears in a timely manner.
- Avoid accelerating by kick-down.
- Do not attempt to slow the vehicle down by shifting to a lower gear using the gear selector lever.
- Select gear ranges **3**, **2** or **1** (▷ page 202) only when driving at moderate speeds (for hill driving).
- Select **C** as the preferred shift program (▷ page 204) for the first 1000 miles (1500 km).

After 1000 miles (1500 km) you may gradually increase vehicle and engine speeds to the permissible maximum.

All of the above instructions, as may apply to your vehicle type, also apply when the first 1000 miles (1500 km) after the engine, the transfer case, the front differential or the rear differential has been replaced.



Always obey applicable speed limits.

▼ Driving instructions

Drive sensibly – save fuel

Fuel consumption, to a great extent, depends on driving habits and operating conditions.

To save fuel you should:

- Keep tires at the recommended inflation pressures.
- Remove unnecessary loads.
- Remove roof rack when not in use.
- Allow engine to warm up under low load use.
- Avoid frequent acceleration and deceleration.
- Have all maintenance work performed at the intervals specified in the Maintenance Booklet and as required by the Maintenance System (U.S. vehicles) or FSS PLUS (Canada vehicles). Contact an authorized Mercedes-Benz Light Truck Center.

Fuel consumption is also increased by driving in cold weather, in stop-and-go traffic, on short trips and in hilly area.

Drinking and driving

Warning!



Drinking and driving and/or taking drugs and driving are a very dangerous combination. Even a small amount of alcohol or drugs can affect your reflexes, perceptions and judgment.

The possibility of a serious or even fatal accident are greatly increased when you drink or take drugs and drive.

Do not drink or take drugs and drive or allow anyone to drive who has been drinking or taking drugs.

Pedals

Warning!



Keep driver's foot area clear at all times. Objects stored in this area may impair pedal movement.

Power assistance

Warning!



With the engine not running, there is no power assistance for the brake and steering systems. In this case, it is important to keep in mind that a considerably higher degree of effort is necessary to brake and steer the vehicle.

Driving instructions

Brakes

Warning!



After driving in heavy rain for some time without applying the brakes or through water deep enough to wet brake components, the first braking action may be somewhat reduced and increased pedal pressure may be necessary to obtain expected braking effect. Maintain a safe distance from vehicles in front.

Resting your foot on the brake pedal will cause excessive and premature wear of the brake pads.

It can also result in the brakes overheating, thereby significantly reducing their effectiveness. It may not be possible to stop the vehicle in sufficient time to avoid an accident.

To help prevent brake disk corrosion after driving on wet road surfaces (particularly salted roads), it is advisable to brake the vehicle with considerable force prior to parking. The heat generated serves to dry the brakes.

If your brake system is normally only subjected to moderate loads, you should occasionally test the effectiveness of the brakes by applying above-normal braking pressure at higher speeds. This will also enhance the grip of the brake pads.

Warning!



Make sure not to endanger any other road users when carrying out these braking maneuvers.

Refer to the description of the Brake Assist System (BAS) (▷ page 99).

If the parking brake is released and the brake warning lamp in the instrument cluster stays on and there is no audible warning (EBP), the brake fluid level in the reservoir is too low.

Brake pad wear or a leak in the system may be the reason for low brake fluid in the reservoir.

Have the brake system inspected immediately. Contact an authorized Mercedes-Benz Light Truck Center.

All checks and service work on the brake system should be carried out by qualified technicians only. Contact an authorized Mercedes-Benz Light Truck Center.

Only install brake pads and brake fluid recommended by Mercedes-Benz.

Warning!

If other than recommended brake pads are installed, or other than recommended brake fluid is used, the braking properties of the vehicle can be degraded to an extent that safe braking is substantially impaired. This could result in an accident.



When driving down long and steep grades, relieve the load on the brakes by shifting into a lower gear to use the engine's braking power. This helps prevent overheating of the brakes and reduces brake pad wear.

When using the engine's braking power, a drive wheel may not spin for an extended period of time, e.g. on slippery road surfaces. This may cause serious damage to the drivetrain which is not covered by the Mercedes-Benz Limited Warranty.

After hard braking, it is advisable to drive on for some time, rather than immediately park, so that the air stream will cool down the brakes faster.

Driving off

Apply the brakes to test them briefly after driving off. Perform this procedure only when the road is clear of other traffic.

Warm up the engine smoothly. Do not place full load on the engine until the operating temperature has been reached.

When starting off on a slippery surface, do not allow a drive wheel to spin for an extended period with the ESP® switched off. Doing so may cause serious damage to the drivetrain which is not covered by the Mercedes-Benz Limited Warranty.



Simultaneously depressing the accelerator pedal and applying the brake reduces engine performance and causes premature brake and drivetrain wear.

Driving instructions

Parking



Set the parking brake whenever parking or leaving the vehicle. In addition, set the automatic transmission to position **P**.

When parking on hills, always turn front wheels towards the curb.

Warning!



To reduce the risk of personal injury, or damage to the vehicle powertrain, as a result of vehicle movement, before turning off the engine and leaving the vehicle always:

- Keep right foot on brake pedal.
- Firmly depress parking brake pedal.
- Set the automatic transmission to position **P**.

- When parked on an incline, turn front wheel towards the road curb.
- Turn the SmartKey to starter switch position **0** and remove, or press KEYLESS-GO* start / stop button (vehicles with KEYLESS-GO*).
- Take the SmartKey or the SmartKey with KEYLESS-GO* with you and lock vehicle when leaving.

Tires

Warning!



If you feel a sudden significant vibration or ride disturbance, or you suspect that possible damage to your vehicle has occurred, you should turn on the hazard warning flashers, carefully slow down, and drive with caution to an area which is a safe distance from the road.

Inspect the tires and the vehicle underbody for possible damage. If the vehicle or tires appear unsafe, have the vehicle towed to the nearest Mercedes-Benz Light Truck Center or tire dealer for repairs.

Treadwear indicators (TWI) are required by law. These indicators are located in six places on the tread circumference and become visible at a tread depth of approximately $\frac{1}{16}$ in (1.6 mm), at which point the tire is considered worn and should be replaced.

The treadwear indicator appears as a solid band across the tread.

Warning!

Although the applicable federal motor vehicle safety laws consider a tire to be worn when the treadwear indicators (TWI) become visible at approximately $\frac{1}{16}$ in (1.6 mm), we recommend that you do not allow your tires to wear down to that level. As tread depth approaches $\frac{1}{8}$ in (3 mm), the adhesion properties on a wet road are sharply reduced.

Depending upon the weather and/or road surface (conditions), the tire traction varies widely.

Specified tire pressures must be maintained. This applies particularly if the tires are subjected to high loads (e.g. high speeds, heavy loads, high ambient temperatures).

Warning!

Do not drive with a flat tire. A flat tire affects the ability to steer or brake the vehicle. You may lose control of the vehicle. Continued driving with a flat tire or driving at high speed with a flat tire will cause excessive heat build-up and possibly a fire.

Hydroplaning

Depending on the depth of the water layer on the road, hydroplaning may occur, even at low speeds and with new tires. Reduce vehicle speed, avoid track grooves in the road and apply brakes cautiously in the rain.

Tire traction

The safe speed on a wet, snow covered or icy road is always lower than on a dry road.

You should pay particular attention to the condition of the road whenever the outside temperatures are close to the freezing point.

Warning!

If ice has formed on the road, tire traction will be substantially reduced. Under such weather conditions, drive, steer and brake with extreme caution.

Driving instructions

Mercedes-Benz recommends winter tires (▷ page 390) with a minimum tread depth of approximately $\frac{1}{6}$ in (4 mm) on all four wheels for the winter season to ensure normal balanced handling characteristics. On packed snow, they can reduce your stopping distance compared to summer tires.

Stopping distance, however, is still considerably greater than when the road is not covered with snow or ice. Exercise appropriate caution.



Avoid spinning of one drive wheel. This may cause serious damage to the drivetrain which is not covered by the Mercedes-Benz Limited Warranty.

Tire speed rating

Regardless of the tire speed rating, local speed limits should be obeyed. Use prudent driving speeds appropriate to prevailing conditions.

Warning!



Even when permitted by law, never operate a vehicle at speeds greater than the maximum speed rating of the tires.

Exceeding the maximum speed for which tires are rated can lead to sudden tire failure, causing loss of vehicle control and possibly resulting in an accident and/or serious injury and possible death, for you and for others.

R 350, R 500

Your vehicle is factory equipped with “H”-rated tires, which have a speed rating of 130 mph (210 km/h).

An electronic speed limiter prevents your vehicle from exceeding a speed of 130 mph (210 km/h).

R 350, R 500 (with Sport Package*)

Your vehicle is factory equipped with “W”-rated tires, which have a speed rating of 168 mph (270 km/h).

An electronic speed limiter prevents your vehicle from exceeding a speed of 130 mph (210 km/h).



For information on speed ratings for winter tires, see “Winter tires” (▷ page 390).

For additional general information on tire speed markings on the tire sidewall, see “Tire speed rating” (▷ page 388).

Winter driving instructions

The most important rule for slippery or icy roads is to drive sensibly and to avoid abrupt acceleration, braking and steering maneuvers. Do not use the cruise control system under such conditions.

When the vehicle is in danger of skidding, move gear selector lever to position **N**. Try to keep the vehicle under control by corrective steering action.



For information on driving with snow chains, see “Snow chains” (> page 391).

Warning!



On slippery road surfaces, never downshift in order to obtain braking action. This could result in drive wheel slip and reduced vehicle control. Your vehicle’s ABS will not prevent this type of control loss.

Road salts and chemicals can adversely affect braking efficiency. Increased pedal force may become necessary to produce the normal brake effect.

Depressing the brake pedal periodically when traveling at length on salt-strewn roads can bring road-salt-impaired braking efficiency back to normal.

If the vehicle is parked after being driven on salt-treated roads, the braking efficiency should be tested as soon as possible after driving is resumed.

Warning!



Make sure not to endanger any other road users when carrying out these braking maneuvers.

Warning!



If the vehicle becomes stuck in snow, make sure that snow is kept clear of the exhaust pipe and from around the vehicle with the engine running. Otherwise, deadly carbon monoxide (CO) gases may enter vehicle interior resulting in unconsciousness and death.

To assure sufficient fresh air ventilation, open a window slightly on the side of the vehicle not facing the wind.

Warning!



The outside temperature indicator is not designed to serve as an ice-warning device and is therefore unsuitable for that purpose. Indicated temperatures just above the freezing point do not guarantee that the road surface is free of ice.

For more information, see “Winter driving” (> page 390).

Driving instructions

Standing water

To prevent water from entering the passenger compartment or the engine compartment if you must drive through standing water, keep in mind that

- the maximum depth of the water may not exceed 10 in (25 cm)
- you must drive slowly



Vehicles with AIRMATIC*: If you have selected the raised level (▷ page 272) before driving through standing water, the maximum water depth is 12 in (30 cm).



Do not drive through flooded areas or water of unknown depth. Before driving through water, determine its depth. Never accelerate before driving into water. The bow wave could force water into the engine and auxiliary equipment, thus damaging them.

If you must drive through standing water, drive slowly to prevent water from entering the passenger compartment or the engine compartment. Water in these areas could cause damage to electrical components or wiring of the engine or transmission, or could result in water being ingested by the engine through the air intake, causing severe internal engine damage. Any such damage is not covered by the Mercedes-Benz Limited Warranty.

Passenger compartment

Warning!



Always fasten items being carried as securely as possible.

In an accident, during hard braking or sudden maneuvers, loose items will be thrown around inside the vehicle, and cause injury to vehicle occupants unless the items are securely fastened in the vehicle.

The rear cargo compartment is the preferred place to carry objects. Always use the partition net when transporting cargo. Partition net cannot secure hard or heavy objects. Always fasten items being carried as securely as possible using the cargo tie-down rings in the cargo floor area and fastening materials.

Driving abroad

Abroad, there is an extensive Mercedes-Benz service network at your disposal. If you plan to drive into areas which are not listed in the index of your Mercedes-Benz Light Truck Center directory, you should request pertinent information from an authorized Mercedes-Benz Light Truck Center.

Control and operation of radio transmitters

Modular COMAND System, radio and telephone*

Warning!



Do not forget that your primary responsibility is to drive the vehicle. Only operate the Modular COMAND System, radio or telephone¹ if road, weather and traffic conditions permit.

Bear in mind that at a speed of just 30 mph (approximately 50 km/h), your vehicle is covering a distance of 44 feet (approximately 14 m) every second.

¹ Observe all legal requirements.

Telephones and two-way radios

Warning!



Never operate radio transmitters equipped with a built-in or attached antenna (i.e. without being connected to an external antenna) from inside the vehicle while the engine is running. Doing so could lead to a malfunction of the vehicle's electronic system, possibly resulting in an accident and/or personal injury.

Radio transmitters, such as a portable telephone or a citizens band unit should only be used inside the vehicle if they are connected to an antenna that is installed on the outside of the vehicle.

Refer to the radio transmitter operation instructions regarding use of an external antenna.

Driving instructions

Catalytic converter

Your Mercedes-Benz is equipped with monolithic-type catalytic converters, an important element in conjunction with the oxygen sensors to achieve substantial control of the pollutants in the exhaust emissions. Keep your vehicle in proper operating condition by following our recommended maintenance instructions as outlined in your Maintenance Booklet.



To prevent damage to the catalytic converters, use only premium unleaded gasoline in this vehicle.

Any noticeable irregularities in engine operation should be repaired promptly. Otherwise, excessive unburned fuel may reach the catalytic converter, causing it to overheat and potentially start a fire.

Warning!



As with any vehicle, do not idle, park or operate this vehicle in areas where combustible materials such as grass, hay or leaves can come into contact with the hot exhaust system, as these materials could be ignited and cause a vehicle fire.

Emission control

Certain engine systems serve to keep the toxic components of the exhaust gases within permissible legal limits.

These systems, of course, will function properly only when maintained strictly according to factory specifications. Any adjustments on the engine should, therefore, be carried out only by qualified Mercedes-Benz Light Truck Center authorized technicians.

Engine adjustments should not be altered in any way. Moreover, the specified service jobs must be carried out regularly according to Mercedes-Benz servicing requirements. For details refer to the Maintenance Booklet.

Warning!



Inhalation of exhaust gas is hazardous to your health. All exhaust gas contains carbon monoxide, and inhaling it can cause unconsciousness and possible death.

Do not run the engine in confined areas (such as a garage) which are not properly ventilated. If you think that exhaust gas fumes are entering the vehicle while driving, have the cause determined and corrected immediately. If you must drive under these conditions, drive only with at least one window fully open at all times.

Coolant temperature

During severe operating conditions and stop-and-go city traffic, the coolant temperature may rise to approx. 248°F (120°C).

The engine should not be operated with the coolant temperature in the red zone. Doing so may cause serious engine damage which is not covered by the Mercedes-Benz Limited Warranty.

Warning!



- Driving when your engine is badly overheated can cause some fluids which may have leaked into the engine compartment to catch fire. You could be seriously burned.
- Steam from an overheated engine can cause serious burns and can occur just by opening the engine hood. Stay away from the engine if you see or hear steam coming from it.

Turn off the engine, get out of the vehicle and do not stand near the vehicle until the engine has cooled down.

At the gas station

Refueling

Warning!



Gasoline is highly flammable and poisonous. It burns violently and can cause serious injury. Whenever you are around gasoline, avoid inhaling fumes and skin contact, extinguish all smoking materials. Never allow sparks, flame or smoking materials near gasoline!

The fuel filler flap is located on the right-hand side of the vehicle towards the rear. Locking/unlocking the vehicle with the remote control automatically locks/unlocks the fuel filler flap.



- ▶ Remove the SmartKey from the starter switch.
- ▶ Push on fuel filler flap at the position indicated the arrow and open fuel filler flap.
- ▶ Turn the fuel cap to the left and hold on to it until possible pressure is released.
- ▶ Take off the fuel cap.



The fuel filler cap is tethered to the fuel filler neck. Do not drop the cap. It could damage the vehicle paint finish.

- ▶ Only fill your tank until the filler nozzle unit cuts out – do not top up or overfill.



To prevent damaging the lens of the plastic tail lamp, make certain that no gasoline comes into contact with it.

Warning!



Overfilling of the fuel tank may create pressure in the system which could cause a gas discharge. This could cause the gas to spray back out when removing the fuel pump nozzle, which could cause personal injury.



- ▶ Replace the fuel cap by turning it clockwise until it audibly engages.
- ▶ Close the fuel filler flap.



Only use premium unleaded gasoline with a minimum Posted Octane Rating of 91 (average of 96 RON / 86 MON). Information on gasoline quality can normally be found on the fuel pump.

For more information on gasoline, see the Factory Approved Service Products pamphlet.



Leaving the engine running and the fuel cap open can cause the yellow fuel tank reserve warning lamp to flash and the  malfunction indicator lamp (USA only) or the  malfunction indicator lamp (Canada only) comes on.

For more information, see “Practical hints” (▷ page 408).

Check regularly and before a long trip

- ▶ Open the hood (▷ page 345).

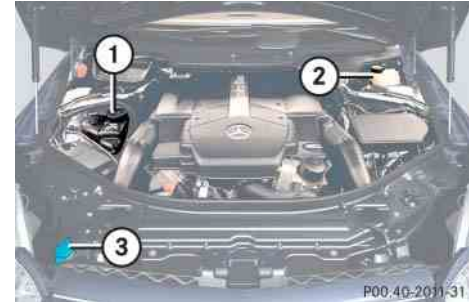

- ① Coolant level
- ② Brake fluid
- ③ Windshield washer system and headlamp cleaning system*

Engine oil level

For more information on engine oil, see “Engine oil” (▷ page 346).

At the gas station

Coolant

For normal replenishing, use water (potable water quality). For more information, see “Coolant level” (▷ page 351) and “Fuels, coolants, lubricants, etc.” (▷ page 521).

Brake fluid



If you find that the brake fluid in the brake fluid reservoir has fallen to the minimum mark or below, have the brake system checked for brake pad thickness and leaks immediately. Notify an authorized Mercedes-Benz Light Truck Center immediately. Do not add brake fluid as this will not solve the problem. For more information, see “Brake fluid” (▷ page 523).

Windshield / rear window washer system and headlamp cleaning system*

For more information on refilling the reservoir, see “Windshield / rear window washer system and headlamp cleaning system*” (▷ page 352).

Vehicle lighting

Check function and cleanliness. For information on replacing light bulbs, see “Replacing bulbs” (▷ page 465).

For more information, see “Exterior lamp switch” (▷ page 147).

Tire inflation pressure

For more information, see “Checking tire inflation pressure” (▷ page 365).

▼ Engine compartment

Hood

Warning!



Do not pull the release lever while the vehicle is in motion. Otherwise the hood could be forced open by passing air flow.

Opening



① Hood lock release lever

- ▶ Pull release lever ① downwards.

The hood is unlocked. Handle ② protrudes slightly from the radiator grille. If not, lift the hood slightly.



To avoid damage to the windshield wipers or hood, never open the hood if the wiper arms are folded forward away from the windshield.



② Handle for opening the hood

- ▶ Press and hold handle ② in direction of arrow.

The hood is unlocked.

- ▶ Pull up on the hood and then release it.

The hood will be automatically held open at shoulder height by gas-filled struts.

Warning!



To help prevent personal injury, stay clear of moving parts when the hood is open and the engine is running. Make sure the hood is properly closed before driving. When closing the hood, use extreme caution not to catch hands or fingers.

The radiator fan may continue to run for approximately 30 seconds or even restart after the engine has been turned off. Stay clear of fan blades.



Engine compartment



Warning!



If you see flames or smoke coming from the engine compartment, or if the coolant temperature gauge indicates that the engine is overheated, do not open the hood. Move away from vehicle and do not open the hood until the engine has cooled. If necessary, call the fire department.

Warning!



The engine is equipped with a transistorized ignition system. Because of the high voltage it is dangerous to touch any components (ignition coils, spark plug sockets, diagnostic socket) of the ignition system

- with the engine running
- while starting the engine
- if ignition is “on” and the engine is turned manually

Closing

Warning!



Be careful that you do not close the hood on anyone.

- ▶ Let the hood drop from a height of approximately 1 ft (30 cm).

The hood will lock audibly.

- ▶ Check to make sure the hood is fully closed.

If you can raise the hood at a point above the headlamps, then it is not properly closed. Open it again and let it drop with somewhat greater force.



Do not push the hood closed manually, as this could damage it.

Engine oil

The amount of oil your engine needs will depend on a number of factors, including driving style. Increased oil consumption can occur when

- the vehicle is new
- the vehicle is driven frequently at higher engine speeds

Engine oil consumption checks should only be made after the vehicle break-in period.



Do not use any special lubricant additives, as these may damage the drive assemblies. Using special additives not approved by Mercedes-Benz may cause damage not covered by the Mercedes-Benz Limited Warranty.

More information on this subject is available at any Mercedes-Benz Light Truck Center.

Checking engine oil level with the control system (R 500 only)



When checking the oil level

- the vehicle must be parked on level ground
- with the engine at operating temperature, the vehicle must have been stationary for at least 5 minutes with the engine turned off
- with the engine not at operating temperature yet, the vehicle must have been stationary for at least 30 minutes with the engine turned off

To check the engine oil level via the multifunction display, do the following:

- ▶ Switch on the ignition (▷ page 38).

The standard display (▷ page 168) should appear in the multifunction display.

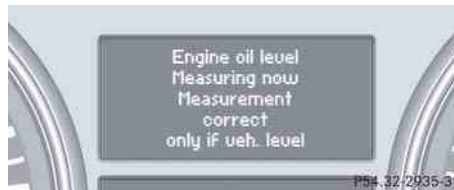

- ▶ Press button  or  on the steering wheel until the following message appears in the multifunction display:



One of the following messages will subsequently appear in the indicator:

- Engine oil level ok
- Add 1.0 qt. to reach max. oil level
(Canada: 1.0 liter)
- Add 1.5 qts. to reach max. oil level
(Canada: 1.5 liters)
- Add 2.0 qts. to reach max. oil level
(Canada: 2.0 liters)



If you want to interrupt the checking procedure, press the  or  button on the multifunction steering wheel.

- ▶ If necessary, add engine oil.

For adding engine oil, see (▷ page 523).

For more information on engine oil, see the “Technical data” section (▷ page 521) and (▷ page 523).

Other display messages

If the SmartKey is not turned to position 2 in the starter switch, the following message will appear:

Switch ignition on to check engine oil level

- ▶ Switch on the ignition (▷ page 38).

Engine compartment

If you see the message:

Observe waiting period

- ▶ If engine is at operating temperature, wait 5 minutes before repeating check procedure.
- ▶ If engine is not at operating temperature, wait 30 minutes before repeating check procedure.

If you see the message:

Engine oil level

Not when engine on

- ▶ Turn off the engine.
- ▶ If the engine is at operating temperature, wait 5 minutes before checking oil.
- ▶ If the engine is not at operating temperature yet, you must wait 30 minutes before checking oil.

If there is excess engine oil with the engine at operating temperature, the following message will appear:

Engine oil level

Reduce oil level

- ▶ Have excess oil siphoned or drained off. Contact an authorized Mercedes-Benz Light Truck Center.



Excess oil must be siphoned or drained off. It could cause damage to the engine and catalytic converter not covered by the Mercedes-Benz Limited Warranty.

For more information on messages in the display concerning engine oil, see the “Practical hints” section (▷ page 437).

Checking engine oil level with the oil dipstick (R 350 only)

When checking the oil level

- the vehicle must be parked on level ground
- with the engine at operating temperature, the vehicle must have been stationary for at least 5 minutes with the engine turned off
- with the engine not at operating temperature yet, the vehicle also must have been stationary for at least 5 minutes with the engine turned off

To check the engine oil level with the oil dipstick, do the following:

- ▶ Open the hood (▷ page 345).



- ① Oil dipstick
- ② Upper mark
- ③ Lower mark

- ▶ Pull out oil dipstick ①.
- ▶ Wipe oil dipstick ① clean.
- ▶ Fully insert oil dipstick ① into the dipstick guide tube.
- ▶ Pull out oil dipstick ① again after approximately 3 seconds to obtain accurate reading.

The oil level is correct when it is between lower mark ③ (min.) and upper mark ② (max.) mark of the oil dipstick.



The filling quantity between the upper and lower marks on the oil dipstick is approximately 2.1 US qt. (2.0 l).

- ▶ If necessary, add engine oil.

For more information on engine oil, see “Technical data” section (▷ page 521) and (▷ page 523).

See the “Practical hints” section (▷ page 437) if the low engine oil level warning lamp in the instrument cluster flashes.

Adding engine oil



Only use approved engine oils and oil filters required for vehicles with Maintenance System (U.S. vehicles) or FSS PLUS (Canada vehicles). For a listing of approved engine oils and oil filters, refer to the Factory Approved Service Products pamphlet in your vehicle literature portfolio, or contact an authorized Mercedes-Benz Light Truck Center.

Using engine oils and oil filters of specification other than those expressly required for the Maintenance System (U.S. vehicles) or FSS PLUS (Canada vehicles), or changing of oil and oil filter at change intervals longer than those called for by the Maintenance System (U.S. vehicles) or FSS PLUS (Canada vehicles) will result in engine damage not covered by the Mercedes-Benz Limited Warranty.

Engine compartment



R 350

① Filler cap



R 500

① Filler cap

- ▶ Unscrew filler cap ① from filler neck.
- ▶ Add engine oil as required. Never over-fill with oil.

Be careful not to spill any oil when adding. Avoid environmental damage caused by oil entering the ground or water.



Excess oil must be siphoned or drained off. It will cause damage to the engine and catalytic converter not covered by the Mercedes-Benz Limited Warranty.

- ▶ Screw filler cap ① back on filler neck.

For more information on engine oil, see “Technical data” section (▷ page 521) and (▷ page 523).

Transmission fluid level

The transmission fluid level does not need to be checked. If you notice transmission fluid loss or gear shifting malfunctions, have an authorized Mercedes-Benz Light Truck Center check the automatic transmission.

Coolant level

The engine coolant is a mixture of water and anticorrosion / antifreeze. To check the coolant level, the vehicle must be parked on level ground and the engine must be cool.

Warning!



In order to avoid any possibly serious burns:

- Use extreme caution when opening the hood if there are any signs of steam or coolant leaking from the cooling system, or if the coolant temperature gauge indicates that the coolant is overheated.
- Do not remove pressure cap on coolant reservoir if coolant temperature is above 158°F (70°C). Allow engine to cool down before removing cap. The coolant reservoir contains hot fluid and is under pressure.

- Using a rag, slowly open the cap approximately $\frac{1}{2}$ turn to relieve excess pressure. If opened immediately, scalding hot fluid and steam will be blown out under pressure.
- Do not spill antifreeze on hot engine parts. Antifreeze contains ethylene glycol which may burn if it comes into contact with hot engine parts.

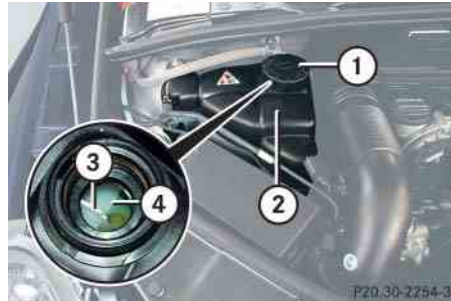

- ① Cap
- ② Coolant expansion tank
- ③ Indicator wall
- ④ Coolant level

- ▶ Using a rag, turn cap ① slowly approximately one half turn counterclockwise to release any excess pressure.
- ▶ Continue turning cap ① counterclockwise and remove it.

Coolant level ④ is correct if the level:

- for cold coolant: reaches the top of indicator wall ③ visible through the filling opening
 - for warm coolant: is approximately 0.6 in (1.5 cm) higher
- ▶ Add coolant as required.
 - ▶ Replace and tighten cap ①.

For more information on coolant, see the “Technical data” section (▷ page 525).

Engine compartment

Windshield/rear window washer system and headlamp cleaning system*

The windshield washer reservoir is located in the engine compartment.



- ① Cap
- ② Windshield washer reservoir

Fluid for the windshield washer system and the headlamp cleaning system* is supplied from the windshield washer reservoir. It has a capacity of 8.0 US qt (7.6 l).

During all seasons, add MB Windshield Washer Concentrate “S” to water. Premix the windshield washer fluid in a suitable container.

Warning!



Washer solvent/antifreeze is highly flammable. Do not spill washer solvent/antifreeze on hot engine parts, because it may ignite and burn. You could be seriously burned.

- ▶ Use the tab to pull cap ① upwards.
- ▶ Refill the reservoir with MB Windshield Washer Concentrate “S” and water (or commercially available premixed windshield washer solvent/antifreeze, depending on ambient temperatures).

Always use washer solvent/antifreeze where temperatures may fall below freezing point. Failure to do so could result in damage to the washer system/reservoir.



Only use washer fluid which is suitable for plastic lenses. Improper washer fluid can damage the plastic lenses of the headlamps.

For more information, see “Windshield and headlamp washer fluid mixing ratio” (▷ page 528).

▼ Tires and wheels

See an authorized Mercedes-Benz Light Truck Center for information on tested and recommended rims and tires for summer and winter operation. They can also offer advice concerning tire service and purchase.

Warning!



Replace rims or tires with the same designation, manufacturer and type as shown on the original part. See an authorized Mercedes-Benz Light Truck Center for further information. If incorrectly sized rims and tires are mounted:

- The wheel brakes or suspension components can be damaged.
- The operating clearance of the wheels and the tires may no longer be correct.

Warning!



Worn, old tires can cause accidents. If the tire tread is badly worn, or if the tires have sustained damage, replace them.

When replacing rims, only use genuine Mercedes-Benz wheel bolts specified for the particular rim type. Failure to do so can result in the bolts loosening and possibly an accident.

Retreaded tires are not tested or recommended by Mercedes-Benz, since previous damage cannot always be recognized on retreads. The operating safety of the vehicle cannot be assured when such tires are used.

Important guidelines

- Only use sets of tires and rims of the same type and make.
- Tires must be of the correct size for the rim.
- Break in new tires for approximately 60 miles (100 km) at moderate speeds.
- Regularly check the tires and rims for damage. Dented or bent rims can cause tire inflation pressure loss and damage to the tire beads.
- If vehicle is heavily loaded, check tire inflation pressure and correct as required.
- Do not allow your tires to wear down too far. Adhesion properties on wet roads are sharply reduced at tread depths under $\frac{1}{8}$ in (3 mm).
- When replacing individual tires, you should mount new tires on the front wheels first (on vehicles with same-sized wheels all around).

Tires and wheels

Tire care and maintenance

Warning!



Regularly check the tires for damage. Damaged tires can cause tire inflation pressure loss. As a result, you could lose control of your vehicle.

Worn, old tires can cause accidents. If the tire tread is badly worn, or if the tires have sustained damage, replace them.

Regularly check your tire inflation pressure at least once a month. For more information on checking tire inflation pressure, see “Recommended tire inflation pressure” (▷ page 363).

Tire inspection

Every time you check your tire inflation pressure, you should also inspect your tires for the following:

- excessive treadwear (▷ page 355)
- cord or fabric showing through the tire’s rubber
- bumps, bulges, cuts, cracks or splits in the tread or side of the tire

Replace the tire if you find any of the above conditions.

Make sure you also inspect the spare tire periodically for condition and inflation. Spare tires will age and become worn over time even if never used, and thus should be inspected and replaced when necessary.

Life of tire

The service life of a tire is dependent upon varying factors including but not limited to:

- Driving style
- Tire inflation pressure
- Distance driven

Warning!



Tires and spare tire should be replaced after 6 years, regardless of the remaining tread.

Tread depth

Do not allow your tires to wear down too far. Adhesion properties on wet roads are sharply reduced at tread depths under $\frac{1}{8}$ in (3 mm).

Treadwear indicators (TWI) are required by law. These indicators are located in six places on the tread circumference and become visible at a tread depth of approximately $\frac{1}{16}$ in (1.6 mm), at which point the tire is considered worn and should be replaced.

Recommended minimum tire tread depth:

- Summer tires $\frac{1}{8}$ in (3 mm)
- Winter tires $\frac{1}{6}$ in (4 mm)

Warning!



Although the applicable federal motor safety laws consider a tire to be worn when the treadwear indicators (TWI) become visible at approximately $\frac{1}{16}$ in (1.6 mm), we recommend that you do not allow your tires

to wear down to that level. As tread depth approaches $\frac{1}{8}$ in (3 mm), the adhesion properties on a wet road are sharply reduced.

Depending upon the weather and/or road surface (conditions), the tire traction varies widely.

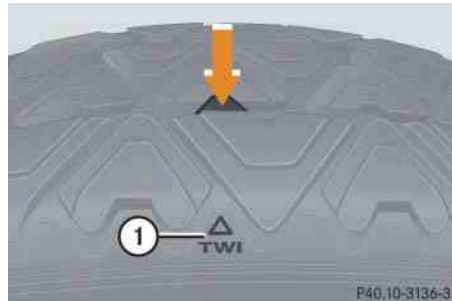

① TWI (Tread Wear Indicator)

The treadwear indicator appears as a solid band across the tread.

Storing tires



Keep unmounted tires in a cool, dry place with as little exposure to light as possible. Protect tires from contact with oil, grease and gasoline.

Cleaning tires



Never use a round nozzle to power wash tires. The intense jet of water can result in damage to the tire.

Always replace a damaged tire.

Tires and wheels

Direction of rotation

Unidirectional tires offer added advantages, such as better hydroplaning performance. To benefit, however, you must make sure the tires rotate in the direction specified.

An arrow on the sidewall indicates the intended direction of rotation (spinning) of the tire.



Spare wheels may be mounted against the direction of rotation (spinning) even with a unidirectional tire for temporary use only until the regular drive wheel has been repaired or replaced. Always observe and follow applicable temporary use restrictions and speed limitations indicated on the spare wheel.

Loading the vehicle

Two labels on your vehicle show how much weight it may properly carry.

- The Tire and Loading Information placard (Example A) or the Vehicle Tire Information placard (Example B) can be found on the driver's door B-pillar. This placard tells you important information about the number of people that can be in the vehicle and the total weight that can be carried in the vehicle. It also contains information on the proper size and recommended tire inflation pressures for the original equipment tires on your vehicle.

- The Certification label, also found on the driver's door B-pillar, tells you about the gross weight capacity of your vehicle, called the Gross Vehicle Weight Rating (GVWR). The GVWR includes the weight of the vehicle, all occupants, fuel and cargo. The Certification label also tells you about the front and rear axle weight capacity, called the Gross Axle Weight Rating (GAWR). The GAWR is the total allowable weight that can be carried by a single axle (front or rear). Never exceed the GVWR or GAWR for either the front axle or rear axle.



① Driver's door B-pillar

Following is a discussion on how to work with the information contained on the two placards with regards to loading your vehicle.

Tire and Loading Information

Warning!



Do not overload the tires by exceeding the specified load limit as indicated on the placard on the driver's door B-pillar. Overloading the tires can overheat them, possibly causing a blowout. Overloading the tires can also result in handling or steering problems, or brake failure.

Your vehicle is equipped with either the Tire and Loading Information placard (Example A) or the Vehicle Tire Information placard (Example B).



Data shown on placard examples are for illustration purposes only. Load limit data are specific to each vehicle and may vary from data shown in the illustrations below. Refer to placard on vehicle for actual data specific to your vehicle.

Placard (Example A)

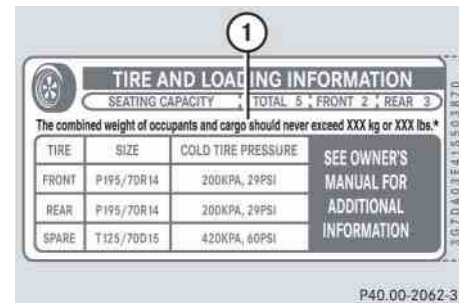

① Load limit information on the Tire and Loading Information placard

Tires and wheels

The placard showing the load limit information is located on the driver's door B-pillar. If your vehicle is equipped with the Tire and Loading Information placard (Example A), locate the statement "The combined weight of occupants and cargo should never exceed XXX kilograms or XXX lbs." on this placard. The combined weight of all occupants, cargo/luggage and trailer tongue load (if applicable) should never exceed the weight referenced in that statement.

Placard (Example B)



- ① Load limit information on the Vehicle Tire Information placard

The placard showing the load limit information is located on the driver's door B-pillar. If your vehicle is equipped with the Vehicle Tire Information placard (Example B), locate the heading "Vehicle Capacity Weight" on this placard. The combined weight of all occupants, cargo/luggage and trailer tongue (if applicable) should never exceed the weight listed next to vehicle capacity weight.

Seating capacity

The seating capacity gives you important information on the number of occupants that can be in the vehicle. Observe front and rear seating capacity. Depending on production date, your vehicle may be equipped with placard Example A or placard Example B.

Your vehicle may not be equipped with placard A nor other placard posting the seating capacity. If this is the case, legal requirements at time of production of your vehicle did not require manufacturers to post the seating capacity.

Never let more people ride in the vehicle than there are designated seating positions and seat belts available. Be sure everyone riding in the vehicle is correctly restrained with a separate seat belt.



Data shown on placard examples are for illustration purposes only. Seating data are specific to each vehicle and may vary from data shown in the illustration below. Refer to placard on vehicle for actual data specific to your vehicle.

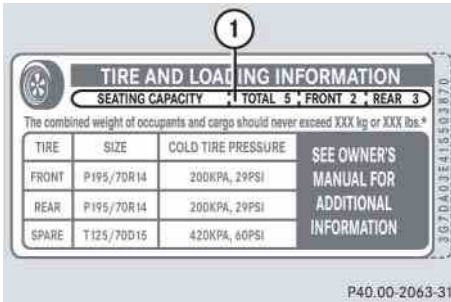

Placard (Example A)

① Seating capacity



Placard (Example B)

① Seating capacity

Steps for determining correct load limit

The following steps have been developed as required of all manufacturers under Title 49, Code of U.S. Federal Regulations, Part 575 pursuant to the “National Traffic and Motor Vehicle Safety Act of 1966”.

Step 1 (Vehicles equipped with placard Example A)

- ▶ Locate the statement “The combined weight of occupants and cargo should never exceed XXX kg or XXX lbs.” on your vehicle’s placard.

Step 1 (Vehicles equipped with placard Example B)

- ▶ Locate the heading “Vehicle Capacity Weight” on your vehicle’s placard.

Step 2

- ▶ Determine the combined weight of the driver and passengers that will be riding in your vehicle.

Step 3

- ▶ Subtract the combined weight of the driver and passengers from XXX kilograms or XXX lbs.

Step 4

- ▶ The resulting figure equals the available amount of cargo and luggage load capacity. For example, if the “XXX” amount equals 1400 lbs. and there will be five 150 lbs. passengers in your vehicle, the amount of available cargo and luggage load capacity is 650 lbs. (1400 - 750 (5 x 150) = 650 lbs.)

Step 5

- ▶ Determine the combined weight of luggage and cargo being loaded on the vehicle. That weight may not safely exceed the available cargo and luggage load capacity calculated in step 4. ▶▶

Tires and wheels

▷▷ Step 6 (if applicable)

- ▶ If your vehicle will be towing a trailer, load from your trailer will be transferred to your vehicle. Consult this manual to determine how this reduces the available cargo and luggage load capacity of your vehicle (▷ page 362).

The following table shows examples on how to calculate total and cargo load capacities with varying seating configurations and number and size of occupants. The following examples use a load limit of 1500 lbs. **This is for illustration purposes only.** Make sure you are using the actual load limit for your vehicle stated on the vehicle's placard (▷ page 357).

Example	Combined weight limit of occupants and cargo from placard	Number of occupants (driver and passengers)	Seating configuration	Occupants weight	Combined weight of all occupants	Available cargo/luggage and trailer tongue weight (total load limit from placard minus combined weight of all occupants)
1	1500 lbs	5	front: 2 rear: 3	Occupant 1: 150 lbs Occupant 2: 180 lbs Occupant 3: 160 lbs Occupant 4: 140 lbs Occupant 5: 120 lbs	750 lbs	1500 lbs - 750 lbs = 750 lbs
2	1500 lbs	3	front: 1 rear: 2	Occupant 1: 200 lbs Occupant 2: 190 lbs Occupant 3: 150 lbs	540 lbs	1500 lbs - 540 lbs = 960 lbs
3	1500 lbs	1	front: 1	Occupant 1: 150 lbs	150 lbs	1500 lbs - 150 lbs = 1350 lbs

The higher the weight of all occupants, the less cargo and luggage load capacity is available.

For more information, see “Trailer tongue load” (> page 362).

Tires and wheels

Certification label

Even after careful determination of the combined weight of all occupants, cargo and the trailer tongue load (if applicable) (▷ page 362) as to not exceed the permissible load limit, you must make sure that your vehicle never exceeds the Gross Vehicle Weight Rating (GVWR) and the Gross Axle Weight Rating (GAWR) for either the front or rear axle. You can obtain the GVWR and GAWR from the Certification label. The Certification Label can be found on the driver's door B-pillar, see "Technical data" (▷ page 510).

Gross Vehicle Weight Rating (GVWR): The total weight of the vehicle, all occupants, all cargo, and the trailer tongue load (▷ page 362) must never exceed the GVWR.

Gross Axle Weight Rating (GAWR): The total allowable weight that can be carried by a single axle (front or rear).

To assure that your vehicle does not exceed the maximum permissible weight limits (GVWR and GAWR for front and rear axle), have the loaded vehicle (including driver, passengers and all cargo and, if applicable, trailer fully loaded) weighed on a suitable commercial scale.

Trailer tongue load

The tongue load of any trailer is an important weight to measure because it affects the load you can carry in your vehicle. If a trailer is towed, the tongue load must be added to the weight of all occupants riding and any cargo you are carrying in the vehicle. The tongue load typically is between 10% and 15% of the trailer weight and everything loaded in it.

Recommended tire inflation pressure

Warning!



Follow recommended tire inflation pressures.

Do not underinflate tires. Underinflated tires wear excessively and/or unevenly, adversely affect handling and fuel economy, and are more likely to fail from being overheated.

Do not overinflate tires. Overinflated tires can adversely affect handling and ride comfort, wear unevenly, increase stopping distance, and result in sudden deflation (blowout) because they are more likely to become punctured or damaged by road debris, potholes etc.

Your vehicle is equipped with either the Tire and Loading Information placard (Example A) or the Vehicle Tire Information Placard (Example B) located on the driver's door B-pillar (▷ page 357).

The tire inflation pressure should be checked regularly and should only be adjusted on cold tires. The tires can be considered cold if the vehicle has been parked for at least 3 hours or driven less than 1 mile (1.6 km).

Follow recommended cold tire inflation pressures listed on placard.

Keeping the tires properly inflated provides the best handling, tread life and riding comfort.

In addition to the tire placard on the driver's door B-pillar, also consult the fuel filler flap for any additional information pertaining to special driving situations. For more information, see "Important notes on tire inflation pressure" (▷ page 364).



Data shown on placard examples are for illustration purposes only. Tire data are specific to each vehicle and may vary from data shown in the illustrations below. Refer to placard on vehicle for actual data specific to your vehicle.

Placard (Example A)

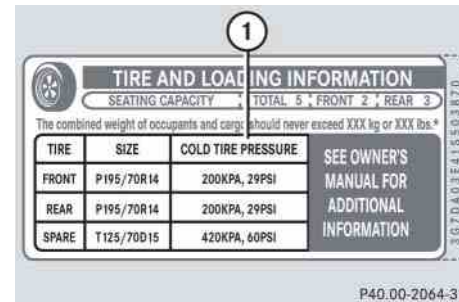

- ① Tire and Loading Information placard with recommended cold tire inflation pressures

Tires and wheels

Placard (Example A) lists the recommended cold tire inflation pressures for maximum loaded vehicle weight. The tire inflation pressures listed apply to the tires installed as original equipment.

Placard (Example B)

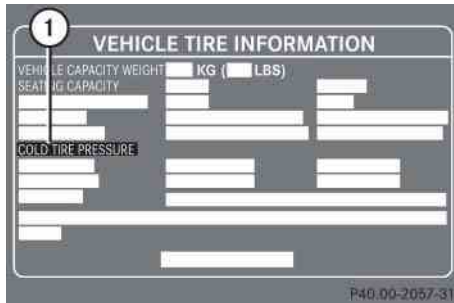

① Vehicle Tire Information placard with recommended tire inflation pressures

Placard (Example B) lists the recommended cold tire inflation pressures for maximum loaded vehicle weight. The tire inflation pressures listed apply to the tires installed as original equipment.

Important notes on tire inflation pressure

Warning!



If the tire inflation pressure drops repeatedly:

- Check the tires for punctures from foreign objects.
- Check to see whether air is leaking from the valves or from around the rim.

Tire temperature and tire inflation pressure are also increased while driving, depending on the driving speed and the tire load.

If you will be driving your vehicle at high speeds of 100 mph (160 km/h) or higher, where it is legal and conditions allow, consult the placard on the inside of the fuel filler flap on how to adjust the cold tire inflation pressure. If you do not adjust the tire inflation pressure, excessive heat can build up and result in sudden tire failure.

Be sure to readjust the tire inflation pressure for normal driving speeds. You should wait until the tires are cold before adjusting the tire inflation pressure.

Some vehicles may have supplemental tire inflation pressure information for vehicle loads less than the maximum loaded vehicle condition. If such information is provided, it can be found on the placard located on the inside of the fuel filler flap.

Tire inflation pressure changes by approximately 1.5 psi (0.1 bar) per 18°F (10°C) of air temperature change. Keep this in mind when checking tire inflation pressure where the temperature is different from the outside temperature.

Checking tire inflation pressure

Regularly check your tire inflation pressure at least once a month.

Check and adjust the tire inflation pressure when the tires are cold. The tires can be considered cold if the vehicle has been parked for at least 3 hours or driven less than 1 mile (1.6 km).

If you check the tire inflation pressure when the tires are warm (the vehicle has been driven for several miles or sitting less than 3 hours), the reading will be approximately 4 psi (0.3 bar) higher than the cold reading. This is normal. Do not let air out to match the specified cold tire inflation pressure. Otherwise, the tire will be underinflated.

Warning!



Follow recommended tire inflation pressures.

Do not underinflate tires. Underinflated tires wear excessively and/or unevenly, adversely affect handling and fuel economy, and are more likely to fail from being overheated.

Do not overinflate tires. Overinflated tires can adversely affect handling and ride comfort, wear unevenly, increase stopping distance, and result in sudden deflation (blowout) because they are more likely to become punctured or damaged by road debris, potholes etc.

Do not overload the tires by exceeding the specified load limit as indicated on the placard on the driver's door B-pillar. Overloading the tires can overheat them, possibly causing a blowout.

Checking tire inflation pressure manually

Follow the steps below to achieve correct tire inflation pressure:

- ▶ Remove the cap from the valve on one tire.
- ▶ Firmly press a tire gauge onto the valve.
- ▶ Read tire inflation pressure on tire gauge and check against the recommended tire inflation pressure on the placard on the driver's door B-pillar (> page 357) or, if available, the inside of the fuel filler flap. If necessary, add air to achieve the recommended tire inflation pressure. >>

Tires and wheels



If you have overfilled the tire, release tire inflation pressure by pushing the metal stem of the valve with e.g. a tip of a pen. Then recheck the tire inflation pressure with the tire gauge.

- ▶ Install the valve cap.
- ▶ Repeat this procedure for each tire.

Run Flat Indicator (Canada only)

While the vehicle is being driven, the Run Flat Indicator monitors the set tire inflation pressures by evaluating each wheel's rotational speed. This allows the system to detect a significant loss of pressure in a tire. If a wheel's rotational speed changes due to falling tire inflation pressure, you will see a corresponding warning message in the multifunction display.

The Run Flat Indicator may function in a restricted manner or with a delay if:

- snow chains are mounted to the vehicle
- winter road conditions prevail
- you are driving on a loose surface (e.g. sand or gravel)
- you are driving in a very sporty manner (involving rapid acceleration or high speeds in curves)

Warning!



When the multifunction display shows the message **Tire pressure Check tires**, one or more of your tires is significantly under-inflated. You should stop and check your tires as soon as possible, and inflate them to the proper tire inflation pressure as indicated on the vehicle's tire information placard. Driving on a significantly under-inflated tire causes the tire to overheat and can lead to tire failure. Under-inflation also reduces fuel efficiency and tire tread life, and may affect the vehicle's handling and stopping ability. Each tire, including the spare, should be checked monthly when cold and set to the recommended tire inflation pressure as specified in the vehicle placard and owner's manual.



The recommended tire inflation pressures for your vehicle can be found on the tire placard located on the driver's door B-pillar (▷ page 357). The tire inflation pressures are not listed in the owner's manual.

Warning!

The Run Flat Indicator does not indicate a warning for wrongly selected tire inflation pressures. Always adjust tire inflation pressure according to the placard on the driver's door B-pillar or fuel filler flap.

The Run Flat Indicator does not replace regular checks of the tire inflation pressures since a gradual pressure loss in all four tires cannot be detected by the Run Flat Indicator.

The Run Flat Indicator is not able to issue a warning due to a sudden dramatic loss of tire inflation pressure (e.g. tire blowout caused by a foreign object). In this case bring the vehicle to a halt by carefully applying the brakes and avoiding abrupt steering maneuvers.

Reactivating the Run Flat Indicator

The tire inflation pressure monitor must be reactivated in the following situations:

- If you have changed the tire inflation pressure
- If you have replaced the wheels or tires
- If you have installed new wheels or tires
- ▶ Using the tire placard on the driver's door B-pillar or, if available, the inside of the fuel filler flap, make sure the tire inflation pressure of all four tires is correct.

Warning!



The Run Flat Indicator can only warn you in a reliable manner if you have set the correct tire inflation pressures for each tire.

If an incorrect tire inflation pressure was set, the system will monitor the pressure according to the incorrect value.

Tires and wheels

- ▶ Switch on the ignition (▷ page 38).

Make sure the standard display menu appears in the multifunction display (▷ page 168).

- ▶ Press button  or  repeatedly until the following message appears in the multifunction display:



- ▶ Press button .

The following message will appear in the multifunction display:
Tire pressure now OK?

If you wish to confirm activation:

- ▶ Press button .

The following message will appear in the multifunction display:
Run Flat Indicator
reactivated

After a certain “learning phase”, the Run Flat Indicator checks the set pressure values for all four tires.

If you wish to cancel activation:

- ▶ Press button .

or

- ▶ Wait until the message
Tire pressure now OK?
disappears.

Checking tire pressure electronically with the Tire Pressure Monitoring System (TPMS), (USA only)



The Tire Pressure Monitoring System (TPMS) is equipped with a combination low tire pressure/TPMS malfunction telltale in the instrument cluster (▷ page 24). Depending on how the telltale illuminates, it indicates a low tire pressure condition or a malfunction in the TPMS system itself:

- If the telltale illuminates continuously, one or more of your tires is significantly underinflated. There is no malfunction in the TPMS.
- If the telltale flashes for 60 seconds and then stays illuminated, the TPMS system itself is not operating properly.

The TPMS only functions on wheels that are equipped with the proper electronic sensors. It monitors the tire inflation pressure, as selected by the driver, in all four tires. A warning is issued to alert you to a decrease in pressure in one or more of the tires.

Warning!

The TPMS does not indicate a warning for wrongly selected inflation pressures. Always adjust tire inflation pressure according to the placard on the driver's door B-pillar or, if available, the supplemental tire pressure information on the inside of the fuel filler flap.

The TPMS is not able to issue a warning due to a sudden dramatic loss of pressure (e.g. tire blowout caused by a foreign object). In this case bring the vehicle to a halt by carefully applying the brakes and avoiding abrupt steering maneuvers.

Warning!

Each tire, including the spare (if provided), should be checked monthly when cold and inflated to the inflation pressure recommended by the vehicle manufacturer on the vehicle placard or the tire inflation pressure label. (If your vehicle has tires of a different size than the size indicated on the vehicle placard or the tire inflation pressure label, you should determine the proper tire inflation pressure for those tires).

As an added safety feature, your vehicle has been equipped with a tire pressure monitoring system (TPMS) that illuminates a low tire pressure telltale when one or more of your tires is significantly underinflated. Accordingly, when the low tire pressure telltale illuminates, you should stop and check your tires as soon as possible, and inflate them to the proper pressure. Driving on a significantly underinflated tire causes the tire to overheat and can lead to tire failure.

Underinflation also reduces fuel efficiency and tire tread life, and may affect the vehicle's handling and stopping ability. Please note that the TPMS is not a substitute for proper tire maintenance, and it is the driver's responsibility to maintain correct tire pressure, even if underinflation has not reached the level to trigger illumination of the TPMS low tire pressure telltale.

Your vehicle has also been equipped with a TPMS malfunction indicator to indicate when the system is not operating properly. The TPMS malfunction indicator is combined with the low tire pressure telltale. When the system detects a malfunction, the telltale will flash for approximately 1 minute and then remain continuously illuminated. This sequence will continue upon subsequent vehicle start-ups as long as the malfunction exists. When the malfunction indicator is illuminated, the system may not be able to detect or signal low tire pressure as intended.



Tires and wheels

▷▷ TPMS malfunctions may occur for a variety of reasons, including the installation of incompatible replacement or alternate tires or wheels on the vehicle that prevent the TPMS from functioning properly. Always check the TPMS malfunction telltale after replacing one or more tires or wheels on your vehicle to ensure that the replacement or alternate tires and wheels allow the TPMS to continue to function properly.



If a condition causing the TPMS to malfunction develops, it may take up to 10 minutes for the system to signal a malfunction using the TPMS telltale flashing and illumination sequence.

The telltale extinguishes after a few minutes driving if the malfunction has been corrected.



Operating radio transmission equipment (e.g. wireless headsets, two-way radios) in or near the vehicle could cause the TPMS to malfunction.

Reactivating the TPMS

The TPMS must be reactivated when you have adjusted the tire inflation pressure to a new level (e.g. because of different load or driving conditions). The TPMS is then recalibrated to the current tire inflation pressures.

Warning!



It is the driver's responsibility to calibrate the TPMS on the recommended cold inflation pressure. Underinflated tires affect the ability to steer or brake the vehicle. You might lose control over the vehicle.

- ▶ Using the tire placard on the driver's door B-pillar (▷ page 357) or, if available, the supplemental tire pressure information on the inside of the fuel filler flap (▷ page 342), make sure the tire inflation pressure of all four tires is correct.



Reactivate the TPMS after adjusting the tire inflation pressure to the inflation pressure recommended for the vehicle operating condition. Tire pressure should only be adjusted on cold tires. Observe the recommended tire inflation pressure on the placard on the driver's door B-pillar (▷ page 357). Some vehicles may have supplemental tire pressure information for driving at high speeds (▷ page 364) or for vehicle loads less than the maximum loaded vehicle condition (▷ page 364). If such information is provided, it can be found on the inside of the fuel filler flap.

- ▶ Press button or on the multifunction steering wheel repeatedly until the standard display menu appears in the multifunction display (▷ page 168).

- ▶ Press the or button repeatedly until you see the following message:

Tire pressure monitor
active
Reactivation possible:
R-button

- ▶ Press the reset button (▷ page 158).

The following message will appear in the multifunction display:
Check current
tire pressure?

- ▶ Press the button.

The following message will appear in the multifunction display:
Tire pressure monitor
reactivated

The TPMS will now monitor the tire inflation pressure values of all four tires.

If you wish to cancel activation:

- ▶ Press the button.

Checking tire pressure electronically with the Advanced Tire Pressure Monitoring System* (Advanced TPMS*), (Canada only)



The Advanced Tire Pressure Monitoring System* (Advanced TPMS*) is equipped with a combination low tire pressure/TPMS malfunction telltale in the instrument cluster (▷ page 24). Depending on how the telltale illuminates, it indicates a low tire pressure condition or a malfunction in the TPMS system itself:

- If the telltale illuminates continuously, one or more of your tires is significantly underinflated. There is no malfunction in the TPMS.
- If the telltale flashes for 60 seconds and then stays illuminated, the TPMS system itself is not operating properly.



Tires and wheels

The TPMS only functions on wheels that are equipped with the proper electronic sensors. It monitors the tire inflation pressure, as selected by the driver, in all four tires. A warning is issued to alert you to a decrease in pressure in one or more of the tires.

Tire pressure inquiries are made using the multifunction display. The present inflation pressures are displayed only after a few minutes' travel time.



Possible differences between the readings of a tire pressure gauge of an air hose, e.g. gas station equipment, and the vehicle's control system can occur. Usually the readings issued by the control system are more precise.

- ▶ Switch on the ignition (▷ page 38).
- ▶ Press the  or  button until the current inflation pressures for each tire appear in the multifunction display.



When the message **Tire pressure** displayed only after driving a few minutes appears in the multifunction display, the individual inflation pressure values are matched with the tires. The individual values are displayed after a few minutes driving.

Warning!



It is the driver's responsibility to calibrate the TPMS on the recommended cold inflation pressure. Underinflated tires affect the ability to steer or brake the vehicle. You might lose control over the vehicle.



With a spare wheel without wheel sensor mounted, the system may still indicate the tire inflation pressure of the removed wheel for some minutes. If this happens, keep in mind that the indicated value where the spare wheel is mounted does not reflect the actual spare tire inflation pressure.

Warning!



The TPMS does not indicate a warning for wrongly selected inflation pressures. Always adjust tire inflation pressure according to the placard on the driver's door B-pillar or, if available, the supplemental tire pressure information on the inside of the fuel filler flap.

The TPMS is not able to issue a warning due to a sudden dramatic loss of pressure (e.g. tire blowout caused by a foreign object). In this case bring the vehicle to a halt by carefully applying the brakes and avoiding abrupt steering maneuvers.

Warning!

Each tire, including the spare (if provided), should be checked monthly when cold and inflated to the inflation pressure recommended by the vehicle manufacturer on the vehicle placard or the tire inflation pressure label. (If your vehicle has tires of a different size than the size indicated on the vehicle placard or the tire inflation pressure label, you should determine the proper tire inflation pressure for those tires).

As an added safety feature, your vehicle has been equipped with a tire pressure monitoring system (TPMS) that illuminates a low tire pressure telltale when one or more of your tires are significantly underinflated. Accordingly, when the low tire pressure telltale illuminates, you should stop and check your tires as soon as possible. Driving on a significantly underinflated tire causes the tire to overheat and can lead to tire failure.

Underinflation also reduces fuel efficiency and tire tread life, and may effect the vehicle's handling and stopping ability. Please note that the TPMS is not a substitute for proper tire maintenance, and it is the driver's responsibility to maintain correct tire pressure, even if underinflation has not reached the level to trigger illumination of the TPMS low tire pressure telltale.

Your vehicle has also been equipped with a TPMS malfunction indicator to indicate when the system is not operating properly. The TPMS malfunction indicator is combined with the low tire pressure telltale. When the system detects a malfunction, the telltale will flash for approximately 1 minute and then remain continuously illuminated. This sequence will continue upon subsequent vehicle start-ups as long as the malfunction exists. When the malfunction indicator is illuminated, the system may not be able to detect or signal low tire pressure as intended.



If a condition causing the TPMS to malfunction develops, it may take up to 10 minutes for the system to signal a malfunction using the TPMS telltale flashing and illumination sequence.

The telltale extinguishes after a few minutes driving if the malfunction has been corrected.



Operating radio transmission equipment (e.g. wireless headsets, two-way radios) in or near the vehicle could cause the TPMS to malfunction.

Tires and wheels

Reactivating Advanced TPMS*

The TPMS must be reactivated when you have adjusted the tire inflation pressure to a new level (e.g. because of different load or driving conditions). The TPMS is then recalibrated to the current tire inflation pressures.

Warning!









It is the driver's responsibility to calibrate the TPMS on the recommended cold inflation pressure. Underinflated tires affect the ability to steer or brake the vehicle. You might lose control over the vehicle.

- ▶ Using the tire placard on the driver's door B-pillar (▷ page 357) or, if available, the supplemental tire pressure information on the inside of the fuel filler flap (▷ page 342), make sure the tire inflation pressure of all four tires is correct.



Reactivate the TPMS after adjusting the tire inflation pressure to the inflation pressure recommended for the vehicle operating condition. Tire pressure should only be adjusted on cold tires. Observe the recommended tire inflation pressure on the placard on the driver's door B-pillar (▷ page 357). Some vehicles may have supplemental tire pressure information for driving at high speeds (▷ page 364) or for vehicle loads less than the maximum loaded vehicle condition (▷ page 364). If such information is provided, it can be found on the inside of the fuel filler flap.

- ▶ Press button  or  on the multifunction steering wheel repeatedly until the standard display menu appears in the multifunction display (▷ page 168).

- ▶ Press the  or  button repeatedly until you see the current inflation pressures for each tire appear in the display or the following message appears in the multifunction display:
Tire pressure displayed
only after driving
a few minutes
- ▶ Press the reset button (▷ page 158).
The following message will appear in the multifunction display:
Check current
tire pressure?
- ▶ Press the  button.
The following message will appear in the multifunction display:
Tire pressure monitor
reactivated
The TPMS will now monitor the tire inflation pressure values of all four tires.
If you wish to cancel activation:
 - ▶ Press the  button.

Potential problems associated with underinflated and overinflated tires

Underinflated tire inflation pressure

Underinflated tires can

- cause excessive and uneven tire wear
- adversely affect fuel economy
- lead to tire failure from being overheated
- adversely affect handling characteristics

Warning!



Follow recommended tire inflation pressures.

Do not underinflate tires. Underinflated tires wear excessively and/or unevenly, adversely affect handling and fuel economy, and are more likely to fail from being overheated.

Overinflated tire inflation pressure

Overinflated tires can:

- adversely affect handling characteristics
- cause uneven tire wear
- be more prone to damage from road hazards
- adversely affect ride comfort
- increase stopping distance

Warning!



Follow recommended tire inflation pressures.

Do not overinflate tires. Overinflated tires can adversely affect handling and ride comfort, wear unevenly, increase stopping distance, and result in sudden deflation (blowout) because they are more likely to become punctured or damaged by road debris, potholes etc.

Tire labeling

Besides tire name (sales designation) and manufacturer name, a number of markings can be found on a tire.

Following are some explanations for the markings on your vehicle's tires:

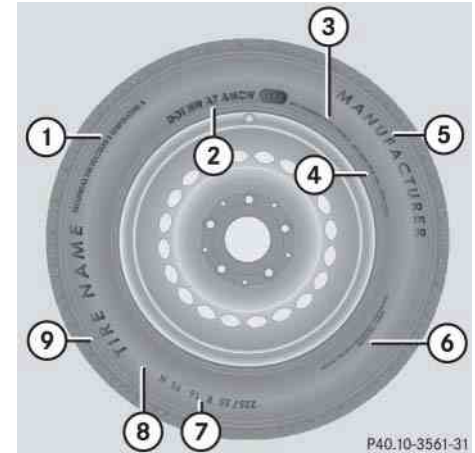

Tires and wheels

- ① Uniform Quality Grading Standards (▷ page 383)
- ② DOT, Tire Identification Number (TIN) (▷ page 380)
- ③ Maximum tire load (▷ page 382)
- ④ Maximum tire inflation pressure (▷ page 382)
- ⑤ Manufacturer
- ⑥ Tire ply material (▷ page 385)
- ⑦ Tire size designation, load and speed rating (▷ page 376)
- ⑧ Load identification (▷ page 380)
- ⑨ Tire name



For illustration purposes only. Actual data on tires are specific to each vehicle and may vary from data shown in above illustration.

For more information, see “Rims and tires” (▷ page 514).

Tire size designation, load and speed rating

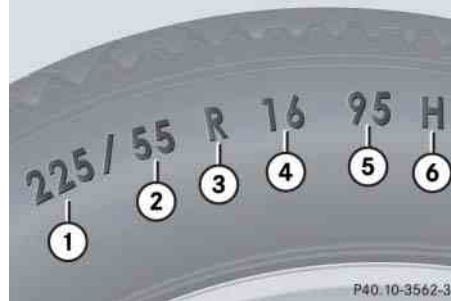

- ① Tire width
- ② Aspect ratio in %
- ③ Radial tire code
- ④ Rim diameter
- ⑤ Tire load rating
- ⑥ Tire speed rating



For illustration purposes only. Actual data on tires are specific to each vehicle and may vary from data shown in above illustration.

General:

Depending on the design standards used, the tire size molded into the sidewall may have no letter or a letter preceding the tire size designation.

No letter preceding the size designation (as illustrated above): Passenger car tire based on European design standards.

Letter “P” preceding the size designation: Passenger car tire based on U.S. design standards.

Letter “LT” preceding the size designation: Light Truck tire based on U.S. design standards.

Letter “T” preceding the size designation: Temporary spare tires which are high pressure compact spares designed for temporary emergency use only.

Tire width

The tire width ① (▷ page 376) indicates the nominal tire width in mm.

Aspect ratio

The aspect ratio ② (▷ page 376) is the dimensional relationship between tire section height and section width and is expressed in percentage. The aspect ratio is arrived at by dividing section height by section width.

Tire code

The tire code ③ (▷ page 376) indicates the tire construction type. The “R” stands for radial tire type. Letter “D” means diagonal or bias ply construction; letter “B” means belted-bias ply construction.

At the tire manufacturer’s option, any tire with a speed capability above 149 mph (240 km/h) can include a “ZR” in the size designation (for example: 245/40 ZR 18). For additional information, see “Tire speed rating” (▷ page 378).

Rim diameter

The rim diameter ④ (▷ page 376) is the diameter of the bead seat, not the diameter of the rim edge. Rim diameter is indicated in inches (in).

Tire load rating

The tire load rating ⑤ (▷ page 376) is a numerical code associated with the maximum load a tire can support.

For example, a load rating of 91 corresponds to a maximum load of 1356 lbs (615 kg) the tire is designed to support. See also “Maximum tire load” (▷ page 382) where the maximum load associated with the load index is indicated in kilograms and lbs.

Warning!



The tire load rating must always be at least half of the GAWR (▷ page 386) of your vehicle. Otherwise, tire failure may be the result which may cause an accident and/or serious personal injury to you or others.

Always replace rims and tires with the same designation, manufacturer and type as shown on the original part.

Warning!



Do not overload the tires by exceeding the specified load limit as indicated on the placard located on the driver’s door B-pillar. Overloading the tires can overheat them, possibly causing a blowout. Overloading the tires can also result in handling or steering problems, or brake failure.

Tires and wheels

For additional information on tire load rating, see “Load identification” (▷ page 380).



Tire load rating ⑤ (▷ page 376) and tire speed rating ⑥ (▷ page 376) are also referred to as “service description”.

Tire speed rating

The tire speed rating ⑥ (▷ page 376) indicates the approved maximum speed for the tire.

Warning!



Even when permitted by law, never operate a vehicle at speeds greater than the maximum speed rating of the tires.

Exceeding the maximum speed for which tires are rated can lead to sudden tire failure, causing loss of vehicle control and possibly resulting in an accident and/or personal injury and possible death, for you and for others.



Tire load rating ⑤ (▷ page 376) and tire speed rating ⑥ (▷ page 376) are also referred to as “service description”.

Summer tires

Index	Speed rating
Q	up to 100 mph (160 km/h)
R	up to 106 mph (170 km/h)
S	up to 112 mph (180 km/h)
T	up to 118 mph (190 km/h)
H	up to 130 mph (210 km/h)
V	up to 149 mph (240 km/h)
W	up to 168 mph (270 km/h)
Y	up to 186 mph (300 km/h)
(Y)	above 186 mph (300 km/h)
ZR	above 149 mph (240 km/h)

- At the tire manufacturer’s option, any tire with a speed capability above 149 mph (240 km/h) can include a “ZR” in the size designation (for example: 245/40 ZR18). To determine the maximum speed capability of the tire, the service description for the tire must be referred to. The service description

is comprised of the tire load rating ⑤ (▷ page 376) and the tire speed rating ⑥ (▷ page 376).

If your tire includes “ZR” in the size designation and no service description ⑤ and ⑥ (▷ page 376) is given, the tire manufacturer must be consulted for the maximum speed capability.

If a service description ⑤ and ⑥ (▷ page 376) is given, the speed capability is limited by the speed symbol in the service description.

Example: 245/40 ZR18 97Y.

In this example, “97Y” is the service description. The letter “Y” designates the speed rating and the speed capability of the tire is limited to 186 mph (300 km/h).

- Any tire with a speed capability above 186 mph (300 km/h) must include a “ZR” in the size designation AND the service description must be placed in parenthesis. Example: 275/40 ZR 18 (99Y). The “(Y)” speed rating in parenthesis designates the maximum speed capability of the tire as being above 186 mph (300 km/h). Consult the tire manufacturer for the actual maximum permissible speed of the tire.

All-season and winter tires

Index	Speed rating
Q M+S ¹	up to 100 mph (160 km/h)
T M+S ¹	up to 118 mph (190 km/h)
H M+S ¹	up to 130 mph (210 km/h)
V M+S ¹	up to 149 mph (240 km/h)

¹ or M+S  for winter tires



Not all M+S rated radial-ply tires provide special winter performance. Make sure the tires you use show M+S and the mountain/snowflake marking  on the tire sidewall. These tires meet specific snow traction performance requirements of the Rubber Manufacturers Association (RMA) and the Rubber Association of Canada (RAC) and have been designed specifically for use in snow conditions.

Tires and wheels

Load identification



① Load identification



For illustration purposes only. Actual data on tires are specific to each vehicle and may vary from data shown in above illustration.

In addition to tire load rating, special load information may be molded into the tire sidewall following the letter designating the tire speed rating ① (▷ page 380).

No specification given: absence of any text (like in above example) indicates a standard load (SL) tire.

XL (Extra Load): designates an extra load (or reinforced) tire.

Light Load: designates a light load tire.

C, D, E: designates load range associated with the maximum load a tire can carry at a specified pressure.

DOT, Tire Identification Number (TIN)

U.S. tire regulations require each new tire manufacturer or tire retreader to mold a TIN into or onto a sidewall of each tire produced.

The TIN is a unique identifier which facilitates efforts by tire manufactures to notify purchasers in recall situations or other safety matters concerning tires and gives purchasers the means to easily identify such tires.

The TIN is comprised of “Manufacturer’s identification mark”, “Tire size”, “Tire type code” and “Date of manufacture”.

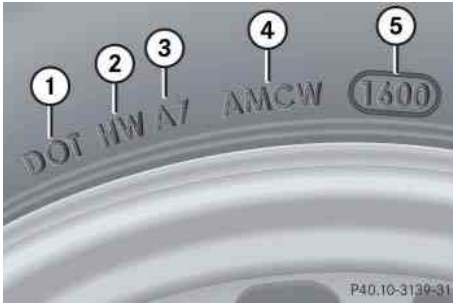

- ① DOT
- ② Manufacturer's identification mark
- ③ Tire size
- ④ Tire type code (at the option of the tire manufacturer)
- ⑤ Date of manufacture



For illustration purposes only. Actual data on tires are specific to each vehicle and may vary from data shown in above illustration.

DOT (Department of Transportation)

A tire branding symbol ① (▷ page 381) which denotes the tire meets requirements of the U.S. Department of Transportation.

Manufacturer's identification mark

The manufacturer's identification mark ② (▷ page 381) denotes the tire manufacturer.

New tires have a mark with two symbols.

Retreaded tires have a mark with four symbols. For more information on retreaded tires, see (▷ page 353).

Tire size

The code ③ (▷ page 381) indicates the tire size.

Tire type code

The code ④ (▷ page 381) may, at the option of the manufacturer, be used as a descriptive code for identifying significant characteristics of the tire.

Date of manufacture

The date of manufacture ⑤ (▷ page 381) identifies the week and year of manufacture.

The first two figures identify the week, starting with "01" to represent the first full week of the calendar year. The second two figures represent the year.

For example, "3202" represents the 32nd week of 2002.

Tires and wheels

Maximum tire load



① Maximum tire load rating



For illustration purposes only. Actual data on tires are specific to each vehicle and may vary from data shown in above illustration.

The maximum tire load is the maximum weight the tires are designed to support.

Warning!



Do not overload the tires by exceeding the specified load limit as indicated on the placard located on the driver's door B-pillar. Overloading the tires can overheat them, possibly causing a blowout. Overloading the tires can also result in handling or steering problems, or brake failure.

For more information on tire load rating (▷ page 377).

For information on calculating total and cargo load capacities (▷ page 359).

Maximum tire inflation pressure



① Maximum permissible tire inflation pressure



For illustration purposes only. Actual data on tires are specific to each vehicle and may vary from data shown in above illustration.

This is the maximum permissible tire inflation pressure for the tire.

Always follow the recommended tire inflation pressure (▷ page 363) for proper tire inflation.

Warning!



Never exceed the max. tire inflation pressure. Follow recommended tire inflation pressures.

Do not underinflate tires. Underinflated tires wear excessively and/or unevenly, adversely affect handling and fuel economy, and are more likely to fail from being overheated.

Do not overinflate tires. Overinflated tires can adversely affect handling and ride comfort, wear unevenly, increase stopping distance, and result in sudden deflation (blowout) because they are more likely to become punctured or damaged by road debris, potholes etc.

Uniform Tire Quality Grading Standards (U.S. vehicles)

Tire manufacturers are required to grade tires based on three performance factors: treadwear, traction and temperature resistance.



- ① Treadwear
- ② Traction
- ③ Temperature resistance



For illustration purposes only. Actual data on tires are specific to each vehicle and may vary from data shown in above illustration.

Quality grades can be found, where applicable, on the tire sidewall between tread shoulder and maximum section width. For example:

Treadwear	Traction	Temperature
200	AA	A

All passenger car tires must conform to federal safety requirements in addition to these grades.

Tires and wheels

Treadwear

The treadwear grade is a comparative rating based on the wear rate of the tire when tested under controlled conditions on a specified government test course. For example, a tire graded 150 would wear one and one-half ($1\frac{1}{2}$) times as well on the government course as a tire graded 100. The relative performance of tires depends upon the actual conditions of their use, however, and may depart significantly from the norm due to variations in driving habits, service practices and differences in road characteristics and climate.

Traction

The traction grades, from highest to lowest, are AA, A, B, and C. Those grades represent the tire's ability to stop on wet pavement as measured under controlled conditions on specified government test surfaces of asphalt and concrete. A tire marked C may have poor traction performance.

Warning!



The traction grade assigned to this tire is based on straight-ahead braking traction tests, and does not include acceleration, cornering, hydroplaning, or peak traction characteristics.

Temperature

The temperature grades are A (the highest), B, and C, representing the tire's resistance to the generation of heat and its ability to dissipate heat when tested under controlled conditions on a specified indoor laboratory test wheel. Sustained high temperature can cause the material of the tire to degenerate and reduce tire life, and excessive temperature can lead to sudden tire failure. The grade C corresponds to a level of performance which all passenger car tires must meet under the Federal Motor Vehicle Safety Standard No. 109. Grades B and A represent higher levels of performance on the laboratory test wheel than the minimum required by law.

Warning!

The temperature grade for this tire is established for a tire that is properly inflated and not overloaded. Excessive speed, underinflation, or excessive loading, either separately or in combination, can cause excessive heat build-up and possible tire failure.

Tire ply material

- ① Plies in sidewall
- ② Plies under tread



For illustration purposes only. Actual data on tires are specific to each vehicle and may vary from data shown in above illustration.

This marking tells you about the type of cord and number of plies in the sidewall and under the tread.

Tire and loading terminology**Accessory weight**

The combined weight (in excess of those standard items which may be replaced) of automatic transmission, power steering, power brakes, power windows, power seats, radio, and heater, to the extent that these items are available as factory-installed equipment (whether installed or not).

Air pressure

The amount of air inside the tire pressing outward on each square inch of the tire. Air pressure is expressed in pounds per square inch (psi), or kilopascal (kPa) or bars.

Aspect ratio

Dimensional relationship between tire section height and section width expressed in percentage.

Tires and wheels

Bar

Another metric unit for air pressure. There are 14.5038 pounds per square inch (psi) to 1 bar; there are 100 kilopascals (kPa) to 1 bar.

Bead

The tire bead contains steel wires wrapped by steel cords that hold the tire onto the rim.

Cold tire inflation pressure

Tire inflation pressure when your vehicle has been sitting for at least 3 hours or driven no more than 1 mile (1.6 km).

Curb weight

The weight of a motor vehicle with standard equipment including the maximum capacity of fuel, oil, and coolant, and, if so equipped, air conditioning and additional optional equipment, but without passengers and cargo.

DOT (Department of Transportation)

A tire branding symbol which denotes the tire meets requirements of the U.S. Department of Transportation.

GAWR (Gross Axle Weight Rating)

The GAWR is the maximum permissible axle weight. The gross vehicle weight on each axle must never exceed the GAWR for the front and rear axle indicated on the Certification label located on the driver's door B-pillar.

GTW (Gross Trailer Weight)

The GTW is the weight of the trailer plus the weight of all cargo, equipment, luggage etc. loaded on the trailer.

GVW (Gross Vehicle Weight)

The GVW comprises the weight of the vehicle including fuel, tools, spare wheel, installed accessories, passengers and cargo and, if applicable, trailer tongue load. The GVW must never exceed the GVWR indicated on the Certification label located on the driver's door B-pillar.

GVWR (Gross Vehicle Weight Rating)

This is the maximum permissible vehicle weight of the fully loaded vehicle (weight of the vehicle including all options, passengers, fuel, and cargo and, if applicable, trailer tongue load). It is indicated on Certification label located on the driver's door B-pillar.

Kilopascal (kPa)

The metric unit for air pressure. There are 6.9 kPa to 1 psi; another metric unit for air pressure is bars. There are 100 kilopascals (kPa) to 1 bar.

Maximum load rating

The maximum load in kilograms and pounds that can be carried by the tire.

Maximum loaded vehicle weight

The sum of curb weight, accessory weight, vehicle capacity weight and production options weight.

Maximum tire inflation pressure

This number is the greatest amount of air pressure that should ever be put in the tire under normal driving conditions.

Normal occupant weight

The number of occupants the vehicle is designed to seat, multiplied by 68 kilograms (150 lbs).

Occupant distribution

The distribution of occupants in a vehicle at their designated seating positions.

Production options weight

The combined weight of those installed regular production options weighing over 5 lbs (2.3 kilograms) in excess of those standard items which they replace, not previously considered in curb weight or accessory weight, including heavy duty brakes, ride levelers, roof rack, heavy duty battery, and special trim.

PSI (Pounds per square inch)

A standard unit of measure for air pressure -> bar, kilopascal (kPa).

Recommended tire inflation pressure

Recommended tire inflation pressure listed on placard located on driver's door B-pillar for normal driving conditions. Provides best handling, tread life and riding comfort.

Rim

A metal support for a tire or a tire and tube assembly upon which the tire beads are seated.

Sidewall

The portion of a tire between the tread and the bead.

TIN (Tire Identification Number)

Unique identifier which facilitates efforts by tire manufacturers to notify purchasers in recall situations or other safety matters concerning tires and gives purchases the means to easily identify such tires. The TIN is comprised of "Manufacturer's identification mark", "Tire size", "Tire type code" and "Date of manufacture".

Tire load rating

Numerical code associated with the maximum load a tire can support.

Tires and wheels

Tire ply composition and material used

This indicates the number of plies or the number of layers of rubber-coated fabric in the tire tread and sidewall. Tire manufacturers also must indicate the ply materials in the tire and sidewall, which include steel, nylon, polyester, and others.

Tire speed rating

Part of tire designation; indicates the speed range for which a tire is approved.

Traction

Force exerted by the vehicle on the road via the tires. The amount of grip provided.

Tread

The portion of a tire that comes into contact with the road.

Treadwear indicators

Narrow bands, sometimes called “wear bars” that show across the tread of a tire when only $1/16$ in (1.6 mm) of tread remains.

TWR (Tongue Weight Rating)

Maximum permissible weight on trailer tongue.

Uniform Tire Quality Grading Standards

A tire information system that provides consumers with ratings for a tire’s traction, temperature and treadwear. Ratings are determined by tire manufacturers using government testing procedures. The ratings are molded into the sidewall of the tire.

Vehicle capacity weight

Rated cargo and luggage load plus 68 kilograms (150 lbs) times the vehicle’s designated seating capacity.

Vehicle maximum load on the tire

Load on an individual tire that is determined by distributing to each axle its share of the maximum loaded vehicle weight and dividing it by two.

Rotating tires

Warning!



Rotate front and rear wheels only if the tires are of the same dimension.

If your vehicle is equipped with mixed-size tires (different tire dimensions front vs. rear), tire rotation is not possible.

Tire rotation can be performed on vehicles with tires of the same dimension all around. If your vehicle is equipped with tires of the same dimension all around, tires can be rotated, observing a front-to-rear rotation pattern that will maintain the intended rotation (spinning) direction of the tire (▷ page 356).

In some cases, such as when your vehicle is equipped with mixed-size tires (different tire dimension front vs. rear), tire rotation is not possible.

If applicable to your vehicle's tire configuration, tires can be rotated according to the tire manufacturer's recommended intervals in the tire manufacturer's warranty pamphlet located in your vehicle literature portfolio. If none is available, tires should be rotated every 3000 to 6000 miles (5000 to 10000 km), or sooner if necessary, according to the degree of tire wear. The same rotation (spinning) direction must be maintained (▷ page 356).

Rotate tires before the characteristic tire wear pattern becomes visible (shoulder wear on front tires and tread center wear on rear tires).

Thoroughly clean the mounting face of wheels and brake disks, i.e. the inner side of the wheels/tires, during each rotation. Check for and ensure proper tire inflation pressure.

Warning!

Have the tightening torque checked after changing a wheel. Wheels could become loose if not tightened with a torque of 110 lb-ft (150 Nm).

Only use genuine Mercedes-Benz wheel bolts specified for your vehicle's rims.

For information on wheel change, see “Flat tire” (▷ page 478).

Winter driving

Before the onset of winter, have your vehicle winterized at an authorized Mercedes-Benz Light Truck Center. This service includes:

- Check of anticorrosion and antifreeze concentration.
- Addition of cleaning concentrate to the water of the windshield and headlamp cleaning system. Add MB Concentrate “S” to a premixed windshield washer solvent / antifreeze which is formulated for temperatures below freezing point (▷ page 528).
- Battery test. Battery capacity drops with decreasing ambient temperature. A well charged battery helps to make sure that the engine can be started even at low ambient temperatures.
- Tire change. Mercedes-Benz recommends M+S rated radial-ply tires with a minimum tread depth of approximately $\frac{1}{6}$ in (4 mm) on all four wheels for the winter season.

Winter tires

Always use winter tires at temperatures below 45°F (7°C) and whenever wintry road conditions prevail. Not all M+S rated radial-ply tires provide special winter performance. Make sure the tires you use show M+S and the mountain/snowflake marking  on the tire sidewall. These tires meet specific snow traction performance requirements of the Rubber Manufacturers Association (RMA) and the Rubber Association of Canada (RAC) and have been designed specifically for use in snow conditions. Use of winter tires is the only way to achieve the maximum effectiveness of the ABS, ESP®, 4-ETS, and EBP in winter operation.

For safe handling, make sure all winter tires mounted are of the same make and have the same tread design.

Warning!



Winter tires with a tread depth under $\frac{1}{6}$ in (4 mm) must be replaced. They are no longer suitable for winter operation.

Always observe the speed rating of the winter tires installed on your vehicle. If the maximum speed for which your tires are rated is below the speed rating of your vehicle, you must place a notice to this effect where it will be seen by the driver. Such notices are available at your tire dealer or any authorized Mercedes-Benz Light Truck Center.

Warning!

If you use your spare tire when winter tires are fitted on the other wheels, be aware that the difference in tire characteristics may very well impair turning stability and that overall driving stability may be reduced. Adapt your driving style accordingly.

Have the spare tire replaced with a winter tire at the nearest authorized Mercedes-Benz Light Truck Center.

Block heater (Canada only)

The engine is equipped with a block heater.

The electrical cable may be installed at an authorized Mercedes-Benz Light Truck Center.

Snow chains

Snow chains should only be driven on snow-covered roads at speeds not to exceed 30 mph (50 km/h). Remove chains as soon as possible when driving on roads without snow.



Even on vehicles with all-wheel-drive, use snow chains on rear tires only.

Some tire sizes do not leave adequate clearance for snow chains. To help avoid serious damage to your vehicle or tires, use of snow chains is not permissible with the spare wheel.



When driving with snow chains, you may wish to deactivate the ESP® (▷ page 101) before setting the vehicle in motion. This will improve the vehicle's traction.

Please observe the following guidelines when using snow chains:

- Use of snow chains is not permissible with all wheel / tire combinations.
- Snow chains should only be used on all four wheels. With only two chains available, they should be mounted on the rear wheels. Follow the manufacturer's mounting instructions.
- Only use snow chains that are approved by Mercedes-Benz. Your authorized Mercedes-Benz Light Truck Center will be glad to advise you on this subject.
- Use of snow chains may be prohibited depending on location. Always check local and state laws before installing snow chains.

Maintenance

We strongly recommend that you have your vehicle serviced by an authorized Mercedes-Benz Light Truck Center, in accordance with the Maintenance Booklet at the times called for by the maintenance service indicator display.

Failure to have the vehicle maintained in accordance with the Maintenance Booklet and maintenance service indicator at the designated times/mileage will result in vehicle damage not covered by the Mercedes-Benz Limited Warranty.

The maintenance service indicator will notify you when your next maintenance service is due.

Starting approximately 1 month before maintenance service is due, one of the following messages will appear in the multifunction display while you are driving or when you switch on the ignition (example service A):

Service A in XXXXX miles (km)
Service A in XXX days
Service A in X day
Carry out Service A

The maintenance services will be indicated by showing a service type A through type H in the multifunction display. Types A through H are classified based on estimated time needed to perform the maintenance service, ranging:

from Service A
 (approx. 1 hour)
to Service H
 (approx. 8 hours)

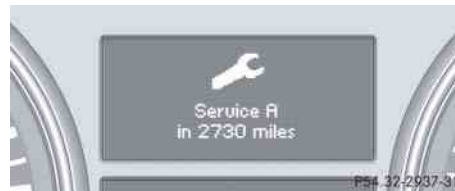

Refer to Maintenance Booklet for a listing of maintenance services and intervals they need to be performed at.



Vehicles equipped with FSS PLUS (Flexible Service System PLUS) only (Canada vehicles): The interval between maintenance services depends on your driving habits. A gentle driving style, moderate engine speeds and the avoidance of short-distance trips will lengthen the interval between services.

Clearing the maintenance service indicator

The maintenance service indicator is automatically cleared after 10 seconds when you switch on the ignition or when reaching the service threshold while driving. You can also clear it yourself.

- ▶ Press reset button on the instrument cluster (▷ page 158).

Maintenance service term exceeded

If you have exceeded the suggested maintenance service term, you will see the following message in the multifunction display:

Service A exceeded by XXXXX miles (km)
 Service A exceeded by XXX days
 Service A exceeded by X day



In addition, a signal sounds when the message appears.

Any authorized Mercedes-Benz Light Truck Center will reset the maintenance service indicator following a completed maintenance service.

Calling up the maintenance service indicator

- ▶ Switch on the ignition (▷ page 38).

The standard display of the control system appears (▷ page 168).

- ▶ Press button  or  on the multifunction steering wheel until the maintenance service indicator with the service symbol  and the service deadline appears in the multifunction display.



If the battery is disconnected, the days of disconnection will not be included in the count shown by the maintenance service indicator. To arrive at the true maintenance service deadline, you will need to subtract these days from the days shown in the maintenance service indicator.

Do not confuse the maintenance service indicator with the engine oil level indicator .

Resetting the maintenance service indicator

In the event that the maintenance service on your vehicle is not carried out by an authorized Mercedes-Benz Light Truck Center, you can have the maintenance service indicator reset. The automotive maintenance facility carrying out the maintenance service will find the information for resetting the maintenance service indicator in the maintenance-relevant information for your vehicle. Such information is available either from either an authorized Mercedes-Benz Light Truck Center or directly from Mercedes-Benz.



If the maintenance service indicator was inadvertently reset, have an authorized Mercedes-Benz Light Truck Center correct it.

Only reset if the proper maintenance service has been performed. Resetting the system without performing the proper service as called for by the maintenance service indicator will result in engine damage and/or other vehicle damage not covered by the Mercedes-Benz Limited Warranty.

▼ Vehicle care

Cleaning and care of the vehicle

Warning!



Many cleaning products can be hazardous. Some are poisonous, others are flammable. Always follow the instructions on the particular container. Always open your vehicle's doors or windows when cleaning the inside.

Never use fluids or solvents that are not designed for cleaning your vehicle.

Always lock away cleaning products and keep them out of reach of children.

While in operation, even while parked, your vehicle is subjected to varying external influences which, if gone unchecked, can attack the paintwork as well as the underbody and cause lasting damage.

Such damage is caused not only by extreme and varying climatic conditions, but also by:

- Air pollution
- Road salt
- Tar
- Gravel and stone chipping

To avoid paint damage, you should immediately remove:

- Grease and oil
- Fuel
- Coolant
- Brake fluid
- Bird droppings
- Insects
- Tree resins, etc.

Frequent washing reduces and /or eliminates the aggressiveness and potency of the above adverse influences.

More frequent washings are necessary to deal with unfavorable conditions:

- near the ocean
- in industrial areas (smoke, exhaust emissions)
- during winter operation

You should check your vehicle from time to time for stone chipping or other damage. Any damage should be repaired as soon as possible to prevent corrosion.

In doing so, do not neglect the underbody of the vehicle. A prerequisite for a thorough check is a washing of the underbody followed by a thorough inspection. Damaged areas need to be re-undercoated.

Your vehicle has been treated at the factory with a wax-base rustproofing in the body cavities which will last for the lifetime of the vehicle. Post-production treatment is neither necessary nor recommended by Mercedes-Benz because of the possibility of incompatibility between materials used in the production process and others applied later.

Vehicle care

We have selected car-care products and compiled recommendations which are specially matched to our vehicles and which always reflect the latest technology. You can obtain Mercedes-Benz approved car-care products at an authorized Mercedes-Benz Light Truck Center.

Scratches, corrosive deposits, corrosion or damage due to negligent or incorrect care cannot always be removed or repaired with the car-care products recommended here. In such cases it is best to seek aid at an authorized Mercedes-Benz Light Truck Center.

The following topics deal with the cleaning and care of your vehicle and give important “how-to” information as well as references to Mercedes-Benz approved car-care products.

Power washer



Follow the instructions provided by the power washer manufacturer on maintaining a distance between the vehicle and the nozzle of the power washer.

Never use a round nozzle to power-wash tires. The intense jet of water can result in damage to the tire.

Always replace a damaged tire.

Always keep the jet of water moving across the surface. Do not aim directly at electrical parts, electrical connectors, seals, or other rubber parts.



Vehicles with KEYLESS-GO*:

If a door handle is hit by a strong jet of water, and a SmartKey with KEYLESS-GO* is in close proximity, i.e. within approximately 3 ft (approximately 1 m), the vehicle could be inadvertently locked or unlocked.

Tar stains

Quickly remove tar stains before they dry and become more difficult to remove. A tar remover is recommended.

Paintwork, painted body components



Affixing stickers, adhesive tape or similar materials to painted body components may damage the paintwork.

Mercedes-Benz approved Paint Care should be applied when water drops on the paint surface do not “bead up”. This should normally be done every 3 to 5 months, depending on the climate and washing detergent used.

Mercedes-Benz approved Paint Cleaner should be applied if the paint surface shows signs of dirt embedding (i.e. loss of gloss).

Do not apply any of these products or wax if your vehicle is parked in the sun or if the hood is still hot.

- ▶ Use the appropriate MB-Touch-Up Stick for quick and provisional repairs of minor paint damage (i.e. chips from stones, vehicle doors, etc.).

Engine cleaning

Prior to cleaning the engine compartment make sure to protect electrical components and connectors from the intrusion of water and cleaning agents.

Corrosion protection, such as MB Anticorrosion Wax, should be applied to the engine compartment after every engine cleaning. Before applying, all control linkage bushings and joints should be lubricated. The poly-V-belt and all pulleys should be protected from any wax.

Vehicle washing

In the winter, thoroughly remove all traces of road salt as soon as possible.

When washing the underbody, do not forget to clean the inner sides of the wheels.



Vehicles with KEYLESS-GO*: If a door handle is hit by a strong jet of water, and a SmartKey with KEYLESS-GO* is in close proximity, i.e. within approximately 3 ft (approximately 1 m), the vehicle could be inadvertently locked or unlocked.

Hand-wash

Do not use hot water or wash your vehicle in direct sunlight.

- ▶ Only use a mild car wash detergent, such as Mercedes-Benz approved Car Shampoo.
- ▶ Thoroughly spray the vehicle with a diffused jet of water.

Direct only a very weak spray towards the ventilation intake.

- ▶ Use plenty of water and rinse the sponge and chamois frequently.
- ▶ Rinse with clean water and thoroughly dry with a chamois.

Do not allow cleaning agents to dry on the finish.

Automatic car wash

You can have your car washed in an automatic car wash from the start. Automatic car washes without brushes are preferable.

If the vehicle is very dirty, prewash it before running it through the automatic car wash.



If you want the gear position to remain in **N** (for example when the vehicle is pulled through a car wash)

- do not remove the SmartKey from the starter switch
- do not turn off the engine using the KEYLESS-GO start/stop button* and open the driver's door

Otherwise, the transmission will shift to **P** and lock the wheels, preventing the vehicle from being pulled through a car wash.



Due to the width of the vehicle, fold in exterior rear view mirrors prior to running the vehicle through an automatic car wash to prevent damage to the mirrors.

Make sure that the windshield wiper switch is set to **0** (> page 59). Otherwise, the rain sensor could activate and cause the wipers to move unintentionally. This may lead to vehicle damage.



After running the vehicle through an automatic car wash, wipe any wax off of the windshield (> page 400). This will prevent smears and reduce wiping noise which can be caused by residual wax on the windshield.

When leaving the car wash, make sure that the mirrors are folded out. Otherwise they may vibrate.

Ornamental moldings

For regular cleaning and care of ornamental moldings, use a damp cloth.



Do not use chrome cleaner on ornamental moldings. Although ornamental moldings may have chrome appearance, they could be made of anodized aluminum that will be damaged when cleaned with chrome cleaner. Instead, use damp cloth to clean those ornamental moldings.

Very dirty ornamental moldings of which you are sure are chrome-plated, use a chrome cleaner. If in doubt whether an ornamental molding is chrome-plated, contact an authorized Mercedes-Benz Light Truck Center.

Headlamps, tail lamps, side markers, turn signal lenses

- ▶ Use a mild car wash detergent, such as Mercedes-Benz approved Car Shampoo, with plenty of water.



Only use window cleaning solutions that are suitable for plastic lamp lenses. Window cleaning solutions which are not suitable may damage the plastic lamp lenses of the headlamps. Therefore, do not use abrasives, solvents or cleaners that contain solvents.

Never apply strong force and only use a soft, non-scratching cloth when cleaning the lenses. Do not attempt to wipe dirty lenses with a dry cloth or sponge. Otherwise you may scratch or damage the lens surface.

Cleaning the Parktronic* system sensors

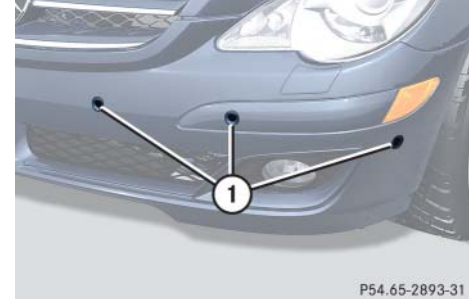

- ① Parktronic* system sensors in front bumper
- ▶ Use a mild car wash detergent, such as Mercedes-Benz approved Car Shampoo, with plenty of water and a soft, non-scratching cloth to clean sensors ① on the bumpers.

Vehicle care



Do not apply strong pressure to the sensor covers. Applying strong pressure may damage the sensor covers.

Follow the instructions provided by the power washer manufacturer on maintaining a distance between the vehicle and the nozzle of the power washer.



To prevent scratches, never apply strong force and only use a soft, non-scratching cloth when cleaning the sensors. Do not attempt to wipe dirty sensors with a dry cloth or sponge.

Cleaning the windows and the wiper blades

Warning!



For safety reasons, switch off wipers and remove SmartKey from starter switch (vehicles with KEYLESS-GO*: Make sure the vehicle's on-board electronics have status **0**) before cleaning the windshield and/or the wiper blades. Otherwise, the wiper motor could suddenly turn on and cause injury.

- ▶ Fold wiper arms forward until they snap into place.
- ▶ Clean the wiper blade inserts with a clean cloth and detergent solution.
- ▶ Use a soft, clean cloth and a mild window cleaning solution on all outside and inside glass surfaces.

An automotive glass cleaner is recommended.



Fold the windshield wiper arms back onto the windshield before turning the SmartKey in the starter switch or pressing the KEYLESS-GO start/stop button (vehicles with KEYLESS-GO*).

Hold on to the wiper when folding the wiper arm back. If released, the force of the impact from the tensioning spring could crack the windshield.



To clean the window interior, do not use a dry cloth, abrasives, solvents or cleaners containing solvents. Do not touch the inside of the front, rear or side windows with hard objects such as an ice scraper or ring. Doing so may damage the windows.

Cleaning the panorama roof with tilt/sliding panel*

The rear part of the tilt/sliding panel* has a protective layer on the inside.

- ▶ Use a soft, clean cloth and a mild window cleaning solution.

An automotive glass cleaner is recommended.



Do not use a dry cloth, abrasives, solvents or cleaners containing solvents. Do not touch the protective layer with hard objects such as an ice scraper or ring. Never apply strong force and only use a soft, non-scratching cloth when cleaning the rear part of the tilt/sliding panel*.

Otherwise you may scratch or damage the protective layer.

Light alloy wheels

If possible, clean wheels once a week.

- ▶ Use Mercedes-Benz approved Wheel Care, a soft bristle brush and a strong spray of water for cleaning the light alloy wheels.



Only use acid-free cleaning materials. Acid may cause corrosion or damage the clear coat.



The vehicle should not be parked for an extended period of time immediately after it has been cleaned, especially not after the wheel rims have been cleaned with wheel rim cleaner. Wheel rim cleaners can lead to increased corrosion of the brake disks and brake pads. Therefore, the vehicle's brake system should always be warmed-up before it is parked after cleaning. To do so, please drive your vehicle for several minutes to allow the brakes to dry.

When applying Mercedes-Benz approved Tire Care and Mercedes-Benz approved Wheel Care products, take care not to spray them on the brake disks.

Plastic and rubber parts

- ▶ Use a gentle dishwashing detergent or mild detergent for delicate fabrics as a washing solution.



Do not use oil or wax on these parts.

Instrument cluster and cup holders

- ▶ Use a gentle dishwashing detergent or mild detergent for delicate fabrics as a washing solution.
- ▶ Wipe with a cloth moistened in a lukewarm solution.



To prevent scratches, do not use scouring agents.

Vehicle care

Hard plastic trim items

- ▶ Use Mercedes-Benz approved Interior Care, a soft, lint-free cloth and apply with light pressure.



To prevent scratches, do not use scouring agents.

Steering wheel

- ▶ Wipe with a damp cloth and dry thoroughly or clean with Mercedes-Benz approved Leather Care.

Carpets

- ▶ Use Mercedes-Benz approved Carpet and Fabric Care for cleaning the carpets.

Headliner and rear window shelf

- ▶ Use a soft bristle brush or a dry-shampoo cleaner in case of excessive dirt.

Seat belts

- ▶ Only use clear, lukewarm water and soap.



The webbing must not be treated with chemical cleaning agents. Do not dry the webbing at temperatures above 176°F (80°C) or in direct sunlight.

Warning!



Do not bleach or dye seat belts as this may severely weaken them. In a crash they may not be able to provide adequate protection.

Wood trims

- ▶ Dampen cloth using water and use damp cloth to clean wood trims in your vehicle.



Do not use solvents like tar remover or wheel cleaner nor polishes or waxes as these may be abrasive.

Wood trims

Dampen cloth using water and use damp cloth to clean wood trims in your vehicle. Do not use solvents like tar remover or wheel cleaner nor polishes or waxes as these may be abrasive.

What to do if ...

Where will I find ...?

Unlocking/locking in an emergency

Opening/closing in an emergency

Replacing SmartKey batteries

Replacing bulbs

Replacing wiper blades

Flat tire

Battery

Jump starting

Towing the vehicle

Fuses



What to do if ...

Lamps in instrument cluster

General information:

If any of the following lamps in the instrument cluster fails to come on during the

bulb self-check when switching on the ignition, have the respective bulb checked and replaced if necessary.

Problem	Possible cause/consequence	Suggested solution
 <p>The yellow ABS indicator lamp comes on while the engine is running.</p>	<p>ABS has detected a malfunction and has switched off. The BAS, ESP®, and 4-ETS are also switched off (see messages in multifunction display).</p> <p>The brake system is still functioning normally but without the ABS available.</p> <p>If the ABS control unit is malfunctioning, other systems such as the navigation system* or the automatic transmission may also be malfunctioning.</p> <p>The charging voltage has fallen below 10 volts. The ABS has switched off.</p> <p>The battery might not be charged sufficiently.</p>	<ul style="list-style-type: none"> ▶ Continue driving with added caution. Wheels may lock during hard braking, reducing steering capability. ▶ Read and observe messages in the multifunction display (▷ page 416). ▶ Have the system checked at an authorized Mercedes-Benz Light Truck Center as soon as possible. <p>Failure to follow these instructions increases the risk of an accident.</p> <ul style="list-style-type: none"> ▶ Switch off electrical consumers that are currently not needed, e.g. seat heating*. ▶ If necessary, have the generator (alternator) and battery checked. <p>When the voltage is above this value again, the ABS is operational again.</p>

Problem		Possible cause/consequence	Suggested solution
BRAKE 	(USA only)	The red brake warning lamp comes on while driving and you hear a warning sound.	▶ Release the parking brake (▷ page 56).
	(Canada only)	The ESP® control unit may be malfunctioning. The driving safety systems may not be available.	▶ Continue driving with added caution. Wheels may lock during hard braking, reducing steering capability. ▶ Read and observe messages in the multifunction display (▷ page 416).
		The red brake warning lamp comes on while driving.	▶ Risk of accident! Carefully stop the vehicle in a safe location or as soon as it is safe to do so and notify an authorized Mercedes-Benz Light Truck Center. Do not add brake fluid! This will not solve the problem.

Warning!







Driving with the brake warning lamp illuminated can result in an accident. Have your brake system checked immediately if the brake warning lamp stays on.



Do not add brake fluid before checking the brake system. Overfilling the brake fluid reservoir can result in spilling brake fluid on hot engine parts and the brake fluid catching fire. You can be seriously burned.



If you find that the brake fluid in the brake fluid reservoir has fallen to the minimum mark or below, have the brake system checked for brake pad thickness and leaks.

What to do if ...



Problem		Possible cause/consequence	Suggested solution
   	<p>(USA only)</p> <p>(Canada only)</p>	<p>The red brake warning lamp comes on while driving. In addition, the yellow ABS malfunction indicator lamp, and the yellow ESP[®] warning lamp come on and a warning will sound.</p>	<p>A malfunction in the Electronic Brake Proportioning (> page 102) was detected.</p> <p>► Have the system checked at an authorized Mercedes-Benz Light Truck Center as soon as possible.</p> <p>Failure to follow these instructions increases the risk of an accident.</p>



Problem	Possible cause/consequence	Suggested solution
<p> (USA only) The yellow engine malfunction indicator lamp comes on while driving.</p> <p> (Canada only)</p>	<p>There is a malfunction in:</p> <ul style="list-style-type: none"> • The fuel management system • The ignition system • The emission control system • Systems which affect emissions <p>Such malfunctions may result in excessive emissions values and may switch the engine to its limp-home (emergency operation) mode.</p>	<p>► Have the vehicle checked as soon as possible by an authorized Mercedes-Benz Light Truck Center. An on-board diagnostic connector is used by the service station to link the vehicle to the shop diagnostics system. It allows the accurate identification of system malfunctions through the readout of diagnostic trouble codes. It is located in the front left area of the footwell next to the parking brake pedal.</p>





Some states may by law require you to visit a workshop immediately as soon as the engine malfunction indicator lamp comes on. Check local requirements.

What to do if ...

Problem			Possible cause/consequence	Suggested solution
 	(USA only)	The yellow engine malfunction indicator lamp comes on while driving.	A loss of pressure has been detected in the fuel system. The fuel cap may not be closed properly or the fuel system may be leaky.	<ul style="list-style-type: none"> ▶ Check the fuel cap (▷ page 342). If it is not closed properly:
	(Canada only)			<ul style="list-style-type: none"> ▶ Close the fuel cap. If it is closed properly:
			Your fuel tank is empty.	<ul style="list-style-type: none"> ▶ After refueling start, turn off and restart the engine three or four times in succession. The limp-home mode is canceled. You do not need to have your vehicle checked.

Problem	Possible cause/consequence	Suggested solution
 The yellow ESP® warning lamp comes on while the engine is running.	<p>The ESP® is deactivated.</p> <p>Risk of accident!</p> <p>Adapt your speed and driving to the prevailing road, weather, and traffic conditions.</p>	<ul style="list-style-type: none"> ▶ Switch the ESP® back on (▷ page 102). <p>If the ESP® cannot be switched back on:</p> <ul style="list-style-type: none"> ▶ Have the system checked at an authorized Mercedes-Benz Light Truck Center as soon as possible.
 The yellow ESP® warning lamp flashes while driving.	<p>The ESP® or traction control has come into operation because of detected traction loss of at least one tire.</p>	<ul style="list-style-type: none"> ▶ When driving off, apply as little throttle as possible. ▶ While driving, ease up on the accelerator. ▶ Adapt your speed and driving to the prevailing road and weather conditions. ▶ Do not deactivate the ESP®. Exceptions: (▷ page 101) <p>Failure to follow these instructions increases the risk of an accident.</p>
<p>The yellow fuel tank reserve warning lamp in the fuel gauge comes on while driving.</p>	<p>The fuel level has gone below the reserve mark.</p>	<ul style="list-style-type: none"> ▶ Refuel at the next gas station (▷ page 342).

What to do if ...

Problem	Possible cause/consequence	Suggested solution
 The red seat belt telltale comes on and a warning chime sounds for approximately 6 seconds after starting the engine with all doors closed.	The seat belt telltale reminds you and your passengers to fasten your seat belts before driving off.	▶ Fasten your seat belts. The seat belt telltale goes out.
 The red seat belt telltale remains illuminated after driving off. The vehicle's speed does not exceed 15 mph (25 km/h).	You and/or your front passenger have forgotten to fasten your seat belts. There are items placed on the front passenger seat and therefore the system senses the front passenger seat as being occupied.	▶ Fasten your seat belts. ▶ Remove the items from the front passenger seat and put them in a safe place.
 The red seat belt telltale flashes and you additionally hear an intermittent warning chime with increasing intensity for a maximum of 60 seconds from the time the vehicle's speed exceeds 15 mph (25 km/h).	You and/or your front passenger have forgotten to fasten your seat belts. There are items placed on the front passenger seat and therefore the system senses the front passenger seat as being occupied.	▶ Fasten your seat belts. ▶ Remove the items from the front passenger seat and put them in a safe place.



After 60 seconds with an unfastened seat belt on one of the front seats, the

warning chime stops sounding and the seat belt telltale illuminates continuously. The seat belt telltale will only go

out if both the driver and front passenger's seat belt are fastened, or the vehicle is standing still and a front door is opened.



Problem	Possible cause/consequence	Suggested solution
<p>SRS The red SRS indicator lamp comes on while driving.</p>	<p>There is a malfunction in the restraint systems. The air bags or emergency tensioning device (ETDs) could deploy unexpectedly or fail to deploy unexpectedly in an accident.</p>	<p>► Drive with added caution to the nearest authorized Mercedes-Benz Light Truck Center.</p>

Warning!



In the event a malfunction of the SRS is indicated as outlined above, the SRS may not be operational. For your safety, we strongly recommend that you visit an authorized Mercedes-Benz Light Truck Center immediately to have the system checked, otherwise the SRS may not be activated when needed in an accident, which could result in serious or fatal injury, or it might deploy unexpectedly and unnecessarily which could result in an accident and/or injury to you or to others.

What to do if ...

Problem	Possible cause/consequence	Suggested solution
 <p>Combination low tire pressure/TPMS malfunction telltale for the TPMS or Advanced TPMS* illuminates continuously.</p>	<p>The TPMS or Advanced TPMS* detects a loss of pressure in at least one tire.</p>	<ul style="list-style-type: none"> ▶ Carefully bring the vehicle to a halt, avoiding abrupt steering and braking maneuvers. Observe the traffic situation around you. ▶ Read and observe messages in the multifunction display. <p>If the tire inflation pressure in the respective tire(s) has (have) been corrected, the combination low tire pressure/TPMS malfunction telltale goes out after few minutes driving.</p>
 <p>Combination low tire pressure/TPMS malfunction telltale for the TPMS or Advanced TPMS* flashes 60 seconds and then stays illuminated.</p>	<p>There is a malfunction in the TPMS or Advanced TPMS*.</p>	<ul style="list-style-type: none"> ▶ Read and observe messages in the multifunction display. ▶ Have the TPMS or Advanced TPMS* checked by an authorized Mercedes-Benz Light Truck Center. <p>After the malfunction has been remedied, the combination low tire pressure/TPMS malfunction telltale goes out after few minutes driving.</p>

Warning!

Each tire, including the spare (if provided), should be checked monthly when cold and inflated to the inflation pressure recommended by the vehicle manufacturer on the vehicle placard or the tire inflation pressure label. (If your vehicle has tires of a different size than the size indicated on the vehicle placard or the tire inflation pressure label, you should determine the proper tire inflation pressure for those tires).

As an added safety feature, your vehicle has been equipped with a tire pressure monitoring system (TPMS) that illuminates a low tire pressure telltale when one or more of your tires is significantly underinflated. Accordingly, when the low tire pressure telltale illuminates, you should stop and check your tires as soon as possible, and inflate them to the proper pressure. Driving on a significantly underinflated tire causes the tire to overheat and can lead to tire failure.

Underinflation also reduces fuel efficiency and tire tread life, and may affect the vehicle's handling and stopping ability. Please note that the TPMS is not a substitute for proper tire maintenance, and it is the driver's responsibility to maintain correct tire pressure, even if under-inflation has not reached the level to trigger illumination of the TPMS low tire pressure telltale.

Your vehicle has also been equipped with a TPMS malfunction indicator to indicate when the system is not operating properly. The TPMS malfunction indicator is combined with the low tire pressure telltale. When the system detects a malfunction, the telltale will flash for approximately 1 minute and then remain continuously illuminated. This sequence will continue upon subsequent vehicle start-ups as long as the malfunction exists. When the malfunction indicator is illuminated, the system may not be able to detect or signal low tire pressure as intended.

TPMS malfunctions may occur for a variety of reasons, including the installation of incompatible replacement or alternate tires or wheels on the vehicle that prevent the TPMS from functioning properly. Always check the TPMS malfunction telltale after replacing one or more tires or wheels on your vehicle to ensure that the replacement or alternate tires and wheels allow the TPMS to continue to function properly.

What to do if ...

Lamp in center console

Problem	Possible cause/consequence	Suggested solution
 PASS AIR BAG OFF The front passenger front air bag off indicator lamp illuminates and remains illuminated with the weight of a typical adult or someone larger than a small individual on the front passenger seat.	The system is malfunctioning.	<ul style="list-style-type: none">▶ Have the system checked as soon as possible by an authorized Mercedes-Benz Light Truck Center.▶ Also read and observe any messages in the multifunction display and follow corrective steps (▷ page 423).

Warning!



If the  **PASS AIR BAG OFF** indicator lamp illuminates and remains illuminated with the weight of a typical adult or someone larger than a small individual on the front passenger seat, do not have any passenger use the front passenger seat until the system has been repaired.

Problem	Possible cause/consequence	Suggested solution
 PASS AIR BAG OFF The front passenger front air bag off indicator lamp does not illuminate and/or does not remain illuminated with the weight of a typical 12-month-old child in a standard child restraint or less on the front passenger seat.	<p>The system is malfunctioning.</p>	<ul style="list-style-type: none"> ▶ Make sure there is nothing between seat cushion and child seat and check installation of the child seat. ▶ Make sure no objects applying supplemental weight onto the seat are present. ▶ Make sure no objects which apply forces to the seat are present (e.g. objects such as books, briefcases etc. lodged behind or around the seat, head restraints pushing against roof etc.). The system may recognize such forces as supplemental weight. ▶ If the front passenger front air bag off indicator lamp remains out, have the system checked as soon as possible by an authorized Mercedes-Benz Light Truck Center. Do not transport a child on the front passenger seat until the system has been repaired. ▶ Also note any messages in the multifunction display and follow corrective steps (▷ page 423).

Warning!



If the  **PASS AIR BAG OFF** indicator lamp does not illuminate or remains out with the

weight of a typical 12-month-old child in a standard child restraint or less on the front passenger seat, do not transport a child on

the front passenger seat until the system has been repaired.

What to do if ...

Vehicle status messages in the multifunction display





Warning and malfunction messages appear in the multifunction display located in the instrument cluster.





Certain warning and malfunction messages are accompanied by an audible signal.

Address these messages accordingly and follow the additional instructions given in this Operator's Manual.

Selecting the vehicle status message memory menu in the control system (▷ page 173) displays both cleared and uncleared messages.

High-priority messages appear in the multifunction display in red color.

Certain messages of high priority cannot be cleared from the multifunction display using the reset button (▷ page 158) or button , , , or  on the multifunction steering wheel.

Other messages of high priority and messages of less immediate priority can be cleared from the multifunction display using the reset button (▷ page 158) or button , , , or  on the multifunction steering wheel. They are then stored in the vehicle status message memory (▷ page 173). Remember that clearing a message will only make the message disappear. Clearing a message will not correct the condition that caused the message to appear.

Warning!



All categories of messages contain important information which should be taken note of and, where a malfunction is indicated, addressed as soon as possible at an authorized Mercedes-Benz Light Truck Center.

Failure to repair condition noted may cause damage not covered by the Mercedes-Benz Limited Warranty, or result in property damage or personal injury.

Warning!



No messages will be displayed if either the instrument cluster or the multifunction display is inoperative.

Contact the nearest authorized Mercedes-Benz Light Truck Center.



Switching on the ignition causes all instrument cluster lamps (except high beam headlamp indicator lamp, and turn signal indicator lamps unless activated) as well as the multifunction display to come on. Make sure the lamps and multifunction display are in working order before starting your journey.

On the pages that follow, you will find a compilation of the most important warning and malfunction messages that may appear in the multifunction display.

For your convenience the messages are divided into two sections:

- Text messages (▷ page 418)
- Symbol messages (▷ page 429)





What to do if ...

Text messages

Display message		Possible cause/consequence	Possible solution
ABS	Malfunction Visit workshop	<p>The ABS has detected a malfunction and has switched off.</p> <p>The ESP® and the BAS are also deactivated.</p> <p>The brake system is still functioning normally but without the ABS available.</p>	<ul style="list-style-type: none"> ▶ Continue driving with added caution. Wheels may lock during hard braking, reducing steering capability. ▶ Have the system checked at an authorized Mercedes-Benz Light Truck Center as soon as possible. <p>Failure to follow these instructions increases the risk of an accident.</p>
	Display malfunction Visit workshop	The ABS or the ABS display is malfunctioning.	<ul style="list-style-type: none"> ▶ Continue driving with added caution. Wheels may lock during hard braking, reducing steering capability ▶ Have the system checked at an authorized Mercedes-Benz Light Truck Center as soon as possible. <p>Failure to follow these instructions increases the risk of an accident.</p>

Display message	Possible cause/consequence	Possible solution
<p>ABS</p> <p>unavailable See Operator's Manual</p>	<p>The ABS was deactivated because of insufficient power supply. The charging voltage has fallen below 10 volts.</p> <p>The brake system is still functioning normally but without the ABS available.</p>	<ul style="list-style-type: none"> ▶ Switch off electrical consumers that are currently not needed, e.g. seat heating*. ▶ If necessary, have the generator (alternator) and the battery checked. <p>When the voltage is above this value again, the ABS is operational again and the message in the multifunction display should disappear.</p>
<p>Cruise control</p> <p>Drive to workshop</p>	<p>Cruise control is malfunctioning.</p>	<ul style="list-style-type: none"> ▶ Have cruise control checked by an authorized Mercedes-Benz Light Truck Center.
<p>ESP</p> <p>unavailable See Operator's Manual</p>	<p>In addition, the yellow ESP® warning lamp  comes on.</p> <p>The ESP® is deactivated because of a malfunction or interrupted power supply.</p>	<ul style="list-style-type: none"> ▶ Continue driving with added caution. ▶ Visit an authorized Mercedes-Benz Light Truck Center as soon as possible. <p>Failure to follow these instructions increases the risk of an accident.</p>

What to do if ...

Display message	Possible cause/consequence	Possible solution
ESP unavailable See Operator's Manual	If the yellow ESP® warning lamp  flashes while driving and this message appears, the electronic traction system has switched off to prevent overheating of the drive wheel brakes.	As soon as the brakes have cooled off, the electronic traction system switches on again. The message in the multifunction display disappears and the ESP® warning lamp  goes out.
	The self-diagnosis has not yet been completed yet.	The display will clear after driving a short distance at a vehicle speed of above 12 mph (20 km/h).
Malfunction Visit workshop	In addition, the yellow ESP® warning lamp  comes on. The ESP® has detected a malfunction and switched off. The ABS may still be operational.	<ul style="list-style-type: none"> ▶ Continue driving with added caution. ▶ Have the system checked at an authorized Mercedes-Benz Light Truck Center as soon as possible. <p>Failure to follow these instructions increases the risk of an accident.</p>
Display malfunction Visit workshop	In addition, the yellow ESP® warning lamp  comes on. The ESP® or the ESP® display is malfunctioning.	<ul style="list-style-type: none"> ▶ Continue driving with added caution. ▶ Visit an authorized Mercedes-Benz Light Truck Center as soon as possible. <p>Failure to follow these instructions increases the risk of an accident.</p>

Display message	Possible cause/consequence	Possible solution
<p>P</p> <p>Gear selector lever in Park</p> <hr/> <p>Gear selector lever in Neutral or Park</p>	<p>You have started the engine or switched on the ignition with KEYLESS-GO* and opened the driver's door with the automatic transmission not set to position P.</p> <hr/> <p>You have attempted to start the engine with the KEYLESS-GO* start/stop button while the automatic transmission was set to position R or D.</p>	<p>▶ Set the automatic transmission to position P.</p> <p>or</p> <p>▶ Close the driver's door</p> <hr/> <p>▶ Set the automatic transmission to position P or N.</p> <p>Make sure the brake pedal is depressed when attempting to start the engine with the KEYLESS-GO* start/stop button.</p>
<p>PRE-SAFE</p> <p>unavailable See Operator's Manual</p>	<p>If ESP® and PRE-SAFE®* malfunction messages are displayed simultaneously, PRE-SAFE®* has been deactivated as a result of these malfunctions. All other occupant safety systems, such as the air bags are still available.</p> <hr/> <p>PRE-SAFE®* itself has failed. All other occupant safety systems, such as the air bags are still available.</p>	<p>▶ Visit an authorized Mercedes-Benz Light Truck Center as soon as possible.</p> <hr/> <p>▶ Visit an authorized Mercedes-Benz Light Truck Center as soon as possible.</p>

What to do if ...

Display message	Possible cause/consequence	Possible solution
SRS Restraint sys. malfunction Drive to workshop	The system is malfunctioning.	► Drive with added caution to the nearest authorized Mercedes-Benz Light Truck Center.

Warning!





In the event a malfunction of the SRS is indicated as outlined above, the SRS may not be operational.

For your safety, we strongly recommend that you visit an authorized Mercedes-Benz Light Truck Center immediately to have the system checked; otherwise the SRS may not be activated when needed in an accident, which could result in serious or fatal injury, or it might deploy unexpectedly and unnecessarily which could also result in injury.

Display message	Possible cause/consequence	Possible solution
Front passenger airbag enabled see Operator's Manual	Front passenger front air bag is activated while driving even though a child, small individual, or object below the system's weight threshold is on the front passenger seat, or the front passenger seat is empty. Objects on the seat or forces acting on the seat may make the system sense supplemental weight.	<p>Stop the vehicle in a safe location as soon as possible and check the front passenger seat for the following:</p> <ul style="list-style-type: none">▶ Turn off the ignition (> page 38).▶ Remove child and child restraint from front passenger seat and properly secure the child in rear seat employing the child restraint if necessary.▶ Remove any other items from on and around the front passenger seat and make sure the storage bag on the back of the front passenger seat is empty.▶ Make sure that no objects which apply forces to the seat are present (e.g. objects such as books, briefcases etc. lodged behind or around the seat, head restraints pushing against roof etc.). The system may recognize such forces as supplemental weight and sense that an occupant on the front passenger seat is of a heavier weight than actually present.▶ Keep the seat unoccupied, close the front passenger door and turn on the ignition (> page 38). <p>(Continued on next page)</p>

What to do if ...

Display message	Possible cause/consequence	Possible solution
Front passenger airbag enabled see Operator's Manual		<p>Monitor the  PASS AIR BAG OFF indicator lamp on the center console (▷ page 89) and the multifunction display in the instrument cluster (▷ page 24) for the following:</p> <p>With the seat unoccupied and the ignition turned on,</p> <ul style="list-style-type: none"> the  PASS AIR BAG OFF indicator lamp on the center console should illuminate and remain illuminated, indicating that the OCS (▷ page 85) has deactivated the air bag. the message Front passenger airbag enabled see Operator's Manual or the message Front passenger airbag disabled see Operator's Manual should not appear in the multifunction display at any time the seat is unoccupied. Wait at last 60 seconds for the system to complete the necessary check cycles and to make sure neither message appears in the multifunction display. <p>If above conditions are met, you can occupy the front passenger seat again. Depending on the front passenger classification sensed by the OCS (▷ page 85), the  PASS AIR BAG OFF indicator lamp will remain illuminated or go out. If above conditions are not met, the system is not working properly. Have the system checked as soon as possible by an authorized Mercedes-Benz Light Truck Center.</p>

Warning!





If the  **PASS AIR BAG OFF** indicator lamp re-

mains out even after performing the above corrective steps, do not have any children 12 years old and under and other small

individuals use the front passenger seat until the system has been repaired.

Display message	Possible cause/consequence	Possible solution
Front passenger airbag disabled see Operator's Manual	Front passenger front air bag is deactivated while driving even though an adult or someone larger than a small individual is occupying the front passenger seat. Forces acting on the seat may make the system sense a decrease in weight.	Stop the vehicle in a safe location as soon as possible and check the front passenger seat for the following: <ul style="list-style-type: none">▶ Turn off the ignition (▷ page 38).▶ Have the front passenger vacate the seat and exit the vehicle.▶ Adjust the seat in a height position (▷ page 43).▶ Make sure that no objects which apply forces to the seat are present (e.g. objects such as books, briefcases etc. lodged underneath, behind or around the seat). Such forces may cause the system to sense that an occupant of a lesser weight than actually present is on the front passenger seat.▶ Keep the seat unoccupied, close the front passenger door and switch on the ignition (▷ page 38). (Continued on next page)

What to do if ...

Display message	Possible cause/consequence	Possible solution
Front passenger airbag disabled see Operator's Manual		<p>Monitor the  PASS AIR BAG OFF indicator lamp on the center console (▷ page 89) and the multifunction display in the instrument cluster (▷ page 24) for the following:</p> <p>With the seat unoccupied and the ignition turned on,</p> <ul style="list-style-type: none"> the  PASS AIR BAG OFF indicator lamp on the center console should illuminate and remain illuminated, indicating that the OCS (▷ page 85) has deactivated the air bag. the message Front passenger airbag enabled see Operator's Manual or the message Front passenger airbag disabled see Operator's Manual should not appear in the multifunction display at any time the seat is unoccupied. Wait at last 60 seconds for the system to complete the necessary check cycles and to make sure neither message appears in the multifunction display. <p>If above conditions are met, you can occupy the front passenger seat again. Depending on the front passenger classification sensed by the OCS (▷ page 85), the  PASS AIR BAG OFF indicator lamp will remain illuminated or go out.</p> <p>If above conditions are not met, the system is not working properly. Have the system checked as soon as possible by an authorized Mercedes-Benz Light Truck Center.</p>

Warning!



If the  **PASS AIR BAG OFF** indicator lamp re-

mains out even after performing the above corrective steps, do not have any children 12 years old and under and other small

individuals use the front passenger seat until the system has been repaired.

Display message	Possible cause/consequence	Possible solution
Check tires Then reactivate Run Flat Indicator	There was a warning message about a loss in the tire inflation pressure and the Run Flat Indicator has not been reactivated yet.	<ul style="list-style-type: none"> ▶ Make sure that the correct tire inflation pressure is set for each tire. ▶ Then reactivate the Run Flat Indicator.
Run Flat Indicator inactive	Run Flat Indicator is malfunctioning.	▶ Have the Run Flat Indicator checked by an authorized Mercedes-Benz Light Truck Center.
Run Flat Indicator unavailable	The Run Flat Indicator has been switched off due to an error.	▶ Have the Run Flat Indicator checked by an authorized Mercedes-Benz Light Truck Center.
Tire pressure Check tires	The Run Flat Indicator indicates that the pressure is too low in one or more tires.	<ul style="list-style-type: none"> ▶ Carefully bring the vehicle to a halt, avoiding abrupt steering and braking maneuvers. Observe the traffic situation around you. ▶ Check and adjust tire inflation pressure as required (▷ page 365). ▶ If necessary, change the wheel (▷ page 478). ▶ Reactivate the Run Flat Indicator after adjusting the tire inflation pressure values (▷ page 365).



What to do if ...

Display message	Possible cause/consequence	Possible solution
Tire pressure displayed only after driving a few minutes	Vehicles with Advanced TPMS*: The tire inflation pressure is being checked.	▶ Drive the vehicle for a few minutes.
Tire pressure monitor inoperative	The TPMS or Advanced TPMS* is malfunctioning.	▶ Have the TPMS or Advanced TPMS* checked by an authorized Mercedes-Benz Light Truck Center.
Tire pressure monitor inoperative No wheel sensors	There are wheels without wheel sensors mounted (e.g. winter tires).	▶ Have the TPMS or Advanced TPMS* checked by an authorized Mercedes-Benz Light Truck Center. ▶ Have the wheel sensors installed by an authorized Mercedes-Benz Light Truck Center.
Tire pressure monitor temporarily unavailable	The TPMS or Advanced TPMS* is unable to monitor the tire pressure due to <ul style="list-style-type: none"> • a nearby radio interference source • excessive wheel sensor temperatures 	▶ As soon as the causes for the malfunction are no longer present, the TPMS or Advanced TPMS* automatically becomes active again after a few minutes of driving.
Tire pressure monitor Wheel sensor missing	One or more sensors malfunction (e.g. battery in one or more wheel sensor is empty). One or more wheels without wheel sensors mounted (e.g. spare tire).	▶ Have the TPMS or Advanced TPMS* checked by an authorized Mercedes-Benz Light Truck Center. ▶ Have the wheel sensors installed by an authorized Mercedes-Benz Light Truck Center. Vehicles with Advanced TPMS*: The tire pressure for the respective tire is shown in the multifunction display.

Symbol messages



Display symbol	Display messages	Possible cause/consequence	Possible solution
	malfunction Visit workshop	<p>The battery is no longer charging.</p> <p>Possible causes:</p> <ul style="list-style-type: none"> • alternator malfunctioning • broken poly-V-belt <p>Do not forget that the brake system requires electrical energy and may be operating with restricted capability. Considerably greater brake pedal force is required and the stopping distance is increased.</p>	<p>► Stop in a safe location or as soon as it is safe to do so and check the poly-V-belt.</p> <p>If it is broken:</p> <ul style="list-style-type: none"> ► Do not continue to drive. Otherwise the engine will overheat due to an inoperative water pump which may result in damage to the engine. Notify an authorized Mercedes-Benz Light Truck Center. <p>If it is intact:</p> <ul style="list-style-type: none"> ► Drive immediately to the nearest authorized Mercedes-Benz Light Truck Center. Adjust driving to be consistent with reduced braking responsiveness.

What to do if ...



Display symbol	Display message	Possible cause/consequence	Possible solution
	Undervoltage Switch off consumers	The battery has insufficient voltage.	▶ Turn off unnecessary electrical consumers.
	Battery/Alternator Stop vehicle	The battery is defective.	▶ Stop the vehicle in a safe location or as soon as it is safe to do so. ▶ Do not continue to drive. ▶ Notify an authorized Mercedes-Benz Light Truck Center.
	Brake wear Visit workshop	The brake pads have reached their wear limit.	▶ Have the brake pads replaced as soon as possible.



Brake pad thickness must be visually inspected by a qualified technician at the intervals specified in the Maintenance Booklet.

Display symbol	Display message	Possible cause/consequence	Possible solution
BRAKE (USA only)  (Canada only)	Release parking brake	You are driving with the parking brake set.	<ul style="list-style-type: none"> ▶ Release the parking brake (> page 56).
BRAKE (USA only)  (Canada only)	Changed braking behavior Drive with extreme care	A malfunction in the Electronic Brake Proportioning (> page 102) was detected.	<ul style="list-style-type: none"> ▶ Continue driving with added caution. Wheels may lock during hard braking, reducing steering capability. ▶ Read and observe messages in the multi-function display. ▶ Have the system checked at an authorized Mercedes-Benz Light Truck Center as soon as possible. <p>Failure to follow these instructions increases the risk of an accident.</p>

What to do if ...

Display symbol	Display message	Possible cause/consequence	Possible solution
 (USA only)  (Canada only)	Brake fluid too low Visit workshop	There is insufficient brake fluid in the reservoir.	► Risk of accident! Stop the vehicle in a safe location or as soon as it is safe to do so and notify an authorized Mercedes-Benz Light Truck Center. Do not add brake fluid! This will not solve the problem.



Warning!



Driving with the message **Brake fluid too low Visit workshop** displayed can result in an accident. Have your brake system checked immediately. Do not add brake fluid before checking the brake system. Overfilling the brake fluid reservoir can result in spilling brake fluid on hot engine parts and the brake fluid catching fire. You can be seriously burned.



If you find that the brake fluid in the brake fluid reservoir has fallen to the minimum mark or below, have the brake system checked for brake pad thickness and leaks.

Display symbol	Display messages	Possible cause/consequence	Possible solution
 (USA only)  (Canada only)	Engine Service	There may be a malfunction in the <ul style="list-style-type: none"> • fuel injection system • ignition system • exhaust system • fuel system 	► Have the engine checked by an authorized Mercedes-Benz Light Truck Center.
	Coolant Check level	The coolant level is too low.	► Add coolant (▷ page 351). ► If you have to add coolant frequently, have the cooling system checked by an authorized Mercedes-Benz Light Truck Center.

Warning!



Do not spill antifreeze on hot engine parts. Antifreeze contains ethylene glycol which may burn if it comes into contact with hot engine parts. You can be seriously burned.



Do not ignore the low engine coolant level warning. Extended driving with the message and symbol displayed may cause serious engine damage not covered by the Mercedes-Benz Limited Warranty.

Do not drive without sufficient amount of coolant in the cooling system. The engine will overheat causing major engine damage.

What to do if ...

Display symbol	Display messages	Possible cause/consequence	Possible solution
	Coolant Stop, engine off	The coolant is too hot.	<ul style="list-style-type: none"> ▶ Stop the vehicle in a safe location or as soon as it is safe to do so and immediately turn off the engine. ▶ Only start the engine again after the message disappears. You could otherwise damage the engine.

Warning!



Driving when your engine is badly overheated can cause some fluids which may have leaked into the engine compartment to catch fire. You could be seriously burned.

Steam from an overheated engine can cause serious burns and can occur just by opening the engine hood. Stay away from the engine if you see or hear steam coming from it.

Turn off the engine, get out of the vehicle and do not stand near the vehicle until the engine has cooled down.





During severe operation conditions and stop-and-go city traffic, the coolant temperature may rise close to 248°F (120°C).



The engine should not be operated with the coolant temperature above 248°F (120°C). Doing so may cause serious damage which is not covered by the Mercedes-Benz Limited Warranty.

Display symbol	Display messages	Possible cause/consequence	Possible solution
	Coolant Stop, engine off	The poly-V-belt could be broken.	<ul style="list-style-type: none"> ▶ Stop the vehicle in a safe location or as soon as it is safe to do so and immediately turn off the engine. ▶ Check the poly-V-belt. <p>If it is broken:</p> <ul style="list-style-type: none"> ▶ Do not continue to drive. Otherwise the engine will overheat due to an inoperative water pump which may result in damage to the engine. Notify an authorized Mercedes-Benz Light Truck Center. <p>If it is intact:</p> <ul style="list-style-type: none"> ▶ Do not continue to drive the vehicle with this message displayed. Doing so could result in serious engine damage that is not covered by the Mercedes-Benz Limited Warranty. ▶ Observe the coolant temperature in the multifunction display (▷ page 168). ▶ Drive immediately to the nearest authorized Mercedes-Benz Light Truck Center.

What to do if ...

Display symbol	Display messages	Possible cause/consequence	Possible solution
	Coolant Visit workshop	The cooling fan for the coolant is malfunctioning.	<ul style="list-style-type: none"> ▶ Observe the coolant temperature in the multifunction display (▷ page 168). ▶ Have the fan replaced as soon as possible.
	Display malfunction Visit workshop	The instrument cluster display is malfunctioning.	<ul style="list-style-type: none"> ▶ Continue driving with added caution. ▶ Visit an authorized Mercedes-Benz Light Truck Center as soon as possible.
		The displays for several systems have malfunctioned. Some systems themselves may also have malfunctioned.	<ul style="list-style-type: none"> ▶ Have the electronic systems checked by an authorized Mercedes-Benz Light Truck Center.
	Display malfunction Visit workshop	<p>Certain electronic systems are unable to relay information to the control system. The following systems may have failed:</p> <ul style="list-style-type: none"> • Coolant temperature display • Tachometer • Cruise control display 	<ul style="list-style-type: none"> ▶ Have the electronic systems checked by an authorized Mercedes-Benz Light Truck Center.
	Door open	You are attempting to drive with one or more doors open.	<ul style="list-style-type: none"> ▶ Close the doors.

Display symbol	Display messages	Possible cause/consequence	Possible solution
	Check eng. oil level when next refueling	The engine oil level is too low.	▶ Check the engine oil level (▷ page 346).
	USA only: Add 1 qt. engine oil when next refueling	The engine oil level is too low.	▶ Add engine oil (▷ page 349) and check the engine oil level (▷ page 346).
	Canada only: Add 1 liter engine oil when next refueling	The engine oil level is too low.	▶ Add engine oil (▷ page 349) and check the engine oil level (▷ page 346).
	Engine oil level Stop, engine off	There is no oil in the engine. There is a danger of engine damage.	▶ Carefully bring the vehicle to a halt as soon as it is safe to do so in a safe location. ▶ Turn off the engine. ▶ Add engine oil (▷ page 349) and check the engine oil level (▷ page 346).
	Engine oil level Reduce oil level	You have added too much engine oil. There is a risk of damaging the engine or the catalytic converter.	▶ Have oil siphoned or drained off. Observe all legal requirements with respect to its disposal.
Change engine oil Visit workshop	It may be that there is water in the engine oil.	▶ Have the engine oil checked.	

What to do if ...

Display symbol	Display messages	Possible cause/consequence	Possible solution
	Engine oil level Visit workshop	The engine oil has dropped to a critical level.	<ul style="list-style-type: none"> ▶ Check the engine oil level (▷ page 346) and add oil as required (▷ page 349). ▶ If you must add engine oil frequently, have the engine checked for possible leaks.
	Oil sensor malfunction Visit workshop	The measuring system is malfunctioning.	<ul style="list-style-type: none"> ▶ Have the measuring system checked by an authorized Mercedes-Benz Light Truck Center.



When the message Add 1 qt. engine oil when next refueling (Canada: 1 liter) appears while the engine is running and at operating temperature, the engine oil level has dropped to approximately the minimum level.

When this occurs, the warning will first come on intermittently and then stay on if the oil level drops further.

Visually check for oil leaks. If no obvious oil leaks are noted, drive to the nearest service station where the engine oil should be topped to the required level with an approved oil specified in the Factory Approved Service Products pamphlet.



The engine oil level warnings should not be ignored. Extended driving with the symbol displayed could result in serious engine damage that is not covered by the Mercedes-Benz Limited Warranty.

Display symbol	Display messages	Possible cause/consequence	Possible solution
	Check gas cap See Operator's Manual	A loss of pressure has been detected in the fuel system. The fuel cap may not be closed properly or the fuel system may be leaky.	<ul style="list-style-type: none"> ▶ Check the fuel cap (▷ page 342). If it is not closed properly: ▶ Close the fuel cap. If it is closed properly: ▶ Have the fuel system checked by an authorized Mercedes-Benz Light Truck Center.
	Hood open Trunk open	You are driving with the hood or the tailgate open.	▶ Close the hood (▷ page 345) or the tailgate (▷ page 124).
		You are trying to lock the vehicle with the KEYLESS-GO* function with a door or the tailgate open.	▶ Close all doors and/or the tailgate (▷ page 124).

What to do if ...

Display symbol	Display messages	Possible cause/consequence	Possible solution
	Key not recognized	The SmartKey with KEYLESS-GO* is not recognized while the engine is running because <ul style="list-style-type: none"> the SmartKey with KEYLESS-GO* is not in the vehicle there is strong radio-frequency interference 	<ul style="list-style-type: none"> ▶ Stop the vehicle as soon as it is safe to do so. ▶ Search for the SmartKey with KEYLESS-GO*. Otherwise the vehicle cannot be centrally locked nor can the engine be started again after the engine is stopped.
		The SmartKey with KEYLESS-GO* is momentarily not recognized.	<ul style="list-style-type: none"> ▶ Change the position of the SmartKey with KEYLESS-GO* in the vehicle. ▶ Operate the vehicle with the SmartKey in the starter switch if necessary.
	Key not recognized	The SmartKey with KEYLESS-GO* is not recognized while the ignition is switched on (▷ page 38) and a door is opened or closed and <ul style="list-style-type: none"> the SmartKey with KEYLESS-GO* is not in the vehicle 	<ul style="list-style-type: none"> ▶ Search for the SmartKey with KEYLESS-GO*. Otherwise the vehicle cannot be locked nor can the engine be started. <ul style="list-style-type: none"> ▶ Change the position of the SmartKey with KEYLESS-GO* in the vehicle.

Display symbol	Display messages	Possible cause/consequence	Possible solution
	Key still in vehicle	A SmartKey with KEYLESS-GO* left in the vehicle was recognized while trying to lock the vehicle from the outside.	► Take the SmartKey with KEYLESS-GO* out of the vehicle.
	Remove key	You have forgotten to remove the SmartKey.	► Remove the SmartKey from the starter switch.
	Replace key Drive to workshop	There is no additional code available for SmartKey or SmartKey with KEYLESS-GO*.	► Visit an authorized Mercedes-Benz Light Truck Center as soon as possible.
	Key Check battery	The batteries in the SmartKey with KEYLESS-GO* are discharged.	► Replace the batteries (▷ page 464).
	Do not forget key	This message appears for a maximum of 60 seconds if the driver's door is opened with the engine shut off and no SmartKey in the starter switch. This message is only a reminder.	► Insert SmartKey in the starter switch. or ► Take the SmartKey with KEYLESS-GO* with you when leaving the vehicle.



What to do if ...

Display symbol	Display messages	Possible cause/consequence	Possible solution
	3rd brake lamp	The high mounted brake lamp is malfunctioning. This message will only appear if all light emitting diodes have stopped working.	► Visit an authorized Mercedes-Benz Light Truck Center as soon as possible.
	Brake lamp, left Substitute bulb on	The left brake lamp is malfunctioning. A substitute bulb is being used.	► Replace the bulb as soon as possible.
	Brake lamp, right Substitute bulb on	The right brake lamp is malfunctioning. A substitute bulb is being used.	► Replace the bulb as soon as possible.
	Brake lamp Drive to workshop	Brake lamp illumination is delayed or lamp is permanently on.	► Visit an authorized Mercedes-Benz Light Truck Center as soon as possible.
	Display malfunction Visit workshop	The display for the lamps or the system is malfunctioning.	► Visit an authorized Mercedes-Benz Light Truck Center as soon as possible.
	Front foglamp, left	The left front fog lamp is malfunctioning.	► Replace the bulb as soon as possible.
	Front foglamp, right	The right front fog lamp is malfunctioning.	► Replace the bulb as soon as possible.
	Rear fog lamp	The rear fog lamp is malfunctioning.	► Replace the bulb as soon as possible.

Display symbol	Display messages	Possible cause/consequence	Possible solution
	Active headlamp currently unavailable	The active Bi-Xenon* headlamp system is malfunctioning.	► Visit an authorized Mercedes-Benz Light Truck Center as soon as possible.
	Active headlamps Substitute bulb on	The active Bi-Xenon* headlamp system is malfunctioning. Another lamp is being used.	► Visit an authorized Mercedes-Benz Light Truck Center as soon as possible.
	Active headlamps inoperative	The active Bi-Xenon* headlamp system is malfunctioning.	► Visit an authorized Mercedes-Benz Light Truck Center as soon as possible.
	Active headlamps Display malfunction	The active Bi-Xenon* headlamp system is malfunctioning.	► Visit an authorized Mercedes-Benz Light Truck Center as soon as possible.
	High beam, left	The left high beam lamp is malfunctioning.	Halogen headlamp: ► Replace the bulb as soon as possible. Bi-Xenon* headlamp: ► Visit an authorized Mercedes-Benz Light Truck Center as soon as possible.
	High beam, right	The right high beam lamp is malfunctioning.	Halogen headlamp: ► Replace the bulb as soon as possible. Bi-Xenon* headlamp: ► Visit an authorized Mercedes-Benz Light Truck Center as soon as possible.

What to do if ...

Display symbol	Display messages	Possible cause/consequence	Possible solution
	License plate lamp, left	The left license plate lamp is malfunctioning.	▶ Replace the bulb as soon as possible.
	License plate lamp, right	The right license plate lamp is malfunctioning.	▶ Replace the bulb as soon as possible.
	Light sensor Drive to workshop	The lamp sensor is malfunctioning. The headlamps do not switch on automatically.	<ul style="list-style-type: none"> ▶ In the control system, set lamp operation to manual mode (▷ page 148). ▶ Switch on headlamps using the exterior lamp switch (▷ page 147). ▶ Visit an authorized Mercedes-Benz Light Truck Center as soon as possible.
	Low beam, left	The left low beam lamp is malfunctioning.	<p>Halogen headlamp:</p> <ul style="list-style-type: none"> ▶ Replace the bulb as soon as possible. <p>Bi-Xenon* headlamp:</p> <ul style="list-style-type: none"> ▶ Visit an authorized Mercedes-Benz Light Truck Center as soon as possible.
Low beam, right	The right low beam lamp is malfunctioning.	<p>Halogen headlamp:</p> <ul style="list-style-type: none"> ▶ Replace the bulb as soon as possible. <p>Bi-Xenon* headlamp:</p> <ul style="list-style-type: none"> ▶ Visit an authorized Mercedes-Benz Light Truck Center as soon as possible. 	

Display symbol	Display messages	Possible cause/consequence	Possible solution
	Marker lamp, front left	The left front side marker lamp is malfunctioning.	▶ Replace the bulb as soon as possible.
	Marker lamp, front right	The right front side marker lamp is malfunctioning.	▶ Replace the bulb as soon as possible.
	Parking lamp, front left Substitute bulb on	The left front parking lamp is malfunctioning. A substitute bulb is being used.	▶ Replace the bulb as soon as possible.
	Parking lamp, front right Substitute bulb on	The right front parking lamp is malfunctioning. A substitute bulb is being used.	▶ Replace the bulb as soon as possible.
	Reverse lamp, left	The left backup lamp is malfunctioning.	▶ Replace the bulb as soon as possible.
	Reverse lamp, right	The right backup lamp is malfunctioning.	▶ Replace the bulb as soon as possible.
	Switch off lights	You have removed the SmartKey from the starter switch and opened the driver's door or removed the SmartKey with KEYLESS-GO* from the vehicle and left the headlamps on.	▶ Turn the exterior lamp switch to  (▷ page 147).

What to do if ...

Display symbol	Display messages	Possible cause/consequence	Possible solution
	Tail lamp, left Substitute bulb on	The left tail lamp is malfunctioning. A substitute bulb is being used.	► Replace the bulb as soon as possible.
	Tail lamp, right Substitute bulb on	The right tail lamp is malfunctioning. A substitute bulb is being used.	► Replace the bulb as soon as possible.
	Turn signal, rear left Substitute bulb on	The left rear turn signal lamp is malfunctioning. A substitute bulb is being used.	► Replace the bulb as soon as possible.
	Turn signal, rear right Substitute bulb on	The right rear turn signal lamp is malfunctioning. A substitute bulb is being used.	► Replace the bulb as soon as possible.
	Turn signal, front left Substitute bulb on	The left front turn signal lamp is malfunctioning. A substitute bulb is being used.	► Replace the bulb as soon as possible.
	Turn signal, front right Substitute bulb on	The right front turn signal lamp is malfunctioning. A substitute bulb is being used.	► Replace the bulb as soon as possible.

Display symbol	Display messages	Possible cause/consequence	Possible solution
	Turn signal in mirror, left	The left turn signal in the side mirror is malfunctioning. This message will only appear if all light emitting diodes have stopped working.	► Visit an authorized Mercedes-Benz Light Truck Center as soon as possible.
	Turn signal in mirror, right	The right turn signal in the side mirror is malfunctioning. This message will only appear if all light emitting diodes have stopped working.	► Visit an authorized Mercedes-Benz Light Truck Center as soon as possible.

What to do if ...

Display symbol	Display messages	Possible cause/consequence	Possible solution
	Rectify tire pressure	The pressure is too low in one or more tires.	▶ Check and correct tire inflation pressure as required.
	Tire pressure Caution: Tire defect	One or more tires are deflating.	▶ Carefully bring the vehicle to a halt, avoiding abrupt steering and braking maneuvers. ▶ If necessary, change the wheel.
	Caution: Tire defect	Vehicles with Advanced TPMS*: One or more tires are deflating. The respective tire is shown in the multifunction display.	▶ Carefully bring the vehicle to a halt, avoiding abrupt steering and braking maneuvers. ▶ If necessary, change the wheel.

Warning!



Do not drive with a flat tire. A flat tire affects the ability to steer or brake the vehicle. You may lose control of the vehicle. Continued driving with a flat tire will cause excessive heat build-up and possibly a fire.





Display symbol	Display messages	Possible cause/consequence	Possible solution
	Tire pressure Check tires	The tire pressure in one or more tires is already below the minimum value.	<ul style="list-style-type: none"> ▶ Carefully bring the vehicle to a halt, avoiding abrupt steering and braking maneuvers. ▶ Check and adjust tire inflation pressure as required. ▶ If necessary, change the wheel.
	Check tires	<p>Vehicles with Advanced TPMS*: The tire pressure in one or more tires is already below the minimum value.</p> <p>The respective tire is shown in the multifunction display.</p>	<ul style="list-style-type: none"> ▶ Carefully bring the vehicle to a halt, avoiding abrupt steering and braking maneuvers. ▶ Check and adjust tire inflation pressure as required. ▶ If necessary, change the wheel.





Warning!



Do not drive with a flat tire. A flat tire affects the ability to steer or brake the vehicle. You may lose control of the vehicle. Continued driving with a flat tire will cause excessive heat build-up and possibly a fire.

What to do if ...

Display symbol	Display messages	Possible cause/consequence	Possible solution
	Seat belt system Drive to workshop	The seat belt system is malfunctioning.	▶ Visit an authorized Mercedes-Benz Light Truck Center as soon as possible.
	Service memory full See Operator's Manual	The maintenance service memory cannot save any more data.	▶ Have the service memory checked by an authorized Mercedes-Benz Light Truck Center.
	Close tilt/sliding sunroof	You have opened the driver's door with the SmartKey removed from the starter switch and the sliding portion of the tilt/sliding sunroof* open.	▶ Close the tilt/sliding sunroof* (▷ page 255).
	Close tilt/sliding sunroof	You have opened the driver's door with the SmartKey removed from the starter switch and the tilt portion of the tilt/sliding sunroof* open.	▶ Close the tilt/sliding sunroof* (▷ page 255).

Display symbol	Display messages	Possible cause/consequence	Possible solution
	Malfunction Drive to workshop	One or more main functions of the Tele Aid* system are malfunctioning.	▶ Have the Tele Aid* system checked by an authorized Mercedes-Benz Light Truck Center.
	Battery Drive to workshop	The emergency power battery for the Tele Aid* system is malfunctioning. If the vehicle battery is also malfunctioning or drained, Tele Aid* will not be operational.	▶ Have the Tele Aid* system checked by an authorized Mercedes-Benz Light Truck Center.
	Function unavailable	This display appears if button  or  on the multifunction steering wheel is pressed and the vehicle is not equipped with a telephone.	
	Washer fluid Check level	The fluid level has dropped to about $\frac{1}{3}$ of total reservoir capacity.	▶ Add washer fluid (▷ page 352).

What to do if ...

Display symbol	Display messages	Possible cause/consequence	Possible solution
 *	Stop, car too low	The AIRMATIC* is inoperative.	<ul style="list-style-type: none"> ▶ Avoid large steering angles. Otherwise a fender or tire could be damaged. ▶ Do not drive faster than 50 mph (80 km/h). ▶ Have the vehicle checked at an authorized Mercedes-Benz Light Truck Center.
	Visit workshop	The AIRMATIC* is malfunctioning.	<ul style="list-style-type: none"> ▶ Do not drive faster than 50 mph (80 km/h) depending on the set vehicle level. ▶ Have the vehicle checked at an authorized Mercedes-Benz Light Truck Center.
	Visit workshop	The AIRMATIC* is functional only to a limited extent.	<ul style="list-style-type: none"> ▶ Do not drive faster than 50 mph (80 km/h) depending on the set vehicle level. ▶ Have the vehicle checked at an authorized Mercedes-Benz Light Truck Center.

Display symbol	Display messages	Possible cause/consequence	Possible solution
 *	wait briefly	The vehicle level is too low.	<ul style="list-style-type: none"> ▶ Do not drive off. The vehicle level control* has not yet adjusted the vehicle level to the necessary height required for driving. ▶ Wait until the message disappears from the multifunction display. You may then drive off.
	Compressor cooling down	Level control was activated too long/too frequently.	<ul style="list-style-type: none"> ▶ Let the compressor cool until the message disappears. The selected level will be set once the compressor has cooled down.
	Level selection not permitted	You are driving too fast for the desired level selection.	<ul style="list-style-type: none"> ▶ Reduce vehicle speed. ▶ Set the next higher level (▷ page 271).



When the message Compressor cooling down appears in the multifunction display, driving is still possible.

Keep in mind that the ride height of the vehicle is not yet reached and you could therefore damage the underbody of the vehicle.

The selected level will be set once the compressor has cooled down.

Where will I find ...?

First aid kit



Check expiration dates and contents for completeness at least once a year and replace missing / expired items.

The first aid kit is stored under the cargo compartment floor, see “Vehicle tool kit” (▷ page 454).



Vehicle tool kit

The vehicle tool kit is stored under the cargo compartment floor.

The vehicle tool kit includes:

- Towing eye bolt
- Wheel wrench
- Alignment bolt
- Vehicle jack
- Fuse chart
- Spare fuses
- Fuse extractor
- Collapsible wheel chock
- Wheel bolts for spare wheel

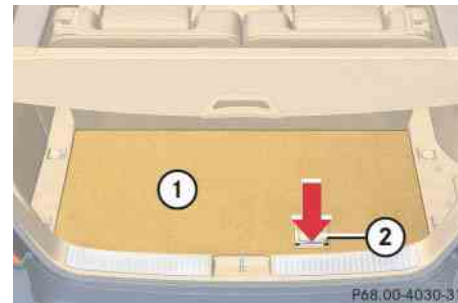

① Cargo compartment floor, lowered

② Handle cover

- ▶ Open the tailgate (▷ page 122).
- ▶ Push in handle cover ② and pull handle in direction of arrow.
- ▶ Lift cargo compartment floor ①.

Where will I find ...?

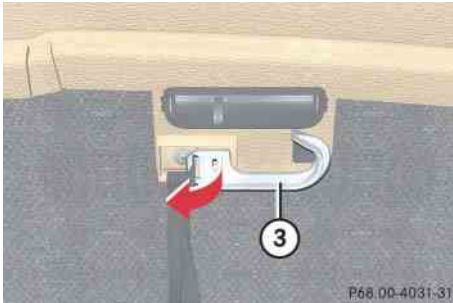

③ Securing hook

- ▶ Release securing hook ③ (located below the floor handle) from holder.

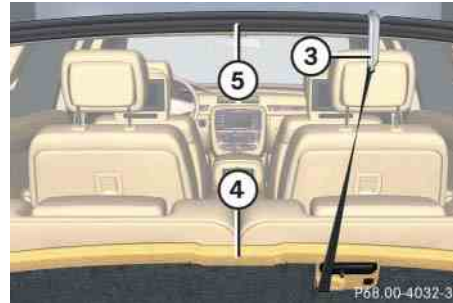

③ Securing hook

- ④ Cargo compartment floor, raised
- ⑤ Upper cargo compartment lip

- ▶ Engage securing hook ③ on upper cargo compartment lip ⑤.



With the cargo compartment cover blind* installed behind the third-row seats (▷ page 288), disengage cargo compartment cover blind* and flip it forward. Otherwise the strap of the securing hook could damage the cargo compartment cover blind*.

You can now access the vehicle tool kit. To remove the vehicle tool kit storage well casing, proceed as described on (▷ page 458).

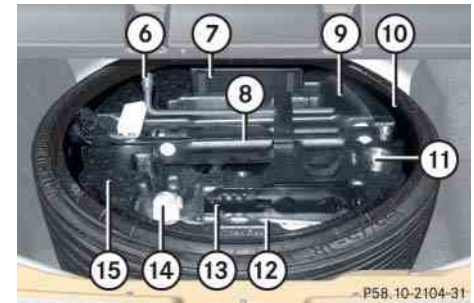

- ⑥ Wheel bolt wrench
- ⑦ Electric air pump
- ⑧ Jack
- ⑨ Spare fuses, fuse extractor, fuse chart
- ⑩ Spare wheel (collapsible tire)
- ⑪ Alignment bolt
- ⑫ Towing eye bolt
- ⑬ Collapsible wheel chock
- ⑭ Spare wheel bolts
- ⑮ Vehicle tool kit storage well casing

- ▶ To remove jack ⑮, loosen the hook and loop fastener.

Where will I find ...?

Vehicle jack

Warning!



The jack is designed exclusively for jacking up the vehicle at the jack take-up brackets built into both sides of the vehicle. To help avoid personal injury, use the jack only to lift the vehicle during a wheel change. Never get beneath the vehicle while it is supported by the jack. Keep hands and feet away from the area under the lifted vehicle. Always firmly set parking brake and block wheels before raising vehicle with jack.

Do not disengage parking brake while the vehicle is raised. Be certain that the jack is always vertical (plumb line) when in use, especially on hills. Always try to use the jack on level surface. Make sure the jack arm is fully seated in the jack take-up bracket. Always lower the vehicle onto sufficient capacity jackstands before working under the vehicle.

The vehicle jack is located underneath the storage compartment floor.

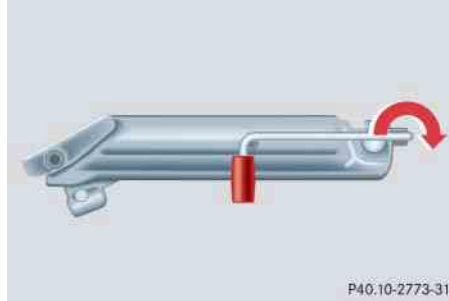

Storage position

- ▶ Remove vehicle jack from its storage compartment (▷ page 454).
- ▶ Push crank handle up.

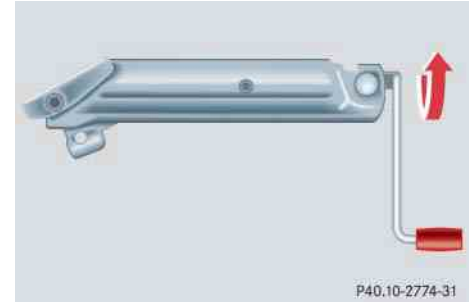

Operational position

- ▶ Turn crank handle clockwise until it engages (operational position).
- Before storing the vehicle jack in its storage compartment:
- The vehicle jack should be fully collapsed.
 - The handle must be folded in (storage position).

Setting up the collapsible wheel chock

The collapsible wheel chock serves to additionally secure the vehicle, e.g. while changing the wheel.

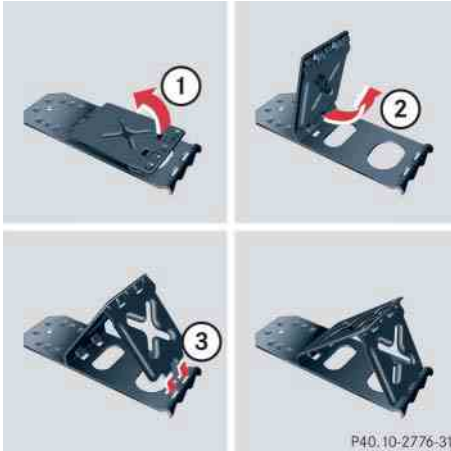

- ① Tilt the plate upward
- ② Fold the lower plate outward
- ③ Insert the plate

- ▶ Tilt both plates upward ①.
- ▶ Fold the lower plate outward ②.
- ▶ Guide the tabs of the lower plate all the way into the openings of base plate ③.

Spare wheel

Your vehicle is equipped with a spare wheel with collapsible tire. The spare wheel is located underneath the cargo compartment floor.

Warning!



The dimensions of the spare wheel are different from those of the road wheels. As a result, the vehicle handling characteristics change when driving with a spare wheel mounted.

The spare wheel should only be used temporarily, and should be replaced with a regular road wheel as quickly as possible.

Where will I find ...?



For information on how to mount the spare wheel, see “Mounting the spare wheel” (▷ page 479).

In case of a flat tire, you may temporarily use the spare wheel when observing the following restrictions:

- Do not exceed a vehicle speed of 50 mph (80 km/h).
- Drive to the nearest tire repair facility to have the flat tire repaired or replaced as appropriate.
- Do not operate the vehicle with more than one spare wheel mounted.

Removing the spare wheel

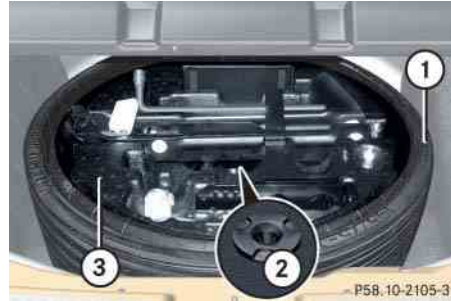

- ① Spare wheel
- ② Retaining screw
- ③ Vehicle tool kit storage well casing

- ▶ Remove the jack from the vehicle tool kit (▷ page 455).
- ▶ Loosen retaining screw ② by turning it counterclockwise.
- ▶ Remove vehicle tool kit storage well casing ③.
- ▶ Remove spare wheel ①.

Unlocking/locking in an emergency

▼ **Unlocking/locking in an emergency**

Unlocking the vehicle

If you cannot unlock the vehicle with the SmartKey or KEYLESS-GO*, open the driver's door using the mechanical key.



Unlocking the driver's door with the mechanical key will trigger the anti-theft alarm system.

To cancel the alarm:

- Press button or on the SmartKey.
- Insert the SmartKey in the starter switch.

Vehicles with KEYLESS-GO*:

- Grasp an outside door handle.
The SmartKey with KEYLESS-GO must be within 3 ft (1 m) of the vehicle.
- Press the KEYLESS-GO start / stop button (▷ page 40).
The SmartKey with KEYLESS-GO must be inside the vehicle.

Removing the mechanical key



SmartKey

- ① Mechanical key locking tab
- ② Mechanical key

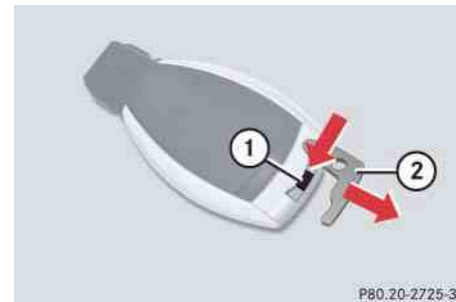

P80.20-2725-31

SmartKey with KEYLESS-GO*

- ① Mechanical key locking tab
- ② Mechanical key
- ▶ Move locking tab ① in direction of arrow.
- ▶ Slide mechanical key ② out of the housing.

Unlocking/locking in an emergency

Unlocking the driver's door



① Unlocking

② Mechanical key

- ▶ Insert mechanical key ② into the driver's door lock until it stops.
- ▶ Turn mechanical key ② counterclockwise to position ① and hold it there.
- ▶ Pull the door handle until the locking knob moves up.
The driver's door is unlocked.
- ▶ Pull the door handle once more to open the driver's door.

Locking the vehicle

If you cannot lock the vehicle with the SmartKey or KEYLESS-GO*, lock the vehicle carrying out the following steps.

- ▶ Close the front passenger door, the rear right door and the tailgate.
- ▶ Open the driver's door and the rear left door.
- ▶ Press the central locking switch on the driver's door (▷ page 131).

The locking knobs of the front passenger door and the rear doors move down.

If the vehicle battery is disconnected or drained:

- ▶ Press down the locking knobs of the front passenger door and the rear doors manually.

- ▶ Exit the vehicle.
- ▶ Close the driver's door.
- ▶ Enter the vehicle through the rear left door.
- ▶ Press down the locking knob of the driver's door.



To prevent inadvertent lockout, make sure to have the SmartKey or SmartKey with KEYLESS-GO* with you before proceeding with the next step. The next step will lock the vehicle.

- ▶ Exit the vehicle.
- ▶ Close the rear left door.
The vehicle is locked.

Unlocking/locking in an emergency

Fuel filler flap

- ▶ Open the tailgate (▷ page 122).

The fuel filler flap release is located behind a cover in the right side trim panel of the cargo compartment.

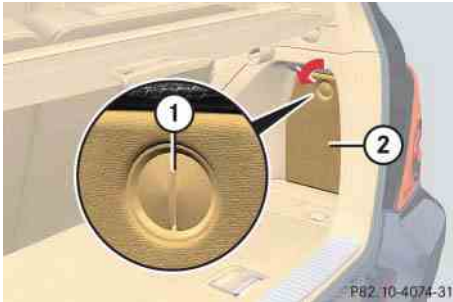

- ① Lock
- ② Cover

- ▶ Insert a suitable object such as a coin into the slot of lock ①.
- ▶ Turn lock ① counterclockwise by 90° in direction of arrow.
- ▶ Remove cover ②.



- ③ Fuel filler flap release

- ▶ Pull red fuel filler flap release ③ in direction of arrow.

The fuel filler flap is unlocked.

- ▶ Open the fuel filler flap (▷ page 342).



The fuel filler flap release may differ, depending on production date. If your vehicle is not equipped with the fuel filler flap release as illustrated, pulling a red fabric cord instead unlocks the fuel filler flap.

Opening/closing in an emergency

Power tilt/sliding sunroof*

You can open or close the tilt/sliding sunroof manually should an electrical malfunction occur.

The tilt/sliding sunroof drive is located behind a cover on the overhead control panel.

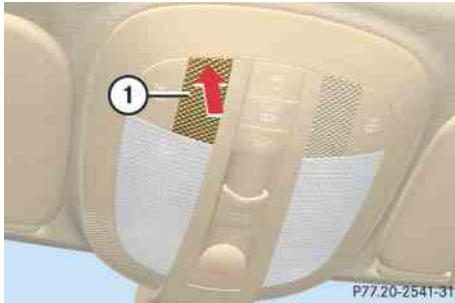

① Cover

- ▶ Remove the SmartKey from the starter switch.

Vehicles with KEYLESS-GO*:

- ▶ Turn off the engine by pressing the KEYLESS-GO start/stop button (▷ page 66).
- ▶ Open the driver's door (this puts the starter switch to position 0, same as with the SmartKey removed from starter switch). The driver's door can then be closed again.
- ▶ Press on cover ① at the position indicated by the arrow.
- ▶ Take off cover ①.

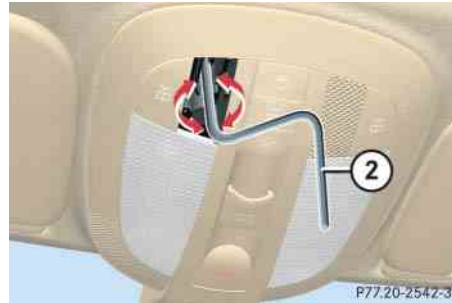

② Crank

- ▶ Take crank ② out of the Operator's Manual pouch.
- ▶ Insert crank ② into hole.
- ▶ Turn crank ② clockwise to
 - slide sunroof closed
 - raise sunroof at the rear
- ▶ Turn crank ② counterclockwise to
 - slide sunroof open
 - lower sunroof at the rear



Turn crank ② slowly and smoothly.

The tilt/sliding sunroof must be synchronized if it has been operated manually (▷ page 258).



The panorama roof with power tilt/sliding panel* cannot be operated as described. Contact an authorized Mercedes-Benz Light Truck Center.

Replacing SmartKey batteries

▼ Replacing SmartKey batteries

If the batteries in the SmartKey or the SmartKey with KEYLESS-GO* are discharged, the vehicle can no longer be locked or unlocked. It is recommended to have the batteries replaced at an authorized Mercedes-Benz Light Truck Center.

Warning!



Keep the batteries out of reach of children.
If a battery is swallowed, seek medical help immediately.

Batteries contain materials that can harm the environment if disposed of improperly. Recycling of batteries is the preferred method of disposal. Many states require sellers of batteries to accept old batteries for recycling.



When replacing batteries, make sure they are clean and free of lint.



When replacing batteries, always replace both batteries. The required replacement batteries are available at any Mercedes-Benz Light Truck Center.

SmartKey

Replacement batteries: Lithium, type CR 2025 or equivalent.

- ▶ Remove mechanical key ① from the SmartKey (> page 459).

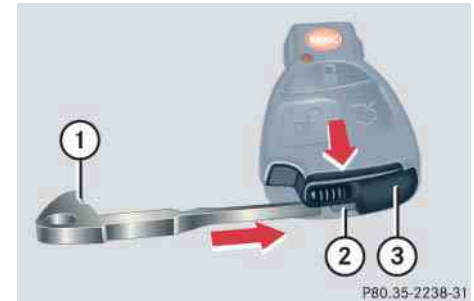

- ① Mechanical key
- ② Slide
- ③ Battery compartment

- ▶ Insert mechanical key ① in side opening in direction of arrow.
- ▶ Using mechanical key ①, push gray slide ② to unlatch battery compartment ③.



Replacing SmartKey batteries

- ▷▷ Pull battery compartment ③ out of the housing in direction of arrow.
- ▶ Remove the batteries in direction of arrow.

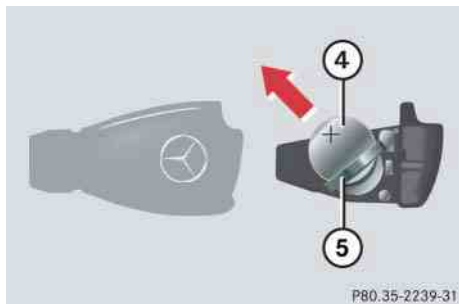

- ④ Battery
- ⑤ Contact spring

- ▶ Using a lint-free cloth, insert new batteries ④ under contact spring ⑤ with the positive terminal (+) facing up.
- ▶ Return battery compartment ③ into housing until it locks into place.
- ▶ Slide mechanical key ① back into SmartKey.
- ▶ Check the operation of the SmartKey.

SmartKey with KEYLESS-GO*

Replacement batteries: Lithium, type CR 2025 or equivalent.

- ▶ Remove mechanical key ① from the SmartKey with KEYLESS-GO (▷ page 459).

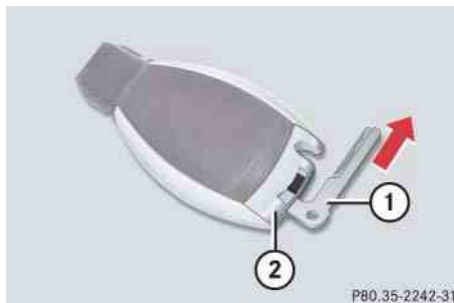

- ① Mechanical key
- ② Battery compartment

- ▶ Insert mechanical key ① into opening.
- ▶ Press mechanical key ① in direction of arrow.

The battery compartment is unlatched.

- ▶ Pull battery compartment ② out of the SmartKey housing.

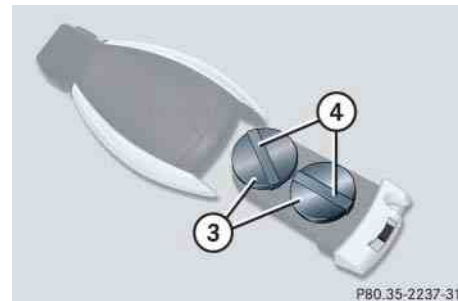

- ③ Batteries
- ④ Contact spring

- ▶ Pull out batteries ④.
- ▶ Using a lint-free cloth, insert new batteries ④ under contact springs ③ with the positive terminal (+) side facing up.
- ▶ Return battery compartment ② into housing until it locks into place.
- ▶ Slide mechanical key ① back into SmartKey.
- ▶ Check the operation of the SmartKey.

▼ Replacing bulbs

Bulbs

Safe vehicle operation depends on proper exterior lighting and signaling. It is therefore essential that all bulbs and lamp assemblies are in good working order at all times.

Correct headlamp adjustment is extremely important. Have headlamps checked and readjusted at regular intervals and when a bulb has been replaced. See an authorized Mercedes-Benz Light Truck Center for headlamp adjustment.



If the headlamps or front fog lamps are fogged up on the inside as a result of high humidity, driving the vehicle a distance with the lights on should clear up the fogging.



Backup bulbs will be brought into use when the following lamps malfunction:

- Turn signal lamps
- Brake lamps
- Parking lamps
- Tail lamps

Read and observe messages in the multifunction display (▷ page 442).

Replacing bulbs

Front lamps

	Lamp	Type
①	Parking/standing lamp	W 5 W
②	Turn signal lamp	PY 21 W
③	Additional turn signal lamp	LED
④	Headlamps: Low beam	H7 (55W)
	Bi-Xenon headlamps*: Low beam ¹	D2S-35 W
⑤	Headlamps: High beam/high beam flasher	H7 (55W)
	Bi-Xenon headlamps*: High beam/high beam flasher spot lamp	H7 (55W)
⑥	Sidemarkers lamp	WY 5 W
⑦	Corner-illuminating front fog lamp*	H 11 (55W)

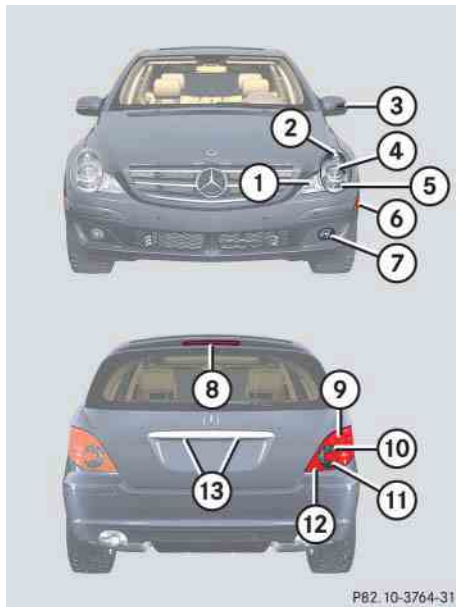

Rear lamps

	Lamp	Type
⑧	High-mounted brake lamp	LED
⑨	Tail, brake, and sidemarkers lamp	P 21 W
⑩	Turn signal lamp	PY 21 W
⑪	Backup lamp	P 21 W
⑫	Rear fog lamp (driver's side only)	P 21 W
⑬	License plate lamps	C 5 W

¹ Vehicles with Bi-Xenon* headlamps: Do not replace the Bi-Xenon bulbs yourself. Contact an authorized Mercedes-Benz Light Truck Center.

Warning!

Bulbs and bulb sockets can be very hot. Allow the lamp to cool down before changing a bulb.

Keep bulbs out of reach of children.

Halogen lamps contain pressurized gas. A bulb can explode if you:

- touch or move it when hot
- drop the bulb
- scratch the bulb

Wear eye and hand protection.

Because of high voltage in Xenon lamps, it is dangerous to replace the bulb or repair the lamp and its components. We recommend that you have such work done by a qualified technician.

Notes on bulb replacement

- Only use 12-volt bulbs of the same type and with the specified watt rating.
- Switch the lights off before changing a bulb to prevent short circuits.
- Always use a clean lint-free cloth when handling bulbs.
- Your hands should be dry and free of oil and grease.
- If the newly installed bulb does not come on, visit an authorized Mercedes-Benz Light Truck Center.

Have the LEDs and bulbs for the following lamps replaced by an authorized Mercedes-Benz Light Truck Center:

- the additional turn signal lamps in the exterior rear view mirrors
- the high mounted brake lamp
- the Bi-Xenon* low beam lamps
- the Bi-Xenon high beam flasher spotlight*
- the front sidemarker lamps

Replacing bulbs

Replacing bulbs for front lamps

Before you start to replace a bulb for a front lamp, do the following first:

- ▶ Turn the exterior lamp switch to position **0** (▷ page 147).
- ▶ Open the hood (▷ page 345).

Halogen headlamps

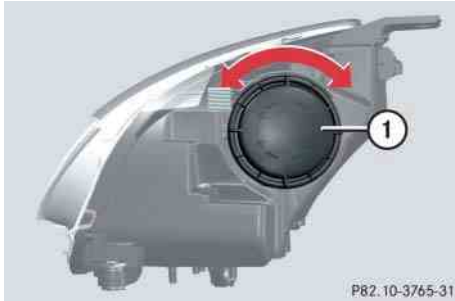

① Low beam/high beam headlamp cover



② Bulb socket for turn signal lamp

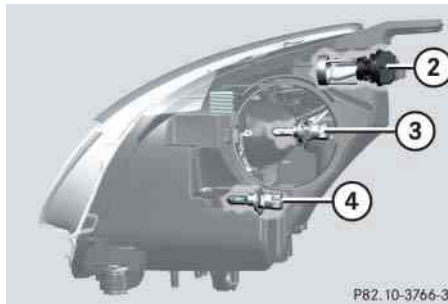

② Bulb socket for turn signal lamp

③ Bulb socket for low beam headlamp

④ Bulb socket for high beam headlamp

Low beam headlamp bulbs

- ▶ Turn cover ① counterclockwise.
- ▶ Remove cover ①.
- ▶ Turn bulb socket ③ counterclockwise.
- ▶ Pull bulb socket ③ out of the headlamp housing.
- ▶ Pull the low beam bulb out of bulb socket ③.
- ▶ Insert the new low beam bulb into bulb socket ③.
- ▶ Insert bulb socket ③ into the headlamp housing.
- ▶ Turn bulb socket ③ clockwise until it engages.
- ▶ Place cover ① on the opening in the headlamp housing.
- ▶ Turn cover ① clockwise until it engages.

High beam headlamp bulbs

- ▶ Turn cover ① counterclockwise.
- ▶ Remove cover ①.
- ▶ Turn bulb socket ④ counterclockwise.
- ▶ Pull bulb socket ④ out of the headlamp housing.
- ▶ Pull the high beam bulb out of bulb socket ④.
- ▶ Insert the new high beam bulb into bulb socket ④.
- ▶ Insert bulb socket ④ into the headlamp housing.
- ▶ Turn bulb socket ④ clockwise until it engages.
- ▶ Place cover ① on the opening in the headlamp housing.
- ▶ Turn cover ① clockwise until it engages.

Front turn signal lamp bulbs

- ▶ Pull bulb socket ② out of the headlamp housing.
- ▶ Pull the turn signal bulb out of bulb socket ②.
- ▶ Insert the new turn signal bulb into bulb socket ②.
- ▶ Insert bulb socket ② into the headlamp housing.

Bi-Xenon headlamps*



- ① Bulb socket for turn signal lamp
- ② Low beam/high beam headlamp cover – Do not remove



- ① Bulb socket for turn signal lamp

Replacing bulbs

Low beam and high beam flasher spot bulbs

Warning!



Do not remove the low beam/high beam cover for the Bi-Xenon* headlamp. Because of high voltage in Bi-Xenon* lamps, it is dangerous to replace the bulb or repair the lamp and its components. We recommend that you have such work done by a qualified technician.

Front turn signal lamp bulbs

- ▶ Pull bulb socket ① out of the headlamp housing.
- ▶ Pull the turn signal bulb out of bulb socket ①.
- ▶ Insert the new turn signal bulb into bulb socket ①.
- ▶ Insert bulb socket ① into the headlamp housing.

Parking and standing lamp bulbs

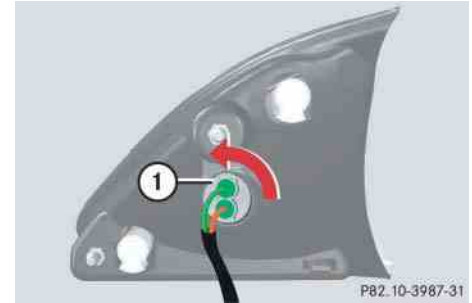

- ① Bulb socket for parking and standing lamp
- ▶ Turn bulb socket ① counterclockwise.
- ▶ Pull bulb socket ① out of the housing.
- ▶ Pull the bulb out of bulb socket ①.
- ▶ Insert the new parking and standing lamp bulb into bulb socket ①.
- ▶ Insert bulb socket ① into the housing.
- ▶ Turn bulb socket ① clockwise until it engages.

Corner-illuminating front fog lamp* bulbs

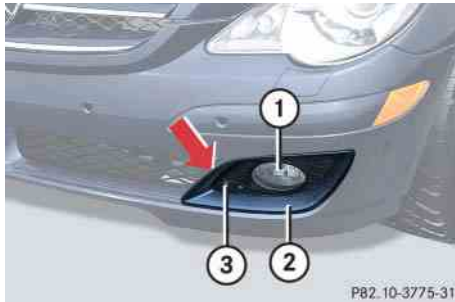

P82.10-3775-31

- ① Corner-illuminating front fog lamp*
- ② Cover
- ③ Retaining screw
- ▶ Remove retaining screw ③.
- ▶ Insert a suitable object (e.g. screwdriver) at point indicated by the arrow and pry out cover ②.
- Cover ② is released.
- ▶ Swing cover ② outwards and take it off.

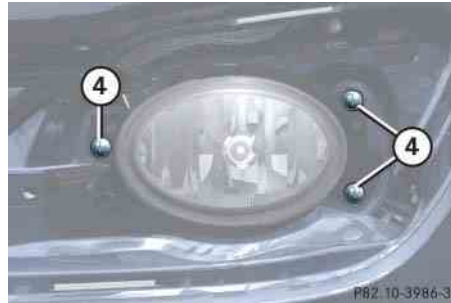

P82.10-3986-31

- ④ Retaining screws
- ▶ Remove screws ④ that retain front fog lamp ①.
- ▶ Remove corner-illuminating front fog lamp ①.

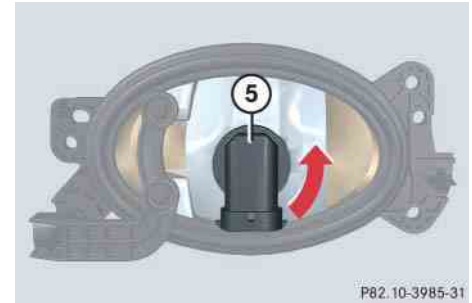

P82.10-3985-31

- ⑤ Corner-illuminating front fog lamp bulb socket
- ▶ Turn bulb socket ⑤ counterclockwise.
- ▶ Pull bulb socket ⑤ out of the housing.
- ▶ Pull the bulb out of bulb socket ⑤.
- ▶ Insert the new corner-illuminating front fog lamp bulb into bulb socket ⑤.
- ▶ Insert bulb socket ⑤ into the housing.▷▷

Replacing bulbs

- ▷▷ Turn bulb socket ⑤ clockwise until it engages.
- ▶ Insert corner-illuminating front fog lamp ① back into bumper.
- ▶ Fasten retaining screws ④.
- ▶ Reinsert cover ② and press it in until it engages.
- ▶ Fasten retaining screw ③.

Additional turn signal lamps bulbs

The additional turn signal lamps in the exterior rear view mirrors have LEDs.

If a malfunction occurs or LEDs fail to function, the entire turn signal unit must be replaced. Have the turn signal unit replaced by an authorized Mercedes-Benz Light Truck Center.

Front sidemarker lamp bulbs

Since replacing the sidemarker lamp bulbs is a technically highly demanding process, we recommend you have the sidemarker lamp bulbs replaced by an authorized Mercedes-Benz Light Truck Center.

Replacing bulbs for rear lamps

Before you start to replace a bulb for a rear lamp, do the following first:

- ▶ Turn the combination switch to position **0** (▷ page 147).

Tail lamp unit



To access the tail lamp units, you have to remove the cover in the corresponding side trim panel of the cargo compartment.

- ▶ Open the tailgate (▷ page 122).

Opening the side trim panels

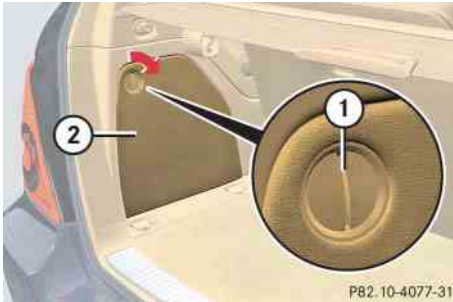

- ① Lock
- ② Cover in left side trim panel

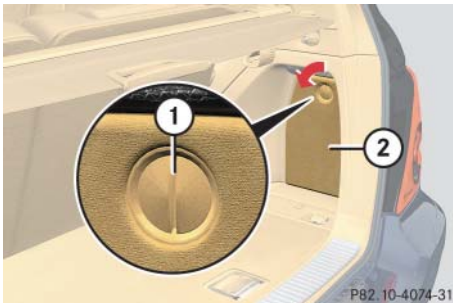

- ① Lock
- ② Cover in right side trim panel

- ▶ Insert a suitable object such as a coin into the slot of lock ①.
- ▶ Turn lock ① clockwise (left side trim panel) or counterclockwise (right side trim panel) by 90° in direction of arrow.
- ▶ Remove cover ②.

Replacing bulbs

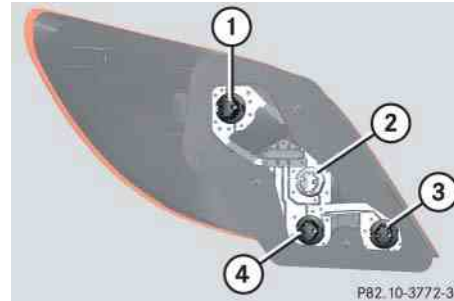

- ① Tail, sidemarkers, standing, and parking lamp bulb socket
- ② Turn signal lamp bulb socket
- ③ Fog lamp bulb socket (driver's side only)
- ④ Backup lamp bulb socket

- ▶ Depending on which bulb needs to be replaced, turn the respective bulb socket ① - ④ counterclockwise.
- ▶ Pull the bulb socket out of the housing.
- ▶ Similarly turn the bulb counterclockwise carefully and pull the bulb out of bulb socket.
- ▶ Insert the new bulb into the bulb socket.
- ▶ Turn the bulb in the bulb socket clockwise carefully.
- ▶ Insert the bulb socket into the housing.
- ▶ Turn the bulb socket clockwise until it engages.

Replacing bulbs

License plate lamp

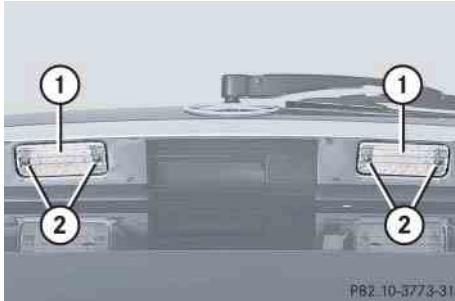

① License plate lamp cover

② Screw

- ▶ Loosen screws ②.
- ▶ Remove license plate lamp cover ①.
- ▶ Replace the license plate lamp bulb.
- ▶ Reinstall license plate lamp cover ①.
- ▶ Retighten screws ②.

▼ Replacing wiper blades

Front wiper blades



Never open the hood when the wiper arms are folded forward.

Hold on to the wiper when folding the wiper arm back. If released, the force of the impact from the tensioning spring could crack the windshield.

Do not allow the wiper arms to contact the windshield glass without a wiper blade inserted.

Make sure the wiper blades are properly installed. Improperly installed wiper blades may cause windshield damage.

For your convenience, we recommend that you have this work carried out by an authorized Mercedes-Benz Light Truck Center.

Removing

Warning!



For safety reasons, switch off wipers and remove the SmartKey from starter switch (vehicles with KEYLESS-GO*: Make sure the vehicle's on-board electronics have status **0**) before replacing a wiper blade. Otherwise the motor could suddenly turn on and cause injury.

- ▶ Remove the SmartKey from the starter switch.
- or
- ▶ Vehicles with KEYLESS-GO*: Make sure the vehicle's on-board electronics have status **0** (▷ page 39).
- ▶ Fold the wiper arms forward until they engage.



- ① Wiper blade
- ② Tab
- ③ Wiper arm

- ▶ Press tabs ② together.
- ▶ Tilt wiper blade ① away from wiper arm ③.
- ▶ Take off wiper blade ① in direction of arrow.

Replacing wiper blades

Installing



- ① Wiper blade
- ② Attachment
- ③ Guide tab
- ④ Opening

- ▶ With guide tab ③ sliding into opening ④, place wiper blade ① onto wiper arm in direction of arrow.

- ▶ Fold wiper blade ① towards wiper arm.
- ▶ Tabs ② must engage into both recesses of attachment ②.
- ▶ Check whether the wiper blade is securely fastened.
- ▶ Fold the wiper arm backward to rest on the windshield.

Make sure to hold on to the wiper when folding the wiper arm back.

Rear wiper blade

Warning!



For safety reasons, switch off wipers and remove SmartKey from starter switch (vehicles with KEYLESS-GO*: Make sure the vehicle's on-board electronics have status 0) before replacing a wiper blade. Otherwise the motor could suddenly turn on and cause injury.



Hold on to the wiper when folding the wiper arm back. If released, the force of the impact from the tensioning spring could crack the rear window.

Do not allow the wiper arms to contact the rear window glass without a wiper blade inserted.

Replacing wiper blades

Make sure the wiper blades are properly installed. Improperly installed wiper blades may cause rear window damage.

For your convenience, we recommend that you have this work carried out by an authorized Mercedes-Benz Light Truck Center.

Removing

- ▶ Remove the SmartKey from the starter switch.

or

- ▶ Vehicles with KEYLESS-GO*: Make sure the vehicle's on-board electronics have status **0** (▶ page 39).

- ▶ Fold wiper arm ① away from the rear window until it engages.

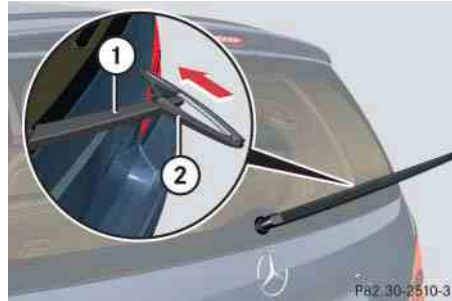

- ① Wiper arm
- ② Wiper blade

- ▶ Turn wiper blade ② to form a right angle with wiper arm ① as shown.
- ▶ Hold wiper arm ① and disengage wiper blade ② by carefully sliding it in direction of arrow.
- ▶ Remove wiper blade ②.

Installing

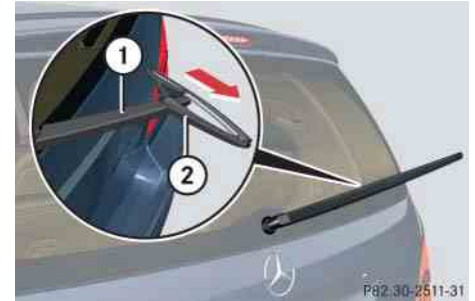

- ① Wiper arm
- ② Wiper blade

- ▶ Insert wiper blade ② into wiper arm ①.
- ▶ Hold wiper arm ① and engage wiper blade ② by pushing it in direction of arrow until it locks into place.
- ▶ Check whether the wiper blade is securely fastened.
- ▶ Fold the wiper arm to rest on the rear window.

Make sure to hold on to the wiper when folding the wiper arm back.

Flat tire

Warning!



The dimensions of the spare wheel are different from those of the road wheels. As a result, the vehicle handling characteristics change when driving with a spare wheel mounted. Adapt your driving style accordingly.

The spare wheel is for temporary use only. When driving with spare wheel mounted, ensure proper tire inflation pressure and do not exceed a vehicle speed of 50 mph (80 km/h).

Drive to the nearest Mercedes-Benz Light Truck Center as soon as possible to have the spare wheel replaced with a regular road wheel.

Never operate the vehicle with more than one spare wheel mounted.

Do not switch off the ESP[®] with a spare wheel mounted.

Preparing the vehicle

- ▶ Park the vehicle in a safe distance from moving traffic on a hard, flat surface when possible.
- ▶ Turn on the hazard warning flasher (▷ page 153).
- ▶ Turn the steering wheel so that the front wheels are in a straight-ahead position.
- ▶ Set the parking brake (▷ page 65).
- ▶ Set the automatic transmission to **P** (▷ page 197).

Vehicles with SmartKey:

- ▶ Turn off the engine (▷ page 66).
- ▶ Remove the SmartKey from the starter switch.

Vehicles with KEYLESS-GO*:

- ▶ Turn off the engine by pressing the KEYLESS-GO* button once (▷ page 66).
- ▶ Open the driver's door (this puts the starter switch in position **0**, same as with the SmartKey removed from the starter switch). The driver's door then can be closed again.
- ▶ Have any passenger exit the vehicle at a safe distance from the roadway.



Open doors only when conditions are safe to do so.

Mounting the spare wheel

Preparing the vehicle

- ▶ Prepare the vehicle as described (▷ page 478).
- ▶ Take the wheel wrench and the vehicle jack from the vehicle tool kit (▷ page 455).
- ▶ Take the spare wheel from the wheel well under the cargo compartment floor (▷ page 458).

Lifting the vehicle

- ▶ Prevent the vehicle from rolling away by blocking wheels with wheel chocks or other sizable objects.

One wheel chock is included with the vehicle tool kit (▷ page 455).

When changing wheel on a level surface:

- ▶ Place the wheel chock in front of and another sizable object behind the wheel that is diagonally opposite to the wheel being changed.

Always try lifting the vehicle using the jack on a level surface. However, should circumstances require you to do so on a hill, place the wheel chock and another sizable object as follows:

- ▶ Place the wheel chock and another sizable object on the downhill side blocking both wheels of the axle not being worked on.

Warning!



The jack is designed exclusively for jacking up the vehicle at the jack take-up brackets built into both sides of the vehicle. To help avoid personal injury, use the jack only to lift the vehicle during a wheel change. Never get beneath the vehicle while it is supported by the jack. Keep hands and feet away from the area under the lifted vehicle. Always firmly set parking brake and block wheels before raising vehicle with jack.

Do not disengage parking brake while the vehicle is raised. Be certain that the jack is always vertical (plumb line) when in use, especially on hills. Always try to use the jack on level surface. Make sure the jack arm is fully seated in the jack take-up bracket. Always lower the vehicle onto sufficient capacity jackstands before working under the vehicle.

Flat tire



① Wheel wrench

- ▶ On wheel to be changed, loosen but do not yet remove the wheel bolts (approximately one full turn with wheel wrench ①).

The jack take-up brackets are located directly behind the front wheel housings and in front of the rear wheel housings.



Do not position the jack on the body of the vehicle, as this may cause damage to the vehicle.

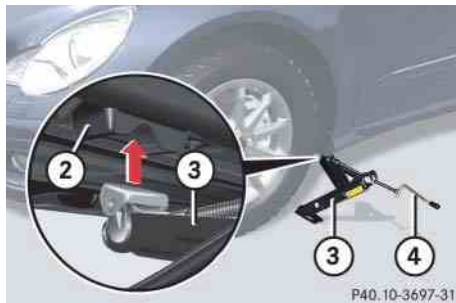

② Take-up bracket

③ Jack

④ Crank

- ▶ Place jack ③ on firm ground.
- ▶ Position jack ③ under the take-up bracket ② so that it is always vertical (plumb-line) as seen from the side, even if the vehicle is parked on an incline.

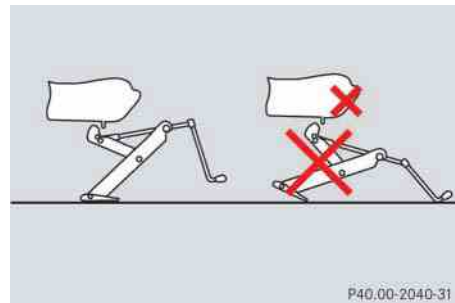

- ▶ Turn crank ④ clockwise until jack ③ is fully seated in take-up bracket ② and the jack base evenly meets the ground.
- ▶ Continue to turn crank ④ until the wheel is a maximum of 1.2 in (3 cm) from the ground.

Warning!



The jack is intended only for lifting the vehicle briefly for wheel changes. It is not suited for performing maintenance work under the vehicle.

- Never start the engine when the vehicle is raised.
- Never lie down under the raised vehicle.

Removing the wheel



① Alignment bolt

- ▶ Unscrew upper-most wheel bolt and remove.
- ▶ Replace this wheel bolt with alignment bolt ① supplied in the vehicle tool kit (▷ page 454).
- ▶ Remove the remaining wheel bolts.



Do not place wheel bolts in sand or dirt. This could result in damage to the bolts and wheel hub threads.

- ▶ Remove the wheel.

Mounting the spare wheel

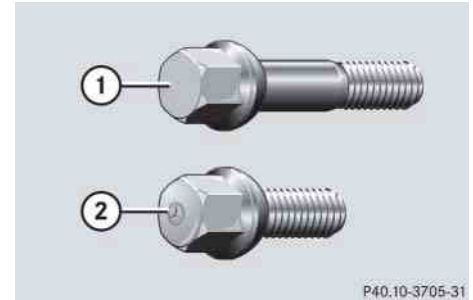

- ① Wheel bolt for 18" and 19" light alloy wheels
- ② Wheel bolt for 17" light alloy wheels or collapsible tire (located in trunk with spare wheel)



Wheel bolts ② must be used when mounting the spare wheel with collapsible tire. The use of any wheel bolts other than wheel bolts ② for the spare wheel with collapsible tire will physically damage the vehicle's brakes.

Flat tire

- ▶ Clean contact surfaces of wheel and wheel hub.



To avoid paint damage, place wheel flat against hub and hold it there while installing first wheel bolt.

Warning!



Always replace wheel bolts that are damaged or rusted.

Never apply oil or grease to wheel bolts.

Damaged wheel hub threads should be repaired immediately. Do not continue to drive under these circumstances! Contact an authorized Mercedes-Benz Light Truck Center or call Roadside Assistance.

Incorrect wheel bolts or improperly tightened wheel bolts can cause the wheel to come off. This could cause an accident. Make sure to use the correct wheel bolts.



- ▶ Guide spare wheel onto the alignment bolt and push it on.
- ▶ Insert wheel bolts and tighten them slightly.
- ▶ Unscrew the alignment bolt, install last wheel bolt and tighten slightly.

Warning!



Only use genuine equipment Mercedes-Benz wheel bolts. Other wheel bolts may come loose.

Do not tighten the wheel bolts when the vehicle is raised. Otherwise the vehicle could fall off the jack.

Inflating the collapsible tire

Warning!



Inflate collapsible tire only after the wheel is properly mounted.

Inflate the collapsible tire using the electric air pump (▷ page 454) before lowering the vehicle.

Warning!



Observe instructions on air pump label.



Do not lower the vehicle before inflating the collapsible tire. Otherwise the rim may be damaged.

- ▶ Take the electric air pump out of the vehicle tool kit storage well (▷ page 454).

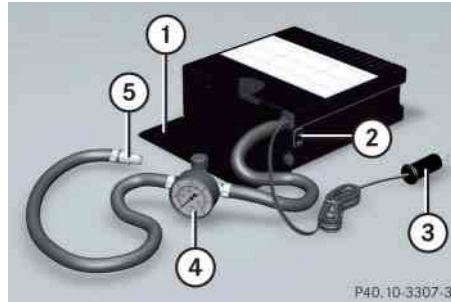

- ① Flap
 - ② On/off switch
 - ③ Electrical plug
 - ④ Air hose with pressure gauge and vent screw
 - ⑤ Union nut
- ▶ Open flap ① on electric air pump.
 - ▶ Pull out electrical plug ③ and air hose with pressure gauge ④.
 - ▶ Remove the valve cap from the collapsible tire valve.

- ▶ Screw union nut ⑤ onto the collapsible tire valve.
- ▶ Insert electrical plug ③ into a power outlet (▷ page 306).



The cigarette lighter* (▷ page 303) is not designed for use with the electric air pump. Use a power outlet (▷ page 306) for electric air pump operation.

- ▶ Turn the SmartKey in the starter switch to position 1.

or

- ▶ Vehicles with KEYLESS-GO*: Press the KEYLESS-GO start/stop button once without depressing the brake pedal.
- ▶ Press I on electric air pump switch ②.

The electric air pump should now switch on and inflate the collapsible tire.



Flat tire

- ▷▷▶ Inflate the spare wheel tire to the recommended tire inflation pressure given in the “Technical data” section (▷ page 514).

This takes about 5 minutes for the collapsible tire.

Warning!



Air hose ④ and union nut ⑤ can become hot during inflation. Exercise proper caution to avoid burning yourself when using the equipment.



Please compare the recommended tire inflation pressure for your vehicle with the tire inflation pressure on the yellow label located on the spare wheel rim.

If the tire inflation pressure on the yellow label on the spare wheel rim differs from the values given in this Operator’s Manual, inflate the tire to the recommended tire inflation pressure given on the yellow label on the spare wheel rim.



Do not operate the electric air pump longer than 8 minutes without interruption. Otherwise it may overheat.

You may operate the electric air pump again after it has cooled off.

- ▶ Press 0 on electric air pump switch ②.
- ▶ Turn the SmartKey in the starter switch to position 0.

or

- ▶ Vehicles with KEYLESS-GO*:
Press the KEYLESS-GO start/stop button twice without depressing the brake pedal.
- ▶ If the tire inflation pressure is above the recommended tire inflation pressure given in this Operator’s Manual, release excess tire inflation pressure using the vent screw.

Warning!



Follow recommend tire inflation pressures.

Do not overinflate tires. Overinflating tires can result in sudden deflation (blowout) because they are more likely to become punctured or damaged by road debris, potholes, etc.

Do not underinflate tires. Underinflated tires wear unevenly, adversely affect handling and fuel economy, and are more likely to fail from being overheated.

- ▶ Detach the electric air pump.
- ▶ Store the electrical plug and the air hose behind the flap and place the electric air pump back in the vehicle tool kit storage well.

Lowering the vehicle

Warning!



Inflate collapsible tire only after the wheel is properly mounted.

Inflate the collapsible tire using the electric air pump (> page 483) before lowering the vehicle.

- ▶ Lower vehicle by turning crank counterclockwise until vehicle is resting fully on its own weight.
- ▶ Remove the jack.

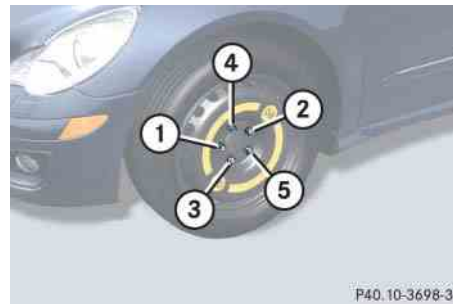

①–⑤ Wheel bolts

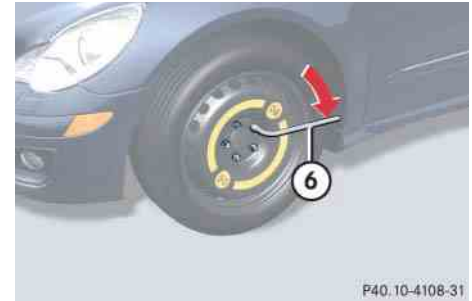

P40.10-4108-31

- ⑥ Wheel wrench
- ▶ Tighten the five wheel bolts evenly, following the diagonal sequence illustrated (1 to 5), until all bolts are tight. Observe a tightening torque of 110 lb-ft (150 Nm).

Warning!



Have the tightening torque checked after changing a wheel. The wheels could come loose if they are not tightened to a torque of 110 lb-ft (150 Nm).



Flat tire

- ▷▷ Store jack and all other vehicle tool kit items back into the storage well.



The removed road wheel cannot be stored in the spare wheel well under the cargo compartment floor, but should be transported in the cargo compartment wrapped in a protective wrap.

▼ **Battery**

The battery is located under the front passenger seat.



Mercedes-Benz recommends to have the battery replaced at authorized Mercedes-Benz Light Truck Center.

The battery should always be sufficiently charged in order to achieve its rated service life.

If you use your vehicle mostly for short-distance trips, you will need to have the battery charge checked more frequently.

When replacing the battery, always use batteries approved by Mercedes-Benz.

If you do not intend to operate your vehicle for an extended period of time, consult an authorized Mercedes-Benz Light Truck Center about steps you need to observe.



Observe all safety instructions and precautions when handling automotive batteries.



Risk of explosion



Keep flames or sparks away from battery. Do not smoke.



Battery acid is caustic. Do not allow it to come into contact with skin, eyes or clothing.

In case it does, immediately flush affected area with clean water and seek medical help if necessary.



Wear eye protection.



Keep children away.



Follow the instructions in this Operator's Manual.

Batteries contain materials that can harm the environment if disposed of improperly. Recycling of batteries is the preferred method of disposal. Many states require sellers of batteries to accept old batteries for recycling.

Battery



The battery is a valve-regulated lead acid (VRLA) battery, also referred to as “fleece” battery. Such batteries do not require topping-up of the electrolyte level. VRLA batteries therefore do not have cell caps and the battery cover is non-removable. Do not attempt to open the battery as otherwise the battery will be damaged.

Even though VRLA batteries do not require topping-up of the electrolyte level and cannot be opened to check the electrolyte level, the battery condition must be checked periodically by performing a battery conductance test. Refer to Maintenance Booklet for battery condition testing intervals.

As with any other battery, the battery may discharge if the vehicle is not operated for an extended period of time. You can connect a battery maintenance charge unit tested and approved for use on your vehicle model or disconnected the battery to prevent battery discharge. Contact an authorized Mercedes-Benz Light Truck Center for more information.



The factory-equipped VRLA battery is leak-proofed. Only use a battery as replacement that has the same security features and is of identical size, voltage, and capacity as the factory-equipped battery.

The battery, the battery ventilation and the lateral plug must always be securely installed when the vehicle is in operation.

Warning!



Jump starting must only be done using the jump-start contacts located in the engine compartment (▷ page 496).

Disconnecting, removing, reinstalling and reconnecting the battery

Warning!



Failure to follow these instructions can result in severe injury or death.

Observe all safety instructions and precautions when handling automotive batteries (▷ page 487).

Never lean over batteries while connecting, you might get injured.

Battery fluid contains sulfuric acid. Do not allow this fluid to come in contact with eyes, skin or clothing. In case it does, immediately flush affected area with water and seek medical help if necessary.

A battery will also produce hydrogen gas, which is flammable and explosive. Keep flames or sparks away from battery, avoid improper connection of jumper cables, smoking etc.



Never loosen or detach battery terminal clamps while the engine is running or the SmartKey is in the starter switch. Otherwise the alternator and other electronic components could be severely damaged.

Have the battery checked regularly by an authorized Mercedes-Benz Light Truck Center.

Contact your authorized Mercedes-Benz Light Truck Center for further information.

Warning!



Do not place metal objects on the battery as this could result in a short circuit.

Use leak-proof battery only to avoid the risk of acid burns in the event of an accident.

Warning!



Disconnecting, removing, reinstalling and reconnecting the battery is a complicated and technically demanding procedure that also requires safety precautions to avoid the risk of injury. We strongly recommend that it be performed by a qualified technician or an authorized Mercedes-Benz Light Truck Center only. Please read the instructions fully before beginning operation and only undertake it if you feel fully capable of performing all of the tasks involved as described in these instructions. Observe all safety instructions and precautions when handling automotive batteries (▷ page 487). Performing the tasks involved incorrectly can cause damage to the vehicle and impair the operating safety of the vehicle, and/or cause severe injury to you or others.

Battery



With a disconnected battery you will no longer be able to turn the SmartKey in the starter switch and pressing the KEYLESS-GO* start/stop button will have no effect.

Step 1 (Disconnecting)



If your battery is discharged, the vehicle must be jump started (▷ page 496) using the jump start contacts in the engine compartment, or an accessory battery charge unit* approved by Mercedes-Benz must be connected using the jump start contacts in the engine compartment (see separate instructions for the accessory battery charge unit*) before any of the following steps can be performed. If the battery cannot be jumped or charged, please contact an authorized Mercedes-Benz Light Truck Center.

- ▶ Set the automatic position to **P** (▷ page 199).
 - ▶ Firmly depress the parking brake (▷ page 65).
 - ▶ Turn off the engine (▷ page 66).
 - ▶ Leave the ignition switched on (▷ page 38).
 - ▶ Switch off all electrical consumers.
 - ▶ Read and observe safety instructions and precautions (▷ page 487).
 - ▶ Open the front passenger door.
-  Open doors only when conditions are safe to do so.
- ▶ Move the front passenger seat to the most rearward position (▷ page 43).

Step 2 (Disconnecting)

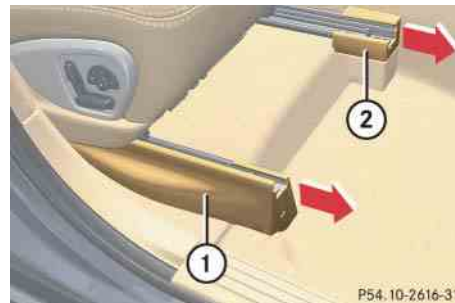

- ① Seat rail covers, front right
 - ② Seat rail covers, front left
- ▶ Pull off right seat rail cover ① in direction of arrow.
 - ▶ Pull left seat rail cover ② in direction of arrow as far as it will go.
Left seat rail cover ② cannot be removed.

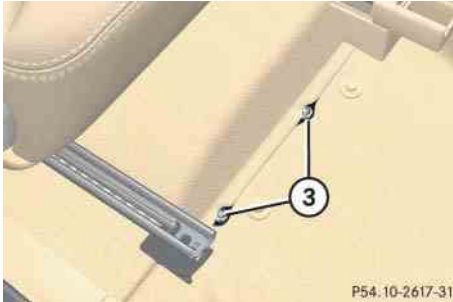

③ Battery cover mounting nuts

- ▶ Using a 6 mm T-handle hex key (not supplied with vehicle) with a minimum shaft length of 12 in (30 cm), unfasten and remove battery cover mounting nuts ② located at the floor carpet perforation.
- ▶ Move the front passenger seat to the most forward position (▷ page 43).
- ▶ Switch off the ignition (▷ page 38).
- ▶ Remove the SmartKey from the starter switch.

Vehicles with KEYLESS-GO*:

- ▶ Make sure the vehicle's on-board electronics have status **0**.

After turning off the engine with the KEYLESS-GO start/stop button, with the driver's door closed, the starter switch is in position **1**. With the driver's door opened, the starter switch is set to position **0**, same as SmartKey removed from starter switch (▷ page 39).

Step 3 (Disconnecting)

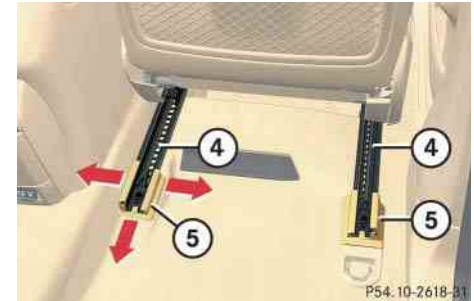

④ Seat rail, rear

⑤ Seat rail cover, rear

- ▶ Pull seat rail cover ⑤ away from seat rail ④ on both sides as indicated by arrows.
- ▶ Pull off seat rail cover ⑤ to the rear as indicated by arrow.

Battery

Step 4 (Disconnecting)



⑥ Floor carpet

- ▶ Pull back and fold floor carpet ⑧ in direction of the arrow.



To release the floor carpet perforations (see dotted line in above illustration), you will have to apply somewhat greater force when pulling the floor carpet back.

Step 5 (Disconnecting)

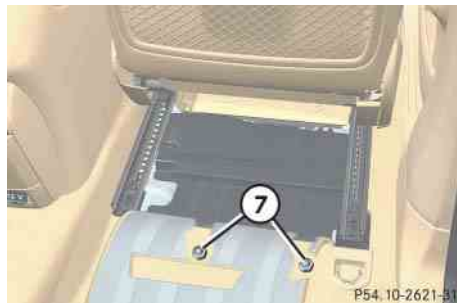

⑦ Battery cover mounting nuts

- ▶ Unfasten and remove battery cover mounting nuts ⑦.

Step 6 (Disconnecting)

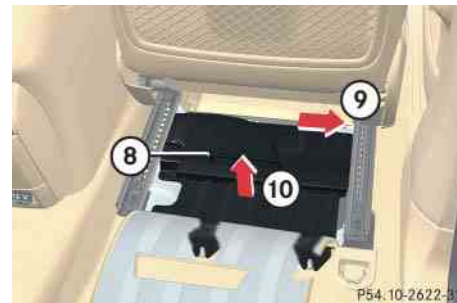

⑧ Battery cover with integrated air channel

- ⑨ Pulling battery cover out
- ⑩ Lifting battery cover

- ▶ Lift battery cover ⑧ slightly in direction of arrow ⑩.
- ▶ Pull battery cover ⑧ in direction of arrow ⑨.
- ▶ Remove battery cover ⑧.

Step 7 (Disconnecting)

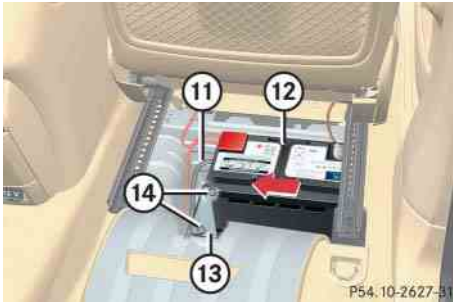

- ⑪ Battery ventilation hose
 - ⑫ Battery
 - ⑬ Battery attachment
 - ⑭ Attachment nuts
- ▶ Pull battery ventilation hose ⑪ out of battery ⑫.
 - ▶ Unfasten and remove attachment nuts ⑭.
 - ▶ Remove battery attachment ⑬.

Step 8 (Disconnecting)

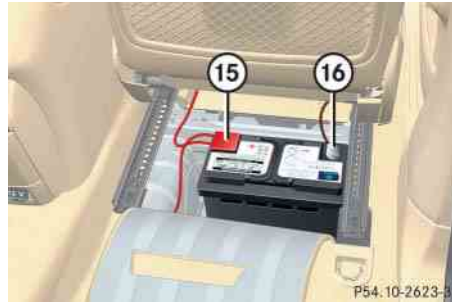

- ⑮ Positive terminal with cover
 - ⑯ Negative terminal
- ▶ Disconnect battery negative lead from negative terminal ⑯.
 - ▶ Remove the cover from positive terminal ⑮.
 - ▶ Disconnect battery positive lead from positive terminal ⑮.

Step 9 (Removing)

- ▶ Take out battery.

Step 10 (Reinstalling)

- ▶ Carry out step 9 (▷ page 493) first and then step 7 (▷ page 493), both in reverse order.

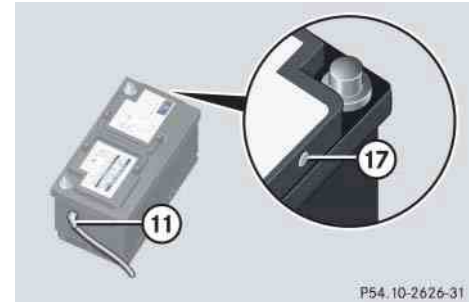

- ⑪ Battery ventilation hose
- ⑰ Vent plug



The battery, battery ventilation hose ⑪, and vent plug ⑰ must always be securely installed when the vehicle is in operation.



Battery

- ▷▷ Carry out step 8 to reconnect the battery (▷ page 493).
 - ▶ Carry out steps 6 to 1 in reverse order to complete reinstall the battery, (▷ page 492) to (▷ page 490).

Step 11 (Reconnecting)

- ▶ If the battery has been removed, carry out step 9 (▷ page 493) first and then step 7 (▷ page 493), both in reverse order, before starting the connecting procedure.
- ▶ Open the driver's door.

- ▶ Make sure the SmartKey is removed from the starter switch.

Vehicles with KEYLESS-GO*:

- ▶ Make sure the vehicle's on-board electronics have status **0**.

With the driver's door opened, the vehicle's on-board electronics have status **0**, same as SmartKey removed from the starter switch (▷ page 39).

- ▶ Connect the positive lead to the positive terminal and fasten its cover (▷ page 493).
- ▶ Connect the negative lead to the negative terminal (▷ page 493).



Never invert the terminal connections!



The following procedures must be carried out following any interruption of battery power (e.g. due to disconnection):

- Set the clock (▷ page 180).

Vehicles with Modular COMAND system with navigation module*: Time and date are set automatically.
- Synchronize the door windows (▷ page 251).
- Synchronize the power tilt/sliding sunroof* (▷ page 258).
- Synchronize the power tilt/sliding panel* (▷ page 262).
- Synchronize the power folding exterior rear view mirrors* (▷ page 211).

Charging the battery

If the battery is discharged, the battery can be charged using the jump-start contacts located in the engine compartment (▷ page 497).

Warning!



Never charge a battery while still installed in the vehicle unless the accessory battery charge unit approved by Mercedes-Benz is being used. Gases may escape during charging and cause explosions that may result in paint damage, corrosion or personal injury.

An accessory battery charge unit specially adapted for Mercedes-Benz vehicles and tested and approved by Mercedes-Benz is available, permitting the charging of the battery in its installed position. Contact an authorized Mercedes-Benz Light Truck Center for information and availability. Charge battery in accordance with the separate instructions for the accessory battery charger.

- ▶ Charge the battery in accordance with the instructions of the battery charger manufacturer.

Batteries contain materials that can harm the environment if disposed of improperly. Large 12-volt storage batteries contain lead. Recycling of batteries is the preferred method of disposal. Many states require sellers of batteries to accept old batteries for recycling.

Jump starting

Warning!



Failure to follow these directions will cause damage to the electronic components, and can lead to a battery explosion and severe injury or death.

Never lean over batteries while connecting or jump starting, you might get injured.

Battery fluid contains sulfuric acid. Do not allow this fluid to come in contact with eyes, skin or clothing. In case it does, immediately flush affected area with water, and seek medical help if necessary.

A battery will also produce hydrogen gas, which is flammable and very explosive. Keep flames or sparks away from battery, avoid improper connection of jumper cables, smoking, etc.

Attempting to jump start a frozen battery can result in it exploding, causing personal injury.

Read all instructions before proceeding.

If the battery is discharged, the engine can be started with jumper cables and the battery of another vehicle. Observe the following:

- Jump starting should only be performed using the jump-start contacts in the engine compartment (▷ page 497).
- Jump starting should only be performed when the engine and catalytic converter are cold.
- Do not start the engine if the battery is frozen. Let the battery thaw out first.
- Only jump start from batteries with the same voltage rating (12V). Jump starting with a more powerful battery could damage the vehicle's electrical system, which will not be covered by the Mercedes-Benz Limited Warranty.
- Use only jumper cables with sufficient cross-section and insulated terminal clamps.

- Always make sure the jumper cables are not on or near pulleys, fans or other parts that move when the engine is started or running.



Avoid repeated and lengthy starting attempts.

Do not attempt to start the engine using a battery quick charge unit.

If the engine does not run after several unsuccessful starting attempts, have it checked at the nearest authorized Mercedes-Benz Light Truck Center.

Excessive unburned fuel generated by repeated failed starting attempts may damage the catalytic converter.

Make sure the jumper cables do not have loose or missing insulation.

Make sure the cable clamps do not touch any other metal part while the other end is still attached to a battery.

Warning!



Keep flames or sparks away from battery. Do not smoke.

Observe all safety instructions and precautions when handling automotive batteries.

The jump-start contacts are located in the engine compartment.

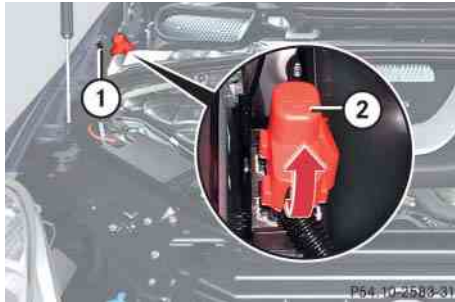

- ① Negative (-) terminal
- ② Positive (+) terminal

- ▶ Make sure the two vehicles do not touch.

- ▶ Turn off all electrical consumers.
- ▶ Apply parking brake.
- ▶ Set automatic transmission to position **P**.
- ▶ Open the hood (> page 345).
- ▶ Open cover of positive terminal ②.

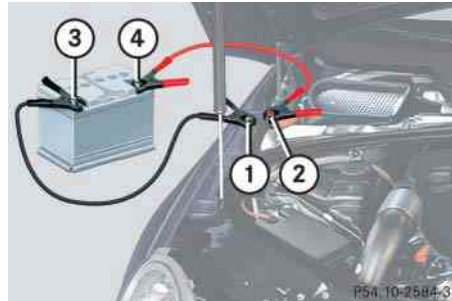

- ① Negative terminal of discharged battery
- ② Positive terminal of discharged battery
- ③ Negative terminal of charged battery
- ④ Positive terminal of charged battery

- ▶ Connect positive terminals ② and ④ with the jumper cable. Clamp cable to charged battery ④ first.
- ▶ Start engine of the vehicle with the charged battery and run at idle speed.
- ▶ Connect negative terminals ① and ③ of the batteries with the jumper cable. Clamp cable to charged battery ③ first.



Never invert the terminal connections!

- ▶ Start the engine of the disabled vehicle.

Jump starting

You can now turn on the electrical consumers. Do not turn on the lights under any circumstances.

- ▶ Remove the jumper cables first from negative terminals ① and ③ and then from the positive terminals ② and ④.

You can now turn on the lights.

- ▶ Have the battery checked at the nearest authorized Mercedes-Benz Light Truck Center.



Do not tow-start the vehicle.

▼ Towing the vehicle

Mercedes-Benz recommends that the vehicle be transported with all wheels off the ground using flatbed or appropriate wheel lift/dolly equipment. This method is preferable to other types of towing.



Use flatbed or wheel lift/dolly equipment, with the SmartKey in starter switch turned to position **0**.

Do not tow with sling-type equipment. Towing with sling-type equipment over bumpy roads will damage radiator and supports.

To prevent damage during transport, do not tie down vehicle by its chassis or suspension parts. Use the towing eyes.

Switch off the ESP® (▷ page 101), tow-away alarm (▷ page 107) and the automatic central locking (▷ page 130).

Do not tow-start the vehicle.

When circumstances do not permit the recommended towing methods, the vehicle may be towed with all wheels on the ground only so far as necessary to have the vehicle moved to a safe location where the recommended towing methods can be employed.



Do not tow with one axle raised. Doing so could damage the transfer case, which is not covered by the Mercedes-Benz Limited Warranty.

All wheels must be on or off the ground. Observe instructions for towing the vehicles with all wheels on the ground.



When towing the vehicle with all wheels on the ground, the automatic transmission must be in position **N** and the SmartKey must be in starter switch position **2**.

When towing the vehicle with all wheels on the ground, the vehicle may be towed only for distances up to 30 miles (50 km) and at a speed not to exceed 30 mph (50 km/h).

If the vehicle is towed with the front axle raised (observe instructions regarding flexible drive shaft), the engine must be shut off (SmartKey in starter switch position **1**). Otherwise, the 4-ETS may become engaged which may cause loss of towing control.

Towing the vehicle



To be certain to avoid additional damage to the vehicle powertrain, however you should observe the following:

- With damage to the front axle
 - raise front axle
 - remove flexible drive shaft between rear axle and transfer case
- With damage to the rear axle
 - raise rear axle
 - tow vehicle with wheel lift or dolly placed under front wheels
- With damage to the transfer case
 - remove flexible drive shaft to the drive axles

Always install new self-locking nuts when reinstalling flexible drive shaft.

Warning!



If circumstances require towing the vehicle with all wheels on the ground, always tow with a tow bar if:

- the engine will not run
- there is a malfunction in the power supply or in the vehicle's electrical system

Prior to towing the vehicle with all wheels on the ground, make sure the SmartKey is in starter switch position **2**.

If the SmartKey is left in starter switch position **0** for an extended period of time, it can no longer be turned in the switch. In this case, the steering is locked. To unlock, remove SmartKey from starter switch and reinsert.

Warning!



With the engine not running, there is no power assistance for the brake and steering systems. In this case, it is important to keep in mind that a considerably higher degree of effort is necessary to brake and steer the vehicle. Adapt your driving accordingly.



To signal turns while being towed with hazard warning flasher in use, turn the SmartKey in starter switch to position **2** and activate combination switch for left or right turn signal in usual manner – only the selected turn signal will operate.

Upon canceling the turn signal, the hazard warning flasher will operate again.



The vehicle cannot be started via tow-start.



If the battery is disconnected or discharged, the automatic transmission will remain locked in position **P** and the SmartKey will not turn in the starter switch. For more information, see “Battery” (▷ page 487) and “Jump starting” (▷ page 496).



When towing the vehicle with all wheels on the ground, note the following:

With the automatic central locking activated and the ignition in position **2** (▷ page 38), the vehicle doors lock if the left front wheel is turning at a speed of approx. 9 mph (15 km/h) or above.

To prevent the vehicle doors from locking, deactivate the automatic central locking (▷ page 130).

Switch off the tow-away alarm (▷ page 107).

Towing of the vehicle should only be done using the towing eye. Never attach tow cable, tow rope or tow rod to vehicle chassis, frame or suspension parts.

Installing towing eye bolts

The front towing eye is located behind a cover on the passenger side below the front bumper.

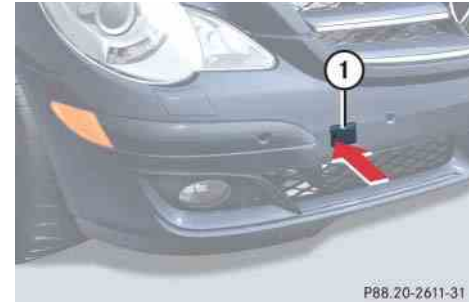

① Towing eye cover

Towing the vehicle

The rear towing eye is located behind the right side cover in the rear bumper panel.

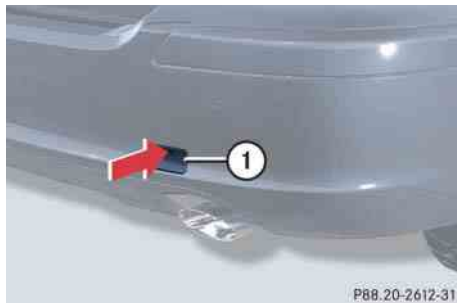

① Towing eye cover

Warning!



In order to avoid possible serious burns or injury, use extreme caution when removing the cover, because the rear exhaust pipe is extremely hot.

- ▶ Press mark on cover ① as indicated by the arrow.
- ▶ Lift off cover ① to reveal the threaded hole for towing eye bolt.
- ▶ Take the towing eye bolt and wheel wrench from the vehicle toolkit (▷ page 455).
- ▶ Screw towing eye bolt in to its stop and tighten with wheel wrench.
- ▶ After use, unscrew towing eye bolt.
- ▶ Store the towing eye bolt and wheel wrench back into the vehicle toolkit (▷ page 455).
- ▶ Engage cover ① at top and press at bottom.

Stranded vehicle

Freeing a stranded vehicle, on which the wheels are dug into sand or mud, should be done with the greatest of care, especially if the vehicle is heavily loaded.

Avoid pulling the vehicle abruptly or diagonally, since it could result in damage to the chassis alignment.

Never try to free a vehicle that is still coupled to a trailer.

If possible, a vehicle equipped with trailer hitch receiver should be pulled backward in its own previously made tracks.

▼ Fuses

The electrical fuses in your vehicle serve to stop the supply of electricity to a device that is malfunctioning. This helps to prevent damage to the other vehicle electronics. If a fuse is blown, the components and systems secured by that fuse will stop operating.

The following aids are available to help you change fuses. They are included with the vehicle tool kit (▷ page 455):

- Fuse chart

The fuse chart explains the fuse allocation and fuse amperages.

- Spare fuses
- Fuse extractor

Warning!



Only use fuses approved for Mercedes-Benz with the specified amperage for the system in question. Otherwise, a short circuit could result and cause a fire.



Only install fuses that have been tested and approved by Mercedes-Benz and that have the specified amperage rating. Otherwise, electrical parts or systems could be damaged.

Never attempt to repair or bridge a blown fuse. Have the cause determined and remedied by an authorized Mercedes-Benz Light Truck Center.

Fuses

Main fuse box

The main fuse box is located on the passenger side of the engine compartment.

- ▶ Open the hood (▷ page 345).

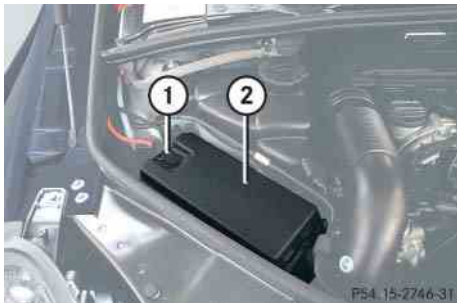

- ① Clamp
- ② Main fuse box cover

- ▶ Switch off the ignition (▷ page 38) and remove the SmartKey from the starter switch.

Vehicles with KEYLESS-GO*:

- ▶ Switch off the ignition (▷ page 39).
- ▶ Open the driver's door (this puts the starter switch in position 0, same as with the SmartKey removed from the starter switch). The driver's door then can be closed again.
- ▶ Release clamp ①.
- ▶ Lift fuse box cover ② up.
- ▶ Install main fuse box cover in reverse order.



The fuse box cover must be installed properly to prevent moisture and/or dirt from entering the fuse box and possibly impairing fuse operation.

Fuse box in cargo compartment

The fuse box is located behind under the cargo compartment cover on the right-hand side of the spare wheel well.

- ▶ Open the tailgate (▷ page 122).
- ▶ Lift the cargo compartment cover (▷ page 454).
- ▶ Secure cargo compartment cover with strap (▷ page 455).

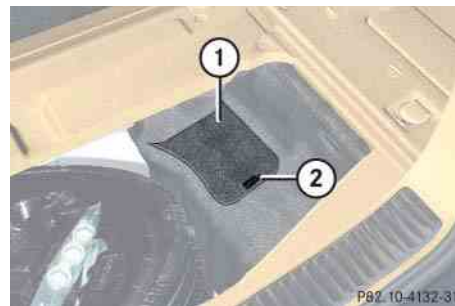

- ① Cover
- ② Handle

- ▶ Lift cover ① at handle ②.

Fuse box in passenger compartment

The fuse box is located behind a cover in the dashboard on the passenger side.

- ▶ Open the front passenger door.



- ① Cover



Do not use sharp objects such as a screwdriver to open fuse box cover ①, as this could damage it.

Opening:

- ▶ Pull cover ① in direction of arrow.

Closing:

- ▶ Clip upper end of cover ② into opening.
- ▶ Push on lower end of cover ② until it engages.

Parts service

Warranty coverage

Identification labels

Layout of poly-V-belt drive

Engine

Rims and tires

Electrical system

Main Dimensions

Weights

Fuels, coolants, lubricants, etc.



The “Technical data” section provides the necessary technical data for your vehicle.

All authorized Mercedes-Benz Centers maintain a stock of Genuine Mercedes-Benz Parts required for maintenance and repair work. In addition, strategically located parts distribution centers provide quick and reliable parts service.

More than 300 000 different parts for Mercedes-Benz models are available.

Genuine Mercedes-Benz Parts are subjected to stringent quality inspections. Each part has been specifically developed, manufactured or selected for and adapted to Mercedes-Benz vehicles.

Therefore, Genuine Mercedes-Benz Parts should be installed.



The use of non-genuine Mercedes-Benz parts and accessories not authorized by Mercedes-Benz could damage the vehicle, which is not covered by the Mercedes-Benz Limited Warranty, or could compromise the vehicle’s durability or safety.

▼ Warranty coverage

Your vehicle is covered under the terms of the warranties printed in the Service and Warranty Information booklet. Your authorized Mercedes-Benz Light Truck Center will exchange or repair any defective parts originally installed on the vehicle in accordance with the terms of the following warranties:

- New Vehicle Limited Warranty
- Emission System Warranty
- Emission Performance Warranty
- California, Maine, Massachusetts, and Vermont Emission Control Systems Warranty

Replacement parts and accessories are covered by the Mercedes-Benz Parts and Accessories warranties, copies of which are available at any Mercedes-Benz Light Truck Center.

Loss of Service and Warranty Information Booklet

Should you lose your Service and Warranty Information booklet, have an authorized Mercedes-Benz Light Truck Center arrange for a replacement. It will be mailed to you.

Identification labels

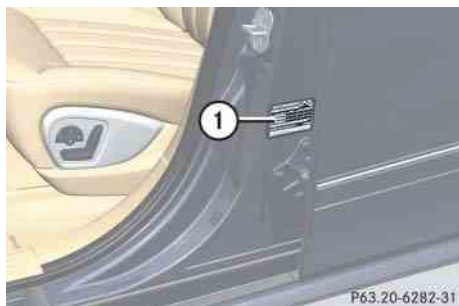

① Certification label (on driver's B-pillar)



Example certification label R 500

- ② Paintwork code
- ③ Vehicle Identification Number (VIN)



Data shown on certification label are for illustration purposes only. These data are specific to each vehicle and may vary from data shown in the illustration. Refer to certification label on vehicle for actual data specific to your vehicle.

The vehicle identification number (VIN) is also embossed underneath the passenger-side seat in the second seat row.

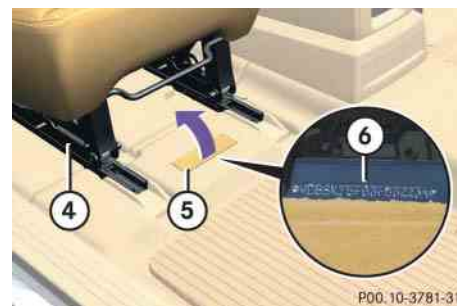

- ④ Second-row seat
- ⑤ Carpet
- ⑥ Vehicle Identification Number (VIN)

► Move second-row seat ④ on passenger side to the rear as far as possible (▷ page 137).

► Fold carpet ⑤ in direction of arrow.

You may have to cut the perforated carpet using a sharp object, e. g. a knife.



When ordering parts, please specify vehicle identification and engine number.

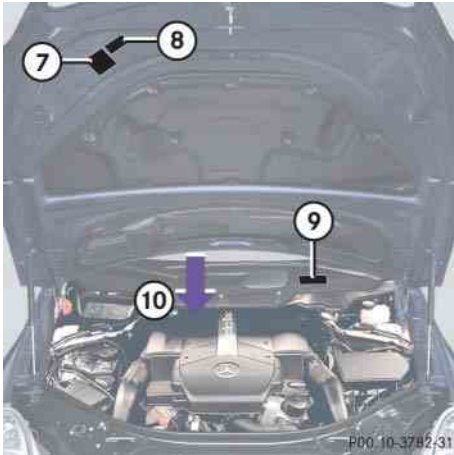

- ⑦ Vacuum line routing diagram label
- ⑧ Emission control information label, includes both federal and California certification exhaust emission standards
- ⑨ VIN, visible (lower edge of windshield)
- ⑩ Engine number (engraved on engine)

Layout of poly-V-belt drive

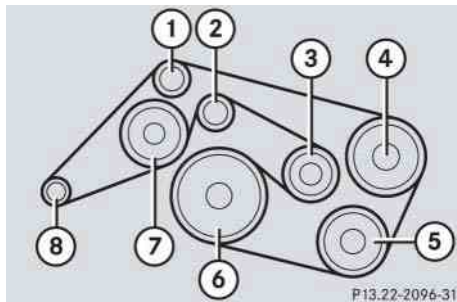

R 350

- ① Idler pulley
- ② Idler pulley
- ③ Automatic belt tensioner
- ④ Power steering pump
- ⑤ Air conditioning compressor
- ⑥ Crankshaft
- ⑦ Coolant pump
- ⑧ Generator (alternator)

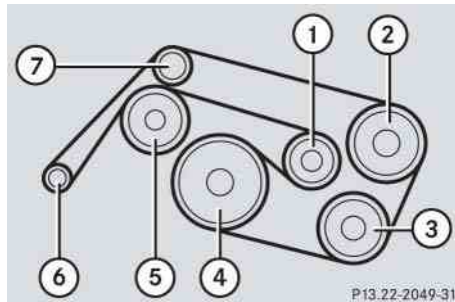

R 500

- ① Automatic belt tensioner
- ② Power steering pump
- ③ Air conditioning compressor
- ④ Crankshaft
- ⑤ Coolant pump
- ⑥ Generator (alternator)
- ⑦ Idler pulley

▼ Engine

Model	R 350 (251.165 ¹)	R 500 (251.175) ¹
Engine	272	113
Mode of operation	4-stroke engine, gasoline injection	4-stroke engine, gasoline injection
No. of cylinders	6	8
Bore	3.66 in (92.90 mm)	3.82 in (97.00 mm)
Stroke	3.39 in (86.00 mm)	3.31 in (84.00 mm)
Total piston displacement	213 cu in (3498 cm ³)	303 cu in (4966 cm ³)
Compression ratio	10.7:1	10:1
Output acc. to SAE J 1349	268 hp / 6000 rpm ² (200 kW / 6000 rpm)	302 hp / 5600 rpm ² (225 kW / 5600 rpm)
Maximum torque acc. to SAE J 1349	258 lb-ft / 2400 - 5000 rpm (350 Nm / 2400 - 5000 rpm)	339 lb-ft / 2700 - 4750 rpm (460 Nm / 2700 - 4750 rpm)
Maximum engine speed	6500 rpm	6300 rpm
Firing order	1-4-3-6-2-5	1-5-4-2-6-3-7-8
Poly-V-belt	2404 mm	2370 mm

¹ The quoted data apply only to the standard vehicle. See an authorized Mercedes-Benz Light Truck Center for the corresponding data of all special bodies and special equipment.

² Premium fuel required. Performance may vary with fuel octane rating.

Rims and tires



Only use tires which have been tested and approved for your vehicle by Mercedes-Benz. Tires approved by Mercedes-Benz are developed to provide best possible performance in conjunction with the driving safety systems on your vehicle such as ABS or ESP®. Tires specially developed for your vehicle and tested and approved by Mercedes-Benz can be identified by finding the following on the tire's sidewall:

- MO = Mercedes-Benz Original equipment tires

Using tires other than those approved by Mercedes-Benz may result in damage that is not covered by the Mercedes-Benz Limited Warranty.



Using tires other than those approved by Mercedes-Benz can have detrimental effects, such as

- poor handling characteristics
- increased noise
- increased fuel consumption

Moreover, tires and rims not approved by Mercedes-Benz may, under load, exhibit dimensional variations and different tire deformation characteristics that could cause them to come into contact with the vehicle body or axle parts. Damage to the tires or the vehicle may be the result.



Further information on tires and rims is available at any authorized Mercedes-Benz Center. A placard with the recommended tire inflation pressures is located on the driver's door B-pillar (▷ page 510). Some vehicles may have supplemental tire inflation pressure information for driving at high speeds (▷ page 364) or for vehicle loads less than the maximum loaded vehicle condition (▷ page 364). If such information is provided, it can be found on the placard located on the inside of the fuel filler flap. The tire inflation pressure should be checked regularly and should only be adjusted on cold tires. Follow tire manufacturer's maintenance recommendation included with vehicle.





The following pages also list the approved wheel rim and tire sizes for equipping your vehicles with winter tires. Winter tires are not available as standard or optional factory equipment, but can be purchased from an authorized Mercedes-Benz Center.

Depending on vehicle model and the standard or optional factory-equipped wheel rim/tire configuration on your vehicle (Appearance Package, Sport Package etc.), equipping your vehicle with winter tires approved for your vehicle model may also require the purchase of two or four wheel rims of the recommended size for use with these winter tires. See an authorized Mercedes-Benz Center for more information.

Rims and tires

Same size tires

	R 350	R 500	R 350 (Sport Package*) R 500 (Sport Package*)
Rims (light alloy)	7.5 J x 17 H2	8 J x 18 H2	8 J x 19 H2
Wheel offset	2.20 in (56 mm)	2.64 in (67 mm)	2.64 in (67 mm)
Summer tires¹	-	-	255/50 R19 103W
All-season tires¹	235/65 R17 104H M+S	255/55 R18 105H M+S	-
Winter tires^{1,2}	235/65 R17 104H M+S 	255/55 R18 105H M+S 	-

¹ Radial-ply tires

² Not available as factory equipment.

Spare wheel (collapsible tire)

	All models
Rim	6.5 B x 18 H2
Wheel offset	1.58 in (40 mm)
Collapsible tire	195/75-18 106P ¹

¹ Must not be used with snow chains.



Please compare the recommended tire inflation pressure for your vehicle with the tire inflation pressure on the yellow label located on the spare wheel rim.

If the tire inflation pressure on the yellow label on the spare wheel rim differs from the values given in this Operator's Manual, inflate the collapsible tire to the recommended tire inflation pressure given on the yellow label on the spare wheel rim.



Please note that the tire inflation pressure of the collapsible tire differs from the tire inflation pressure of the road tires.

Inflate the collapsible tire to 44 psi (3.0 bar).

Electrical system

Model	R 350	R 500
Generator (alternator)	14 V / 150 A	14 V / 180 A
Starter motor	12 V / 1.4 kW	12 V / 1.7 kW
Battery	12 V / 70 Ah	2 V / 95 Ah
Spark plugs	NGK PLKR 6A	NGK PFR 5R-11
Electrode gap	0.031 in (0.8 mm)	0.031 in (0.8 mm)
Tightening torque	15 - 22 lb-ft (20 - 30 Nm)	15 - 22 lb-ft (20 - 30 Nm)

▼ Main Dimensions

Model	R 350, R 500
Overall vehicle length	203.0 in (5 157 mm)
Overall vehicle width	75.7 in (1 922 mm)
Overall vehicle height	65.4 in (1 661 mm)
Wheelbase	126.6 in (3 215 mm)
Track, front	65.6 in (1 665 mm)
Track, rear	65.3 in (1 658 mm)
Ground clearance	5.8 in (148 mm)
Turning circle	40.7 ft (12.4 m)

Weights

Roof load max.	220 lb (100 kg)
----------------	-----------------

Fuels, coolants, lubricants, etc.

▼ **Fuels, coolants, lubricants, etc.**

Capacities

Vehicle components and their respective lubricants must match.

Therefore only use products tested and approved by Mercedes-Benz.

Please refer to the Factory Approved Service Products pamphlet, or inquire at your Mercedes-Benz Light Truck Center.

	Model	Capacity	Fuels, coolants, lubricants, etc.
Engine with oil filter	R 350	8.5 US qt (8.0 l)	Approved engine oils
	R 500	9.0 US qt (8.5 l)	
Automatic transmission		9.5 US qt (9.0 l)	MB Automatic Transmission Fluid
Transfer case		0.53 US qt (0.5 l)	MB Automatic Transmission Fluid
Rear axle		1.2 US qt (1.1 l)	Hypoid gear oil
Front axle		1.2 US qt (1.1 l)	Hypoid gear oil
Power steering		approx. 1.3 US qt (1.2 l)	MB Power Steering Fluid
Front wheel hubs		approx. 1.5 oz (43 g) each	High temperature roller bearing grease
Brake system		-	MB Brake Fluid (DOT 4+)

Fuels, coolants, lubricants, etc.

	Model	Capacity	Fuels, coolants, lubricants, etc.
Cooling system	R 350 R 500	10 US qt (9.5 l) 11.1 US qt (10.5 l)	MB Anticorrosion / Antifreeze
Fuel Tank including a reserve of		21.1 US gal (80.0 l) approx. 3.4 US gal (13.0 l)	Premium unleaded gasoline: Minimum Posted Octane 91 (Avg. of 96 RON / 86 MON)
Air conditioning system			R-134a refrigerant and special PAG lubricant oil (never R-12)
Windshield washer and headlamp cleaning system*		8.2 US qt (7.8 l)	MB Windshield Washer Concentrate ¹

¹ Use MB Windshield Washer Concentrate “S” and water for temperatures above freezing or MB Windshield Washer Concentrate “S” and commercially available premixed windshield washer solvent / antifreeze for temperatures below freezing. Follow suggested mixing ratios (▷ page 528).

Engine oils

Engine oils are specifically tested for their suitability in our engines and durability for our service intervals. Therefore, only use approved engine oils and oil filters required for vehicles with Maintenance System (U.S. vehicles) or FSS (Canada vehicles). For a listing of approved engine oils and oil filters, refer to the Factory Approved Service Products pamphlet, or contact an authorized Mercedes-Benz Light Truck Center.



Using engine oils and oil filters of specification other than those expressly required for the Maintenance System (U.S. vehicles) or FSS PLUS (Canada vehicles), or changing of oil and oil filter at change intervals longer than those called for by the Maintenance System (U.S. vehicles) or FSS PLUS (Canada vehicles) will result in engine damage not covered by the Mercedes-Benz Limited Warranty.

Please follow Maintenance System (U.S. vehicles) or FSS PLUS (Canada vehicles) recommendations for scheduled oil changes. Failure to do so could result in engine damage not covered by the Mercedes-Benz Limited Warranty.

Engine oil additives

Do not blend oil additives with engine oil. They may damage the engine.

Damage or malfunctions resulting from blending oil additives are not covered by the Mercedes-Benz Limited Warranty.

Air conditioning refrigerant

R-134a (HFC) refrigerant and special PAG lubricating oil are used in the air conditioning system.

Never use R-12 (CFC) or mineral-based lubricating oil. Otherwise damage to the system will occur.

Brake fluid

During vehicle operation, the boiling point of the brake fluid is continuously reduced through the absorption of moisture from the atmosphere.

Warning!



Under extremely strenuous operating conditions, this moisture content can lead to the formation of bubbles in the system, thus reducing the system's efficiency.

Therefore, the brake fluid must be replaced regularly. Refer to your vehicle's Maintenance Booklet for replacement interval.

Only brake fluid approved by Mercedes-Benz is recommended. Your authorized Mercedes-Benz Light Truck Center will provide you with additional information.

Premium unleaded gasoline

Warning!



Gasoline is highly flammable and poisonous. It burns violently and can cause serious injury. Whenever you are around gasoline, avoid inhaling fumes and skin contact, extinguish all smoking materials. Never allow sparks, flame or smoking materials near gasoline!



To maintain the engine's durability and performance, premium unleaded gasoline must be used. If premium unleaded is not available and low octane fuel is used, follow these precautions:

- Have the fuel tank only partially filled with unleaded regular and fill up with premium unleaded as soon as possible.
- Avoid full throttle driving and abrupt acceleration.
- Do not exceed an engine speed of 3000 rpm if the vehicle is loaded with a light load such as two persons and no luggage.
- Do not exceed $\frac{2}{3}$ of maximum accelerator pedal position if the vehicle is fully loaded or operating in mountainous terrain.

Fuel requirements

Only use premium unleaded fuel.

- The octane number (posted at the pump) must be 91 min. It is an average of both the Research (R) octane number and the Motor (M) octane number: $(R+M) / 2$. This is also known as the ANTI-KNOCK INDEX.

Unleaded gasoline containing oxygenates such as ethanol, IPA, IBA and TBA can be used provided the ratio of any one of these oxygenates to gasoline does not exceed 10%; MTBE must not exceed 15%.

The ratio of methanol to gasoline must not exceed 3% plus additional cosolvents.

Using mixtures of ethanol and methanol is not allowed. Gasohol, which contains 10% ethanol and 90% unleaded gasoline, can be used.

These blends must also meet all other fuel requirements, such as resistance to spark knock, boiling range, vapor pressure, etc.

Gasoline additives

A major concern among engine manufacturers is carbon build-up caused by gasoline. Mercedes-Benz recommends only the use of quality gasoline containing additives that prevent the build-up of carbon deposits.

After an extended period of using fuels without such additives carbon deposits can build up, especially on the intake valves and in the combustion area, leading to engine performance problems such as:

- Warm-up hesitation
- Unstable idle
- Knocking / pinging
- Misfire
- Power loss

In areas where carbon deposits may be encountered due to lack of availability of gasolines which contain these additives, Mercedes-Benz recommends the use of additives approved by us for use on Mercedes-Benz vehicles. Refer to Factory Approved Service Products pamphlet for a listing of approved product(s). Follow directions on product label.

Do not blend other specific fuel additives with fuel. This only results in unnecessary costs and may be harmful to the engine operation.

Damage or malfunction resulting from poor fuel quality or from blending additional fuel additives other than those tested and approved by us for use on Mercedes-Benz vehicles listed in the Factory Approved Service Products pamphlet are not covered by the Mercedes-Benz Limited Warranty.

Coolants

The engine coolant is a mixture of water and anticorrosion/antifreeze, which provides:

- Corrosion protection
- Freeze protection
- Boiling protection (by increasing the boiling point)

The cooling system was filled at the factory with a coolant providing freeze protection to approximately -35°F (-37°C) and corrosion protection.

If the antifreeze mixture is effective to -22°F (-30°C), the boiling point of the coolant in the pressurized cooling system is reached at approximately 266°F (130°C).

Fuels, coolants, lubricants, etc.

The coolant solution must be used year round to provide the necessary corrosion protection and increase boil-over protection. Refer to Maintenance Booklet for replacement interval.

To provide important corrosion protection, the solution must be at least 45% anticorrosion/antifreeze (equivalent to freeze protection to approx. - 22°F [-30°C]). If you use a solution that is more than 55% anticorrosion/antifreeze (freeze protection to approx. - 49°F [-45°C]), the engine temperature will increase due to the lower heat transfer capability of the solution. Therefore, do not use more than this amount of anticorrosion/antifreeze.

If the coolant level is low, water and MB 325.0 anticorrosion/antifreeze should be used to bring it up to the proper level (have cooling system checked for signs of leakage). Please make sure the mixture is in accordance with label instructions.

The water in the cooling system must meet minimum requirements, which are usually satisfied by normal drinking water. If you are not sure about the water quality, consult an authorized Mercedes-Benz Light Truck Center.

Anticorrosion/antifreeze

Your vehicle contains a number of aluminum parts. The use of aluminum components in motor vehicle engines necessitates that anticorrosion/antifreeze coolant used in such engines be specifically formulated to protect the

aluminum parts. (Failure to use such anti-corrosion/antifreeze coolant will result in a significantly shortened service life.)

Therefore, the following product is strongly recommended for use in your vehicle: Mercedes-Benz 325.0 anticorrosion/antifreeze agent.

Before the start of the winter season (or once a year in hot southern regions), you should have the anticorrosion/antifreeze concentration checked. The coolant is also regularly checked each time you bring your vehicle to an authorized Mercedes-Benz Light Truck Center for service.

Anticorrosion/antifreeze quantity

Model	Approx. freeze protection	
	- 35°F (- 37°C)	- 49°F (- 45°C)
R 350	5.0 US qt (4.75 l)	5.5 US qt (5.2 l)
R 500	5.6 US qt (5.25 l)	6.1 US qt (5.8 l)

Fuels, coolants, lubricants, etc.

Windshield washer and headlamp cleaning* system

Both the windshield washer and headlamp cleaning* system are supplied from the windshield washer fluid reservoir.

The windshield and headlamp washer fluid reservoir has a capacity of approx.

8.2 US qt (7.8 l).

- ▶ Refill the reservoir with MB Windshield Washer Concentrate and water (or concentrate and commercially available premixed windshield washer solvent/antifreeze, depending on ambient temperatures).

Warning!



Washer solvent/antifreeze is highly flammable. Do not spill washer solvent/antifreeze on hot engine parts, because it may ignite and burn. You could be seriously burned.

Windshield and headlamp washer fluid mixing ratio

For temperatures above freezing point, use MB Windshield Washer Concentrate “MB SummerFit” and water:

- 1 part “MB SummerFit” to 100 parts water
(1.34 fl oz [40 ml] “MB SummerFit” to 1 gal [4.0 l] water)

For temperatures below freezing point, use MB Windshield Washer Concentrate “MB SummerFit” and commercially available premixed windshield washer solvent / antifreeze:

- 1 part “MB SummerFit” to 100 parts solvent
(1.34 fl oz [40 ml] “MB SummerFit” to 1 gal [4.0 l] solvent)

ABS

(Antilock Brake System)

Prevents the wheels from locking up during braking so that the vehicle can continue to be steered.

Accessory weight

(▷ page 385)

ADS

(Adaptive Damping System)

Automatically adapts the optimum suspension damping to prevailing driving conditions.

Airmatic*

Automatically selects the optimum suspension tuning and ride height for your vehicle. Airmatic consists of two components:

- Adaptive Damping System
- Vehicle level control

Air pressure

(▷ page 385)

Alignment bolt

Metal pin with thread. The centering pin is an aid used when changing a tire to align the wheel with the wheel hub.

Aspect ratio

(▷ page 385)

Bar

(▷ page 386)

BAS

(Brake Assist System)

System for potentially reducing braking distances in emergency braking situations. The system is activated when it senses an emergency based on how fast the brake is applied.

Bead

(▷ page 386)

Bi-Xenon headlamps*

Headlamps which use an electric arc as the light source and produce a more intense light than filament headlamps. Bi-Xenon headlamps produce low beam and high beam.

CAC

(Customer Assistance Center)

Mercedes-Benz customer service center, which can help you with any questions about your vehicle and provide assistance in the event of a breakdown.

CAN system

(Controller Area Network)

Data bus network serving to control vehicle functions such as door locking or windshield wiping.

Cockpit

All instruments, switches, buttons and indicator / warning lamps in the passenger compartment needed for vehicle operation and monitoring.

Cold tire inflation pressure

(▷ page 386)

Collapsible tire

An especially compact spare tire that must be inflated with a provided air pump before using. It should only be used to bring the vehicle to the nearest service station.

Control system

The control system is used to call up vehicle information and to change component settings. Information and messages appear in the multifunction display. The driver uses the buttons on the multifunction steering wheel to navigate through the system and to adjust settings.

Cruise control

Driving convenience system for automatically maintaining the vehicle speed set by the driver.

Curb weight

(▷ page 386)

DOT

(Department of Transportation)

(▷ page 386)

Engine number

The number set by the manufacturer and placed on the cylinder block to uniquely identify each engine produced.

Engine oil viscosity

Measurement for the inner friction (viscosity) of the oil at different temperatures. The higher the temperature an oil can tolerate without becoming thin, or the lower the temperature it can tolerate without becoming viscous, the better the viscosity.

ESP®

(Electronic Stability Program)

Improves vehicle handling and directional stability.

ETD

(Emergency Tensioning Device)

Device which deploys in certain frontal and rear collisions exceeding the system's threshold to tighten the seat belts.

->SRS

FSS PLUS (Canada vehicles)

(Flexible Service System PLUS)

Maintenance service indicator in the speedometer display that informs the driver when the next vehicle maintenance service is due. FSS evaluates engine temperature, oil level, vehicle speed, engine speed, distance driven and the time elapsed since your last service, and calls for the next maintenance service accordingly.

GAWR

(Gross Axle Weight Rating)

(▷ page 386)

Gear range

Number of gears which are available to the automatic transmission for shifting. The automatic gear shifting process can be adapted to specific operating conditions using the gear selector lever.

GPS

(Global Positioning System)
Satellite-based system for relaying geographic location information to and from vehicles equipped with special receivers. Employs CD or DVD digital maps for navigation.

GVW

(Gross Vehicle Weight)
(▷ page 386)

GVWR

(Gross Vehicle Weight Rating)
(▷ page 386)

Instrument cluster

The displays and indicator/warning lamps in the driver's field of vision, including the tachometer, speedometer, engine temperature and fuel gauge.

Kickdown

Depressing the accelerator past the point of resistance shifts the transmission down to the lowest possible gear. This very quickly accelerates the vehicle and should not be used for normal acceleration needs.

Kilopascal (kPa)

(▷ page 386)

Line of fall

The direct line that an object moves downhill when influenced by the force of gravity alone.

Locking knob

Knob on the door which indicates whether the door is locked or unlocked. Pushing the locking knob down on an individual door from inside will lock that door.

Maintenance System (U.S. vehicles)

Maintenance service indicator in the multifunction display that informs the driver when the next vehicle maintenance service is due. The Maintenance system tracks distance driven and the time elapsed since the last maintenance service, calculates other maintenance service work required, and calls for the next service accordingly.

Maximum load rating

(▷ page 387)

Maximum loaded vehicle weight

(▷ page 387)

Maximum tire inflation pressure

(▷ page 387)

Modular COMAND System

Information and operating center for vehicle sound and communications systems, including the radio and the radio and navigation system, as well as for other optional equipment (CD changer, telephone, etc.).

Memory function*

Used to store three individual seat, steering wheel and mirror positions.

MON

(Motor Octane Number)

The Motor Octane Number for gasoline as determined by a standardized method. It is an indication of a gasoline's ability to resist undesired detonation (knocking). The average of both the MON (Motor Octane Number) and ->RON (Research Octane Number) is posted at the pump, also known as ANTI-KNOCK INDEX.

Multifunction display

The display field in the instrument cluster used to present information provided by the control system.

Multifunction steering wheel

Steering wheel with buttons for operating the control system.

Normal occupant weight

(▷ page 387)

Overspeed range

Engine speeds within the red marking on the tachometer dial. Avoid this engine speed range, as it may result in serious engine damage that is not covered by the Mercedes-Benz Limited Warranty.

Occupant distribution

(▷ page 387)

Parktronic (Parking assist)*

System which uses visual and acoustic signals to assist the driver during parking maneuvers.

Poly-V-belt drive

Drives engine-components (alternator, AC compressor, etc.) from the engine.

Power train

Collective term designating all components used to generate and transmit motive power to the drive axles, including

- engine
- clutch / torque converter
- transmission
- transfer case
- drive shaft
- differential
- axle shafts / axles

PRE-SAFE®*

(Preventive Occupant Safety System)
Vehicles equipped with PRE-SAFE®* take preventive measures when the system senses certain driving dynamics suggesting a possible accident.

Production options weight

(▷ page 387)

Program mode selector switch

Used to switch the automatic transmission between standard operation (S) and comfort operation (C).

PSI

(Pounds per square inch)
(▷ page 387)

Recommended tire inflation pressure

(▷ page 387)

REST

(Residual Engine Heat Utilization)
Feature that uses the engine heat stored in the coolant to heat the vehicle interior for a short time after the engine has been turned off.

Restraint system

Seat belts, belt tensioner, air bags and child seat restraint systems. As independent systems, their protective functions complement one another.

Rim

(▷ page 387)

RON

(Research Octane Number)
The Research Octane Number for gasoline as determined by a standardized method. It is an indication of a gasoline's ability to resist undesired detonation (knocking). The average of both the →MON (Motor Octane Number) and RON (Research Octane Number) is posted at the pump, also known as ANTI-KNOCK INDEX.

Sidewall

(▷ page 387)

SRS

(Supplemental Restraint System)
Seat belts, emergency tensioning device and air bags. Though independent systems, they are closely interfaced to provide effective occupant protection.

Tele Aid System*

(Telematic Alarm Identification on Demand)
The Tele Aid system consists of three types of response: automatic and manual emergency, roadside assistance and information. Tele Aid is initially activated by completing a subscriber agreement and placing an acquaintance call.
The Tele Aid system is operational provided that the vehicle's battery is charged, properly connected, not damaged and cellular and GPS coverage is available.

Telematics*

A combination of the terms "telecommunications" and "informatics".

Tightening torque

Force times lever arm (e.g. a wheel wrench) with which threaded fasteners such as wheel bolts are tightened.

TIN

(Tire Identification Number)

(▷ page 387)

Tire load rating

(▷ page 387)

Tire ply composition and material used

(▷ page 388)

Tire speed rating

(▷ page 388)

Traction

(▷ page 388)

Transfer case

Speed of rotation / torque converter that works together with the ->automatic transmission.

Tread

(▷ page 388)

Treadwear indicators

(▷ page 388)

TWR

(Tongue Weight Rating)

(▷ page 388)

Uniform Tire Quality Grading Standards

(▷ page 388)

Vehicle capacity weight

(▷ page 388)

Vehicle level control

The ground clearance of the vehicle is automatically controlled according to a selected setting and speed. The driver can set the ground clearance manually for example on very rough roads.

VIN

(Vehicle Identification Number)

The number set by the manufacturer and placed on the body to uniquely identify each vehicle produced.

- A**
- ABS 97, 529
 - ABS control 97
 - Malfunction indicator lamp 404
 - Messages in display 418
 - Warning lamp 404
 - Accelerator position, automatic transmission 203
 - Accessory weight 385, 529
 - Accident
 - In case of 63
 - Activating
 - Air circulation mode 242
 - Air conditioning (cooling) 226
 - Air recirculation mode 225, 239
 - Anti-theft alarm system 105
 - Central locking (control system) 188
 - Defrosting 223
 - Easy-entry/exit feature* 189
 - Electric air pump 483
 - ESP® 102
 - Exterior headlamps 58
 - Hazard warning flasher 154
 - Headlamps 58
 - High beams 151
 - Ignition 38
 - Immobilizer 66, 104
 - Rear window defroster 215
 - Rear window wiper 62
 - Residual heat 243
 - Residual heat* 228
 - Seat heating* 142
 - Tow-away alarm 107
 - Warning indicators (Parktronic*) 276
 - Windshield wipers 59
 - Adding
 - Coolant 351
 - Engine oil 349
 - Additional turn signal lamps
 - Replacing bulbs 466
 - Adjusting 42
 - Air distribution 222, 236
 - Air volume 222, 237
 - Backrest tilt 44
 - Exterior rear view mirror 48
 - Head restraint height 44
 - Head restraint tilt 45
 - Instrument cluster illumination 158
 - Interior rear view mirror 48
 - Mirrors 47
 - Multicontour seat* 136
 - Seat cushion depth 136
 - Seat cushion tilt 44
 - Seat fore and aft adjustment 43
 - Seat height 44
 - Seats 42
 - Steering column height 47
 - Steering wheel 45
 - Adjusting steering column in or out 47
 - Adjusting steering column up or down 47
 - Air bags 71
 - Children 72
 - Front 75
 - Passenger 75
 - Safety guidelines 74
 - Side impact 76
 - Window curtain 76
 - Air conditioning
 - Turning off 226
 - Turning on 226
 - Air conditioning refrigerant 523
 - Air distribution
 - Adjusting 222, 236
 - Air pressure 385, 529
 - Air pressure see Tire inflation pressure
 - Air pump, electric
 - Turning on 483

- Air recirculation mode 224, 239
 - Activating 225, 239
 - Deactivating 226, 240
- Air volume
 - Adjusting 222, 237
- AIRMATIC* 269
- Alarm
 - Audible 95, 106
 - Canceling 106
 - Visual 104
- Alarm system
 - Anti-theft 104
- Alignment bolt (vehicle tool kit) 481, 529
- Anticorrosion/antifreeze 527
- Antiglare
 - Automatic 209
- Antilock brake system (ABS) 529
- Anti-theft alarm system
 - Arming 105
 - Canceling alarm 106
 - Disarming 106
- Anti-theft systems
 - Anti-theft alarm system 104
 - Immobilizer 104
 - Tow-away alarm 106
- Aquaplaning see Hydroplaning
- Armrest
 - Storage compartment in front of 296
 - Storage compartments 296
- Ashtray
 - Front center console 303
- Aspect ratio 385, 529
- ATF (automatic transmission fluid) 350
- AUDIO menu 170
 - Selecting radio station 170
 - Selecting satellite radio* station 171
- Audio system
 - CD mode 171
- Automatic antiglare for rear view mirror 209
- Automatic central locking
 - Activating/deactivating (control system) 188
- Automatic climate control*
 - Front defroster 238
 - Residual ventilation 243
- Automatic climate control* (3-zone) 230
 - Adjusting air distribution 236
 - Adjusting air volume 237
 - Air recirculation mode 239
 - Rear passenger compartment 244
 - Residual heat utilization 243
 - Setting the temperature 236
- Automatic headlamp mode 148
- Automatic lighting control
 - Activating 155
 - Deactivating 155
- Automatic locking when driving 130
- Automatic shift program
 - Automatic transmission* 204
- Automatic transmission
 - Accelerator position 203
 - Emergency operation (Limp Home Mode) 207
 - Gear ranges 202
 - Gear selector lever position 199, 200
 - Gear shifting malfunctions 207
 - Kickdown 203
 - Transmission fluid 350
- Automatic transmission*
 - Automatic shift program 204

B

Backup lamps
 Replacing bulbs 466

Bar 386, 529

BAS 99, 529

Batteries, SmartKey
 Check lamp 113, 119

Batteries, vehicle
 Messages in display 430

Battery discharged
 Jump starting 496

Battery, SmartKey 463

Battery, vehicle 487
 Charging 495
 Dis-/reconnecting 489
 Removing/installing 489

Bead 386, 529

Bi-Xenon* headlamps 529
 Replacing bulbs 466

Block heater (Canada only) 391

Blocking
 Rear door window operation 93

Bottle opener 300

Brake assist system (BAS) 529

Brake fluid 523
 Message in display 432

Brake lamps
 Replacing bulbs 466

Brake pads
 Message in display 430

Brakes 332
 Warning lamp 405

Break-in period 330

Bulbs, replacing 465
 Additional turn signal lamps 466

Backup lamps 466

Bi-Xenon* headlamps 466

Brake lamps 466

Front fog lamp 471

Front fog lamps* 466

Front lamps 466

Headlamps 466

License plate lamps 466, 474

Parking lamps 466

Rear fog lamps 472

Rear side marker lamp bulbs 472

Sidemarkers lamps 466

Standing lamps 466

Tail lamp assemblies 472

Tail lamps 466

Turn signal lamps 466

C

CAC (Customer Assistance Center) 529

California
 Important notice 11

Call priority
 Tele Aid* 318

Calling up
 Range (distance to empty) 193
 Service indicator 393

CAN system 529

Capacities
 Fuels, coolants, lubricants, etc. 521

Card holder 300

Cargo compartment
 Extending 283
 Fuse box 504
 Lamp 157
 Tie-down rings 281

Cargo compartment cover blind* 288
 Closing 288
 Installing 289
 Opening 288
 Removing 288

Cargo tie-down rings 281

Carpets, cleaning 402

- Catalytic converter 340
- CD player
 - Operating 171
- CD-changer* 294
- Center console 29
 - Lower part 30
 - PASS AIR BAG OFF indicator lamp 414
 - Upper part 29
- Central locking
 - Automatic 130
 - Switch 131
 - Switching on/off (control system) 188
 - Unlocking from inside 131
- Central locking switch 131
- Certification label 510
- Changing
 - SmartKey setting 189
- Charging
 - Vehicle battery 495
- CHECK ENGINE malfunction indicator lamp 407, 408
- Checking
 - Coolant level 351
 - Oil level 346
 - Tire inflate pressure 344
 - Vehicle lighting 344
- Checking tire pressure electronically with the Advanced Tire Pressure Monitoring System* (Advanced TPMS*) 371
- Checking tire pressure electronically with the Tire Pressure Monitoring System (TPMS) 368
- Child safety 82
 - Air bags 72
 - Infant and child restraint systems 78, 82
 - LATCH child seat mounts 92
- Child safety switch see Blocking of rear door window operation
- Cigarette lighter
 - Front center console 303
- Cigarette lighter* 305
- Cleaning
 - Headlamps 208
 - Headliner 402
 - Light alloy wheels 401
 - Plastic and rubber parts 402
 - Steering wheel 402
 - Windows 400
 - Windshield 60
- Cleaning tires 355
- Climate control 216
 - Adjusting 222
 - Adjusting air volume 222
 - deactivating 220
 - Front defroster 223
 - Rear passenger compartment 228
 - Setting the temperature 222
- Clock 180
- Closing
 - Glove box 294
 - Hood 346
 - Panorama sliding/pop-up roof 260
 - Power tilt/sliding sunroof* 462
 - Side windows 249
 - Tailgate 124, 128, 129
 - Tilt/sliding sunroof* 255
 - Windows 248

- Closing the tailgate from the inside
 - electrically* 124
- Closing the tailgate from the outside (vehicles without KEYLESS-GO*) 126
- Closing tilt/sliding sunroof*
 - In an emergency 462
- Cockpit 22, 529
- Cold tire inflation pressure 386, 529
- Collapsible tire 457, 530
- Collapsible wheel chock 457
- Combination switch
 - High beam flasher 58
 - Turn signals 58
 - Windshield wipers 59
- Compass 186, 327
 - Adjustment 186
 - Calibration 187
 - Setting the compass zone 186
- Control and operation of radio transmitters 339
- Control system 530
 - AUDIO menu 170
 - Convenience submenu 189
 - Display digital speedometer 169
 - Functions 165
 - Instrument cluster submenu 178, 180
 - Lighting submenu 182
 - Malfunction memory menu 173
 - Menus 164, 165
 - Selecting radio system 170
 - Selecting satellite radio* system 171
 - Settings menu 174
 - Standard display menu 168
 - Submenus 163, 165
 - TEL* menu 194
 - Trip computer menu 192
 - Vehicle submenu 186
- Convenience submenu 189
 - Activating easy-entry/exit feature* 189
- Coolant 351, 525
 - Adding 351
 - Anticorrosion/antifreeze quantity 526
 - Checking level 351
 - Messages in display 433, 436
 - Temperature 341
- Coolant level
 - Checking 351
- Corner-illuminating front fog lamps* 152
- Cruise control 264, 530
 - Canceling 266
 - Driving downhill 265
 - Driving uphill 265
 - Setting current speed 265
 - Setting speeds 269
- Cruise control lever 264
- Cup holder
 - Front center console 299
 - In rear center console 301
- Cup holders 299
 - Cleaning 401
- Curb weight 386, 530
- Customer Assistance Center (CAC) 529

D

- Daytime running lamp mode 149
 - Setting 182
- Deactivating
 - Air conditioning 227
 - Air conditioning (cooling) 242
 - Air recirculation mode 226, 240
 - Alarm 106
 - Anti-theft alarm system 106
 - Automatic climate control* (3-zone) 234
 - Central locking (control system) 188
 - Climate control system 220
 - Cruise control 266
 - Defrost 223, 238
 - Engine 66
 - ESP® 101
 - Hazard warning flasher 154
 - Headlamps 65
 - Immobilizer 104
 - Interior lighting delayed switch-off 185
 - Rear passenger compartment ventilation and climate control 245
 - Rear window defroster 215
 - Rear window wiper 62
 - Residual heat 228, 243
 - Seat heating* 143
 - Tow-away alarm 107
- Deep water see Standing water
- Defogging
 - Windshield 224, 238
- Delayed switch-off
 - Interior lighting 185
- Department of Transportation see DOT
- Dialing
 - A number (telephone*) 195
- Difficulties
 - While driving see Problems while driving
- Digital speedometer 168
- Direction of rotation (tires) 356
- Discharged battery
 - Jump starting 496
- Disconnecting
 - Vehicle battery 489
- Display
 - Selecting 179
- Displays
 - Digital speedometer 169
 - Maintenance service indicator 392
 - Messages 347
 - Selecting 179
 - Showing malfunctions 173
- Distance to empty (range)
 - Calling up 192
- Door control panel 34
- Door entry lamps 157
- Door handle 34
- Door unlock
 - With Tele Aid* 319
- Door windows 248
 - Automatic closing 250
 - Automatic opening 250

- Closing 248
- Closing fully (Express-close) 250
- Opening 248
- Opening fully (Express-open) 250
- Stopping 250
- Synchronizing 251
- Doors
 - Message in display 436
 - Opening from inside vehicle 121
 - Opening from outside 112
- DOT 386, 530
- Downhill driving
 - Cruise control 265
- Drinking and driving 331
- Drive sensibly-save fuel 331
- Driving 50, 56
 - Abroad 339
 - In winter 337
 - Problems 62
 - Safety systems 97
 - Through standing water 338
- Driving abroad 339
- Driving off 333
- Driving safety systems
 - 4-ETS 102
 - ABS 97
 - BAS 99
 - EBP 102
 - ESP® 99
- Driving systems 264
 - AIRMATIC* 269
 - Cruise control 264
 - Driving safety systems 97
 - Parktronic* 274
- Driving tips 203
 - Accelerator position 203
 - Kickdown 203
- E**
 - Easy-entry/exit feature* 132
 - Activating 189
 - EBP 102
 - Electrical fuses 503
 - Electrical system
 - Technical data 518
 - Electronic Brake Proportioning see EBP
 - Electronic Stability Program see ESP®
 - Electronic Traction System see 4-ETS
- Emergency calls
 - Initiating an emergency call 314
 - With Tele Aid* 313
- Emergency operation (Limp Home Mode) 207
- Emergency operations
 - Closing tilt/sliding sunroof* 462
 - Locking the vehicle 460
 - Opening tilt/sliding sunroof* 462
 - Remote door unlock 319
 - Unlocking the vehicle 459
- Emergency tensioning device see ETD
- Emission control 340
- Emission control label 511
- Ending
 - A call (telephone*) 195
- Engine
 - Message in the display 433
 - Starting 53
 - Starting with KEYLESS-GO* 54
 - Technical data 513
 - Turning off 66
- Engine cleaning 397
- Engine compartment
 - Hood 345
 - Main fuse box 504

- Engine malfunction indicator lamp 407, 433
- Engine malfunction indicator lamp (Canada only) 27
- Engine malfunction indicator lamp (USA only) 27
- Engine number 530
- Engine oil 346, 523
 - Adding 349
 - Additives 523
 - Checking level 346
 - Consumption 346
 - Display messages 437-438
 - Messages in display 347, 437-438
 - Viscosity 530
- ESP® 25, 99, 530
 - Switching off 101
 - Switching on 102
 - Warning lamp 409
- ETD 530
 - Safety guidelines 74
- ETD (Emergency tensioning device) 80
- Extending cargo compartment 283
- Exterior mirrors
 - Folding 211
- Exterior rear view mirrors
 - Adjusting 48
 - Power folding* 211
 - Synchronizing 211
- F**
- Fastening the seat belts 50
- First aid kit 454
- Flat tire 478
 - Lowering the vehicle 485
 - Preparing the vehicle 479
 - Spare wheel 457
- Flexible Service System PLUS (FSS PLUS) 530
- Floormats* 328
- Fluid level
 - Automatic transmission 350
- Fog lamp, rear
 - Switching on 151
- Fog lamps, front*
 - Messages in display 442
 - Replacing bulbs 466
 - Switching on 151
- Folding
 - Exterior mirrors 211
- 4-ETS 102
- Front air bags 75
- Front defroster 223, 238
- Front fog lamps
 - Indicator lamp 147
- Front lamps
 - Messages in display 442
 - Replacing bulbs 466, 468
- Front seats
 - Head restraints 44
- Front towing eye 501
- Front wiper blades
 - Installing 476, 477
 - Removing 475
- FSS PLUS (Flexible Service System PLUS) 530
- Fuel 343
 - Additives 525
 - Fuel reserve warning lamp 409
 - Gasoline additives 525
 - Premium unleaded gasoline 343, 524
 - Requirements 524
- Fuel additives 525
- Fuel cap
 - Message in display 439

- Fuel consumption statistics
 - After start 192
 - Since last reset 193
- Fuel filler flap
 - Locking 342
 - Opening 461
 - Unlocking 342
- Fuel requirements 524
- Fuel tank
 - Filler flap 342
- Fuels, coolants, lubricants etc. 521
- Functions (control system) 165
 - Resetting 176
- Fuses 503
 - Fuse box in cargo compartment 504
 - Fuse box in passenger compartment 505
 - Main fuse box 504
- G**
- Garage door opener* 320
- Gasoline additives 525
- Gasoline see Fuel
- GAWR 386, 530
- Gear range 530
 - Automatic transmission 202
 - Limiting 202
 - Shifting into optimal 207
- Gear range limit
 - Canceling 207
- Gear selector lever
 - Message in the display 421
 - Position 200
 - Position (automatic transmission) 199
- Global
 - Locking 112
 - Unlocking 112
- Global Positioning System (GPS) 531
- Glove box 294
 - Closing 294
 - Opening 294
- Good visibility 208
- GPS 531
- Gross Axle Weight Rating see GAWR
- Gross Trailer Weight see GTW
- Gross Vehicle Weight Rating see GVWR
- Gross Vehicle Weight see GVW
- GTW 386
- GVW 386, 531
- GVWR 386, 531
- H**
- Hard plastic trim items, cleaning 402
- Hazard warning flasher 153
 - Switching off 154
 - Switching on 154
- Head restraints
 - Front seats 44
 - Rear seats 139
- Headlamp cleaning system* 352
- Headlamps
 - Automatic control 148
 - Bi-Xenon* 529
 - Cleaning lenses 399
 - Cleaning system* 208, 352
 - Refilling washer fluid 352
 - Replacing bulbs 466
 - Switching off 65
 - Switching on 58
 - Washer fluid 528
 - Washer system 528

- Headliner
 - Cleaning 402
- Height adjustment
 - Head restraints 44
 - Seat belts 52
 - Steering wheel 45
- High beam flasher 58, 152
- High beam headlamps
 - Messages in display 443
 - Switching on 151
- Hood 345
 - Closing 346
 - Message in display 439
 - Opening 345
- Hooks
 - Loading 282
- Hydroplaning 335
- I**
- Identification labels 510
 - Certification label 510
 - Vehicle identification number (VIN) 511
- Ignition 38
 - Switching on 54
- Immobilizer 104
 - Activating 104
 - Deactivating 104
- Infant and child restraint systems 82
 - Installing 90
 - LATCH child seat mounts 92
- Information
 - About service and warranty 10
 - Button for Tele Aid* 317
- Infrared reflecting windshield* 328
- Inside rear view mirror
 - Antiglare 209
- Installing
 - Front wiper blades 476, 477
 - Infant and child restraint systems 90
 - Vehicle battery 489
- Instrument cluster 24, 158, 531
 - Cleaning 401
 - Illumination 158
 - Lamps in 409
 - Outside temperature indicator 159
 - Selecting language 178
- Instruments and controls see Cockpit
- Interior lighting 154
 - Activating automatic control 155
 - Deactivating automatic control 155
 - Delayed switch-off 185
 - Manual operation 155
- Interior rear view mirror
 - Adjusting 48
- Intermittent wiping 60
- J**
- Jump starting 496
- K**
- Key, Mechanical 459
- KEYLESS-GO*
 - Closing tailgate 128, 129
 - Loss of SmartKey with KEYLESS-GO* 121
 - Starting the engine 54
 - Turning off engine 66
 - Unlocking and opening, tailgate 120
 - Unlocking with 37
- Kickdown 203, 531
- Kilometers/miles in speedometer 178
- Kilopascal 386
- Kilopascal (kPa) 531
- Km/h or mph in speedometer 178

- L**
- Labels, identification 510
 - Lamp bulbs, exterior 465
 - Lamps, exterior
 - Front 466
 - Light sensor 444
 - Messages in display 442, 444
 - Rear 466
 - Lamps, indicator and warning
 - ABS 404
 - Air bag Off 76
 - Battery (SmartKey with KEYLESS-GO*) 118
 - Battery (SmartKey) 112
 - Brakes 405
 - CHECK ENGINE 407, 408
 - CHECK Engine malfunction indicator lamp 408
 - Engine diagnostics 407, 408
 - ESP® 409
 - Front fog lamps 147
 - Fuel reserve 409
 - Rear fog lamp 147
 - Seat belts 410
 - SRS 411
 - Language
 - Multifunction display 178
 - Setting 178
 - LATCH child seat anchors 92
 - LATCH child seat mounts 92
 - Layout of poly-V-belt drive 512
 - Lever
 - For cruise control 264
 - License plate lamps
 - Messages in display 444
 - Replacing bulbs 466, 474
 - Light alloy wheels
 - Cleaning 401
 - Light sensor 444
 - Lighter see cigarette lighter*
 - Lighting 147
 - Automatic headlamp mode 148
 - Cargo compartment lamp 157
 - Daytime running lamp mode 149
 - Door entry lamps 157
 - Front fog lamps* 151
 - High beams 151
 - Instrument cluster illumination 158
 - Interior 154
 - Locator lighting 150
 - Low beam 147
 - Night security illumination 150
 - Parking lamps 147
 - Rear fog lamp 151
 - Settings (control system) 182
 - Standing lamps 147
 - Limiting the gear range 202
 - Limp Home Mode 207
 - Line of fall 531
 - Loading 279
 - Cargo compartment cover blind* 288
 - Cargo tie-down rings 281
 - Hooks 282
 - Instructions 280
 - Parcel nets 298
 - Partition net* 290
 - Roof rack 279
 - Loading terminology 385
 - Loading the vehicle 356
 - Locator lighting 150
 - Setting 183
 - Lock button 531
 - Lock buttons
 - Door handle (KEYLESS-GO*) 68

- Locking 67, 110
 - Automatic while driving 130
 - Centrally from inside 131
 - Fuel filler flap 342
 - Global (SmartKey with KEYLESS-GO*) 118
 - Global, SmartKey 112
 - Vehicle in an emergency 460
 - Locking the vehicle 120
 - Loss of Service and Warranty Information Booklet 509
 - Loss of SmartKey 114
 - Loss of Smartkey with KEYLESS-GO* 121
 - Low beam bulbs
 - Replacing bulbs 468
 - Low tire pressure telltale 25
 - Lowering
 - Vehicle 485
- M**
- Main dimensions 519
 - Main fuse box 504
 - Maintenance 12
 - Maintenance service
 - Overdue 393
 - Resetting maintenance service indicator 394
 - When due 392
 - Maintenance service indicator 392
 - Resetting 394
 - Maintenance System (U.S. vehicles) 531
 - Malfunction
 - Displaying 173
 - Malfunction memory 173
 - Calling up 173
 - Manual operations
 - Fuel filler flap 461
 - Interior lighting control 155
 - Locking the vehicle 460
 - Power tilt/sliding sunroof* 462
 - Unlocking the driver's door 459
 - Manual seat
 - Adjusting head restraint tilt 45
 - MAXCOOL maximum cooling 239
 - Maximum inflation pressure 387
 - Maximum load rating 387, 531
 - Maximum loaded vehicle weight 387, 531
 - Maximum tire inflation pressure 531
 - Mechanical key 459
 - Memory function 144, 532
 - Storing exterior rear view mirror parking positions 146
 - Storing SmartKey dependent settings 145
 - Memory function*
 - Recalling positions from memory 145
 - Menus 164
 - AUDIO 170
 - In control system 164, 165
 - Malfunction memory 173
 - Settings menu 174
 - Standard display 168
 - Submenus 163
 - TEL* 194
 - Trip computer 192
 - Miles/kilometers in speedometer
 - Setting 178

Mirrors

- Adjusting 47
- Automatic antiglare for rear view mirror 209
- Exterior rear view mirror 48
- Storing exterior rear view mirror parking position 146

Modular Control System 531

MON 343

MON (Motor Octane Number) 532

Mph or km/h in speedometer 178

Multicontour seat* 136

Multifunction display 532

- Selecting language 178
- Standard display 165

Multifunction display messages

- ABS 418
- Batteries 430
- Brake fluid 432
- Brake pads 430
- Coolant 436
- Coolant level 433
- Doors 436
- EBP (Electronic Brake Proportioning) 431
- Engine oil 437, 438

Fuel cap 439

Hood 439

Lamps 444

Lamps, exterior 442

Oil 437–438

Parking brake 431

SmartKey 441

SmartKey with KEYLESS-GO* 440

Tele Aid* 450, 451

Telephone* 451

Washer fluid 451

Multifunction steering wheel 28, 532

N

Navigation system 172

Night security illumination 150

Normal occupant weight 387, 532

O

Occupant Classification System 85

Self-test 90

Occupant distribution 387

Occupant safety 70

- Children and air bags 72
- Children in the vehicle 82
- Fastening the seat belt 50
- Infant and child restraint systems 82
- LATCH child seat mounts 92
- Seat belts 50, 74

Oil

- Adding 349
- Consumption 346
- Dipstick 346
- Filler neck 349
- Viscosity 530

One-touch gearshifting

- Canceling gear range limit 207

Opening

- Doors from the inside 121
- Fuel filler flap 342
- Fuel filler flap manually 461
- Glove box 294
- Hood 345

- Panorama sliding/pop-up roof 260
 - Power tilt/sliding sunroof* 462
 - Tailgate 122
 - Tilt/sliding sunroof* 255
 - Tilt/Sliding sunroof* in an emergency 462
 - Windows 248
 - Opening the tailgate from the inside 122, 123, 124
 - Opening the tailgate from the inside electrically* 123
 - Opening the tailgate from the outside 122
 - Operating
 - CD player 171
 - Radio 170
 - Radio transmitters 339
 - Telephone* 194
 - Vehicle outside the USA or Canada 13
 - Operating safety 17
 - Operator's Manual 10
 - Ornamental moldings 399
 - Outside temperature indicator 159
 - Overhead control panel 31
 - Overspeed range 532
- P**
- Paintwork 397
 - Panic alarm 95
 - Panic button on remote control 95
 - Panorama roof with power tilt/sliding panel* 259
 - Panorama roof with tilt/sliding panel
 - Cleaning 401
 - Parcel nets 298
 - Parking 334
 - Parking and locking 64
 - Parking brake 56, 65
 - Engaging 65
 - Message in display 431
 - Releasing 56
 - Parking lamps
 - Replacing bulbs 466
 - Parking position
 - Exterior rear view mirrors 146
 - Parktronic* 274, 532
 - Cleaning system sensor 399
 - Range of the sensors 275
 - Sensor cover 399
 - Warning indicators 276
 - Partition net* 290
 - Engaging 291
 - Removing 292, 293
 - Tightening 291
 - Parts service 508
 - Passenger compartment 338
 - Fuse box 505
 - Interior lighting 154
 - Passenger safety see Occupant safety
 - Pedals 331
 - Phone book*
 - Loading 195
 - Quick search 195
 - Phone number*
 - Dialing 195
 - Redialing 196
 - Plastic and rubber parts
 - Cleaning 402
 - Plastic parts, cleaning 401
 - Poly-V-belt drive 532
 - Layout 512
 - Positions (Memory function*)
 - Recalling from memory 145
 - Storing in memory 145

- Potential problems associated with
 - underinflated and overinflated tires 375
- Pounds per square inch see PSI
- Power assistance 331
- Power outlets 306
- Power seat*
 - Adjusting backrest tilt 44
 - Adjusting seat cushion tilt 44
 - Adjusting seat height 44
 - Seat fore and aft adjustment 43
- Power seats*
 - Adjusting head restraint height 44
- Power tilt/sliding sunroof* 255
 - Closing 462
 - Opening 462
- Power train 532
- Power washer 396
- Power windows
 - Blocking of rear door window operation 93
 - Cleaning 400
 - Door windows 248
 - Synchronizing 251
- Practical hints
 - First aid kit 454
 - Fuses 503
 - Jump starting 496
 - Lamp in center console 414
 - Lamps in instrument cluster 404
 - Messages in the display 416
 - Spare wheel 457
 - Vehicle jack 456
 - Vehicle tool kit 454
- Premium unleaded gasoline 524
- PRE-SAFE®* 81, 532
- Preventive occupant safety* see PRE-SAFE®*
- Problems
 - While driving 62
 - With vehicle 18
- Product information 9
- Production options weight 387, 532
- Program mode selector switch 533
- PSI 387, 388, 533
- Q**
- Quick search
 - Phone book* 195
- R**
- Radio
 - Selecting stations 170
 - Selecting stations (satellite*) 171
- Radio transmitters, control and operation 339
- Range (distance to empty)
 - Calling up 193
- Range of the sensors
 - Parktronic* 275
- Rear automatic climate control* 244
- Rear center console* 308
- Rear climate control 228
- Rear door window
 - Blocking operation 93
- Rear door window sunshade* 214
- Rear fog lamp
 - Indicator lamp 147
 - Switching on 151
- Rear lamp bulbs
 - Replacing 472
- Rear lamps
 - Messages in display 442
- Rear lamps see Tail lamps
- Rear passenger compartment ventilation 228

- Rear passenger compartment ventilation and climate control
 - Deactivating 245
- Rear passenger compartment ventilation and rear automatic climate control 244
- Rear towing eye 502
- Rear view mirror automatic antiglare 209
- Rear view mirrors see Mirrors
- Rear window defroster 215
 - Activating 215
 - Deactivating 215
- Rear window wiper switch 61
- Rear window wiper/washer 61
- Rear wiper blade
 - Removing 477
 - Replacing 476
- Recommended inflation pressure 387
- Recommended tire inflation pressure 533
- Reconnecting
 - Vehicle battery 489
- Recovery services
 - For stolen vehicle 319
- Refrigerant
 - Air conditioning 523
- Regular checks 343
- Remote control
 - Integrated 110
 - SmartKey 110
 - SmartKey with KEYLESS-GO* 115
- Remote door unlock
 - With Tele Aid* 319
- Removing
 - Front wiper blades 475
 - Rear wiper blade 477
 - Vehicle battery 489
 - Wheel 481
- Removing spare wheel 458
- Replacing
 - Backup lamp bulbs 472
 - Brake lamp bulbs 472
 - Bulbs 465
 - Front lamp bulbs 468
 - License plate lamp bulbs 474
 - Low beam bulbs 468
 - Rear fog lamp bulbs 472
 - Rear lamp bulbs 466, 472
 - Rear side marker lamp bulbs 472
 - Rear turn signal bulbs 472
 - Rear wiper blade 476
 - Wiper blades 475
- Replacing front fog lamp* bulb 471
- Reporting
 - Safety defects 19
- Reset button in the instrument cluster 175, 176
- Resetting
 - All functions of a submenu 176
 - Fuel consumption 193
 - Maintenance service indicator 394
 - Trip odometer 159
- Residual heat 227
- Residual heat utilization 243, 533
- Residual heat* utilization 228
- Residual ventilation 227, 243
- REST (Residual engine heat utilization) 533
- Restraint system 533
- Restraint system see Infant and child restraint systems
- Rim 387, 533
- Rims and tires 514
- Roadside assistance 12
 - Tele Aid* 315
- Roller sunblinds 259
- RON 343
- RON (Research Octane Number) 533

- Roof rack 279
- Rubber parts
 - Cleaning 402
- Rubber parts, cleaning 401
- Run Flat Indicator (Canada only) 366
- S**
- Safety
 - Occupant 70
- Safety belts see Seat belts
- Safety defects
 - Reporting 19
- Safety systems
 - Driving 97
- Seat belt force limiter 80
- Seat belt height adjustment 52
- Seat belts 77
 - Cleaning 402
 - Fastening 50
 - Height adjustment 52
 - Proper use of 52, 79
 - Safety guidelines 74
 - Warning lamp 410
- Seat cushion depth
 - Adjusting 136
- Seat heating*
 - Switching off 143
 - Switching on 142
- Seating capacity 358
- Seats 132
 - Adjusting 42
 - Easy entry/exit feature* 132
 - Heating* 141
 - Multicontour seat* 136
- Securing cargo
 - Cargo tie-down rings 281
- Selecting display 179
- Self-test
 - Occupant Classification System 90
 - Tele Aid* 312
- Service
 - Calling up the service indicator 393
 - Parts 508
- Service and Warranty Booklet
 - Loss of 509
- Service and warranty information 10
- Service indicator
 - Calling up 393
 - Clearing 393
- Service life (tires) 354
- Setting
 - Convenience functions 177, 189
 - Cruise control 265
 - Day (clock) 181
 - Daytime running lamp mode 182
 - Higher speed in cruise control 267
 - Hours (clock) 180
 - Individual vehicle settings 174
 - Interior lighting delayed
 - switch-off 185
 - Lamps and lighting (control
 - system) 182
 - Language, multifunction display 178, 179
 - Locator lighting 183
 - Lower speed in cruise control 267
 - Miles/kilometers in
 - speedometer 178
 - Minutes (clock) 180
 - Month (clock) 181
 - Slower speed in cruise control 267
 - Speed in cruise control 269
 - Speedometer display mode 178
 - Temperature (interior) 222, 236
 - Units in speedometer 178
 - Year (clock) 181

- Setting current speed 265
- Settings
 - Convenience functions 189
 - Factory, SmartKey 112
 - Lighting (control system) 182
 - Menus and submenus 163
 - Resetting all (control system) 175
 - Resetting in the submenu 176
 - Selective 112, 118
- Settings menu
 - Individual vehicle settings 174
 - Submenus 176
- Shifting
 - Gear selector lever positions 200
 - Into optimal gear range (automatic transmission) 207
- Side impact air bags 76
- Side marker lamps
 - Cleaning lenses 399
- Side windows
 - Closing 249
- Sidemarkers lamps
 - Replacing bulbs 466
- Sidewall 387, 533, 534
- Simultaneous wiping and washing
 - Rear window wiper/washer 62
 - Windshield wipers 60
- Single wipe 60
- Sliding/pop-up roof*
 - Stopping 262
- SmartKey 110
 - Battery 463
 - Battery check lamp 112, 118
 - Checking the batteries 113, 119
 - Factory setting 112
 - Global locking 112
 - Global locking and unlocking 112
 - Global unlocking 112
 - Loss of 114
 - Selective setting 112
 - Starter switch positions 38
 - Unlocking with 36
- SmartKey with KEYLESS-GO* 114
 - Factory setting 118
 - Global locking 118
 - Loss of 121
 - Messages in display 440
 - Remote control 115
 - Selective setting 118
 - Unlocking 114
- Snow chains 391
- Spare wheel 457, 517
 - Removing 458
- Speed
 - Setting current 265
- Speed settings
 - Cruise control 267, 269
- Speedometer 25
 - Settings units 178
- Speedometer display mode
 - Selecting 178
- SRS 79, 533
 - Indicator lamp 411
- SRS indicator lamp 27
- Standing lamps
 - Replacing bulbs 466
- Standing water
 - Driving instructions 338
- Starting difficulties 55
- Starting position 38
- Starting the engine 53
- Steering column
 - Height adjustment 47
 - Length adjustment 47

- Steering wheel
 - Adjusting 45
 - Cleaning 402
 - Electrical adjustment* 46
- Steering wheel gearshift control
 - Automatic transmission 205
- Stolen vehicle
 - Recovery services 319
- Stopping
 - Sliding/pop-up roof* 262
- Stopping door windows 250
- Storage compartments 294
 - Armrest 296
 - Glove box 294
 - Storage compartment in front of armrest 296
- Storing (Memory function*)
 - Positions in memory 145
- Storing tires 355
- Stranded vehicle 502
- Submenus
 - Convenience 189
 - For settings 163
 - In control system 165
 - Instrument cluster 178, 180
 - Lighting 182
- Resetting functions in Control system 176
- Selecting 176
- Settings menu 176
- Vehicle 186
- Sun visor 212
- Sunshade*
 - Rear door window 214
 - Third-row 214
- Supplemental Restraint System (SRS) 533
- Switching off
 - Automatic central locking (control system) 188
 - ESP® 101
 - Hazard warning flasher 154
 - Headlamps 65
 - Seat heating* 143
- Switching on
 - Automatic central locking (control system) 188
 - ESP® 102
 - Front fog lamps* 151
 - Hazard warning flasher 154
 - Headlamps 58
 - High beams 151
- Rear fog lamp 151
- Seat heating* 142
- Windshield wipers 59
- Synchronizing
 - Panorama sliding/pop-up roof* 262
 - Power windows 251
 - Tilt/sliding sunroof* 258
- T**
- Tachometer 159
 - Displaying gear range 202
 - Overspeed range 159
- Tail lamps 472
 - Cleaning lenses 399
 - Replacing bulbs 466
- Tailgate
 - Closing 124
 - Closing from the inside electrically* 124
 - Closing from the outside (vehicles without KEYLESS-GO*) 126
 - Opening 122
 - Opening from the inside electrically* 123

- Opening from the outside 122
- Unlocking and opening with
 - KEYLESS-GO* 120
- Unlocking with SmartKey 114
- Tar stains 396
- Technical data 523
 - Brake fluid 523
 - Coolants 525
 - Electrical system 518
 - Engine 513
 - Engine oil 523
 - Engine oil additives 523
 - Fuel requirements 524
 - Gasoline additives 525
 - Main dimensions 519
 - Premium unleaded gasoline 524
 - Rims and tires 514
 - Weights 520
 - Windshield washer and headlamp
 - cleaning* system 528
- Tele Aid System* 533
- Tele Aid* 311
 - Call priority 318
 - Emergency calls 313
 - Information 317
 - Initiating an emergency call
 - manually 314
 - Messages in display 450, 451
 - Remote door unlock 319
 - Roadside assistance 315
 - Stolen vehicle recovery services 319
 - System self-check 312
- Telematics* 533
- Telephone* 310
 - Answering a call 195
 - Dialing a number from the phone
 - book 195
 - Ending a call 195
 - Loading phone book* 195
 - Messages in the display 451
 - Operating 194
 - Redialing 196
- Temperature
 - Setting interior temperature 222, 236
 - Tires 364
- Third-row sunshade* 214
- 3-zone automatic climate control* 230
- Ticket holder 300
- Tie-down rings (Cargo
 - compartment) 281
- Tightening torque 533
- Tightening torque (Wheel bolts) 485
- Tilt
 - Head restraint 45
- Tilt/sliding sunroof*
 - Closing 255
 - Opening 255
 - Synchronizing 258
- Time
 - Setting day 181
 - Setting hours 180
 - Setting minutes 180
 - Setting month 181
 - Setting year 181
- TIN 387, 534
- Tire
 - Vehicle maximum load on 388
- Tire and Loading Information 357
- Tire and loading terminology 385
- Tire care and maintenance 354
- Tire Identification Number see TIN

- Tire inflation pressure
 - Checking 344, 363, 365
 - Tire inflation pressure see the placard on the fuel filler flap
 - Tire inspection 354
 - Tire load rating 387, 534
 - Tire ply composition and material used 388
 - Tire speed rating 336, 378, 388, 534
 - Tire terminology 385
 - Tire traction 335
 - Tires 353, 514
 - Direction of rotation 356
 - Driving instructions 334
 - Low tire pressure telltale 412
 - Retreads 353
 - Rims and tires 514
 - Rotating 388
 - Run Flat Indicator 366
 - Service life 354
 - Temperature 364, 384
 - TPMS malfunction telltale 412
 - Tread depth 355, 390
 - Wear pattern 389
 - Winter 390
 - Tools 454
 - Tow-away alarm 106
 - Arming 106
 - Disarming 106
 - Disarming for transport 106
 - Towing eye
 - Front 501
 - Rear 502
 - Towing the vehicle
 - Stranded vehicle 502
 - TPMS malfunction telltale* 25
 - Traction 205, 388, 534
 - Transfer case 534
 - Tread 388, 534
 - Tread depth 355
 - Tread depth (tires) 390
 - Treadwear indicators 388, 534
 - Trip computer 192
 - Trip odometer
 - Resetting 159
 - Turn signal lamps
 - Cleaning lenses 399
 - Replacing bulbs 466
 - Turn signals 58
 - Turning off the engine 66
 - TWR (Tongue Weight Rating) 534
- U**
- Uniform Tire Quality Grading Standards 388, 534
 - Units
 - Setting speedometer units 178
 - Unlocking 36, 110
 - Centrally from inside 131
 - Driver's door in an emergency 459
 - Fuel filler flap 342
 - Global 112
 - Global (SmartKey with KEYLESS-GO*) 118
 - In an emergency 459
 - Selective settings 112, 118
 - Tailgate with SmartKey 114
 - Vehicle in an emergency 319
 - With the SmartKey 36
 - With the SmartKey with KEYLESS-GO* 114
 - Unlocking and opening
 - Tailgate with KEYLESS-GO* 120
 - Unlocking with KEYLESS-GO* 37
 - Uphill driving
 - Cruise control 265

Useful features 294
Ashtrays* 302
Cup holders 299
Power outlets 306
Storage compartments 294
Tele Aid* 311
Telephone* 310

V

Vehicle
Data recording 20
Individual settings 174, 177
Locking in an emergency 460
Lowering 485
Proper use of 17
Unlocking in an emergency 459
Vehicle capacity weight 388, 534
Vehicle care
Engine cleaning 397
Light alloy wheels 401
Ornamental moldings 399
Paintwork 397
Parktronic* system sensor 399
Plastic and rubber parts 402

Power washer 396
Steering wheel 402
Tar stains 396
Vehicle washing 397
Vehicle identification number (VIN) 511
Vehicle jack 456
Vehicle lighting
Checking 344
Vehicle loading terminology 385
Vehicle maximum load on the tire 388
Vehicle tool kit 454
Collapsible wheel chock 455, 457
Vehicle washing 397
VIN (Vehicle Identification Number) 511,
534

W

Warning indicators
Parktronic* 276
Warning sounds
Drivers seat belts 77
Parking brake 57
Warranty coverage 509
Washer fluid see Windshield washer fluid
Washing the vehicle 395
Wear pattern (tires) 389
Weights 520
Wheel change
Tightening torque 485
Wheels
Tires and wheels 353
Window curtain air bags 76
Windows, cleaning 400
Windshield
Cleaning wiper blades 400
Defogging 224, 238

- Infrared reflecting* 328
 - Refilling washer fluid 352
 - Replacing wiper blades 475
 - Washer fluid 352, 528
 - Washer system 528
 - Windshield washer fluid 528
 - Message in display 451
 - Mixing ratio 528
 - Refilling 352
 - Wiping with 60
 - Windshield washer system 528
 - Windshield wiper switch 59
 - Windshield wipers 59
 - Fast wiper speed 59
 - Intermittent 59
 - Intermittent wiping 59
 - Interval wiping 60
 - Normal wiper speed 59
 - Rear window wiper/washer 61
 - Replacing wiper blades 475
 - Simultaneous wiping and washing 62
 - Single wipe 60
 - Switching on 59
 - Wiping with windshield washer fluid 60
 - Winter driving
 - Snow chains 391
 - Tires 390
 - Winter driving instructions 337
 - Winter tires 390
 - Wiper blades
 - Replacing 475
 - Wiper/washer
 - Rear window 61
 - Wiping
 - And washing simultaneously 60
 - Intermittent 59, 60
 - Interval 59
 - With windshield washer fluid 60
 - Wiping and washing simultaneously 62
 - Wood trims, cleaning 402
- X**
- Xenon headlamps*
 - Bi-Xenon* 529

Service and Literature

Your authorized Mercedes-Benz Light Truck Center has trained technicians and genuine Mercedes-Benz parts to service your vehicle properly. For expert advice and quality service, contact an authorized Mercedes-Benz Light Truck Center.

If you are interested in obtaining service literature for your vehicle, please contact an authorized Mercedes-Benz Light Truck Center. We consider this the best way for you to obtain accurate information for your vehicle.

For further information you can find us on the Mercedes-Benz web-site *www.mbusa.com* or *www.mercedes-benz.ca*.

Warning!



To help avoid personal injury, be extremely careful when performing any service work or repairs. Improper or incomplete service or the use of incorrect or inappropriate parts or materials may damage the vehicle or its equipment, which may in turn result in personal injury.

If you have questions about carrying out any type of service, turn to the advice of an authorized Mercedes-Benz Light Truck Center.

We reserve the right to modify the technical details of the vehicle as given in the data and illustrations of this Operator's Manual. Reprinting, translation and copying, even of excerpts, is not permitted without our prior authorization in writing.

Title illustration no. P00.01-3056-31

Press time June 13, 2005

GSP/TIP

Printed in Germany

