



2115841971

Order No. 6515 1158 13 Part No. 211 584 19 71 USA Edition B 2006

Operator's Manual E-Class Wagon



Operator's Manual  
E-Class Wagon



Mercedes-Benz

E 350

E 350 4MATIC

E 500 4MATIC

E 55 AMG

Our company and staff congratulate you on the purchase of your new Mercedes-Benz.

Your selection of our product is a demonstration of your trust in our company name. Furthermore, it exemplifies your desire to own an automobile that will be as easy as possible to operate and provide years of service.

Your Mercedes-Benz represents the efforts of many skilled engineers and craftsmen. To help assure your driving pleasure, as well as your and your passengers' safety, we ask you to make a small investment of time:

- Please read this manual carefully, then return it to your vehicle where it will be handy for your reference.
- Please follow the recommendations contained in this manual. They are designed to assist you with the operation of your Mercedes-Benz.
- Please pay attention to the warnings and cautions contained in this manual. They are designed to help improve the safety of the vehicle operator and occupants.

We extend our best wishes for many miles of safe, pleasurable driving.

Mercedes-Benz USA, LLC  
A DaimlerChrysler Company

<b>Introduction</b> .....	9
Product information .....	9
Operator's Manual .....	10
Service and warranty information ..	10
Important notice for California retail buyers and lessees of Mercedes-Benz automobiles .....	11
Maintenance .....	12
Roadside Assistance .....	12
Change of address or ownership....	12
Operating your vehicle outside the USA or Canada.....	13
Where to find it.....	14
Symbols.....	15
Operating safety .....	16
Proper use of the vehicle .....	16
Problems with your vehicle.....	17
Reporting safety defects.....	18
Reporting safety defects .....	18
Vehicle data recording.....	19
Information regarding electronic recording devices.....	19

<b>At a glance</b> .....	21
Cockpit.....	22
Instrument cluster .....	24
Multifunction steering wheel .....	26
Center console .....	27
Upper part .....	27
Lower part .....	28
Overhead control panel .....	29
Storage compartments.....	30
Door control panel.....	32

<b>Getting started</b> .....	33
Unlocking .....	34
Unlocking with the SmartKey .....	34
Unlocking with KEYLESS-GO* .....	35
Starter switch positions.....	36
Adjusting.....	40
Seats .....	40
Steering wheel.....	42
Mirrors.....	45
Driving.....	47
Fastening the seat belts .....	47
Starting the engine .....	50
Parking brake .....	52
Driving .....	53
Switching on headlamps.....	54
Turn signals .....	54
Windshield wipers.....	55
Rear window wiper/washer .....	57
Problems while driving.....	58
Parking and locking.....	59
Parking brake .....	60
Switching off headlamps.....	61
Turning off engine .....	61
Releasing seat belts.....	62
Locking.....	62

<b>Safety and Security</b> .....	65	<b>Controls in detail</b> .....	105	Memory function .....	140
Occupant safety .....	66	Locking and unlocking .....	106	Storing positions into memory .....	141
Air bags .....	67	SmartKey .....	106	Recalling positions from memory .....	141
Seat belts .....	72	SmartKey with KEYLESS-GO* .....	111	Storing exterior rear view	
Active head restraints .....	76	Opening the doors		mirror parking position .....	141
Children in the vehicle .....	77	from the inside .....	119	Lighting .....	143
Blocking of rear door		Opening the tailgate .....	120	Exterior lamp switch .....	143
window operation .....	89	Closing the tailgate .....	122	Combination switch .....	147
Panic alarm .....	90	Automatic central locking .....	127	Hazard warning flasher .....	147
Activating .....	90	Locking and unlocking		Interior lighting in the front .....	148
Deactivating .....	90	from the inside .....	128	Door entry lamps .....	150
Driving safety systems .....	91	Seats .....	129	Interior lighting in the rear .....	150
ABS .....	91	Front seat active head restraints .....	129	Instrument cluster .....	151
BAS .....	93	Rear seat head restraints .....	129	Instrument cluster illumination .....	151
ESP® .....	93	Lumbar support .....	133	Coolant temperature indicator .....	152
Electrohydraulic brake system .....	96	Drive-Dynamic seat* with		Trip odometer .....	153
Four wheel electronic traction		multicontour features .....	133	Tachometer .....	153
system (4MATIC) with the ESP® .....	99	Seat heating* .....	135	Outside temperature indicator .....	153
Anti-theft systems .....	101	Seat ventilation* .....	136		
Immobilizer .....	101	Folding bench seat in cargo			
Anti-theft alarm system .....	101	compartment .....	137		
Tow-away alarm .....	103				

Control system .....	155	Good visibility .....	197	4-zone automatic climate control* .....	214
Multifunction display .....	155	Headlamp cleaning system* .....	197	Deactivating the climate control	
Multifunction steering wheel .....	156	Rear view mirrors .....	197	system .....	219
Menus .....	158	Sun visors .....	199	Operating the climate control	
Standard display menu .....	161	Roller sunblind* in the rear doors .....	200	system in automatic mode .....	220
AUDIO menu .....	161	Rear window defroster .....	200	Setting the temperature .....	221
NAV* menu .....	163	Dual-zone automatic climate control		Adjusting air distribution .....	222
Distronic* menu .....	163	(USA only) .....	202	Adjusting air volume .....	223
Vehicle status message		Deactivating the climate control		Front defroster .....	223
memory menu .....	164	system .....	206	Maximum cooling MAX COOL .....	224
Settings menu .....	165	Operating the climate control		Air recirculation mode .....	224
Trip computer menu .....	180	system in automatic mode .....	206	Air conditioning .....	227
TEL menu* .....	181	Setting the temperature .....	207	Residual heat and ventilation	
Automatic transmission .....	184	Adjusting air distribution .....	208	(Canada only) .....	228
Gear selector lever position .....	186	Adjusting air volume .....	209	Rear climate control .....	229
Driving tips .....	187	Front defroster .....	209	Power windows .....	231
Gear ranges .....	188	Air recirculation mode .....	210	Opening and closing	
Automatic shift program .....	189	Air conditioning .....	212	the windows .....	231
Gear selector lever one-touch		Rear passenger compartment		Synchronizing power windows .....	233
gearshifting .....	190	adjustable air vents .....	213	Summer opening feature .....	234
Steering wheel gearshift control				Convenience closing feature .....	234
one-touch gearshifting E 55 AMG .....	191			Power tilt/sliding sunroof* .....	236
Manual shift program E 55 AMG .....	193			Opening and closing the power	
Emergency operation				tilt/sliding sunroof .....	236
(Limp Home Mode) .....	196			Synchronizing the power	
				tilt/sliding sunroof .....	238

# Contents

Driving systems .....	239		
Cruise control.....	239		
Distronic* .....	243		
Airmatic DC (Dual Control)* .....	255		
Loading .....	260		
Split rear bench seat .....	260		
Expanding the cargo compartment.....	262		
Loading instructions .....	263		
Cargo tie-down rings .....	264		
Cargo management system* (Canada only) .....	265		
Storage box in cargo compartment (Canada only) .....	268		
Twin roller blind.....	269		
Useful features .....	272		
Storage compartments.....	272		
Cup holders.....	274		
Ashtrays .....	277		
Cigarette lighter .....	278		
Power outlet .....	279		
Heated steering wheel* .....	279		
Floor mats .....	280		
Telephone* .....	281		
Tele Aid .....	282		
Garage door opener .....	290		
<b>Operation</b> .....	299		
The first 1 000 miles (1 500 km).....	300		
Driving instructions.....	301		
Drive sensibly – save fuel.....	301		
Drinking and driving .....	301		
Pedals .....	301		
Power assistance .....	302		
Brakes.....	302		
Driving off .....	304		
Parking.....	304		
Tires .....	305		
Hydroplaning.....	305		
Tire traction.....	306		
Tire speed rating .....	306		
Winter driving instructions .....	307		
Standing water .....	308		
Passenger compartment .....	309		
Driving abroad.....	309		
Control and operation of radio transmitter .....	309		
Catalytic converter.....	310		
Emission control .....	310		
Coolant temperature .....	311		
		At the gas station .....	312
		Refueling.....	312
		Check regularly and before a long trip .....	313
		Engine compartment .....	315
		Hood .....	315
		Engine oil .....	316
		Transmission fluid level.....	320
		Coolant level.....	321
		Batteries .....	322
		Windshield washer system and headlamp cleaning system* .....	323
		Tires and wheels.....	324
		Important guidelines .....	324
		Tire care and maintenance.....	325
		Direction of rotation.....	327
		Loading the vehicle .....	327
		Recommended tire inflation pressure.....	333
		Checking tire inflation pressure ...	335
		MO <i>Extended</i> system* .....	340
		Tire labeling .....	340
		Load identification .....	344
		DOT, Tire Identification Number (TIN) .....	345
		Maximum tire load .....	346

Maximum tire inflation pressure ..	347		
Uniform Tire Quality Grading Standards (U.S. vehicles) .....	348		
Tire ply material .....	350		
Tire and loading terminology .....	350		
Rotating tires .....	353		
Winter driving .....	355		
Winter tires .....	355		
Block heater* (Canada only) .....	356		
Snow chains.....	356		
Maintenance.....	358		
Maintenance service indicator message.....	358		
Calling up the maintenance service indicator display.....	360		
Resetting the maintenance service indicator.....	361		
Vehicle care.....	362		
Cleaning and care of vehicle .....	362		
		<b>Practical hints .....</b>	<b>371</b>
		What to do if .....	372
		Lamps in instrument cluster .....	372
		Lamp in center console.....	381
		Vehicle status messages in the multifunction display.....	383
		Where will I find ...? .....	419
		First aid kit.....	419
		Vehicle tool kit, jack and spare wheel .....	419
		Unlocking/locking in an emergency...	424
		Unlocking the vehicle.....	424
		Locking the vehicle .....	425
		Fuel filler flap emergency release .	425
		Manually unlocking the gear selector lever .....	426
		Opening/closing in an emergency .....	427
		Power tilt/sliding sunroof* .....	427
		Resetting activated head restraints....	428
		Replacing SmartKey batteries .....	429
		SmartKey .....	429
		SmartKey with KEYLESS-GO* .....	430
		Replacing bulbs.....	431
		Bulbs.....	431
		Replacing bulbs for front lamps ....	434
		Replacing bulbs for rear lamps .....	436
		Replacing wiper blades .....	437
		Removing front wiper blades .....	437
		Installing front wiper blades .....	438
		Removing rear wiper blade .....	438
		Installing rear wiper blade .....	439
		Flat tire.....	440
		Preparing the vehicle .....	440
		Sealing tires with TIREFIT .....	440
		Mounting the spare wheel .....	445
		MO <i>Extended</i> system* .....	451
		Batteries.....	452
		Disconnecting the battery .....	453
		Removing the battery .....	454
		Charging and reinstalling the battery .....	454
		Reconnecting the battery .....	455
		Jump starting.....	456
		Towing the vehicle.....	458
		Installing towing eye bolt.....	461





### ▼ Product information

Please observe the following in your own best interest:

We recommend using Genuine Mercedes-Benz parts as well as conversion parts and accessories explicitly approved by us for your vehicle model.

We have tested these parts to determine their reliability, safety and special suitability for Mercedes-Benz vehicles.

We are unable to make an assessment for other products and therefore cannot be held responsible for them, even if in individual cases an official approval or authorization by governmental or other agencies should exist. Use of such parts and accessories could adversely affect the safety, performance or reliability of your vehicle. Please do not use them.

Genuine Mercedes-Benz parts as well as conversion parts and accessories approved by us are available at your authorized Mercedes-Benz Center where you will receive comprehensive information, also on permissible technical modifications, and where proper installation will be performed.

This Operator's Manual contains a great deal of useful information. We urge you to read it carefully and familiarize yourself with the vehicle before driving.

For your own safety and longer service life of the vehicle, we urge you to follow the instructions and warnings contained in this manual. Ignoring them could result in damage to the vehicle or personal injury to you or others. Vehicle damage caused by failure to follow instructions is not covered by the Mercedes-Benz Limited Warranty.

Your vehicle may have some or all of the equipment described in this manual. Therefore, you may find explanations for optional equipment not installed in your vehicle. If you have any questions about the operation of any equipment, your authorized Mercedes-Benz Center will be glad to demonstrate the proper procedures.

We continuously strive to improve our product, and ask for your understanding that we reserve the right to make changes in design and equipment. Therefore, information, illustrations and descriptions in this Operator's Manual might differ from your vehicle.

Optional equipment is also described in this manual, including operating instructions wherever necessary. Since they are special-order items, the descriptions and illustrations herein may vary slightly from the actual equipment of your vehicle.

If there are any equipment details that are not shown or described in this Operator's Manual, your authorized Mercedes-Benz Center will be glad to inform you of correct care and operating procedures. The Operator's Manual and Maintenance Booklet are important documents and should be kept with the vehicle.

### Service and warranty information

---

The Service and Warranty Information Booklet contains detailed information about the warranties covering your Mercedes-Benz, including:

- New Car Limited Warranty
- Emission System Warranty
- Emission Performance Warranty
- California, Maine, Massachusetts, and Vermont Emission Control System Warranty (California, Maine, Massachusetts, and Vermont only)
- State Warranty Enforcement Laws (Lemon Laws)

### **Important notice for California retail buyers and lessees of Mercedes-Benz automobiles**

Under California law you may be entitled to a replacement of your vehicle or a refund of the purchase price or lease price, if Mercedes-Benz USA, LLC and / or its authorized repair or service facilities fail to fix one or more substantial defects or malfunctions in the vehicle that are covered by its express warranty after a reasonable number of repair attempts. During the period of 18 months from original delivery of the vehicle or the accumulation of 18000 miles (approximately 29000 km) on the odometer of the vehicle, whichever occurs first, a reasonable number of repair attempts is presumed for a retail buyer or lessee if one or more of the following occurs:

- (1) the same substantial defect or malfunction results in a condition that is likely to cause death or serious bodily injury if the vehicle is driven, that defect or malfunction has been subject to repair two or more times, and you have directly notified Mercedes-Benz USA, LLC in writing of the need for its repair,
- (2) the same substantial defect or malfunction of a less serious nature than category (1) has been subject to repair four or more times and you have directly notified us in writing of the need for its repair, or
- (3) the vehicle is out of service by reason of repair of the same or different substantial defects or malfunctions for a cumulative total of more than 30 calendar days.

Written notification should be sent to us, not a dealer, at Mercedes-Benz USA, LLC, Customer Assistance Center, One Mercedes Drive, Montvale, NJ 07645-0350.

#### Maintenance

---

The Maintenance Booklet describes all the necessary maintenance work which should be performed at regular intervals.

Always have the Maintenance Booklet with you when you take the vehicle to your authorized Mercedes-Benz Center for service. The service advisor will record each service in the booklet for you.

#### Roadside Assistance

---

The Mercedes-Benz Roadside Assistance Program provides factory trained technical help in the event of a breakdown. Calls to the toll-free Roadside Assistance number

**1-800-FOR-MERCEdes (in the USA)**  
**1-800-387-0100 (in Canada)**

will be answered by Mercedes-Benz Customer Assistance Representatives 24 hours a day, 365 days a year.

For additional information refer to the Mercedes-Benz Roadside Assistance Program brochure in your vehicle literature portfolio.

#### Change of address or ownership

---

If you change your address, be sure to send in the "Change of Address Notice" found in the Service and Warranty Information Booklet, or simply call the Mercedes-Benz Customer Assistance Center (in the USA) at 1-800-FOR-MERCEdes, or Customer Service (in Canada) at 1-800-387-0100. It is in your own interest that we can contact you should the need arise.

If you sell your Mercedes, please leave all literature with the vehicle to make it available to the next operator.

If you bought this vehicle used, be sure to send in the "Notice of Purchase of Used Car" found in the Service and Warranty Information Booklet, or call the Mercedes-Benz Customer Assistance Center (in the USA) at 1-800-FOR-MERCEdes, or Customer Service (in Canada) at 1-800-387-0100.

## Operating your vehicle outside the USA or Canada

---

If you plan to operate your vehicle in foreign countries, please be aware that:

- service facilities or replacement parts may not be readily available,
- unleaded gasoline for vehicles with catalytic converters may not be available; the use of leaded fuels will damage the catalyts,
- gasoline may have a considerably lower octane rating, and improper fuel can cause engine damage.

Certain Mercedes-Benz models are available for delivery in Europe under our European Delivery Program. For details, consult your authorized Mercedes-Benz Center or write to:

In the USA:

Mercedes-Benz USA, LLC  
European Delivery Department  
One Mercedes Drive  
Montvale, NJ 07645-0350

In Canada:

Mercedes-Benz Canada, Inc.  
European Delivery Department  
98 Vanderhoof Avenue  
Toronto, Ontario M4G 4C9

### Where to find it

This Operator's Manual is designed to provide comprehensive support information for you, the vehicle operator. Each section has its own reference color.

#### At a glance

Here you will find an overview of all the controls that can be operated from the driver's seat.

#### Getting started

Here you will find all the information you need for your first drive. You should read this section first if this is your first Mercedes-Benz vehicle or if you are renting or borrowing this vehicle.

#### Safety and Security

Here you will find descriptions of the safety and security features of your vehicle.

#### Controls in detail

Here you will find detailed information about the equipment installed in your vehicle. This section expands on the "Getting started" section and also describes technical innovations. If you are already familiar with the basic functions of your vehicle, this section will be of particular interest to you.

#### Operation

Here you will find all the information you need for the proper operation of your vehicle.

#### Practical hints

This section provides fast assistance for dealing with problems you may encounter.

#### Technical data

All important technical data for your vehicle can be found in this section.

#### Indexes

The glossary provides explanations of the most important technical terms.

The table of contents and the index are designed to help you find information quickly and easily.

The following publications are part of your vehicle documentation:

- this Operator's Manual
- the Maintenance Booklet

Separate operating instructions will be provided as required depending on the equipment options installed in your vehicle.

## ▼ Symbols

Registered trademarks<sup>®</sup>:

- ESP<sup>®</sup> is a registered trademark of DaimlerChrysler.
- HomeLink<sup>®</sup> is a registered trademark of Prince, a Johnson Controls Company.

The following symbols are found in this Operator's Manual:

- \* Optional equipment is identified with an asterisk. Since standard equipment varies between models, the descriptions and illustrations in this manual may differ slightly from the actual equipment of your vehicle.

### Warning!



Warning notices draw your attention to hazards that may endanger your health or life, or the health or life of others.



Highlights hazards that may result in damage to your vehicle.



Helpful hints or further information you may find useful.

- ▶ This symbol points to instructions for you to follow.
- ▶ A number of these symbols appearing in succession indicates a multiple-step procedure.
- ▷ Page This symbol tells you where to look for further information on a topic.
- ▷▷ This continuation symbol marks an interrupted procedure which will be continued on the next page.
- > In the glossary of technical terms, this symbol is used to indicate cross-references to term definitions.
- Display Words appearing in the multi-function display are printed in the type shown here.



#### Warning!



Work improperly carried out on electronic components and associated software could cause them to cease functioning. Because the vehicle's electronic components are interconnected, any modifications made may produce an undesired effect on other systems. Electronic malfunctions could seriously impair the operating safety of your vehicle.

See your authorized Mercedes-Benz Center for repairs or modifications to electronic components.

Other improper work or modifications on the vehicle could also have a negative impact on the operating safety of the vehicle.

Some safety systems only function while the engine is running. You should therefore never turn off the engine while driving.

#### Warning!



Heavy blows against the vehicle underbody or tires / wheels, for example when running over an obstacle, road debris or a pothole, may cause serious damage to and impair the operating safety of your vehicle. If you feel a sudden strong vibration or ride disturbance, or you suspect that damage to your vehicle has occurred, you should turn on your hazard warning flashers, carefully slow down, and drive with caution to an area which is a safe distance from the road.

Inspect the vehicle underbody and tires / wheels for possible damage. If the vehicle appears unsafe, have it towed to the nearest authorized Mercedes-Benz Center or other qualified maintenance or repair facility for further inspection or repairs.

#### Proper use of the vehicle

Proper use of the vehicle requires that you are familiar with the following information and rules:

- the safety precautions in this manual
- the “Technical data” section in this manual
- traffic rules and regulations
- motor vehicle laws and safety standards

#### Warning!



Various warning labels are attached to your vehicle. These warning labels are intended to make you and others aware of various risks. You should not remove any of these warning labels unless explicitly instructed to do so by information on the label itself. Removal of any of these labels may cause you and others to be unaware of certain risks which may result in an accident and/or personal injury.

### ▼ Problems with your vehicle

If you should experience a problem with your vehicle, particularly one that you believe may affect its safe operation, we urge you to immediately contact an authorized Mercedes-Benz Center to have the problem diagnosed and corrected if required. If the matter is not handled to your satisfaction, please discuss the problem with the Mercedes-Benz Center management, or if necessary contact us at one of the following addresses:

In the USA:

Customer Assistance Center  
Mercedes-Benz USA, LLC  
One Mercedes Drive  
Montvale, NJ 07645-0350

In Canada:

Customer Relations Department  
Mercedes-Benz Canada, Inc.  
98 Vanderhoof Avenue  
Toronto, Ontario M4G 4C9

### Reporting safety defects

For the USA only:

The following text is published as required of manufacturers under Title 49, Code of U.S. Federal Regulations, Part 575 pursuant to the “National Traffic and Motor Vehicle Safety Act of 1966.”

#### **Reporting safety defects**

---

If you believe that your vehicle has a defect which could cause a crash or could cause injury or death, you should immediately inform the National Highway Traffic Safety Administration (NHTSA) in addition to notifying Mercedes-Benz USA, LLC.

If NHTSA receives similar complaints, it may open an investigation, and if it finds that a safety defect exists in a group of vehicles, it may order a recall and remedy campaign. However, NHTSA cannot become involved in individual problems between you, your dealer, or Mercedes-Benz USA, LLC.

To contact NHTSA, you may either call the Auto Safety Hotline toll-free at 1-888-327-4236 (or 366-0123 in Washington, D.C. area) or write to: NHTSA, U.S. Department of Transportation, Washington, D.C. 20590. You can also obtain other information about motor vehicle safety from the Hotline.

## ▼ Vehicle data recording

### Information regarding electronic recording devices

---

(Including notice pursuant to California Code § 9951)

Please note that your vehicle is equipped with devices that can record vehicle systems data and, if equipped with the Tele Aid system, may transmit some data in certain accidents.

This information helps, for example, to diagnose vehicle systems after a collision and to continuously improve vehicle safety. DaimlerChrysler may access the information and share it with others

- for safety research or vehicle diagnosis purposes
- with the consent of the vehicle owner or lessee
- in response to an official request by law enforcement or other government agency
- for use in dispute resolution involving DaimlerChrysler, its affiliates or sales/service organization and/or
- as otherwise required or permitted by law.

Please check the Tele Aid subscription service agreement for details regarding the information that may be recorded or transmitted via that system.



## At a glance

Cockpit

Instrument cluster

Multifunction steering wheel

Center console

Overhead control panel

Storage compartments

Door control panel



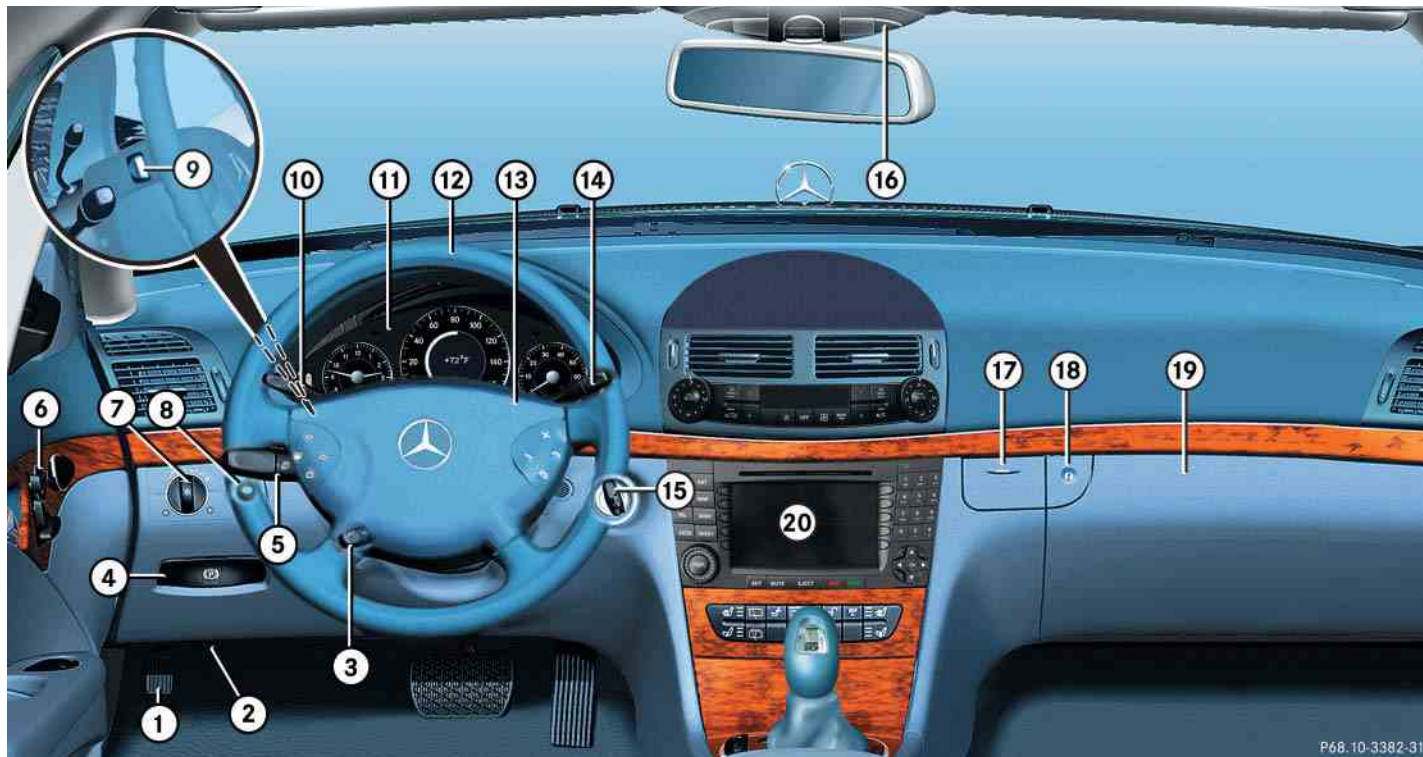

P68.10-3382-31

Item	Page
① Parking brake pedal	52, 60
② Hood lock release	315
③ Steering wheel adjustment stalk	43
Heated steering wheel*	279
④ Parking brake release	52
⑤ Combination switch	
• Turn signals	54
• Windshield wipers	55
• High beam	54
⑥ Door control panel	32
⑦ Exterior lamp switch	143

Item	Page
⑧ Headlamp washer button*	197
⑨ Steering wheel gearshift control (E55 AMG only)	191
⑩ Cruise control lever	
• Cruise control	239
• Distronic*	243
⑪ Instrument cluster	24, 151
⑫ Multifunction steering wheel	26, 156
⑬ Horn	
⑭ Lever for voice control system*, see separate operating instructions	





Item	Page
⑮ Starter switch	36
⑯ Overhead control panel	29
⑰ Mobile phone/Glasses box	272
⑱ Glove box lid release, glove box lock	272
⑲ Glove box	272
⑳ Center console	27













Instrument cluster



P54.30-8030-31





Item	Page
①  Left turn signal indicator lamp	
②  ABS/ESP <sup>®</sup> warning lamp	373
③ <b>Speedometer</b>	
④ <b>Multifunction display</b>	155
⑤  Distance warning lamp	377
Vehicles without DISTRONIC*: Warning lamp without function. It illuminates when the ignition is on. It should go out when the engine is running.	
⑥  Right turn signal indicator lamp	
⑦ <b>Coolant temperature indicator with:</b>	152
 Coolant temperature warning lamp	376

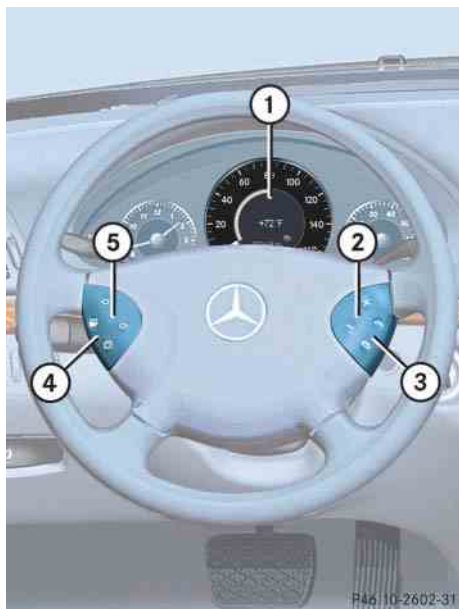

Item	Page
⑧ <b>Tachometer with:</b>	
 Supplemental Restraint System (SRS) indicator lamp	380
 Antilock Brake System (ABS) indicator lamp	372
 Seat belt telltale	377
 Low beam headlamp indicator lamp	54
 High beam headlamp indicator lamp	147
⑨ <b>Main odometer with:</b>	
• Gear selector lever position	50
• Program mode	189
⑩ <b>Clock with:</b>	170
 Brake warning lamp, USA only	374
 Brake warning lamp, Canada only	374

Item	Page
 Engine malfunction indicator lamp, USA only	375
 Engine malfunction indicator lamp, Canada only	375
 Combination low tire pressure/TPMS malfunction telltale*	378
⑪ <b>Fuel display with:</b>	
 Fuel reserve warning lamp	377
⑫ <b>Reset button for:</b>	
• Resetting trip odometer	153
• Adjusting instrument cluster illumination	151
• Confirming new time settings	170

## Multifunction steering wheel



Item	Page
① Multifunction display in speedometer	155
<b>Operating control system</b>	156
② Selecting the submenu or setting the volume: Press button	
 up/to increase	
 down/to decrease	
③ Telephone*: Press button	
 to take a call to dial a call	
 to end a call to reject an incoming call	

Item	Page
④ Menu systems: Press button	
 for next menu	
 for previous menu	
⑤ Moving within a menu: Press button	
 for next display	
 for previous display	

## ▼ Center console

## Upper part



Item	Page
① Dual-zone automatic climate control, USA only	202
4-zone automatic climate control*	214
② COMAND system, see separate operating instructions	
③ Seat heating*, front passenger side	135
Seat ventilation*, front passenger side	136
④ Electronic Stability Program (ESP®) control switch	95
⑤ Central locking switch	128

Item	Page
⑥ Opening/closing button for storage tray or CD changer*, see separate operating instructions	272
⑦ Rear seat head restraints switch, folding down	129
⑧ Rear window wiper	57
⑨ Seat heating*, driver's side	135
Seat ventilation*, driver's side	136
⑩ Hazard warning flasher switch	147
⑪ Front passenger front air bag off indicator lamp	84

## Center console

### Lower part

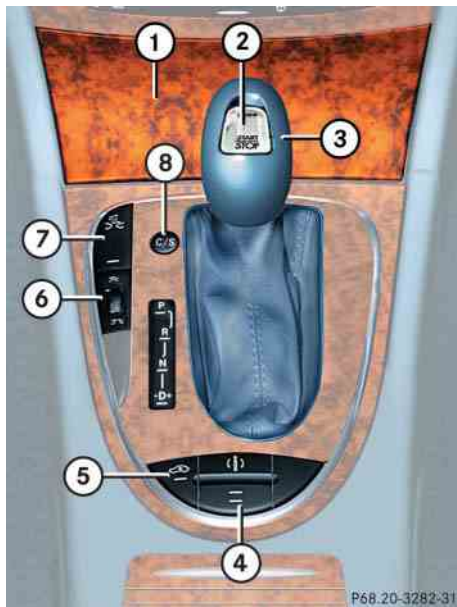

Item	Page
① Ashtray	277
② KEYLESS-GO* start/stop button	38
③ Gear selector lever for automatic transmission	50, 184
④ Adaptive Damping System (ADS)* switch	255

Item	Page
⑤ Vehicle level control switch*	256
⑥ Thumbwheel for setting distance for DISTRONIC*	251
⑦ Distance warning function* on/off switch	252
⑧ Program mode selector switch for automatic transmission	189

## Overhead control panel

## ▼ Overhead control panel

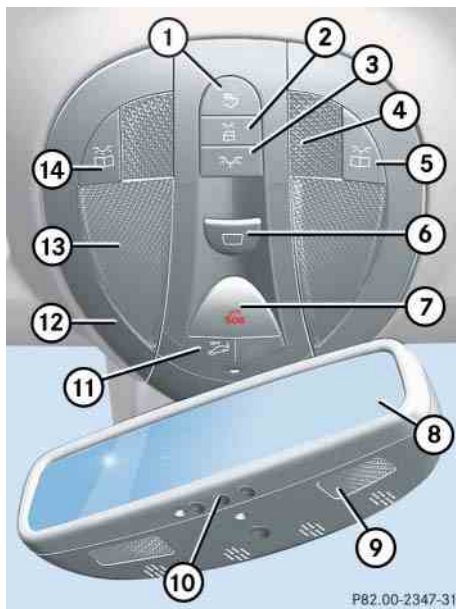

P82.00-2347-31

Item	Page
① Rear interior lighting on/off	150
② Automatic interior lighting	148
③ Front interior lighting on/off	148
④ Temperature sensor	
⑤ Right reading lamp on/off	149
⑥ Tilt/sliding sunroof*	236
⑦ Tele Aid (emergency call system) button	282

Item	Page
⑧ Rear view mirror	197
⑨ Reading lamps	148
⑩ Garage door opener	290
⑪ Tow-away alarm button	103
⑫ Ambient lighting	174
⑬ Interior lighting	
⑭ Left reading lamp on/off	149

Storage compartments

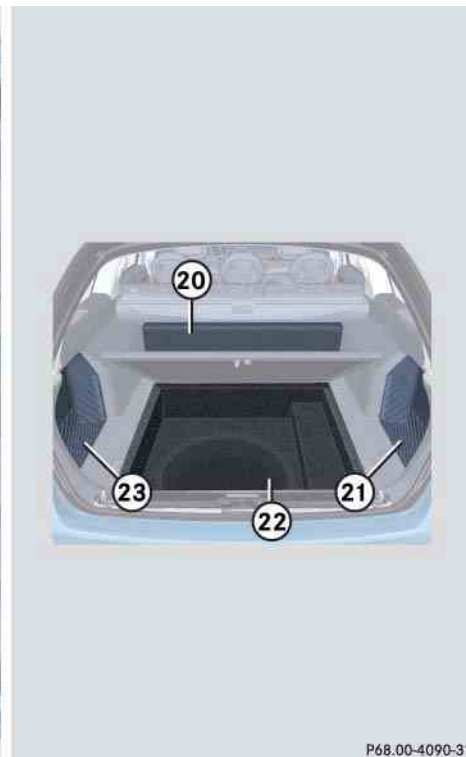
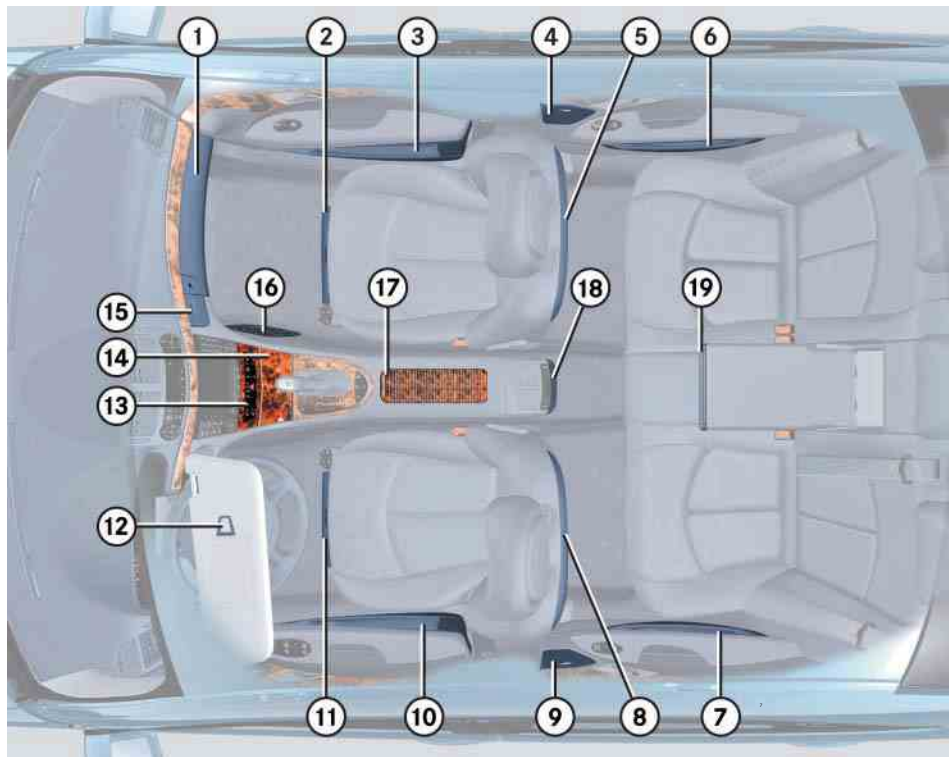

P68.00-4090-31

	Item	Page
①	Glove box	272
②	Front passenger seat storage compartment with first aid kit	419
③	Door pocket	
④	Ashtray	278
⑤	Ruffled storage bag	273
⑥	Door pocket	
⑦	Door pocket	
⑧	Ruffled storage bag	273
⑨	Ashtray	278
⑩	Door pocket	
⑪	Driver's seat storage compartment	419
⑫	Sun visor card clip	
⑬	Storage tray or CD changer*	272

	Item	Page
⑭	Ashtray with cigarette lighter	278
⑮	Mobile phone/Glasses box	272
⑯	Parcel net in front passenger footwell	274
⑰	Storage compartment with cup holders	275
⑱	Rear storage compartment in the rear center console	273
⑲	Cup holder in the rear armrest	276
⑳	Storage box, Canada only	268
㉑	Storage compartment*	
㉒	Luggage box (Vehicles without foldable third row, E 55 AMG only)	
㉓	Storage compartment*	



### Door control panel

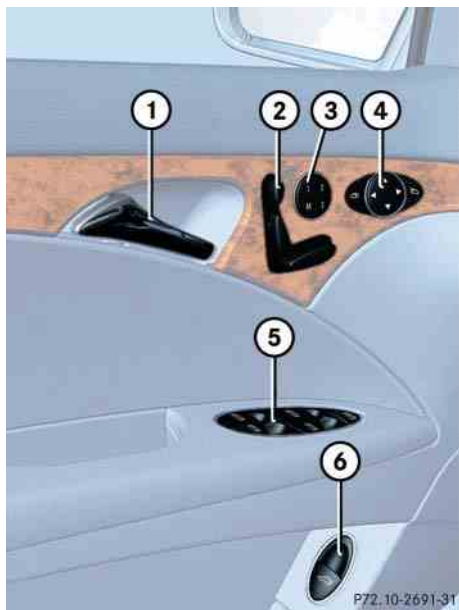

	Item	Page
①	Door handle	119
②	Seat adjustment	41
③	Memory function (for storing seat, exterior mirror and steering wheel settings)	140
④	Exterior rear view mirror adjustment	45
⑤	Switches for opening/closing front and rear side windows, rear window override switch	231
⑥	Remote tailgate release switch, Tailgate opening system*	121

Unlocking

Adjusting

Driving

Parking and locking

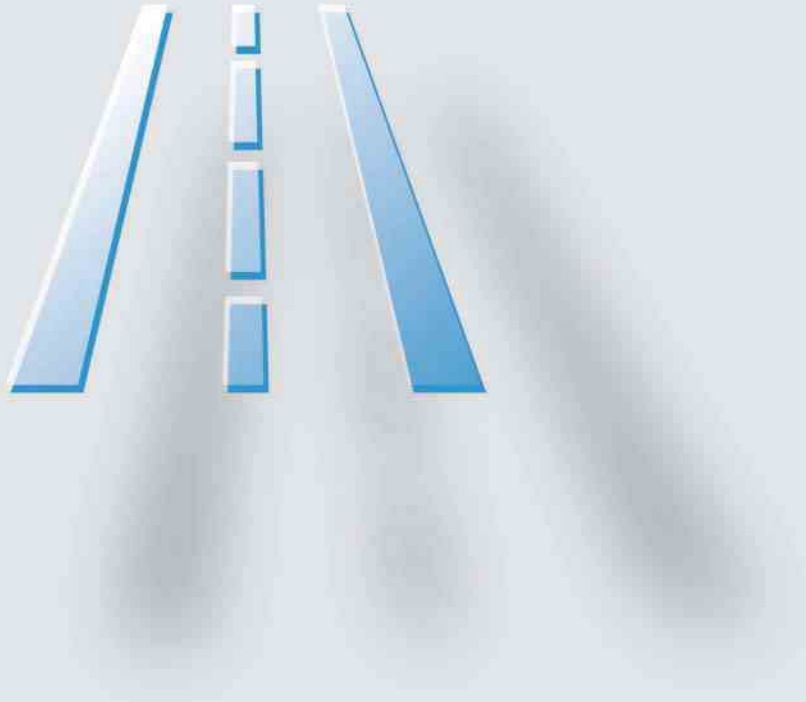

### Unlocking





The “Getting started” section provides an overview of the vehicle’s most basic functions.

If you are already familiar with the basic functions described here, the “Controls in detail” section will provide you with further information. The corresponding page references are located at the end of each segment.

#### Unlocking with the SmartKey



#### SmartKey with remote control

- ①  Lock button
- ②  Unlock button for tailgate\*
- ③  Unlock button
- ④  PANIC (▷ page 90)

#### Warning!



When leaving the vehicle, always remove the SmartKey from the starter switch, take it with you, and lock the vehicle. Do not leave children unattended in the vehicle, or with access to an unlocked vehicle. Unsupervised use of vehicle equipment may cause an accident and/or serious personal injury.

- ▶ Press unlock button  on the SmartKey.
  - All turn signal lamps flash once.
  - An acoustic signal sounds once (if equipped and feature activated). For more information, see “Factory setting” (▷ page 108).
  - The locking knobs in the doors move up.
  - The anti-theft alarm system is disarmed.



The electrohydraulic brake system is activated (▷ page 96).

- ▶ Get in the vehicle and insert the SmartKey in the starter switch.

For more information, see “Locking and unlocking” (▷ page 106).

### Unlocking with KEYLESS-GO\*

With the KEYLESS-GO function, you can lock and unlock the vehicle without using the remote control buttons on the SmartKey and start the engine without inserting the SmartKey in the starter switch.



To unlock the vehicle, the SmartKey with KEYLESS-GO must be outside the vehicle, no further than approximately 3 feet (1 meter) away from the door.

### Warning!



When leaving the vehicle, always take the SmartKey with KEYLESS-GO with you, and lock the vehicle. Do not leave children unattended in the vehicle, or with access to an unlocked vehicle. Unsupervised use of vehicle equipment may cause an accident and/or serious personal injury.

- ▶ Pull an outside door handle.

- All turn signal lamps flash once.
- An acoustic signal sounds once (if equipped and feature activated). For more information, see “Factory setting” (▷ page 114).
- The locking knobs in the doors move up.
- The anti-theft alarm system is disarmed.



The electrohydraulic brake system is activated (▷ page 96).

- ▶ Get in the vehicle.

For more information, see “SmartKey with KEYLESS-GO\*” (▷ page 111).

#### Starter switch positions

##### Warning!



When leaving the vehicle, always remove the SmartKey or SmartKey with KEYLESS-GO\* from the starter switch, take it with you, and lock the vehicle. Do not leave children unattended in the vehicle, or with access to an unlocked vehicle. Unsupervised use of vehicle equipment may cause an accident and/or serious personal injury.

#### SmartKey



#### Starter switch

- 0** For removing SmartKey
- 1** Power supply for some electrical consumers, such as seat adjustment

**2** Ignition (power supply for all electrical consumers) and driving position.

All lamps (except low beam headlamp indicator lamp, high beam headlamp indicator lamp, and turn signal indicator lamps unless activated) in the instrument cluster come on. If a lamp in the instrument cluster fails to come on when the ignition is switched on, have it checked and replaced if necessary. If a lamp in the instrument cluster remains on after starting the engine or comes on while driving, refer to “Lamps in instrument cluster” (▷ page 372).

**3** Starting position



When you switch on the ignition, the indicator and warning lamps (except low beam headlamp indicator lamp, high beam headlamp indicator lamp, and turn signal indicator lamps unless activated) in the instrument cluster come on. The indicator and warning lamps (except low beam headlamp indicator lamp, high beam headlamp indicator lamp, and turn signal indicator lamps if activated) should go out when the engine is running. This indicates that the respective systems are operational.



The SmartKey can only be removed from the starter switch with the gear selector lever in position **P**.



If the SmartKey cannot be turned in the starter switch, the starter battery may not be sufficiently charged.

- Check the battery and charge it if necessary (▷ page 429).
- Get a jump start (▷ page 456).

To prevent accelerated battery discharge or a completely discharged battery, always remove the SmartKey from the starter switch when the engine is not in operation.

For information on starting the engine using the SmartKey, see “Starting with the SmartKey” (▷ page 50).

### SmartKey with KEYLESS-GO\*

Pressing the KEYLESS-GO start/stop button on the gear selector lever corresponds to turning the SmartKey to the various starter switch positions.

If you firmly depress the brake pedal during pressing the KEYLESS-GO start/stop button, the engine starts automatically.



The function of the SmartKey overrules the KEYLESS-GO function.

### Unlocking

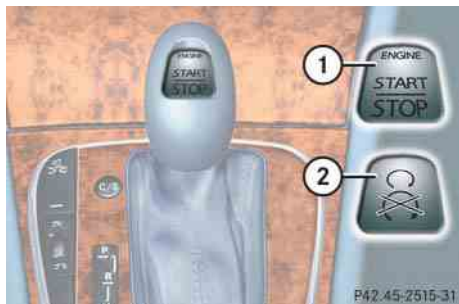

#### KEYLESS-GO start/stop button

- ① USA only
- ② Canada only

The SmartKey with KEYLESS-GO must be located in the vehicle.

- ▶ Make sure the gear selector lever is set to **P**.
- ▶ Do not depress the brake pedal.

#### Position 0

Before you press the KEYLESS-GO start/stop button, the vehicle's on-board electronics have status **0** (as with SmartKey removed).

#### Position 1

- ▶ Press KEYLESS-GO start/stop button once.

This supplies power for some electrical consumers, such as seat adjustment.



If you now press the KEYLESS-GO start/stop button

- once again, the ignition (position **2**) is switched on.
- twice, the power supply is again switched off.

#### Ignition (or position 2)

- ▶ Press KEYLESS-GO start/stop button twice.

This supplies power for all electrical consumers. All lamps in the instrument cluster (except low beam headlamp indicator lamp, high beam headlamp indicator lamp, and turn signal indicator lamps unless activated) come on. If a lamp in the instrument cluster fails to come on when the ignition is switched on, have it checked and replaced if necessary. If a lamp in the instrument cluster remains on after starting the engine or comes on while driving, see "Lamps in instrument cluster" (▶ page 372).



If you now press the KEYLESS-GO start/stop button once, the power supply is again switched off.



When you switch on the ignition, the indicator and warning lamps (except low beam headlamp indicator lamp, high beam headlamp indicator lamp, and turn signal indicator lamps unless activated) in the instrument cluster come on. The indicator and warning lamps (except low beam headlamp indicator lamp, high beam headlamp indicator lamp, and turn signal indicator lamps if activated) should go out when the engine is running. This indicates that the respective systems are operational.

For information on starting the engine using the KEYLESS-GO start/stop button, see “Starting with KEYLESS-GO\*” (▷ page 51).



### Adjusting

#### Warning!



All seat, head restraint, steering wheel, and rear view mirror adjustments, as well as fastening of seat belts, must be done before the vehicle is put into motion.

### Seats

#### Warning!



Do not adjust the driver's seat while driving. Adjusting the seat while driving could cause the driver to lose control of the vehicle.

Never ride in a moving vehicle with the seat backrest in an excessively reclined position as this can be dangerous. You could slide under the seat belt in a collision. If you slide under it, the belt would apply force at the abdomen or neck. That could cause serious or fatal injuries. The seat back and seat belts provide the best restraint when the wearer is in a nearly upright position and belts are properly positioned on the body.

Your seat must be adjusted so that you can correctly fasten your seat belt (▷ page 47).

Never place hands under the seat or near any moving parts while a seat is being adjusted.

#### Warning!



When leaving the vehicle, always remove the SmartKey or the SmartKey with KEYLESS-GO\* from the starter switch, take it with you, and lock the vehicle.

Even with the SmartKey or the SmartKey with KEYLESS-GO\* removed from the starter switch or the SmartKey with KEYLESS-GO\* removed from the vehicle, the power seats can be operated when the respective door is open. Therefore, do not leave children unattended in the vehicle, or with access to an unlocked vehicle. Unsupervised use of vehicle equipment may cause an accident and/or serious personal injury.

#### Warning!



According to accident statistics, children are safer when properly restrained in the rear seating positions than in the front seating position. Thus, we strongly recommend that children be placed in the rear seats. Regardless of seating position, children 12 years old and under must be seated and properly secured in an appropriate infant or toddler restraint, or booster seat recommended for the size and weight of the child. For additional information, see "Children in the vehicle" (▷ page 77).

A child's risk of serious or fatal injuries is significantly increased if the child restraints are not properly secured in the vehicle and the child is not properly secured in the child restraint.

## Seat adjustment

The seat adjustment switches are located on the front doors.

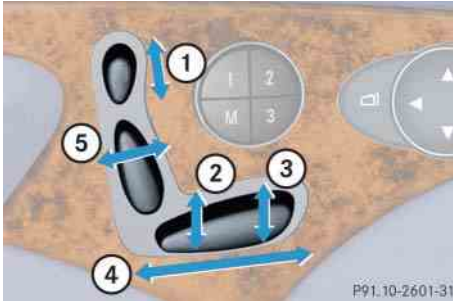

- ① Head restraint height
- ② Seat height
- ③ Seat cushion tilt
- ④ Seat fore and aft adjustment
- ⑤ Backrest tilt

- ▶ Switch on the ignition (▷ page 36).  
or
- ▶ Open the respective door.



The memory function (▷ page 140) lets you store the settings for the seat position together with the settings for the steering wheel and the exterior rear view mirrors.

## Seat fore and aft adjustment

- ▶ Press the switch forward or backward in direction of arrow ④.

Adjust a comfortable seating position that still allows you to reach the accelerator/brake pedal safely. The position should be as far to the rear as possible, consistent with ability to properly operate controls.



When moving the seat, make sure there are no items in the footwell or behind the seats. Otherwise you could damage the seats.

## Seat cushion tilt

- ▶ Press the switch up or down in direction of arrow ③ until your upper legs are lightly supported.

## Backrest tilt

- ▶ Press the switch forward or backward in direction of arrow ⑤ until your arms are slightly angled when holding the steering wheel.

## Seat height

- ▶ Press the switch up or down in direction of arrow ②.

### Adjusting

#### Head restraint height

- ▶ Press the switch up or down in direction of arrow ①.



Adjust the head restraint in such a way that it is as close to the head as possible.

#### Warning!



For your protection, drive only with properly positioned head restraints.

Adjust head restraint so that the center of the head restraint supports the back of the head at eye level. This will reduce the potential for injury to the head and neck in the event of an accident or similar situation.

Do not drive the vehicle without the seat head restraints. Head restraints are intended to help reduce injuries during an accident.

#### Head restraint tilt

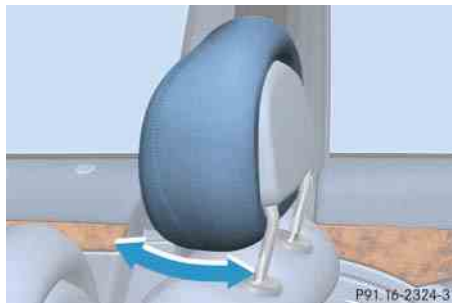

Manually adjust the angle of the head restraint.

- ▶ Push or pull on the lower edge of the head restraint cushion.



Adjust the head restraint in such a way that it is as close to the head as possible.

For more information on seats, see the “Controls in detail” section (▷ page 129).

#### Steering wheel

#### Warning!



Do not adjust the steering wheel while driving. Adjusting the steering wheel while driving could cause the driver to lose control of the vehicle.

When leaving the vehicle, always remove the SmartKey or the SmartKey with KEYLESS-GO\* from the starter switch, take it with you, and lock the vehicle.

Even with the SmartKey or the SmartKey with KEYLESS-GO\* removed from the starter switch or the SmartKey with KEYLESS-GO\* removed from the vehicle, the steering wheel adjustment feature can be operated when the driver's door is open. Therefore, do not leave children unattended in the vehicle, or with access to an unlocked vehicle. Unsupervised use of vehicle equipment may cause an accident and/or serious personal injury.

## Steering wheel adjustment

The stalk for steering wheel adjustment is located on the lower left of the steering column.

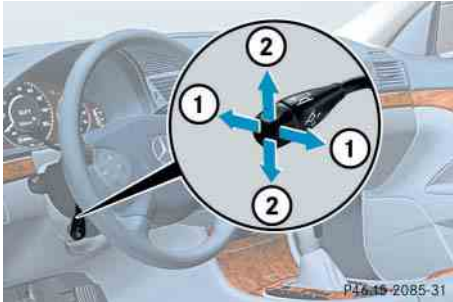

- ① Adjusting steering column, in or out
  - ② Adjusting steering column, up or down
- ▶ Switch on the ignition (▷ page 36).
- or
- ▶ Open the driver's door.

## Adjusting steering column in or out

- ▶ Move stalk in direction of arrows ① until a comfortable steering wheel position is reached with your arms slightly bent at the elbow.

## Adjusting steering column up or down

- ▶ Move stalk in direction of arrows ②. Make sure your legs can move freely and all the displays (incl. malfunction and indicator lamps) on the instrument cluster are clearly visible.



The memory function (▷ page 140) lets you store the settings for the steering wheel together with the settings for the exterior rear view mirrors and the driver's seat position.

## Easy-entry/exit feature

This feature allows for easier entry into and exit from the vehicle. When entering and exiting the vehicle, the steering wheel is in its uppermost position.

The easy-entry/exit feature can be activated or deactivated in the Convenience sub-menu of the control system (▷ page 177).

### Warning!



You must make sure no one can become trapped or injured by the moving steering wheel when the easy-entry/exit feature is activated.

To stop steering wheel movement, do one of the following:

- Move steering column stalk.
- Press one of the memory buttons or the memory button **M** (▷ page 140).



### Adjusting

- ▷▷ Do not leave children unattended in the vehicle, or with access to an unlocked vehicle. Children could open the driver's door and unintentionally activate the easy-entry/exit feature, which could result in an accident and/or serious personal injury.

With the easy-entry/exit feature activated, the steering wheel will return to its last set position when you:

- close the driver's door with the ignition switched on,  
or
- insert the SmartKey into the starter switch or press the KEYLESS-GO\* start/stop button (▷ page 38) once with the driver's door closed



The last set steering wheel position is stored when

- the ignition is switched off
- the position is stored in memory (▷ page 140)

With the easy-entry/exit feature activated, the steering wheel tilts upwards when you:

- remove the SmartKey from the starter switch,  
or
- open the driver's door with the SmartKey in starter switch position **0** or **1** or the KEYLESS-GO\* start/stop button (▷ page 38) in position **1**.



If the current position for the steering wheel is in the uppermost tilt position, the steering wheel will no longer be able to move upward when the easy-entry/exit feature is activated.

The adjustment procedure is briefly interrupted when the engine is started.

#### Warning!



Let the system complete the adjustment procedure before setting the vehicle in motion. All steering wheel adjustment must be completed before setting the vehicle in motion. Driving off with the steering wheel still adjusting could cause the driver to lose control of the vehicle.

## Mirrors

Adjust the interior and exterior rear view mirrors before driving so that you have a good view of the road and traffic conditions.

### Warning!



In case of an accident, liquid electrolyte may escape the mirror housing if the mirror glass breaks.

Electrolyte has an irritating effect. Do not allow the liquid to come into contact with eyes, skin, clothing, or respiratory system. In case it does, immediately flush affected area with water, and seek medical help if necessary.



Electrolyte drops coming into contact with the vehicle paint finish can only be completely removed while in their liquid state and by applying plenty of water.

## Interior rear view mirror

- ▶ Manually adjust the interior rear view mirror.

For more information, see “Rear view mirrors” (▷ page 197).

## Exterior rear view mirrors

### Warning!



Exercise care when using the passenger-side exterior rear view mirror. The mirror surface is convex (outwardly curved surface for a wider field of view). Objects in mirror are closer than they appear. Check your interior rear view mirror or glance over your shoulder before changing lanes.

The buttons are located on the driver's door.

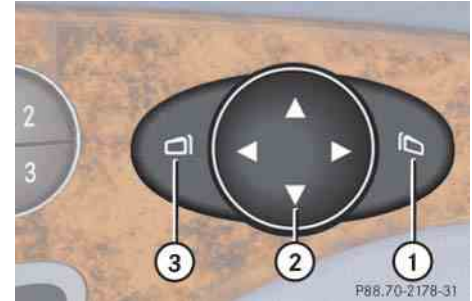

- ① Passenger-side exterior rear view mirror button
- ② Adjustment button
- ③ Driver's side exterior rear view mirror button

### Adjusting

- ▶ Switch on the ignition (▷ page 36).
- ▶ Press button ③ for the driver's side exterior rear view mirror or button ① for the passenger-side exterior rear view mirror.
- ▶ Push adjustment button ② up, down, left or right according to the desired setting.



If an exterior rear view mirror was forcibly pushed forward (hit from the rear) or forcibly pushed rearward (hit from the front), reposition it by applying firm pressure until it snaps into place. The mirror housing is now properly positioned and you can adjust the mirror normally.



The memory function (▷ page 140) lets you store the setting for the seat position together with the setting for the steering wheel and the exterior rear view mirrors.

At low ambient temperatures, the exterior rear view mirrors will be heated automatically.

For more information, see “Activating exterior rear view mirror parking position” (▷ page 198).

For more information, see “Rear view mirrors” (▷ page 197).

## ▼ Driving

### Warning!



Do not lay any objects in the driver's footwell. Be careful that floor mats or carpets in the driver's footwell have sufficient clearance for the pedals.

During sudden driving or braking maneuvers the objects could get caught between the pedals. You could then no longer brake or accelerate.

### Fastening the seat belts

### Warning!



Always fasten your seat belt before driving off. Always make sure all of your passengers are properly restrained, even those sitting in the rear and pregnant women.

Failure to wear and properly fasten and position your seat belt greatly increases your risk of injuries and their likely severity in an accident. You and your passengers should always wear seat belts.

If you are ever in an accident, your injuries can be considerably more severe without your seat belt properly buckled. Without your seat belt buckled, you are much more likely to hit the interior of the vehicle or be ejected from it. You can be seriously injured or killed.

In the same crash, the possibility of injury or death is lessened if you are wearing your seat belt. The air bags can only provide the protection they were designed to afford if the occupants are using their seat belts (> page 72).

### Warning!



According to accident statistics, children are safer when properly restrained in the rear seating positions than in the front seating position. Thus, we strongly recommend that children be placed in the rear seats. Regardless of seating position, children 12 years old and under must be seated and properly secured in an appropriate infant or toddler restraint, or booster seat recommended for the size and weight of the child. For additional information, see "Children in the vehicle" (> page 77).

A child's risk of serious or fatal injuries is significantly increased if the child restraints are not properly secured in the vehicle and the child is not properly secured in the child restraint.



#### Warning!



Never let more people ride in the vehicle than there are seat belts available. Be sure everyone riding in the vehicle is correctly restrained with a separate seat belt. Never use a seat belt for more than one person at a time.

#### Warning!



Never ride in a moving vehicle with the seat backrest in an excessively reclined position as this can be dangerous. You could slide under the seat belt in a collision. If you slide under it, the belt would apply force at the abdomen or neck. That could cause serious or even fatal injuries. The seat backrest and seat belt provide the best restraint when the wearer is in a nearly upright position and the belt is properly positioned on the body.

#### Warning!



Read and observe the additional warning notices printed in the “Safety and Security” section (▷ page 70) and (▷ page 73).



- ① Belt outlet
- ② Latch plate
- ③ Buckle
- ④ Release button

► With a smooth motion, pull the belt from belt outlet ①.

- ▶ Place the shoulder portion of the belt across the top of your shoulder and the lap portion across your hips.
- ▶ Push latch plate ② into buckle ③ until it clicks.
- ▶ If necessary, tighten the lap portion to a snug fit by pulling shoulder portion up.

### Belt outlet height adjustment

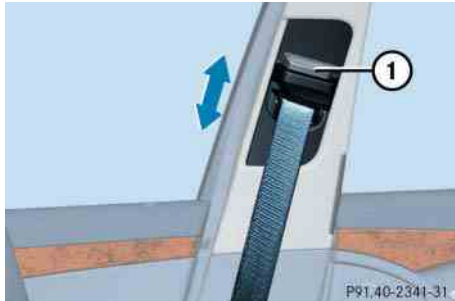

#### ① Release button

- ▶ Press release button ① and move the seat belt height adjuster upward or downward.

### Proper use of seat belts

- Do not twist the belt when fastening.
- Adjust seat belt so that the shoulder portion is located as close as possible to the middle of the shoulder (it should not touch the neck). Never pass the shoulder portion of the belt under your arm.
- Position the lap belt as low as possible on your hips (over hip joint) and not across the abdomen.
- Place the seat backrest in a nearly upright position.
- Never use a seat belt for more than one person at a time.
- Do not fasten a seat belt around a person and another object at the same time. When using a seat belt to secure infant or toddler restraints or children in booster seats, always follow the child seat manufacturer's instructions.

- Check your seat belt periodically during travel to make sure that it is properly positioned.
- Make sure that the seat belt is always fitted snugly. Take special care of this when wearing loose clothing.

### Warning!



Do not pass belts over sharp edges. They could tear.

Do not allow the belt to get caught in the door or in the seat adjustment mechanism. This could damage the belt.

Never attempt to make modifications to seat belts. This could impair the effectiveness of the belts.

Do not bleach or dye seat belts as this may severely weaken them. In a crash they may not be able to provide adequate protection.

Damaged seat belts or belts that were highly stressed in an accident must be replaced. Contact an authorized Mercedes-Benz Center.

#### Starting the engine

##### Warning!



Inhalation of exhaust gas is hazardous to your health. All exhaust gas contains carbon monoxide, and inhaling it can cause unconsciousness and possible death.

Do not run the engine in confined areas (such as a garage) which are not properly ventilated. If you think that exhaust gas fumes are entering the vehicle while driving, have the cause determined and corrected immediately. If you must drive under these conditions, drive only with at least one window fully open.

#### Automatic transmission

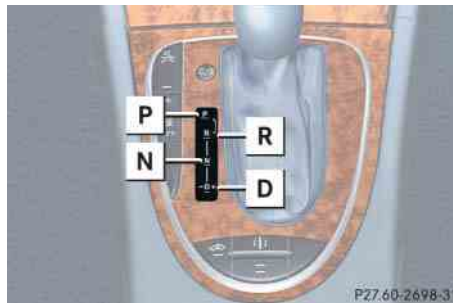

##### Gearshift pattern for automatic transmission

- P** Park position with gear selector lever lock
- R** Reverse gear
- N** Neutral
- D** Drive position

For more information, see the “Controls in detail” section (▷ page 184).

#### Starting with the SmartKey

For information on turning off the engine with the SmartKey, see “Turning off engine” (▷ page 61).

- ▶ Make sure the gear selector lever is set to **P**.
- ▶ Do not depress the accelerator.
- ▶ Turn the SmartKey in the starter switch to position **3** and hold until the engine starts (▷ page 36).



You can also use the “touch-start” function. Turn the SmartKey to position **3** and release it again immediately. The engine then starts automatically.

## Starting with KEYLESS-GO\*

### Warning!



As long as the SmartKey with KEYLESS-GO is in your vehicle, the vehicle can be started. Therefore, never leave children unattended in the vehicle, as they could otherwise accidentally start the engine.

When leaving the vehicle, always take the SmartKey with KEYLESS-GO with you and lock the vehicle. Do not leave children unattended in the vehicle, or with access to an unlocked vehicle.

You can start your vehicle without the SmartKey in the starter switch using the KEYLESS-GO start/stop button on the gear selector lever.

For information on turning off the engine with KEYLESS-GO, see “Turning off with KEYLESS-GO\*” (▷ page 61).

The SmartKey with KEYLESS-GO must be located in the vehicle.

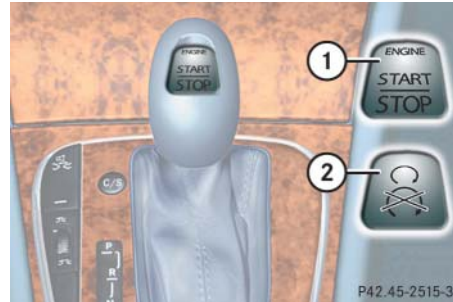

### KEYLESS-GO start/stop button

- ① USA only
- ② Canada only

- ▶ Make sure the gear selector lever is set to **P**.
  - ▶ Depress the brake pedal during the starting procedure. Do not depress accelerator.
- The gear selector lever lock is released.
- ▶ Press KEYLESS-GO start/stop button once.

The engine starts if the SmartKey with KEYLESS-GO is in the vehicle.

## Starting difficulties

If the engine does not start as described, carry out the following steps:

- ▶ If you are starting the engine with the SmartKey, turn SmartKey in starter switch to position **0** and repeat starting procedure.
  - ▶ If you are starting the engine with KEYLESS-GO: Close any doors that may be open to allow for better detection of the SmartKey with KEYLESS-GO.
- Or:
- Start the engine with the SmartKey as radio signals from another source may be interfering with the SmartKey with KEYLESS-GO.
- ▶ Repeat the starting procedure (▷ page 50). Remember that extended starting attempts can drain the battery.
  - ▶ Get a jump start (▷ page 456).

### Driving

If the engine does not start after several starting attempts, there could be a malfunction in the engine electronics or in the fuel supply system.

- ▶ Notify an authorized Mercedes-Benz Center.

#### Parking brake



- ① Parking brake pedal
- ② Release handle

- ▶ Release the parking brake by pulling on release handle ②.

The warning lamp **BRAKE** (USA only) or **(P)** (Canada only) in the instrument cluster goes out.

#### Warning!



When leaving the vehicle, always remove the SmartKey or the SmartKey with KEYLESS-GO\* from the starter switch, take it with you, and lock the vehicle. Do not leave children unattended in the vehicle, or with access to an unlocked vehicle. Children could release the parking brake, which could result in an accident and/or serious injury.

## Driving

- ▶ Depress the brake pedal.
- ▶ Move the gear selector lever to position **D** or **R**.



Wait for the gear selection process to complete before setting the vehicle in motion.

- ▶ Release the brake pedal.
- ▶ Carefully depress the accelerator pedal.

Once the vehicle is in motion, the automatic central locking system engages and the locking knobs drop down.



You can open a locked door from the inside. Open door only when conditions are safe to do so.



If you hear a warning signal and the message **Release parking brake** appears in the multifunction display when driving off, you have forgotten to release the parking brake.

Release the parking brake.

After a cold start, the automatic transmission engages at a higher revolution. This allows the catalytic converter to heat up more quickly to operating temperature.

### Warning!



On slippery road surfaces, never downshift in order to obtain braking action. This could result in drive wheel slip and reduced vehicle control. Your vehicle's ABS will not prevent this type of loss of control.

### Warning!



It is dangerous to shift the gear selector lever out of **P** or **N** if the engine speed is higher than idle speed. If your foot is not firmly on the brake pedal, the vehicle could accelerate quickly forward or in reverse. You could lose control of the vehicle and hit someone or something. Only shift into gear when the engine is idling normally and when your right foot is firmly on the brake pedal.

For more information on driving, see “Driving instructions” (▷ page 301).



Simultaneously depressing the accelerator pedal and applying the brake reduces engine performance and causes premature brake and drivetrain wear.

### Switching on headlamps

#### Low beam headlamps

The exterior lamp switch is located on the dashboard to the left of the steering wheel.



#### Exterior lamp switch

- ① Off
- ② Low beam headlamps on

- ▶ Turn the exterior lamp switch to position .

The low beam headlamp indicator lamp  in the instrument cluster comes on (▷ page 143).

#### High beam

The combination switch is located on the left of the steering column.



#### Combination switch

- ① High beam
- ② High beam flasher

- ▶ Push the combination switch in direction of arrow ①.

The high beam headlamp indicator lamp  in the instrument cluster comes on (▷ page 24).

For more information on headlamps, see “Lighting” (▷ page 143).

#### Turn signals

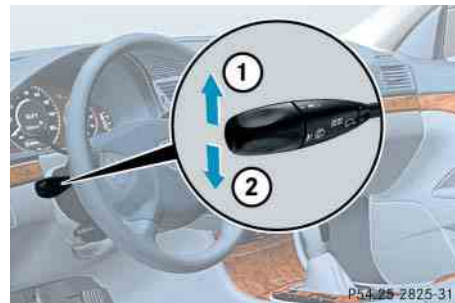

The combination switch is located on the left of the steering column.



#### Combination switch

- ① Turn signals, right
- ② Turn signals, left

- ▶ Press the combination switch in direction of arrow ① or ②.

The corresponding turn signal indicator lamp  or  in the instrument cluster flashes.

The combination switch resets automatically after major steering wheel movements.



To signal minor directional changes such as changing lanes, press the combination switch only to point of resistance and release. The corresponding turn signals will flash three times.

## Windshield wipers

The combination switch is located on the left of the steering column.



### Combination switch

- ① Single wipe  
Wiping with windshield washer fluid
  - ② Switching on windshield wipers
- Switch on the ignition (► page 36).



Do not operate the windshield wipers when the windshield is dry. Dust that accumulates on a windshield might scratch the glass and/or damage the wiper blades when wiping occurs on a dry windshield. If it is necessary to operate the windshield wipers in dry weather conditions, always operate the windshield wipers with windshield washer fluid (► page 56).

### Switching on windshield wipers

- Turn the combination switch to the desired position depending on the intensity of the rain.
- 0 Windshield wipers off
  - I Intermittent wiping
  - II Normal wiper speed
  - III Fast wiper speed



#### Intermittent wiping



Do not leave windshield wipers in intermittent setting when the vehicle is taken to an automatic car wash or during windshield cleaning. Windshield wipers will operate in the presence of water sprayed on the windshield, and windshield wipers may be damaged as a result.

Intermittent wiping interval is dependent on wetness of windshield.

- ▶ Turn the combination switch to position **I**.

After the initial wipe, pauses between wipes are automatically controlled by the rain sensor.



Intermittent wiping is interrupted when the vehicle is at a standstill and a front door is opened. This protects persons getting into or out of the vehicle from being sprayed.

Intermittent wiping will be continued when

- all doors are closed
- and
- the gear selector lever is in position **D** or **R**
- or
- the wiper setting is changed using the combination switch

#### Single wipe

- ▶ Press the combination switch briefly in direction of arrow ① to the resistance point.

The windshield wipers wipe one time without washer fluid.

#### Wiping with windshield washer fluid

- ▶ Push the combination switch in direction of arrow ① past the resistance point.

The windshield wipers operate with washer fluid.



To prevent smears on the windshield, wipe with windshield washer fluid every now and then even when it is raining.

For information on filling up the washer reservoir, see “Windshield washer system and headlamp cleaning system\*” (▷ page 323).



If anything blocks the windshield wipers (leaves, snow, etc.), switch them off immediately.

- For safety reasons, stop the vehicle in a safe location
  - remove SmartKey from starter switch
- or
- turn off the engine by pressing the KEYLESS-GO\* start/stop button and open the driver's door (with the driver's door open, starter switch is in position **0**, same as with SmartKey removed from starter switch)

before attempting to remove any blockage.

- Remove blockage.
- Turn the windshield wipers on again.

If windshield wipers fail to function at all in switch position **I**,

- set the combination switch to the next highest wiper speed
- have the windshield wipers checked at the nearest authorized Mercedes-Benz Center

## Rear window wiper/washer

The button is located on the center console.



- ① Intermittent wipe
- ② Indicator lamp
- ③ Rear window washer system



The rear window wiper engages automatically if the gear selector lever is moved to position **R** with the windshield wipers switched on.

- ▶ Switch on the ignition (▷ page 36)

### Driving

#### Activating intermittent wipe

- ▶ Press upper section ① of the button.  
Indicator lamp ② comes on.

#### Deactivating intermittent wipe

- ▶ Press upper section ① of the button again.  
Indicator lamp ② goes out.

#### Wiping with window washer fluid

- ▶ Press and hold lower half ③ of the button.  
The rear window is wiped for a further 5 seconds after the button is released.

#### Problems while driving

##### The engine runs erratically and misfires

- An ignition cable may be damaged.
  - The engine electronics may not be operating properly.
  - Unburned gasoline may have entered the catalytic converter and damaged it.
- ▶ Give very little gas.
  - ▶ Have the problem repaired by an authorized Mercedes-Benz Center as soon as possible.

##### The coolant temperature is above 248°F (120°C)

The coolant is too hot and is no longer cooling the engine.

- ▶ Stop the vehicle as soon as possible in a safe location and turn off the engine. Allow engine and coolant to cool.
- ▶ Check the coolant level and add coolant if necessary (▷ page 321).

#### In case of accident

If the vehicle is leaking fuel:

- ▶ Do not start the engine under any circumstances.
- ▶ Notify local fire and/or police authorities.

If the extent of the damage cannot be determined:

- ▶ Notify an authorized Mercedes-Benz Center.

If no damage can be determined on the

- major assemblies
  - fuel system
  - engine mount:
- ▶ Start the engine in the usual manner.

## ▼ Parking and locking

You have now completed your first drive. You have properly stopped and parked your vehicle. End your drive as follows.

### Warning!



With the engine not running, there is no power assistance for the brake and steering systems. In this case, it is important to keep in mind that a considerably higher degree of effort is necessary to brake and steer the vehicle.

### Warning!



Vehicles with Airmatic\*: If you have selected the Comfort suspension tuning (▷ page 255), the vehicle lowers slightly when it is locked. You should therefore make sure that no one is standing near the wheel arches or lying underneath the vehicle when it is being locked. Otherwise, personal injury could result.

### Warning!



Do not park this vehicle in areas where combustible materials such as grass, hay or leaves can come into contact with the hot exhaust system, as these materials could be ignited and cause a vehicle fire.

To reduce the risk of personal injury as a result of vehicle movement, before turning off the engine and leaving the vehicle always:

- Keep right foot on brake pedal.
- Firmly depress parking brake pedal.
- Move the gear selector lever to position **P**.
- Slowly release brake pedal.
- When parked on an incline, turn front wheel towards the road curb.

- Turn the SmartKey to starter switch position **0** and remove, or press start- / stop button (vehicles with KEYLESS-GO\*).
- Take the SmartKey or the SmartKey with KEYLESS-GO\* and lock vehicle when leaving.



Vehicles with Airmatic\*: If you have selected the Comfort suspension tuning (▷ page 255), the vehicle lowers slightly when you lock it within approximately 60 seconds after switching off the engine. When parking, make sure that your vehicle cannot come into contact with other objects, such as a curb, while lowering. Your vehicle could otherwise be damaged.

### Parking and locking

#### Parking brake

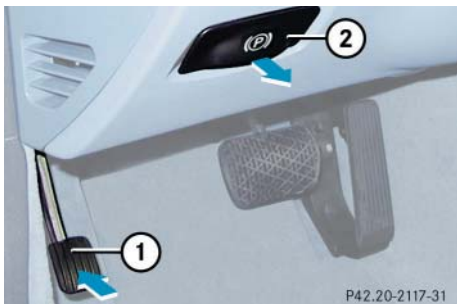

- ① Parking brake pedal
- ② Release handle

- ▶ Step firmly on parking brake pedal ①.

When the engine is running, the warning lamp **BRAKE** (USA only) or  (Canada only) in the instrument cluster will be illuminated.

#### Warning!



When leaving the vehicle, always remove the SmartKey or the SmartKey with KEYLESS-GO\* from the starter switch, take it with you and lock the vehicle. Do not leave children unattended in the vehicle, or with access to an unlocked vehicle. Children could release the parking brake and/or move the gear selector lever from position **P**, either of which could result in an accident and/or serious injury.

#### Warning!



Getting out of your vehicle with the gear selector lever not fully engaged in position **P** is dangerous. Also, when parked on an incline, position **P** alone may not prevent your vehicle from moving, possibly hitting people or objects.

Always set the parking brake in addition to shifting to position **P**.

When parked on an incline, turn front wheels towards the road curb.

### Switching off headlamps

- ▶ Turn the exterior lamp switch to **0** (▷ page 54).

For more information, see the “Controls in detail” section (▷ page 143).

### Turning off engine

- ▶ Move the gear selector lever to position **P**.
- ▶ Apply the parking brake (▷ page 60).



Always set the parking brake in addition to shifting to position **P**.

On slopes, turn the front wheels towards the road curb.

### Turning off with the SmartKey

- ▶ Turn the SmartKey in the starter switch (▷ page 36) to position **0** and remove it.  
The immobilizer is activated.



The SmartKey can only be removed from the starter switch with the gear selector lever in position **P**.

### Turning off with KEYLESS-GO\*

- ▶ Place the gear selector lever in **P**.
- ▶ Press the KEYLESS-GO start/stop button to shut off the engine.

With the driver's door closed, the starter switch is now in position **1**. With the driver's door opened, the starter switch is set to position **0**, same as SmartKey removed from starter switch (▷ page 36).



If you hear a warning signal, you have either

- forgotten to switch off the vehicle's exterior lamps before opening the driver's door,
- or
- tried to turn off the engine while the gear selector lever is not in **P**.

Turn off the lights or place the gear selector lever in **P**.

### Parking and locking

#### Releasing seat belts

- ▶ Press the seat belt release button (▷ page 48).

Allow the retractor to completely rewind the seat belt by guiding the latch plate.



Make sure the seat belt retracts fully so that the seat belt and/or latch plate cannot get caught or pinched in the door or in the seat mechanism. This can damage the seat belt and impair the effectiveness of the seat belt, and/or cause damage to the door and/or door trim panel. Such damage is not covered by the Mercedes-Benz Limited Warranty.

Damaged seat belts must be replaced. Contact an authorized Mercedes-Benz Center.

#### Locking

##### Warning!



To prevent possible personal injury, always keep hands and fingers away from the door openings when closing the doors. Be especially careful when small children are around.

Before closing doors, make sure that there is no possibility of someone getting caught in a door during closing.

##### Warning!



When leaving the vehicle, always take the SmartKey or the SmartKey with KEYLESS-GO\* with you, and lock the vehicle. Do not leave children unattended in the vehicle, or with access to an unlocked vehicle. Unsupervised use of vehicle equipment may cause an accident and/or serious personal injury.



A warning sounds and the message **Switch off lights** appears in the multifunction display if the vehicle's exterior lamps are not switched off

- with the SmartKey removed from the starter switch and the driver's door open
- with the engine turned off using the KEYLESS-GO\* start/stop button and the driver's door open (same as SmartKey removed from starter switch)

Switch off the exterior lamps.

- ▶ Exit the vehicle and close all doors and the tailgate.

### Locking with the SmartKey

- ▶ After exiting the vehicle, press lock button  on the SmartKey (▷ page 34).
  - All turn signal lamps flash three times.
  - An acoustic signal sounds three times (if equipped and feature activated).  
For more information, see “Factory setting” (▷ page 108).
  - The locking knobs in the doors move down.
  - The anti-theft alarm system is armed.

For more information, see the “Controls in detail” section (▷ page 106).

### Locking with KEYLESS-GO\*

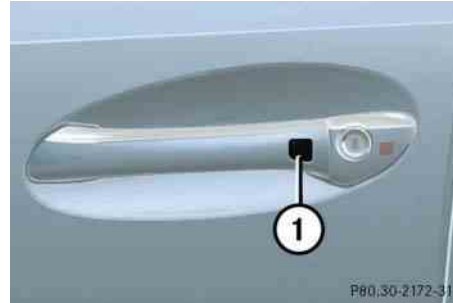

① Lock button

- ▶ After exiting the vehicle, press lock button ① on an outside door handle or on the tailgate.
  - All turn signal lamps flash three times.
  - An acoustic signal sounds three times (if equipped and feature activated).  
For more information, see “Factory setting” (▷ page 114).
  - The locking knobs in the doors move down.
  - The anti-theft alarm system is armed.

For more information, see the “Controls in detail” section (▷ page 111).





## Safety and Security

Occupant safety

Panic alarm

Driving safety systems

Anti-theft systems



### Occupant safety



In this section you will learn the most important facts about the restraint system components of the vehicle.

- Seat belts (▷ page 72)
- Child restraints (▷ page 78)
- Lower anchors and tethers for children (LATCH) (▷ page 88)

Supplemental Restraint System (SRS) with

- Air bags (▷ page 67)
- Air bag control unit (with crash sensors)
- Emergency tensioning device (ETD) for seat belts (▷ page 76)

Air bag system components with

-   indicator lamp (▷ page 84)
- Front passenger seat with Occupant Classification System (OCS) (▷ page 81)

As independent systems, their protective functions work in conjunction with each other.



For information on infants and children traveling with you in the vehicle and restraint systems for infants and children, see “Children in the vehicle” (▷ page 77).

The SRS system conducts a self-test when the ignition is switched on and in regular intervals while the engine is running. This facilitates early detection of malfunctions. The **SRS** indicator lamp in the instrument cluster lights up when the ignition is switched on and goes out no later than a few seconds after the engine has been started.

The SRS components are in operational readiness if the **SRS** indicator lamp is not lit when the engine is running.

A malfunction in the system has been detected if the **SRS** indicator lamp:

- fails to go out after approximately 4 seconds after the engine was started
- does not come on at all

- comes on after the engine was started or while driving

#### Warning!



In the event that the **SRS** indicator lamp comes on during driving or does not come on at all, the SRS self-check has detected a malfunction. For your safety, we strongly recommend that you visit an authorized Mercedes-Benz Center immediately to have the system checked; otherwise the SRS may not be activated when needed in an accident, which could result in serious or fatal injury, or it might deploy unexpectedly and unnecessarily which could also result in injury.

In addition, improper repair work on the SRS creates a risk of rendering the SRS inoperative or causing unintended air bag deployment. Work on the SRS must therefore only be performed by qualified technicians. Contact an authorized Mercedes-Benz Center.

If it is necessary to modify an air bag system to accommodate a person with disabilities, contact your local authorized Mercedes-Benz Center or call our Customer Assistance Center at 1-800-FOR-MERcedes (1-800-367-6372) for details.

## Air bags

### Warning!



Air bags are designed to reduce the potential of injury and fatality in certain frontal impacts (front air bags), side impacts (side impact air bags and head protection window curtain air bags) or rollovers (head protection window curtain air bags). However, no system available today can totally eliminate injuries and fatalities.

The activation of the air bags temporarily releases a small amount of dust from the air bags. This dust, however, is neither injurious to your health, nor does it indicate a fire in the vehicle. The dust might cause some temporary breathing difficulty for people with asthma or other breathing trouble. To avoid this, you may wish to get out of the vehicle as soon as it is safe to do so. If you have any breathing difficulty but cannot get out of the vehicle after the air bag inflates, then get fresh air by opening a window or door.

### Warning!



To reduce the risk of injury when the front air bags inflate, it is very important for the driver and front passenger to always be in a properly seated position and to wear their respective seat belts.

For maximum protection in the event of a collision always be in normal seated position with your back against the backrest. Fasten your seat belt and make sure that it is properly positioned on your body.

Since the air bag inflates with considerable speed and force, a proper seating and hands on steering wheel position will help to keep you at a safe distance from the air bag. Occupants who are unbelted, out of position or too close to the air bag can be seriously injured or killed by an air bag as it inflates with great force in the blink of an eye:

- Sit properly belted in a nearly upright position with your back against the seat backrest.



### Occupant safety



- Adjust the driver seat as far as possible rearward, still permitting proper operation of vehicle controls. The distance from the center of the driver's breastbone to the center of the air bag cover on the steering wheel must be at least 10 in (25 cm) or more. You should be able to accomplish this by a combination of adjustments to the seat and steering wheel. If you have any problems, please see your authorized Mercedes-Benz Center.
- Do not lean your head or chest close to the steering wheel or dashboard.
- Keep hands on the outside of steering wheel rim. Placing hands and arms inside the rim can increase the risk and potential severity of hand/arm injury when driver front air bag inflates.
- Adjust the front passenger seat as far as possible rearward from the dashboard when the seat is occupied.

- Occupants, especially children, should never place their bodies or lean their heads in the area of the door where the side impact air bag inflates. This could result in serious injuries or death should the air bag be triggered. Always sit nearly upright, properly use the seat belts and use an appropriately sized infant or toddler restraint or booster seat recommended for the size and weight of the child.

Failure to follow these instructions can result in severe injuries to you or other occupants.

If you sell your vehicle, it is important that you make the buyer aware of this safety information. Be sure to give the buyer this Operator's Manual.

#### Warning!



Accident research shows that the safest place for children in an automobile is in the rear seat.

It should be noted that with respect to both front and rear side impact air bags there is a possibility for a side impact air bag related injury if occupants, especially children, are not properly seated or restrained when next to a side impact air bag which needs to deploy rapidly in a side impact in order to do its job.

To help avoid the possibility of injury, please follow these guidelines:

- (1) Occupants, especially children, should never place their bodies or lean their heads in the area of the door where the side impact air bag inflates. This could result in serious injuries or death should the side impact air bag be deployed.

(2) Always sit nearly upright, properly use the seat belts and for children 12 years old and under, use an appropriately sized infant or toddler restraint or booster seat recommended for the size and weight of the child.

(3) Always wear seat belts properly.

If you believe that, even with the use of these guidelines, it would be safer for your rear seat occupants to have the rear mounted side impact air bags deactivated, then deactivation can be accomplished upon your written request to do so at your authorized Mercedes-Benz Center at an additional cost.

Please contact your local authorized Mercedes-Benz Center or call our Customer Assistance Center at 1-800-FOR-MERCEdes (1-800-367-6372) for details.



Air bags are designed to deploy only in certain frontal impacts (front air bags), side impacts (side impact and head protection window curtain air bags) which exceed preset thresholds and in certain rollovers (head protection window curtain air bags). Only during these events will they provide their supplemental protection.

The driver and passengers should always wear their seat belts. Otherwise it is not possible for air bags to provide their supplemental protection.

In case of other types of impacts and impacts below air bag deployment thresholds, air bags will not be deployed. The driver and passenger will then be protected to the extent possible by a properly fastened seat belt. A properly fastened seat belt is also needed to provide the best possible protection in a rollover.

We caution you not to rely on the presence of the air bags in order to avoid wearing your seat belt.

It is important to your safety and that of your passengers that you replace deployed air bags and repair any malfunctioning air bags to make sure that the vehicle will continue to provide supplemental crash protection for occupants.

### Occupant safety

#### Safety guidelines for the seat belt, emergency tensioning device and air bag

##### Warning!



- Damaged seat belts or belts that were highly stressed in an accident must be replaced and their anchoring points must also be checked. Use only belts installed or supplied by an authorized Mercedes-Benz Center.
- Air bags and emergency tensioning devices (ETDs) are designed to function on a one-time-only basis. An air bag or ETD that was activated must be replaced.
- No modifications of any kind may be made to any components or wiring of the SRS. This includes changing or removing any component or part of the SRS, the installation of additional trim material, badges etc. over the steering wheel hub, front passenger front air bag cover, outboard sides of the front seat backrests, door trim panels,

or door frame trims, and installation of additional electrical/electronic equipment on or near SRS components and wiring. Keep area between air bags and occupants free from objects (e.g. packages, purses, umbrellas, etc.).

- Do not pass belts over sharp edges. They could tear.
- Do not make any modification that could change the effectiveness of the belts.
- Do not bleach or dye seat belts as this may severely weaken them. In a crash they may not be able to provide adequate protection.
- Do not hang items such as coat hangers from the coat hooks or handles over the door. These items may turn into projectiles and cause head and other injuries when curtain air bag is deployed.
- Never place your feet on the instrument panel, dashboard, or on the seat. Always keep both feet on the floor in front of the seat.

- Air bag system components will be hot after an air bag has inflated. Do not touch.
- In addition, improper repair work on the SRS creates a risk of rendering the SRS inoperative or causing unintended air bag deployment. Work on the SRS must therefore only be performed by qualified technicians. Contact an authorized Mercedes-Benz Center.
- For your protection and the protection of others, when scrapping the air bag unit or emergency tensioning device, our safety instructions must be followed. These instructions are available from your authorized Mercedes-Benz Center.
- Given the considerable deployment speed, required inflation volume, and the textile structure of the air bags, there is the possibility of abrasions or other more significant injuries resulting from air bag deployment.

**Warning!**

Only use seat covers which have been tested and approved by Mercedes-Benz for your vehicle model. Using other seat covers may interfere with or prevent the deployment of the front side impact air bags. Contact your authorized Mercedes-Benz Center for availability.

When you sell your vehicle we strongly urge you to give notice to the subsequent owner that it is equipped with an SRS by alerting them to the applicable section in the Operator's Manual.

**Front air bags**

- ① Driver's air bag
- ② Passenger air bag

Driver and front passenger air bags are deployed:

- in the event of certain frontal impacts
- if impact exceeds a preset deployment threshold
- independently of the side impact air bags



The front air bags in this vehicle have been designed to inflate in two stages. This allows the air bag to have different rates of inflation that are based on the rate of relevant vehicle deceleration as assessed by the air bag control unit.

On the front passenger side, the front air bag deployment is additionally influenced by the passenger's weight category as identified by the Occupant Classification System (OCS) (> page 81).

The lighter the front passenger side occupant, the higher the vehicle deceleration rate required for the second stage inflation of the air bag.

The air bags will not deploy in impacts which do not exceed the system's deployment thresholds. You will then be protected by the fastened seat belts.



### Occupant safety

The passenger front air bag will only be deployed if:

- the system, based on OCS weight sensor readings, senses that the front passenger seat is occupied
- the **PASS AIR BAG OFF**  indicator lamp in the center console is not lit (▷ page 84)
- the impact exceeds a preset deployment threshold

### Side impact air bags, window curtain air bags

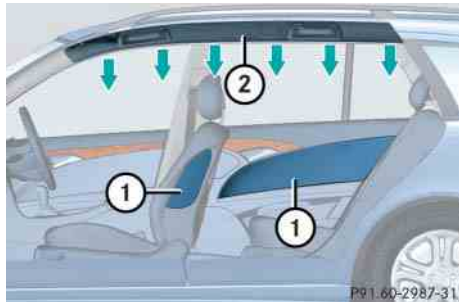

- ① Side impact air bags
- ② Window curtain air bag

The side impact air bags ① and window curtain air bags ② are deployed:

- on the impacted side of the vehicle
- in impacts exceeding a preset deployment threshold
- independently of the front air bags

In addition, the window curtain air bags ② are deployed:

- in certain vehicle rollovers

The side impact air bags ① and window curtain air bags ② are not deployed in impacts which do not exceed the system's deployment threshold.



### Seat belts

When the engine is started the seat belt telltale  illuminates for a maximum of 6 seconds and a warning chime sounds to remind you and your passengers to fasten your seat belts.

If after these 6 seconds, the driver's or the front passenger's seat belt (with the front passenger seat occupied) are not fastened with all doors closed,

- and the vehicle speed does not exceed 15 mph (25 km/h), the seat belt telltale  remains illuminated for as long as either the driver's or front passenger's seat belt is not fastened.

- and the vehicle speed exceeds 15 mph (25 km/h), the seat belt telltale  starts flashing and a warning chime sounds with increasing intensity until both the driver's and front passenger's seat belt are fastened, or for a maximum of 60 seconds from the time the vehicle speed exceeded 15 mph (25 km/h) if either the driver's or front passenger's seat belt remains unfastened.

If the driver's or front passenger's seat belt remains unfastened after 60 seconds, the seat belt telltale  stops flashing and the warning chime stops sounding. The seat belt telltale  then continues to be illuminated for as long as either the driver's or front passenger's seat belt are not fastened.

The seat belt telltale  will only go out if both the driver's and front passenger's seat belt (with the front passenger seat occupied) are fastened, or the vehicle is standing still and a front door is opened.

For more information, see “Practical hints” (▷ page 377).

Always wear your seat belt. All vehicle occupants always need to have their seat belts fastened and wear them properly.

In addition, applicable motor vehicle safety laws require you to wear seat belts. Even where this is not the case, we strongly recommend that all vehicle occupants have their seat belts fastened and wear them properly.

For more information, see “Fastening the seat belts” (▷ page 47).



For information on infants and children traveling with you in the vehicle and restraint systems for infants and children, see “Children in the vehicle” (▷ page 77).

### Warning!



Always fasten your seat belt before driving off. Always make sure all of your passengers are properly restrained, even those sitting in the rear and pregnant women.

Failure to wear and properly fasten and position your seat belt greatly increases your risk of injuries and their likely severity in an accident. You and your passengers should always wear seat belts.

If you are ever in an accident, your injuries can be considerably more severe without your seat belt properly buckled. Without your seat belt buckled, you are much more likely to hit the interior of the vehicle or be ejected from it. You can be seriously injured or killed.

In the same crash, the possibility of injury or death is lessened if you are properly wearing your seat belt. Air bags can only protect as they are designed if the occupants are properly wearing their seat belts.

### Occupant safety

#### Warning!



Never ride in a moving vehicle with the seat backrest in an excessively reclined position as this can be dangerous. You could slide under the seat belt in a collision. If you slide under it, the belt would apply force at the abdomen or neck. That could cause serious or even fatal injuries. The seat backrest and seat belt provide the best restraint when the wearer is in a nearly upright position and the belt is properly positioned on the body.

#### Warning!



Never let more people ride in the vehicle than there are seat belts available. Be sure everyone riding in the vehicle is correctly restrained with a separate seat belt. Never use a seat belt for more than one person at a time.

#### Warning!



Damaged seat belts or belts that were highly stressed in an accident must be replaced and their anchoring points must also be checked.

Only use seat belts which have been approved by Mercedes-Benz.

Do not make any modifications to the seat belts. This can lead to unintended activation or to failure.

Do not bleach or dye seat belts as this may severely weaken them. In a crash they may not be able to provide adequate protection.

Have all work carried out only by qualified technicians. Contact an authorized Mercedes-Benz Center.

#### Warning!



#### USE SEAT BELTS PROPERLY

- Seat belts can only work when used properly. Never wear seat belts in any other way than as described in this section, as that could result in serious injuries in case of an accident.
- Each occupant should wear their seat belt at all times, because seat belts help reduce the likelihood of and potential severity of injuries in accidents, including rollovers. The integrated restraint system includes SRS (driver air bag, passenger front air bag, side impact air bags, head protection window curtain air bags for side windows), ETD (seat belt emergency tensioning device), and front seat knee bolsters.

The system is designed to enhance the protection offered to properly belted occupants in certain frontal (front air bags and ETD) and side (side impact and window curtain air bags and ETD) impacts which exceed preset deployment thresholds and in certain rollovers (window curtain air bags and ETD).

- Never wear the shoulder belt under your arm, against your neck or off your shoulder. In a frontal crash, your body would move too far forward. That would increase the chance of head and neck injuries. The belt would also apply too much force to the ribs or abdomen, which could severely injure internal organs such as your liver or spleen.
- Never wear belts over rigid or breakable objects in or on your clothing, such as eyeglasses, pens, SmartKeys etc., as these might cause injuries.
- Position the lap belt as low as possible on your hips and not across the abdomen. If the belt is positioned across your abdomen, it could cause serious injuries in a crash.
- Never use a seat belt for more than one person at a time. Do not fasten a seat belt around a person and another person or other objects.
- Belts should not be worn twisted. In a crash, you wouldn't have the full width of the belt to distribute impact forces. The twisted belt against your body could cause injuries.
- Pregnant women should also use a lap-shoulder belt. The lap belt portion should be positioned as low as possible on the hips to avoid any possible pressure on the abdomen.
- Never place your feet on the instrument panel, dashboard, or on the seat. Always keep both feet on the floor in front of the seat.
- When using a seat belt to secure infant or toddler restraints or children in booster seats, always follow the child seat manufacturer's instructions.

### Occupant safety

#### Emergency tensioning device (ETD), seat belt force limiter

The seat belts for the front and rear outer seats are equipped with emergency tensioning devices and belt force limiters.

The ETD is designed to activate in the following cases:

- in frontal or rear-end impacts exceeding a preset severity level
- in certain vehicle rollovers
- if the restraint systems are operational and functioning correctly, see

**SRS** indicator lamp (▷ page 66)



The ETDs for the front seats will only activate if the front seat belts are fastened (latch plate properly inserted into buckle).

The ETDs for the rear outer seats will activate with or without the respective seat belts fastened.

In an impact, emergency tensioning devices remove slack from the belts. Belt force limiters reduce the force exerted by the seat belts on occupants during a crash.

#### Warning!



An emergency tensioning device (ETD) that was activated must be replaced.

When disposing of the emergency tensioning device, our safety instructions must be followed. These are available at your authorized Mercedes-Benz Center.

#### Automatic comfort-fit feature seat belt

An automatic comfort-fit feature for front seats reduces the retracting force of the seat belts when they are in normal use.

#### Active head restraints

The active head restraints are intended to offer the driver and front passenger increased protection from head and neck injury. In the event of a rear-end collision, the head restraints on the driver's and front passenger's seats are designed to move forward in the direction of travel, providing the head with increased support earlier on in the collision sequence. The active head restraints move forward whether the seat is occupied or not.

#### Warning!



Only use seat or head restraint covers which have been tested and approved by Mercedes-Benz for your vehicle model. Using other seat or head restraint covers may interfere with or prevent the activation of the active head restraints. Contact your authorized Mercedes-Benz Center for availability.

**Warning!**

For your protection, drive only with properly positioned head restraints.

Adjust head restraint so that the center of the head restraint supports the back of the head at eye level. This will reduce the potential for injury to the head and neck in the event of an accident or similar situation.

Do not drive the vehicle without the seat head restraints. Head restraints are intended to help reduce injuries during an accident.

You cannot remove the active head restraint on the driver's and passenger's seats.

For removal of the active head restraints we recommend that you contact an authorized Mercedes-Benz Center.

For information on resetting the activated active head restraints, see "Resetting activated head restraints" (▷ page 428).

For information on head restraint adjustment, see "Seats" (▷ page 40).

**Children in the vehicle**

If an infant or child is traveling with you in the vehicle:

- Secure the child using an infant or child restraint appropriate to the age and size of the child.
- Make sure that the infant or child is properly secured at all times while the vehicle is in motion.

Infant and child restraint seats and information on choosing an appropriate restraint system can be obtained from any Mercedes-Benz Center.

### Occupant safety

#### Infant and child restraint systems

We recommend all infants and children be properly restrained at all times while the vehicle is in motion.

All lap-shoulder belts except the driver's seat belt have special seat belt retractors for secure fastening of child restraints.

To fasten a child restraint, follow child restraint instructions for mounting. Then pull the shoulder belt out completely and let it retract. During seat belt retraction, a ratcheting sound can be heard to indicate that the special seat belt retractor is activated. The belt is now locked. Push down on child restraint to take up any slack.

To deactivate, release seat belt buckle and let seat belt retract completely. The seat belt can again be used in the usual manner.



Information on child seats with mounting fittings for tether anchorages (▷ page 86).

For information on LATCH-type child seat mounts (▷ page 88).



The use of infant or child restraints is required by law in all 50 states, the District of Columbia, the U.S. territories and all Canadian provinces.

Infants and small children should be seated in an appropriate infant or child restraint system properly secured by a lap/shoulder belt or, if so equipped, a top tether anchorage point and a child restraint lower anchorage system that complies with U.S. Federal Motor Vehicle Safety Standards 213 and 225 and Canadian Motor Vehicle Safety Standards 213 and 210.2.

#### Warning!



Never release the seat belt buckle while the vehicle is in motion, since the special seat belt retractor will be deactivated.



A statement by the child restraint manufacturer of compliance with this standard can be found on the instruction label on the restraint and in the instruction manual provided with the restraint.

When using any infant or child restraint system, be sure to carefully read and follow all manufacturer's instructions for installation and use.

Please read and observe warning labels affixed to the inside of the vehicle and to infant or child restraints.

**Warning!**

According to accident statistics, children are safer when properly restrained in the rear seating positions than in the front seating position. Thus, we strongly recommend that children be placed in the rear seats whenever possible. Regardless of seating position, children 12 years old and under must be seated and properly secured in an appropriate infant or child restraint recommended for the size and weight of the child.

The infant or child restraint must be properly secured with the vehicle's seat belt, the seat belt and top tether strap, or lower anchors and top tether strap, fully in accordance with the child seat manufacturer's instructions.

Children can be killed or seriously injured by an inflating air bag. Note the following important information when circumstances require you to place a child in the front passenger seat:

- Your vehicle is equipped with air bag technology designed to turn off the front passenger front air bag in your vehicle when the OCS senses the weight of a typical 12-month-old child or less along with the weight of a standard appropriate child restraint on the front passenger seat.
- A child in a rear-facing child restraint on the front passenger seat will be seriously injured or even killed if the front passenger front air bag inflates in a collision which could occur under some circumstances, even with the air bag technology installed in your vehicle. The only means to completely eliminate this risk is to never place a child in a rear-facing child restraint in the front seat. We therefore strongly recommend that you always place a child in a rear-facing child restraint in the back seat.

- If you must install a rear-facing child restraint on the front passenger seat because circumstances require you to do so, make sure that the

 indicator lamp is illuminated, indicating that the front passenger air bag is deactivated. Should the light not illuminate or go out while the restraint is installed, please check installation. Periodically check the indicator lamp while driving to make sure the lamp is illuminated. If the



indicator lamp goes out or remains out, do not transport a child on the front passenger seat until the system has been repaired. A child in a rear-facing child restraint on the front passenger seat will be seriously injured or even killed if the front passenger front air bag inflates.

 indicator lamp goes out or remains out, do not transport a child on the front passenger seat until the system has been repaired. A child in a rear-facing child restraint on the front passenger seat will be seriously injured or even killed if the front passenger front air bag inflates.



indicator lamp goes out or remains out, do not transport a child on the front passenger seat until the system has been repaired. A child in a rear-facing child restraint on the front passenger seat will be seriously injured or even killed if the front passenger front air bag inflates.





### Occupant safety



- If you have to place a child in a forward-facing child restraint on the front passenger seat, move the seat as far back as possible, use the proper child restraint recommended for the age, size and weight of the child, and secure child restraint with the vehicle's seat belt according to the child seat manufacturer's instructions. For children larger than the typical 12-month-old child, the front passenger air bag may or may not be activated (▷ page 82).

#### Warning!



Infants and small children should never share a seat belt with another occupant. During an accident, they could be crushed between the occupant and seat belt.

A child's risk of serious or fatal injuries is significantly increased if the child restraints are not properly secured in the vehicle and the child is not properly secured in the child restraint.

Children too big for a toddler restraint must ride in seats using regular seat belts. Position shoulder belt across chest and shoulder, not face or neck. A booster seat may be necessary to achieve proper belt positioning for children from 41 lbs until they reach a height where a lap/shoulder belt fits properly without a booster.

When the child restraint is not in use, remove it from the vehicle or secure it with the seat belt to prevent the child restraint from becoming a projectile in the event of an accident.

Do not leave children unattended in the vehicle, even if the children are secured in a child restraint system. Unsupervised children in a child restraint system may use vehicle equipment and may cause an accident and/or serious personal injury.

## Occupant Classification System

The Occupant Classification System (OCS) automatically turns the front passenger front air bag on or off based on the classified occupant weight category determined by weight sensor readings from the front passenger seat.



The system does not deactivate the front passenger side impact air bag, the window curtain air bag and the emergency tensioning device.



Occupants must sit properly belted in a nearly upright position with their back against the seat backrest and feet on the floor to be correctly classified. If the occupant's weight is transferred to another object in the vehicle (e.g. by leaning on armrests), the OCS may not be able to properly approximate the occupant's weight category.

Furthermore, the occupant weight may appear to increase or decrease due to objects hanging on the seat, other passengers pushing on the seat, objects lodged underneath the seat or stuffed between seat and middle console or between seat and door or due to objects applying pressure on the back of the seat. Always make sure that the seat has clearance in all directions at all times.





If your seat, including your trim cover and cushion needs to be serviced in any way, take the vehicle to your authorized Mercedes-Benz Center.

Only seat accessories approved by Mercedes-Benz may be used.

Both driver and the front passenger should always use the   indicator lamp as an indication of whether or not the front passenger is properly positioned.

### Warning!



If the   indicator lamp illuminates when an adult or someone larger than a small individual is in the front passenger seat, have the front passenger re-position himself or herself in the seat until the light goes out, or check whether objects are caught under or around the seat.



More information about air bag display messages (▷ page 390).



In the event of a collision, the air bag control unit will not allow front passenger front air bag deployment when the OCS classified the front passenger seat occupant as being up to or less than the weight of a typical 12-month-old child in a standard child restraint or if the front passenger seat is sensed as being empty.











### Occupant safety







When the OCS senses that the front passenger seat occupant is classified as being up to or less than the weight of a typical 12-month-old child in a standard child restraint, the   indicator lamp will illuminate when the engine is started and remain illuminated, indicating that the front passenger front air bag is deactivated.

When the OCS senses that the front passenger seat is classified as being empty, the   indicator lamp will illuminate when the engine is started and remain illuminated, indicating that the front passenger front air bag is deactivated.

When the OCS senses that the front passenger seat occupant is classified as being heavier than the weight of a typical 12-month-old child seated in a standard child restraint or as being a small individual (such as a young teenager or a small adult), the   indicator lamp will illuminate for approximately 6 seconds when the engine is started and then, depending on occupant weight sensor readings from the seat, remain illuminated or go out. With the   indicator lamp illuminated, the front passenger front air bag is deactivated. With the   indicator lamp out, the front passenger front air bag is activated.

When the OCS senses that the front passenger seat occupant is classified as an adult or someone larger than a small individual, the   indicator lamp will illuminate for approximately 6 seconds when the engine is started and then go out, indicating that the front passenger front air bag is activated.

If the   indicator lamp is illuminated, the front passenger front air bag is deactivated and will not be deployed.

If the   indicator lamp is not illuminated, the front passenger front air bag is activated and will be deployed:

- in the event of certain frontal impacts
- if impact exceeds a preset deployment threshold
- independently of the side impact air bags.

If the front passenger front air bag is deployed, the rate of inflation will be influenced by:

- the rate of relevant vehicle deceleration as assessed by the air bag control unit
- front passenger's weight category as identified by the Occupant Classification System (OCS).

**Warning!**

According to accident statistics, children are safer when properly restrained in the rear seating positions than in the front seating position. Thus, we strongly recommend that children be placed in the rear seats whenever possible. Regardless of seating position, children 12 years old and under must be seated and properly secured in an appropriate infant or child restraint recommended for the size and weight of the child.

The infant or child restraint must be properly secured with the vehicle's seat belt, the seat belt and top tether strap, or lower anchors and top tether strap, fully in accordance with the child seat manufacturer's instructions.

Children can be killed or seriously injured by an inflating air bag. Note the following important information when circumstances require you to place a child in the front passenger seat:

- Your vehicle is equipped with air bag technology designed to turn off the front passenger front air bag in your vehicle when the system senses the weight of a typical 12-month-old child or less along with the weight of a standard appropriate child restraint on the front passenger seat.
- A child in a rear-facing child restraint on the front passenger seat will be seriously injured or even killed if the front passenger front air bag inflates in a collision which could occur under some circumstances, even with the air bag technology installed in your vehicle. The only means to completely eliminate this risk is to never place a child in a rear-facing child restraint in the front seat. We therefore strongly recommend that you always place a child in a rear-facing child restraint in the back seat.

- If you must install a rear-facing child restraint on the front passenger seat because circumstances require you to do so, make sure that the

 indicator lamp is illuminated, indicating that the front passenger air bag is deactivated. Should the light not illuminate or go out while the restraint is installed, please check installation. Periodically check the indicator lamp while driving to make sure the lamp is illuminated. If the

 indicator lamp goes out or remains out, do not transport a child on the front passenger seat until the system has been repaired. A child in a rear-facing child restraint on the front passenger seat will be seriously injured or even killed if the front passenger front air bag inflates.

 indicator lamp goes out or remains out, do not transport a child on the front passenger seat until the system has been repaired. A child in a rear-facing child restraint on the front passenger seat will be seriously injured or even killed if the front passenger front air bag inflates.

 indicator lamp goes out or remains out, do not transport a child on the front passenger seat until the system has been repaired. A child in a rear-facing child restraint on the front passenger seat will be seriously injured or even killed if the front passenger front air bag inflates.



### Occupant safety



- If you have to place a child in a forward-facing child restraint on the front passenger seat, move the seat as far back as possible, use the proper child restraint recommended for the age, size and weight of the child, and secure child restraint with the vehicle's seat belt according to the child seat manufacturer's instructions. For children larger than the typical 12-month-old child, the front passenger air bag may or may not be activated (▷ page 82).



Deployment of the driver front air bag does not mean that the front passenger front air bag also should have deployed.

The Occupant Classification System (▷ page 81) may have determined:



- that the seat was empty or occupied by the weight up to or less than that of a typical 12-month-old child seated in a standard child restraint - both instances where the system suppresses deployment of the passenger front air bag even though the impact met the criteria and was of sufficient severity to deploy the driver front air bag.

- that the seat was occupied by a small individual (such as a young teenager or a small adult) or a child weighing more than the weight of a typical 12-month-old child in a standard child restraint - instances where the system may suppress deployment of the passenger front air bag even though the impact met the criteria and was of sufficient severity to deploy the driver front air bag.

The  indicator lamp is located in the center console.





① Indicator lamp

The  indicator lamp  ① will be illuminated, except with the SmartKey removed or in starter switch position **0**.

### Warning!







If the  indicator lamp and the   indicator lamp are lit at the same time, there is a malfunction in the Occupant Classification System. The front passenger front air bag will be deactivated in this case.



In order to ensure proper operation of the air bag system and OCS:

- Have the system checked as soon as possible by qualified technicians. Contact an authorized Mercedes-Benz Center.
- Do not place more than 4.4 lbs (2 kg) into the ruffled storage bag on the back of the front passenger seat. Otherwise, the OCS may not be able to properly approximate the occupant weight category.

- Do not place objects under and/or around the front passenger seat.
- Do not hang anything from or attach any items to the seats.
- Do not stuff objects such as books between the middle console and the front passenger seat.
- Do not move the front passenger seat backwards against stiff objects.
- Sit properly belted in a nearly upright position with your back against the seat backrest.
- Do not lean on the armrests or lift yourself from the seat by using the handle over the door as this may cause the OCS to be unable to correctly approximate the occupant weight category.
- Only have the seat repaired or replaced by an authorized Mercedes-Benz Center.
- Read and observe all warnings in this chapter.

### Self-test Occupant Classification System

After turning the SmartKey in the starter switch to position **1** or **2** or pressing the KEYLESS-GO\* start/stop button once or twice, the   indicator lamp ① located in the center console illuminates. If an adult occupant is properly sitting on the front passenger seat and the system senses the occupant as being an adult, the   indicator lamp will illuminate and go out after approximately 6 seconds.

If the seat is not occupied and the system senses the front passenger seat as being empty, the   indicator lamp will illuminate and not go out.

### Occupant safety

#### Warning!



If the indicator lamp should not illuminate, the system is not functioning. You must see an authorized Mercedes-Benz Center before seating any child on the front passenger seat.

For more information, see the “Practical hints” section (▷ page 390).

#### Warning!



Never place anything between seat cushion and child seat (e.g. pillow), since it reduces the effectiveness of the Occupant Classification System. The bottom of the child seat must make full contact with the passenger seat cushion. An incorrectly mounted child seat could cause injuries to the child in case of an accident, instead of increasing protection for the child.

Follow the manufacturer’s instructions for installation of child seats.

#### Installation of infant and child restraint systems

Prior to installing a tether strap, note the following steps:

- ▶ Roll up retractable luggage cover and partition net.
- ▶ Remove storage box (if so equipped) (▷ page 269).

If the storage box is not removed:

- the top tether anchorage ring located on the floor (▷ page 87) for use with a child restraint in the rear center seat position cannot be accessed.
- the hook of the top tether strap when attached to the anchorage ring on an outer rear seat backrest may push against the storage box and prevent the backrest from properly locking into position.
- ▶ If you place a child seat in the left or center rear seat position, remove twin roller blind (▷ page 271) and return seat to its original position.



Do not reinstall twin roller blind with a child seat and top tether installed in the left and center rear seat position.

- ▶ If you place a child seat in the right rear seat position, the twin roller blind can remain installed if so desired.
- ▶ Fold the rear backrest slightly forward (▷ page 260).
- ▶ Guide top tether strap between head restraint and top of seat back.  
  
Head restraints must be installed (if removable) and positioned such that the top tether strap can pass freely between the head restraint and top of the seat back.  
  
Make sure the tether strap is not twisted.
- ▶ Fold the rear backrest back until it locks in place (▷ page 261).



With a child seat and top tether installed in the right rear seat position and twin roller blind installed, make sure the top tether strap is positioned between seat backrest and twin roller blind.

### Warning!



Always lock backrest in its upright position when rear seat bench is occupied by passengers, or the extended cargo compartment is not in use. Check for secure locking by pushing and pulling on the backrest.

Anchorage rings ① are located on the back side of the outer rear backrests and on the floor behind the rear center seat.

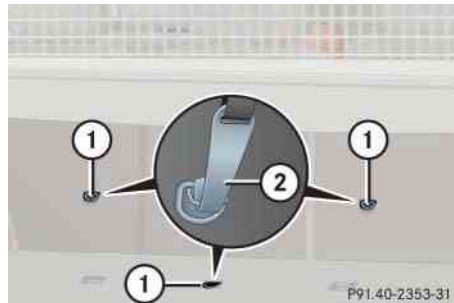

- ① Anchorage ring
- ② Hook

- ▶ Fold up anchorage ring ①.
- ▶ Securely fasten hook ②, which is part of the tether strap, to anchorage ring ①.



For safety, make sure the hook has attached to the ring beyond the safety catch, as illustrated below.

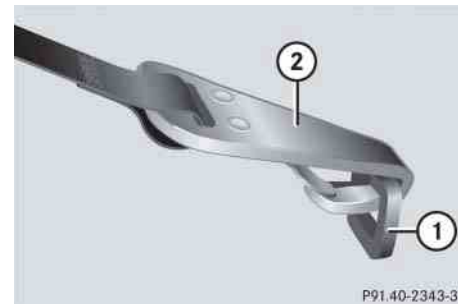

- ① Anchorage ring
- ② Hook

Once the top tether anchorage hook is attached, the child restraint itself can be secured. Secure the child restraint and tighten the top tether strap according to the child restraint manufacturer's instructions.



### Occupant safety

#### Child seat anchors - LATCH type

This vehicle is equipped with two LATCH (Lower Anchors and Tethers for Children) type anchors (at each of the outer rear seats) for the installation of a “LATCH” child seat with the matching mounting fittings.

The anchors are located behind an upholstery blend.



- ① Indicates the position of the anchors
- ② Anchors

- ▶ Lift up upholstery blend to access the anchors.
- ▶ Install child seat according to the manufacturer’s instructions.



Make sure the seat belt for the center seat can operate freely with a child seat installed.



Non-LATCH type child seats may also be used and can be installed using the vehicle’s seat belt system (▷ page 78). Install child seat according to the manufacturer’s instructions.

#### Warning!



Children too big for a toddler restraint must ride in seats using regular seat belts. Position shoulder belt across chest and shoulder, not face or neck. A booster seat may be necessary to achieve proper belt positioning for children over 41 lbs until they reach a height where a lap/shoulder belt fits properly without a booster.

Install child seat according to manufacturer’s instructions.

The child seat must be firmly attached in the right and left side anchors ②.

An incorrectly mounted child seat may come loose during an accident which could result in serious injury or death to the child.

Damaged or impact damaged child seats or child seat mounting fittings must be replaced.

Do not leave children unattended in the vehicle, even if the children are secured in a child restraint system.

### Blocking of rear door window operation



- ① Override switch
- ② Indicator lamp

- ▶ Press override switch ①.  
Indicator lamp ② comes on. The rear door windows can no longer be operated using the switches located in the rear doors.



Operation of the rear door windows with the switches located on the door control panel of the driver's door is still possible.

### Warning!



Activate the override switch when children are riding in the back seats of the vehicle. The children may otherwise injure themselves, e.g. by becoming trapped in the window opening.

When leaving the vehicle, always remove the SmartKey or SmartKey with KEYLESS-GO\* from the starter switch, take it with you, and lock the vehicle. Do not leave children unattended in the vehicle, or with access to an unlocked vehicle. Unsupervised use of vehicle equipment can cause an accident and/or serious personal injury.

For more information on power windows, see the “Controls in detail” section (▷ page 231).

### Panic alarm

An audible alarm and flashing exterior lamps will operate for approximately 2½ minutes.



① **PANIC** button



USA only:

This device complies with Part 15 of the FCC Rules. Operation is subject to the following two conditions:

(1) This device may not cause harmful interference, and

(2) this device must accept any interference received, including interference that may cause undesired operation.

Any unauthorized modification to this device could void the user's authority to operate the equipment.



Canada only:

This device complies with RSS-210 of Industry Canada. Operation is subject to the following two conditions:

(1) This device may not cause interference, and

(2) this device must accept any interference received, including interference that may cause undesired operation of the device.

Any unauthorized modification to this device could void the user's authority to operate the equipment.

### Activating

▶ Press and hold button ① for at least 1 second.

### Deactivating

▶ Press button ① again.

or

▶ Insert the SmartKey or the SmartKey with KEYLESS-GO\* in the starter switch.

or

▶ Press the KEYLESS-GO\* start/stop button.

The SmartKey with KEYLESS-GO must be inside the vehicle.

## ▼ Driving safety systems

In this section you will find information on the following driving safety systems:

- ABS (Antilock Brake System)
- BAS (Brake Assist System)
- ESP® (Electronic Stability Program)
- Electrohydraulic brake system
- 4MATIC (Four Wheel Electronic Traction System)



In winter operation, the maximum effectiveness of the ABS, the BAS, the ESP®, electrohydraulic brake system and 4MATIC is only achieved with winter tires (▷ page 355), or snow chains as required.

### Warning!



The following factors increase the risk of accidents:

- Excessive speed, especially in turns
- Wet and slippery road surfaces
- Following another vehicle too closely

The ABS, BAS, ESP®, electrohydraulic brake system and 4MATIC cannot reduce this risk.

Always adjust your driving style to the prevailing road and weather conditions.

## ABS

### Warning!



Do not pump the brake pedal. Use firm, steady brake pedal pressure instead. Pumping the brake pedal defeats the purpose of the ABS and significantly reduces braking effectiveness.

The Antilock Brake System (ABS) regulates the brake pressure so that the wheels do not lock during braking. This allows you to maintain the ability to steer your vehicle.

The ABS is functional above a speed of approximately 5 mph (8 km/h) independent of road surface conditions.

On slippery road surfaces, the ABS will respond even to light brake pressure.

The  indicator lamp in the instrument cluster comes on when you switch on the ignition. It goes out when the engine is running.

### Driving safety systems

#### Braking

If the ABS activates during braking, the ABS/ESP<sup>®</sup> warning lamp  in the instrument cluster dial flashes. Because of the electrohydraulic brake system, you will not feel any pulsation in the brake pedal.

- ▶ Keep firm and steady pressure on the brake pedal.

Continuous, steady brake pedal pressure yields the advantages provided by the ABS, namely braking power and the ability to steer the vehicle.

The ABS/ESP<sup>®</sup> warning lamp  flashes whenever the ABS is activated which can be an indication of hazardous road conditions and functions as a reminder to take extra care while driving.

#### Emergency brake maneuver

- ▶ Keep continuous full pressure on the brake pedal.

#### Warning!



When the ABS is malfunctioning, the BAS and the ESP<sup>®</sup> are also switched off.

When the ABS is malfunctioning, the wheels may lock during hard braking, reducing steering capability and extending the braking distance.

#### Warning!



The ABS cannot prevent the natural laws of physics from acting on the vehicle, nor can it increase braking or steering efficiency beyond that afforded by the condition of the vehicle brakes and tires or the traction afforded. The ABS cannot prevent accidents, including those resulting from excessive speed in turns, following another vehicle too closely, or hydroplaning. Only a safe, attentive, and skillful driver can prevent accidents. The capabilities of an ABS equipped vehicle must never be exploited in a reckless or dangerous manner which could jeopardize the user's safety or the safety of others.

For more information, see the “Practical hints” section (▷ page 373).

## BAS

The Brake Assist System (BAS) operates in emergency situations. If you apply the brakes very quickly, the BAS automatically provides full brake boost, thereby potentially reducing the braking distance.

- ▶ Apply continuous full braking pressure until the emergency braking situation is over.

The ABS will prevent the wheels from locking.

When you release the brake pedal, the brakes function again as normal. The BAS is then deactivated.

### Warning!



If the BAS is malfunctioning, the brake system is still functioning normally, but without the additional brake boost available that BAS would normally provide in an emergency braking maneuver. Therefore, the braking distance may increase.

### Warning!





The BAS cannot prevent the natural laws of physics from acting on the vehicle, nor can it increase braking efficiency beyond that afforded by the condition of the vehicle brakes and tires or the traction afforded. The BAS cannot prevent accidents, including those resulting from excessive speed in turns, following another vehicle too closely, or hydroplaning. Only a safe, attentive, and skillful driver can prevent accidents. The capabilities of a BAS equipped vehicle must never be exploited in a reckless or dangerous manner which could jeopardize the user's safety or the safety of others.

## ESP®

The Electronic Stability Program (ESP®) is operational as soon as the engine is running and monitors the vehicle's traction (force of adhesive friction between the tires and the road surface) and handling.

The ESP® recognizes when a wheel is spinning or if the vehicle starts to skid. By applying brakes to the appropriate wheel and by limiting engine output, the ESP® works to stabilize the vehicle. The ESP® is especially useful while driving off and on wet or slippery road surfaces. The ESP® also stabilizes the vehicle during braking maneuvers.

The ABS/ESP® warning lamp  in the instrument cluster flashes when the ESP® is engaged.

The ABS/ESP® warning lamp  in the instrument cluster comes on when you switch on the ignition. It goes out when the engine is running.

### Driving safety systems

#### Warning!



Never switch off the ESP<sup>®</sup> when you see the ABS/ESP<sup>®</sup> warning lamp  flashing in the instrument cluster. In this case proceed as follows:

- While driving off, apply as little throttle as possible.
- While driving, ease up on the accelerator.
- Adapt your speed and driving style to the prevailing road conditions.

Failure to observe these guidelines could cause the vehicle to skid.

The ESP<sup>®</sup> cannot prevent accidents resulting from excessive speed.

#### Warning!



The ESP<sup>®</sup> cannot prevent the natural laws of physics from acting on the vehicle, nor can it increase the traction afforded. The ESP<sup>®</sup> cannot prevent accidents, including those resulting from excessive speed in turns, or hydroplaning. Only a safe, attentive, and skillful driver can prevent accidents. The capabilities of an ESP<sup>®</sup> equipped vehicle must never be exploited in a reckless or dangerous manner which could jeopardize the user's safety or the safety of others.



The ESP<sup>®</sup> will only function properly if you use wheels of the recommended tire size (▷ page 472).



Vehicles without 4MATIC:

Because of the ESP's<sup>®</sup> automatic operation, the engine and the ignition must be shut off (SmartKey in starter switch position **0** or **1** or KEYLESS-GO start/stop button\* in position **0** or **1**) when:

- the parking brake is being tested on a brake test dynamometer
- the vehicle is being towed with the front axle raised

Active braking action through the ESP<sup>®</sup> may otherwise seriously damage the brake system.

For information on vehicles with 4MATIC, see “Four wheel electronic traction system (4MATIC) with the ESP<sup>®</sup>” (▷ page 99).

For more information, see the “Practical hints” section (▷ page 373).

### Switching off the ESP®

#### Warning!



The ESP® should not be switched off during normal driving other than in the circumstances described below. Disabling of the system will reduce vehicle stability in driving maneuvers.

Do not switch off the ESP® when a Minispare or collapsible tire is mounted.

To improve the vehicle's traction, turn off the ESP® in driving situations where it would be advantageous to have drive wheels spin and thus cut into surfaces for better grip such as:

- when driving with snow chains
- in deep snow
- in sand or gravel



Turn on the ESP® immediately if the aforementioned circumstances do not apply anymore.

When you switch off the ESP®

- the ESP® does not stabilize the vehicle
- the engine output is not limited, which allows the drive wheels to spin and thus cut into surfaces for better grip
- the traction control will still brake a spinning wheel
- the ESP® continues to operate when you are braking
- you cannot activate DISTRONIC\*



When the ESP® is switched off and one or more drive wheels are spinning, the ABS/ESP® warning lamp  in the speedometer flashes. However, the ESP® will then not stabilize the vehicle.

The switch is located on the center console.



① ESP® switch (off/on)

- ▶ Press ESP® switch ① until the ABS/ESP® warning lamp  in the instrument cluster comes on.

The ESP® is deactivated.



### Driving safety systems

#### Warning!



When the ABS/ESP<sup>®</sup> warning lamp  is illuminated continuously, the ESP<sup>®</sup> is switched off.

Adapt your speed and driving to the prevailing road conditions and to the non-operating status of the ESP<sup>®</sup>.



Avoid spinning of a drive wheel for an extended period with the ESP<sup>®</sup> switched off. This may cause serious damage to the drivetrain which is not covered by the Mercedes-Benz Limited Warranty.

#### Switching on the ESP<sup>®</sup>

- ▶ Press ESP<sup>®</sup> switch .

The ABS/ESP<sup>®</sup> warning lamp  in the instrument cluster goes out.

You are now again in normal driving mode with the ESP<sup>®</sup> switched on.





Turn on the ESP<sup>®</sup> immediately if the aforementioned circumstances do not apply anymore.

#### Electrohydraulic brake system

The electrohydraulic brake system combines a hydraulic brake circuit with electronically controlled brake servo assistance. You have increased braking safety and improved braking comfort.

#### Warning!



Never ignore a brake malfunction indicated in the speedometer display, for example by the  (USA only) or  (Canada only) warning lamp. Refer to the “Practical hints” section (▷ page 374). Also read and observe the messages in the instrument cluster display (▷ page 383).

**Warning!**

The electrohydraulic brake system requires electrical power to operate.

A malfunction in the vehicle's power supply or electrical system may impair brake system operation and switch it into its emergency operation mode. In such a case, the red brake warning lamp (▷ page 374) and warning messages in the instrument cluster (▷ page 383) come on while driving. To brake, the driver must then apply significantly greater brake pedal pressure and depress the pedal much further to obtain the expected braking effect. If necessary, apply full pressure to the brake pedal. Brakes may only be applied to the front wheels. Stopping distance is increased!

If there is a malfunction in the electrohydraulic brake system, we recommend that the vehicle be transported with all wheels off the ground using flatbed or appropriate wheel lift/dolly equipment. A tow bar must be used if circumstances do not permit the use of the recommended towing methods and the vehicle requires towing with all four wheels on the ground. Towing the vehicle with all four wheels on the ground is only permissible for distances up to 30 miles (50 km) and at a speed not to exceed 30 mph (50 km/h). For more information, refer to "Towing the vehicle" (▷ page 458).

The electrohydraulic brake system is automatically activated when you:

- unlock the vehicle with the SmartKey or the KEYLESS-GO\*
- open the driver's or passenger door
- turn the SmartKey in the starter switch to position **1**
- in vehicles with KEYLESS-GO\*, press the start/stop button on the gear selector lever once
- depress the brake pedal
- release the parking brake

### Driving safety systems



If the electrohydraulic brake system is activated as the brake pedal is first depressed, you may feel a reduced pedal resistance and longer pedal travel than normal. When releasing the pedal, you may also feel the brake pedal pulsate and you may hear a sound which is caused by the activation of the electrohydraulic brake system pump. This is normal and not an indication of a malfunction. Pedal travel returns to normal when you release the brake pedal and the sound soon ceases.

If you experience the above while driving and the red brake warning lamp (> page 374) illuminates and/or warning messages appear in the instrument cluster (> page 383), the brake system is malfunctioning. Follow the instructions of the warning message(s) and have the brake system checked immediately.

#### Warning!



Have brake pad replacement and other work on the electrohydraulic brake system carried out by qualified technicians only. Contact an authorized Mercedes-Benz Center for further information. The electrohydraulic brake system must be deactivated prior to working on the system. High pressure is intermittently built up in the system as part of its automatic self-test. In addition, the system is automatically activated when the vehicle is unlocked by SmartKey, when the driver or passenger door is opened, when the starter switch is turned to position **1**, when the brake pedal is depressed or when the parking brake is released. Failure to deactivate the system prior to maintenance will cause brake pistons to extend and brake fluid to leak, which may result in injuries (contusions and acid burns). Extended brake pistons may also cause injury.

The electrohydraulic brake servo assistance switches off automatically

- approximately 2 minutes after you turned the SmartKey in the starter switch to position **0** or removed the SmartKey
- approximately 2 minutes after you pressed the KEYLESS-GO\* start/stop button to turn off the engine or power supply and opened the driver's door (with driver's door open, the starter switch is set to position **0**, same as SmartKey removed from starter switch)
- approximately 20 seconds after you locked the vehicle from outside

### Note on driving with the electrohydraulic brake system

- Following extended periods of only minor loads to your brake system, you should occasionally apply the brakes when traveling at high speeds. This improves the grip of the brake pads.

#### Warning!



Be very careful not to endanger other road users when you apply the brakes.

- After driving on wet or snow-covered roads, you should apply your brakes firmly before parking your vehicle. This produces heat which serves to dry the brake disks and help prevent corrosion.
- On long and steep grades, shift to a lower gear (gear range **1**, **2**, or **3**) to prevent the brakes from overheating and to reduce brake wear.
- After hard braking, it is advisable to drive on for some time so that the air stream will cool down the brakes faster.
- Only Mercedes-Benz approved components (e.g. brake pads) should be installed on your vehicle. Brake pads not approved by Mercedes-Benz may impair the safety of your vehicle.

### Four wheel electronic traction system (4MATIC) with the ESP®

Models with all-wheel-drive only.

The 4MATIC improves vehicle's ability to use available traction, e.g. during winter operation in mountains under snowy conditions, by applying power to all four wheels.

### Driving safety systems

#### Warning!



If you see the ESP<sup>®</sup> warning lamp  flashing in the speedometer, proceed as follows:

- While driving off, apply as little throttle as possible
- While driving, ease up on the accelerator
- Adapt your speed and driving style to the prevailing road conditions

Failure to observe these guidelines could cause the vehicle to skid.

The ESP<sup>®</sup> cannot prevent accidents resulting from excessive speed.



Do not tow with one axle raised.

Otherwise the transfer case can be damaged, which is not covered by the Mercedes-Benz Limited Warranty.



Performance testing must only be conducted on a two-axle dynamometer.

Otherwise the transfer case can be damaged, which is not covered by the Mercedes-Benz Limited Warranty.



Because of the ESP's<sup>®</sup> automatic operation, the engine and the ignition must be shut off (SmartKey in starter switch position **0** or **1** or KEYLESS-GO start/stop button\* in position **0** or **1**) when the parking brake is being tested on a brake test dynamometer.

Active braking action through ESP<sup>®</sup> may otherwise seriously damage the front or rear axle brake system.

Operational tests with the engine running can only be conducted on a two-axle dynamometer.

## ▼ Anti-theft systems

### Immobilizer

---

The immobilizer prevents unauthorized persons from starting your vehicle.

### Activating

#### *With the SmartKey*

- ▶ Remove the SmartKey from the starter switch.

#### *With KEYLESS-GO\**

- ▶ Turn off the engine by means of the start/stop button on the gear selector lever.
- ▶ Open the driver's door.

### Deactivating

#### *With the SmartKey*

- ▶ Switch on the ignition.

#### *With KEYLESS-GO\**

- ▶ Start the engine by means of the start/stop button on the gear selector lever.



In case the engine cannot be started (yet the vehicle's battery is charged), the system is not operational. Contact an authorized Mercedes-Benz Center or call 1-800-FOR-MERCEdes (in the USA), or 1-800-387-0100 (in Canada).

### Anti-theft alarm system

---

Once the alarm system has been armed, a visual and audible alarm is triggered when someone opens:

- a door
- the tailgate
- the hood

The alarm will stay on, even if the activating element (a door, for example) is immediately closed.

The alarm system will also be triggered when

- someone attempts to raise the vehicle
- the vehicle is opened using the mechanical key
- someone opens a door from the inside

### Anti-theft systems



If the alarm stays on for more than 30 seconds, a call to the Response Center is initiated automatically by the Tele Aid system (> page 282) provided Tele Aid service was subscribed to and properly activated, and that necessary cellular service and GPS coverage are available.

#### Arming the alarm system

The indicator lamp located in the central locking switch in the center console.



① Indicator lamp

- ▶ Lock the vehicle with the SmartKey or KEYLESS-GO\*.

The turn signal lamps flash three times to indicate that the alarm system is armed. The indicator lamp ① begins to flash after approximately 30 seconds after arming the alarm system.



If the turn signal lamps do not flash three times, one of the following elements may not be properly closed:

- a door
- the tailgate
- the hood

Close the respective element and lock the vehicle again.

#### Disarming the alarm system

- ▶ Unlock your vehicle with the SmartKey or KEYLESS-GO\*.



The turn signal lamps flash once to indicate that the alarm system is disarmed.



The alarm system will rearm automatically after approximately 40 seconds if neither a door nor the tailgate was opened.

#### Canceling the alarm

##### *With the SmartKey*

- ▶ Insert the SmartKey in the starter switch.
- or
- ▶ Press button  or  on the SmartKey.

**With KEYLESS-GO\***

- ▶ Pull an outside door handle.

The SmartKey with KEYLESS-GO must be within 3 ft (1 m) of the vehicle.

or

- ▶ Press the KEYLESS-GO\* start/stop button (▷ page 37).

The SmartKey with KEYLESS-GO must be inside the vehicle.

**Tow-away alarm**

Once the tow-away alarm is armed, a visual and audible alarm will be triggered when someone attempts to raise the vehicle.



The tow-away protection alarm is triggered, for example, if the vehicle is lifted on one side.

If the alarm stays on for more than 30 seconds, a call to the Response Center is initiated automatically by the Tele Aid system\* (▷ page 282), provided that the Tele Aid service was subscribed to and properly activated, and that necessary cellular service and GPS coverage are available.

**Arming tow-away alarm**

- ▶ Lock the vehicle with the SmartKey or KEYLESS-GO\*.

The tow-away alarm is automatically armed after about 30 seconds.



### Anti-theft systems

#### Disarming tow-away alarm

To prevent triggering the tow-away alarm feature, switch off the tow-away alarm before towing the vehicle, or when parking on a surface subject to movement, such as a ferry or auto train.

The button is located on the overhead control panel.



#### ① Tow-away alarm off button

- ▶ Switch off the ignition and remove the SmartKey from the starter switch.



You cannot disarm the tow-away alarm when the ignition is switched on.

- ▶ Press button ①.

The indicator lamp in the button ① comes on briefly.

- ▶ Exit and lock the vehicle with the SmartKey or (vehicles with KEYLESS-GO\*) the lock button at each door handle.





When you unlock the vehicle, the tow-away protection disarms automatically.

The tow-away alarm remains disarmed until you lock the vehicle again.

#### Canceling tow-away alarm

##### *With the SmartKey*

- ▶ Insert the SmartKey in the starter switch.
- or
- ▶ Press button  or  on the SmartKey.

##### *With KEYLESS-GO\**

- ▶ Pull an outside door handle.

The SmartKey with KEYLESS-GO must be within 3 ft (1 m) of the vehicle.

or

- ▶ Press the KEYLESS-GO\* start/stop button (▷ page 38).

The SmartKey with KEYLESS-GO must be inside the vehicle.

Locking and unlocking

Seats

Memory function

Lighting

Instrument cluster

Control system

Automatic transmission

Good visibility

Dual-zone automatic climate control (USA only)

4-zone automatic climate control\*

Power windows

Power tilt/sliding sunroof\*

Driving systems

Loading

Useful features

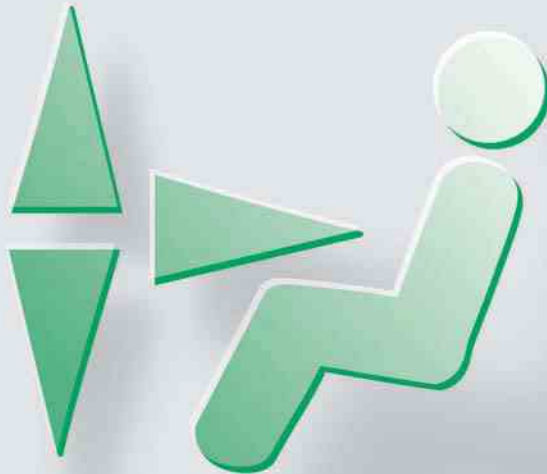

### Locking and unlocking

In the “Controls in detail” section you will find detailed information on how to operate the equipment installed on your vehicle. If you are already familiar with the basic functions of your vehicle, this section will be of particular interest to you.

To quickly familiarize yourself with the basic functions of the vehicle, refer to the “Getting started” section of this manual. The corresponding page numbers are given at the beginning of each segment.

For more information on locking and unlocking, see “Getting started” (▷ page 34) and (▷ page 59).

#### SmartKey

Your vehicle comes supplied with two SmartKeys, each with remote control and a removable mechanical key. The locking tabs for the mechanical key portion of the two SmartKeys are a different color to help distinguish each key unit.



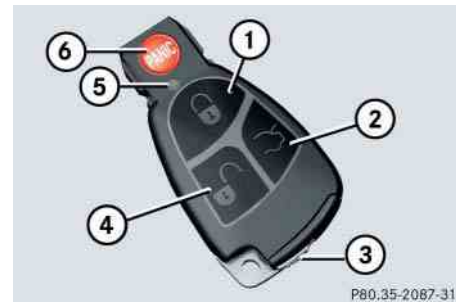

The SmartKey provides an extended operating range. To prevent theft, however, it is advisable to only unlock the vehicle when you are in close proximity to it.

The SmartKey centrally locks and unlocks

- the doors
- the tailgate
- the fuel filler flap



#### SmartKey with remote control

- ①  Lock button
- ②  Unlock button\* for the tailgate
- ③ Mechanical key locking tab
- ④  Unlock button
- ⑤  Battery check lamp
- ⑥  PANIC (▷ page 90)

**Warning!**

When leaving the vehicle, always remove the SmartKey from the starter switch, take it with you and lock the vehicle. Do not leave children unattended in the vehicle, or with access to an unlocked vehicle. It is possible for children to open a locked door from the inside, which could result in an accident and/or serious personal injury.



To prevent possible malfunction, avoid exposing the SmartKey to high levels of electromagnetic radiation.



USA only:

This device complies with Part 15 of the FCC Rules. Operation is subject to the following two conditions:

- (1) This device may not cause harmful interference, and
- (2) this device must accept any interference received, including interference that may cause undesired operation.

Any unauthorized modification to this device could void the user's authority to operate the equipment.



Canada only:

This device complies with RSS-210 of Industry Canada. Operation is subject to the following two conditions:

- (1) This device may not cause interference, and
- (2) this device must accept any interference received, including interference that may cause undesired operation of the device.

Any unauthorized modification to this device could void the user's authority to operate the equipment.



The electrohydraulic brake system is activated (▷ page 96).



You can also open and close the power windows and tilt/sliding sunroof\* using the SmartKey (▷ page 234).

### Locking and unlocking

#### Factory setting



Your vehicle may be equipped with an acoustic lock and unlock confirmation signal feature. If your vehicle is equipped with this feature and the feature is activated, an acoustic signal will sound when the vehicle is locked or unlocked using the SmartKey.

To determine whether or not your vehicle is equipped with this feature, contact an authorized Mercedes-Benz Center. If equipped and you wish to activate or deactivate the feature, or adjust its signal volume, also contact an authorized Mercedes-Benz Center.

#### *Global unlocking*

- ▶ Press button .
- All turn signal lamps flash once.
  - An acoustic signal sounds once (if equipped and feature activated).
  - The locking knobs in the doors move up.
  - The anti-theft alarm system is disarmed.

The vehicle will lock again automatically and reactivate the anti-theft alarm system within approximately 40 seconds of unlocking if:



- neither a door nor the tailgate is opened
- the SmartKey is not inserted in the starter switch
- the central locking switch is not activated

#### *Global locking*

- ▶ Press button .
- All turn signal lamps flash three times.
  - An acoustic signal sounds three times (if equipped and feature activated).
  - The locking knobs in the doors move down.
  - The anti-theft alarm system is armed.

### Selective setting

If you frequently travel alone, you may wish to reprogram the SmartKey so that pressing  only unlocks the driver's door and the fuel filler flap.

- ▶ Press and hold buttons  and  simultaneously for about 5 seconds until battery check lamp  (▷ page 106) flashes twice.

The SmartKey will then function as follows:

- The anti-theft alarm system is disarmed.

### Global unlocking



- ▶ Press button  twice.
  - All turn signal lamps flash once.
  - An acoustic signal sounds once (if equipped and feature activated).
  - The locking knobs in the doors move up.
  - The anti-theft alarm system is disarmed.

### Global locking

- ▶ Press button .
  - All turn signal lamps flash three times.
  - An acoustic signal sounds three times (if equipped and feature activated).
  - The locking knobs in the doors move down.

- The anti-theft alarm system is armed.

### Restoring to factory setting

- ▶ Press and hold buttons  and  simultaneously for about 6 seconds until battery check lamp  (▷ page 106) flashes twice.

### Unlocking driver's door and fuel filler flap

- ▶ Press button  once.
  - All turn signal lamps flash once.
  - An acoustic signal sounds once (if equipped and feature activated). For more information, see “Factory setting” (▷ page 108).
  - The locking knob in the driver's door moves up.

### Locking and unlocking





If you can no longer lock or unlock the vehicle with the SmartKey, then either the batteries in the SmartKey are discharged, the SmartKey is malfunctioning or the vehicle battery is drained.

- Check the batteries in the SmartKey (▷ page 117) and replace them if necessary (▷ page 429).
- Use the mechanical key to unlock the driver's door (▷ page 424).
- Use the mechanical key to lock the driver's door (▷ page 425).
- Have the vehicle battery and the battery connections checked.

If the SmartKey is malfunctioning, contact an authorized Mercedes-Benz Center.

#### Checking the batteries

- ▶ Press button  or .

Battery check lamp  (▷ page 106) comes on briefly to indicate that the SmartKey batteries are in order.





If battery check lamp  does not come on briefly during check, then the SmartKey batteries are discharged.

Replace the batteries (▷ page 429).

You can obtain the required batteries at any authorized Mercedes-Benz Center.



If the batteries are checked within signal range of the vehicle, pressing the button  or  will lock or unlock the vehicle accordingly.

#### Unlocking and opening the tailgate

You can unlock and open the tailgate separately.

A minimum height clearance of 6.76 ft (2.06 m) is required to open the tailgate.

- ▶ Press and hold button  until tailgate unlocks and begins to open.



The tailgate swings open upwards automatically. Always make sure there is sufficient overhead clearance.

Vehicles with tailgate opening/closing system\*: To stop the opening procedure, press button  on the SmartKey. The tailgate stops moving.



If the vehicle was previously centrally locked, the tailgate will lock automatically when closed.

To confirm locking all turn signal lamps flash three times.

### Loss of SmartKey or mechanical key

If you lose a SmartKey or mechanical key, you should do the following:

- ▶ Have the SmartKey deactivated by an authorized Mercedes-Benz Center.
- ▶ Report the loss of the SmartKey or the mechanical key immediately to your car insurance company.
- ▶ If necessary, have the mechanical lock replaced.

Your authorized Mercedes-Benz Center will be glad to supply you with a replacement.

### SmartKey with KEYLESS-GO\*

Vehicles equipped with KEYLESS-GO come with two SmartKeys with KEYLESS-GO, each with remote control and a removable mechanical key. The locking tabs for the mechanical key portion of the two SmartKeys with KEYLESS-GO are a different color to help distinguish each SmartKey with KEYLESS-GO unit.

The function of the SmartKey overrides the KEYLESS-GO function.

The KEYLESS-GO function is integrated into the SmartKey. On these vehicles, the validity of the SmartKey with KEYLESS-GO is checked every time you pull an outside door handle.

If the SmartKey with KEYLESS-GO is valid, your vehicle unlocks

- the doors
- the tailgate
- the fuel filler flap

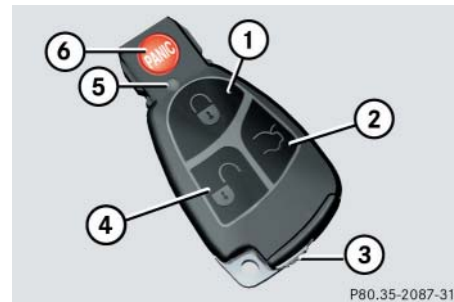

### SmartKey with KEYLESS-GO

- ① Lock button
- ② Unlock button\* for the tailgate
- ③ Mechanical key locking tab
- ④ Unlock button
- ⑤ Battery check lamp
- ⑥ PANIC button (▷ page 90)



When any outside door handle other than the driver's outside door handle is pulled, the vehicle is centrally unlocked.



### Locking and unlocking

#### Warning!



When leaving the vehicle, always take the SmartKey with KEYLESS-GO with you and lock the vehicle. Do not leave children unattended in the vehicle, or with access to an unlocked vehicle. It is possible for children to open a locked door from the inside, which could result in an accident and/or serious personal injury.



To prevent possible malfunction, avoid exposing the SmartKey with KEYLESS-GO to high levels of electromagnetic radiation.



USA only:

This device complies with Part 15 of the FCC Rules. Operation is subject to the following two conditions:

- (1) This device may not cause harmful interference, and
- (2) this device must accept any interference received, including interference that may cause undesired operation.

Any unauthorized modification to this device could void the user's authority to operate the equipment.



Canada only:

This device complies with RSS-210 of Industry Canada. Operation is subject to the following two conditions:

- (1) This device may not cause interference, and
- (2) this device must accept any interference received, including interference that may cause undesired operation of the device.

Any unauthorized modification to this device could void the user's authority to operate the equipment.



You can also open and close the power windows and tilt/sliding sunroof\* using the SmartKey (▷ page 234).



When you unlock the vehicle, the electrohydraulic brake system is activated (▷ page 96).

### Important notes on using KEYLESS-GO

- You can also use the SmartKey with KEYLESS-GO like a normal SmartKey (▷ page 106).
- You can combine KEYLESS-GO functions with normal SmartKey functions (e.g. unlocking with KEYLESS-GO and locking with button ).
- Always carry the SmartKey with KEYLESS-GO with you.
- Never store the SmartKey with KEYLESS-GO together with:
  - Electronic items such as a cellular phone or another SmartKey with KEYLESS-GO
  - Metallic objects such as coins or metal foil

Doing so could impair the function of the KEYLESS-GO system.
- To lock or unlock the vehicle, the SmartKey with KEYLESS-GO must be located outside the vehicle within approximately 3 ft (1 m) of a door or the tailgate.
- In order to start the engine with the SmartKey with KEYLESS-GO:
  - The SmartKey with KEYLESS-GO must be located in the vehicle.
  - All the doors must be closed.
  - The brake pedal must be firmly depressed. Do not depress the accelerator.
- If you have started the engine with the KEYLESS-GO start/stop button (▷ page 38), you can only turn it off again with this button, even if you have put the SmartKey in the starter switch in the meantime.
- This does not apply if, after starting, the selector lever is still in position **P** and then the SmartKey is inserted in the starter switch. The SmartKey will then have priority over the KEYLESS-GO function and the vehicle's electrical system will operate according to the position of the SmartKey in the starter switch, even stopping the engine.
- If the SmartKey with KEYLESS-GO is positioned farther away from the vehicle, the system may no longer recognize the SmartKey with KEYLESS-GO. The vehicle cannot be locked or the engine started via the KEYLESS-GO system.

### Locking and unlocking

- If the SmartKey with KEYLESS-GO is removed from the vehicle while the ignition is switched on (e.g. if passenger exits the vehicle with the SmartKey with KEYLESS-GO), the message *Key not recognized* will appear in the multifunction display while driving off.

Find the SmartKey or change its present location immediately (e.g. place it on the front passenger seat or insert it in shirt pocket).

- Remember that the engine can be started by anyone with a SmartKey with KEYLESS-GO that is left inside the vehicle. If you leave the SmartKey with KEYLESS-GO behind when exiting and locking the vehicle, the message *Key still in vehicle* will appear in the multifunction display.

#### Factory setting



Your vehicle may be equipped with an acoustic lock and unlock confirmation signal feature. If your vehicle is equipped with this feature and the feature is activated, an acoustic signal will sound when the vehicle is locked or unlocked using the SmartKey with KEYLESS-GO.

To determine whether or not your vehicle is equipped with this feature, contact an authorized Mercedes-Benz Center. If equipped and you wish to activate or deactivate the feature, or adjust its signal volume, also contact an authorized Mercedes-Benz Center.

#### Global unlocking

- ▶ Pull an outside door handle.
  - All turn signal lamps flash once.
  - An acoustic signal sounds once (if equipped and feature activated).
  - The locking knobs in the doors move up.
  - The anti-theft alarm system is disarmed.

The vehicle will lock again automatically and reactivate the anti-theft alarm system within approximately 40 seconds if:



- neither a door nor the tailgate is opened
- the central locking switch is not activated

### ***Global locking***

- ▶ Press lock button on an outside door handle (▷ page 63) or tailgate (▷ page 118).
  - All turn signal lamps flash three times.
  - An acoustic signal sounds three times (if equipped and feature activated).
  - The locking knobs in the doors move down.
  - The anti-theft alarm system is armed.

### ***Selective setting***

If you frequently travel alone, you may wish to reprogram the SmartKey with KEYLESS-GO so when you pull the driver's outside door handle, only the driver's door and the fuel filler flap unlocks.

- ▶ Press and hold buttons  and  simultaneously for about 5 seconds until battery check lamp  (▷ page 111) flashes twice.

The SmartKey with KEYLESS-GO will then function as follows:

### ***Unlocking driver's door and fuel filler flap***

- ▶ Pull the driver's outside door handle.
  - All turn signal lamps flash once.
  - An acoustic signal sounds once (if equipped and feature activated). For more information, see "Factory setting" (▷ page 114).
  - The locking knob in the driver's door moves up.
  - The anti-theft alarm system is disarmed.

### Locking and unlocking



#### *Global unlocking*

- ▶ Pull any outside door handle other than the driver's outside door handle.
  - All turn signal lamps flash once.
  - An acoustic signal sounds once (if equipped and feature activated).
  - The locking knobs in the doors move up.
  - The anti-theft alarm system is disarmed.

#### *Global locking*

- ▶ Press lock button on an outside door handle (▷ page 63) or tailgate (▷ page 118).
  - All turn signal lamps flash three times.
  - An acoustic signal sounds three times (if equipped and feature activated).
  - The locking knobs in the doors move down.
  - The anti-theft alarm system is armed.

#### *Restoring to factory setting*

- ▶ Press and hold buttons  and  simultaneously for about 6 seconds until battery check lamp  (▷ page 111) flashes twice.





If you can no longer lock or unlock the vehicle with the SmartKey with KEYLESS-GO, then the batteries in the SmartKey are discharged, the SmartKey with KEYLESS-GO is malfunctioning or the vehicle battery is drained.

- Check the batteries in the SmartKey with KEYLESS-GO (▷ page 117) and replace them if necessary (▷ page 429).
- Use the mechanical key to unlock the driver's door (▷ page 424).
- Use the mechanical key to lock the driver's door (▷ page 425).
- Have the vehicle battery checked by an authorized Mercedes-Benz Center.

If the SmartKey with KEYLESS-GO is malfunctioning, contact an authorized Mercedes-Benz Center.

### Checking the batteries

- ▶ Press button  or .

Battery check lamp  (▷ page 111) comes on briefly to indicate that the SmartKey batteries are in order.





If battery check lamp  does not come on briefly during check, then the SmartKey batteries are discharged.

Replace the batteries (▷ page 429).

You can obtain the required batteries at any authorized Mercedes-Benz Center.



If the batteries are checked within signal range of the vehicle, pressing the button  or  will lock or unlock the vehicle accordingly.

### Unlocking and opening the tailgate

You can unlock and open the tailgate separately.

A minimum height clearance of 6.76 ft (2.06 m) is required to open the tailgate.

The handle is located in the rear license plate recess.

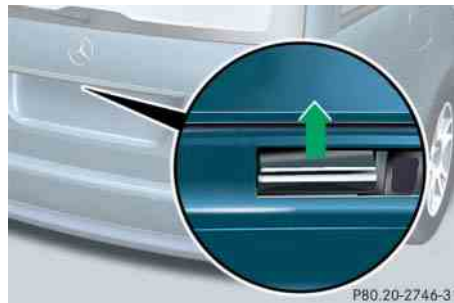

- ▶ Pull on the handle.  
or
- ▶ Press and hold button  until the tailgate unlocks and opens.



The tailgate swings open upwards automatically. Always make sure there is sufficient overhead clearance.

Vehicles with tailgate opening/closing system\*: to stop the opening procedure, press button  on the SmartKey. The tailgate stops moving.



If the vehicle was previously centrally locked, the tailgate will lock automatically when closed (▷ page 122).

To confirm locking all turn signal lamps flash three times.

### Locking and unlocking

#### Global locking using the lock button on the tailgate

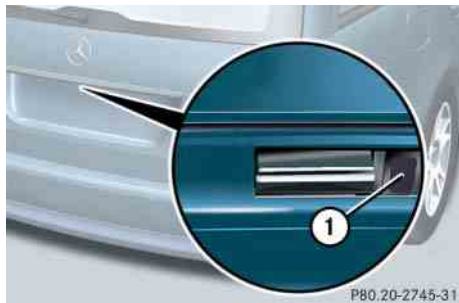

#### ① Lock button

- ▶ Press lock button ① on the tailgate.
- All turn signal lamps flash three times.
- An acoustic signal sounds three times (if equipped and feature activated).  
For more information, see “Factory setting” (▷ page 114).
- The locking knobs in the doors move down.
- The anti-theft alarm system is armed.



To prevent a possible inadvertent lock-out, the tailgate will open automatically if a SmartKey with KEYLESS-GO is recognized inside the vehicle.



If the vehicle was previously centrally locked with KEYLESS-GO, the tailgate will lock automatically after closing it.

To confirm locking all turn signal lamps flash three times.



You can also lock the vehicle using the lock button on an outside door handle (▷ page 63) or KEYLESS-GO locking/closing switch (▷ page 126).

#### Loss of the SmartKey with KEYLESS-GO

If you lose your SmartKey with KEYLESS-GO, you should do the following:

- ▶ Have the SmartKey with KEYLESS-GO deactivated by an authorized Mercedes-Benz Center.
- ▶ Report the loss immediately to your car insurance company.
- ▶ Have the mechanical lock replaced if necessary.

Your authorized Mercedes-Benz Center will be glad to supply you with a replacement.

### Opening the doors from the inside

You can open a locked door from the inside. Open door only when conditions are safe to do so.

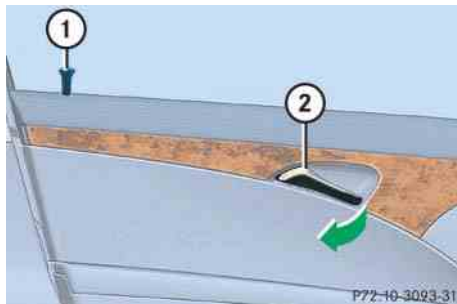

- ① Locking knob
- ② Inside door handle

### Front doors

- ▶ Pull on door handle ② on the respective front door to open door.

If door was locked, locking knob ① will move up.



### Rear doors

- ▶ Pull up locking knob ① on the respective rear door to unlock door.
- ▶ Pull on door handle ② on the respective rear door to open door.



If the vehicle has previously been locked with the SmartKey or KEYLESS-GO\*, opening a door from the inside will trigger the anti-theft alarm system.

To cancel the alarm, do one of the following:

- Press button  or  on the SmartKey.
- Insert the SmartKey in the starter switch.

In vehicles with KEYLESS-GO\*:

- Press the KEYLESS-GO\* start/stop button (▷ page 38).

The SmartKey with KEYLESS-GO must be inside the vehicle.

- Pull an outside door handle.

The SmartKey with KEYLESS-GO must be within 3 ft (1 m) of the vehicle.



### Locking and unlocking

#### Opening the tailgate

##### Opening the tailgate from the outside

A minimum height clearance of 6.76 ft (2.06 m) is required to open the tailgate.

The handle is located above the rear license plate recess.

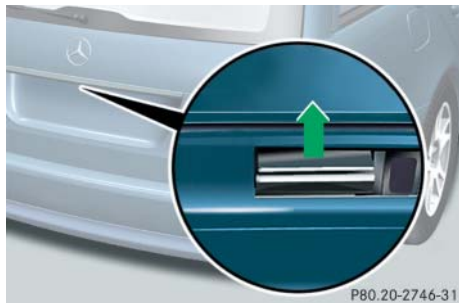

In vehicles without KEYLESS-GO\*: The vehicle must be unlocked.

- ▶ Pull on the handle.

The tailgate opens.



The tailgate swings open upwards automatically. Always make sure there is sufficient overhead clearance.

Vehicles with tailgate opening/closing system\*: to stop the opening procedure, press button  on the SmartKey. The tailgate stops moving.



The tailgate can also be opened using button  on the SmartKey or SmartKey with KEYLESS-GO.



If the vehicle was previously centrally locked, the tailgate will lock automatically after closing it (▶ page 122).

To confirm locking all turn signal lamps flash three times.

##### Opening the tailgate from the inside with handle

You can open the tailgate from the inside if the vehicle is stationary.

A minimum height clearance of 6.76 ft (2.06 m) is required to open the tailgate.

The handle is located on the inside of the tailgate.



- ① Handle
- ② Catch

- ▶ To unlock the tailgate, move the catch ② to the right.
- ▶ Pull handle ① down and swing tailgate upward.



Always make sure there is sufficient overhead clearance.



To lock the tailgate, move the catch ② to the left.

### Warning!



When leaving the vehicle, always remove the SmartKey or the SmartKey with KEYLESS-GO\* from the starter switch, take it with you, and lock the vehicle. Do not leave children unattended in the vehicle. Children could open the tailgate from the inside, which could result in an accident and/or serious personal injury.

### Opening the tailgate from the inside automatically\*

In vehicles with tailgate opening/closing system\* you can open the tailgate from the inside if the vehicle is stationary.

A minimum height clearance of 6.76 ft (2.06 m) is required to open the tailgate.

The switch is located on the driver's door.



① Remote tailgate release switch with indicator lamp

- ▶ Pull and hold remote tailgate release switch ① until
  - the tailgate is completely open (opened to its full extent),
- or
- the tailgate has reached the desired opening angle.

The tailgate stops moving as soon as you release the switch. The indicator lamp in the switch comes on. It remains lit until the tailgate is closed again.

### Locking and unlocking



The tailgate swings open upwards as long as you pull and hold the remote tailgate release switch. Always make sure there is sufficient overhead clearance. To stop the opening procedure, release the remote tailgate release switch.



The tailgate can also be opened using button  on the SmartKey or SmartKey with KEYLESS-GO\*.

#### Limiting opening height of tailgate\*

Vehicles with tailgate opening/closing system\*:

The tailgate opening height can be limited when transporting goods on a roof rack (e.g. presence of an optional MB sport luggage container). When activated, the tailgate opens to approximately the height of the roof edge.

- ▶ Activate the limiting opening height of tailgate using the control system (▷ page 176).

#### Closing the tailgate



① Handle

- ▶ Lower tailgate using handle ①.
- ▶ Close tailgate with hands placed flat on the tailgate.



- ① Strap in vehicles with folding bench seat
- ▶ Pull the tailgate down from the inside of the vehicle using strap ①.

### Warning!



To prevent possible personal injury, always keep hands and fingers away from the cargo compartment opening when closing the tailgate. Be especially careful when small children are around.

### Warning!



Only drive with the tailgate closed as, among other dangers such as blocked visibility, exhaust fumes may enter the vehicle interior.



To prevent an inadvertent lockout, do not place the SmartKey in the cargo compartment.

Vehicles with KEYLESS-GO\*:  
To prevent a possible inadvertent lockout, the tailgate will open automatically if a SmartKey with KEYLESS-GO is recognized inside the vehicle.

### Closing the tailgate from the outside (vehicles without KEYLESS-GO\*)

In vehicles with tailgate opening/closing system\* you can close the tailgate separately from the outside using the tailgate closing switch.



- ① Tailgate closing switch
- ▶ Press tailgate closing switch ① briefly. The tailgate closes.

### Locking and unlocking



You can also close the tailgate by hand.

If the tailgate comes into contact with an object while closing (e.g. luggage that has been piled too high), the closing procedure is stopped and the tailgate reopens slightly.

#### Warning!



Monitor the closing procedure carefully to make sure no one is in danger of being injured. To prevent possible personal injury, always keep hands and fingers away from the cargo compartment opening when closing the tailgate. Be especially careful when small children are around. To stop the closing procedure, do one of the following:

- press the tailgate closing switch ① (▷ page 123)
- press button  on the SmartKey
- pull the remote tailgate switch (on the driver's door) (▷ page 121)

Even with the SmartKey removed from the starter switch, the tailgate closing switch can be operated. Therefore, do not leave children unattended in the vehicle, or with access to an unlocked vehicle. Unsupervised use of vehicle equipment may cause an accident and/or serious personal injury.

#### Warning!



Only drive with the tailgate closed as, among other dangers such as blocked visibility, exhaust fumes may enter the vehicle interior.



Do not place the SmartKey in the open cargo compartment. You may lock yourself out.



If the vehicle was previously centrally locked, the tailgate will lock automatically after closing it.

To confirm locking all turn signal lamps flash three times.

### Closing the tailgate from the outside (vehicles with KEYLESS-GO\*)

In vehicles with tailgate opening/closing system\* you can close the tailgate separately from the outside using the tailgate closing switch.



#### ① Tailgate closing switch

- ▶ Make sure you have the SmartKey with KEYLESS-GO with you.
- ▶ Press tailgate closing switch ① briefly. The tailgate closes.



You can also close the tailgate by hand.

If the tailgate comes into contact with an object while closing (e.g. luggage that has been piled too high), the closing procedure is stopped and the tailgate reopens slightly.



To prevent a possible inadvertent lock-out, the tailgate will open automatically if a SmartKey with KEYLESS-GO is recognized inside the vehicle.

### Warning!



Monitor the closing procedure carefully to make sure no one is in danger of being injured. To prevent possible personal injury, always keep hands and fingers away from the cargo compartment opening when closing the tailgate. Be especially careful when small children are around. To stop the closing procedure, do one of the following:

- press KEYLESS-GO locking / closing switch ① (▷ page 126)
- press the tailgate closing switch ① (▷ page 125)
- press button  on the SmartKey with KEYLESS-GO (▷ page 111)
- pull the remote tailgate switch (on the driver's door) (▷ page 121)



### Locking and unlocking

- ▷▷ Even with the SmartKey with KEYLESS-GO removed from the vehicle, the tailgate closing switch can be operated. Therefore, do not leave children unattended in the vehicle, or with access to an unlocked vehicle. Unsupervised use of vehicle equipment may cause an accident and/or serious personal injury.

#### Warning!



Only drive with the tailgate closed as, among other dangers such as blocked visibility, exhaust fumes may enter the vehicle interior.



If the vehicle was previously centrally locked, the tailgate will lock automatically after closing it.

To confirm locking all turn signal lamps flash three times.

#### Closing the tailgate and locking the vehicle from the outside (vehicles with KEYLESS-GO\*)

In vehicles with tailgate opening/closing system\* and KEYLESS-GO, you can close the tailgate and lock the vehicle simultaneously from the outside using the KEYLESS-GO locking/closing switch.



#### ① KEYLESS-GO locking/closing switch

- ▶ Make sure you have SmartKey with KEYLESS-GO with you.

- ▶ Press switch ① briefly.

- The tailgate closes.
- All turn signal lamps flash three times.
- The locking knobs in the doors move down.
- The anti-theft alarm system is armed.



You can also close the tailgate by hand.

If the tailgate comes into contact with an object while closing (e.g. luggage that has been piled too high), the closing procedure is stopped and the tailgate reopens slightly.



To prevent a possible inadvertent lock-out, the tailgate will open automatically if a SmartKey with KEYLESS-GO is recognized inside the vehicle.

**Warning!**

Monitor the closing procedure carefully to make sure no one is in danger of being injured. To prevent possible personal injury, always keep hands and fingers away from the cargo compartment opening when closing the tailgate. Be especially careful when small children are around. To stop the closing procedure, do one of the following:

- press KEYLESS-GO locking / closing switch ①
- press tailgate closing switch ① (▷ page 125)
- press button  on the SmartKey with KEYLESS-GO (▷ page 111)
- pull the remote tailgate switch (on the driver's door) (▷ page 121)

Even with the SmartKey with KEYLESS-GO removed from the vehicle, the locking/closing switch can be operated. Therefore, do not leave children unattended in the vehicle,

or with access to an unlocked vehicle. Unsupervised use of vehicle equipment may cause an accident and/or serious personal injury.

**Warning!**

Only drive with the tailgate closed as, among other dangers such as blocked visibility, exhaust fumes may enter the vehicle interior.

**Automatic central locking**

The doors and the tailgate automatically lock when the ignition is switched on and the wheels are turning at vehicle speeds of approximately 9 mph (15 km/h) or more.

You can open a locked door from the inside. Open door only when conditions are safe to do so.



The doors unlock automatically after an accident if the force of the impact exceeds a preset threshold.

The vehicle automatically locks when the ignition is switched on and the wheels are turning at vehicle speeds of approximately 9 mph (15 km/h) or more. You could therefore lock yourself out when the vehicle

- is pushed or towed
- is on a test stand

For more information on towing the vehicle, see “Towing the vehicle” (▷ page 458).

You can deactivate the automatic locking mode using the control system (▷ page 176).



### Locking and unlocking

#### Locking and unlocking from the inside

You can lock or unlock the doors and the tailgate from inside using the central locking switch. This can be useful, for example, if you want to lock the vehicle before starting to drive.

The fuel filler flap cannot be locked or unlocked with the central locking switch.

#### Warning!



When leaving the vehicle, always remove the SmartKey or the SmartKey with KEYLESS-GO\* from the starter switch, take it with you, and lock the vehicle. Do not leave children unattended in the vehicle, or with access to an unlocked vehicle. Unsupervised use of vehicle equipment may cause an accident and/or serious personal injury.

The switch is located in the center console.



#### Central locking switch

- ① Locking
- ② Unlocking



You can open a locked door from the inside. Open door only when conditions are safe to do so.

If the vehicle was previously centrally locked using the SmartKey, it will not unlock using the central locking switch.

If the vehicle was previously locked with the central locking switch

- while in the selective remote control mode, only the front door opened from the inside is unlocked.
- while in the global remote control mode, the vehicle is unlocked completely when a front door is opened from the inside.

#### Locking

- ▶ Press lower half ① of the central locking switch.

If all doors are closed, the vehicle locks.

#### Unlocking

- ▶ Press upper half ② of the central locking switch.

The vehicle unlocks.

## ▼ Seats

For more information on seat adjustment, see the “Getting started” section (▷ page 41).

### Front seat active head restraints

#### Warning!



For your protection, drive only with properly positioned head restraints.

Adjust head restraint so that the center of the head restraint supports the back of the head at eye level. This will reduce the potential for injury to the head and neck in the event of an accident or similar situation.

Do not drive the vehicle without the seat head restraints. Head restraints are intended to help reduce injuries during an accident.

You cannot remove the active head restraint on the driver’s and passenger’s seats.

For removal of the active head restraints we recommend that you contact an authorized Mercedes-Benz Center.



Adjust the head restraint in such a way that it is as close to the head as possible.

For information on head restraint adjustment, see “Seats” (▷ page 42).

For information on active head restraints, see “Active head restraints” (▷ page 76).

### Rear seat head restraints

#### Folding head restraints back

The rear seat head restraints can be folded backward for increased visibility.

#### Warning!



For safety reasons, always drive with the rear head restraints in the upright position when the rear seats are occupied.

Keep the area around head restraints clear of articles (e.g. clothing) to not obstruct the folding operation of the head restraints.

## Seats

### *Folding head restraints back with switch in the center console*



① Head restraint release switch

- ▶ Switch on the ignition (▷ page 36).
- ▶ Press the symbol-side on switch ① to release the head restraints.

The head restraints will fold backward.

### *Folding head restraints back manually (rear outer seats only)*

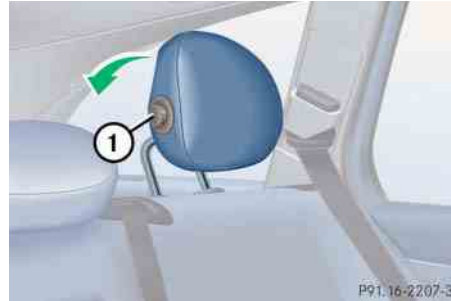

① Release button

- ▶ Push release button ① and fold the head restraints backward.

### *Placing head restraints upright*



- ▶ Pull the head restraint forward until it locks into position.



Make sure the head restraints engage when placing them upright. Otherwise their protective function cannot be assured.

### Head restraint height (rear outer seats only)



#### ① Release button

#### Raising:

- ▶ Manually adjust the height of the head restraint by pulling it upward.

If the head restraint is fully retracted, push release button ① and pull the head restraint out.

#### Lowering:

- ▶ To lower the head restraint, push release button ① and push down on the head restraint.

#### Warning!



For your protection, drive only with properly positioned head restraints.

Adjust head restraint so that the head restraint supports the back of the head at eye level. This will reduce the potential for injury to the head and neck in the event of an accident or similar situation.

Do not drive the vehicle without the seat head restraints. Head restraints are intended to help reduce injuries during an accident.

### Head restraint tilt (rear outer seats only)

Two different head restraint angle positions are available.

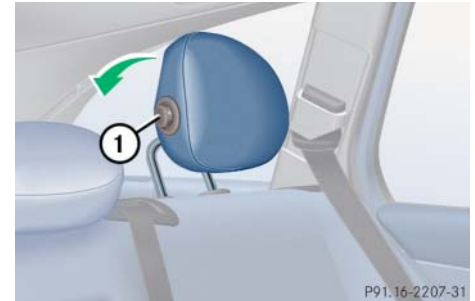

#### ① Release button

- ▶ Press the release button ① and tilt the head restraint to the desired position.

#### Removing and installing rear seat head restraints

##### Warning!



For your protection, drive only with properly positioned head restraints.

Adjust head restraint so that the head restraint supports the back of the head at eye level. This will reduce the potential for injury to the head and neck in the event of an accident or similar situation.

Do not drive the vehicle without the seat head restraints. Head restraints are intended to help reduce injuries during an accident.

Do not interchange head restraints from front and rear seat.

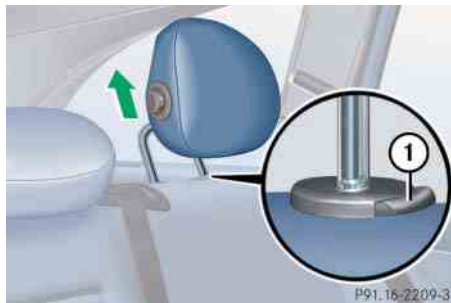

① Release button

#### Removing rear seat head restraints

- ▶ Fold back head restraint (▷ page 129).
- ▶ Pull head restraint to its highest position.
- ▶ Push release button ① and pull out head restraint.

#### Installing rear seat head restraints

- ▶ Insert head restraint and push it down until it engages.
- ▶ Push button ① and adjust head restraint to desired position.



When installing the head restraints, make sure that:

- The proper head restraint for each seat is installed. The bars of the head restraint designed for the middle rear seat are of even length and shorter than those designed for use on the outer rear seats.
- The head restraints engage fully.

## Lumbar support

The curvature of the driver's seat can be adjusted to help enhance lower back support and seating comfort.

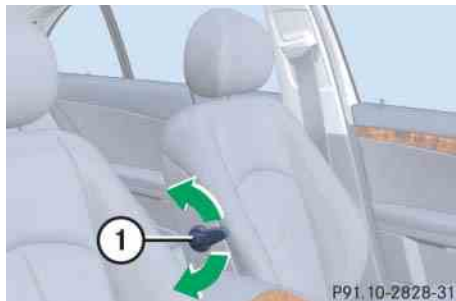

### ① Adjustment lever

- Move adjustment lever ① in direction of the arrows until you have reached a comfortable seating position.

## Drive-Dynamic seat\* with multicon-tour features

The Drive-Dynamic seat automatically adjusts the lateral support provided by the backrest to your driving style.

The Drive-Dynamic seat electronically controls the air pressure in the air chambers of the backrest side bolsters. This function improves driving comfort and pleasure.

In addition, the Drive-Dynamic seat has a movable seat cushion and inflatable air cushions built into the backrest to provide additional lumbar and side support. The seat cushion movement, backrest cushion height and curvature can be continuously varied with switches on the right side of the seat on the driver side, or the left side of the seat on the passenger side after turning the SmartKey in the starter switch to position **2** or pressing the KEY-LESS-GO\* start/stop button twice.

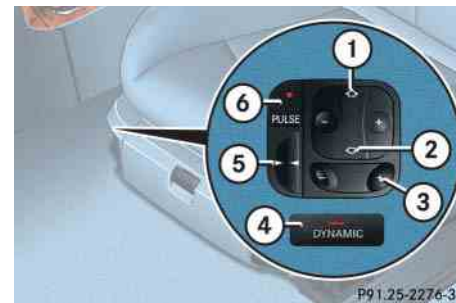

- ① Backrest center
- ② Backrest bottom
- ③ Seat cushion depth
- ④ Activate drive dynamic function
- ⑤ Backrest side bolsters
- ⑥ Massage function

- Switch on the ignition (▷ page 36).

## Seats

### Multicontour features

#### Seat cushion depth

- ▶ Adjust the seat cushion depth to the length of your upper leg using switch ③.

#### Backrest contour

- ▶ Move the backrest support to the bottom by using button ② or to the center by using button ①.
- ▶ Adjust the contour of the backrest to the desired position using **+** or **-**.

#### Backrest side bolsters

- ▶ Adjust the side bolsters so that they provide good lateral support using switch ⑤.

### Drive-dynamic features

#### Activating

- ▶ Press button ④ (▷ page 133).

The indicator lamp on the button comes on and the following display appears in the multifunction display for about 5 seconds.



You can adjust the characteristics of the Drive-Dynamic seat using the control system (▷ page 179).

#### Deactivating

- ▶ Press button ④ (▷ page 133) again.

The indicator lamp on the button goes out.



When the engine is turned off, the last cushion setting is retained in memory. The cushion is automatically adjusted to this setting when the engine is restarted.

#### Massage function (PULSE)

The massage function can help prevent muscle tension during long drives.

- ▶ Press button ⑥ (▷ page 133).

The indicator lamp on the button comes on. The air cushions in the lumbar area pulsate.



The massage function turns off automatically after approximately 5 minutes.

### Seat heating\*

Both switches for the front seats are located in the center console. The red indicator lamps in the switch come on to show which heating level you have selected.

Level	
<b>3</b>	Three indicator lamps on (highest level) The seat heating automatically switches to level <b>2</b> after approximately 5 minutes.
<b>2</b>	Two indicator lamps on The seat heating automatically switches to level <b>1</b> after approximately 10 minutes.
<b>1</b>	One indicator lamp on (lowest level) The seat heating automatically switches off after approximately 20 minutes.
<b>off</b>	No indicator lamp on



① Seat heating switch

- ▶ Switch on the ignition (▷ page 36).

### Switching seat heating on

- ▶ Press switch ① repeatedly until the desired heating level is set.

One or more red indicator lamps on the switch show the selected heating level.

### Switching seat heating off

- ▶ Press switch ① repeatedly until all indicator lamps go out.



If one or more of the lamps on the seat heating switch are flashing, there is insufficient voltage available since too many electrical consumers are turned on. The seat heating switches off automatically.

The seat heating will switch back on again automatically as soon as sufficient voltage is available.



## Seats

### Seat ventilation\*

The switch is located on the center console. Seat ventilation can be activated manually with the ignition on, or by the summer opening feature (▷ page 234).

The blue indicator lamps on the switch show the ventilation level selected:

Level	
3	Three indicator lamps on (highest level)
2	Two indicator lamps on
1	One indicator lamp on (lowest level)
off	No indicator lamp on



① Seat ventilation switch

- ▶ Switch on the ignition (▷ page 36).

### Switching seat ventilation on

- ▶ Press button ① repeatedly until the desired ventilation level is set.



The seat ventilation is automatically set to the highest level if activated via summer opening feature (▷ page 234).

### Switching seat ventilation off

- ▶ Press button ① repeatedly until all indicator lamps go out.



If one or more of the lamps on the seat ventilation switch are flashing, there is insufficient voltage available since too many electrical consumers are turned on. The seat ventilation switches off automatically.

The seat ventilation will switch back on again automatically as soon as sufficient voltage is available.

## Folding bench seat in cargo compartment



The folding bench seat in the cargo compartment is approved only for persons up to a height of 4.6 ft (1.40 m) and a maximum weight of 110 lbs (50 kg).

The twin roller blind must be installed when the folding bench seat is in use.

### Warning!



When using the folding bench seat in the cargo compartment, the seats in front of it must be in the driving position.

Only drive when the head restraints for the folding bench seat have been properly adjusted. The head restraints should be adjusted so that the back of the head is supported at approximately eye level. This can reduce a child's risk of injury in the event of an accident.

### Warning!



Make sure that the seat belt is positioned correctly on the body and is engaged in the seat belt buckle.

Damaged covers should be replaced with original covers only.

Do not leave children unattended in the vehicle, even when they are secured in a child restraint system.

Make sure that luggage and other objects are adequately secured. The load could otherwise injure someone in the event of an accident, during hard braking or steering maneuvers.

## Folding out the folding bench seat

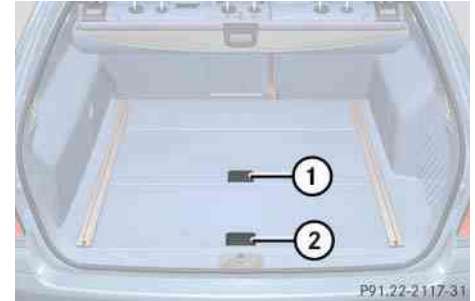

- ① Release handle for seat backrest
- ② Release handle for seat cushion

Before folding out the seat backrest, you must:

- fold the rear seat backrests into an upright position and lock them into place
- move the handle for the twin roller blind into the upper position



The rear seat backrests can be adjusted to a more reclined position to make the folding bench seat more comfortable (▷ page 262).

## Seats

- ▶ Pull release handle ① and fold seat backrest for the folding bench seat upward.



### ③ Mountings for seat belts

- ▶ Hook seat belts into mountings ③.
- ▶ Pull release handle ② and fold seat cushion for the folding bench seat into sitting position.
- ▶ Press seat cushion as far down as it will go.  
The backrest will then also engage properly.
- ▶ Fold head restraints into upright position.

## Removing and installing seat cushions



You must remove the seat cushion when you want to raise the loading floor, e.g. in the event of a flat tire.

### Removing

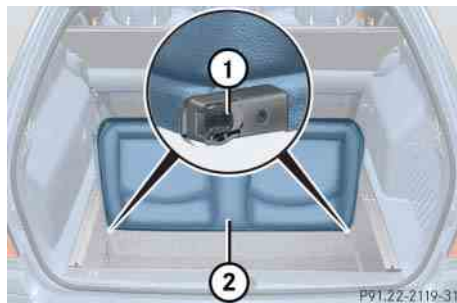

- ① Seat guides
- ② Seat cushion

- ▶ Fold seat cushion ② upward and remove it from seat guides ①.

### Installing



- ▶ Insert seat cushion ② into seat guides ① from behind ③ at a slight angle.
- ▶ Fold seat cushion ② back into original position ④ until it engages.

### Folding back folding bench seat

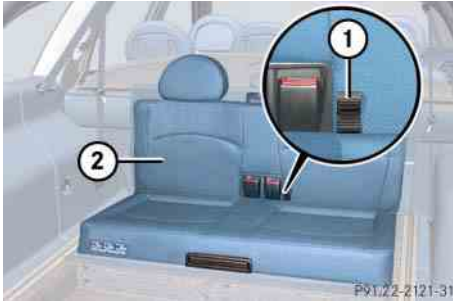

- ① Tab
- ② Backrest

- ▶ Pull seat cushion upward using tab ① and fold it back into original position until it engages.



- ① Release knob

- ▶ Press release knob ① and fold head restraints down.



To avoid damage, insert the head restraints completely into their guides and engage the seat belt buckles in their guides.



- ① Release catch

- ▶ Press release catch ① and push head restraints as far in as they will go.
- ▶ Fold seat backrest of folding bench seat back into original position until it engages.

### Memory function

Prior to operating the vehicle, the driver should check and adjust the seat height, seat position fore and aft, and seat backrest angle if necessary, to ensure adequate control, reach and comfort. The head restraint should also be adjusted for proper height. See also the section on air bags (▷ page 67) for more information on proper seat positioning.

In addition, adjust the steering wheel to ensure adequate control, reach, operation and comfort. Both the interior and outside rear view mirrors should be adjusted for adequate rear vision.

Fasten seat belts. Infants and small children should be seated in a properly secured restraint system that complies with U.S. Federal Motor Vehicle Safety Standards 213 and 225 and Canadian Motor Vehicle Safety Standards 213 and 210.2.

The following settings are stored when using the buttons on the driver's door:

- Driver's seat, backrest and head restraint position and settings for multicontour seat
- Steering wheel position
- Exterior rear view mirror positions

The following settings are stored when using the buttons on the front passenger door:

- Front passenger seat, backrest and head restraint position and settings for multicontour seat

The memory button and memory position buttons are located on the door.



**M** Memory button

**1, 2, 3** Memory position button

▶ Switch on the ignition (▷ page 36).

or

▶ Open the respective door.

#### Warning!



Do not activate the memory function while driving. Activating the memory function while driving could cause the driver to lose control of the vehicle.

### Storing positions into memory

---

- ▶ Adjust the seats, steering wheel and exterior rear view mirrors to the desired position (▷ page 40).
- ▶ Press memory button **M**.
- ▶ Release memory button **M** and press memory position button **1**, **2** or **3** within 3 seconds.

All the settings are stored at the selected position.

### Recalling positions from memory

---



Do not operate the power seats using the memory button if the seat backrest is in an excessively reclined position. Doing so could cause damage to front or rear seats.

- ▶ Press and hold memory position button **1**, **2** or **3** until the seat, steering wheel and exterior rear view mirrors have completely moved to the stored positions.



Releasing the memory position button stops movement to the stored positions immediately.

### Storing exterior rear view mirror parking position

---

For easier parking, you can adjust the passenger-side exterior rear view mirror so that you can see the right rear wheel as soon as you engage reverse gear **R**.

For information on activating the parking position, see “Activating exterior rear view mirror parking position” (▷ page 198).

### Memory function

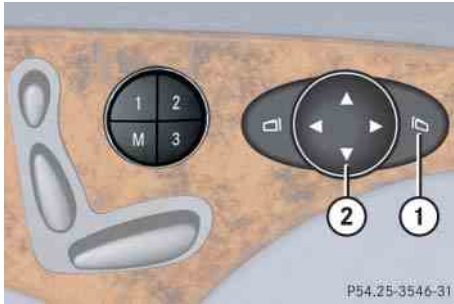

- ① Passenger side, exterior rear view mirror
- ② Adjustment button
- ▶ Stop the vehicle.
- ▶ Switch on the ignition (▷ page 36).
- ▶ Press button ①.

The passenger-side exterior rear view mirror is selected.

- ▶ Adjust the exterior rear view mirror with button ② so that you see the rear wheel and the road curb.
- ▶ Press memory button **M**.
- ▶ Within 3 seconds, press bottom of adjustment button ②.

The parking position is stored if the mirror does not move.



If the mirror does move, repeat the above steps. After the setting is stored, you can move the mirror again.

▼ Lighting

For information on how to switch on the headlamps and use the turn signals, see “Switching on headlamps” (▷ page 54) and see “Turn signals” (▷ page 54).



If you drive in countries where vehicles drive on the other side of the road than the country where the vehicle is registered, you must have the headlamps modified for symmetrical low beams. Relevant information can be obtained at your authorized Mercedes-Benz Center.



Vehicles equipped with active Bi-Xenon\* headlamps:

The active Bi-Xenon headlamps monitor your steering angle and driving speed, then automatically shift their beams to either side to better follow the curvature of the road ahead, increasing usable illumination over conventional headlamps.

**Exterior lamp switch**

The exterior lamp switch is located on the dashboard to the left of the steering wheel.



**Exterior lamp switch**

- 0** Off  
Daytime running lamp mode (▷ page 144)
- AUTO** Automatic headlamp mode  
Daytime running lamp mode (▷ page 144)
- Parking lamps (also tail lamps, license plate lamps, side marker lamps, instrument panel lamps)

- Low beam headlamps (or high beam headlamps when the combination switch is pushed forward) and parking lamps
- P** Standing lamps, right (turn left one stop)
- P** Standing lamps, left (turn left two stops)
- Indicator lamp for front fog lamps
- Indicator lamp for rear fog lamp



With the SmartKey removed from the starter switch or the engine turned off with KEYLESS-GO\* and the driver's door open, a warning sounds if the parking lamps or low beam headlamps are switched on.

The message *Switch off lamps* appears in the multifunction display.



### Lighting

#### Manual headlamp mode

The low beam headlamps and the parking lamps can be switched on and off with the exterior lamp switch.

#### Automatic headlamp mode

The following lamps switch on and off automatically depending on the brightness of the ambient light:

- Low beam headlamps
- Tail and parking lamps
- License plate lamps
- Side marker lamps



#### Warning!



If the exterior lamp switch is set to **AUTO**,

- the headlamps may switch off unexpectedly when the system senses bright ambient light, for example light from oncoming traffic.
- the headlamps will not be automatically switched on under foggy conditions.

To minimize risk to you and to others, activate headlamps by turning exterior lamp switch to  when driving or when traffic and /or ambient lighting conditions require you to do so.

In low ambient lighting conditions, only switch from position **AUTO** to  with the vehicle at a standstill in a safe location. Switching from **AUTO** to  will briefly switch off the headlamps. Doing so while driving in low ambient lighting conditions may result in an accident.

The automatic headlamp feature is only an aid to the driver. The driver is responsible for the operation of the vehicle's lights at all times.

- ▶ Turn exterior lamp switch to position **AUTO**.

With the SmartKey in starter switch position **1** or the KEYLESS-GO\* start/stop button pressed once, only the parking lamps will switch on and off automatically.

When the engine is running, the low beam headlamps, the tail and parking lamps, the licence plate lamps and the side marker lamps will switch on and off automatically.

#### Daytime running lamp mode

- ▶ Turn the exterior lamp switch to position **0** or **AUTO**.

When the engine is running, the low beam headlamps are automatically switched on.

In low ambient light conditions, the following lamps will switch on additionally:

- Tail and parking lamps
- License plate lamps
- Side marker lamps

For nighttime driving you should turn the exterior lamp switch to position  to permit activation of the high beam headlamps.



With the daytime running lamp mode activated and the exterior lamp switch in position **0**, the high beam headlamps cannot be switched on.



The high beam flasher is available at all times.

### Canada only

The daytime running lamp mode is mandatory and therefore in a constant mode.

When the engine is running, and you shift from a driving position to position **N** or **P**, the low beam headlamps will switch off with a three-minute delay.



When the engine is running, and you

- turn the exterior lamp switch to position , the parking lamps switch on additionally.
- turn the exterior lamp switch to position , the manual headlamp mode has priority over the daytime running lamp mode.

The corresponding exterior lamps switch on (▷ page 54).

### USA only

By default, the daytime running lamp mode is deactivated. Activate the daytime running lamp mode using the control system, see “Setting daytime running lamp mode (USA only)” (▷ page 172).

When the engine is running, and you turn the exterior lamp switch to position  or , the manual headlamp mode has priority over the daytime running lamp mode.

The corresponding exterior lamps switch on (▷ page 54).

### Locator lighting and night security illumination



Locator lighting and night security illumination are described in the “Control system” section, see (▷ page 173) and (▷ page 174).

### Lighting

#### Fog lamps

##### Warning!



In low ambient lighting or foggy conditions, only switch from position **AUTO** to  with the vehicle at a standstill in a safe location. Switching from **AUTO** to  will briefly switch off the headlamps. Doing so while driving in low ambient lighting conditions may result in an accident.



Fog lamps will operate with the parking lamps and / or the low beam headlamps on. Fog lamps should only be used in conjunction with low beam headlamps. Consult your State or Province Motor Vehicle Regulations regarding permissible lamp operation.



Fog lamps cannot be switched on with the exterior lamp switch in position **AUTO**. For switching on the fog lamps, turn the exterior lamp switch to position .

#### Front fog lamps

- ▶ Switch on the low beam headlamps (▷ page 143).
- ▶ Pull out the exterior lamp switch to first stop.

The front fog lamps are switched on.

The green indicator lamp  in the exterior lamp switch comes on (▷ page 24).

- ▶ Push in the exterior lamp switch.

The front fog lamps are switched off.

The green indicator lamp  in the exterior lamp switch goes out.

#### Rear fog lamp (driver's side only)

- ▶ Switch on the front fog lamps.
- ▶ Pull out the exterior lamp switch to second stop.

The rear fog lamp is switched on.

The yellow indicator lamp  in the exterior lamp switch comes on (▷ page 24).

- ▶ Push in the exterior lamp switch to first stop.

The rear fog lamp is switched off.

The yellow indicator lamp  in the exterior lamp switch goes out.

The front fog lamps remain lit.

### Combination switch

The combination switch is located on the left side of the steering column.



### Combination switch

- ① High beam
- ② High beam flasher

### High beam

- ▶ Turn the exterior lamp switch to position  or **AUTO** (▷ page 143).
- ▶ Push the combination switch in direction of arrow ① to switch on the high beam.

The high beam headlamp indicator lamp  in the instrument cluster comes on (▷ page 24).

- ▶ Pull the combination switch in direction of arrow ② to its original position to switch off the high beam.

The high beam headlamp indicator lamp  in the instrument cluster goes out.

### High beam flasher

- ▶ Pull the combination switch briefly in direction of arrow ②.

### Hazard warning flasher

The hazard warning flasher can be switched on at all times, even with the SmartKey removed from the starter switch or with the SmartKey with KEYLESS-GO\* removed from the vehicle.

The hazard warning flasher switches on automatically when an air bag deploys.

The hazard warning flasher switch is located on the upper part of the center console.

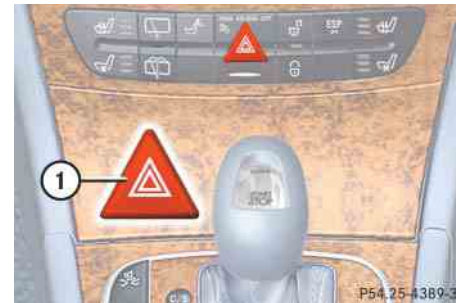

- ① Hazard warning flasher switch

### Lighting

#### Switching on hazard warning flasher

- ▶ Press the hazard warning flasher switch ①.

All turn signals are flashing.



With the hazard warning flasher activated and the combination switch set for either left or right turn, only the respective left or right turn signals will operate when the ignition is switched on.

#### Switching off hazard warning flasher

- ▶ Press hazard warning flasher switch ① again.



If the hazard warning flasher has been activated automatically, press hazard warning flasher switch ① once to switch it off.

#### Interior lighting in the front



- ① Left front reading lamp on / off
- ② Rear interior lighting on / off
- ③ Automatic control on / off
- ④ Front interior lighting on / off
- ⑤ Right front reading lamp on / off
- ⑥ Ambient lighting
- ⑦ Interior lighting
- ⑧ Front reading lamps

The controls are located in the overhead control panel.



Leaving an interior light switch in the ON position for extended periods of time with the engine turned off could result in a discharged battery.

#### Automatic control

##### Activating

- ▶ Press automatic control switch ③.

The interior lighting switches on in darkness when you:

- unlock the vehicle
- remove the SmartKey from the starter switch
- open a door
- open the tailgate

The interior lighting switches off automatically following an adjustable time delay.

For more information, see “Setting interior lighting delayed shut-off” (▷ page 175).



If the door remains open, the interior lighting switches off automatically after approximately 5 minutes.

### **Deactivating**

- ▶ Press automatic control switch ③ again.

The interior lighting remains switched off in darkness, even when you:

- unlock the vehicle
- remove the SmartKey from the starter switch
- open a door
- open the tailgate

### **Manual control**

#### **Front interior lighting**

- ▶ Press front interior lighting switch ④.  
The front interior lighting switches on.
- ▶ Press front interior lighting switch ④ again.  
The front interior lighting switches off.

#### **Rear interior lighting**

- ▶ Press rear interior lighting switch ②.  
The rear interior lighting switches on.
- ▶ Press rear interior lighting switch ② again.  
The rear interior lighting switches off.



The setting selected for the interior lighting is used for the cargo compartment as well.

If the tailgate remains open, the cargo compartment lamp switches off automatically after approximately 10 minutes.

### **Front reading lamps**

The front reading lamps are located in the lower edge of the interior rear view mirror.

- ▶ Press front reading lamp switch ① or ⑤ to switch on the desired front reading lamp.
- ▶ Press front reading lamp switch ① or ⑤ again to switch off the respective front reading lamp.

### Lighting

#### Door entry lamps

For better orientation in the dark, the corresponding door entry lamps will switch on in the darkness when you open a door and the automatic control is activated.

The door entry lamps will switch off when the corresponding door is closed.



If you turn the SmartKey in the starter switch to position **0** and switch off the headlamps, the door entry lamps will remain lit for approximately 5 minutes.

#### Interior lighting in the rear

The overhead control panel is located above the rear seat bench.

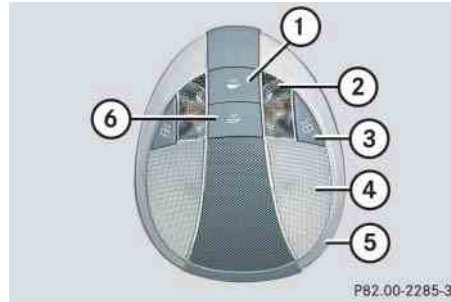

- ① Ambient lighting switch, to brighten
- ② Rear reading lamp
- ③ Rear reading lamp on / off
- ④ Rear interior lamp
- ⑤ Ambient lighting
- ⑥ Ambient lighting switch, to dim

#### Rear reading lamps

- ▶ Press respective rear reading lamp switch ③ to switch on the corresponding rear reading lamp.
- ▶ Press respective rear reading lamp switch ③ again to switch off the corresponding rear reading lamp.

#### Ambient lighting

- ▶ Press ambient lighting switch ① or ⑥ repeatedly until ambient lighting ⑤ has reached the desired intensity.

You can switch the ambient lighting on and off, using the Control system (> page 174).

## ▼ Instrument cluster

A full view illustration of the instrument cluster can be found in the “At a glance” section of this manual (▷ page 24).

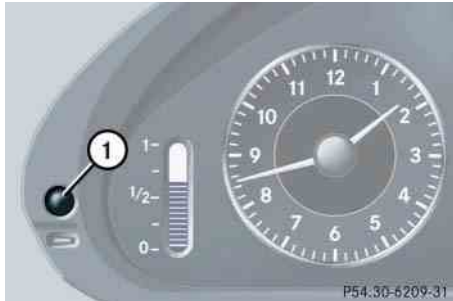

### ① Reset button

The instrument cluster is activated when you

- open a door
- switch on the ignition (▷ page 36)
- press the reset button ①
- switch on the exterior lamps

You can modify the instrument cluster settings in the instrument cluster submenu of the control system (▷ page 168).

### Warning!



If the instrument cluster or the multifunction display, or both, are inoperative or malfunctioning, warning messages will not be relayed when potential danger exists. This may cause you and others to be unaware of certain risks and/or personal injury.

Contact the nearest authorized Mercedes-Benz Center as soon as possible.

## Instrument cluster illumination

Use the reset button ① to adjust the illumination brightness for the instrument cluster.



The instrument cluster illumination is dimmed or brightened automatically to suit ambient light conditions.

The instrument cluster illumination will also be adjusted automatically when you switch on the vehicle's exterior lamps.



### Instrument cluster

#### To brighten illumination

- ▶ Turn the reset button ① in the instrument cluster clockwise.

The instrument cluster illumination will brighten.

#### To dim illumination

- ▶ Turn the reset button ① in the instrument cluster counterclockwise.

The instrument cluster illumination will dim.

#### Coolant temperature indicator

##### Warning!



- Driving when your engine is overheated can cause some fluids which may have leaked into the engine compartment to catch fire. You could be seriously burned.
- Steam from an overheated engine can cause serious burns and can occur just by opening the hood. Stay away from the engine if you see or hear steam coming from it.

Turn off the engine, get out of the vehicle and do not stand near the vehicle until the engine has cooled down.





Excessive coolant temperature trigger a warning in the multifunction display (▷ page 376).

During severe operating conditions, e.g. stop-and-go traffic, the coolant temperature may rise close to 248°F (120°C).

The engine should not be operated with the coolant temperature above 248°F (120°C). Doing so may cause serious engine damage which is not covered by the Mercedes-Benz Limited Warranty.

## Trip odometer

Make sure you are viewing the trip odometer display (▷ page 155).

- ▶ If it is not displayed, press button  or  repeatedly until the trip odometer appears.
- ▶ Press and hold the reset button  (▷ page 151) until the trip odometer is reset.

## Tachometer

The red marking on the tachometer denotes excessive engine speed.



Avoid driving at excessive engine speeds, as it may result in serious engine damage that is not covered by the Mercedes-Benz Limited Warranty.

To help protect the engine, the fuel supply is interrupted if the engine is operated within the red marking.

## Outside temperature indicator

### Warning!



The outside temperature indicator is not designed to serve as an ice-warning device and is therefore unsuitable for that purpose.

Indicated temperatures just above the freezing point do not guarantee that the road surface is free of ice. The road may still be icy, especially in wooded areas or on bridges.

The outside temperature is displayed in the instrument cluster (▷ page 24).

The temperature sensor is located in the front bumper area. Due to its location, the sensor can be affected by road or engine heat during idling or slow driving. This means that the accuracy of the displayed temperature can only be verified by comparison to a thermometer placed next to the sensor, not by comparison to external displays (e.g. bank signs etc.).

When moving the vehicle into colder ambient temperatures (e.g. when leaving your garage), you will notice a delay before the lower temperature is displayed.

A delay also occurs when ambient temperatures rise. This prevents inaccurate temperature indications caused by heat radiated from the engine during idling or slow driving.

### ▼ Control system

The control system is activated as soon as the SmartKey in the starter switch is turned to position **1** or as soon as the KEYLESS-GO start/stop button\* is in position **1**. The control system enables you to:

- call up information about your vehicle
- change vehicle settings.

For example, you can use the control system to find out when your vehicle is next due for service, to set the language for messages in the instrument cluster display, and much more.



The displays for the audio systems (radio, CD player) will appear in English, regardless of the language selected.

### Warning!



A driver's attention to the road and traffic conditions must always be his / her primary focus when driving.

For your safety and the safety of others, selecting features through the multifunction steering wheel should only be done by the driver when traffic and road conditions permit it to be done safely.

Bear in mind that at a speed of just 30 mph (approximately 50 km / h), your vehicle is covering a distance of 44 feet (approximately 14 m) every second.

The control system relays information to the multifunction display.

### Multifunction display



- ① Outside temperature
- ② Trip odometer
- ③ Automatic transmission program mode
- ④ Main odometer
- ⑤ Current gear selector lever position

Above illustration shows the standard display.

For more information on menus displayed in the multifunction display, see “Menus” (▷ page 158).

## Control system

### Multifunction steering wheel

The displays in the multifunction display and the settings in the control system (▷ page 155) are controlled by the buttons on the multifunction steering wheel.

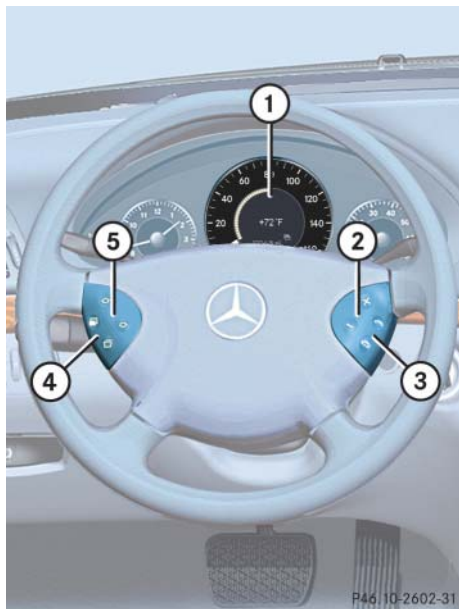

- ① Multifunction display in the speedometer

#### Operating the control system

- ② Selecting the submenu or setting the volume:

Press button

 up/to increase

 down/to decrease

- ③ Telephone\*:
- Press button

 to take a call  
to dial a call

 to end a call  
to reject an incoming call

- ④ Menu systems:
- Press button

 for next menu

 for previous menu

- ⑤ Moving within a menu:
- Press button

 for next display





 for previous display

Pressing any of the buttons on the multifunction steering wheel will alter what is shown in the multifunction display.

The information available in the multifunction display is arranged in menus, each containing a number of functions or sub-menus.

The individual functions are then found within the relevant menu (radio or CD operations under AUDIO, for example). These functions serve to call up relevant information or to customize the settings for your vehicle.

It is helpful to think of the menus, and the functions within each menu, as being arranged in a circular pattern.

- If you press button  or  repeatedly, you will pass through each menu one after the other.
- If you press button  or  repeatedly, you will pass through each function display, one after the other, in the current menu.

In the *Settings* menu, instead of functions you will find a number of submenus for calling up and changing settings. For instructions on using these submenus, see the “Settings menu” section (▷ page 165).

The number of menus available in the system depends on which optional equipment is installed in your vehicle.

The menus are described on the following pages.

### Menus

This is what you will see when you scroll through the menus.

The table on the next page provides an overview of the individual menus.

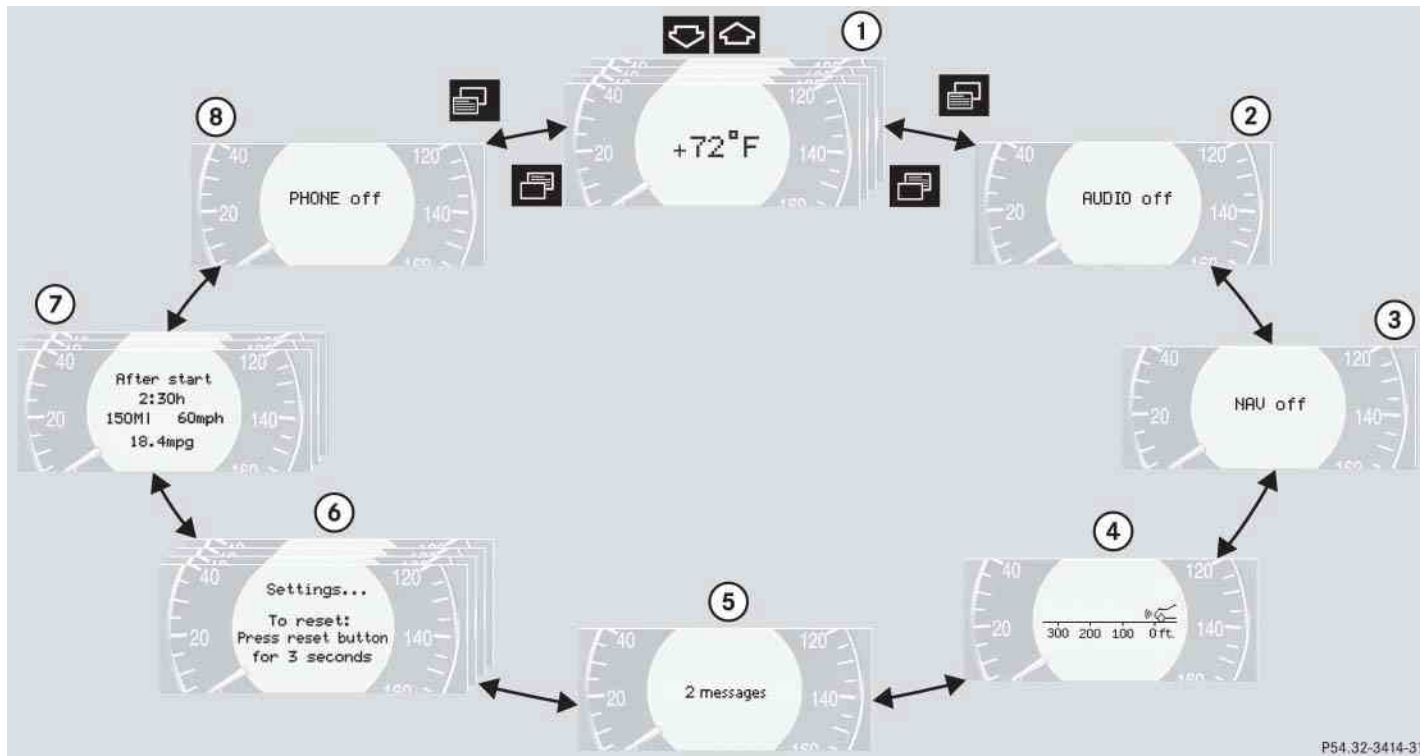

P54.32-3414-31

Menus, submenus and functions

	Menu ① <b>Standard display</b> (▷ page 161)	Menu ② <b>AUDIO</b> (▷ page 161)	Menu ③ <b>NAV*</b> (▷ page 163)	Menu ④ <b>Distronic*</b> (▷ page 163)
Commands/submenus	Digital speedometer Call up maintenance system display Check tire inflation pressure* Check engine oil level	Select radio station Operate CD player	Show route guidance instructions, current direction traveled	Call up settings



## Control system

	<b>Menu ⑤</b> <b>Vehicle status message memory<sup>1</sup></b> (▷ page 164)	<b>Menu ⑥</b> <b>Settings</b> (▷ page 165)	<b>Menu ⑦</b> <b>Trip computer</b> (▷ page 180)	<b>Menu ⑧</b> <b>TEL*</b> (▷ page 181)
<b>Commands/submenus</b>	Call up vehicle malfunction, warning and system status messages stored in memory	Reset to factory settings Instrument cluster submenu Time/Date submenu Lighting submenu Vehicle submenu Convenience submenu Dynamic seat* submenu	Fuel consumption statistics after start Fuel consumption statistics since the last reset Call up range	Load phone book Search for name in phone book



<sup>1</sup> The vehicle status message memory menu is only displayed if there is a message stored.



The headings used in the menus table are designed to facilitate navigation within the system and are not necessarily identical to those shown in the control system displays.

The first function displayed in each menu will automatically show you which part of the system you are in.



### Standard display menu

- ▶ Press button  or  repeatedly to select the functions in the standard display menu.

The following functions are available:

Function	Page
Calling up digital speedometer	161
Calling up maintenance service indicator	358
Checking tire inflation pressure*	335
Checking engine oil level	317

### Display digital speedometer

- ▶ Press button  or  repeatedly until the digital speedometer appears in the multifunction display.

### AUDIO menu



The functions in the AUDIO menu operate the audio equipment which you currently have turned on.

If no audio equipment is currently turned on, the message **AUDIO off** appears in the multifunction display.



The following functions are available:

Function	Page
Select radio station	161
Select satellite radio station*	162
Operate CD player	162

### Select radio station

- ▶ Turn on COMAND and select radio. Refer to separate COMAND operating instructions.
- ▶ Press button  or  repeatedly until you see the currently tuned station in the multifunction display.



- ① Waveband setting
  - ② Station frequency
- ▶ Press button  or  repeatedly until the desired station is found.



You can only store new stations using the corresponding feature on the radio, see separate operating instructions.

You can also operate the radio in the usual manner.

### Control system

#### Select satellite radio station\* (USA only)

The satellite radio is treated as a radio application.

- ▶ Select SAT radio with the corresponding softkey in the radio menu.



- ① SAT mode and preset number
  - ② Setting for station selection using memory
  - ③ Channel name or number
- ▶ Press button or repeatedly until the desired channel is found.



Additional optional satellite radio equipment and a subscription to satellite radio service provider are required for satellite radio operation. Contact an authorized Mercedes-Benz Center for details and availability for your vehicle.

For more information, refer to separate COMAND operating instructions.

#### Operate the CD player

- ▶ Turn on COMAND and select CD. Refer to separate COMAND operating instructions.
- ▶ Press button or repeatedly until the settings for the CD currently being played appear in the multifunction display.

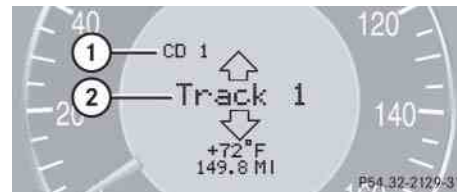



- ① Current CD (for CD changer\*)
  - ② Current track
- ▶ Press button or repeatedly until the desired track is selected.



To select a CD from the magazine, press a number on the COMAND system key pad located in the center console.

## NAV\* menu

The NAV menu contains the functions needed to operate your navigation system.



- ▶ Press button  or  repeatedly until you see the message NAV in the multifunction display.
- If COMAND is switched off, the message NAV off appears in the multifunction display.
- With COMAND switched on but route guidance not activated, the direction of travel and, if available, the name of the street currently traveled on appear in the multifunction display.
- With COMAND switched on and route guidance activated, the direction of travel and maneuver instructions appear in the multifunction display.

Please refer to the COMAND manual for instructions on how to activate the route guidance system.

## Distronic\* menu

Use the Distronic menu to display the current settings for your Distronic system. What information is shown in the multifunction display depends on whether the Distronic system is active or inactive.

Please refer to the “Driving systems” section of this manual (▶ page 243) for instructions on how to activate Distronic.

- ▶ Press button  or  repeatedly until you see one of the following two pictures in the multifunction display.

## Distronic deactivated

When Distronic is deactivated, you will see the standard display in the multifunction display.

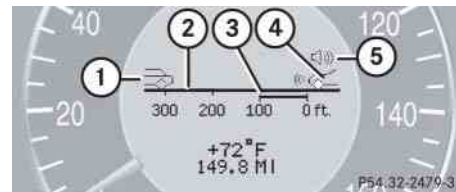

- ① Vehicle ahead, if detected
- ② Actual distance to vehicle ahead
- ③ Preset distance threshold to vehicle ahead
- ④ Your vehicle
- ⑤ Symbol for activated distance warning function

### Control system

#### Distronic activated

With DISTRONIC activated, the DISTRONIC display is shown in the multifunction display and one or two segments around the set speed are illuminated in the speedometer.

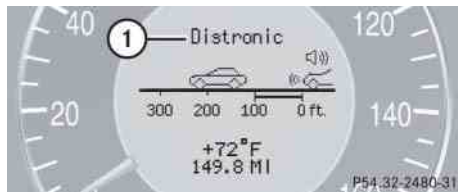

① DISTRONIC activated

#### Vehicle status message memory menu



Use the vehicle status message memory menu to scan malfunction and warning messages that may be stored in the system. Such messages appear in the multifunction display and are based on conditions or system status the vehicle's system has recorded.

The vehicle status message memory menu only appears if there are any messages stored.

#### Warning!



Malfunction and warning messages are only indicated for certain systems and are intentionally not very detailed. The malfunction and warning messages are simply a reminder with respect to the operation of certain systems and do not replace the owner's and / or driver's responsibility to maintain the vehicle's operating safety by having all required maintenance and safety checks performed on the vehicle and by bringing the vehicle to an authorized Mercedes-Benz Center to address the malfunction and warning messages (▷ page 383).



- ▶ Press button  or  repeatedly until the vehicle status message memory appears in the multifunction display.

If the vehicle status message memory menu does not appear, then there are no messages stored.

### Vehicle status messages have been recorded

If conditions have occurred causing status messages to be recorded, the number of messages appears in the multifunction display:



► Press button  or .

The stored messages will now be displayed in the order in which they have occurred. For malfunction and warning messages, see “Vehicle status messages in the multifunction display” (▷ page 383).



Should the vehicle’s system record any conditions while driving, the number of messages will reappear in the multifunction display when the SmartKey in the starter switch is turned to position **0** or removed from the starter switch.



The vehicle status message memory will be cleared when you turn the SmartKey in the starter switch to position **1** or **2**. You will then only see high-priority messages in the multifunction display (▷ page 383).

### Settings menu

In the Settings menu there are two functions:

- The function To reset: Press reset button for 3 seconds, with which you can reset all the settings to the original factory settings.
  - A collection of submenus with which you can make individual settings for your vehicle.
- Press button  or  repeatedly until the Settings menu is seen in the multifunction display.



### Control system

#### Resetting all settings

You can reset all the functions of all submenus to the factory settings.

- ▶ Press the reset button in the instrument cluster (▷ page 151) for approximately 3 seconds.

In the multifunction display you will see the request to press the reset button again to confirm.

- ▶ Press the reset button again.

The functions of all the submenus will reset to factory settings.



The settings you have changed will not be reset unless you confirm the action by pressing the reset button a second time. After approximately 5 seconds, the **Settings** menu reappears in the multifunction display.

For safety reasons, the **Lamp circuit headlamp** function in the **Lighting** submenu is not reset while driving.

#### Submenus in the Settings menu

- ▶ Press button

In the multifunction display you see the collection of the submenus.



- ▶ Press button

The selection marker moves to the next submenu.

The submenus are arranged by hierarchy. Scroll down with button , scroll up with button .

With the selection marker on the desired submenu, use the button to access the individual functions within that submenu. Once within the submenu, you can use the button to move to the next function or the button to move to the previous function within that submenu.

The settings themselves are made with button or .

The table below shows what settings can be changed within the various menus. Detailed instructions on making individual settings can be found on the following pages.

INSTRUMENT CLUSTER	TIME/DATE	LIGHTING	VEHICLE	CONVENIENCE	DYNAMIC SEAT*
Select speedometer display mode	Synchronizing the time	Set daytime running lamp mode (USA only)	Set automatic locking	Activate easy-entry / exit feature	Set level for dynamic seat, driver
Select language	Set time (hours)	Set locator lighting	Limiting opening height of tailgate*	Set parking position for exterior rear view mirror	Set level for dynamic seat, passenger
Select display (speed display or outside temperature) for status line	Set time (minutes)	Setting ambient lighting			
Select display (speed display or outside temperature) for basic display	Set date (month)	Setting headlamps delayed shut-off			
	Set date (day)	Setting interior lighting delayed shut-off			
	Set date (year)				



## Control system

### Instrument cluster submenu

Access the Instr. cluster submenu via the Settings menu. Use the Instr. cluster submenu to change the instrument cluster display settings. The following functions are available:

Function	Page
Select speedometer display mode	168
Select language	168
Select display (speed display or outside temperature) for status display	169
Select display (speed display or outside temperature) for basic display	169

### Selecting speedometer display mode

- ▶ Move the selection marker with button **+** or **-** to the Instr. cluster submenu.
- ▶ Press button **▲** or **▼** repeatedly until the message Display unit Speed-/odometer appears in the multifunction display.

The selection marker is on the current setting.



- ▶ Press button **+** or **-** to set speedometer unit to km or miles.

### Selecting language

- ▶ Move the selection marker with button **+** or **-** to the Instr. cluster submenu.
- ▶ Press button **▲** or **▼** repeatedly until the message Language appears in the multifunction display.

The selection marker is on the current setting.



- ▶ Press button **+** or **-** to select the language to be used for the multifunction display messages.

Available languages:

- German (Deutsch)
- English (English)
- French (Français)
- Italian (Italiano)
- Spanish (Español)
- Dutch (Nederlands)
- Danish (Dansk)
- Swedish (Svenska)
- Portuguese (Português)
- Turkish (Türkçe)

### Selecting display (speed display or outside temperature) for status display

- ▶ Move the selection marker with button **+** or **-** to the Instr. cluster submenu.
- ▶ Press button **↶** or **↷** repeatedly until the message Status line display appears in the multifunction display.

The selection marker is on the current setting.



- ▶ Press button **+** or **-** to select the status line to Speed or Outside temp..



You will see the status indicator when you have called up a different display from the standard display.

### Selecting display (speed display or outside temperature) for basic display

- ▶ Move the selection marker with button **+** or **-** to the Instr. cluster submenu.
- ▶ Press button **↶** or **↷** repeatedly until the message Basic display appears in the multifunction display.

The selection marker is on the current setting.



- ▶ Press button **+** or **-** to select the display permanently shown in the multifunction display.

## Control system

### Time /Date submenu

Access the Time/Date submenu via the Settings menu. Use the Time/Date submenu to change the time and date display settings. The following functions are available:

Function	Page
Synchronizing the time	170
Set time (hours)	170
Set time (minutes)	171
Set date (month)	171
Set date (day)	171
Set date (year)	172



Information on setting the time, refer to separate COMAND instructions.

### Synchronizing the time

This function can only be seen on vehicles with COMAND and navigation module\*.

- ▶ Move the selection marker with button **+** or **-** to the Time/Date submenu.
- ▶ Press button or repeatedly until the message Time sync. with head unit appears in the multifunction display.

The selection marker is on the current setting.



- ▶ Press button **+** or **-** to select the desired setting.

### Set time (hours)

This function can only be seen when time synchronization is switched off.

- ▶ Move the selection marker with button **+** or **-** to the Time/Date submenu.
- ▶ Press button or repeatedly until the message Clock, hours appears in the multifunction display.

The selection marker is on the hour setting.



- ▶ Press button **+** or **-** to set the hours.
- ▶ Confirm by pressing reset button (▷ page 151).

### Set time (minutes)

This function can only be seen when time synchronization is switched off.

- ▶ Move the selection marker with button **+** or **-** to the Time/Date submenu.
- ▶ Press button **↶** or **↷** repeatedly until the message **Clock, minutes** appears in the multifunction display.

The selection marker is on the minute setting.



- ▶ Press button **+** or **-** to set the minutes.
- ▶ Confirm by pressing reset button (▷ page 151).

### Set date (month)

- ▶ Move the selection marker with button **+** or **-** to the Time/Date submenu.
- ▶ Press button **↶** or **↷** repeatedly until the message **Set date month** appears in the multifunction display.

The selection marker is on the month setting.



- ▶ Press button **+** or **-** to set the month.

### Set date (day)

- ▶ Move the selection marker with button **+** or **-** to the Time/Date submenu.
- ▶ Press button **↶** or **↷** repeatedly until the message **Set date day** appears in the multifunction display.

The selection marker is on the day setting.



- ▶ Press button **+** or **-** to set the day.

## Control system

### Set date (year)

- ▶ Move the selection marker with button **+** or **-** to the Time/Date submenu.
- ▶ Press button **↶** or **↷** repeatedly until the message **Set date year** appears in the multifunction display.

The selection marker is on the year setting.



- ▶ Press button **+** or **-** to set the year.

### Lighting submenu

Access the Lighting submenu via the Settings menu. Use the Lighting submenu to change the lamp and lighting settings on your vehicle. The following functions are available:

Function	Page
Set daytime running lamp mode (USA only)	172
Setting locator lighting	173
Setting ambient lighting	174
Setting headlamps delayed shut-off	174
Setting interior lighting delayed shut-off	175

### Setting daytime running lamp mode (USA only)



This function is not available in countries where the daytime running lamp mode is mandatory and therefore in a constant mode.

- ▶ Move the selection marker with button **+** or **-** to the Lighting submenu.
- ▶ Press button **↶** or **↷** repeatedly until the message **Lamp circuit headlamp** appears in the multifunction display.

The selection marker is on the current setting.



- ▶ Press button **+** or **-** to select manual operation (manual) or daytime running lamp mode (constant) activated.

With daytime running lamp mode activated and the exterior lamp switch at position **0** or **AUTO**, the low beam headlamps are switched on when the engine is running.

In low ambient light conditions the following lamps will switch on additionally:

- Parking lamps
- Tail lamps
- License plate lamps
- Side marker lamps

For more information on the daytime running lamp mode, see “Lighting” (▷ page 143).



For safety reasons, resetting the Lighting submenu to factory settings while driving (▷ page 166) will not deactivate the daytime running lamp mode.

The following message appears in the multifunction display: Lighting - Cannot be completely reset to factory settings while driving.

### Setting locator lighting

With the locator lighting feature activated and the exterior lamp switch in position **AUTO**, the following lamps will switch on during darkness when the vehicle is unlocked using button **U** on the SmartKey or SmartKey with KEYLESS-GO\*:

- Parking lamps
- Tail lamps
- License plate lamps
- Side marker lamps
- Front fog lamps



The locator lighting switches off when the driver's door is opened.

If you do not open a door after unlocking the vehicle with the SmartKey, the lamps will switch off automatically after approximately 40 seconds.

- ▶ Move the selection marker with button **+** or **-** to the Lighting submenu.





### Control system

- ▷▷ Press button  or  repeatedly until the message **Function Surround lighting** appears in the multifunction display.





The selection marker is on the current setting.





- ▶ Press button  or  to switch the locator lighting function on or off.
- ▶ Turn the exterior lamp switch to position **AUTO** when exiting the vehicle. The locator lighting feature is activated.

### Setting ambient lighting

Use this function to adjust the brightness of the ambient lighting.

- ▶ Move the selection marker with button  or  to the **Lighting** submenu.
- ▶ Press button  or  repeatedly until the message **Ambient light Level** appears in the multifunction display. The selection marker is on the current setting.



- ▶ Press button  or  to select the desired brightness of the ambient lighting. The setting 1 represents the darkest level and setting 5 the brightest level. The ambient light is switched off at setting 0.

### Setting night security illumination (Headlamps delayed shut-off)

Use this function to set whether you would like the exterior lamps to remain on for 15 seconds during darkness after exiting the vehicle and closing all doors.

With the delayed shut-off feature activated and the exterior lamp switch in position **AUTO** before the engine is turned off, the following lamps will switch on when the engine is turned off:

- Parking lamps
- Tail lamps
- License plate lamps
- Side marker lamps
- Front fog lamps

If after turning off the engine you do not open a door or do not close an opened door, the lamps will automatically switch off after 60 seconds.



You can reactivate this function within 10 minutes by opening a door.

- ▶ Move the selection marker with button **+** or **-** to the Lighting submenu.
- ▶ Press button **↶** or **↷** repeatedly until the message **Headlamps delayed shut-off** appears in the multifunction display.

The selection marker is on the current setting.



- ▶ Press button **+** or **-** to switch Headlamps delayed shut-off on or off.

- ▶ Turn the exterior lamp switch to position **AUTO** before turning off the engine.

You can temporarily deactivate the delayed shut-off feature:

- ▶ Before exiting the vehicle, turn the SmartKey in the starter switch to position **0**.
- ▶ Then turn it to position **2** and back to position **0**.

The delayed shut-off feature is deactivated. It will reactivate as soon as you reinsert the SmartKey in the starter switch.

Vehicles with KEYLESS-GO\*:

- ▶ Press the KEYLESS-GO start/stop button on the gear selector lever (▷ page 38).

### Setting interior lighting delayed shut-off

Use this function to set whether you would like the interior lighting to remain lit for 10 seconds during darkness after you have removed the SmartKey from the starter switch.

- ▶ Move the selection marker with button **+** or **-** to the Lighting submenu.
- ▶ Press button **↶** or **↷** repeatedly until the message **Interior lighting delayed shut-off** appears in the multifunction display.

The selection marker is on the current setting.

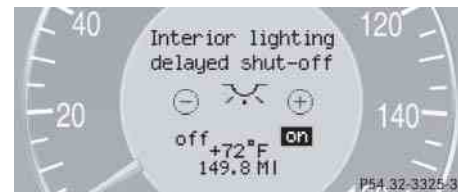

- ▶ Press button **+** or **-** to switch Interior lighting delayed shut-off on or off.



## Control system

### Vehicle submenu

Access the Vehicle submenu via the Settings menu. Use the Vehicle submenu to make general vehicle settings. The following functions are available:

Function	Page
Set automatic locking	176
Limiting opening height of tailgate*	176

### Setting automatic locking

Use this function to activate or deactivate the automatic central locking. With the automatic central locking system activated, the vehicle is centrally locked at vehicle speeds of approximately 9 mph (15 km/h).

- ▶ Move the selection marker with button **+** or **-** to the Vehicle submenu.
- ▶ Press button **↶** or **↷** repeatedly until the message Automatic door lock appears in the multifunction display.

The selection marker is on the current setting.



- ▶ Press button **+** or **-** to switch Automatic door lock on or off.

### Limiting opening height of tailgate\*

Use this function to activate or deactivate the limiting opening height of tailgate.

- ▶ Move the selection marker with button **+** or **-** to the Vehicle submenu.
- ▶ Press button **↶** or **↷** repeatedly until the message Opening limiter Tailgate appears in the multifunction display.

The selection marker is on the current setting.



- ▶ Press button **+** or **-** to switch Opening limiter Tailgate on or off.

### Convenience submenu

Access the Convenience submenu via the Settings menu. Use the Convenience submenu to change the settings for a number of convenience features. The following functions are available:

Function	Page
Activate easy-entry / exit feature	177
Set parking position for exterior rear view mirror	178

### Activating easy-entry / exit feature

Use this function to activate and deactivate the easy-entry / exit feature (▷ page 43).

#### Warning!



You must make sure no one can become trapped or injured by the moving steering wheel when the easy-entry / exit feature is activated.

To stop the steering wheel adjustment, do one of the following:

- Move steering column stalk (▷ page 43).
- Press one of the memory position buttons or the memory button **M** (▷ page 140).

Do not leave children unattended in the vehicle, or with access to an unlocked vehicle. Children could open the driver's door and unintentionally activate the easy-entry / exit feature, which could result in an accident and/or serious personal injury.

- ▶ Move the selection marker with button **+** or **-** to the Convenience submenu.
- ▶ Press button **↶** or **↷** repeatedly until the message Function Easy-entry feature appears in the multifunction display.

The selection marker is on the current setting.

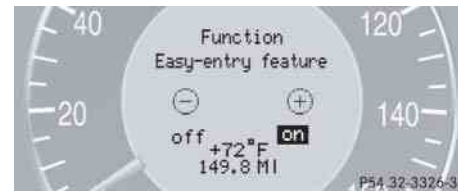

- ▶ Press button **+** or **-** to switch Function Easy-entry feature on or off.

### Control system

#### *Setting parking position for exterior rear view mirror*

Use the Mirror adjustment parking aid function to select whether the passenger-side exterior rear view mirror should be turned downward during parking maneuvers when reverse gear **R** is engaged. For additional information, see “Activating exterior rear view mirror parking position” (▷ page 198).

- ▶ Move the selection marker to the Convenience submenu using button **+** or **-**.
- ▶ Press button **↶** or **↷** repeatedly until the message Mirror adjustment parking aid appears in the multifunction display.

The selection marker is on the current setting.



- ▶ Press button **+** or **-** to switch Mirror adjustment parking aid on or off.

#### **Dynamic seat\* submenu**

Access the Dynamic Seat submenu via the Settings menu. Use the Dynamic Seat submenu to change the settings for the dynamic seats. The following functions are available:

Function	Page
Adjust driver seat	179
Adjust passenger seat	179

### Adjusting the dynamic seat

The function dynamic seat adjustment lets you determine the way the seat adjusts while driving.

- ▶ Move the selection marker with button **+** or **-** to the Dynamic Seat submenu.
- ▶ Press button **↶** or **↷** repeatedly until the message Dyn. multi-cont. seat, driver for the driver seat or Dyn. multi-cont. seat, fr. pass. for the passenger seat appears in the multifunction display.

The selection marker is on the current setting.



- ▶ Press button **+** or **-** to switch function to Weak or Powerful.

The following settings are available:

Weak	(Comfort) Less lateral support and slow air pressure build-up in the air chambers of the backrest side bolsters
Powerful	(Sporty) Strong lateral support and fast air pressure build-up in the air chambers of the backrest side bolsters





## Control system

### Trip computer menu

Use the trip computer menu to call up statistical data on your vehicle. The following information is available:

Function	Page
Fuel consumption statistics after start	180
Fuel consumption statistics since last reset	180
Call up range (distance to empty)	181





### Fuel consumption statistics after start

- ▶ Press button  or  repeatedly until you see the first function of the trip computer menu.
- ▶ Press button  or  repeatedly until the message **After start** appears in the multifunction display.



- ① Distance driven since start
- ② Time elapsed since start
- ③ Average speed since start
- ④ Average fuel consumption since start

### Fuel consumption since last reset

- ▶ Press button  or  repeatedly until you see the first function of the trip computer menu.
- ▶ Press button  or  repeatedly until the message **After reset** appears in the multifunction display.



- ① Distance driven since last reset
- ② Time elapsed since last reset
- ③ Average speed since last reset
- ④ Average fuel consumption since last reset



All statistics stored since the last engine start will be reset approximately 4 hours after the SmartKey in the starter switch is turned to position **0** or removed from the starter switch.

Resetting will not occur if you turn the SmartKey back to position **1** or **2** within this time period.

### Resetting fuel consumption statistics

- ▶ Press button or repeatedly until you see the first function of the trip computer menu.
- ▶ Press button or repeatedly until you see the reading that you want to reset in the multifunction display.
- ▶ Press and hold the reset button in the instrument cluster (▷ page 151) until the value is reset to 0.

### Calling up range (distance to empty)

- ▶ Press button or repeatedly until you see the first function of the trip computer menu.
- ▶ Press button or repeatedly until the message **Range:** appears in the multifunction display.

In the multifunction display you will see the calculated range based on the current fuel tank level.

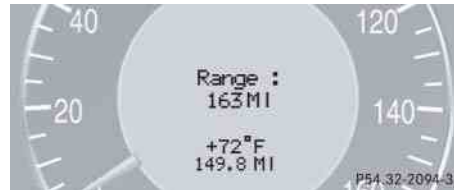

### TEL menu\*

#### Warning!



A driver's attention to the road must always be his / her primary focus when driving. For your safety and the safety of others, we recommend that you pull over to a safe location and stop before placing or taking a telephone call. If you choose to use the telephone while driving, please use the hands-free device and only use the telephone when weather, road and traffic conditions permit.

Some jurisdictions prohibit the driver from using a cellular telephone while driving a vehicle.



Bear in mind that at a speed of just 30 mph (approximately 50 km / h), your vehicle is covering a distance of 44 feet (approximately 14 m) every second.

Never operate radio transmitters equipped with a built-in or attached antenna (i.e. without being connected to an external antenna) ▷▷

### Control system

▷▷ from inside the vehicle while the engine is running. Doing so could lead to a malfunction of the vehicle's electronic system, possibly resulting in an accident and/or personal injury.

You can use the functions in the **Te1** menu to operate your telephone, provided it is connected to a hands-free system and switched on.

- ▶ Switch on the telephone and COMAND.
- ▶ Press button  or  on the steering wheel repeatedly until the **Te1** menu appears in the multifunction display.

Which messages will appear in the multifunction display depends on whether your telephone is switched on or off:

- If the telephone is off, the message in the multifunction display is: **PHONE off**.

- If the telephone is on:

The telephone will then search for a network. During this time the multifunction display is empty.

As soon as the telephone has found a network, **READY** appears in the multifunction display.



This standby message indicates that your telephone is ready for use and you can operate it using the control system.

#### Answering a call

When your telephone is ready to receive calls, you can answer a call at any time. In the multifunction display you will then see the message:



- ▶ Press button .

You have answered the call. In the multifunction display you see the length of the call.



If you do not wish to accept a call, press button .





#### Ending a call

- ▶ Press button .

You have ended the call. In the multifunction display you will again see the standby message.



### Dialing a number from the phone book

If your telephone is ready to receive calls, you may select and dial a number from the phone book at any time.

- ▶ Press button  or  repeatedly until you see the **Te1** menu in the multifunction display.
- ▶ Press button  or .



The control system reads the phone book which is stored in the telephone. This may take up to 30 seconds. In the multifunction display you will see the message *Please wait*.

When the message *Please wait* disappears, the phone book has been loaded.

- ▶ Press button  or  repeatedly until the desired name appears in the multifunction display.

The stored names are displayed in ascending or descending alphabetical order.



If you press and hold button  or  for longer than 1 second, the system scrolls rapidly through the list of names until you release the button again.

Cancel the quick search mode by pressing button .

- ▶ Press button .

The system dials the selected phone number.



- If the connection is successful, the name of the party you called and the duration of the call will appear in the multifunction display.





- If no connection is made, the control system stores the dialed number in the redial memory.

### Redialing

The control system stores the most recently dialed phone numbers. This eliminates the need to search through your entire phone book.

- ▶ Press button  or  repeatedly until you see the **Te1** menu in the multifunction display.
- ▶ Press button .

In the multifunction display you see the first number in the redial memory.

- ▶ Press button  or  repeatedly until the desired name appears in the multifunction display.
- ▶ Press button .

The control system dials the selected phone number.



### Automatic transmission

For more information on driving with an automatic transmission, see “Automatic transmission” (▷ page 50).

Your vehicle’s transmission adapts its gear shifting process to your individual driving style by continually adjusting the shift points up or down. These shift point adjustments are performed based on current operating and driving conditions.

If the operating conditions change, the automatic transmission reacts by adjusting its shift program.



During the brief warm-up, transmission upshifting is delayed. This allows the catalytic converter to heat up more quickly to operating temperature.

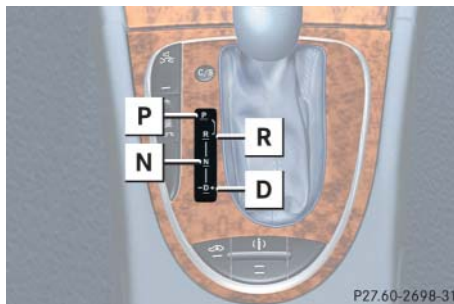

#### Gearshift pattern for automatic transmission

The automatic transmission selects individual gears automatically, depending on:

- the gear selector lever position **D** (▷ page 186) with gear ranges (▷ page 188)
- the selected program mode: **(C/S)** (▷ page 189)  
or  
**(M/C/S)** (E 55 AMG only) (▷ page 194)

- the position of the accelerator pedal (▷ page 187)
- the vehicle speed

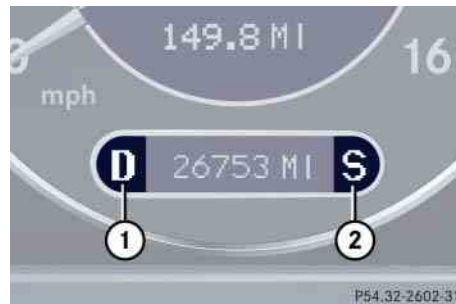

- ① Current gear range/gear selector lever position
- ② Current program mode

The current gear range/gear selector lever position and program mode (C/S) or (M/C/S) (E 55 AMG only) appear in the multifunction display.

An additional indication of the current gear selector lever position can be found on the cover of the shifting-gate.

The indicators come on when you activate a switch (e.g. unlocking the vehicle or opening a door) and go out after approximately 15 minutes.

**Warning!**

It is dangerous to shift the gear selector lever out of **P** or **N** if the engine speed is higher than idle speed. If your foot is not firmly on the brake pedal, the vehicle could accelerate quickly forward or reverse. You could lose control of the vehicle and hit someone or something. Only shift into gear when the engine is idling normally and when your right foot is firmly on the brake pedal.



Allow engine to warm up under low load use. Do not place full load on the engine until the operating temperature has been reached.

Shift into reverse gear **R** or parking position **P** only when the vehicle is stopped.

Avoid spinning of a drive wheel for an extended period when driving off on slippery road surfaces. This may cause serious damage to the drivetrain which is not covered by the Mercedes-Benz Limited Warranty.

When the gear selector lever is in position **D**, you can influence transmission shifting by:

- limiting the gear range
- changing gears manually

## Automatic transmission

### Gear selector lever position

	Effect
<b>P</b>	<p><b>Park position</b></p> <p>Gear selector lever position when the vehicle is parked. Place gear selector lever in position <b>P</b> only when vehicle is stopped. The park position is not intended to serve as a brake when the vehicle is parked. Rather, the driver should always set the parking brake in addition to placing the gear selector lever in position <b>P</b> to secure the vehicle.</p>

	Effect
	<p>The SmartKey can only be removed from the starter switch with the gear selector lever in position <b>P</b>. With the SmartKey removed, the gear selector lever is locked in position <b>P</b>.</p> <p>If the vehicle's electrical system is malfunctioning, the gear selector lever could remain locked in position <b>P</b> (▷ page 426).</p>
<b>R</b>	<p><b>Reverse gear</b></p> <p>Place gear selector lever in position <b>R</b> only when vehicle is stopped.</p>

	Effect
<b>N</b>	<p><b>Neutral</b></p> <p>No power is transmitted from the engine to the drive axle. When the brakes are released, the vehicle can be moved freely (pushed or towed).</p> <p>To avoid damage to the transmission, never engage <b>N</b> while driving.</p> <p>If the ESP<sup>®</sup> is deactivated or malfunctioning: Move gear selector lever to <b>N</b> only if the vehicle is in danger of skidding, e.g. on icy roads.</p>
<b>D</b>	<p><b>Drive</b></p> <p>The transmission shifts automatically. All forward gears are available.</p>



Coasting the vehicle, or driving for any other reason with gear selector lever in **N** can result in transmission damage that is not covered by the Mercedes-Benz Limited Warranty.

**Warning!**

Getting out of your vehicle with the gear selector lever not fully engaged in position **P** is dangerous. Also, position **P** alone is not intended to or capable of preventing your vehicle from moving, possibly hitting people or objects.

Always set the parking brake in addition to shifting to position **P** (▷ page 60).

When parked on an incline, turn the front wheels towards the road curb.

Do not park this vehicle in areas where combustible materials such as grass, hay or leaves can come into contact with the hot exhaust system, as these materials could be ignited and cause a vehicle fire.

**Warning!**

When leaving the vehicle, always remove the SmartKey or the SmartKey with KEYLESS-GO\* from the starter switch, take it with you, and lock the vehicle. Do not leave children unattended in the vehicle, or with access to an unlocked vehicle. Children could move the gear selector lever from position **P**, which could result in an accident and/or serious personal injury.

**Driving tips****Accelerator position**

Your driving style influences the transmission's shifting behavior:

Less throttle	Earlier upshifting
More throttle	Later upshifting

**Kickdown**

Use kickdown when you want maximum acceleration.

- ▶ Press the accelerator past the point of resistance.  
The transmission shifts into a lower gear.
- ▶ Ease on the accelerator when you have reached the desired speed.  
The transmission shifts up again.

### Automatic transmission

#### Stopping

When you stop briefly, e.g. at traffic lights:

- ▶ Leave the transmission in gear.
- ▶ Hold the vehicle with the brake.

When you stop longer with the engine idling and/or on a hill:

- ▶ Set the parking brake.
- ▶ Move the gear selector lever to position **P**.

#### Maneuvering

When you maneuver in tight areas, e.g. when pulling into a parking space:

- ▶ Control the vehicle speed by gradually releasing the brakes.
- ▶ Accelerate gently.
- ▶ Never abruptly step on the accelerator.

#### Working on the vehicle

##### Warning!



When working on the vehicle, set the parking brake and move gear selector lever to position **P**. Otherwise the vehicle could roll away.

#### Gear ranges

With the gear selector lever in position **D** and driving in the automatic shift program **C** or **S** (▷ page 189), you can select a gear range for the automatic transmission to operate within:

Gear selector lever (▷ page 190): You can limit the gear range by pressing the gear selector lever to the left (**D-**), and reverse the gear range limit by pressing the gear selector lever to the right (**D+**).

Steering wheel gearshift control (E 55 AMG only) (▷ page 191): You can limit the gear range by pressing the respective downshift button on the steering wheel gearshift control, and reverse the gear range limit by pressing the respective upshift button on the steering wheel gearshift control.

The selected gear range appears in the multifunction display (▷ page 184). If you press on the accelerator when the engine

has reached its rpm limit, the transmission will upshift beyond any gear range limit selected.

	Effect
<b>6</b>	The transmission shifts through sixth gear only (applies to vehicles with 7-speed automatic transmission only).
<b>5</b>	The transmission shifts through fifth gear only (applies to vehicles with 7-speed automatic transmission only).
<b>4</b>	The transmission shifts through fourth gear only.
<b>3</b>	The transmission shifts through third gear only.  With this selection you can use the braking effect of the engine.

	Effect
<b>2</b>	The transmission shifts through second gear only.  Allows the use of engine's braking power when driving: <ul style="list-style-type: none"> <li>• on steep downgrades</li> <li>• in mountainous regions</li> <li>• under extreme operating conditions</li> </ul>
<b>1</b>	The transmission operates in first gear only.  For maximum use of engine's braking effect on very steep or lengthy downgrades.

### Automatic shift program

The program mode selector switch is located on the lower part of the center console.



① Program mode selector switch

**C** Comfort For comfort driving

**S** Sport For standard driving

The current gear selector lever position and the selected program mode (C/S) are indicated in the multifunction display (> page 184).

### Automatic transmission



Never change the program mode when the gear selector lever is out of position **P**. This could result in a change of driving characteristics for which you may not be prepared.



The last selected program mode (**C** or **S**) is switched on when the engine is restarted.

- ▶ Press program mode selector switch ① repeatedly until the letter of the desired shift program appears in the multifunction display (▷ page 184).

Select **C** for comfort driving:

- The vehicle starts out in second gear (both forward and reverse) for gentler starts. This does not apply if full throttle is applied or gear range **1** is selected.
- Traction and driving stability are improved on icy roads.
- Upshifts occur earlier even when you give more gas. The engine then operates at lower rpms and the wheels are less likely to spin.

### Gear selector lever one-touch gearshifting

---

Even with an automatic transmission, you can change the gears manually and limit or extend the gear range for automatic shifting with the gear selector lever in position **D** and driving in the automatic program mode **C** or **S**.



Allow engine to warm up under low load use. Do not place full load on the engine until the operating temperature has been reached.

Shift into reverse gear **R** or parking position **P** only when the vehicle is stopped.

Avoid spinning of a drive wheel for an extended period when driving off on slippery road surfaces. This may cause serious damage to the drivetrain which is not covered by the Mercedes-Benz Limited Warranty.

## Downshifting

### Warning!



On slippery road surfaces, never downshift in order to obtain braking action. This could result in drive wheel slip and reduced vehicle control. Your vehicle's ABS will not prevent this type of loss of control.

- ▶ Briefly press the gear selector lever to the left in the **D-** direction.

The transmission will shift from the current gear to the next lower gear as permitted by the shift program. This action simultaneously limits the gear range of the transmission (▷ page 188).



To avoid overrevving the engine when the gear selector lever is moved to the **D-** direction, the transmission will not shift to a lower gear if the engine's max. speed would be exceeded.

## Upshifting

- ▶ Briefly press the gear selector lever to the right in the **D+** direction.

The transmission will shift from the current gear to the next higher gear as permitted by the shift program. This action simultaneously extends the gear range of the transmission.

### Canceling gear range limit

- ▶ Press and hold the gear selector lever in the **D+** direction until **D** reappears in the multifunction display.

The transmission will shift from the current gear range directly to gear range **D**.

### Shifting into optimal gear range

- ▶ Press and hold the gear selector lever in the **D-** direction.

The transmission will automatically select the gear range suited for optimal acceleration and deceleration. This may involve shifting down one or more gears.

## Steering wheel gearshift control one-touch gearshifting E 55 AMG

The steering wheel gearshift control provides an alternative method for changing the gears manually and limiting or extending the gear range for automatic shifting with the gear selector lever in position **D** and driving in the automatic program mode **C** or **S**.



For information on using the steering wheel gearshift control in manual program mode **M** (E 55 AMG only), see "Manual shift program" (▷ page 193).



To avoid overrevving the engine when downshifting with steering wheel gearshift buttons, the transmission will not shift to a lower gear if the engine's max. speed would be exceeded.



### Automatic transmission



Allow engine to warm up under low load use. Do not place full load on the engine until the operating temperature has been reached.

Shift into reverse gear **R** or parking position **P** only when the vehicle is stopped.

Avoid spinning of a drive wheel for an extended period when driving off on slippery road surfaces. This may cause serious damage to the drivetrain which is not covered by the Mercedes-Benz Limited Warranty.

The steering wheel gearshift buttons are located to the left and right of the steering wheel.

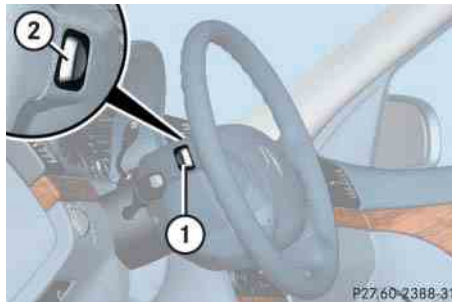

- ① Left button: downshift
- ② Right button: upshift



You cannot shift with the steering wheel gearshift buttons when the gear selector lever is in position **P**, **N** or **R**.

The last selected program mode (**C** or **S**) is switched on when the engine is restarted in the automatic program mode.

The following instructions describe operation of the steering wheel gearshift control when driving in the automatic program mode **C** or **S**.

For instructions on operating the steering wheel gearshift control and gear selector lever in the manual program mode **M**, see “Manual shift program E 55 AMG” (▷ page 193).

## Downshifting

### Warning!



On slippery road surfaces, never downshift in order to obtain braking action. This could result in drive wheel slip and reduced vehicle control. Your vehicle's ABS will not prevent this type of loss of control.

- ▶ Briefly press button ① on the left side of the steering wheel.

The transmission will shift to the next lower gear as permitted by the shift program. This action simultaneously limits the gear range of the transmission (▷ page 188) when you are driving in the automatic program mode (**C** or **S**).

## Upshifting

- ▶ Briefly press button ② on the right side of the steering wheel.

The transmission will shift to the next higher gear as permitted by the shift program. This action simultaneously extends the gear range of the transmission when you are driving in the automatic program mode (**C** or **S**).

### Canceling gear range limit

- ▶ Press and hold button ② on the right side of the steering wheel until **D** reappears in the multifunction display.

The transmission will shift from the current gear range directly to gear range **D**.

### Shifting into optimal gear range

- ▶ Press and hold button ① on the left side of the steering wheel.

The transmission will automatically select the gear range suited for optimal acceleration and deceleration. This may involve shifting down one or more gears.

## Manual shift program E 55 AMG

In addition to the automatic shift program **C** or **S**, your vehicle is equipped with the manual shift program **M**.

In the manual program mode **M**, system-controlled automatic gearshifting is switched off and you need to change the gears by manually upshifting or downshifting using the steering wheel gearshift buttons to the left and right of the steering wheel (▷ page 192) or the gear selector lever.

### Automatic transmission



Allow engine to warm up under low load use. Do not place full load on the engine until the operating temperature has been reached.

Shift into reverse gear **R** or parking position **P** only when the vehicle is stopped.

Avoid spinning of a drive wheel for an extended period when driving off on slippery road surfaces. This may cause serious damage to the drivetrain which is not covered by the Mercedes-Benz Limited Warranty.

The program mode selector switch is located on the lower part of the center console.

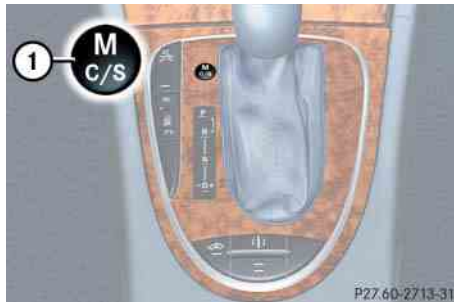

① Program mode selector switch

<b>M</b> Manual	For manual gear shifting
<b>C</b> Comfort	For comfort driving
<b>S</b> Sport	For standard driving

The current gear selector lever position and the selected program mode (M/C/S) are indicated in the multifunction display (▷ page 184).



For information on automatic program modes **C** or **S**, see “Automatic shift program” (▷ page 189), “Gear selector lever one-touch gearshifting” (▷ page 190), and “Steering wheel gearshift control one-touch gearshifting” (▷ page 191).

### Activating manual shift program

- ▶ Press program mode selector switch ① repeatedly until the **M** for the manual program mode **M** appears in the multifunction display.

The transmission switches to the manual program mode **M**. Automatic shifting is switched off. The gear range is not limited.

You can change the gears manually when the gear selector lever is in position **D**. You can upshift or downshift through the gears in succession.



The manual program mode **M** will not be stored. When the engine is turned off with the manual program mode **M** selected, the transmission will go to the automatic program mode (**C** or **S**) when the engine is restarted.

### Upshifting



In the manual program mode **M**, the transmission will not upshift, even if the engine has reached its overrevving range. Shift up to the next gear before the engine has reached its overrevving range. Make absolutely certain that the engine speed does not reach the red marking on the tachometer (▷ page 24). Otherwise the engine could be damaged which is not covered by the Mercedes-Benz Limited Warranty.

- ▶ Briefly press the gear selector lever to the right in the **D+** direction.

or

- ▶ Briefly press button ② on the right side of the steering wheel (▷ page 192).

The transmission shifts to the next higher gear.

If, instead of the manual program mode symbol **M**, the symbol appears in the multifunction display (▷ page 184), shift to the next higher gear. The fuel supply will otherwise be interrupted to prevent the engine from overrevving.

### Automatic transmission

#### Downshifting

##### Warning!



On slippery road surfaces, never downshift in order to obtain braking action. This could result in drive wheel slip and reduced vehicle control. Your vehicle's ABS will not prevent this type of loss of control.

- ▶ Briefly press the gear selector lever to the left in the **D**- direction.

or

- ▶ Briefly press button **①** on the left side of the steering wheel (▷ page 192).

The transmission shifts to the next lower gear.



When you brake or stop, the transmission shifts down to a gear from which you can easily accelerate or take off.

#### Kickdown

Using the kickdown when driving in the manual program mode **M** is not possible.

#### Deactivating manual shift program

- ▶ Press the program mode selector switch (▷ page 194) repeatedly until **C** or **S** appears in the multifunction display.

or

- ▶ Restart the engine.

The transmission will go to the automatic program mode (**C** or **S**).

The manual program mode **M** is not stored.

#### Emergency operation (Limp Home Mode)

If vehicle acceleration worsens or the transmission no longer shifts, the transmission is most likely operating in limp home (emergency operation) mode. In this mode only second gear and reverse gear can be activated.

- ▶ Stop the vehicle.
- ▶ Move gear selector lever to **P**.
- ▶ Turn off the engine.
- ▶ Wait at least 10 seconds before restarting.
- ▶ Restart the engine.
- ▶ Move gear selector lever to position **D** (for second gear) or **R**.
- ▶ Have the transmission checked at an authorized Mercedes-Benz Center as soon as possible.

### ▼ Good visibility

For information on windshield wipers, see “Windshield wipers” (▷ page 55).

#### Headlamp cleaning system\*

The button is located on the left side of the dashboard.



① Headlamp washer button

▶ Switch on the ignition (▷ page 36).

▶ Press button ①.

The headlamps are cleaned with a high-pressure water jet.



The headlamps will automatically be cleaned when you have

- switched on the headlamps and
- operated the windshield wipers with windshield washer fluid fifteen times

When you switch off the ignition, the counter resets.

For more information on filling up the washer reservoir, see “Windshield washer system and headlamp cleaning system\*” (▷ page 323).

#### Rear view mirrors

For more information on setting the rear view mirrors, see “Mirrors” (▷ page 45).

#### Auto-dimming mirrors

The reflection brightness of the exterior rear view mirror on the driver’s side and the interior rear view mirror will respond automatically to glare when

- the ignition is switched on and
- incoming light from headlamps falls on the sensor in the interior rear view mirror

The rear view mirrors will not react if

- reverse gear is engaged
- the interior lighting is turned on

### Good visibility

#### Warning!



The auto-dimming function does not react if incoming light is not aimed directly at sensors in the interior rear view mirror.

The interior rear view mirror and the exterior rear view mirror on the driver's side do not react, for example, when transporting cargo which covers the rear window.

Glare can endanger you and others.

#### Warning!



In case of an accident, liquid electrolyte may escape from the mirror housing if the mirror glass breaks.

Electrolyte has an irritating effect. Do not allow the liquid to come into contact with eyes, skin, clothing, or respiratory system. In case it does, immediately flush affected area with water, and seek medical help if necessary.



Electrolyte drops coming into contact with the vehicle paint finish can be completely removed only while in the liquid state by applying plenty of water.

#### Warning!



Exercise care when using the passenger-side exterior rear view mirror. The mirror surface is convex (outwardly curved surface for a wider field of view). Objects in mirror are closer than they appear. Check your interior rear view mirror or glance over your shoulder before changing lanes.

### Activating exterior rear view mirror parking position

Follow these steps to activate the mirror parking position so that the passenger-side exterior rear view mirror will be turned downward to the stored position.

The buttons are located on the driver's door.

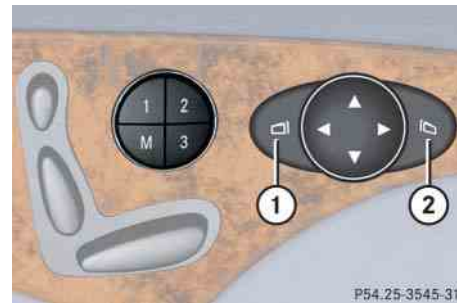

- ① Driver's side exterior rear view mirror button
  - ② Passenger-side exterior rear view mirror button
- Make sure you have stored a parking position for the passenger-side exterior rear view mirror (▷ page 141).

► Make sure the Mirror adjustment parking aid function in the Convenience submenu of the control system is switched to on (▷ page 178).

► Switch on the ignition (▷ page 36).

► Press button ② for the passenger-side exterior rear view mirror.

► Place the gear selector lever in reverse gear **R**.

The passenger-side exterior rear view mirror will be turned downward to the stored position.

The exterior rear view mirror returns to its previously stored driving position:

- 10 seconds after you put the gear selector lever out of position **R**
- immediately once your vehicle exceeds a speed of approximately 6 mph (10 km/h)
- immediately when you press button ① for driver's side mirror.

### Sun visors

The sun visors protect you from sun glare while driving.

#### Warning!



Do not use the vanity mirror while driving. Keep the mirrors in the sun visors closed while vehicle is in motion. Reflected glare can endanger you and others.

- Swing sun visor ① down when you experience glare.

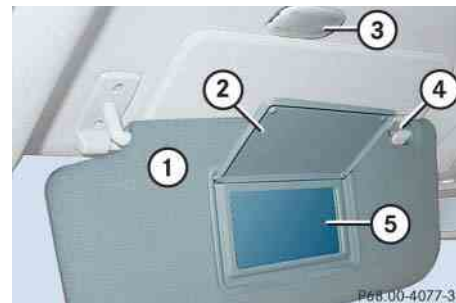

- ① Sun visor
- ② Mirror cover
- ③ Mirror lamp
- ④ Mounting
- ⑤ Vanity mirror

- To use the vanity mirror ⑤, lift up the mirror cover ②.



If sun visor ① is disengaged from mounting ④ with mirror cover ② open, mirror lamp ③ will switch off.



### Good visibility

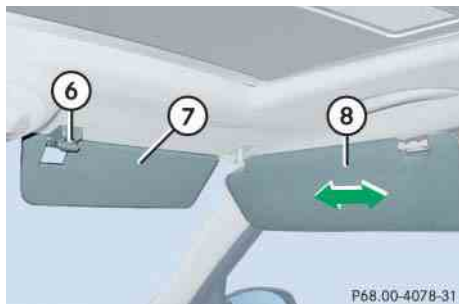

- ⑥ Mounting
- ⑦ Additional visor\*
- ⑧ Sun visor

If sunlight enters through a side window:

- ▶ Disengage sun visor ⑧ from mounting ⑥.
- ▶ Pivot sun visor ⑧ to the side.
- ▶ Adjust the sun visor ⑧ by pushing or pulling in direction of the arrows.



Close mirror cover ② (if open) before you disengage the sun visor ⑧ from mounting ⑥ and pivot it to the side.

### Roller sunblind\* in the rear doors

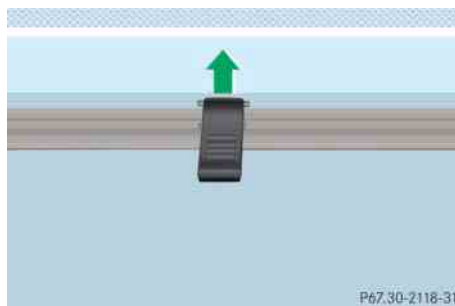

- ▶ Pull the roller sunblind out using the hooks.
- ▶ Attach the hooks at the top.





Always guide the sunblind by hand. Do not let it snap back, as the retractor could be damaged.

### Rear window defroster

The rear window defroster uses a large amount of power. To keep the battery drain to a minimum, switch off the defroster as soon as the rear window is clear. The defroster is automatically deactivated after approximately 6 to 17 minutes of operation depending on the outside temperature.

### Activating

- ▶ Press button  (> page 216) or  (> page 217) or  (> page 204) on the respective climate control panel.

The indicator lamp on the button comes on.

## Deactivating

- ▶ Press button  or  again.

The indicator lamp on the button goes out.

### Warning!



Any accumulation of snow and ice should be removed from the rear window before driving. Visibility could otherwise be impaired, endangering you and others.



If the rear window defroster switches off too soon and the indicator lamp starts flashing, this means that too many electrical consumers are operating simultaneously and there is insufficient voltage in the battery. The system responds automatically by deactivating the rear window defroster.

As soon as the battery has sufficient voltage, the rear window defroster automatically turns itself back on.

### Dual-zone automatic climate control (USA only)

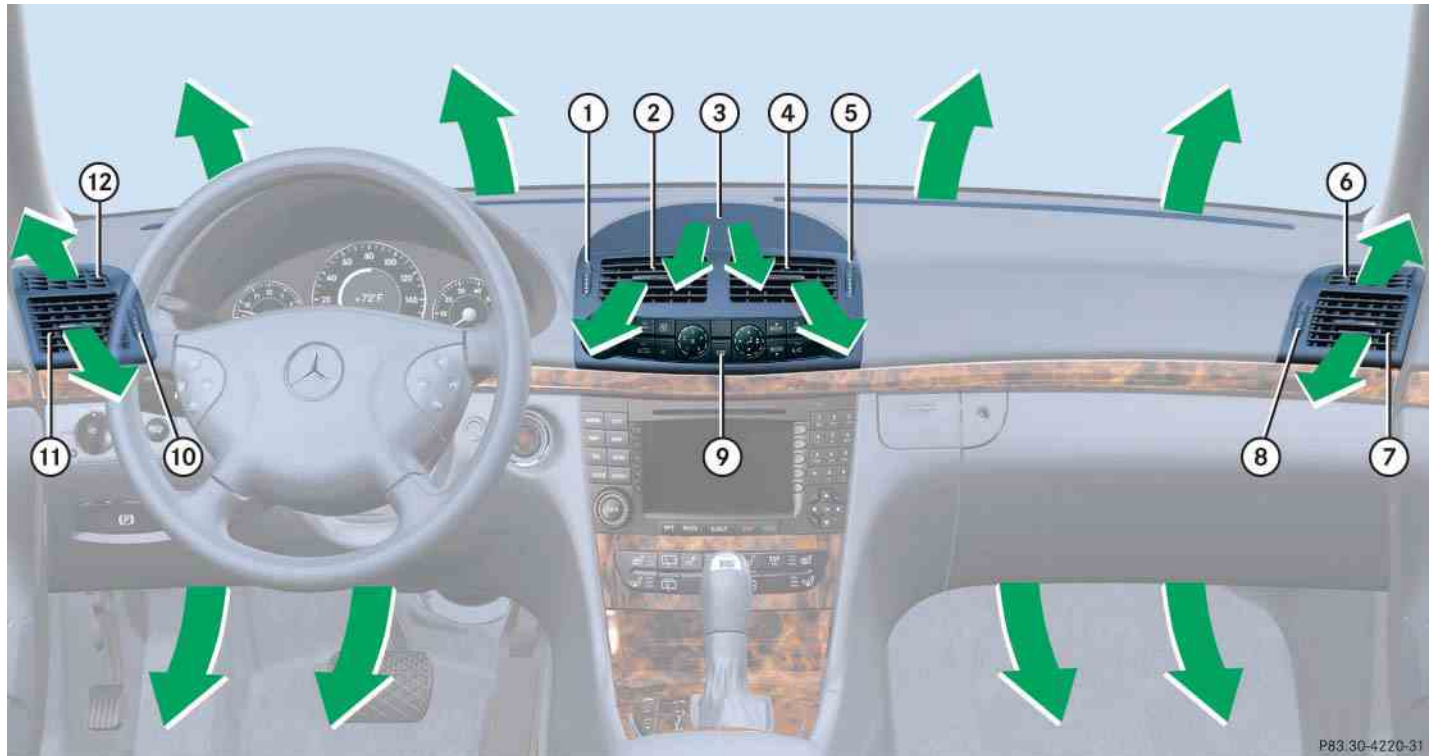

## Dual-zone automatic climate control (USA only)

- ① Thumbwheel for air volume control for left center air vent
- ② Left center air vent, adjustable
- ③ Cockpit air vent, fixed
- ④ Right center air vent, adjustable
- ⑤ Thumbwheel for air volume control for right center air vent
- ⑥ Right side defroster vent, fixed
- ⑦ Right side air vent, adjustable
- ⑧ Thumbwheel for air volume control for right side air vent
- ⑨ Climate control panel
- ⑩ Thumbwheel for air volume control for left side air vent
- ⑪ Left side air vent, adjustable
- ⑫ Left side defroster vent, fixed



For draft-free ventilation, move the sliders for the center air vents ② and ④ to the middle position.

### Dual-zone automatic climate control (USA only)

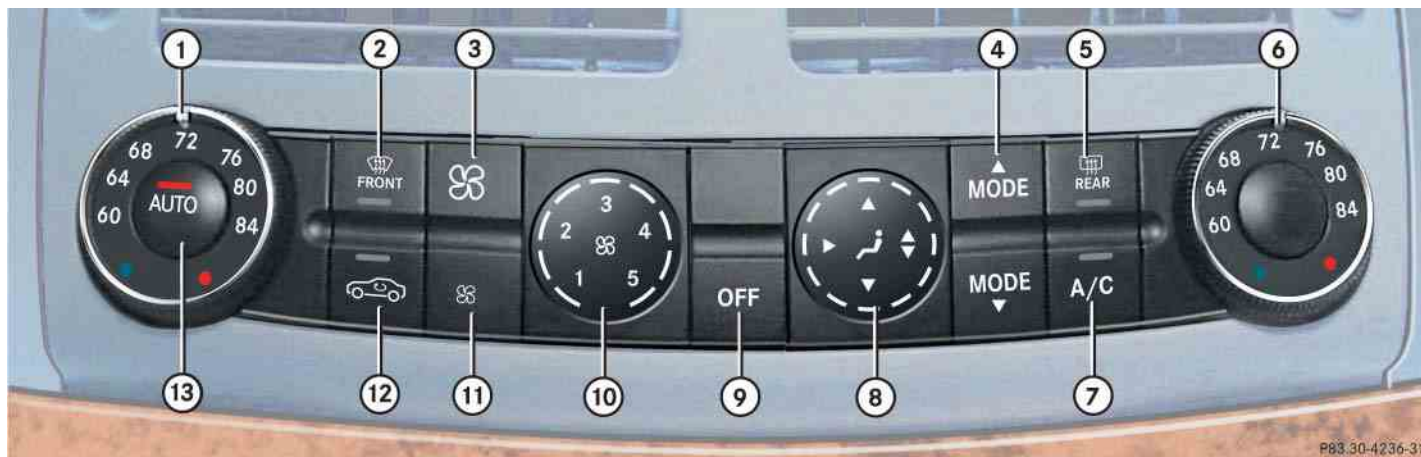

P83.30-4236-31

① Temperature control, left

② Front defroster

③ Increase air volume

④ Air distribution

⑤ Rear window defroster

⑥ Temperature control, right

⑦ AC cooling on/off

⑧ Air distribution display

⑨ Climate control on/off

⑩ Air volume display

⑪ Decrease air volume

⑫ Air recirculation

⑬ Air distribution and air volume  
(automatic, manual)

## Dual-zone automatic climate control (USA only)

The climate control is operational whenever the engine is running. You can operate the climate control system in either the automatic or manual mode. The system cools or heats the interior depending on the selected interior temperature and the current outside temperature.

**Warning!**

When operating the climate control, the air that enters the passenger compartment through the air vents can be very hot or very cold (depending on the set temperature). This may cause burns or frostbite to unprotected skin in the immediate area of the air vents. Always keep sufficient distance between unprotected parts of the body and the air vents. If necessary, use the air distribution control (> page 204) to direct the air to air vents in the vehicle interior that are not in the immediate area of unprotected skin.

Nearly all dust particles, pollutants and odors are filtered out before outside air enters the passenger compartment through the air distribution system.

The air conditioning will not engage (no cooling) if the **A/C** mode is deactivated (> page 212).

**Warning!**

Follow the recommended settings for heating and cooling given on the following pages. Otherwise the windows could fog up, impairing visibility and endangering you and others.



Severe conditions (e.g. strong air pollution) may require replacement of the filter before its scheduled interval. A clogged filter will reduce the air volume to the interior.

If the vehicle interior is hot, ventilate the interior before driving off, see “Summer opening feature” (> page 234). The climate control will then adjust the interior temperature to the set value much faster.

Keep the air intake grille in front of the windshield free of snow and debris.

Do not obstruct air flow by placing objects on the air flow-through exhaust slots below the rear window.

### Dual-zone automatic climate control (USA only)

#### Deactivating the climate control system

##### Deactivating

- ▶ Press button **OFF** (▷ page 204).



When the climate control system is deactivated, the outside air supply and circulation are also deactivated. Only choose this setting for a short time. Otherwise the windows could fog up.

##### Reactivating

- ▶ Make sure the ignition is switched on.
- ▶ Press button **OFF** (▷ page 204) again.

The previous settings are once again in effect.



To switch the system on, you can also press another button, with the exception of .

#### Operating the climate control system in automatic mode



When operating the climate control system in automatic mode, you will only rarely need to adjust the temperature, air volume and air distribution.

In automatic mode, cooling with dehumidify is switched on. This function can be switched off if necessary.

#### Activating

- ▶ Press button **AUTO** (▷ page 204) while the engine is running.



The indicator lamp on the button comes on. The air volume and air distribution are adjusted automatically.

- ▶ Use temperature controls ① and ② (▷ page 204) to separately adjust the air temperature on each side of the passenger compartment.

The temperature of the vehicle interior is adjusted automatically.

## Dual-zone automatic climate control (USA only)

## Deactivating

- ▶ Press button  or  (▷ page 204).

The indicator lamp on the button **AUTO** goes out. The automatic operation of air volume switches off. The selected blower speed is shown in the air volume display ⑩ (▷ page 204).

or

- ▶ Press air distribution button ④ (▷ page 204).

The indicator lamp on the button **AUTO** goes out. The automatic operation of air distribution switches off. The selected air distribution is shown in the air distribution display ⑧ (▷ page 204).

## Setting the temperature

Use temperature controls ① and ⑥ (▷ page 204) to separately adjust the air temperature on each side of the passenger compartment. You should raise or lower the temperature setting in small increments, preferably starting at 72°F (22°C). The climate control will adjust to the set temperature as fast as possible.

## Increasing

- ▶ Turn temperature control ① and/or ⑥ (▷ page 204) slightly clockwise.

The climate control system will correspondingly adjust the interior air temperature.

## Decreasing

- ▶ Turn temperature control ① and/or ⑥ (▷ page 204) slightly counterclockwise.

The climate control system will correspondingly adjust the interior air temperature.







### Dual-zone automatic climate control (USA only)

#### Adjusting air distribution

Use air distribution control ④ (▷ page 204) to adjust the air distribution.

The following symbols are located on the air distribution display ⑧ (▷ page 204):

Symbol	Function
	Directs air through the cockpit, side and rear passenger compartment air vents
	Directs air to the windows
	Directs air into the entire vehicle interior
	Directs air to the footwells

- ▶ Use air distribution control ④ (▷ page 204) until the desired symbol appears in the display ⑧ (▷ page 204).

The indicator lamp on button **AUTO** goes out.



You can also turn the air distribution control to a position between two symbols.

#### Opening the cockpit air vent and center air vents

- ▶ Turn thumbwheels ① and ⑤ (▷ page 202) upward.

The cockpit air vent ③ and the center air vents ② and ④ are open.

#### Closing the cockpit air vent and center air vents

- ▶ Turn thumbwheels ① and ⑤ (▷ page 202) downward.

The cockpit air vent ③ and the center air vents ② and ④ are closed.

#### Opening the side air vents

- ▶ Turn thumbwheels ⑧ and ⑩ (▷ page 202) upward.

The side air vents ⑦ and ⑪ are open.

#### Closing the side air vents



- ▶ Turn thumbwheels ⑧ and ⑩ (▷ page 202) downward.

The side air vents ⑦ and ⑪ are closed.

## Dual-zone automatic climate control (USA only)

## Adjusting air volume

Nine blower speeds are available.

- ▶ Press button  to decrease or  to increase air volume (▷ page 204) to the desired level.

The indicator lamp on button **AUTO** (▷ page 204) goes out. The automatic operation of air volume switches off. The selected blower speed is shown in the air volume display ⑩ (▷ page 204).

## Front defroster

You can use this setting to defrost the windshield, for example if it is iced up. You can also defog the windshield and the side windows.



Keep this setting selected only until the windshield or the side windows are clear again.

## Activating

- ▶ Press button  (▷ page 204).

The indicator lamp on the button comes on.

The air conditioning switches automatically to the following functions:

- cooling on to dehumidify
- maximum blowing and heating power (depends on cooling temperature)
- air flows onto the windshield and the front side windows
- the air recirculation mode is switched off

## Deactivating

- ▶ Press button  (▷ page 204) again.

The indicator lamp on the button goes out. Defrosting is turned off.

The previous settings are once again in effect.



The cooling remains switched on.

## Windshield fogged on the outside





Keep this setting selected only until the windshield is clear again.

- ▶ Switch the windshield wipers on (▷ page 55).
- ▶ Close the cockpit air vent.
- ▶ Press button **AUTO** (▷ page 204).

The indicator lamp on the button comes on. The air volume and air distribution are adjusted automatically.

If the automatic air distribution is switched off:

- ▶ Turn air distribution control ④ to  or  (▷ page 204).

### Dual-zone automatic climate control (USA only)

#### Air recirculation mode

Switch to air recirculation mode to prevent unpleasant odors from entering the vehicle from the outside (e.g. before a driving through a tunnel). This setting cuts off the intake of outside air and recirculates the air in the passenger compartment.

#### Warning!



Fogged windows impair visibility, endangering you and others. If the windows begin to fog on the inside, switching off the air recirculation mode immediately should clear interior window fogging. If interior window fogging persists, make sure the air conditioning (▷ page 212) is activated, or press button .

#### Activating

- ▶ Briefly press button  (▷ page 204).

The indicator lamp on the button comes on.



The air recirculation mode is activated automatically at high outside temperatures.

The indicator lamp on button  is not lit when the air recirculation mode is automatically switched on.

A quantity of outside air is added after approximately 30 minutes.

If you have turned off the air conditioning (▷ page 212) or the outside temperature is below 41°F (5°C), the air recirculation mode will not switch on automatically.

#### Warning!



Never operate the windows and tilt/sliding sunroof\* if there is the possibility of anyone being harmed by the opening or closing procedure.



In case the procedure causes potential danger:

The closing of the side windows can be immediately halted by pressing or pulling the respective window switch. The closing of the tilt/sliding sunroof can be immediately halted by moving the switch for the tilt/sliding sunroof in any direction.

The closing of the side windows and the tilt/sliding sunroof can be reversed by again pressing and holding the  button.

## Dual-zone automatic climate control (USA only)



Press and hold button  for approximately 2 seconds. The side windows and tilt/sliding sunroof\* will close. You can release button  once the closing procedure has begun. The windows and tilt/sliding sunroof\* continue closing until they are fully closed.

## Deactivating

▶ Press button  (▷ page 204).



The indicator lamp on the button goes out.





The air recirculation mode is deactivated automatically:

- after 5 minutes if the outside temperature is below approximately 41°F (5°C)
- after 5 minutes if the air conditioning is turned off
- after 30 minutes if the outside temperature is above approximately 41°F (5°C)



Press and hold button  for approximately 2 seconds. The side windows and/or tilt/sliding sunroof\* will return to their previous position. You can release button  once the opening procedure has begun. The windows and tilt/sliding sunroof\* continue opening until they have reached their previous position.

A window or tilt/sliding sunroof\* will only return to its previous position if it has not been moved to another position using the respective window switch or tilt/sliding sunroof\* switch after it was closed with button .

A window or tilt/sliding sunroof\* that has been moved will remain in its current position if button  is used to re-open the remaining windows or tilt/sliding sunroof\*.

### Dual-zone automatic climate control (USA only)

#### Air conditioning

The cooling function, only operational when the engine is running, cools the vehicle interior down to the selected temperature. The cooling function also dehumidifies the air in the vehicle interior, thus preventing the windows from fogging up.



Condensation may drip out from underneath the vehicle. This is normal and not an indication of a malfunction.

#### Warning!



If you turn off the cooling function, the vehicle will not be cooled when weather conditions are warm. The windows can fog up more quickly. Window fogging may impair visibility and endanger you and others.

#### Deactivating

It is possible to deactivate the air conditioning (cooling) function of the climate control system. The air in the vehicle will then no longer be cooled or dehumidified.

- ▶ Press button  (▷ page 204).

The indicator lamp on the button goes out.

#### Activating

Moist air can fog up the windows. You can dehumidify the air with the air conditioning.

- ▶ Press button  (▷ page 204) again.

The indicator lamp on the button comes on.

The air conditioning uses the refrigerant R134a. This refrigerant is free of CFCs which are harmful to the ozone layer.



If the air conditioning cannot be turned on again, this indicates that the air conditioning is losing refrigerant. The compressor has turned itself off.

Have the air conditioning checked at the nearest authorized Mercedes-Benz Center.

## Dual-zone automatic climate control (USA only)

### Rear passenger compartment adjustable air vents

The air conditioning for the rear passenger compartment is controlled via the climate control panel (▷ page 204).



The temperature at the center air vents for the rear passenger compartment ① and ② is the same as at the dashboard center air vents.

The air vents for the rear passenger compartment are located in the rear center console.

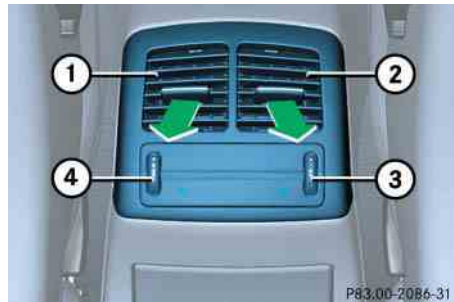

- ① Left center air vent
- ② Right center air vent
- ③ Thumbwheel for air volume control for right rear center air vent
- ④ Thumbwheel for air volume control for left rear center air vent

### Adjusting air distribution

- ▶ Push the slide for the left center vent ① or right center vent ② to the left, right, up or down.

The air flow is directed in the corresponding direction.



For draft-free ventilation, push slides ① and ② upward.

### Adjusting air volume

- ▶ Turn thumbwheel ③ or ④ up or down.

The air volume is increased or decreased.

### 4-zone automatic climate control\*

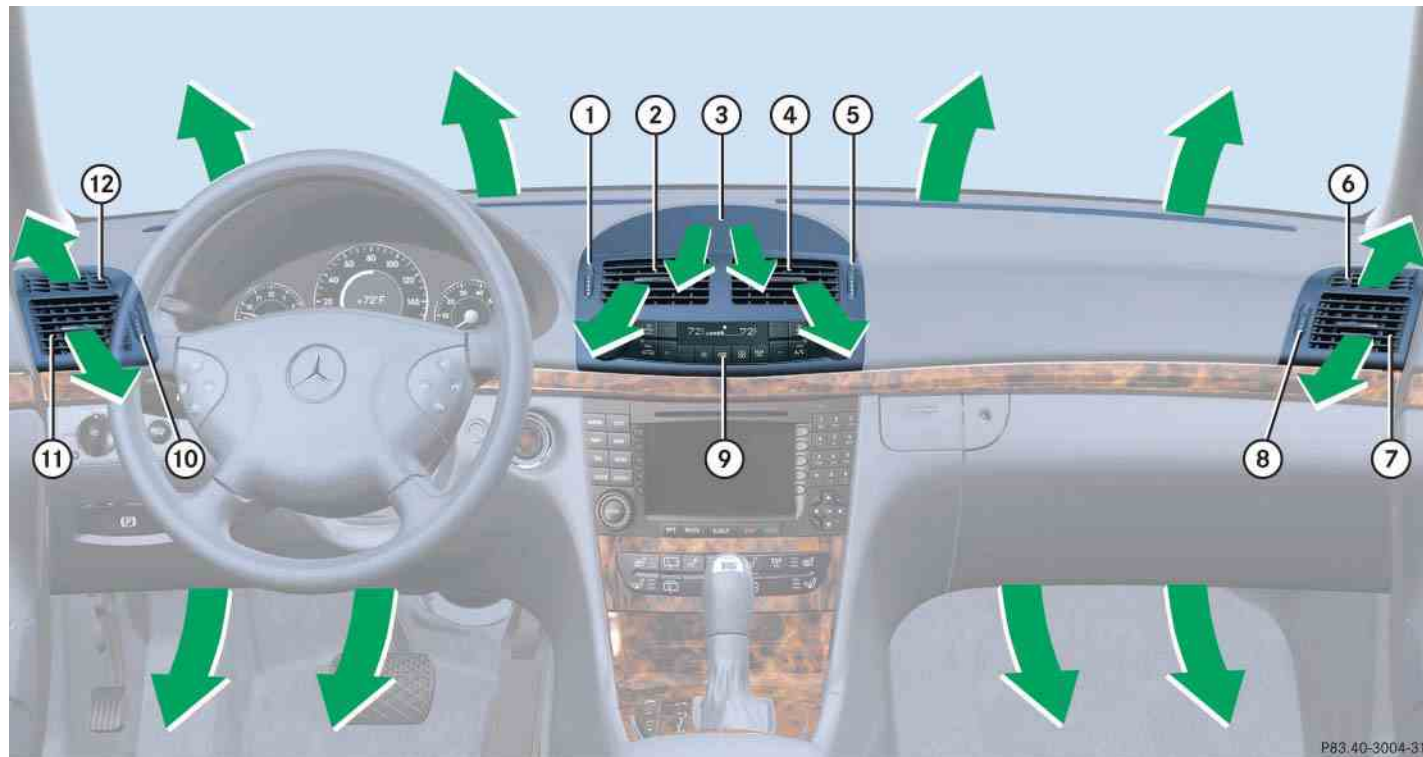

## 4-zone automatic climate control\*

- ① Thumbwheel for air volume control for left center air vent
- ② Left center air vent, adjustable
- ③ Cockpit air vent, fixed
- ④ Right center air vent, adjustable
- ⑤ Thumbwheel for air volume control for right center air vent
- ⑥ Right side defroster vent, fixed
- ⑦ Right side air vent, adjustable
- ⑧ Thumbwheel for air volume control for right side air vent
- ⑨ Climate control panel
- ⑩ Thumbwheel for air volume control for left side air vent
- ⑪ Left side air vent, adjustable
- ⑫ Left side defroster vent, fixed



For draft-free ventilation, move the sliders for the center air vents ② and ④ (> page 214) to the middle position.

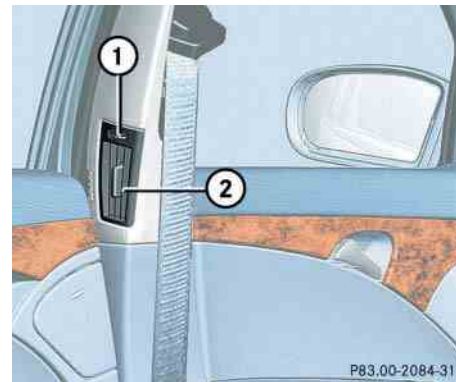

- ① Thumbwheel for air volume control for side air vent
- ② Side air vent, adjustable



### 4-zone automatic climate control\*



#### USA only

① Air distribution, left

② Front defroster

③ Temperature rocker switch, left

④ Display

⑤ Temperature rocker switch, right

⑥ Rear window defroster

⑦ Air distribution, right

⑧ Air distribution and air volume, right  
(automatic, manual)

⑨ AC cooling on/off

⑩ Rear air-conditioning remote control

⑪ Increase air volume

⑫ Climate control on/off

⑬ Decrease air volume

⑭ Air recirculation

⑮ Air distribution and air volume, left  
(automatic, manual)

## 4-zone automatic climate control\*



### Canada only

① Air distribution, left	⑦ Air distribution, right	⑫ Climate control on/off
② Front defroster	⑧ Air distribution and air volume, right (automatic, manual)	⑬ Decrease air volume
③ Temperature rocker switch, left	⑨ AC cooling on/off	⑭ Residual heat/ventilation
④ Display	⑩ Rear air-conditioning remote control	⑮ Air recirculation
⑤ Temperature rocker switch, right	⑪ Increase air volume	⑯ Air distribution and air volume, left (automatic, manual)
⑥ Rear window defroster		

### 4-zone automatic climate control\*

#### Warning!



When operating the climate control, the air that enters the passenger compartment through the air vents can be very hot or very cold (depending on the set temperature). This may cause burn or frostbite to unprotected skin in the immediate area of the air vents. Always keep sufficient distance between unprotected parts of the body and the air vents. If necessary, use the air distribution controls (▷ page 217) to direct the air to air vents in the vehicle interior that are not in the immediate area of unprotected skin.

The climate control is a 4-zone intelligent climate control system. Your vehicle interior is divided into 4 zones.



With the help of a sun sensor, the climate control determines the relation of the sun to the vehicle and automatically adjusts the inside temperature for every individual zone.

You can set the temperature for each of the 4 zones separately.

The climate control is operational whenever the engine is running. It cools the vehicle's interior according to the angle and intensity of the sun's rays, the outside temperature and the selected temperature. You can operate the climate control system in either the automatic or manual mode.

Nearly all dust particles, pollutants and odors are filtered out before outside air enters the passenger compartment through the air distribution system.

The air conditioning will not engage (no cooling) if the **A/C** mode (▷ page 227) is deactivated.

### Warning!



Follow the recommended settings for heating and cooling given on the following pages. Otherwise the windows could fog up, impairing visibility and endangering you and others.



Severe conditions (e.g. strong air pollution) may require replacement of the filter before its scheduled interval. A clogged filter will reduce the air volume to the interior.

If the vehicle interior is hot, ventilate the interior before driving off, see “Summer opening feature” (▷ page 234). The climate control will then adjust the interior temperature to the set value much faster.

Keep the air intake grille in front of the windshield free of snow and debris.

Do not obstruct air flow by placing objects on the air flow-through exhaust slots below the rear window.

## Deactivating the climate control system

### Deactivating

- ▶ Press button **OFF** (▷ page 216) or (▷ page 217) until the display ④ (▷ page 216) or (▷ page 217) is cleared.



When the climate control system is deactivated, the outside air supply and circulation are also deactivated. Only choose this setting for a short time. Otherwise the windows could fog up.

### 4-zone automatic climate control\*

#### Reactivating

- ▶ Make sure the ignition is switched on.
- ▶ Press button **OFF** (▷ page 216) or (▷ page 217) again.

The previous settings are once again in effect.



To switch the system on, you can also press another button, with the exception of **RES**, **MEM** and **REST** (▷ page 216) or (▷ page 217).

#### Operating the climate control system in automatic mode



When operating the climate control system in automatic mode, you will only rarely need to adjust the temperature, air volume and air distribution.

In automatic mode, cooling with dehumidify is switched on. This function can be switched off if necessary.



The automatic climate control system can also be switched on or off separately for the left and right sides of the passenger compartment, as required.

#### Activating

- ▶ Switch on the ignition (▷ page 36).
- ▶ Press one button **AUTO** (▷ page 216) or (▷ page 217).



The indicator lamp on the button comes on. **AUTO** appears in the display ④ (▷ page 216) or (▷ page 217). The air volume and air distribution are adjusted automatically.

- ▶ Use temperature controls ① and ⑥ (▷ page 216) or (▷ page 217) to separately adjust the air temperature on each side of the passenger compartment.

The temperature of the vehicle interior is adjusted automatically.

## 4-zone automatic climate control\*

## Deactivating

- ▶ Press button  or  (▷ page 216) or (▷ page 217).

The indicator lamp on the button goes out. AUTO disappears in the display ④ (▷ page 216) or (▷ page 217). The automatic operation of air volume switches off.

or

- ▶ Turn air distribution controls ① and ⑦ (▷ page 216) or (▷ page 217) on each side of the passenger compartment to the desired symbol.

The indicator lamps on the buttons **AUTO** go out. AUTO disappears in the display ④ (▷ page 216) or (▷ page 217). The automatic operation of air distribution switches off.

## Setting the temperature

Use temperature control rocker switches ③ and ⑤ (▷ page 216) or (▷ page 217) to separately adjust the air temperature on each side of the passenger compartment. You should raise or lower the temperature setting in small increments, preferably starting at 72°F (22°C). The adjusted temperature appears in the display ④ (▷ page 216) or (▷ page 217). The climate control will adjust to the set temperature as fast as possible.



You can also adjust the temperature in the rear passenger compartment (▷ page 216) or (▷ page 217).



When operating the climate control system in automatic mode, you will only rarely need to adjust the temperature, air volume and air distribution.

## Increasing

- ▶ Push top of temperature control rocker switch ③ and/or ⑤ (▷ page 216) or (▷ page 217).

The climate control system will correspondingly adjust the interior air temperature.

## Decreasing

- ▶ Push bottom of temperature control rocker switch ③ and/or ⑤ (▷ page 216) or (▷ page 217).





The climate control system will correspondingly adjust the interior air temperature.

### 4-zone automatic climate control\*

#### Adjusting air distribution

Use the air distribution controls ① and ⑦ (▷ page 216) or (▷ page 217) to separately adjust the air distribution on each side of the passenger compartment.

The following symbols are located on the controls:

Symbol	Function
	Directs air through the cockpit, side and rear passenger compartment air vents
	Directs air to the windshield and through the side air vents
	Directs air into the entire vehicle interior
	Directs air to the footwells

- ▶ Turn air distribution controls ① and ⑦ (▷ page 216) or (▷ page 217) on each side of the passenger compartment to the desired symbol.

The indicator lamps on the buttons **AUTO** go out. The automatic air distribution is switched off. The air distribution is controlled according to the selected control setting.



You can also turn the air distribution control to a position between two symbols.

#### Opening the cockpit air vent and center air vents

- ▶ Turn thumbwheels ① and ⑤ (▷ page 214) upward.

The cockpit air vent ③ and the side air vents ② and ④ are open.

#### Closing the cockpit air vent and center air vents

- ▶ Turn thumbwheels ① and ⑤ (▷ page 214) downward.

The cockpit air vent ③ and the side air vents ② and ④ are closed.

#### Opening the side air vents

- ▶ Turn thumbwheels ⑧ and ⑩ (▷ page 214) upward.

The side air vents ⑦ and ⑪ are open.



#### Closing the side air vents

- ▶ Turn thumbwheels ⑧ and ⑩ (▷ page 214) downward.



The side air vents ⑦ and ⑪ are closed.

## 4-zone automatic climate control\*

## Adjusting air volume

Use buttons **AUTO** (▷ page 216) or (▷ page 217) for automatic mode or air volume buttons  or  (▷ page 216) or (▷ page 217) to adjust air volume manually.

Nine blower speeds are available.

- ▶ Press button  to decrease or button  to increase air volume to the desired level.

The indicator lamps on the buttons **AUTO** go out. **AUTO** disappears in the display ④ (▷ page 216) or (▷ page 217) and the automatic mode is switched off. The selected blower speed is shown in the display ④.



## Front defroster

You can use this setting to defrost the windshield, for example if it is iced up. You can also defog the windshield and the side windows.



Keep this setting selected only until the windshield or the side windows are clear again.

## Activating



- ▶ Press button  or  (▷ page 216) or (▷ page 217).

The indicator lamp on the button comes on. Display ④ (▷ page 216) or (▷ page 217) is cleared.

The air conditioning switches automatically to the following functions:

- cooling on to dehumidify
- maximum blowing and heating power (depends on cooling temperature)
- air flows onto the windshield and the front side windows
- the air recirculation mode is switched off

## Deactivating

- ▶ Press button  or  (▷ page 216) or (▷ page 217) again.

The indicator lamp on the button goes out. Defrosting is turned off.

The previous settings are once again in effect.



The cooling remains switched on.



### 4-zone automatic climate control\*

#### Windshield fogged on the outside





Keep this setting selected only until the windshield is clear again.

- ▶ Switch the windshield wipers on (▷ page 55).
- ▶ Press one button **AUTO** (▷ page 216) or (▷ page 217).

The indicator lamp on the button comes on. **AUTO** appears in the display ④ (▷ page 216) or (▷ page 217). The air volume and air distribution are adjusted automatically.

If the automatic mode of the climate control is switched off:

- ▶ Turn air distribution control ① and ⑦ to  or  (▷ page 216) or (▷ page 217).

#### Maximum cooling MAX COOL

If the left and right air distribution controls as well as the airflow volume control are set to **AUTO** and there is a high need for cooling, the display “MAX COOL” appears in the front and rear display (▷ page 229).



This provides the fastest possible cooling of the vehicle interior (when windows and tilt/sliding sunroof\* are closed).

#### Air recirculation mode

Switch to air recirculation mode to prevent unpleasant odors from entering the vehicle from the outside (e.g. before driving through a tunnel). This setting cuts off the intake of outside air and recirculates the air in the passenger compartment.

#### Warning!



Fogged windows impair visibility, endangering you and others. If the windows begin to fog on the inside, switching off the air recirculation mode immediately should clear interior window fogging. If interior window fogging persists, make sure the air conditioning (▷ page 227) is activated, or press button  or .

## Activating

- ▶ Press button  (▷ page 216) or (▷ page 217).

The indicator lamp on the button comes on.



The air recirculation mode is activated automatically at high outside temperatures and if the concentration of carbon monoxide and nitrogen oxide in the outside air increases, for example in a tunnel.

The indicator lamp on button  is not lit when the air recirculation mode is automatically switched on.

A quantity of outside air is added after approximately 30 minutes.

## Warning!





Never operate the side windows and tilt/sliding sunroof\* if there is the possibility of anyone being harmed by the opening or closing procedure.

In case the procedure causes potential danger:

The closing of the side windows can be immediately halted by pressing or pulling the respective window switch. The closing of the tilt/sliding sunroof can be immediately halted by moving the switch for the tilt/sliding sunroof in any direction.

The closing of the side windows and the tilt/sliding sunroof can be reversed by again pressing and holding the  button.



Press and hold button  for approximately 2 seconds. The side windows and tilt/sliding sunroof\* will close. You can release button  once the closing procedure has begun. The windows and tilt/sliding sunroof\* continue closing until they are fully closed.

### 4-zone automatic climate control\*

#### Deactivating

- ▶ Press button  (▷ page 216) or (▷ page 217).



The indicator lamp on the button goes out.





The air recirculation mode is deactivated automatically:

- after 5 minutes if the outside temperature is below approximately 41°F (5°C)
- after 5 minutes if the air conditioning is turned off
- after 30 minutes if the outside temperature is above approximately 41°F (5°C)



Press and hold button  for approximately 2 seconds. The side windows and or tilt/sliding sunroof\* will return to their previous position. You can release button  once the opening procedure has begun. The windows and tilt/sliding sunroof\* continue opening until they have reached their previous position.

A window or tilt/sliding sunroof\* will only return to its previous position if it has not been moved to another position using the respective window switch or tilt/sliding sunroof\* switch after it was closed with button .

A window or tilt/sliding sunroof\* that has been moved will remain in its current position if button  is used to re-open the remaining windows or tilt/sliding sunroof\*.

#### Combination filter with pollutant-sensitive air-recirculation mode

The combination filter reduces pollutants and unpleasant odors in the outside air. The pollutant-sensitive air-recirculation mode automatically switches off the supply of outside air when pollutants are detected in the air.



The pollutant-sensitive air-recirculation mode is not possible if you have switched off the air conditioning or if the temperature falls below 41°F (5°C).

## Air conditioning

The cooling function, only operational when the engine is running, cools the vehicle interior down to the selected temperature. The cooling function also dehumidifies the air in the vehicle interior, thus preventing the windows from fogging up.



Condensation may drip out from underneath the vehicle. This is normal and not an indication of a malfunction.

### Warning!



If you turn off the cooling function, the vehicle will not be cooled when weather conditions are warm. The windows can fog up more quickly. Window fogging may impair visibility and endanger you and others.

## Deactivating

It is possible to deactivate the air conditioning (cooling) function of the climate control system. The air in the vehicle will then no longer be cooled or dehumidified.

- ▶ Press button  (▷ page 216) or (▷ page 217).

The indicator lamp on the button goes out.

## Activating

Moist air can fog up the windows. You can dehumidify the air with the air conditioning.

- ▶ Press button  (▷ page 216) or (▷ page 217) again.

The indicator lamp on the button comes on.

The air conditioning uses the refrigerant R134a. This refrigerant is free of CFCs which are harmful to the ozone layer.



If the air conditioning cannot be turned on again, this indicates that the air conditioning is losing refrigerant. The compressor has turned itself off.

Have the air conditioning checked at the nearest authorized Mercedes-Benz Center.

### 4-zone automatic climate control\*

#### Residual heat and ventilation (Canada only)

With the engine switched off, it is possible to continue to heat or ventilate the interior for up to 30 minutes. This feature makes use of the residual heat produced by the engine.



If you switch on the residual heat function when temperatures are high, only the ventilation will be switched on.



Regardless of the selected air volume, the blower operates at low speed.



How long the system will provide heating depends on

- the coolant temperature
- the temperature set by the operator

The blower will run at speed setting 1 regardless of the air distribution control setting.

#### Activating

- ▶ Switch off the ignition.
- ▶ Press button **REST** (▷ page 217).  
**REST** in the display ④ (▷ page 217) comes on.

#### Deactivating

- ▶ Press button **REST** (▷ page 217) again.  
**REST** in the display ④ (▷ page 217) goes out.



The residual heat is automatically turned off:

- when the ignition is switched on
- after about 30 minutes
- if the battery voltage drops
- if the coolant temperature is too low

## 4-zone automatic climate control\*

### Rear climate control

The rear climate control is adjusted via the front climate control panel (▷ page 216) or (▷ page 217) or the rear climate control panel.

The rear climate control panel is located in the rear center console.

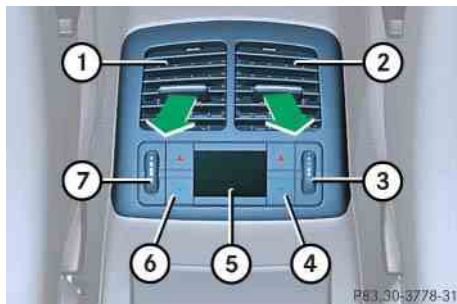

- ① Left rear center air vent, adjustable
- ② Right rear center air vent, adjustable
- ③ Thumbwheel for air volume control for right rear center air vent
- ④ Temperature rocker switch, right
- ⑤ Display
- ⑥ Temperature rocker switch, left
- ⑦ Thumbwheel for air volume control for left rear center air vent

### Setting the temperature

Use temperature control rocker switches ④ and ⑥ to separately adjust the air temperature on each side of the rear passenger compartment.



You can also adjust the rear temperature using the front climate control panel (▷ page 216) or (▷ page 217).

You should raise or lower the temperature setting in small increments, preferably starting at 72°F (22°C). The adjusted temperature appears in the display ⑤. The rear climate control will adjust to the set temperature as fast as possible.

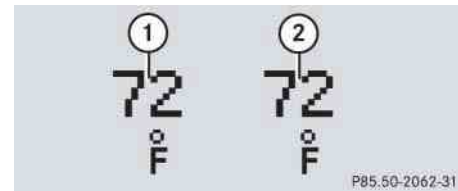

- ① Temperature, left
  - ② Temperature, right
- ▶ Adjust the temperature to the desired setting for each side of the passenger compartment using the left and right temperature buttons.

The temperature in the rear passenger compartment is adjusted automatically.



### 4-zone automatic climate control\*



The rear climate control will not cool the air when the air conditioning is switched off (▷ page 227).

#### Adjusting air distribution

- ▶ Push the slide for the left center vent ① or right center vent ② (▷ page 229) to the left, right, up, or down.

The air flow is directed in the corresponding direction.



For draft-free ventilation, push slides ① and ② (▷ page 229) upward.



#### Adjusting air volume

- ▶ Turn thumbwheel ③ or ⑦ (▷ page 229) up or down.

The air volume is increased or decreased.

#### Adjusting the rear settings with the front control panel

You can adjust the temperature for the rear climate control from the front climate control panel.

- ▶ Press button  or  (▷ page 216) or (▷ page 217).

The display switches over.

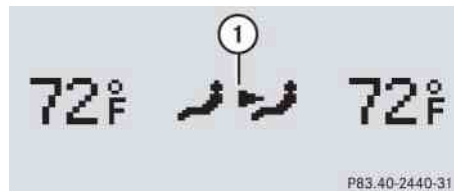



- ① Rear climate control display

- ▶ Set the desired temperature for the rear passenger compartment using temperature rocker switches ④ and ⑥ (▷ page 229).

After approximately 5 seconds after the last adjustment, the display switches back to its standard display.



You can also press button  or  (▷ page 216) or (▷ page 217) once more to switch back to the standard display.

## ▼ Power windows

### Opening and closing the windows

The side windows are opened and closed electrically. The switches for all of the side windows are on the driver's door. The switches for the respective windows are on the front passenger door and the rear doors.



- ① Rear window override switch  
(▷ page 89)
- ② Right front window
- ③ Right rear window
- ④ Left rear window
- ⑤ Left front window

### Warning!



When closing the windows, make sure that there is no danger of anyone being harmed by the closing procedure.

The closing of the door windows can be immediately halted by releasing the switch or, if switch was pulled past the resistance point and released, by either pressing or pulling the respective switch.

The door windows are equipped with the express-close and automatic reversal function. If the window encounters an obstruction that blocks its path in a circumstance where you pulled the switch past the resistance point and released it to close the window, the automatic reversal function will stop the window and open it slightly.

If the window encounters an obstruction that blocks its path in a circumstance where you are closing the window by pulling and holding the switch, by pressing and holding button  on the SmartKey, by pressing

and holding the lock button (vehicles with KEYLESS-GO\*) on an outside door handle, or by pressing and holding the air recirculation button  on the climate control, the automatic reversal function will not operate.

When leaving the vehicle, always remove the SmartKey or SmartKey with KEYLESS-GO\* from the starter switch, take it with you, and lock the vehicle. Do not leave children unattended in the vehicle, or with access to an unlocked vehicle. Unsupervised use of vehicle equipment can cause an accident and/or serious personal injury.



### Power windows



You can also open or close the windows using the SmartKey, see “Summer opening feature” (▷ page 234) and “Convenience closing feature” (▷ page 234).

Depending on current position, the windows may also open or close when the air recirculation button  in the control panel of the climate control (▷ page 204), (▷ page 216) or (▷ page 217) is pressed and held.



Operating the windows from the rear is not possible if you activate the override switch (▷ page 89).



With the SmartKey in starter switch position **0** or removed from the starter switch, the power windows can be operated:

- until you open the driver’s or front passenger’s door
- for at least 5 minutes.

- ▶ Switch on the ignition (▷ page 36).

#### Opening the windows

- ▶ Press switch ② to ⑤ to the resistance point.

The corresponding window will move downwards until you release the switch.

#### Closing the windows

- ▶ Pull switch ② to ⑤ to the resistance point.

The corresponding window will move upwards until you release the switch.

#### Warning!



If you pull and hold the switch up when closing the window, and upward movement of the window is blocked by some obstruction including but not limited to arms, hands, fingers, etc., the automatic reversal will not operate.

#### Fully opening the windows (Express-open)

- ▶ Press switch ② to ⑤ past the resistance point and release.

The corresponding window opens completely.

### Fully closing the windows (Express-close)

- ▶ Pull switch ② to ⑤ past the resistance point and release.

The corresponding window closes completely.

If the upward movement of the window is blocked during the closing procedure, the window will stop and open slightly.

#### Warning!



Driver's door only:

If within 5 seconds switch is again pulled past the resistance point and released, the automatic reversal will not operate.



If the upward movement of the window is blocked during the closing procedure, the window will stop and open slightly.

Remove the obstruction, pull the respective power window switch again past the resistance point and release.

If the window still does not close when there is no obstruction, pull and hold the respective power window switch. The side window will then close without the obstruction sensor function.

### Stopping windows during Express-operation

- ▶ Press or pull the respective power window switch again.

### Synchronizing power windows

The power windows must be synchronized

- after the battery has been disconnected
- if the power windows cannot be fully opened (Express-open) or closed (Express-close)

#### Synchronizing

- ▶ Close all doors.
- ▶ Switch on the ignition (▷ page 36).
- ▶ Pull switch ② to ⑤ until the side windows are completely closed.
- ▶ Hold on to switches ② to ⑤ for approximately 1 second.

The power windows are synchronized.

### Power windows

#### Summer opening feature



If the weather is warm, you can ventilate the vehicle before driving off by simultaneously:

- opening the side windows
- opening the tilt/sliding sunroof\*
- turning on the seat ventilation\* for the driver's seat





The seat ventilation\* for the driver's seat is automatically set to the highest level if activated via summer opening feature.



- ▶ Aim transmitter eye of the SmartKey or SmartKey with KEYLESS-GO\* at the driver's outside door handle. The SmartKey or SmartKey with KEYLESS-GO\* must be in close proximity to the driver's outside door handle.
- ▶ Press and hold button  until the windows and the tilt/sliding sunroof\* have reached the desired position.
- ▶ Release button  to interrupt procedure.

#### Convenience closing feature

When you lock the vehicle, you can close the windows and the tilt/sliding sunroof\* simultaneously.

- ▶ Aim transmitter eye of the SmartKey or SmartKey with KEYLESS-GO\* at the driver's outside door handle (▷ page 234). The SmartKey or SmartKey with KEYLESS-GO\* must be in close proximity to the driver's outside door handle.
- ▶ Press and hold button  until the windows and the tilt/sliding sunroof\* are completely closed.
- ▶ Release button  to interrupt procedure.

Vehicles with KEYLESS-GO\*:



- ▶ Press and hold the lock button on an outside door handle (▷ page 63) until the windows and the tilt/sliding sunroof\* are completely closed.
- ▶ Release the lock button on the outside door handle to interrupt procedure.

### Warning!



When closing the side windows and the tilt/sliding sunroof\*, make sure that there is no danger of anyone being harmed by the closing procedure.

If potential danger exists, proceed as follows:

- Release button  to stop the closing procedure. To open, press and hold button . To continue the closing procedure after making sure that there is no danger of anyone being harmed by the closing procedure, press and hold button .

Vehicles with KEYLESS-GO\*:

- Release the lock button (▷ page 63) on the outside door handle to stop the closing procedure.
- Pull on the outside door handle and hold firmly. The side windows and the tilt/sliding sunroof\* will open for as long as the door handle is held but the door not opened.

### Power tilt/sliding sunroof\*

#### Opening and closing the power tilt/sliding sunroof

The tilt/sliding sunroof is opened and closed electrically. The switch for the tilt/sliding sunroof is on the overhead control panel.



#### Sunroof switch

- ① Push back to slide sunroof open
- ② Push forward to slide sunroof closed
- ③ Push up to raise sunroof at rear
- ④ Pull down to lower sunroof at rear

With the sunroof closed or tilted open, a screen can be slid into the sunroof opening to guard against sun rays. When sliding the sunroof open, the screen will also retract.



#### Warning!



When closing the tilt/sliding sunroof, make sure there is no danger of anyone being harmed by the closing procedure.

The opening/closing procedure of the tilt/sliding sunroof can be immediately halted by releasing the switch or, if the switch was moved past the resistance point and released, by moving the switch in any direction.

The tilt/sliding sunroof is made out of glass. In the event of an accident, the glass may shatter. This may result in an opening in the roof.

In a vehicle rollover, occupants not wearing their seat belts or not wearing them properly may be thrown out of the opening. Such an opening also presents a potential for injury for occupants wearing their seat belts properly as entire body parts or portions of them may protrude from the passenger compartment.

When leaving the vehicle, always remove the SmartKey or the SmartKey with KEYLESS-GO\* from the starter switch, take it with you, and lock the vehicle. Do not leave children unattended in the vehicle, or with access to an unlocked vehicle. Unsupervised use of vehicle equipment can cause an accident and/or serious personal injury.



To avoid damaging the seals, do not transport any objects with sharp edges which can stick out of the tilt/sliding sunroof.

Do not open the tilt/sliding sunroof if there is snow or ice on the roof, as this could result in malfunctions.

The tilt/sliding sunroof can be opened or closed manually should an electrical malfunction occur (▷ page 427).



You can also open or close the tilt/sliding sunroof using the SmartKey, see “Summer opening feature” (▷ page 234) and “Convenience closing feature” (▷ page 234).

Depending on current position, the tilt/sliding sunroof may also open or close when the air recirculation button  in the control panel of the climate control (▷ page 204), (▷ page 216) or (▷ page 217) is pressed and held.

- ▶ Switch on the ignition (▷ page 36).

### Opening and closing the power tilt/sliding sunroof

- ▶ To open, close, raise or lower the tilt/sliding sunroof, move the sunroof switch to resistance point in the required direction of arrows ① to ④.

Release the sunroof switch when the tilt/sliding sunroof has reached the desired position.

### Fully opening (Express-open) and closing (Express-close) the power tilt/sliding sunroof

- ▶ To open or close the tilt/sliding sunroof, move the sunroof switch past the resistance point in direction of arrow ① to ② and release.

The tilt/sliding sunroof opens or closes completely.

### Power tilt/sliding sunroof\*

#### *Stopping the power tilt/sliding sunroof during Express-operation*

- ▶ Move the sunroof switch in any direction.



If the movement of the tilt/sliding sunroof is blocked during the Express-close procedure, the tilt/sliding sunroof will stop and reopen slightly.

#### **Synchronizing the power tilt/sliding sunroof**

---

The tilt/sliding sunroof must be synchronized

- after the battery has been disconnected or discharged
- after the tilt/sliding sunroof has been closed manually (▷ page 427)
- after a malfunction
- if the tilt/sliding sunroof does not open smoothly

- ▶ Remove the respective fuse from the main fuse box (▷ page 462).
- ▶ Reinsert the fuse in the main fuse box.
- ▶ Switch on the ignition (▷ page 36).
- ▶ Move and hold the sunroof switch in direction of arrow ③ until the tilt/sliding sunroof is fully raised at the rear.  
Keep holding the sunroof switch in direction of arrow ③ for approximately 1 second.
- ▶ Check the Express-open feature (▷ page 237).  
If the tilt/sliding sunroof opens completely, the roof is synchronized. Otherwise repeat the above steps.

## ▼ Driving systems

The driving systems of your vehicle are described on the following pages:

- Cruise control and Distronic\*, with which the vehicle can maintain a preset speed
- Airmatic DC\* adjusts the vehicle suspension characteristics automatically and controls the vehicle level

For information on BAS, ABS, electrohydraulic brake system and ESP® driving systems, see “Driving safety systems” (▷ page 91).

### Cruise control

The cruise control automatically maintains the speed you set for your vehicle.

Use of cruise control is recommended for driving at a constant speed for extended periods of time. You can set or resume cruise control at any speed above 20 mph (30 km/h).

The cruise control function is operated by means of the cruise control lever.

The cruise control lever is the uppermost lever on the left-hand side of the steering column (▷ page 22).

### Warning!



The cruise control is a convenience system designed to assist the driver during vehicle operation. The driver is and must remain at all times responsible for the vehicle speed and for safe brake operation.

Only use the cruise control if the road, traffic and weather conditions make it advisable to travel at a steady speed.

- The use of cruise control can be dangerous on winding roads or in heavy traffic because conditions do not allow safe driving at a steady speed.
- The use of cruise control can be dangerous on slippery roads. Rapid changes in tire traction can result in wheel spin and loss of control.
- Deactivate the cruise control when driving in fog.

The “Resume” function should only be operated if the driver is fully aware of the previously set speed and wishes to resume this particular preset speed.



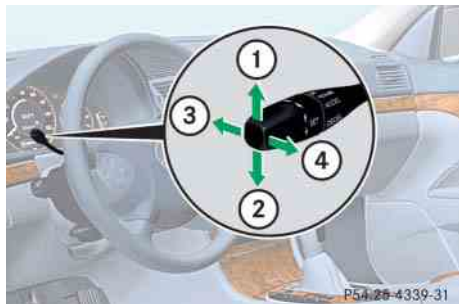

- ① Set current or higher speed
- ② Set current or lower speed
- ③ Cancel cruise control
- ④ Resume at last set speed

#### Warning!



The cruise control brakes automatically so that the set speed is not exceeded.

Keep in mind that the cruise control is a convenience system designed to assist the driver during vehicle operation. The driver is and must remain at all times responsible for the vehicle speed and for safe brake operation.

#### Setting current speed

- ▶ Accelerate or decelerate to the desired speed.
- ▶ Briefly lift ① or depress ② the cruise control lever.

The current speed is set.

- ▶ Remove your foot from the accelerator pedal.

Cruise control is activated.

The selected speed appears in the multi-function display for approximately 5 seconds, and the corresponding speedometer segments from the selected speed to the vehicle maximum speed are illuminated.



On uphill or downhill grades, the cruise control may not be able to maintain the set speed. Once the grade eases, the set speed will be resumed.

On downhill grades, the cruise control maintains the set speed with active braking action.

In addition, on longer downhill grades the automatic transmission will automatically downshift.

### Canceling cruise control

There are several ways to cancel the cruise control:

- ▶ Step on the brake pedal.

The cruise control is canceled. The last speed set is stored for later use.

or

- ▶ Briefly push the cruise control lever in direction of arrow ③ (▷ page 240).

The cruise control is canceled. The last speed set is stored for later use.



The last stored speed is canceled when you turn off the engine.



The cruise control switches off automatically if

- you step on the brake pedal.
- you depress the parking brake pedal.

In this case the segments in the multifunction display (▷ page 245) go out and no warning sounds.

- the vehicle speed is below 20 mph (30 km/h).
- the ESP<sup>®</sup> is in operation or switched off with the ESP<sup>®</sup> switch (▷ page 96).
- you move the gear selector lever to position **N** while driving.

The segments in the multifunction display (▷ page 245) go out, and an acoustic warning sounds.



Moving gear selector lever to position **N** while driving also cancels the cruise control. However, the gear selector lever should not be moved to position **N** while driving except to coast when the vehicle is in danger of skidding (e.g. on icy roads).



Depressing the accelerator pedal does not deactivate the cruise control. After brief acceleration (e.g. for passing), the cruise control will resume the last speed set.

### Driving systems

#### Setting a higher speed

- ▶ Lift cruise control lever in direction of arrow ① (▷ page 240) and hold it up until the desired speed is reached.
- ▶ Release the cruise control lever.  
The new speed is set.

#### Setting a lower speed

- ▶ Depress the cruise control lever in direction of arrow ② (▷ page 240) and hold it down until the desired speed is reached.
- ▶ Release cruise control lever.  
The new speed is set.



When you use the cruise control lever to decelerate, the brake system will automatically brake the vehicle if the engine's braking power does not brake the vehicle sufficiently.

#### Fine adjustment in 1 mph (Canada: 1 km/h) increments

##### *Faster*

- ▶ Briefly tip the cruise control lever in direction of arrow ① (▷ page 240).

##### *Slower*

- ▶ Briefly tip the cruise control lever in direction of arrow ② (▷ page 240).

#### Setting to last stored speed ("Resume" function)

##### **Warning!**



The speed stored in memory should only be set again if prevailing road conditions permit. Possible acceleration or deceleration differences arising from returning to the pre-set speed could cause an accident and/or serious injury to you and others.

- ▶ Briefly pull the cruise control lever in direction of arrow ④ (▷ page 240).  
The cruise control resumes the last set speed.
- ▶ Remove your foot from the accelerator pedal.

The selected speed appears in the multi-function display for approximately 5 seconds, and the corresponding speedometer segments from the selected speed to the vehicle maximum speed are illuminated.

## Distronic\*

When activated, the Distronic adaptive cruise control system increases driving convenience afforded by the cruise control during travel on expressways and other major roads.

- If the Distronic distance sensor detects a slower moving vehicle directly ahead, your vehicle speed will be reduced so that you follow that vehicle at a preset distance.
- If there is no vehicle directly ahead of you, Distronic will function in the same way as cruise control (▷ page 248).

### Warning!



Distronic adaptive cruise control is no substitute for active driving involvement. It does not react to stationary objects, nor recognize or predict the curvature and lane layout or the movement of vehicles ahead. Distronic can only apply a maximum of 20% of the vehicle's braking power.

It is the driver's responsibility at all times to be attentive to road, traffic and weather conditions and to provide the steering, braking and other driving inputs necessary to retain control of the vehicle.

### Warning!



Distronic is a convenience system, its speed adjustment reduction capability is intended to make cruise control more effective and usable when traffic speeds vary. It is not however, intended to, nor does it, replace the need for extreme care. The responsibility for the vehicle speed and the distance to the vehicle ahead, including most importantly brake operation to assure safe stopping distance, always rests with the driver.

Distronic cannot take street and traffic conditions into account.

### Warning!



Distronic requires familiarity with its operational characteristics. We strongly recommend that you review the following information carefully before operating the system.



USA only:

This device complies with Part 15 of the FCC Rules. Operation is subject to the following two conditions:

- (1) This device may not cause harmful interference, and
- (2) this device must accept any interference received, including interference that may cause undesired operation.

Any unauthorized modification to this device could void the user's authority to operate the equipment.

### Driving systems



Canada only:

This device complies with RSS-210 of Industry Canada. Operation is subject to the following two conditions:

- (1) This device may not cause interference, and
- (2) this device must accept any interference received, including interference that may cause undesired operation of the device.

Any unauthorized modification to this device could void the user's authority to operate the equipment.

#### Warning!



Distronic cannot take street and traffic conditions into account. Only use Distronic if the road, weather and traffic conditions make it advisable to travel at a steady speed.

#### Warning!



Use of Distronic can be dangerous on slippery roads. Rapid changes in tire traction can result in wheel spin and loss of control.

Distronic does not act upon adverse sight distance conditions. Do not use Distronic during conditions of fog and heavy rain, snow or sleet.

#### Warning!



Distronic cannot take weather conditions into account. Switch off Distronic or do not turn it on if:

- roads are slippery or covered with snow or ice. The wheels could lose traction while braking or accelerating, and the vehicle could skid.
- the sensor is dirty or visibility is diminished due to snow, rain or fog. The distance control could be impaired.

Always pay attention to traffic conditions even while Distronic is switched on. Otherwise, you may not be able to recognize dangerous situations until it is too late and could cause an accident resulting in personal or fatal injury to you or others.

**Warning!**

Close attention to road and traffic conditions is imperative at all times, regardless of whether or not Distronic is activated.

Use of Distronic can be dangerous on winding roads or in heavy traffic because conditions do not allow safe driving at a steady speed.

Distronic will not react to stationary objects in the roadway (e.g. a stopped vehicle in a traffic jam or a disabled vehicle). Distronic will also not respond to oncoming vehicles.

Switch off Distronic:

- when changing from the left to the right lane if vehicles are moving more slowly in the left lane
- when entering a turn lane or highway off ramp
- in complex driving situations, such as in highway construction zones

In these situations, Distronic will continue to maintain the set speed unless deactivated.

Distronic is designed and intended only to maintain a set speed and keep a set distance from moving objects in front of it.

**Warning!**

The “Resume” function should only be operated if the driver is fully aware of the previously set speed and wishes to resume this particular preset speed.

**Distronic displays in the speedometer dial**

## ① Set speed

If Distronic is activated, one or two segments come on around the set speed.



The vehicle speed displayed on the speedometer can briefly vary from the speed setting on the Distronic system.

### Driving systems



#### ① Segments

If Distronic detects a vehicle directly ahead, the segments (representing the difference) from the speed of the vehicle ahead to the set speed come on.

If Distronic calculates that there is a danger of collision:

- The distance warning lamp  in the instrument cluster comes on red.
- An intermittent warning sounds.

- ▶ Immediately brake the vehicle to avoid a collision.

Under no circumstances should the driver await the intermittent warning sound before braking. See the following warning note.

The intermittent warning sound ceases and the red distance warning lamp  goes out when the necessary distance to the vehicle ahead is again established.

#### Warning!



An intermittent warning sounds and the distance warning lamp  in the instrument cluster is illuminated if the Distronic system calculates that the distance to the vehicle ahead and your vehicle's current speed indicate that Distronic will not be capable of slowing the vehicle sufficiently to maintain the preset following distance, which creates a danger of a collision.

Immediately brake the vehicle to increase the distance to the vehicle in front of you. The warning sound is intended as a final caution that you have not interceded with your own braking inputs to avoid a potentially dangerous situation. Do not wait for the operation of the warning signal to intercede with your own braking, as that will result in potentially dangerous emergency braking which will not always result in an impact being avoided.

Tailgating increases the risk of an accident.



**Warning!**

Distronic brakes your vehicle with a maximum deceleration of  $6.5 \text{ ft/s}^2$  ( $2 \text{ m/s}^2$ ). This corresponds to about 20% of the maximum deceleration ability of your vehicle.

Distronic brakes the vehicle in an effort to restore the preset distance or to maintain the speed.

**Distronic menu in the control system**

In the Distronic menu you can read the current settings for Distronic. What appears in the multifunction display depends on whether Distronic and the distance warning function are turned on or off.

- ▶ Press button  or  repeatedly until you see one of the following displays.

**Distronic deactivated**

When Distronic is deactivated you will see the standard display of Distronic in the multifunction display.

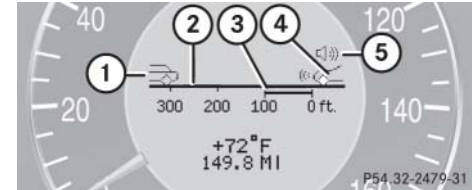

- ① Vehicle ahead, if detected
- ② Actual distance to vehicle ahead
- ③ Preset distance threshold to vehicle ahead
- ④ Your vehicle
- ⑤ Symbol for activated distance warning function



## Driving systems

### Distronic activated

If you turn DISTRONIC on, you will see the set speed in the multifunction display for about 5 seconds. When DISTRONIC is activated, you will see the following display in the multifunction display.

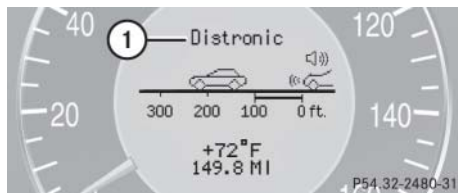

① DISTRONIC activated

### Cruise control lever

The DISTRONIC system is operated by means of the cruise control lever.

The cruise control lever is the uppermost lever on the left-hand side of the steering column.

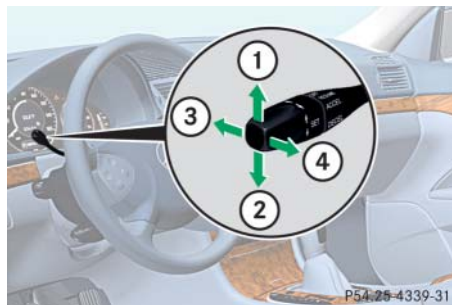

- ① Set current or higher speed
- ② Set current or lower speed
- ③ Deactivate DISTRONIC
- ④ Resume at last set speed

### Activating DISTRONIC

You can activate DISTRONIC if

- you are driving between 20 mph (30 km/h) and 110 mph (180 km/h)
- the ESP® is activated (> page 93)

If DISTRONIC has not been activated after pressing the cruise control lever you will see the message --- in the multifunction display.

In the following cases you cannot activate DISTRONIC

- up to 2 minutes after starting the engine
- when you brake
- if you have set the parking brake
- if the gear selector lever is in position **P**, **R** or **N**
- if the ESP® is switched off

### Setting the current speed

- ▶ Accelerate or decelerate to the desired speed.
- ▶ Briefly lift or depress the cruise control lever.

The current speed is set.

- ▶ Remove your foot from the accelerator pedal.



If you do not take your foot off the accelerator completely, the following message will appear in the multifunction display:

Distronic  
override

The distance to a slower moving vehicle in front of you will not be set. Your vehicle speed will then be determined only by the accelerator pedal position.

### Setting a higher speed

- ▶ Briefly tip the cruise control lever in direction of arrow ① (▷ page 248) to increase vehicle speed in increments of 5 mph (Canada: 10 km/h).

The new speed is set.

The stored speed is displayed in the multifunction display for approximately 5 seconds (▷ page 248), and one or two segments around the stored speed come on in the speedometer (▷ page 245).



Depressing the accelerator pedal does not deactivate Distronic. After brief acceleration (e.g. for passing), the cruise control will resume the last speed set.

### Setting a lower speed

- ▶ Briefly tip the cruise control lever in direction of arrow ② (▷ page 248) to decrease vehicle speed in increments of 5 mph (Canada: 10 km/h).

The new speed is set.

The stored speed is displayed in the multifunction display for approximately 5 seconds (▷ page 248), and one or two segments around the stored speed come on in the speedometer (▷ page 245).



When you use the cruise control lever to decelerate, the brakes will be applied to support deceleration.

In addition, the transmission will automatically downshift on long downhill grades.

### Driving systems

#### Fine adjustment in 1 mph (Canada: 1 km/h) increments

##### *Faster*

- ▶ Briefly tip the cruise control lever in direction of arrow ④ (▷ page 248).

#### Setting to last stored speed ("Resume" function)

##### **Warning!**



The speed stored in memory should only be set again if prevailing road conditions permit. Possible acceleration or deceleration differences arising from returning to the preset speed could cause an accident and/or serious injury to you and others.

- ▶ Briefly tip the cruise control lever in direction of arrow ④ (▷ page 248).  
Distronic is activated and set to the last stored speed.
- ▶ Remove your foot from the accelerator pedal.

#### Deactivating Distronic

There are several ways to deactivate the Distronic system:

- ▶ Briefly tip the cruise control lever in direction of arrow ③ (▷ page 248).

or

- ▶ Step on the brake pedal.

Distronic will be deactivated. The last speed set will be stored into memory.



The following message will appear in the multifunction display for approximately 5 seconds:

Distronic off

The last stored speed is deleted when you turn off the engine.

DISTRONIC deactivates automatically when

- you set the parking brake
- you drive slower than 20 mph (30 km/h)
- the ESP® is active (▷ page 93) or you deactivate the ESP®
- you move the gear selector lever into position **N**

A signal will sound. The *DISTRONIC OFF* message appears in the multifunction display for approximately 5 seconds.

### Warning!



DISTRONIC switches off and releases the brakes when the vehicle decelerates below the minimum speed of 20 mph (30 km/h) by operation of the system. At that time the driver must apply the brakes in order to reduce vehicle speed further or bring it to a stop.

### Setting the following distance in DISTRONIC

You can set the specified following distance for DISTRONIC by varying the time setting between 1.0 and 2.0 seconds. Using this time setting and the current speed of your vehicle, DISTRONIC calculates and sets the required following distance to the vehicle ahead. The set distance will be shown in the multifunction display.

The thumbwheel for making the time setting is located on the lower section of the center console.

### Warning!



It is up to the driver to exercise discretion to select the appropriate setting given road conditions, traffic, driver's preferred driving style and applicable laws and driving recommendations for safe following distance.

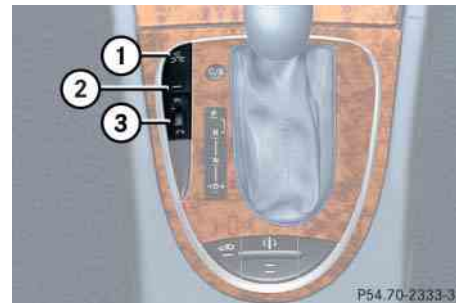

- ① Distance warning function on/off switch
- ② Indicator lamp
- ③ Thumbwheel for setting distance

### Increasing distance

Increasing the distance setting tells DISTRONIC to maintain a greater following distance to the vehicle ahead.

- ▶ Turn thumbwheel ③ towards .

### Driving systems

#### Decreasing distance

Decreasing the distance setting tells Distronic to maintain a smaller following distance to the vehicle ahead.

- ▶ Turn thumbwheel ③ towards .

#### Distance warning function

When Distronic is deactivated, this function will continue to warn you when recognizing a stationary obstacle or a slower vehicle moving in the vehicle's path and the danger of a collision exists:

- The distance warning lamp  in the instrument cluster comes on.
- An intermittent warning will sound if necessary.

If these warnings are issued, you must brake manually to maintain a safe distance and avoid a collision with the vehicle ahead.

When pressing the brake pedal, the warning sound ceases. The warning sound will also cease when the distance to the vehi-

cle ahead is sufficient again without applying the brakes. In this case, the distance warning lamp will also go out.

#### Warning!



If the distance warning lamp  in the instrument cluster comes on while driving and/or an intermittent warning sounds, immediate attention on the part of the driver is required. As required by the traffic situation, apply the brakes and navigate around a possible obstacle. However, do not drive by relying on the distance warning function, as this will result in an emergency braking application. Especially depending on road surface conditions and driver reaction, this will not always enable you to avoid a collision.



Complex driving situations are not always fully recognized by Distronic. This could result in wrong or missing distance warnings.

#### Activating

- ▶ Press switch ①.

Indicator lamp ② on the switch comes on. A loudspeaker symbol appears in the multifunction display (> page 248).

#### Deactivating

- ▶ Press switch ①.

Indicator lamp ② on the switch goes out. No loudspeaker symbol appears in the multifunction display.

## Driving with Distronic

This section describes a number of driving situations where special precaution is required on the part of the driver. Be prepared to brake in such situations. This will deactivate the Distronic system.

### Warning!



Distronic works to maintain the speed selected by the driver unless a moving obstacle proceeding directly ahead of it in the same travel direction is detected (e.g. following another vehicle ahead of you at a distance set by Distronic). This means that:

- Your vehicle can pass another vehicle after you change lanes.
- While in a sharp turn or if the vehicle in front is in a sharp turn, Distronic could lose sight of a vehicle traveling in front of it, then your vehicle could accelerate to the previously selected speed.

Distronic regulates only the distance between your vehicle and those directly ahead of it, but does not register stationary objects in the road, e.g.:

- a stopped vehicle in a traffic jam
- a disabled vehicle
- an oncoming vehicle

The driver must always be on the alert, observe all traffic and intercede as required by steering or braking the vehicle.

### Warning!



Distronic should not be used in snowy or icy road conditions.

The most likely cause for a malfunctioning system is a dirty sensor (located behind the hood grille), especially at times of snow and ice or heavy rain. In such a case, Distronic will switch off, and the message Distronic Currently unavailable See Operator's Manual appears in the multifunction display.

For cleaning and care of the Distronic sensor, see "Cleaning the Distronic\* system sensor cover" (▷ page 366).



If the message

Distronic

Currently unavailable

See Operator's Manual

disappears during driving and the last speed stored flashes for approximately 5 seconds, the dirt (e.g. slush) has dissolved; Distronic works again.

#### *Turns and bends*

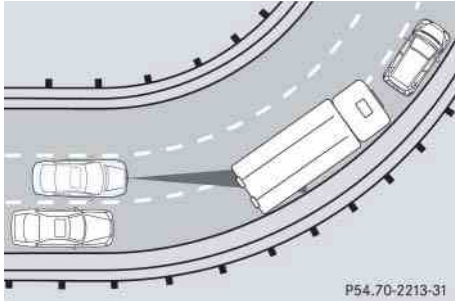

In turns or bends, Distronic may not detect a moving vehicle in front, or it may detect one too soon. This may cause your vehicle to brake late or unexpectedly.

#### *Offset driving*

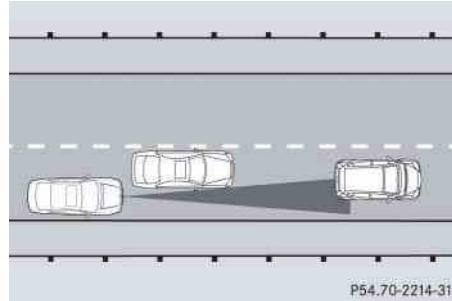

A vehicle traveling in your lane but offset from your direct line of travel may not be detected by Distronic. There will be insufficient distance to the vehicle ahead.

#### *Lane changing*

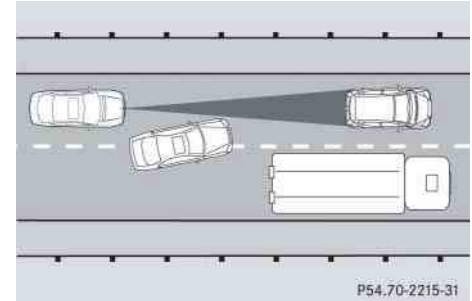

Distronic has not yet detected the vehicle changing lanes. There will be insufficient distance to the lane-changing vehicle.

### Narrow vehicles

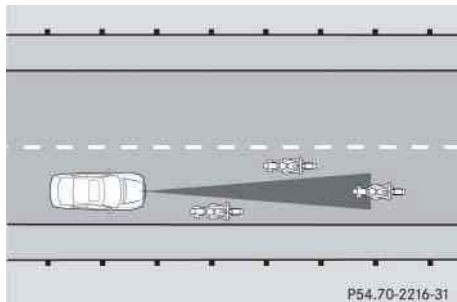

Because of their narrow profile, the vehicles traveling near the outer edges of the lane have not yet been detected by Distronic. There will be insufficient distance to the vehicles ahead.

### Airmatic DC (Dual Control)\*

Airmatic automatically selects the optimum suspension tuning and ride height for your vehicle. The Airmatic consists of two components:

- Adaptive Damping System (ADS)
- Vehicle level control

The ADS automatically selects the optimum damping for the respective driving conditions. At the same time the suspension is set to either Sport 1, Sport 2 or Comfort.

### Suspension tuning

The suspension tuning is set according to:

- Your driving style
- Road surface conditions
- Your choice of suspension style, Sport 1, Sport 2 or Comfort, which you select using the damping button ① (▷ page 256).

The following suspension styles are available:

- Comfort
  - Both indicator lamps ② (▷ page 256) are off.
- Sport 1
  - One indicator lamp ② (▷ page 256) is on.
- Sport 2
  - Both indicator lamps ② (▷ page 256) are on.



### Driving systems

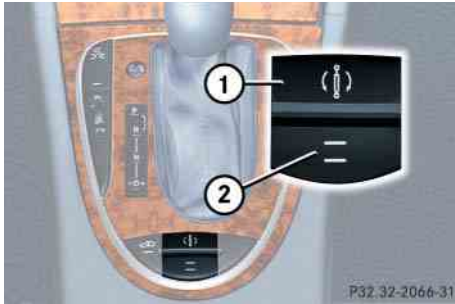

- ① Damping button
- ② Indicator lamps

- ▶ Start the engine.
- ▶ Press the damping button ① until the desired suspension style is set.



If you have selected the Comfort suspension tuning, the vehicle lowers slightly when you lock it within approximately 60 seconds after switching off the engine. When parking, make sure that your vehicle cannot come into contact with other objects, such as a curb, while lowering. Your vehicle could otherwise be damaged.



The selected suspension style is stored in memory, even after the SmartKey is removed from the starter switch.

### Vehicle level control

Your vehicle automatically adjusts its ride height to

- increase vehicle safety
- reduce fuel consumption

The following vehicle chassis ride heights can be selected:

- Normal
- Raised

The vehicle chassis ride height is raised or lowered according to the selected level setting and to the vehicle speed:

- At a speed exceeding approximately 68 mph (110 km/h) with normal level set or exceeding 75 mph (120 km/h) with raised level set, the ride height is reduced automatically. The table on the next page provides an overview of the vehicle levels.
- With decreasing speed, the ride height is again raised to the normal level.



These height adjustments are so small that you may not notice any change.

Select the “Raised” level only when required by current driving conditions. Otherwise

- handling may be impaired
- fuel consumption may increase

**Warning!**

To help avoid personal injury, keep hands and feet away from wheel housing area, and stay away from under the vehicle when lowering the vehicle chassis.

### Driving systems

The following vehicle level settings can be selected when the vehicle is stationary and the engine is running:

Vehicle level when stationary	Indicator lamp	Suspension tuning	Use for	Ride height increase over normal	Automatic lowering
Normal	Lamp off	Comfort	For driving on normal roads	None	Max. approx. 0.4 in (10 mm)
Normal	Lamp off	Sport 1 or 2	For driving on normal roads	None	Max. approx. 0.6 in (15 mm)
Raised	Lamp on	Comfort	For driving on rough roads or with snow chains	Approx. 0.8 in (20 mm)	Max. approx. 1.2 in (30 mm)
Raised	Lamp on	Sport 1 or 2	For driving on rough roads or with snow chains	Approx. 0.8 in (20 mm)	Max. approx. 1.4 in (35 mm)

The button is located in the lower section of the center console.

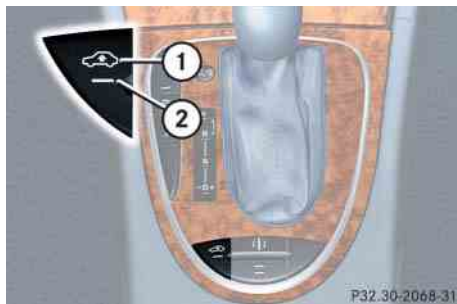

① Vehicle level control button

② Indicator lamp

- ▶ Start the engine (▷ page 36).
- ▶ Briefly press button ① to change from normal level to raised level. When vehicle is at raised level, pressing the button will return the vehicle to normal level.

When raised level is set, indicator lamp ② in the button comes on.

When normal level is set, indicator lamp ② in the button goes out.



At a speed of approximately above 75 mph (120 km/h) or if the speed amounts to between 50 mph (80 km/h) and 75 mph (120 km/h) for approximately five minutes, the setting raised is canceled. The indicator lamp ② in the button goes out.

If you do not drive in this speed range, the raised level remains stored even if the SmartKey is removed from the starter switch.

### Loading

#### Split rear bench seat

To expand the cargo compartment, you can fold down the left and right rear seat backrests.

The two sections can be folded down separately to enlarge the cargo compartment.

#### Warning!



When expanding the cargo compartment, always fold the seat cushions fully forward.

Unless you are transporting cargo, the backrests must remain properly locked in the up-right position.

In an accident, during hard braking or sudden maneuvers, loose items will be thrown around inside the vehicle, and cause injury to vehicle occupants unless the items are securely fastened in the vehicle.

Always use the cargo tie down rings (> page 264).

#### Folding the backrest forward



You must always release the seat cushion and fold it up before folding the seat backrests forward. The upholstery on the backrest may otherwise be damaged.

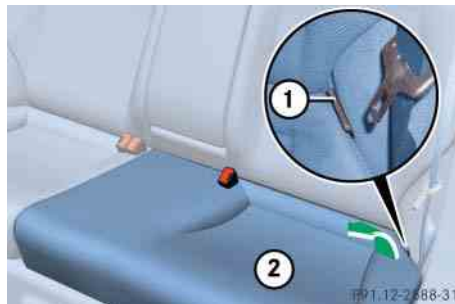

- ① Release catch
- ② Seat cushion

- ▶ Pull release catch ① and use it to pull seat cushion ② up.



If tall persons have occupied the driver's and front passenger seats, it may be necessary to move these seats forward slightly in order to fold the rear seat backrests forward.

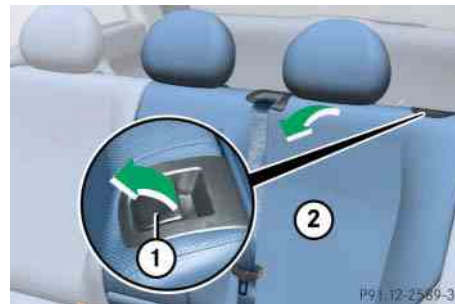

- ① Release catch
- ② Seat backrest

- ▶ Pull release catch ① up.

The seat backrest is released and the head restraints fold back.

- ▶ Fold the seat backrest ② forward.



If the rear center seat is to be occupied while driving, it may be necessary to fold the seat belt buckle up again.

### Returning seat backrest to original position

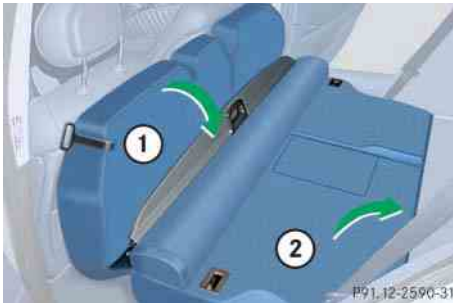

- ① Seat cushion
- ② Seat backrest

- ▶ Swing seat backrest ② to the rear until it engages.

- ▶ Swing seat cushion ① to the rear and press down from the rear of the cushion until it audibly engages.



- ▶ Swing the head restraint forward by hand until it engages.

### Warning!



Always lock backrest in its upright position when rear seat bench is occupied, or the extended cargo compartment is not in use. Check for secure locking by pushing and pulling on the backrest.

In an accident, during hard braking or sudden maneuvers, loose items will be thrown around inside the vehicle, and cause injury to vehicle occupants unless the items are securely fastened in the vehicle.

To help avoid personal injury during a collision or sudden maneuver, exercise care when transporting cargo.

### Loading

#### Adjusting seat backrest position

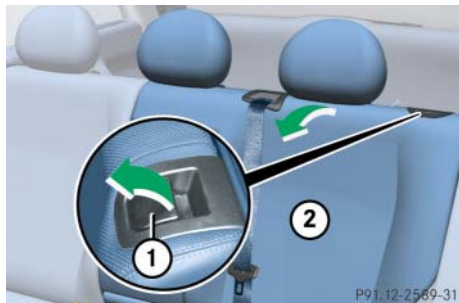

- ① Release catch
- ② Seat backrest



The seat backrests can be placed in an alternative upright position. This creates a larger cargo compartment area or provides for improved seating comfort on the folding bench seat, if required.

- ▶ Pull right seat release catch ① up and fold seat backrest forward.
- ▶ With the seat backrest released, pull release catch ① up again.
- ▶ Pull left seat release catch ① up and fold seat backrest forward.
- ▶ With the seat backrest released, pull release catch ① up again.
- ▶ Fold left seat backrest to the rear until it engages.
- ▶ Fold right seat backrest to the rear until it engages.

The seat backrests are now in the alternative position.

#### Expanding the cargo compartment

Removing the rear seat cushions will provide you with a larger, flat cargo compartment.

- ▶ Fold the seat cushions forward (> page 260).

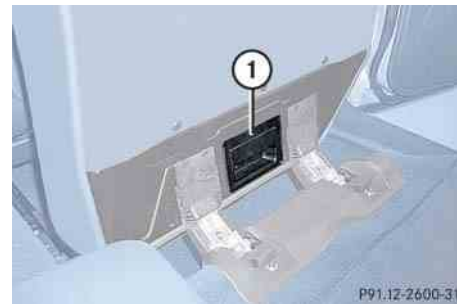

- ① Release lever
- ▶ Pull seat cushion release lever ① and remove the seat cushion by pulling it upward.
- ▶ Remove the head restraints (> page 132).



Leave the seat cushion hinge in this position. The upholstery could be damaged if you fold the hinge back.



- ▶ Fold the seat backrest forward (▷ page 260).

### Loading instructions

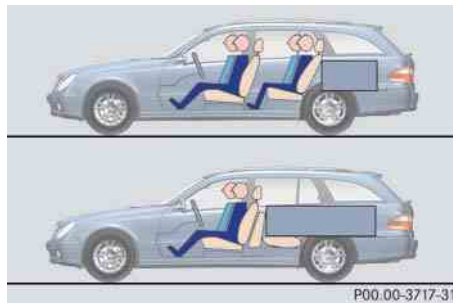

The total load weight including vehicle occupants and luggage/cargo should not exceed the load limit or vehicle capacity weight indicated on the corresponding placard located on the driver's door B-pillar.

The handling characteristics of a fully loaded vehicle depend greatly on the load distribution. It is therefore recommended to load the vehicle according to the illustrations shown, with the heaviest items being placed towards the front of the vehicle.

Always place items being carried against front or rear seat backrests, and fasten them as securely as possible.

The heaviest portion of the cargo should always be kept as low as possible since it influences the handling characteristics of the vehicle.



#### Warning!



Always fasten items being carried as securely as possible.

In an accident, during hard braking or sudden maneuvers, loose items will be thrown around inside the vehicle and can cause injury to vehicle occupants unless the items are securely fastened in the vehicle.

To help avoid personal injury during a collision or sudden maneuver, exercise care when transporting cargo. Put luggage or cargo in the cargo compartment if possible. Do not pile luggage or cargo higher than the seat backs.

Never drive vehicle with tailgate open. Deadly carbon monoxide (CO) gases may enter vehicle interior resulting in unconsciousness and death.

#### Cargo tie-down rings

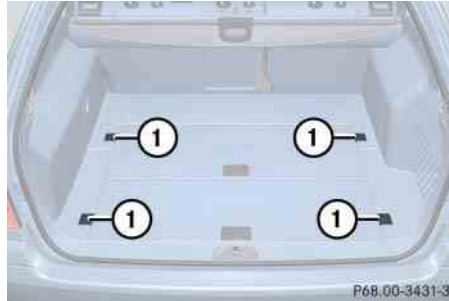

Four rings ① are located in the cargo compartment.

- ▶ Carefully secure cargo by applying even load on all rings with rope of sufficient strength to hold down the cargo.

Always follow loading instructions (▷ page 263).

#### Rear seat

There is a cargo tie-down ring located on each side of the footwell under the rear seat.

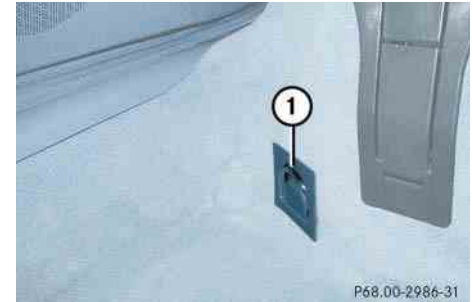

### Cargo management system\* (Canada only)

Your vehicle may be equipped with a cargo management system and accompanying accessories which enable you to utilize your cargo compartment in a variety of ways. You can store the cargo management system in the pouch that comes with the vehicle.



The pouch and telescoping rod can be placed in the storage box in the cargo compartment.

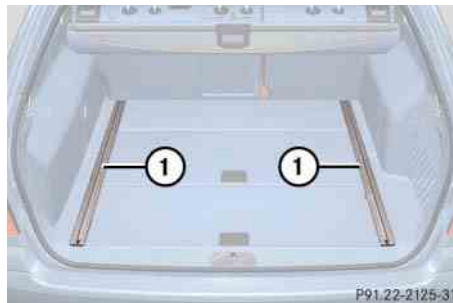

① Cargo rails

### Inserting the mounting elements into the cargo rails

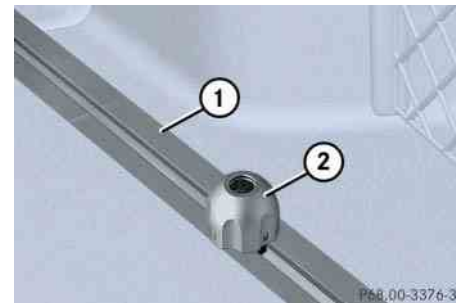

- ① Cargo rail
- ② Mounting element

You can move the mounting element to various engaging points on the cargo rail and fix it in place.

These engaging points are located 2 inches apart from one another on the cargo rail and are indicated by markings. ▷▷

### Loading



You can turn the mounting element in the cargo rail to four positions:



To lock the mounting element.





To insert or remove the cargo tie-down ring, the belt reel or the telescoping rod.



To insert or remove the mounting element.



To move the mounting element to the next engaging point.

- ▶ Turn mounting element ② to .
- ▶ Insert mounting element ② in cargo rail ①.
- ▶ Turn mounting element ② until it engages in the  position.

You should be able to feel the mounting element engage in the cargo rail.

### Inserting the cargo tie-down ring in the mounting element





- ① Cargo tie-down ring
- ② Mounting element

### Warning!



The cargo tie-down rings should be subject to equal loads. Make sure to comply with the information provided in the loading instructions (▷ page 263).

- ▶ Turn mounting element ② in the cargo rail to .
- ▶ Insert cargo tie-down ring ① into mounting element ②.
- ▶ Turn mounting element ② until it engages in the .

You should be able to feel the mounting element engage in the cargo rail.

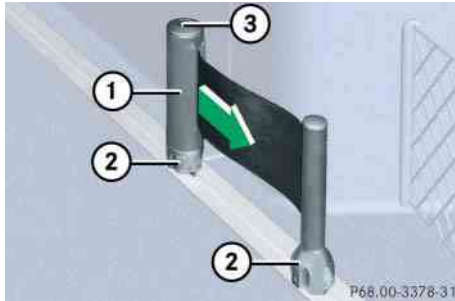

### Belt reel



- ① Belt reel
- ② Mounting element
- ③ Locking button



The belt reel can be used to tighten light-weight loads against the side wall of the cargo compartment, thus securing them from slipping.

- ▶ Insert two mounting elements ② into a cargo rail.
- ▶ Turn mounting element ② in the cargo rail to .
- ▶ Insert belt reel ① into mounting element ②.
- ▶ Turn mounting element ② in the cargo rail until it engages in the  position.

You should be able to feel the mounting element engage in the cargo rail.

- ▶ Press locking button ③ on the belt reel and pull cargo net out in direction of arrow.
- ▶ Place load between the cargo net and the side wall of the cargo compartment.
- ▶ Press locking button ③ on belt reel. With the other hand, slowly pull net over load until it is taut.

### Telescoping rod

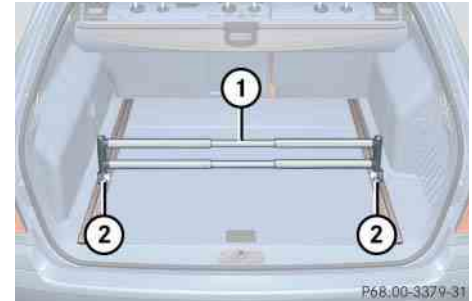



- ① Telescoping rod
- ② Mounting element



The telescoping rod can be used to tighten the load against the rear seats so as to secure it from slipping.

### Loading

- ▶ Insert one mounting element ② into each cargo rail.
- ▶ Turn mounting element ② in cargo rail to .
- ▶ Insert telescoping rod ① into mounting element ②.
- ▶ Turn mounting element ② in cargo rail until it engages in the  position.

You should be able to feel the mounting element engage in the cargo rail.

### Storage box in cargo compartment (Canada only)

#### Warning!



When you are using the storage box in the cargo compartment, the backrests of the seats in front of it must be completely engaged to the rear, and the twin roller blind must be installed.

Do not exceed the storage box's maximum load of 44 lbs (20 kg), as it could otherwise become detached during an accident or sharp braking maneuvers, and could injure you or other passengers.

When leaving the vehicle, always remove the SmartKey or the SmartKey with KEYLESS-GO\* from the starter switch, take it with you, and lock the vehicle. Do not leave children unattended in the vehicle, or with access to an unlocked vehicle. Unsupervised use of vehicle equipment may cause an accident and/or serious personal injury.

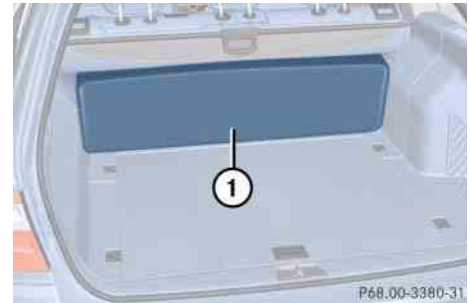

① Storage box

### Installing the storage box

- ▶ Fold rear seat backrests forward (▷ page 260).
- ▶ Insert storage box from behind into cargo compartment with the opening pointing in direction of travel.
- ▶ Press locking hooks of storage box into the space between the rear seat backrest and the cargo compartment.
- ▶ Fold rear seat backrest to the rear (▷ page 261).



The storage box is additionally held in place from above by the twin roller blind.

### Loading the storage box

- ▶ Fold rear seat backrests forward (▷ page 260).
- ▶ Fill storage box with cargo through the opening on the front side.



The storage box in the cargo compartment is covered by the rear bench seat and can hold a maximum of 44 lbs (20 kg) cargo.

- ▶ Fold rear seat backrest to the rear (▷ page 261).

### Removing the storage box

- ▶ Fold rear seat backrests forward (▷ page 260).
- ▶ Slide locking hooks of storage box forward out of the retainers.
- ▶ Pull storage box to the rear and remove it from cargo compartment.
- ▶ Fold rear seat backrest to the rear (▷ page 261).

### Twin roller blind

The twin roller blind contains a cargo net and a cargo compartment cover.

It is located on the seat backrest of the rear bench seat.

### Cargo net

#### Warning!



The cargo net cannot hold back heavy loads. The transported load should therefore always be tied down.

Objects which are insufficiently secured could otherwise injure you if they are thrown around in the event of an accident, during hard braking or steering maneuvers.

### Loading

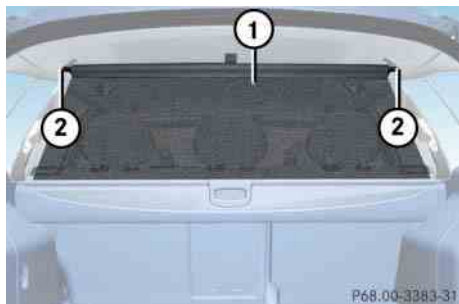

- ① Cargo net
- ② Mountings for cargo net

- ▶ Pull cargo net ① up and hook it onto mountings ②.



You can use the cargo net even when the rear seat backrest is folded forward. The cargo net should then be hooked onto the front mountings.

### Cargo compartment cover

The cargo compartment cover unlocks automatically while the tailgate is opening/closing and is automatically raised/lowered.



When loading the vehicle, make sure not to load the cargo compartment over the lower edge of the side windows.

The twin roller blind could otherwise be damaged when the tailgate is being closed.

It is therefore unnecessary to roll up the cargo compartment cover before loading and unloading.

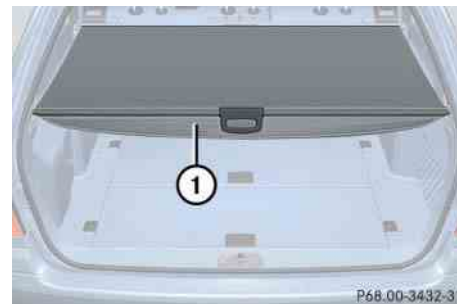

- ① Cargo compartment cover

### *Rolling up the cargo compartment cover*

- ▶ Unhook cargo compartment cover from its anchorages on the left and right sides.
- ▶ Slowly guide cargo compartment cover back until it stops.

### Removing the twin roller blind

- ▶ Roll up cargo net and cargo compartment cover.
- ▶ Fold both rear seat cushions forward (▷ page 260).
- ▶ Push twin roller blind to the left out of its anchorage on the rear seat backrest and remove it.



### Storage compartments

#### Warning!



To help avoid personal injury during a collision or sudden maneuver, exercise care when storing objects in the vehicle. Put luggage or cargo in the cargo compartment if possible. Do not pile luggage or cargo higher than the seat backs.

Luggage nets cannot secure hard or heavy objects.

Keep compartment lids closed. This will help to prevent stored objects from being thrown around and injuring vehicle occupants during an accident.

### Glove box

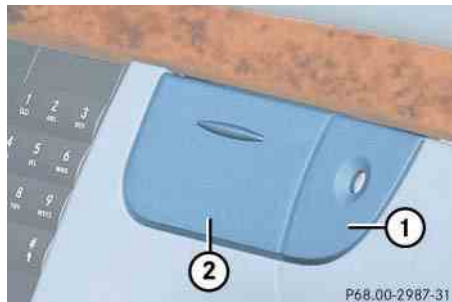

- ① Glove box lid release
- ② Compartment for mobile phone/glasses

#### Opening the glove box

- ▶ Push glove box lid release ①.

The glove box lid opens downward.

#### Closing the glove box

- ▶ Push glove box lid up to close.



Close the compartment for glasses ② first before closing the glove box.

### Storage compartment in the center console (no CD changer\* installed)



- ① Opening/closing button

- ▶ Press button ① to open.

The control panel swings out upward and the storage compartment extends out.



Never place any medications in the storage compartment. If there is a power failure, the storage compartment cannot be opened.

- ▶ Press button ① to close.

### Storage compartment in the rear center console



- Briefly press the top of the compartment.  
It extends automatically.

### Ruffled storage bags



Ruffled storage bags are located on the back of the front seats.

### Warning!



Do not place objects with a combined weight of more than 4.4 lbs (2 kg) into the ruffled storage bag. Otherwise, the Occupant Classification System OCS (> page 81) may not be able to properly approximate the occupant weight category.

The ruffled storage bag is intended for storing light-weight items only.

Heavy objects, objects with sharp edges or fragile objects may not be transported in the ruffled storage bag. In an accident, during hard braking, or sudden maneuvers, they could be thrown around inside the vehicle and cause injury to vehicle occupants.

The ruffled storage bag cannot protect transported goods in the event of an accident.

### Useful features

#### Parcel net in front passenger footwell

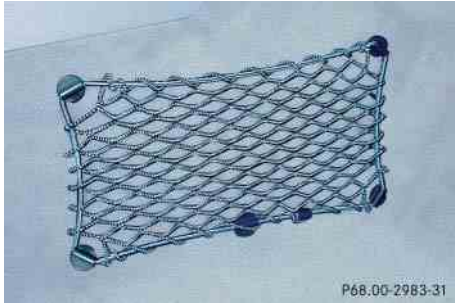

A small convenience parcel net is located in the front passenger footwell. It is for small and light items, such as road maps, mail, etc.

#### Warning!



The parcel net is intended for storing light-weight items only.

Heavy objects, objects with sharp edges or fragile objects may not be transported in the parcel net. In an accident, during hard braking, or sudden maneuvers, they could be thrown around inside the vehicle and cause injury to vehicle occupants.

The parcel net cannot protect transported goods in the event of an accident.

#### Cup holders

#### Warning!



In order to help prevent spilling liquids on vehicle occupants and/or vehicle equipment, only use containers that fit into the cup holder. Use lids on open containers and do not fill containers to a height where the contents, especially hot liquids, could spill during braking, vehicle maneuvers, or in an accident. Liquids spilled on vehicle occupants may cause serious personal injury. Liquids spilled on vehicle equipment may cause damage not covered by the Mercedes-Benz Limited Warranty.

When not in use, keep the cup holder closed. An open cup holder may cause injury to you or others when contacted during braking, vehicle maneuvers, or in an accident.

Keep in mind that objects placed in the cup holder may come loose during braking, vehicle maneuvers, or in an accident and be thrown around in the vehicle interior. Objects thrown around in the vehicle interior may cause an accident and/or serious personal injury.

### Storage compartment with cup holder in the center armrest

The storage compartment in the center armrest contains a removable dual cup holder.

#### Opening storage compartment

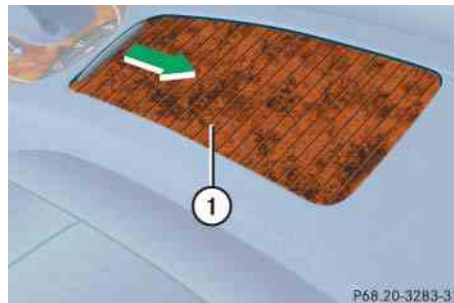

① Cover

► Slide cover ① in direction of arrow.



② Dual cup holder

③ Telephone\* compartment

#### Closing storage compartment

► Slide cover ① back.



The cup holder can be removed to increase storage space and for cleaning. Clean the cup holder only with clear, lukewarm water.

Make sure to insert the cup holder in the guides when reinstalling it (> page 276).

### Useful features

#### Removing cup holder

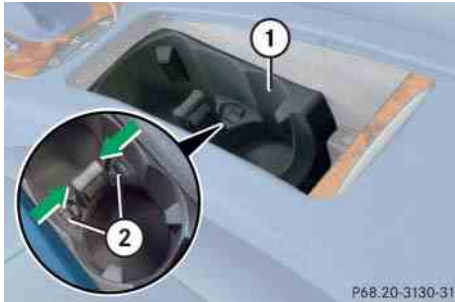

① Dual cup holder

② Locking pins

- ▶ Move both locking pins ② in direction of arrows.
- ▶ Take cup holder ① out upward.

#### Reinstalling cup holder



③ Locking pins

- ▶ Insert cup holder.
- ▶ Move both locking pins ③ in direction of arrows.

#### Rear cup holder

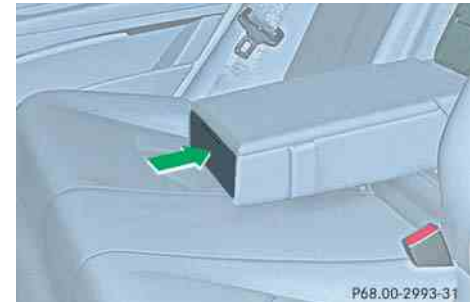

- ▶ Briefly press the front of the rear armrest.

The cup holder extends automatically.

### Cup holder in the folding third row bench seat



- ▶ Briefly press the front of the cup holder.  
The cup holder unlocks.
- ▶ Pull the cup holder until it engages.

### Ashtrays

#### Center console ashtray



#### Opening ashtray

- ▶ Briefly press the marking on the bottom of cover ①.  
The cover opens automatically.

#### Removing ashtray insert

#### Warning!



Remove front ashtray only with vehicle standing still. Set the parking brake to secure vehicle from movement. Move gear selector lever to position **N**. With gear selector lever in position **N**, turn off the engine.

- ▶ Secure vehicle from movement by setting the parking brake. Move the gear selector lever to position **N**.
- Now you have more room to take out the insert.
- ▶ Push sliding button ② to the right and hold.
- ▶ Grip and remove insert from ashtray frame.

### Useful features

#### *Reinstalling ashtray insert*

- ▶ Install insert by pushing it back into frame until it engages again.

#### **Rear seat ashtray**



#### *Opening rear seat ashtray*

- ▶ Briefly press the top of the ashtray.  
The cover opens automatically.

#### **Cigarette lighter**

##### **Warning!**



Never touch the heating element or sides of the lighter; they are extremely hot. Hold the knob only.

When leaving the vehicle, always remove the SmartKey or the SmartKey with KEYLESS-GO\* from the starter switch, take it with you, and lock the vehicle. Do not leave children unattended in the vehicle, or with access to an unlocked vehicle. Unsupervised use of vehicle equipment may cause an accident and/or serious personal injury.

The cigarette lighter is located in the center console compartment in front of the center armrest (▷ page 28).



#### ① Cigarette lighter

- ▶ Switch on the ignition (▷ page 36).
- ▶ Push in cigarette lighter ①.

The lighter will pop out automatically when hot.



The lighter socket can be used to accommodate 12V DC electrical accessories (up to a maximum of 85 W) designed for use with the standard “cigarette lighter” plug type. Keep in mind, however, that connecting accessories to the lighter socket (for example extensive connecting and disconnecting, or using plugs that do not fit properly) can damage the lighter socket. With the socket damaged, the lighter may no longer be able to be placed in the heating (pushed-in) position, or the lighter may pop out too early with the lighter not hot enough.

To help avoid damaging the cigarette lighter socket, we recommend connecting 12V DC electrical accessories designed for use with a standard “cigarette lighter” plug type to the 12V power outlets in your vehicle whenever possible.

### Power outlet

The power outlet is located in the rear passenger compartment.



- ▶ Switch on the ignition (▷ page 36).
- ▶ Flip up cover and insert electrical plug (cigarette lighter type).



The power outlet can be used to accommodate 12V DC electrical accessories (e.g. air pump, auxiliary lamps) up to a maximum of 180 W.

An additional power outlet is located on the left side in the cargo compartment.

### Heated steering wheel\*

The steering wheel heating warms up the leather area of the steering wheel.

The stalk is on the lower left-hand side of the steering wheel.

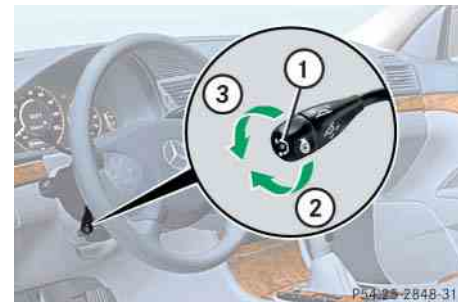

- ① Indicator lamp
- ② Switching off
- ③ Switching on



### Useful features

#### Switching on

- ▶ Switch on the ignition (▷ page 36).
- ▶ Turn switch at the tip of stalk in direction of arrow ③.

The steering wheel is heated. Indicator lamp ① comes on.



The steering wheel heating is temporarily suspended while indicator lamp ① remains on when

- the temperature of the vehicle interior is above 86°F (30°C)
- the temperature of the steering wheel is above 95°F (35°C)

When these conditions do not apply anymore, steering wheel heating continues.

#### Switching off

- ▶ Turn switch at the tip of stalk in direction of arrow ②.

The heated steering wheel is switched off. Indicator lamp ① goes out.



Indicator lamp ① flashes or goes out

- in case of power surge or undervoltage
- in case of a steering wheel heating malfunction



The steering wheel heating switches off automatically when you remove the SmartKey from the starter switch or, on vehicles with KEYLESS-GO\*, when you switch off the ignition (▷ page 61) and open the driver's door.

For information on steering wheel, see “Multifunction steering wheel” (▷ page 156).

#### Floor mats

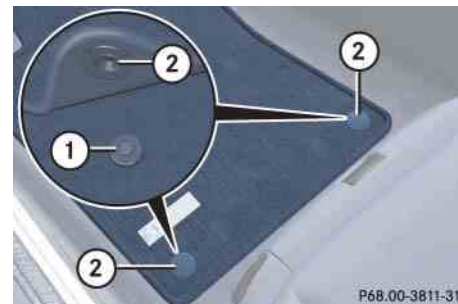

- ① Retainer pin
- ② Eyelet



To install or remove the floor mat more easily, move the driver's seat or front passenger seat as far to the rear as possible (▷ page 41).

**Warning!**

Whenever you are using floormats, make sure there is enough clearance and that the floormats are securely fastened.

Floormats should always be securely fastened using eyelets ② and retainer pins ①.

Before driving off, check that the floormats are securely in place and adjust them if necessary. A loose floormat could slip and hinder proper functioning of the pedals.

**Removing**

- ▶ Pull floormat off of retainer pins ①.
- ▶ Remove the floormat.

**Installing**

- ▶ Lay down the floormat.
- ▶ Press the floormat eyelets ② onto retainer pins ①.

**Telephone\*****Warning!**

Never operate radio transmitters equipped with a built-in or attached antenna (i.e. without being connected to an external antenna) from inside the vehicle while the engine is running. Doing so could lead to a malfunction of the vehicle's electronic system, possibly resulting in an accident and/or serious personal injury.

Radio transmitters, such as a portable telephone or a citizens band unit, should only be used inside the vehicle if they are connected to an antenna that is installed on the outside of the vehicle.

The external antenna must be approved by Mercedes-Benz. Please contact an authorized Mercedes-Benz Center for information on the installation of an approved external antenna. Refer to the radio transmitter operation instructions regarding use of an external antenna.

**Warning!**

Please do not forget that your primary responsibility is to drive the vehicle. A driver's attention to the road must always be his/her primary focus when driving. For your safety and the safety of others, we recommend that you pull over to a safe location and stop before placing or taking a telephone call.

If you choose to use the telephone<sup>1</sup> while driving, please use the hands-free device and only use the telephone when road, weather and traffic conditions permit. Some jurisdictions prohibit the driver from using a cellular telephone while driving a vehicle.



Only operate the COMAND (Cockpit Management and Data System) if road, weather and traffic conditions permit.



<sup>1</sup> Observe all legal requirements.

### Useful features

▷▷ Bear in mind that at a speed of just 30 mph (approximately 50 km/h), your vehicle is covering a distance of 44 feet (approximately 14 m) every second.

You can take and place telephone calls using buttons  and  on the steering wheel. To carry out other telephone functions, use the control system (▷ page 181).

See separate operating manual for instructions on how to use the telephone.

### Tele Aid



The initial activation of the Tele Aid system may only be performed by completing the subscriber agreement and placing an acquaintance call using button . Failure to complete either of these steps will result in a system that is not activated.

If you have any questions regarding activation, please call the Response Center at 1-800-756-9018 (in the USA) or 1-888-923-8367 (in Canada).

Shortly after the completion of your acquaintance call, you will receive a user ID and password. By visiting [www.mbusa.com](http://www.mbusa.com) and selecting “Tele Aid” (USA only), you will have access to account information, remote door unlock and more.



### The Tele Aid system



(Telematic Alarm Identification on Demand)

The Tele Aid system consists of three types of response:

- automatic and manual emergency
- Roadside Assistance and
- information



The Tele Aid system is operational providing that the vehicle’s battery is charged, properly connected, not damaged and cellular and GPS coverage is available.

The speaker volume of a Tele Aid call can be adjusted when using the volume control on the multifunction steering wheel. To raise, press button  and to lower, press button  or use the volume knob on your COMAND headunit.

- ▶ To activate, press the SOS button, the Roadside Assistance button  or the Information button , depending on the type of response required.





The SOS button is located above the interior rear view mirror.

The Roadside Assistance button  and the Information button  are located below the center armrest cover.



The Tele Aid system utilizes the cellular network for communication and the GPS (Global Positioning System) satellites for vehicle location. If either of these signals are unavailable, the Tele Aid system may not function and if this occurs, assistance must be summoned by other means.

### System self-check

Initially, after switching on the ignition, malfunctions are detected and indicated (the indicator lamps in the SOS button, the Roadside Assistance button  and the Information button  stay on longer than 10 seconds or do not come on). The message *Tele Aid malfunction Drive to workshop* appears in the multifunction display.

### Warning!



If the indicator lamps in the SOS button, in the Roadside Assistance button and/or in the Information button remain illuminated constantly in red and/or the message *Tele Aid malfunction Drive to workshop* is displayed in the multifunction display after the system self-check, a malfunction in the system has been detected.

If a malfunction is indicated as outlined above, the system may not operate as expected. Have the system checked at the nearest Mercedes-Benz Center as soon as possible.

### Useful features

#### Emergency calls

An emergency call is initiated automatically following an accident in which the emergency tensioning devices (ETDs) or air bags deploy.

An emergency call can also be initiated manually by opening the cover next to the interior rear view mirror labeled SOS, then briefly pressing the button located under the cover. See (> page 285) for instructions on initiating an emergency call manually.

Once the emergency call is in progress, the indicator lamp in the SOS button will begin to flash. The message *Connecting call* appears in the multifunction display and the audio system is muted. When the connection is established, the message *Call connected* appears in the multifunction display. All information relevant to the emergency, such as the location of the vehicle (determined by the GPS satellite location system), vehicle model, identification number and color are generated.

A voice connection between the Response Center and the occupants of the vehicle will be established automatically soon after the emergency call has been initiated. The Response Center will attempt to determine more precisely the nature of the emergency provided they can speak to an occupant of the vehicle.

The Tele Aid system is available if:

- it has been activated and is operational. Activation requires a subscription for monitoring services, connection and cellular air time
- the relevant cellular phone network and GPS signals are available and pass the information on to the Response Center



Location of the vehicle on a map is only possible if the vehicle is able to receive signals from the GPS satellite network and pass the information on to the Response Center.

**Warning!**

If the indicator lamp in the SOS button is flashing continuously and there was no voice connection to the Response Center established, then the Tele Aid system could not initiate an emergency call (e.g. the relevant cellular phone network is not available). The message *Call failed* appears in the multifunction display for approximately 10 seconds.

Should this occur, assistance must be summoned by other means.

**Initiating an emergency call manually**

- ① Cover
- ② SOS button

- ▶ Briefly press on cover ①.  
The cover will open.
- ▶ Press SOS button ② briefly.  
The indicator lamp in SOS button ② will flash until the emergency call is concluded.
- ▶ Wait for a voice connection to the Response Center.
- ▶ Close cover after the emergency call is concluded.

**Warning!**

If you feel at any way in jeopardy when in the vehicle (e.g. smoke or fire in the vehicle, vehicle in a dangerous road location), please do not wait for voice contact after you have pressed the emergency button. Carefully leave the vehicle and move to a safe location. The Response Center will automatically contact local emergency officials with the vehicle's approximate location if they receive an automatic SOS signal and cannot make voice contact with the vehicle occupants.

### Useful features

#### Roadside Assistance button

Located below the center armrest cover is the Roadside Assistance button .

- ▶ Press and hold the button (for longer than 2 seconds).

A call to a Mercedes-Benz Roadside Assistance dispatcher will be initiated. The button will flash while the call is in progress. The message `Connecting call` will appear in the multifunction display and the audio system is muted.

When the connection is established, the message `Call connected` appears in the multifunction display. The Tele Aid system will transmit data generating the vehicle identification number, model, color and location (subject to availability of cellular and GPS signals).

A voice connection between the Roadside Assistance dispatcher and the occupants of the vehicle will be established.



- ▶ Describe the nature of the need for assistance.

The Mercedes-Benz Roadside Assistance dispatcher will either dispatch a qualified Mercedes-Benz technician or arrange to tow your vehicle to the nearest authorized Mercedes-Benz Center. For services such as labor and/or towing, charges may apply. Refer to the Roadside Assistance manual for more information.

The following is only available in the USA:

- Sign and Drive services: Services such as a jump start, a few gallons of fuel or the replacement of a flat tire with the vehicle spare tire are obtainable.



The indicator lamp on the Roadside Assistance button  remains illuminated in red for approximately 10 seconds during the system self-check after switching on the ignition (together with the SOS button and the Information button .

See system self-check (▷ page 283) when the indicator lamp does not come on in red or stays on longer than approximately 10 seconds.

If the indicator lamp on the Roadside Assistance button  is flashing continuously and there was no voice connection to the Response Center established, then the Tele Aid system could not initiate a Roadside Assistance call (e.g. the relevant cellular phone network is not available). The message `Call failed` appears in the multifunction display.

Roadside Assistance calls can be terminated using button  on the multifunction steering wheel or the respective button for ending a telephone call on the COMAND headunit.

### Information button

The Information button  is located below the center armrest cover.

- ▶ Press and hold button (for longer than 2 seconds).



A call to the Customer Assistance Center will be initiated. The button will flash while the call is in progress. The message *Connecting call* will appear in the multifunction display and the audio system is muted.

When the connection is established, the message *Call connected* appears in the multifunction display. The Tele Aid system will transmit data generating the vehicle identification number, model, color and location (subject to availability of cellular and GPS signals).

A voice connection between the Customer Assistance Center representative and the occupants of the vehicle will be established. Information regarding the operation of your vehicle, the nearest authorized Mercedes-Benz Center or Mercedes-Benz USA products and services is available to you.

For more details concerning the Tele Aid system, please visit [www.mbusa.com](http://www.mbusa.com) and use your ID and password (sent to you separately) to learn more (USA only).



The indicator lamp on the Information button  remains illuminated in red for approximately 10 seconds during the system self-check after switching on the ignition (together with the SOS button and the Roadside Assistance button ).

See system self-check (▷ page 283) when the indicator lamp does not come on in red or stays on longer than approximately 10 seconds.

If the indicator lamp on the Information button  is flashing continuously and there was no voice connection to the Response Center established, then the Tele Aid system could not initiate an Information call (e.g. the relevant cellular phone network is not available). The message *Call failed* appears in the multifunction display.

Information calls can be terminated using button  on the multifunction steering wheel or the respective button for ending a telephone call on the COMAND headunit.



### Useful features



If the indicator lamps do not start flashing after pressing one of the buttons or remain illuminated (in red) at any time, the Tele Aid system has detected a malfunction or the service is not currently active, and may not initiate a call. Visit an authorized Mercedes-Benz Center and have the system checked or contact the Response Center at 1-800-756-9018 (in the USA) or 1-888-923-8367 (in Canada) as soon as possible.

### Call priority

If other service calls such as a Roadside Assistance call or Information call are active, an Emergency call is still possible. In this case, the Emergency call will take priority and override all other active calls.



The indicator lamp in the respective button flashes until the call is concluded. Calls can only be terminated by a Response Center or Customer Assistance Center representative except Roadside Assistance and Information calls, which can also be terminated by pressing button  on the multifunction steering wheel or the respective button for ending a telephone call on the COMAND headunit.



If the indicator lamp continues to flash or the system does not reset, contact the Response Center at 1-800-756-9018 (in the USA) or 1-888-923-8367 (in Canada), or Mercedes-Benz Customer Assistance at 1-800-FOR-MERCEdes (1-800-367-6372) in the USA or Customer Service at 1-800-387-0100 in Canada.



When a Tele Aid call has been initiated, the COMAND system audio is muted and the selected mode (radio or CD) pauses. The optional cellular phone (if installed) switches off. If you must use this phone, the vehicle must be parked. Disconnect the coiled cord and place the call. The COMAND navigation\* system (if engaged) will continue to run. The multifunction display in the instrument cluster is available for use, and spoken commands are only available by pressing the RPT button on the COMAND unit. A pop-up window will appear in the COMAND display to indicate that a Tele Aid call is in progress.

### Remote door unlock

In case you have locked your vehicle unintentionally (e.g. SmartKey inside vehicle), and the reserve SmartKey is not handy:

- ▶ Contact the Mercedes-Benz Response Center at 1-800-756-9018 (in the USA) or 1-888-923-8367 (in Canada).

You will be asked to provide your password which you provided when you completed the subscriber agreement.

- ▶ Then return to your vehicle and pull the tailgate recessed handle for a minimum of 20 seconds until the SOS button is flashing.

The message **Call connected** appears in the multifunction display.

As an alternative, you may unlock the vehicle via Internet using the ID and password sent to you shortly after the completion of your acquaintance call.

The Response Center will then unlock your vehicle with the remote door unlocking feature.



The remote door unlock feature is available if the relevant cellular phone network is available.

The SOS button will flash and the message **Call connected** will appear in the multifunction display to indicate receipt of the door unlock command.

Once the vehicle is unlocked, a Response Center specialist will attempt to establish voice contact with the vehicle occupants.

If the tailgate recessed handle was pulled for more than 20 seconds before door unlock authorization was received by the Response Center, you must wait 15 minutes before pulling the tailgate recessed handle again.

### Useful features

#### Stolen Vehicle Recovery services

In the event your vehicle was stolen:

- ▶ Report the incident to the police.  
The police will issue a numbered incident report.
- ▶ Pass this number on to the Mercedes-Benz Response Center along with your password issued to you when you subscribed to the service.

The Response Center will then attempt to covertly contact the vehicle's Tele Aid system. Once the vehicle is located, the Response Center will contact the local law enforcement and you. The vehicle's location will only be provided to law enforcement.



When the anti-theft alarm or the tow-away alarm stays on for more than 30 seconds, a call is initiated automatically to the Response Center. See anti-theft alarm system (▷ page 101) and tow-away alarm (▷ page 103).

#### Garage door opener

The integrated remote control is capable of operating up to three separately controlled devices. It provides a convenient way to replace up to three hand-held remote controls used to operate devices such as garage door openers, gate openers, or other devices compatible with HomeLink® or some other systems.

Before the integrated remote control can be used, it must be programmed to the garage door opener, gate operator or other device you wish to operate. See the following instructions for programming information.



#### Interior rear view mirror with integrated remote control

- ① Indicator lamp
- ② ③ ④ Signal transmitter button

Needed for programming (not part of vehicle equipment):

- ⑤ Hand-held remote control of garage door opener, gate operator or other device
- ⑥ Hand-held remote control button

**Warning!**

Before programming the integrated remote control to a garage door opener or gate operator, make sure people and objects are out of the way of the device to prevent potential harm or damage. When programming a garage door opener, the door moves up or down. When programming a gate operator, the gate opens or closes.

Do not use the integrated remote control with any garage door opener that lacks safety stop and reverse features as required by U.S. federal safety standards (this includes any garage door opener model manufactured before April 1, 1982).

A garage door that cannot detect an object - signaling the door to stop and reverse - does not meet current U.S. federal safety standards.

When programming a garage door opener, park vehicle outside the garage.

Do not run the engine while programming the integrated remote control. Inhalation of exhaust gas is hazardous to your health. All exhaust gas contains carbon monoxide, and inhaling it can cause unconsciousness and possible death.

**Programming the integrated remote control**

Step 1:

- ▶ Switch on the ignition (▷ page 36).

Step 2:

- ▶ If you have previously programmed an signal transmitter button and wish to retain its programming, proceed to step 3.

If you are programming the integrated remote control for the first time, press and hold the two outer signal transmitter buttons ② and ④ and release them only when the indicator lamp ① begins to flash after approximately 20 seconds (do not hold the button for longer than 30 seconds). This procedure erases any previous settings for all three channels and initializes the memory.

If you later wish to program a second and/or third hand-held transmitter to the remaining two signal transmitter buttons, do not repeat this step and begin directly with step 3. ▷▷

### Useful features

#### ▷▷ Step 3:

- ▶ Hold the end of the hand-held remote control ⑤ of the device you wish to train approximately 2 to 5 in (5 to 12 cm) away from the signal transmitter button (②, ③ or ④) to be programmed, while keeping the indicator lamp ① in view.

#### Step 4:

- ▶ Using both hands, simultaneously press the hand-held remote control button ⑥ and the desired signal transmitter button (②, ③ or ④). Do not release the buttons until step 5 is completed.

The indicator lamp ① will flash, first slowly and then rapidly.



The indicator lamp ① flashes immediately the first time the signal transmitter button is programmed. If this button has already been programmed, the indicator lamp will only start flashing after 20 seconds.

#### Step 5:

- ▶ After the indicator lamp ① changes from a slow to a rapidly flashing light, release the hand-held remote control button and the signal transmitter button.

#### Step 6:

- ▶ Press and hold the just-trained signal transmitter button (②, ③ or ④) and observe the indicator lamp ①.

If the indicator lamp ① stays on constantly, programming is complete and your device should activate when the respective signal transmitter button (②, ③ or ④) is pressed and released.



If the indicator lamp ① flashes rapidly for about 2 seconds and then turns to a constant light, continue with programming steps 8 through 12 as your garage door opener may be equipped with the “rolling code” feature.

#### Step 7:

- ▶ To program the remaining two signal transmitter buttons, repeat the steps above starting with step 3.

### ***Rolling code programming***

To train a garage door opener (or other rolling code devices) with the rolling code feature, follow these instructions after completing the “Programming” portion (steps 1 through 6) of this text. (A second person may make the following training procedures quicker and easier.)

Step 8:

- ▶ Locate “training” button on the garage door opener motor head unit.

Exact location and color of the button may vary by garage door opener brand. Depending on manufacturer, the “training” button may also be referred to as “learn” or “smart” button. If there is difficulty locating the transmitting button, refer to the garage door opener operator’s manual.

Step 9:

- ▶ Press the “training” button on the garage door opener motor head unit.

The “training light” is activated.

You have 30 seconds to initiate the following two steps.

Step 10:

- ▶ Return to the vehicle and firmly press, hold for 2 seconds and release the programmed signal transmitter button (②, ③ or ④).

Step 11:

- ▶ Press, hold for 2 seconds and release same signal transmitter button a second time to complete the training process.



Some garage door openers (or other rolling code equipped devices) may require you to press, hold for 2 seconds and release the same signal transmitter button a third time to complete the training process.

Step 12:

- ▶ Confirm the garage door operation by pressing the programmed signal transmitter button (②, ③ or ④).

Step 13:

- ▶ To program the remaining two signal transmitter buttons, repeat the steps above starting with step 3.

### Useful features

#### ***Gate operator/Canadian programming***

Canadian radio-frequency laws require transmitter signals to “time-out” (or quit) after several seconds of transmission which may not be long enough for the integrated signal transmitter to pick up the signal during programming. Similar to this Canadian law, some U.S. gate operators are designed to “time-out” in the same manner.

If you live in Canada or if you are having difficulties programming a gate operator (regardless of where you live) by using the programming procedures, replace step 4 with the following:

Step 4:

- ▶ Press and hold the signal transmitter button (②, ③ or ④). Do not release this button until it has been successfully trained.
- ▶ While still holding down the signal transmitter button (②, ③ or ④), “cycle” your hand-held remote control button ⑥ as follows: Press and hold button ⑥ for 2 seconds, then release it for 2 seconds, and again press and hold it for 2 seconds. Repeat this sequence on the hand-held remote control until the frequency signal has been learned. Upon successful training, the indicator lamp ① will flash slowly and then rapidly after several seconds.
- ▶ Proceed with programming step 5 and step 6 to complete.



Upon completion of programming the integrated remote control, make sure you retain the hand-held remote control that came with the garage door opener, gate operator or other device. You may need it for use in other vehicles, for future programming of an integrated remote control, or simply for continued use as a hand-held remote control to operate the respective device in other situations.

### Reprogramming a single signal transmitter button

To program a device using a signal transmitter button previously trained, follow these steps:

- ▶ Switch on the ignition (▷ page 36).
- ▶ Press and hold the desired signal transmitter button (②, ③ or ④). Do not release the button.
- ▶ The indicator lamp ① will begin to flash after 20 seconds. Without releasing the signal transmitter button, proceed with programming starting with step 3.

### Operation of integrated remote control

- ▶ Switch on the ignition (▷ page 36).
- ▶ Select and press the appropriate integrated signal transmitter button (②, ③ or ④) to activate the remote controlled device.

The integrated remote control transmitter continues to send the signal as long as the button is pressed – up to 20 seconds.

### Erasing the integrated remote control memory

- ▶ Switch on the ignition (▷ page 36).
- ▶ Simultaneously press and hold down the outer signal transmitter buttons ② and ④, for approximately 20 seconds, until the indicator lamp ① flashes rapidly. Do not hold for longer than 30 seconds.

The codes of all three channels are erased.



If you sell your vehicle, erase the codes of all three channels.



### Useful features

#### Programming tips

If you are having difficulty programming the integrated remote control, here are some helpful tips:

- Check the frequency of the hand-held remote control ⑤ (typically located on the reverse side of the remote). The integrated remote control is compatible with radio-frequency devices operating between 288-399 MHz.
- Put a new battery in the hand-held remote control ⑤. This will increase the likelihood of the hand-held remote control sending a faster and more accurate signal to the integrated remote control.
- While performing step 3, hold the hand-held remote control ⑥ at different lengths and angles from the signal transmitter button (②, ③ or ④) you are programming. Attempt varying angles at the distance of 2 to 5 inches (5 to 12 cm) away or the same angle at varying distances.

- If another hand-held remote control is available for the same device, try the programming steps again using that other hand-held remote control. Make sure new batteries are in the hand-held remote control before beginning the procedure.
- Straighten the antenna wire from the garage door opener assembly. This may help improve transmitting and/or receiving signals.



Certain types of garage door openers are incompatible with the integrated remote control. If you should experience further difficulties with programming the integrated remote control, contact an authorized Mercedes-Benz Center, or call Mercedes-Benz Customer Assistance Center (in the USA only) at 1-800-FOR-MERCEdes, or Customer Service (in Canada) at 1-800-387-0100.



USA only:

This device complies with Part 15 of the FCC Rules. Operation is subject to the following two conditions:

- (1) This device may not cause harmful interference, and
- (2) this device must accept any interference received, including interference that may cause undesired operation.

Any unauthorized modification to this device could void the user's authority to operate the equipment.



Canada only:

This device complies with RSS-210 of Industry Canada. Operation is subject to the following two conditions:

- (1) This device may not cause interference, and
- (2) this device must accept any interference received, including interference that may cause undesired operation of the device.

Any unauthorized modification to this device could void the user's authority to operate the equipment.



**The first 1000 miles (1500 km)**

**Driving instructions**

**At the gas station**

**Engine compartment**

**Tires and wheels**

**Winter driving**

**Maintenance**

**Vehicle care**



### The first 1 000 miles (1 500 km)

In the “Operation” section you will find detailed information on operating, maintaining and caring for your vehicle.

The more cautiously you treat your vehicle during the break-in period, the more satisfied you will be with its performance later on.

- Drive your vehicle during the first 1 000 miles (1 500 km) at varying but moderate vehicle and engine speeds.
- During this period, avoid heavy loads (full throttle driving) and excessive engine speeds (no more than  $\frac{2}{3}$  of maximum rpm in each gear).
- Avoid accelerating by kick-down.
- Do not attempt to slow the vehicle down by shifting to a lower gear using the selector lever.
- Select positions **3**, **2** or **1** only when driving at moderate speeds (for hill driving).
- Select **C** as the preferred shift program (▷ page 189) for the first 1 000 miles (1 500 km).

After 1 000 miles (1 500 km) you may gradually increase vehicle and engine speeds to the permissible maximum.



Additional instructions for AMG vehicles:

- During the first 1 000 miles (1 500 km), do not exceed a speed of 85 mph (140 km/h).
- During this period, avoid engine speeds above 4500 rpm in each gear.

All of the above, as may apply to your vehicle type, also apply when driving the first 1 000 miles (1 500 km) after the engine or the rear differential has been replaced.



Always obey applicable speed limits.

## ▼ Driving instructions

### Drive sensibly – save fuel

---

Fuel consumption, to a great extent, depends on driving habits and operating conditions.

To save fuel you should:

- Keep tires at the recommended inflation pressures.
- Remove unnecessary loads.
- Remove roof rack when not in use.
- Allow engine to warm up under low load use.
- Avoid frequent acceleration and deceleration.
- Have all maintenance work performed at the intervals specified in the Maintenance Booklet and as required by the Maintenance System. Contact an authorized Mercedes-Benz Center.

Fuel consumption is also increased by driving in cold weather, in stop-and-go traffic, on short trips and in hilly area.

### Drinking and driving

---

#### Warning!



Drinking and driving and/or taking drugs and driving are very dangerous combinations. Even a small amount of alcohol or drugs can affect your reflexes, perceptions and judgment.

The possibility of a serious or even fatal accident are greatly increased when you drink or take drugs and drive.

Do not drink or take drugs and drive or allow anyone to drive who has been drinking or taking drugs.

### Pedals

---

#### Warning!



Keep driver's foot area clear at all times. Objects stored in this area may impair pedal movement.

### Driving instructions

#### Power assistance

##### Warning!



The brake system requires electrical energy for operation.

A malfunction in the vehicle's power supply or electrical system may impair brake system operation and switch it into its emergency operation mode. In such a case, the red brake warning lamp (▷ page 374) and warning messages in the instrument cluster (▷ page 383) come on while driving. To brake, the driver must then apply significantly greater brake pedal pressure and depress the pedal much further to obtain the expected braking effect. If necessary, apply full pressure to the brake pedal. Brakes may only be applied to the front wheels. Stopping distance is increased!

If there is a malfunction in the electrohydraulic brake system, we recommend that the vehicle be transported with all wheels off the ground using flatbed or appropriate wheel lift/dolly equipment. A tow bar must be used if circumstances do not permit the use of the recommended towing methods and the vehicle requires towing with all four wheels on the ground. Towing the vehicle with all four wheels on the ground is only permissible for distances up to 30 miles (50 km) and at a speed not to exceed 30 mph (50 km/h). For more information, refer to "Towing the vehicle" (▷ page 458). For more information, see "Electrohydraulic brake system" (▷ page 96).

With the engine not running, there is no power assistance for the brake and steering systems. In this case, it is important to keep in mind that a considerably higher degree of effort is necessary to brake and steer the vehicle.

#### Brakes

##### Warning!



After driving in heavy rain for some time without applying the brakes or through water deep enough to wet brake components, the first braking action may be somewhat reduced and increased pedal pressure may be necessary to obtain expected braking effect. Maintain a safe distance from vehicles in front.

Resting your foot on the brake pedal will cause excessive and premature wear of the brake pads.

It can also result in the brakes overheating, thereby significantly reducing their effectiveness. It may not be possible to stop the vehicle in sufficient time to avoid an accident.

To help prevent brake disk corrosion after driving on wet road surfaces (particularly salted roads), it is advisable to brake the vehicle with considerable force prior to parking. The heat generated serves to dry the brakes.

If your brake system is normally only subjected to moderate loads, you should occasionally test the effectiveness of the brakes by applying above-normal braking pressure at higher speeds. This will also enhance the grip of the brake pads.

**Warning!**

Make sure not to endanger any other road users when carrying out these braking maneuvers.

Refer to the description of the Brake Assist System (BAS) (▷ page 93).

If the parking brake is released and the brake warning lamp in the instrument cluster stays on, there is a malfunction in the electrohydraulic brake system (▷ page 96) or the brake fluid level in the reservoir is too low.

Brake pad wear or a leak in the system may be the reason for low brake fluid in the reservoir.

Have the brake system inspected by qualified technicians immediately. Contact an authorized Mercedes-Benz Center.

All checks and service work on the brake system should be carried out by qualified technicians only. Contact an authorized Mercedes-Benz Center.

Only install brake pads and brake fluid recommended by Mercedes-Benz.

**Warning!**

If other than recommended brake pads are installed, or other than recommended brake fluid is used, the braking properties of the vehicle can be degraded to an extent that safe braking is substantially impaired. This could result in an accident.

Be certain to read and observe the warning notices on brake pad replacement (▷ page 397).



When driving down long and steep grades, relieve the load on the brakes by shifting into a lower gear to use the engine's braking power. This helps prevent overheating of the brakes and reduces brake pad wear.

After hard braking, it is advisable to drive on for some time, rather than immediately park, so that the air stream will cool down the brakes faster.



### Driving instructions

#### Driving off

Apply the brakes to test them briefly after driving off. Perform this procedure only when the road is clear of other traffic.

Warm up the engine smoothly. Do not place full load on the engine until the operating temperature has been reached.

When starting off on a slippery surface, do not allow a drive wheel to spin for an extended period with the ESP<sup>®</sup> switched off. Doing so may cause serious damage to the drivetrain which is not covered by the Mercedes-Benz Limited Warranty.



Simultaneously depressing the accelerator pedal and applying the brake reduces engine performance and causes premature brake and drivetrain wear.

#### Parking



Set the parking brake whenever parking or leaving the vehicle. In addition, move gear selector lever to position **P**. When parking on hills, always set the parking brake and turn front wheel against road curb.

#### Warning!



Do not park this vehicle in areas where combustible materials such as grass, hay or leaves can come into contact with the hot exhaust system, as these materials could be ignited and cause a vehicle fire.

To reduce the risk of personal injury as a result of vehicle movement, before turning off the engine and leaving the vehicle always:

- Keep right foot on brake pedal.
- Firmly depress parking brake pedal.

- Move the gear selector lever to position **P**.
- Slowly release brake pedal.
- When parked on an incline, turn front wheel towards the road curb.
- Turn the SmartKey in the starter switch to position **0** and remove the SmartKey from the starter switch, or press KEYLESS-GO\* start/stop button (vehicles with KEYLESS-GO\*).
- Take the SmartKey or the SmartKey with KEYLESS-GO\* with you and lock vehicle when leaving.

## Tires

### Warning!



If you feel a sudden significant vibration or ride disturbance, or you suspect that possible damage to your vehicle has occurred, you should turn on the hazard warning flashers, carefully slow down, and drive with caution to an area which is a safe distance from the road.

Inspect the tires and the vehicle underbody for possible damage. If the vehicle or tires appear unsafe, have the vehicle towed to the nearest Mercedes-Benz Center or tire dealer for repairs.

Treadwear indicators (TWI) are required by law. These indicators are located in six places on the tread circumference and become visible at a tread depth of approximately  $\frac{1}{16}$  in (1.6 mm), at which point the tire is considered worn and should be replaced.

The treadwear indicator appears as a solid band across the tread.

### Warning!



Although the applicable federal motor vehicle safety laws consider a tire to be worn when the treadwear indicators (TWI) become visible at approximately  $\frac{1}{16}$  in (1.6 mm), we recommend that you do not allow your tires to wear down to that level. As tread depth approaches  $\frac{1}{8}$  in (3 mm), the adhesion properties on a wet road are sharply reduced.

Depending upon the weather and/or road surface (conditions), the tire traction varies widely.

Specified tire inflation pressures must be maintained. This applies particularly if the tires are subjected to high loads (e.g. high speeds, heavy loads, high ambient temperatures).

### Warning!



Do not drive with a flat tire. A flat tire affects the ability to steer or brake the vehicle. You may lose control of the vehicle. Continued driving with a flat tire or driving at high speed with a flat tire will cause excessive heat build-up and possibly a fire.

## Hydroplaning

Depending on the depth of the water layer on the road, hydroplaning may occur, even at low speeds and with new tires. Reduce vehicle speed, avoid track grooves in the road and apply brakes cautiously in the rain.

### Driving instructions

#### Tire traction

The safe speed on a wet, snow covered or icy road is always lower than on a dry road.

You should pay particular attention to the condition of the road whenever the outside temperatures are close to the freezing point.

#### Warning!



If ice has formed on the road, tire traction will be substantially reduced. Under such weather conditions, drive, steer and brake with extreme caution.

Mercedes-Benz recommends winter tires (▷ page 355) with a minimum tread depth of approximately  $\frac{1}{6}$  in (4 mm) on all four wheels for the winter season to make sure normal balanced handling characteristics. On packed snow, they can reduce your stopping distance compared to summer tires. Stopping distance, however, is still considerably greater than when the road is not covered with snow or ice. Exercise appropriate caution.



Avoid spinning of a drive wheel. This may cause serious damage to the drivetrain which is not covered by the Mercedes-Benz Limited Warranty.

#### Tire speed rating

Regardless of the tire speed rating, local speed limits should be obeyed. Use prudent driving speeds appropriate to prevailing conditions.

#### Warning!



Even when permitted by law, never operate a vehicle at speeds greater than the maximum speed rating of the tires.

Exceeding the maximum speed for which tires are rated can lead to sudden tire failure, causing loss of vehicle control and possibly resulting in an accident and/or personal injury and possible death, for you and for others.

**E 350, E 350 4MATIC**  
**E 500, E 500 4MATIC**  
**E 350 (Appearance Package\*)**

Your vehicle is factory equipped with “H”-rated tires, which have a speed rating of 130 mph (210 km/h).

An electronic speed limiter prevents your vehicle from exceeding a speed of 130 mph (210 km/h).

**E 350 (Sport Package\*)**  
**E 500 (Sport Package\*)**  
**E 55 AMG**

Your vehicle is factory equipped with “ZR”-rated tires, which have a speed rating of above 149 mph (240 km/h).

An electronic speed limiter prevents your vehicle from exceeding a speed of 130 mph (210 km/h).

E 55 AMG: An electronic speed limiter prevents your vehicle from exceeding a speed of 155 mph (250 km/h).

**E 350 4MATIC (Sport Package\*)<sup>1</sup>**  
**E 500 4MATIC (Sport Package\*)**

Your vehicle is factory equipped with “Y”-rated tires, which have a speed rating of 186 mph (300 km/h).

An electronic speed limiter prevents your vehicle from exceeding a speed of 130 mph (210 km/h).



For information on speed ratings for winter tires, see “Winter driving” (▷ page 355).

For additional general information on tire speed markings on tire sidewall, see “Tire speed rating” (▷ page 352).

<sup>1</sup> Not available in Canada.

### Winter driving instructions

The most important rule for slippery or icy roads is to drive sensibly and to avoid abrupt acceleration, braking and steering maneuvers. Do not use the cruise control system under such conditions.

When the vehicle is in danger of skidding, move gear selector lever to position **N**. Try to keep the vehicle under control by corrective steering action.



For more information on driving with snow chains, see “Snow chains” (▷ page 356).

### Warning!



On slippery road surfaces, never downshift in order to obtain braking action. This could result in drive wheel slip and reduced vehicle control. Your vehicle’s ABS will not prevent this type of control loss.

### Driving instructions

Road salts and chemicals can adversely affect braking efficiency. Increased pedal force may become necessary to produce the normal braking effect.

Depressing the brake pedal periodically when traveling at length on salt-strewn roads can bring road-salt-impaired braking efficiency back to normal.

If the vehicle is parked after being driven on salt-treated roads, the braking efficiency should be tested as soon as possible after driving is resumed.

#### Warning!



Make sure not to endanger any other road users when carrying out these braking maneuvers.

#### Warning!



If the vehicle becomes stuck in snow, make sure that snow is kept clear of the exhaust pipe and from around the vehicle with the engine running. Otherwise, deadly carbon monoxide (CO) gases may enter vehicle interior resulting in unconsciousness and death.

To assure sufficient fresh air ventilation, open a window slightly on the side of the vehicle not facing the wind.

#### Warning!



The outside temperature indicator is not designed to serve as an ice-warning device and is therefore unsuitable for that purpose. Indicated temperatures just above the freezing point do not guarantee that the road surface is free of ice.

For more information, see “Winter driving” (▷ page 355).

### Standing water



Do not drive through flooded areas or water of unknown depth. Before driving through water, determine its depth. Never accelerate before driving into water. The bow wave could force water into the engine and auxiliary equipment, thus damaging them.

If you must drive through standing water, drive slowly to prevent water from entering the passenger compartment or the engine compartment. Water in these areas could cause damage to electrical components or wiring of the engine or transmission, or could result in water being ingested by the engine through the air intake causing severe internal engine damage. Any such damage is not covered by the Mercedes-Benz Limited Warranty.

## Passenger compartment

### Warning!



Always fasten items being carried as securely as possible.

In an accident, during hard braking or sudden maneuvers, loose items will be thrown around inside the vehicle, and cause injury to vehicle occupants unless the items are securely fastened in the vehicle.

The cargo compartment is the preferred place to carry objects.

## Driving abroad

Abroad, there is an extensive Mercedes-Benz service network at your disposal. If you plan to drive into areas which are not listed in the index of your Mercedes-Benz Center directory, you should request pertinent information from your authorized Mercedes-Benz Center.

## Control and operation of radio transmitter

### COMAND, radio and telephone\*

### Warning!



Please do not forget that your primary responsibility is to drive the vehicle safely. Only operate the COMAND (Cockpit Management and Data System), radio or telephone<sup>1</sup> if road, weather and traffic conditions permit.

Bear in mind that at a speed of just 30 mph (approximately 50 km/h), your vehicle is covering a distance of 44 feet (approximately 14 m) every second.

<sup>1</sup> Observe all legal requirements.

## Telephones and two-way radios

### Warning!



Never operate radio transmitters equipped with a built-in or attached antenna (i.e. without being connected to an external antenna) from inside the vehicle while the engine is running. Doing so could lead to a malfunction of the vehicle's electronic system, possibly resulting in an accident and/or personal injury.

Radio transmitters, such as a portable telephone or a citizens band unit should only be used inside the vehicle if they are connected to an antenna that is installed on the outside of the vehicle.

Refer to the radio transmitter operation instructions regarding use of an external antenna.

### Driving instructions

#### Catalytic converter

---

Your vehicle is equipped with monolithic-type catalytic converters, an important element in conjunction with the oxygen sensors to achieve substantial control of the pollutants in the exhaust emissions. Keep your vehicle in proper operating condition by following our recommended maintenance instructions as outlined in your Maintenance Booklet.



To prevent damage to the catalytic converters, only use premium unleaded gasoline in this vehicle.

Any noticeable irregularities in engine operation should be repaired promptly. Otherwise, excessive unburned fuel may reach the catalytic converter, causing it to overheat, which could potentially start a fire.

#### Warning!



As with any vehicle, do not idle, park or operate this vehicle in areas where combustible materials such as grass, hay or leaves can come into contact with the hot exhaust system, as these materials could be ignited and cause a vehicle fire.

#### Emission control

---

Certain systems of the engine serve to keep the toxic components of the exhaust gases within permissible limits required by law.

These systems, of course, will function properly only when maintained strictly according to factory specifications. Any adjustments on the engine should, therefore, be carried out only by qualified Mercedes-Benz Center authorized technicians. Engine adjustments should not be altered in any way. Moreover, the specified service jobs must be carried out regularly according to Mercedes-Benz servicing requirements. For details refer to the Maintenance Booklet.

**Warning!**

Inhalation of exhaust gas is hazardous to your health. All exhaust gas contains carbon monoxide, and inhaling it can cause unconsciousness and lead to death.

Do not run the engine in confined areas (such as a garage) which are not properly ventilated. If you think that exhaust gas fumes are entering the vehicle while driving, have the cause determined and corrected immediately. If you must drive under these conditions, drive only with at least one window fully open at all times.

**Coolant temperature**

During severe operating conditions and stop-and-go city traffic, the coolant temperature may rise close to approximately 248°F (120°C).

The engine should not be operated with the coolant temperature over 248°F (120°C). Doing so may cause serious engine damage which is not covered by the Mercedes-Benz Limited Warranty.

**Warning!**

- Driving when your engine is badly overheated can cause some fluids, which may have leaked into the engine compartment, to catch fire. You could be seriously burned.
- Steam from an overheated engine can cause serious burns and can occur just by opening the engine hood. Stay away from the engine if you see or hear steam coming from it.

Turn off the engine, get out of the vehicle and do not stand near the vehicle until the engine has cooled down.



### At the gas station

#### Refueling

##### Warning!



Gasoline is highly flammable and poisonous. It burns violently and can cause serious injury. Whenever you are around gasoline, avoid inhaling fumes and skin contact, extinguish all smoking materials. Never allow sparks, flame or smoking materials near gasoline!

The fuel filler flap is located on the right-hand side of the vehicle towards the rear. Locking/unlocking the vehicle with the remote control automatically locks/unlocks the fuel filler flap.



- ▶ Turn the engine off
  - by turning the SmartKey to position **0**.
  - by pressing the KEYLESS-GO\* start/stop button. Open the driver's door (with the driver's door open, starter switch is now in position **0**, same as SmartKey removed from starter switch).
- ▶ Remove the SmartKey from the starter switch.
- ▶ Open the fuel filler flap by pushing at the point indicated by the arrow.

The fuel filler flap springs open.

- ▶ Turn the fuel cap to the left and hold on to it until possible pressure is released.
- ▶ Take off the cap and set it in the recess on the fuel filler flap.

To prevent fuel vapors from escaping into open air, fully insert filler nozzle unit.

- ▶ Only fill your tank until the filler nozzle unit cuts out – **do not top up or over-fill**.



##### Warning!



Overfilling of the fuel tank may create pressure in the system which could cause a gas discharge. This could cause the gasoline to spray back out when removing the fuel pump nozzle, which could cause personal injury.

- ▶ Replace fuel cap by turning it clockwise until it audibly engages.
- ▶ Close the fuel filler flap.



Leaving the engine running and the fuel cap open can cause the yellow fuel tank reserve warning lamp to flash and the  malfunction indicator lamp (USA only) or the  malfunction indicator lamp (Canada only) to illuminate.

For more information, see also “Practical hints” (▷ page 375).



Only use premium unleaded gasoline with a minimum Posted Octane Rating of 91 (average of 96 RON / 86 MON). Information on gasoline quality can normally be found on the fuel pump.

For more information on gasoline, see the Factory Approved Service Products pamphlet.

### Check regularly and before a long trip



- ① Windshield washer and headlamp cleaning system\*
- ② Brake fluid
- ③ Coolant level



Opening the hood, see (▷ page 315).

### Windshield washer system and headlamp cleaning system\*

For information on refilling the reservoir, see “Windshield washer system and headlamp cleaning system\*” (▷ page 323).

### Brake fluid



If you find that the brake fluid in the brake fluid reservoir has fallen to the minimum mark or below, have the brake system checked for brake pad thickness and leaks immediately. Notify an authorized Mercedes-Benz Center immediately. Do not add brake fluid as this will not solve the problem. For more information, see “Practical hints” (▷ page 374).

For information on brake fluid, see “Fuels, coolants, lubricants, etc.” (▷ page 485).

### At the gas station

#### Coolant

For normal replenishing, use water (potable water quality). For more information on coolant, see “Coolant level” (▷ page 321) and see “Fuels, coolants, lubricants etc.” (▷ page 482).

#### Engine oil level

For more information on engine oil level, see “Engine oil” (▷ page 316).

#### Vehicle lighting

Check function and cleanliness. For more information on replacing light bulbs, see “Replacing bulbs” (▷ page 431).

For more information, see “Exterior lamp switch” (▷ page 143).

#### Tire inflation pressure

For more information, see “Checking tire inflation pressure” (▷ page 335).

### ▼ Engine compartment

#### Hood

#### Warning!



Do not pull the release lever while the vehicle is in motion. Otherwise the hood could be forced open by passing air flow.

#### Opening



① Hood release

- ▶ Pull lever ① downwards.

The hood is unlocked and handle ② will extend out of the radiator grille.



To avoid damage to the windshield wipers or hood, never open the hood if the wiper arms are folded forward away from the windshield.



② Handle for opening the hood

- ▶ Pull handle ② to its stop out of radiator grille.
- ▶ Pull up on the hood (do not pull up on the handle) and then release it.

The hood will be automatically held open at shoulder height by gas-filled struts.

#### Warning!



To help prevent personal injury, stay clear of moving parts when the hood is open and the engine is running. Make sure the hood is properly closed before driving. When closing the hood, use extreme caution not to catch hands or fingers.

The radiator fan may continue to run for approximately 30 seconds or even restart after the engine has been turned off. Stay clear of fan blades.

### Engine compartment

#### Warning!



If you see flames or smoke coming from the engine compartment, or if the coolant temperature gauge indicates that the engine is overheated, do not open the hood. Move away from vehicle and do not open the hood until the engine has cooled. If necessary, call the fire department.

#### Warning!



The engine is equipped with a transistorized ignition system. Because of the high voltage it is dangerous to touch any components (ignition coils, spark plug sockets, diagnostic socket) of the ignition system

- with the engine running
- while starting the engine
- if ignition is “on” and the engine is turned manually

### Closing

#### Warning!



Be careful that you do not close the hood on anyone.

- ▶ Let the hood drop from a height of approximately 1 ft (30 cm).

The hood will lock audibly.

- ▶ Check to make sure the hood is fully closed.

If you can raise the hood at a point above the headlamps, then it is not properly closed. Open it again and let it drop with somewhat greater force.

### Engine oil

The amount of oil your engine needs will depend on a number of factors, including driving style. Higher oil consumption can occur when

- the vehicle is new
- the vehicle is driven frequently at higher engine speeds

Engine oil consumption checks should only be made after the vehicle break-in period.



Do not use any special lubricant additives, as these may damage the drive assemblies. Using special additives not approved by Mercedes-Benz may cause damage not covered by the Mercedes-Benz Limited Warranty.

More information on this subject is available at any Mercedes-Benz Center.

### Checking engine oil level with the control system (E 500, E 55 AMG)



When checking the oil level

- the vehicle must be parked on level ground
- with the engine at operating temperature, the vehicle must have been stationary for at least 5 minutes with the engine turned off
- with the engine not at operating temperature yet, the vehicle must have been stationary for at least 30 minutes with the engine turned off

To check the engine oil level via the multifunction display, do the following:

- ▶ Switch on the ignition (▷ page 36).

The standard display (▷ page 155) should appear in the multifunction display.



- ▶ Press button  or  on the multifunction steering wheel until the following message is seen in the multifunction display:



One of the following messages will subsequently appear in the multifunction display:

- Engine oil level ok
- Add 1.0 Qt. to reach max. oil level (Canada: 1.0 Liter)
- Add 1.5 Qts. to reach max. oil level (Canada: 1.5 Liters)
- Add 2.0 Qts. to reach max. oil level (Canada: 2.0 Liters)



If you want to interrupt the checking procedure, press button  or  on the multifunction steering wheel.

- ▶ If necessary, add engine oil.

For adding engine oil, see (▷ page 319).

For more information on engine oil, see the “Technical data” section (▷ page 482) and (▷ page 485).

#### Other display messages

If the SmartKey or KEYLESS-GO start/stop button\* is not in position **2**, the following message will appear:

Switch ignition on to check engine oil level

- ▶ Switch on the ignition (▷ page 36).

If you see the message:

Observe waiting period



### Engine compartment

- ▷▷ If engine is at operating temperature, wait 5 minutes before repeating check procedure.
- ▶ If engine is not at operating temperature yet, wait 30 minutes before repeating check procedure.

If you see the message:

Engine oil level  
Not when engine on

- ▶ Turn off the engine.
- ▶ If the engine is at operating temperature, wait 5 minutes before checking oil.
- ▶ If the engine is not at operating temperature yet, you must wait 30 minutes before checking oil.

If there is excess engine oil with the engine at operating temperature, the following message will appear:

Engine oil level  
Reduce oil level

- ▶ Have excess oil siphoned or drained off. Contact an authorized Mercedes-Benz Center.



Excess oil must be siphoned or drained off. It could cause damage to the engine and catalytic converter not covered by the Mercedes-Benz Limited Warranty.

For more information on messages in the multifunction display concerning engine oil, see the “Practical hints” section (▷ page 404).

### Checking engine oil level with the oil dipstick (E 350 only)

When checking the oil level

- the vehicle must be parked on level ground
- with the engine at operating temperature, the vehicle must have been stationary for at least 5 minutes with the engine turned off
- with the engine not at operating temperature yet, the vehicle must have been stationary for at least 30 minutes with the engine turned off

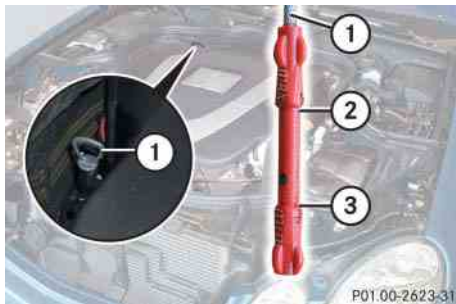

- ① Oil dipstick
- ② Upper (max) mark
- ③ Lower (min) mark

To check the engine oil level with the oil dipstick, do the following:

- ▶ Open the hood (▷ page 315).
- ▶ Pull out oil dipstick ①.
- ▶ Wipe oil dipstick ① clean.
- ▶ Fully insert oil dipstick ① into the dipstick guide tube.

- ▶ Pull out oil dipstick ① again after approximately 3 seconds to obtain accurate reading.

The oil level is correct when it is between the lower (min) mark ③ and upper (max) mark ② of oil dipstick ①.



The filling quantity between the upper and lower marks on the oil dipstick is approximately 2.1 US qt. (2.0 l).

- ▶ If necessary, add engine oil.

For adding engine oil, see “Adding engine oil”.

For more information on engine oil, see “Fuels, coolants, lubricants etc.” (▷ page 482).

For more information on messages in the multifunction display concerning engine oil, see the “Practical hints” section (▷ page 383).

## Adding engine oil



Only use approved engine oils and oil filters required for vehicles with Maintenance System (U.S. vehicles) or FSS PLUS (Canada vehicles). For a listing of approved engine oils and oil filters, refer to the Factory Approved Service Products pamphlet in your vehicle literature portfolio, or contact an authorized Mercedes-Benz Center.

Using engine oils and oil filters of specification other than those expressly required for the Maintenance System (U.S. vehicles) or FSS PLUS (Canada vehicles), or changing of oil and oil filter at change intervals longer than those called for by the Maintenance System (U.S. vehicles) or FSS PLUS (Canada vehicles) will result in engine damage not covered by the Mercedes-Benz Limited Warranty.



### Engine compartment



E 350



E 500

- ▶ Unscrew filler cap ① from filler neck.
- ▶ Add engine oil as required. Be careful not to overfill with oil.

Be careful not to spill any oil when adding. Avoid environmental damage caused by oil entering the ground or water.



Excess oil must be siphoned or drained off. It could cause damage to the engine and catalytic converter not covered by the Mercedes-Benz Limited Warranty.

- ▶ Screw filler cap ① back on filler neck.

For more information on engine oil, see the “Technical data” section (▷ page 482) and (▷ page 485).

### Transmission fluid level

The transmission fluid level does not need to be checked. If you notice transmission fluid loss or gear shifting malfunctions, have an authorized Mercedes-Benz Center check the transmission.

## Coolant level

The engine coolant is a mixture of water and anticorrosion/antifreeze. To check the coolant level, the vehicle must be parked on level ground and the engine must be cool.

The coolant expansion tank is located on the driver's side of the engine compartment.

### Warning!



In order to avoid any possibly serious burns:

- Use extreme caution when opening the hood if there are any signs of steam or coolant leaking from the cooling system, or if the coolant temperature gauge indicates that the coolant is overheated.
- Do not remove pressure cap on coolant reservoir if coolant temperature is above 158°F (70°C). Allow engine to cool down before removing cap. The coolant reservoir contains hot fluid and is under pressure.

- Do not spill antifreeze on hot engine parts. Antifreeze contains ethylene glycol which may burn if it comes into contact with hot engine parts.
- Using a rag, slowly open the cap approximately  $\frac{1}{2}$  turn to relieve excess pressure. If opened immediately, scalding hot fluid and steam will be blown out under pressure.



① Coolant expansion tank

- ▶ Using a rag, turn the cap slowly approximately one half turn to the left to release any excess pressure.

- ▶ Continue turning the cap to the left and remove it.

The coolant level is correct if the level:

- for cold coolant: reaches the black top part of the reservoir
- for warm coolant: is approximately 0.6 in (1.5 cm) higher

- ▶ Add coolant as required.
- ▶ Replace and tighten cap.

For more information on coolant, see the “Technical data” section (▷ page 487).

## Engine compartment

### Batteries

Your vehicle is equipped with two batteries:

- Main battery (located in the cargo compartment).
- Auxiliary battery (located in the engine compartment).

These batteries should always be sufficiently charged in order to achieve their rated service life. Refer to Maintenance Booklet for battery maintenance intervals.

If you use your vehicle mostly for short-distance trips, you will need to have the battery charge checked more frequently.

When replacing batteries, always use batteries approved by Mercedes-Benz.

If you do not intend to operate your vehicle for an extended period of time, consult an authorized Mercedes-Benz Center about steps you need to observe.



Observe all safety instructions and precautions when handling automotive batteries.



Risk of explosion



Keep flames or sparks away from battery. Do not smoke.



Battery acid is caustic. Do not allow it to come into contact with skin, eyes or clothing.

In case it does, immediately flush affected area with clean water and seek medical help if necessary.



Wear eye protection.



Keep children away.



Follow the instructions in this Operator's Manual.

Batteries contain materials that can harm the environment if disposed of improperly. Recycling of batteries is the preferred method of disposal. Many states require sellers of batteries to accept old batteries for recycling.

## Windshield washer system and headlamp cleaning system\*

The windshield washer reservoir is located in the engine compartment.

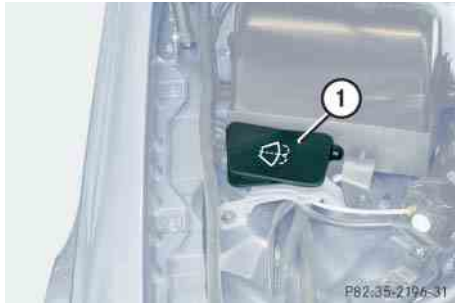

### ① Washer fluid reservoir

Fluid for the windshield washer system and the headlamp cleaning system is supplied from the windshield washer reservoir. It has a capacity of:

- 4.8 US qt (4.5 l) in vehicles without headlamp cleaning system
- 7.4 US qt (7.0 l) in vehicles with headlamp cleaning system

During all seasons, add MB Windshield Washer Concentrate “S” to water. Premix the windshield washer fluid in a suitable container.

- ▶ Refill the reservoir with MB Windshield Washer Concentrate and water (or commercially available premixed windshield washer solvent/antifreeze, depending on ambient temperatures).

Always use washer solvent/antifreeze where temperatures may fall below freezing point. Failure to do so could result in damage to the washer system/reservoir.

### Warning!



Washer solvent/antifreeze is highly flammable. Do not spill washer solvent/ antifreeze on hot engine parts, because it may ignite and burn. You could be seriously burned.



Only use washer fluid which is suitable for plastic lenses. Improper washer fluid can damage the plastic lenses of the headlamps.

For more information, see “Windshield and headlamp washer fluid mixing ratio” (▷ page 490).

### Tires and wheels

See an authorized Mercedes-Benz Center for information on tested and recommended rims and tires for summer and winter operation. They can also offer advice concerning tire service and purchase.

#### Warning!



Replace rims or tires with the same designation, manufacturer and type as shown on the original part. See an authorized Mercedes-Benz Center for further information. If incorrectly sized rims and tires are mounted:

- The wheel brakes or suspension components can be damaged.
- The correct operating clearance of the wheels and the tires are no longer guaranteed.

#### Warning!



Worn, old tires can cause accidents. If the tire tread is badly worn, or if the tires have sustained damage, replace them.

When replacing rims, only use Genuine Mercedes-Benz wheel bolts specified for the particular rim type. Failure to do so can result in the bolts loosening and possibly an accident.

Retreaded tires are not tested or recommended by Mercedes-Benz, since previous damage cannot always be recognized on retreads. Mercedes-Benz can therefore not assure the operating safety of the vehicle when such tires are used.

#### Important guidelines

- Only use sets of tires and rims of the same type and make.
- Tires must be of the correct size for the rim.
- Break in new tires for approximately 60 miles (100 km) at moderate speeds.
- Regularly check the tires and rims for damage. Dented or bent rims can cause tire inflation pressure loss and damage to the tire beads.
- If vehicle is heavily loaded, check tire inflation pressure and correct as required.
- Do not allow your tires to wear down too far. Adhesion properties on wet roads are sharply reduced at tread depths under  $\frac{1}{8}$  in (3 mm).
- When replacing individual tires, you should mount new tires on the front wheels first (on vehicles with same-sized wheels all around).

## Tire care and maintenance

### Warning!



Regularly check the tires for damage. Damaged tires can cause tire inflation pressure loss. As a result, you could lose control of your vehicle.

Worn, old tires can cause accidents. If the tire tread is badly worn, or if the tires have sustained damage, replace them.

Regularly check your tire inflation pressure at least once a month. For more information on checking tire inflation pressure, see “Recommended tire inflation pressure” (▷ page 333).

## Tire inspection

Every time you check your tire inflation pressure, you should also inspect your tires for the following:

- excessive treadwear (▷ page 326)
- cord or fabric showing through the tire’s rubber
- bumps, bulges, cuts, cracks or splits in the tread or side of the tire

Replace the tire if you find any of the above conditions.

Make sure you also inspect the spare tire periodically for condition and inflation. Spare tires will age and become worn over time even if never used, and thus should be inspected and replaced when necessary.

## Life of tire

The service life of a tire is dependent upon varying factors including but not limited to:

- Driving style
- Tire inflation pressure
- Distance driven

### Warning!



Tires and spare tire should be replaced after 6 years, regardless of the remaining tread.

### Tires and wheels

#### Tread depth

Do not allow your tires to wear down too far. Adhesion properties on wet roads are sharply reduced at tread depths under  $\frac{1}{8}$  in (3 mm).

Treadwear indicators (TWI) are required by law. These indicators are located in six places on the tread circumference and become visible at a tread depth of approximately  $\frac{1}{16}$  in (1.6 mm), at which point the tire is considered worn and should be replaced.

Recommended minimum tire tread depth:

- Summer tires  $\frac{1}{8}$  in (3 mm)
- Winter tires  $\frac{1}{6}$  in (4 mm)

#### Warning!



Although the applicable federal motor safety laws consider a tire to be worn when the treadwear indicators (TWI) become visible at approximately  $\frac{1}{16}$  in (1.6 mm), we recommend that you do not allow your tires

to wear down to that level. As tread depth approaches  $\frac{1}{8}$  in (3 mm), the adhesion properties on a wet road are sharply reduced.

Depending upon the weather and/or road surface (conditions), the tire traction varies widely.

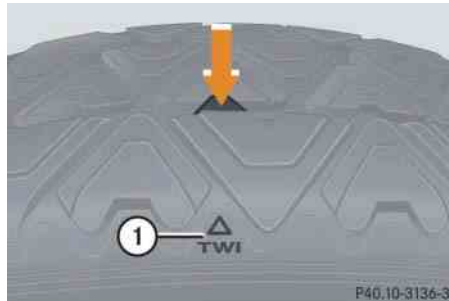

① TWI (Tread Wear Indicator)

The treadwear indicator appears as a solid band across the tread.

#### Storing tires



Keep unmounted tires in a cool, dry place with as little exposure to light as possible. Protect tires from contact with oil, grease and gasoline.

#### Cleaning tires



Never use a round nozzle to power wash tires. The intense jet of water can result in damage to the tire.

Always replace a damaged tire.

## Direction of rotation

Unidirectional tires offer added advantages, such as better hydroplaning performance. To benefit, however, you must make sure the tires rotate in the direction specified.

An arrow on the sidewall indicates the intended direction of rotation (spinning) of the tire.



Spare wheels may be mounted against the direction of rotation (spinning) even with a unidirectional tire for temporary use only until the regular drive wheel has been repaired or replaced. Always observe and follow applicable temporary use restrictions and speed limitations indicated on the spare wheel.

## Loading the vehicle

Two labels on your vehicle show how much weight it may properly carry.

- The Tire and Loading Information placard (Example A) or the Vehicle Tire Information placard (Example B) can be found on the driver's door B-pillar. This placard tells you important information about the number of people that can be in the vehicle and the total weight that can be carried in the vehicle. It also contains information on the proper size and recommended tire inflation pressures for the original equipment tires on your vehicle.

- The Certification label, also found on the driver's door B-pillar tells you about the gross weight capacity of your vehicle, called the Gross Vehicle Weight Rating (GVWR). The GVWR includes the weight of the vehicle, all occupants, fuel and cargo. The Certification label also tells you about the front and rear axle weight capacity, called the Gross Axle Weight Rating (GAWR). The GAWR is the total allowable weight that can be carried by a single axle (front or rear). Never exceed the GVWR or GAWR for either the front axle or rear axle.



## Tires and wheels

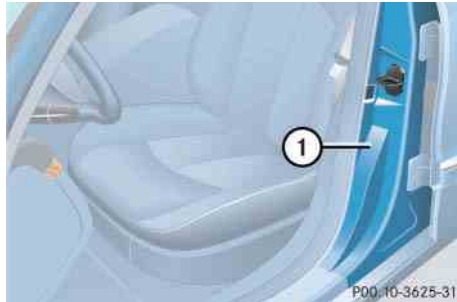

① Driver's door B-pillar

Following is a discussion on how to work with the information contained on the two placards with regards to loading your vehicle.

### Tire and Loading Information

#### Warning!



Do not overload the tires by exceeding the specified load limit or vehicle capacity weight as indicated on the placard on the driver's door B-pillar. Overloading the tires can overheat them, possibly causing a blowout. Overloading the tires can also result in handling or steering problems, or brake failure.

Your vehicle is equipped with either the Tire and Loading Information placard (Example A) or the Vehicle Tire Information placard (Example B).



Data shown on placard examples are for illustration purposes only. Load limit data are specific to each vehicle and may vary from data shown in the illustrations below. Refer to placard on vehicle for actual data specific to your vehicle.

#### Placard (Example A)

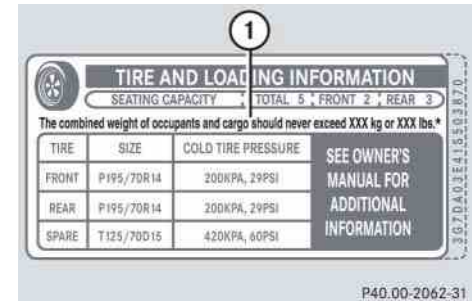

① Load limit information on the Tire and Loading Information placard

The placard showing the load limit information is located on the driver’s door B-pillar. If your vehicle is equipped with the Tire and Loading Information placard (Example A), locate the statement “The combined weight of occupants and cargo should never exceed XXX kilograms or XXX lbs.” on this placard. The combined weight of all occupants, cargo/luggage and trailer tongue load (if applicable) should never exceed the weight referenced in that statement.

**Placard (Example B)**



① Load limit information on the Vehicle Tire Information placard

The placard showing the load limit information is located on the driver’s door B-pillar. If your vehicle is equipped with the Vehicle Tire Information placard (Example B), locate the heading “Vehicle Capacity Weight” on this placard. The combined weight of all occupants, cargo/luggage and trailer tongue (if applicable) should never exceed the weight listed next to vehicle capacity weight.

**Seating capacity**

The seating capacity gives you important information on the number of occupants that can be in the vehicle. Observe front and rear seating capacity. Your vehicle is equipped with either placard Example A or placard Example B located on the driver’s door B-pillar (▷ page 328).



Data shown on placard examples are for illustration purposes only. Seating data are specific to each vehicle and may vary from data shown in the illustrations below. Refer to placard on vehicle for actual data specific to your vehicle.

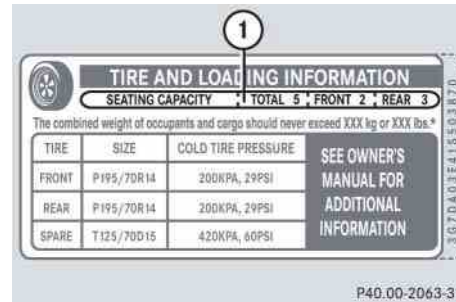

**Placard (Example A)**

① Seating capacity

## Tires and wheels



### Placard (Example B)

- ① Seating capacity

### Steps for determining correct load limit

The following steps have been developed as required of all manufacturers under Title 49, Code of U.S. Federal Regulations, Part 575 pursuant to the “National Traffic and Motor Vehicle Safety Act of 1966”.

**Step 1** (Vehicles equipped with placard Example A)

- ▶ Locate the statement “The combined weight of occupants and cargo should never exceed XXX kg or XXX lbs.” on your vehicle’s placard.

**Step 1** (Vehicles equipped with placard Example B)

- ▶ Locate the heading “Vehicle Capacity Weight” on your vehicle’s placard.

**Step 2**

- ▶ Determine the combined weight of the driver and passengers that will be riding in your vehicle.

**Step 3**

- ▶ Subtract the combined weight of the driver and passengers from XXX kilograms or XXX lbs.

**Step 4**

- ▶ The resulting figure equals the available amount of cargo and luggage load capacity. For example, if the “XXX” amount equals 1400 lbs. and there will be five 150 lbs. passengers in your vehicle, the amount of available cargo and luggage load capacity is 650 lbs. (1400-750 (5 x150) = 650 lbs.).

**Step 5**

- ▶ Determine the combined weight of luggage and cargo being loaded on the vehicle. That weight may not safely exceed the available cargo and luggage load capacity calculated in step 4.

**Step 6** (if applicable)

- ▶ If your vehicle will be towing a trailer, load from your trailer will be transferred to your vehicle. Consult this manual to determine how this reduces the available cargo and luggage load capacity of your vehicle (▷ page 332).

The following table shows examples on how to calculate total and cargo load capacities with varying seating configurations and number and size of occupants. The following examples use a load limit of 1500 lbs. **This is for illustration purposes only.** Make sure you are using the actual load limit for your vehicle stated on the vehicle’s placard (▷ page 328).

Example	Combined weight limit of occupants and cargo from placard	Number of occupants (driver and passengers)	Seating configuration	Occupants weight	Combined weight of all occupants	Available cargo/luggage and trailer tongue weight (total load limit or vehicle capacity weight from placard minus combined weight of all occupants)
1	1500 lbs	5	front: 2 rear: 3	Occupant 1: 150 lbs Occupant 2: 180 lbs Occupant 3: 160 lbs Occupant 4: 140 lbs Occupant 5: 120 lbs	750 lbs	1500 lbs - 750 lbs = 750 lbs
2	1500 lbs	3	front: 1 rear: 2	Occupant 1: 200 lbs Occupant 2: 190 lbs Occupant 3: 150 lbs	540 lbs	1500 lbs - 540 lbs = 960 lbs
3	1500 lbs	1	front: 1	Occupant 1: 150 lbs	150 lbs	1500 lbs - 150 lbs = 1350 lbs

The higher the weight of all occupants, the less cargo and luggage load capacity is available.

For more information, see “Trailer tongue load” (> page 332).

### Tires and wheels

#### ***Certification label***

Even after careful determination of the combined weight of all occupants, cargo and the trailer tongue load (if applicable) (▷ page 332) as to not exceed the permissible load limit, you must make sure that your vehicle never exceeds the Gross Vehicle Weight Rating (GVWR) and the Gross Axle Weight Rating (GAWR) for either the front or rear axle. You can obtain the GVWR and GAWR from the Certification label. The Certification Label can be found on the driver's door B-pillar, see "Technical data" (▷ page 468).

**Gross Vehicle Weight Rating (GVWR):** The total weight of the vehicle, all occupants, all cargo, and the trailer tongue load (▷ page 332) must never exceed the GVWR.

**Gross Axle Weight Rating (GAWR):** The total allowable weight that can be carried by a single axle (front or rear).

To assure that your vehicle does not exceed the maximum permissible weight limits (GVWR and GAWR for front and rear axle), have the loaded vehicle (including driver, passengers and all cargo and, if applicable, trailer fully loaded) weighed on a suitable commercial scale.

#### ***Trailer tongue load***

The tongue load of any trailer is an important weight to measure because it affects the load you can carry in your vehicle. If a trailer is towed, the tongue load must be added to the weight of all occupants riding and any cargo you are carrying in the vehicle. The tongue load typically is 10 percent of the trailer weight and everything loaded in it.

Your Mercedes-Benz has been designed primarily to carry passengers and their cargo. Mercedes-Benz does not recommend trailer towing with your vehicle.

## Recommended tire inflation pressure

### Warning!



Follow recommended tire inflation pressures.

Do not underinflate tires. Underinflated tires wear excessively and/or unevenly, adversely affect handling and fuel economy, and are more likely to fail from being overheated.

Do not overinflate tires. Overinflated tires can adversely affect handling and ride comfort, wear unevenly, increase stopping distance, and result in sudden deflation (blowout) because they are more likely to become punctured or damaged by road debris, potholes etc.

Your vehicle is equipped with either the Tire and Loading Information placard (Example A) or the Vehicle Tire Information placard (Example B) located on the driver's door B-pillar (▷ page 328).

The tire inflation pressure should be checked regularly and should only be adjusted on cold tires. The tires can be considered cold if the vehicle has been parked for at least 3 hours or driven less than 1 mile (1.6 km).

Follow recommended cold tire inflation pressures listed on placard.

Keeping the tires properly inflated provides the best handling, tread life and riding comfort.

In addition to the tire placard on the driver's door B-pillar, also consult the fuel filler flap for any additional information pertaining to special driving situations. For more information, see "Important notes on tire inflation pressure" (▷ page 334).



Data shown on placard examples are for illustration purposes only. Tire data are specific to each vehicle and may vary from data shown in the illustrations below. Refer to placard on vehicle for actual data specific to your vehicle.

## Placard (Example A)

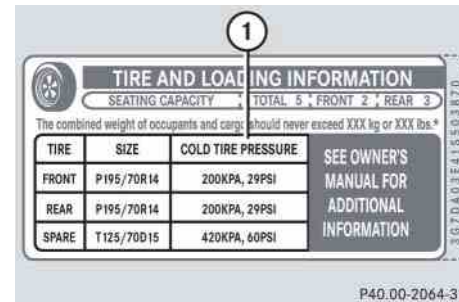

- ① Tire and Loading Information placard with recommended cold tire inflation pressures

Placard (Example A) lists the recommended cold tire inflation pressures for maximum loaded vehicle weight. The tire inflation pressures listed apply to the tires installed as original equipment.

## Tires and wheels

### Placard (Example B)

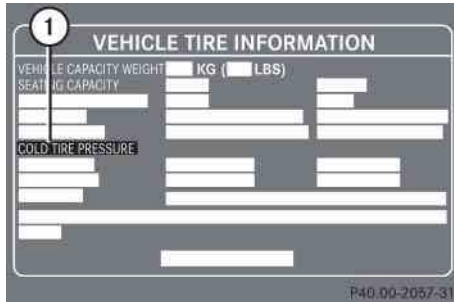

① Vehicle Tire Information placard with recommended cold tire inflation pressures

Placard (Example B) lists the recommended cold tire inflation pressures for maximum loaded vehicle weight. The tire inflation pressures listed apply to the tires installed as original equipment.



Placard (Example B) may list recommended cold tire inflation pressures for different vehicle loads.

### Important notes on tire inflation pressure

#### Warning!



If the tire inflation pressure repeatedly drops:

- Check the tires for punctures from foreign objects.
- Check to see whether air is leaking from the valves or from around the rim.

Tire temperature and tire inflation pressure are also increased while driving, depending on the driving speed and the tire load.

If you will be driving your vehicle at high speeds of 100 mph (160 km/h) or higher, where it is legal and conditions allow, consult the placard on the inside of the fuel filler flap on how to adjust the cold tire inflation pressure. If you do not adjust the tire inflation pressure, excessive heat can build up and result in sudden tire failure.

Be sure to readjust the tire inflation pressure for normal driving speeds. You should wait until the tires are cold before adjusting the tire inflation pressure.

Some vehicles may have supplemental tire inflation pressure information for vehicle loads less than the maximum loaded vehicle condition. If such information is provided, it can be found on the placard located on the inside of the fuel filler flap.

Tire inflation pressure changes by approximately 1.5 psi (0.1 bar) per 18°F (10°C) of air temperature change. Keep this in mind when checking tire inflation pressure where the temperature is different from the outside temperature.

## Checking tire inflation pressure

Regularly check your tire inflation pressure at least once a month.

Check and adjust the tire inflation pressure when the tires are cold. The tires can be considered cold if the vehicle has been parked for at least 3 hours or driven less than 1 mile (1.6 km).

If you check the tire inflation pressure when the tires are warm (the vehicle has been driven for several miles or sitting less than 3 hours), the reading will be approximately 4 psi (0.3 bar) higher than the cold reading. This is normal. Do not let air out to match the specified cold tire inflation pressure. Otherwise, the tire will be underinflated.

## Checking tire inflation pressure manually

Follow the steps below to achieve correct tire inflation pressure:

- ▶ Remove the cap from the valve on one tire.

- ▶ Firmly press a tire gauge onto the valve.
- ▶ Read tire inflation pressure on tire gauge and check against the recommended tire inflation pressure on the placard on the driver's door B-pillar (▷ page 328). If necessary, add air to achieve the recommended tire inflation pressure.



If you have overfilled the tire, release tire inflation pressure by pushing the metal stem of the valve with e.g. a tip of a pen. Then recheck the tire inflation pressure with the tire gauge.

- ▶ Install the valve cap.
- ▶ Repeat this procedure for each tire.

## Checking tire pressure electronically with the Tire Pressure Monitoring System\* (TPMS\*), (USA only)



The Tire Pressure Monitoring System\* (TPMS\*) is equipped with a combination low tire pressure/TPMS malfunction telltale in the instrument cluster (▷ page 25). Depending on how the telltale illuminates, it indicates a low tire pressure condition or a malfunction in the TPMS system itself:

- If the telltale illuminates continuously, one or more of your tires is significantly under-inflated. There is no malfunction in the TPMS.
- If the telltale flashes for 60 seconds and then stays illuminated, the TPMS system itself is not operating properly.



### Tires and wheels

The TPMS only functions on wheels that are equipped with the proper electronic sensors. It monitors the tire inflation pressure, as selected by the driver, in all four tires. A warning is issued to alert you to a decrease in pressure in one or more of the tires.

#### Warning!



The TPMS does not indicate a warning for wrongly selected inflation pressures. Always adjust tire inflation pressure according to the placard on the driver's door B-pillar or, if available, the supplemental tire pressure information on the inside of the fuel filler flap.

The TPMS is not able to issue a warning due to a sudden dramatic loss of pressure (e.g. tire blowout caused by a foreign object). In this case bring the vehicle to a halt by carefully applying the brakes and avoiding abrupt steering maneuvers.

#### Warning!



Each tire, including the spare (if provided), should be checked monthly when cold and inflated to the inflation pressure recommended by the vehicle manufacturer on the vehicle placard or the tire inflation pressure label. (If your vehicle has tires of a different size than the size indicated on the vehicle placard or the tire inflation pressure label, you should determine the proper tire inflation pressure for those tires).

As an added safety feature, your vehicle has been equipped with a tire pressure monitoring system (TPMS) that illuminates a low tire pressure telltale when one or more of your tires is significantly under-inflated. Accordingly, when the low tire pressure telltale illuminates, you should stop and check your tires as soon as possible, and inflate them to the proper pressure. Driving on a significantly under-inflated tire causes the tire to overheat and can lead to tire failure.

Under-inflation also reduces fuel efficiency and tire tread life, and may affect the vehicle's handling and stopping ability. Please note that the TPMS is not a substitute for proper tire maintenance, and it is the driver's responsibility to maintain correct tire pressure, even if under-inflation has not reached the level to trigger illumination of the TPMS low tire pressure telltale.

Your vehicle has also been equipped with a TPMS malfunction indicator to indicate when the system is not operating properly. The TPMS malfunction indicator is combined with the low tire pressure telltale. When the system detects a malfunction, the telltale will flash for approximately one minute and then remain continuously illuminated. This sequence will continue upon subsequent vehicle start-ups as long as the malfunction exists. When the malfunction indicator is illuminated, the system may not be able to detect or signal low tire pressure as intended.

TPMS malfunctions may occur for a variety of reasons, including the installation of incompatible replacement or alternate tires or wheels on the vehicle that prevent the TPMS from functioning properly. Always check the TPMS malfunction telltale after replacing one or more tires or wheels on your vehicle to ensure that the replacement or alternate tires and wheels allow the TPMS to continue to function properly.



If a condition causing the TPMS to malfunction develops, it may take up to 10 minutes for the system to signal a malfunction using the TPMS telltale flashing and illumination sequence.

The telltale extinguishes after a few minutes driving if the malfunction has been corrected.



Operating radio transmission equipment (e.g. wireless headsets, two-way radios) in or near the vehicle could cause the TPMS to malfunction.

### **Reactivating the TPMS\***

The TPMS must be reactivated when you have adjusted the tire inflation pressure to a new level (e.g. because of different load or driving conditions). The TPMS is then recalibrated to the current tire inflation pressures.

#### **Warning!**



It is the driver's responsibility to calibrate the TPMS on the recommended cold inflation pressure. Underinflated tires affect the ability to steer or brake the vehicle. You might lose control over the vehicle.

- ▶ Using the tire placard on the driver's door B-pillar (▷ page 328) or, if available, the supplemental tire pressure information on the inside of the fuel filler flap (▷ page 312), make sure the tire inflation pressure of all four tires is correct.



## Tires and wheels



Reactivate the TPMS after adjusting the tire inflation pressure to the inflation pressure recommended for the vehicle operating condition. Tire pressure should only be adjusted on cold tires. Observe the recommended tire inflation pressure on the placard on the driver's door B-pillar (▷ page 328). Some vehicles may have supplemental tire pressure information for driving at high speeds (▷ page 334) or for vehicle loads less than the maximum loaded vehicle condition. If such information is provided, it can be found on the inside of the fuel filler flap.

- ▶ Press button or on the multifunction steering wheel repeatedly until the standard display menu appears in the multifunction display (▷ page 155).
- ▶ Press the or button repeatedly until you see the flowing message:  
Tire pressure  
monitor active  
Reactivation possible:  
R-button
- ▶ Press the reset button.  
  
The following message will appear in the multifunction display:  
Check current  
tire pressure?

- ▶ Press the button.

The following message will appear in the multifunction display:

Tire pres. monitor  
reactivated

After driving a few minutes the system verifies that the current tire inflation pressures are within the system's specified range. Afterwards the current tire inflation pressures are accepted as reference pressures and then monitored.

If you wish to cancel activation:

- ▶ Press the button.

## Potential problems associated with underinflated and overinflated tires

### *Underinflated tire inflation pressure*

Underinflated tires can:

- cause excessive and uneven tire wear
- adversely affect fuel economy
- lead to tire failure from being overheated
- adversely affect handling characteristics

### Warning!



Follow recommended tire inflation pressures.

Do not underinflate tires. Underinflated tires wear excessively and/or unevenly, adversely affect handling and fuel economy, and are more likely to fail from being overheated.

### *Overinflated tire inflation pressure*

Overinflated tires can:

- adversely affect handling characteristics
- cause uneven tire wear
- be more prone to damage from road hazards
- adversely affect ride comfort
- increase stopping distance

### Warning!



Follow recommended tire inflation pressures.

Do not overinflate tires. Overinflated tires can adversely affect handling and ride comfort, wear unevenly, increase stopping distance, and result in sudden deflation (blowout) because they are more likely to become punctured or damaged by road debris, potholes etc.

### Tires and wheels

#### MOExtended system\*

The MOExtended system allows you to continue driving your vehicle even if there is a total loss of pressure in one or more tires.

You may only use the MOExtended system with the Tire Pressure Monitoring System\* (TPMS\*) (▷ page 335).

For information on driving in case of pressure loss in one or more tires (emergency mode), see the “Practical hints” section (▷ page 451).

#### Tire labeling

Besides tire name (sales designation) and manufacturer name, a number of markings can be found on a tire.

Following are some explanations for the markings on your vehicle’s tires:

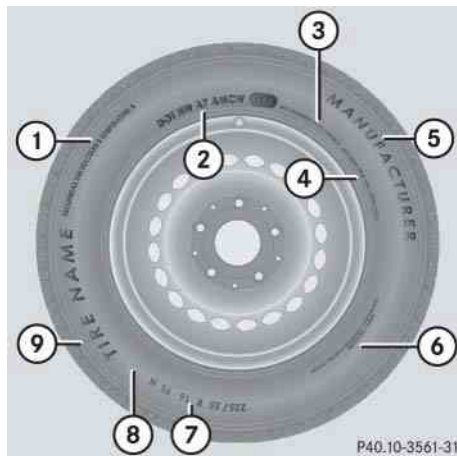

- ① Uniform Quality Grading Standards (▷ page 348)
- ② DOT, Tire Identification Number (TIN) (▷ page 345)
- ③ Maximum tire load (▷ page 346)
- ④ Maximum tire inflation pressure (▷ page 347)
- ⑤ Manufacturer
- ⑥ Tire ply material (▷ page 350)
- ⑦ Tire size designation, load and speed rating (▷ page 341)
- ⑧ Load identification (▷ page 344)
- ⑨ Tire name



For illustration purposes only. Actual data on tires are specific to each vehicle and may vary from data shown in above illustration.

For more information, see “Rims and tires” (▷ page 472).

## Tire size designation, load and speed rating

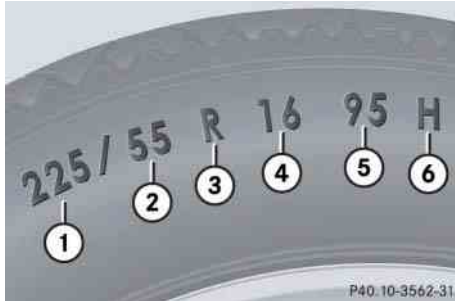

- ① Tire width
- ② Aspect ratio in %
- ③ Radial tire code
- ④ Rim diameter
- ⑤ Tire load rating
- ⑥ Tire speed rating



For illustration purposes only. Actual data on tires are specific to each vehicle and may vary from data shown in above illustration.

General:

Depending on the design standards used, the tire size molded into the sidewall may have no letter or a letter preceding the tire size designation.

No letter preceding the size designation (as illustrated above): Passenger car tire based on European design standards.

Letter “P” preceding the size designation: Passenger car tire based on U.S. design standards.

Letter “LT” preceding the size designation: Light Truck tire based on U.S. design standards.

Letter “T” preceding the size designation: Temporary spare tires which are high pressure compact spares designed for temporary emergency use only.

### ***Tire width***

The tire width ① (▷ page 341) indicates the nominal tire width in mm.

### ***Aspect ratio***

The aspect ratio ② (▷ page 341) is the dimensional relationship between tire section height and section width and is expressed in percentage. The aspect ratio is arrived at by dividing section height by section width.

### ***Tire code***

The tire code ③ (▷ page 341) indicates the tire construction type. The “R” stands for radial tire type. Letter “D” means diagonal or bias ply construction; letter “B” means belted-bias ply construction.

At the tire manufacturer’s option, any tire with a speed capability above 149 mph (240 km/h) can include a “ZR” in the size designation (for example: 245/40 ZR 18). For additional information, see “Tire speed rating” (▷ page 343).

### Tires and wheels

#### **Rim diameter**

The rim diameter ④ (▷ page 341) is the diameter of the bead seat, not the diameter of the rim edge. Rim diameter is indicated in inches (in).

#### **Tire load rating**

The tire load rating ⑤ (▷ page 341) is a numerical code associated with the maximum load a tire can support.

For example, a load rating of 91 corresponds to a maximum load of 1356 lbs (615 kg) the tire is designed to support. See also “Maximum tire load” (▷ page 346) where the maximum load associated with the load index is indicated in kilograms and lbs.

#### **Warning!**



The tire load rating must always be at least half of the GAWR (▷ page 351) of your vehicle. Otherwise, tire failure may be the result which may cause an accident and/or serious personal injury to you or others.

Always replace rims and tires with the same designation, manufacturer and type as shown on the original part.

#### **Warning!**



Do not overload the tires by exceeding the specified load limit or vehicle capacity weight as indicated on the placard located on the driver’s door B-pillar. Overloading the tires can overheat them, possibly causing a blowout. Overloading the tires can also result in handling or steering problems, or brake failure.

For additional information on tire load rating, see “Load identification” (▷ page 344).



Tire load rating ⑤ (▷ page 341) and Tire speed rating ⑥ (▷ page 341) are also referred to as “service description”.

### Tire speed rating

The tire speed rating ⑥ (▷ page 341) indicates the approved maximum speed for the tire.

#### Warning!



Even when permitted by law, never operate a vehicle at speeds greater than the maximum speed rating of the tires.

Exceeding the maximum speed for which tires are rated can lead to sudden tire failure, causing loss of vehicle control and possibly resulting in an accident and/or personal injury and possible death, for you and for others.



Tire load rating ⑤ (▷ page 341) and Tire speed rating ⑥ (▷ page 341) are also referred to as “service description”.

### Summer tires

Index	Speed rating
Q	up to 100 mph (160 km/h)
R	up to 106 mph (170 km/h)
S	up to 112 mph (180 km/h)
T	up to 118 mph (190 km/h)
H	up to 130 mph (210 km/h)
V	up to 149 mph (240 km/h)
W	up to 168 mph (270 km/h)
Y	up to 186 mph (300 km/h)
(Y)	above 186 mph (300 km/h)
ZR	above 149 mph (240 km/h)

- At the tire manufacturer’s option, any tire with a speed capability above 149 mph (240 km/h) can include a “ZR” in the size designation (for example: 245/40 ZR18). To determine the maximum speed capability of the tire, the service description for the tire must be referred to. The service description

is comprised of the tire load rating ⑤ (▷ page 341) and the tire speed rating ⑥ (▷ page 341).

If your tire includes “ZR” in the size designation and no service description ⑤ and ⑥ (▷ page 341) is given, the tire manufacturer must be consulted for the maximum speed capability.

If a service description ⑤ and ⑥ (▷ page 341) is given, the speed capability is limited by the speed symbol in the service description.

Example: 245/40 ZR18 97Y.

In this example, “97Y” is the service description. The letter “Y” designates the speed rating and the speed capability of the tire is limited to 186 mph (300 km/h).



## Tires and wheels

- Any tire with a speed capability above 186 mph (300 km/h) must include a “ZR” in the size designation AND the service description must be placed in parenthesis. Example: 275/40 ZR 18 (99Y). The “(Y)” speed rating in parenthesis designates the maximum speed capability of the tire as being above 186 mph (300 km/h). Consult the tire manufacturer for the actual maximum permissible speed of the tire.

### All-season and winter tires

Index	Speed rating
Q M+S <sup>1</sup>	up to 100 mph (160 km/h)
T M+S <sup>1</sup>	up to 118 mph (190 km/h)
H M+S <sup>1</sup>	up to 130 mph (210 km/h)
V M+S <sup>1</sup>	up to 149 mph (240 km/h)

<sup>1</sup> or M+S  for winter tires



Not all M+S rated tires provide special winter performance. Make sure the tires you use show M+S and the mountain/snowflake  marking on the tire sidewall. These tires meet specific snow traction performance requirements of the Rubber Manufacturers Association (RMA) and the Rubber Association of Canada (RAC) and have been designed specifically for use in snow conditions.

### Load identification



#### ① Load identification



For illustration purposes only. Actual data on tires are specific to each vehicle and may vary from data shown in above illustration.

In addition to tire load rating, special load information may be molded into the tire sidewall following the letter designating the tire speed rating ① (▷ page 343).

No specification given: absence of any text (like in above example) indicates a standard load (SL) tire.

XL or Extra Load: designates an extra load (or reinforced) tire.

Light Load: designates a light load tire.

C, D, E: designates load range associated with the maximum load a tire can carry at a specified pressure.

### DOT, Tire Identification Number (TIN)

U.S. tire regulations require each new tire manufacturer or tire retreader to mold a TIN into or onto a sidewall of each tire produced.

The TIN is a unique identifier which facilitates efforts by tire manufacturers to notify purchasers in recall situations or other safety matters concerning tires and gives purchasers the means to easily identify such tires.

The TIN is comprised of “Manufacturer’s identification mark”, “Tire size”, “Tire type code” and “Date of manufacture”.

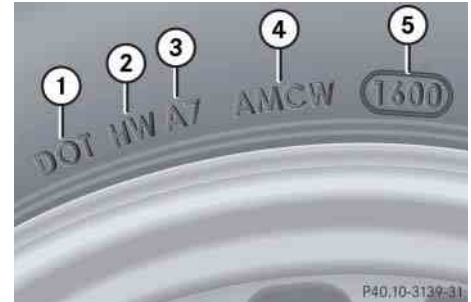

- ① DOT
- ② Manufacturer’s identification mark
- ③ Tire size
- ④ Tire type code (at the option of the tire manufacturer)
- ⑤ Date of manufacture



For illustration purposes only. Actual data on tires are specific to each vehicle and may vary from data shown in above illustration.

### Tires and wheels

#### DOT (Department of Transportation)

A tire branding symbol ① (▷ page 345) which denotes the tire meets requirements of the U.S. Department of Transportation.

#### Manufacturer's identification mark

The manufacturer's identification mark ② (▷ page 345) denotes the tire manufacturer.

New tires have a mark with two symbols.

Retreaded tires have a mark with four symbols. For more information on retreaded tires, see (▷ page 324).

#### Tire size

The code ③ (▷ page 345) indicates the tire size.

#### Tire type code

The code ④ (▷ page 345) may, at the option of the manufacturer, be used as a descriptive code for identifying significant characteristics of the tire.

#### Date of manufacture

The date of manufacture ⑤ (▷ page 345) identifies the week and year of manufacture.

The first two figures identify the week, starting with "01" to represent the first full week of the calendar year. The second two figures represent the year.

For example, "3202" represents the 32nd week of 2002.

#### Maximum tire load



#### ① Maximum tire load rating



For illustration purposes only. Actual data on tires are specific to each vehicle and may vary from data shown in above illustration.

The maximum tire load is the maximum weight the tires are designed to support.

**Warning!**

Do not overload the tires by exceeding the specified load limit or vehicle capacity weight as indicated on the placard located on the driver's door B-pillar. Overloading the tires can overheat them, possibly causing a blowout. Overloading the tires can also result in handling or steering problems, or brake failure.

For more information on tire load rating (▷ page 342).

For information on calculating total and cargo load capacities (▷ page 330).

**Maximum tire inflation pressure**

- ① Maximum permissible tire inflation pressure



For illustration purposes only. Actual data on tires are specific to each vehicle and may vary from data shown in above illustration.

This is the maximum permissible tire inflation pressure for the tire.

Always follow the recommended tire inflation pressure (▷ page 333) for proper tire inflation.

**Warning!**

Never exceed the max. tire inflation pressure. Follow recommended tire inflation pressures.

Do not underinflate tires. Underinflated tires wear excessively and/or unevenly, adversely affect handling and fuel economy, and are more likely to fail from being overheated.

Do not overinflate tires. Overinflated tires can adversely affect handling and ride comfort, wear unevenly, increase stopping distance, and result in sudden deflation (blowout) because they are more likely to become punctured or damaged by road debris, potholes etc.

## Tires and wheels

### Uniform Tire Quality Grading Standards (U.S. vehicles)

Tire manufacturers are required to grade tires based on three performance factors: treadwear, traction and temperature resistance.

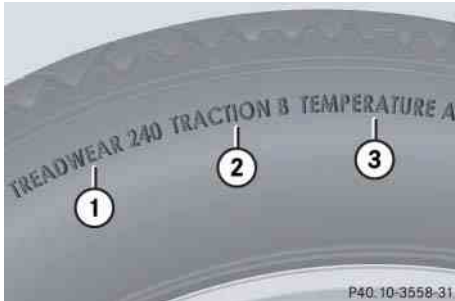

- ① Treadwear
- ② Traction
- ③ Temperature resistance



For illustration purposes only. Actual data on tires are specific to each vehicle and may vary from data shown in above illustration.

Quality grades can be found, where applicable, on the tire sidewall between tread shoulder and maximum section width. For example:

Treadwear	Traction	Temperature
200	AA	A

All passenger car tires must conform to federal safety requirements in addition to these grades.

### Treadwear

The treadwear grade is a comparative rating based on the wear rate of the tire when tested under controlled conditions on a specified government test course. For example, a tire graded 150 would wear one and one-half ( $1\frac{1}{2}$ ) times as well on the government course as a tire graded 100. The relative performance of tires depends upon the actual conditions of their use, however, and may depart significantly from the norm due to variations in driving habits, service practices and differences in road characteristics and climate.

## Traction

The traction grades, from highest to lowest, are AA, A, B, and C. Those grades represent the tire's ability to stop on wet pavement as measured under controlled conditions on specified government test surfaces of asphalt and concrete. A tire marked C may have poor traction performance.

### Warning!



The traction grade assigned to this tire is based on straight-ahead braking traction tests, and does not include acceleration, cornering, hydroplaning, or peak traction characteristics.

## Temperature

The temperature grades are A (the highest), B, and C, representing the tire's resistance to the generation of heat and its ability to dissipate heat when tested under controlled conditions on a specified indoor laboratory test wheel. Sustained high temperature can cause the material of the tire to degenerate and reduce tire life, and excessive temperature can lead to sudden tire failure. The grade C corresponds to a level of performance which all passenger car tires must meet under the Federal Motor Vehicle Safety Standard No. 109. Grades B and A represent higher levels of performance on the laboratory test wheel than the minimum required by law.

### Warning!



The temperature grade for this tire is established for a tire that is properly inflated and not overloaded. Excessive speed, underinflation, or excessive loading, either separately or in combination, can cause excessive heat build-up and possible tire failure.

### Tires and wheels

#### Tire ply material



- ① Plies in sidewall
- ② Plies under tread



For illustration purposes only. Actual data on tires are specific to each vehicle and may vary from data shown in above illustration.

This marking tells you about the type of cord and number of plies in the sidewall and under the tread.

#### Tire and loading terminology

##### Accessory weight

The combined weight (in excess of those standard items which may be replaced) of automatic transmission, power steering, power brakes, power windows, power seats, radio, and heater, to the extent that these items are available as factory-installed equipment (whether installed or not).

##### Air pressure

The amount of air inside the tire pressing outward on each square inch of the tire. Air pressure is expressed in pounds per square inch (psi), or kilopascal (kPa) or bar.

##### Aspect ratio

Dimensional relationship between tire section height and section width expressed in percentage.

##### Bar

Another metric unit for air pressure. There are 14.5038 pounds per square inch (psi) to 1 bar; there are 100 kilopascals (kPa) to 1 bar.

##### Bead

The tire bead contains steel wires wrapped by steel cords that hold the tire onto the rim.

##### Cold tire inflation pressure

Tire inflation pressure when your vehicle has been sitting for at least 3 hours or driven no more than 1 mile (1.6 km).

##### Curb weight

The weight of a motor vehicle with standard equipment including the maximum capacity of fuel, oil, and coolant, and, if so equipped, air conditioning and additional optional equipment, but without passengers and cargo.

**DOT (Department of Transportation)**

A tire branding symbol which denotes the tire meets requirements of the U.S. Department of Transportation.

**GAWR (Gross Axle Weight Rating)**

The GAWR is the maximum permissible axle weight. The gross vehicle weight on each axle must never exceed the GAWR for the front and rear axle indicated on the certification label located on the driver's door B-pillar.

**GVW (Gross Vehicle Weight)**

The GVW comprises the weight of the vehicle including fuel, tools, spare wheel, installed accessories, passengers and cargo and, if applicable, trailer tongue load. The GVW must never exceed the GVWR indicated on the certification label located on the driver's door B-pillar.

**GVWR (Gross Vehicle Weight Rating)**

This is the maximum permissible vehicle weight of the fully loaded vehicle (weight of the vehicle including all options, passengers, fuel, and cargo and, if applicable, trailer tongue load). It is indicated on certification label located on the driver's door B-pillar.

**Kilopascal (kPa)**

The metric unit for air pressure. There are 6.9 kPa to 1 psi; another metric unit for air pressure is bar. There are 100 kilopascals (kPa) to 1 bar.

**Maximum load rating**

The maximum load in kilograms and pounds that can be carried by the tire.

**Maximum loaded vehicle weight**

The sum of curb weight, accessory weight, vehicle capacity weight and production options weight.

**Maximum tire inflation pressure**

This number is the greatest amount of air pressure that should ever be put in the tire under normal driving conditions.

**Normal occupant weight**

The number of occupants the vehicle is designed to seat, multiplied by 68 kilograms (150 lbs).

**Occupant distribution**

The distribution of occupants in a vehicle at their designated seating positions.

**Production options weight**

The combined weight of those installed regular production options weighing over 5 lbs (2.3 kilograms) in excess of those standard items which they replace, not previously considered in curb weight or accessory weight, including heavy duty brakes, ride levelers, roof rack, heavy duty battery, and special trim.



### Tires and wheels

#### PSI (Pounds per square inch)

A standard unit of measure for air pressure  
-> bar, kilopascal (kPa).

#### Recommended tire inflation pressure

Recommended tire inflation pressure listed on placard located on driver's door B-pillar for normal driving conditions. Provides best handling, tread life and riding comfort.

#### Rim

A metal support for a tire or a tire and tube assembly upon which the tire beads are seated.

#### Sidewall

The portion of a tire between the tread and the bead.

#### TIN (Tire Identification Number)

Unique identifier which facilitates efforts by tire manufacturers to notify purchasers in recall situations or other safety matters concerning tires and gives purchases the means to easily identify such tires. The TIN is comprised of "Manufacturer's identification mark", "Tire size", "Tire type code" and "Date of manufacture".

#### Tire load rating

Numerical code associated with the maximum load a tire can support.

#### Tire ply composition and material used

This indicates the number of plies or the number of layers of rubber-coated fabric in the tire tread and sidewall. Tire manufacturers also must indicate the ply materials in the tire and sidewall, which include steel, nylon, polyester, and others.

#### Tire speed rating

Part of tire designation; indicates the speed range for which a tire is approved.

#### Traction

Force exerted by the vehicle on the road via the tires. The amount of grip provided.

#### Tread

The portion of a tire that comes into contact with the road.

#### Treadwear indicators

Narrow bands, sometimes called "wear bars" that show across the tread of a tire when only  $\frac{1}{16}$  in (1.6 mm) of tread remains.

### Uniform Tire Quality Grading Standards

A tire information system that provides consumers with ratings for a tire's traction, temperature and treadwear. Ratings are determined by tire manufacturers using government testing procedures. The ratings are molded into the sidewall of the tire.

### Vehicle capacity weight

Rated cargo and luggage load plus 68 kilograms (150 lbs) times the vehicle's designated seating capacity.

### Vehicle maximum load on the tire

Load on an individual tire that is determined by distributing to each axle its share of the maximum loaded vehicle weight and dividing it by two.

### Rotating tires

#### Warning!



Rotate front and rear wheels only if the tires are of the same dimension.

If your vehicle is equipped with mixed-size tires (different tire dimensions front vs. rear), tire rotation is not possible.

Tire rotation can be performed on vehicles with tires of the same dimension all around. If your vehicle is equipped with tires of the same dimension all around, tires can be rotated, observing a front-to-rear rotation pattern that will maintain the intended rotation (spinning) direction of the tire (▷ page 327).

In some cases, such as when your vehicle is equipped with mixed-size tires (different tire dimension front vs. rear), tire rotation is not possible.

If applicable to your vehicle's tire configuration, tires can be rotated according to the tire manufacturer's recommended intervals in the tire manufacturer's warranty pamphlet located in your vehicle literature portfolio. If none is available, tires should be rotated every 3000 to 6000 miles (5000 to 10000 km), or sooner if necessary, according to the degree of tire wear. The same rotation (spinning) direction must be maintained (▷ page 327).

Rotate tires before the characteristic tire wear pattern becomes visible (shoulder wear on front tires and tread center wear on rear tires).

Thoroughly clean the mounting face of wheels and brake disks, i.e. the inner side of the wheels/tires, during each rotation. Check for and ensure proper tire inflation pressure, activating the Tire Pressure Monitoring System\* (TPMS\*) (▷ page 335) if necessary.

### Tires and wheels

#### Warning!



Have the tightening torque checked after changing a wheel. Wheels could become loose if not tightened with a torque of 96 lb-ft (130 Nm).

Only use Genuine Mercedes-Benz wheel bolts specified for your vehicle's rims.

For information on wheel change, see the “Practical hints” section (▷ page 422) and (▷ page 445).

## ▼ Winter driving

Before the onset of winter, have your vehicle winterized at an authorized Mercedes-Benz Center. This service includes:

- Check of anticorrosion and antifreeze concentration.
- Addition of cleaning concentrate to the water of the windshield and headlamp cleaning system.  
Add MB Concentrate “S” to a premixed windshield washer solvent/antifreeze which is formulated for temperatures below freezing point (▷ page 488).
- Battery test. Battery capacity drops with decreasing ambient temperature. A well charged battery helps to make sure that the engine can be started and the electrohydraulic brake system will be fully operational, even at low ambient temperatures.
- Tire change.

## Winter tires

Always use winter tires at temperatures below 45°F (7°C) and whenever wintry road conditions prevail. Not all M+S rated tires provide special winter performance. Make sure the tires you use show the mountain/snowflake  marking on the tire sidewall. These tires meet specific snow traction performance requirements of the Rubber Manufacturers Association (RMA) and The Rubber Association of Canada (RAC) and have been designed specifically for use in snow conditions. Use of winter tires is the only way to achieve the maximum effectiveness of the ABS, ESP® and 4MATIC in winter operation.

For safe handling, make sure that all mounted winter tires are of the same make and have the same tread design.

### Warning!



Winter tires with a tread depth of less than  $\frac{1}{6}$  in (4 mm) must be replaced. They are no longer suitable for winter operation.

Always observe the speed rating of the winter tires installed on your vehicle. If the maximum speed for which your tires are rated is below the speed rating of your vehicle, you must place a notice to this effect where it will be seen by the driver. Such notices are available at your tire dealer or any authorized Mercedes-Benz Center.

#### Warning!



If you use your spare tire when winter tires are fitted on the other wheels, be aware that the difference in tire characteristics may very well impair turning stability and that overall driving stability may be reduced. Adapt your driving style accordingly.

Have the spare tire replaced with a winter tire at the nearest authorized Mercedes-Benz Center.

#### Block heater\* (Canada only)

The engine is equipped with a block heater.

The electrical cable may be installed at an authorized Mercedes-Benz Center.

#### Snow chains



When driving with snow chains, always select the raised level of the level control system Airmatic\* (▷ page 256). Other settings may result in damage to your vehicle.

Snow chains should only be driven on snow-covered roads at speeds not to exceed 30 mph (50 km/h). Remove chains as soon as possible when driving on roads without snow.



When driving with snow chains, you may wish to deactivate the ESP® (▷ page 95) before setting the vehicle in motion. This will improve the vehicle's traction.

Please observe the following guidelines when using snow chains:

- Use of snow chains is not permissible with all wheel/tire combinations.
- Snow chains should only be used on the rear wheels. Follow the manufacturer's mounting instructions.
- Only use snow chains that are approved by Mercedes-Benz. Your authorized Mercedes-Benz Center will be glad to advise you on this subject.
- Use of snow chains may be prohibited depending on location. Always check local and state laws before installing snow chains.



Even on vehicles with all-wheel-drive, use snow chains on rear tires only.

Some tire sizes do not leave adequate clearance for snow chains. To help avoid serious damage to your vehicle or tires, use of snow chains is not permissible with the following tire sizes:

- 265 / 35 ZR18 XL (Extra load)
- T 155/70 R17 110 M
- T 175/55-18 95P

We strongly recommend that you have your vehicle serviced by an authorized Mercedes-Benz Center, in accordance with the Maintenance Booklet at the times called for by the maintenance service indicator display.

Failure to have the vehicle maintained in accordance with the Maintenance Booklet and maintenance service indicator at the designated times/mileage will result in vehicle damage not covered by the Mercedes-Benz Limited Warranty.

#### Maintenance service indicator message

The maintenance service indicator will notify you when your next maintenance service is due.

Starting approximately 1 month before maintenance service is due, one of the following messages will appear in the multifunction display while you are driving or when you switch on the ignition (example service A):

Service A in XXXX Miles (Km)

Service A in XXX Days

Service A in X Day

Service A due now

The maintenance services will be indicated by showing a service type A through type H in the multifunction display. Types A through H are classified based on estimated time needed to perform the maintenance service, ranging:

from Service A

(approximately 1 hour)

to Service H

(approximately 8 hours)

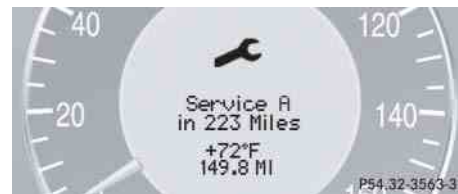

Refer to Maintenance Booklet for a listing of maintenance services and intervals they need to be performed at.



Vehicles equipped with FSS PLUS (Flexible Service System PLUS) only (Canada vehicles): The interval between maintenance services depends on your driving habits. A gentle driving style, moderate engine speeds and the avoidance of short-distance trips will lengthen the interval between services.

### Clearing the maintenance service indicator message

The maintenance service indicator message is automatically cleared

- after approximately 10 seconds when you switch on the ignition or when reaching the service threshold while driving
- after approximately 30 seconds, once the suggested maintenance service term has passed

You can also clear it yourself:



- ▶ Press the reset button ① on the left side of the instrument cluster.

The maintenance service indicator message is cleared and the standard display appears in the multifunction display (▷ page 155).



#### Maintenance service term exceeded

If you have exceeded the suggested maintenance service term, you will see the following message in the multifunction display:

Service A exceeded by XXXXX Miles (Km)

Service A exceeded by XXX Days





Service A exceeded by X Day

In addition, a signal sounds when the message appears.

Any authorized Mercedes-Benz Center will reset the maintenance service indicator following a completed maintenance service.

#### Calling up the maintenance service indicator display

You can call up the maintenance service indicator display at any time to check when the next maintenance service is due.

- ▶ Switch on the ignition (▷ page 36).
- ▶ Press button  or  on the multifunction steering repeatedly until the standard display appears in the multifunction display (▷ page 155).
- ▶ Press button  or  until the maintenance service indicator display with the service symbol  and the service deadline appears in the multifunction display.



If the battery is disconnected, the days of disconnection will not be included in the count shown by the maintenance service indicator. To arrive at the true maintenance service deadline, you will need to subtract these days from the days shown in the maintenance service indicator message or maintenance service indicator display.

Do not confuse the maintenance service indicator with the engine oil level indicator .

## Resetting the maintenance service indicator

---

In the event that the maintenance service on your vehicle is not carried out by an authorized Mercedes-Benz Center, you can have the maintenance service indicator reset. The automotive maintenance facility carrying out the maintenance service will find the information for resetting the maintenance service indicator in the maintenance-relevant information for your vehicle. Such information is available from either your authorized Mercedes-Benz Center or directly from Mercedes-Benz.



If the maintenance service indicator was inadvertently reset, have an authorized Mercedes-Benz Center correct it.

Only reset if the proper maintenance service has been performed. Resetting the system without performing the proper service as called for by the maintenance service indicator will result in engine damage and/or other vehicle damage not covered by the Mercedes-Benz Limited Warranty.

### Cleaning and care of vehicle

#### Warning!



Many cleaning products can be hazardous. Some are poisonous, others are flammable. Always follow the instructions on the particular container. Always open your vehicle's doors or windows when cleaning the inside.

Never use fluids or solvents that are not designed for cleaning your vehicle.

Always lock away cleaning products and keep them out of reach of children.

While in operation, even while parked, your vehicle is subjected to varying external influences which, if gone unchecked, can attack the paintwork as well as the vehicle underbody and cause lasting damage.

Such damage is caused not only by extreme and varying climatic conditions, but also by:

- Air pollution
- Road salt
- Tar
- Gravel and stone chipping

To avoid paint damage, you should immediately remove:

- Grease and oil
- Fuel
- Coolant
- Brake fluid
- Bird droppings
- Insects
- Tree resins etc.

Frequent washing reduces and/or eliminates the aggressiveness and potency of the above adverse influences.

More frequent washings are necessary to deal with unfavorable conditions:

- near the ocean
- in industrial areas (smoke, exhaust emissions)
- during winter operation

You should check your vehicle from time to time for stone chipping or other damage. Any damage should be repaired as soon as possible to prevent corrosion.

In doing so, do not neglect the underbody of the vehicle. A prerequisite for a thorough check is a washing of the underbody followed by a thorough inspection. Damaged areas need to be re-undercoated.

Your vehicle has been treated at the factory with a wax-base rustproofing in the body cavities which will last for the lifetime of the vehicle. Post-production treatment is neither necessary nor recommended by Mercedes-Benz because of the possibility of incompatibility between materials used in the production process and others applied later.

We have selected car-care products and compiled recommendations which are specially matched to our vehicles and which always reflect the latest technology. You can obtain Mercedes-Benz approved car-care products at an authorized Mercedes-Benz Center.

Scratches, corrosive deposits, corrosion or damage due to negligent or incorrect care cannot always be removed or repaired with the car-care products recommended here. In such cases it is best to seek aid at an authorized Mercedes-Benz Center.

The following topics deal with the cleaning and care of your vehicle and give important “how-to” information as well as references to Mercedes-Benz approved car-care products.

### Power washer



Follow the instructions provided by the power washer manufacturer on maintaining a distance between the vehicle and the nozzle of the power washer.

Never use a round nozzle to power-wash tires. The intense jet of water can result in damage to the tire.

Always replace a damaged tire.

Always keep the jet of water moving across the surface. Do not aim directly at electrical parts, electrical connectors, seals, or other rubber parts.



Vehicles with KEYLESS-GO\*:  
If a door handle is hit by a strong jet of water, and a SmartKey with KEYLESS-GO\* is in close proximity, i.e. within approximately 3 ft (approximately 1 m), the vehicle could be inadvertently locked or unlocked.

### Tar stains

Quickly remove tar stains before they dry and become more difficult to remove. A tar remover is recommended.

### Paintwork, painted body components



Affixing stickers, adhesive tape or similar materials to painted body components may damage the paintwork.

Mercedes-Benz approved Paint Care should be applied when water drops on the paint surface do not “bead up”. This should normally be done every 3 to 5 months, depending on the climate and washing detergent used.

Mercedes-Benz approved Paint Cleaner should be applied if the paint surface shows signs of embedded dirt (i.e. loss of gloss).

Do not apply any of these products or wax if your vehicle is parked in the sun or if the hood is still hot.

### Vehicle care

- ▶ Use the appropriate MB-Touch-Up Stick for quick and provisional repairs of minor paint damage (i.e. chips from stones, vehicle doors, etc.).

#### Engine cleaning

Prior to cleaning the engine compartment, make sure to protect electrical components and connectors from contact with water and cleaning agents.

Corrosion protection, such as MB Anticorrosion Wax should be applied to the engine compartment after every engine cleaning. Before applying, all control linkage bushings and joints should be lubricated. The poly-V-belt and all pulleys should be protected from any wax.

#### Vehicle washing

In the winter, thoroughly remove all traces of road salt as soon as possible.

When washing the vehicle underbody, do not forget to clean the inner sides of the wheels.



Vehicles with KEYLESS-GO\*:

If a door handle is hit by a strong jet of water, and a SmartKey with KEYLESS-GO\* is in close proximity, i.e. within approximately 3 ft (approximately 1 m), the vehicle could be inadvertently locked or unlocked.

#### Hand-wash

Do not use hot water or wash your vehicle in direct sunlight.

- ▶ Only use a mild car wash detergent, such as Mercedes-Benz approved Car Shampoo.
  - ▶ Thoroughly spray the vehicle with a diffused jet of water.
- Direct only a very weak spray towards the ventilation intake.
- ▶ Use plenty of water and rinse the sponge and chamois frequently.

- ▶ Rinse with clean water and thoroughly dry with a chamois.

Do not allow cleaning agents to dry on the finish.

#### Automatic car wash

You can have your car washed in an automatic car wash from the start. Automatic car washes without brushes are preferable.

If the vehicle is very dirty, prewash it before running it through the automatic car wash.



Due to the width of the vehicle, fold in exterior rear view mirrors prior to running the vehicle through an automatic car wash to prevent damage to the mirrors.

Make sure that the windshield wiper switch is set to **0** (> page 36). Otherwise, the rain sensor could activate and cause the wipers to move unintentionally. This may lead to vehicle damage.



After running the vehicle through an automatic car wash, wipe any wax off of the windshield (> page 366) and the wiper blade inserts (> page 366). This will prevent smears and reduce wiping noise which can be caused by residual wax on the windshield.

When leaving the car wash, make sure that the mirrors are folded out. Otherwise they may vibrate.

### Ornamental moldings

For regular cleaning and care of ornamental moldings, use a damp cloth.



Do not use chrome cleaner on ornamental moldings. Although ornamental moldings may have chrome appearance, they could be made of anodized aluminum that will be damaged when cleaned with chrome cleaner. Instead, use a damp cloth to clean those ornamental moldings.

For very dirty ornamental moldings of which you are sure are chrome-plated, use a chrome cleaner. If in doubt whether an ornamental molding is chrome-plated, contact an authorized Mercedes-Benz Center.

### Headlamps, tail lamps, side markers, turn signal lenses

- ▶ Use a mild car wash detergent, such as Mercedes-Benz approved Car Shampoo, with plenty of water.



Only use window cleaning solutions that are suitable for plastic lamp lenses. Window cleaning solutions which are not suitable may damage the plastic lamp lenses of the headlamps. Therefore, do not use abrasives, solvents or cleaners that contain solvents.

Never apply strong force and only use a soft, non-scratching cloth when cleaning the lenses. Do not attempt to wipe dirty lenses with a dry cloth or sponge.

Otherwise you may scratch or damage the lens surface.

## Vehicle care

### Cleaning the DISTRONIC\* system sensor cover

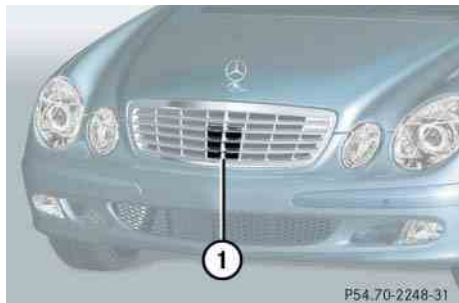

① DISTRONIC system sensor cover

- ▶ Switch off the ignition (▷ page 36).
- ▶ Use a mild car wash detergent, such as Mercedes-Benz approved Car Shampoo, with plenty of water and a non-scratching cloth to clean sensor cover ①.



To prevent scratches or damage, never apply strong force and only use a soft, non-scratching cloth when cleaning the sensor cover ①. Do not attempt to wipe dirty sensors with a dry cloth or sponge.

- ▶ Restart the engine after cleaning sensor cover ①.

### Cleaning the windows and the wiper blades



The windshield wipers must be in a vertical position before folding them away from the windshield. They could otherwise damage the hood.

Never open the hood when the wiper arms are folded forward.

- ▶ Switch on the ignition (▷ page 36).
- ▶ Turn combination switch to wiper setting II (▷ page 55).

- ▶ With wiper arms in vertical position, switch off the ignition (▷ page 61).

### Warning!



For safety reasons, switch off wipers and remove SmartKey from starter switch (vehicles with KEYLESS-GO\*: Make sure the vehicle's on-board electronics have status 0) before cleaning the windshield the windshield and/or the wiper blades. Otherwise, the wiper motor could suddenly turn on and cause injury.

- ▶ Fold the wiper arms forward until they snap into place.
- ▶ Clean the wiper blade inserts with a clean cloth and detergent solution.
- ▶ Use a soft, clean cloth and a mild window cleaning solution on all outside and inside glass surfaces.

An automotive glass cleaner is recommended.



Fold the windshield wiper arms back onto the windshield before turning the SmartKey in the starter switch or pressing the KEYLESS-GO start/stop button (vehicles with KEYLESS-GO\*).

Hold on to the wiper when folding the wiper arm back. If released, the force of the impact from the tensioning spring could crack the windshield.



To clean the window interior, do not use a dry cloth, abrasives, solvents or cleaners containing solvents. Do not touch the inside of the front, rear or side windows with hard objects such as an ice scraper or ring. Doing so may damage the windows.

### Light alloy wheels

If possible, clean wheels once a week.

- ▶ Use Mercedes-Benz approved Wheel Care, a soft bristle brush and a strong spray of water for cleaning the light alloy wheels.



Only use acid-free cleaning materials. Acid may cause corrosion or damage the clear coat.



The vehicle should not be parked for an extended period of time immediately after it has been cleaned, especially not after the wheel rims have been cleaned with wheel rim cleaner. Wheel rim cleaners can lead to increased corrosion of the brake disks and brake pads. Therefore, the vehicle's brake system should always be warmed-up before it is parked after cleaning. To do so, please drive your vehicle for several minutes to allow the brakes to dry.

When applying Mercedes-Benz approved Tire Care and Mercedes-Benz approved Wheel Care products, take care not to spray them on the brake disks.

### Plastic and rubber parts

- ▶ Use a gentle dishwashing detergent or mild detergent for delicate fabrics as a washing solution.



Do not use oil or wax on these parts.

### Instrument cluster and cup holders

- ▶ Use a gentle dishwashing detergent or mild detergent for delicate fabrics as a washing solution.
- ▶ Wipe with a cloth moistened in a lukewarm solution.



To prevent scratches, do not use scouring agents.



### Vehicle care

#### Hard plastic trim items

- ▶ Use Pour Mercedes-Benz approved Interior Care, a soft, lint-free cloth and apply with light pressure onto.



To prevent scratches, do not use scouring agents.

#### Steering wheel and gear selector lever

- ▶ Wipe with a damp cloth and dry thoroughly or clean with Mercedes-Benz approved Leather Care.

#### Carpets

- ▶ Use Mercedes-Benz approved Carpet and Fabric Care for cleaning the carpets.

#### Headliner and shelf below rear window

- ▶ Use a soft bristle brush or a dry-shampoo cleaner in case of excessive dirt.

#### Seat belts

- ▶ Only use clear, lukewarm water and soap.



The webbing must not be treated with chemical cleaning agents. Do not dry the webbing at temperatures above 176°F (80°C) or in direct sunlight.

#### Warning!



Do not bleach or dye seat belts as this may severely weaken them. In a crash they may not be able to provide adequate protection.

#### Upholstery

Using aftermarket seat covers or wearing clothing that have the tendency to give off coloring (e.g. when wet, etc.) may cause the upholstery to become permanently discolored. By lining the seats with a proper intermediate cover, contact-discoloration will be prevented.

#### Leather upholstery

- ▶ Wipe leather upholstery with a damp cloth and dry thoroughly or clean with Mercedes-Benz approved Leather Care.

Exercise particular care when cleaning perforated leather as its underside should not become wet.

***Nubuck leather upholstery (E 55 AMG)***

The nubuck leather upholstery is treated with a protective coating.

- ▶ Wipe nubuck leather upholstery with damp microfiber cloth to remove dust and other light stains.
- ▶ Carefully dab nubuck leather upholstery with a dry microfiber cloth to remove oil stains.



Do not use Mercedes-Benz approved Leather Care or any solvents to clean nubuck leather upholstery.

Avoid hard scrubbing on nubuck leather upholstery.

**Wood trims**

- ▶ Dampen cloth using water and use damp cloth to clean wood trims in your vehicle.



Do not use solvents like tar remover or wheel cleaner nor polishes or waxes as these may be abrasive.



What to do if ...

Where will I find ...?

Unlocking/locking in an emergency

Opening/closing in an emergency

Resetting activated head restraints

Replacing SmartKey batteries

Replacing bulbs

Replacing wiper blades

Flat tire

Batteries

Jump starting

Towing the vehicle

Fuses



### What to do if ...

#### Lamps in instrument cluster

General information:

If any of the following lamps in the instrument cluster fails to come on during the

bulb self-check when switching on the ignition, have the respective bulb checked and replaced if necessary.

Problem	Possible cause/consequence	Suggested solution
 <p>The yellow ABS indicator lamp comes on while driving.</p>	<p>The ABS has detected a malfunction and has switched off. The BAS and the ESP<sup>®</sup> are also switched off (see messages in multifunction display).</p> <p>The electrohydraulic brake system is still functioning normally but without the ABS available.</p> <p>If the ABS control unit is malfunctioning, other systems such as Distronic*, or the automatic transmission may also be malfunctioning.</p> <p>The charging voltage has fallen below 10 volts. The ABS has switched off.</p> <p>The battery may not be sufficiently charged.</p>	<ul style="list-style-type: none"> <li>▶ Continue driving with added caution. Wheels may lock during hard braking, reducing steering capability.</li> <li>▶ Read and observe messages in the multifunction display (▷ page 383).</li> <li>▶ Have the system checked at an authorized Mercedes-Benz Center as soon as possible.</li> </ul> <p>Failure to follow these instructions increases the risk of an accident.</p> <ul style="list-style-type: none"> <li>▶ Switch off electrical consumers that are currently not needed, e.g. seat heating.</li> <li>▶ If necessary, have the generator and battery checked.</li> </ul> <p>When the voltage is above this value again, the ABS is operational again.</p>

Problem	Possible cause/consequence	Suggested solution
 <p>The yellow ABS/ESP<sup>®</sup> warning lamp comes on while driving.</p>	<p>The ESP<sup>®</sup> is deactivated. Risk of accident! Adapt your speed and driving to the prevailing road, weather, and traffic conditions.</p>	<ul style="list-style-type: none"> <li>▶ Switch the ESP<sup>®</sup> back on (▷ page 96).</li> </ul> <p>If the ESP<sup>®</sup> cannot be switched back on, have the system checked at an authorized Mercedes-Benz Center as soon as possible.</p>
<p>The yellow ABS/ESP<sup>®</sup> warning lamp flashes while driving.</p>	<p>The ABS, ESP<sup>®</sup> or traction control has come into operation because of detected traction loss in at least one tire. Distronic* is deactivated.</p>	<ul style="list-style-type: none"> <li>▶ When driving off, apply as little throttle as possible.</li> <li>▶ While driving, ease up on the accelerator.</li> <li>▶ Adapt your speed and driving to the prevailing road and weather conditions.</li> <li>▶ Do not deactivate the ESP<sup>®</sup>. Exceptions: (▷ page 95)</li> </ul> <p>Failure to follow these instructions increases the risk of an accident.</p>

### What to do if ...

Problem		Possible cause/consequence	Suggested solution
<b>BRAKE</b>	(USA only)	The red brake warning lamp comes on while driving and you hear a warning sound.	<ul style="list-style-type: none"> <li>▶ Release the parking brake.</li> <li>▶ Observe the additional message in the multifunction display.</li> </ul>
<b>(i)</b>	(Canada only)	The red brake warning lamp comes on while driving.	
		<ul style="list-style-type: none"> <li>• There is a malfunction in the electrohydraulic brake system.</li> <li>• There is insufficient brake fluid in the reservoir.</li> </ul>	<ul style="list-style-type: none"> <li>▶ Risk of accident! Do not drive any further. Consult a Mercedes-Benz Service Center. Under no circumstances should you top up the brake fluid. This will not solve the problem.</li> </ul>

### Warning!





Driving with the brake warning lamp illuminated can result in an accident. Have your brake system checked immediately if the brake warning lamp stays on. Do not add brake fluid before checking the brake system.

Overfilling the brake fluid reservoir can result in spilling brake fluid on hot engine parts and the brake fluid catching fire. You can be seriously burned.



If you find that the brake fluid in the brake fluid reservoir has fallen to the minimum mark or below, have the brake system checked for brake pad thickness and leaks.

Problem	Possible cause/consequence	Suggested solution
<p> (USA only)</p> <p> (Canada only)</p> <p>The yellow engine malfunction indicator lamp comes on while driving.</p>	<p>There is a malfunction in:</p> <ul style="list-style-type: none"> <li>• The fuel management system</li> <li>• The ignition system</li> <li>• The emission control system</li> <li>• Systems which affect emissions</li> </ul> <p>Such malfunctions may result in excessive emissions values and may switch the engine to its limp-home (emergency operation) mode.</p> <p>A loss of pressure has been detected in the fuel system. The fuel cap may not be closed properly or the fuel system may be leaky.</p> <p>Your fuel tank is empty.</p>	<p>▶ Have the vehicle checked as soon as possible by an authorized Mercedes-Benz Center. An on-board diagnostic connector is used by the service station to link the vehicle to the shop diagnostics system. It allows the accurate identification of system malfunctions through the readout of diagnostic trouble codes. It is located in the front left area of the footwell next to the parking brake.</p> <p>▶ Check the fuel cap. If it is not closed properly:</p> <p>▶ Close the fuel cap. If it is closed properly:</p> <p>▶ Have the fuel system checked by an authorized Mercedes-Benz Center.</p> <p>▶ After refuelling start, turn off and restart the engine three or four times in succession.</p> <p>The limp-home mode is canceled. You do not need to have your vehicle checked.</p>



### What to do if ...

Problem	Possible cause/consequence	Suggested solution
 <p>The red coolant warning lamp comes on when the engine is running.</p>	<p>There is insufficient coolant in the reservoir.</p> <p>If this warning lamp comes on frequently, there is a leak in the cooling system.</p> <p>If the coolant level is correct, the electric radiator fan may be broken.</p>	<ul style="list-style-type: none"> <li>▶ Immediately add coolant to prevent engine from overheating (▷ page 321).</li> <li>▶ Have the cooling system checked.</li> <li>▶ If the coolant temperature is below 257°F (125°C), you can continue driving to the nearest authorized Mercedes-Benz Center.</li> <li>▶ Avoid high engine loads (e.g. driving uphill) and stop-and-go driving.</li> </ul>
<p>The red coolant warning lamp comes on while driving and you hear a warning sound.</p>	<p>The coolant temperature has exceeded 257°F (125°C).</p>	<ul style="list-style-type: none"> <li>▶ Stop as soon as possible in a safe location and allow the engine and coolant to cool down.</li> </ul>

### Warning!





Driving when your engine is badly overheated can cause some fluids which may have leaked into the engine compartment to



catch fire. You could be seriously burned.

Steam from an overheated engine can cause serious burns and can occur just by opening the engine hood. Stay away from the engine if you see or hear steam coming from it.

Turn off the engine, get out of the vehicle and do not stand near the vehicle until the engine has cooled down.

Problem	Possible cause/consequence	Suggested solution
 Only vehicles with DISTRONIC*: The red distance warning lamp comes on while driving.	You are too close to the vehicle in front of you to maintain selected speed.	<ul style="list-style-type: none"> <li>▶ Apply the brakes immediately to increase the following distance.</li> </ul>
Only vehicles with DISTRONIC*: The red distance warning lamp comes on while driving and you hear a warning chime sound.	<ul style="list-style-type: none"> <li>• You are gaining too rapidly on the vehicle ahead of you.</li> <li>• The distance warning system has recognized a stationary obstacle on your probable line of travel.</li> </ul>	<ul style="list-style-type: none"> <li>▶ Apply the brakes immediately.</li> <li>▶ Carefully observe the traffic situation. You may need to brake or maneuver to avoid hitting an obstacle.</li> </ul>
 The yellow fuel tank reserve warning lamp comes on while driving.	The fuel level has gone below the reserve mark.	<ul style="list-style-type: none"> <li>▶ Refuel at the next gas station (▷ page 312).</li> </ul>
 The red seat belt telltale comes on after starting the engine with all doors closed.	The seat belt telltale reminds you and your passengers to fasten your seat belts before driving off.	<ul style="list-style-type: none"> <li>▶ Fasten your seat belts.</li> </ul>
The red seat belt telltale flashes and you additionally hear an intermittent warning signal with increasing intensity for a maximum of 60 seconds when the vehicle's speed exceeds 15 mph (25 km/h).	<p>You and/or your front passenger have forgotten to fasten your seat belts.</p> <p>There are items placed on the front passenger seat and therefore the system senses the front passenger seat as being occupied.</p>	<ul style="list-style-type: none"> <li>▶ Fasten your seat belts.</li> <li>▶ Remove the items from the front passenger seat and put them in a safe place.</li> </ul>

### What to do if ...

Problem	Possible cause/consequence	Suggested solution
 <p>Combination low tire pressure/TPMS malfunction telltale for the TPMS* illuminates continuously.</p>	<p>The TPMS* detects a loss of pressure in at least one tire.</p>	<ul style="list-style-type: none"> <li>▶ Carefully bring the vehicle to a halt, avoiding abrupt steering and braking maneuvers. Observe the traffic situation around you.</li> <li>▶ Read and observe messages in the multifunction display.</li> </ul> <p>If the tire inflation pressure in the respective tire(s) has (have) been corrected, the combination low tire pressure/TPMS malfunction telltale goes out after few minutes driving.</p>
 <p>Combination low tire pressure/TPMS malfunction telltale for the TPMS* flashes for 60 seconds and then stays illuminated.</p>	<p>There is a malfunction in the TPMS*.</p>	<ul style="list-style-type: none"> <li>▶ Read and observe messages in the multifunction display.</li> <li>▶ Have the TPMS* checked by an authorized Mercedes-Benz Center.</li> </ul> <p>After the malfunction has been remedied the combination low tire pressure/TPMS malfunction telltale goes out after few minutes driving.</p>

**Warning!**

Each tire, including the spare (if provided), should be checked monthly when cold and inflated to the inflation pressure recommended by the vehicle manufacturer on the vehicle placard or the tire inflation pressure label. (If your vehicle has tires of a different size than the size indicated on the vehicle placard or the tire inflation pressure label, you should determine the proper tire inflation pressure for those tires).

As an added safety feature, your vehicle has been equipped with a tire pressure monitoring system (TPMS) that illuminates a low tire pressure telltale when one or more of your tires is significantly under-inflated. Accordingly, when the low tire pressure telltale illuminates, you should stop and check your tires as soon as possible, and inflate them to the proper pressure. Driving on a significantly under-inflated tire causes the tire to overheat and can lead to tire failure.

Under-inflation also reduces fuel efficiency and tire tread life, and may affect the vehicle's handling and stopping ability. Please note that the TPMS is not a substitute for proper tire maintenance, and it is the driver's responsibility to maintain correct tire pressure, even if under-inflation has not reached the level to trigger illumination of the TPMS low tire pressure telltale.

Your vehicle has also been equipped with a TPMS malfunction indicator to indicate when the system is not operating properly. The TPMS malfunction indicator is combined with the low tire pressure telltale. When the system detects a malfunction, the telltale will flash for approximately one minute and then remain continuously illuminated. This sequence will continue upon subsequent vehicle start-ups as long as the malfunction exists. When the malfunction indicator is illuminated, the system may not be able to detect or signal low tire pressure as intended.

TPMS malfunctions may occur for a variety of reasons, including the installation of incompatible replacement or alternate tires or wheels on the vehicle that prevent the TPMS from functioning properly. Always check the TPMS malfunction telltale after replacing one or more tires or wheels on your vehicle to ensure that the replacement or alternate tires and wheels allow the TPMS to continue to function properly.

### What to do if ...



Problem	Possible cause/consequence	Suggested solution
<b>SRS</b> The red SRS indicator lamp comes on while driving.	There is a malfunction in the restraint systems. The air bags or emergency tensioning devices (ETDs) could deploy unexpectedly or fail to activate in an accident.	► Drive with added caution to the nearest authorized Mercedes-Benz Center.

#### Warning!





In the event a malfunction of the SRS is indicated as outlined above, the SRS may not be operational. For your safety, we strongly recommend that you visit an authorized Mercedes-Benz Center immediately to have the system checked; otherwise the SRS may not be activated when needed in an accident, which could result in serious or fatal injury, or it might deploy unexpectedly and unnecessarily which could also result in an accident and/or injury to you or to others.

## Lamp in center console



Problem	Possible cause/consequence	Suggested solution
<p> </p> <p>The indicator lamp illuminates and remains illuminated with the weight of a typical adult or someone larger than a small individual on the front passenger seat.</p>	<p>The system is malfunctioning.</p>	<ul style="list-style-type: none"> <li>▶ Have the system checked as soon as possible by an authorized Mercedes-Benz Center.</li> <li>▶ Read and observe messages in the multifunction display and follow corrective steps (▷ page 390).</li> </ul>

### Warning!





If the   indicator lamp illuminates and remains illuminated with the weight of a typical adult or someone larger than a small individual on the front passenger seat, do not have any passenger use the front passenger seat until the system has been repaired.

### What to do if ...

Problem	Possible cause/consequence	Suggested solution
<p> </p> <p>The indicator lamp does not illuminate and/or does not remain illuminated with the weight of a typical 12-month-old child in a standard child restraint or less on the front passenger seat.</p>	<p>The system is malfunctioning.</p>	<ul style="list-style-type: none"> <li>▶ Make sure that there is nothing between seat cushion and child seat and check installation of the child seat.</li> <li>▶ Make sure that no objects applying supplemental weight onto the seat are present.</li> <li>▶ Make sure that no objects which apply forces to the seat are present (e.g. objects such as books, brief-cases etc. lodged behind or around the seat, head restraints pushing against roof etc.). The system may recognize such forces as supplemental weight.</li> <li>▶ If the light remains out, have the system checked as soon as possible by an authorized Mercedes-Benz Center. Do not transport a child on the front passenger seat until the system has been repaired.</li> <li>▶ Read and observe messages in the multifunction display and follow corrective steps (▷ page 390).</li> </ul>

### Warning!



If the   indicator lamp does not illuminate or remains out with the weight of

a typical 12-month-old child in a standard child restraint or less on the front passenger seat,

do not transport a child on the front passenger seat until the system has been repaired.

## Vehicle status messages in the multifunction display





Warning and malfunction messages appear in the multifunction display located in the instrument cluster.





Certain warning and malfunction messages are accompanied by an audible signal.

Address these messages accordingly and follow the additional instructions given in this Operator's Manual.

Selecting the vehicle status message memory menu in the control system (▷ page 164) displays both cleared and uncleared messages.

High-priority messages appear in the multifunction display in red color.

Certain messages of high priority cannot be cleared from the multifunction display using the reset button (▷ page 151) or button , ,  or  on the multifunction steering wheel.

Other messages of high priority and messages of less immediate priority can be cleared from the multifunction display using the reset button (▷ page 151) or button , ,  or  on the multifunction steering wheel. They are then stored in the vehicle status message memory (▷ page 164). Remember that clearing a message will only make the message disappear. Clearing a message will not correct the condition that caused the message to appear.

### Warning!



All categories of messages contain important information which should be taken note of and, where a malfunction is indicated, addressed as soon as possible at an authorized Mercedes-Benz Center.

Failure to repair condition noted may cause damage not covered by the Mercedes-Benz Limited Warranty, or result in property damage or personal injury.

### Warning!



No messages will be displayed if either the instrument cluster or the multifunction display is inoperative.

Contact the nearest authorized Mercedes-Benz Center.



### What to do if ...



Switching on the ignition causes all instrument cluster lamps (except low beam headlamp indicator lamp, high beam headlamp indicator lamp, and turn signal indicator lamps unless activated) as well as the multifunction display to come on. Make sure the lamps and multifunction display are in working order before starting your journey.

On the pages that follow, you will find a compilation of the most important warning and malfunction messages that may appear in the multifunction display.

For your convenience the messages are divided into two sections:

- Text messages (▷ page 385)
- Symbol messages (▷ page 395)

Text messages

Display	Display message	Possible cause/consequence	Possible solution
ABS	Malfunction Visit workshop	<p>The ABS has detected a malfunction and has switched off.</p> <p>The ESP® and the BAS are also deactivated.</p> <p>The electrohydraulic brake system is still functioning normally but without the ABS available.</p>	<ul style="list-style-type: none"> <li>▶ Continue driving with added caution. Wheels will lock during hard braking, reducing steering capability.</li> <li>▶ Have the system checked at an authorized Mercedes-Benz Center as soon as possible.</li> </ul> <p>Failure to follow these instructions increases the risk of an accident.</p>
	Display malfunction Visit workshop	The ABS or the ABS display is malfunctioning.	<ul style="list-style-type: none"> <li>▶ Continue driving with added caution. Wheels will lock during hard braking, reducing steering capability.</li> <li>▶ Visit an authorized Mercedes-Benz Center as soon as possible.</li> </ul> <p>Failure to follow these instructions increases the risk of an accident.</p>

### What to do if ...

Display	Display message	Possible cause/consequence	Possible solution
Low Battery	Conven. functions temporarily unavailable	The battery has insufficient voltage and can no longer supply convenience functions such as the rear window defroster.	As soon as the on-board voltage is sufficient, the consumers will switch on again.
Please note:	Conven. functions available again	On-board voltage is sufficient; the consumers will switch on again.	
Cruise control	Drive to workshop	Cruise control or Distronic* is malfunctioning.	▶ Have the cruise control or Distronic* checked by an authorized Mercedes-Benz Center.
Distronic	External interference Reactivate	The Distronic* is switched off and is temporarily unavailable.	▶ Try activating the Distronic* again later.
	Drive to workshop	The Distronic* is malfunctioning or the display is malfunctioning.	▶ Visit an authorized Mercedes-Benz Center as soon as possible.

Display	Display message	Possible cause/consequence	Possible solution
DISTRONIC	Currently unavailable See Operator's Manual	DISTRONIC* is switched off if: <ul style="list-style-type: none"> <li>the DISTRONIC* cover in the area of the radiator grille is dirty</li> <li>the functionality is impaired by heavy rain or thick fog</li> </ul>	<ul style="list-style-type: none"> <li>If necessary, clean the DISTRONIC* cover in the area of the radiator grille.</li> <li>Restart the vehicle.</li> </ul> <p>or</p> <p>DISTRONIC* becomes operational again without the engine being restarted when:</p> <ul style="list-style-type: none"> <li>dirt on the grille falls off while driving (e.g. slush or snow)</li> <li>the system recognizes full sensor availability (due to lessening rain or the road surface drying)</li> <li>the message in the multifunction display disappears</li> <li>the speed last stored flashes in the multifunction display for 5 seconds.</li> </ul> <p>You can operate DISTRONIC* as usual again.</p>

**Warning!**



DISTRONIC\* cannot take weather conditions into account. Switch off DISTRONIC\* or do not turn it on if the sensor is dirty or visibility is

diminished as a result of snow, rain or fog. The distance control may be impaired even before the system is able to detect a dirty sensor. The message

DISTRONIC  
Currently unavailable  
See Operator's Manual  
will be displayed in the multifunction display and DISTRONIC\* will be turned off.

### What to do if ...

Display	Display message	Possible cause/consequence	Possible solution
ESP	Malfunction Visit workshop	The ESP <sup>®</sup> has detected a malfunction and switched off.  The ABS may not be operational.  The electrohydraulic brake system is still functioning normally but without the ESP <sup>®</sup> available.	<ul style="list-style-type: none"> <li>▶ Continue driving with added caution.</li> <li>▶ Have the system checked at an authorized Mercedes-Benz Center as soon as possible.</li> </ul> <p>Failure to follow these instructions increases the risk of an accident.</p>
	unavailable See Operator's Manual	The ESP <sup>®</sup> is deactivated because the power supply was interrupted.  The electrohydraulic brake system is still functioning normally but without the ESP <sup>®</sup> available.	<ul style="list-style-type: none"> <li>▶ Synchronize the ESP<sup>®</sup>. With the vehicle stationary, turn the steering wheel completely to the left and then to the right to synchronize the ESP<sup>®</sup>.</li> </ul> <p>If the ESP<sup>®</sup> message does not go out:</p> <ul style="list-style-type: none"> <li>▶ Continue driving with added caution.</li> <li>▶ Have the system checked at an authorized Mercedes-Benz Center as soon as possible.</li> </ul> <p>Failure to follow these instructions increases the risk of an accident.</p>







**!**  
When synchronizing the ESP<sup>®</sup>, make sure you can turn the steering wheel in

both directions as far as it will go without the wheels hitting any objects, e.g. a road curb.

Display	Display message	Possible cause/consequence	Possible solution
ESP	Display malfunction Visit workshop	The ESP® or the ESP® display is malfunctioning.	<ul style="list-style-type: none"> <li>▶ Continue driving with added caution.</li> <li>▶ Have the system checked at an authorized Mercedes-Benz Center as soon as possible.</li> </ul> <p>Failure to follow these instructions increases the risk of an accident.</p>
P	Gear selector lever in Park	You have attempted to turn off the engine with the KEYLESS-GO* start/stop button with the gear selector lever not in <b>P</b> . You have opened the driver's door with the gear selector lever not in <b>P</b> .	<ul style="list-style-type: none"> <li>▶ Place the gear selector lever in position <b>P</b>.</li> </ul>
P/N	Shift to Neutral or Park	You have attempted to start the engine with the KEYLESS-GO* start/stop button while the gear selector lever was in position <b>R</b> or <b>D</b> .	<ul style="list-style-type: none"> <li>▶ Place the gear selector lever in position <b>P</b> or <b>N</b>. Make sure the brake pedal is depressed.</li> </ul>



### What to do if ...

Display messages	Possible cause/consequence	Possible solution
<p>Front passenger airbag activated See Operator's Manual</p>	<p>Front passenger front air bag is activated while driving even though a child, small individual, or object below the system's weight threshold is on the front passenger seat, or the front passenger seat is empty. Objects on the seat or forces acting on the seat may make the system sense supplemental weight.</p>	<p>Stop the vehicle in a safe location as soon as possible and check the front passenger seat for the following:</p> <ul style="list-style-type: none"> <li>▶ Switch off the ignition (▷ page 36).</li> <li>▶ Open the front passenger door.</li> <li>▶ Remove child and child restraint from front passenger seat and properly secure the child in rear seat employing the child restraint if necessary.</li> <li>▶ Remove any other items from on and around the front passenger seat and make sure the storage pocket on the back of the front passenger seat is empty.</li> <li>▶ Make sure that no objects which apply forces to the seat are present (e.g. objects such as books, briefcases etc. lodged behind or around the seat, head restraints pushing against roof etc.). The system may recognize such forces as supplemental weight and sense that an occupant on the front passenger seat is of a greater weight than actually present.</li> <li>▶ Keep the seat unoccupied, close the front passenger door and turn on the ignition (▷ page 36).</li> </ul> <p>(Continued on next page)</p>

Display messages	Possible cause/consequence	Possible solution
<p>Front passenger airbag activated See Operator's Manual</p>		<p>Monitor the   indicator lamp on the center console (▷ page 27) and the multifunction display in the instrument cluster (▷ page 26) for the following:</p> <p>With the seat unoccupied and the ignition turned on,</p> <ul style="list-style-type: none"> <li>the   indicator lamp on the center console should illuminate and remain illuminated, indicating that the OCS (▷ page 81) has deactivated the front passenger front air bag.</li> <li>the message <code>Front passenger airbag activated See Operator's Manual</code> or the message <code>Front passenger airbag deactivated See Operator's Manual</code> should not appear in the multifunction display at any time the seat is unoccupied. Wait at last 60 seconds for the system to complete the necessary check cycles and to make sure neither message appears in the multifunction display.</li> </ul> <p>If above conditions are met, you can occupy the front passenger seat again. Depending on the front passenger classification sensed by the OCS (▷ page 81), the   indicator lamp will remain illuminated or go out.</p> <p>If above conditions are not met, the system is not working properly. Have the system checked as soon as possible by an authorized Mercedes-Benz Center.</p>

**Warning!**



If the   indicator lamp remains







out even after performing the above corrective steps, do not have any children 12 years old and under and other small individuals

use the front passenger seat until the system has been repaired.





### What to do if ...

Display messages	Possible cause/consequence	Possible solution
<p>Front passenger airbag deactivated See Operator's Manual</p>	<p>Front passenger front air bag is deactivated while driving even though an adult or someone larger than a small individual is occupying the front passenger seat. Forces acting on the seat may make the system sense a decrease in weight.</p>	<p>Stop the vehicle in a safe location as soon as possible and check the front passenger seat for the following:</p> <ul style="list-style-type: none"> <li>▶ Switch off the ignition (▷ page 36).</li> <li>▶ Have the front passenger vacate the seat and exit the vehicle.</li> <li>▶ Adjust the seat in a height position (▷ page 41).</li> <li>▶ Make sure that no objects which apply forces to the seat are present (e.g. objects such as books, briefcases etc. lodged underneath, behind or around the seat). Such forces may cause the system to sense that an occupant of a lesser weight than actually present is on the front passenger seat.</li> <li>▶ Keep the seat unoccupied, close the front passenger door and turn on the ignition (▷ page 36).</li> </ul> <p>(Continued on next page)</p>

Display messages	Possible cause/consequence	Possible solution
<p>Front passenger airbag deactivated See Operator's Manual</p>		<p>Monitor the   indicator lamp on the center console (▷ page 27) and the multifunction display in the instrument cluster (▷ page 26) for the following:</p> <p>With the seat unoccupied and the ignition turned on,</p> <ul style="list-style-type: none"> <li>the   indicator lamp on the center console should illuminate and remain illuminated, indicating that the OCS (▷ page 81) has deactivated the front passenger front air bag.</li> <li>the message Front passenger airbag activated See Operator's Manual or the message Front passenger airbag deactivated See Operator's Manual should not appear in the multifunction display at any time the seat is unoccupied. Wait at last 60 seconds for the system to complete the necessary check cycles and to make sure neither message appears in the multifunction display.</li> </ul> <p>If above conditions are met, you can occupy the front passenger seat again. Depending on the front passenger classification sensed by the OCS (▷ page 81), the   indicator lamp will remain illuminated or go out.</p> <p>If above conditions are not met, the system is not working properly. Have the system checked as soon as possible by an authorized Mercedes-Benz Center.</p>

**Warning!**



If the   indicator lamp remains

illuminated with an adult occupant on the front passenger seat even after performing the above corrective steps, do not have any

passenger use the front passenger seat until the system has been repaired.



### What to do if ...





Display message	Possible cause/consequence	Possible solution
Tire pres. monitor inoperative	The TPMS* is malfunctioning.	▶ Have the TPMS* checked by an authorized Mercedes-Benz Center.
Tire pres. monitor inoperative No wheel sensors	There are wheels without wheel sensors mounted (e.g. winter tires).	▶ Have the TPMS* checked by an authorized Mercedes-Benz Center. ▶ Have the wheel sensors installed by an authorized Mercedes-Benz Center.
Tire pres. monitor Wheel sensor missing	One or more sensors malfunction (e.g. battery in one or more wheel sensor is empty). One or more wheels without wheel sensors mounted (e.g. spare tire).	▶ Have the TPMS* checked by an authorized Mercedes-Benz Center. ▶ Have the wheel sensors installed by an authorized Mercedes-Benz Center.  The tire pressure for the respective tire is shown in the multifunction display.
Tire pres. monitor currently unavailable	The TPMS* is unable to monitor the tire pressure due to <ul style="list-style-type: none"> <li>• a nearby radio interference source.</li> <li>• excessive wheel sensor temperatures.</li> </ul>	▶ As soon as the causes for the malfunction are no longer present, the TPMS* automatically becomes active again after a few minutes driving.

Symbol messages

Display symbol	Display messages	Possible cause/consequence	Possible solution
	Low voltage Switch off consumers	The battery has insufficient voltage.	▶ Turn off unnecessary electrical consumers.
	Visit workshop	<p>The battery was charged with a battery charger or jump started.</p> <p>The battery is no longer charging. Possible causes:</p> <ul style="list-style-type: none"> <li>• alternator malfunctioning</li> <li>• broken poly-V-belt</li> </ul> <p>Do not forget that the brake system requires electrical energy and may be operating with restricted capability. Considerably greater brake pedal force is required and the stopping distance is increased.</p>	<p>▶ Have the battery checked at a service station.</p> <p>▶ Stop immediately in a safe location or as soon as it is safe to do so and check the poly-V-belt.</p> <p>If it is broken:</p> <p>▶ Do not continue to drive. Otherwise the engine will overheat due to an inoperative water pump which may result in damage to the engine. Notify an authorized Mercedes-Benz Center.</p> <p>If it is intact:</p> <p>▶ Drive immediately to the nearest authorized Mercedes-Benz Center. Adjust driving to be consistent with reduced braking responsiveness.</p>

### What to do if ...



Display symbol	Display messages	Possible cause/consequence	Possible solution
	Battery/Alternator Stop vehicle	The battery is malfunctioning.  The electrohydraulic brake system requires electrical energy and therefore has only limited operation. Considerably greater brake pedal force is required and the stopping distance is increased.	<ul style="list-style-type: none"> <li>▶ Stop the vehicle in a safe location as soon as it is safe to do so. Adjust driving to be consistent with reduced braking responsiveness.</li> <li>▶ Notify an authorized Mercedes-Benz Center.</li> </ul>
	Low voltage Start engine	The battery has insufficient voltage.	▶ Start the engine (▷ page 50).
	Malfunction Electrical consumers switched off	The consumer battery has insufficient voltage and can no longer supply the convenience functions such as seat ventilation*.	The electrical consumers will come back online as soon as on-board voltage is sufficient.
	Backrest, right rear not locked	The rear seat backrest is not engaged.	▶ Adjust the rear seat backrest until it is fully engaged in position.
	Backrest, left rear not locked	The rear seat backrest is not engaged.	▶ Adjust the rear seat backrest until it is fully engaged in position.



Display symbol	Display messages	Possible cause/consequence	Possible solution
	Brake wear Visit workshop	The brake pads have reached their wear limit.	<ul style="list-style-type: none"> <li>▶ Brake pad thickness must be visually inspected at the intervals specified in the Maintenance Booklet.</li> <li>▶ Have the brake pads replaced as soon as possible.</li> </ul>
	Reduced braking power Depress brake pedal fully	<p>The electrohydraulic brake system is in emergency operation mode. Considerably greater brake pedal force is required and the stopping distance is increased.</p> <p>The maximum speed is limited to 55 mph (90 km/h).</p>	<ul style="list-style-type: none"> <li>▶ Do <b>not</b> drive any further.</li> <li>▶ Stop the vehicle in a safe location as soon as it is safe to do so and notify an authorized Mercedes-Benz Center.</li> <li>▶ Prevent the vehicle from rolling away by blocking the wheels with wheel chocks or other sizable objects.</li> <li>▶ Call for Roadside Assistance.</li> </ul>
(USA only)  (Canada only) 	Reduced braking power Start engine	The battery has insufficient voltage and cannot supply sufficient power to the electrohydraulic brake system.	<ul style="list-style-type: none"> <li>▶ Start the engine (▷ page 50). The message disappears when sufficient voltage is available.</li> </ul>

 Brake pad thickness must be visually inspected by a qualified technician at

the intervals specified in the Maintenance Booklet.

### What to do if ...

Display symbol	Display messages	Possible cause/consequence	Possible solution
(USA only)  (Canada only) 	Reduced braking power Visit workshop	The electrohydraulic brake system is in emergency operation mode. Considerable brake pedal force is required and the stopping distance is increased.	<ul style="list-style-type: none"> <li>▶ Continue driving with added caution.</li> <li>▶ Adjust driving to be consistent with reduced braking responsiveness.</li> <li>▶ Visit an authorized Mercedes-Benz Center as soon as possible.</li> </ul>
	Service brake Visit workshop	There are malfunctions, but the electrohydraulic brake system is operating normally.	<ul style="list-style-type: none"> <li>▶ Visit an authorized Mercedes-Benz Center as soon as possible.</li> </ul>
	Brake overheated Drive on, but with even greater care	The brake system is overheated due to an excessive load on the brakes.	<ul style="list-style-type: none"> <li>▶ Relieve the load on the brake system.</li> <li>▶ Drive more smoothly and think ahead to avoid unnecessary braking.</li> <li>▶ When driving down slopes, shift into a lower gear to use the engine's braking power (▷ page 191).</li> <li>▶ Cautiously continue driving so that the air stream will cool down the brakes.</li> </ul>
	Release parking brake	You are driving with the parking brake set.	<ul style="list-style-type: none"> <li>▶ Release the parking brake (▷ page 52).</li> </ul>

Display symbol	Display messages	Possible cause/consequence	Possible solution
(USA only)  (Canada only) 	Brake fluid Visit workshop	There is insufficient brake fluid in the reservoir.	▶ Risk of accident! Stop the vehicle in a safe location as soon as it is safe to do so and notify an authorized Mercedes-Benz Center. Do not add brake fluid! This will not solve the problem.

**Warning!**



Driving with the message Brake fluid Visit workshop displayed can result in an accident. Have your brake system checked immediately.

If there is a malfunction in the electrohydraulic brake system, we recommend that the vehicle be transported with all wheels off the ground using flatbed or appropriate wheel lift/dolly equipment.

A tow bar must be used if circumstances do not permit the use of the recommended towing methods and the vehicle requires towing with all four wheels on the ground.

Towing the vehicle with all four wheels on the ground is only permissible for distances up to 30 miles (50 km) and at a speed not to exceed 30 mph (50 km/h). For more information, refer to “Towing the vehicle” (▷ page 458).

If the electrohydraulic brake system enters its emergency operation mode, the driver must apply significantly greater brake pedal pressure and depress the pedal much further than normal to obtain braking effect. If necessary, apply full pressure to the brake pedal. Brakes may only be applied to the front wheels. Stopping distance is increased!



Do not add brake fluid before checking the brake system. Overfilling the brake fluid reservoir can result in spilling brake fluid on hot engine parts and the brake fluid catching fire. You can be seriously burned.



If you find that the brake fluid in the brake fluid reservoir has fallen to the minimum mark or below, have the brake system checked for brake pad thickness and leaks.



### What to do if ...

Display symbol	Display messages	Possible cause/consequence	Possible solution
 (USA only)  (Canada only)	Engine Service	There may be a malfunction in the: <ul style="list-style-type: none"> <li>• fuel injection system</li> <li>• ignition system</li> <li>• exhaust system</li> <li>• fuel system</li> </ul>	► Have the measuring system checked by an authorized Mercedes-Benz Center.
	Coolant Check Level	The coolant level is too low.	► Add coolant (▷ page 321). ► If you have to add coolant frequently, have the cooling system checked by an authorized Mercedes-Benz Center.

### Warning!



Do not spill antifreeze on hot engine parts. Antifreeze contains ethylene glycol which may burn if it comes into contact with hot engine parts. You can be seriously burned.



Do not ignore the low engine coolant level warning. Extended driving with the message and symbol displayed may cause serious engine damage not covered by the Mercedes-Benz Limited Warranty.

Do not drive without sufficient amount of coolant in the cooling system. The engine will overheat causing major engine damage.

Display symbol	Display messages	Possible cause/consequence	Possible solution
	Coolant Stop, engine off	The coolant is too hot.	<ul style="list-style-type: none"> <li>▶ Stop the vehicle in a safe location as soon as it is safe to do so.</li> <li>▶ Only start the engine again after the message disappears. You could otherwise damage the engine.</li> </ul>

**Warning!**



Driving when your engine is badly overheated can cause some fluids which may have leaked into the engine compartment to catch fire. You could be seriously burned.

Steam from an overheated engine can cause serious burns and can occur just by opening the engine hood. Stay away from the engine if you see or hear steam coming from it.

Turn off the engine, get out of the vehicle and do not stand near the vehicle until the engine has cooled down.



During severe operation conditions and stop-and-go city traffic, the coolant temperature may rise close to 248°F (120°C).



The engine should not be operated with the coolant temperature above 248°F (120°C). Doing so may cause serious damage which is not covered by the Mercedes-Benz Limited Warranty.

### What to do if ...

Display symbol	Display messages	Possible cause/consequence	Possible solution
	Coolant Stop, engine off	The poly-V-belt could be broken.	<ul style="list-style-type: none"> <li>▶ Stop the vehicle in a safe location as soon as it is safe to do so and immediately turn off the engine.</li> <li>▶ Check the poly-V-belt.</li> </ul> <p>If it is broken:</p> <ul style="list-style-type: none"> <li>▶ Do not continue to drive. Otherwise the engine will overheat due to an inoperative water pump which may result in damage to the engine. Notify an authorized Mercedes-Benz Center.</li> </ul> <p>If it is intact:</p> <ul style="list-style-type: none"> <li>▶ Do not continue to drive the vehicle with this message displayed. Doing so could result in serious engine damage that is not covered by the Mercedes-Benz Warranty.</li> <li>▶ Drive immediately to the nearest authorized Mercedes-Benz Center.</li> </ul>
	Coolant Visit workshop	The cooling fan for the coolant is malfunctioning.	<ul style="list-style-type: none"> <li>▶ Observe the coolant temperature display.</li> <li>▶ Have the fan replaced as soon as possible.</li> </ul>

Display symbol	Display messages	Possible cause/consequence	Possible solution
	Display malfunction Visit workshop	The displays for several systems have malfunctioned. Some systems themselves may also have malfunctioned.	<ul style="list-style-type: none"> <li>▶ Continue driving with added caution. When the display is malfunctioning, warnings and malfunction messages might not be displayed.</li> <li>▶ Have the electronic systems checked by an authorized Mercedes-Benz Center.</li> </ul>
	Display malfunction Visit workshop	<p>Certain electronic systems are unable to relay information to the control system. The following systems may have failed:</p> <ul style="list-style-type: none"> <li>• Coolant temperature display</li> <li>• Tachometer</li> <li>• Cruise control display</li> </ul>	<ul style="list-style-type: none"> <li>▶ Have the electronic systems checked by an authorized Mercedes-Benz Center.</li> </ul>
	Doors open	You are attempting to drive with one or more doors open.	<ul style="list-style-type: none"> <li>▶ Close the doors.</li> </ul>

### What to do if ...

Display symbol	Display messages	Possible cause/consequence	Possible solution
	<p>USA only: Add 1 Qt. engine oil at next refueling</p> <p>Canada only: Add 1 Liter engine oil at next refueling</p>	<p>E 500, E 55 AMG only: The engine oil level is too low.</p>	<ul style="list-style-type: none"> <li>▶ Check the engine oil level (▷ page 317) and add engine oil as required (▷ page 319).</li> <li>▶ If you must add engine oil frequently, have the engine checked for possible leaks.</li> </ul>
	<p>Check oil level at next refueling</p>	<p>E 350 only: The engine oil has dropped to a critical level.</p>	<ul style="list-style-type: none"> <li>▶ Check the engine oil level (▷ page 318) and add oil as required (▷ page 319).</li> <li>▶ If you must add engine oil frequently, have the engine checked for possible leaks.</li> </ul>

When the message Add 1 Qt. (Canada: 1 Liter) engine oil at next refueling (E 500, E 55 AMG) or Check oil level at next refueling (E 350) appears while the engine is running and at operating temperature, the engine oil level has dropped to approximately the minimum level.

When this occurs, the warning will first come on intermittently and then stay on if the oil level drops further.

Visually check for oil leaks. If no obvious oil leaks are noted, drive to the nearest service station where the engine oil should be topped to the required level with an approved oil specified in the Factory Approved Service Products pamphlet.





The engine oil level warnings should not be ignored. Extended driving with the symbol displayed could result in serious engine damage that is not covered by the Mercedes-Benz Limited Warranty.

Display symbol	Display messages	Possible cause/consequence	Possible solution
	Engine oil level Stop, engine off	E 500, E 55 AMG only: There is no oil in the engine. There is a danger of engine damage.	<ul style="list-style-type: none"> <li>▶ Carefully bring the vehicle to a halt as soon as possible.</li> <li>▶ Turn off the engine.</li> <li>▶ Add engine oil (▷ page 319) and check the engine oil level (▷ page 317).</li> </ul>
	Engine oil level Visit workshop	E 500, E 55 AMG only: The engine oil has dropped to a critical level.	<ul style="list-style-type: none"> <li>▶ Check the engine oil level (▷ page 317) and add oil as required (▷ page 319).</li> <li>▶ If you must add engine oil frequently, have the engine checked for possible leaks.</li> </ul>
	Change engine oil Visit workshop	E 500, E 55 AMG only: It may be that there is water in the engine oil.	<ul style="list-style-type: none"> <li>▶ Have the engine oil and the cooling system checked.</li> </ul>



### What to do if ...

Display symbol	Display messages	Possible cause/consequence	Possible solution
	Engine oil level Reduce oil level	E 500, E 55 AMG only: You have added too much engine oil. There is a risk of damaging: <ul style="list-style-type: none"> <li>• the engine</li> <li>• the catalytic converter</li> </ul>	▶ Have oil siphoned or drained off. Observe all legal requirements with respect to its disposal.
	Oil sensor malfunction Visit workshop	E 500, E 55 AMG only: The measuring system is malfunctioning.	▶ Have the measuring system checked by an authorized Mercedes-Benz Center.
	Change engine oil Visit workshop	E 500, E 55 AMG only: It may be that there is water in the engine oil.	▶ Have the engine oil and the cooling system checked.

Display symbol	Display messages	Possible cause/consequence	Possible solution
	Hood open	You are driving with the hood open.	▶ Close the hood (▷ page 315).
	Key Check battery	The SmartKey with KEYLESS-GO* batteries are discharged.	▶ Change the batteries (▷ page 429).
	Key not recognized	The SmartKey with KEYLESS-GO* is not recognized while the engine is running because <ul style="list-style-type: none"> <li>• the SmartKey with KEYLESS-GO* is not in the vehicle</li> <li>• there is strong radio-frequency interference</li> </ul>	▶ Stop the vehicle in a safe location as soon as it is safe to do so. ▶ Search for the SmartKey. Otherwise the vehicle cannot be centrally locked nor can the engine be started again after the engine is stopped.
	Key not recognized	The SmartKey with KEYLESS-GO* is momentarily not recognized.	▶ Change the position of the SmartKey in the vehicle. ▶ Operate the vehicle with the SmartKey in the starter switch if necessary.
	Key still in vehicle	A SmartKey with KEYLESS-GO* left in the vehicle was recognized while locking the vehicle from the outside.	▶ Take the SmartKey out of the vehicle.
	Keyless Go Check system	The KEYLESS-GO* system is malfunctioning.	▶ Visit an authorized Mercedes-Benz Center as soon as possible.





### What to do if ...

Display symbol	Display messages	Possible cause/consequence	Possible solution
	Do not forget key	This display appears (for a maximum of 60 seconds) if the driver's door is opened with the engine shut off and no SmartKey in the starter switch. This message is only a reminder.	<ul style="list-style-type: none"> <li>▶ Insert SmartKey in the starter switch.</li> <li>▶ Take the SmartKey with KEYLESS-GO* with you when leaving the vehicle.</li> </ul>
	Remove key	You have forgotten to remove the SmartKey.	<ul style="list-style-type: none"> <li>▶ Remove the SmartKey from the starter switch.</li> </ul>
	Replace key	There is no additional code available for SmartKey or SmartKey with KEYLESS-GO*.	<ul style="list-style-type: none"> <li>▶ Visit an authorized Mercedes-Benz Center as soon as possible.</li> </ul>
	Reserve fuel	The fuel level has dropped below the reserve mark.	<ul style="list-style-type: none"> <li>▶ Refuel at the next gas station (▷ page 312).</li> </ul>
	Check gas cap See Operator's Manual	A loss of pressure has been detected in the fuel system. The fuel cap may not be closed properly or the fuel system may be leaky.	<ul style="list-style-type: none"> <li>▶ Check the fuel cap (▷ page 312). If it is not closed properly:</li> <li>▶ Close the fuel cap.</li> <li>If it is closed properly:</li> <li>▶ Have the fuel system checked by an authorized Mercedes-Benz Center.</li> </ul>

Display symbol	Display messages	Possible cause/consequence	Possible solution
	Brake lamp Drive to workshop	Brake lamp illumination is delayed or lamp is permanently on.	▶ Visit an authorized Mercedes-Benz Center as soon as possible.
	Brake lamp, left Substitute bulb on	The left brake lamp is malfunctioning. A substitute bulb is being used.	▶ Visit an authorized Mercedes-Benz Center as soon as possible.
	Brake lamp, right Substitute bulb on	The right brake lamp is malfunctioning. A substitute bulb is being used.	▶ Visit an authorized Mercedes-Benz Center as soon as possible.
	Display malfunction Visit workshop	The display for the lamps or the system is malfunctioning.	▶ Visit an authorized Mercedes-Benz Center as soon as possible.
	Front foglamp, left	The left front fog lamp is malfunctioning.	▶ Replace the bulb as soon as possible.
	Front foglamp, right	The right front fog lamp is malfunctioning.	▶ Replace the bulb as soon as possible.
	Active headlamps currently unavailable	The active headlamps are malfunctioning.	▶ Visit an authorized Mercedes-Benz Center as soon as possible.
	Active headlamps Backup lamp on	The active headlamps are malfunctioning. Another light is being used.	▶ Visit an authorized Mercedes-Benz Center as soon as possible.
	Active headlamps malfunction Drive to workshop	The active headlamps have malfunctioned several times in succession.	▶ Visit an authorized Mercedes-Benz Center as soon as possible.

### What to do if ...

Display symbol	Display messages	Possible cause/consequence	Possible solution
	High beam, left	The left high beam lamp is malfunctioning.	▶ Replace the bulb as soon as possible.
	High beam, right	The right high beam lamp is malfunctioning.	▶ Replace the bulb as soon as possible.
	License plate lamp, left	The left license plate lamp is malfunctioning.	▶ Replace the bulb as soon as possible.
	License plate lamp, right	The right license plate lamp is malfunctioning.	▶ Replace the bulb as soon as possible.
	Light sensor Drive to workshop	The lamp sensor is malfunctioning. The headlamps switch on automatically.	▶ In the control system, set lamp operation to manual mode (▷ page 172). ▶ Switch on headlamps using the exterior lamp switch.
	Low beam, left	The left low beam lamp is malfunctioning.	Halogen headlamp: ▶ Replace the bulb as soon as possible. Bi-Xenon* headlamp: ▶ Visit an authorized Mercedes-Benz Center as soon as possible.
	Backup lamp, left	The left reverse lamp is malfunctioning.	▶ Replace the bulb as soon as possible.
	Backup lamp, right	The right reverse lamp is malfunctioning.	▶ Replace the bulb as soon as possible.

Display symbol	Display messages	Possible cause/consequence	Possible solution
	Low beam, right	The right low beam lamp is malfunctioning.	Halogen headlamp: ▶ Replace the bulb as soon as possible. Bi-Xenon* headlamp: ▶ Visit an authorized Mercedes-Benz Center as soon as possible.
	Front Marker light, left	The front left side marker lamp is malfunctioning.	▶ Visit an authorized Mercedes-Benz Center as soon as possible.
	Front Marker light, right	The front right side marker lamp is malfunctioning.	▶ Visit an authorized Mercedes-Benz Center as soon as possible.
	Fr. Park. lamp, left	The left parking lamps are malfunctioning.	▶ Visit an authorized Mercedes-Benz Center as soon as possible.
	Fr. Park. lamp, right	The right parking lamps are malfunctioning.	▶ Visit an authorized Mercedes-Benz Center as soon as possible.
	Rear foglamp Substitute bulb on	The rear fog lamp is malfunctioning. A substitute bulb is being used.	▶ Replace the bulb as soon as possible.
	Switch off lamps	Lamps have been turned on although the SmartKey in the starter switch is in position <b>0</b> .	▶ Switch off the headlights.

### What to do if ...

Display symbol	Display messages	Possible cause/consequence	Possible solution
	Taillamp, left Substitute bulb on	The left tail lamp is malfunctioning. A substitute bulb is being used.	► Visit an authorized Mercedes-Benz Center as soon as possible.
	Taillamp, right Substitute bulb on	The right tail lamp is malfunctioning. A substitute bulb is being used.	► Visit an authorized Mercedes-Benz Center as soon as possible.
	Turn sig., left rear Substitute bulb on	The left rear turn signal lamp is malfunctioning. A substitute bulb is being used.	► Replace the bulb as soon as possible.
	Turn sig., right rear Substitute bulb on	The right rear turn signal lamp is malfunctioning. A substitute bulb is being used.	► Replace the bulb as soon as possible.
	Turn sig., left front	The left front turn signal lamp is malfunctioning.	► Replace the bulb as soon as possible.
	Turn sig., right front	The right front turn signal lamp is malfunctioning.	► Replace the bulb as soon as possible.
	Turn signal, left mirror	The left turn signal in the side mirror is malfunctioning. This message will only appear if all light emitting diodes have stopped working.	► Have the LEDs replaced as soon as possible.
	Turn signal, right mirror	The right turn signal in the side mirror is malfunctioning. This message will only appear if all light emitting diodes have stopped working.	► Have the LEDs replaced as soon as possible.





Display symbol	Display messages	Possible cause/consequence	Possible solution
	Please rectify tire pressure	The pressure is too low in one or more tires.	▶ Check and correct tire inflation pressure as required (▷ page 335).
	Tire pressure Caution, tire defect	One or more tires are deflating.	▶ Carefully bring the vehicle to a halt, avoiding abrupt steering and braking maneuvers. ▶ If necessary, change the wheel (▷ page 445).
	Tire pressure Check tires	The tire pressure in one or more tires is already below the minimum value.	▶ Carefully bring the vehicle to a halt, avoiding abrupt steering and braking maneuvers. ▶ Check and adjust tire pressure as required. ▶ If necessary, change the wheel (▷ page 445).



**Warning!**



Do not drive with a flat tire. A flat tire affects the ability to steer or brake the vehicle. You may lose control of the vehicle. Continued driving with a flat tire will cause excessive heat build-up and possibly a fire.

### What to do if ...

Display symbol	Display messages	Possible cause/consequence	Possible solution
	Seat belt system Drive to workshop	The seat belt system is malfunctioning.	▶ Visit an authorized Mercedes-Benz Center as soon as possible.
	Service memory full See Operator's Manual	The maintenance system service memory cannot save any more data.	▶ Have the service memory checked by an authorized Mercedes-Benz Center.
	Close tilt/sliding sunroof	You have opened the driver's door with the SmartKey removed from the starter switch and the sliding portion of the tilt/sliding sunroof* open.	▶ Close the tilt/sliding sunroof* (▷ page 236).
	Close tilt/sliding sunroof	You have opened the driver's door with the SmartKey removed from the starter switch and the tilting portion of the tilt/sliding sunroof* open.	▶ Close the tilt/sliding sunroof* (▷ page 236).

Display symbol	Display messages	Possible cause/consequence	Possible solution
	Tele Aid malfunction Drive to workshop	One or more main functions of the Tele Aid system are malfunctioning.	▶ Have the Tele Aid system checked by an authorized Mercedes-Benz Center.
	Restraint system malfunction Visit workshop	The system is malfunctioning.	▶ Drive with added caution to the nearest authorized Mercedes-Benz Center.

**Warning!**









In the event a malfunction of the SRS is indicated as outlined above, the SRS may not be operational.

For your safety, we strongly recommend that you visit an authorized Mercedes-Benz Center immediately to have the system checked; otherwise the SRS may not be activated when needed in an accident, which could result in serious or fatal injury, or it might deploy unexpectedly and unnecessarily which could also result in injury.



### What to do if ...

Display symbol	Display messages	Possible cause/consequence	Possible solution
	Function unavailable	This display appears if button  or  on the multifunction steering wheel is pressed and the vehicle is not equipped with a telephone.	
	Tailgate open	This message will appear whenever the cargo compartment is open.	▶ Close the cargo compartment.
	Washer fluid, please refill	The fluid level has dropped to about $\frac{1}{3}$ of total reservoir capacity.	▶ Add washer fluid (▷ page 323).

Display symbol	Display messages	Possible cause/consequence	Possible solution
	Vehicle rising	Your vehicle is adjusting to your level selection.	
	Vehicle rising Please wait briefly	The vehicle level is too low.	<ul style="list-style-type: none"> <li>▶ Do not drive off.</li> </ul> <p>The Airmatic* has not yet adjusted the vehicle level to the necessary height required for driving.</p> <ul style="list-style-type: none"> <li>▶ Wait until the message disappears from the multifunction display.</li> </ul> <p>You may then drive off.</p>
	Stop, car too low	The Airmatic* is malfunctioning.	<p>Avoid excessive steering input. The fender or tires could otherwise be damaged. Listen for scraping noises. Do not drive faster than 50 mph (80 km/h).</p> <ul style="list-style-type: none"> <li>▶ Drive to the side of the road and select a higher vehicle level. Depending on the type of malfunction, this may raise the vehicle's level.</li> </ul> <p>There is otherwise danger of an accident.</p>

### What to do if ...

Display symbol	Display messages	Possible cause	Possible solution
	Visit workshop	<p>The system is functional only to a limited extent.</p> <p>The system display or the system is malfunctioning.</p>	<ul style="list-style-type: none"> <li>▶ Do not drive faster than 50 mph (80 km/h).</li> <li>▶ Have the vehicle checked at an authorized Mercedes-Benz Center.</li> </ul>
	<p>Display malfunction</p> <p>Visit workshop</p>	<p>The system display or the system is malfunctioning.</p>	<ul style="list-style-type: none"> <li>▶ Do not drive faster than 50 mph (80 km/h).</li> <li>▶ Have the vehicle checked at an authorized Mercedes-Benz Center.</li> </ul>

## ▼ Where will I find ...?

### First aid kit

The first aid kit is in the storage compartment at the front edge of the front passenger seat.

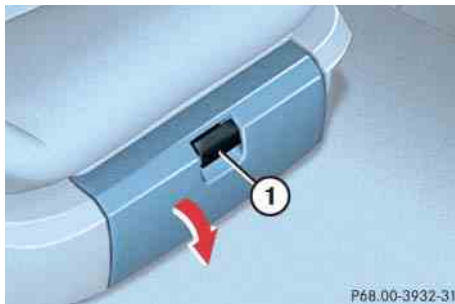

① Tab

- ▶ Pull tab ① upward.
- ▶ Fold the covering forward.
- ▶ Remove the first aid kit.



Check expiration dates and contents for completeness at least once a year and replace missing/expired items.

### Vehicle tool kit, jack and spare wheel

The vehicle tool kit, jack and spare wheel are stored in the compartment underneath the third row seat cushions and footwell (▷ page 420) or underneath the cargo compartment floor (E 55 AMG only).

The vehicle tool kit includes:

- One pair of universal pliers
- One towing eye bolt
- One wheel wrench
- One alignment bolt
- One fuse extractor
- Spare fuses
- Collapsible wheel chock
- A pair of gloves

### Vehicles without foldable third row seat (E 55 AMG only) - Vehicle tool kit, jack and collapsible tire

The vehicle tool kit is located in the cargo compartment underneath the cargo compartment floor.

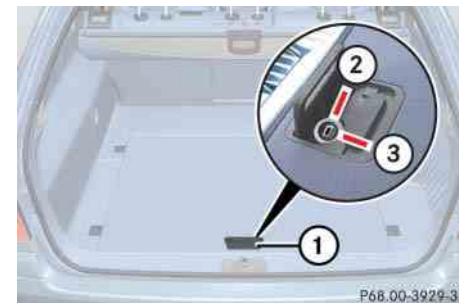

① Release handle

② Unlocking

- ▶ Pull release handle ① and fold cargo compartment floor upward.
- ▶ If the cargo compartment floor is locked, insert mechanical key (▷ page 429) into the lock and turn it to position ②.

### Where will I find ...?

#### Vehicles with foldable third row seat - Vehicle tool kit, jack and spare wheel (except E 55 AMG) or TIREFIT (E 55 AMG only)

The vehicle tool kit is located in the cargo compartment underneath the third row seat cushions and footwell.

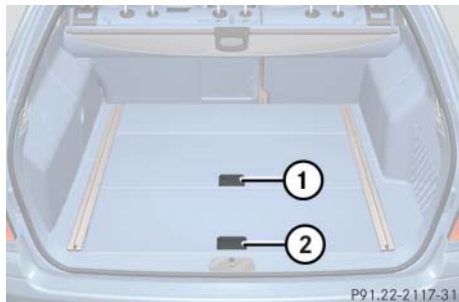

- ① Release handle for seat backrest
- ② Release handle for seat cushion

- ▶ Pull release handle ① and fold seat backrest for the folding bench seat upward.
- ▶ Pull release handle ②, fold seat cushion upward and remove it (▷ page 138).

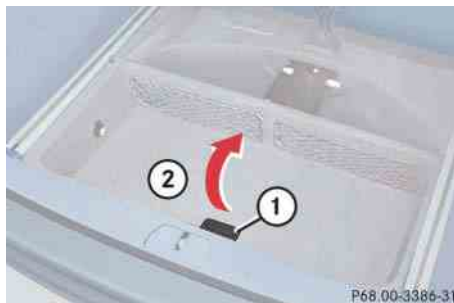

- ① Release handle
- ② Footwell

- ▶ Pull release handle ① and fold footwell ② up.
- ▶ To lock, fold footwell ② back into its original position and press it down until it engages.

#### Vehicle tool kit (vehicles with spare wheel)



In order to access the vehicle tool kit, you must first detach the side cover.



- ① Handle
- ② Cover

- ▶ Turn handle ① to the right as far as it will go and remove cover ②.

**Vehicle tool kit (vehicles with TIREFIT)**

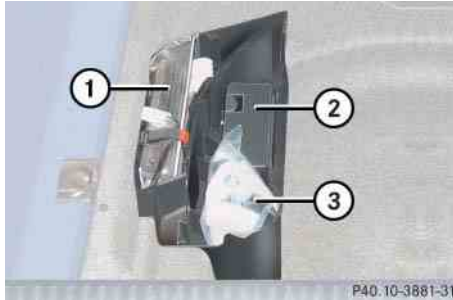

- ① Vehicle tool kit and jack
- ② Electric air pump
- ③ TIREFIT kit

**Vehicle jack**

**Warning!**



The jack is designed exclusively for jacking up the vehicle at the jack take-up brackets built into both sides of the vehicle. To help avoid personal injury, use the jack only to lift the vehicle during a wheel change. Never get beneath the vehicle while it is supported by the jack. Keep hands and feet away from the area under the lifted vehicle. Always firmly set parking brake and block wheels before raising vehicle with jack.

Do not disengage parking brake while the vehicle is raised. Be certain that the jack is always vertical (plumb line) when in use, especially on hills. Always try to use the jack on level surface. Make sure the jack arm is fully seated in the jack take-up bracket. Always lower the vehicle onto sufficient capacity jackstands before working under the vehicle.

The vehicle jack is located in the cargo compartment underneath the third row seat cushions and footwell (▷ page 420) or underneath the cargo compartment floor (▷ page 419).

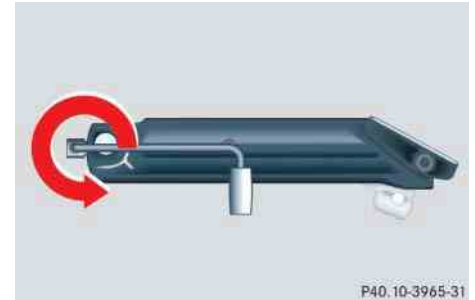

**Storage position**

- ▶ Remove vehicle jack from its compartment.
- ▶ Turn crank handle in direction of arrow as far as it will go.

### Where will I find ...?

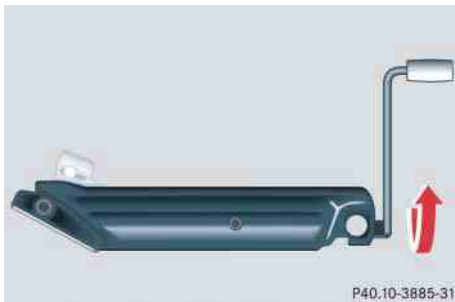

#### Operational position

- ▶ Turn crank handle clockwise.

Before storing the vehicle jack in its compartment:

- It should be fully collapsed.
- The handle must be folded in (storage position).

#### Spare wheel

If your vehicle is equipped with a spare wheel (Minispare or collapsible tire), it is located in the cargo compartment underneath the third row seat cushions and footwell (▷ page 420) or underneath the cargo compartment floor (▷ page 419). To access the spare wheel, fold seat cushions and footwell up (▷ page 420).

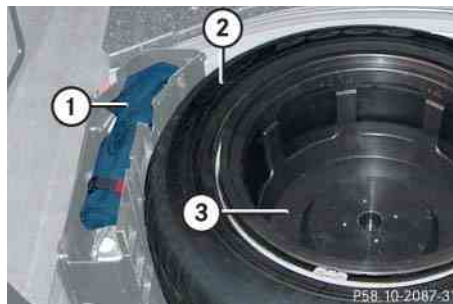

- ① Vehicle tool kit  
Wheel bolt wrench and Jack
- ② Spare wheel
- ③ Luggage bowl

#### Removing the spare wheel

- ▶ Turn luggage bowl ③ counterclockwise.
- ▶ Remove spare wheel ②.

#### Storing the spare wheel

- ▶ Place spare wheel ② in wheel well.
- ▶ Turn luggage bowl ③ clockwise to its stop to secure the spare wheel.

#### Warning!



The dimensions of the spare wheel (Minispare or collapsible tire) are different from those of the road wheels. As a result, the vehicle handling characteristics change when driving with a spare wheel mounted. The Minispare wheel and collapsible tire should only be used temporarily, and replaced with a regular road wheel as quickly as possible.

In the case of a flat tire, you may temporarily use the spare wheel when observing the following restrictions:

- Do not exceed a vehicle speed of 50 mph (80 km/h).
- Drive to the nearest tire repair facility to have the flat tire repaired or replaced as appropriate.
- Do not operate vehicle with more than one spare wheel mounted.

For more information see the “Technical data” section (▷ page 478).

### Setting up the collapsible wheel chock

The collapsible wheel chock serves to additionally secure the vehicle, e.g. while changing the wheel.

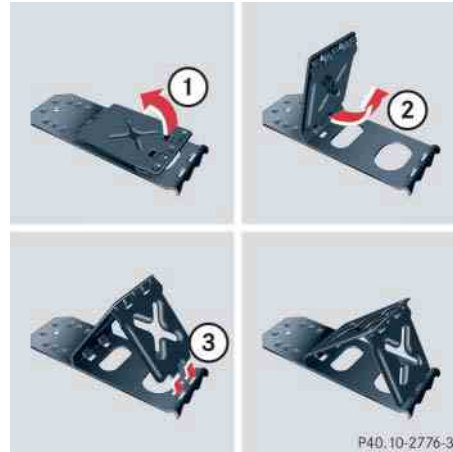

- ① Tilt the plates upward
- ② Fold the lower plate outward
- ③ Insert the plate

- ▶ Tilt both plates upward ①.
- ▶ Fold the lower plate outward ②.
- ▶ Guide the tabs of the lower plate all the way into the openings of the base plate ③.





### Unlocking/locking in an emergency

#### Unlocking the vehicle

If you cannot unlock the vehicle with the SmartKey or SmartKey with KEYLESS-GO\*, open the driver's door and the tailgate using the mechanical key.



Unlocking your vehicle with the mechanical key will trigger the anti-theft alarm system. To cancel the alarm, do one of the following:

- ▶ Press button  or  on the SmartKey.
- ▶ Insert the SmartKey in the starter switch.

Vehicles with KEYLESS-GO\*

- ▶ Pull the outside door handle.
- ▶ Press the KEYLESS-GO\* start/stop button.

#### Removing the mechanical key



① Mechanical key locking tab

② Mechanical key

- ▶ Move locking tab ① in direction of arrow.
- ▶ Slide mechanical key ② out of the housing.

#### Unlocking the driver's door

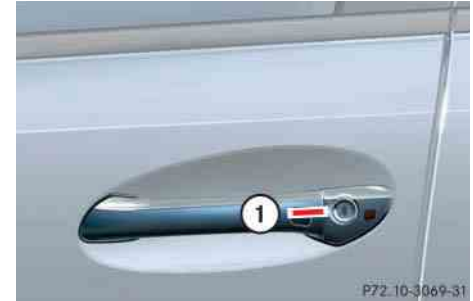

① Unlocking

- ▶ Insert the mechanical key into the driver's door lock until it stops.
- ▶ Turn the mechanical key counterclockwise to position ①.

The driver's door is unlocked.

Unlocking/locking in an emergency

**Locking the vehicle**

If you are unable to lock the vehicle with the SmartKey or SmartKey with KEYLESS-GO\*, do the following:

- ▶ Close the passenger door, the rear doors and the tailgate.
- ▶ Press the central locking switch in the center console (▷ page 128).
- ▶ Check to see whether the locking knobs on the doors have moved down.
- ▶ If necessary, push them down manually.

Except for the driver's door, the vehicle should now be locked.



① Locking

- ▶ Remove the mechanical key out of the SmartKey (▷ page 424).
- ▶ Insert the mechanical key into the driver's door lock until it stops.
- ▶ Turn the mechanical key clockwise to position ①.

The driver's door is locked.

**Fuel filler flap emergency release**

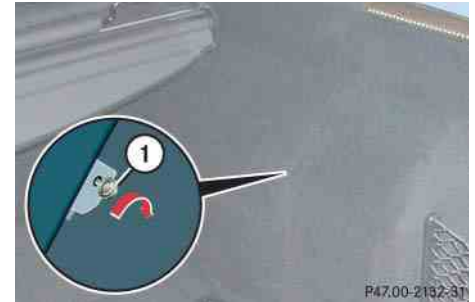

① Release knob

- ▶ Remove right-side tail trim.
- ▶ Turn release knob ① clockwise (arrow).

The fuel filler flap can now be opened.

### Unlocking/locking in an emergency

#### Manually unlocking the gear selector lever

In case of power failure, the gear selector lever can be manually unlocked, e.g. to tow the vehicle.

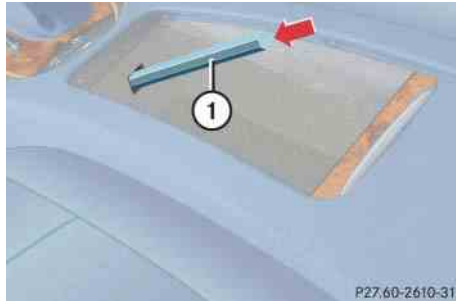

① Pin

- ▶ Open the storage compartment in the center armrest (▷ page 275).
- ▶ Take out the cup holder (▷ page 276).
- ▶ Insert a suitable object ① (e.g. a pin) through the hole and press the pin downward.
- ▶ Remove pin ①.



The gear selector lever is locked again when moving it to position **P**.

Opening/closing in an emergency

▼ Opening/closing in an emergency

Power tilt/sliding sunroof\*

You can open or close the tilt/sliding sunroof manually should an electrical malfunction occur.

The tilt/sliding sunroof drive is located behind cover ① of the interior overhead light.

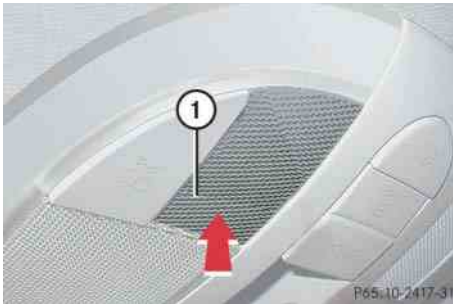

① Cover

- ▶ Remove the SmartKey from the starter switch.
- ▶ Press on cover ① in direction of the arrow to release it.



Do not disconnect the electrical connectors.

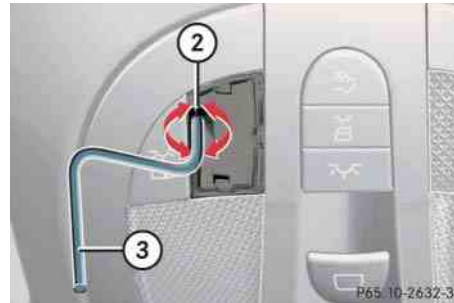

② Hole

③ Crank

- ▶ Take crank ③ out of the glove box.
- ▶ Insert crank ③ through hole ②.
- ▶ Turn crank ③ clockwise to:
  - slide sunroof closed
  - raise sunroof at the rear

- ▶ Turn crank ③ counterclockwise to:
  - slide sunroof open
  - lower sunroof at the rear



Turn crank ③ slowly and smoothly.

The tilt/sliding sunroof must be synchronized after being operated manually (▷ page 238).

### Resetting activated head restraints

If the active head restraints have been triggered in an accident, the active head restraints must be reset. Otherwise, the active head restraints cannot offer any additional protection in the event of another rear-end collision.



For your convenience, we recommend that you have this work carried out by an authorized Mercedes-Benz Center.

You will find the reset tool for manually operating the head restraints in the Mercedes-Benz vehicle literature pouch.



- ▶ Take the reset tool out of the Mercedes-Benz vehicle literature pouch.
- ▶ Guide reset tool into center of head restraint between head restraint cushion and rear head restraint cover.



Be careful not to damage upholstery.

- ▶ Press reset tool forward in direction of arrow.

- ▶ Press reset tool downward until you hear the head restraint release mechanism audibly engage.
- ▶ Pull out reset tool.
- ▶ Firmly press head restraint cushion backward towards the rear of the vehicle until it engages.

#### Warning!



When pushing back the head restraint cushion, take care that your fingers do not become caught between the head restraint cushion and the cover. Failing to do so may lead to injury.

- ▶ Repeat this procedure on the active head restraints for second head restraint.

For information on active head restraints, see “Active head restraints” (▷ page 76).

For information on head restraint adjustment, see “Seats” (▷ page 42).

Replacing SmartKey batteries

▼ Replacing SmartKey batteries

If the batteries in the SmartKey are discharged, the vehicle can no longer be locked or unlocked. It is recommended to have the batteries replaced at an authorized Mercedes-Benz Center.

**Warning!**



Keep the batteries out of reach of children.  
If a battery is swallowed, seek medical help immediately.

Batteries contain materials that can harm the environment if disposed of improperly. Recycling of batteries is the preferred method of disposal. Many states require sellers of batteries to accept old batteries for recycling.



When inserting the batteries, make sure they are clean and free of lint.



When replacing batteries, always replace both batteries.

The required replacement batteries are available at any Mercedes-Benz Center.

SmartKey

Replacement batteries: Lithium, type CR 2025 or equivalent.

- ▶ Remove the mechanical key ① (> page 424).

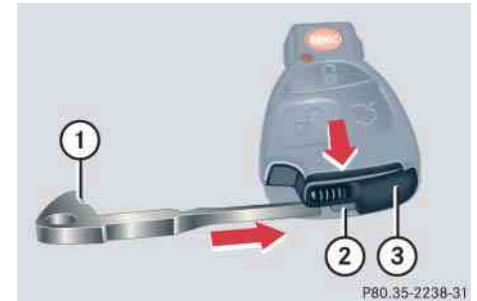

- ① Mechanical key
  - ② Slide
  - ③ Battery compartment
- ▶ Insert the mechanical key ① in direction of arrow in side opening.
  - ▶ Using mechanical key ①, push gray slide ② to unlatch battery compartment ③.



### Replacing SmartKey batteries

- ▷▷ Pull battery compartment ③ (▷ page 429) out of the housing in direction of arrow.
- ▶ Remove the batteries ④ in direction of arrow.

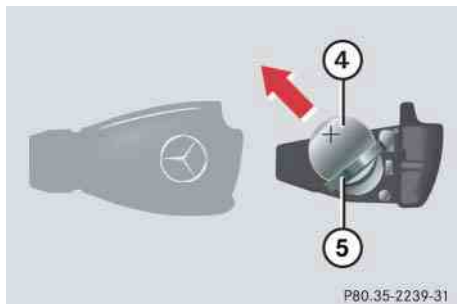

- ④ Battery
- ⑤ Contact spring

- ▶ Using a lint-free cloth, insert new batteries ④ under the contact spring ⑤ with the positive terminal (+) side facing up.
- ▶ Return battery compartment ③ (▷ page 429) into housing until it locks into place.

- ▶ Slide mechanical key ① (▷ page 429) back into the SmartKey.
- ▶ Check the operation of the SmartKey.

#### SmartKey with KEYLESS-GO\*

Replacement batteries: Lithium, type CR 2025 or equivalent.

- ▶ Remove the mechanical key (▷ page 424).
- ▶ Insert the mechanical key ① (▷ page 429) in side opening and push grey slide ② (▷ page 429).

Battery compartment ③ (▷ page 429) is unlatched.

- ▶ Pull battery compartment ③ (▷ page 429) out of the housing in direction of arrow.

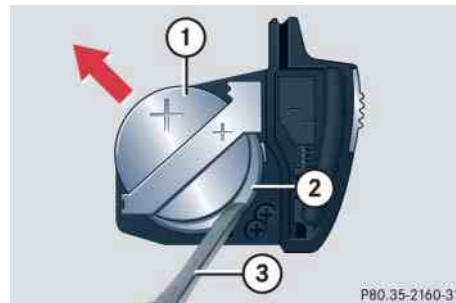

- ① Battery
- ② Tilt battery up
- ③ Mechanical key

- ▶ Using mechanical key ③ apply pressure to position ②. Battery ① tilts up slightly.
- ▶ Pull out batteries ① in direction of arrow.
- ▶ Using a lint-free cloth, insert new batteries with the positive terminal (+) side facing up.
- ▶ Return battery compartment ③ (▷ page 429) into housing until it locks into place.

## ▼ Replacing bulbs

### Bulbs

---

Safe vehicle operation depends on proper exterior lighting and signaling. It is therefore essential that all bulbs and lamp assemblies are in good working order at all times.

Correct headlamp adjustment is extremely important. Have headlamps checked and readjusted at regular intervals and when a bulb has been replaced. See your authorized Mercedes-Benz Center for headlamp adjustment.



If the headlamps or front fog lamps are fogged up on the inside as a result of high humidity, driving the vehicle a distance with the lights on should clear up the fogging.



Substitute bulbs will be brought into use when lamps malfunction. Read and observe messages in the multifunction display (▷ page 409).



## Replacing bulbs

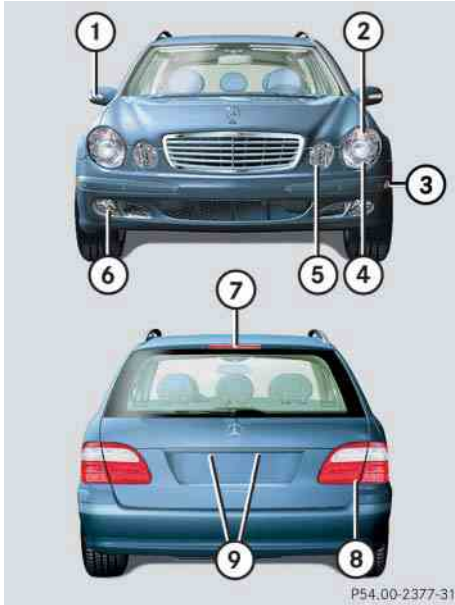

P54.00-2377-31

### Front lamps

	Lamp	Type
①	Additional turn signal lamp	LED
②	Turn signal lamp	1156 NA
③	Side marker lamp	W 5 W
④	Halogen headlamp: Low beam	H7 (55 W)
	Bi-Xenon* headlamp: Low and high beam <sup>1</sup>	D2S-35 W
⑤	Halogen headlamp: High beam/high beam flasher	H7 (55 W)
	Bi-Xenon* headlamp: High beam flasher	H7 (55 W)
	Parking and standing lamp	W 5 W
⑥	Front fog lamp	H1 (55 W)

<sup>1</sup> Vehicles with Bi-Xenon\* headlamps: Low beam and high beam use the same D2S-35W lamp. Do not replace the Bi-Xenon bulbs yourself. Contact your authorized Mercedes-Benz Center.

### Rear lamps

	Lamp	Type
⑦	High mounted brake lamp	LED
⑧	Brake, tail, parking, standing, backup lamp and turn signal lamp. Rear fog lamp (only driver's side)	HiP LED*
⑨	License plate lamps	C 5 W

**Warning!**

Bulbs and bulb sockets can be very hot. Allow the lamp to cool down before changing a bulb.

Keep bulbs out of reach of children.

Halogen lamps contain pressurized gas. A bulb can explode if you:

- touch or move it when hot
- drop the bulb
- scratch the bulb

Wear eye and hand protection.

Because of high voltage in Bi-Xenon\* lamps, it is dangerous to replace the bulb or repair the lamp and its components. We recommend that you have such work done by a qualified technician.

**Notes on bulb replacement**

- Only use 12-volt bulbs of the same type and with the specified watt rating.
- Switch lights off before changing a bulb to prevent short circuits.
- Always use a clean lint-free cloth when handling bulbs.
- Your hands should be dry and free of oil and grease.
- If the newly installed bulb does not light up, visit an authorized Mercedes-Benz Center.

- Have the LEDs and bulbs for the following lamps replaced by an authorized Mercedes-Benz Center:
  - Additional turn signals in the exterior rear view mirrors
  - High mounted brake lamp
  - Bi-Xenon\* lamps
  - Front fog lamps
  - Rear lamps (except license plate lamps)
  - Front side marker lamps



Have the headlamp adjustment checked regularly.

### Replacing bulbs

#### Replacing bulbs for front lamps



- ① Housing cover for low beam halogen or Bi-Xenon\* headlamp

#### Warning!



Do not remove the cover ① for the Bi-Xenon\* headlamp. Because of high voltage in Bi-Xenon\* lamps, it is dangerous to replace the bulb or repair the lamp and its components. We recommend that you have such work done by a qualified technician.

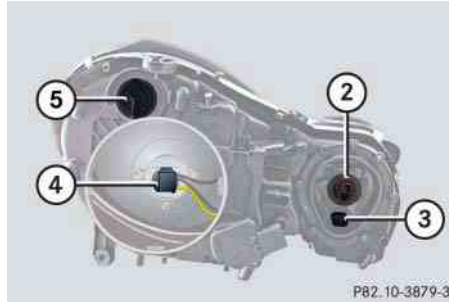

- ② Bulb socket for high beam headlamp/high beam flasher bulb  
③ Bulb socket for parking and standing lamp bulb  
④ Bulb socket for low beam headlamp bulb (halogen headlamps only)  
⑤ Bulb socket for turn signal lamp bulb

Before you start to replace a bulb for a front lamp, do the following first:

- ▶ Turn the exterior lamp switch to position **0** (▷ page 143).
- ▶ Open the hood (▷ page 315).

#### Low beam bulb (halogen headlamps only)

- ▶ Turn housing cover ① counterclockwise and remove it.
- ▶ Turn bulb socket ④ with the bulb counterclockwise and remove it.
- ▶ Pull the bulb out of bulb socket ④.
- ▶ Press the new bulb gently into bulb socket ④.
- ▶ Place bulb socket ⑤ back into the lamp and turn it clockwise until it engages.
- ▶ Align housing cover ① and turn it clockwise until it engages.

### High beam bulb/high beam flasher bulb (halogen headlamps)/high beam flasher bulb (Bi-Xenon\* headlamps)

- ▶ Turn bulb socket ② with the bulb counterclockwise and remove it.
- ▶ Pull the bulb out of bulb socket ②.
- ▶ Press the new bulb gently into bulb socket ②.
- ▶ Place bulb socket ② back into the lamp and turn it clockwise until it engages.

### Front turn signal lamp bulb

- ▶ Turn bulb socket ⑤ with the bulb counterclockwise and remove it.
- ▶ Press gently onto the bulb and turn counterclockwise out of bulb socket ⑤.
- ▶ Press the new bulb gently into bulb socket ⑤ and turn clockwise until it engages.
- ▶ Place bulb socket ⑤ back into the lamp and turn it clockwise until it engages.

### Parking and standing lamp bulb

- ▶ Turn bulb socket ③ with the bulb counterclockwise and remove it.
- ▶ Pull the bulb out of bulb socket ③.
- ▶ Press the new bulb gently into bulb socket ③.
- ▶ Place bulb socket ③ back into the lamp and turn clockwise until it engages.

### Additional turn signal lamp bulbs

The additional turn signal lamps in the exterior rear view mirrors have LEDs.

If a malfunction occurs or LEDs fail to function, the entire turn signal unit must be replaced. Have the turn signal unit replaced by an authorized Mercedes-Benz Center.

### Front side marker lamp bulbs

Since replacing the side marker lamp bulbs is a technically highly demanding process, we recommend you have the side marker lamp bulbs replaced by an authorized Mercedes-Benz Center.

### Replacing bulbs

#### Replacing bulbs for rear lamps

##### Tail lamp unit

The tail lamps are equipped with HiP bulbs.

##### Warning!



The bulbs in the tail lamps cannot be replaced individually. The tail lamp bulbs are under pressure and could explode during an attempt to replace them.

If the tail lamps are malfunctioning, have them exchanged at an authorized Mercedes-Benz Center.

#### License plate lamp

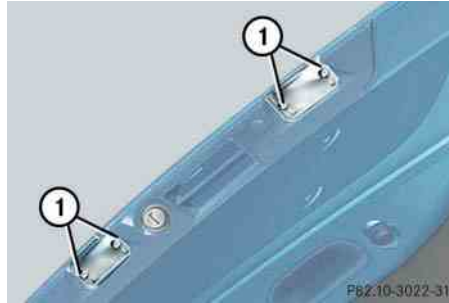

##### ① Screw

- ▶ Turn the exterior lamp switch to position **0** (▷ page 143).
- ▶ Loosen both screws ①.
- ▶ Remove the license plate lamp.
- ▶ Replace the bulb.
- ▶ Reinstall the license plate lamp.
- ▶ Retighten screws ①.

## ▼ Replacing wiper blades



The windshield wipers must be in a vertical position before folding them away from the windshield. They could otherwise damage the hood.



### Removing front wiper blades

#### Warning!



For safety reasons, switch off wipers and remove SmartKey from starter switch (vehicles with KEYLESS-GO\*: Make sure the vehicle's on-board electronics have status **0**) before replacing a wiper blade. Otherwise, the wiper motor could suddenly turn on and cause injury.

- ▶ Turn SmartKey in starter switch to position **1**.
- ▶ Turn combination switch to wiper setting **II** (▷ page 55).
- ▶ With wiper arm in the vertical position, turn SmartKey in starter switch to position **0**.
- ▶ Fold the wiper arm forward until it snaps into place.



- ▶ Turn the wiper blade at a right angle to wiper arm.
- ▶ Slide the wiper blade sideways out of the retainer.

### Replacing wiper blades

#### Installing front wiper blades

- ▶ Slide the wiper blade onto wiper arm until it locks in place.
- ▶ Rotate the wiper blade into position parallel to wiper arm.
- ▶ Fold the wiper arm backward to rest on the windshield. Make sure you hold on to the wiper when folding the wiper arm back.



Never open the hood when the wiper arm is folded forward.

Hold on to the wiper when folding the wiper arm back. If released, the force of the impact from the tensioning spring could crack the windshield.

Do not allow the wiper arms to contact the windshield glass without a wiper blade inserted.

Make certain that the wiper blades are properly installed. Improperly installed wiper blades may cause windshield damage.

For your convenience, we recommend that you have this work carried out by an authorized Mercedes-Benz Center.

#### Removing rear wiper blade

##### Warning!



For safety reasons, switch off wipers and remove SmartKey from starter switch (vehicles with KEYLESS-GO\*): Make sure the vehicle's on-board electronics have status **0** before replacing a wiper blade. Otherwise the motor could suddenly turn on and cause injury.

- ▶ Fold the wiper arm forward until it engages.

Replacing wiper blades

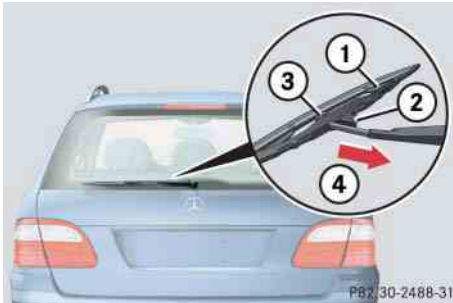

- ① Wiper blade
- ② Tab
- ③ Attachment
- ④ Removing

- ▶ Turn the wiper blade ① at a right angle to wiper arm.
- ▶ Press tab ② down and push wiper blade ① downward in direction of arrow ④.
- ▶ Remove wiper blade ①.

Installing rear wiper blade

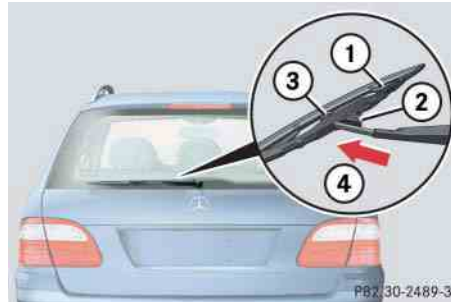

- ① Wiper blade
- ② Tab
- ③ Attachment
- ④ Installing

- ▶ Slide the wiper blade ① into attachment ③ in direction of arrow ④.
- ▶ Let tab ② latch into attachment ③ until it locks in place.

- ▶ Check if the wiper blade is securely fastened.

- ▶ Fold the wiper arm backward to rest on the rear windshield.

Make sure you hold on to the wiper arm when folding it back.



### Flat tire

#### Preparing the vehicle

- ▶ Park the vehicle in a safe distance from moving traffic on a hard, flat surface when possible.
- ▶ Turn on the hazard warning flasher (▷ page 147).
- ▶ Turn the steering wheel so that the front wheels are in a straight ahead position.
- ▶ Set the parking brake (▷ page 60).
- ▶ Move the gear selector lever to **P**.

#### Vehicles with SmartKey:

- ▶ Turn off the engine (▷ page 61).
- ▶ Remove the SmartKey from the starter switch.

#### Vehicles with SmartKey with KEYLESS-GO\*:

- ▶ Turn off the engine by pressing the KEYLESS-GO\* start/stop button on the gear selector lever once (▷ page 61).
- ▶ Open the driver's door (this puts the ignition in position **0**, same as with the SmartKey removed from the starter switch). The driver's door then can be closed again.
- ▶ Have any passenger exit the vehicle at a safe distance from the roadway.



Open door only when conditions are safe to do so.

#### Sealing tires with TIREFIT

E 55 AMG vehicles with foldable third row seat are equipped with TIREFIT.

#### Warning!



Keep TIREFIT away from sparks, open flame or heat source.

Do not smoke.

Small tire punctures, particularly those in the tread, can be sealed with TIREFIT. TIREFIT can be used in ambient temperatures down to  $-4^{\circ}\text{F}$  ( $-20^{\circ}\text{C}$ ).

**Warning!**



TIREFIT is a limited repair device. TIREFIT cannot be used for cuts or punctures larger than approximately 0.16 in (4 mm) and tire damage caused by driving with extremely low tire inflation pressure, or on a flat tire, or a damaged wheel.

Do not drive the vehicle under such circumstances.

Contact your nearest Mercedes-Benz Center for assistance or call Roadside Assistance.

- ▶ Foreign objects (e.g. screws or nails) should not be removed from the tire.
- ▶ Take TIREFIT, the sticker, and the electric air pump out of the cargo compartment.
- ▶ Attach the sticker where it will be easily seen by the driver on the instrument cluster.

**Warning!**



Take care not to allow the contents of TIREFIT to come in contact with hair, eyes or clothing. TIREFIT is harmful if inhaled, swallowed or absorbed through the skin - causes skin, eye and respiratory irritation.

Any contact with eyes or skin should be flushed immediately with plenty of water.

If clothing comes in contact with TIREFIT, change clothing as soon as possible.

In case of allergic reaction or rash, consult a physician immediately.

**Warning!**



Keep TIREFIT out of reach of children. If swallowed, rinse mouth immediately with plenty of water and drink plenty of water.

Do not induce vomiting!

Consult a physician immediately.

Keep away from open flame or heat source.



If sealant has leaked out, let it dry. You can then peel it off.

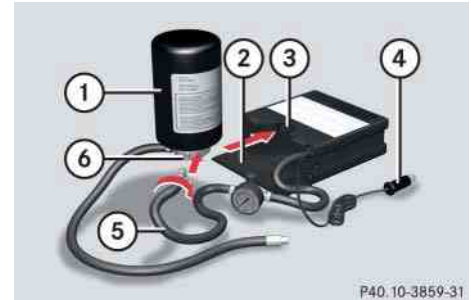

P40.10-3859-31

- ① TIREFIT container
- ② Flap
- ③ Notch
- ④ Electrical plug
- ⑤ Air hose
- ⑥ Flange

- ▶ Open flap ② on the electric air pump.
- ▶ Pull plug ④ and air hose ⑤ out of the pump housing.



### Flat tire

- ▷▷ Screw the air pump's air hose ⑤ onto flange ⑥ of the TIREFIT container.
- ▶ Stick TIREFIT container ① upside down into notch ③ of the electric air pump.

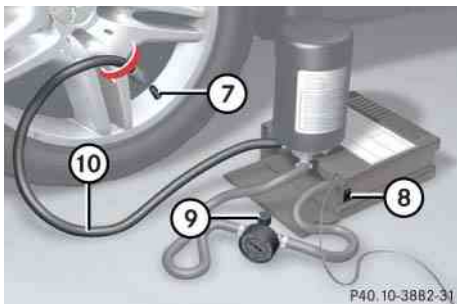

- ⑦ Tire valve
- ⑧ Electric air pump switch
- ⑨ Air hose with pressure gauge and vent screw
- ⑩ Filler hose

#### Warning!



Observe safety instructions on air pump label.

- ▶ Unscrew the valve cap from tire valve ⑦.
  - ▶ Screw filler hose ⑩ onto tire valve ⑦.
  - ▶ Insert electrical plug ④ into the vehicle cigarette lighter socket (▷ page 278).
  - ▶ Turn the SmartKey in the starter switch to position 1 (▷ page 36).
  - or
  - ▶ Press the KEYLESS-GO\* start/stop button (▷ page 38) on the gear selector lever once. Do not depress brake pedal.
  - ▶ Press I on electric air pump switch ⑧.
- The electric air pump should now switch on and inflate the tire.



Do not operate the electric air pump longer than 8 minutes without interruption. Otherwise it may overheat.

You may operate the air pump again after it has cooled off.

After 5 minutes, the pressure gauge must display at least 26 psi (1.8 bar). The air hose can become hot during inflation. Please exercise appropriate caution.

- ▶ If this tire inflation pressure is not attained, turn off the electric air pump, detach the filler hose from the tire valve, and drive vehicle back and forth very slowly approximately 30 ft (10 m).

This serves to better distribute the TIREFIT sealant material inside the tire.

- ▶ Unscrew the air pump's air hose ⑤ from flange ⑥ of the TIREFIT container.
- ▶ Screw air hose ⑤ onto tire valve ⑦.
- ▶ Inflate the tire again.

**Warning!**

If a tire inflation pressure of 26 psi (1.8 bar) is not attained, tire is too severely damaged for TIREFIT to provide a reliable tire repair.

In this case, TIREFIT cannot properly seal the tire.

Do not drive the vehicle.

Contact the nearest Mercedes-Benz Center or call Roadside Assistance.

- ▶ After attaining a tire inflation pressure of 26 psi (1.8 bar), press **0** on electric air pump switch **(8)**.

The electric air pump should now be switched off.

- ▶ Turn the SmartKey in the ignition to position **0** (▷ page 36).  
or
- ▶ Press the KEYLESS-GO\* start/stop button (▷ page 38) on the gear selector lever twice. Do not depress brake pedal.
- ▶ Detach the electric air pump.  
The air hose may still be hot. Please exercise appropriate caution.
- ▶ Place the electric air pump back in the cargo compartment.
- ▶ Close the cargo compartment.
- ▶ Drive away immediately.  
The TIREFIT sealant will distribute itself evenly inside the tire.

**Warning!**

Do not exceed vehicle speed of 50 mph (80 km/h). A TIREFIT repair is not designed to operate at higher speeds.

The sticker must be attached on the instrument cluster where it will be easily seen by the driver.

Vehicle handling characteristics may change. Adapt your driving accordingly.



### Flat tire

- ▶▶ After driving vehicle for an initial 10 minutes, check tire inflation pressure using the pressure gauge on the air pump.

#### Warning!



If tire inflation pressure has fallen below 20 psi (1.3 bar) do not continue to drive the vehicle.

Park your vehicle safely away from the roadway and contact the nearest authorized Mercedes-Benz Center or Roadside Assistance.

If tire inflation pressure is at least 20 psi (1.3 bar), inflate tire to correct pressure (see placard on the driver's door B-pillar), and drive vehicle to nearest tire repair facility to have tire repaired or replaced.

Recommended duration of use:  
300 miles (500 km) at 50 mph (80 km/h)  
with the recommended tire inflation pressure.

#### Warning!



Follow recommend inflation pressures.

Do not overinflate tires. Overinflating tires can result in sudden deflation (blowout) because they are more likely to become punctured or damaged by road debris, potholes, etc.

Do not underinflate tires. Underinflated tires wear unevenly, adversely affect handling and fuel economy, and are more likely to fail from being overheated.

Do not overload the tires by exceeding the specified vehicle capacity weight (as indicated by the label on the pillar in the driver's door opening). Overloading the tires can overheat them, possibly causing a blowout.

- ▶ Visit an authorized Mercedes-Benz Center as soon as possible to obtain a new TIREFIT kit.
- ▶ Bring used TIREFIT materials to an authorized Mercedes-Benz Center for proper disposal.

#### Warning!



Do not exceed vehicle speed of 50 mph (80 km/h). A TIREFIT repair is not designed to operate at higher speeds.

The sticker must be attached on the instrument cluster where it will be easily seen by the driver.

Vehicle handling characteristics may change. Adapt your driving accordingly.

- ▶ Replace your TIREFIT container every four years. Replacement containers are available at your authorized Mercedes-Benz Center.

## Mounting the spare wheel

### Warning!



The dimensions of the spare wheel (Minispare or collapsible tire) are different from those of the road wheels. As a result, the vehicle handling characteristics change when driving with a spare wheel mounted. Adapt your driving style accordingly.

The spare wheel is for temporary use only. When driving with spare wheel mounted, ensure proper tire pressure and do not exceed a vehicle speed of 50 mph (80 km/h).

Drive to the nearest Mercedes-Benz Center as soon as possible to have the spare wheel replaced with a regular road wheel.

Never operate the vehicle with more than one spare wheel mounted.

Do not switch off the ESP® when a Minispare wheel or spare wheel with collapsible tire is mounted.

## Preparing the vehicle

Prepare the vehicle as described (▷ page 440).

Vehicles with Minispare wheel (except E 55 AMG):

- ▶ Take the Minispare wheel, wheel wrench and the jack out of the cargo compartment (▷ page 422).

Vehicles with collapsible tire (E 55 AMG without folding third row seat only):

- ▶ Take the collapsible tire, wheel wrench, jack and electric air pump out of the cargo compartment (▷ page 422).

## Lifting the vehicle

- ▶ Prevent the vehicle from rolling away by blocking wheels with wheel chocks or other sizable objects.

One wheel chock is included with the vehicle tool kit (▷ page 419).

When changing wheel on a level surface:

- ▶ Place the wheel chock in front of and another sizable object behind the wheel that is diagonally opposite to the wheel being changed.

Always try lifting the vehicle using the jack on a level surface. However, should circumstances require you to do so on a hill, place the wheel chock and the other sizeable object as follows:

- ▶ Place the wheel chock and another sizable object on the downhill side blocking both wheels of the axle not being worked on.



### Flat tire



#### Warning!



The jack is designed exclusively for jacking up the vehicle at the jack take-up brackets built into either side of the vehicle. To help avoid personal injury, use the jack only to lift the vehicle during a wheel change. Never get beneath the vehicle while it is supported by the jack. Keep hands and feet away from the area under the lifted vehicle. Always firmly set parking brake and block wheels before raising vehicle with jack.

Do not disengage parking brake while the vehicle is raised. Be certain that the jack is always vertical (plumb line) when in use, especially on hills. Always try to use the jack on level surface. Be sure that the jack arm is fully seated in the jack take-up bracket. Always lower the vehicle onto sufficient capacity jackstands before working under the vehicle.



- ▶ On wheel to be changed, loosen but do not yet remove the wheel bolts (approximately one full turn with wrench).

The jack take-up brackets are located directly behind the front wheel housings and in front of the rear wheel housings.

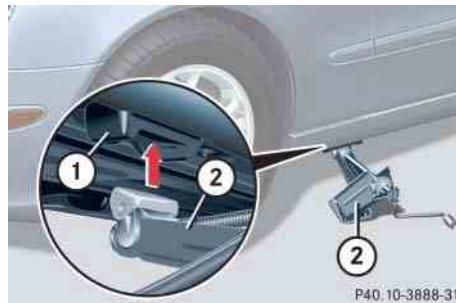

- ① Jack take-up bracket
- ② Jack

- ▶ Place jack ② on firm ground.
- ▶ Position jack ② under take-up bracket ① so that it is always vertical (plumb-line) as seen from the side, even if the vehicle is parked on an incline.

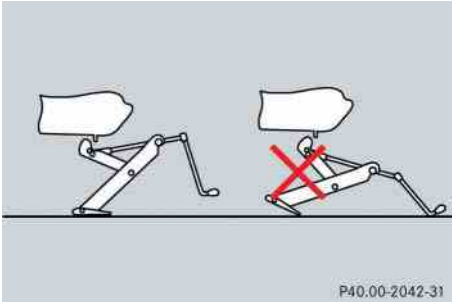

P40.00-2042-31

- ▶ Jack up the vehicle until the wheel is a maximum of 1.2 in (3 cm) from the ground. Never start engine while vehicle is raised.

### Warning!



Position the jack only on the jack take-up brackets designed for this purpose. If the jack is not properly positioned, the vehicle may slip off of the jack.

### Warning!



The jack is intended only for lifting the vehicle briefly for wheel changes. It is not suited for performing maintenance work under the vehicle.

- Never start the engine when the vehicle is raised.
- Never lie down under the raised vehicle.

### Removing the wheel



P40.10-2887-31

- ① Alignment bolt
- ▶ Unscrew upper-most wheel bolt and remove.

- ▶ Replace this wheel bolt with alignment bolt ① supplied in the tool kit.
- ▶ Remove the remaining bolts.



Do not place wheel bolts in sand or dirt. This could result in damage to the bolt and wheel hub threads.

- ▶ Remove the wheel.

### Mounting the spare wheel

- ▶ Clean contact surfaces of wheel and wheel hub.



To avoid paint damage, place wheel flat against hub and hold it there while installing first wheel bolt.





### Flat tire



#### Warning!



Always replace wheel bolts that are damaged or rusted.

Never apply oil or grease to wheel bolts.

Damaged wheel hub threads should be repaired immediately. Do not continue to drive under these circumstances! Contact an authorized Mercedes-Benz Center or call Roadside Assistance.

Incorrect wheel bolts or improperly tightened wheel bolts can cause the wheel to come off. This could cause an accident. Be sure to use the correct wheel bolts.

- ▶ Guide the spare wheel onto the alignment bolt and push it on.
- ▶ Insert wheel bolts and tighten them slightly.



- ▶ Unscrew the alignment bolt, install last wheel bolt and tighten slightly.

#### Warning!



Only use Genuine equipment Mercedes-Benz wheel bolts. Other wheel bolts may come loose.

Do not tighten the wheel bolts when the vehicle is raised. Otherwise the vehicle could fall off the jack.

Vehicles with collapsible tire (E 55 AMG without folding third row seat only):

- ▶ Continue the procedure by following the instructions under “Inflating the collapsible tire” (▷ page 449) and then “Lowering the vehicle” (▷ page 450).

Vehicles with Minispare wheel (except E 55 AMG):

- ▶ Continue the procedure by following the instructions under “Lowering the vehicle” (▷ page 450).

### Inflating the collapsible tire (E 55 AMG without foldable third row seat only)

#### Warning!



Inflate collapsible tire only after the wheel is properly mounted.

Inflate the collapsible tire using the electric air pump before lowering the vehicle.

#### Warning!



Observe instructions on air pump label.



Do not lower the vehicle before inflating the collapsible tire. Otherwise the rim may be damaged.

- ▶ Take the electric air pump out of the cargo compartment (▷ page 420).

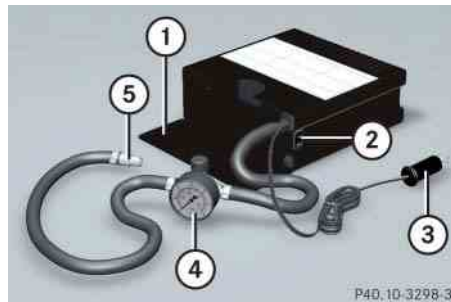

- ① Flap
  - ② On/off switch
  - ③ Electrical plug
  - ④ Air hose with pressure gauge and vent screw
  - ⑤ Union nut
- ▶ Open flap ① on electric air pump.
  - ▶ Pull out electrical plug ③ and air hose with pressure gauge ④.
  - ▶ Remove the valve cap from the collapsible tire valve.
  - ▶ Screw union nut ⑤ onto the collapsible tire valve.

- ▶ Insert electrical plug ③ into vehicle cigarette lighter socket (▷ page 278).
  - ▶ Turn the SmartKey in the starter switch to position 1.
  - ▶ Press I on electric air pump switch ②.
- The electric air pump should now switch on and inflate the collapsible tire.
- ▶ Inflate the tire to approximately 51 psi (3.5 bar).

This takes about 5 minutes for the collapsible tire. Air hose ④ and union nut ⑤ can become hot during inflation. Exercise proper caution to avoid burning yourself when using the equipment.



Do not operate the electric air pump longer than 8 minutes without interruption. Otherwise it may overheat.

You may operate the electric air pump again after it has cooled off.



### Flat tire

- ▶▶ Press **0** on electric air pump switch (2).
- ▶ Turn the SmartKey in the starter switch to position **0**.
- ▶ If the tire pressure is above 51 psi (3.5 bar), release excess tire pressure using the vent screw.

#### Warning!



Follow recommend inflation pressures.

Do not overinflate tires. Overinflating tires can result in sudden deflation (blowout) because they are more likely to become punctured or damaged by road debris, potholes, etc.

Do not underinflate tires. Underinflated tires wear unevenly, adversely affect handling and fuel economy, and are more likely to fail from being overheated.

- ▶ Detach the electric air pump.
- ▶ Store the electrical plug (3) and the air hose (4) behind the flap (1) and place the electric air pump back in the design-

ated storage space underneath the cargo compartment floor (▶ page 419).

#### Lowering the vehicle

- ▶ Lower vehicle by turning crank counterclockwise until vehicle is resting fully on its own weight.
- ▶ Remove the jack.

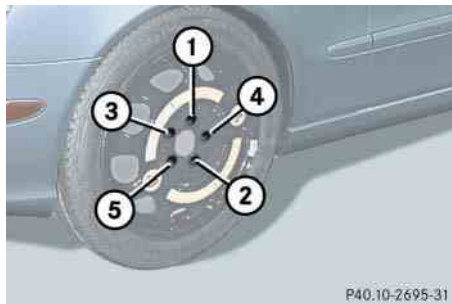

① - ⑤ Wheel bolts

- ▶ Tighten the five wheel bolts evenly, following the diagonal sequence illustrated (① to ⑤), until all bolts are tight. Observe a tightening torque of 96 lb-ft (130 Nm).

#### Warning!



Have the tightening torque checked after changing a wheel. The wheels could come loose if they are not tightened to a torque of 96 lb-ft (130 Nm).

Before storing the jack, it should be fully collapsed, with handle folded in (storage position).

- ▶ Store the jack and the other vehicle tools in the designated storage space underneath the cargo compartment floor (▶ page 419).



Wrap the damaged wheel in the protective film that comes with the spare wheel and put the wheel in the cargo compartment.

Do not activate the tire pressure monitoring system\* until the depressurized tire is no longer in the vehicle.

### MOExtended system\*

The MOExtended system allows you to continue driving your vehicle even if there is a total loss of pressure in one or more tires.

You may only use the MOExtended system with the Tire Pressure Monitoring System\* (TPMS\*) (▷ page 335).



The maximum distance in emergency mode depends on the vehicle's load. It is 30 miles (50 km) if the vehicle is partially loaded and 18 miles (30 km) if the vehicle is fully loaded.

The point at which the maximum driving distance begins in emergency mode is when the warning message appears in the multifunction display indicating that there is a loss of tire inflation pressure.

Do not exceed the maximum speed of 50 mph (80 km/h).

### Warning!



In emergency mode, your vehicle's driving characteristics are diminished in such situations as:

- driving around curves
- while braking
- while accelerating rapidly

Therefore, your driving style must be adapted accordingly. Avoid abrupt steering and driving maneuvers, as well as driving over obstacles (road curbs, potholes, or off-road areas). This is especially important if the vehicle is heavily loaded.

The emergency driving distance that can be achieved greatly depends on the demands placed on the vehicle. Depending on speed, load, driving maneuvers, road conditions, outside temperature, etc., the distance can be significantly shorter or, if the vehicle is driven cautiously, somewhat longer.

Do not continue driving in emergency mode if

- you notice knocking sounds
- the vehicle starts to shake
- smoke develops and you smell rubber
- ESP® is intervening continuously
- you notice tears on the tire sidewalls

After driving in emergency mode, you must have the rims inspected by an authorized Mercedes-Benz Center to check if they are suitable for further use. The failed tire must be replaced in any case.



When replacing individual or all tires on the vehicle, make sure only matching tires marked with "MOExtended" are mounted in the size specified for your vehicle.

### Batteries

Your vehicle is equipped with two batteries:

- Main battery (battery for starter and electrical consumers; located in the cargo compartment).
- Auxiliary battery (back-up battery; stabilizes the electrical system if the main battery is discharged; located in the engine compartment).

The main battery is located in the cargo compartment on the right-hand side under a cover.

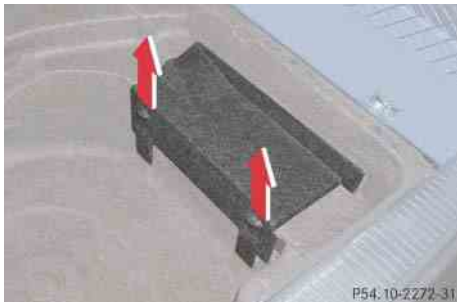

- ▶ Pull cover up and detach it.

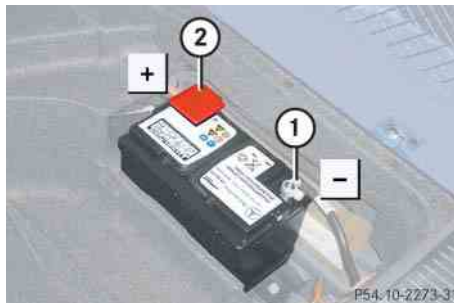

- ① Negative terminal
- ② Positive terminal

#### Warning!



Jump starting must only be done using the designated terminal connections in the engine compartment (▷ page 457).

#### Warning!



Failure to follow these instructions can result in severe injury or death.

Observe all safety instructions and precautions when handling automotive batteries (▷ page 322).

Never lean over batteries while connecting, you might get injured.

Battery fluid contains sulfuric acid. Do not allow this fluid to come in contact with eyes, skin or clothing. In case it does, immediately flush affected area with water and seek medical help if necessary.

A battery will also produce hydrogen gas, which is flammable and explosive. Keep flames or sparks away from battery, avoid improper connection of jumper cables, smoking etc.



Never loosen or detach battery terminal clamps while the engine is running or the SmartKey is in the starter switch. Otherwise the alternator and other electronic components could be severely damaged.

Have the battery checked regularly by an authorized Mercedes-Benz Center.

Refer to Maintenance Booklet for maintenance intervals or contact an authorized Mercedes-Benz Center for further information.

**Warning!**

Do not place metal objects on the battery as this could result in a short circuit.

Use leak-proof battery only to avoid the risk of acid burns in the event of an accident.

**Warning!**

The electrohydraulic brake system requires electrical power to operate.

A malfunction in the vehicle's power supply or electrical system may impair brake system operation and switch it into its emergency operation mode. The same applies if battery is disconnected. To brake, the driver must then apply significantly greater brake pedal pressure and depress the pedal much further to obtain the expected braking effect. If necessary, apply full pressure to the brake pedal. Brakes may only be applied to the front wheels. Stopping distance is increased! Adjust your driving style accordingly. For more information, refer to "Electrohydraulic brake system" (> page 96).

**Disconnecting the battery****Warning!**

With a disconnected battery

- you will no longer be able to turn the SmartKey in the starter switch and pressing the KEYLESS-GO\* start/stop button on the gear selector lever will have no effect
- the gear selector lever will remain locked in position **P**

- ▶ Depress parking brake firmly or move gear selector lever to position **P**.
- ▶ Turn off all electrical consumers. >>

### Batteries

- ▷▷ Remove SmartKey from starter switch.

Vehicles with KEYLESS-GO\*:

- ▶ Press the start/stop button until the engine shuts off.
- ▶ Open the driver's door.
- ▶ Open the cargo compartment.
- ▶ Read and observe safety instructions and precautions (▷ page 452).
- ▶ Access the cargo compartment underneath the third row seat cushions and footwell (▷ page 420).
- ▶ Remove cover to access battery (▷ page 452).
- ▶ Disconnect battery negative lead ①.
- ▶ Remove cover ② from the positive terminal.
- ▶ Disconnect the battery positive lead.

### Removing the battery

- ▶ Remove the screw-nuts securing the battery.
- ▶ Remove the battery bracket.
- ▶ Pull out the battery ventilation tube from the battery (depending on battery arrangement in your vehicle model, the ventilation tube is located either on the left or right side of the battery).
- ▶ Take out the battery.

### Charging and reinstalling the battery

#### Warning!



Never charge a battery while still installed in the vehicle unless the accessory battery charge unit\* approved by Mercedes-Benz is being used. Gases may escape during charging and cause explosions that may result in paint damage, corrosion or personal injury.

An accessory battery charge unit\* specially adapted for Mercedes-Benz vehicles and tested and approved by Mercedes-Benz is available, permitting the charging of the battery in its installed position. Contact an authorized Mercedes-Benz Center for information and availability. Charge battery in accordance with the separate instructions for the accessory battery charger\*.

- ▶ Charge battery in accordance with the instructions of the battery charger manufacturer.

- ▶ Reinstall the charged battery. Follow the previously described steps in reverse order.



The battery, its filler caps and the battery ventilation tube must always be securely installed when the vehicle is in operation.

### Reconnecting the battery

- ▶ Turn off all electrical consumers.
- ▶ Remove SmartKey from starter switch.
- ▶ Connect the positive lead and fasten its cover.
- ▶ Connect the negative lead.



Never invert the terminal connections!



The following procedures must be carried out following any interruption of battery power (e.g. due to reconnection):

- Set the clock (▶ page 170) (see COMAND operator's manual).
- Resynchronize the ESP<sup>®</sup> (▶ page 388).
- Resynchronize the side windows (▶ page 233).
- Resynchronize the tilt/sliding sunroof\* (▶ page 238).

Batteries contain materials that can harm the environment if disposed of improperly. Large 12 volt storage batteries contain lead. Recycling of batteries is the preferred method of disposal. Many states require sellers of batteries to accept old batteries for recycling.



### Jump starting

#### Warning!



Failure to follow these directions will cause damage to the electronic components, and can lead to a battery explosion and severe injury or death.

Never lean over batteries while connecting or jump starting, you might get injured.

Battery fluid contains sulfuric acid. Do not allow this fluid to come in contact with eyes, skin or clothing. In case it does, immediately flush affected area with water, and seek medical help if necessary.

A battery will also produce hydrogen gas, which is flammable and very explosive. Keep flames or sparks away from battery, avoid improper connection of jumper cables, smoking, etc.

Attempting to jump start a frozen battery can result in it exploding, causing personal injury.

Read all instructions before proceeding.

If the battery is discharged, the engine can be started with jumper cables and the battery of another vehicle. Observe the following:

- Jump starting should only be performed when the engine and catalytic converter are cold.
- Do not start the engine if the battery is frozen. Let the battery thaw out first.
- Only jump start from batteries with the same voltage rating (12 V). Jump starting with a more powerful battery could damage the vehicle's electrical system, which will not be covered by the Mercedes-Benz Limited Warranty.
- Use only jumper cables with sufficient cross-section and insulated terminal clamps.
- Always make sure the jumper cables are not on or near pulleys, fans or other parts that move when the engine is started or running.



Jump starting may only be performed on the designated jump start terminals located in the engine compartment (> page 457).

Avoid repeated and lengthy starting attempts.

Do not attempt to start the engine using a battery quick charge unit.

If the engine does not run after several unsuccessful starting attempts, have it checked at the nearest authorized Mercedes-Benz Center.

Excessive unburned fuel generated by repeated failed starting attempts may damage the catalytic converter.

Make sure the jumper cables do not have loose or missing insulation.

Make sure the cable clamps do not touch any other metal part while the other end is still attached to a battery.

**Warning!**



Keep flames or sparks away from battery. Do not smoke.

Observe all safety instructions and precautions when handling automotive batteries (▷ page 322).

The jump-start contacts are located in the engine compartment.

- ▶ Make sure the two vehicles do not touch.
- ▶ Turn off all electrical consumers.
- ▶ Apply parking brake.
- ▶ Shift gear selector lever to position **P**.
- ▶ Open the hood (▷ page 315).
- ▶ Open cover ② of the positive terminal.
- ▶ Connect positive terminal ② and the positive terminal of the charged battery with the jumper cable. Clamp cable to charged battery first.

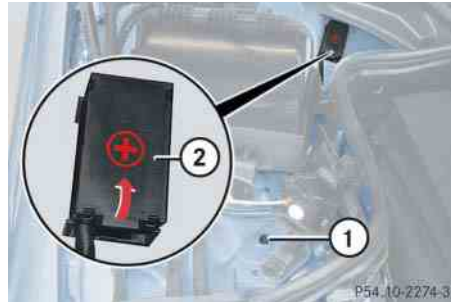

- ① Negative (-) terminal
- ② Cover of Positive (+) terminal



Never invert the terminal connections!

- ▶ Start engine of the vehicle with the charged battery and run at idle speed.
- ▶ Connect negative terminal ① and the negative terminal of the charged battery with the jumper cable. Clamp cable to charged battery first.
- ▶ Start the engine of the disabled vehicle.



The message *Malfunction - electric consumers switched off* may appear in the instrument cluster. It will disappear as soon as the battery is sufficiently charged.

Now you can again turn on the electrical consumers. Do not turn on the lights under any circumstances.

- ▶ Remove the jumper cables first from negative terminals on each battery and then from the positive terminals on each battery.

Now you can turn on the lights.

- ▶ Have the battery checked at the nearest authorized Mercedes-Benz Center.



Do not tow-start the vehicle.

### Towing the vehicle

Mercedes-Benz recommends that the vehicle be transported with all wheels off the ground using flatbed or appropriate wheel lift/dolly equipment. This method is preferable to other types of towing.



Use flatbed or wheel lift/dolly equipment with SmartKey in starter switch turned to position **0**.

Do not tow with sling-type equipment. Towing with sling-type equipment over bumpy roads will damage radiator and supports.

To prevent damage during transport, do not tie down vehicle by its chassis or suspension parts.

Switch off the tow-away alarm and the automatic central locking.

Do not tow-start the vehicle.

When circumstances do not permit the recommended towing methods, the vehicle may be towed with all wheels on the ground or front wheels raised (except vehicles with 4MATIC) only so far as necessary to have the vehicle moved to a safe location where the recommended towing methods can be employed.



Vehicles with 4MATIC:  
Do not tow with one axle raised. Doing so could damage the transfer case, which is not covered by the Mercedes-Benz Limited Warranty.

All wheels must be on or off the ground. Observe instructions for towing the vehicle with all wheels on the ground.



If the vehicle is towed with the front axle raised (not permissible for vehicles with 4MATIC), the engine must be shut off (SmartKey in starter switch position **0** or **1**). Otherwise the ESP® will immediately be engaged and will apply the rear wheel brakes.

When towing the vehicle with all wheels on the ground, the gear selector lever must be in position **N** and the SmartKey must be in starter switch position **2**.

When towing the vehicle with all wheels on the ground or the front axle raised, the vehicle may be towed only for distances up to 30 miles (50 km) and at a speed not to exceed 30 mph (50 km/h).



To be certain to avoid a possibility of damage to the drivetrain, however, we recommend the drive shaft be disconnected at the rear axle drive flange (vehicles with 4MATIC: disconnected at the front and rear axle drive flanges) for any towing beyond a short tow to a nearby garage.

**Warning!**

If circumstances require towing the vehicle with all wheels on the ground, always tow with a tow bar if:

- the engine will not run
- there is a malfunction in the electrohydraulic brake system
- there is a malfunction in the power supply or in the vehicle's electrical system

as that will be necessary to adequately control the towed vehicle.

Prior to towing the vehicle with all wheels on the ground, make certain the SmartKey is in starter switch position **2**.

If the SmartKey is left in the starter switch position **0** for an extended period of time, it can no longer be turned in the switch. In this case, the steering is locked. To unlock, remove SmartKey from starter switch and reinsert.

**Warning!**

The brake system requires electrical power to operate.

A malfunction in the vehicle's power supply or electrical system may impair brake system operation and switch it into its emergency operation mode. To brake, the driver must then apply significantly greater brake pedal pressure and depress the pedal much further to obtain the expected braking effect. If necessary, apply full pressure to the brake pedal. Brakes may only be applied to the front wheels. Stopping distance is increased! Adapt your driving style accordingly. For more information, refer to "Electrohydraulic brake system" (▷ page 96).

With the engine not running, there is no power assistance for the steering system. In this case, it is important to keep in mind that a considerably higher degree of effort is necessary to steer the vehicle. Adapt your driving accordingly.

### Towing the vehicle



To signal turns while being towed with the hazard warning flasher in use, turn SmartKey in starter switch to position **2** and activate the combination switch for the left or right turn signal in the usual manner – only the selected turn signal will operate.

Upon canceling the turn signal, the hazard warning flasher will operate again.



When towing the vehicle with all wheels on the ground, please note the following:

With the automatic central locking activated and the SmartKey in starter switch position **2**, or KEYLESS-GO\* start/stop button in position **2**, the vehicle doors lock if the left front wheel as well as the right rear wheel are turning at vehicle speeds of approximately 9 mph (15 km/h) or more.

Switch off the tow-away alarm (▷ page 103).

To prevent the vehicle door locks from locking, deactivate the automatic central locking (▷ page 127).

Towing of the vehicle should only be done using the properly installed towing eye bolt. Never attach tow cable, tow rope or tow rod to the vehicle chassis, frame or suspension parts.



The gear selector lever will remain locked in position **P** and the SmartKey will not turn in the starter switch if the battery is disconnected or discharged. For more information, see “Battery” (▷ page 452) and “Jump starting” (▷ page 456).

For information on manual unlocking of the gear selector lever, see (▷ page 426).

## Installing towing eye bolt

### Front of vehicle

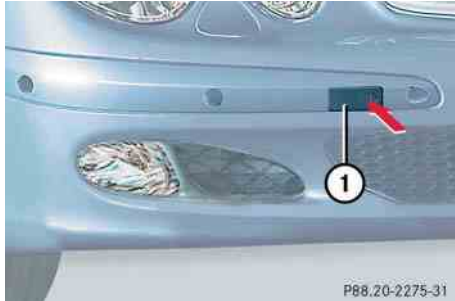

- ① Cover on right side of front bumper

To remove cover:

- ▶ Press mark on cover ① in direction of arrow.
- ▶ Lift cover ① off to reveal the threaded hole for towing eye bolt.

The towing eye bolt is supplied with the tool kit (located in the storage compartment under the cargo compartment floor).

- ▶ Screw towing eye bolt in to its stop and tighten with lug wrench.

To reinstall cover:

- ▶ Fit cover ① and snap into place.

### Rear of vehicle

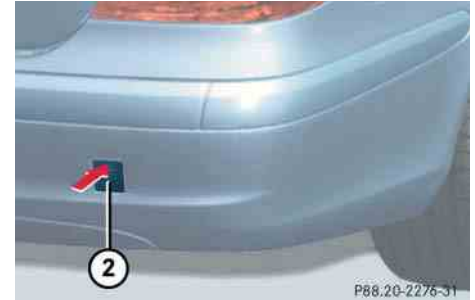

- ② Cover on right side of rear bumper

To remove cover:

- ▶ Pull cover ② in direction of arrow.
- ▶ Fold cover ② down to reveal the threaded hole for the towing eye bolt.

The towing eye bolt is supplied with the tool kit (located in the storage compartment under the cargo compartment floor).

- ▶ Screw towing eye bolt in to its stop and tighten with lug wrench.

To reinstall cover:

- ▶ Fit cover ② and snap into place.

### Fuses

Fuses are designed to protect the electrical circuits in your vehicle from a short circuit. If a fuse is blown, the component(s) and systems secured by that fuse will stop operating.

The following aids are available to help you replace fuses (▷ page 462):

- Fuse chart
- Spare fuses
- Fuse extractor

#### Warning!



Only use fuses approved by Mercedes-Benz with the specified amperage for the system in question. Using other fuses may cause an overload leading to a fire, and/or cause damage to electrical components and/or systems.



Never attempt to repair or bridge a blown fuse. Have the cause determined and remedied by an authorized Mercedes-Benz Center.



Keep the fuse boxes free by contamination and wetness. Otherwise, electrical parts or systems could be damaged.

The electrical fuses are located in different fuse boxes:

- Main fuse box in passenger compartment (▷ page 463)
- Fuse box in cargo compartment (▷ page 463)

### Aids for replacing fuses

---

#### Fuse chart

The fuse chart is located in the fuse box in the passenger compartment (▷ page 463). The amperages of the fuses are also given there.

#### Spare fuses

Spare fuses are located in the vehicle tool kit in the cargo compartment (▷ page 419).

#### Fuse extractor

The fuse extractor is located in the vehicle tool kit in the cargo compartment (▷ page 419).

### Main fuse box in passenger compartment

The main fuse box is located behind a cover in the dashboard on the driver's side.

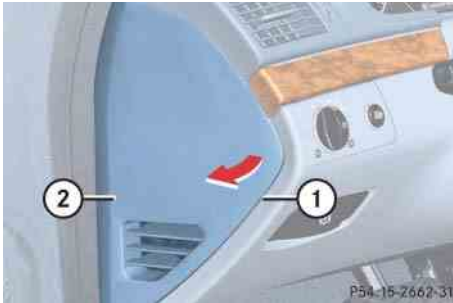

- ① Recess in the cover
- ② Cover



Do not use sharp objects such as a screw driver to open the fuse box cover ② in the dashboard, as this could damage it.

### Opening

- ▶ Open the driver's door.
- ▶ Insert flat, blunt object as a lever in recess ① on the edge of cover ②.
- ▶ Loosen cover ② from the dashboard using lever.
- ▶ Using your hands, pull cover ② in direction of arrow and remove.

### Closing

- ▶ Hook cover ② into the opening at the front.
- ▶ Press cover ② back on until it engages.

### Fuse box in cargo compartment

The fuse box is located behind the left-hand trim panel in the cargo compartment.

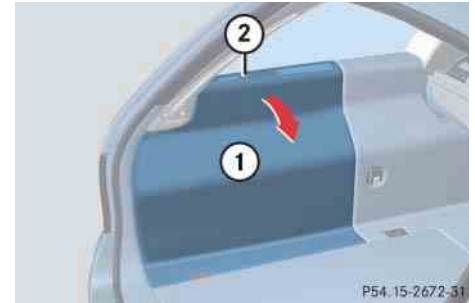

- ① Trim panel
- ② Button for unlocking trim panel

### Opening trim panel

- ▶ Press button ②.
- ▶ Fold down trim panel ①.

### Closing trim panel

- ▶ Fold up trim panel ①.





**Parts service**

**Warranty coverage**

**Identification labels**

**Layout of poly-V-belt drive**

**Engine**

**Rims and tires**

**Electrical system**

**Main dimensions and weight**

**Fuels, coolants, lubricants etc.**



The “Technical data” section provides the necessary technical data for your vehicle.

All authorized Mercedes-Benz Centers maintain a stock of Genuine Mercedes-Benz parts required for maintenance and repair work. In addition, strategically located parts distribution centers provide quick and reliable parts service.

More than 300 000 different parts for Mercedes-Benz models are available.

Genuine Mercedes-Benz parts are subjected to stringent quality inspections. Each part has been specifically developed, manufactured or selected for and adapted to Mercedes-Benz vehicles.

Therefore, Genuine Mercedes-Benz parts should be installed.



The use of non-genuine Mercedes-Benz parts and accessories not authorized by Mercedes-Benz could damage the vehicle, which is not covered by the Mercedes-Benz Limited Warranty, or could compromise the vehicle’s durability or safety.

### ▼ Warranty coverage

Your vehicle is covered under the terms of the warranties printed in the Service and Warranty Information Booklet. Your authorized Mercedes-Benz Center will exchange or repair any defective parts originally installed in the vehicle in accordance with the terms of the following warranties:

- New Car Limited Warranty
- Emission System Warranty
- Emission Performance Warranty
- California, Maine, Massachusetts, and Vermont Emission Control System Warranty

Replacement parts and accessories are covered by the Mercedes-Benz Parts and Accessories Warranties, copies of which are available at any authorized Mercedes-Benz Center.

### Loss of Service and Warranty Information Booklet

---

Should you lose your Service and Warranty Information Booklet, have your authorized Mercedes-Benz Center arrange for a replacement. It will be mailed to you.

### Identification labels



① Certification label (includes Paintwork code)



② Vehicle Identification Number (VIN)

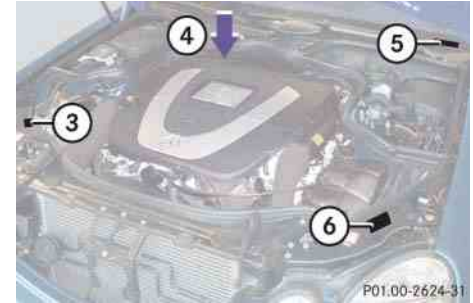

#### Example E 350

- ③ Vacuum line routing diagram label
- ④ Engine number (engraved on engine)
- ⑤ Vehicle Identification Number (VIN) (lower edge of windshield)
- ⑥ Emission control information label, includes both federal and California certification exhaust emission standards



When ordering parts, please specify vehicle identification and engine numbers.

▼ Layout of poly-V-belt drive

E 350/E 350 4MATIC

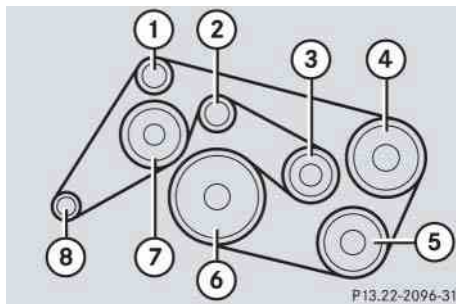

- ① Idler pulley
- ② Idler pulley
- ③ Automatic belt tensioner
- ④ Power steering pump
- ⑤ Air conditioning compressor
- ⑥ Crankshaft
- ⑦ Coolant pump
- ⑧ Generator (alternator)

E 500/E 500 4MATIC

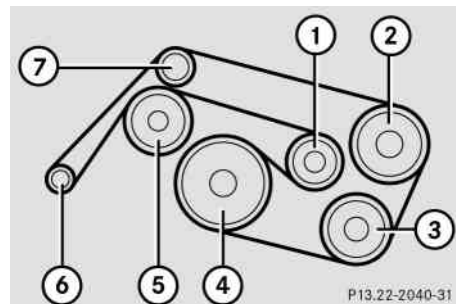

- ① Automatic belt tensioner
- ② Power steering pump
- ③ Air conditioning compressor
- ④ Crankshaft
- ⑤ Coolant pump
- ⑥ Generator (alternator)
- ⑦ Idler pulley

E 55 AMG

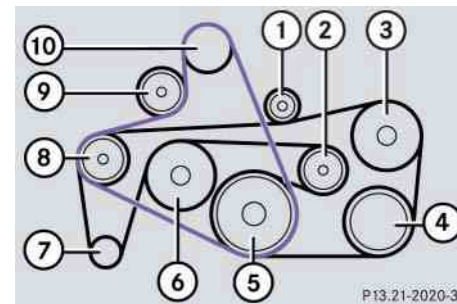

The E 55 AMG has two poly-V-belts (belt one shown in purple/belt two shown in black).

- ① Idler pulley
- ② Automatic belt tensioner
- ③ Power steering pump
- ④ Air conditioning compressor
- ⑤ Crankshaft
- ⑥ Coolant pump
- ⑦ Generator (alternator)
- ⑧ Idler pulley
- ⑨ Automatic belt tensioner
- ⑩ Super charger

**Engine**

Model	<b>E 350 (211.256<sup>1</sup>) E 350 4MATIC (211.287<sup>1</sup>)</b>	<b>E 500<sup>2</sup> (211.270<sup>1</sup>) E 500 4MATIC (211.283<sup>1</sup>)</b>
<b>Engine</b>	272	113
<b>Mode of operation</b>	4-stroke engine, gasoline injection	4-stroke engine, gasoline injection
<b>No. of cylinders</b>	6	8
<b>Bore</b>	3.66 in (92.90 mm)	3.82 in (97.00 mm)
<b>Stroke</b>	3.39 in (86.00 mm)	3.31 in (84.00 mm)
<b>Total piston displacement</b>	213.5 cu in (3498 cm <sup>3</sup> )	303.0 cu in (4966 cm <sup>3</sup> )
<b>Compression ratio</b>	10.7:1	10:1
<b>Output acc. to SAE J 1349</b>	268 hp / 6000 rpm <sup>3</sup> (200 kW / 6000 rpm)	302 hp / 5600 rpm <sup>2</sup> (225 kW / 5600 rpm)
<b>Maximum torque acc. to SAE J 1349</b>	258 lb-ft / 2400 rpm - 5000 rpm (350 Nm / 2400 rpm - 5000 rpm)	339 lb-ft / 2700 rpm - 4250 rpm (460 Nm / 2700 rpm - 4250 rpm)
<b>Maximum engine speed</b>	6500 rpm	6300 rpm
<b>Firing order</b>	1-4-3-6-2-5	1-5-4-2-6-3-7-8
<b>Poly-V-belt</b>	2404 mm	2390 mm

<sup>1</sup> The quoted data apply only to the standard vehicle. See an authorized Mercedes-Benz Center for the corresponding data of all special bodies and special equipment.

<sup>2</sup> Not available in the U.S.

<sup>3</sup> Premium fuel required. Performance may vary with fuel octane rating.

<b>Model</b>	<b>E 55 AMG (211.276<sup>1</sup>)</b>
<b>Engine</b>	113
<b>Mode of operation</b>	4-stroke engine, gasoline injection
<b>No. of cylinders</b>	8
<b>Bore</b>	3.82 in (97.00 mm)
<b>Stroke</b>	3.60 in (92.00 mm)
<b>Total piston displacement</b>	331.8 cu in (5439 cm <sup>3</sup> )
<b>Compression ratio</b>	9:1
<b>Output acc. to SAE J 1349</b>	469 hp/6 100 rpm <sup>2</sup> (350 kW/6 100 rpm)
<b>Maximum torque acc. to SAE J 1349</b>	516 lb-ft/2 650 rpm - 4 500 rpm (700 Nm/2 650 rpm - 4 500 rpm)
<b>Maximum engine speed</b>	6 500 rpm
<b>Firing order</b>	1-5-4-2-6-3-7-8
<b>Poly-V-belts</b>	Belt one: 1 289 mm Belt two: 2 449 mm

<sup>1</sup> The quoted data apply only to the standard vehicle. See an authorized Mercedes-Benz Center for the corresponding data of all special bodies and special equipment.

<sup>2</sup> Premium fuel required. Performance may vary with fuel octane rating.



### Rims and tires



Only use tires which have been tested and approved for your vehicle by Mercedes-Benz. Tires approved by Mercedes-Benz are developed to provide best possible performance in conjunction with the driving safety systems on your vehicle such as ABS or ESP®. Tires specially developed for your vehicle and tested and approved by Mercedes-Benz can be identified by finding the following on the tire's sidewall:

- MO = Mercedes-Benz Original equipment tires

AMG vehicles:

Does not apply to all approved tires on AMG vehicles. For information on tested and approved tires for AMG vehicles, contact an authorized Mercedes-Benz Center.

- MOE = Mercedes-Benz Original Extended (tires with limited run-flat characteristics) original equipment tires

Using tires other than those approved by Mercedes-Benz may result in damage that is not covered by the Mercedes-Benz Limited Warranty.



For information on driving with MOExtended tires, see "MOExtended system\*" (▷ page 451).



Using tires other than those approved by Mercedes-Benz can have detrimental effects, such as

- poor handling characteristics
- increased noise
- increased fuel consumption

Moreover, tires and rims not approved by Mercedes-Benz may, under load, exhibit dimensional variations and different tire deformation characteristics that could cause them to come into contact with the vehicle body or axle parts. Damage to the tires or the vehicle may be the result.



Further information on tires and rims is available at any authorized Mercedes-Benz Center. A placard with the recommended tire inflation pressures is located on the driver's door B-pillar. Some vehicles may have supplemental tire inflation pressure information for driving at high speeds (> page 334) or for vehicle loads less than the maximum loaded vehicle condition. If such information is provided, it can be found on the placard located on the inside of the fuel filler flap. The tire inflation pressure should be checked regularly and should only be adjusted on cold tires. Follow tire manufacturer's maintenance recommendation included with the vehicle.





The following pages also list the approved wheel rim and tire sizes for equipping your vehicles with winter tires. Winter tires are not available as standard or optional factory-equipment, but can be purchased from an authorized Mercedes-Benz Center.

Depending on vehicle model and the standard or optional factory-equipped wheel rim/tire configuration on your vehicle (Appearance Package, Sport Package etc.), equipping your vehicle with winter tires approved for your vehicle model may also require the purchase of two or four wheel rims of the recommended size for use with these winter tires. See an authorized Mercedes-Benz Center for more information.

Rims and tires

Same size tires

17" tires

	<b>E 350 E 350 4MATIC E 500 4MATIC</b>	<b>E 350 (Appearance Package*) E 500</b>
<b>Rims (light alloy)</b>	8 J x 17 H2	8 J x 17 H2
<b>Wheel offset</b>	1.5 in (38 mm)	1.5 in (38 mm)
<b>Summer tires<sup>1</sup></b>	-	245/45 R17 95H
<b>All-season tires<sup>1</sup></b>	245/45 R17 95H M+S	-
<b>Winter tires<sup>1,2</sup></b>	245/45 R17 99V XL (Extra Load) M+S 	245/45 R17 99V XL (Extra Load) M+S 

<sup>1</sup> Radial-ply tires

<sup>2</sup> Not available as factory equipment.

18" tires

	<b>E 55 AMG</b>	<b>E 350 4MATIC (Sport Package*)<sup>1</sup></b> <b>E 500 4MATIC (Sport Package*)</b>
<b>Rims (light alloy)</b>	8 J x 18 EH2	8 J x 18 EH2
<b>Wheel offset</b>	1.18 in (30 mm)	1.18 in (30 mm)
<b>Summer tires<sup>2</sup></b>	-	245/40 ZR18 97Y XL (Extra Load)
<b>All-season tires</b>	-	-
<b>Winter tires<sup>2,3</sup></b>	245/40 R18 97V XL (Extra Load) M+S 	-

<sup>1</sup> Not available in Canada.

<sup>2</sup> Radial-ply tires

<sup>3</sup> Not available as factory equipment.

## Rims and tires

### Mixed size tires

		<b>E 350 (Sport Package*)</b> <b>E 500 (Sport Package*)</b> <b>E 55 AMG</b>
<b>Front axle:</b>	<b>Rims (light alloy)</b>	8 J x 18 EH2
	<b>Wheel offset</b>	1.18 in (30 mm)
	<b>Summer tires<sup>1</sup></b>	245/40 ZR18
<b>Rear axle:</b>	<b>Rims (light alloy)</b>	9 J x 18 EH2
	<b>Wheel offset</b>	1.54 in (39 mm)
	<b>Summer tires<sup>1</sup></b>	265/35 ZR18 XL (Extra Load) <sup>2</sup>

<sup>1</sup> Radial-ply tires

<sup>2</sup> Must not be used with snow chains.

**MOExtended tires\***

	<b>E 350</b> <b>E 350 (Appearance Package*)</b> <b>E 350 4MATIC</b> <b>E 500</b> <b>E 500 4MATIC</b>
<b>Rims (light alloy)</b>	8 J x 17 H2
<b>Wheel offset</b>	1.5 in (38 mm)
<b>Summer tires</b> <sup>1,2</sup>	245/45 R17 95 W <i>MOExtended</i>
<b>All-season tires</b>	-
<b>Winter tires</b> <sup>1,2,3</sup>	245/45 R17 99V XL (Extra Load) M+S  <i>MOExtended</i>

<sup>1</sup> Radial-ply tires

<sup>2</sup> Must be used in conjunction with Tire Pressure Monitoring System (U.S. vehicles) only.

<sup>3</sup> Not available as factory equipment.

## Rims and tires

### Spare wheel



Please compare the recommended tire inflation pressure for your vehicle with the tire inflation pressure on the yellow label located on the spare wheel rim.

If the tire inflation pressure on the yellow label on the spare wheel rim differs from the values given in this Operator's Manual, inflate the spare wheel tire to the recommended tire inflation pressure given on the yellow label on the spare wheel rim.



Please note that the tire inflation pressure of the Minispare and the collapsible tire differs from the tire inflation pressure of the road tires.

Make sure the Minispare wheel is inflated to approximately 61 psi (4.2 bar).

Inflate the collapsible tire (▷ page 449) to approximately 51 psi (3.5 bar).

### Minispare wheel (except E 55 AMG)

<b>Rim</b>	4 B x 17
<b>Wheel offset</b>	1.34 (34 mm)
<b>Tire</b>	T 155/70 R17 110 M <sup>1</sup>

<sup>1</sup> Must not be used with snow chains.

### Collapsible tire (E 55 AMG without folding third row seat only)

<b>Rim</b>	6 B x 18
<b>Wheel offset</b>	0.98 (25 mm)
<b>Tire</b>	175/55-18 95P <sup>1</sup>

<sup>1</sup> Must not be used with snow chains.



E 55 AMG with folding third row seat is equipped with TIREFIT (▷ page 440).

▼ Electrical system

Model	E 350, E 350 4MATIC	E 500, E 500 4MATIC	E 55 AMG
Generator (alternator)	14 V/150 A	14 V/150 A	14 V/180 A
Starter motor	14 V/1.7 kW	14 V/1.7 kW	14 V/1.7 kW
Battery (auxiliary)	12 V/12 Ah	12 V/12 Ah	12 V/12 Ah
Battery (main)	12 V/95 Ah	12 V/95 Ah	12 V/95 Ah
Spark plugs	Bosch Platin Y 7 MPP33 NGK PLKR 6A	Bosch F8 DPP 332U NGK PFR 5R-11	NGK IL FR 6 A
Electrode gap	0.031 in (0.8 mm)	0.039 in (1.00 mm)	0.031 in (0.8 mm)
Tightening torque	15 - 22 lb-ft (20 - 30 Nm)	18.5 - 22 lb-ft (25 - 30 Nm)	18.5 - 22 lb-ft (25 - 30 Nm)



Main dimensions and weight

Main dimensions

Model	E 350	E 500 <sup>1</sup>	E 55 AMG
Overall vehicle length	191.7 in (4868 mm)	191.7 in (4868 mm)	191.8 in (4871 mm)
Overall vehicle width (exterior view mirrors folded out)	78.3 in (1990 mm)	78.3 in (1990 mm)	78.3 in (1990 mm)
Overall vehicle height	58.9 in (1495 mm)		
Overall vehicle height (Airmatic DC*) (optional on E 350; standard on E 500 /E 55 AMG)	58.4 in (1483 mm)	58.5 in (1485 mm)	58.5 in (1485 mm)
Wheelbase	112.4 in (2854 mm)	112.4 in (2854 mm)	112.4 in (2854 mm)
Track, front	61.4 in (1559 mm)	61.7 in (1567 mm)	62.3 in (1583 mm)
Track, rear	61.1 in (1552 mm)	61.4 in (1560 mm)	61.3 in (1558 mm)

<sup>1</sup> Not available in the U.S.

Main dimensions and weight

Model	E 320 4MATIC	E 500 4MATIC
Overall vehicle length	191.7 in (4868 mm)	191.7 in (4868 mm)
Overall vehicle width (exterior view mirrors folded out)	78.3 in (1990 mm)	78.3 in (1990 mm)
Overall vehicle height	58.9 in (1495 mm)	
Overall vehicle height (Airmatic DC*) (optional on E 350; standard on E 500)	58.4 in (1483 mm)	58.5 in (1485 mm)
Wheelbase	112.4 in (2854 mm)	112.4 in (2854 mm)
Track, front	61.3 in (1557 mm)	61.6 in (1565 mm)
Track, rear	61.1 in (1552 mm)	61.4 in (1560 mm)

Weight

---

Max. roof load	220 lbs (100 kg)
----------------	------------------

## Fuels, coolants, lubricants etc.

### Capacities

Vehicle components and their respective lubricants must match. Therefore only use products tested and approved by Mercedes-Benz.

Please refer to the Factory Approved Service Products Pamphlet, or inquire at your authorized Mercedes-Benz Center.

	Model	Capacity	Fuels, coolants, lubricants etc.		
<b>Engine with oil filter</b>	E 350 E 350 4MATIC E 500 4MATIC	8.5 US qt (8.0 l)	Approved engine oils		
	E 500	8.0 US qt (7.5 l)			
	E 55 AMG	9.0 US qt (8.5 l)			
	<b>Automatic transmission</b>	E 350 E 500		8.5 US qt (8.0 l)	MB Automatic Transmission Fluid
		E 350 4MATIC E 500 4MATIC		6.9 US qt (6.5 l)	
E 55 AMG		8.0 US qt (7.5 l)			
<b>Front axle</b>		E 350 4MATIC E 500 4MATIC	0.63 US qt (0.6 l)	Hypoid gear oil SAE 85 W 90	

**Fuels, coolants, lubricants etc.**

	<b>Model</b>	<b>Capacity</b>	<b>Fuels, coolants, lubricants etc.</b>
<b>Rear axle</b>	E 350 E 350 4MATIC	1.06 US qt (1.0 l)	Hypoid gear oil SAE 85 W 90
	E 500 E 500 4MATIC E 55 AMG	1.37 US qt (1.3 l)	
<b>Transfer case</b>	E 350 4MATIC E 500 4MATIC	0.62 US qt (0.585 l)	MB Transfer Case Fluid
<b>Power steering</b>		approx. 0.95 US qt (0.9 l)	MB Power Steering Fluid (Pentosin CHF 11S)
<b>Front wheel hubs</b>		approx. 3.0 oz (85 g) each	High temperature roller bearing grease
<b>Brake system</b>		1.1 US qt (1.05 l)	MB Brake Fluid (DOT 4+)
<b>Cooling system</b>	E 350 E 350 4MATIC	10.7 US qt (10.0 l)	MB 325.0 Anticorrosion/Antifreeze
	E 500 E 500 4MATIC	11.9 US qt (11.3 l)	
	E 55 AMG	13.8 US qt (13.2 l)	

Fuels, coolants, lubricants etc.

	Model	Capacity	Fuels, coolants, lubricants etc.
<b>Fuel tank</b>		21.12 US gal (80.0 l)	Gasoline engines:
<b>including a reserve of</b>	all except E 55 AMG	2.38 US gal (9.0 l)	Premium unleaded gasoline Minimum Posted Octane 91 (Avg. of 96 RON/86 MON)
<b>including a reserve of</b>	E 55 AMG	3.7 US gal (14.0 l)	Diesel engine: Diesel fuels according to ASTM D 975 grades 1-D and 2-D
<b>Air conditioning system</b>			R-134a refrigerant and special PAG lubricant oil (never R-12)
<b>Windshield washer</b>		4.8 US qt (4.5 l)	MB Windshield Washer Concentrate <sup>1</sup>
<b>Windshield washer and head- lamp cleaning system</b>		7.4 US qt (7.0 l)	MB Windshield Washer Concentrate <sup>1</sup>

<sup>1</sup> Use MB Windshield Washer Concentrate “S” and water for temperatures above freezing or MB Windshield Washer Concentrate “S” and commercially available pre-mixed windshield washer solvent/antifreeze for temperatures below freezing point. Follow suggested mixing ratios (▷ page 490).

## Engine oils

Engine oils are specifically tested for their suitability in our engines and durability for our service intervals. Therefore, only use approved engine oils and oil filters required for vehicles with Maintenance System (U.S. vehicles) or FSS PLUS (Canada vehicles). For a listing of approved engine oils and oil filters, refer to the Factory Approved Service Products pamphlet, or contact an authorized Mercedes-Benz Center.



Using engine oils and oil filters of specification other than those expressly required for the Maintenance System (U.S. vehicles) or FSS PLUS (Canada vehicles), or changing of oil and oil filter at change intervals longer than those called for by the Maintenance System (U.S. vehicles) or FSS PLUS (Canada vehicles) will result in engine damage not covered by the Mercedes-Benz Limited Warranty.

Please follow Maintenance System (U.S. vehicles) or FSS PLUS (Canada vehicles) recommendations for scheduled oil changes. Failure to do so could result in engine damage not covered by the Mercedes-Benz Limited Warranty.

## Engine oil additives

Do not blend oil additives with engine oil. They may damage the engine.

Damage or malfunctions resulting from blending oil additives are not covered by the Mercedes-Benz Limited Warranty.

## Air conditioning refrigerant

R-134a (HFC) refrigerant and special PAG lubricating oil are used in the air conditioning system.

Never use R-12 (CFC) or mineral-based lubricating oil. Otherwise damage to the system will occur.

## Brake fluid

During vehicle operation, the boiling point of the brake fluid is continuously reduced through the absorption of moisture from the atmosphere.

### Warning!



Under extremely strenuous operating conditions, this moisture content can lead to the formation of bubbles in the system, thus reducing the system's efficiency.

Therefore, the brake fluid must be replaced regularly. Refer to your vehicle's Maintenance Booklet for replacement interval.

Only brake fluid approved by Mercedes-Benz is recommended. Your authorized Mercedes-Benz Center will provide you with additional information.

#### Premium unleaded gasoline

##### Warning!



Gasoline is highly flammable and poisonous. It burns violently and can cause serious injury. Whenever you are around gasoline, avoid inhaling fumes and skin contact, extinguish all smoking materials. Never allow sparks, flame or smoking materials near gasoline!



To maintain the engine's durability and performance, premium unleaded gasoline must be used. If premium unleaded gasoline is not available and low octane fuel is used, follow these precautions:

- Have the fuel tank only partially filled with unleaded regular and fill up with premium unleaded as soon as possible
- Avoid full throttle driving and abrupt acceleration
- Do not exceed an engine speed of 3000 rpm if the vehicle is loaded with a light load such as two persons and no luggage
- Do not exceed  $\frac{2}{3}$  of maximum accelerator pedal position if the vehicle is fully loaded or operating in mountainous terrain

#### Gasoline additives

A major concern among engine manufacturers is carbon build-up caused by gasoline. Mercedes-Benz recommends only the use of quality gasoline containing additives that prevent the build-up of carbon deposits.

After an extended period of using fuels without such additives, carbon deposits can build up especially on the intake valves and in the combustion area, leading to engine performance problems such as:

- Warm-up hesitation
- Unstable idle
- Knocking/pinging
- Misfire
- Power loss

In areas where carbon deposits may be encountered due to lack of availability of gasolines which contain these additives, Mercedes-Benz recommends the use of additives approved by us for use on Mercedes-Benz vehicles. Refer to Factory Approved Service Products Pamphlet for a listing of approved product(s). Follow directions on product label.

Do not blend other fuel additives with fuel. This only results in unnecessary costs and may be harmful to the engine operation.

Damage or malfunction resulting from poor fuel quality or from blending additional fuel additives other than those tested and approved by us for use on Mercedes-Benz vehicles listed in the Factory Approved Service Products pamphlet are not covered by the Mercedes-Benz Limited Warranty.

### Fuel requirements

Use only premium unleaded gasoline meeting ASTM standard D 439:

- The octane number (posted at the pump) must be 91 min. It is an average of both the Research (R) Octane Number and the Motor (M) Octane Number:  $(R+M) / 2$ . This is also known as the ANTI-KNOCK INDEX.

Unleaded gasoline containing oxygenates such as ethanol, IPA, IBA and TBA can be used provided the ratio of any one of these oxygenates to gasoline does not exceed 10%; MTBE must not exceed 15%.

The ratio of methanol to gasoline must not exceed 3% plus additional cosolvents.

Using mixtures of ethanol and methanol is not allowed. Gasohol, which contains 10% ethanol and 90% unleaded gasoline, can be used.

These blends must also meet all other fuel requirements, such as resistance to spark knock, boiling range, vapor pressure, etc.

### Coolants

The engine coolant is a mixture of water and anticorrosion/antifreeze, which provides:

- Corrosion protection
- Freeze protection
- Boiling protection (by increasing the boiling point)

The cooling system was filled at the factory with a coolant providing freeze protection to approximately  $-22^{\circ}\text{F}$  ( $-30^{\circ}\text{C}$ ) and corrosion protection.

If the antifreeze mixture is effective to  $-22^{\circ}\text{F}$  ( $-30^{\circ}\text{C}$ ), the boiling point of the coolant in the pressurized cooling system is reached at approximately  $266^{\circ}\text{F}$  ( $130^{\circ}\text{C}$ ).

The coolant solution must be used year-round to provide the necessary corrosion protection and increase boil-over protection. Refer to Maintenance Booklet for replacement interval.



### Fuels, coolants, lubricants etc.

Coolant system design and coolant used determine the replacement interval. The replacement interval published in the Maintenance Booklet is only applicable if MB 325.0 anticorrosion/antifreeze solution or other Mercedes-Benz approved products of equal specification (see Factory Approved Service Products pamphlet) are used to renew the coolant concentration or bring it back up to the proper level.

To provide important corrosion protection, the solution must be at least 45% anticorrosion/antifreeze [equivalent to freeze protection to approximately - 22°F (-30°C)]. If you use a solution that is more than 55% anticorrosion/antifreeze [freeze protection to approximately - 49°F (-45°C)], the engine temperature will increase due to the lower heat transfer capability of the solution. Therefore, do not use more than this amount of anticorrosion/antifreeze.

If the coolant level is low, water and MB 325.0 anticorrosion/antifreeze should be used to bring it up to the proper level (have cooling system checked for signs of leakage). Please make sure the mixture is in accordance with label instructions.

The water in the cooling system must meet minimum requirements, which are usually satisfied by normal drinking water. If you are not sure about the water quality, consult your authorized Mercedes-Benz Center.

#### Anticorrosion/antifreeze

Your vehicle contains a number of aluminum parts. The use of aluminum components in motor vehicle engines necessitates that anticorrosion/antifreeze coolant used in such engines be specifically formulated to protect the aluminum parts. (Failure to use such anticorrosion/antifreeze coolant will result in a significantly shortened service life).

Therefore, the following product is strongly recommended for use in your vehicle: MB 325.0 anticorrosion/antifreeze agent.

Before the start of the winter season (or once a year in hot southern regions), you should have the anticorrosion/antifreeze concentration checked. The coolant is also regularly checked each time you bring your vehicle to your authorized Mercedes-Benz Center for service.

*Anticorrosion/antifreeze quantity*

Model	Approx. freeze protection	
	- 35°F (- 37°C)	- 49°F (- 45°C)
<b>E 350/E 350 4MATIC</b>	5.3 US qt (5.0 l)	5.9 US qt (5.5 l)
<b>E 500/E 500 4MATIC</b>	6.0 US qt (5.65 l)	6.6 US qt (6.2 l)
<b>E 55 AMG</b>	7.0 US qt (6.6 l)	7.7 US qt (7.3 l)

### Fuels, coolants, lubricants etc.

#### Windshield and headlamp washer system

Both the windshield and headlamp washer systems are supplied from the windshield washer fluid reservoir.

The washer fluid reservoir has a capacity of approximately:

- 7.4 US qt. (7.0 l) in vehicles with a headlamp cleaning system\* or heated reservoir
- 4.8 US qt. (4.5 l) in vehicles without a headlamp cleaning system

- ▶ Refill the reservoir with MB Windshield Washer Concentrate and water (or concentrate and commercially available premixed windshield washer solvent/antifreeze, depending on ambient temperatures).

#### Warning!



Washer solvent/antifreeze is highly flammable. Do not spill washer solvent/antifreeze on hot engine parts, because it may ignite and burn. You can be seriously burned.

#### Windshield and headlamp washer fluid mixing ratio

For temperatures above freezing point, use MB Windshield Washer Concentrate “S” and water:

- 1 part “S” to 100 parts water  
(1.34 fl oz [40 ml] “S” to 1 gallon [4.0 l] water)

For temperatures below freezing point, use MB Windshield Washer Concentrate “S” and commercially available premixed windshield washer solvent/antifreeze:

- 1 part “S” to 100 parts solvent  
(1.34 fl oz [40 ml] “S” to 1 gallon [4.0 l] solvent)

**ABS**

(Antilock Brake System)

Prevents the wheels from locking up during braking so that the vehicle can continue to be steered.

**Accessory weight**

(▷ page 350)

**ADS**

(Adaptive Damping System)

Automatically adapts the optimum suspension damping to prevailing driving conditions.

**Air pressure**

(▷ page 350)

**Airmatic DC\***

(Airmatic Dual Control)

Automatically selects the optimum suspension tuning and ride height for your vehicle. Airmatic consists of two components:

- Adaptive Damping System
- Vehicle level control

**Alignment bolt**

Metal pin with thread. The centering pin is an aid used when changing a tire to align the wheel with the wheel hub.

**Aspect ratio**

(▷ page 350)

**Bar**

(▷ page 350)

**BAS**

(Brake Assist System)

System for potentially reducing braking distances in emergency braking situations. The system is activated when it senses an emergency based on how fast the brake is applied.

**Bead**

(▷ page 350)

**Bi-Xenon headlamps\***

Headlamps which use an electric arc as a light source and produce a more intense light than filament headlamps. Bi-Xenon headlamps produce low beam and high beam.

**CAC**

(Customer Assistance Center)

Mercedes-Benz customer service center which can help you with any questions about your vehicle and provide assistance in the event of a breakdown.

**CAN system**

(Controller Area Network)

Data bus network serving to control vehicle functions such as door locking or windshield wiping.

**Cockpit**

All instruments, switches, buttons and indicator/warning lamps in the passenger compartment needed for vehicle operation and monitoring.

**Cold tire inflation pressure**

(▷ page 350)

### COMAND

(Cockpit Management and Data System)

Information and operating center for vehicle sound and communications systems, including the radio and navigation system, as well as other optional equipment (CD changer, telephone, etc.).

### Control system

The control system is used to call up vehicle information and to change component settings. Information and messages appear in the multifunction display. The driver uses the buttons on the multifunction steering wheel to navigate through the system and to adjust settings.

### Cruise control

Driving convenience system for automatically maintaining the vehicle speed set by the driver.

### Curb weight

(▷ page 350)

### Distronic\*

A driving convenience cruise control system which helps the driver maintain a pre-selected speed:

- If there is no vehicle directly ahead, the system operates in the same way as conventional ->cruise control.
- If a slower moving vehicle is ahead, Distronic will reduce your vehicle speed to the extent permitted by reduced throttle and up to 20% braking power to maintain the preset minimum following distance.

### DOT

(Department of Transportation)  
(▷ page 351)

### Electrohydraulic brake system

Electronically controlled hydraulic braking system for increased braking safety and comfort.

### Engine number

The number set by the manufacturer and placed on the cylinder block to uniquely identify each engine produced.

### Engine oil viscosity

Measurement for the inner friction (viscosity) of the oil at different temperatures. The higher the temperature an oil can tolerate without becoming thin, or the lower the temperature it can tolerate without becoming viscous, the better the viscosity.

### ESP®

(Electronic Stability Program)  
Improves vehicle handling and directional stability.

### ETD

(Emergency Tensioning Device)  
Device which deploys in certain frontal and rear collisions exceeding the system's threshold to tighten the seat belts.  
->SRS

**FSS PLUS (Canada vehicles)**

(Flexible Service System PLUS)  
Maintenance service indicator in the multifunction display that informs the driver when the next vehicle maintenance service is due. FSS evaluates engine temperature, oil level, vehicle speed, engine speed, distance driven and the time elapsed since your last service, calculates other maintenance service work required, and calls for the next maintenance service accordingly.

**GAWR**

(Gross Axle Weight Rating)  
(▷ page 351)

**Gear range**

Number of gears which are available to the automatic transmission for shifting. The automatic gear shifting process can be adapted to specific operating conditions using the selector lever.

**GPS**

(Global Positioning System)  
Satellite-based system for relaying geographic location information to and from vehicles equipped with special receivers. Employs DVD digital maps for navigation.

**GVW**

(Gross Vehicle Weight)  
(▷ page 351)

**GVWR**

(Gross Vehicle Weight Rating)  
(▷ page 351)

**Instrument cluster**

The displays and indicator/warning lamps in the driver's field of vision, including the tachometer, speedometer and fuel gauge.

**KEYLESS-GO\***

System for entering and operating the vehicle without the use of a SmartKey.

**Kickdown**

Depressing the accelerator past the point of resistance shifts the transmission down to the lowest possible gear. This very quickly accelerates the vehicle and should not be used for normal acceleration needs.

**Kilopascal (kPa)**

(▷ page 351)

**Locking knob**

Knob on the door which indicates whether the door is locked or unlocked. Pushing the locking knob down on an individual door from inside will lock that door.

### **Maintenance System (U.S. vehicles)**

Maintenance service indicator in the multifunction display that informs the driver when the next vehicle maintenance service is due. The Maintenance System in your vehicle tracks distance driven and the time elapsed since your last maintenance service, calculates other maintenance service work required, and calls for the next maintenance service accordingly.

### **Maximum loaded vehicle weight**

(▷ page 351)

### **Maximum load rating**

(▷ page 351)

### **Maximum tire inflation pressure**

(▷ page 351)

### **Memory function\***

Used to store three individual seat, steering wheel and exterior mirror positions.

### **MON**

(Motor Octane Number)

The Motor Octane Number for gasoline as determined by a standardized method. It is an indication of a gasoline's ability to resist undesired detonation (knocking). The average of both the MON (Motor Octane Number) and →RON (Research Octane Number) is posted at the pump, also known as ANTI-KNOCK INDEX.

### **Multifunction display**

The display field in the instrument cluster used to present information provided by the control system.

### **Multifunction steering wheel**

Steering wheel with buttons for operating the control system.

### **Normal occupant weight**

(▷ page 351)

### **Overspeed range**

Engine speeds within the red marking on the tachometer dial. Avoid this engine speed range, as it may result in serious engine damage that is not covered by the Mercedes-Benz Limited Warranty.

### **Poly-V-belt drive**

Drives engine-components (alternator, AC compressor, etc.) from the engine.

### **Power train**

Collective term designating all components used to generate and transmit motive power to the drive axles, including:

- Engine
- Clutch/torque converter
- Transmission
- Transfer case\*
- Drive shaft
- Axle shafts/axles

**Production options weight**

(▷ page 351)

**Program mode selector switch**

Used to switch the automatic transmission between standard operation **S** and operation **C**.

**PSI**

(Pounds per square inch)  
(▷ page 352)

**Recommended tire inflation pressure**

(▷ page 333)

**Restraint systems**

Seat belts, belt tensioners, air bags and child restraint systems. As independent systems, their protective functions complement one another.

**Rim**

(▷ page 352)

**RON**

(Research Octane Number)  
The Research Octane Number for gasoline as determined by a standardized method. It is an indication of a gasoline’s ability to resist undesired detonation (knocking). The average of both the →MON (Motor Octane Number) and RON (Research Octane Number) is posted at the pump, also known as ANTI-KNOCK INDEX.

**Shift lock**

When the vehicle is parked, this lock prevents the transmission selector lever from being moved out of position **P** without the ignition or engine on and brake pedal depressed.

**Sidewall**

(▷ page 352)

**SRS**

(Supplemental Restraint System)  
Seat belts, emergency tensioning device and air bags. Though independent systems, they are closely interfaced to provide effective occupant protection.

**Tele Aid System**

(Telematic Alarm Identification on Demand)

The Tele Aid system consists of three types of response: automatic and manual emergency, roadside assistance and information. Tele Aid is initially activated by completing a subscriber agreement and placing an acquaintance call.

The Tele Aid system is operational provided that the vehicle’s battery is charged, properly connected, not damaged and cellular and GPS coverage is available.

**Telematics\***

A combination of the terms “telecommunications” and “informatics”.

**Tightening torque**

Force times lever arm (e.g. a lug wrench) with which threaded fasteners such as wheel bolts are tightened.

**TIN**

(Tire Identification Number)  
(▷ page 352)



### **Tire load rating**

(▷ page 352)

### **Tire ply composition and material used**

(▷ page 352)

### **Tire speed rating**

(▷ page 352)

### **TPMS**

(▷ page 335)

### **Traction**

(▷ page 352)

### **Tread**

(▷ page 352)

### **Treadwear indicators**

(▷ page 352)

### **Uniform Tire Quality Grading Standards**

(▷ page 353)

### **Vehicle capacity weight**

(▷ page 353)

### **Vehicle level control\***

The ground clearance of the vehicle is automatically controlled according to a selected setting and speed. The driver can set the ground clearance manually for example on very rough roads.

### **Vehicles Maintenance System (U.S. vehicles)**

Maintenance service indicator in the multifunction display that informs the driver when the next vehicle maintenance service is due. The Vehicle Maintenance System in your vehicle tracks distance driven and the time elapsed since your last maintenance service, calculates other maintenance service work required, and calls for the next maintenance service accordingly.

### **Vehicle maximum load on the tire**

(▷ page 353)

### **VIN**

(Vehicle Identification Number)

The number set by the manufacturer and placed on the body to uniquely identify each vehicle produced.

### **Voice control system\***

Voice control system for car phones, portable cell phones and audio systems (radio, CD, etc.).

- A**
- ABS 91, 491
    - Indicator lamp 372
    - Messages in display
  - Accelerator position
    - Automatic transmission 187
  - Accessory weight 350
  - Accident 58
  - Active head restraints 76
  - Air bags 67
    - Children 68
    - Front, Driver 71
    - Front, Passenger 71
    - Safety guidelines 70
    - Side impact 72
    - Window curtain 72
  - Air conditioning refrigerant 485
  - Air conditioning system see Climate control system
  - Air conditioning, Cooling 212, 227
  - Air distribution 208, 222
  - Air pressure 350
  - Air pressure see Tire inflation pressure 335
  - Air pump, electric
    - Turning on 449
  - Air recirculation mode 210, 224
  - Air vents 208, 222
  - Air volume 209, 223
  - Airmatic DC (Dual Control)\* 255, 491
    - Messages in display 417
    - Suspension tuning 255
    - Vehicle level control 256
  - Alarm system see Anti-theft systems
  - Alignment bolt (vehicle tool kit) 419, 447, 491
  - Anticorrosion/antifreeze 488
  - Antilock Brake System see ABS
  - Anti-theft systems 101
    - Anti-theft alarm system 101
    - Immobilizer 101
    - Tow-away alarm 103
  - Aquaplaning see Hydroplaning 305
  - Ashtray 277
  - Aspect ratio 350
  - AUDIO menu 161
    - Selecting radio station 161
    - Selecting satellite radio\* station 162
  - Audio system
    - CD mode 162
  - Auto-dimming
    - Rear view mirrors 197
  - Automatic central locking, Control system 176
  - Automatic headlamp mode 144
  - Automatic lighting control, Interior lighting 148
  - Automatic locking when driving 176
  - Automatic shift program, Automatic transmission 189
  - Automatic transmission 184
    - Accelerator position 187
    - Emergency operation (Limp Home Mode) 196
    - Gear ranges 188
    - Gear selector lever one-touch gearshifting 190
    - Gear selector lever position 184, 186
    - Gear shifting malfunctions 196
    - Kickdown 187
    - Kickdown, Manual shift program E 55 AMG 196
    - Manual (One-touch) gearshifting 190
    - Manual shift program E 55 AMG 193

- Shift program mode selector
    - switch 189
  - Shift program mode selector switch,
    - Manual shift program E 55
    - AMG 194
  - Starting engine 50
  - Steering wheel gearshift control
    - one-touch gearshifting E 55
    - AMG 191
  - Winter program mode 189
- B**
- Backrest 260
    - Folding rearward 261
    - Seat 41
    - Seat, multicontour 133
  - Backup lamps
    - Messages in display 409
    - Replacing bulbs 431
  - Bar 350
  - BAS 93, 491
  - Batteries, SmartKey
    - Changing 429, 430
    - Checking battery condition 110, 117
  - Batteries, SmartKey with KEYLESS-GO\*
    - Changing 429, 430
    - Checking battery condition 117

- Batteries, Vehicle
  - Charging 454
  - Disconnecting 453
  - Installing 454
  - Jump starting 456
  - Messages in display 386, 395, 396
  - Reconnecting 455
  - Removing 454
- Bead 350
- Beverage holder see Cup holders
- Bi-Xenon headlamps\* see Headlamps
- Block heater\* (Canada only) 356
- Brake Assist System see BAS
- Brake fluid
  - Checking 313
  - Messages in display 399
- Brake lamp
  - Cleaning lenses 365
  - Messages in display 409
  - Replacing bulbs 431
- Brake pads
  - Message in display 397
- Brakes 302
  - Warning lamp 374
- Break-in period 300
- Bulbs see Replacing bulbs

**C**

- CAC 491
- California retail buyers and lessees, important notice for 11
- Can holder see Cup holders
- CAN system 491
- Capacities and recommended
  - fuel/lubricants 482
- Cargo compartment
  - Fuse box 463
  - Tie-down rings 264
- Cargo compartment cover 270
- Cargo management system\* 265
  - Belt reel 267
  - Cargo tie-down ring 266
  - Mounting elements 265
  - Telescoping rod 267
- Cargo net 269
- Cargo tie-down rings 264
- Carpets, cleaning 368
- Catalytic converter 310
- CD player 162

- Center console
  - Lower part 28
  - PASS AIR BAG OFF indicator lamp 381
  - Upper part 27
- Centigrade see Temperature display mode
- Central locking
  - Automatic 127, 176
  - Locking/unlocking from inside 128
- Central locking switch 128
- Certification label 468
- Checking
  - Oil level 316
- Children in the vehicle 77
  - Air bags 68
  - Blocking of rear window operation 89
  - Indicator lamp, front passenger front air bag
  - Infant and child restraint systems 78
  - LATCH-type child seat anchors 88
  - Occupant Classification System (OCS)
- Cigarette lighter 278
- Climate control system
  - 4-zone automatic climate control 214
  - Air conditioning refrigerant 485
  - Air conditioning, Cooling 212, 227
  - Air distribution 208, 222
  - Air recirculation mode 210, 224
  - Air volume 209, 223
  - Automatic mode 206, 220
  - Control panel, Rear 213, 229
  - Deactivating system 206, 219
  - Dual-zone automatic climate control 202
  - Front defroster 209, 223
  - Maximum cooling MAX COOL 224
  - Rear climate control 229
  - Residual engine heat (REST) 228
- Clock 25, 170
  - Setting time 171
- Cockpit 22, 491
- Cockpit Management and Data System see COMAND
- Cold tire inflation pressure 350
- Collapsible tire 478
- Collapsible wheel chock 423
- COMAND 492
- COMAND see separate COMAND operating instructions
- Combination switch 54, 147
- Control system 155, 492
  - Multifunction display 155
  - Multifunction steering wheel 156
  - Resetting to factory default 166
- Control system menus 158, 159
  - AUDIO 161
  - Distronic\* 163
  - NAV\* 163
  - Settings 165
  - Standard display 161
  - TEL\* 181
  - Trip computer 180
  - Vehicle status message memory 164
- Control system submenus 157
  - Convenience 177
  - Instrument cluster 168
  - Lighting 172
  - Time/Date 170
  - Vehicle 176
- Controller Area Network see CAN system
- Convenience submenu
  - Setting parking position for exterior rear view mirror 178

- Coolant
  - Anticorrosion/antifreeze mixing ratio and quantity 489
  - Capacities 483
  - Checking coolant level 321
  - Messages in display 400, 401, 402
  - Temperature 311
  - Temperature indicator 152
  - Warning lamp 376
- Cruise control 239, 492
  - Message in display 386
- Cup holders 274
  - Cleaning 367
- Curb weight 350
- Customer Assistance Center see CAC
- D**
- Date display, setting 171, 172
- Daytime running lamp mode 144
  - Setting 172, 173
- Deep water see Standing water
- Defogging windshield 209, 224
- Defrosting, Front 209, 223
- Defrosting, Rear 200
- Delayed shut-off
  - Exterior lamps 174
  - Interior lighting 175
- Department of Transportation see DOT
- Diesel see Fuel
- Difficulties
  - While driving 58
  - With starting 51
- Digital clock see Clock
- Digital speedometer 161
- Dimensions, vehicle 480
- Direction of rotation (tires) 327
- Displays
  - Digital speedometer 161
  - Distronic\* 245
  - Maintenance service indicator 358
  - Messages in display 395
  - Multifunction display 155
  - Outside temperature 155, 169
  - Symbol messages 395
  - Text messages 385
  - Vehicle status message memory 165
  - Vehicle system settings, Control system 155
- Distance to empty (Range), Trip computer 180
- Distronic\* 243, 492
  - Activating/deactivating 248
  - Cleaning system sensor 366
  - Control system 163
  - Distance warning function 252
  - Driving hints 253
  - Menu 247
  - Messages in display 386
  - Sensor cover 366
  - Warning and indicator lamps 246
- Door
  - Entry lamps 150
  - Locking/unlocking, SmartKey 34, 108
  - Locking/unlocking, SmartKey with KEYLESS-GO\* 35, 114
  - Message in display 403
  - Opening from inside/outside 119
  - Remote door unlock (Tele Aid) 289
  - Unlocking, Mechanical key 424
- Door control panel 32
- Door handle 32
- DOT 351, 492
- Drinking and driving 301

Drive-Dynamic seat\* with multicontour features 133  
 Massage function 134

Driving  
 Abroad 309  
 Hydroplaning 305  
 In winter 307  
 Instructions 47, 301  
 Problems 58  
 Safety systems 91  
 Through standing water 308  
 With DISTRONIC\* 253

Driving safety systems  
 4MATIC  
 ABS 91  
 BAS 93  
 Electrohydraulic brake system 96  
 ESP® 93, 492

**E**

Easy-entry/exit feature 43, 177  
 Electrical fuses see Fuses  
 Electrical system, Technical data 479

Electrohydraulic brake system 96, 492  
 Activating/deactivating 97  
 Driving hints 99  
 Messages in display 397, 398  
 Self-check 98  
 Warning lamp 96

Electronic Stability Program see ESP® 93, 492

Emergency calls  
 Tele Aid calls 284

Emergency operation (Limp Home Mode) 196

Emergency operations  
 Fuel filler flap 425  
 Gear selector lever, Unlocking 426  
 Locking/unlocking the vehicle 424  
 Remote door unlock 289  
 Tilt/sliding sunroof\*, Manual operation 427

Emergency tensioning device see ETD

Emergency, In case of  
 Battery, Jump starting 456  
 First aid kit 419  
 Flat tire, changing 440  
 Fuses  
 Hazard warning flasher 147  
 Instrument cluster, Indicator lamps 372, 373, 374, 375, 376, 377, 378, 380  
 Roadside Assistance 12  
 Towing the vehicle 458

Emission control 310  
 Emission control information label 468  
 Emission control system warranties 10  
 Emission control vacuum line routing diagram label 468

- Engine
  - Belt layout 469
  - Block heater\* (Canada only) 356
  - Cleaning 364
  - Compartment 315
  - Malfunction indicator lamp 375, 400
  - Maximum engine speed 471
  - Message in the display 375, 400
  - Number 468, 492
  - Starting 50
  - Starting with KEYLESS-GO\* 51
  - Tachometer 25
  - Technical data 470
  - Turning off with KEYLESS-GO\* 61
  - Turning off with the SmartKey 61
- Engine compartment
  - Hood 315
- Engine coolant see Coolant
- Engine malfunction indicator lamp 375, 400
- Engine oil
  - Adding 319
  - Additives 485
  - Changing 319
  - Checking level (Control system) 317
  - Checking level (Dipstick) 318
  - Consumption 316
  - Filler neck 320
  - Messages in display 317, 405
  - Recommended engine oils and oil filter 485
  - Viscosity 492
- Engine oil level 314
- ESP® 93, 492
  - Four wheel electronic traction system with ESP® 99
  - Messages in display 388
  - Warning lamp 373
- ETD 492
  - Safety guidelines 70
- Exterior rear view mirrors
  - Parking position 178
- F**
  - Factory, SmartKey with KEYLESS-GO\* 114
  - Filler neck, Engine oil 320
  - First aid kit 419
  - Flat tire 440
    - Lowering the vehicle 450
    - Mounting the spare wheel 445, 447
    - Preparing the vehicle 440
    - Sealing tires with TIREFIT 440
    - Spare wheel 445
    - TIREFIT kit 440
  - Flexible Service System see FSS
  - Floor mats 280
  - Fluids
    - Automatic transmission fluid 482
    - Brake fluid 483
    - Capacities 482
    - Engine coolant 483
    - Engine oil 482
    - Power steering fluid 483
    - Windshield washer and headlamp cleaning system 484
  - Fog lamps 146
    - Messages in display 409
    - Replacing bulbs 433

- Folding bench seat
  - Folding back 139
- Folding bench seat in cargo compartment 137
- Four wheel electronic traction system with ESP<sup>®</sup> see 4MATIC
- 4MATIC 99
- Front air bags 71
- Front lamps see Headlamps
- Front passenger front air bag
  - Messages in display
- Front passenger front air bag off indicator lamp 72, 84
- Front seat head restraints see Head restraints
- FSS (Canada vehicles) 358
- Fuel 301, 313
  - Additives 486
  - Capacities, Fuel tank 484
  - Diesel fuel 484, 487
  - Filling the tank 312
  - Fuel filler flap and cap 312
  - Fuel reserve warning lamp 377, 408
  - Premium unleaded gasoline 313
  - Requirements
    - Gasoline additives 486
    - Premium unleaded gasoline 486
  - Requirements, Diesel fuel 487
  - Requirements, Octane rating (Gasoline engine) 487
  - Technical data 482
- Fuel consumption statistics
  - After start 180
  - Since last reset 180
- Fuel filler flap 312
  - Locking/unlocking 312
  - Opening 312
  - Opening in an emergency 425
- Fuel reserve warning lamp 25, 408
- Fuel tank
  - Capacity 484
  - Filler flap 312
- Fuel, Premium unleaded gasoline 313, 484, 487
- Fuels, coolants, lubricants etc.
  - Capacities 482
- Fuses 462
  - Aids for replacing fuses 462
  - Fuse box (main) in passenger compartment 463
  - Fuse box in cargo compartment 463
  - Fuse chart 462
  - Fuse extractor 462
  - Replacing 462
  - Spare fuses 462
- G**
- Garage door opener 29, 290
- Gasoline see Fuel
- GAWR 351
- Gear range 493
  - Automatic transmission 188
  - Limiting 188
  - Shifting into optimal 191
- Gear selector lever 50, 184
  - Lock 50
  - Message in display 389
  - Position indicator 184, 186
  - Unlocking in an emergency 426



- Gear selector lever, Cleaning 368
- Global Positioning System see GPS
- Glove box 272
- Good visibility 197
- GPS 493
- Gross Axle Weight Rating see GAWR
- Gross Vehicle Weight Rating see GVWR
- Gross Vehicle Weight see GVW
- GVW 351
- GVWR 351
- H**
- Halogen headlamps see Headlamps
- Hard plastic trim items, cleaning 368
- Hazard warning flasher 147
- Head restraints 129
  - Folding back 132
  - Front seat, Adjusting 42
  - Rear seat, Removing and installing
  - Removing and installing 132
- Headlamp cleaning system\* 197
- Headlamp shut-off delay see Delayed shut-off, Exterior lamps
- Headlamps
  - Automatic headlamp mode 144
  - Bi-Xenon\*
  - Cleaning lenses 365
  - Cleaning system\* 197
  - Halogen 434
  - High beam see High beam flasher
  - High beam see High beam headlamps
  - Low beam see Low beam headlamps
  - Manual headlamp mode 144
  - Messages in display 409, 410, 411, 412
  - Replacing bulbs 434
  - Switch 54
- Headliner and shelf below rear window, Cleaning and care of 368
- Heated seats\* 135
- Heated steering wheel\* 279
- Height adjustment
  - Vehicle level control 256
- High beam flasher 147
- High beam headlamps
  - Indicator lamp 25
  - Messages in display 410
  - Replacing bulbs 432
  - Switching on
- High mounted brake lamp 432
- Hood 315
  - Message in display 407
- Horn 23
- Hydroplaning 305
- I**
- Identification labels 468
- Identification Number, Vehicle (VIN) 468
- Ignition 36, 50
  - Switching on 51
- Immobilizer 101
- Indicator lamps see Lamps, indicator and warning
- Infant and child restraint systems see Children in the vehicle
- Inflation pressure see Tires, Inflation pressure
- Inside door handle 119
- Instrument cluster 24, 151, 493
  - Cleaning 367
  - Illumination brightness 151
  - Lamps 372
  - Messages in display see Multifunction display messages
  - Multifunction display 155

Instrument lighting see Instrument cluster,  
 Illumination brightness  
 Instrument panel see Instrument cluster  
 Instruments and controls see Cockpit  
 Interior lighting  
   Delayed shut-off 175  
 Interior rear view mirror 45  
   Auto-dimming mirrors 197  
 Interior storage spaces see Storage com-  
 partments

**J**

Jack 422  
 Jump starting 456

**K**

Key, Mechanical 424  
 Key, SmartKey  
   Battery check lamp 106  
   Changing batteries 429  
   Factory setting 108  
   Locking/unlocking 34  
   Locking/unlocking, Global  
     setting 108  
   Locking/unlocking, Selective  
     setting 109  
   Loss of 111  
   Messages in display 408  
   Opening and closing the power  
     tilt/sliding sunroof\* 234  
   Opening and closing the  
     windows 234  
   Positions in starter switch 36  
   Remote control 106  
   Starting the engine 50  
   Turning off engine 61

Key, SmartKey with KEYLESS-GO\*  
   Battery check lamp 111  
   Changing batteries 429, 430  
   Factory setting 114  
   Locking, Tailgate 115  
   Locking/unlocking 35  
   Locking/unlocking, Selective  
     setting 115  
   Loss of 118  
   Messages in display 407  
   Opening and closing the power  
     tilt/sliding sunroof\* 234  
   Opening and closing the  
     windows 234  
   Starting the engine 51  
   Turning off engine 61  
   Unlocking, Tailgate 117  
 KEYLESS-GO\* 493  
 KEYLESS-GO\* see Key, SmartKey with  
 KEYLESS-GO\*  
 Kickdown 187, 493  
 Kilopascal 351

**L**

## Labels

- Certification 468
- Emission control information 468
- Emission control vacuum line routing 468

## Lamp sensor

- Message in display 411

## Lamps, exterior

- Light sensor 410, 411
- Messages in display 409, 410, 411, 412

## Lamps, indicator and warning

- ABS 25, 372
- Battery (SmartKey) 109, 115
- Brakes 374
- CHECK ENGINE 375
- Coolant 376
- Distance warning lamp\* 246
- Electrohydraulic brake system 96
- Engine diagnostics 375
- Engine malfunction 25, 375
- ESP<sup>®</sup> 25, 373
- Fog lamps 146
- Front passenger front air bag off 27, 72, 382

- Fuel reserve 25, 377
- High beam headlamps 25
- Instrument cluster 372, 373, 374, 375, 376, 377, 378, 380
- Low beam headlamps 25
- Maintenance service indicator 358
- Seat belt telltale 25
- Seat belts 377
- SRS 66
- Turn signals 25

## Language, Setting 168

LATCH-type child seat anchors see Children in the vehicle

## License plate lamps 432

- Messages in display 410
- Replacing bulbs 436

## Light alloy wheels, cleaning 367

## Light sensor see Lamp sensor

## Lighter see Cigarette lighter 278

## Lighting

- Daytime running lamp mode 144

## Lighting, Exterior and interior 143

## Limp Home Mode 196

## Loading 260

- Split rear bench seat\* 260

## Loading see Vehicle loading

## Locator lighting 173

## Lock button 493

- Door handle (KEYLESS-GO\*) 63

## Loss of Service and Warranty Information

## Booklet 467

## Loss of SmartKeys 111, 118

## Low beam headlamps 54

- Indicator lamp 25
- Messages in display 410
- Replacing bulbs 432
- Switching on 54

## Lubricants 482

## Lumbar support 133

**M**

## Maintenance 12

- Calling up service indicator 360
- Clearing service indicator message 359
- FSS (Canada vehicles) 358
- Maintenance System (U.S. vehicles) 358
- Resetting service indicator 361
- Service indicator 358
- Service indicator message 358
- Service term exceeded 360

- Maintenance System (U.S. vehicles) 494
  - Manual headlamp mode see Headlamps
  - Manual shift program E 55 AMG 193
    - Deactivating 196
  - Maximum inflation pressure 351
  - Maximum load rating 351
  - Maximum loaded vehicle weight 351
  - Mechanical key 424
  - Memory function 494
  - Memory function see Seats
  - Menus see Control system menus
  - Messages in display see Multifunction display messages
  - Mirrors
    - Adjusting 45
    - Auto-dimming 197
    - Exterior rear view mirror 45
    - Exterior rear view mirror parking positions 178, 198
    - Interior rear view mirror 45
  - MO*Extended* system\* 340, 451
  - MO*Extended* tires\* 477
  - MON 313
  - Motor Octane Number see MON
  - Multifunction display 155, 494
    - Changing settings see Control system menus and Control system sub-menus
    - Selecting language 168
  - Multifunction display messages 385
    - ABS
    - Batteries 386, 395, 396
    - Brake fluid 399
    - Brake lamps 409
    - Brake pads 397
    - Check engine 375
    - Coolant 400, 401, 402
    - Cruise control 386
    - Distronic\* 386
    - Door 403
    - Electrohydraulic brake system 397, 398
    - Engine oil 317, 404, 405, 406
    - ESP® 388, 389
    - Fog lamps 409, 411
    - Fuel reserve tank 408
    - Headlamps 409, 410, 411
    - Hood 407
    - Key, SmartKey 408
    - Key, SmartKey with
  - KEYLESS-GO\* 407
  - Panorama roof with power tilt/sliding panel\* 414
  - Parking brake 398
  - Parking lamps 411
  - Power tilt/sliding sunroof\* 414
  - Seat belts 414
  - SRS 415
  - Tailgate 416
  - Tele Aid 414
  - Telephone\* 416
  - Tires 413
  - Turn signals 412
    - Windshield washer fluid 416
  - Multifunction steering wheel 26, 156, 494
    - Button operation 156
- N**
- Navigation system
    - See separate COMAND operating instructions 163
  - Net, parcel 274
  - Neutral gear position 186
  - Night security illumination 145
  - Normal occupant weight 351
  - Number, vehicle identification (VIN) 468

**O**

Occupant Classification System see OCS

Occupant distribution 351

Occupant safety 66

Air bags 67

Children and air bags 68

Children in the vehicle 77

Fastening the seat belt 47

Front passenger front air bag off indicator lamp 84

Infant and child restraint systems 78

LATCH-type child seat anchors 88

OCS

Seat belts 47, 70

OCS

Self-test 85

Odometer 155

Oil level see Engine oil, Checking level

Oil see Engine oil

One-touch gearshifting 190

Operating safety 16

Ornamental moldings, Cleaning 365

Outside temperature see Displays

Overdue maintenance service 358, 360

Overhead control panel 29

Overspeed range, engine 494

**P**

Paintwork, Cleaning 363

Panic alarm 90

Panorama roof with power tilt/sliding panel\*

Messages in display 414

Parcel net

Front passenger footwell 274

Parking 304

On hills 59, 304

Over things that burn, Potential consequences 59, 304

Parking brake 52, 60

Message in display 398

Parking lamps

Messages in display 411

Replacing bulbs 411

Parking position

Exterior rear view mirrors 141, 178, 198

Gear position 50, 186

Parts service 466

PASS AIR BAG OFF indicator lamp see

Front passenger front air bag off indicator lamp

Passenger compartment

Interior lighting 148

Interior rear view mirror 45

Main fuse box 463

Parcel net in front passenger footwell 274

Passenger safety see Occupant safety

Pedals 301

Phone see Telephone\*

Plastic parts, cleaning 367

Pliers, universal (vehicle tool kit) 419

Poly-V-belt drive 494

Layout 469

Positions (Memory function) see Seats

Power assistance 302

Power outlet 279

- Power seat see Seats
- Power tilt/sliding sunroof\* 236
  - Emergency operations 427
  - Messages in display 414
  - Opening/closing 236
  - Opening/closing in an emergency 427
  - Stopping 238
  - Synchronizing 238
- Power train 494
- Power washer 363
- Power windows 231
  - Cleaning 366
  - Operating 231
  - Rear door window, Blocking operation 89
  - Synchronizing 233
- Practical hints 372
  - Collapsible wheel chock 423
  - Spare wheel 422
- Problems
  - While driving 58
  - With vehicle 17
- Product information 9
- Production options weight 351
- Program mode selector switch 495
  - Automatic transmission 189
  - Manual shift program E 55 AMG, automatic transmission 194
- PSI 352
- PULSE function (Massage function) see Drive-Dynamic seat\* with multicontour features
- R**
- Radio
  - Selecting stations 161
  - Selecting stations (satellite\*) 162
- Radio transmitters 309
- Range (distance to empty) 181
- Reading lamp, front 149
- Reading lamp, rear 150
- Rear bench seat
  - Foldable 260
- Rear door window
  - Blocking operation 89
- Rear fog lamp see Fog lamps 146
- Rear lamps see Tail lamps
- Rear seat ashtray see Ashtray
- Rear seat head restraints see Head restraints
- Rear view mirrors see Mirrors
- Rear window defroster 200
- Recommended inflation pressure 352
- Recovery services, Stolen vehicle (Tele Aid) 290
- Refrigerant, Air conditioning 485
- Refueling 312
- Regular checks 313
- Reminder, Seat belt see Seat belts, Telltale 377
- Remote control, SmartKey 106
- Remote door unlock (Tele Aid) 289
- Replacing bulbs
  - Additional turn signals 435
  - Brake lamps 433
  - Headlamps 434
  - High beam headlamps 432
  - High mounted brake lamp 432
  - License plate lamps 432, 436
  - Low beam headlamps 432, 434
  - Parking lamps 432, 435
  - Side marker lamps 431
  - Side marker lamps, front 435
  - Tail lamps 432, 436
  - Turn signal lamps 431, 432, 435
- Reporting safety defects 18
- Research Octane Number see RON

- Reset button, In instrument cluster 25, 151, 166
- Rest tool
  - Depository 428
- Restraint system see Children in the vehicle
- Restraint system see SRS
- Reverse gear position 186
- Rim 352
- Rims 472
- Roadside Assistance 12
- Roller sunblind\* 200
- RON 313, 495
- Rubber parts, cleaning 367
- S**
- Safety
  - Driving safety systems 91
  - Occupant 66
  - Reporting defects 18
- Safety belts see Seat belts 47
- Satellite radio\* 162
- Seat belt force limiter 76
- Seat belts 72
  - Children in the vehicle
  - Cleaning 368
  - Fastening 47
  - Height adjustment 49
  - Message in display 414
  - Proper use of 49, 74
  - Safety guidelines 70
  - Telltale 25, 377
  - Warning lamp 377
- Seat cushions
  - Removing and installing 138
- Seating capacity 329
- Seats 40, 129
  - Drive-Dynamic seat\* with multicontour features 133
  - Easy-entry/exit feature 43
  - Heater\* 135
  - Memory function 140
  - Split rear bench seat\* 260
  - Ventilation 136
- Securing cargo
  - Cargo tie-down rings 264
- Selector lever see Gear selector lever
- Self-test
  - OCS 85
  - Tele Aid 283
- Service and warranty information 10
- Service intervals see Maintenance, Service indicator
- Service life, Tires 325
- Service see Maintenance
- Service system see FSS (Canada vehicles) or Maintenance System (US vehicles)
- Service, Parts 466
- Settings 114
  - Control system menus 157
  - Control system submenus 157
  - Date 171, 172
  - Factory, SmartKey 108
  - Individual, Vehicle 165
  - Memory function 140
  - Resetting all, Control system 166
  - Selective, SmartKey 109
  - Selective, SmartKey with KEYLESS-GO\* 115
  - Time 171
- Shelf below rear window, cleaning 368
- Shift lock 495
- Shift program mode 189

- Shifting
    - Into optimal gear range (automatic transmission) 191
  - Side impact air bags 72
  - Side marker lamps
    - Cleaning lenses 365
  - Side windows see Power windows
  - Sidewall 352
  - SmartKey see Key, SmartKey
  - Snow chains 356
  - Snow tires 355
  - Spare fuses 462
  - Spare wheel 422
    - Mounting 445
  - Speed settings
    - Cruise control 242
    - Distronic\* 249
  - Speedometer 25, 245
  - Split rear bench seat\* 260
  - SRS 66, 495
    - Indicator lamp 25, 380
    - Message in display 415
  - SRS indicator lamp 25
  - Standing lamps 143
  - Standing water, Driving through 308
  - Starter switch 36
    - Positions 36
  - Starting difficulties, Engine 51
  - Starting, Engine 50
  - Steering column 43
  - Steering wheel 42
    - Buttons 26
  - Steering wheel gearshift control one-touch gearshifting E 55 AMG
    - Automatic transmission 191
  - Steering wheel, Cleaning 368
  - Stolen Vehicle Recovery services 290
  - Storage box in cargo compartment 268
  - Storage compartments 30
    - Center console 272
    - Cup holder 275
    - Glove box 272
    - Parcel net in front passenger footwell
    - Rear center console 273
    - Ruffled storage bags 273
  - Storing
    - Tires 326
  - Submenus
    - In control system
  - Submenus see Control system submenus
  - Sun visors 199
  - Sunroof see Power tilt/sliding sunroof\*
  - Supplemental Restraint System see SRS
  - Suspension tuning
    - For comfortable driving style 255
    - For sporty driving style 255
  - Suspension tuning see Airmatic DC (Dual Control)\*
  - Symbols used in this operator's manual 15
- T**
- Tachometer 25, 153
    - Overspeed range 153
  - Tail lamps 436
    - Cleaning lenses 365
    - Messages in display 412
    - Replacing bulbs 436
  - Tailgate
    - Closing 122
    - Lock button, KEYLESS-GO\* 118
    - Message in display 416
    - Opening 110, 120
  - Tar stains 363



## Technical data

- Air conditioning refrigerant 485
- Brake fluid 485
- Capacities fuels, coolants, lubricants etc. 482
- Coolant 487
- Electrical system 479
- Engine 470
- Engine oil additives 485
- Engine oils 485
- Fuel requirements 487
- Gasoline additives 486
- Premium unleaded gasoline 486
- Rims and tires 472
- Weight 481
- Windshield washer and headlamp cleaning system 484

- Tele Aid 282, 495
  - Emergency calls 284
  - Information 287
  - Initiating an emergency call manually 285
  - Message in display 415
  - Messages in display 414
  - Remote door unlock 289
  - Roadside Assistance 286
  - SOS button 285
  - Stolen Vehicle Recovery services 290
  - System self-check 283
- Telematics\* 495
- Telephone\* 26, 181, 281
  - Answering/ending a call 182
  - Message in display 416
  - Operation 181
  - Phone book\* 183
  - Redialing 183

- Temperature
  - Display mode
  - Interior temperature 207, 221
  - Setting display unit

Tether attachment points, see Children in the vehicle

- Tie-down rings, Cargo compartment 264
- Tightening torque 450, 495
- Time 171, 172
  - Setting minutes 171
- TIN 352
- Tire
  - Vehicle maximum load on 353
- Tire and Loading Information Placard 328
- Tire and Loading Terminology 350
- Tire Identification Number see TIN
- Tire inflation pressure 442
  - Checking
- Tire load rating 352
- Tire ply composition and material used 352
- Tire Pressure Monitoring System\* (TPMS\*), (USA only)
  - Checking tire pressure electronically 335
- Tire speed rating 352
- TIREFIT
  - Instructions for use 440
- TIREFIT kit 440

- Tires 324, 472
  - Air pressure
  - Care and maintenance 325
  - Chains 356
  - Cleaning 326
  - Direction of rotation, Spinning 327
  - Driving instructions 305
  - Important notes, Tire inflation pressure 334
  - Inflation pressure 335, 339
  - Information Placard 328
  - Inspection 325
  - Messages in display 413
  - MO*Extended* system\* 340, 451
  - Problems under-/overinflation 339
  - Retreads 324
  - Rims and tires 472
  - Rotation 353
  - Service life 325
  - Sizes 474
  - Snow 355
  - Speed rating 306, 343
  - Storing 326
  - Temperature 334, 349
  - Terminology 350
  - TPMS malfunction telltale 378
- Traction 306
  - Tread depth 326, 355
  - Wear pattern 353
  - Winter 355
- Tools 419
- Top tether see Children in the vehicle
- Tow-away alarm 103
- Towing eye bolt 461
- Towing the vehicle 458
- Traction 190, 352
- Transmission fluid level 320
- Transmission gear selector lever see Gear selector lever
- Traveling abroad 309
- Tread 352
- Tread depth 326, 355
- Treadwear indicators 352
- Trip computer 180
- Trip odometer 153
- Turn signal lamps
  - Cleaning lenses 365
  - Messages in display 412
  - Replacing bulbs 435
- Turn signals 54
  - Additional in mirrors 432
  - Bulbs 432
  - Cleaning lenses 365
  - Indicator lamps 25
- Turning off engine 61
- Twin roller blind 269
- U**
- Uniform Tire Quality Grading Standards 353
- Units, Settings
  - Speedometer 168
  - Temperature 168
- Unleaded gasoline, Premium 486
- Uphill driving
  - Cruise control 240
- Upholstery
  - Cleaning 368
- Useful features 272

**V**

Vacuum line routing diagram label 468

## Vehicle

Battery 452

Care 362

Control system, settings menu 155

Dimensions 480

Individual settings 165, 167

Locking/unlocking 34, 59, 106

Locking/unlocking in an  
emergency 424, 425

Lowering 450

Modifications and alterations, Operat-  
ing safety 16

Towing 458

Washing 362

Weight 481

Vehicle capacity weight 353

Vehicle Identification Number see VIN

Vehicle jack 421

Vehicle level control see Airmatic DC (Dual  
Control)\*

Vehicle lighting 314

## Vehicle loading

Cargo tie-down rings 264

Instructions 263

Load limit 330

Terminology 350

Vehicle maximum load on the tire 353

Vehicle Recovery services, Stolen (Tele  
Aid) 290

Vehicle status message memory 164

Vehicle tool kit 419

Vehicle jack 421

Vehicle washing 364

VIN 496

Voice control system\* 496

**W**

Warning lamps see Lamps, Indicator and  
warning

## Warning sounds

Distance warning function\* 252

Distronic\* 246

Parking brake 53

Seat belt telltale 72

Warranty coverage 467

Washer fluid see Windshield washer fluid

Washer reservoir level 490

Washing the vehicle 362

Wear pattern, Tires 353

Weight, Vehicle 481

## Wheel

Change 445

Removing 447

Spare 447

Tightening torque 450

Wheels, Sizes 474

Wheels, Tires and 324

Window curtain air bags 72

Windows see Power windows 231

Windows, cleaning 366

## Windshield

Cleaning 56

Cleaning wiper blades 366

Defogging 209, 224

Windshield washer fluid 490

Message in display 416

Mixing ratio

Refilling 323

Wiping 56

Windshield washer system 490

Windshield wipers 55

Replacing wiper blade 438, 439

## Winter driving

- Block heater\* (Canada only) 356

- Snow chains 356

- Tires 355

Winter driving instructions 307

Winter tires 355

Wood trims, cleaning 369

**X**

Xenon headlamps\* see Headlamps







## Service and Literature

Your authorized Mercedes-Benz Center has trained technicians and original Mercedes-Benz parts to service your vehicle properly.  
For expert advice and quality service, see your authorized Mercedes-Benz Center.

If you are interested in obtaining service literature for your vehicle, please contact an authorized Mercedes-Benz Center.  
We consider this the best way for you to obtain accurate information for your vehicle.

For further information you can find us on the Mercedes-Benz web-site *www.mbusa.com* or *www.mercedes-benz.ca*.

### Warning!



To help avoid personal injury, be extremely careful when performing any service work or repairs. Improper or incomplete service or the use of incorrect or inappropriate parts or materials may damage the vehicle or its equipment, which may in turn result in personal injury.

If you have any questions about carrying out any type of service, turn to the advice of an authorized Mercedes-Benz Center.

We reserve the right to modify the technical details of the vehicle as given in the data and illustrations of this Operator's Manual.  
Reprinting, translation and copying, even of excerpts, is not permitted without our prior authorization in writing.

Title illustration no. P00.01-2508-31

Press time May 10, 2005

GSP/TIP

Printed in Germany



