



2035845771

Order No. 6515 0160 13 Part No. 203 584 57 71 USA Edition A 2006

Operator's Manual C-Class Sedan



Operator's Manual  
C-Class Sedan



Mercedes-Benz

C 230

C 230 Sport

C 280

C 280 4MATIC

C 350

C 350 4MATIC

C 350 Sport

Our company and staff congratulate you on the purchase of your new Mercedes-Benz.

Your selection of our product is a demonstration of your trust in our company name. Furthermore, it exemplifies your desire to own an automobile that will be as easy as possible to operate and provide years of service.

Your Mercedes-Benz represents the efforts of many skilled engineers and craftsmen. To help assure your driving pleasure, and also the safety of you and your passengers, we ask you to make a small investment of time:

- Please read this manual carefully, then return it to your vehicle where it will be handy for your reference.
- Please follow the recommendations contained in this manual. They are designed to acquaint you with the operation of your Mercedes-Benz.
- Please pay attention to the warnings and cautions contained in this manual. They are designed to help improve the safety of the vehicle operator and occupants.

We extend our best wishes for many miles of safe, pleasurable driving.

Mercedes-Benz USA, LLC  
A DaimlerChrysler Company

<b>Introduction</b> .....	9
Product information .....	9
Operator's Manual .....	10
Service and warranty information ..	10
Important notice for California retail buyers and lessees of	
Mercedes-Benz automobiles .....	11
Maintenance .....	12
Roadside Assistance .....	12
Change of address or ownership....	12
Operating your vehicle outside the USA or Canada.....	13
Where to find it.....	14
Symbols.....	15
Operating safety .....	16
Proper use of the vehicle .....	16
Problems with your vehicle.....	17
Reporting safety defects.....	18
Reporting Safety Defects .....	18
Vehicle data recording.....	19
Information regarding electronic recording devices.....	19

<b>At a glance</b> .....	21
Cockpit.....	22
Instrument cluster .....	24
Multifunction steering wheel .....	26
Center console .....	27
Upper part .....	27
Lower part .....	28
Overhead control panel .....	29
Door control panel.....	30

<b>Getting started</b> .....	31
Unlocking .....	32
Unlocking with the SmartKey .....	32
Starter switch positions .....	33
Adjusting .....	35
Seats .....	35
Steering wheel .....	40
Mirrors.....	43
Driving.....	45
Fastening the seat belt .....	45
Starting the engine .....	48
Parking brake .....	50
Driving .....	51
Switching on headlamps.....	52
Turn signals .....	53
Windshield wipers.....	53
Problems while driving.....	56
Parking and locking.....	57
Parking brake .....	58
Switching off headlamps.....	59
Turning off engine .....	59
Releasing seat belts.....	59
Locking.....	60

<b>Safety and Security</b> .....	61	<b>Controls in detail</b> .....	97	Lighting .....	118
Occupant safety .....	62	Locking and unlocking .....	98	Exterior lamp switch .....	118
Air bags .....	63	SmartKey .....	98	Combination switch .....	122
Seat belts .....	69	Opening the doors from		Corner-illuminating front fog lamps* (C 280, C 350 4MATIC: with	
Active head restraint .....	73	the inside .....	102	Bi-Xenon* headlamps) .....	123
Children in the vehicle .....	74	Opening the trunk .....	103	Hazard warning flasher .....	124
Blocking of rear door window		Closing the trunk .....	104	Interior lighting .....	125
operation .....	85	Trunk emergency release .....	105	Door entry lamps .....	126
Panic alarm* .....	86	Valet locking .....	106	Trunk lamp .....	126
Activating .....	86	Automatic central locking .....	107	Instrument cluster .....	127
Deactivating .....	86	Locking and unlocking from		Instrument cluster illumination ....	127
Driving safety systems .....	87	the inside .....	107	Coolant temperature gauge .....	128
ABS .....	87	Seats .....	109	Trip odometer .....	128
BAS .....	88	Front seat active head restraints .	109	Tachometer .....	129
ESP® .....	89	Rear seat head restraints .....	109	Outside temperature indicator ....	129
Four wheel electronic traction		Lumbar support* .....	112	Control system .....	130
system (4MATIC) with the ESP® ....	92	Multicontour seats*		Multifunction display .....	130
Anti-theft systems .....	93	(Canada only) .....	113	Multifunction steering wheel .....	131
Immobilizer .....	93	Seat heating* .....	113	Menus .....	133
Anti-theft alarm system* .....	93	Memory function* .....	115	Standard display menu .....	135
Tow-away alarm* .....	95	Storing positions into memory ....	116	AUDIO menu .....	136
		Recalling positions from memory .	116	NAV* menu .....	138
		Storing exterior rear view mirror		Vehicle status message memory	
		parking position .....	117	menu .....	138
				Settings menu .....	140

Trip computer menu.....	155	Adjusting air distribution and volume.....	180	Audio system.....	199
TEL menu* .....	157	Adjusting air volume .....	181	Audio and telephone, operation....	199
Manual transmission .....	160	Front defroster.....	181	Operating safety .....	199
Shifting into reverse.....	161	Air recirculation mode .....	182	Operating and display elements ...	200
Automatic transmission*.....	162	Air conditioning.....	183	Button and soft key operation .....	202
Gear selector lever position .....	164	Rear passenger compartment adjustable air vents.....	184	Operation.....	202
Driving tips.....	165	Automatic climate control* (Canada only) .....	186	Radio operation .....	207
Gear ranges .....	166	Deactivating the automatic climate control system.....	189	Introduction to satellite radio* (USA only).....	211
Automatic shift program .....	167	Operating the climate control system in automatic mode.....	189	CD mode.....	216
One-touch gearshifting.....	168	Setting the temperature.....	190	GSM network phones .....	225
Emergency operation (Limp Home Mode) .....	169	Adjusting air distribution.....	190	TDMA or CDMA network phones ..	231
Good visibility .....	170	Adjusting air volume .....	191	Emergency calls “911” .....	237
Headlamp cleaning system* .....	170	Front defroster.....	191	Power windows .....	240
Rear view mirrors.....	170	Maximum cooling MAXCOOL .....	192	Opening and closing the windows	240
Sun visors .....	173	Air recirculation mode .....	192	Synchronizing power windows.....	242
Rear window sunshade* .....	174	Charcoal filter .....	194	Summer opening feature .....	243
Rear window defroster.....	175	Air conditioning.....	196	Convenience closing feature.....	243
Climate control.....	176	Residual heat and ventilation .....	197	Power tilt/sliding sunroof* .....	244
Deactivating the climate control system .....	179	Rear passenger compartment adjustable air vents.....	197	Opening and closing the power tilt/sliding sunroof.....	244
Operating the climate control system in automatic mode.....	179			Synchronizing the power tilt/sliding sunroof.....	246
Setting the temperature.....	180			Driving systems.....	247
				Cruise control .....	247



Maximum tire load .....	327		
Maximum tire inflation pressure ..	328		
Uniform Tire Quality Grading Standards (U.S. vehicles) .....	328		
Tire ply material .....	330		
Tire and loading terminology .....	331		
Rotating tires .....	335		
Winter driving .....	336		
Winter tires .....	336		
Block heater (Canada only) .....	337		
Snow chains .....	337		
Maintenance .....	338		
Maintenance service indicator message .....	338		
Calling up the maintenance service indicator display .....	339		
Resetting the maintenance service indicator .....	340		
Vehicle care .....	341		
Cleaning and care of the vehicle ..	341		
		<b>Practical hints</b> .....	349
		What to do if ... .....	350
		Lamps in instrument cluster .....	350
		Lamp in center console .....	356
		Vehicle status messages in the multifunction display .....	358
		Where will I find ...? .....	383
		First aid kit .....	383
		Vehicle tool kit .....	383
		Minispare wheel .....	386
		Spare wheel bolts .....	388
		Unlocking/locking in an emergency ...	389
		Unlocking the vehicle .....	389
		Locking the vehicle .....	390
		Fuel filler flap .....	391
		Manually unlocking the transmission gear selector lever ...	392
		Opening/closing in an emergency ....	393
		Power tilt/sliding sunroof* .....	393
		Resetting activated head restraints ...	394
		Resetting activated head restraints .....	394
		Replacing SmartKey batteries .....	395
		SmartKey .....	396
		Replacing bulbs .....	397
		Bulbs .....	398
		Replacing bulbs for front lamps ....	400
		Replacing bulbs for rear lamps ....	403
		Replacing wiper blades .....	405
		Removing wiper blades .....	405
		Installing wiper blades .....	405
		Flat tire .....	406
		Preparing the vehicle .....	406
		Mounting the Minispare wheel .....	406
		MO <i>Extended system</i> * .....	411
		Battery .....	412
		Disconnecting the battery .....	413
		Removing the battery .....	413
		Charging and reinstalling the battery .....	414
		Reconnecting the battery .....	414
		Jump starting .....	415
		Towing the vehicle .....	417
		Installing towing eye bolt .....	420
		Fuses .....	421
		Aids for replacing fuses .....	421
		Main fuse box in passenger compartment .....	422
		Fuse box in engine compartment .	422
		Fuse box in trunk .....	423



# Contents

<b>Technical data</b> .....	425	Fuels, coolants, lubricants, etc. ....	440	<b>Technical terms</b> .....	449
Parts service .....	426	Capacities .....	440		
Warranty coverage.....	427	Engine oils.....	442		
Loss of Service and Warranty		Engine oil additives .....	442	<b>Index</b> .....	455
Information Booklet.....	427	Air conditioning refrigerant .....	442		
Identification labels.....	428	Brake fluid.....	442		
Layout of poly-V-belt drive .....	429	Premium unleaded gasoline .....	443		
Engine .....	430	Gasoline additives .....	443		
Rims and Tires .....	432	Fuel requirements .....	444		
Same size tires .....	434	Coolants.....	444		
Mixed size tires .....	435	Windshield washer and headlamp			
Minispare wheel .....	436	cleaning system* .....	448		
Electrical system.....	437				
Main dimensions.....	438				
Weights.....	439				

### ▼ Product information

Please observe the following in your own best interest:

We recommend using Genuine Mercedes-Benz parts as well as conversion parts and accessories explicitly approved by us for your vehicle model.

We have tested these parts to determine their reliability, safety and special suitability for Mercedes-Benz vehicles.

We are unable to make an assessment for other products and therefore cannot be held responsible for them, even if in individual cases an official approval or authorization by governmental or other agencies should exist. Use of such parts and accessories could adversely affect the safety, performance or reliability of your vehicle. Please do not use them.

Genuine Mercedes-Benz parts as well as conversion parts and accessories approved by us are available at your authorized Mercedes-Benz Center where you will receive comprehensive information, also on permissible technical modifications, and where proper installation will be performed.

### Operator's Manual

This Operator's Manual contains a great deal of useful information. We urge you to read it carefully and familiarize yourself with the vehicle before driving.

For your own safety and longer service life of the vehicle, we urge you to follow the instructions and warnings contained in this manual. Ignoring them could result in damage to the vehicle or personal injury to you or others. Vehicle damage caused by failure to follow instructions is not covered by the Mercedes-Benz Limited Warranty.

Your vehicle may have some or all of the equipment described in this manual. Therefore, you may find explanations for optional equipment not installed in your vehicle. If you have any questions about the operation of any equipment, your authorized Mercedes-Benz Center will be glad to demonstrate the proper procedures.

We continuously strive to improve our product, and ask for your understanding that we reserve the right to make changes in design and equipment. Therefore, information, illustrations and descriptions in this Operator's Manual might differ from your vehicle.

Optional equipment is also described in this manual, including operating instructions wherever necessary. Since they are special-order items, the descriptions and illustrations herein may vary slightly from the actual equipment of your vehicle.

If there are any equipment details that are not shown or described in this Operator's Manual, your authorized Mercedes-Benz Center will be glad to inform you of correct care and operating procedures.

The Operator's Manual and Maintenance Booklet are important documents and should be kept with the vehicle.

### Service and warranty information

---

The Service and Warranty Information Booklet contains detailed information about the warranties covering your Mercedes-Benz, including:

- New Car Limited Warranty
- Emission System Warranty
- Emission Performance Warranty
- California, Maine, Massachusetts, and Vermont Emission Control System Warranty (California, Maine, Massachusetts, and Vermont only)
- State Warranty Enforcement Laws (Lemon Laws)

### **Important notice for California retail buyers and lessees of Mercedes-Benz automobiles**

Under California law you may be entitled to a replacement of your vehicle or a refund of the purchase price or lease price, if Mercedes-Benz USA, LLC and/or its authorized repair or service facilities fail to fix one or more substantial defects or malfunctions in the vehicle that are covered by its express warranty after a reasonable number of repair attempts. During the period of 18 months from original delivery of the vehicle or the accumulation of 18000 miles (approximately 29000 km) on the odometer of the vehicle, whichever occurs first, a reasonable number of repair attempts is presumed for a retail buyer or lessee if one or more of the following occurs:

- (1) the same substantial defect or malfunction results in a condition that is likely to cause death or serious bodily injury if the vehicle is driven, that defect or malfunction has been subject to repair two or more times, and you have directly notified Mercedes-Benz USA, LLC in writing of the need for its repair,
- (2) the same substantial defect or malfunction of a less serious nature than category (1) has been subject to repair four or more times and you have directly notified us in writing of the need for its repair, or
- (3) the vehicle is out of service by reason of repair of the same or different substantial defects or malfunctions for a cumulative total of more than 30 calendar days.

Written notification should be sent to us, not a dealer, at Mercedes-Benz USA, LLC, Customer Assistance Center, One Mercedes Drive, Montvale, NJ 07645-0350.

#### Maintenance

---

The Maintenance Booklet describes all the necessary maintenance work which should be performed at regular intervals.

Always have the Maintenance Booklet with you when you take the vehicle to your authorized Mercedes-Benz Center for service. The service advisor will record each service in the booklet for you.

#### Roadside Assistance

---

The Mercedes-Benz Roadside Assistance Program provides factory-trained technical help in the event of a breakdown. Calls to the toll-free Roadside Assistance number

**1-800-FOR-MERCEdes (in the USA)**  
**1-800-387-0100 (in Canada)**

will be answered by Mercedes-Benz Customer Assistance Representatives 24 hours a day, 365 days a year.

For additional information refer to the Mercedes-Benz Roadside Assistance Program Brochure in your vehicle literature portfolio.

#### Change of address or ownership

---

If you change your address, be sure to send in the "Change of Address Notice" found in the Service and Warranty Information Booklet, or simply call the Mercedes-Benz Customer Assistance Center (in the USA) at 1-800-FOR-MERCEdes, or Customer Service (in Canada) at 1-800-387-0100. It is in your own interest that we can contact you should the need arise.

If you sell your Mercedes, please leave all literature with the vehicle to make it available to the next operator.

If you bought this vehicle used, be sure to send in the "Notice of Purchase of Used Car" found in the Service and Warranty Information Booklet, or call the Mercedes-Benz Customer Assistance Center (in the USA) at 1-800-FOR-MERCEdes, or Customer Service (in Canada) at 1-800-387-0100.

## Operating your vehicle outside the USA or Canada

---

If you plan to operate your vehicle in foreign countries, please be aware that

- service facilities or replacement parts may not be readily available,
- unleaded gasoline for vehicles with catalytic converters may not be available; the use of leaded fuels will damage the catalyts,
- gasoline may have a considerably lower octane rating, and improper fuel can cause engine damage.

Certain Mercedes-Benz models are available for delivery in Europe under our European Delivery Program. For details, consult an authorized Mercedes-Benz Center or write to:

In the USA:

Mercedes-Benz USA, LLC  
European Delivery Department  
One Mercedes Drive  
Montvale, NJ 07645-0350

In Canada:

Mercedes-Benz Canada, Inc.  
European Delivery Department  
98 Vanderhoof Avenue  
Toronto, Ontario M4G 4C9

### Where to find it

This Operator's Manual is designed to provide comprehensive support information for you, the vehicle operator. Each section has its own reference color.

#### At a glance

Here you will find an overview of all the controls that can be operated from the driver's seat.

#### Getting started

Here you will find all the information you need for your first drive. You should read this section first if this is your first Mercedes-Benz vehicle or if you are renting or borrowing this vehicle.

#### Safety and Security

Here you will find descriptions of the safety and security features of your vehicle.

#### Controls in detail

Here you will find detailed information about the equipment installed in your vehicle. This section expands on the "Getting started" section and also describes technical innovations. If you are already familiar with the basic functions of your vehicle, this section will be of particular interest to you.

#### Operation

Here you will find all the information you need for the proper operation of your vehicle.

#### Practical hints

This section provides fast assistance for dealing with problems you may encounter.

#### Technical data

All important technical data for your vehicle can be found in this section.

#### Indexes

The glossary provides explanations of the most important technical terms.

The table of contents and the index are designed to help you find information quickly and easily.

The following publications are part of your vehicle documentation:

- this Operator's Manual
- the Maintenance Booklet

Separate operating instructions will be provided as required depending on the equipment options installed in your vehicle.

## ▼ Symbols

Trademarks:

- ESP® is a registered trademark of DaimlerChrysler.
- HomeLink® is a registered trademark of Prince, a Johnson Controls Company.
- SIRIUS and related marks are trademarks of Sirius Satellite Radio Inc.

The following symbols are found in this Operator's Manual:

- \* Optional equipment is identified with an asterisk. Since standard equipment varies between models, the descriptions and illustrations in this manual may differ slightly from the actual equipment of your vehicle.

### Warning!



Warning notices draw your attention to hazards that may endanger your health or life, or the health or life of others.



Highlights hazards that may result in damage to your vehicle.



Helpful hints or further information you may find useful.

- ▶ This symbol points to instructions for you to follow.
- ▶ A number of these symbols appearing in succession indicates a multiple-step procedure.
  - ▷ Page This symbol tells you where to look for further information on a topic.
  - ▷▷ This continuation symbol marks an interrupted procedure which will be continued on the next page.
  - > In the glossary of technical terms, this symbol is used to indicate cross-references to term definitions.
- Display Words appearing in the multi-function display are printed in the type shown here.



#### Warning!



Work improperly carried out on electronic components and associated software could cause them to cease functioning. Because the vehicle's electronic components are interconnected, any modifications made may produce an undesired effect on other systems. Electronic malfunctions could seriously impair the operating safety of your vehicle.

See an authorized Mercedes-Benz Center for repairs or modifications to electronic components.

Other improper work or modifications on the vehicle could also have a negative impact on the operating safety of the vehicle.

Some safety systems only function while the engine is running. You should therefore never turn off the engine while driving.

#### Warning!



Heavy blows against the vehicle underbody or tires/wheels, for example when running over an obstacle, road debris or a pothole, may cause serious damage and impair the operating safety of your vehicle. If you feel a sudden significant vibration or ride disturbance, or you suspect that damage to your vehicle has occurred, you should turn on your hazard warning flashers, carefully slow down, and drive with caution to an area which is a safe distance from the road.

Inspect the vehicle underbody and tires/wheels for possible damage. If the vehicle appears unsafe, have it towed to the nearest authorized Mercedes-Benz Center or other qualified maintenance or repair facility for further inspection or repairs.

#### Proper use of the vehicle

Proper use of the vehicle requires that you are familiar with the following information and rules:

- the safety precautions in this manual
- the “Technical data” section in this manual
- traffic rules and regulations
- motor vehicle laws and safety standards

#### Warning!



Various warning labels are attached to your vehicle. These warning labels are intended to make you and others aware of various risks. You should not remove any of these warning labels unless explicitly instructed to do so by information on the label itself. Removal of any of these labels may cause you and others to be unaware of certain risks which may result in an accident and/or personal injury.

### ▼ Problems with your vehicle

If you should experience a problem with your vehicle, particularly one that you believe may affect its safe operation, we urge you to immediately contact an authorized Mercedes-Benz Center to have the problem diagnosed and corrected if required. If the matter is not handled to your satisfaction, please discuss the problem with the Mercedes-Benz Center management, or if necessary contact us at one of the following addresses:

In the USA:

Customer Assistance Center  
Mercedes-Benz USA, LLC  
One Mercedes Drive  
Montvale, NJ 07645-0350

In Canada:

Customer Relations Department  
Mercedes-Benz Canada, Inc.  
98 Vanderhoof Avenue  
Toronto, Ontario, M4G 4C9

### Reporting safety defects

For the USA only:

The following text is published as required of manufacturers under Title 49, Code of U.S. Federal Regulations, Part 575 pursuant to the “National Traffic and Motor Vehicle Safety Act of 1966”.

#### **Reporting Safety Defects**

---

If you believe that your vehicle has a defect which could cause a crash or could cause injury or death, you should immediately inform the National Highway Traffic Safety Administration (NHTSA) in addition to notifying Mercedes-Benz USA, LLC.

If NHTSA receives similar complaints, it may open an investigation, and if it finds that a safety defect exists in a group of vehicles, it may order a recall and remedy campaign. However, NHTSA cannot become involved in individual problems between you, your dealer, or Mercedes-Benz USA, LLC.

To contact NHTSA, you may either call the Auto Safety Hotline toll-free at 1-888-327-4236 (or 366-0123 in Washington, D.C. area) or write to: NHTSA, U.S. Department of Transportation, Washington, D.C. 20590. You can also obtain other information about motor vehicle safety from the Hotline.

## ▼ Vehicle data recording

### Information regarding electronic recording devices

---

(Including notice pursuant to California Code § 9951)

Please note that your vehicle is equipped with devices that can record vehicle systems data and, if equipped with the Tele Aid system, may transmit some data in certain accidents.

This information helps, for example, to diagnose vehicle systems after a collision and to continuously improve vehicle safety. DaimlerChrysler may access the information and share it with others

- for safety research or vehicle diagnosis purposes
- with the consent of the vehicle owner or lessee
- in response to an official request by law enforcement or other government agency
- for use in dispute resolution involving DaimlerChrysler, its affiliates or sales/service organization and/or
- as otherwise required or permitted by law.

Please check the Tele Aid subscription service agreement for details regarding the information that may be recorded or transmitted via that system.



## At a glance

Cockpit

Instrument cluster

Multifunction steering wheel

Center console

Overhead control panel

Door control panel



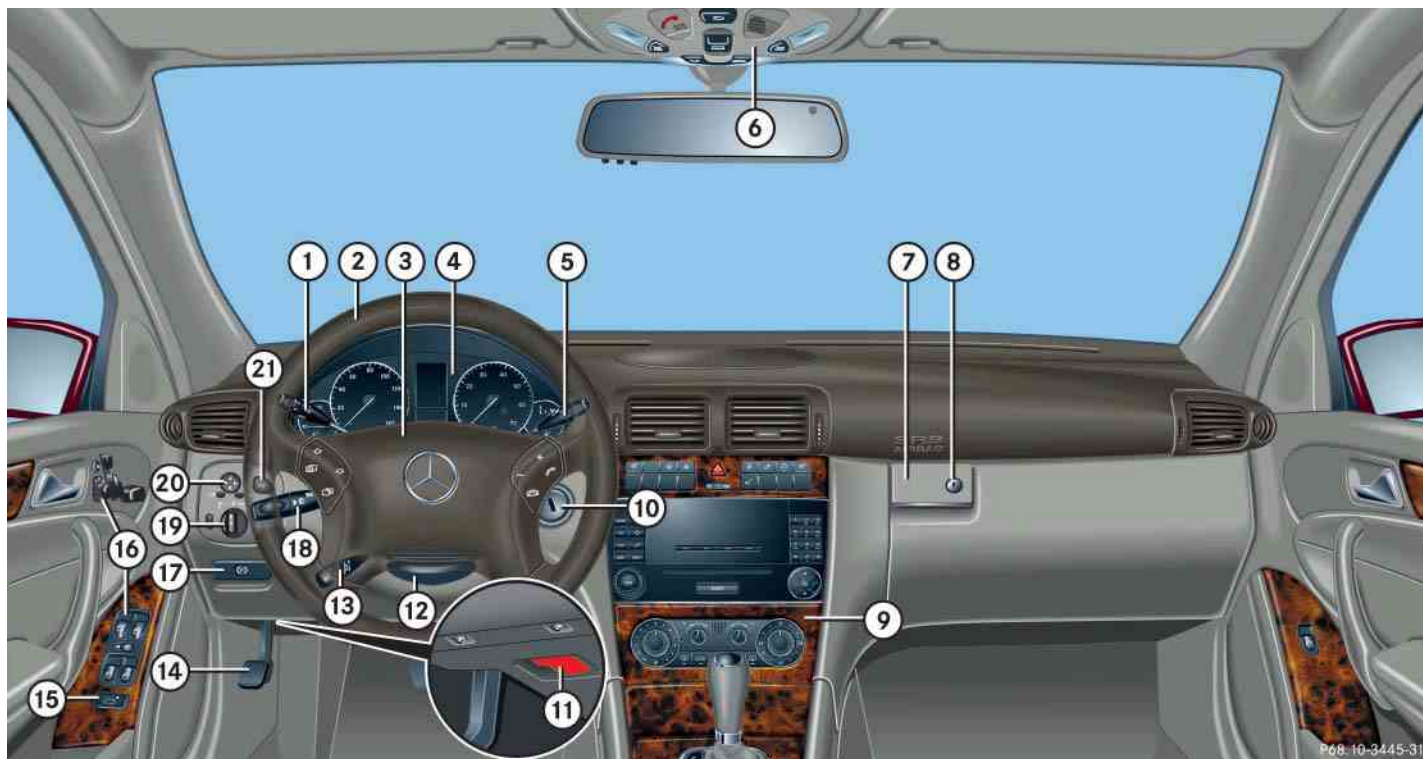

Item	Page
① Cruise control lever	247
② Multifunction steering wheel	26, 131
③ Horn	
④ Instrument cluster	24, 127
⑤ Lever for voice control system*, see separate operating instructions	
⑥ Overhead control panel	29
⑦ Glove box lid release	257
⑧ Glove box lock	257





Item	Page
⑨ Center console	27
⑩ Starter switch	33
⑪ Hood lock release	297
⑫ Steering wheel adjustment handle (manual)	40
⑬ Steering wheel adjustment lever (electrical)*	41
⑭ Parking brake pedal	50, 58
⑮ Remote trunk opening switch	104
⑯ Door control panel	30
⑰ Parking brake release	50





Item	Page
⑱ Combination switch	
• Turn signals	53
• Windshield wipers	53
• High beam	52
⑲ Exterior lamp switch	52, 118
⑳ Exterior rear view mirror adjustment	43, 117
㉑ Headlamp washer button*	170







P54.32-3565-31





Item	Page
① <b>Speedometer with:</b>	
 Electronic Stability Program (ESP®) warning lamp	89, 354
 Brake warning lamp, USA only	50, 58, 351
 Brake warning lamp, Canada only	50, 58, 351
 Low beam headlamp indicator lamp	52, 118
②  Left turn signal indicator lamp	53
③ <b>Multifunction display with:</b>	130
Trip odometer	128
Main odometer	130
Gear selector lever position*	49, 130, 164



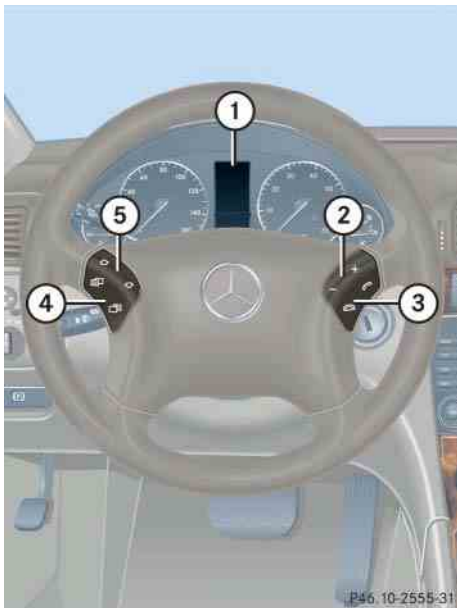

Item	Page
Program mode*	167
Status indicator (outside temperature/digital speedometer)	129, 144
Digital clock	130
④  Right turn signal indicator lamp	53
⑤ <b>Tachometer with:</b>	129
 Antilock Brake System (ABS) indicator lamp	87, 350
 Engine malfunction indicator lamp, USA only	352, 353
 Engine malfunction indicator lamp, Canada only	352, 353
 Supplemental Restraint System (SRS) indicator lamp	62, 355

Item	Page
 Seat belt telltale	69, 355
 High beam headlamp indicator lamp	52, 122
⑥ <b>Fuel gauge with:</b>	
Fuel reserve warning lamp	354
 The arrow indicates that the fuel filler cap is on the rear right-hand side.	
⑦ Coolant temperature gauge	128
⑧ <b>Reset button for:</b>	127
• Resetting trip odometer	128
• Resetting all settings	140
• Instrument cluster illumination	127

## Multifunction steering wheel



	Item	Page
①	Multifunction display	130
	<b>Operating control system</b>	131
②	Selecting the submenu or setting the volume: Press button	
	 up/to increase	
	 down/to decrease	
③	Telephone*: Press button	
	 to take a call	
	 to end a call	

	Item	Page
④	Menu systems: Press button	
	 for next menu	
	 for previous menu	
⑤	Moving within a menu: Press button	
	 for next display	
	 for previous display	



C 230 Sport and C 350 Sport:  
Steering wheel in these vehicles will vary from steering wheel shown. However, multifunction steering wheel symbols and feature description apply to Sport models as well.

## ▼ Center console

## Upper part



P68.20-3473-31

Item	Page
① Seat heating*, driver's side	113
② Rear window sunshade switch*	174
③ ESP® control switch	89
④ Hazard warning flasher switch – switching on/off	124
⑤ Central locking switch	107
Central unlocking switch	107
⑥ Switch for folding back rear seat head restraints	111
⑦ Tow-away alarm switch*	95
Anti-theft alarm system indicator lamp*	94

Item	Page
⑧ Seat heating*, passenger side	113
⑨ Front passenger front air bag off indicator lamp	80, 357, 366
⑩ Audio system, or COMAND* (see separate operating instructions)	199
⑪ Climate control	176
Automatic climate control* (Canada only)	186
Rear window defroster	175

## Center console

### Lower part

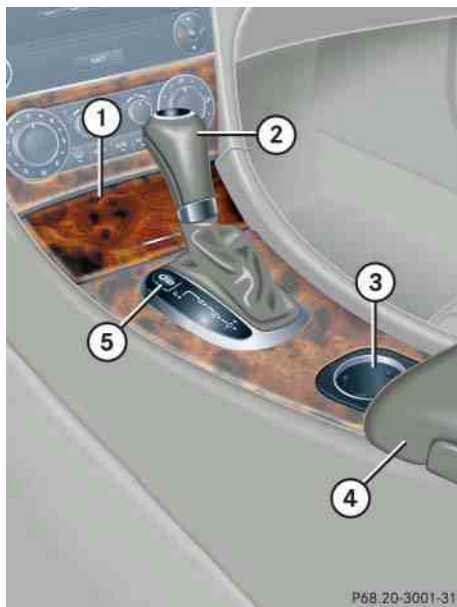

	Item	Page
①	Ashtray	261
	Cigarette lighter	262
②	Gear selector lever for automatic transmission*	49, 164
	Gearshift lever for manual transmission	48, 160
③	Cup holder	259
④	Armrest	258
⑤	Program mode selector switch for automatic transmission*	167

## ▼ Overhead control panel



Item	Page
① Rear interior lighting on/off	126
② Power tilt/sliding sunroof*	244
③ Right reading lamp on/off	126
④ Interior lighting control	125
⑤ Interior rear view mirror	43, 170
⑥ Hands-free microphone for Tele Aid* (emergency call system) and telephone*	157, 225, 265
⑦ Garage door opener*	273
⑧ Left reading lamp on/off	126
⑨ Tele Aid* (emergency call system) button	265

## Door control panel



	Item	Page
①	Door handle	102
②	Memory function* (for storing seat, exterior mirror and steering wheel settings)	115
③	Switches for seat adjustment*	35, 109
④	Switches for opening/closing front door windows	240
⑤	Rear door window override switch	85
⑥	Switches for opening/closing rear door windows	240
⑦	Remote trunk lid switch	104

**Unlocking**

**Adjusting**

**Driving**

**Parking and locking**

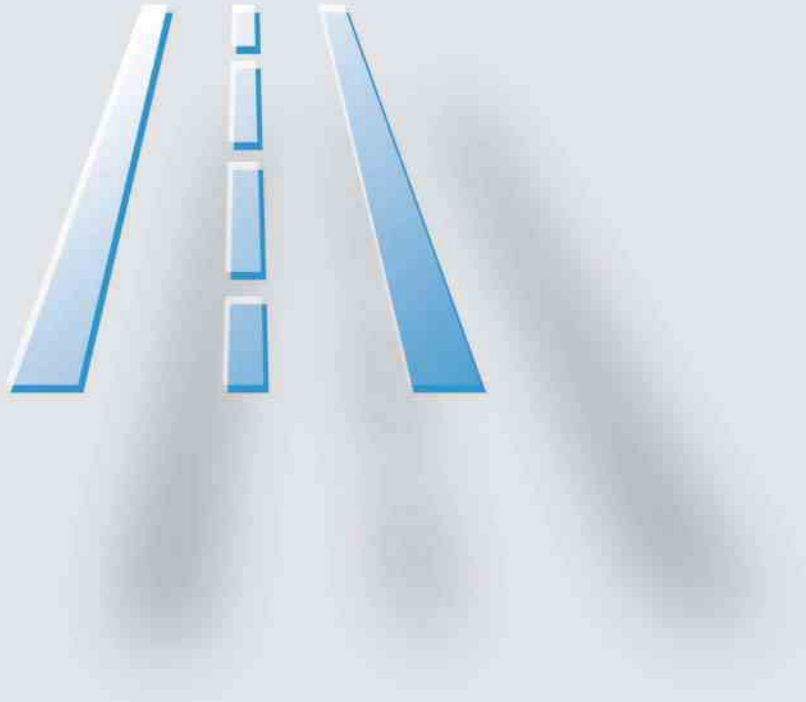



### Unlocking





The “Getting started” section provides an overview of the vehicle’s most basic functions. First-time Mercedes-Benz owners should pay special attention to the information given here.

If you are already familiar with the basic functions described here, the “Controls in detail” section (▷ page 98) will provide you with further information. The corresponding page references are located at the end of each segment.

#### Unlocking with the SmartKey



#### SmartKey with remote control

- ①  Lock button
- ②  Opening button for trunk
- ③  Unlock button
- ④  Panic button\* (▷ page 86)



Canada only:

Only vehicles equipped with an anti-theft alarm system\* have SmartKeys with integrated panic button\* ④.

- ▶ Press unlock button  on the SmartKey.

All turn signal lamps flash once. The locking knobs in the doors move up. The anti-theft alarm system\* is disarmed.

- ▶ Get in the vehicle and insert the SmartKey in the starter switch.

For more information, see “Locking and unlocking” (▷ page 98).

## Starter switch positions

### Warning!



When leaving the vehicle, always remove the SmartKey from the starter switch, take it with you, and lock the vehicle. Do not leave children unattended in the vehicle, or with access to an unlocked vehicle. Unsupervised use of vehicle equipment may cause an accident and/or serious personal injury.

## SmartKey

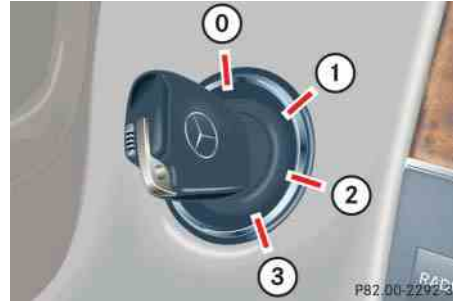

## Starter switch

- 0** For removing SmartKey  
The steering is locked when the SmartKey is removed from the starter switch.
- 1** Power supply for some electrical consumers, such as seat adjustment

- 2** Ignition (power supply for all electrical consumers) and driving position.  
All lamps (except low beam headlamp indicator lamp, high beam headlamp indicator lamp, and turn signal indicator lamps unless activated) in the instrument cluster come on. If a lamp in the instrument cluster fails to come on when the ignition is switched on, have it checked and replaced if necessary. If a lamp in the instrument cluster remains on after starting the engine or comes on while driving, see “Lamps in instrument cluster” (▷ page 350).
- 3** Starting position

### Unlocking



When you switch on ignition, the indicator and warning lamps (except low beam headlamp indicator lamp, high beam headlamp indicator lamp, and turn signal indicator lamps unless activated) in the instrument cluster come on. The indicator and warning lamps (except low beam headlamp indicator lamp, high beam headlamp indicator lamp, and turn signal indicator lamps if activated) will go out when the engine is running. This indicates that the respective systems are operational.



Vehicles with automatic transmission\*:  
The SmartKey can only be removed from the starter switch with the gear selector lever in position **P**.



If the SmartKey cannot be turned in the starter switch, the battery may not be sufficiently charged.

- Check the battery and charge it if necessary (▷ page 412).
- Get a jump start (▷ page 415).

To prevent accelerated vehicle battery discharge or a completely discharged battery, always remove the SmartKey from the starter switch when the engine is not in operation.

## ▼ Adjusting

### Warning!



All seat, head restraint, steering wheel, and rear view mirror adjustments, as well as fastening of seat belts, must be done before the vehicle is put into motion.

## Seats

The seats can be adjusted either manually or electrically, depending on the vehicle's equipment.

For more information, see “Seats” (▷ page 109).

### Warning!



Do not adjust the driver's seat while driving. Adjusting the seat while driving could cause the driver to lose control of the vehicle.

Never ride in a moving vehicle with the seat back in an excessively reclined position as this can be dangerous. You could slide under the seat belt in a collision. If you slide under it, the belt would apply force at the abdomen or neck. That could cause serious or fatal injuries. The seat back and seat belts provide the best restraint when the wearer is in a nearly upright position and belts are properly positioned on the body. Your seat must be adjusted so that you can correctly fasten your seat belt (▷ page 45).

Never place hands under the seat or near any moving parts while a seat is being adjusted.

### Warning!



When leaving the vehicle, always remove the SmartKey from the starter switch, take it with you, and lock the vehicle.

Even with the SmartKey removed from the starter switch, the power seats\* can be operated when the respective door is open. Therefore, do not leave children unattended in the vehicle, or with access to an unlocked vehicle. Unsupervised use of vehicle equipment may cause an accident and/or serious personal injury.

#### Warning!



According to accident statistics, children are safer when properly restrained in the rear seating positions than in the front seating position. Thus, we strongly recommend that children be placed in the rear seats whenever possible. Regardless of seating position, children 12 years old and under must be seated and properly secured in an appropriate infant, or toddler restraint, or booster seat recommended for the size and weight of the child. For additional information, see “Children in the vehicle” (▷ page 74).

A child’s risk of serious or fatal injuries is significantly increased if the child restraints are not properly secured in the vehicle and/or the child is not properly secured in the child restraint.



When moving the seats, make sure that there are no items in the footwell or behind the seat. Otherwise you could damage the seats.

#### Manual seat adjustment

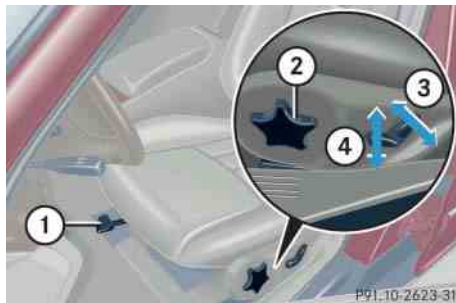

- ① Seat fore and aft adjustment
- ② Seat cushion tilt
- ③ Seat backrest tilt
- ④ Seat height

#### Seat fore and aft adjustment

- ▶ Lift handle ①.
- ▶ Slide seat to the desired position.

Adjust seat to a comfortable seating position that still allows you to reach the accelerator/brake pedal safely. The position should be as far rearward as possible, consistent with ability to properly operate controls.

- ▶ Allow handle ① to reengage with an audible click.
- ▶ Check for proper engagement before driving.

**Seat cushion tilt**

- ▶ Turn handwheel ② forward or backward until your upper legs are lightly supported.

**Seat backrest tilt**

- ▶ Switch on the ignition (▷ page 33).
- ▶ Press switch ③ in direction of arrow until your arms are slightly angled when holding the steering wheel.

**Seat height**

- ▶ Switch on the ignition (▷ page 33).
- ▶ Press switch ④ in direction of arrow until your legs are lightly supported.

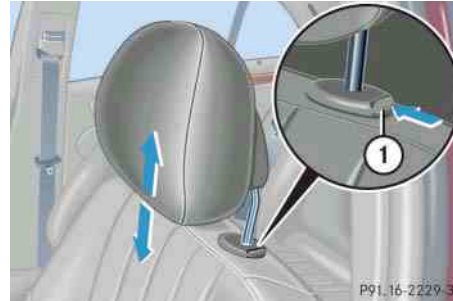
**Head restraint height**

## ① Release button

## Raising:

- ▶ Manually adjust the height of the head restraint by pulling it upward.

## Lowering:

- ▶ To lower head the restraint, push release button ① and push down on the head restraint.



Adjust the head restraint in such a way that it is as close to the head as possible.

**Warning!**

For your protection, drive only with properly positioned head restraints.

Adjust head restraint so that the head restraint supports the back of the head at eye level. This will reduce the potential for injury to the head and neck in the event of an accident or similar situation.

Do not drive the vehicle without the seat head restraints. Head restraints are intended to help reduce injuries during an accident.

### Adjusting

#### Head restraint tilt



Manually adjust the angle of the head restraint.

- ▶ Push or pull on the lower edge of the head restraint cushion.

For more information, see “Seats” (▷ page 109).

#### Power seat\* adjustment

The seat adjustment switches are located on the respective front door.

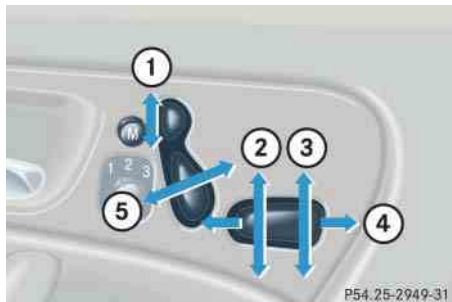

- ① Head restraint height
- ② Seat height
- ③ Seat cushion tilt
- ④ Seat fore and aft adjustment
- ⑤ Seat backrest tilt

- ▶ Switch on the ignition (▷ page 33).

or

- ▶ Open the respective door.



The memory function\* (▷ page 115) lets you store the settings for the power seat\*, the steering wheel adjustment (electrical\*) and the exterior rear view mirrors.

#### Seat fore and aft adjustment

- ▶ Press switch forward or backward in direction of arrow ④.

Adjust seat to a comfortable seating position that still allows you to reach the accelerator/brake pedal safely. The position should be as far rearward as possible, consistent with ability to properly operate controls.

**Seat cushion tilt**

- ▶ Press switch up or down in direction of arrow ③ until your upper legs are lightly supported.

**Seat backrest tilt**

- ▶ Press switch forward or backward in direction of arrow ⑤ until your arms are slightly angled when holding the steering wheel.

**Seat height**

- ▶ Press switch up or down in direction of arrow ②.

**Head restraint height**

- ▶ Press switch up or down in direction of arrow ①.



Adjust the head restraint in such a way that it is as close to the head as possible.

**Warning!**

For your protection, drive only with properly positioned head restraints.

Adjust head restraint so that the head restraint supports the back of the head at eye level. This will reduce the potential for injury to the head and neck in the event of an accident or similar situation.

Do not drive the vehicle without the seat head restraints. Head restraints are intended to help reduce injuries during an accident.

**Head restraint tilt**

Manually adjust the angle of the head restraint.

- ▶ Push or pull on the lower edge of the head restraint cushion.

For more information, see “Seats” (▷ page 109).



#### Steering wheel

##### Warning!



Do not adjust the steering wheel while driving. Adjusting the steering wheel while driving, or driving without the steering wheel adjustment feature locked could cause the driver to lose control of the vehicle.

When leaving the vehicle, always remove the SmartKey from the starter switch, take it with you, and lock the vehicle.

Even with the SmartKey removed from the starter switch, the electrical steering wheel adjustment feature\* can be operated when the driver's door is open. Therefore, do not leave children unattended in the vehicle, or with access to an unlocked vehicle. Unsupervised use of vehicle equipment may cause an accident and/or serious personal injury.

#### Steering wheel adjustment, manual

##### Warning!



Only adjust the steering wheel with the vehicle at a standstill and make sure the steering column is securely locked in place before driving off.

Driving without the steering column locked may cause an unexpected steering wheel movement which could cause the driver to lose control of the vehicle. Make sure the steering column is securely locked by trying to move it up and down, and in and out before driving off.

The handle for steering wheel adjustment is located on the lower left of the steering column.



##### ① Handle

- ▶ To unlock the steering column, pull handle ① out to its stop limit.
- ▶ Move steering wheel to the desired position.

Make sure your legs can move freely and that all the displays (including malfunction and indicator lamps) on the instrument cluster are clearly visible.

- ▶ To lock the steering column, push handle ① all the way in until it engages.

The steering wheel is locked into position again.

- ▶ Make sure the steering wheel is securely locked by trying to move it up and down, and in and out before driving off.



Do not drive the vehicle until you have properly locked the steering column.

### Steering wheel adjustment, electrical\*

The lever for the electrical steering wheel adjustment is located on the lower left of the steering column.

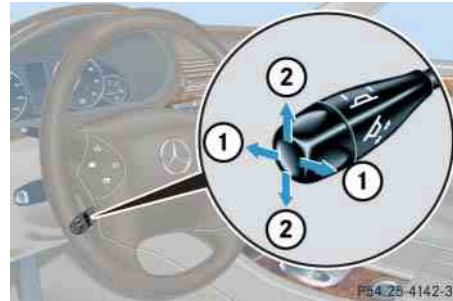

- ① Adjusting steering column, in or out
  - ② Adjusting steering column, up or down
- ▶ Switch on the ignition (▷ page 33).  
or
  - ▶ Open the driver's door.



The memory function\* (▷ page 115) lets you store the settings for the power seat\*, the steering wheel adjustment (electrical\*) and the exterior rear view mirrors.

### *Adjusting steering column in or out*

- ▶ Move the lever in direction of arrows ① until a comfortable steering wheel position is reached with your arms slightly bent at the elbow.

### *Adjusting steering column up or down*

- ▶ Move the lever in direction of arrows ②.

Make sure your legs can move freely and that all the displays (including malfunction and indicator lamps) on the instrument cluster are clearly visible.

### Adjusting

#### *Easy-entry/exit feature\**

This feature allows for easier entry into and exit from the vehicle. When entering and exiting the vehicle, the steering wheel is in its uppermost position.

The easy-entry/exit feature can be activated or deactivated in the *Convenience* sub-menu of the control system (▷ page 153).

#### Warning!



You must make sure no one can become trapped or injured by the moving steering wheel when the easy-entry/exit feature is activated.

To cancel steering wheel movement, do one of the following:

- Move steering column stalk\* (▷ page 41).
- Press memory position switch\* (▷ page 116).

Do not leave children unattended in the vehicle, or with access to an unlocked vehicle.

Children could open the driver's door and unintentionally activate the easy-entry/exit feature, which could result in an accident and/or serious personal injury.

With the easy-entry/exit feature activated, the steering wheel will return to its last set position when you:

- close the driver's door with the ignition switched on,  
or
- insert the SmartKey into the starter switch with the driver's door closed.



The last set steering wheel position is stored when

- the ignition is switched off
- the position is stored in memory (▷ page 115)

With the easy-entry/exit feature activated, the steering wheel tilts upwards when you:

- remove the SmartKey from the starter switch,  
or
- open the driver's door with the SmartKey in starter switch position **0** or **1**.



If the current position for the steering wheel is in the uppermost tilt position, the steering wheel will no longer be able to move upward when the easy-entry/exit feature is activated.

The adjustment procedure is briefly interrupted when the engine is started.

**Warning!**

Let the system complete the adjustment procedure before setting the vehicle in motion. All steering wheel adjustments must be completed before setting the vehicle in motion. Driving off with the steering wheel still adjusting could cause the driver to lose control of the vehicle.

**Mirrors**

Adjust the interior and exterior rear view mirrors before driving so that you have a good view of the road and traffic conditions.

**Warning!**

In case of an accident, liquid electrolyte may escape the mirror housing if the mirror glass breaks.

Electrolyte has an irritating effect. Do not allow the liquid to come into contact with eyes, skin, clothing, or respiratory system. In case it does, immediately flush affected area with water, and seek medical help if necessary.



Electrolyte drops coming into contact with the vehicle paint finish can only be completely removed while in their liquid state and by applying plenty of water.

**Interior rear view mirror**

- ▶ Manually adjust the interior rear view mirror.

For more information, see “Rear view mirrors” (▶ page 170).

**Exterior rear view mirrors****Warning!**

Exercise care when using the passenger-side exterior rear view mirror. The mirror surface is convex (outwardly curved surface for a wider field of view). Objects in mirror are closer than they appear. Check your interior rear view mirror or glance over your shoulder before changing lanes.

### Adjusting



If an exterior rear view mirror housing is forcibly pushed forward (hit from the rear) or rearward (hit from the front), reposition it by applying firm pressure until it snaps into place. The exterior rear view mirror housing is now properly positioned and you can adjust the mirror normally.



The memory function\* (▷ page 115) lets you store the settings for the power seat\*, the steering wheel adjustment (electrical\*) and the exterior rear view mirrors.

The buttons are located above the exterior lamp switch.

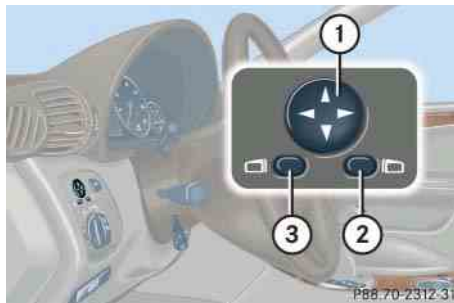

- ① Adjustment button
- ② Passenger-side exterior rear view mirror button
- ③ Driver's side exterior rear view mirror button

- ▶ Switch on the ignition (▷ page 33).
- ▶ Press button ③ for the driver's side exterior rear view mirror or button ② for passenger-side exterior rear view mirror.

- ▶ Press adjustment button ① up, down, left, or right according to the desired setting.



At low ambient temperatures, the exterior rear view mirrors will be heated automatically.

For more information, see "Rear view mirrors" (▷ page 170).

## ▼ Driving

### Warning!



Do not lay any objects in the driver's footwell. Be careful that floor mats or carpets in the driver's footwell have sufficient clearance for the pedals.

During sudden driving or braking maneuvers the objects could get caught between the pedals. You could then no longer brake or accelerate.

### Fastening the seat belt

### Warning!



Always fasten your seat belt before driving off. Always make sure your passengers are properly restrained, even those sitting in the rear and pregnant women.

Failure to wear and properly fasten and position your seat belt greatly increases your risk of injuries and their likely severity in an accident. You and your passengers should always wear seat belts.

If you are ever in an accident, your injuries can be considerably more severe without your seat belt properly buckled. Without your seat belt buckled, you are much more likely to hit the interior of the vehicle or be ejected from it. You can be seriously injured or killed.

In the same crash, the possibility of injury or death is lessened if you are wearing your seat belt. The air bags can only provide the protection they were designed to afford if the occupants are using their seat belts (▷ page 69).

### Warning!



According to accident statistics, children are safer when properly restrained in the rear seating positions than in the front seating position. Thus, we strongly recommend that children be placed in the rear seats. Regardless of seating position, children 12 years old and under must be seated and properly secured in an appropriate infant or toddler restraint, or booster seat recommended for the size and weight of the child. For additional information, see "Children in the vehicle" (▷ page 74).

A child's risk of serious or fatal injuries is significantly increased if the child restraints are not properly secured in the vehicle and/or the child is not properly secured in the child restraint.

#### Warning!



Never let more people ride in the vehicle than there are seat belts available. Be sure everyone riding in the vehicle is correctly restrained with a separate seat belt. Never use a seat belt for more than one person at a time.

#### Warning!



Never ride in a moving vehicle with the seat backrest in an excessively reclined position as this can be dangerous. You could slide under the seat belt in a collision. If you slide under it, the belt would apply force at the abdomen or neck. That could cause serious or even fatal injuries. The seat backrest and seat belt provide the best restraint when the wearer is in a nearly upright position and the belt is properly positioned on the body.

#### Warning!



Read and observe the additional warning notices printed in the “Safety and Security” section (> page 66) and (> page 69).

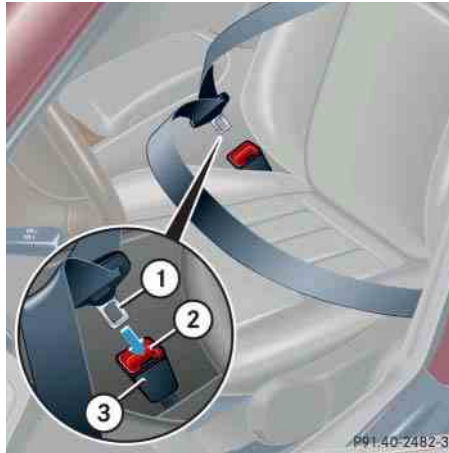

- ① Latch plate
- ② Release button
- ③ Buckle

- ▶ With a smooth motion, pull the belt from the belt outlet.
- ▶ Place the shoulder portion of the belt across the top of your shoulder and the lap portion across your hips.
- ▶ Push latch plate ① into buckle ③ until it engages.
- ▶ If necessary, tighten the lap portion to a snug fit by pulling shoulder portion up.

### Belt outlet height adjustment

Adjust seat belt so that shoulder portion is located as close as possible to the middle of your shoulder (it should not touch the neck or pass under the arm).

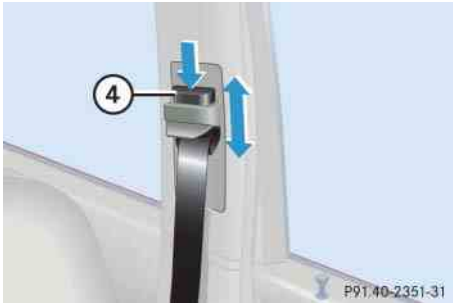

#### Belt outlet, front seats

- ④ Release button

#### Raising

- ▶ Slide belt outlet upward.

#### Lowering

- ▶ Press button ④ and slide belt outlet downward.

For more information, see “Safety guidelines for the seat belt, emergency tensioning device and air bag” (▷ page 66).

#### Proper use of seat belts

- Do not twist the seat belt when fastening.
- Adjust seat belt so that the shoulder portion is located as close as possible to the middle of the shoulder (it should not touch the neck). Never pass the shoulder portion of the belt under your arm. For this purpose, you can adjust the height of the belt outlet.
- Position the lap belt as low as possible on your hips (over hip joint) and not across the abdomen.

- Place the seat backrest in a nearly upright position.
- Never use a seat belt for more than one person at a time.
- Do not fasten a seat belt around a person and another object at the same time.
- When using a seat belt to secure infant or toddler restraints or children in booster seats, always follow the child seat manufacturer’s instructions.
- Check your seat belt during travel to make sure that it is properly positioned.
- Make sure that the seat belt is always fitted snugly. Take special care of this when wearing loose clothing.



#### Warning!



Do not pass belts over sharp edges. They could tear.

Do not allow the belt to get caught in the door or in the seat adjustment mechanism. This could damage the belt.

Never attempt to make modifications to seat belts. This could impair the effectiveness of the belts.

Do not bleach or dye seat belts as this may severely weaken them. In a crash, they may not be able to provide adequate protection.

Damaged seat belts or belts that were highly stressed in an accident must be replaced. Contact an authorized Mercedes-Benz Center.

#### Starting the engine

#### Warning!



Inhalation of exhaust gas is hazardous to your health. All exhaust gas contains carbon monoxide, and inhaling it can cause unconsciousness and possible death.

Do not run the engine in confined areas (such as garage) which are not properly ventilated. If you think that exhaust gas fumes are entering the vehicle while driving, have the cause determined and corrected immediately. If you must drive under these conditions, drive only with at least one window fully open.

#### Manual transmission



#### Gearshift pattern for manual transmission

For more information, see “Manual transmission” (> page 160).

**Starting**

- ▶ Depress brake pedal.
- ▶ Make sure the gearshift lever is in neutral position (no gear selected).
- ▶ Fully depress clutch pedal.

Otherwise the engine cannot be started due to the integrated safety interlock.

- ▶ Do not depress the accelerator.
- ▶ Turn the SmartKey in the starter switch to position **3** (▷ page 33) and hold until the engine starts.

For information on turning off the engine, see “Turning off engine” (▷ page 59).

**Automatic transmission\*****Gearshift pattern for automatic transmission**

- P** Park position with gear selector lever lock
- R** Reverse gear
- N** Neutral position
- D** Drive position

For more information, see “Automatic transmission\*” (▷ page 162).

**Starting**

- ▶ Place the gear selector lever in position **P**.
- ▶ Do not depress the accelerator.
- ▶ Turn the SmartKey in the starter switch to position **3** (▷ page 33) and release it again immediately. The engine then starts automatically.

For information on turning off the engine, see “Turning off engine” (▷ page 59).

#### Starting difficulties

If the engine does not start as described, carry out the following steps:

- ▶ Turn the SmartKey in starter switch to position **0** and repeat the starting procedure (▷ page 48).

Remember that extended starting attempts can drain the vehicle battery.

- ▶ Get a jump start (▷ page 415).

If the engine does not start after several starting attempts, there could be a malfunction in the engine electronics or in the fuel supply system.

- ▶ Notify an authorized Mercedes-Benz Center.

#### Parking brake

##### Warning!



When leaving the vehicle, always remove the SmartKey from the starter switch, take it with you, and lock the vehicle. Do not leave children unattended in the vehicle, or with access to an unlocked vehicle. Children could release the parking brake, which could result in an accident and/or serious injury.

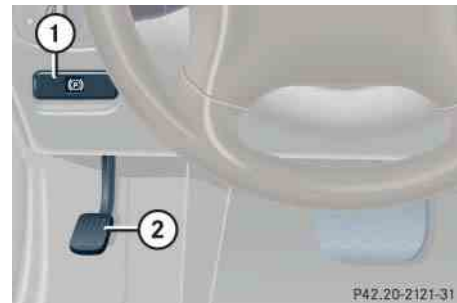

- ① Release handle
- ② Parking brake pedal

- ▶ Release parking brake by pulling on handle ①.

The warning lamp **BRAKE** (USA only) or **(P)** (Canada only) in the instrument cluster goes out.

## Driving

### Warning!



On slippery road surfaces, never downshift in order to obtain braking action. This could result in drive wheel slip and reduced vehicle control. Your vehicle's ABS will not prevent this type of loss of control.



If you hear a warning signal and the message *Release parking brake* appears in the multifunction display when driving off, you have forgotten to release the parking brake.



Simultaneously depressing the accelerator pedal and applying the brake reduces engine performance and causes premature brake and drivetrain wear.



Once the vehicle is in motion, the automatic central locking system engages and the locking knobs drop down.

For more information, see “Automatic central locking” (▷ page 107).



Do not run cold engine at high engine speeds. Running a cold engine at high engine speeds may shorten the service life of the engine.

### Manual transmission

- ▶ Depress the brake pedal.
- ▶ Fully depress the clutch pedal.
- ▶ Move gearshift lever to first gear to drive forward, or to reverse gear to drive rearward.
- ▶ Simultaneously release the brake pedal and slowly the clutch pedal.
- ▶ Carefully depress the accelerator pedal.

### Automatic transmission\*



Wait for the gear selection process to complete before setting the vehicle in motion.

- ▶ Depress the brake pedal.
- ▶ Move gear selector lever to position **D** to drive forward, or to position **R** to drive rearward.



Place the gear selector lever in position **P** or **R** only when the vehicle is stopped in order to avoid damaging the transmission.

- ▶ Release the brake pedal.
- ▶ Carefully depress the accelerator pedal.





### Warning!



It is dangerous to shift the gear selector lever out of **P** or **N** if the engine speed is higher than idle speed. If your foot is not firmly on the brake pedal, the vehicle could accelerate quickly forward or in reverse. You could lose control of the vehicle and hit someone or something. Only shift into gear when the engine is idling normally and when your right foot is firmly on the brake pedal.

## Switching on headlamps

### Low beam headlamps

The exterior lamp switch is located on the dashboard to the left of the steering wheel.



### Exterior lamp switch

- ① Off
- ② Low beam headlamps on
- ▶ Turn exterior lamp switch to position

The low beam headlamp indicator lamp in the instrument cluster comes on (▷ page 24).

## High beam

The combination switch is located on the left of the steering column.



### Combination switch

- ① High beam
- ② High beam flasher
- ▶ Push combination switch in direction of arrow ①.

The high beam headlamp indicator lamp in the instrument cluster comes on (▷ page 24).

For more information on headlamps, see “Lighting” (▷ page 118).

## Turn signals



The combination switch is located on the left of the steering column.



### Combination switch

- ① Turn signals, right
- ② Turn signals, left

- ▶ Press combination switch in direction of arrow ① or ②.

The corresponding turn signal indicator lamp  or  in the instrument cluster flashes (▷ page 24).

The combination switch resets automatically after major directional changes.



To signal minor directional changes, press combination switch only to point of resistance and release. The corresponding turn signals will flash three times.

## Windshield wipers

The combination switch is located on the left of the steering column.

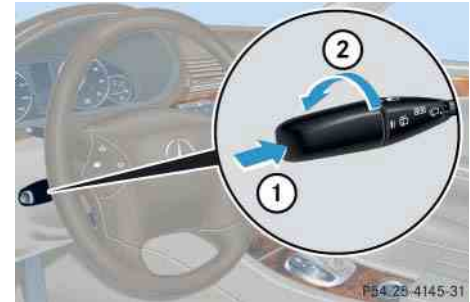

### Combination switch

- ① Single wipe  
Wiping with windshield washer fluid
  - ② Switching on windshield wipers
- ▶ Switch on the ignition (▷ page 33).



Do not operate the windshield wipers when the windshield is dry. Dust that accumulates on a windshield might scratch the glass and/or damage the wiper blades when wiping occurs on a dry windshield. If it is necessary to operate the windshield wipers in dry weather conditions, always operate the windshield wipers with windshield washer fluid (▷ page 55).

#### Switching on windshield wipers

- ▶ Turn the combination switch to the desired position depending on the intensity of the rain.
  - O** Windshield wipers off
  - I** Intermittent wiping
  - II** Normal wiper speed
  - III** Fast wiper speed

#### Intermittent wiping



Vehicles with rain sensor\*:  
Do not leave windshield wipers in intermittent setting when the vehicle is taken to an automatic car wash or during windshield cleaning. Windshield wipers will operate in the presence of water sprayed on the windshield, and windshield wipers may be damaged as a result.

Vehicles with rain sensor\*:  
Intermittent wiping interval is dependent on wetness of windshield.

- ▶ Turn the combination switch to position **I**.

Vehicles with rain sensor\*:  
After the initial wipe, pauses between wipes are automatically controlled by the rain sensor.



Intermittent wiping is interrupted when the vehicle is at a standstill and a front door is opened. This protects persons getting into or out of the vehicle from being sprayed.

Intermittent wiping will be continued when

- all doors are closed
- and
- the clutch pedal is depressed (vehicles with manual transmission)
- or
- the gear selector lever is in position **D** or **R** (vehicles with automatic transmission\*)
- or
- the wiper setting is changed using the combination switch

### Single wipe

- ▶ Press the combination switch briefly in direction of arrow ① to the resistance point.

The windshield wipers wipe one time without washer fluid.

### Wiping with windshield washer fluid

- ▶ Press the combination switch in direction of arrow ① past the resistance point.

The windshield wipers operate with washer fluid.



To prevent smears on the windshield, wipe with windshield washer fluid every now and then even when it is raining.

For information on filling up the washer reservoir, see “Windshield washer system and headlamp cleaning system\*” (▷ page 303).



If anything blocks the windshield wipers (leaves, snow, etc.), switch them off immediately.

- For safety reasons, stop the vehicle in a safe location and remove SmartKey from starter switch before attempting to remove any blockage.
- Remove blockage.
- Turn the windshield wipers on again.

If the windshield wipers fail to function at all with combination switch in position I,

- set the combination switch to the next higher wiper speed
- have the windshield wipers checked at the nearest authorized Mercedes-Benz Center



#### Problems while driving

---

##### The engine runs erratically and misfires

- An ignition cable may be damaged.
- The engine electronics may not be operating properly.
- Unburned gasoline may have entered the catalytic converter and damaged it.
- ▶ Give very little gas.
- ▶ Have the problem repaired by an authorized Mercedes-Benz Center as soon as possible.

##### The coolant temperature is above 248°F (120°C)

The coolant is too hot and is no longer cooling the engine.

- ▶ Stop the vehicle in a safe location as soon as possible and turn off the engine. Allow engine and coolant to cool.
- ▶ Check the coolant level and add coolant if necessary (▷ page 301).

##### In case of accident

If the vehicle is leaking gasoline:

- ▶ Do not start the engine under any circumstances.
- ▶ Notify local fire and/or police authorities.

If the extent of the damage cannot be determined:

- ▶ Notify an authorized Mercedes-Benz Center.

If no damage can be determined on the

- Major assemblies
- Fuel system
- Engine mount
- ▶ Start the engine in the usual manner.

## ▼ Parking and locking

You have now completed your first drive. You have properly stopped and parked your vehicle. End your drive as follows.

### Warning!



Vehicles with manual transmission: Wait until the vehicle is stationary before removing the SmartKey from the starter switch. The vehicle cannot be steered when the SmartKey is removed.

### Warning!



With the engine not running, there is no power assistance for the brake and steering system. In this case, it is important to keep in mind that a considerably higher degree of effort is necessary to brake and steer the vehicle.

### Warning!



Do not park this vehicle in areas where combustible materials such as grass, hay or leaves can come into contact with the hot exhaust system, as these materials could be ignited and cause a vehicle fire.

To reduce the risk of personal injury as a result of vehicle movement, before turning off the engine and leaving the vehicle always:

- Keep right foot on brake pedal.
- Manual transmission: Move the gear-shift lever to neutral position (no gear is selected).
- Firmly depress parking brake pedal.
- Automatic transmission\*: Move the gear selector lever to position **P**.

- Slowly release brake pedal.
- When parked on an incline, turn front wheels towards the road curb.
- Turn the SmartKey in the starter switch to position **0** and remove the SmartKey from the starter switch.
- Take the SmartKey and lock the vehicle when leaving.

#### Parking brake

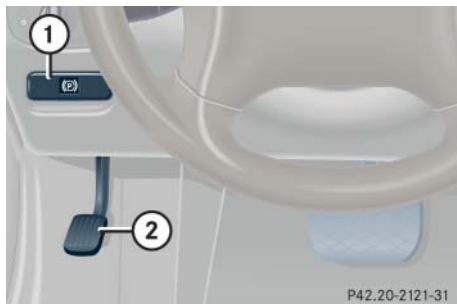

- ① Release handle
  - ② Parking brake pedal
- Step firmly on parking brake pedal ②.

When the engine is running, the brake warning lamp **BRAKE** (USA only) or **(P)** (Canada only) in the instrument cluster comes on.

#### Warning!



When leaving the vehicle, always remove the SmartKey from the starter switch, take it with you, and lock the vehicle. Do not leave children unattended in the vehicle, or with access to an unlocked vehicle. Children could release the parking brake and/or move the gear selector lever\* from position **P**, either of which could result in an accident and/or serious injury.

#### Warning!



Getting out of your vehicle with the gear selector lever\* not fully engaged in position **P** is dangerous. Also, when parked on an incline, position **P** alone may not prevent your vehicle from moving, possibly hitting people or objects.

Always set the parking brake in addition to shifting to position **P** (manual transmission: first or reverse gear).

When parked on an incline, turn front wheel towards the road curb.

### Switching off headlamps

- ▶ Turn exterior lamp switch to **0** (▷ page 52).

For more information, see “Lighting” (▷ page 118).

### Turning off engine

- ▶ Manual transmission: Move the gear-shift lever into first or reverse gear.
- ▶ Automatic transmission\*: Place the gear selector lever in position **P**.



Always set the parking brake in addition to shifting to position **P** (manual transmission: first or reverse gear).

On slopes, turn the front wheels towards the road curb.

- ▶ Turn the SmartKey in the starter switch to position **0**.
- ▶ Remove the SmartKey from the starter switch.  
The immobilizer is activated.



Vehicles with automatic transmission: The SmartKey can only be removed from the starter switch with the gear selector lever in position **P**.

### Releasing seat belts

- ▶ Press the seat belt release button (▷ page 46).

Allow the retractor to completely rewind the seat belt by guiding the latch plate.



Make sure the seat belt retracts fully so that the seat belt and/or latch plate cannot get caught or pinched in the door or in the seat mechanism. This can damage the seat belt and impair the effectiveness of the seat belt, and/or cause damage to the door and/or door trim panel. Such damage is not covered by the Mercedes-Benz Limited Warranty.

Damaged seat belts must be replaced. Contact an authorized Mercedes-Benz Center.

#### Locking

##### Warning!



To prevent possible personal injury, always keep hands and fingers away from the door openings when closing the doors. Be especially careful when small children are around.

Before closing doors, make sure there is no possibility of someone getting caught in a door during closing.

##### Warning!



When leaving the vehicle, always remove the SmartKey from the starter switch, take it with you, and lock the vehicle. Do not leave children unattended in the vehicle, or with access to an unlocked vehicle. Unsupervised use of vehicle equipment may cause an accident and/or serious personal injury.



With the SmartKey removed and the driver's door open, a warning sounds if the vehicle's exterior lamps are not switched off.

The message *Switch off lights* appears in the multifunction display.

- ▶ Exit the vehicle and close all doors.
- ▶ Press the lock button  on the SmartKey (▷ page 32).

With the hood, trunk and all doors closed, all turn signal lamps flash three times. The locking knobs in the doors move down.

The anti-theft alarm system\* is armed.

For more information, see “Locking and unlocking” (▷ page 98).

## Safety and Security

Occupant safety

Panic alarm\*

Driving safety systems

Anti-theft systems



### Occupant safety

In this section you will learn the most important facts about the restraint system components of the vehicle.

Restraint system with

- Seat belts (▷ page 69)
- Child restraints (▷ page 82)
- Lower anchors and tethers for children (LATCH) (▷ page 83)

Supplemental Restraint System (SRS) with

- Air bags (▷ page 63)
- Air bag control unit (with crash sensors)
- Emergency tensioning device (ETD) for seat belts (▷ page 72)

Air bag system components with

-  indicator lamp (▷ page 80)
- Front passenger seat with Occupant Classification System (OCS) (▷ page 77)

As independent systems, their protective effects work in conjunction with each other.



For information on infants and children traveling with you in the vehicle and restraint systems for infants and children, see “Children in the vehicle” (▷ page 74).

The SRS system conducts a self-test when the ignition is switched on and in regular intervals while the engine is running. This facilitates early detection of malfunctions. The **SRS** indicator lamp in the instrument cluster comes on when the ignition is switched on and goes out no later than a few seconds after the engine has been started.

The SRS components are in operational readiness if the **SRS** indicator lamp is not lit when the engine is running.

A malfunction in the system has been detected if the **SRS** indicator lamp:

- fails to go out after approximately 4 seconds after the engine was started
- does not come on at all
- comes on after the engine was started or while driving.

## Air bags

### Warning!



In the event that the **SRS** indicator lamp comes on during driving or does not come on at all, the SRS self-check has detected a malfunction. For your safety, we strongly recommend that you visit an authorized Mercedes-Benz Center immediately to have the system checked; otherwise the SRS may not deploy when needed in an accident, which could result in serious or fatal injury, or it might deploy unexpectedly and unnecessarily which could also result in injury.

In addition, improper work on the SRS creates a risk of rendering the SRS inoperative or causing unintended air bag deployment. Work on the SRS must therefore only be performed by qualified technicians. Contact an authorized Mercedes-Benz Center.

If it is necessary to modify an air bag system to accommodate a person with disabilities, contact your local authorized Mercedes-Benz Center or call our Customer Assistance Center at 1-800-FOR-MERCEdes (1-800-367-6372) for details.

### Warning!



Air bags are designed to reduce the potential of injury and fatality in certain frontal impacts (front air bags) or side impacts (front side impact air bags, rear side impact air bags\* and head protection window curtain air bags). However, no system available today can totally eliminate injuries and fatalities.

The deployment of the air bags temporarily releases a small amount of dust from the air bags. This dust, however, is neither injurious to your health, nor does it indicate a fire in the vehicle. The dust might cause some temporary breathing difficulty for people with asthma or other breathing trouble. To avoid this, you may wish to get out of the vehicle as soon as it is safe to do so. If you have any breathing difficulty but cannot get out of the vehicle after the air bag inflates, then get fresh air by opening a window or door.



### Occupant safety

#### Warning!



To reduce the risk of injury when the front air bags inflate, it is very important for the driver and front passenger to always be in a properly seated position and to wear their respective seat belts.

For maximum protection in the event of a collision always be in normal seated position with your back against the backrest. Fasten your seat belt and ensure it is properly positioned on your body.

Since the air bag inflates with considerable speed and force, a proper seating and hands on steering wheel position will help to keep you at a safe distance from the air bag. Occupants who are unbelted, out of position or too close to the air bag can be seriously injured or killed by an air bag as it inflates with great force in the blink of an eye:

- Sit properly belted in a nearly upright position with your back against the seat backrest.

- Adjust the driver seat as far as possible rearward, still permitting proper operation of vehicle controls. The distance from the center of the driver's breastbone to the center of the air bag cover on the steering wheel must be at least 10 in (25 cm) or more. You should be able to accomplish this by a combination of adjustments to the seat and steering wheel. If you have any problems, please see your authorized Mercedes-Benz Center.
- Do not lean your head or chest close to the steering wheel or dashboard.
- Keep hands on the outside of steering wheel rim. Placing hands and arms inside the rim can increase the risk and potential severity of hand/arm injury when driver front air bag inflates.
- Adjust the front passenger seat as far as possible rearward from the dashboard when the seat is occupied.

- Occupants, especially children, should never place their bodies or lean their heads in the area of the door or the rear side trim panel where the front side impact air bag\* inflates. This could result in serious injuries or death should the air bag be triggered. Always sit nearly upright, properly use the seat belts and use an appropriately sized infant or toddler restraint or booster seat recommended for the size and weight of the child.

Failure to follow these instructions can result in severe injuries to you or other occupants.

If you sell your vehicle, it is important that you make the buyer aware of this safety information. Be sure to give the buyer this Operator's Manual.

**Warning!**

Accident research shows that the safest place for children in an automobile is in the rear seat.

It should be noted that with respect to both front side impact air bag and/or rear side impact air bag\* there is a possibility for a side impact air bag related injury if occupants, especially children, are not properly seated or restrained when next to a side impact air bag which needs to deploy rapidly in a side impact in order to do its job.

To help avoid the possibility of injury, please follow these guidelines:

- (1) Occupants, especially children, should never place their bodies or lean their heads in the area of the door where the front side impact air bag and/or rear side impact air bag\* inflates. This could result in serious injuries or death should the front side impact air bag and/or rear side impact air bag\* be activated.

- (2) Always sit nearly upright, properly use the seat belts and for children 12 years old and under, use an appropriately sized infant or toddler restraint or booster seat recommended for the size and weight of the child.

- (3) Always wear seat belts properly.

If you believe that, even with the use of these guidelines, it would be safer for your rear seat occupants to have the rear mounted side impact air bags\* deactivated, then deactivation can be accomplished upon your written request to do so at your authorized Mercedes-Benz Center at an additional cost.

Please contact your local authorized Mercedes-Benz Center or call our Customer Assistance Center at 1-800-FOR-MERCEdes (1-800-367-6372) for details.



Air bags are designed to activate only in certain frontal impacts (front air bags), or side impacts (front side impact air bags, rear side impact air bags\* and head protection window curtain air bags) which exceed preset thresholds.

Only during these types of impacts, if of sufficient severity to meet the deployment thresholds, will they provide their supplemental protection.

The driver and passengers should always wear their seat belts. Otherwise it is not possible for air bags to provide their supplemental protection.

In cases of other frontal impacts, angled impacts, roll-overs, other side impacts, rear collisions, or other accidents, the air bags will not be activated. The driver and the passenger will then be protected by the fastened seat belts.

### Occupant safety

We caution you not to rely on the presence of the air bags in order to avoid wearing your seat belt.

Your vehicle was originally equipped with air bags that are designed to activate in certain impacts exceeding a preset threshold to reduce the potential and severity of injury. It is important to your safety and that of your passengers that you replace deployed air bags and repair any malfunctioning air bags to make sure the vehicle will continue to provide supplemental crash protection for occupants.

#### Safety guidelines for the seat belt, emergency tensioning device and air bag

##### Warning!



- Damaged seat belts or belts that were highly stressed in an accident must be replaced and their anchoring points must also be checked. Only use belts installed or supplied by an authorized Mercedes-Benz Center.
  - Air bags and emergency tensioning devices (ETDs) are designed to function on a one-time-only basis. An air bag or ETD that was activated must be replaced.
  - Do not pass belts over sharp edges. They could tear.
  - Do not make any modification that could change the effectiveness of the belts.
  - Do not bleach or dye seat belts as this may severely weaken them. In a crash they may not be able to provide adequate protection.
- No modifications of any kind may be made to any components or wiring of the SRS. This includes changing or removing any component or part of the SRS, the installation of additional trim material, badges etc. over the steering wheel hub, front passenger front air bag cover, outboard sides of the front seat backrests, door trim panels, or door frame trims, and installation of additional electrical/electronic equipment on or near SRS components and wiring. Keep area between air bags and occupants free from objects (e.g. packages, purses, umbrellas, etc.).
  - Do not hang items such as coat hangers from the coat hooks or handles over the door. These items may turn into projectiles and cause head and other injuries when curtain air bag is deployed.
  - Never place your feet on the instrument panel, dashboard, or on the seat. Always keep both feet on the floor in front of the seat.
  - Air bag system components will be hot after an air bag has inflated. Do not touch.

- In addition, improper repair work on the SRS creates a risk of rendering the SRS inoperative or causing unintended air bag deployment. Work on the SRS must therefore only be performed by qualified technicians. Contact an authorized Mercedes-Benz Center.
- For your protection and the protection of others, when scrapping the air bag unit or emergency tensioning device, our safety instructions must be followed. These instructions are available from your authorized Mercedes-Benz Center.
- Given the considerable deployment speed, required inflation volume, and the textile structure of the air bags, there is the possibility of abrasions or other, potentially more serious injuries resulting from air bag deployment.

When you sell your vehicle we strongly urge you to give notice to the subsequent owner that it is equipped with an SRS by alerting them to the applicable section in the Operator's Manual.

### Front air bags



- ① Driver's air bag
- ② Passenger front air bag

Driver and front passenger air bags are deployed

- in the event of certain frontal impacts
- if impact exceeds a preset deployment threshold
- independently of the front side impact air bags and/or rear side impact air bags\*



The front air bags in this vehicle have been designed to inflate in two stages. This allows the air bag to have different rates of inflation that are based on the rate of relevant vehicle deceleration as assessed by the air bag control unit.

On the front passenger side, the front air bag deployment is additionally influenced by the passenger's weight category as identified by the Occupant Classification System (OCS) (> page 77).

The lighter the front passenger side occupant, the higher the vehicle deceleration rate required for the second stage inflation of the air bag.

### Occupant safety

The air bags will not deploy in impacts which do not exceed the system's deployment thresholds. You will then be protected by the fastened seat belts.

The passenger front air bag will only be deployed if

- the system, based on OCS weight sensor readings, senses that the front passenger seat is occupied
- the 

### Front side impact air bags, rear side impact air bags\*, window curtain air bags\*



- ① Window curtain air bag
- ② Front side impact air bags
- ③ Rear side impact air bags\*

The front side impact air bags, rear side impact air bags\* and window curtain air bags are deployed

- on the impacted side of the vehicle
- in impacts exceeding a preset deployment threshold
- independently of the front air bags

The front side impact air bags, rear side impact air bags\* and window curtain air bags are not deployed in impacts which do not exceed the system's deployment threshold.

The front passenger side impact air bag will only deploy if the system senses that the front passenger seat is occupied.

## Seat belts

Always wear your seat belt. All vehicle occupants always need to have their seat belts fastened and wear them properly.

In addition, applicable motor vehicle safety laws require you to wear seat belts. Even where this is not the case, we strongly recommend that all vehicle occupants have their seat belts fastened and wear them properly.

For more information, see “Fastening the seat belt” (▷ page 45).



For information on infants and children traveling with you in the vehicle and restraint systems for infants and children, see “Children in the vehicle” (▷ page 74).

### Warning!



Always fasten your seat belt before driving off. Always make sure your passengers are properly restrained, even those sitting in the rear and pregnant women.

Failure to wear and properly fasten and position your seat belt greatly increases your risk of injuries and their likely severity in an accident. You and your passengers should always wear seat belts.

If you are ever in an accident, your injuries can be considerably more severe without your seat belt properly buckled. Without your seat belt buckled, you are much more likely to hit the interior of the vehicle or be ejected from it. You can be seriously injured or killed.

In the same crash, the possibility of injury or death is lessened if you are properly wearing your seat belt. Air bags can only protect as they are designed if the occupants are properly wearing their seat belts.

### Warning!



Never ride in a moving vehicle with the seat backrest in an excessively reclined position as this can be dangerous. You could slide under the seat belt in a collision. If you slide under it, the belt would apply force at the abdomen or neck. That could cause serious or even fatal injuries. The seat backrest and seat belt provide the best restraint when the wearer is in a nearly upright position and the belt is properly positioned on the body.

### Warning!



Never let more people ride in the vehicle than there are seat belts available. Be sure everyone riding in the vehicle is correctly restrained with a separate seat belt. Never use a seat belt for more than one person at a time.

### Occupant safety

#### Warning!



Damaged seat belts or belts that were highly stressed in an accident must be replaced and their anchoring points must also be checked.

Only use seat belts which have been approved by Mercedes-Benz.

Do not make any modifications to the seat belts. This can lead to unintended activation of the ETDs or to failure.

Do not bleach or dye seat belts as this may severely weaken them. In a crash, they may not be able to provide adequate protection.

Have all work carried out only by qualified technicians. Contact an authorized Mercedes-Benz Center.

#### Warning!



#### USE SEAT BELTS PROPERLY

- Each occupant should wear his or her seat belt at all times, because seat belts help reduce the likelihood and potential severity of injuries in accidents, including rollovers. The integrated restraint system includes SRS (driver air bag, passenger front air bag, front side impact air bags\*, rear side impact air bags\*, head protection window curtain air bags for side windows), ETD (seat belt emergency tensioning device), and front seat knee bolsters.

The system is designed to enhance the protection offered to properly belted occupants in certain frontal (front air bags and ETD) and side (front side impact air bags, rear side impact air bags\*, window curtain air bags and ETD) impacts which exceed preset deployment thresholds.



- Seat belts can only work when used properly. Never wear seat belts in any other way than as described in this section, as that could result in serious injuries in case of an accident.
- Never wear the shoulder belt under your arm, against your neck or off your shoulder. In a crash, your body would move too far forward. That would increase the chance of head and neck injuries. The belt would also apply too much force to the ribs or abdomen, which could severely injure internal organs such as your liver or spleen.
- Never wear belts over rigid or breakable objects in or on your clothing, such as eyeglasses, pens, keys etc., as these might cause injuries.
- Position the lap belt as low as possible on your hips and not across the abdomen. If the belt is positioned across your abdomen, it could cause serious injuries in a crash.

- Never use a seat belt for more than one person at a time. Do not fasten a seat belt around a person and another person or other objects.
- Belts should not be worn twisted. In a crash, you wouldn't have the full width of the belt to manage impact forces. The twisted belt against your body could cause injuries.
- Pregnant women should also use a lap-shoulder belt. The lap belt portion should be positioned as low as possible on the hips to avoid any possible pressure on the abdomen.
- Never place your feet on the instrument panel, dashboard or on the seat. Always keep both feet on the floor in front of the seat.



### Enhanced seat belt reminder system

When the engine is started, the seat belt telltale  illuminates for a maximum of 6 seconds and a warning chime sounds to remind you and your passengers to fasten your seat belts.

If after these 6 seconds the driver's or the front passenger's seat belt (with the front passenger seat occupied) are not fastened with all doors closed,

- and the vehicle speed does not exceed 25 km/h, the seat belt telltale  remains illuminated for as long as either the driver's or front passenger's seat belt is not fastened.
- and the vehicle speed exceeds 25 km/h, the seat belt telltale  starts flashing and a warning chime sounds with increasing intensity until both the driver's and front passenger's seat belt are fastened, or for a maximum of 60 seconds from the time the

vehicle speed exceeded 25 km/h if either the driver's or front passenger's seat belt remains unfastened.

If the driver's or front passenger's seat belt remains unfastened after 60 seconds, the seat belt telltale  stops flashing and the warning chime stops sounding. The seat belt telltale  then continues to be illuminated for as long as either the driver's or front passenger's seat belt are not fastened.

The seat belt telltale  will only go out if both the driver and front passenger's seat belt (with the front passenger seat occupied) are fastened, or the vehicle is standing still and a front door is opened.

For more information on the seat belt telltale , see "Practical hints" (▷ page 355).



### Occupant safety

#### Emergency tensioning device (ETD), seat belt force limiter

The seat belts for the front and rear outer seats are equipped with emergency tensioning devices and belt force limiters.

The ETD is designed to activate in the following cases:

- in frontal or rear-end impacts exceeding a preset severity level.
- if the restraint systems are operational and functioning correctly, see **SRS** indicator lamp (▷ page 62).



The ETDs for the front seats will only activate if the respective front seat belt is fastened (latch plate properly inserted into buckle).

The ETDs for the rear outer seats will activate with or without the respective seat belt fastened.

In an impact, emergency tensioning devices remove slack from the belts in such a way that the seat belts fit more snugly against the body. Belt force limiters reduce the force exerted by the seat belts on occupants during a crash.

#### Warning!



An emergency tensioning device (ETD) that was activated must be replaced.

When scrapping the emergency tensioning device, our safety instructions must be followed. These are available at your authorized Mercedes-Benz Center.

## Active head restraint

The active head restraints are intended to offer the driver and front passenger increased protection from head and neck injury. In the event of a rear-end collision, the active head restraints on the driver's and front passenger's seats are designed to move forward in the direction of travel, providing the head with increased support earlier on in the collision sequence. The active head restraints move forward whether the seat is occupied.

### Warning!



Only use seat- or head restraint covers which have been tested and approved by Mercedes-Benz for your vehicle model. Using other seat- or head restraint covers may interfere with or prevent the activation of the active head restraints. Contact your authorized Mercedes-Benz Center for availability.

### Warning!



For your protection, drive only with properly positioned head restraints.

Adjust head restraints so that the center of the head restraint supports the back of the head at eye level. This will reduce the potential for injury to the head and neck in the event of an accident or similar situation.

Do not drive the vehicle without the seat head restraints. Head restraints are intended to help reduce injuries during an accident.

You cannot remove the active head restraints on the driver's and passenger's seats.

For removal of the active head restraints we recommend that you contact an authorized Mercedes-Benz Center.

For information on head restraint adjustment, see "Seats" (▷ page 35).

For information on resetting the activated active head restraints, see "Resetting activated head restraints" (▷ page 394).

### Occupant safety

#### Children in the vehicle

If an infant or child is traveling with you in the vehicle:

- Secure the child using an infant or child restraint appropriate to the age and size of the child.
- Make sure the infant or child is properly secured at all times while the vehicle is in motion.

Infant and child restraint seats and information on choosing an appropriate restraint system can be obtained from any Mercedes-Benz Center.

#### Infant and child restraint systems

We recommend all infants and children be properly restrained at all times while the vehicle is in motion.

All lap-shoulder belts except the driver's seat belt have special seat belt retractors for secure fastening of child restraints.

To fasten a child restraint, follow child restraint instructions for mounting. Then pull the shoulder belt out completely and let it retract. During seat belt retraction, a ratcheting sound can be heard to indicate that the special seat belt retractor is activated. The belt is now locked. Push down on child restraint to take up any slack.

To deactivate, release seat belt buckle and let seat belt retract completely. The seat belt can again be used in the usual manner.



For information on child seats with anchor fittings for tether anchorages, see "Installation of infant and child restraint systems" (▷ page 82).

For information on child seat anchors - LATCH-type (▷ page 83).

#### Warning!



Never release the seat belt buckle while the vehicle is in motion, since the special seat belt retractor will be deactivated.



The use of infant or child restraints is required by law in all 50 states, the District of Columbia, the U.S. territories and all Canadian provinces.

Infants and small children should be seated in an appropriate infant or child restraint system properly secured by a lap-shoulder belt or, if so equipped, a child restraint lower anchorage system that complies with U.S. Federal Motor Vehicle Safety Standards 213 and 225 and Canadian Motor Vehicle Safety Standards 213 and 210.2.



A statement by the child restraint manufacturer of compliance with this standard can be found on the instruction label on the restraint and in the instruction manual provided with the restraint.

When using any infant or child restraint system, be sure to carefully read and follow all manufacturer's instructions for installation and use.

Please read and observe warning labels affixed to inside of vehicle and to infant or child restraints.

#### Warning!



According to accident statistics, children are safer when properly restrained in the rear seating positions than in the front seating position. Thus, we strongly recommend that children be placed in the rear seats whenever possible. Regardless of seating position, children 12 years old and under must be seated and properly secured in an appropriate infant or child restraint recommended for the size and weight of the child.





The infant or child restraint must be properly secured with the vehicle's seat belt, the seat belt and top tether strap, or lower anchors and top tether strap, fully in accordance with the child seat manufacturer's instructions.

Children can be killed or seriously injured by an inflating air bag. Note the following important information when circumstances require you to place a child in the front passenger seat:



### Occupant safety



- Your vehicle is equipped with air bag technology designed to turn off the front passenger front air bag in your vehicle when the OCS senses the weight of a typical 12-month-old child or less along with the weight of a standard appropriate child restraint on the front passenger seat.
- A child in a rear-facing child restraint on the front passenger seat will be seriously injured or even killed if the front passenger front air bag inflates in a collision which could occur under some circumstances, even with the air bag technology installed in your vehicle. The only means to completely eliminate this risk is to never place a child in a rear-facing child restraint in the front seat. We therefore strongly recommend that you always place a child in a rear-facing child restraint in the back seat.
- If you must install a rear-facing child restraint on the front passenger seat because circumstances require you to do so, make sure that the  indicator lamp is illuminated, indicating that the front passenger air bag is deactivated. Should the  indicator lamp not illuminate or go out while the restraint is installed, please check installation. Periodically check the  indicator lamp while driving to make sure the  indicator lamp is illuminated. If the  indicator lamp goes out or remains out, do not transport a child on the front passenger seat until the system has been repaired. A child in a rear-facing child restraint on the front passenger seat will be seriously injured or even killed if the front passenger front air bag inflates.
- If you have to place a child in a forward-facing child restraint on the front passenger seat, move the seat as far back as possible, use the proper child restraint recommended for the age, size and weight of the child, and secure child restraint with the vehicle's seat belt according to the child seat manufacturer's instructions. For children larger than the typical 12-month-old child, the front passenger front air bag may or may not be activated (▷ page 78).

#### Warning!



Infants and small children should never share a seat belt with another occupant. During an accident, they could be crushed between the occupant and seat belt.

A child's risk of serious or fatal injuries is significantly increased if the child restraints are not properly secured in the vehicle and/or the child is not properly secured in the child restraint.

Children too big for a toddler restraint must ride in seats using regular seat belts. Position shoulder belt across chest and shoulder, not face or neck. A booster seat may be necessary to achieve proper belt positioning for children from 18.6 kg (41 lbs) until they reach a height where a lap/shoulder belt fits properly without a booster.

When the child restraint is not in use, remove it from the vehicle or secure it with the seat belt to prevent the child restraint from becoming a projectile in the event of an accident.

Do not leave children unattended in the vehicle, even if the children are secured in a child restraint system. Unsupervised children in a child restraint system may use vehicle equipment and may cause an accident and/or serious personal injury.

### Occupant Classification System

The Occupant Classification System (OCS) automatically turns the front passenger front air bag on or off based on the classified occupant weight category determined by weight sensor readings from the front passenger seat.





The system does not deactivate the front passenger side impact air bag, the window curtain air bag and the emergency tensioning device.

Occupants must sit properly belted in a nearly upright position with their back against the seat backrest and feet on the floor to be correctly classified. If the occupant's weight is transferred to another object in the vehicle (e.g. by leaning on armrests), the OCS may not be able to properly approximate the occupant's weight category.







If your seat, including your trim cover and cushion needs to be serviced in any way, take the vehicle to your authorized Mercedes-Benz Center.

Only seat accessories approved by Mercedes-Benz may be used.

Both driver and the front passenger should always use the   indicator lamp as an indication of whether or not the front passenger is properly positioned.

### Warning!



If the   indicator lamp illuminates when an adult or someone larger than a small individual is in the front passenger seat, have the front passenger re-position himself or herself in the seat until the   indicator lamp goes out.



More information about air bag display messages (▷ page 357).











### Occupant safety







In the event of a collision, the air bag control unit will not allow front passenger front air bag deployment when the OCS classified the front passenger seat occupant as being up to or less than the weight of a typical 12-month-old child in a standard child restraint or if the front passenger seat is sensed as being empty.



When the OCS senses that the front passenger seat occupant is classified as being up to or less than the weight of a typical 12-month-old child in a standard child restraint, the   indicator lamp will illuminate when the engine is started and remain illuminated, indicating that the front passenger front air bag is deactivated.

When the OCS senses that the front passenger seat is classified as being empty, the   indicator lamp will illuminate when the engine is started and remain illuminated, indicating that the front passenger front air bag is deactivated.

When the OCS senses that the front passenger seat occupant is classified as being heavier than the weight of a typical 12-month-old child seated in a standard child restraint or as being a small individual (such as a young teenager or a small adult), the   indicator lamp will illuminate for approximately 6 seconds when the engine is started and then, depending on occupant weight sensor readings from the seat, remain illuminated or go out. With the   indicator lamp illuminated, the front passenger front air bag is deactivated. With the   indicator lamp out, the front passenger front air bag is activated.

When the OCS senses that the front passenger seat occupant is classified as an adult or someone larger than a small individual, the   indicator lamp will illuminate for approximately 6 seconds when the engine is started and then go out, indicating that the front passenger front air bag is activated.

If the   indicator lamp is illuminated, the front passenger front air bag is deactivated and will not be deployed.

If the   indicator lamp is not illuminated, the front passenger front air bag is activated and will be deployed:

- in the event of certain frontal impacts
- if impact exceeds a preset deployment threshold
- independently of the side impact air bags (front side impact air bag and/or rear side impact air bag \*).

If the front passenger front air bag is deployed, the rate of inflation will be influenced by:

- the rate of relevant vehicle deceleration as assessed by the air bag control unit
- front passenger's weight category as identified by the Occupant Classification System (OCS).











**Warning!**

According to accident statistics, children are safer when properly restrained in the rear seating positions than in the front seating position. Thus, we strongly recommend that children be placed in the rear seats whenever possible. Regardless of seating position, children 12 years old and under must be seated and properly secured in an appropriate infant or child restraint recommended for the size and weight of the child.

The infant or child restraint must be properly secured with the vehicle's seat belt, the seat belt and top tether strap, or lower anchors and top tether strap, fully in accordance with the child seat manufacturer's instructions.

Children can be killed or seriously injured by an inflating air bag. Note the following important information when circumstances require you to place a child in the front passenger seat:

- Your vehicle is equipped with air bag technology designed to turn off the front passenger front air bag in your vehicle when the system senses the weight of a typical 12-month-old child or less along with the weight of a standard appropriate child restraint on the front passenger seat.
- A child in a rear-facing child restraint on the front passenger seat will be seriously injured or even killed if the front passenger front air bag inflates in a collision which could occur under some circumstances, even with the air bag technology installed in your vehicle. The only means to completely eliminate this risk is to never place a child in a rear-facing child restraint in the front seat. We therefore strongly recommend that you always place a child in a rear-facing child restraint in the back seat.

- If you must install a rear-facing child restraint on the front passenger seat because circumstances require you to do so, make sure that the   indicator lamp is illuminated, indicating that the front passenger front air bag is deactivated. Should the   indicator lamp not illuminate or go out while the restraint is installed, please check installation. Periodically check the   indicator lamp while driving to make sure the   indicator lamp is illuminated. If the   indicator lamp goes out or remains out, do not transport a child on the front passenger seat until the system has been repaired. A child in a rear-facing child restraint on the front passenger seat will be seriously injured or even killed if the front passenger front air bag inflates. >>



### Occupant safety



- If you have to place a child in a forward-facing child restraint on the front passenger seat, move the seat as far back as possible, use the proper child restraint recommended for the age, size and weight of the child, and secure child restraint with the vehicle's seat belt according to the child seat manufacturer's instructions. For children larger than the typical 12-month-old child, the front passenger front air bag may or may not be activated (▷ page 78).



Deployment of the driver front air bag does not mean that the front passenger front air bag also should have deployed.



The Occupant Classification System (▷ page 77) may have determined:

- that the seat was empty or occupied by the weight up to or less than that of a typical 12-month-old child seated in a standard child restraint - both instances where the system suppresses deployment of the front passenger front air bag even though the impact met the criteria and was of sufficient severity to deploy the driver front air bag.
- that the seat was occupied by a small individual (such as a young teenager or a small adult) or a child weighing more than the weight of a typical 12-month-old child in a standard child restraint - instances where the system may suppress deployment of the front passenger front air bag even though the impact met the criteria and was of sufficient severity to deploy the driver front air bag.

The  indicator lamp is located in the center console.





- ① Front passenger front air bag off indicator lamp

The  indicator lamp ① will be illuminated, except with the SmartKey removed or in starter switch position 0.

### Warning!





If the  indicator lamp and the  indicator lamp are lit at the same time, there is a malfunction in the Occupant Classification System. The front passenger front air bag will be deactivated in this case.

In order to ensure proper operation of the air bag system and OCS:

- Have the system checked as soon as possible by qualified technicians. Contact an authorized Mercedes-Benz Center.
- Sit properly belted in a nearly upright position with your back against the seat backrest.
- Do not lean on the armrests or lift yourself from the seat by using the handle over the door as this may cause the OCS to be unable to correctly approximate the occupant weight category.
- Only have the seat repaired or replaced by an authorized Mercedes-Benz Center.
- Read and observe all warnings in this chapter.

### Self-test Occupant Classification System

After turning the SmartKey in the starter switch to position **1** or **2**, the

 **PASSENGER AIR BAG OFF** indicator lamp ① located in the center console illuminates. If an adult occupant is properly sitting on the front passenger seat and the system senses the occupant as being an adult, the  **PASSENGER AIR BAG OFF** indicator lamp will illuminate and go out after approximately 6 seconds.

If the seat is not occupied and the system senses the front passenger seat as being empty, the  **PASSENGER AIR BAG OFF** indicator lamp will illuminate and not go out.

#### Warning!



If the  **PASSENGER AIR BAG OFF** indicator lamp should not illuminate, the system is not functioning. You must see an authorized Mercedes-Benz Center before seating any child on the front passenger seat.

For more information, see “Lamp in center console” (▷ page 357).

#### Warning!



Never place anything between seat cushion and child seat (e.g. pillow), since it reduces the effectiveness of the Occupant Classification System. The bottom of the child seat must make full contact with the passenger seat cushion. An incorrectly mounted child seat could cause injuries to the child in case of an accident, instead of increasing protection for the child.

Follow the manufacturer’s instructions for installation of child seats.

### Occupant safety

#### Installation of infant and child restraint systems

This vehicle is equipped with tether anchorages for a top tether strap at each of the rear seating positions.

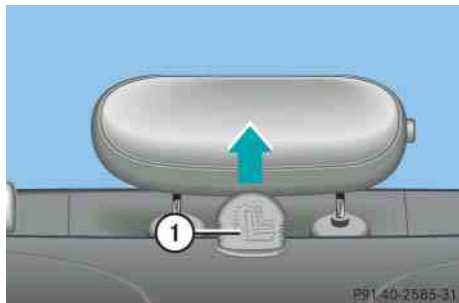

① Cover of top anchorage ring

- ▶ Make sure the rear backrest is locked in its upright position (▷ page 255).

#### Warning!



Always lock backrest in its upright position when rear seat bench is occupied by passengers, or the extended cargo area is not in use. Check for secure locking by pushing and pulling on the backrest.

- ▶ Remove cover ① from anchorage ring ③.
- ▶ Guide tether strap between head restraint and top of seat back.

Head restraint must be installed (if removable) and positioned such that the top tether strap can pass freely between the head restraint and top of seat back.

Make sure the tether strap is not twisted.

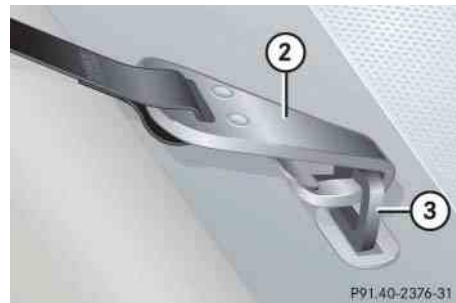

② Hook

③ Anchorage ring

- ▶ Securely fasten hook ②, which is part of the tether strap, to anchorage ring ③.

Once the top tether anchorage hook is attached, the child restraint itself can be secured. Tighten the top tether strap according to the child restraint manufacturer's instructions.



For safety, make sure the hook has attached to the ring beyond the safety catch, as illustrated.

- ▶ Reinstall cover ① after removing the tether strap.

### Child seat anchors – LATCH-type

This vehicle is equipped with two LATCH- (Lower Anchors and Tethers for Children) type anchors (at each of the outer rear seats) for the installation of a LATCH-type child seat with the matching mounting fittings.

#### Warning!



Children too big for a toddler restraint must ride in seats using regular seat belts. Position shoulder belt across chest and shoulder, not face or neck.

A booster seat may be necessary to achieve proper belt positioning for children from 41 lbs until they reach a height where a lap/shoulder belt fits properly without a booster.

Install child seat according to manufacturer's instructions.

The child seat must be firmly attached in the right and left side anchors ①.

An incorrectly mounted child seat may come loose during an accident which could result in serious injury or death to the child.

Damaged or impact damaged child seats or child seat mounting fittings must be replaced.

Do not leave children unattended in the vehicle, even if the children are secured in a child restraint system.

### Occupant safety



The child seat must be firmly attached in the right and left side anchors ①.

With a child seat installed in the left rear seat, the seat belt for the center seat occupied by a passenger must operate freely. Guide seat belt between its seat cushion mount and backrest mount along outside of right side child seat anchor.



Non-LATCH-type child seats may also be used and can be installed using the vehicle's seat belt system. Install child seat according to the manufacturer's instructions.

The LATCH-type anchors are located between the seat cushion and the backrest.

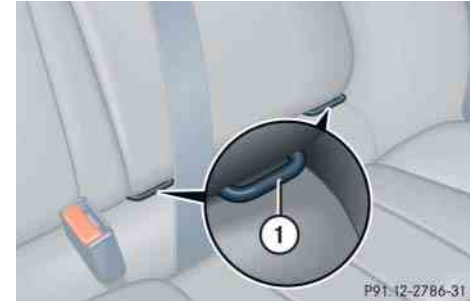

#### ① Anchors

- ▶ Install child seat according to the manufacturer's instructions.

### Blocking of rear door window operation

You can block the rear door window operation (for instance when you have children riding in the rear passenger compartment).

The override switch is located on the door control panel of the driver's door.

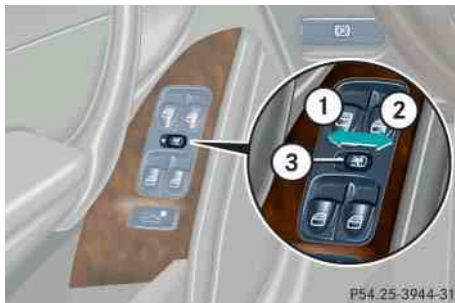

- ① Deactivating override switch
- ② Activating override switch
- ③ Override switch

### Warning!



Activate the override switch when children are riding in the back seats of the vehicle. The children may otherwise injure themselves, e.g. by becoming trapped in the window opening.

When leaving the vehicle, always remove the SmartKey from the starter switch, take it with you, and lock the vehicle. Do not leave children unattended in the vehicle, or with access to an unlocked vehicle. Unsupervised use of vehicle equipment can cause an accident and/or serious personal injury.

### Activating override switch

- ▶ Slide override switch ③ to the right.

The rear door windows can no longer be operated using the respective switch located in the rear doors.



Operation of the rear door windows with the switches located on the door control panel of the driver's door is still possible.

### Deactivating override switch

- ▶ Slide override switch ③ to the left.

The rear door windows can be operated again using the respective switch located in the rear doors.

For more information, see "Power windows" (▷ page 240).

### Panic alarm\*

An audible alarm and flashing exterior lamps will operate for approximately 2<sup>1</sup>/<sub>2</sub> minutes.



① **PANIC** button



Canada only:

Only vehicles equipped with an anti-theft alarm system\* have SmartKeys with integrated panic button ①.



USA only:

This device complies with Part 15 of the FCC Rules. Operation is subject to the following two conditions:

- (1) This device may not cause harmful interference, and
- (2) this device must accept any interference received, including interference that may cause undesired operation.

Any unauthorized modification to this device could void the user's authority to operate the equipment.



Canada only:

This device complies with RSS-210 of Industry Canada. Operation is subject to the following two conditions:

- (1) This device may not cause interference, and

- (2) this device must accept any interference received, including interference that may cause undesired operation of the device.

Any unauthorized modification to this device could void the user's authority to operate the equipment.

#### Activating

- ▶ Press and hold button ① for at least 1 second.

#### Deactivating

- ▶ Press button ① again.
- or
- ▶ Insert SmartKey in starter switch.

## ▼ Driving safety systems

In this section you will find information on the following driving safety systems:

- ABS (Antilock Brake System)
- BAS (Brake Assist System)
- ESP® (Electronic Stability Program)
- 4MATIC (Four Wheel Electronic Traction System)



In winter operation, the maximum effectiveness of the ABS, ESP®, and 4MATIC (if so equipped) is only achieved with winter tires (▷ page 336), or snow chains as required.

### Warning!



The following factors increase the risk of accidents:

- Excessive speed, especially in turns
- Wet and slippery road surfaces
- Following another vehicle too closely

The ABS, BAS, ESP®, and 4MATIC (if so equipped) cannot reduce this risk.

Always adjust your driving style to the prevailing road and weather conditions.

## ABS

### Warning!



Do not pump the brake pedal. Use firm, steady brake pedal pressure instead. Pumping the brake pedal defeats the purpose of the ABS and significantly reduces braking effectiveness.

The Antilock Brake System (ABS) regulates the brake pressure so that the wheels do not lock during braking. This allows you to maintain the ability to steer your vehicle.

The ABS is functional above a speed of approximately 5 mph (8 km/h) independent of road surface conditions.

On slippery road surfaces, the ABS will respond even to light brake pressure.

The  indicator lamp in the instrument cluster (▷ page 24) comes on when you switch on the ignition. It goes out when the engine is running.



### Driving safety systems

#### Braking

At the instant one of the wheels is about to lock up, a slight pulsation can be felt in the brake pedal, indicating that the ABS is in the regulating mode.

- ▶ Keep firm and steady pressure on the brake pedal while experiencing the pulsation.

Continuous steady brake pedal pressure yields the advantages provided by the ABS, namely braking power and ability to steer the vehicle.

The pulsating brake pedal can be an indication of hazardous road conditions and functions as a reminder to take extra care while driving.

#### Emergency brake maneuver

- ▶ Keep continuous full pressure on the brake pedal.

#### Warning!



The ABS cannot prevent the natural laws of physics from acting on the vehicle, nor can it increase braking or steering efficiency beyond that afforded by the condition of the vehicle brakes and tires or the traction afforded. The ABS cannot prevent accidents, including those resulting from excessive speed in turns, following another vehicle too closely, or hydroplaning. Only a safe, attentive, and skillful driver can prevent accidents. The capabilities of an ABS equipped vehicle must never be exploited in a reckless or dangerous manner which could jeopardize the user's safety or the safety of others.

For more information, see "Practical hints" (▷ page 350) and (▷ page 360).

#### BAS

The Brake Assist System (BAS) operates in emergency situations. If you apply the brakes very quickly, the BAS automatically provides full brake boost, thereby potentially reducing the braking distance. Apply continuous full braking pressure until the emergency braking situation is over. The ABS will prevent the wheels from locking.

When you release the brake pedal, the brakes function again as normal. The BAS is then deactivated.

#### Warning!



If the BAS is malfunctioning, the brake system is still functioning normally, but without the additional brake boost available that BAS would normally provide in an emergency braking maneuver. Therefore, the braking distance may increase.

**Warning!**

The BAS cannot prevent the natural laws of physics from acting on the vehicle, nor can it increase braking efficiency beyond that afforded by the condition of the vehicle brakes and tires or the traction afforded. The BAS cannot prevent accidents, including those resulting from excessive speed in turns, following another vehicle too closely, or hydroplaning. Only a safe, attentive, and skillful driver can prevent accidents. The capabilities of a BAS equipped vehicle must never be exploited in a reckless or dangerous manner which could jeopardize the user's safety or the safety of others.

**ESP®**

The Electronic Stability Program (ESP®) is operational as soon as the engine is running and monitors the vehicle's traction (force of adhesive friction between the tires and the road surface) and handling.

The ESP® recognizes when a wheel is spinning or if the vehicle starts to skid. By applying brakes to the appropriate wheel and by limiting the engine output, the ESP® works to stabilize the vehicle. The ESP® is especially useful while driving off and on wet or slippery road surfaces. The ESP® also stabilizes the vehicle during braking maneuvers.

The ESP® warning lamp  in the speedometer flashes when the ESP® is engaged.

The ESP® warning lamp  in the speedometer comes on when you switch on the ignition. It goes out when the engine is running.

**Warning!**

Never switch off the ESP® when you see the ESP® warning lamp  flashing in the speedometer. In this case, proceed as follows:

- While driving off, apply as little throttle as possible.
- While driving, ease up on the accelerator.
- Adapt your speed and driving style to the prevailing road conditions.

Failure to observe these guidelines could cause the vehicle to skid.

The ESP® cannot prevent accidents resulting from excessive speed.

#### Warning!



The ESP® cannot prevent the natural laws of physics from acting on the vehicle, nor can it increase the traction afforded. The ESP® cannot prevent accidents, including those resulting from excessive speed in turns or hydroplaning. Only a safe, attentive, and skillful driver can prevent accidents. The capabilities of an ESP® equipped vehicle must never be exploited in a reckless or dangerous manner which could jeopardize the user's safety or the safety of others.



The ESP® will only function properly if you use wheels of the recommended tire size (▷ page 432).



Vehicles without 4MATIC:  
Because of the ESP®'s automatic operation, the engine must be turned off (SmartKey in starter switch position **0** or **1**) when

- the parking brake is being tested on a brake test dynamometer
- the vehicle is being towed with the front axle raised

Active braking action through the ESP® may otherwise seriously damage the brake system.

For information on vehicles with 4MATIC, see “Four wheel electronic traction system (4MATIC) with the ESP®” (▷ page 92).

For more information, see “Practical hints” (▷ page 354) and (▷ page 360).

#### Switching off the ESP®

#### Warning!



The ESP® should not be switched off during normal driving other than in the circumstances described below. Disabling of the system will reduce vehicle stability in standard driving maneuvers.

Do not switch off the ESP® when a Minispare wheel is mounted.

To improve the vehicle's traction, turn off the ESP® in driving situations where it would be advantageous to have the drive wheels spin and thus cut into surfaces for better grip such as:

- when driving with snow chains
- in deep snow
- in sand or gravel



Turn on the ESP® immediately if the aforementioned circumstances do not apply anymore.

When you switch off the ESP®

- the ESP® does not stabilize the vehicle
- the engine output is not limited, which allows the drive wheels to spin and thus cut into surfaces for better grip
- the traction control will still brake a spinning wheel
- the ESP® continues to operate when you are braking



When the ESP® is switched off and one or more drive wheels are spinning, the ESP® warning lamp  in the speedometer flashes. However, the ESP® will then not stabilize the vehicle.

The switch is located on the upper part of the center console.



① ESP® switch (off/on)

- ▶ With the engine running, press switch ①.

The ESP® warning lamp  in the speedometer comes on.

The ESP® is deactivated.

### Warning!



When the ESP® warning lamp  is illuminated continuously, the ESP® is switched off.

Adapt your speed and driving to the prevailing road conditions and to the non-operating status of the ESP®.



Avoid spinning of a drive wheel for an extended period with the ESP® switched off. This may cause serious damage to the drivetrain which is not covered by the Mercedes-Benz Limited Warranty.

### Switching on the ESP®

- ▶ Press ESP® switch ①.

The ESP® warning lamp  in the speedometer goes out.

You are now again in normal driving mode with the ESP® switched on.

### Driving safety systems

#### Four wheel electronic traction system (4MATIC) with the ESP®

Models with all-wheel-drive only.

The 4MATIC improves vehicle's ability to use available traction, e.g. during winter operation in mountains under snowy conditions, by applying power to all four wheels.

#### Warning!



If you see the ESP® warning lamp  flashing in the speedometer, proceed as follows:

- While driving off, apply as little throttle as possible
- While driving, ease up on the accelerator
- Adapt your speed and driving style to the prevailing road conditions

Failure to observe these guidelines could cause the vehicle to skid.

The ESP® cannot prevent accidents resulting from excessive speed.



Do not tow with one axle raised.

Otherwise the transfer case can be damaged, which is not covered by the Mercedes-Benz Limited Warranty.



Performance testing must only be conducted on a two-axle dynamometer.

Otherwise the transfer case can be damaged, which is not covered by the Mercedes-Benz Limited Warranty.



Because of the ESP®'s automatic operation, the engine must be shut off (SmartKey in starter switch position **0** or **1**) when the parking brake is being tested on a brake test dynamometer.

Active braking action through ESP® may otherwise seriously damage the front or rear axle brake system.

Operational tests with the engine running can only be conducted on a two-axle dynamometer.



At highly demanding operating conditions, the electronic traction system may temporarily switch off to prevent overheating of the drive wheel brakes. The message `unavailable` See Operator's Manual will then appear in the multifunction display while the ESP® warning lamp  is flashing. The ESP® is still functioning normally.

## ▼ Anti-theft systems

### Immobilizer

The immobilizer prevents unauthorized persons from starting your vehicle.

#### Activating

- ▶ Remove the SmartKey from the starter switch.

#### Deactivating

- ▶ Switch on the ignition (▷ page 33).



Starting the engine will also deactivate the immobilizer.

In case the engine cannot be started (yet the vehicle's battery is charged), the system is not operational. Contact an authorized Mercedes-Benz Center or call 1-800-FOR-MERCEdes (in the USA), or 1-800-387-0100 (in Canada).

### Anti-theft alarm system\*

Once the alarm system has been armed, a visual and audible alarm is triggered when someone opens

- a door
- the trunk
- the hood

The alarm system will also be triggered when

- someone attempts to raise the vehicle
- opening the vehicle with the mechanical key
- someone opens a door from the inside
- someone opens the trunk with the emergency release button



The alarm will stay on even if the activating element (e. g. a door) is immediately closed.



If the alarm stays on for more than 30 seconds, a call to the Response Center is initiated automatically by the Tele Aid system\* (▷ page 265) provided Tele Aid service was subscribed to and properly activated, and that necessary cellular service and GPS coverage are available.

### Anti-theft systems

#### Arming the alarm system

The indicator lamp is in the switch for the tow-away alarm\* in the center console.



① Indicator lamp

- ▶ Lock your vehicle with the SmartKey.

The turn signal lamps flash three times to indicate that the alarm system is activated.

Indicator lamp ① begins to flash after approximately 30 seconds after arming the alarm system.



If the turn signal lamps do not flash three times, one of the following elements may not be properly closed:

- a door
- the trunk
- the hood

Close the respective element and lock the vehicle again.

#### Disarming the alarm system

- ▶ Unlock your vehicle with the SmartKey.



The turn signal lamps flash once to indicate that the alarm system is disarmed.



The alarm system will rearm automatically after approximately 40 seconds if neither a door nor the trunk lid was opened.

#### Canceling the alarm

To cancel the alarm:

- ▶ Press the  or  button on the SmartKey.

or

- ▶ Insert the SmartKey in the starter switch.

### Tow-away alarm\*

Once the tow-away alarm is armed, a visual and audible alarm will be triggered when someone attempts to raise the vehicle.



The tow-away protection alarm is triggered, for example, if the vehicle is lifted on one side.

If the alarm stays on for more than 30 seconds, a call to the Response Center is initiated automatically by the Tele Aid system\* (▷ page 265) provided Tele Aid service was subscribed to and properly activated, and that necessary cellular service and GPS coverage are available.

### Arming tow-away alarm

- ▶ Lock your vehicle with the SmartKey.

The tow-away alarm is automatically armed after about 30 seconds.



When you unlock your vehicle, the tow-away protection disarms automatically. The tow-away alarm remains disarmed until you lock the vehicle again.

### Disarming tow-away alarm

To prevent triggering the tow-away alarm, switch off the tow-away alarm feature before towing the vehicle, or when parking on a surface subject to movement, such as a ferry or auto train.

The switch is located on the center console.



- ① Tow-away alarm off switch
- ② Indicator lamp

- ▶ Switch off ignition (▷ page 33).
- ▶ Remove the SmartKey from the starter switch.





### Anti-theft systems



You cannot disarm the tow-away alarm while the ignition is switched on.

- ▶ Press tow-away alarm deactivation switch ①.



Indicator lamp ② in tow-away alarm deactivation switch comes on briefly.

- ▶ Exit your vehicle.
- ▶ Lock your vehicle with the SmartKey.

The tow-away alarm remains disarmed until you lock your vehicle again.

### Canceling the alarm

To cancel the alarm:

- ▶ Press the  or  button on the SmartKey.

or

- ▶ Insert the SmartKey in the starter switch.

**Locking and unlocking**

**Seats**

**Memory function\***

**Lighting**

**Instrument cluster**

**Control system**

**Manual transmission**

**Automatic transmission\***

**Good visibility**

**Climate control**

**Automatic climate control\* (Canada only)**

**Audio system**

**Power windows**

**Power tilt/sliding sunroof\***

**Driving systems**

**Loading**

**Useful features**

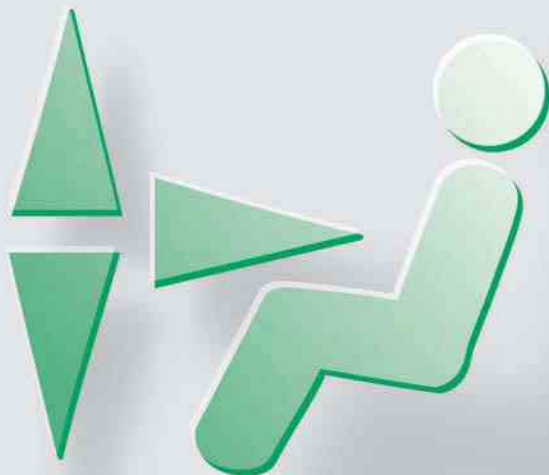

### Locking and unlocking

In the “Controls in detail” section you will find detailed information on how to operate the equipment installed on your vehicle. If you are already familiar with the basic functions of your vehicle, this section will be of particular interest to you.

To quickly familiarize yourself with the basic functions of the vehicle, refer to the “Getting started” section of this manual. The corresponding page numbers are given at the beginning of each segment.

For more information on locking and unlocking, see “Getting started” (▷ page 32) and (▷ page 57).

#### SmartKey

Your vehicle comes supplied with two SmartKeys, each with remote control and a removable mechanical key.

The locking tabs for the mechanical key portion of the two SmartKeys are a different color to help distinguish each SmartKey unit.

The SmartKey provides an extended operating range. To prevent theft, however, it is advisable to only unlock the vehicle when you are in close proximity to it.

The SmartKey centrally locks and unlocks:

- the doors
- the trunk
- the fuel filler flap

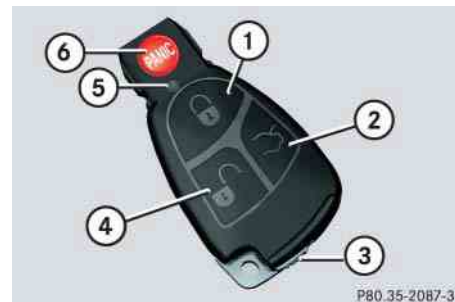

#### SmartKey with remote control

- ① Lock button
- ② Opening button for trunk
- ③ Mechanical key locking tab
- ④ Unlock button
- ⑤ Battery check lamp
- ⑥ PANIC button\* (▷ page 86)



Canada only:

Only vehicles equipped with an anti-theft alarm system\* have SmartKeys with integrated panic button ⑥.

**Warning!**

When leaving the vehicle, always remove the SmartKey from the starter switch, take it with you, and lock the vehicle. Do not leave children unattended in the vehicle, or with access to an unlocked vehicle. It is possible for children to open a locked door from the inside, which could result in an accident and/or serious injury.



To prevent possible malfunction, avoid exposing the SmartKey to high levels of electromagnetic radiation.



USA only:

This device complies with Part 15 of the FCC Rules. Operation is subject to the following two conditions:

- (1) This device may not cause harmful interference, and
- (2) this device must accept any interference received, including interference that may cause undesired operation.

Any unauthorized modification to this device could void the user's authority to operate the equipment.



Canada only:

This device complies with RSS-210 of Industry Canada. Operation is subject to the following two conditions:

- (1) This device may not cause interference, and
- (2) this device must accept any interference received, including interference that may cause undesired operation of the device.

Any unauthorized modification to this device could void the user's authority to operate the equipment.



You can also open or close the power windows and the tilt/sliding sunroof\* using the SmartKey, see “Summer opening feature” (▷ page 243) and “Convenience closing feature” (▷ page 243).

### Locking and unlocking

#### Factory setting

##### *Global unlocking*

- ▶ Press button .

All turn signal lamps flash once. The locking knobs in the doors move up. The anti-theft alarm system\* is disarmed.

The vehicle will lock again automatically and reactivate the anti-theft alarm system\* within approximately 40 seconds of unlocking if:

- neither a door nor the trunk is opened
- the SmartKey is not inserted in the starter switch
- the central locking switch is not activated



##### *Global locking*

- ▶ Press button .

With the hood, trunk and all doors closed, all turn signal lamps flash three times. The locking knobs in the doors move down. The anti-theft alarm system\* is armed.

##### **Selective setting**

If you frequently travel alone, you may wish to reprogram the SmartKey so that pressing  only unlocks the driver's door and the fuel filler flap.

- ▶ Press and hold buttons  and  simultaneously for about 5 seconds.

Battery check lamp  flashes twice.

The SmartKey will then function as follows:

##### *Unlocking driver's door and fuel filler flap*

- ▶ Press button  once.

All turn signal lamps flash once. The locking knob in the driver's door moves up. The anti-theft alarm system\* is disarmed.

##### *Global unlocking*

- ▶ Press button  twice.



All turn signal lamps flash once. The locking knobs in the doors move up. The anti-theft alarm system\* is disarmed.

**Global locking**

- ▶ Press button .

With the trunk and all doors closed, all turn signal lamps flash three times. The locking knobs in the doors move down. The anti-theft alarm system\* is armed.

**Restoring to factory setting**

- ▶ Press and hold buttons  and  simultaneously for about 6 seconds until battery check lamp  flashes twice. The SmartKey is set to factory setting again.



If you can no longer lock or unlock the vehicle with the SmartKey, then either the batteries in the SmartKey are discharged, the SmartKey is malfunctioning or the vehicle battery is drained.

- Check the batteries in the SmartKey (▷ page 101) and replace them if necessary (▷ page 396).
- Use the mechanical key to unlock the driver's door (▷ page 389) and the trunk (▷ page 390).
- Use the mechanical key to lock the driver's door (▷ page 390) and the trunk (▷ page 106).
- Have the vehicle battery and the battery connections checked (▷ page 412).

If the SmartKey is malfunctioning, contact an authorized Mercedes-Benz Center.

**Checking the batteries**

- ▶ Press button  or .

Battery check lamp  comes on briefly to indicate that the SmartKey batteries are in order.





If battery check lamp  does not come on briefly during check, then the SmartKey batteries are discharged.

Replace the batteries (▷ page 396).

You can obtain the required batteries at any authorized Mercedes-Benz Center.



If the batteries are checked within signal range of the vehicle, pressing the  or  button will lock or unlock the vehicle accordingly.

### Locking and unlocking

#### Unlocking and opening the trunk

You can unlock and open the trunk separately.

A minimum height clearance of 5.71 ft (1.74 m) is required to open the trunk lid.

- ▶ Press button  until trunk lid unlocks and begins to open.



The trunk lid swings open upwards automatically. Always make sure there is sufficient overhead clearance.



If the trunk does not open, it is still locked separately (▶ page 106).

#### Loss of SmartKey or mechanical key

If you lose a SmartKey or mechanical key, you should do the following:

- ▶ Have the SmartKey deactivated by an authorized Mercedes-Benz Center.
- ▶ Report the loss of the SmartKey or the mechanical key immediately to your car insurance company.
- ▶ If necessary, have the mechanical lock replaced.

Your authorized Mercedes-Benz Center will be glad to supply you with a replacement.

#### Opening the doors from the inside

You can open a locked door from the inside. Open door only when conditions are safe to do so.





- ① Locking knob
- ② Inside door handle





If the vehicle has previously been locked with the SmartKey, opening a door from the inside will trigger the anti-theft alarm system\*.

To cancel the alarm, do one of the following:



- Press button  or  on the SmartKey.
- Insert the SmartKey in the starter switch.

### Front doors

- ▶ Pull on door handle  on the respective front door to open door.

If door was locked, locking knob  will move up.

### Rear doors

- ▶ Pull up locking knob  on the respective rear door to unlock door.
- ▶ Pull on door handle  on the respective rear door to open door.

### Opening the trunk

#### Opening the trunk from the outside

A minimum height clearance of 5.71 ft (1.74 m) is required to open the trunk lid.

The handle is located above the rear license plate recess.

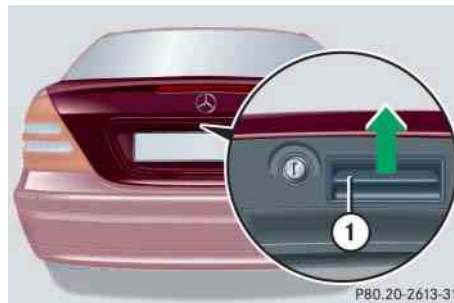

 Handle

The vehicle must be unlocked.

- ▶ Pull on handle .

The trunk opens.



The trunk lid swings open upwards automatically. Always make sure there is sufficient overhead clearance.



If the trunk does not open, it is still locked separately (▶ page 106).

The trunk can also be opened using button  on the SmartKey or from its inside in an emergency, see “Trunk emergency release” (▶ page 105).



### Locking and unlocking

#### Opening the trunk from the inside

You can open the trunk from the inside if the vehicle is stationary.

A minimum height clearance of 5.71 ft (1.74 m) is required to open the trunk lid.

The remote trunk opening switch is located on the driver's door.



① Remote trunk opening switch with indicator lamp

- ▶ Press switch ① until the trunk begins to open.

The indicator lamp in the switch remains lit as long as the trunk is open.



The trunk lid swings open upwards automatically. Always make sure there is sufficient overhead clearance.



If the trunk does not open, it is still locked separately (▷ page 106).

The trunk can also be opened using button  on the SmartKey or from its inside in an emergency, see “Trunk emergency release” (▷ page 105).

#### Closing the trunk

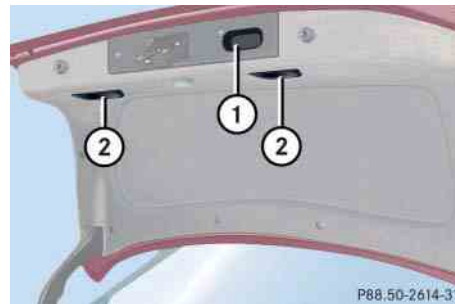

- ① Handle
- ② Handles

- ▶ Lower trunk lid by pulling firmly on handle ① or handles ②.
- ▶ Close trunk lid with hands placed flat on the trunk lid.

### Trunk emergency release

With the emergency release button, the trunk can be opened from inside the trunk.

The emergency release button is located on the inside of the trunk lid.

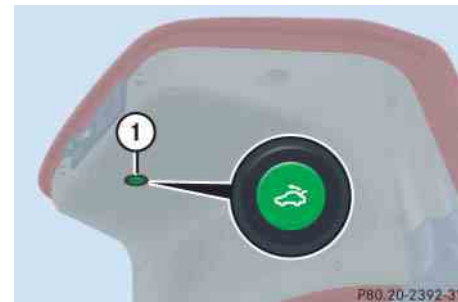

① Emergency release button

- ▶ Briefly press emergency release button ①.

The trunk unlocks and the trunk lid opens.



The trunk lid swings open upwards automatically.

### Warning!



To prevent possible personal injury, always keep hands and fingers away from the trunk opening when closing the trunk. Be especially careful when small children are around.

When leaving the vehicle, always remove the SmartKey from the starter switch, take it with you, and lock the vehicle. Do not leave children unattended in the vehicle, or with access to an unlocked vehicle. Unsupervised use of vehicle equipment may cause an accident and/or serious personal injury.



Do not place the SmartKey in the open trunk. You may lock yourself out.



If the vehicle was previously centrally locked, the trunk will lock automatically after closing it. The turn signals will flash three times to confirm locking.

### Warning!



Only drive with the trunk closed as, among other dangers such as a blocked visibility, exhaust fumes may enter the vehicle interior.

### Locking and unlocking

Illumination of the emergency release button:

- The button flashes 30 minutes after opening the trunk.
- The button flashes 60 minutes after closing the trunk.



The emergency release button unlocks and opens the trunk while the vehicle is standing still or in motion.





The emergency release button does not open the trunk lid if the vehicle battery is discharged or disconnected.



If the vehicle has previously been locked with the SmartKey, opening the trunk from the inside using the emergency release button will trigger the anti-theft alarm system\*.

To cancel the alarm, do one of the following:

- Press button  or  on the SmartKey.
- Insert the SmartKey in the starter switch.

### Valet locking



To deny any unauthorized person access to the trunk, lock it separately with the mechanical key. Leave only the SmartKey less its mechanical key with the vehicle.

The lock is located next to the handle above the rear license plate recess.

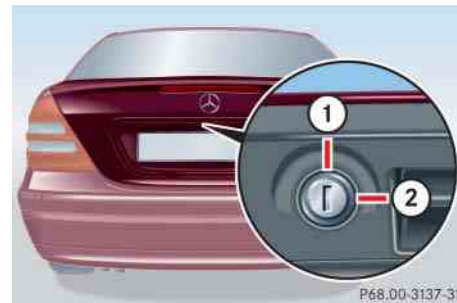

① Neutral position

② Locked

► Close the trunk (▷ page 104).

- ▶ Pull the mechanical key out of the SmartKey (▷ page 389).
- ▶ Insert the mechanical key in the trunk lid lock.
- ▶ Turn the mechanical key clockwise to position ② and remove the mechanical key in that position to lock the trunk.

The trunk remains locked even when the vehicle is centrally unlocked.



You can only cancel the separate trunk locking mode by means of the mechanical key.

- ▶ Insert the mechanical key in the trunk lid lock.
- ▶ Turn the mechanical key counterclockwise to neutral position ① and remove the mechanical key in that position to unlock the trunk.

You can now open the trunk (▷ page 103).

### Automatic central locking

The doors and the trunk automatically lock when the ignition is switched on and the wheels are turning at vehicle speeds of approximately 9 mph (15 km/h) or more.

You can open a locked door from the inside. Open door only when conditions are safe to do so.



The doors unlock automatically after an accident if the force of the impact exceeds a preset threshold.

To prevent the vehicle door locks from locking, deactivate the automatic central locking when the vehicle

- is pushed or towed
- is on a test stand

You can deactivate the automatic locking mode using the control system, see “Set automatic locking” (▷ page 152).

### Locking and unlocking from the inside

You can lock or unlock the doors and the trunk from inside using the central locking or unlocking switch. This can be useful, for example, if you want to lock the vehicle before starting to drive.

You cannot lock or unlock the fuel filler flap with the central locking or unlocking switch.

#### Warning!



When leaving the vehicle, always remove the SmartKey from the starter switch, take it with you, and lock the vehicle. Do not leave children unattended in the vehicle, or with access to an unlocked vehicle. Unsupervised use of vehicle equipment may cause an accident and/or serious personal injury.

### Locking and unlocking

The switches are located in the center console.



- ① Central locking switch
- ② Central unlocking switch



You can open a locked door from the inside. Open door only when conditions are safe to do so.

If the vehicle was previously centrally locked using the SmartKey, it will not unlock using the central unlocking switch ②.

If the vehicle was previously locked with the central locking switch ①

- while in the selective remote control mode, only the door opened from the inside is unlocked.
- while in the global remote control mode, the complete vehicle is unlocked when a door is opened from the inside.

### Locking

- ▶ Press central locking switch ①.

If all doors are closed, the vehicle locks.

### Unlocking

- ▶ Press central unlocking switch ②.

The vehicle unlocks.

## ▼ Seats

For information on seat adjustment, see “Adjusting” (▷ page 35).

### Front seat active head restraints

#### Warning!



For your protection, drive only with properly positioned head restraints.

Adjust head restraint so that the head restraint supports the back of the head at eye level. This will reduce the potential for injury to the head and neck in the event of an accident or similar situation.

Do not drive the vehicle without the seat head restraints. Head restraints are intended to help reduce injuries during an accident.

You cannot remove the active head restraints on the driver’s and passenger’s seat.

For removal of the active head restraints we recommend that you contact an authorized Mercedes-Benz Center.



Adjust the head restraint in such a way that it is as close to the head as possible.

For information on head restraint adjustment, see “Seats” (▷ page 35).  
For information on active head restraints, see “Active head restraint” (▷ page 73).

### Rear seat head restraints

#### Warning!



For safety reasons, always drive with the rear head restraints in the upright position when the rear seats are occupied.

Keep the area around head restraints clear of articles (e.g. clothing) to not obstruct the folding operation of the head restraints.

### Seats

#### Head restraint height (rear outer seats)

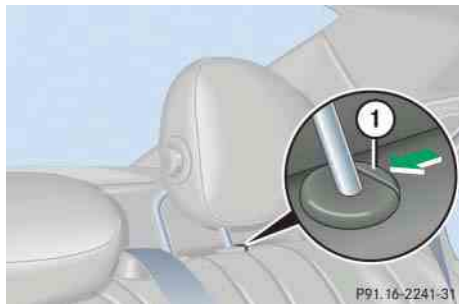

① Release button

#### Raising

- ▶ Manually adjust the height of the head restraint by pulling it upward.

If the head restraint is fully retracted, push release button ① and pull the head restraint out.

#### Lowering

- ▶ To lower the head restraint, push release button ① and push down on the head restraint.



Adjust the head restraint in such a way that it is as close to the head as possible.

#### Warning!



For your protection, drive only with properly positioned head restraints.

Adjust head restraint so that the head restraint supports the back of the head at eye level. This will reduce the potential for injury to the head and neck in the event of an accident or similar situation.

Do not drive the vehicle without the seat head restraints. Head restraints are intended to help reduce injuries during an accident.

#### Folding head restraints back with release button

The rear seat head restraints can be folded backward for increased visibility.

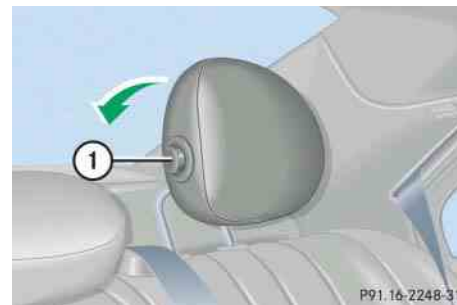

① Release button

- ▶ Push release button ①.

The head restraint will fold backward.



You can also fold the rear outer seat head restraints back using the switch in the center console (▷ page 111).

### Folding head restraints back with switch in the center console



① Switch for rear seat head restraints

- ▶ Start the engine (▷ page 48).
- ▶ Press switch ①.

The rear seat head restraints will fold backward.

### Placing head restraints upright



- ▶ Pull the head restraint forward until it locks into position.

#### Warning!



Make sure the head restraints engage when placing them upright. Otherwise their protective function cannot be assured.

### Head restraint tilt (rear outer seats)

Two different head restraint angle positions are available:

- ▶ Press the release button (▷ page 110) and tilt the head restraint to the desired position.

### Removing and installing rear seat head restraints (rear outer seats)



Adjust the head restraint in such a way that it is as close to the head as possible.



The rear center seat head restraint cannot be removed.



### Warning!



For your protection, drive only with properly positioned head restraints.

Adjust head restraint so that the head restraint supports the back of the head at eye level. This will reduce the potential for injury to the head and neck in the event of an accident or similar situation.

Do not drive the vehicle without the seat head restraints. Head restraints are intended to help reduce injuries during an accident.

Do not interchange head restraints from front and rear seat.

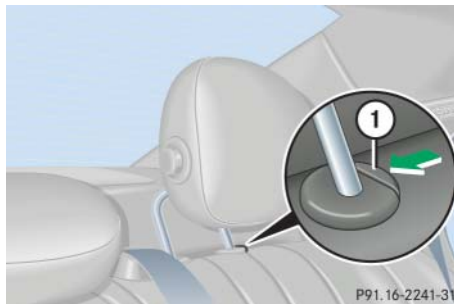

① Release button

### Removing rear seat head restraints

- ▶ Fold back head restraint (▷ page 110).
- ▶ Pull head restraint to its highest position.
- ▶ Push release button ① and pull out head restraint.

### Installing rear seat head restraints

- ▶ Insert head restraint and push it down until it engages.
- ▶ Push button ① and adjust head restraint to desired position.

### Lumbar support\*

The curvature of the driver's seat can be adjusted to help enhance lower back support and seating comfort.

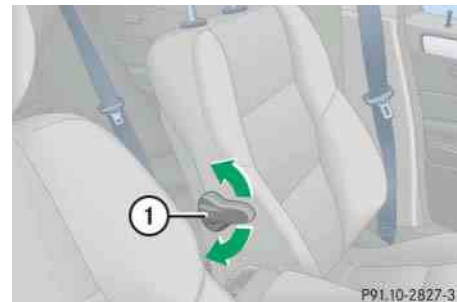

① Adjustment lever

- ▶ Move adjustment lever ① in the direction of arrows until you have reached a comfortable seating position.

### Multicontour seats\* (Canada only)

This driver's multicontour seat has a movable seat cushion and inflatable air cushions built into the backrest to provide additional lumbar and side support.

The seat cushion movement, backrest cushion height and curvature can be continuously varied with switches on the side of the seat after switching on ignition.

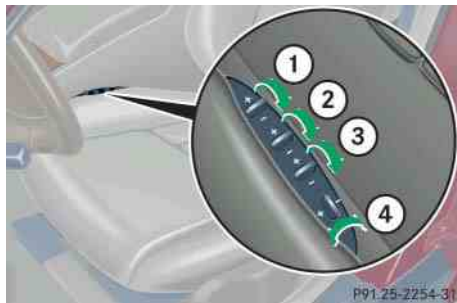

- ① Seat cushion depth
- ② Backrest bottom
- ③ Backrest center
- ④ Backrest side bolster adjustment

- ▶ Switch on the ignition (▷ page 33).

### Seat cushion depth

- ▶ Adjust the seat cushion depth to the length of your upper leg using switch ①.

### Backrest contour

- ▶ Adjust the contour of the backrest to the desired position using switches ② and ③.

### Backrest side bolsters

- ▶ Adjust the backrest side bolsters so that they provide good lateral support using switch ④.

### Seat heating\*

The switches for the front seats are located in the center console.



- ① Seat heating switch
- ② Indicator lamps

### Seats

The red indicator lamps ② in the switch show the heating level selected.

Level	
<b>3</b>	Three indicator lamps on (highest level). After approximately 5 minutes, seat heating is automatically switched to level <b>2</b> .
<b>2</b>	Two indicator lamps on. After approximately 10 minutes, seat heating is automatically switched to level <b>1</b> .
<b>1</b>	One indicator lamp on (lowest level). After approximately 20 minutes, seat heating is automatically switched off.
<b>off</b>	No indicator lamp on.

- ▶ Switch on the ignition (▷ page 33).

#### Switching on seat heating

- ▶ Press switch ① once.  
Three red indicator lamps ② in the switch come on.
- ▶ Continue pressing switch ① until desired seat heating level is reached.

#### Switching off seat heating

- ▶ Press switch ① repeatedly until all indicator lamps ② go out.



If one or more of the indicator lamps ② on the seat heating switch are flashing, there is insufficient voltage due to too many electrical consumers are turned on. The seat heating switches off automatically.

The seat heating will switch back on again automatically as soon as sufficient voltage is available.

### ▼ Memory function\*

Prior to operating the vehicle, the driver should check and adjust the seat height, seat position fore and aft, and seat backrest angle if necessary, to ensure adequate control, reach and comfort. The head restraint should also be adjusted for proper height. See also the section on air bags (▷ page 63) for proper seat positioning.

In addition, adjust the steering wheel to ensure adequate control, reach, operation and comfort. Both the interior and exterior rear view mirrors should be adjusted for adequate rear vision.

Fasten seat belts. Infants and small children should be seated in a properly secured restraint system that complies with U.S. Federal Motor Vehicle Safety Standards 213 and 225 and Canadian Motor Vehicle Safety Standards 213 and 210.2.

With the memory function you can store up to three different settings.

The following settings are stored for the driver's seat when using the buttons on the driver's door:

- Driver's seat, backrest and head restraint position
- Steering wheel position
- Exterior rear view mirrors

The following settings are stored for the front passenger seat when using the buttons (if so equipped depending on vehicle equipment configuration) on the passenger door:

- Front passenger seat, backrest and head restraint position

#### Warning!



Do not activate the memory function while driving. Activating the memory function while driving could cause the driver to lose control of the vehicle.

### Memory function\*

The memory button and memory position switch are located on the door.

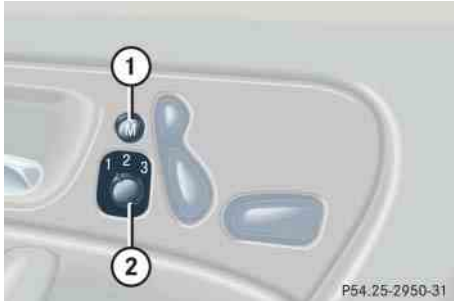

① Memory button

② Memory position switch

▶ Switch on the ignition (▷ page 33).

or

▶ Open the respective door.

### Storing positions into memory

- ▶ Adjust the seat, steering wheel and exterior rear view mirrors to the desired position (▷ page 35).
- ▶ Turn memory position switch ② to the desired memory position.
- ▶ Press memory button ①.
- ▶ Release memory button ① and press memory position switch ② within 3 seconds.

All settings are stored to the selected position.

### Recalling positions from memory



Do not operate the power seats using the memory button if the seat backrest is in an excessively reclined position. Doing so could cause damage to front or rear seats.

- ▶ Turn memory position switch ② to the desired memory position.
- ▶ Press and hold memory position switch ② until the seat, steering wheel and exterior rear view mirrors have completely moved to the stored positions.



Releasing the memory position switch stops movement to the stored positions immediately.

#### Storing exterior rear view mirror parking position

For easier parking, you can adjust the passenger-side exterior rear view mirror so that you can see the right rear wheel as soon as you engage reverse gear **R**.

For information on activating the parking position feature, see “Activating exterior rear view mirror parking position\*” (▷ page 172).



- ① Memory button
- ② Adjustment button
- ③ Passenger-side exterior rear view mirror button

- ▶ Stop the vehicle in a safe location.
- ▶ Switch on the ignition (▷ page 33).

- ▶ Press button ③.

The passenger-side exterior rear view mirror is selected.

- ▶ Adjust the exterior rear view mirror with button ② so that you see the rear wheel and the road curb.

- ▶ Press memory button ①.

- ▶ Within 3 seconds, press bottom of adjustment button ②.

The parking position is stored if the mirror does not move.



If the mirror does move, repeat the above steps. After the setting is stored, you can move the mirror again.

### Lighting

For information on how to switch on the headlamps and use the turn signals, see “Switching on headlamps” (▷ page 52) and “Turn signals” (▷ page 53).



If you drive in countries where vehicles drive on the other side of the road than the country where the vehicle is registered, you must have the headlamps modified for symmetrical low beams. Relevant information can be obtained at your authorized Mercedes-Benz Center.

#### Exterior lamp switch

The exterior lamp switch is located on the dashboard to the left of the steering wheel.



Exterior lamp switch

- 0** Off  
Daytime running lamp mode (▷ page 120)
- AUTO** Automatic headlamp mode  
Daytime running lamp mode (▷ page 120)
- ▷◁** Parking lamps (also tail lamps, license plate lamps, side marker lamps, instrument panel lamps)
- ☾** Low beam headlamps (or high beam headlamps when the combination switch is pushed forward) and parking lamps
- P↔** Standing lamps, right (turn left one stop)
- ↔P** Standing lamps, left (turn left two stops)
- ☾** Indicator lamp for front fog lamps
- 0☾** Indicator lamp for rear fog lamp



With the SmartKey removed from the starter switch and the driver's door open, a warning sounds if the parking lamps or low beam headlamps are switched on.

The message *Switch off lights.* appears in the multifunction display.

### Manual headlamp mode

The low beam headlamps and the parking lamps can be switched on and off with the exterior lamp switch.

### Automatic headlamp mode

The following lamps switch on and off automatically depending on the brightness of the ambient light:

- Low beam headlamps
- Tail and parking lamps
- License plate lamps
- Side marker lamps



### Warning!



If the exterior lamp switch is set to **AUTO**,

- the headlamps may switch off unexpectedly when the system senses bright ambient light, for example light from oncoming traffic.
- the headlamps will not be automatically switched on under foggy conditions.

To minimize risk to you and to others, activate headlamps by turning exterior lamp switch to  when driving or when traffic and / or ambient lighting conditions require you to do so.

In low ambient lighting conditions, only switch from position **AUTO** to  with the vehicle at a standstill in a safe location. Switching from **AUTO** to  will briefly switch off the headlamps. Doing so while driving in low ambient lighting conditions may result in an accident.

The automatic headlamp feature is only an aid to the driver. The driver is responsible for the operation of the vehicle's lights at all times.

- ▶ Turn the exterior lamp switch to position **AUTO**.

With the SmartKey in starter switch position **1**, only the parking lamps will switch on and off automatically.

When the engine is running, the low beam headlamps, the tail and parking lamps, the license plate lamps, and the side marker lamps will switch on and off automatically.



### Lighting

#### Daytime running lamp mode

- ▶ Turn the exterior lamp switch to position **0** or **AUTO**.

When the engine is running, the low beam headlamps are switched on.

In low ambient light conditions, the following lamps will switch on additionally:

- Tail and parking lamps
- License plate lamps
- Side marker lamps

For nighttime driving you should turn the exterior lamp switch to position  to permit activation of the high beam headlamps.



With the daytime running lamp mode activated and the exterior lamp switch in position **0**, the high beam headlamps cannot be switched on.



The high beam flasher is available at all times.

#### Canada only:

The daytime running lamp mode is mandatory and therefore in a constant mode.

Vehicles with automatic transmission\*: When the engine is running, and you shift from a driving position to position **N** or **P**, the low beam headlamps will switch off with a three-minute delay.



When the engine is running, and you

- turn the exterior lamp switch to position , the parking lamps switch on additionally.
- turn the exterior lamp switch to position , the manual headlamp mode has priority over the daytime running lamp mode.

The corresponding exterior lamps switch on (▷ page 118).

#### USA only:

By default, the daytime running lamp mode is deactivated. Activate the daytime running lamp mode using the control system, see “Set daytime running lamp mode (USA only)” (▷ page 149).

When the engine is running, and you turn the exterior lamp switch to position  or , the manual headlamp mode has priority over the daytime running lamp mode.

The corresponding exterior lamps switch on (▷ page 118).



## Locator lighting and night security illumination

The locator lighting and the night security illumination are described in the “Control system” section, see “Set locator lighting” (▷ page 150) and “Setting night security illumination” (▷ page 151).

## Fog lamps

### Warning!



In low ambient lighting or foggy conditions, only switch from position **AUTO** to  with the vehicle at a standstill in a safe location. Switching from **AUTO** to  will briefly switch off the headlamps. Doing so while driving in low ambient lighting conditions may result in an accident.



Fog lamps will operate with the parking lamps and/or the low beam headlamps on. Fog lamps should only be used in conjunction with low beam headlamps. Consult your State or Province Motor Vehicle Regulations regarding permissible lamp operation.



Fog lamps cannot be switched on with the exterior lamp switch in position **AUTO**. For switching on the fog lamps, turn the exterior lamp switch to position  first.

## Front fog lamps

- ▶ Switch on the low beam headlamps (▷ page 118).
- ▶ Pull out the exterior lamp switch to first stop.

The front fog lamps switch on.

The green indicator lamp  in the exterior lamp switch comes on (▷ page 118).

- ▶ Push in the exterior lamp switch.

The front fog lamps switch off.

The green indicator lamp  in the exterior lamp switch goes out.

### Lighting

#### Rear fog lamp (driver's side only)

- ▶ Switch on the front fog lamps (▷ page 121).
- ▶ Pull out the exterior lamp switch to second stop.

The rear fog lamp is switched on.

The yellow indicator lamp  in the exterior lamp switch comes on (▷ page 118).

- ▶ Push in the exterior lamp switch to first stop.

The rear fog lamp switches off.

The yellow indicator lamp  in the exterior lamp switch goes out.

The front fog lamps remain lit.

#### Combination switch

The combination switch is located on the left of the steering column.



#### Combination switch

- ① High beam
- ② High beam flasher

#### High beam

- ▶ Turn the exterior lamp switch to position  or **AUTO** (▷ page 118).
- ▶ Push the combination switch in direction of arrow ① to switch on the high beam.

The high beam headlamp indicator lamp  in the instrument cluster comes on (▷ page 24).

- ▶ Pull the combination switch in direction of arrow ② to its original position to switch off the high beam.

The high beam headlamp indicator lamp  in the instrument cluster goes out.

#### High beam flasher

- ▶ Pull the combination switch briefly in direction of arrow ②.

### Corner-illuminating front fog lamps\* (C 280, C 350 4MATIC: with Bi-Xenon\* headlamps)

The corner-illuminating front fog lamps improve illumination of the road into which you are turning.

The corner-illuminating front fog lamps will operate with the engine running and with

- the exterior lamp switch in position  (▷ page 118)  
or
- the exterior lamp switch in position **AUTO** (▷ page 118)  
or
- the daytime running lamp mode activated (▷ page 120)



Corner-illuminating front fog lamps will only come on in low ambient lighting conditions.

The corner-illuminating front fog lamps function is not available at a vehicle speed above 25 mph (40 km/h).

#### Driving forward

#### *Switching on corner-illuminating front fog lamps*

- ▶ Depending on whether you are turning left or right, switch on the left or right turn signal (▷ page 53).

The respective front fog lamp comes on and illuminates the road onto which you are turning.



The corner-illuminating front fog lamps will come on automatically depending on the steering angle, even if you did not switch on either turn signal. If the corner-illuminating front fog lamps came on automatically, they will also go out automatically depending on the steering angle.

### Lighting

#### ***Switching off corner-illuminating front fog lamps***

The combination switch for the turn signal resets automatically after major steering wheel movements. This will switch off the corner-illuminating front fog lamps if they were activated by switching on the left or right turn signal.

If the turn signal should stay on after making the turn, the turn signal and cornering fog lamp can be switched off by returning the combination switch to its original position.

#### **Driving rearward**

#### ***Switching on corner-illuminating front fog lamps***

- ▶ Place the gear selector lever (manual transmission: gearshift lever) in position **R**.

The inverse front fog lamp comes on automatically depending on the steering direction and steering angle.

#### ***Switching off corner-illuminating front fog lamps***

- ▶ Place the gear selector lever (manual transmission: gearshift lever) out of position **R**.

The respective front fog lamp goes out.

#### **Hazard warning flasher**

The hazard warning flasher can be switched on at all times, even with the SmartKey removed from the starter switch.

The hazard warning flasher switches on automatically when an air bag deploys.

The hazard warning flasher switch is located on the upper part of the center console.



① Hazard warning flasher switch

### Switching on hazard warning flasher

- ▶ Press hazard warning flasher switch ①.

All turn signals are flashing.



With the hazard warning flasher activated and the combination switch set for either left or right turn, only the respective turn signals will operate when the SmartKey is in the starter switch position **1** or **2**.

### Switching off hazard warning flasher

- ▶ Press hazard warning flasher switch ① again.



If the hazard warning flasher has been activated automatically, press hazard warning flasher switch ① once to switch it off.

### Interior lighting

The controls are located in the overhead control panel.



- ① Rear interior lights on/off
- ② Right front reading lamp on/off
- ③ Rocker switch for automatic control system
- ④ Left front reading lamp on/off



Leaving an interior light switch in the ON position for extended periods of time with the engine turned off could result in a discharged battery.

### Automatic control

#### Activating

- ▶ Press rocker switch ③ to center position.

Interior lamps are switched on in darkness, when you

- unlock the vehicle
- open a door
- remove the SmartKey from the starter switch

The interior lamps are switched off after a preset time, see “Set interior lighting delayed shut-off” (▷ page 152).



If the door remains open, the interior lamps switch off automatically after approximately 5 minutes, when the SmartKey is removed or in starter switch position **0**.

### Lighting

#### Deactivating

- ▶ Press the  symbol on rocker switch ③.

The interior lighting remains switched off, even when you

- unlock the vehicle
- open a door
- remove the SmartKey from the starter switch

#### Manual control

#### Switching all front interior lights on and off

- ▶ Press the  symbol on rocker switch ③.

The front interior lights come on.

- ▶ Press rocker switch ③ to center position to activate the automatic control.

#### Switching rear interior lights on and off

- ▶ Press button .

The lights in the rear passenger compartment come on.

- ▶ Press button  again.

The lights in the rear passenger compartment go out.

#### Switching front reading lamp on and off

- ▶ Press right or left button .

The right reading lamp comes on.

- ▶ Press right or left button  again.

The right reading lamp goes out.

#### Door entry lamps

---

The appropriate door entry lamp switches on if a door is opened in darkness and if the interior lighting is switched to automatic function.

The entry lamp switches off automatically when the door is closed.



If you turn the SmartKey in the starter switch to position **0** and switch off the exterior headlamps, the door entry lamps will remain lit for approximately 5 minutes.

#### Trunk lamp

---

The trunk lamp switches on if the trunk is opened.

If you leave the trunk open for an extended period of time, the trunk lamp will switch off automatically after approximately 10 minutes.

## ▼ Instrument cluster

For a full view illustration of the instrument cluster, see “At a glance” (▷ page 24).



### ① Reset button

The instrument cluster is activated when you

- open a door
- switch on ignition (▷ page 33)
- press reset button ①
- switch on the exterior lighting

You can change the instrument cluster settings in the Instrument cluster submenu of the control system (▷ page 143).

## Instrument cluster illumination

Use reset button ① to adjust the illumination brightness for the instrument cluster.



The instrument cluster illumination is dimmed or brightened automatically to suit ambient light conditions.

The instrument cluster illumination will also be adjusted automatically when you switch on the vehicle's exterior lamps.

## To brighten illumination

- ▶ Turn reset button ① clockwise.

The instrument cluster illumination will brighten.

## To dim illumination

- ▶ Turn reset button ① counterclockwise.

The instrument cluster illumination will dim.



#### Coolant temperature gauge

The coolant temperature gauge is on the left side in the instrument cluster (▷ page 24).

#### Warning!





- Driving when your engine is badly overheated can cause some fluids which may have leaked into the engine compartment to catch fire. You could be seriously burned.
- Steam from an overheated engine can cause serious burns and can occur just by opening the hood. Stay away from the engine if you see or hear steam coming from it.

Turn off the engine, get out of the vehicle and do not stand near the vehicle until the engine has cooled down.

During severe operating conditions, e.g. stop-and-go traffic, the coolant temperature may rise close to 248°F (120°C).

The engine should not be operated with the coolant temperature above 248°F (120°C). Doing so may cause serious engine damage which is not covered by the Mercedes-Benz Limited Warranty.

#### Trip odometer

- ▶ Make sure you are viewing the trip odometer and main odometer in the multifunction display (▷ page 130).
- ▶ If it is not displayed, press button  or  on the multifunction steering wheel (▷ page 131) until the trip odometer appears in the multifunction display.
- ▶ Press and hold the reset button in the instrument cluster (▷ page 127) until the trip odometer is reset.

## Tachometer

The red marking on the tachometer (▷ page 24) denotes excessive engine speed.



Avoid driving at excessive engine speeds, as it may result in serious engine damage that is not covered by the Mercedes-Benz Limited Warranty.

To help protect the engine, the fuel supply is interrupted if the engine is operated within the red marking.

## Outside temperature indicator

### Warning!



The outside temperature indicator is not designed to serve as an ice-warning device and is therefore unsuitable for that purpose.

Indicated temperatures just above the freezing point do not guarantee that the road surface is free of ice. The road may still be icy, especially in wooded areas or on bridges.

The outside temperature is indicated in the multifunction display (▷ page 130).

The temperature sensor is located in the front bumper area. Due to its location, the sensor can be affected by road or engine heat during idling or slow driving. Therefore, the accuracy of the displayed temperature can only be verified by comparison to a thermometer placed next to the sensor, not by comparison to external displays (e.g. bank signs, etc.).

When moving the vehicle into colder ambient temperatures (e.g. when leaving your garage), you will notice a delay before the lower temperature is displayed.

A delay also occurs when ambient temperatures rise. This prevents inaccurate temperature indications caused by heat radiated from the engine during idling or slow driving.

### Control system

The control system is activated as soon as the SmartKey in the starter switch is turned to position **1**. The control system enables you to

- call up information about your vehicle
- change vehicle settings

For example, you can use the control system to find out when your vehicle is next due for service, to set the language for messages in the instrument cluster display, and much more.



The displays for the audio systems (radio, CD player) will appear in English, regardless of the language selected.

#### Warning!



A driver's attention to the road and traffic conditions must always be his/her primary focus when driving.

For your safety and the safety of others, selecting features through the multifunction steering wheel should only be done by the driver when traffic and road conditions permit it to be done safely.

Bear in mind that at a speed of just 30 mph (approximately 50 km/h), your vehicle is covering a distance of 44 feet (approximately 14 m) every second.

The control system relays information to the multifunction display.

### Multifunction display



- ① Trip odometer
- ② Main odometer
- ③ Current program mode (automatic transmission\*)
- ④ Current gear selector lever position/gear range (automatic transmission\*)
- ⑤ Digital clock
- ⑥ Status indicator (outside temperature/digital speedometer)

### Multifunction steering wheel

The displays in the multifunction display and the settings in the control system are controlled by the buttons on the multifunction steering wheel.

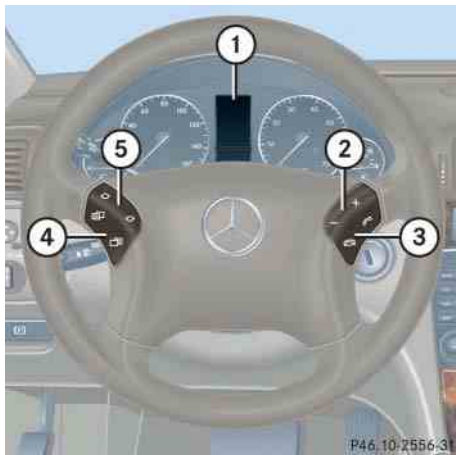

- ① Multifunction display

#### Operating the control system

- ② Selecting the submenu or setting the volume:  
Press button
  - up/to increase
  - down/to decrease
- ③ Telephone\*:  
Press button
  - to take a call
  - to end a call
- ④ Menu systems:  
Press button
  - for next menu
  - for previous menu
- ⑤ Moving within a menu:  
Press button
  - for next display
  - for previous display

Pressing any of the buttons on the multifunction steering wheel will alter what is shown in the multifunction display.

The information available in the multifunction display is arranged in menus, each containing a number of functions or sub-menus.





The individual functions are then found within the relevant menu (radio or CD operations under AUDIO, for example). These functions serve to call up relevant information or to customize the settings for your vehicle.



C 230 Sport and C 350 Sport:  
Steering wheel in these vehicles will vary from steering wheel shown. However, multifunction steering wheel symbols and feature description apply to Sport models as well.

### Control system

It is helpful to think of the menus, and the functions within each menu, as being arranged in a circular pattern.

- If you press button  or  repeatedly, you will pass through each menu one after the other.
- If you press button  or  repeatedly, you will pass through each function display, one after the other, in the current menu.

In the **Settings** menu, instead of functions you will find a number of submenus for calling up and changing settings. For instructions on using these submenus, see “Submenus in the Settings menu” (▷ page 141).

The number of menus available in the system depends on which optional equipment is installed in your vehicle.



The headings used in the menu table are designed to facilitate navigation within the system and are not necessarily identical to those shown in the control system displays.

The first function displayed in each menu will automatically show you which part of the system you are in.

Menus

This is what you will see when you scroll through the menus.

The table on the next page provides an overview of the individual menus.

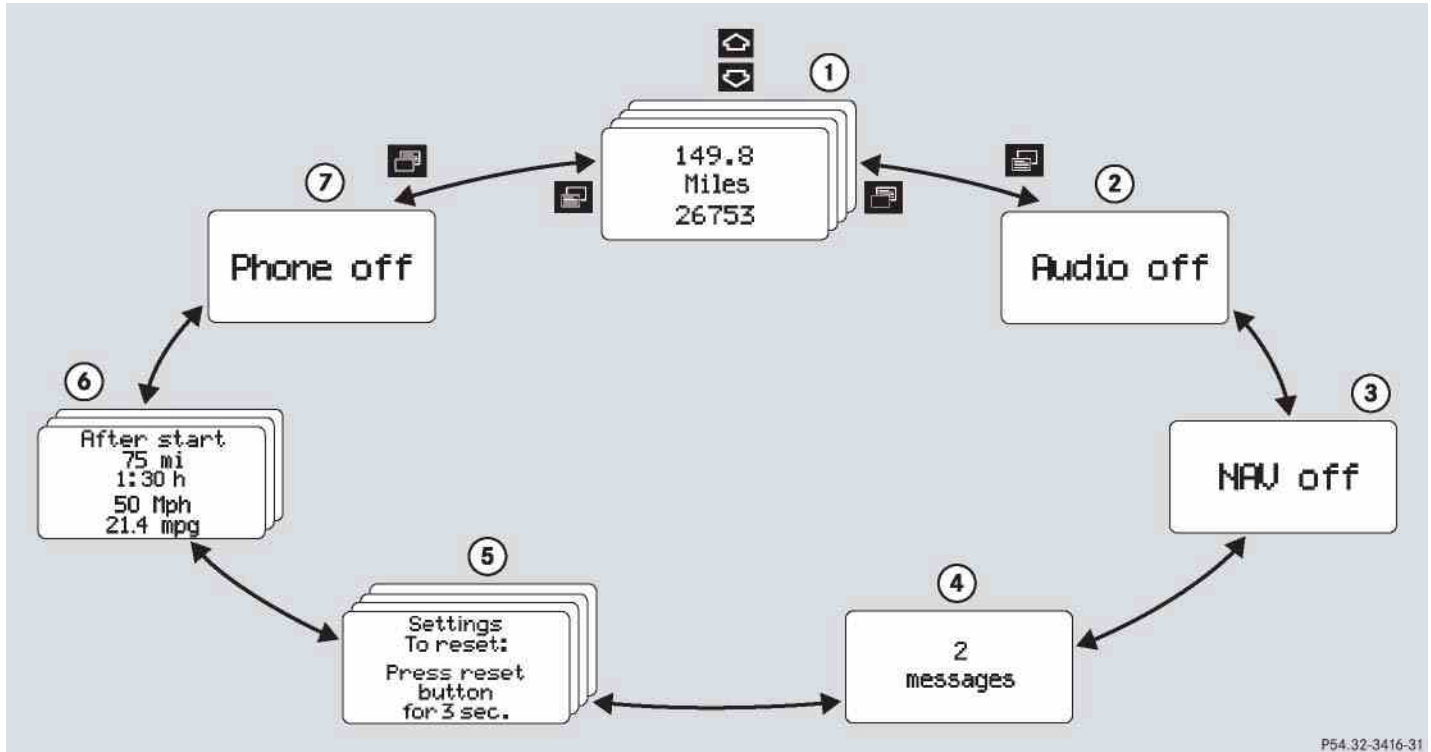

P54-32-3416-31

## Control system

### Menus, submenus and functions

	Menu ① Standard display (▷ page 135)	Menu ② AUDIO (▷ page 136)	Menu ③ NAV* (▷ page 138)	Menu ④ Vehicle status message memory (▷ page 138)	Menu ⑤ Settings (▷ page 140)	Menu ⑥ Trip computer (▷ page 155)	Menu ⑦ Telephone* (▷ page 157)
Commands/submenus	Run Flat Indicator* (Canada only)	Select radio station	Show route guidance instructions, current direction traveled	Call up vehicle malfunction, warning and system status messages stored in memory <sup>1</sup>	Reset to factory settings	Fuel consumption statistics after start	Load phone book
	Digital speedometer or outside temperature	Select satellite radio station* (USA only)			Instrument cluster submenu	Fuel consumption statistics since the last reset	Search for name in phone book
	Call up maintenance service display	Operate CD player*			Time/Date submenu	Call up range	
					Lighting submenu Vehicle submenu Convenience submenu		

<sup>1</sup> The vehicle status message memory menu is only displayed if there is a message stored.





### Standard display menu

In the standard display, the main odometer and the trip odometer are shown in the multifunction display.



- ① Trip odometer
- ② Main odometer

If another display is shown instead of the standard display:

- ▶ Press button  or  repeatedly until you see the standard display.
- ▶ Press button  or  to select the functions in the standard display menu.

The following functions are available:

Function	Page
Run Flat Indicator* (Canada only)	317
Call up digital speedometer or outside temperature	135
Call up maintenance service display	338

### Display digital speedometer or outside temperature

- ▶ Press button  or  repeatedly until you see the digital speedometer.

The current vehicle speed is shown in the multifunction display.



- ① Digital speedometer



Select either the display of the digital speedometer or the outside temperature indicator (▶ page 144).



## Control system

### AUDIO menu

The functions in the **AUDIO** menu operate the audio equipment which you currently have turned on.

If no audio equipment is currently turned on, the message *Audio off* appears in the multifunction display.



The following functions are available:

Function	Page
Select radio station	136
Select satellite radio station* (USA only)	137
Operate CD player*	137

### Select radio station

- ▶ Turn on the radio (▷ page 202).

Vehicles with COMAND\*:  
Refer to separate operating instructions.

- ▶ Press button  or  repeatedly until the currently tuned station appears in the multifunction display.

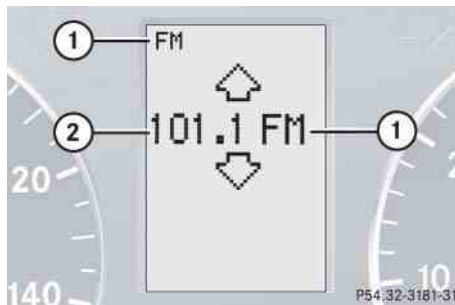

- ① Waveband setting
- ② Station frequency

- ▶ Press button  or  repeatedly until the desired station is found.



You can only store new stations using the corresponding feature on the radio (▷ page 210).

Vehicles with COMAND\*:  
Refer to separate operating instructions.

You can also operate the radio in the usual manner.



### Select satellite radio station\* (USA only)

The satellite radio is treated as a radio application.

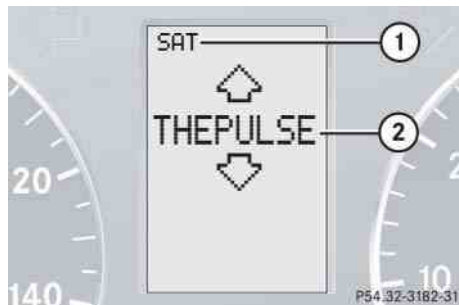
- ▶ Select satellite radio with the corresponding soft key (SAT) in the radio menu.



- ① SAT mode and preset number
- ② Channel name or number

- ▶ Press button  or  repeatedly until the desired channel is found.





For more information on satellite radio operation, see “Introduction to satellite radio\* (USA only)” (▷ page 211).

Vehicles with COMAND\*:  
Refer to separate operating instructions.

### Operate the CD player\*

- ▶ Turn on the radio and select the CD player or the CD Changer (▷ page 216).

Vehicles with COMAND\*:  
Refer to separate operating instructions.

- ▶ Press button  or  repeatedly until the settings for the CD currently being played appear in the multifunction display.

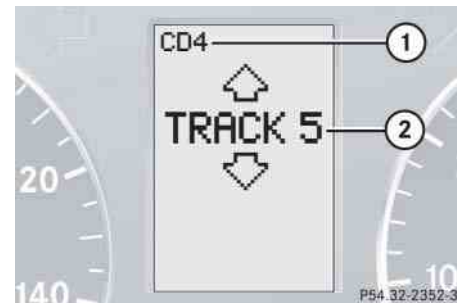

- ① Current CD (for CD changer\*)
- ② Current track



### Control system



▷▷ Press button  or  repeatedly until the desired track is selected.



To select a CD from the magazine, press a number on the audio system or the COMAND\* system key pad located in the center dashboard.

### NAV\* menu

The NAV menu contains the functions needed to operate your navigation system.

- ▶ Press button  or  repeatedly until the message NAV appears in the multifunction display.
- If COMAND\* is switched off, the message NAV off appears in the multifunction display.
- With COMAND\* switched on but route guidance not activated, the direction of travel and, if available, the name of the street currently traveled on appear in the multifunction display.
- With COMAND\* switched on and route guidance activated, the direction of travel and maneuver instructions appear in the multifunction display.

Please refer to the COMAND\* manual for instructions on how to activate the route guidance system\*.



### Vehicle status message memory menu

Use the vehicle status message memory menu to scan malfunction and warning messages that may be stored in the system. Such messages appear in the multifunction display and are based on conditions or system status the vehicle's system has recorded.

The vehicle status message memory menu only appears if there are any messages stored.

**Warning!**

Malfunction and warning messages are only indicated for certain systems and are intentionally not very detailed. The malfunction and warning messages are simply a reminder with respect to the operation of certain systems and do not replace the owner's and/or driver's responsibility to maintain the vehicle's operating safety by having all required maintenance and safety checks performed on the vehicle and by bringing the vehicle to an authorized Mercedes-Benz Center to address the malfunction and warning messages (▷ page 358).

- ▶ Press button  or  repeatedly until the vehicle status message memory appears in the multifunction display.

If the vehicle status message memory does not appear, then there are no messages stored.

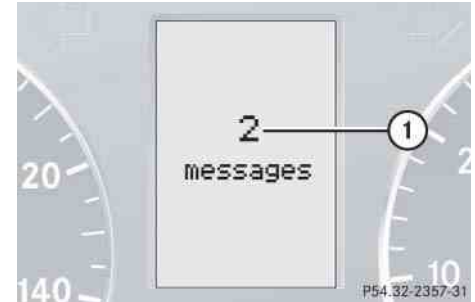

**Vehicle status messages have been recorded**

If conditions have occurred causing status messages to be recorded, the number of messages appears in the multifunction display:



- ① Number of messages

### Control system

- ▶ Press button  or .

The stored messages will now be displayed in the order in which they have occurred. For malfunction and warning messages, see “Vehicle status messages in the multifunction display” (▷ page 358).



Should the vehicle’s system record any conditions while driving, the number of messages will reappear in the multifunction display when the SmartKey in the starter switch is turned to position **0** or removed from the starter switch.



The vehicle status message memory will be cleared when you turn the SmartKey in the starter switch to position **1** or **2**. You will then only see high-priority messages in the multifunction display (▷ page 358).

### Settings menu

In the Settings menu there are two functions:

- The function **Reset to factory settings**, with which you can reset all the settings to the original factory settings.
  - A collection of submenus with which you can make individual settings for your vehicle.
- ▶ Press button  or  repeatedly until the Settings menu appears in the multifunction display.

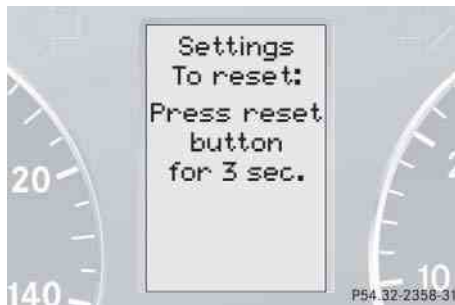

### Resetting all settings

You can reset all the functions of all submenus to the factory settings.

- ▶ Press the reset button in the instrument cluster (▷ page 127) for approximately 3 seconds.

The request to press the reset button once more to confirm appears in the multifunction display.

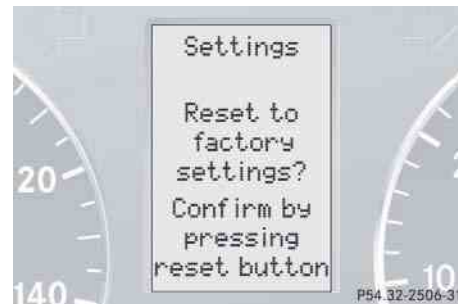

- ▶ Press the reset button once more.

The functions of all the submenus will reset to factory settings.



The settings you have changed will not be reset unless you confirm the action by pressing the reset button a second time. After approximately 5 seconds, the **Settings** menu reappears in the multifunction display.

For safety reasons, the following function are not reset while driving:

- the HdLamp mode function in the Lighting submenu

### Submenus in the Settings menu

- ▶ Press button .

The collection of the submenus appears in the multifunction display.

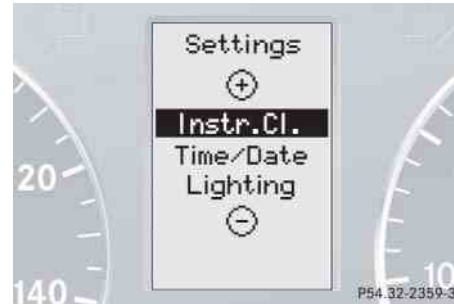

- ▶ Press button .

The selection marker moves to the next submenu.

The submenus are arranged by hierarchy. Scroll down with button , scroll up with button .

With the selection marker on the desired submenu, use the button to access the individual functions within that submenu. Once within the submenu, you can use the button to move to the next function or the button to move to the previous function within that submenu.

The settings themselves are made with button or .

### Control system

The table below shows what settings can be changed within the various menus.

Detailed instructions on making individual settings can be found on the following pages.

Instrument cluster	Time/Date	Lighting	Vehicle	Convenience
Select speedometer display mode	Time synchronization with head unit*	Set daytime running lamp mode (USA only)	Set automatic locking	Activate easy-entry/exit feature
Select language	Set time (hours)	Set locator lighting		Set parking position for exterior rear view mirror
Select display (speed display or outside temperature) for status indicator	Set time (minutes)	Set night security illumination		
	Select automatic time change (Daylight Saving Time (DST) summer/Standard time winter)	Set interior lighting delayed shut-off		
	Set date (month)			
	Set date (day)			
	Set date (year)			

### Instrument cluster submenu

Access the Instr.Cl. submenu via the Settings menu. Use the Instr.Cl. submenu to change the instrument cluster display settings.

The following functions are available:

Function	Page
Select speedometer display mode	143
Select language	143
Select display (speed display or outside temperature) for status indicator	144

### Select speedometer display mode

- ▶ Move the selection marker with button **+** or **-** to the Instr.Cl. submenu.
- ▶ Press button **↶** or **↷** repeatedly until the message **Disp.Unit** Speed/odo appears in the multifunction display.

The selection marker is on the current setting.



- ▶ Press button **+** or **-** to set speedometer unit to Km or Miles.

### Select language

- ▶ Move the selection marker with button **+** or **-** to the Instr.Cl. submenu.
- ▶ Press button **↶** or **↷** repeatedly until the message **Language** appears in the multifunction display.

The selection marker is on the current setting.





### Control system

- ▷▷ Press button **+** or **-** to select the language to be used for the multifunction display messages.

Available languages:

- German (Deutsch)
- English (English)
- French (français)
- Italian (italiano)
- Spanish (Español)
- Dutch (Nederlands)
- Danish (Dansk)
- Swedish (Svenska)
- Portuguese (Português)
- Turkish (Türkçe)

### **Select display (digital speedometer or outside temperature) for status indicator**

- ▶ Move the selection marker with button **+** or **-** to the Instr.Cl. submenu.
- ▶ Press button **▲** or **▼** repeatedly until the message *Status line display* appears in the multifunction display.

The selection marker is on the current setting.

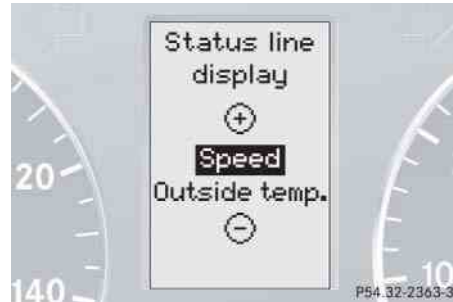

- ▶ Press button **+** or **-** to select the desired setting.

The selected display is then shown continuously in the lower display.

The other display now appears in the menu of the standard display:

- Digital speedometer  
or
- Outside temperature

### Time/Date submenu

Access the Time/Date submenu via the Settings menu. Use the Time/Date submenu to change the instrument cluster display settings.

The following functions are available:

Function	Page
Time synchronization with head unit*	145
Set time (hours)	145
Set time (minutes)	146
Select automatic time change (Daylight Saving Time (DST) summer/Standard time winter)	147
Set date (month)	147
Set date (day)	148
Set date (year)	148

### Time synchronization with head unit\*

This function can only be seen on vehicles with COMAND\* and navigation module\*.

- ▶ Move the selection marker with button **+** or **-** to the Time/Date submenu.
- ▶ Press button **▲** or **▼** repeatedly until the message Time synchro. w/Head Unit appears in the multifunction display.

The selection marker is on the current setting.



- ▶ Press button **+** or **-** to select the desired setting.

### Set the time (hours)

This function can be seen in vehicles with audio system, or in vehicles with COMAND\* if the time synchronization with head unit\* feature was set to Off.



Vehicles with COMAND\*: For information on setting the time, refer to the separate COMAND operating instructions.

- ▶ Move the selection marker with button **+** or **-** to the Time/Date submenu.
- ▶ Press button **▲** or **▼** repeatedly until the message Time Hours appears in the multifunction display. ▶▶

### Control system

- ▷▷ The selection marker is on the hour setting.



- ▶ Press button **+** or **-** to set the hour.

### Set the time (minutes)

This function can be seen in vehicles with audio system, or in vehicles with COMAND\* if the time synchronization with head unit\* feature was set to Off.



Vehicles with COMAND\*:  
For information on setting the time,  
refer to the separate COMAND  
operating instructions.

- ▶ Move the selection marker with button **+** or **-** to the Time/Date submenu.
- ▶ Press button **↶** or **↷** repeatedly until the message *Time Minutes* appears in the multifunction display.

- The selection marker is on the minute setting.



- ▶ Press button **+** or **-** to set the minutes.

### Select automatic time change (Daylight Saving Time (DST) summer/Standard time winter)

This function can be seen in vehicles with audio system, or in vehicles with COMAND\* if the time synchronization with head unit\* feature was set to Off.

- ▶ Move the selection marker with button **+** or **-** to the Time/Date submenu.
- ▶ Press button **↶** or **↷** repeatedly until the message Change-over Summer / Winter time appears in the multifunction display.

The selection marker is on the current setting.



- ▶ Press button **+** or **-** to select if the changeover between summer and winter time should be automatic or manual.

### Set the date (month)

This function can be seen in vehicles with audio system, or in vehicles with COMAND\* if the time synchronization with head unit\* feature was set to Off.



Vehicles with COMAND\*:  
For information on setting the date, refer to the separate COMAND operating instructions.

- ▶ Move the selection marker with button **+** or **-** to the Time/Date submenu.
- ▶ Press button **↶** or **↷** repeatedly until the message Date Set MM appears in the multifunction display.

The selection marker is on the month setting.



- ▶ Press button **+** or **-** to set the month.

### Control system

#### Set the date (day)

This function can be seen in vehicles with audio system, or in vehicles with COMAND\* if the time synchronization with head unit\* feature was set to Off.



Vehicles with COMAND\*:  
For information on setting the date, refer to the separate COMAND operating instructions.

- ▶ Move the selection marker with button **+** or **-** to the Time/Date submenu.
- ▶ Press button **↶** or **↷** repeatedly until the message **Date Set day** appears in the multifunction display.

The selection marker is on the day setting.



- ▶ Press button **+** or **-** to set the day.

#### Set the date (year)

This function can be seen in vehicles with audio system, or in vehicles with COMAND\* if the time synchronization with head unit\* feature was set to Off.



Vehicles with COMAND\*:  
For information on setting the date, refer to the separate COMAND operating instructions.

- ▶ Move the selection marker with button **+** or **-** to the Time/Date submenu.
- ▶ Press button **↶** or **↷** repeatedly until the message **Date Set YY** appears in the multifunction display.

The selection marker is on the year setting.



- ▶ Press button **+** or **-** to set the year.

### Lighting submenu

Access the Lighting submenu via the Settings menu. Use the Lighting submenu to change the lamp and lighting settings on your vehicle.

The following functions are available:

Function	Page
Set daytime running lamp mode (USA only)	149
Set locator lighting	150
Set night security illumination	151
Set interior lighting delayed shut-off	152

### Set daytime running lamp mode (USA only)



This function is not available in countries where the daytime running lamp mode is mandatory and therefore in a constant mode.

- ▶ Move the selection marker with button **+** or **-** to the Lighting submenu.
- ▶ Press button **↶** or **↷** repeatedly until the message Hd1 amp mode appears in the multifunction display. ▷▷

### Control system

- ▷▷ The selection marker is on the current setting.

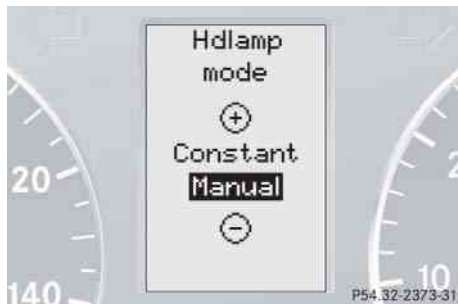

- ▶ Press button **+** or **-** to select manual operation (Manual) or daytime running lamp mode (Constant) activated.

With daytime running lamp mode activated and the exterior lamp switch in position **0** or **AUTO**, the low beam headlamps are switched on when the engine is running.

In low ambient light conditions the following lamps will switch on additionally:

- Parking lamps
- Tail lamps
- License plate lamps
- Side marker lamps

For more information on the daytime running lamp mode, see “Lighting” (▷ page 118).



For safety reasons, resetting the settings to factory settings (▷ page 140) while driving will not deactivate the daytime running lamp mode.

The following message appears in the multifunction display:

Lighting - Cannot be completely reset to factory sets. while driving.

### Set locator lighting



With the locator lighting feature activated and the exterior lamp switch in position **AUTO**, the following lamps will switch on during darkness when the vehicle is unlocked with the SmartKey:

- Parking lamps
- Tail lamps
- License plate lamps
- Side marker lamps
- Front fog lamps

The locator lighting switches off when the driver's door is opened.



If you do not open a door after unlocking the vehicle with the SmartKey, the lamps will switch off automatically after approximately 40 seconds.

- ▶ Move the selection marker with button **+** or **-** to the Lighting submenu.

- ▶ Press button  or  repeatedly until the message Surround lighting appears in the multifunction display.

The selection marker is on the current setting.



- ▶ Press button  or  to switch the locator lighting function On.
- ▶ Turn the exterior lamp switch to position **AUTO** when exiting the vehicle (▷ page 118).

The locator lighting feature is activated.

### Set night security illumination (Headlamps delayed shut-off)

Use this function to set whether or not the exterior lamps illuminate during darkness after exiting the vehicle and all doors closed.





With the delayed shut-off feature activated and the exterior lamp switch in position **AUTO** before the engine is turned off, the following lamps will switch on when the engine is turned off and remain lit for approximately 15 seconds:

- Parking lamps
- Tail lamps
- License plate lamps
- Side marker lamps
- Front fog lamps

If after turning off the engine you do not open a door or do not close an opened door, the lamps will automatically switch off after 60 seconds.



You can reactivate this function within 10 minutes by opening a door.

- ▶ Move the selection marker with button  or  to the Lighting submenu.
- ▶ Press button  or  repeatedly until the message Hd lamp delay off appears in the multifunction display.

The selection marker is on the current setting.





### Control system

▷▷ Press button **+** or **-** to switch the delayed shut-off feature off or on.

- ▶ Turn the exterior lamp switch to position **Auto** before turning off the engine (▷ page 118).

The headlamps delayed shut-off feature is activated.

You can temporarily deactivate the delayed shut-off feature:

- ▶ Before exiting the vehicle, turn the SmartKey in the starter switch to position **0**.
- ▶ Then turn it to position **2** and back to position **0**.

The delayed shut-off feature is deactivated. It will reactivate as soon as you reinsert the SmartKey in the starter switch.

### Set interior lighting delayed shut-off

Use this function to set whether or not the interior lighting to remains lit during darkness for approximately 10 seconds after you have removed the SmartKey from the starter switch.

- ▶ Move the selection marker with button **+** or **-** to the **Lighting** submenu.
- ▶ Press button **▲** or **▼** repeatedly until the message **Int. light delay off** appears in the multifunction display.

The selection marker is on the current setting.

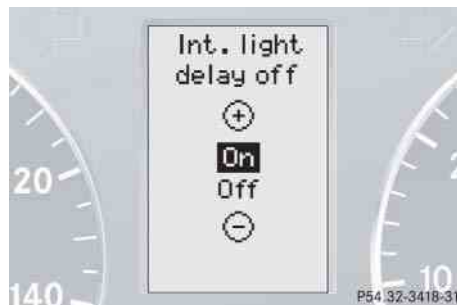

- ▶ Press button **+** or **-** to switch the delayed shut-off feature off or on.

### Vehicle submenu

Access the **Vehicle** submenu via the **Settings** menu. Use the **Vehicle** submenu to make general vehicle settings.



The following function is available:

Function	Page
Set automatic locking	152

### Set automatic locking

Use this function to activate or deactivate the automatic central locking. With the automatic central locking system activated, the vehicle is centrally locked at vehicle speeds of approximately 9 mph (15 km/h).

- ▶ Move the selection marker with button **+** or **-** to the **Vehicle** submenu.

- ▶ Press button  or  repeatedly until the message Automatic door lk. appears in the multifunction display.

The selection marker is on the current setting.



- ▶ Press button  or  to switch the automatic central locking On or Off.

### Convenience submenu

Access the Convenience submenu via the Settings menu. Use the Convenience submenu to change the settings for a number of convenience features.

The following functions are available:

Function	Page
Activate easy-entry/exit feature*	153
Set parking position* for exterior rear view mirror	154

### Activate easy-entry/exit feature\*

Use this function to activate and deactivate the easy-entry/exit feature (▷ page 42).

#### Warning!



You must make sure no one can become trapped or injured by the moving steering wheel when the easy-entry/exit feature is activated.

To cancel steering wheel movement, do one of the following:

- Move steering column stalk\* (▷ page 41).
- Press memory position switch\* (▷ page 116).

Do not leave children unattended in the vehicle, or with access to an unlocked vehicle. Children could open the driver's door and unintentionally activate the easy-entry/exit feature, which could result in an accident and/or serious personal injury.

### Control system

- ▶ Move the selection marker with button **+** or **-** to the Convenience submenu.
- ▶ Press button **↕** or **↔** repeatedly until the message **Easy-entry feature** appears in the multifunction display.

The selection marker is on the current setting.



- ▶ Press button **+** or **-** to switch the easy-entry feature On or Off.

#### **Set parking position\* for exterior rear view mirror**

Use the **Mirror set.** parking aid function to select whether the passenger-side exterior rear view mirror should be turned downward during parking maneuvers when reverse gear **R** is engaged. For additional information, see “Activating exterior rear view mirror parking position\*” (▷ page 172).

- ▶ Move the selection marker with button **+** or **-** to the Convenience submenu.

- ▶ Press button **↕** or **↔** repeatedly until the message **Mirror set.** parking aid appears in the multifunction display.

The selection marker is on the current setting.



- ▶ Press button **+** or **-** to switch function On or Off.





## Trip computer menu

Use the trip computer menu to call up statistical data on your vehicle.

The following information is available:

Function	Page
Fuel consumption statistics after start	155
Fuel consumption statistics since last reset	156
Distance to empty	156

## Fuel consumption statistics after start

- ▶ Press button  or  repeatedly until the first function of the trip computer menu appears in the multifunction display.
- ▶ Press button  or  repeatedly until the message *After start* appears in the multifunction display.

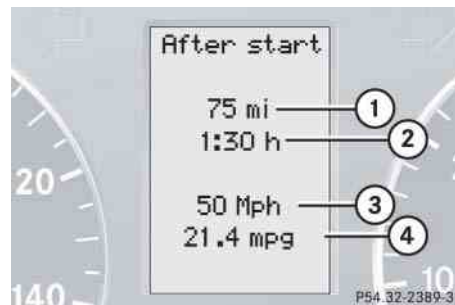

- ① Distance driven since start
- ② Time elapsed since start
- ③ Average speed since start
- ④ Average fuel consumption since start







All statistics stored since the last engine start will be reset approximately 4 hours after the SmartKey in the starter switch is turned to position **0** or removed from the starter switch.

Resetting will not occur if you turn the SmartKey back to position **1** or **2** within this time period.

### Control system



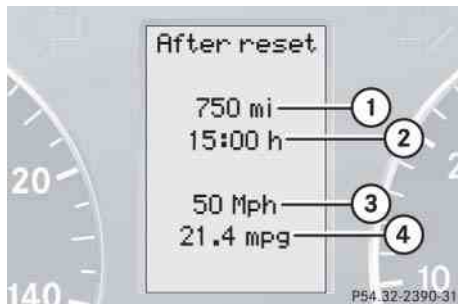

#### Fuel consumption since last reset

- ▶ Press button  or  repeatedly until the first function of the trip computer menu appears in the multifunction display.
- ▶ Press button  or  repeatedly until the message **After reset** appears in the multifunction display.







- ① Distance driven since last reset
- ② Time elapsed since last reset
- ③ Average speed since last reset
- ④ Average fuel consumption since last reset

#### Resetting fuel consumption statistics

- ▶ Press button  or  repeatedly until the first function of the trip computer menu appears in the multifunction display.
- ▶ Press button  or  repeatedly until the reading that you want to reset appears in the multifunction display.
- ▶ Press and hold the reset button in the instrument cluster (▷ page 127) until the value is reset to 0.

#### Distance to empty

- ▶ Switch on the ignition (▷ page 33).
- ▶ Press button  or  repeatedly until the first function of the trip computer menu appears in the multifunction display.
- ▶ Press button  or  repeatedly until the message **Distance** appears in the multifunction display.

The calculated range based on the current fuel tank level appears in the multifunction display.



### TEL menu\*

#### Warning!





A driver's attention to the road must always be his/her primary focus when driving. For your safety and the safety of others, we recommend that you pull over to a safe location and stop before placing or taking a telephone call. If you choose to use the telephone while driving, please use the hands-free device and only use the telephone when weather, road and traffic conditions permit.

Some jurisdictions prohibit the driver from using a cellular telephone while driving a vehicle.

Bear in mind that at a speed of just 30 mph (approximately 50 km/h), your vehicle is covering a distance of 44 feet (approximately 14 m) every second.

Never operate radio transmitters equipped with a built-in or attached antenna (i.e. without being connected to an external antenna) from inside the vehicle while the engine is running. Doing so could lead to a malfunction of the vehicle's electronic system, possibly resulting in an accident and personal injury.

You can use the functions in the TEL menu to operate your telephone, provided it is connected to a hands-free system and switched on.

- ▶ Switch on the telephone and Audio or COMAND\*.
- ▶ Press button  or  on the steering wheel repeatedly until the message TEL appears in the multifunction display.

Which messages will appear in the multifunction display depends on whether your telephone is switched on or off:

- If the telephone is off, the message `Phone off` appears in the multifunction display.
- If the telephone is on:

The telephone will then search for a network. During this time the multifunction display is empty.

As soon as the telephone has found a network, the message `READY` appears in the multifunction display.



This standby message indicates that your telephone is ready for use and you can operate it using the control system.

### Control system

#### Answering a call

When your telephone is ready to receive calls, you can answer a call at any time. In the multifunction display you will then see the message:



- ▶ Press button .

You have answered the call. The duration of the call appears in the multifunction display.





#### Ending a call

- ▶ Press button .

You have ended the call. The standby message appears in the multifunction display.



#### Dialing a number from the phone book

If your telephone is ready to receive calls, you may select and dial a number from the phone book at any time.

- ▶ Press button  or  repeatedly until the message TEL appears in the multifunction display.
- ▶ Press button  or .

The control system reads the phone book which is stored in the telephone. This may take up to 30 seconds. The message *Please wait* appears in the multifunction display.

When the message *Please wait* disappears, the phone book has been loaded.

- ▶ Press button  or  repeatedly until the desired name appears in the multifunction display.

The stored names are displayed in ascending or descending alphabetical order.

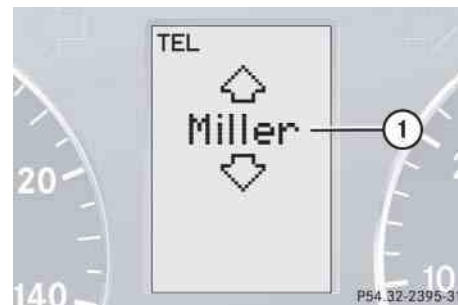

- ① Name from the phone book



If you press and hold button or for longer than 1 second, the system scrolls rapidly through the list of names until you release the button again.

Cancel the quick search mode by pressing button .

- ▶ Press button .

The system dials the selected phone number.

- If the connection is successful, the name of the party you called and the duration of the call will appear in the multifunction display.



- If no connection is made, the control system stores the dialed number in the redial memory.

### Redialing

The control system stores the most recently dialed phone numbers. This eliminates the need to search through your entire phone book.

- ▶ Press button or repeatedly until the message TEL appears in the multifunction display.

- ▶ Press button .

The first number in the redial memory appears in the multifunction display.

- ▶ Press button or repeatedly until the desired name appears in the multifunction display.

- ▶ Press button .

The control system dials the selected phone number.



### Manual transmission

Manual transmission is standard equipment on select models and not available on all models.

For information on driving with a manual transmission, see “Manual transmission” (▷ page 48).

#### Warning!



For vehicles equipped with a manual transmission, getting out of your vehicle with the gearshift lever not engaged in first or reverse gear and parking brake engaged is dangerous.

Also, when parked on an incline, an engaged first or reverse gear alone may not prevent your vehicle from moving, possibly hitting people or objects.

Always set the parking brake in addition to engaging first or reverse gear (▷ page 58).

When parked on an incline, turn front wheels towards the road curb.

Do not park this vehicle in areas where combustible materials such as grass, hay or leaves can come into contact with the hot exhaust system, as these materials could be ignited and cause a vehicle fire.

#### Warning!



When leaving the vehicle, always remove the SmartKey from the starter switch, take it with you, and lock the vehicle. Do not leave children unattended in the vehicle, or with access to an unlocked vehicle. Children could move the gearshift lever, which could result in an accident and/or serious injury.

#### Warning!



On slippery road surfaces, never downshift in order to obtain braking action. This could result in drive wheel slip and reduced vehicle control. Your vehicle's ABS will not prevent this type of loss of control.



**Gearshift pattern for manual transmission**



When you are shifting into the **5th** or **6th** gear, make sure that you press the gearshift lever to the right. Otherwise, you could accidentally shift into the **3rd** or **4th** gear and damage the transmission.

Downshifting gears leading to overrevving the engine can result in engine damage that is not covered by the Mercedes-Benz Limited Warranty.

Never hold the vehicle stopped on a hill by using the clutch pedal. The clutch may be damaged which is not covered by the Mercedes-Benz Limited Warranty.

Do not exceed the engine speed limits. Refer to tachometer (▷ page 129) for engine speeds.

### Shifting into reverse



Only shift into reverse gear **R** when the vehicle is stationary, as the transmission could otherwise be damaged.

- ▶ Stop the vehicle completely.
- ▶ Fully depress clutch pedal.
- ▶ Move the gearshift lever to neutral position (no gear selected).
- ▶ Move the gearshift lever to the left until you feel a certain resistance.
- ▶ Push the gearshift lever past this resistance.
- ▶ Then move the gearshift lever forward into position **R**.

### Automatic transmission\*

Automatic transmission is standard equipment on select models and available as optional equipment on select other models.

For more information on driving with an automatic transmission see “Automatic transmission\*” (▷ page 49).

Your vehicle’s transmission adapts its gear shifting process to your individual driving style by continually adjusting the shift points up or down. These shift point adjustments are performed based on current operating and driving conditions.

If the operating conditions change, the automatic transmission reacts by adjusting its shift program.



During the brief warm-up, transmission upshifting is delayed. This allows the catalytic converter to heat up more quickly to operating temperature.

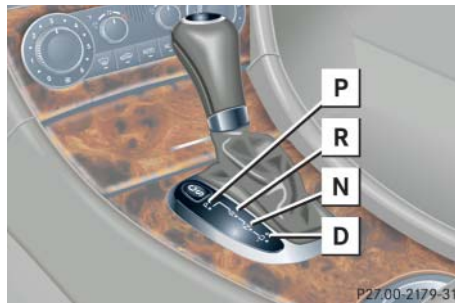

**Gearshift pattern for automatic transmission**

The automatic transmission selects individual gears automatically, depending on:

- the gear selector lever position **D** (▷ page 164) with gear ranges (▷ page 166)
- the selected program mode (**C/S**) (▷ page 167)
- the position of the accelerator pedal (▷ page 165)
- the vehicle speed



- ① Current gear range/gear selector lever position
- ② Current program mode

The current gear range/gear selector lever position and program mode (C/S) appear in the multifunction display.

An additional indication of the current gear selector lever position can be found on the cover of the shifting-gate.

The indicators come on when you activate a switch (e.g. unlocking the vehicle or opening a door) and go out after approximately 15 minutes.

#### Warning!



It is dangerous to shift the gear selector lever out of **P** or **N** if the engine speed is higher than idle speed. If your foot is not firmly on the brake pedal, the vehicle could accelerate quickly forward or reverse. You could lose control of the vehicle and hit someone or something. Only shift into gear when the engine is idling normally and when your right foot is firmly on the brake pedal.



Allow engine to warm up under low load use. Do not place full load on the engine until the operating temperature has been reached.

Shift into reverse gear **R** or parking position **P** only when the vehicle is stopped.

Avoid spinning of a drive wheel for an extended period when driving off on slippery road surfaces. This may cause serious damage to the drivetrain which is not covered by the Mercedes-Benz Limited Warranty.

When the gear selector lever is in position **D**, you can influence transmission shifting by:

- limiting the gear range
- changing gears manually

### Automatic transmission\*

#### Gear selector lever position

	Effect
<b>P</b>	<p><b>Park position</b></p> <p>Gear selector lever position when the vehicle is parked. Place gear selector lever in position <b>P</b> only when vehicle is stopped. The park position is not intended to serve as a brake when the vehicle is parked. Rather, the driver should always set the parking brake in addition to placing the gear selector lever in position <b>P</b> to secure the vehicle.</p>

	Effect
	<p>The SmartKey can only be removed from the starter switch with the gear selector lever in position <b>P</b>. With the SmartKey removed, the gear selector lever is locked in position <b>P</b>.</p> <p>If the vehicle's electrical system is malfunctioning, the gear selector lever could remain locked in position <b>P</b> (▷ page 392).</p>
<b>R</b>	<p><b>Reverse gear</b></p> <p>Place gear selector lever in position <b>R</b> only when vehicle is stopped.</p>

	Effect
<b>N</b>	<p><b>Neutral</b></p> <p>No power is transmitted from the engine to the drive axle. When the brakes are released, the vehicle can be moved freely (pushed or towed).</p> <p>To avoid damage to the transmission, never engage <b>N</b> while driving.</p> <p>If the ESP® is deactivated or malfunctioning: Move gear selector lever to <b>N</b> only if the vehicle is in danger of skidding, e.g. on icy roads.</p>
<b>D</b>	<p><b>Drive</b></p> <p>The transmission shifts automatically. All forward gears are available.</p>



Coasting the vehicle, or driving for any other reason with gear selector lever in **N** can result in transmission damage that is not covered by the Mercedes-Benz Limited Warranty.

### Warning!



Getting out of your vehicle with the gear selector lever not fully engaged in position **P** is dangerous. Also, position **P** alone is not intended to or capable of preventing your vehicle from moving, possibly hitting people or objects.

Always set the parking brake in addition to shifting to position **P** (▷ page 58).

When parked on an incline, turn the front wheels towards the road curb.

Do not park this vehicle in areas where combustible materials such as grass, hay or leaves can come into contact with the hot exhaust system, as these materials could be ignited and cause a vehicle fire.

### Warning!



When leaving the vehicle, always remove the SmartKey from the starter switch, take it with you, and lock the vehicle. Do not leave children unattended in the vehicle, or with access to an unlocked vehicle. Children could move the gear selector lever from position **P**, which could result in an accident and/or serious personal injury.

## Driving tips

### Accelerator position

Your driving style influences the transmission's shifting behavior:

Less throttle	Earlier upshifting
More throttle	Later upshifting

### Kickdown

Use kickdown when you want maximum acceleration.

- ▶ Press the accelerator past the point of resistance.  
The transmission shifts into a lower gear.
- ▶ Ease on the accelerator when you have reached the desired speed.  
The transmission shifts up again.

### Automatic transmission\*

#### Stopping

When you stop briefly, e.g. at traffic lights:

- ▶ Leave the transmission in gear.
- ▶ Hold the vehicle with the brake.

When you stop longer with the engine idling and/or on an hill:

- ▶ Set the parking brake.
- ▶ Move the gear selector lever to position **P**.

#### Maneuvering

When you maneuver in tight areas, e.g. when pulling into a parking space:

- ▶ Control the vehicle speed by gradually releasing the brakes.
- ▶ Accelerate gently.
- ▶ Never abruptly step on the accelerator.

#### Working on the vehicle

##### Warning!



When working on the vehicle, set the parking brake and move gear selector lever to position **P**. Otherwise the vehicle could roll away.

#### Gear ranges

With the gear selector lever in position **D**, you can select a gear range for the automatic transmission to operate within.

You can limit the gear range by pressing the gear selector lever to the left (**D-**), and reverse the gear range limit by pressing the gear selector lever to the right (**D+**).

The selected gear range appears in the multifunction display (▷ page 163). If you press on the accelerator when the engine has reached its rpm limit, the transmission will upshift beyond any gear range limit selected.

	Effect
<b>6</b>	The transmission shifts through sixth gear only (applies to vehicles with 7-speed automatic transmission only).
<b>5</b>	The transmission shifts through fifth gear only (applies to vehicles with 7-speed automatic transmission only).
<b>4</b>	The transmission shifts through fourth gear only.
<b>3</b>	The transmission shifts through third gear only.  With this selection you can use the braking effect of the engine.

	Effect
<b>2</b>	The transmission shifts through second gear only.  Allows the use of engine's braking power when driving: <ul style="list-style-type: none"> <li>• on steep downgrades</li> <li>• in mountainous regions</li> <li>• under extreme operating conditions</li> </ul>
<b>1</b>	The transmission operates in first gear only.  For maximum use of engine's braking effect on very steep or lengthy downgrades.

### Automatic shift program

The program mode selector switch is located on the lower part of the center console.

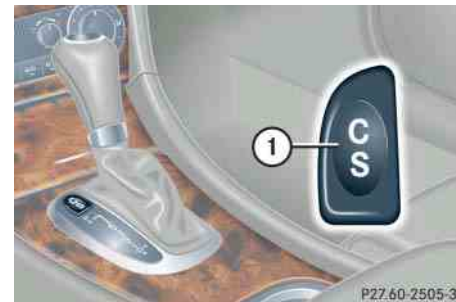

① Program mode selector switch

**C** Comfort      For comfort driving

**S** Sport      For standard driving

The current gear selector lever position and the selected program mode (C/S) are indicated in the multifunction display (▷ page 163).



### Automatic transmission\*



Never change the program mode when the gear selector lever is out of position **P**. This could result in a change of driving characteristics for which you may not be prepared.



The last selected program mode (**C** or **S**) is switched on when the engine is restarted.

- ▶ Press program mode selector switch ① repeatedly until the letter of the desired program mode appears in the multifunction display.

Select **C** for comfort driving:

- The vehicle starts out in second gear (both forward and reverse) for gentler starts. This does not apply if full throttle is applied or gear range **1** is selected.
- Traction and driving stability are improved on icy roads.
- Upshifts occur earlier even when you give more gas. The engine then operates at lower rpms and the wheels are less likely to spin.

### One-touch gearshifting

Even with an automatic transmission, you can change the gears manually and limit or extend the gear range for automatic shifting with the gear selector lever in position **D**.



Allow engine to warm up under low load use. Do not place full load on the engine until the operating temperature has been reached.

Shift into reverse gear **R** or parking position **P** only when the vehicle is stopped.

Avoid spinning of a drive wheel for an extended period when driving off on slippery road surfaces. This may cause serious damage to the drivetrain which is not covered by the Mercedes-Benz Limited Warranty.

## Downshifting

### Warning!



On slippery road surfaces, never downshift in order to obtain braking action. This could result in drive wheel slip and reduced vehicle control. Your vehicle's ABS will not prevent this type of loss of control.

- ▶ Briefly press the gear selector lever to the left in the **D-** direction.

The transmission will shift from the current gear to the next lower gear as permitted by the shift program. This action simultaneously limits the gear range of the transmission (▷ page 166).



To avoid overrevving the engine when the gear selector lever is moved to the **D-** direction, the transmission will not shift to a lower gear if the engine's max. speed would be exceeded.

## Upshifting

- ▶ Briefly press the gear selector lever to the right in the **D+** direction.

The transmission will shift from the current gear to the next higher gear as permitted by the shift program. This action simultaneously extends the gear range of the transmission.

### Canceling gear range limit

- ▶ Press and hold the gear selector lever in the **D+** direction until **D** reappears in the multifunction display.

The transmission will shift from the current gear range directly to gear range **D**.

### Shifting into optimal gear range

- ▶ Press and hold the gear selector lever in the **D-** direction.

The transmission will automatically select the gear range suited for optimal acceleration and deceleration. This may involve shifting down one or more gears.

## Emergency operation (Limp Home Mode)

If vehicle acceleration worsens or the transmission no longer shifts, the transmission is most likely operating in limp home (emergency operation) mode. In this mode only second gear and reverse gear can be activated.

- ▶ Stop the vehicle in a safe location.
- ▶ Move gear selector lever to **P**.
- ▶ Turn off the engine.
- ▶ Wait at least 10 seconds before restarting.
- ▶ Restart the engine.
- ▶ Move gear selector lever to position **D** (for second gear) or **R**.
- ▶ Have the transmission checked at an authorized Mercedes-Benz Center as soon as possible.

### Good visibility

For information on the windshield wipers, see “Windshield wipers” (▷ page 53).

#### Headlamp cleaning system\*

The button is located on the left side of the dashboard.



#### ① Headlamp washer button

- ▶ Switch on the ignition (▷ page 33).
- ▶ Press button ①.

The headlamps are cleaned with a high-pressure water jet.



The headlamps will automatically be cleaned when you have

- switched on the headlamps and
- operated the windshield wipers with windshield washer fluid 15 times

When you switch off the ignition, the counter resets.

For information on filling up the washer reservoir, see “Windshield washer system and headlamp cleaning system\*” (▷ page 303).

#### Rear view mirrors

For more information on setting the rear view mirrors, see “Mirrors” (▷ page 43).

#### Interior rear view mirror, antiglare position



#### ① Lever

- ▶ Tilt the mirror to the antiglare night position by moving lever ① towards the windshield.

The interior rear view mirror is dimmed.

### Auto-dimming rear view mirrors\*

The reflection brightness of the exterior rear view mirror on the driver's side and the interior rear view mirror will respond automatically to glare when

- the ignition is switched on and
- incoming light from headlamps falls on the sensor in the interior rear view mirror.

The rear view mirror will not react if

- reverse gear **R** is engaged
- the interior lighting is turned on

#### Warning!



The auto-dimming function does not react if incoming light is not aimed directly at sensors in the interior rear view mirror.

The interior rear view mirror and the exterior rear view mirror on the driver's side do not react, for example, if the rear window sunshade\* is in raised position.

Glare can endanger you and others.

#### Warning!



In case of an accident, liquid electrolyte may escape from the mirror housing if the mirror glass breaks.

Electrolyte has an irritating effect. Do not allow the liquid to come into contact with eyes, skin, clothing, or respiratory system. In case it does, immediately flush affected area with water, and seek medical help if necessary.



Electrolyte drops coming into contact with the vehicle paint finish can be completely removed only while in the liquid state and by applying plenty of water.

#### Warning!



Exercise care when using the passenger-side exterior rear view mirror. The mirror surface is convex (outwardly curved surface for a wider field of view). Objects in mirror are closer than they appear. Check your interior rear view mirror or glance over your shoulder before changing lanes.

### Good visibility

#### Activating exterior rear view mirror parking position\*

Follow these steps to activate the mirror parking position so that the passenger-side exterior rear view mirror will be turned downward during parking maneuvers to the stored position.

The buttons are located above the exterior lamp switch.



- ① Driver's side exterior rear view mirror button
- ② Passenger-side exterior rear view mirror button

- ▶ Switch on the ignition (▷ page 33).
- ▶ Store a parking position for the passenger-side exterior rear view mirror (▷ page 117).
- ▶ Switch the *Mirror set. parking aid* function in the *Convenience* submenu of the control system to *On* (▷ page 154).
- ▶ Press button ② for the passenger-side exterior rear view mirror.
- ▶ Place the gear selector lever in reverse gear **R**.

The passenger-side exterior rear view mirror turns downwards to the stored position.

The passenger-side exterior rear view mirror returns to its previously stored driving position:

- 10 seconds after you put the gear selector lever out of position **R**
- immediately once your vehicle exceeds a speed of approximately 6 mph (10 km/h)
- immediately when you press button ① for the driver's side exterior rear view mirror

### Sun visors

The sun visors protect you from sun glare while driving.

#### Warning!



Do not use the vanity mirror while driving.

Keep the mirrors in the sun visors closed while vehicle is in motion. Reflected glare can endanger you and others.

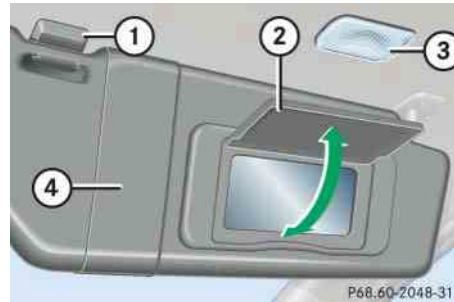

- ① Mounting
- ② Mirror cover
- ③ Mirror lamp
- ④ Sun visor

- ▶ Swing sun visor ④ down when you experience glare.
- ▶ To use illuminated mirror, lift up mirror cover ②.

#### i

If sun visor ④ is disengaged from mounting ① with mirror cover ② open, mirror lamp ③ will switch off.

#### i

If sunlight enters through a side window, close mirror cover ② (if open), disengage sun visor ④ from mounting ① and pivot to the side.

### Good visibility

#### Rear window sunshade\*

##### Warning!



When operating the rear window sunshade, make sure there is no danger of anyone being harmed by the raising or lowering procedure.

The raising or lowering procedure can be immediately halted by briefly pressing the switch.

Briefly press switch again to raise or lower the rear window sunshade completely.

##### Warning!



When leaving the vehicle, always remove the SmartKey from the starter switch, take it with you, and lock the vehicle. Do not leave children unattended in the vehicle, or with access to an unlocked vehicle. Unsupervised use of vehicle equipment can cause an accident and/or serious personal injury.

The switch is located in the center console.



① Rear window sunshade switch



Make sure that the movement of the rear window sunshade is not restricted by objects on the rear window shelf. Otherwise, the sunshade or the objects could be damaged.

- ▶ Switch on the ignition (▷ page 33).

Always raise or lower the sunshade fully for its support against the window frame.

#### Raising the sunshade

- ▶ Press switch ① briefly.

The sunshade is raised completely.

#### Stopping the raising procedure

- ▶ Press switch ① again.

The sunshade stops.

#### Lowering the sunshade

- ▶ Press switch ① briefly.

The sunshade is lowered completely.

#### Stopping the lowering procedure

- ▶ Press switch ① again.

The sunshade stops.

## Rear window defroster

The rear window defroster uses a large amount of power. To keep the battery drain to a minimum, switch off the defroster as soon as the rear window is clear.



The defroster is automatically deactivated after approximately 6 to 17 minutes of operation depending on the outside temperature.

### Warning!



Any accumulation of snow and ice should be removed from the rear window before driving. Visibility could otherwise be impaired, endangering you and others.

## Activating

- ▶ Press button  or  in the climate control panel (▷ page 177) or automatic climate control panel\* (▷ page 187).

The indicator lamp on the button comes on.

## Deactivating

- ▶ Press button  or  again.

The indicator lamp on the button goes out.



If the rear window defroster switches off too soon and the indicator lamp starts flashing, this means that too many electrical consumers are operating simultaneously and there is insufficient voltage in the battery. The system responds automatically by deactivating the rear window defroster.

As soon as the battery has sufficient voltage, the rear window defroster automatically turns itself back on.



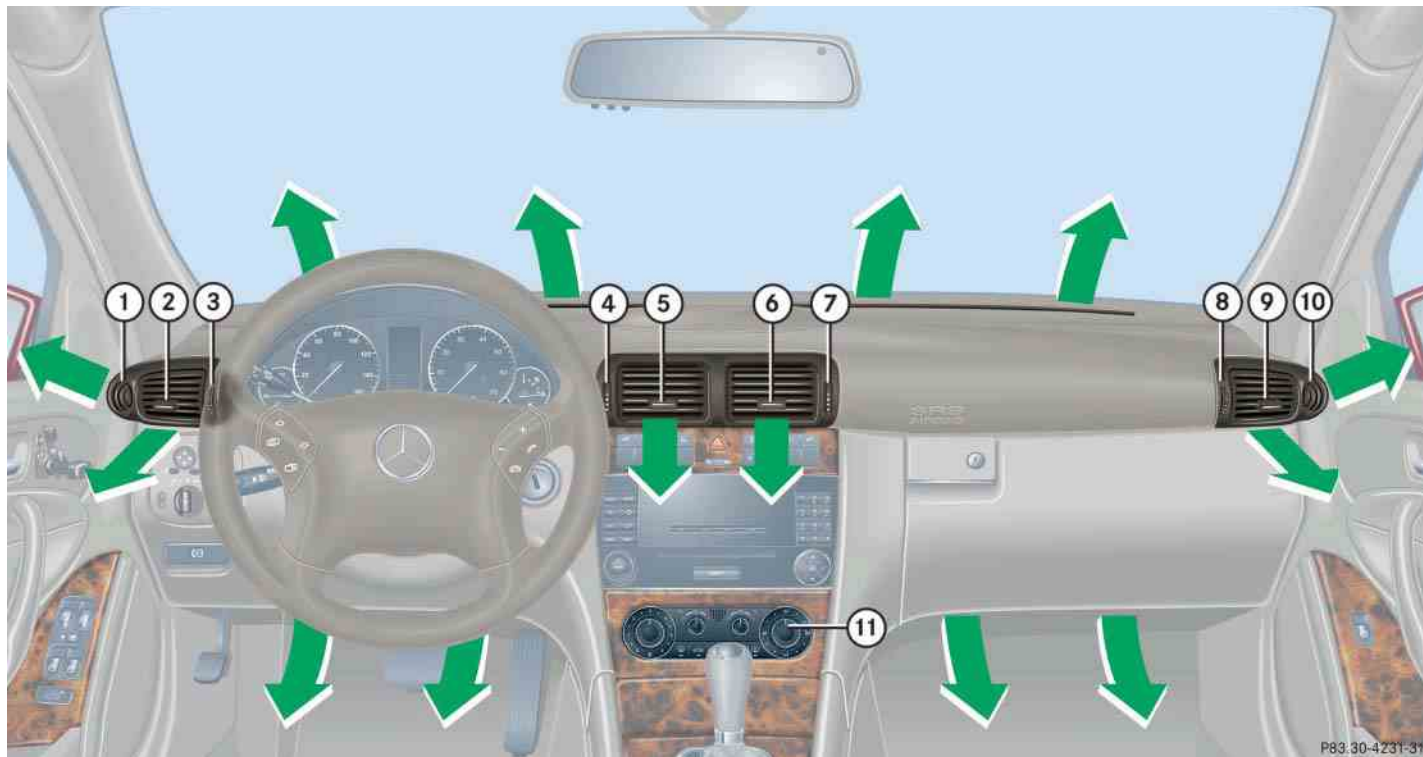

Item
① Left side defroster vent, fixed
② Left side air vent, adjustable
③ Thumbwheel for air volume control for left side air vent
④ Thumbwheel for air volume control for left center air vent
⑤ Left center air vent, adjustable
⑥ Right center air vent, adjustable
⑦ Thumbwheel for air volume control for right center air vent
⑧ Thumbwheel for air volume control for right side air vent
⑨ Right side air vent, adjustable
⑩ Right side defroster vent, fixed
⑪ Climate control panel



Climate control panel (USA only)



Climate control panel (Canada only)

Item
① Air volume control
② Left side temperature control
③ Right side temperature control
④ Air distribution control
⑤ Rear window defroster
⑥ AC cooling on/off
⑦ Air distribution and air volume (automatic mode)
⑧ Air recirculation
⑨ Front defroster



For draft-free ventilation, move the sliders for the air vents ②, ⑤, ⑥, and ⑨ to the middle position.

### Climate control

The climate control is operational whenever the engine is running. You can operate the climate control system in either the automatic or manual mode. The system cools or heats the interior depending on the selected interior temperature and the current outside temperature.

#### Warning!



When operating the climate control, the air that enters the passenger compartment through the air vents can be very hot or very cold (depending on the set temperature). This may cause burns or frostbite on unprotected skin in the immediate area of the air vents. Always keep sufficient distance between unprotected parts of the body and the air vents. If necessary, use the air distribution control (▷ page 180) to direct the air to air vents in the vehicle interior that are not in the immediate area of unprotected skin.

Nearly all dust particles, pollutants and odors are filtered out before outside air enters the passenger compartment through the air distribution system.

The air conditioning will not engage (no cooling) if the mode **A/C** is deactivated (▷ page 183).

#### Warning!



Follow the recommended settings for heating and cooling given on the following pages. Otherwise the windows could fog up, impairing visibility and endangering you and others.



Severe conditions (e.g. strong air pollution) may require replacement of the filter before its scheduled interval. A clogged filter will reduce the air volume to the interior.

If the vehicle interior is hot, ventilate the interior before driving off, see “Summer opening feature” (▷ page 243). The climate control will then adjust the interior temperature to the set value much faster.

Keep the air intake grille in front of the windshield free of snow and debris.

Do not obstruct air flow by placing objects on the air flow-through exhaust slots below the rear window.

## Deactivating the climate control system

### Deactivating

- ▶ Set air volume control ① (▷ page 177) to position **0**.



When the climate control system is deactivated, the outside air supply and circulation are also deactivated. Only choose this setting for a short time. Otherwise the windows could fog up.

### Reactivating

- ▶ Set air volume control ① (▷ page 177) to any speed.

## Operating the climate control system in automatic mode



When operating the climate control system in automatic mode, you will only rarely need to adjust the temperature, air volume and air distribution.

In automatic mode, cooling with dehumidify is switched on. This function can be switched off if necessary.

### Activating

- ▶ Press button **AUTO** (▷ page 177) while the engine is running.

The indicator lamp on the button comes on. The air volume and air distribution are adjusted automatically.

- ▶ Use temperature controls ② and ③ (▷ page 177) to separately adjust the air temperature on each side of the passenger compartment.

The temperature of the vehicle interior is adjusted automatically.

### Deactivating

- ▶ Press button **AUTO** (▷ page 177) again.

The indicator lamp on the button goes out. The automatic operation of air volume and air distribution switches off.

### Climate control

#### Setting the temperature

Use temperature controls ② and ③ (▷ page 177) to separately adjust the air temperature on each side of the passenger compartment. You should raise or lower the temperature setting in small increments, preferably starting at 72°F (22°C). The climate control will adjust to the set temperature as fast as possible.

#### Increasing

- ▶ Turn temperature control ② and/or ③ (▷ page 177) slightly clockwise.

The climate control system will correspondingly adjust the interior air temperature.





#### Decreasing

- ▶ Turn temperature control ② and/or ③ (▷ page 177) slightly counterclockwise.

The climate control system will correspondingly adjust the interior air temperature.

#### Adjusting air distribution and volume

Use air distribution control ④ (▷ page 177) to adjust the air distribution. The following symbols are located on the controls:

Symbol	Function
	Directs air through the center, side and rear passenger compartment air vents
	Directs air to the windshield and the side defroster vents
	Directs air into the entire vehicle interior
	Directs air to the footwells

- ▶ Press button **AUTO** (▷ page 177).

The indicator lamp on the button goes out. The automatic air distribution is switched off. The air distribution is controlled according to the selected control setting.

- ▶ Turn air distribution control ④ (▷ page 177) to the desired symbol.

#### Opening center and side air vents

- ▶ Turn thumbwheels ③, ④, ⑦ and ⑧ (▷ page 176) upward.

The center air vents ⑤ and ⑥ and side air vents ② and ⑨ are open.

#### Closing center and side air vents

- ▶ Turn thumbwheels ③, ④, ⑦ and ⑧ (▷ page 176) downward.

The center air vents ⑤ and ⑥ and side air vents ② and ⑨ are closed.

## Adjusting air volume

Six blower speeds are available.

- ▶ Press button **AUTO** (▷ page 177).

The indicator lamp in the button goes out. The automatic air volume control is switched off. The air volume is adjusted according to the currently selected setting.

- ▶ Use the air volume control ④ (▷ page 177) to adjust the air volume.



## Front defroster

You can use this setting to defrost the windshield, for example if it is iced up. You can also defog the windshield and the side windows.



Keep this setting selected only until the windshield or the side windows are clear again.

## Activating



- ▶ Press button  or  (▷ page 177).

The indicator lamp on the button comes on.

The air conditioning switches automatically to the following functions:

- maximum blowing and heating power
- air flows onto the windshield and the front side windows
- the air recirculation mode is switched off

## Deactivating

- ▶ Press button  or  (▷ page 177) again.

The indicator lamp on the button goes out. Defrosting is turned off.



The cooling remains switched on.

## Windshield fogged on the outside





Keep this setting selected only until the windshield is clear again.

- ▶ Switch the windshield wipers on (▷ page 53).
- ▶ Press button **AUTO** (▷ page 177).

The indicator lamp on the button comes on. Air distribution and air volume are adjusted automatically.

If the automatic mode of the climate control is switched off:

- ▶ Turn air distribution control ④ to  or  (▷ page 177).



### Climate control

#### Air recirculation mode

Switch to air recirculation mode to prevent unpleasant odors from entering the vehicle from the outside (e.g. before driving through a tunnel). This setting cuts off the intake of outside air and recirculates the air in the passenger compartment.

#### Warning!



Fogged windows impair visibility, endangering you and others. If the windows begin to fog on the inside, switching off the air recirculation mode immediately should clear interior window fogging. If interior window fogging persists, make sure the air conditioning (▷ page 183) is activated, or press button  or .

#### Activating

- ▶ Press button  (▷ page 177).

The indicator lamp on the button comes on.



The air recirculation mode is activated automatically at high outside temperatures.

The indicator lamp on button  is not lit when the air recirculation mode is automatically switched on.

A quantity of outside air is added after approximately 30 minutes.

#### Warning!





Never operate the side windows and the tilt/sliding sunroof\* if there is the possibility of anyone being harmed by the closing procedure.

In the event that the closing procedure causes potential danger, the closing of the side windows can be immediately halted by pressing or pulling the respective window switch. The closing of the tilt/sliding sunroof\* can be immediately halted by moving the tilt/sliding sunroof\* switch in the overhead control panel in any direction.

The closing of the side windows and tilt/sliding sunroof\* can be reversed by again pressing and holding the  button.



Press and hold button  for approx. 2 seconds. The side windows and tilt/sliding sunroof\* will close. You can release button  once the closing procedure has begun. The windows and tilt/sliding sunroof\* continue closing until they are fully closed.

## Deactivating

- Press button  (▷ page 177).



The indicator lamp on the button goes out.





The air recirculation mode is deactivated automatically:

- after 5 minutes if the outside temperature is below approximately 41°F (5°C)
- after 5 minutes if the air conditioning is turned off
- after 30 minutes if the outside temperature is above approximately 41°F (5°C)



Press and hold button  for approx. 2 seconds. The side windows and or tilt/sliding sunroof\* will return to their previous position. You can release button  once the opening procedure has begun. The windows and tilt/sliding sunroof\* continue opening until they have reached their previous position.

A window or tilt/sliding sunroof\* will only return to its previous position if it has not been moved to another position using the respective window switch or tilt/sliding sunroof\* switch after it was closed with button . A window or tilt/sliding sunroof\* that was moved will remain in its current position if button  is used to re-open the remaining windows or tilt/sliding sunroof\*.

## Air conditioning

The cooling function, only operational when the engine is running, cools the vehicle interior down to the selected temperature. The cooling function also dehumidifies the air in the vehicle interior, thus preventing the windows from fogging up.



Condensation may drip out from underneath the vehicle. This is normal and not an indication of a malfunction.

### Warning!



If you turn off the cooling function, the vehicle will not be cooled when weather conditions are warm. The windows can fog up more quickly. Window fogging may impair visibility and endanger you and others.



### Climate control

#### Deactivating

It is possible to deactivate the air conditioning (cooling) function of the climate control system. The air in the vehicle will then no longer be cooled or dehumidified.

- ▶ Press button  (▷ page 177).

The indicator lamp on the button goes out.

The cooling function switches off after a short delay.

#### Activating

Moist air can fog up the windows. You can dehumidify the air with the air conditioning.

- ▶ Press button  (▷ page 177).

The indicator lamp on the button comes on.

The air conditioning uses the refrigerant R134a. This refrigerant is free of CFCs which are harmful to the ozone layer.



If the air conditioning cannot be turned on again, this indicates that the air conditioning is losing refrigerant. The compressor has turned itself off.

Have the air conditioning checked at the nearest authorized Mercedes-Benz Center.

#### Rear passenger compartment adjustable air vents

The air conditioning for the rear passenger compartment is controlled via the climate control panel (▷ page 177).



The temperature at the center air vents for the rear passenger compartment ① and ③ is the same as at the dashboard center air vents.

The air vents for the rear passenger compartment are located in the rear center console.



- ① Left center air vent
- ② Thumbwheel for air volume control for center air vents
- ③ Right center air vent

### Adjusting air distribution

- ▶ Push the slide for the left center vent ① or right center vent ③ to the left, right, up, or down.

The air flow is directed in the corresponding direction.



For draft-free ventilation, push slides ① and ③ upward.

### Adjusting air volume

- ▶ Turn thumbwheel ② up or down.

The air volume is increased or decreased.

### Automatic climate control\* (Canada only)

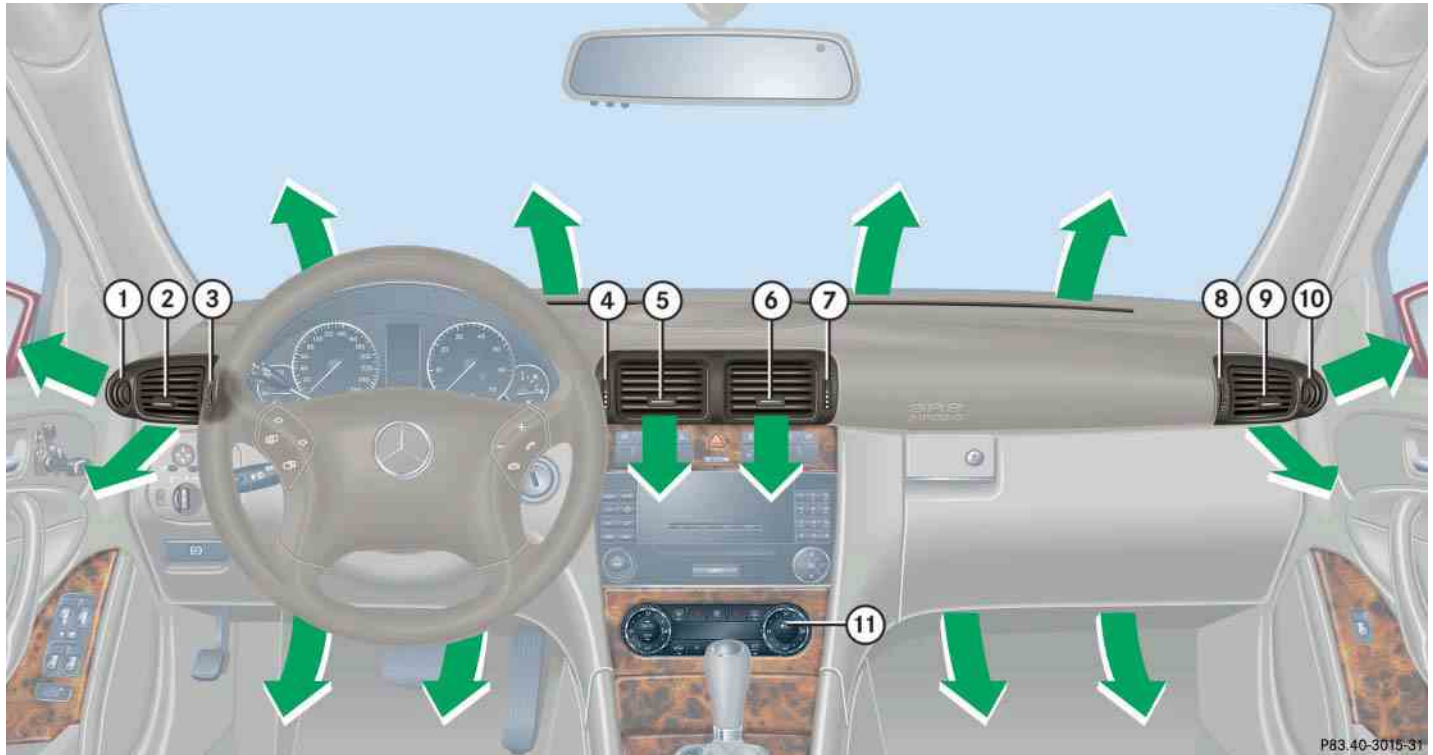

## Automatic climate control\* (Canada only)

Item
① Left side defroster vent, fixed
② Left side air vent, adjustable
③ Thumbwheel for air volume control for left side air vent
④ Thumbwheel for air volume control for left center air vent
⑤ Left center air vent, adjustable
⑥ Right center air vent, adjustable
⑦ Thumbwheel for air volume control for right center air vent
⑧ Thumbwheel for air volume control for right side air vent
⑨ Right side air vent, adjustable
⑩ Right side defroster vent, fixed
⑪ Automatic climate control panel



Automatic climate control panel

Item
① Left side air distribution control
② Front defroster
③ Temperature control, left, raising
④ Display
⑤ Air volume control, raising
⑥ Temperature control, right, raising
⑦ Rear window defroster
⑧ Right side air distribution control
⑨ Charcoal filter
⑩ AC cooling on/off Residual heat/ventilation
⑪ Temperature control, right, lowering
⑫ Air volume control, lowering
⑬ Temperature control, left, lowering
⑭ Air recirculation
⑮ Automatic climate control on/off (complete system)
⑯ Air distribution and air volume (automatic mode)



For draft-free ventilation, move the sliders for the air vents ②, ⑤, ⑥, and ⑨ to the middle position.

### Automatic climate control\* (Canada only)

The automatic climate control is operational whenever the engine is running. You can operate the climate control system in either the automatic or manual mode. The system cools or heats the interior depending on the selected interior temperature and the current outside temperature.

#### Warning!



When operating the automatic climate control, the air that enters the passenger compartment through the air vents can be very hot or very cold (depending on the set temperature). This may cause burns or frostbite on unprotected skin in the immediate area of the air vents. Always keep sufficient distance between unprotected parts of the body and the air vents. If necessary, use the air distribution control (▷ page 190) to direct the air to air vents in the vehicle interior that are not in the immediate area of unprotected skin.

Nearly all dust particles, pollutants and odors are filtered out before outside air enters the passenger compartment through the air distribution system.

The air conditioning will not engage (no cooling) if the mode **A/C** is deactivated (▷ page 196).

#### Warning!



Follow the recommended settings for heating and cooling given on the following pages. Otherwise the windows could fog up, impairing visibility and endangering you and others.



Severe conditions (e.g. strong air pollution) may require replacement of the filter before its scheduled interval. A clogged filter will reduce the air volume to the interior.

If the vehicle interior is hot, ventilate the interior before driving off, see “Summer opening feature” (▷ page 243). The automatic climate control will then adjust the interior temperature to the set value much faster.

Keep the air intake grille in front of the windshield free of snow and debris.

Do not obstruct air flow by placing objects on the air flow-through exhaust slots below the rear window.

## Automatic climate control\* (Canada only)

### Deactivating the automatic climate control system

#### Deactivating

- ▶ Press button **OFF** (▷ page 187).

The indicator lamp on the button comes on.

The automatic climate control system is deactivated.



When the air conditioning is switched off, the outside air supply and circulation are also switched off. Only choose this setting for a short time. Otherwise the windows could fog up.

#### Reactivating

- ▶ Press button **OFF** (▷ page 187).

The indicator lamp on the button goes out.

### Operating the climate control system in automatic mode



When operating the automatic climate control system in automatic mode, you will only rarely need to adjust the temperature, air volume and air distribution.

In automatic mode, cooling with dehumidify is switched on. This function can be switched off if necessary.



The automatic climate control system can be switched on or off separately for the left and right sides of the passenger compartment, as required.

### Activating

- ▶ Press button **AUTO** (▷ page 187) while the engine is running.

The indicator lamp on the button comes on. The air volume and air distribution are adjusted automatically.

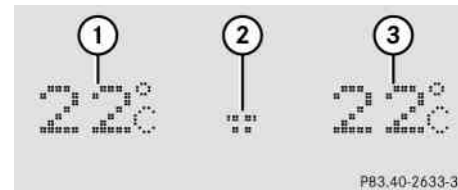

- ① Temperature, left
  - ② Blower speed
  - ③ Temperature, right
- ▶ Use temperature controls ③ and ⑬ or ⑥ and ⑪ (▷ page 187) to separately adjust the air temperature on each side of the passenger compartment.

The temperature of the vehicle interior is adjusted automatically.

### Automatic climate control\* (Canada only)

#### Deactivating

- ▶ Press button **AUTO** (▷ page 187) again.

The indicator lamp on the button goes out. The automatic operation of air volume and air distribution switches off.

#### Setting the temperature

Use temperature controls ③ and ⑬ for the left side or ⑥ and ⑪ for the right side (▷ page 187) to separately adjust the air temperature on each side of the passenger compartment. You should raise or lower the temperature setting in small increments, preferably starting at 22°C (72°F). The climate control will adjust to the set temperature as fast as possible.

#### Increasing

- ▶ Press temperature button ③ and/or ⑥ (▷ page 187) until the desired temperature appears in the control panel display ④ (▷ page 187).

The automatic climate control system will correspondingly adjust the interior air temperature.





#### Decreasing

- ▶ Press temperature button ⑪ and/or ⑬ (▷ page 187) until the desired temperature appears in the control panel display ④ (▷ page 187).

The automatic climate control system will correspondingly adjust the interior air temperature.

#### Adjusting air distribution

Use air distribution controls ① and ⑧ (▷ page 187) to separately adjust the air distribution on each side of the passenger compartment. The following symbols are found on the controls:

Symbol	Function
	Directs air through the center, side and rear passenger compartment air vents
	Directs air to the windshield and the side defroster vents
	Directs air into the entire vehicle interior
	Directs air to the footwells

## Automatic climate control\* (Canada only)

- ▶ Turn air distribution control ① or ⑧ (▷ page 187) to the desired symbol.

The indicator lamp on the button **AUTO** (▷ page 187) goes out.

The automatic air distribution is switched off. The air distribution is controlled according to the selected control setting.



You can also turn the air distribution control to a position between two symbols.

### Opening center and side air vents

- ▶ Turn thumbwheels ③, ④, ⑦ and ⑧ (▷ page 186) upward.

The center air vents ⑤ and ⑥ and side air vents ② and ⑨ (▷ page 187) are open.

### Closing center and side air vents

- ▶ Turn thumbwheels ③, ④, ⑦ and ⑧ (▷ page 186) downward.

The center air vents ⑤ and ⑥ and side air vents ② and ⑨ (▷ page 186) are closed.

### Adjusting air volume

Use button **AUTO** (▷ page 187) for automatic mode or air volume controls or (▷ page 187) to adjust air volume manually.

Seven blower speeds are available.

- ▶ Press button to decrease or (▷ page 187) to increase air volume to the desired level.

The indicator lamp on the button **AUTO** goes out.

The automatic air distribution remains switched on.

### Front defroster

You can use this setting to defrost the windshield, for example if it is iced up. You can also defog the windshield and the side windows.



Keep this setting selected only until the windshield or the side windows are clear again.

### Activating

- ▶ Press button (▷ page 187).

The indicator lamp on the button comes on.



### Automatic climate control\* (Canada only)

The air conditioning switches automatically to the following functions:

- cooling on to dehumidify
- maximum blowing and heating power
- air flows onto the windshield and the front side windows
- the air recirculation mode is switched off

#### Deactivating

- ▶ Press button  (▷ page 187) again.

The indicator lamp on the button goes out.

The previous settings are once again in effect.



The cooling remains switched on.

#### Windshield fogged on the outside



Keep this setting selected only until the windshield is clear again.

- ▶ Switch the windshield wipers on (▷ page 54).

If the automatic mode of the climate control is switched off:

- ▶ Turn air distribution control ① or ⑧ to  or  (▷ page 187).

#### Maximum cooling MAXCOOL

If the left and right air distribution controls as well as the airflow volume control are set to **AUTO** (▷ page 187) and there is a high need for cooling, the display “MAXCOOL” appears.

This provides the fastest possible cooling of the vehicle interior (when side windows and tilt/sliding sunroof\* are closed).

#### Air recirculation mode

Switch to air recirculation mode to prevent unpleasant odors from entering the vehicle from the outside (e.g. before driving through a tunnel). This setting cuts off the intake of outside air and recirculates the air in the passenger compartment.

#### Warning!



Fogged windows impair visibility, endangering you and others. If the windows begin to fog on the inside, switching off the air recirculation mode immediately should clear interior window fogging. If interior window fogging persists, make sure the air conditioning (▷ page 187) is activated, or press button .

## Automatic climate control\* (Canada only)

## Activating

- ▶ Press button  (▷ page 187).

The indicator lamp on the button comes on.



The air recirculation mode is activated automatically at high outside temperatures.

The indicator lamp on the button  is not lit when the air recirculation mode is automatically switched on.

A quantity of outside air is added after approximately 30 minutes.



**Warning!**

Never operate the side windows and the tilt/sliding sunroof\* if there is the possibility of anyone being harmed by the closing procedure.

In the event that the closing procedure causes potential danger, the closing of the side windows can be immediately halted by pressing or pulling the respective window switch. The closing of the tilt/sliding sunroof\* can be immediately halted by moving the tilt/sliding sunroof\* switch in the overhead control panel in any direction.

The closing of the side windows and tilt/sliding sunroof\* can be reversed by again pressing and holding the button .



Press and hold button  for approx. 2 seconds. The side windows and tilt/sliding sunroof\* will close. You can release button  once the closing procedure has begun. The windows and tilt/sliding sunroof\* continue closing until they are fully closed.

### Automatic climate control\* (Canada only)

#### Deactivating

- ▶ Press button  (▷ page 187) again.



The indicator lamp on the button goes out.





The air recirculation mode is deactivated automatically:

- after 5 minutes if the outside temperature is below approximately 5°C (41°F)
- after 5 minutes if the air conditioning is turned off
- after 30 minutes if the outside temperature is above approximately 5°C (41°F)



Press and hold button  for approx. 2 seconds. The side windows and or tilt/sliding sunroof\* will return to their previous position. You can release button  once the opening procedure has begun. The windows and tilt/sliding sunroof\* continue opening until they have reached their previous position.

A window or tilt/sliding sunroof\* will only return to its previous position if it has not been moved to another position using the respective window switch or tilt/sliding sunroof\* switch after it was closed with button . A window or tilt/sliding sunroof\* that was moved will remain in its current position if button  is used to re-open the remaining windows or tilt/sliding sunroof\*.

#### Charcoal filter

An activated charcoal filter markedly reduces bad odors and removes pollutants from air entering the passenger compartment. The charcoal filter can be activated or deactivated.

The system switches automatically to the air recirculation mode, if the

- charcoal filter is switched on
- carbon monoxide (CO) or nitrogen oxide (NO<sub>x</sub>) concentration of the outside air increases beyond a predetermined level



The automatic air recirculation mode does not function if the **A/C** mode is deactivated (indicator lamp on button  not lit), or if the outside temperature has fallen below 5°C (41°F).

## Automatic climate control\* (Canada only)

## Activating

- ▶ Press button  (▷ page 187).

The indicator lamp on the button comes on.



The activated charcoal filter should be switched off when windows fog up on the inside, or if the passenger compartment needs to be quickly heated or cooled down.



The activated charcoal filter should be switched off when windows fog up on the inside, or if the passenger compartment needs to be quickly heated or cooled down.

## Warning!



Never operate the side windows and the tilt/sliding sunroof\* if there is the possibility of anyone being harmed by the closing procedure.

In the event that the closing procedure causes potential danger, the closing of the side windows can be immediately halted by pressing or pulling the respective window switch. The closing of the tilt/sliding sunroof\* can be immediately halted by moving the tilt/sliding sunroof\* switch in the overhead control panel in any direction.



The closing of the side windows and tilt/sliding sunroof\* can be reversed by again pressing and holding the button .



## Deactivating

- ▶ Press button  (▷ page 187).

The indicator lamp on the button goes out.



Press and hold button  for approx. 2 seconds. The side windows and or tilt/sliding sunroof\* will return to their previous position. You can release button  once the opening procedure has begun. The windows and tilt/sliding sunroof\* continue opening until they have reached their previous position.

A window or tilt/sliding sunroof\* will only return to its previous position if it has not been moved to another position using the respective window switch or tilt/sliding sunroof\* switch after it was closed with button . A window or tilt/sliding sunroof\* that was moved will remain in its current position if button  is used to re-open the remaining windows or tilt/sliding sunroof\*.

### Automatic climate control\* (Canada only)

#### Air conditioning

The cooling function, only operational when the engine is running, cools the vehicle interior down to the selected temperature. The cooling function also dehumidifies the air in the vehicle interior, thus preventing the windows from fogging up.



Condensation may drip out from underneath the vehicle. This is normal and not an indication of a malfunction.

#### Warning!



If you turn off the cooling function, the vehicle will not be cooled when weather conditions are warm. The windows can fog up more quickly. Window fogging may impair visibility and endanger you and others.

#### Deactivating

It is possible to deactivate the air conditioning (cooling) function of the automatic climate control system. The air in the vehicle will then no longer be cooled or dehumidified.

- ▶ Press button  (▷ page 187).

The indicator lamp on the button goes out.

The cooling function switches off after a short delay.

#### Activating

Moist air can fog up the windows. You can dehumidify the air with the air conditioning.

- ▶ Press button  (▷ page 187) again.

The indicator lamp on the button comes on.

The air conditioning uses the refrigerant R134a. This refrigerant is free of CFCs which are harmful to the ozone layer.



If the air conditioning cannot be turned on again, this indicates that the air conditioning is losing refrigerant. The compressor has turned itself off.

Have the air conditioning checked at the nearest authorized Mercedes-Benz Center.

## Automatic climate control\* (Canada only)

**Residual heat and ventilation**

With the engine switched off, it is possible to continue to heat or ventilate the interior for up to 30 minutes. This feature makes use of the residual heat produced by the engine.



How long the system will provide heating depends on

- the coolant temperature
- the temperature set by the operator

The blower will run at speed setting 1 regardless of the air distribution control setting.

**Activating**

- ▶ Switch off the ignition (▷ page 33).
- ▶ Press button  (▷ page 187).

The indicator lamp on the button comes on.

**Deactivating**

- ▶ Press button  (▷ page 187).

The indicator lamp on the button goes out.

The residual heat is automatically turned off:

- when the ignition is switched on
- after about 30 minutes
- if the battery voltage drops

**Rear passenger compartment adjustable air vents**

The air conditioning for the rear passenger compartment is controlled via the automatic climate control panel (▷ page 187).



The temperature at the center air vents for the rear passenger compartment ① and ③ is the same as at the dashboard center air vents.

### Automatic climate control\* (Canada only)

The air vents for the rear passenger compartment are located in the rear center console.

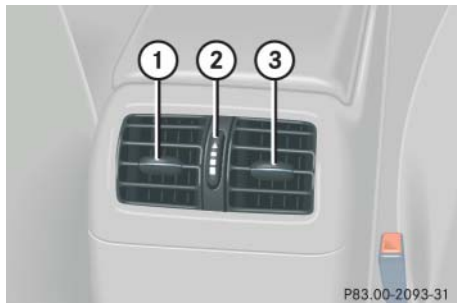

- ① Left center air vent
- ② Thumbwheel for air volume control for center air vents
- ③ Right center air vent

#### Adjusting air distribution

- ▶ Push the slide for the left center vent ① or right center vent ③ to the left, right, up, or down.

The air flow is directed in the corresponding direction.



For draft-free ventilation, push slides ① and ③ upward.

#### Adjusting air volume

- ▶ Turn thumbwheel ② up or down.

The air volume is increased or decreased.

## ▼ Audio system

### Audio and telephone, operation

These instructions are intended to help you become familiar with your Mercedes-Benz audio system. They contain useful tips and a detailed description of the user functions.

#### Warning!



In order to avoid distraction which could lead to an accident, the driver should enter system settings with the vehicle at a standstill and operate the system only when road and traffic conditions permit. Always pay full attention to traffic conditions first before operating system controls while driving.

Bear in mind that at a speed of just 30 mph (approximately 50 km/h), your car is covering a distance of 44 feet (approximately 14 m) every second.

### Operating safety

#### Warning!



Any alterations made to electronic components can cause malfunctions.

The radio, amplifier, CD changer\*, satellite radio\*, and telephone\* are interconnected. When one of the components is not operational or has not been removed/replaced properly, the function of other components may be impaired.

This condition might seriously impair the operating safety of your vehicle.

We recommend that you have any service work on electronic components carried out by an authorized Mercedes-Benz Center.



## Audio system

### Operating and display elements

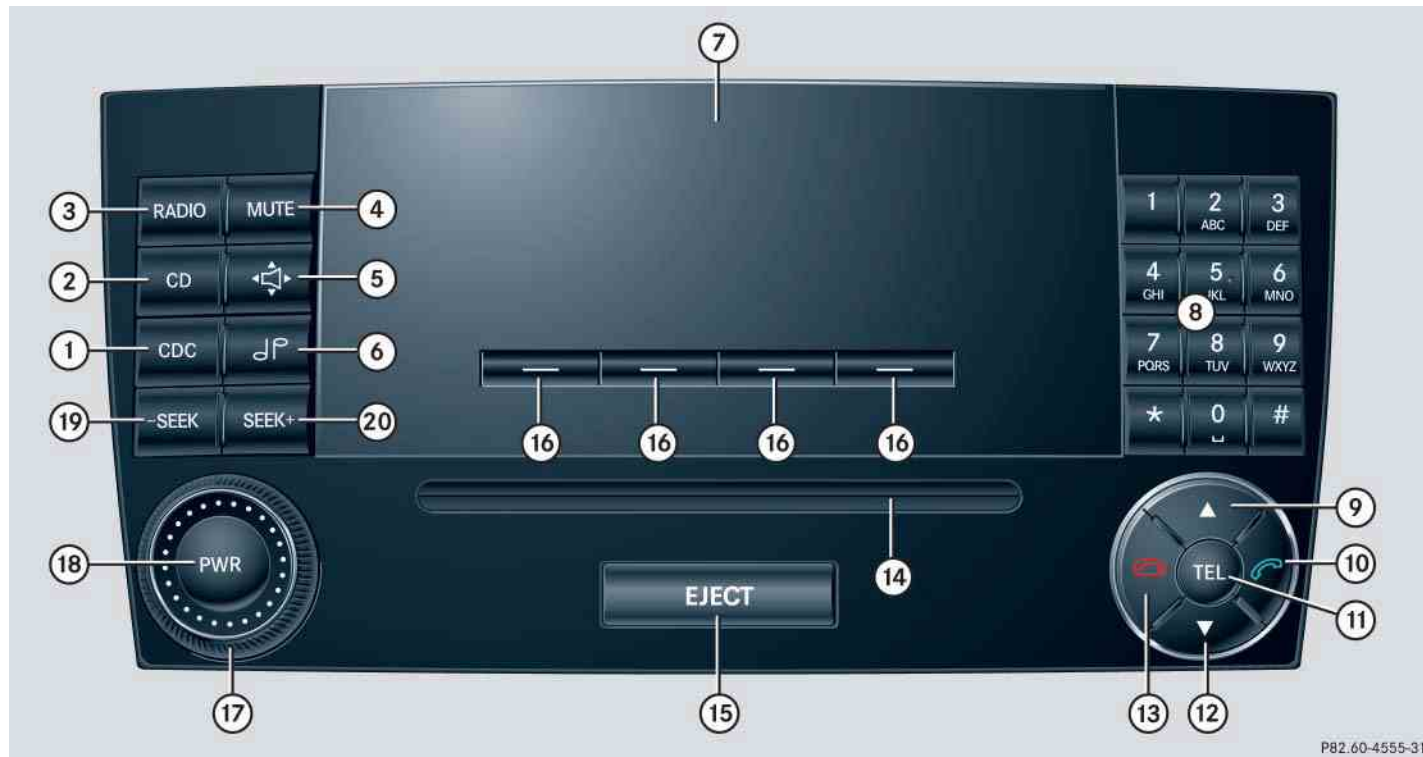

P82.60-4555-31

Item	Page
① CD changer mode selector	216
AUX mode selector	207
② Single CD mode selector	220
③ Radio mode selector	
④ Mute function (radio)	210
Pause (CD)	224
⑤ Volume distribution	205
⑥ Sound settings	203
⑦ Display	
⑧ Alphanumeric keypad	

Item	Page
⑨ Speed dialing memory (telephone) in descending order	
⑩ Accepting a call (telephone)	229
⑪ Telephone mode selector	225
⑫ Speed dialing memory (telephone) in ascending order	226
⑬ Terminating a call (telephone)	230
⑭ CD slot	
⑮ CD ejection	220

Item	Page
⑯ Soft keys	202
⑰ Volume	203
⑱ Switching on/off	202
⑲ Manual tuning/seek tuning (radio)	209
Track search, reverse (CD)	223
⑳ Manual tuning/seek tuning (radio)	209
Track search, fast forward (CD)	223

### Audio system

#### Button and soft key operation

In these instructions, the alphanumeric keypad (right side of radio panel) and the function buttons (left side of radio panel) are referred to as “buttons”. The four keys below the display panel are referred to as “soft keys”.



Do not press directly in the display face. Otherwise, the display will be damaged.

#### Operation

##### Switching the unit on/off

##### *Switching on*

- ▶ Turn the SmartKey in the starter switch to position **1** or **2**.
- ▶ If the audio system was on as you removed the SmartKey from the starter switch, the audio system will automatically come back on as you turn the SmartKey to position **1** or **2**.

or

- ▶ Press  button.



If the radio is switched on without the key in the starter switch, it will automatically switch off again after approx. 30 minutes.

If your vehicle is equipped with a telephone, the display may prompt you to enter your PIN (GSM network) or code (TDMA or CDMA network).

### Switching off

- ▶ Remove SmartKey from starter switch.  
or
- ▶ Press  button.



Should excessively high temperatures occur while the audio system is being operated, the display will dim. If temperatures continue to rise, HIGH TEMP will appear in the display, after which the audio system will be switched off for a cooling-down period.

### Adjusting the volume

- ▶ Turn rotary control of  button.  
The volume will increase or decrease depending on the direction turned.



If your vehicle equipment includes a Mercedes-Benz specified mobile telephone\*, you can adjust its volume separately from the volume of the audio system while the telephone is being used.

### Adjusting sound functions

The bass and treble functions are called up by pressing the  button.

Settings for bass and treble are stored separately for the AM and FM wavebands, weather band, CD mode and telephone mode.

#### Bass

- ▶ Press  button repeatedly until BASS appears in the display.



- ▶ Press + or - soft key to increase or decrease tone level accordingly.
- or
- ▶ Press RES soft key briefly to reset bass tones to their center level.

The radio switches back to the standard radio menu 8 seconds after the last soft key is pressed.

### Audio system

#### Adjusting treble

- ▶ Press **⏮** button repeatedly until **TREBLE** appears in the display.



- ▶ Press + or - soft key to increase or decrease tone level accordingly.
- or
- ▶ Press **RES** soft key briefly to reset treble tones to their center level.

The radio switches back to the standard radio menu 8 seconds after the last soft key is pressed.

#### Sound system\*

You can either program the sound settings manually (▷ page 203) or choose settings via preset sound characteristics.

You can select from among the following settings:

- **STANDARD**: conventional stereo sound.
  - **SURROUND**: the sound is set for better three-dimensional acoustic characteristics.
  - **SPEECH**: the sound is optimized for the spoken word.
- ▶ Press **⏮** button repeatedly until **STANDARD**, **SURROUND**, or **SPEECH** appears in the display.

- ▶ Press **<<<** or **>>>** soft key repeatedly until the desired sound setting has been reached.

The sound is set accordingly.

or

- ▶ Press **RES** soft key briefly.

The sound setting is reset depending on the sound source activated.

- Radio mode: **STANDARD**
- CD/AUX mode: **SURROUND**
- Telephone: **SPEECH**

The radio switches back to the standard radio menu 8 seconds after the last soft key is pressed.

### Returning sound functions to factory settings

- ▶ Press  button to call up settings menu in the display.



- ▶ Press RES soft key briefly; the respective sound function is reset to its center level.

or

- ▶ Press and hold RES soft key until RESET appears in the display.

The sound settings for bass and treble are returned to their center level and the volume is set to a predefined level.

Vehicles with sound system\*:

The sound setting is reset depending on the sound source activated.

- Radio mode: STANDARD
- CD/AUX mode: SURROUND
- Telephone: SPEECH

The radio switches back to the standard radio menu 4 seconds after the last soft key is pressed.



### Adjusting volume distribution

Call up fader and balance functions by pressing the  button.

#### Fader

- ▶ Press  button repeatedly until FADER appears in the display.



- ▶ Press  or  soft key.

The volume is distributed accordingly between the front and rear of the vehicle.

or

- ▶ Press RES soft key briefly.

The fader is reset to its center level.

The radio switches back to the standard radio menu 8 seconds after the last soft key is pressed.

### Audio system

#### Adjusting balance

- ▶ Press  button repeatedly until BALANCE appears in the display.



- ▶ Press <<< or >>> soft key.

The volume is distributed between the left and right sides of the vehicle.

or

- ▶ Press RES soft key briefly.

The balance is reset to its center level.

The radio switches back to the standard radio menu 8 seconds after the last button is pressed.

#### Returning volume distribution to factory settings

- ▶ Press  button to call up settings menu in the display.



- ▶ Press RES soft key briefly; the respective volume distribution is reset to its center (flat) level.

or

- ▶ Press and hold RES soft key until RESET appears in the display.

The volume distribution settings for fader and balance are set to their center level.

The radio switches back to the standard radio menu 4 seconds after the last soft key is pressed.

#### Telephone\* muting

If your vehicle equipment includes a Mercedes-Benz specified mobile telephone\*, you can adjust its volume separately from the volume of the audio system while the telephone is being used.

### Connecting an external audio source (AUX) to the radio\*

An optional dealer-installed cinch-connector\* for connecting an external audio source may become available for your vehicle model. Feature description is based on preliminary information at time of printing. Contact an authorized Mercedes-Benz Center for availability.

You can adjust the volume (▷ page 203), the sound settings (▷ page 203) and the volume distribution (▷ page 205) for the AUX input.

### Calling up AUX mode

- ▶ Press and hold **CDC** button until AUX appears in the display.

### Canceling AUX mode

- ▶ Press any audio source button.

### Radio operation

#### Selecting radio mode

- ▶ Press **RADIO** button.

#### Calling up wavebands

You can choose from among the FM, AM, and WB wavebands.

Weather band (▷ page 210).



FM waveband:	87.7.....107.9 MHz
AM waveband:	530.....1710 KHz

### Calling up wavebands for radios without SAT

- ▶ Press FM or AM soft key to switch between FM and AM.

The FM and AM wavebands are called up one after another.

or

- ▶ Press WB soft key.

The weather band menu is called up.

The waveband currently selected appears in the upper left-hand corner of the display.



### Audio system

#### Calling up wavebands for radios with SAT

- ▶ Press FM, AM, or WB soft key repeatedly until desired waveband has been selected.

The FM, AM, and WB wavebands are called up one after another.

The waveband currently selected appears in the upper left-hand corner of the display.

#### Selecting a station

The following options are available for selecting a station:

- Direct frequency input (▷ page 208)
- Manual tuning (▷ page 209)
- Automatic seek tuning (▷ page 209)
- Scan search (▷ page 209)
- Station memory (▷ page 209)
- Automatic station memory (Autostore) (▷ page 210)

The station search proceeds in the following frequency increments:

- 200 kHz in FM range
- 10 kHz in AM range

#### Direct frequency input

- ▶ Select desired waveband.



- ▶ Press **\*** button.
- ▶ Enter desired frequency with buttons **1** to **0**.



You can only enter frequencies within the respective waveband.

If a button is not pressed within 4 seconds, the radio will return to the last station tuned.

### Manual tuning

- ▶ Select desired waveband.
- ▶ Press **SEEK+** or **-SEEK** button for approx. 3 seconds.
- ▶ Press button repeatedly until desired frequency has been reached.

Step-by-step station tuning takes place in ascending or descending order. Each time the button is pressed, the radio tunes further by 0.2 MHz. During manual tuning, the radio is muted.

### Automatic seek tuning

- ▶ Select desired waveband.
- ▶ Press **SEEK+** or **-SEEK** button briefly.

The radio will tune to the next highest or next lowest receivable frequency.



If no station is received after two consecutive scans of the complete frequency range, then the scan stops at the frequency from which it began.

### Scan search

- Starting scan search
  - ▶ Select desired waveband.



- ▶ Press **SC** soft key.
 

SC will appear in the display. The radio briefly tunes in all receivable stations on the waveband selected.
- Ending scan search
  - ▶ Press **SC** soft key or **SEEK+** or **-SEEK**.
 

The station last played will be selected and SC disappears from the display.

### Station memory

You can store ten AM and ten FM stations in the memory.

- Storing stations
  - ▶ Tune in desired station.
  - ▶ Press and hold desired station button **1** to **0** until a brief signal tone is heard.
 

The frequency is stored on the selected station button.
- Calling up stations
  - ▶ Press desired station button **1** to **0** briefly.

### Audio system

#### *Autostore – automatic station memory*

The Autostore memory function provides an additional memory level. The station memory for manually stored stations is not overwritten.

- Calling up Autostore memory level and storing stations



- ▶ Press AS soft key briefly.

The radio switches to the Autostore memory level. AS and SEARCH appear in the display and the radio finds the ten stations with the strongest signals. These stations are stored on the station buttons **1** to **0** in order of signal strength.

- Calling up stations
  - ▶ Press desired station button **1** to **0**.
- Leaving the Autostore memory level
  - ▶ Press FM or AM soft key briefly.

#### *Interrupting radio mode*

The radio mode is interrupted by an incoming call on the telephone\* (▷ page 229).

- Mute on
  - ▶ Press **MUTE** button.
  - The radio mode is interrupted and MUTED appears in the display.
- Mute off
  - ▶ Press **MUTE** button.
  - The radio mode is again active.

#### Weather band



- ▶ Press WB soft key.

The weather band station last received is tuned in.

#### *Selecting a weather band station directly*

- ▶ Select desired weather band station with buttons **1** to **7** PORS.
- If a station cannot be tuned in, a search is automatically started.

### Search

- ▶ Press **SEEK+** or **-SEEK** button to tune in the next receivable weather band station.



If no weather band station is received after three consecutive scans of the complete frequency range, then the scan stops at the channel with which it began and **NO WB FOUND** appears in the display.

If this happens, switch back to standard radio mode.

### Scan search

- Starting scan search
  - ▶ Press **SC** soft key.  
**SC** will appear in the display. The radio briefly tunes in all receivable weather band stations.
- Ending scan search
  - ▶ Press **SC** soft key or **SEEK+** or **-SEEK**.  
The weather band station last played will be selected and **SC** disappears from the display.

### Introduction to satellite radio\* (USA only)

---

SIRIUS satellite radio provides 100 channels of digital-quality radio, among others music, sports, news, and entertainment, free of commercials. SIRIUS satellite radio uses a fleet of high-power satellites to broadcast 24 hours per day, coast to coast, in the contiguous U.S.

This diverse, satellite-delivered programming is available for a monthly subscription fee.

For more information and service availability call the SIRIUS Service Center (▷ page 216), or contact [www.siriusradio.com](http://www.siriusradio.com).

### Audio system



Additional satellite radio equipment and a subscription to a satellite radio service provider are required for the satellite radio operation described here.

Contact an authorized Mercedes-Benz Center for details and availability for your vehicle.

Note that categories and channels shown in illustrations are dependent on programming content delivered by the service provider. Programming content is subject to change. Therefore, channels and categories shown in illustrations and descriptions contained in this manual may differ from the channels and categories delivered by the service provider.



Satellite radio service may be unavailable or interrupted from time to time for a variety of reasons, such as environmental or topographic conditions and other things beyond the service provider's or our control. Service might also not be available in certain places (e.g., in tunnels, parking garages, or within or next to buildings) or near other technologies.

#### Program categories

The channels are categorized. Categories allow you to tune to stations broadcasting a certain type of program (category mode) (▷ page 214).

#### Calling up the SAT main menu

- ▶ Press SAT soft key.

SAT is displayed in the upper left-hand corner of the display.

Prior to activation of the satellite radio service (▷ page 212).

After activation of satellite radio service (▷ page 213).

#### *Prior to activation of the satellite radio service*



The telephone number of the SIRIUS Service Center (888-539-7474) is displayed.

- ▶ Press ESN soft key.

The twelve-digit electronic serial number (ESN) of the SAT tuner\* installed in your vehicle is displayed.

This information is required to call the SIRIUS Service Center for an activation request.



Credit card information may also be required for your application.

The activation process takes approximately 5 to 10 minutes after calling the SIRIUS Service Center.

### **After activation of the satellite radio service**

The satellite radio main menu appears. The radio station selected last is audible, provided it can be received.



The system will tune to a default station if no station had been selected previously.



The first channel 001 is called up and the PTY system changes to All categories.

If no station can be received, **ACQUIRING** appears in the display.

If the Satellite radio service is not activated, **ACQUIRING** will also appear in the radio display and **NO SAT** will appear in the multifunction display.

### **Selecting a station**

The following options are available:

- Selecting a station using the selected category (▷ page 214).
- Tuning via station presets (▷ page 213).
- Tuning via scan search (▷ page 215).
- Tuning via manual channel input (▷ page 214).
- Tuning via the program category list (▷ page 214).

### **Tuning via station presets**

Ten satellite radio station presets are available.

You can access the presets via number keys.

### Audio system

#### Accessing via number keys

- ▶ Enter number of preset you wish to select, e.g. **1**.

The radio plays the station stored under this number and the PTY function changes to the category corresponding to the station.

#### Tuning via manual channel input



Example: tuning in channel 16

- ▶ Press **\*** button.  
Input line appears in the main radio menu.
- ▶ Use number keys to enter desired channel within 8 seconds, e.g. **16**.

The system tunes to channel 16.

The station you have selected begins to play.



You can only enter available channel numbers.

#### Tuning via the program category list

The category list contains all currently receivable categories of programs. It is arranged alphabetically.

- Selecting a category
  - ▶ Press PTY soft key.



The current PTY category of the station is displayed.

- ▶ Press <<< or >>> soft key.  
This switches between the individual categories.

When changing the category, the channel selected last in the new category becomes audible.

The system will automatically switch to a station of the selected category if the currently selected station is not of the selected category. Otherwise, the currently selected station remains tuned.

- Tuning a station within the selected category

The channels identified for the currently selected category are arranged numerically. Only one entry is visible at a time.

- ▶ Press **SEEK+** or **-SEEK** button briefly.  
The next station within the category is started.

or

- ▶ Press and hold **SEEK+** or **-SEEK** button for approx. 3 seconds until desired station has been reached.

### *Tuning via scan search*

Scan search is characterized as follows:

- Scan search plays a channel for approx. 8 seconds and then skips to the next channel within the current category.
- Scan search can be terminated manually.
  - ▶ Press **SC** soft key.  
The search starts. **SC** appears in the display.
  - ▶ Press **SC** soft key again.  
The search stops.

### **Obtaining additional text information**

Additional text information (artist, title) related to the current channel can be displayed.

- ▶ Press **INF** soft key.

The title being played is displayed.

- ▶ Press **INF** soft key again.

The name of the artist performing the title being played is displayed.



If a button is not pressed within 4 seconds, the radio will return to the standard display.



### Audio system

#### Storing stations

- ▶ Tune in desired station.
- ▶ Press and hold desired station button **1** to **0** until a brief signal tone is heard.

The frequency is stored on the selected station button.

The radio saves the current station at the memory preset selected. The memory preset selected appears in the status line, e.g. S3.



There are ten presets available.

An existing entry is overwritten in the memory list when a new entry is given.

#### Calling up the ESN information menu

- ▶ Press INF soft key.
- ▶ Press ESN soft key.

The twelve-digit electronic serial number (ESN) of the SAT tuner\* installed in your vehicle is displayed.

- ▶ Press RET soft key to exit the menu.

#### CD mode

---

#### Safety precautions

##### Warning!



The single CD player and the CD changer\* are Class 1 laser products. There is a danger of invisible laser radiation if the housing is opened or damaged.

Do not open the housing. The single CD player and the CD changer\* do not contain any parts that can be serviced by the user. For safety reasons, have any service work which may be necessary performed only by qualified personnel.

**Warning!**

In order to avoid distraction which could lead to an accident, the driver should insert CDs with the vehicle at a standstill and operate the audio system only if permitted by road, weather and traffic conditions. Bear in mind that at a speed of just 30 mph (approximately 50 km/h), your car covers a distance of 44 feet (approximately 14 m) every second.

**General notes**

The system may not be able to play audio CDs with copy protection.

Playing copied CDs may cause malfunctions during playback.



If you affix stickers to the CDs, they can become warped due to the heat that develops in the CD drive or CD changer\*.

In certain situations, the CDs can then no longer be ejected and cause damage to the drive. Such damage is not covered by the Mercedes-Benz Limited Warranty.



Your CD drive or CD changer\* has been designed to play CDs which correspond to the EN 60908 standard. You can therefore only use CDs with a maximum thickness of 1.3 mm.

If you insert thicker data carriers, e.g. ones that have data on both sides (one side with DVD data, the other side with audio data), they cannot be ejected and will damage the drive.

Do not use CDs with an 8 cm diameter, not even with a CD adapter. Attempting to play CDs with an 8 cm diameter or playing such CDs with an adapter may cause damage to the CD drive. Such damage is not covered by the Mercedes-Benz Limited Warranty.

Should excessively high or low temperatures occur while in CD changer mode\*, CD TEMP will appear in the display, and the CD will be muted until the temperature has reached an acceptable level for the system to continue operation.

The single CD player and the CD changer\* play audio CDs.

### Audio system

#### *Tips on handling CDs*

- Handle CDs carefully to prevent interference during playback.
- Avoid scratches, fingerprints and dust on the CDs.
- Do not write on CDs or apply any labels or other material to them.
- Clean CDs from time to time with a commercially available cleaning cloth. Never wipe the CD in a circular motion; instead, wipe it in a straight line starting in the center and moving outward. Do not use solvents, anti-static sprays, etc. for cleaning.
- Replace the CD in its case after use.
- Protect CDs from heat and direct sunlight.

#### **MP3**

The CD changer\* can play audio CDs as well as CDs with MP3 files.

#### ***Information on MP3 data carriers***



CD media, CD burning software and CD writers are available in great variety. Due to this variety, it cannot be guaranteed that the CD changer will be able to play every user-written CD.

The burning process can lead to data errors and aging of the medium may result in data loss. Therefore, the CD changer may be restricted in its ability to play MP3 data carriers; it may play them with reduced sound quality, or it may not be able to play them at all.

Problems may be encountered during playback of user-written CDs with a storage capacity of more than 700 MB. These CDs do not meet valid standards as of this printing.

#### ***Compatible MP3 data carriers***

The CD changer can read the following data carriers in MP3 mode:

- CD-DA
- CD-R
- CD-RW

#### ***Compatible file systems and compression methods***

Use Romeo or Joliet. Depending on file format used, up to 128 characters are possible.

The following compression methods are compatible:

- MP3
- WMA
- WAV

### Compatible bit and sampling rates

Fixed and variable bit rates of up to 320 kBit/s are possible.

The following table lists possible sampling rates:

MPEG1 Audio Layer3	44.1 KHz, 48 KHz, 32 KHz
MPEG2 Audio Layer3	22.5 KHz, 24 KHz, 16 KHz
MPEG2.5 Audio Layer3	11.025 KHz, 12 KHz, 8 KHz
WMA	32 KHz, 44.1 KHz, 48 KHz



Only use MP3 tracks with a bit rate of 128 kBit/s or higher and with the specified sampling rates.

The use of rates other than those specified may lead to noticeably inferior sound quality.

### Information on copyright

The music tracks that you create for use in MP3 mode or that you play in MP3 mode are subject to copyright laws under applicable international and national regulations.

In many countries, the reproduction of copyrighted materials is not permitted, even if only for personal use, without the express prior consent of the copyright holder.

Please check the current copyright laws for your country and comply with them.

These restrictions do not apply, for example, to your own compositions and recordings, or for recordings for which authorization has been obtained from the copyright holder.

### MP3 playback

You can play an MP3 CD on the CD changer\* as you would any standard audio CD. All of the functions described for the CD changer also apply for the playback of MP3 CDs. Keep in mind that the single CD player in the audio system unit is not able to read MP3 CDs.

The first 99 tracks on the CD, including tracks in subdirectories, are recognized and played. Any additional tracks will not be played.



Due to the branched data structure, playback of the first track may be delayed slightly.

### Audio system

#### Operating the single CD player in the audio system unit

##### *Loading a CD*

The single CD player in the audio system unit has capacity for one CD. The CD slot for loading the drive is located underneath the soft keys.

- ▶ Make sure the system is switched on.
- ▶ Insert CD into CD slot. The label side of the CD must face upwards.

The system automatically pulls the CD into the CD slot. The audio CD begins to play.



If a CD is already loaded, it must be ejected before inserting a new CD. Inserting a second CD in the slot with another CD still loaded will cause damage to the CD drive not covered by the Mercedes-Benz Limited Warranty.



If a CD has been inserted incorrectly or cannot be read, **WRONG CDO** will appear in the display.

##### *Ejecting a CD*

- ▶ Make sure the system is switched on.
- ▶ Press **EJECT** button.

The system ejects the CD. **NO CD** will appear in the display.

- ▶ Remove CD from slot.



If you do not take the CD out of the CD slot within approx. 15 seconds, the system automatically pulls the CD back in and plays it.

If a CD is pulled back in, press **EJECT** button for 5 seconds; the CD will then be ejected.

#### Operational readiness of CD changer\*

If a CD changer\* has been installed in the vehicle, it can be operated from the front control panel of the audio system. A loaded magazine must be installed to play CDs.

The CD changer\* is located in the glove box.

#### Loading/unloading the CD magazine



The CD changer\* may not be able to play audio CDs with copy protection.

- ▶ Slide changer door to the right and press  button.
- ▶ Magazine will be ejected.

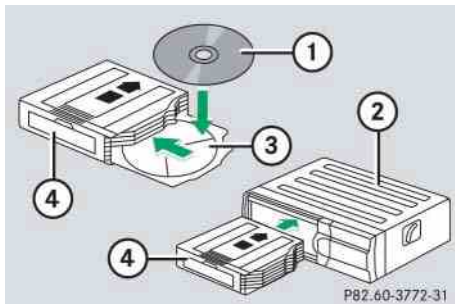

- ① CD
- ② CD changer
- ③ CD tray
- ④ CD magazine

- ▶ Remove magazine ④ and pull CD tray ③ fully out.
- ▶ Place CD ① in recess of tray, label side up.

- ▶ Push tray into magazine in direction of arrow.



CDs which have been inserted improperly or are unreadable will not be played.

- ▶ Push magazine into CD changer\* ② in direction of arrow and close sliding door.

### Playing CDs

#### Single CD player in the audio unit

- ▶ Press **CD** button.

CD 0 will appear in the upper left-hand corner of the display.

The CD will resume playback at the point where it was switched off.

#### CD changer\*

- ▶ Press **cdb** button.

CD and the selected magazine slot number appear in the upper left-hand corner of the display.

If you have not removed a CD since the last time the CD audio source was activated, the last CD listened to will begin to play at the point where it was switched off.

After the last track on a CD has finished, the next CD is automatically played.

### Audio system

#### Playing tracks

You have the following options:

- Audio system with CD changer\*: selecting CDs
- Direct track entry
- Track skip forward/reverse
- Fast forward/reverse
- Scan
- Random tracks
- Repeat track

#### Selecting CDs in the audio unit with CD changer\*



P82.60-4455-31

- ▶ You can select from among the inserted CDs with buttons

**0** to **6**.

**0** = CD player in the audio unit

**1** to **6** = CDs in the CD changer\*

The magazine slot number of the selected CD appears next to CD in the display, and the number of the currently played track appears next to TRACK.



If there is no CD in the selected magazine slot, NO CD appears in the display with the corresponding slot number.

#### Direct track entry



P82.60-4456-31

You can make a direct selection from among the tracks on a CD.

- ▶ Press **\*** button.
- ▶ Enter track number using buttons **1** to **0**.

The number of the track being played appears next to TRACK in the display.

You can only enter available track numbers.

**Skipping tracks forward/backward**

- Skipping tracks forward
  - ▶ Press **SEEK+** button briefly.  
The next track will be played.

- Skipping tracks backward

- ▶ Press **-SEEK** button briefly.

If the track has been playing for more than 10 seconds, the unit skips back to the beginning of the track currently playing. If less than 10 seconds have been played, the unit skips back to the beginning of the previous track.

Pressing the **-SEEK** or **SEEK+** button repeatedly will result in multiple tracks being skipped.

**Fast forward/reverse**

- Fast forward
  - ▶ Press and hold **SEEK+** button until desired point has been reached.
- Reverse
  - ▶ Press and hold **-SEEK** button until desired point has been reached.



The track number and the relative time of the track is shown in the display during the search.

**Scan**

- Starting scan
  - ▶ Press **SC** soft key.  
SC will appear in the display.  
Each track on the current CD will be played for approx. 8 seconds in ascending order.
- Ending scan
  - ▶ Press **SC** soft key or **-SEEK** or **SEEK+**.

**Random play**

The random function (RDM) plays the tracks of the current CD in random order.



When you start the RDM function, the RPT function is automatically switched off.

- Switching on random
  - ▶ Press **RDM** soft key.  
RDM appears in the display.  
A randomly selected track is played.
- Switching off random
  - ▶ Press **RDM** soft key again.



### Audio system

#### Repeat

The track being played is repeated until the repeat function is switched off.



When you start the RPT function, the RDM function is automatically switched off.

- Switching on repeat
  - ▶ Press RPT soft key.  
RPT appears in the display.
- Switching off repeat
  - ▶ Press RPT soft key again.

#### Pause function

The CD changer mode is interrupted by an incoming call on the telephone\* (▷ page 229).

- Switching on pause function



- ▶ Press **MUTE** button.  
The CD changer mode is interrupted and PAUSE appears in the display.
- Switching off pause function
  - ▶ Press **MUTE** button.  
The CD changer mode is active again.

#### Track and time display



- ▶ Press T soft key.  
The number of the track being played and the elapsed playing time appear in the display.
- ▶ Press T soft key again.  
The total number of tracks and the total playing time of the CD appear in the display.
- ▶ Press T soft key.  
The standard CD playback menu appears in the display.

## GSM network phones

Using your Mercedes-Benz specified mobile telephone\*, a number of functions and operating steps can be performed and displayed in the audio system display.

Further operating instructions not covered here can be found in the operating instructions for the multifunction steering wheel and the cellular telephone\*.

If your audio system is set up for telephone operation, the  symbol will appear in the display.

When you insert your Mercedes-Benz specified mobile telephone\* into the telephone cradle, you will be prompted to enter your PIN for 30 seconds (> page 225). This display disappears when you press any button.

When your mobile telephone is inserted into the telephone cradle, you will see the reception strength in the upper right-hand corner of the display.

## Switching on the telephone

### Switching on the telephone

- ▶ Press **TEL** button.

If the telephone was previously switched off, PROCESSING appears in the display and you will then be prompted to enter your PIN.

### Switching off the telephone

- ▶ Press **TEL** button for approx. 3 seconds.

PROCESSING appears in the display until the telephone is off. Afterward, PHONE OFF appears in the display.

## PIN entry



- ▶ Enter PIN number using buttons **1** to **0**.
- ▶ If necessary, correct number entered with the CLR soft key. Press soft key briefly to delete the last digit entered; press soft key and hold to delete the complete number.
- ▶ Press OK soft key after entering correct PIN.
- ▶ READY or ROAMING will appear in the display.

### Audio system



If the PIN is entered incorrectly three times, **NEED PUK** will appear in the display. Enter PUK via your telephone. Please refer to the separate telephone operating instructions for more information.

#### Adjusting the volume

- ▶ Turn rotary control of  button during a telephone call.

The volume will increase or decrease depending on the direction turned.



The volume can be adjusted separately for telephone mode and audio mode.



#### Adjusting sound

- ▶ Adjust sound during a telephone call. Sound adjustment (> page 203).

### Placing a call

#### Entering a telephone number and starting the dialing process



- ▶ Enter desired telephone number using buttons  to .

The number can have up to 32 digits, but only twelve of these are visible in the display.

- ▶ If necessary, correct number entered with the **CLR** soft key. Press soft key briefly to delete the last digit entered; press soft key and hold to delete the complete number.
- ▶ After correct telephone number has been entered, press  button.



If the telephone number has been saved together with a name in the telephone book, the name will appear in the display.

#### Phone book

The numbers stored in the phone book of the telephone can be called up either by name or number.

In addition, incoming calls are stored in the phone book.



This is only possible, however, when the call information transmitted includes the number of the person calling. If the telephone number is not transmitted, NO NUMBER will be stored in the phone book.

- Searching and calling up telephone book entries by name

You can access your mobile telephone's phone book using the audio system. You can access both the main entries and the sub-entries of your phone book.



- ▶ Press MEM soft key or press button or .
  - ▶ Press desired numerical key to .
- The stored entries are selected according to the alphabetical order of the initial letters (e.g. for S-Schneider, press button four times).

or

- ▶ Press and hold button or .
- The system jumps from one initial letter to the next in ascending or descending order.
- ▶ Press and hold button or until desired initial letter has been reached.

or

- ▶ Press button or repeatedly until desired entry has been reached.

The stored entries are selected in alphabetical order with the sub-entries.



Several sub-entries can be stored for each main entry (name). These entries are marked by a corresponding abbreviation that appears in the upper left-hand corner of the display. The following abbreviations for sub-entries are possible:





CEL = Mobile phone  
 HOM = Home  
 WOR = Work  
 FAX = Fax  
 PAG = Pager  
 TEL = Main











### Audio system

- ▷▷ ▶ When you have selected a number, press  button.  
The call will be made.
- Viewing the telephone number of a telephone book entry
  - ▶ Search for desired entry.
  - ▶ Press NUM soft key.  
The telephone number of the phone book entry appears in the display.
- Returning calls received



- ▶ Press MEM soft key or press button  or .
- ▶ Press RCV soft key (received calls).  
The number of received calls and then the call last received appear briefly in the display.
- ▶ Select desired telephone number with button  or .
- ▶ When you have selected a number, press  button.  
The call will be made.

- Speed dial  
If you have stored telephone numbers as speed dial numbers in your telephone, you can also enter these with buttons  to  on the radio head unit.
  - ▶ Press desired button  to  briefly.
  - ▶ Press  button.  
The call will be made.
- Turbo dial  
If you have stored telephone numbers as turbo dial numbers in your telephone, you can also enter these with buttons  to  on the radio head unit.
  - ▶ Press desired button  to  until the call is made.

**Redial**

If the number you have dialed is busy, you can again place calls to the last ten telephone numbers dialed using the redial function.



If you have activated the automatic redial function on your telephone, the number of the person being called is automatically redialed after a short waiting period if there is a busy signal. Refer to the separate operating instructions for the mobile telephone.

- Manual redial



- ▶ Press button.

The telephone number last dialed will appear in the display.

- ▶ Select desired telephone number with button or .

The letter L and the number of the memory position appears in the left-hand corner of the display. The numbers are stored in the order of the calls received.

- ▶ When you have selected a number, press button.

The call will be made.

**Accepting an incoming call**

If the telephone is active in the background (reception symbol is visible in the display), the audio source is muted when an incoming call is received. A ringing tone can be heard and the caller's telephone number, or the name under which the telephone number has been saved in the phone book, appears in the display. If the caller's number is not transmitted with the call, CALL will appear in the display.

- ▶ Press button.

The call is accepted.

### Audio system

#### *Muting a call*

It is possible to mute a call; the caller is then no longer able to hear you.

- Mute on
  - ▶ Press MUT soft key.
  - ▶ MIC MUTE will appear in the display.
- Mute off
  - ▶ Press MUT soft key again.

#### *Terminating a call*

- ▶ Press  button.

The current call is terminated and the muted audio source becomes active again.

#### *Talking with two callers at the same time*

If you wish to receive or place another call during an already active call, you can accept or place the second call and switch between the callers or combine them into one call. Note that the features described here are depending on availability from your mobile phone service provider.

- Placing/accepting a second call
  - ▶ Place new call by entering telephone number manually.
  - ▶ Press  button.

You are connected to the second caller; the first caller is kept on hold.



or





- ▶ Press  button to accept a second call.



You will be notified of the second call acoustically, but you will not see this in the display.

You are connected with the second caller; the first caller is kept on hold.

- Switching between calls
  - ▶ Press  and  buttons.  
This switches between the calls.  
The non-active call is kept on hold.

- Terminating a call
  - ▶ Press  button.  
The current call is terminated. You are again connected with the caller previously placed on hold.
- Combining two calls
  - ▶ Press  and  buttons.  
The calls are combined into one call.
- Terminating a combined call
  - ▶ Press  button.  
The connection to both callers is terminated.

### TDMA or CDMA network phones

Using your Mercedes-Benz specified mobile telephone\*, a number of functions and operating steps can be performed and displayed in the audio system display.

Further operating instructions not covered here can be found in the operating instructions for the multifunction steering wheel and the mobile telephone\*.

If your audio system is set up for telephone operation, the  symbol will appear in the display.

When you insert your Mercedes-Benz specified mobile telephone\* into the telephone cradle, you will be prompted to enter your PIN for 30 seconds (▷ page 231). This display disappears when you press any button.

When your mobile telephone is inserted into the telephone cradle, you will see the reception strength in the upper right-hand corner of the display.



### Switching on the telephone

#### Switching on the telephone

- ▶ Press  button.

If you have programmed an unlock code for the telephone, you must now enter the code.



- ▶ Enter code using buttons  to .
- ▶ If necessary, correct number entered with the CLR soft key. Press soft key briefly to delete the last digit entered; press soft key and hold to delete the complete number.





### Audio system

- ▶▶ Press OK soft key after entering correct code.

The telephone is unlocked. If you have entered an incorrect code, you must enter the correct code.

#### Switching off the telephone

- ▶ Press **TEL** button for approx. 3 seconds.

PROCESSING appears in the display until the telephone is off. Afterward, PHONE OFF appears in the display.

#### Adjusting the volume

- ▶ Turn rotary control of  button during a telephone call.

The volume will increase or decrease depending on the direction turned.



The volume can be adjusted separately for telephone mode and audio mode.

#### Adjusting sound

- ▶ Adjust sound during a telephone call. Sound adjustment (▶ page 203).

#### Placing a call

#### Entering a telephone number and starting the dialing process



- ▶ Enter desired telephone number using buttons **1** to **0**.

The number can have up to 32 digits, but only twelve of these are visible in the display.

- ▶ If necessary, correct number entered with the CLR soft key. Press soft key briefly to delete the last digit entered; press soft key and hold to delete the complete number.
- ▶ After correct telephone number has been entered, press  button.



If the telephone number has been saved together with a name in the phone book, the name will appear in the display.

#### Phone book

The numbers stored in the phone book of the mobile telephone can be called up either by name or number.

In addition, incoming calls are stored in the phone book.



This is only possible, however, when the call information transmitted includes the number of the person calling. If the telephone number is not transmitted, NO NUMBER will be stored in the phone book.

- Searching and calling up phone book entries by name

You can access your mobile telephone's phone book with the audio system. You can access both the main entries and the sub-entries of your phone book.



- ▶ Press MEM soft key or press button or .
- ▶ Press desired numerical key to .

The stored entries are selected according to the alphabetical order of the initial letters (e.g. for S-Schneider, press button four times).

or

- ▶ Press and hold button or .

The system jumps from one initial letter to the next in ascending or descending order.

- ▶ Press and hold button or until desired initial letter has been reached.

or

- ▶ Press button or repeatedly until desired entry has been reached.

The stored entries are selected in alphabetical order with the sub-entries.



Several sub-entries can be stored for each main entry (name). These entries are marked by a corresponding abbreviation that appears in the upper left-hand corner of the display. The following abbreviations for sub-entries are possible:





CEL = Mobile phone  
 HOM = Home  
 WOR = Work  
 FAX = Fax  
 PAG = Pager  
 TEL = Main











### Audio system

- ▷▷ ▶ When you have selected a number, press  button.  
The call will be made.
- Viewing the telephone number of a phone book entry
  - ▶ Search for desired entry.
  - ▶ Press NUM soft key.  
The telephone number of the phone book entry appears in the display.
- Returning calls received



- ▶ Press MEM soft key or press button  or .
- ▶ Press RCV soft key (received calls).  
The number of received calls and then the call last received appear briefly in the display.
- ▶ Select desired telephone number with button  or .
- ▶ When you have selected a number, press  button.  
The call will be made.

- Speed dial  
If you have stored telephone numbers as speed dial numbers in your telephone, you can also enter these with buttons  to  on the radio unit.
  - ▶ Press desired button  to  briefly.
  - ▶ Press  button.  
The call will be made.
- Turbo dial  
If you have stored telephone numbers as turbo dial numbers in your telephone, you can also enter these with buttons  to  on the radio unit.
  - ▶ Press desired button  to  until the call is made.

**Redial**

If the number you have dialed is busy, you can again place calls to the last ten telephone numbers dialed using the redial function.



If you have activated the automatic redial function on your mobile telephone, the number of the person being called is automatically redialed after a short waiting period if there is a busy signal. Refer to the separate operating instructions for the mobile telephone.

- Manual redial



P82.60-4621-31

- ▶ Press button.

The telephone number last dialed will appear in the display.

- ▶ Select desired telephone number with button or .

The letter L and the number of the memory position appears in the left-hand corner of the display. The numbers are stored in the order of the calls received.

- ▶ When you have selected a number, press button.

The call will be made.

**Accepting an incoming call**

If the telephone is active in the background (reception symbol is visible in the display), the audio source is muted when an incoming call is received. A ringing tone can be heard and the caller's telephone number, or the name under which the telephone number has been saved in the telephone book, appears in the display. If the caller's number is not relayed, CALL will appear in the display.

- ▶ Press button.

The call is accepted.

### Audio system

#### *Muting a call*

It is possible to mute a call; the caller is then no longer able to hear you.

- Mute on
  - ▶ Press MUT soft key.
  - ▶ MIC MUTE will appear in the display.
- Mute off
  - ▶ Press MUT soft key again.

#### *Terminating a call*

- ▶ Press  button.

The current call is terminated and the muted audio source becomes active again.

#### *Accepting a second incoming call*



If you receive another call during an already active call, you can accept the second call and switch between the two.

- Accepting a second call
  - ▶ Place new call by entering telephone number manually.



You will be notified of the second call acoustically, but you will not see this in the display.

You are connected to the second caller; the first caller is kept on hold.

- Switching between calls
  - ▶ Press  button.  
This switches between the calls. The non-active call is kept on hold.
- Terminating a call
  - ▶ Press  button.  
The current call is terminated. The connection to the caller previously kept on hold is also interrupted; however, reconnection is indicated by an acoustic signal.

### Placing a second call

If you wish to place another call during an already active call, you can place the second call and switch between the callers or combine them into one call. Note that this feature is dependent on availability from your mobile phone service provider.

- Placing a second call

- ▶ Place a new call by entering telephone number manually.
- ▶ Press  button.

You are connected to the second caller; the first caller is kept on hold.

- Terminating a call
  - ▶ Press  button.

The current call is terminated. The connection to the caller previously kept on hold is also interrupted; however, reconnection is indicated by an acoustic signal.
- Combining two calls
  - ▶ Press  button.

The calls are combined into one call.
- Terminating a combined call
  - ▶ Press  button.

The connection to both callers is terminated.

### Emergency calls “911”

The following describes how to dial a “911” emergency call using the audio system head unit when a Mercedes-Benz specified mobile phone\* is inserted in the phone cradle\*. Unless otherwise specified, the descriptions refer to the audio system head unit.

Consult the separate telephone operating instructions that came with your mobile phone\* for information on how to place a “911” emergency call on the mobile phone\*.

#### Warning!



The “911” emergency call system is a public service. Using it without due cause is a criminal offense.

### Audio system

The following conditions must be met for a “911” emergency call:

- Telephone must be switched on.
- The corresponding mobile communications network must be available.



Emergency calls may not be possible with all telephone networks or if certain network services and/or telephone functions are active. Check with your local service providers.

If you cannot make an emergency call, you will have to initiate rescue measures yourself.

### GSM network phones

#### *Placing a “911” emergency call using audio head unit with the phone locked*

- ▶ Press **TEL** button to switch to telephone operation.  
PIN? appears in the audio display.
- ▶ Enter 9 1 1 using the number keypad on the audio head unit.
- ▶ Press OK soft key or  button for dialing to begin.  
DIALING appears in the audio display while the telephone establishes the connection.
- ▶ Wait until the emergency call center answers, then describe the emergency.

#### *Placing a “911” emergency call using audio head unit with the phone unlocked*

- ▶ Press **TEL** button to switch to telephone operation.
- ▶ Enter 9 1 1 using the number keypad on the audio head unit.
- ▶ Press  button for dialing to begin.  
DIALING appears in the audio display while the telephone establishes the connection.
- ▶ Wait until the emergency call center answers, then describe the emergency.



If no SIM card is in the mobile phone, NO SERVICE appears in the audio display. In that case, you only can make an emergency call on the mobile phone itself, without the use of the head unit.

## TDMA/CDMA network phones

### *Placing a “911” emergency call using audio head unit with the phone locked*

- ▶ Press **TEL** button to switch to telephone operation.  
CODE? appears in the audio display.
- ▶ Enter 911 using the number keypad on the audio head unit.
- ▶ Press OK soft key or  button for dialing to begin.  
DIALING appears in the audio display while the telephone establishes the connection.
- ▶ Wait until the emergency call center answers, then describe the emergency.

### *Placing a “911” emergency call using audio head unit with the phone unlocked*

- ▶ Press **TEL** button to switch to telephone operation.
- ▶ Enter 911 using the number keypad on the audio head unit.
- ▶ Press  button for dialing to begin.  
DIALING appears in the audio display while the telephone establishes the connection.
- ▶ Wait until the emergency call center answers, then describe the emergency.



### Power windows

#### Opening and closing the windows

The side windows are opened and closed electrically. The switches for all the side windows are on the driver's door. The switches for the respective windows are on the front passenger door and the rear doors.



- ① Left front window
- ② Right front window
- ③ Right rear window
- ④ Left rear window
- ⑤ Rear window override switch  
(▷ page 85)



#### Warning!



When closing the power windows, make sure there is no danger of anyone being harmed by the closing procedure.

The closing of the door windows can be immediately halted by releasing the switch or, if switch was pulled past the resistance point and released, by either pressing or pulling the respective switch.



If the window encounters an obstruction that blocks its path in a circumstance where you pulled the switch past the resistance point and released it to close the window, the automatic reversal function will stop the window and open it slightly.

If the window encounters an obstruction that blocks its path in a circumstance where you are closing the window by pulling and holding the switch, by pressing and holding button  on the SmartKey, or by pressing and holding button  or  on the climate control panel, the automatic reversal function will not operate.

When leaving the vehicle, always remove the SmartKey from the starter switch, take it with you, and lock the vehicle. Do not leave children unattended in the vehicle, or with access to an unlocked vehicle. Unsupervised use of vehicle equipment can cause an accident and/or serious personal injury.



You can also open or close the power windows using the SmartKey, see “Summer opening feature” (▷ page 243) and “Convenience closing feature” (▷ page 243).

Depending on current position, the windows may also open or close when the air recirculation button  in the control panel of the climate control (▷ page 177) or automatic climate control\* (Canada only) (▷ page 187), or the charcoal filter button  in the control panel of the automatic climate control\* (Canada only) (▷ page 194) is pressed and held.

- ▶ Switch on the ignition (▷ page 33).

### Opening the windows

- ▶ Press switch ① to ④ to the resistance point.

The corresponding window will move downwards until you release the switch.

### Closing the windows

- ▶ Pull switch ① to ④ to the resistance point.

The corresponding window will move upwards until you release the switch.

### Warning!



If you pull and hold the switch up when closing the window, and upward movement of the window is blocked by some obstruction including but not limited to arms, hands, fingers, etc., the automatic reversal will not operate.

### Fully opening the windows (Express-open)

- ▶ Press switch ① to ④ past the resistance point and release.

The corresponding window opens completely.

### Fully closing the windows (Express-close)

- ▶ Pull switch ① to ④ past the resistance point and release.

The corresponding window closes completely.

### Power windows



If the upward movement of the window is blocked during the closing procedure, the window will stop and open slightly.

Remove the obstruction, pull the switch again past the resistance point and release.

If the window still does not close when there is no obstruction, then pull and hold the switch again. The side window will then close without the obstruction sensor function.

#### Warning!



Driver's door only:

If within 5 seconds you again pull the switch past the resistance point and release, the automatic reversal will not function.

#### Stopping windows

- ▶ Press or pull respective switch again.

#### Synchronizing power windows

The power windows must be resynchronized each time



- after the battery has been disconnected or discharged.
  - if the power windows cannot be fully opened (Express-open) or closed (Express-close).
- ▶ Switch on the ignition (▷ page 33).
  - ▶ Pull the power window switches until the side windows are closed.  
Hold the switches for approximately 1 second.  
The power windows are synchronized.

### Summer opening feature

If the weather is warm, you can ventilate the vehicle before driving off by simultaneously:

- opening the side windows
- opening the tilt/sliding sunroof\*



- ▶ Aim transmitter eye at the driver's door handle. The SmartKey must be in close proximity to the door handle.
- ▶ Press and hold button  until the windows and the tilt/sliding sunroof\* have reached the desired position.
- ▶ Release button  to interrupt procedure.



### Convenience closing feature



#### Warning!



When closing the windows and the tilt/sliding sunroof\*, make sure that there is no danger of anyone being harmed by the closing procedure.

If potential danger exists, proceed as follows:

- Release button  to stop the closing procedure. To open, press and hold button . To continue the closing procedure after making sure that there is no danger of anyone being harmed by the closing procedure, press and hold button .

- ▶ Aim transmitter eye at the driver's door handle. The SmartKey must be in close proximity to the door handle.
- ▶ Press and hold button  until the windows and the tilt/sliding sunroof\* are completely closed.
- ▶ Release the  button to stop procedure.

Make sure all windows and the tilt/sliding sunroof\* are properly closed before leaving the vehicle.

### Power tilt/sliding sunroof\*

#### Opening and closing the power tilt/sliding sunroof

The tilt/sliding sunroof can be opened and closed electrically. The switch for the tilt/sliding sunroof is on the overhead control panel.



#### Sunroof switch

- ① Push up to raise sunroof at rear
- ② Pull down to lower sunroof at rear
- ③ Push forward to slide sunroof closed
- ④ Push back to slide sunroof open

With the sunroof closed or tilted open, a screen can be slid into the roof opening to guard against sun rays. When sliding the sunroof open, the screen will also retract.



#### Screen

#### Warning!



When closing the tilt/sliding sunroof, make sure there is no danger of anyone being harmed by the closing procedure.

The opening/closing procedure of the tilt/sliding sunroof can be immediately halted by releasing the switch or, if the switch was moved past the resistance point and released, by moving the switch in any direction.

The tilt/sliding sunroof is made out of glass. In the event of an accident, the glass may shatter. This may result in an opening in the roof.

In a vehicle rollover, occupants not wearing their seat belts or not wearing them properly may be thrown out of the opening. Such an opening also presents a potential for injury for occupants wearing their seat belts properly as entire body parts or portions of them may protrude from the passenger compartment.

When leaving the vehicle, always remove the SmartKey from the starter switch, take it with you, and lock the vehicle. Do not leave children unattended in the vehicle, or with access to an unlocked vehicle. Unsupervised use of vehicle equipment can cause an accident and/or serious personal injury.





To avoid damaging the seals, do not transport any objects with sharp edges which can stick out of the tilt/sliding sunroof.

Do not open the tilt/sliding sunroof if there is snow or ice on the roof, as this could result in malfunctions.

The tilt/sliding sunroof can be opened or closed manually should an electrical malfunction occur (▷ page 393).



You can also open or close the tilt/sliding sunroof using the SmartKey, see “Summer opening feature” (▷ page 243) and “Convenience closing feature” (▷ page 243).

Depending on current position, the tilt/sliding sunroof may also open or close when the air recirculation button  in the control panel of the climate control (▷ page 177) or automatic climate control\* (Canada only) (▷ page 192), or the charcoal filter button  in the control panel of the automatic climate control\* (Canada only) (▷ page 194) is pressed and held.

- ▶ Switch on the ignition (▷ page 33).

### Opening and closing the power tilt/sliding sunroof

- ▶ To open, close, raise, or lower the tilt/sliding sunroof, move the sunroof switch to resistance point in the required direction of arrows ① to ④.

Release the sunroof switch when the tilt/sliding sunroof has reached the desired position.

### Fully opening (Express-open) and closing (Express-close) the power tilt/sliding sunroof

- ▶ To open or close the tilt/sliding sunroof, move the sunroof switch past the resistance point in the required direction of arrow ① to ④ and release.

The tilt/sliding sunroof opens or closes completely.

### Power tilt/sliding sunroof\*

#### Stopping the power tilt/sliding sunroof during Express-operation

- ▶ Move the sunroof switch in any direction.



If the movement of the tilt/sliding sunroof is blocked during the closing procedure, the tilt/sliding sunroof will stop and reopen slightly.

#### Synchronizing the power tilt/sliding sunroof

---

The tilt/sliding sunroof must be synchronized

- after the battery has been disconnected or discharged
- after the tilt/sliding sunroof has been closed manually (▷ page 393)
- after a malfunction
- if the tilt/sliding sunroof does not open smoothly

- ▶ Switch on the ignition (▷ page 33).
- ▶ Move and hold the sunroof switch in the direction of arrow ① (▷ page 244) until the tilt/sliding sunroof is fully raised at the rear.

Hold the sunroof switch for approximately 1 second.

- ▶ Check the Express-open feature (▷ page 245).

If the tilt/sliding sunroof opens completely, the tilt/sliding sunroof is synchronized. Otherwise repeat the above steps.

## ▼ Driving systems

The driving system of your vehicle is described on the following pages:

- Cruise control, with which the vehicle can maintain a preset speed.

For information on the BAS, ABS, and ESP® driving systems, see “Driving safety systems” (▷ page 87).

### Cruise control

Cruise control automatically maintains the speed you set for your vehicle.

Use of cruise control is recommended for driving at a constant speed for extended periods of time. You can set or resume cruise control at any speed over 20 mph (30 km/h).

The cruise control function is operated by means of the cruise control lever.

The cruise control lever is the uppermost lever on the left-hand side of the steering column (▷ page 22).

### Warning!



Cruise control is a convenience system designed to assist the driver during vehicle operation. The driver is and must remain at all times responsible for the vehicle speed and for safe brake operation.

Only use cruise control if the road, traffic and weather conditions make it advisable to travel at a steady speed.

- The use of cruise control can be dangerous on winding roads or in heavy traffic because conditions do not allow safe driving at a steady speed.
- The use of cruise control can be dangerous on slippery roads. Rapid changes in tire traction can result in wheel spin and loss of control.
- Deactivate cruise control when driving in fog.

The “Resume” function should only be operated if the driver is fully aware of the previously set speed and wishes to resume this particular preset speed.



### Driving systems

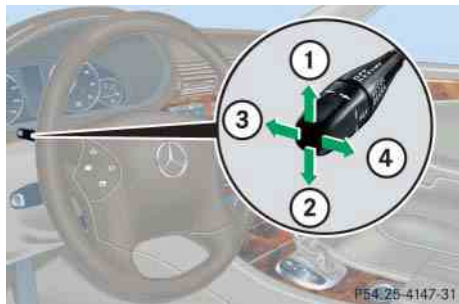

- ① Sets current or higher speed
- ② Sets current or lower speed
- ③ Cancels cruise control
- ④ Resumes at last set speed

#### Setting current speed

- ▶ Accelerate or decelerate to the desired speed.
- ▶ Briefly lift ① or depress ② the cruise control lever.

The current speed is set.

- ▶ Remove your foot from the accelerator pedal.

Cruise control is activated.



On uphill or downhill grades, cruise control may not be able to maintain the set speed. Once the grade eases, the set speed will be resumed.

#### Canceling cruise control

There are several ways to cancel cruise control:

- ▶ Step on the brake pedal.

Cruise control is canceled. The last speed set is stored for later use.

or

- ▶ Briefly push the cruise control lever to position ③.

Cruise control is canceled. The last speed set is stored for later use.



Vehicles with automatic transmission: Moving the gear selector lever to position **N** while driving also cancels cruise control. However, the gear selector lever should not be moved to position **N** while driving, except to coast when the vehicle is in danger of skidding (e.g. on icy roads).



Vehicles with manual transmission: The set cruise controlled speed is switched off when declutching exceeds 4 seconds during shifting a new gear.



The last stored speed is canceled when you turn off the engine.

**Setting a higher speed**

- ▶ Lift cruise control lever to position ① and hold it up until the desired speed is reached.
- ▶ Release cruise control lever.  
The new speed is set.



Depressing the accelerator pedal does not deactivate cruise control. After brief acceleration (e.g. for passing), cruise control will resume the last speed set.

**Setting a lower speed**

- ▶ Depress cruise control lever to position ② and hold it down until the desired speed is reached.
- ▶ Release cruise control lever.  
The new speed is set.



Vehicles with automatic transmission: When you use the cruise control lever to decelerate, the transmission will automatically downshift if the engine's braking power does not brake the vehicle sufficiently.

**Fine adjustment in 1 mph  
(Canada: 1 km/h) increments****Faster**

- ▶ Briefly tip cruise control lever in direction of arrow ①.

**Slower**

- ▶ Briefly tip cruise control lever in direction of arrow ②.

**Setting to last stored speed  
“Resume” function)****Warning!**

The speed stored in memory should only be set again if prevailing road conditions permit. Possible acceleration or deceleration differences arising from returning to preset speed could cause an accident and/or serious injury to you and others.

- ▶ Briefly push cruise control lever to position ④.  
The cruise control resumes the last set speed.
- ▶ Remove your foot from the accelerator pedal.

## Loading

### Roof rack\*

#### Warning!



Only use roof racks approved by Mercedes-Benz for your vehicle model to avoid damage to the vehicle. Follow manufacturer's installation instructions.



- ▶ Mount the roof rack only between the fastening points (see arrows).
- ▶ Secure the roof rack according to manufacturer's instructions for installation.



Load the roof rack in such a way that the vehicle cannot be damaged while driving.

Make sure

- you can fully raise the tilt/sliding sunroof\*.
- you can fully open the trunk.

### Ski sack\* (Canada only)

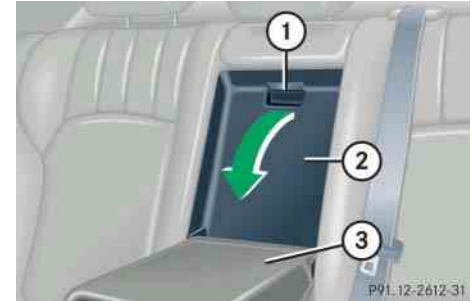

- ① Handle
- ② Cover
- ③ Armrest

### Unfolding and loading

- ▶ Fold armrest ③ down (arrow).
- ▶ Pull handle ① and swing cover ② down.

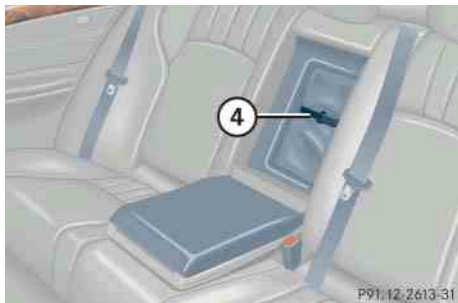

④ Hook and loop fastener

- ▶ Unfasten hook and loop fastener ④.
- ▶ Pull ski sack into passenger compartment and unfold.

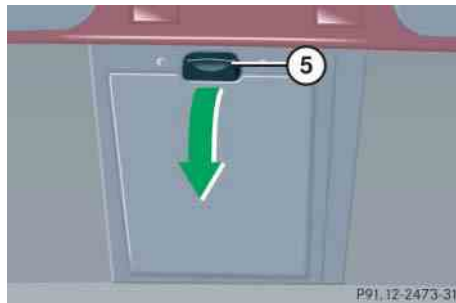

⑤ Button

- ▶ Open trunk lid.
  - ▶ Press button ⑤.
- The flap opens downward.



- ▶ From trunk, slide skis into ski sack.

### Warning!



The ski sack is designed for up to four pairs of skis. Do not load the ski sack with other objects.

Always fasten the ski sack securely. In an accident, an unfastened ski sack can cause injury to vehicle occupants.



### Loading



⑥ Strap

- ▶ Tighten strap ⑥ by pulling at the loose end (arrow) until the skis in the ski sack are tightly secured.

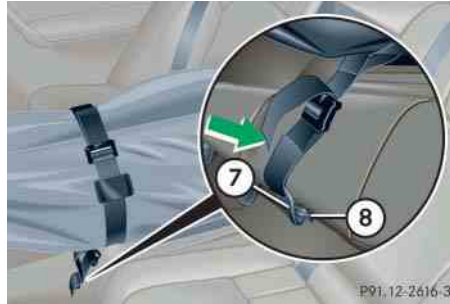

⑦ Hook

⑧ Eye

- ▶ Connect hook ⑦ to eye ⑧.

Tighten strap by pulling at the loose end (arrow).

### Unloading and folding

- ▶ Loosen the straps.
- ▶ Disconnect hook ⑦ from eye ⑧.
- ▶ Unload skis.
- ▶ Close flap in trunk.
- ▶ Fold and flatten ski sack lengthwise.
- ▶ Place folded ski sack inside recess of backrest.
- ▶ Fasten hook and loop fastener.
- ▶ Close ski sack compartment cover.

### Removing the ski sack

You can remove the ski sack for cleaning or drying.

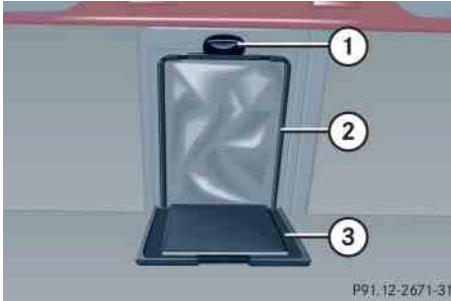

- ① Button
- ② Ski sack frame
- ③ Flap

- ▶ Open trunk lid.
- ▶ Press button ①.

The flap ③ opens downward.

- ▶ Press button ① firmly until ski sack frame ② is released.
- ▶ Pull ski sack frame ② with ski sack out.

### Warning!



Never drive vehicle with trunk open while the ski sack is removed. Deadly carbon monoxide (CO) gases may enter vehicle interior, resulting in unconsciousness and death.



To prevent unauthorized persons from accessing the trunk, always close the flap.

### Installing the ski sack

Install the ski sack in the reverse order.

- ▶ Push ski sack frame ② with ski sack inward until the ski sack frame snaps into place.
- ▶ Close flap ③.
- ▶ Close trunk lid.

### Split rear bench seat\*

To expand the cargo area, you can fold down the left and right rear seat backrests.

The two sections can be folded down separately.

### Warning!



When expanding the luggage area, always fold the seat cushions fully forward.

Unless you are transporting cargo, the backrests must remain properly locked in the upright position.

In an accident, during hard braking or sudden maneuvers, loose items will be thrown around inside the vehicle, and cause injury to vehicle occupants unless the items are securely fastened in the vehicle.

Always use the cargo tie down rings\* (▶ page 256).

### Loading

#### Folding the backrest forward

The release handle ① is located in the trunk.

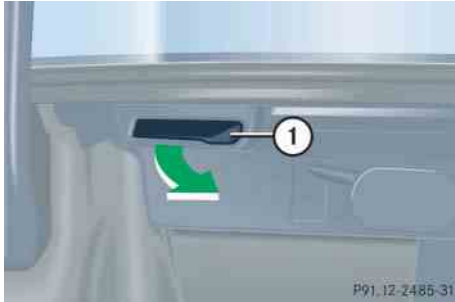

- ▶ Pull release handle ①.
- ▶ Fully retract and fold rearward head restraints (▷ page 111).

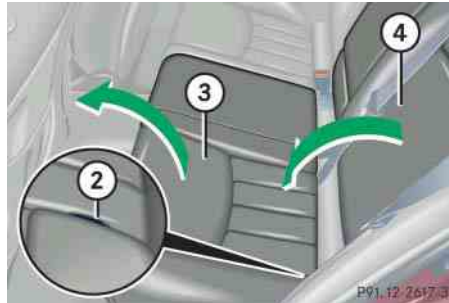

- ▶ Pull release handle ②.
- ▶ Fold seat cushion ③ forward.
- ▶ Fold backrest ④ forward.



Always release the seat cushion and fold it forward before folding the seat backrests forward. Otherwise, the backrest covering may be damaged.

#### Returning the backrest to original position

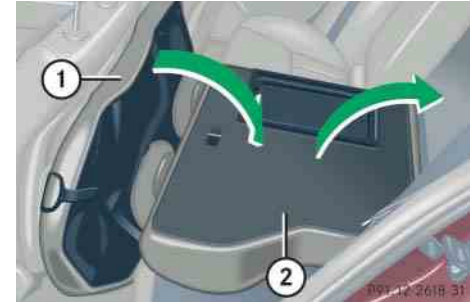

- ▶ Fold backrest ② rearward until it engages.
- ▶ Fold seat cushion ① rearward until it locks into position.

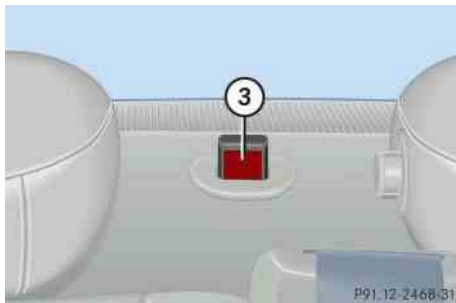

If the backrest is not locked into position, a red indicator ③ will be visible.

- ▶ Check for secure locking by pushing and pulling on the backrest.

### Warning!



If a red indicator is visible with the backrest up, then the backrest is not properly locked into position.

Always lock backrest in its upright position when rear seat bench is occupied, cargo is being carried in the trunk, or the extended cargo compartment is not in use. Check for secure locking by pushing and pulling on the backrest.

In an accident, during hard braking or sudden maneuvers, loose items will be thrown around inside the vehicle, and cause injury to vehicle occupants unless the items are securely fastened in the vehicle.

To help avoid personal injury during a collision or sudden maneuver, exercise care when transporting cargo.



To prevent unauthorized persons from access to the trunk, always lock backrest in its upright position.

### Loading instructions

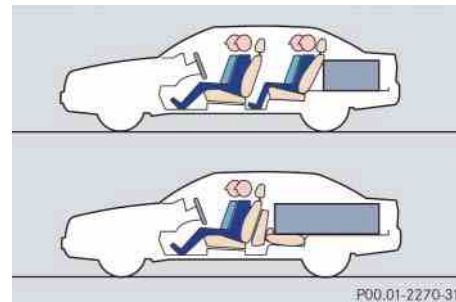

The total load weight including vehicle occupants and luggage/cargo should not exceed the load limit or vehicle capacity weight indicated on the corresponding placard located on the driver's door B-pillar.

The handling characteristics of a fully loaded vehicle depend greatly on the load distribution. It is therefore recommended to load the vehicle according to the illustrations shown, with the heaviest items being placed towards the front of the vehicle.



### Loading

Always place items being carried against front or rear seat backrests, and fasten them as securely as possible.

The heaviest portion of the cargo should always be kept as low as possible since it influences the handling characteristics of the vehicle.

#### Warning!



Always fasten items being carried as securely as possible.

In an accident, during hard braking or sudden maneuvers, loose items will be thrown around inside the vehicle and can cause injury to vehicle occupants unless the items are securely fastened in the vehicle.

To help avoid personal injury during a collision or sudden maneuver, exercise care when transporting cargo.

Never drive vehicle with trunk open. Deadly carbon monoxide (CO) gases may enter vehicle interior resulting in unconsciousness and death.



The trunk is the preferred place to carry objects.

The enlarged cargo area should only be used for items which do not fit in the trunk alone.

#### Cargo tie-down rings\*

The four cargo tie-down rings are located in the trunk.

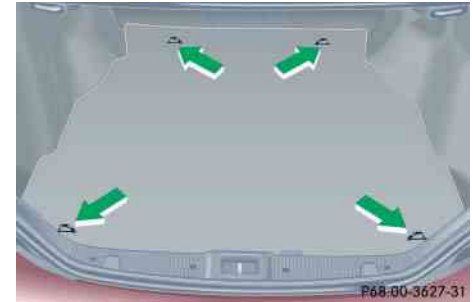

#### Cargo tie-down rings

- ▶ Carefully secure cargo by applying even load on all rings with rope sufficient strength to hold down the cargo.

Always follow loading instructions (▷ page 255).

## ▼ Useful features

### Storage compartments

#### Warning!



To help avoid personal injury during a collision or sudden maneuver, exercise care when storing objects in the vehicle. Put luggage or cargo in the trunk if possible. Do not pile luggage or cargo higher than the seat backs. Do not place anything on the shelf below the rear window.

Luggage nets cannot secure hard or heavy objects.

Keep compartment lids closed. This will help to prevent stored objects from being thrown about and injuring vehicle occupants during an accident.

### Glove box

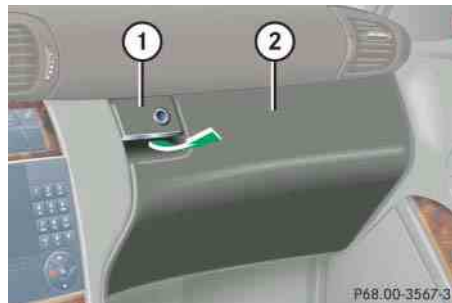

- ① Glove box lid release
- ② Glove box

#### Opening glove box

- ▶ Pull glove box lid release ①.
- The glove box lid opens ② downward.

#### Closing glove box

- ▶ Push glove box lid ② up to close.



Audio system/COMAND\* with CD changer\*: The CD changer\* is located in the glove box.

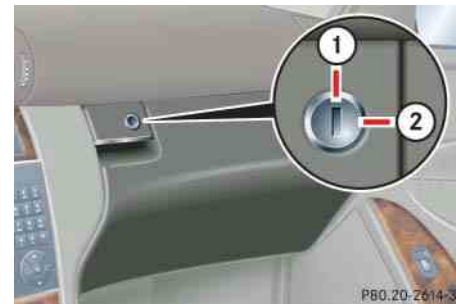

- ① Unlocking
- ② Locking

#### Locking glove box

- ▶ Insert mechanical key (▷ page 389) into the glove box lock and turn it to position ②.

#### Unlocking glove box

- ▶ Turn mechanical key in the glove box lock to position ①.

### Useful features

#### Armrest storage compartments

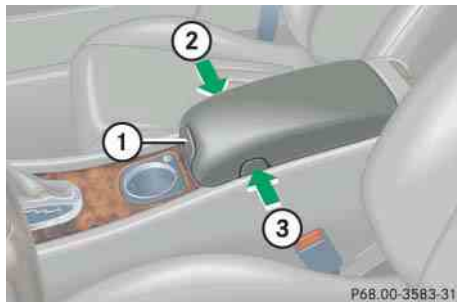

- ① Handle
- ② Button, passenger side
- ③ Button, driver's side

#### Opening storage compartment

- ▶ Pull handle ① and lift armrest.

#### Closing storage compartment

- ▶ Press armrest down until it engages into place.

#### Opening telephone compartment

- ▶ Press button ③ on driver's side or button ② on passenger side and lift armrest.

#### Closing telephone compartment

- ▶ Press armrest down until it engages into place.

#### Armrest in the rear passenger compartment



- ▶ Pull the top of the armrest out and fold it down.

#### Parcel net in front passenger footwell (all models, except C 280 4MATIC and C 350 4MATIC)

A small convenience parcel net is located in the front passenger footwell. It is for small and light items, such as road maps, mail, etc.

#### Warning!



The parcel net is intended for storing light-weight items only.

Heavy objects, objects with sharp edges or fragile objects may not be transported in the parcel net. In an accident, during hard braking, or sudden maneuvers, they could be thrown around inside the vehicle and cause injury to vehicle occupants.

The parcel net cannot protect transported goods in the event of an accident.

## Cup holders

### Warning!



In order to help prevent spilling liquids on vehicle occupants and/or vehicle equipment, only use containers that fit into the cup holder. Use lids on open containers and do not fill containers to a height where the contents, especially hot liquids, could spill during braking, vehicle maneuvers, or an accident. Liquids spilled on vehicle occupants may cause serious personal injury. Liquids spilled on vehicle equipment may cause damage not covered by the Mercedes-Benz Limited Warranty.

When not in use, keep the cup holder closed. An open cup holder may cause injury to you or others when contacted during braking, vehicle maneuvers, or in an accident.

Keep in mind that objects placed in the cup holder may come loose during braking, vehicle maneuvers, or in an accident and be thrown around in the vehicle interior. Objects thrown around in the vehicle interior may cause an accident and/or serious personal injury.

### Cup holders in front of seat armrest

Underneath the swiveling cup holder is another stationary cup holder. You can only use this when the swiveling cup holder is pulled out and completely turned outward.

### Sliding out swiveling cup holder



- ▶ Push button ①.

The cup holder slides upward.



No objects should be in the swiveling cup holder when the swiveling cup holder is slid upward. Otherwise the swiveling cup holder or the objects could be damaged.

### Useful features

#### Turning swiveling cup holder outward



- ▶ Turn the cup holder in direction of arrow ② until it engages.  
You can now use both cup holders.

#### Turning swiveling cup holder inward and sliding it in



- ▶ Turn the cup holder in direction of arrow ③ until it engages.
- ▶ Press the cup holder in direction of arrow ④ until it engages.



No objects should be in the stationary cup holder when the swiveling cup holder is turned inward and pushed in. Otherwise the swiveling cup holder or the objects could be damaged.

#### Cup holder in rear seat armrest

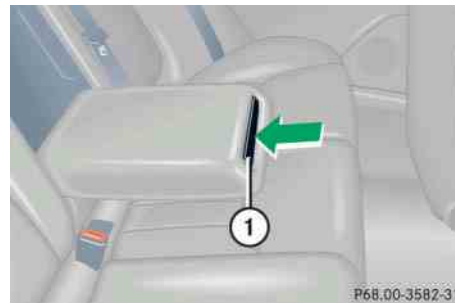

- ① Cup holder

#### Opening cup holder

- ▶ Briefly press the front of cup holder ①.  
The cup holder slides out slightly.
- ▶ Pull out the cup holder until it stops.

#### Closing cup holder

- ▶ Slide cup holder back until it engages.

### Ashtrays

#### Center console ashtray

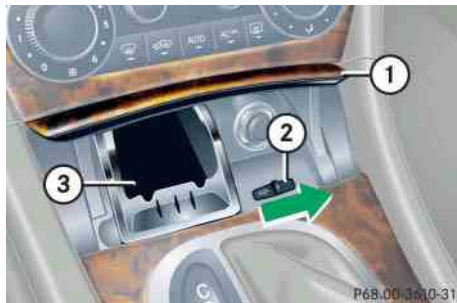

- ① Cover plate
- ② Sliding button
- ③ Ashtray insert

- ▶ Briefly press the bottom of cover plate ①.

The cover plate opens automatically.

#### Removing ashtray insert

#### Warning!



Remove front ashtray only with vehicle standing still. Set the parking brake to secure vehicle from movement. Move gear selector lever to position **N** (manual transmission: second gear). With gear selector lever in position **N** (manual transmission: second gear) turn off the engine.

- ▶ Secure vehicle from movement by setting the parking brake.
- ▶ Move the gear selector lever to position **N** (manual transmission: second gear).

Now you have more room to take out the ashtray insert.

- ▶ Push sliding button ② to the right.  
The ashtray insert ③ slides out slightly.
- ▶ Remove the ashtray insert.

#### Reinstalling ashtray insert

- ▶ Push the ashtray insert ③ down into the retainer until it engages.
- ▶ Push down cover plate ① to close ashtray.

The cover plate engages.

#### Rear seat ashtray



- ① Button
- ② Ashtray insert
- ③ Cover

- ▶ Pull at top of cover ③.

### Useful features

#### *Removing ashtray insert*

- ▶ Push button ① to disengage ashtray insert ② and remove it.

#### *Reinstalling ashtray insert*

- ▶ Push the ashtray insert ② down into the retainer until it engages.
- ▶ Push at top of cover ③ to close ashtray.

#### Cigarette lighter

##### Warning!



Never touch the heating element or sides of the lighter; they are extremely hot. Hold the knob only.

When leaving the vehicle, always remove the SmartKey from the starter switch, take it with you, and lock the vehicle. Do not leave children unattended in the vehicle, or with access to an unlocked vehicle. Unsupervised use of vehicle equipment may cause an accident and/or serious personal injury.

- ▶ Switch on the ignition (▷ page 33).



- ① Cover plate
- ② Cigarette lighter

- ▶ Briefly press the bottom of cover plate ①.

The cover plate opens automatically.

- ▶ Push in cigarette lighter ②.

The cigarette lighter will pop out automatically when hot.



The lighter socket can be used to accommodate 12V DC electrical accessories (up to a maximum of 85 W) designed for use with the standard “cigarette lighter” plug type. Keep in mind, however, that connecting accessories to the lighter socket (for example extensive connecting and disconnecting, or using plugs that do not fit properly) can damage the lighter socket. With the socket damaged, the lighter may no longer be able to be placed in the heating (pushed-in) position, or the lighter may pop out too early with the lighter not hot enough.

To help avoid damaging the cigarette lighter socket, we recommend connecting 12V DC electrical accessories designed for use with the standard “cigarette lighter” plug type to the 12V power outlets (▷ page 263) in your vehicle whenever possible.

- ▶ Push down cover plate ① to close ashtray.

The cover plate engages.

### Power outlet

The power outlet is located in the rear passenger compartment.



- ① Power outlet
- ② Cover

- ▶ Switch on the ignition (▷ page 33).
- ▶ Pull at top of cover ②.
- ▶ Flip cover ① to the left and insert electrical plug (cigarette lighter type).



The power outlet can be used to accommodate 12V DC electrical accessories (e.g. air pump, auxiliary lamps) up to a maximum of 180 W.



### Useful features

#### Telephone\*

##### Warning!



Never operate radio transmitters equipped with a built-in or attached antenna (i.e. without being connected to an external antenna) from inside the vehicle while the engine is running. Doing so could lead to a malfunction of the vehicle's electronic system, possibly resulting in an accident and personal injury.

Radio transmitters, such as a portable telephone or a citizens band unit, should only be used inside the vehicle if they are connected to an antenna that is installed on the outside of the vehicle.

The external antenna must be approved by Mercedes-Benz. Please contact an authorized Mercedes-Benz Center for information on the installation of an approved external antenna. Refer to the radio transmitter operation instructions regarding use of an external antenna.

##### Warning!





Please do not forget that your primary responsibility is to drive the vehicle. A driver's attention to the road must always be his/her primary focus when driving. For your safety and the safety of others, we recommend that you pull over to a safe location and stop before placing or taking a telephone call.

If you choose to use the telephone<sup>1</sup> while driving, please use the hands-free device and only use the telephone when road, weather and traffic conditions permit. Some jurisdictions prohibit the driver from using a cellular telephone while driving a vehicle.

Only operate the COMAND\* (Cockpit Management and Data System)<sup>1</sup> if road, weather and traffic conditions permit.

Bear in mind that at a speed of just 30 mph (approximately 50 km/h), your vehicle is covering a distance of 44 feet (approximately 14 m) every second.

<sup>1</sup> Observe all legal requirements.

You can take and place telephone calls using the  and  buttons on the steering wheel. To carry out other telephone functions, use the control system (▷ page 157).

See separate operating manual for instructions on how to use the telephone.

## Tele Aid\*



The initial activation of the Tele Aid system may only be performed by completing the subscriber agreement and placing an acquaintance call using the  button. Failure to complete either of these steps will result in a system that is not activated.

If you have any questions regarding activation, please call the Response Center at 1-800-756-9018 (in the USA) or 1-888-923-8367 (in Canada).

Shortly after the completion of your Tele Aid acquaintance call, you will receive a user ID and password. By visiting [www.mbusa.com](http://www.mbusa.com) and selecting “Tele Aid” (USA only), you will have access to account information, remote door unlock and more.



## The Tele Aid system



(Telematic Alarm Identification on Demand)

The Tele Aid system consists of three types of response:

- automatic and manual emergency
- roadside assistance
- information

The Tele Aid system is operational providing that the vehicle’s battery is charged, properly connected, not damaged and cellular and GPS coverage is available.



The speaker volume of a Tele Aid call can be adjusted when using the volume control on the audio system or COMAND\* System or on the multifunction steering wheel. To raise, turn the rotary volume control on audio system or COMAND\* System clockwise or press button  on the multifunction steering wheel. To lower, turn the rotary volume control on audio system or COMAND\* System control counterclockwise or press button  on the multifunction steering wheel.

- ▶ To activate, press the SOS button, the Roadside Assistance button  or the Information button , depending on the type of response required.

### Useful features



The SOS button is located in the overhead control panel.

The Roadside Assistance button  and the Information button  are located below the center armrest cover.





The Tele Aid system utilizes the cellular network for communication and the GPS (Global Positioning System) satellites for vehicle location. If either of these signals are unavailable, the Tele Aid system may not function and if this occurs, assistance must be summoned by other means.



When a Tele Aid call has been initiated, the audio system or COMAND\* System unit is muted and the selected mode (radio, tape or CD) pauses. The optional cellular phone (if installed) and inserted in cradle switches off. If you must use this phone, we recommend that you use it only with the vehicle at a standstill in a safe location. Remove the phone from the cradle and place the call. The navigation\* system (if engaged) will continue to run. The multifunction display in the instrument cluster is available for use, and spoken commands are only available by pressing the RPT button on audio system or COMAND\* System unit. A pop-up window will appear in the audio system or COMAND\* System unit display to indicate that a Tele Aid call is in progress. After the TeleAid call has ended, the optional cellular phone switches on again. A PIN entry might be necessary.

### System self-check

Initially, after switching on ignition, malfunctions are detected and indicated (the indicator lamps in the SOS button, the Roadside Assistance button  and the Information button  stay on longer than 10 seconds or do not come on). The message Malfunction. Drive to workshop appears in the multifunction display.

#### Warning!



If the indicator lamps on the SOS button, on the Roadside Assistance button, and/or on the Information button remain illuminated continuously in red and/or the message Malfunction. Drive to workshop is displayed in the multifunction display after the system self-check, a malfunction in the system has been detected.

If a malfunction is indicated as outlined above, the system may not operate as expected. Have the system checked at the nearest Mercedes-Benz Center as soon as possible.

## Emergency calls

An emergency call is initiated automatically following an accident in which the emergency tensioning devices (ETDs) or air bags deploy.

An emergency call can also be initiated manually by opening the cover next to the interior rear view mirror labeled SOS, then briefly pressing the button located under the cover. See (> page 268) for instructions on initiating an emergency call manually.

Once the emergency call is in progress, the indicator lamp on the SOS button will begin to flash. The message **Connecting Call** appears in the multifunction display. When the connection is established, the message **Call connected** appears in the multifunction display. All information relevant to the emergency, such as the location of the vehicle (determined by the GPS satellite location system), vehicle model, identification number and color are generated.

A voice connection between the Response Center and the occupants of the vehicle will be established automatically soon after the emergency call has been initiated. The Response Center will attempt to determine more precisely the nature of the accident provided they can speak to an occupant of the vehicle.

The Tele Aid system is available if

- it has been activated and is operational. Activation requires a subscription for monitoring services, connection and cellular air time
- the relevant cellular phone network and GPS signals are available and pass the information on to the response center



Location of the vehicle on a map is only possible if the vehicle is able to receive signals from the GPS satellite network and pass the information on to the Response Center.

### Warning!



If the indicator lamp in the SOS button is flashing continuously and there was no voice connection to the Response Center established, then the Tele Aid system could not initiate an emergency call (e.g. the relevant cellular phone network is not available). The message **Call failed** appears in the multifunction display for approximately 10 seconds.

Should this occur, assistance must be summoned by other means.

#### Initiating an emergency call manually



- ① Cover
- ② SOS button

- ▶ Briefly press on cover ①.

The cover will open.

- ▶ Press SOS button ② briefly.

The indicator lamp in SOS button ② will flash until the emergency call is concluded.

- ▶ Wait for a voice connection to the Response Center.
- ▶ Close cover ① after the emergency call is concluded.

#### Warning!



If you feel at any way in jeopardy when in the vehicle (e.g. smoke or fire in the vehicle, vehicle in a dangerous road location), please do not wait for voice contact after you have pressed the emergency button. Carefully leave the vehicle and move to a safe location. The Response Center will automatically contact local emergency officials with the vehicle's approximate location if they receive an automatic SOS signal and cannot make voice contact with the vehicle occupants.

#### Roadside Assistance button

The Roadside Assistance button  is located below the center armrest cover.

- ▶ Open the storage compartment under the center armrest (▷ page 258).
- ▶ Press and hold button (for longer than 2 seconds).

A call to a Mercedes-Benz Roadside Assistance dispatcher will be initiated. The button will flash while the call is in progress. The message *Connecting call* will appear in the multifunction display.

When the connection is established, the message *Call connected* appears in the multifunction display. The Tele Aid system will transmit data generating the vehicle identification number, model, color and location (subject to availability of cellular and GPS signals).



While the call is connected you can change to the navigation menu by pressing NAVI button on the audio system or COMAND\* System unit.

A voice connection between the Roadside Assistance dispatcher and the occupants of the vehicle will be established.



- Describe the nature of the need for assistance.

The Mercedes-Benz Roadside Assistance dispatcher will either dispatch a qualified Mercedes-Benz technician or arrange to tow your vehicle to the nearest Mercedes-Benz Center. For services such as labor and/or towing, charges may apply. Refer to the Roadside Assistance Manual for more information.

These programs are only available in the USA:

- Sign and Drive services: Services such as jump start, a few gallons of fuel or the replacement of a flat tire with the vehicle spare tire are obtainable.



The indicator lamp on the Roadside Assistance button  remains illuminated in red for approximately 10 seconds during the system self-check after switching on the ignition (together with the SOS button and the Information button ).

See system self-check (▷ page 266) if the indicator lamp does not come on in red or stays on longer than approximately 10 seconds.

### Useful features

If the indicator lamp on the Roadside Assistance button  is flashing continuously and there was no voice connection to the Response Center established, then the Tele Aid system could not initiate a Roadside Assistance call (e.g. the relevant cellular phone network was not available). The message `Call failed` appears in the multifunction display.

Roadside Assistance calls can be terminated using the  button on the multifunction steering wheel or the END Button on the audio system or COMAND\* System.

#### Information button

The Information button  is located below the center armrest cover.

- ▶ Open the storage compartment under the center armrest (▷ page 258).
- ▶ Press and hold button (for longer than 2 seconds).

A call to the Customer Assistance Center will be initiated. The button will flash while the call is in progress. The message `Connecting call` will appear in the multifunction display.

When the connection is established, the message `Call connected` appears in the multifunction display. The Tele Aid system will transmit data generating the vehicle identification number, model, color and location (subject to availability of cellular and GPS signals).





While the call is connected, you can change to the navigation menu by pressing NAVI button on the audio system or COMAND\* System.

A voice connection between the Customer Assistance Center representative and the occupants of the vehicle will be established. Information regarding the operation of your vehicle, the nearest Mercedes-Benz Center or Mercedes-Benz USA products and services is available to you.

For more details concerning the Tele Aid system, please visit [www.mbusa.com](http://www.mbusa.com) and use your ID and password (sent to you separately) to learn more (USA only).



The indicator lamp in the Information button  remains illuminated in red for approximately 10 seconds during the system self-check after switching on the ignition (together with the SOS button and the Roadside Assistance button .

See system self-check (▷ page 266) if the indicator lamp does not come on in red or stays on longer than approximately 10 seconds.

If the indicator lamp in the Information button  is flashing continuously and there was no voice connection to the Response Center established, then the Tele Aid system could not initiate an Information call (e.g. the relevant cellular phone network is not available). The message *Call failed* appears in the multifunction display.

Information calls can be terminated using the  button on the multifunction steering wheel or the END Button on the audio system or COMAND\* System.



If the indicator lamps do not start flashing after pressing one of the buttons or remain illuminated (in red) at any time, the Tele Aid system has detected a malfunction or the service is not currently active, and may not initiate a call. Visit your authorized Mercedes-Benz Center and have the system checked or contact the Response Center at 1-800-756-9018 (in the USA) or 1-888-923-8367 (in Canada) as soon as possible.

### Call priority

If other service calls such as a Roadside Assistance call or Information call are active, an Emergency call is still possible. In this case, the Emergency call will take priority and override all other active calls.



The indicator lamp in the respective button flashes until the call is concluded. Emergency calls can only be terminated by a Response Center or Customer Assistance Center representative, whereas Roadside Assistance and Information calls can also be terminated by pressing button  on the multifunction steering wheel or using the END button on the audio system or COMAND\* System.





If the indicator lamp continues to flash or the system does not reset, contact the Response Center at 1-800-756-9018 (in the USA) or 1-888-923-8367 (in Canada), or Mercedes-Benz Customer Assistance at 1-800-FOR-MERCEdes (1-800-367-6372) in the USA or Customer Service at 1-800-387-0100 in Canada.

#### Remote door unlock

In case you have locked your vehicle unintentionally (e.g. SmartKey inside vehicle), and the reserve SmartKey is not handy:

- ▶ Contact the Mercedes-Benz Response Center at 1-800-756-9018 (in the USA) or 1-888-923-8367 (in Canada).

You will be asked to provide your password which you provided when you completed the subscriber agreement.

- ▶ Then return to your vehicle and pull the trunk recessed handle for a minimum of 20 seconds until the SOS button is flashing.

The message *Connecting call* appears in the multifunction display.

As an alternative, you may unlock the vehicle via Internet using the ID and password sent to you shortly after the completion of your acquaintance call.

The Response Center will then unlock your vehicle with the remote door unlocking feature.



The remote door unlock feature is available if the relevant cellular phone network is available.

The SOS button will flash and the message *Connecting call* will appear in the multifunction display to indicate receipt of the door unlock command.

Once the vehicle is unlocked, a Response Center specialist may attempt to establish voice contact with the vehicle occupants.

If the tailgate recessed handle was pulled for more than 20 seconds before door unlock authorization was received by the Response Center, you must wait 15 minutes before pulling the tailgate recessed handle again.

### Stolen Vehicle Recovery services

In the event your vehicle was stolen:

- ▶ Report the incident to the police.  
The police will issue a numbered incident report.
- ▶ Pass this number on to the Mercedes-Benz Response Center along with your password issued to you when you subscribed to the service.

The Response Center will then attempt to covertly contact the vehicle's Tele Aid system. Once the vehicle is located, the Response Center will contact the local law enforcement and you. The vehicle's location will only be provided to law enforcement.



When the anti-theft alarm or the tow-away alarm stays on for more than 30 seconds, a call is initiated automatically to the Response Center. See anti-theft alarm system\* (▷ page 93) and tow-away alarm\* (▷ page 95).

### Garage door opener\*

The integrated remote control is capable of operating up to three separately controlled devices. It provides a convenient way to replace up to three hand-held remote controls used to operate devices such as garage door openers, gate openers, or other devices compatible with HomeLink® or some other systems.

Before the integrated remote control can be used, it must be programmed to the garage door opener, gate operator or other device you wish to operate. See the following instructions for programming information.

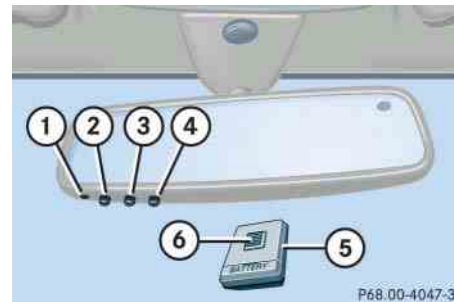

#### Interior rear view mirror with integrated remote control

- ① Indicator lamp
- ② ③ ④ Signal transmitter button

Needed for programming (not part of vehicle equipment):

- ⑤ Hand-held remote control of garage door opener, gate operator or other device
- ⑥ Hand-held remote control button

#### Warning!



Before programming the integrated remote control to a garage door opener or gate operator, make sure people and objects are out of the way of the device to prevent potential harm or damage. When programming a garage door opener, the door moves up or down. When programming a gate operator, the gate opens or closes.

Do not use the integrated remote control with any garage door opener that lacks safety stop and reverse features as required by U.S. federal safety standards (this includes any garage door opener model manufactured before April 1, 1982).

A garage door that cannot detect an object - signaling the door to stop and reverse - does not meet current U.S. federal safety standards.

When programming a garage door opener park the vehicle outside the garage.

Do not run the engine while programming the integrated remote control. Inhalation of exhaust gas is hazardous to your health. All exhaust gas contains carbon monoxide, and inhaling it can cause unconsciousness and possible death.

#### Programming or reprogramming the integrated remote control

Step 1:

- ▶ Switch on the ignition (▷ page 33).

Step 2:

- ▶ If you have previously programmed a signal transmitter button and wish to retain its programming, proceed to step 3.

If you are programming the integrated remote control for the first time, press and hold the two outer signal transmitter buttons ② and ④ and release them only when the indicator lamp ① begins to flash after approximately 20 seconds (do not hold the button for longer than 30 seconds). This procedure erases any previous settings for all three channels and initializes the memory.

If you later wish to program a second and/or third hand-held transmitter to the remaining two signal transmitter buttons, do not repeat this step and begin directly with step 3.

## Step 3:

- ▶ Hold the end of the hand-held remote control ⑤ of the device you wish to train approximately 2 to 5 in (5 to 12 cm) away from the signal transmitter button (②, ③ or ④) to be programmed, while keeping the indicator lamp ① in view.

## Step 4:

- ▶ Using both hands, simultaneously press the hand-held remote control button ⑥ and the desired signal transmitter button (②, ③ or ④). Do not release the buttons until step 5 is completed.

The indicator lamp ① will flash, first slowly and then rapidly.



The indicator lamp ① flashes immediately the first time the signal transmitter button is programmed. If this button has already been programmed, the indicator lamp will only start flashing after 20 seconds.

## Step 5:

- ▶ After the indicator lamp ① changes from a slow to a rapidly flashing light, release the hand-held remote control button and the signal transmitter button.

## Step 6:

- ▶ Press and hold the just-trained signal transmitter button (②, ③ or ④) and observe the indicator lamp ①.

If the indicator lamp ① stays on constantly, programming is complete and your device should activate when the respective signal transmitter button (②, ③ or ④) is pressed and released.



If the indicator lamp ① flashes rapidly for about 2 seconds and then turns to a constant light, continue with programming steps 8 through 12 as your garage door opener may be equipped with the “rolling code” feature.



#### ▷▷ Step 7:

- ▶ To program the remaining two signal transmitter buttons, repeat the steps above starting with step 3.

#### ***Rolling code programming***

To train a garage door opener (or other rolling code devices) with the rolling code feature, follow these instructions after completing the “Programming” portion (steps 1 through 6) of this text. (A second person may make the following training procedures quicker and easier.)

#### Step 8:

- ▶ Locate “training” button on the garage door opener motor head unit.

Exact location and color of the button may vary by garage door opener brand. Depending on manufacturer, the “training” button may also be referred to as “learn” or “smart” button. If there is difficulty locating the transmitting button, refer to the garage door opener operator’s manual.

#### Step 9:

- ▶ Press the “training” button on the garage door opener motor head unit.

The “training light” is activated.

You have 30 seconds to initiate the following two steps.

#### Step 10:

- ▶ Return to the vehicle and firmly press, hold for 2 seconds and release the programmed signal transmitter button (②, ③ or ④).

#### Step 11:

- ▶ Press, hold for 2 seconds and release same signal transmitter button a second time to complete the training process.

**i**

Some garage door openers (or other rolling code equipped devices) may require you to press, hold for 2 seconds and release the same signal transmitter button a third time to complete the training process.

## Step 12:

- ▶ Confirm the garage door operation by pressing the programmed signal transmitter button (②, ③ or ④).

## Step 13:

- ▶ To program the remaining two signal transmitter buttons, repeat the steps above starting with step 3.

**Gate operator/Canadian programming**

Canadian radio-frequency laws require transmitter signals to “time-out” (or quit) after several seconds of transmission which may not be long enough for the integrated signal transmitter to pick up the signal during programming. Similar to this Canadian law, some U.S. gate operators are designed to “time-out” in the same manner.

If you live in Canada or if you are having difficulties programming a gate operator (regardless of where you live) by using the programming procedures, replace step 4 with the following:

## Step 4:

- ▶ Press and hold the signal transmitter button (②, ③ or ④). Do not release this button until it has been successfully trained.
- ▶ While still holding down the signal transmitter button (②, ③ or ④), “cycle” your hand-held remote control button ⑥ as follows: Press and hold button ⑥ for 2 seconds, then release it for 2 seconds, and again press and hold it for 2 seconds. Repeat this sequence on the hand-held remote control until the frequency signal has been learned. Upon successful training, the indicator lamp ① will flash slowly and then rapidly after several seconds. ▷▷

### Useful features

- ▷▷ Proceed with programming step 5 and step 6 to complete.



Upon completion of programming the integrated remote control, make sure you retain the hand-held remote control that came with the garage door opener, gate operator or other device. You may need it for use in other vehicles, for future programming of an integrated remote control, or simply for continued use as a hand-held remote control to operate the respective device in other situations.

### Reprogramming a single signal transmitter button

To program a device using a signal transmitter button previously trained, follow these steps:

- ▶ Switch on the ignition (▷ page 33).
- ▶ Press and hold the desired signal transmitter button (②, ③ or ④). Do not release the button.
- ▶ The indicator lamp ① will begin to flash after 20 seconds. Without releasing the signal transmitter button, proceed with programming starting with step 3.

### Operation of integrated remote control

- ▶ Switch on the ignition (▷ page 33).
- ▶ Select and press the appropriate integrated signal transmitter button (②, ③ or ④) to activate the remote controlled device.

The integrated remote control transmitter continues to send the signal as long as the button is pressed – up to 20 seconds.

### Erasing the integrated remote control memory

- ▶ Switch on the ignition (▷ page 33).
- ▶ Simultaneously press and hold down the outer signal transmitter buttons ② and ④, for approximately 20 seconds, until the indicator lamp ① flashes rapidly. Do not hold for longer than 30 seconds.

The codes of all three channels are erased.



If you sell your vehicle, erase the codes of all three channels.

### Programming tips

If you are having difficulty programming the integrated remote control, here are some helpful tips:

- Check the frequency of the hand-held remote control ⑤ (typically located on the reverse side of the remote). The integrated remote control is compatible with radio-frequency devices operating between 288-399 MHz.
- Put a new battery in the hand-held remote control ⑤. This will increase the likelihood of the hand-held remote control sending a faster and more accurate signal to the integrated remote control.
- While performing step 3, hold the hand-held remote control ⑤ at different lengths and angles from the signal transmitter button (②, ③ or ④) you are programming. Attempt varying angles at the distance of 2 to 5 inches (5 to 12 cm) away or the same angle at varying distances.

- If another hand-held remote control is available for the same device, try the programming steps again using that other hand-held remote control. Make sure new batteries are in the hand-held remote control before beginning the procedure.
- Straighten the antenna wire from the garage door opener assembly. This may help improve transmitting and/or receiving signals.



Certain types of garage door openers are incompatible with the integrated remote control. If you should experience further difficulties with programming the integrated remote control, contact an authorized Mercedes-Benz Center, or call Mercedes-Benz Customer Assistance Center (in the USA only) at 1-800-FOR-MERCEdes, or Customer Service (in Canada) at 1-800-387-0100.



### Useful features



USA only:

This device complies with Part 15 of the FCC Rules. Operation is subject to the following two conditions:

- (1) This device may not cause harmful interference, and
- (2) this device must accept any interference received, including interference that may cause undesired operation.

Any unauthorized modification to this device could void the user's authority to operate the equipment.



Canada only:

This device complies with RSS-210 of Industry Canada. Operation is subject to the following two conditions:

- (1) This device may not cause interference, and
- (2) this device must accept any interference received, including interference that may cause undesired operation of the device.

Any unauthorized modification to this device could void the user's authority to operate the equipment.

**The first 1000 miles (1500 km)**

**Driving instructions**

**At the gas station**

**Engine compartment**

**Tires and wheels**

**Winter driving**

**Maintenance**

**Vehicle care**



### The first 1 000 miles (1 500 km)

In the “Operation” section you will find detailed information on operating, maintaining and caring for your vehicle.

The more cautiously you treat your vehicle during the break-in period, the more satisfied you will be with its performance later on.

- Drive your vehicle during the first 1 000 miles (1 500 km) at varying but moderate vehicle and engine speeds.
- During this period, avoid heavy loads (full throttle driving) and excessive engine speeds (no more than  $\frac{2}{3}$  of maximum rpm in each gear).
- Shift gears in a timely manner.
- Avoid accelerating by kick-down.
- Do not attempt to slow the vehicle down by shifting to a lower gear using the gear selector lever.
- Select positions **3**, **2** or **1** only when driving at moderate speeds (for hill driving).
- Select **C** as the preferred shift program (▷ page 167) for the first 1 000 miles (1 500 km).

After 1 000 miles (1 500 km) you may gradually increase vehicle and engine speeds to the permissible maximum.

All of the above instructions, as may apply to your vehicle type, also apply when driving the first 1 000 miles (1 500 km) after the engine or the rear differential has been replaced.



Always obey applicable speed limits.

## ▼ Driving instructions

### Drive sensibly – save fuel

---

Fuel consumption, to a great extent, depends on driving habits and operating conditions.

To save fuel you should:

- Keep tires at the recommended tire inflation pressures.
- Remove unnecessary loads.
- Remove roof rack when not in use.
- Allow engine to warm up under low load use.
- Avoid frequent acceleration and deceleration.
- Have all maintenance work performed at the intervals specified in the Maintenance Booklet and as required by the maintenance service display. Contact an authorized Mercedes-Benz Center.

Fuel consumption is also increased by driving in cold weather, in stop-and-go traffic, on short trips and in hilly area.

### Drinking and driving

---

#### Warning!



Drinking and driving and/or taking drugs and driving are very dangerous combinations. Even a small amount of alcohol or drugs can affect your reflexes, perceptions and judgment.

The possibility of a serious or even fatal accident are greatly increased when you drink or take drugs and drive.

Do not drink or take drugs and drive or allow anyone to drive who has been drinking or taking drugs.

### Pedals

---

#### Warning!



Keep driver's foot area clear at all times. Objects stored in this area may impair pedal movement.

### Power assistance

---

#### Warning!



With the engine not running, there is no power assistance for the brake and steering systems. In this case, it is important to keep in mind that a considerably higher degree of effort is necessary to brake and steer the vehicle.

## Driving instructions

### Brakes

#### Warning!



After driving in heavy rain for some time without applying the brakes or through water deep enough to wet brake components, the first braking action may be somewhat reduced and increased pedal pressure may be necessary to obtain expected braking effect. Maintain a safe distance from vehicles in front.

Resting your foot on the brake pedal will cause excessive and premature wear of the brake pads.

It can also result in the brakes overheating, thereby significantly reducing their effectiveness. It may not be possible to stop the vehicle in sufficient time to avoid an accident.

To help prevent brake disk corrosion after driving on wet road surfaces (particularly salted roads), it is advisable to brake the vehicle with considerable force prior to parking. The heat generated serves to dry the brakes.

If your brake system is normally only subject to moderate loads, you should occasionally test the effectiveness of the brakes by applying above-normal braking pressure at higher speeds. This will also enhance the grip of the brake pads.

#### Warning!



Make sure not to endanger any other road users when carrying out these braking maneuvers.

Refer to the description of the Brake Assist System (BAS) (▷ page 88).

If the parking brake is released and the brake warning lamp in the instrument cluster stays on, the brake fluid level in the reservoir is too low.

Brake pad wear or a leak in the system may be the reason for low brake fluid in the reservoir.

Have the brake system inspected immediately. Contact an authorized Mercedes-Benz Center.

All checks and service work on the brake system should be carried out by qualified technicians only. Contact an authorized Mercedes-Benz Center.

Only install brake pads and brake fluid recommended by Mercedes-Benz.

**Warning!**

If other than recommended brake pads are installed, or other than recommended brake fluid is used, the braking properties of the vehicle can be degraded to an extent that safe braking is substantially impaired. This could result in an accident.



When driving down long and steep grades, relieve the load on the brakes by shifting into a lower gear to use the engine's braking power. This helps prevent overheating of the brakes and reduces brake pad wear.

After hard braking, it is advisable to drive on for some time, rather than immediately park, so that the air stream will cool down the brakes faster.

**Driving off**

Apply the brakes to test them briefly after driving off. Perform this procedure only when the road is clear of other traffic.

Warm up the engine smoothly. Do not place full load on the engine until the operating temperature has been reached.

When starting off on a slippery surface, do not allow a drive wheel to spin for an extended period with the ESP® switched off. Doing so may cause serious damage to the drivetrain which is not covered by the Mercedes-Benz Limited Warranty.



Simultaneously depressing the accelerator pedal and applying the brake reduces engine performance and causes premature brake and drivetrain wear.

**Parking**

Set the parking brake whenever parking or leaving the vehicle. In addition, move gear selector lever to position **P** (manual transmission: first or reverse gear).

When parking on hills, always turn front wheels towards the road curb.

**Warning!**

Do not park this vehicle in areas where combustible materials such as grass, hay or leaves can come into contact with the hot exhaust system, as these materials could be ignited and cause a vehicle fire.

To reduce the risk of personal injury as a result of vehicle movement, before turning off the engine and leaving the vehicle always:

- Keep right foot on brake pedal.



### Driving instructions



- Manual transmission: Move gearshift lever to neutral position (no gear selected).
- Firmly depress parking brake pedal.
- Automatic transmission\*: Move the gear selector lever to position **P**.
- Slowly release brake pedal.
- When parked on an incline, turn front wheels towards the road curb.
- Turn the SmartKey in the starter switch to position **0** and remove the SmartKey from the starter switch.
- Take the SmartKey and lock vehicle when leaving.

### Tires

#### Warning!



If you feel a sudden significant vibration or ride disturbance, or you suspect that possible damage to your vehicle has occurred, you should turn on the hazard warning flashers, carefully slow down, and drive with caution to an area which is a safe distance from the road.

Inspect the tires and the vehicle underbody for possible damage. If the vehicle or tires appear unsafe, have the vehicle towed to the nearest Mercedes-Benz Center or tire dealer for repairs.

Treadwear indicators (TWI) are required by law. These indicators are located in six places on the tread circumference and become visible at a tread depth of approximately  $\frac{1}{16}$  in (1.6 mm), at which point the tire is considered worn and should be replaced.

The treadwear indicator appears as a solid band across the tread.

#### Warning!



Although the applicable federal motor vehicle safety laws consider a tire to be worn when the treadwear indicators (TWI) become visible at approximately  $\frac{1}{16}$  in (1.6 mm), we recommend that you do not allow your tires to wear down to that level. As tread depth approaches  $\frac{1}{8}$  in (3 mm), the adhesion properties on a wet road are sharply reduced.

Depending upon the weather and/or road surface (conditions), the tire traction varies widely.

Specified tire inflation pressures must be maintained. This applies particularly if the tires are subjected to high loads (e.g. high speeds, heavy loads, high ambient temperatures).

**Warning!**

Do not drive with a flat tire. A flat tire affects the ability to steer or brake the vehicle. You may lose control of the vehicle. Continued driving with a flat tire or driving at high speed with a flat tire will cause excessive heat build-up and possibly a fire.

**Hydroplaning**

Depending on the depth of the water layer on the road, hydroplaning may occur, even at low speeds and with new tires. Reduce vehicle speed, avoid track grooves in the road and apply brakes cautiously in the rain.

**Tire traction**

The safe speed on a wet, snow covered or icy road is always lower than on a dry road.

You should pay particular attention to the condition of the road whenever the outside temperatures are close to the freezing point.

**Warning!**

If ice has formed on the road, tire traction will be substantially reduced. Under such weather conditions, drive, steer and brake with extreme caution.

Mercedes-Benz recommends winter tires (▷ page 336) with a minimum tread depth of approximately  $\frac{1}{6}$  in (4 mm) on all four wheels for the winter season to ensure normal balanced handling characteristics. On packed snow, they can reduce your stopping distance compared to summer tires. Stopping distance, however, is still considerably greater than when the road is not covered with snow or ice. Exercise appropriate caution.



Avoid spinning of a drive wheel. This may cause serious damage to the drivetrain which is not covered by the Mercedes-Benz Limited Warranty.



### Driving instructions

#### Tire speed rating

Regardless of the tire speed rating, local speed limits should be obeyed. Use prudent driving speeds appropriate to prevailing conditions.

#### Warning!



Even when permitted by law, never operate a vehicle at speeds greater than the maximum speed rating of the tires.

Exceeding the maximum speed for which tires are rated can lead to sudden tire failure, causing loss of vehicle control and possibly resulting in an accident and/or personal injury and possible death, for you and for others.

#### **C 230<sup>1</sup>, C 280, C 280 4MATIC, C 350, C 350 4MATIC**

Your vehicle is factory equipped with “H”-rated tires, which have a speed rating of 130 mph (210 km/h).

An electronic speed limiter prevents your vehicle from exceeding a speed of 130 mph (210 km/h).

#### **C 230 Sport, C 350 Sport**

Your vehicle is factory equipped with “W”-rated tires, which have a speed rating of 168 mph (270 km/h).

An electronic speed limiter prevents your vehicle from exceeding a speed of 130 mph (210 km/h).



For information on speed rating for winter tires, see “Winter tires” (> page 336).

For additional general information on tire speed markings on tire sidewall, see “Tire speed rating” (> page 323).

<sup>1</sup> Canada only

## Winter driving instructions

The most important rule for slippery or icy roads is to drive sensibly and to avoid abrupt acceleration, braking and steering maneuvers. Do not use the cruise control system under such conditions.

When the vehicle is in danger of skidding, move gear selector lever to position **N** or in case of manual transmission declutch. Try to keep the vehicle under control by corrective steering action.



For information on driving with snow chains, see “Snow chains” (> page 337).

### Warning!



On slippery road surfaces, never downshift in order to obtain braking action. This could result in drive wheel slip and reduced vehicle control. Your vehicle’s ABS will not prevent this type of control loss.

Road salts and chemicals can adversely affect braking efficiency. Increased pedal force may become necessary to produce the normal braking effect.

Depressing the brake pedal periodically when traveling at length on salt-strewn roads can bring road-salt-impaired braking efficiency back to normal.

If the vehicle is parked after being driven on salt-treated roads, the braking efficiency should be tested as soon as possible after driving is resumed.

### Warning!



Make sure not to endanger any other road users when carrying out these braking maneuvers.

### Warning!



If the vehicle becomes stuck in snow, make sure snow is kept clear of the exhaust pipe and from around the vehicle with the engine running. Otherwise, deadly carbon monoxide (CO) gases may enter vehicle interior resulting in unconsciousness and death.

To assure sufficient fresh air ventilation, open a window slightly on the side of the vehicle not facing the wind.

### Warning!



The outside temperature indicator is not designed to serve as an ice-warning device and is therefore unsuitable for that purpose. Indicated temperatures just above the freezing point do not guarantee that the road surface is free of ice.

For more information, see “Winter driving” (> page 336).

### Driving instructions

#### Standing water



Do not drive through flooded areas or water of unknown depth. Before driving through water, determine its depth. Never accelerate before driving into water. The bow wave could force water into the engine and auxiliary equipment, thus damaging them.

If you must drive through standing water, drive slowly to prevent water from entering the passenger compartment or the engine compartment. Water in these areas could cause damage to electrical components or wiring of the engine or transmission, or could result in water being ingested by the engine through the air intake causing severe internal engine damage. Any such damage is not covered by the Mercedes-Benz Limited Warranty.

#### Passenger compartment

##### Warning!



Always fasten items being carried as securely as possible.

In an accident, during hard braking or sudden maneuvers, loose items will be thrown around inside the vehicle, and cause injury to vehicle occupants unless the items are securely fastened in the vehicle.

The trunk is the preferred place to carry objects.

#### Driving abroad

Abroad, there is an extensive Mercedes-Benz service network at your disposal. If you plan to drive into areas which are not listed in the index of your Mercedes-Benz Center directory, you should request pertinent information from an authorized Mercedes-Benz Center.

## Control and operation of radio transmitters

### COMAND\*, radio and telephone\*

#### Warning!



Please do not forget that your primary responsibility is to drive the vehicle safely. Only operate the COMAND (Cockpit Management and Data System), radio or telephone<sup>1</sup> if road, weather and traffic conditions permit.

Bear in mind that at a speed of just 30 mph (approximately 50 km/h), your vehicle is covering a distance of 44 feet (approximately 14 m) every second.

<sup>1</sup> Observe all legal requirements.

### Telephones\* and two-way radios

#### Warning!



Never operate radio transmitters equipped with a built-in or attached antenna (i.e. without being connected to an external antenna) from inside the vehicle while the engine is running. Doing so could lead to a malfunction of the vehicle's electronic system, possibly resulting in an accident and personal injury.

Radio transmitters, such as a portable telephone or a citizens band unit should only be used inside the vehicle if they are connected to an antenna that is installed on the outside of the vehicle.

Refer to the radio transmitter operation instructions regarding use of an external antenna.

### Catalytic converter

Your Mercedes-Benz is equipped with monolithic-type catalytic converters, an important element in conjunction with the oxygen sensors to achieve substantial control of the pollutants in the exhaust emissions. Keep your vehicle in proper operating condition by following our recommended maintenance instructions as outlined in your Maintenance Booklet.



To prevent damage to the catalytic converters, only use premium unleaded gasoline in this vehicle.

Any noticeable irregularities in engine operation should be repaired promptly. Otherwise, excessive unburned fuel may reach the catalytic converter, causing it to overheat and potentially start a fire.

#### Warning!



As with any vehicle, do not idle, park or operate this vehicle in areas where combustible materials such as grass, hay or leaves can come into contact with the hot exhaust system, as these materials could be ignited and cause a vehicle fire.

#### Emission control

Certain systems of the engine serve to keep the toxic components of the exhaust gases within permissible limits required by law.

These systems, of course, will function properly only when maintained strictly according to factory specifications. Any adjustments on the engine should, therefore, be carried out only by qualified Mercedes-Benz Center authorized technicians. Engine adjustments should not be altered in any way. Moreover, the specified service jobs must be carried out regularly according to Mercedes-Benz servicing requirements. For details refer to the Maintenance Booklet.

#### Warning!



Inhalation of exhaust gas is hazardous to your health. All exhaust gas contains carbon monoxide, and inhaling it can cause unconsciousness and possible death.

Do not run the engine in confined areas (such as a garage) which are not properly ventilated. If you think that exhaust gas fumes are entering the vehicle while driving, have the cause determined and corrected immediately. If you must drive under these conditions, drive only with at least one window fully open at all times.

## Coolant temperature

---

During severe operating conditions and stop-and-go city traffic, the coolant temperature may rise close to approximately 248°F (120°C).

The engine should not be operated with the coolant temperature over 248°F (120°C). Doing so may cause serious engine damage which is not covered by the Mercedes-Benz Limited Warranty.

### Warning!



- Driving when your engine is badly overheated can cause some fluids, which may have leaked into the engine compartment, to catch fire. You could be seriously burned.
- Steam from an overheated engine can cause serious burns and can occur just by opening the hood. Stay away from the engine if you see or hear steam coming from it.

Turn off the engine, get out of the vehicle and do not stand near the vehicle until the engine has cooled down.

### At the gas station

#### Refueling

##### Warning!



Gasoline is highly flammable and poisonous. It burns violently and can cause serious injury. Whenever you are around gasoline, avoid inhaling fumes and skin contact, extinguish all smoking materials. Never allow sparks, flame or smoking materials near gasoline!

The fuel filler flap is located on the right-hand side of the vehicle towards the rear. Locking/unlocking the vehicle with the SmartKey automatically locks/unlocks the fuel filler flap.

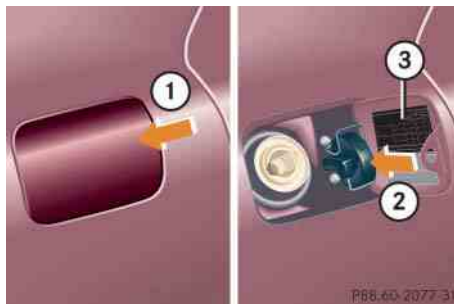

- ① To open the fuel filler flap
- ② To insert the fuel filler cap
- ③ Supplemental tire inflation pressure information

- ▶ Turn the engine off by turning the SmartKey to position **0**.
- ▶ Remove the SmartKey from the starter switch.
- ▶ Open the fuel filler flap by pushing at the point indicated by arrow ①. The fuel filler flap springs open.

- ▶ Turn fuel cap counterclockwise and hold on to it until possible pressure is released.
- ▶ Take off cap and set it in direction of arrow ② in the recess on the fuel filler flap.  
  
To prevent fuel vapors from escaping into open air, fully insert filler nozzle unit.
- ▶ Only fill your tank until the filler nozzle unit cuts out – **do not top up or overfill.**



##### Warning!



Overfilling of the fuel tank may create pressure in the system which could cause a gas discharge. This could cause the gas to spray back out when removing the fuel pump nozzle, which could cause personal injury.

- ▶ Replace fuel cap by turning it clockwise until it audibly engages.
- ▶ Close fuel filler flap.



Leaving the engine running and the fuel cap open can cause the yellow fuel tank reserve warning lamp to flash and the  malfunction indicator lamp (USA only) or the  malfunction indicator lamp (Canada only) to illuminate.

For more information, see “Practical hints” (▷ page 352) and (▷ page 353).

### Check regularly and before a long trip

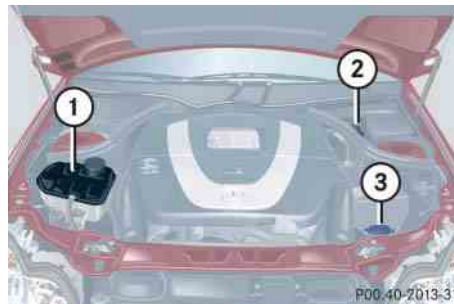

- ① Coolant
- ② Brake fluid (fuse box cover removed)
- ③ Windshield washer and headlamp cleaning system\*



Opening the hood, see (▷ page 297).

### Coolant

For normal replenishing, use water (potable water quality). For more information, see “Coolant level” (▷ page 301) and see “Fuels, coolants, lubricants, etc.” (▷ page 440).

### Brake fluid



If you find that the brake fluid in the brake fluid reservoir has fallen to the minimum mark or below, have the brake system checked for brake pad thickness and leaks immediately. Notify an authorized Mercedes-Benz Center immediately. Do not add brake fluid as this will not solve the problem. For more information, see “Practical hints” (▷ page 351).

Removing fuse box cover (▷ page 422).



### At the gas station

#### Windshield washer and headlamp cleaning system\*

For more information on filling up the washer reservoir, see “Windshield washer system and headlamp cleaning system\*” (▷ page 303).

#### Engine oil level

For more information on engine oil level, see “Engine oil” (▷ page 298).

#### Vehicle lighting

Check function and cleanliness. For more information on replacing light bulbs, see “Replacing bulbs” (▷ page 397).

Exterior lamp switch (▷ page 118).

#### Tire inflation pressure

More information on tire inflation pressure (▷ page 316).

## ▼ Engine compartment

### Hood

#### Warning!



Do not pull the release lever while the vehicle is in motion. Otherwise the hood could be forced open by passing air flow.

### Opening

The hood lock release lever is located to the left of the steering wheel under the dashboard.



① Hood lock release lever

- ▶ Pull lever ① downwards.

The hood is unlocked and handle ② will extend out of the radiator grille.



To avoid damage to the windshield wipers or hood, never open the hood if the wiper arms are folded forward away from the windshield.



② Handle for opening the hood

- ▶ Pull handle ② to its stop out of radiator grille.
- ▶ Pull up on the hood (do not pull up on the handle) and then release it.

The hood will be automatically held open at shoulder height by gas-filled struts.

#### Warning!



To help prevent personal injury, stay clear of moving parts when the hood is open and the engine is running. Make sure the hood is properly closed before driving. When closing the hood, use extreme caution not to catch hands or fingers.

The radiator fan may continue to run for approximately 30 seconds or even restart after the engine has been turned off. Stay clear of fan blades.

### Engine compartment

#### Warning!



If you see flames or smoke coming from the engine compartment, or if the coolant temperature gauge indicates that the engine is overheated, do not open the hood. Move away from vehicle and do not open the hood until the engine has cooled. If necessary, call the fire department.

#### Warning!



The engine is equipped with a transistorized ignition system. Because of the high voltage it is dangerous to touch any components (ignition coils, spark plug sockets, diagnostic socket) of the ignition system

- with the engine running
- while starting the engine
- if ignition is “on” and the engine is turned manually

### Closing

#### Warning!



Be careful that you do not close the hood on anyone.

- ▶ Let the hood drop from a height of approximately 1 ft (30 cm).

The hood will lock audibly.

- ▶ Check to make sure the hood is fully closed.

If you can raise the hood at a point above the headlamps, then it is not properly closed. Open it again and let it drop with somewhat greater force.

### Engine oil

The amount of oil your engine needs will depend on a number of factors, including driving style. Higher oil consumption can occur when

- the vehicle is new
- the vehicle is driven frequently at higher engine speeds

Engine oil consumption checks should only be made after the vehicle break-in period.



Do not use any special lubricant additives, as these may damage the drive assemblies. Using special additives not approved by Mercedes-Benz may cause damage not covered by the Mercedes-Benz Limited Warranty. More information on this subject is available at any Mercedes-Benz Center.

## Checking engine oil level with the oil dipstick

When checking the oil level

- the vehicle must be parked on level ground
- with the engine at operating temperature, the vehicle must have been stationary for at least 5 minutes with the engine turned off
- with the engine not at operating temperature yet, the vehicle must have been stationary for at least 30 minutes with the engine turned off

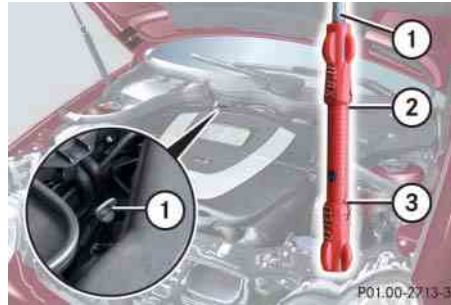

- ① Oil dipstick
- ② Upper (max) mark
- ③ Lower (min) mark

To check the engine oil level with the oil dipstick, do the following:

- ▶ Open the hood (▷ page 297).
- ▶ Pull out oil dipstick ①.
- ▶ Wipe oil dipstick ① clean.
- ▶ Fully insert oil dipstick ① into the dipstick guide tube.

- ▶ Pull out oil dipstick ① again after approximately 3 seconds to obtain accurate reading.

The oil level is correct when it is between the lower (min) mark ③ and upper (max) mark ② of oil dipstick ①.



The filling quantity between the upper and lower marks on the oil dipstick is approximately 2.1 US qt. (2.0 l).

- ▶ If necessary, add engine oil.

For adding engine oil, see “Adding engine oil” (▷ page 300).

For more information on engine oil, see “Fuels, coolants, lubricants, etc.” (▷ page 440).

For more information on messages in the multifunction display concerning engine oil, see the “Practical hints” section (▷ page 375).

### Engine compartment

#### Adding engine oil



Only use approved engine oils and oil filters required for vehicles with Maintenance System (U.S. vehicles) or FSS (Canada vehicles). For a listing of approved engine oils and oil filters, refer to the Factory Approved Service Products pamphlet in your vehicle literature portfolio, or contact an authorized Mercedes-Benz Center.

Using engine oils and oil filters of specification other than those expressly required for the Maintenance System (U.S. vehicles) or FSS (Canada vehicles), or changing of oil and oil filter at change intervals longer than those called for by the Maintenance System (U.S. vehicles) or FSS (Canada Vehicles) will result in engine damage not covered by the Mercedes-Benz Limited Warranty.



① Filler cap

- ▶ Unscrew filler cap ① from filler neck.
- ▶ Add engine oil as required. Be careful not to overfill with oil.

Be careful not to spill any oil when adding. Avoid environmental damage caused by oil entering the ground or water.



Excess oil must be siphoned or drained off. It could cause damage to the engine and catalytic converter not covered by the Mercedes-Benz Limited Warranty.

- ▶ Screw filler cap ① back on filler neck.

For more information on engine oil, see the “Technical data” section (▷ page 440) and (▷ page 442).

#### Transmission fluid level

The transmission fluid level does not need to be checked. If you notice transmission fluid loss or gear shifting malfunctions, have an authorized Mercedes-Benz Center check the transmission.

## Coolant level

The engine coolant is a mixture of water and anticorrosion/antifreeze. To check the coolant level, the vehicle must be parked on level ground and the engine must be cool.

### Warning!



In order to avoid any possibly serious burns:

- Use extreme caution when opening the hood if there are any signs of steam or coolant leaking from the cooling system, or if the coolant temperature gauge indicates that the coolant is overheated.
- Do not remove pressure cap on coolant reservoir if coolant temperature is above 158°F (70°C). Allow engine to cool down before removing cap. The coolant reservoir contains hot fluid and is under pressure.

- Using a rag, slowly open the cap approximately  $1/2$  turn to relieve excess pressure. If opened immediately, scalding hot fluid and steam will be blown out under pressure.
- Do not spill antifreeze on hot engine parts. Antifreeze contains ethylene glycol which may burn if it comes into contact with hot engine parts.

The coolant expansion tank is located on the passenger side of the engine compartment.



- ① Coolant expansion tank
- ② Cap

- ▶ Using a rag, turn cap ② slowly approximately one half turn to the left to release any excess pressure.
- ▶ Continue turning the cap to the left and remove it.

The coolant level is correct if the level

- for cold coolant: reaches the black top part of the reservoir
  - for warm coolant: is approx. 0.6 in (1.5 cm) higher
- ▶ Add coolant as required.
  - ▶ Replace and tighten cap.

For more information on coolant, see “Coolants” (▷ page 444).

## Engine compartment

### Battery

Your vehicle's battery is located in the engine compartment on the right hand side (▷ page 412).

The battery should always be sufficiently charged in order to achieve its rated service life. Refer to Maintenance Booklet for battery maintenance intervals.

If you use your vehicle mostly for short-distance trips, you will need to have the battery charge checked more frequently.

When replacing the battery, always use batteries approved by Mercedes-Benz.

If you do not intend to operate your vehicle for an extended period of time, consult an authorized Mercedes-Benz Center about steps you need to observe.



Observe all safety instructions and precautions when handling automotive batteries.



Risk of explosion.



Keep flames or sparks away from battery. Do not smoke.



Battery acid is caustic. Do not allow it to come into contact with skin, eyes or clothing.

In case it does, immediately flush affected area with clear water and seek medical help if necessary.



Wear eye protection.



Keep children away.



Follow the instructions in this Operator's Manual.

Batteries contain materials that can harm the environment if disposed of improperly. Recycling of batteries is the preferred method of disposal. Many states require sellers of batteries to accept old batteries for recycling.

## Windshield washer system and headlamp cleaning system\*

The windshield washer reservoir is located in the engine compartment.



### ① Washer fluid reservoir

Fluid for the windshield washer system and the headlamp cleaning system\* is supplied from the windshield washer reservoir. It has a capacity of:

- 3.2 US qt (3.0 l) in vehicles without headlamp cleaning system
- 6.4 US qt (6.0 l) in vehicles with headlamp cleaning system

During all seasons, add MB Windshield Washer Concentrate “S” to water. Premix the windshield washer fluid in a suitable container.

### Warning!



Washer solvent/antifreeze is highly flammable. Do not spill washer solvent/antifreeze on hot engine parts, because it may ignite and burn. You could be seriously burned.

- ▶ Refill the reservoir with MB Windshield Washer Concentrate and water (or commercially available premixed windshield washer solvent/antifreeze, depending on ambient temperatures).

Always use washer solvent/antifreeze where temperatures may fall below the freezing point. Failure to do so could result in damage to the washer system/reservoir.



Only use washer fluid which is suitable for plastic lenses. Improper washer fluid can damage the plastic lenses of the headlamps.

For more information, see “Windshield washer and headlamp cleaning system\*” (▷ page 448).



### Tires and wheels

See an authorized Mercedes-Benz Center for information on tested and recommended rims and tires for summer and winter operation. They can also offer advice concerning tire service and purchase.

#### Warning!



Replace rims or tires with the same designation, manufacturer and type as shown on the original part. See an authorized Mercedes-Benz Center for further information. If incorrectly sized rims and tires are mounted:

- The wheel brakes or suspension components can be damaged.
- The operating clearance of the wheels and the tires may no longer be correct.

#### Warning!



Worn, old tires can cause accidents. If the tire tread is badly worn, or if the tires have sustained damage, replace them.

When replacing rims, only use genuine Mercedes-Benz wheel bolts specified for the particular rim type. Failure to do so can result in the bolts loosening and possibly an accident.

Retreaded tires are not tested or recommended by Mercedes-Benz, since previous damage cannot always be recognized on retreads. The operating safety of the vehicle cannot be assured when such tires are used.

#### Important guidelines

- Only use sets of tires and rims of the same type and make.
- Tires must be of the correct size for the rim.
- Break in new tires for approximately 60 miles (100 km) at moderate speeds.
- Regularly check the tires and rims for damage. Dented or bent rims can cause tire inflation pressure loss and damage to the tire beads.
- If vehicle is heavily loaded, check tire inflation pressure and correct as required.
- Do not allow your tires to wear down too far. Adhesion properties on wet roads are sharply reduced at tread depths under  $\frac{1}{8}$  in (3 mm).
- When replacing individual tires, you should mount new tires on the front wheels first (on vehicles with same-sized wheels all around).

## Tire care and maintenance

### Warning!



Regularly check the tires for damage. Damaged tires can cause tire inflation pressure loss. As a result, you could lose control of your vehicle.

Worn, old tires can cause accidents. If the tire tread is badly worn, or if the tires have sustained damage, replace them.

Regularly check your tire inflation pressure at least once a month. For more information on checking tire inflation pressure see “Recommended tire inflation pressure” (▷ page 314).

## Tire inspection

Every time you check your tire inflation pressure, you should also inspect your tires for wear and damage for the following:

- excessive treadwear (▷ page 306)
- cord or fabric showing through the tire’s rubber
- bumps, bulges, cuts, cracks, or splits in the tread or side of the tire

Replace the tire if you find any of the above conditions.

Make sure you also inspect the spare tire periodically for condition and tire inflation pressure. Spare tires will age and become worn over time even if never used, and thus should be inspected and replaced when necessary.

## Life of tire

The service life of a tire is dependent upon varying factors including but not limited to:

- Driving style
- Tire inflation pressure
- Distance driven

### Warning!



Tires and spare tire should be replaced after 6 years, regardless of the remaining tread.

### Tires and wheels

#### Tread depth

Do not allow your tires to wear down too far. Adhesion properties on wet roads are sharply reduced at tread depths under  $\frac{1}{8}$  in (3 mm).

Treadwear indicators (TWI) are required by law. These indicators are located in six places on the tread circumference and become visible at a tread depth of approximately  $\frac{1}{16}$  in (1.6 mm), at which point the tire is considered worn and should be replaced.

Recommended minimum tire tread depth:

- Summer tires  $\frac{1}{8}$  in (3 mm)
- Winter tires  $\frac{1}{6}$  in (4 mm)

#### Warning!



Although the applicable federal motor safety laws consider a tire to be worn when the treadwear indicators (TWI) become visible at approximately  $\frac{1}{16}$  in (1.6 mm), we recommend that you do not allow your tires

to wear down to that level. As tread depth approaches  $\frac{1}{8}$  in (3 mm), the adhesion properties on a wet road are sharply reduced.

Depending upon the weather and/or road surface (conditions), the tire traction varies widely.

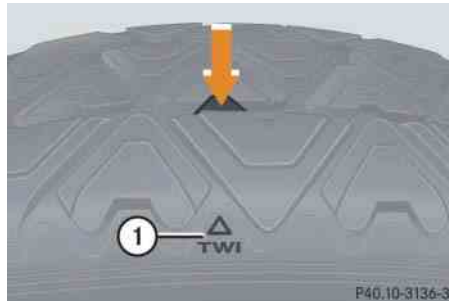

① TWI (Tread Wear Indicator)

The treadwear indicator appears as a solid band across the tread.

#### Storing tires



Keep unmounted tires in a cool, dry place with as little exposure to light as possible. Protect tires from contact with oil, grease and gasoline.

#### Cleaning tires



Never use a round nozzle to power wash tires. The intense jet of water can result in damage to the tire.

Always replace a damaged tire.

## Direction of rotation

Unidirectional tires offer added advantages, such as better hydroplaning performance. To benefit, however, you must make sure the tires rotate in the direction specified.

An arrow on the sidewall indicates the intended direction of rotation (spinning) of the tire.



Spare wheels may be mounted against the direction of rotation (spinning) even with a unidirectional tire for temporary use only until the regular drive wheel has been repaired or replaced. Always observe and follow applicable temporary use restrictions and speed limitations indicated on the spare wheel.

## Loading the vehicle

Two labels on your vehicle show how much weight it may properly carry.

- The Tire and Loading Information placard (Example A) or the Vehicle Tire Information placard (Example B) can be found on the driver's door B-pillar. This placard tells you important information about the number of people that can be in the vehicle and the total weight that can be carried in the vehicle. It also contains information on the proper size and recommended tire inflation pressures for the original equipment tires on your vehicle.

- The Certification label, also found on the driver's door B-pillar tells you about the gross weight capacity of your vehicle, called the Gross Vehicle Weight Rating (GVWR). The GVWR includes the weight of the vehicle, all occupants, fuel and cargo. The Certification label also tells you about the front and rear axle weight capacity, called the Gross Axle Weight Rating (GAWR). The GAWR is the total allowable weight that can be carried by a single axle (front or rear). Never exceed the GVWR or GAWR for either the front axle or rear axle.

## Tires and wheels

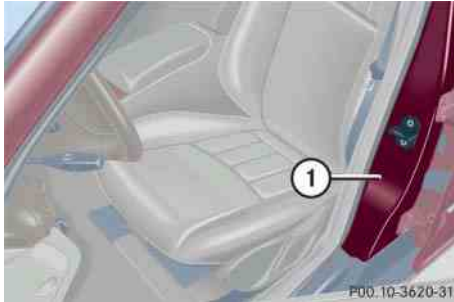

① Driver's door B-pillar

Following is a discussion on how to work with the information contained on the two placards with regards to loading your vehicle.

### Tire and Loading Information

#### Warning!



Do not overload the tires by exceeding the specified load limit or vehicle capacity weight as indicated on the placard on the driver's door B-pillar. Overloading the tires can overheat them, possibly causing a blowout. Overloading the tires can also result in handling or steering problems, or brake failure.

Your vehicle is equipped with either the Tire and Loading Information placard (Example A) or the Vehicle Tire Information placard (Example B).



Data shown on placard examples are for illustration purposes only. Load limit data are specific to each vehicle and may vary from data shown in the illustrations below. Refer to placard on vehicle for actual data specific to your vehicle.

#### Placard (Example A)

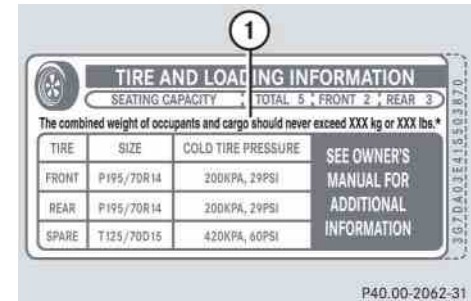

① Load limit information on the Tire and Loading Information placard

The placard showing the load limit information is located on the driver’s door B-pillar. If your vehicle is equipped with the Tire and Loading Information placard (Example A), locate the statement “The combined weight of occupants and cargo should never exceed XXX kilograms or XXX lbs.” on this placard. The combined weight of all occupants, cargo / luggage and trailer tongue load (if applicable) should never exceed the weight referenced in that statement.

**Placard (Example B)**



① Load limit information on the Vehicle Tire Information placard

The placard showing the load limit information is located on the driver’s door B-pillar. If your vehicle is equipped with the Vehicle Tire Information placard (Example B), locate the heading “Vehicle Capacity Weight” on this placard. The combined weight of all occupants, cargo / luggage and trailer tongue (if applicable) should never exceed the weight listed next to vehicle capacity weight.

**Seating capacity**

The seating capacity gives you important information on the number of occupants that can be in the vehicle. Observe front and rear seating capacity. Your vehicle is equipped with either placard Example A or placard Example B located on the driver’s door B-pillar (▷ page 308).



Data shown on placard examples are for illustration purposes only. Load limit data are specific to each vehicle and may vary from data shown in the illustrations below. Refer to placard on vehicle for actual data specific to your vehicle.

## Tires and wheels

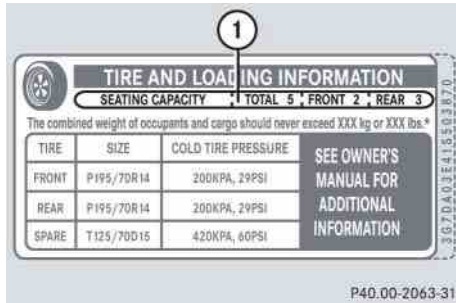

**Placard (Example A)**

① Seating capacity

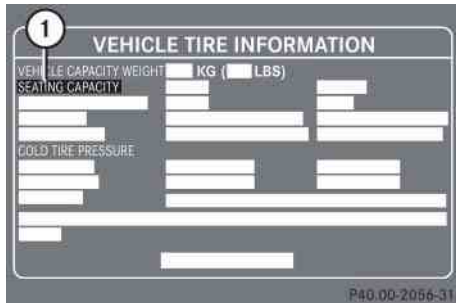

**Placard (Example B)**

① Seating capacity

### Steps for determining correct load limit

The following steps have been developed as required of all manufacturers under Title 49, Code of U.S. Federal Regulations, Part 575 pursuant to the “National Traffic and Motor Vehicle Safety Act of 1966”.

**Step 1** (Vehicles equipped with placard Example A)

- ▶ Locate the statement “The combined weight of occupants and cargo should never exceed XXX kg or XXX lbs.” on your vehicle’s placard.

**Step 1** (Vehicles equipped with placard Example B)

- ▶ Locate the heading “Vehicle Capacity Weight” on your vehicle’s placard.

**Step 2**

- ▶ Determine the combined weight of the driver and passengers that will be riding in your vehicle.

**Step 3**

- ▶ Subtract the combined weight of the driver and passengers from XXX kilograms or XXX lbs.

**Step 4**

- ▶ The resulting figure equals the available amount of cargo and luggage load capacity. For example, if the “XXX” amount equals 1400 lbs and there will be five 150 lbs passengers in your vehicle, the amount of available cargo and luggage load capacity is 650 lbs (1400-750 (5 x 150) = 650 lbs).

**Step 5**

- ▶ Determine the combined weight of luggage and cargo being loaded on the vehicle. That weight may not safely exceed the available cargo and luggage load capacity calculated in step 4.

**Step 6** (if applicable)

- ▶ If your vehicle will be towing a trailer, load from your trailer will be transferred to your vehicle. Consult this manual to determine how this reduces the available cargo and luggage load capacity of your vehicle (▷ page 313).

The following table shows examples on how to calculate total and cargo load capacities with varying seating configurations and number and size of occupants. The following examples use a load limit of 1500 lbs. **This is for illustration purposes only.** Make sure you are using the actual load limit for your vehicle stated on the vehicle's placard (▷ page 308).



## Tires and wheels

Example	Combined weight limit of occupants and cargo from placard	Number of occupants (driver and passengers)	Seating configuration	Occupants weight	Combined weight of all occupants	Available cargo/luggage and trailer tongue weight (total load limit or vehicle capacity weight from placard minus combined weight of all occupants)
1	1500 lbs	5	front: 2 rear: 3	Occupant 1: 150 lbs Occupant 2: 180 lbs Occupant 3: 160 lbs Occupant 4: 140 lbs Occupant 5: 120 lbs	750 lbs	1500 lbs - 750 lbs = 750 lbs
2	1500 lbs	3	front: 1 rear: 2	Occupant 1: 200 lbs Occupant 2: 190 lbs Occupant 3: 150 lbs	540 lbs	1500 lbs - 540 lbs = 960 lbs
3	1500 lbs	1	front: 1	Occupant 1: 150 lbs	150 lbs	1500 lbs - 150 lbs = 1350 lbs

The higher the weight of all occupants, the less cargo and luggage load capacity is available.

For more information, see “Trailer tongue load” (> page 313).

***Certification label***

Even after careful determination of the combined weight of all occupants, cargo and the trailer tongue load (if applicable) (▷ page 313) as to not exceed the permissible load limit, you must make sure that your vehicle never exceeds the Gross Vehicle Weight Rating (GVWR) and the Gross Axle Weight Rating (GAWR) for either the front or rear axle. You can obtain the GVWR and GAWR from the Certification label. The Certification Label can be found on the driver's door B-pillar, see "Technical data" (▷ page 428).

**Gross Vehicle Weight Rating (GVWR):** The total weight of the vehicle, all occupants, all cargo, and the trailer tongue load (▷ page 313) must never exceed the GVWR.

**Gross Axle Weight Rating (GAWR):** The total allowable weight that can be carried by a single axle (front or rear).

To assure that your vehicle does not exceed the maximum permissible weight limits (GVWR and GAWR for front and rear axle), have the loaded vehicle (including driver, passengers and all cargo and, if applicable, trailer fully loaded) weighed on a suitable commercial scale.

***Trailer tongue load***

The tongue load of any trailer is an important weight to measure because it affects the load you can carry in your vehicle. If a trailer is towed, the tongue load must be added to the weight of all occupants riding and any cargo you are carrying in the vehicle. The tongue load typically is ten percent of the trailer weight and everything loaded in it.

Your Mercedes-Benz has been designed primarily to carry passengers and their cargo. Mercedes-Benz does not recommend trailer towing with your vehicle.

## Tires and wheels

### Recommended tire inflation pressure

#### Warning!



Follow recommended tire inflation pressures.

Do not underinflate tires. Underinflated tires wear excessively and /or unevenly, adversely affect handling and fuel economy, and are more likely to fail from being overheated.

Do not overinflate tires. Overinflated tires can adversely affect handling and ride comfort, wear unevenly, increase stopping distance, and result in sudden deflation (blowout) because they are more likely to become punctured or damaged by road debris, potholes etc.

Your vehicle is equipped with either the Tire and Loading Information placard (Example A) or the Vehicle Tire Information placard (Example B) located on the driver's door B-pillar (▷ page 308).

The tire inflation pressure should be checked regularly and should only be adjusted on cold tires. The tires can be considered cold if the vehicle has been parked for at least three hours or driven less than one mile (1.6 km).

Follow recommended cold tire inflation pressures listed on placard.

Keeping the tires properly inflated provides the best handling, tread life and riding comfort.

In addition to the tire placard on the driver's door B-pillar, also consult the fuel filler flap for any additional information pertaining to special driving situations. For more information, see "Important notes on tire inflation pressure" (▷ page 315).



Data shown on placard examples are for illustration purposes only. Tire data are specific to each vehicle and may vary from data shown in the illustrations below. Refer to placard on vehicle for actual data specific to your vehicle.

### Placard (Example A)

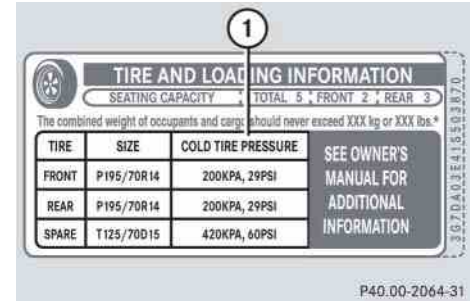

- ① Tire and Loading Information placard with recommended cold tire inflation pressures

Placard (Example A) lists the recommended cold tire inflation pressures for maximum loaded vehicle weight. The tire inflation pressures listed apply to the tires installed as original equipment.

## Placard (Example B)

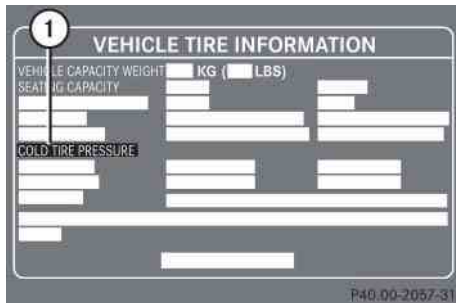

- ① Vehicle Tire Information placard with recommended cold tire inflation pressures

Placard (Example B) lists the recommended cold tire inflation pressures for maximum loaded vehicle weight. The tire inflation pressures listed apply to the tires installed as original equipment.



Placard (Example B) may list recommended cold tire inflation pressures for different vehicle loads.

## Important notes on tire inflation pressure

**Warning!**

If the tire inflation pressure repeatedly drops:

- Check the tires for punctures from foreign objects.
- Check to see whether air is leaking from the valves or from around the rim.

Tire temperature and tire inflation pressure are also increased while driving, depending on the driving speed and the tire load.

If you will be driving your vehicle at high speeds of 100 mph (160 km/h) or higher, where it is legal and conditions allow, consult the placard on the inside of the fuel filler flap on how to adjust the cold tire inflation pressure. If you do not adjust the tire inflation pressure, excessive heat can build up and result in sudden tire failure.

Be sure to readjust the tire inflation pressure for normal driving speeds. You should wait until the tires are cold before adjusting the tire inflation pressure.

Some vehicles may have supplemental tire inflation pressure information for vehicle loads less than the maximum loaded vehicle condition. If such information is provided, it can be found on the placard located on the inside of the fuel filler flap.

Tire inflation pressure changes by approximately 1.5 psi (0.1 bar) per 18°F (10°C) of air temperature change. Keep this in mind when checking tire inflation pressure where the temperature is different from the outside temperature.

### Tires and wheels

#### Checking tire inflation pressure

Regularly check your tire inflation pressure at least once a month.

Check and adjust the tire inflation pressure when the tires are cold. The tires can be considered cold if the vehicle has been parked for at least three hours or driven less than one mile (1.6 km).

If you check the tire inflation pressure when the tires are warm (the vehicle has been driven for several miles or sitting less than three hours), the reading will be approximately 4 psi (0.3 bar) higher than the cold reading. This is normal. Do not let air out to match the specified cold tire inflation pressure. Otherwise, the tire will be underinflated.

#### Warning!



Follow recommended tire inflation pressures.

Do not overinflate tires. Overinflating tires can result in sudden deflation (blowout) because they are more likely to become punctured or damaged by road debris, potholes, etc.

Do not underinflate tires. Underinflated tires wear unevenly, adversely affect handling and fuel economy, and are more likely to fail from being overheated.

Do not overload the tires by exceeding the specified load limit or vehicle capacity weight as indicated on the placard on the driver's door B-pillar. Overloading the tires can overheat them, possibly causing a blowout.

#### Checking tire inflation pressure manually

Follow the steps below to achieve correct tire inflation pressure:

- ▶ Remove the cap from the valve on one tire.
- ▶ Firmly press a tire gauge onto the valve.
- ▶ Read tire inflation pressure on tire gauge and check against the recommended tire inflation pressure on the placard on the driver's door B-pillar (▷ page 314). If necessary, add air to achieve the recommended tire inflation pressure.



If you have overfilled the tire, release tire inflation pressure by pushing the metal stem of the valve with e.g. a tip of a pen. Then recheck the tire inflation pressure with the tire gauge.

- ▶ Install the valve cap.
- ▶ Repeat this procedure for each tire.

### Run Flat Indicator\* (Canada only)

While the vehicle is being driven, the Run Flat Indicator monitors the set tire inflation pressures by evaluating each wheel's rotational speed. This allows the system to detect a significant loss of pressure in a tire. If a wheel's rotational speed changes due to falling tire inflation pressure, you will see a corresponding warning message in the multifunction display.

The Run Flat Indicator\* may function in a restricted manner or with a delay if:

- snow chains are mounted to the vehicle
- winter road conditions prevail in presence of ice and snow
- you are driving on a loose surface (e.g. sand or gravel)
- you are driving in a very sporty manner (involving rapid acceleration or high speeds in curves)

### Warning!



When the multifunction display shows the message **Tire pressure Check tires**, one or more of your tires is significantly under-inflated. You should stop and check your tires as soon as possible, and inflate them to the proper tire inflation pressure as indicated on the vehicle's tire information placard. Driving on a significantly under-inflated tire causes the tire to overheat and can lead to tire failure. Under-inflation also reduces fuel efficiency and tire tread life, and may affect the vehicle's handling and stopping ability. Each tire, including the spare, should be checked monthly when cold and set to the recommended tire inflation pressure as specified in the vehicle placard and owner's manual.

### Tires and wheels



The recommended tire inflation pressures for your vehicle can be found on the tire placard located on the driver's door B-pillar (▷ page 314). The tire inflation pressures are not listed in the owner's manual.

#### Warning!



The Run Flat Indicator\* does not provide a warning for wrongly selected tire inflation pressures. Always adjust tire inflation pressure according to the placard on the driver's door B-pillar or fuel filler flap.

The Run Flat Indicator\* does not replace regular checks of the tire inflation pressures since a gradual pressure loss in all four tires cannot be detected by the Run Flat Indicator\*.

The Run Flat Indicator\* is not able to issue a warning due to a sudden dramatic loss of tire inflation pressure (e.g. tire blowout caused by a foreign object). In this case bring the vehicle to a halt by carefully applying the brakes and avoiding abrupt steering maneuvers.

#### **Reactivating the Run Flat Indicator\***

The tire inflation pressure monitor must be reactivated in the following situations:

- If you have changed the tire inflation pressure
- If you have replaced the wheels or tires
- If you have installed new wheels or tires
- ▶ Using the tire placard on the driver's door B-pillar or, if available, the inside of the fuel filler flap, make sure the tire inflation pressure of all four tires is correct.



**Warning!**

The Run Flat Indicator\* can only warn you in a reliable manner if you have set the correct tire inflation pressures for each tire.

If an incorrect tire inflation pressure was set, the system will monitor the pressure according to the incorrect value.

- ▶ Switch on the ignition (▷ page 33).

The standard display menu appears in the multifunction display (▷ page 135).

- ▶ Press button  or  repeatedly until the following message appears in the multifunction display:

Run Flat Indicator  
active  
Reactivation possible: +

- ▶ Press button .

The following message will appear in the multifunction display:

Tire pres. OK now?

If you wish to confirm activation:

- ▶ Press button .

The following message will appear in the multifunction display:

Run Flat Indicator  
Reactivated

After a certain “learning phase”, the Run Flat Indicator checks the set pressure values for all four tires.

If you wish to cancel activation:

- ▶ Press button .

or

- ▶ Wait until the message  
Tire pres. OK now?  
disappears.

**Potential problems associated with underinflated and overinflated tires*****Underinflated tire inflation pressure***

Underinflated tires can:

- cause excessive and uneven tire wear
- adversely affect fuel economy
- lead to tire failure from being overheated
- adversely affect handling characteristics

**Warning!**

Follow recommended tire inflation pressures.

Do not underinflate tires. Underinflated tires wear excessively and / or unevenly, adversely affect handling and fuel economy, and are more likely to fail from being overheated.



### Tires and wheels

#### ***Overinflated tire inflation pressure***

Overinflated tires can:

- adversely affect handling characteristics
- cause uneven tire wear
- be more prone to damage from road hazards
- adversely affect ride comfort
- increase stopping distance

#### **Warning!**



Follow recommended tire inflation pressures.

Do not overinflate tires. Overinflated tires can adversely affect handling and ride comfort, wear unevenly, increase stopping distance, and result in sudden deflation (blowout) because they are more likely to become punctured or damaged by road debris, potholes etc.

#### ***MOExtended system\* (Canada only)***

The *MOExtended* system allows you to continue driving your vehicle even if there is a total loss of pressure in one or more tires.

You may only use the *MOExtended* system in conjunction with the Run Flat Indicator\* (▷ page 317).

For information on driving in case of pressure loss in one or more tires (emergency mode), see the “Practical Hints” section (▷ page 411).

### Tire labeling

Besides tire name (sales designation) and manufacturer name, a number of markings can be found on a tire.

Following are some explanations for the markings on your vehicle's tires:

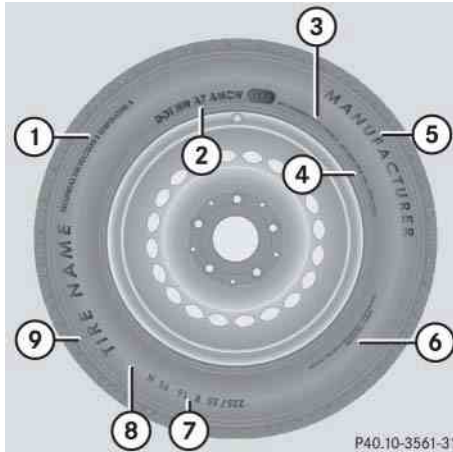

- ① Uniform Quality Grading Standards (▷ page 328)
- ② DOT, Tire Identification Number (TIN) (▷ page 326)
- ③ Maximum tire load (▷ page 327)
- ④ Maximum tire inflation pressure (▷ page 328)
- ⑤ Manufacturer
- ⑥ Tire ply material (▷ page 330)
- ⑦ Tire size designation, load and speed rating (▷ page 321)
- ⑧ Load identification (▷ page 325)
- ⑨ Tire name



For illustration purposes only. Actual data on tires is specific to each vehicle and may vary from data shown in above illustration.

For more information, see “Rims and Tires” (▷ page 432).

### Tire size designation, load and speed rating

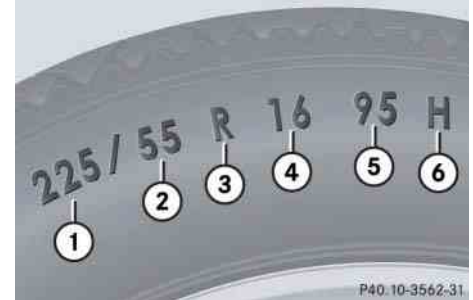

- ① Tire width
- ② Aspect ratio in %
- ③ Radial tire code
- ④ Rim diameter
- ⑤ Tire load rating
- ⑥ Tire speed rating



For illustration purposes only. Actual data on tires is specific to each vehicle and may vary from data shown in above illustration.

### Tires and wheels

General:

Depending on the design standards used, the tire size molded into the sidewall may have no letter or a letter preceding the tire size designation.

No letter preceding the size designation (as illustrated above): Passenger car tire based on European design standards.

Letter “P” preceding the size designation: Passenger car tire based on U.S. design standards.

Letter “LT” preceding the size designation: Light Truck tire based on U.S. design standards.

Letter “T” preceding the size designation: Temporary spare tires which are high pressure compact spares designed for temporary emergency use only.

#### ***Tire width***

The tire width ① (▷ page 321) indicates the nominal tire width in mm.

#### ***Aspect ratio***

The aspect ratio ② (▷ page 321) is the dimensional relationship between tire section height and section width and is expressed in percentage. The aspect ratio is arrived at by dividing section height by section width.

#### ***Tire code***

The tire code ③ (▷ page 321) indicates the tire construction type. The “R” stands for radial tire type. Letter “D” means diagonal or bias ply construction; letter “B” means belted-bias ply construction.

At the tire manufacturer’s option, any tire with a speed capability above 149 mph (240 km/h) can include a “ZR” in the size designation (for example: 245/40 ZR 18). For additional information, see “Tire speed rating” (▷ page 323).

#### ***Rim diameter***

The rim diameter ④ (▷ page 321) is the diameter of the bead seat, not the diameter of the rim edge. Rim diameter is indicated in inches (in).

#### ***Tire load rating***

The tire load rating ⑤ (▷ page 321) is a numerical code associated with the maximum load a tire can support.

For example, a load rating of 91 corresponds to a maximum load of 1356 lbs (615 kg) the tire is designed to support. See also “Maximum tire load” (▷ page 327) where the maximum load associated with the load index is indicated in kilograms and lbs.

**Warning**

The tire load rating must always be at least half of the GAWR (▷ page 331) of your vehicle. Otherwise, tire failure may be the result which may cause an accident and/or serious personal injury to you or others.

Always replace rims and tires with the same designation, manufacturer and type as shown on the original part.

**Warning!**

Do not overload the tires by exceeding the specified load limit or vehicle capacity weight as indicated on the placard located on the driver's door B-pillar. Overloading the tires can overheat them, possibly causing a blowout. Overloading the tires can also result in handling or steering problems, or brake failure.

For additional information on tire load rating, see “Load identification” (▷ page 325).



Tire load rating ⑤ (▷ page 321) and Tire speed rating ⑥ (▷ page 321) are also referred to as “service description”.

***Tire speed rating***

The tire speed rating ⑥ (▷ page 321) indicates the approved maximum speed for the tire.

**Warning!**

Even when permitted by law, never operate a vehicle at speeds greater than the maximum speed rating of the tires.

Exceeding the maximum speed for which tires are rated can lead to sudden tire failure, causing loss of vehicle control and possibly resulting in an accident and/or personal injury and possible death, for you and for others.



Tire load rating ⑤ (▷ page 321) and Tire speed rating ⑥ (▷ page 321) are also referred to as “service description”.

## Tires and wheels

### Summer tires

Index	Speed rating
Q	up to 100 mph (160 km/h)
R	up to 106 mph (170 km/h)
S	up to 112 mph (180 km/h)
T	up to 118 mph (190 km/h)
H	up to 130 mph (210 km/h)
V	up to 149 mph (240 km/h)
W	up to 168 mph (270 km/h)
Y	up to 186 mph (300 km/h)
(Y)	above 186 mph (300 km/h)
ZR	above 149 mph (240 km/h)

- At the tire manufacturer’s option, any tire with a speed capability above 149 mph (240 km/h) can include a “ZR” in the size designation (for example: 245/40 ZR18). To determine the maximum speed capability of the tire, the service description for the tire must be referred to. The service description is comprised of the tire load rating ⑤ (▷ page 321) and the tire speed rating ⑥ (▷ page 321).

If your tire includes “ZR” in the size designation and no service description ⑤ and ⑥ (▷ page 321) is given, the tire manufacturer must be consulted for the maximum speed capability.

If a service description ⑤ and ⑥ (▷ page 321) is given, the speed capability is limited by the speed symbol in the service description.

Example: 245/40 ZR18 97Y.

In this example, “97Y” is the service description. The letter “Y” designates the speed rating and the speed capability of the tire is limited to 186 mph (300 km/h).

- Any tire with a speed capability above 186 mph (300 km/h) must include a “ZR” in the size designation AND the service description must be placed in parenthesis. Example: 275/40 ZR 18 (99Y). The “(Y)” speed rating in parenthesis designates the maximum speed capability of the tire as being above 186 mph (300 km/h). Consult the tire manufacturer for the actual maximum permissible speed of the tire.

All-season and winter tires

Index	Speed rating
Q M+S <sup>1</sup>	up to 100 mph (160 km/h)
T M+S <sup>1</sup>	up to 118 mph (190 km/h)
H M+S <sup>1</sup>	up to 130 mph (210 km/h)
V M+S <sup>1</sup>	up to 149 mph (240 km/h)

<sup>1</sup> or M+S  for winter tires



Not all M+S rated tires provide special winter performance. Make sure the tires you use show M+S and the mountain/snowflake  marking on the tire sidewall. These tires meet specific snow traction performance requirements of the Rubber Manufacturers Association (RMA) and the Rubber Association of Canada (RAC) and have been designed specifically for use in snow conditions.

Load identification



① Load identification



For illustration purposes only. Actual data on tires is specific to each vehicle and may vary from data shown in above illustration.

In addition to tire load rating, special load information may be molded into the tire sidewall following the letter designating the tire speed rating ① (▷ page 325).

No specification given: absence of any text (like in above example) indicates a standard load (SL) tire.

XL or Extra Load: designates an extra load (or reinforced) tire.

Light Load: designates a light load tire.

C, D, E: designates load range associated with the maximum load a tire can carry at a specified pressure.

## Tires and wheels

### DOT, Tire Identification Number (TIN)

U.S. tire regulations require each new tire manufacturer or tire retreader to mold a TIN into or onto a sidewall of each tire produced.

The TIN is a unique identifier which facilitates efforts by tire manufacturers to notify purchasers in recall situations or other safety matters concerning tires and gives purchasers the means to easily identify such tires.

The TIN is comprised of “Manufacturer’s identification mark”, “Tire size”, “Tire type code”, and “Date of manufacture”.

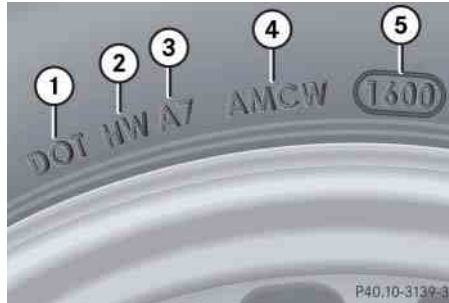

- ① DOT
- ② Manufacturer’s identification mark
- ③ Tire size
- ④ Tire type code (at the option of the tire manufacturer)
- ⑤ Date of manufacture



For illustration purposes only. Actual data on tires is specific to each vehicle and may vary from data shown in above illustration.

### DOT (Department of Transportation)

A tire branding symbol ① (▷ page 326) which denotes the tire meets requirements of the U.S. Department of Transportation.

### Manufacturer’s identification mark

The manufacturer’s identification mark ② (▷ page 326) denotes the tire manufacturer.

New tires have a mark with two symbols.

Retreaded tires have a mark with four symbols. For more information on retreaded tires, see (▷ page 304).

### Tire size

The code ③ (▷ page 326) indicates the tire size.

### Tire type code

The code ④ (▷ page 326) may, at the option of the manufacturer, be used as a descriptive code for identifying significant characteristics of the tire.

### Date of manufacture

The date of manufacture ⑤ (▷ page 326) identifies the week and year of manufacture.

The first two figures identify the week, starting with “01” to represent the first full week of the calendar year. The second two figures represent the year.

For example, “3202” represents the 32nd week of 2002.

### Maximum tire load



#### ① Maximum tire load rating



For illustration purposes only. Actual data on tires is specific to each vehicle and may vary from data shown in above illustration.

The maximum tire load is the maximum weight the tires are designed to support.

### Warning!



Do not overload the tires by exceeding the specified load limit or vehicle capacity weight as indicated on the placard located on the driver's door B-pillar. Overloading the tires can overheat them, possibly causing a blowout. Overloading the tires can also result in handling or steering problems, or brake failure.

For more information on tire load rating (▷ page 322).

For information on calculating total and cargo load capacities (▷ page 310).



## Tires and wheels

### Maximum tire inflation pressure

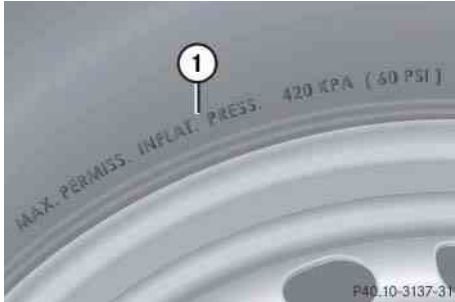

- ① Maximum permissible tire inflation pressure



For illustration purposes only. Actual data on tires is specific to each vehicle and may vary from data shown in above illustration.

This is the maximum permissible tire inflation pressure for the tire.

Always follow the recommended tire inflation pressure (▷ page 314) for proper tire inflation.

### Warning!



Never exceed the max. tire inflation pressure. Follow recommended tire inflation pressures.

Do not underinflate tires. Underinflated tires wear excessively and / or unevenly, adversely affect handling and fuel economy, and are more likely to fail from being overheated.

Do not overinflate tires. Overinflated tires can adversely affect handling and ride comfort, wear unevenly, increase stopping distance, and result in sudden deflation (blowout) because they are more likely to become punctured or damaged by road debris, potholes etc.

### Uniform Tire Quality Grading Standards (U.S. vehicles)

Tire manufacturers are required to grade tires based on three performance factors: treadwear, traction, and temperature resistance.

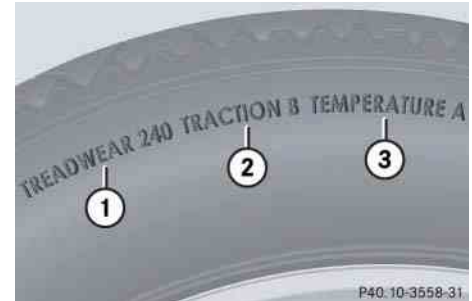

- ① Treadwear
- ② Traction
- ③ Temperature resistance



For illustration purposes only. Actual data on tires is specific to each vehicle and may vary from data shown in above illustration.

Quality grades can be found, where applicable, on the tire sidewall between tread shoulder and maximum section width. For example:

Treadwear	Traction	Temperature
200	AA	A

All passenger car tires must conform to federal safety requirements in addition to these grades.

### Treadwear

The treadwear grade is a comparative rating based on the wear rate of the tire when tested under controlled conditions on a specified government test course. For example, a tire graded 150 would wear one and one-half ( $1\frac{1}{2}$ ) times as well on the government course as a tire graded 100. The relative performance of tires depends upon the actual conditions of their use, however, and may depart significantly from the norm due to variations in driving habits, service practices and differences in road characteristics and climate.

### Traction

The traction grades, from highest to lowest, are AA, A, B, and C. Those grades represent the tire's ability to stop on wet pavement as measured under controlled conditions on specified government test surfaces of asphalt and concrete. A tire marked C may have poor traction performance.

#### Warning!



The traction grade assigned to this tire is based on straight-ahead braking traction tests, and does not include acceleration, cornering, hydroplaning, or peak traction characteristics.

### Tires and wheels

#### Temperature

The temperature grades are A (the highest), B, and C, representing the tire's resistance to the generation of heat and its ability to dissipate heat when tested under controlled conditions on a specified indoor laboratory test wheel. Sustained high temperature can cause the material of the tire to degenerate and reduce tire life, and excessive temperature can lead to sudden tire failure. The grade C corresponds to a level of performance which all passenger car tires must meet under the Federal Motor Vehicle Safety Standard No. 109. Grades B and A represent higher levels of performance on the laboratory test wheel than the minimum required by law.

#### Warning!



The temperature grade for this tire is established for a tire that is properly inflated and not overloaded. Excessive speed, underinflation, or excessive loading, either separately or in combination, can cause excessive heat build-up and possible tire failure.

#### Tire ply material



- ① Pliers in sidewall
- ② Pliers under tread



For illustration purposes only. Actual data on tires is specific to each vehicle and may vary from data shown in above illustration.

This marking tells you about the type of cord and number of plies in the sidewall and under the tread.

## Tire and loading terminology

---

### Accessory weight

The combined weight (in excess of those standard items which may be replaced) of automatic transmission, power steering, power brakes, power windows, power seats, radio, and heater, to the extent that these items are available as factory-installed equipment (whether installed or not).

### Air pressure

The amount of air inside the tire pressing outward on each square inch of the tire. Air pressure is expressed in pounds per square inch (psi), or kilopascal (kPa) or bars.

### Aspect ratio

Dimensional relationship between tire section height and section width expressed in percentage.

### Bar

Another metric unit for air pressure. There are 14.5038 pounds per square inch (psi) to 1 bar; there are 100 kilopascals (kPa) to 1 bar.

### Bead

The tire bead contains steel wires wrapped by steel cords that hold the tire onto the rim.

### Cold tire inflation pressure

Tire inflation pressure when your vehicle has been sitting for at least three hours or driven no more than one mile (1.6 km).

### Curb weight

The weight of a motor vehicle with standard equipment including the maximum capacity of fuel, oil, and coolant, and, if so equipped, air conditioning and additional optional equipment, but without passengers and cargo.

### DOT (Department of Transportation)

A tire branding symbol which denotes the tire meets requirements of the U.S. Department of Transportation.

### GAWR (Gross Axle Weight Rating)

The GAWR is the maximum permissible axle weight. The gross vehicle weight on each axle must never exceed the GAWR for the front and rear axle indicated on the certification label located on the driver's door B-pillar.

### Tires and wheels

#### **GVW (Gross Vehicle Weight)**

The GVW comprises the weight of the vehicle including fuel, tools, spare wheel, installed accessories, passengers and cargo and, if applicable, trailer tongue load. The GVW must never exceed the GVWR indicated on the certification label located on the driver's door B-pillar.

#### **GVWR (Gross Vehicle Weight Rating)**

This is the maximum permissible vehicle weight of the fully loaded vehicle (weight of the vehicle including all options, passengers, fuel, and cargo and, if applicable, trailer tongue load). It is indicated on certification label located on the driver's door B-pillar.

#### **Kilopascal (kPa)**

The metric unit for air pressure. There are 6.9 kPa to 1 psi; another metric unit for air pressure is bars. There are 100 kilopascals (kPa) to 1 bar.

#### **Maximum load rating**

The maximum load in kilograms and pounds that can be carried by the tire.

#### **Maximum loaded vehicle weight**

The sum of curb weight, accessory weight, vehicle capacity weight and production options weight.

#### **Maximum tire inflation pressure**

This number is the greatest amount of air pressure that should ever be put in the tire under normal driving conditions.

#### **Normal occupant weight**

The number of occupants the vehicle is designed to seat, multiplied by 68 kilograms (150 lbs).

#### **Occupant distribution**

The distribution of occupants in a vehicle at their designated seating positions.

**Production options weight**

The combined weight of those installed regular production options weighing over 5 lbs (2.3 kilograms) in excess of those standard items which they replace, not previously considered in curb weight or accessory weight, including heavy duty brakes, ride levelers, roof rack, heavy duty battery, and special trim.

**PSI (Pounds per square inch)**

A standard unit of measure for air pressure -> bar, kilopascal (kPa).

**Recommended tire inflation pressure**

Recommended tire inflation pressure listed on placard located on driver's door B-pillar for normal driving conditions. Provides best handling, tread life and riding comfort.

**Rim**

A metal support for a tire or a tire and tube assembly upon which the tire beads are seated.

**Sidewall**

The portion of a tire between the tread and the bead.

**TIN (Tire Identification Number)**

Unique identifier which facilitates efforts by tire manufacturers to notify purchasers in recall situations or other safety matters concerning tires and gives purchases the means to easily identify such tires. The TIN is comprised of "Manufacturer's identification mark", "Tire size", "Tire type code" and "Date of manufacture".

**Tire load rating**

Numerical code associated with the maximum load a tire can support.

**Tire ply composition and material used**

This indicates the number of plies or the number of layers of rubber-coated fabric in the tire tread and sidewall. Tire manufacturers also must indicate the ply materials in the tire and sidewall, which include steel, nylon, polyester, and others.

**Tire speed rating**

Part of tire designation; indicates the speed range for which a tire is approved.

### Tires and wheels

#### Traction

Force exerted by the vehicle on the road via the tires. The amount of grip provided.

#### Tread

The portion of a tire that comes into contact with the road.

#### Treadwear indicators

Narrow bands, sometimes called “wear bars” that show across the tread of a tire when only  $\frac{1}{16}$  in (1.6 mm) of tread remains.

#### Uniform Tire Quality Grading Standards

A tire information system that provides consumers with ratings for a tire’s traction, temperature and treadwear. Ratings are determined by tire manufacturers using government testing procedures. The ratings are molded into the sidewall of the tire.

#### Vehicle capacity weight

Rated cargo and luggage load plus 68 kilograms (150 lbs) times the vehicle’s designated seating capacity.

#### Vehicle maximum load on the tire

Load on an individual tire that is determined by distributing to each axle its share of the maximum loaded vehicle weight and dividing it by two.

## Rotating tires

### Warning!



Rotate front and rear wheels only if the tires are of the same dimension.

If your vehicle is equipped with mixed-size tires (different tire dimensions front vs. rear), tire rotation is not possible.

Tire rotation can be performed on vehicles with tires of the same dimension all around. If your vehicle is equipped with tires of the same dimension all around, tires can be rotated, observing a front-to-rear rotation pattern that will maintain the intended rotation (spinning) direction of the tire (▷ page 307).

In some cases, such as when your vehicle is equipped with mixed-size tires (different tire dimension front vs. rear), tire rotation is not possible.

If applicable to your vehicle's tire configuration, tires can be rotated according to the tire manufacturer's recommended intervals in the tire manufacturer's warranty pamphlet located in your vehicle literature portfolio. If none is available, tires should be rotated every 3000 to 6000 miles (5000 to 10000 km), or sooner if necessary, according to the degree of tire wear. The same rotation (spinning) direction must be maintained (▷ page 307).

Rotate tires before the characteristic tire wear pattern becomes visible (shoulder wear on front tires and tread center wear on rear tires).

Thoroughly clean the mounting face of wheels and brake disks, i.e. the inner side of the wheels/tires, during each rotation. Check for and ensure proper tire inflation pressure.

### Warning!



Have the tightening torque checked after changing a wheel. Wheels could become loose if not tightened with a torque of 80 lb-ft (110 Nm).

Only use genuine Mercedes-Benz wheel bolts specified for your vehicle's rims.

For information on wheel change, see the "Practical hints" section (▷ page 383) and (▷ page 406).



### Winter driving

Before the onset of winter, have your vehicle winterized at an authorized Mercedes-Benz Center. This service includes:

- Check of anticorrosion and antifreeze concentration.
- Addition of cleaning concentrate to the water of the windshield and headlamp cleaning system. Add MB Concentrate “S” to a premixed windshield washer solvent/antifreeze which is formulated for below freezing temperatures (▷ page 448).
- Battery test. Battery capacity drops with decreasing ambient temperature. A well charged battery helps to make sure that the engine can be started, even at low ambient temperatures.
- Tire change.

### Winter tires

Always use winter tires at temperatures below 45°F (7°C) and whenever wintry road conditions prevail. Not all M+S rated tires provide special winter performance. Make sure the tires you use show M+S and the mountain/snowflake  marking on the tire sidewall. These tires meet specific snow traction performance requirements of the Rubber Manufacturers Association (RMA) and the Rubber Association of Canada (RAC) and have been designed specifically for use in snow conditions. Use of winter tires is the only way to achieve the maximum effectiveness of the ABS, ESP®, and 4MATIC in winter operation.

For safe handling, make sure that all mounted winter tires are of the same make and have the same tread design.

### Warning!



Winter tires with a tread depth of less than  $\frac{1}{6}$  in (4 mm) must be replaced. They are no longer suitable for winter operation.

Always observe the speed rating of the winter tires installed on your vehicle. If the maximum speed for which your tires are rated is below the speed rating of your vehicle, you must place a notice to this effect where it will be seen by the driver. Such notices are available from your tire dealer or from any authorized Mercedes-Benz Center.

**Warning!**

If you use your spare tire when winter tires are fitted on the other wheels, be aware that the difference in tire characteristics may very well impair turning stability and that overall driving stability may be reduced. Adapt your driving style accordingly.

Have the spare tire replaced with a winter tire at the nearest authorized Mercedes-Benz Center.

**Block heater (Canada only)**

The engine is equipped with a block heater.

The electrical cable may be installed at an authorized Mercedes-Benz Center.

**Snow chains**

Snow chains should only be driven on snow-covered roads at speeds not to exceed 30 mph (50 km/h). Remove chains as soon as possible when driving on roads without snow.



When driving with snow chains, you may wish to deactivate the ESP® (▷ page 89) before setting the vehicle in motion. This will improve the vehicle's traction.

Please observe the following guidelines when using snow chains:

- Use of snow chains is not permissible with all wheel/tire combinations.
- Snow chains should only be used on the rear wheels. Follow the manufacturer's mounting instructions.

- Only use snow chains that are approved by Mercedes-Benz. Your authorized Mercedes-Benz Center will be glad to advise you on this subject.
- Use of snow chains may be prohibited depending on location. Always check local and state laws before installing snow chains.



Some tire sizes do not leave adequate clearance for snow chains. To help avoid serious damage to your vehicle or tires, use of snow chains is not permissible with the following tire sizes:

- 245/40 R17 91W
- 245/40 R17 91W MO*Extended*
- T 125/90 R16 98M
- T 125/80 R17 99M

We strongly recommend that you have your vehicle serviced by an authorized Mercedes-Benz Center, in accordance with the Maintenance Booklet at the times called for by the maintenance service indicator display.

Failure to have the vehicle maintained in accordance with the Maintenance Booklet and maintenance service indicator at the designated times/mileage will result in vehicle damage not covered by the Mercedes-Benz Limited Warranty.

#### Maintenance service indicator message

The maintenance service indicator will notify you when your next maintenance service is due.

Starting approximately 1 month before your next maintenance service is due, one of the following messages will appear in the multifunction display while you are driving or when you switch on the ignition (example service A):

Service A in XXXXX Miles (Km)

Service A in XXX Days

Service A due now



The type of maintenance service due is indicated in the multifunction display:



Basic service (A)



Extended service (B)



Vehicles equipped with FSS (Flexible Service System) only (Canada vehicles): The interval between maintenance services depends on your driving habits. A gentle driving style, moderate engine speeds and the avoidance of short-distance trips will lengthen the interval between services.

### Clearing the maintenance service indicator message

The maintenance service indicator is automatically cleared

- after approximately 10 seconds when you switch on the ignition or when reaching the maintenance service threshold while driving
- after approximately 30 seconds, once the suggested maintenance service term has passed

You can also clear it yourself.



① Reset button

- ▶ Press reset button ① on the instrument cluster.

The maintenance service indicator message is cleared and the standard display appears in the multifunction display (▷ page 135).

### Maintenance service term exceeded







If you have exceeded the suggested maintenance service term, you will see the following message in the multifunction display:

Service A exceeded by XXXX Miles (Km)  
Service A exceeded by XXX Days

In addition, a signal sounds when the message appears.

Any authorized Mercedes-Benz Center will reset the maintenance service indicator following a completed maintenance service.

### Calling up the maintenance service indicator display

- ▶ Switch on the ignition (▷ page 33).
- ▶ Press button  or  on the multifunction steering wheel repeatedly until the standard display appears in the multifunction display (▷ page 130).
- ▶ Press button  or  until the maintenance service indicator display with the service symbol  or  and the service deadline appears in the multifunction display.



If the battery is disconnected, the days of disconnection will not be included in the count shown by the maintenance service indicator. To arrive at the true maintenance service deadline, you will need to subtract these days from the days shown in the maintenance service indicator message or maintenance service indicator display.

Do not confuse the maintenance service indicator with the engine oil level indicator .

#### Resetting the maintenance service indicator

---

In the event that the maintenance service on your vehicle is not carried out by an authorized Mercedes-Benz Center, you can have the maintenance service indicator reset. The automotive maintenance facility carrying out the maintenance service will find the information for resetting the maintenance service indicator in the maintenance-relevant information for your vehicle. Such information is available from either your authorized Mercedes-Benz Center or directly from Mercedes-Benz.



If the maintenance service indicator was inadvertently reset, have an authorized Mercedes-Benz Center correct it.

Only reset if the proper maintenance service has been performed. Resetting the system without performing the proper service as called for by the maintenance service indicator will result in engine damage and/or other vehicle damage not covered by the Mercedes-Benz Limited Warranty.

## ▼ Vehicle care

### Cleaning and care of the vehicle

#### Warning!



Many cleaning products can be hazardous. Some are poisonous, others are flammable. Always follow the instructions on the particular container. Always open your vehicle's doors or windows when cleaning the inside.

Never use fluids or solvents that are not designed for cleaning your vehicle.

Always lock away cleaning products and keep them out of reach of children.

While in operation, even while parked, your vehicle is subjected to varying external influences which, if gone unchecked, can attack the paintwork as well as the underbody and cause lasting damage.

Such damage is caused not only by extreme and varying climatic conditions, but also by:

- Air pollution
- Road salt
- Tar
- Gravel and stone chipping

To avoid paint damage, you should immediately remove:

- Grease and oil
- Fuel
- Coolant
- Brake fluid
- Bird droppings
- Insects
- Tree resins, etc.

Frequent washing reduces and/or eliminates the aggressiveness and potency of the above adverse influences.

More frequent washings are necessary to deal with unfavorable conditions:

- near the ocean
- in industrial areas (smoke, exhaust emissions)
- during winter operation

You should check your vehicle from time to time for stone chipping or other damage. Any damage should be repaired as soon as possible to prevent corrosion.

In doing so, do not neglect the underbody of the vehicle. A prerequisite for a thorough check is a washing of the underbody followed by a thorough inspection. Damaged areas need to be re-undercoated.

Your vehicle has been treated at the factory with a wax-base rustproofing in the body cavities which will last for the lifetime of the vehicle. Post-production treatment is neither necessary nor recommended by Mercedes-Benz because of the possibility of incompatibility between materials used in the production process and others applied later.

### Vehicle care

We have selected car-care products and compiled recommendations which are specially matched to our vehicles and which always reflect the latest technology. You can obtain Mercedes-Benz approved car-care products at an authorized Mercedes-Benz Center.

Scratches, corrosive deposits, corrosion or damage due to negligent or incorrect care cannot always be removed or repaired with the car-care products recommended here. In such cases it is best to seek aid at an authorized Mercedes-Benz Center.

The following topics deal with the cleaning and care of your vehicle and give important “how-to” information as well as references to Mercedes-Benz approved car-care products.

#### Power washer



Follow the instructions provided by the power washer manufacturer on maintaining a distance between the vehicle and the nozzle of the power washer.

Never use a round nozzle to power-wash tires. The intense jet of water can result in damage to the tire.

Always replace a damaged tire.

Always keep the jet of water moving across the surface. Do not aim directly at electrical parts, electrical connectors, seals, or other rubber parts.

#### Tar stains

Quickly remove tar stains before they dry and become more difficult to remove. A tar remover is recommended.

#### Paintwork, painted body components



Affixing stickers, adhesive tape or similar materials to painted body components may damage the paintwork.

Mercedes-Benz approved Paint Care should be applied when water drops on the paint surface do not “bead up”. This should normally be done every 3 to 5 months, depending on the climate and washing detergent used.

Mercedes-Benz approved Paint Cleaner should be applied if the paint surface shows signs of embedded dirt (i.e. loss of gloss).

Do not apply any of these products or wax if your vehicle is parked in the sun or if the hood is still hot.

- ▶ Use the appropriate MB-Touch-Up Stick for quick and provisional repairs of minor paint damage (i.e. chips from stones, vehicle doors, etc.).

### Engine cleaning

Prior to cleaning the engine compartment, make sure to protect electrical components and connectors from the intrusion of water and cleaning agents.

Corrosion protection, such as MB Anticorrosion Wax, should be applied to the engine compartment after every engine cleaning. Before applying, all control linkage bushings and joints should be lubricated. The poly-V-belt and all pulleys should be protected from any wax.

### Vehicle washing

In the winter, thoroughly remove all traces of road salt as soon as possible.

When washing the vehicle underbody, do not forget to clean the inner sides of the wheels.

### Hand-wash

Do not use hot water or wash your vehicle in direct sunlight.

- ▶ Only use a mild car wash detergent, such as Mercedes-Benz approved Car Shampoo.
- ▶ Thoroughly spray the vehicle with a diffused jet of water.

Direct only a very weak spray towards the ventilation intake.

- ▶ Use plenty of water and rinse the sponge and chamois frequently.
- ▶ Rinse with clean water and thoroughly dry with a chamois.

Do not allow cleaning agents to dry on the finish.

### Automatic car wash

You can have your car washed in an automatic car wash from the start. Automatic car washes without brushes are preferable.

If the vehicle is very dirty, prewash it before running it through the automatic car wash.



Due to the width of the vehicle, fold in exterior rear view mirrors prior to running the vehicle through an automatic car wash to prevent damage to the mirrors.

Make sure that the windshield wiper switch is set to **0** (▷ page 53). Otherwise, the rain sensor could activate and cause the wipers to move unintentionally. This may lead to vehicle damage.



### Vehicle care



After running the vehicle through an automatic car wash, wipe any wax off of the windshield (▷ page 345). This will prevent smears and reduce wiping noise which can be caused by residual wax on the windshield.

When leaving the car wash, make sure that the mirrors are folded out. Otherwise they may vibrate.

#### Ornamental moldings

For regular cleaning and care of ornamental moldings, use a damp cloth.



Do not use chrome cleaner on ornamental moldings. Although ornamental moldings may have chrome appearance, they could be made of anodized aluminum that will be damaged when cleaned with chrome cleaner. Instead, use a damp cloth to clean those ornamental moldings.

For very dirty ornamental moldings of which you are sure are chrome-plated, use a chrome cleaner. If in doubt whether an ornamental molding is chrome-plated, contact an authorized Mercedes-Benz Center.

#### Headlamps, tail lamps, side markers, turn signal lenses

- ▶ Use a mild car wash detergent, such as Mercedes-Benz approved Car Shampoo, with plenty of water.



Only use window cleaning solutions that are suitable for plastic lamp lenses. Window cleaning solutions which are not suitable may damage the plastic lamp lenses of the headlamps. Therefore, do not use abrasives, solvents or cleaners that contain solvents.

Never apply strong force and only use a soft, non-scratching cloth when cleaning the lenses. Do not attempt to wipe dirty lenses with a dry cloth or sponge. Otherwise you may scratch or damage the lens surface.

## Cleaning the windows and the wiper blades



The windshield wipers must be in a vertical position before folding them away from the windshield. They could otherwise damage the hood.

Never open the hood when the wiper arms are folded forward.

- ▶ Switch on the ignition (▷ page 33).
- ▶ Turn combination switch to wiper setting II (▷ page 53).
- ▶ With wiper arms in vertical position, switch off the ignition (▷ page 33).

### Warning!



For safety reasons, switch off wipers and remove SmartKey from starter switch before cleaning the windshield and/or the wiper blades. Otherwise, the wiper motor could suddenly turn on and cause injury.

- ▶ Fold the wiper arms forward until they snap into place.
- ▶ Clean the wiper blade inserts with a clean cloth and detergent solution.
- ▶ Use a soft, clean cloth and a mild window cleaning solution on all outside and inside glass surfaces.

An automotive glass cleaner is recommended.



Fold the windshield wiper arms back onto the windshield before turning the SmartKey in the starter switch.

Hold on to the wiper when folding the wiper arm back. If released, the force of the impact from the tensioning spring could crack the windshield.



To clean the window interior, do not use a dry cloth, abrasives, solvents or cleaners containing solvents. Do not touch the inside of the front, rear or side windows with hard objects such as an ice scraper or ring. Doing so may damage the windows.

### Vehicle care

#### Light alloy wheels

If possible, clean wheels once a week.

- ▶ Use Mercedes-Benz approved Wheel Care, a soft bristle brush and a strong spray of water for cleaning the light alloy wheels.



Only use acid-free cleaning materials. Acid may cause corrosion or damage the clear coat.



The vehicle should not be parked for an extended period of time immediately after it has been cleaned, especially not after the wheel rims have been cleaned with wheel rim cleaner. Wheel rim cleaners can lead to increased corrosion of the brake disks and brake pads. Therefore, the vehicle's brake system should always be warmed-up before it is parked after cleaning. To do so, please drive your vehicle for several minutes to allow the brakes to dry.

When applying Mercedes-Benz approved Tire Care and Mercedes-Benz approved Wheel Care products, take care not to spray them on the brake disks.

#### Plastic and rubber parts

- ▶ Use a gentle dishwashing detergent or mild detergent for delicate fabrics as a washing solution.



Do not use oil or wax on these parts.

#### Instrument cluster and cup holders

- ▶ Use a gentle dishwashing detergent or mild detergent for delicate fabrics as a washing solution.
- ▶ Wipe with a cloth moistened in a luke-warm solution.



To prevent scratches, do not use scouring agents.

### Hard plastic trim items

- ▶ Use Mercedes-Benz approved Interior Care, a soft, lint-free cloth and apply with light pressure.



To prevent scratches, do not use scouring agents.

### Steering wheel and gear selector lever

- ▶ Wipe with a damp cloth and dry thoroughly or clean with Mercedes-Benz approved Leather Care.

### Carpets

- ▶ Use Mercedes-Benz approved Carpet and Fabric Care for cleaning the carpets.

### Headliner and shelf below rear window

- ▶ Use a soft bristle brush or a dry-shampoo cleaner in case of excessive dirt.

### Seat belts

- ▶ Only use clear, lukewarm water and soap.



The webbing must not be treated with chemical cleaning agents. Do not dry the webbing at temperatures above 176°F (80°C) or in direct sunlight.

### Warning!



Do not bleach or dye seat belts as this may severely weaken them. In a crash they may not be able to provide adequate protection.

### Vehicle care

#### Upholstery

Using aftermarket seat covers or wearing clothing that have the tendency to give off coloring (e.g. when wet, etc.) may cause the upholstery to become permanently discolored. By lining the seats with a proper intermediate cover, contact-discoloration will be prevented.

#### *Leather upholstery*

- ▶ Wipe leather upholstery with a damp cloth and dry thoroughly or clean with Mercedes-Benz approved Leather Care.

Exercise particular care when cleaning perforated leather as its underside should not become wet.

#### *MB Tex upholstery*

- ▶ Use Mercedes-Benz approved Interior Care onto a soft, lint-free cloth and apply with light pressure for cleaning the upholstery.

#### Wood trims

- ▶ Dampen cloth using water and use damp cloth to clean wood trims in your vehicle.



Do not use solvents like tar remover or wheel cleaner nor polishes or waxes as these may be abrasive.

What to do if ...

Where will I find ...?

Unlocking/locking in an emergency

Opening/closing in an emergency

Resetting activated head restraints

Replacing SmartKey batteries

Replacing bulbs

Replacing wiper blades

Flat tire

Battery

Jump starting

Towing the vehicle

Fuses



### What to do if ...



#### Lamps in instrument cluster

General information:

If any of the following lamps in the instrument cluster fails to come on during the

bulb self-check when switching on the ignition, have the respective bulb checked and replaced if necessary.

Problem	Possible cause/consequence	Suggested solution
 The yellow ABS indicator lamp comes on while driving.	<p>The ABS has detected a malfunction and has switched off. The BAS and the ESP® are also switched off (see messages in display).</p> <p>The brake system is still functioning normally but without the ABS available.</p> <p>If the ABS control unit is malfunctioning, other systems such as the navigation system* or the automatic transmission* may also be malfunctioning.</p> <p>The charging voltage has fallen below ten volts. The ABS has switched off.</p> <p>The battery might not be charged sufficiently.</p>	<ul style="list-style-type: none"> <li>▶ Continue driving with added caution. Wheels may lock during hard braking, reducing steering capability.</li> <li>▶ Read and observe messages in the display (▷ page 358).</li> <li>▶ Have the system checked at an authorized Mercedes-Benz Center as soon as possible.</li> </ul> <p>Failure to follow these instructions increases the risk of an accident.</p> <ul style="list-style-type: none"> <li>▶ Switch off electrical consumers that are currently not needed, e.g. seat heating*.</li> <li>▶ If necessary, have the generator (alternator) and battery checked.</li> </ul> <p>When the voltage is above this value again, the ABS is operational again.</p>

Problem	Possible cause/consequence	Suggested solution
<p><b>BRAKE</b> (USA only)</p> <p> (Canada only)</p> <p>The red brake warning lamp comes on while driving and you hear a warning sound.</p>	<p>You are driving with the parking brake set.</p>	<p>► Release the parking brake (▷ page 50).</p>
<p><b>BRAKE</b> (USA only)</p> <p> (Canada only)</p> <p>The red brake warning lamp comes on while driving.</p>	<p>There is insufficient brake fluid in the reservoir.</p>	<p>► Risk of accident! Carefully stop the vehicle and notify an authorized Mercedes-Benz Center. Do not add brake fluid! This will not solve the problem.</p>

**Warning!**





Driving with the brake warning lamp illuminated can result in an accident. Have your brake system checked immediately if the brake warning lamp stays on. Don't add brake fluid before checking the brake system. Overfilling the brake fluid reservoir can result in spilling brake fluid on hot engine parts and the brake fluid catching fire. You can be seriously burned.





If you find that the brake fluid in the brake fluid reservoir has fallen to the minimum mark or below, have the brake system checked for brake pad thickness and leaks.





### What to do if ...

Problem	Possible cause/consequence	Suggested solution
<p> (USA only)</p> <p> (Canada only)</p> <p>The yellow engine malfunction indicator lamp comes on while driving.</p>	<p>There is a malfunction in:</p> <ul style="list-style-type: none"> <li>• The fuel management system</li> <li>• The ignition system</li> <li>• The emission control system</li> <li>• Systems which affect emissions</li> </ul> <p>Such malfunctions may result in excessive emissions values and may switch the engine to its limp-home (emergency operation) mode.</p> <p>A loss of pressure has been detected in the fuel system. The fuel cap may not be closed properly or the fuel system may be leaky.</p>	<ul style="list-style-type: none"> <li>▶ Have the vehicle checked as soon as possible by an authorized Mercedes-Benz Center.</li> </ul> <p>An on-board diagnostic connector is used by the service station to link the vehicle to the shop diagnostics system. It allows the accurate identification of system malfunctions through the readout of diagnostic trouble codes. It is located in the front left area of the footwell next to the parking brake pedal.</p> <ul style="list-style-type: none"> <li>▶ Check the fuel cap (▷ page 294).</li> </ul> <p>If it is not closed properly:</p> <ul style="list-style-type: none"> <li>▶ Close the fuel cap.</li> </ul> <p>If it is closed properly:</p> <ul style="list-style-type: none"> <li>▶ Have the fuel system checked by an authorized Mercedes-Benz Center.</li> </ul>

Problem	Possible cause/consequence	Suggested solution
<p> (USA only)</p> <p> (Canada only)</p> <p>The yellow engine malfunction indicator lamp comes on while driving.</p>	<p>Your fuel tank is empty.</p>	<p>► After refuelling start, turn off and restart the engine three or four times in succession.</p> <p>The limp-home mode is canceled. You do not need to have your vehicle checked.</p>

### What to do if ...

Problem	Possible cause/consequence	Suggested solution
 <p>The yellow ESP® warning lamp comes on while driving.</p>	<p>The ESP® is deactivated.</p> <p>Risk of accident!</p> <p>Adapt your speed and driving to the prevailing road, weather and traffic conditions.</p>	<ul style="list-style-type: none"> <li>▶ Switch the ESP® back on (▷ page 89).</li> </ul> <p>If the ESP® cannot be switched back on, have the system checked at an authorized Mercedes-Benz Center as soon as possible.</p>
<p>The yellow ESP® warning lamp flashes while driving.</p>	<p>The ESP® or traction control has come into operation because of detected traction loss in at least one tire.</p>	<ul style="list-style-type: none"> <li>▶ When driving off, apply as little throttle as possible.</li> <li>▶ While driving, ease up on the accelerator.</li> <li>▶ Adapt your speed and driving to the prevailing road and weather conditions.</li> <li>▶ Do not deactivate the ESP®. Exceptions: (▷ page 89).</li> </ul> <p>Failure to follow these instructions increases the risk of an accident.</p>
<p>The yellow fuel tank reserve warning lamp in the fuel gauge (▷ page 24) comes on while driving.</p>	<p>The fuel level has gone below the reserve mark.</p>	<ul style="list-style-type: none"> <li>▶ Refuel at the next gas station (▷ page 294).</li> </ul>

Problem	Possible cause/consequence	Suggested solution
 <p>The red seat belt telltale comes on after starting the engine with all doors closed.</p>	<p>The seat belt telltale reminds you and your passengers to fasten your seat belts before driving off.</p>	<ul style="list-style-type: none"> <li>▶ Fasten your seat belts.</li> </ul>
<p>The red seat belt telltale flashes and you additionally hear an intermittent warning signal with increasing intensity for a maximum of 60 seconds when the vehicle's speed exceeds 15 mph (25 km/h).</p>	<p>You and/or your front passenger have forgotten to fasten your seat belts.</p> <p>There are items placed on the front passenger seat and therefore the system senses the front passenger seat as being occupied.</p>	<ul style="list-style-type: none"> <li>▶ Fasten your seat belts.</li> <li>▶ Remove the items from the front passenger seat and put them in a safe place.</li> </ul>
 <p>The red SRS indicator lamp comes on while driving.</p>	<p>There is a malfunction in the restraint systems. The air bags or emergency tensioning devices (ETDs) could deploy unexpectedly or fail to deploy in an accident.</p>	<ul style="list-style-type: none"> <li>▶ Drive with added caution to the nearest authorized Mercedes-Benz Center.</li> </ul>

**Warning!**





In the event a malfunction of the SRS is indicated as outlined above, the SRS may not be operational.

For your safety, we strongly recommend that you visit an authorized Mercedes-Benz Center immediately to have the system checked; otherwise the SRS may not be deployed when needed in an accident,

which could result in serious or fatal injury, or it might deploy unexpectedly and unnecessarily which could also result in an accident and/or injury to you or to others.



### What to do if ...



#### Lamp in center console

Problem	Possible cause/consequence	Suggested solution
  The front passenger front air bag off indicator lamp illuminates and remains illuminated with the weight of a typical adult or someone larger than a small individual on the front passenger seat.	The system is malfunctioning.	<ul style="list-style-type: none"><li>▶ Have the system checked as soon as possible by an authorized Mercedes-Benz dealer.</li><li>▶ Also note any messages in the multifunction display and follow corrective steps (▷ page 358).</li></ul>

#### Warning!



If the   indicator lamp illuminates and remains illuminated with the weight of a typical adult or someone larger than a small individual on the front passenger seat, do not have any passenger use the front passenger seat until the system has been repaired.

Problem	Possible cause/consequence	Suggested solution
  <p>The front passenger front air bag off indicator lamp does not illuminate and/or does not remain illuminated with the weight of a typical 12-month-old child in a standard child restraint or less on the front passenger seat.</p>	<p>The system is malfunctioning.</p>	<ul style="list-style-type: none"> <li>▶ Make sure there is nothing between seat cushion and child seat and check installation of the child seat.</li> <li>▶ Make sure that no objects applying supplemental weight onto the seat are present.</li> <li>▶ If the front passenger front air bag off indicator lamp remains out, have the system checked as soon as possible by an authorized Mercedes-Benz dealer. Do not transport a child on the front passenger seat until the system has been repaired.</li> <li>▶ Also note any messages in the multifunction display and follow corrective steps (▷ page 364).</li> </ul>

**Warning!**



If the  indicator lamp does not illuminate or remains out with the weight of a typical 12-month-old child in a standard child restraint or less on the front passenger seat, do not transport a child on the front passenger seat until the system has been repaired.

### What to do if ...

#### Vehicle status messages in the multifunction display





Warning and malfunction messages appear in the multifunction display located in the instrument cluster.





Certain warning and malfunction messages are accompanied by an audible signal.

Address these messages accordingly and follow the additional instructions given in this Operator's Manual.

Selecting the vehicle status message memory menu in the control system (▷ page 138) displays both cleared and uncleared messages.

High-priority messages appear in the multifunction display in red color.

Certain messages of high priority cannot be cleared from the multifunction display using the reset button (▷ page 127) or button , , , or  on the steering wheel.

Other messages of high priority and messages of less immediate priority can be cleared from the multifunction display using the reset button (▷ page 127) or button , , , or  on the steering wheel. They are then stored in the vehicle status message memory (▷ page 138). Remember that clearing a message will only make the message disappear. Clearing a message will not correct the condition that caused the message to appear.

#### Warning!



All categories of messages contain important information which should be taken note of and, where a malfunction is indicated, addressed as soon as possible at an authorized Mercedes-Benz Center.

Failure to repair condition noted may cause damage not covered by the Mercedes-Benz Limited Warranty, or result in property damage or personal injury.

#### Warning!



No messages will be displayed if either the instrument cluster or the multifunction display is inoperative.

Contact your nearest authorized Mercedes-Benz Center.



Switching on the ignition causes all instrument cluster lamps (except low beam headlamp indicator lamp, high beam headlamp indicator lamp, and turn signal indicator lamps unless activated) as well as the multifunction display to come on. Make sure the lamps and multifunction display are in working order before starting your journey.

On the pages that follow, you will find a compilation of the most important warning and malfunction messages that may appear in the multifunction display.

For your convenience the messages are divided into two sections:

- Text messages (▷ page 360)
- Symbol messages (▷ page 369)



### What to do if ...

#### Text messages

Display message	Possible cause/consequence	Possible solution
<p>ABS malfunction Visit workshop</p>	<p>The ABS has detected a malfunction and has switched off. The ESP®, BAS and the Run Flat Indicator* are also deactivated.</p> <p>The brake system is still functioning normally but without the systems specified above.</p>	<ul style="list-style-type: none"> <li>▶ Continue driving with added caution. Wheels may lock during hard braking, reducing steering capability.</li> <li>▶ Have the system checked at an authorized Mercedes-Benz Center as soon as possible.</li> </ul> <p>Failure to follow these instructions increases the risk of an accident.</p>
<p>Display malfunction Visit workshop</p>	<p>The ABS or the ABS display is malfunctioning.</p>	<ul style="list-style-type: none"> <li>▶ Continue driving with added caution. Wheels may lock during hard braking, reducing steering capability.</li> <li>▶ Have the system checked at an authorized Mercedes-Benz Center as soon as possible.</li> </ul> <p>Failure to follow these instructions increases the risk of an accident.</p>

Display message	Possible cause/consequence	Possible solution
<p>ESP unavailable See Operator's Manual</p>	<p>The ESP® was deactivated because of a malfunction or interrupted power supply. The BAS and the Run Flat Indicator* are also deactivated.</p> <p>The ABS might not be operational.</p> <p>The brake system is still functioning normally but without the systems specified above.</p> <p>If the yellow ESP® warning lamp  flashes while driving and this message appears, the electronic traction system has switched off to prevent overheating of the drive wheel brakes.</p> <p>The self-diagnosis has not been completed yet.</p> <p>The ESP®, BAS and the Run Flat Indicator* are temporarily deactivated.</p> <p>The brake system is still functioning normally but without the systems specified above.</p>	<ul style="list-style-type: none"> <li>▶ Continue driving with added caution.</li> <li>▶ Visit an authorized Mercedes-Benz Center as soon as possible.</li> </ul> <p>Failure to follow these instructions increases the risk of an accident.</p> <p>As soon as the brakes have cooled off, the electronic traction system switches on again.</p> <p>The display will clear after driving a short distance at more than 12 mph (20 km/h).</p>

### What to do if ...

Display message	Possible cause/consequence	Possible solution
ESP unavailable See Operator's Manual	<p>The charging voltage has fallen below 10 volts. The battery might not be charged sufficiently.</p> <p>The ESP®, BAS and the Run Flat Indicator* are deactivated.</p> <p>The brake system is still functioning normally but without the systems specified above.</p>	<ul style="list-style-type: none"> <li>▶ Continue driving with added caution.</li> <li>▶ If necessary, have the generator and battery checked.</li> </ul> <p>When the voltage is above this value again, the ESP® is operational again.</p>
ESP malfunction Visit workshop	<p>The ESP® is deactivated because of a malfunction.</p> <p>The ESP®, BAS and the Run Flat Indicator* are deactivated.</p> <p>The brake system is still functioning normally but without the systems specified above.</p>	<ul style="list-style-type: none"> <li>▶ Continue driving with added caution.</li> <li>▶ Visit an authorized Mercedes-Benz Center as soon as possible.</li> </ul> <p>Failure to follow these instructions increases the risk of an accident.</p>
Display malfunction Visit workshop	<p>The ESP® or the ESP® display is malfunctioning.</p>	<ul style="list-style-type: none"> <li>▶ Continue driving with added caution.</li> <li>▶ Visit an authorized Mercedes-Benz Center as soon as possible.</li> </ul> <p>Failure to follow these instructions increases the risk of an accident.</p>

Display message	Possible cause/consequence	Possible solution
SRS Restraint system malfunction Drive to workshop	The system is malfunctioning.	► Drive with added caution to the nearest authorized Mercedes-Benz Center.

**Warning!**





In the event a malfunction of the SRS is indicated as outlined above, the SRS may not be operational.

For your safety, we strongly recommend that you visit an authorized Mercedes-Benz Center immediately to have the system checked; otherwise the SRS may not be deployed when needed in an accident, which could result in serious or fatal injury, or it might deploy unexpectedly and unnecessarily which could also result in injury.

### What to do if ...

Display message	Possible cause/consequence	Possible solution
<p>Front-pass. airbag activated See Operator's Manual</p>	<p>Front passenger front air bag is activated while driving even though a child, small individual, or object below the system's weight threshold is on the front passenger seat, or the front passenger seat is empty. Objects on the seat or forces acting on the seat may make the system sense supplemental weight.</p>	<p>Stop the vehicle in a safe location as soon as possible and check the front passenger seat for the following:</p> <ul style="list-style-type: none"> <li>▶ Switch off the ignition (▷ page 33).</li> <li>▶ Remove child and child restraint from front passenger seat and properly secure the child in rear seat employing the child restraint if necessary.</li> <li>▶ Make sure that no objects applying supplemental weight onto the seat are present. The system may recognize such supplemental weight and sense that an occupant on the front passenger seat is of a greater weight than actually present.</li> <li>▶ Keep the seat unoccupied, close the front passenger door and switch on the ignition (▷ page 33).</li> </ul> <p>(Continued on next page)</p>

Display message	Possible cause/ consequence	Possible solution
<p>Front-pass. airbag activated See Operator's Manual</p>		<p>Monitor the  indicator lamp on the center console (▷ page 27) and the multifunction display in the instrument cluster (▷ page 24) for the following:</p> <p>With the seat unoccupied and the ignition turned on,</p> <ul style="list-style-type: none"> <li>the  indicator lamp on the center console should illuminate and remain illuminated, indicating that the OCS (▷ page 77) has deactivated the air bag.</li> <li>the message Front-pass. airbag activated See Operator's Manual or the message Front-pass. airbag deactivated See Operator's Manual should not appear in the multifunction display at any time the seat is unoccupied. Wait at last 60 seconds for the system to complete the necessary check cycles and to make sure neither message appears in the multifunction display.</li> </ul> <p>If above conditions are met, you can occupy the front passenger seat again. Depending on the front passenger classification sensed by the OCS (▷ page 77), the  indicator lamp will remain illuminated or go out.</p> <p>If above conditions are not met, the system is not working properly. Have the system checked as soon as possible by an authorized Mercedes-Benz Center.</p>

**Warning!**









If the  indicator lamp remains

out even after performing the above corrective steps, do not have any children 12 years old and under and other small individuals

use the front passenger seat until the system has been repaired.



### What to do if ...

Display message	Possible cause/consequence	Possible solution
Front-pass. airbag deactivated See Operator's Manual	Front passenger front air bag is deactivated while driving even though an adult or someone larger than a small individual is occupying the front passenger seat. Forces acting on the seat may make the system sense a decrease in weight.	Stop the vehicle in a safe location as soon as possible and check the front passenger seat for the following: <ul style="list-style-type: none"><li>▶ Switch off the ignition (▷ page 33).</li><li>▶ Have the front passenger vacate the seat and exit the vehicle.</li><li>▶ Keep the seat unoccupied, close the front passenger door and switch on the ignition (▷ page 33).</li></ul> (Continued on next page)

Display message	Possible cause/ consequence	Possible solution
<p>Front-pass. airbag deactivated See Operator's Manual</p>		<p>Monitor the   indicator lamp on the center console (▷ page 27) and the multifunction display in the instrument cluster (▷ page 24) for the following:</p> <p>With the seat unoccupied and the ignition turned on,</p> <ul style="list-style-type: none"> <li>the   indicator lamp on the center console should illuminate and remain illuminated, indicating that the OCS (▷ page 77) has deactivated the air bag.</li> <li>the message <code>Front-pass. airbag activated See Operator's Manual</code> or the message <code>Front-pass. airbag deactivated See Operator's Manual</code> should not appear in the multifunction display at any time the seat is unoccupied. Wait at last 60 seconds for the system to complete the necessary check cycles and to make sure neither message appears in the multifunction display.</li> </ul> <p>If above conditions are met, you can occupy the front passenger seat again. Depending on the front passenger classification sensed by the OCS (▷ page 77), the   indicator lamp will remain illuminated or go out.</p> <p>If above conditions are not met, the system is not working properly. Have the system checked as soon as possible by an authorized Mercedes-Benz Center.</p>

**Warning!**



If the   indicator lamp remains

illuminated with an adult occupant on the front passenger seat even after performing the above corrective steps, do not have any

passenger use the front passenger seat until the system has been repaired.



### What to do if ...

Display message	Possible cause/consequence	Possible solution
Run Flat Indicator inactive	The Run Flat Indicator* is malfunctioning.	▶ Have the Run Flat Indicator* checked by an authorized Mercedes-Benz Center.
Check tires Then reactivate Run Flat Indicator	There was a warning message about a loss in tire inflation pressure and the Run Flat Indicator* has not been reactivated yet.	▶ Make sure that the correct tire inflation pressure is set for each tire. ▶ Then reactivate the Run Flat Indicator*.
Run Flat Indicator unavailable	The Run Flat Indicator* has been switched off due to an error.	▶ Have the Run Flat Indicator* checked by an authorized Mercedes-Benz Center.
Tire pressure Check tires	The Run Flat Indicator* indicates that the pressure is too low in one or more tires.	▶ Carefully bring the vehicle to a halt, avoiding abrupt steering and braking maneuvers. Observe the traffic situation around you. ▶ Check and adjust the tire inflation pressure as required (▷ page 316). ▶ If necessary, change the wheel (▷ page 406). ▶ Reactivate the Run Flat Indicator* after adjusting the tire inflation pressure values (▷ page 318).

#### Warning!







Do not drive with a flat tire. A flat tire affects the ability to steer or brake the vehicle.

You may lose control of the vehicle. Continued driving with a flat tire will cause excessive heat build-up and possibly a fire.

Symbol messages

Display symbol	Display message	Possible cause/consequence	Possible solution
	Battery Alternator Visit workshop	The battery is no longer charging. Possible causes: <ul style="list-style-type: none"> <li>• broken poly-V-belt</li> <li>• alternator malfunctioning</li> </ul>	<p>▶ Stop immediately and check the poly-V-belt in a safe location or as soon as it is safe to do so.</p> <p>If it is broken:</p> <p>▶ Do not continue to drive. Otherwise the engine will overheat due to an inoperative water pump which may result in damage to the engine. Notify an authorized Mercedes-Benz Center.</p> <p>If it is intact:</p> <p>▶ Drive immediately to the nearest authorized Mercedes-Benz Center.</p>
	Low voltage Charge battery	The battery has insufficient voltage.	▶ Start the engine (> page 48).
	Low voltage Consumers off	The battery has insufficient voltage.	▶ Turn off unnecessary electrical consumers.

### What to do if ...

Display symbol	Display message	Possible cause/consequence	Possible solution
 (USA only)  (Canada only)	Release Parking brake	You are driving with the parking brake set.	► Release the parking brake (▷ page 50).
	Brake wear Visit workshop	The brake pads have reached their wear limit.	► Have the brake pads replaced as soon as possible.
 (USA only)  (Canada only)	Brake fluid Visit workshop	There is insufficient brake fluid in the reservoir.	► Risk of accident! Stop the vehicle and notify an authorized Mercedes-Benz Center. Do not add brake fluid! This will not solve the problem.

### Warning!



Driving with the message Brake fluid Visit workshop. displayed can result in an accident. Have your brake system checked immediately. Do not add brake fluid before checking the brake system. Overfilling the brake fluid reservoir can result in spilling brake fluid on hot engine parts and the brake fluid catching fire. You can be seriously burned.



If you find that the brake fluid in the brake fluid reservoir has fallen to the minimum mark or below, have the brake system checked for brake pad thickness and leaks.



Brake pad thickness must be visually checked by a qualified technician at the intervals specified in the Maintenance booklet.

Display symbol	Display message	Possible cause/consequence	Possible solution
	Coolant Check level	The coolant level is too low.	<ul style="list-style-type: none"> <li>▶ Add coolant (▷ page 301).</li> <li>▶ If you have to add coolant frequently, have the cooling system checked by an authorized Mercedes-Benz Center.</li> </ul>

**Warning!**



Do not spill antifreeze on hot engine parts. Antifreeze contains ethylene glycol which may burn if it comes into contact with hot engine parts. You can be seriously burned.



Do not ignore the low engine coolant level warning. Extended driving with the message and symbol displayed may cause serious engine damage not covered by the Mercedes-Benz Limited Warranty.

Do not drive without sufficient amount of coolant in the cooling system. The engine will overheat causing major engine damage.

### What to do if ...

Display symbol	Display message	Possible cause/consequence	Possible solution
	Coolant Stop, engine off!	The coolant is too hot.	<ul style="list-style-type: none"> <li>▶ Stop the vehicle in a safe location and turn off the engine.</li> <li>▶ Only start the engine again after the message disappears. You could otherwise damage the engine.</li> </ul>

#### Warning!



Driving when your engine is badly overheated can cause some fluids which may have leaked into the engine compartment to catch fire. You could be seriously burned.

Steam from an overheated engine can cause serious burns and can occur just by opening the hood. Stay away from the engine if you see or hear steam coming from it.

Turn off the engine, get out of the vehicle and do not stand near the vehicle until the engine has cooled down.





During severe operating conditions and stop-and-go city traffic, the coolant temperature may rise close to 248°F (120°C).



The engine should not be operated with the coolant temperature above 248°F (120°C). Doing so may cause serious engine damage which is not covered by the Mercedes-Benz Limited Warranty.

Display symbol	Display message	Possible cause/consequence	Possible solution
	Coolant Stop, engine off!	The poly-V-belt could be broken.	<ul style="list-style-type: none"> <li>▶ Stop the vehicle in a safe location and immediately turn off the engine.</li> <li>▶ Check the poly-V-belt.</li> </ul> <p>If it is broken:</p> <ul style="list-style-type: none"> <li>▶ Do not continue to drive. Otherwise the engine will overheat due to an inoperative water pump which may result in damage to the engine. Notify an authorized Mercedes-Benz Center.</li> </ul> <p>If it is intact:</p> <ul style="list-style-type: none"> <li>▶ Do not continue to drive the vehicle with this message displayed. Doing so could result in serious engine damage that is not covered by the Mercedes-Benz Limited Warranty.</li> <li>▶ Observe the coolant temperature gauge in the instrument cluster (▷ page 24).</li> <li>▶ Drive immediately to the nearest authorized Mercedes-Benz Center.</li> </ul>
	Coolant Visit workshop.	The cooling fan for the coolant is malfunctioning.	<ul style="list-style-type: none"> <li>▶ Observe the coolant temperature gauge in the instrument cluster (▷ page 24).</li> <li>▶ Have the fan replaced as soon as possible.</li> </ul>

### What to do if ...

Display symbol	Display message	Possible cause/consequence	Possible solution
	Cruise contr. Drive to workshop	Cruise control is malfunctioning.	▶ Visit an authorized Mercedes-Benz Center.
	Display malfunction Visit workshop	The instrument cluster display is malfunctioning.	▶ Continue driving with added caution. ▶ Visit an authorized Mercedes-Benz Center as soon as possible.
		The displays for several systems have malfunctioned. Some systems themselves may also have malfunctioned.	▶ Have the electronic systems checked by an authorized Mercedes-Benz Center.
	Display malfunction Visit workshop	Certain electronic systems are unable to relay information to the control system. The following systems may have failed: <ul style="list-style-type: none"> <li>• Coolant temperature display</li> <li>• Tachometer</li> <li>• Cruise control display</li> </ul>	▶ Have the electronic systems checked by an authorized Mercedes-Benz Center.
	Doors open	You are attempting to drive with one or more doors open.	▶ Close the doors.

Display symbol	Display message	Possible cause/consequence	Suggested solution
	Check oil level at next gas station	The engine oil has dropped to a critical level.	<ul style="list-style-type: none"> <li>▶ Check the engine oil level (▷ page 299) and add oil as required (▷ page 300).</li> <li>▶ If you must add engine oil frequently, have the engine checked for possible leaks.</li> </ul>

When the message `Check oil level at next gas station` appears while the engine is running and at operating temperature, the engine oil level has dropped to approximately the minimum level.

When this occurs, the warning will first come on intermittently and then stay on if the oil level drops further.



Visually check for oil leaks. If no obvious oil leaks are noted, drive to the nearest service station where the engine oil should be topped to the required level with an approved oil specified in the Factory Approved Service Products pamphlet.



The engine oil level warnings should not be ignored. Extended driving with the symbol displayed could result in serious engine damage that is not covered by the Mercedes-Benz Limited Warranty.





### What to do if ...

Display symbol	Display message	Possible cause/consequence	Possible solution
	Check gas cap. See Operator's Manual	A loss of pressure has been detected in the fuel system. The fuel cap may not be closed properly or the fuel system may be leaky.	<ul style="list-style-type: none"> <li>▶ Check the fuel cap (▷ page 294).</li> </ul> If it is not closed properly: <ul style="list-style-type: none"> <li>▶ Close the fuel cap.</li> </ul> If it is closed properly: <ul style="list-style-type: none"> <li>▶ Have the fuel system checked by an authorized Mercedes-Benz Center.</li> </ul>
	Hood open	You are attempting to drive with the hood open.	<ul style="list-style-type: none"> <li>▶ Close the hood (▷ page 297).</li> </ul>
	Remove key.	You have forgotten to remove the SmartKey.	<ul style="list-style-type: none"> <li>▶ Remove the SmartKey from the starter switch.</li> </ul>
	Replace key Drive to workshop	No additional code available for SmartKey.	<ul style="list-style-type: none"> <li>▶ Change the SmartKey.</li> </ul>

Display symbol	Display message	Possible cause/consequence	Possible solution
	3rd brake lamp	The high mounted brake lamp is malfunctioning. This message will only appear if all light emitting diodes have stopped working.	► Visit an authorized Mercedes-Benz Center as soon as possible.
	Backup lamp, left	The left backup lamp is malfunctioning.	► Replace the bulb as soon as possible.
	Backup lamp, right	The right backup lamp is malfunctioning.	► Replace the bulb as soon as possible.
	Brake lamp Drive to workshop	Brake lamp illumination is delayed or lamp is permanently on.	► Visit an authorized Mercedes-Benz Center as soon as possible.
	Brake lamp left	The left brake lamp is malfunctioning.	► Replace the bulb as soon as possible.
	Brake lamp right	The right brake lamp is malfunctioning.	► Replace the bulb as soon as possible.
	Display malfunction. Visit workshop	The display for the lamps or the system is malfunctioning.	► Visit an authorized Mercedes-Benz Center as soon as possible.
	Front foglamp left	The left front fog lamp is malfunctioning.	► Visit an authorized Mercedes-Benz Center as soon as possible.
	Front foglamp right	The right front fog lamp is malfunctioning.	► Visit an authorized Mercedes-Benz Center as soon as possible.
	Front left side marker lamp	The left front side marker lamp is malfunctioning.	► Visit an authorized Mercedes-Benz Center as soon as possible.
Front right sider marker lamp	The right front side marker lamp is malfunctioning.	► Visit an authorized Mercedes-Benz Center as soon as possible.	



### What to do if ...

Display symbol	Display message	Possible cause/consequence	Possible solution
	High beam left	The left high beam lamp is malfunctioning.	▶ Replace the bulb as soon as possible.
	High beam right	The right high beam lamp is malfunctioning.	▶ Replace the bulb as soon as possible.
	License plate lamp, left	The left license plate lamp is malfunctioning.	▶ Replace the bulb as soon as possible.
	License plate lamp, right	The right license plate lamp is malfunctioning.	▶ Replace the bulb as soon as possible.
	Light sensor Drive to workshop	The lamp sensor is malfunctioning. The headlamps switch on automatically.	<ul style="list-style-type: none"> <li>▶ In the control system, set lamp operation to manual (▷ page 149).</li> <li>▶ Switch on the headlamps using the exterior lamp switch (▷ page 118).</li> <li>▶ Visit an authorized Mercedes-Benz Center as soon as possible.</li> </ul>
	Low beam left	The left low beam lamp is malfunctioning.	<p>Halogen headlamp:</p> <ul style="list-style-type: none"> <li>▶ Replace the bulb as soon as possible.</li> </ul> <p>Bi-Xenon* headlamp:</p> <ul style="list-style-type: none"> <li>▶ Visit an authorized Mercedes-Benz Center as soon as possible.</li> </ul>

Display symbol	Display message	Possible cause/consequence	Possible solution
	Low beam right	The right low beam lamp is malfunctioning.	Halogen headlamp: ▶ Replace the bulb as soon as possible. Bi-Xenon* headlamp: ▶ Visit an authorized Mercedes-Benz Center as soon as possible.
	Parking lamp left front	The left front parking lamp is malfunctioning.	▶ Replace the bulb as soon as possible.
	Parking lamp right front	The right front parking lamp is malfunctioning.	▶ Replace the bulb as soon as possible.
	Rear fog lamp Substit. bulb on	The rear fog lamp is malfunctioning. A substitute bulb is being used.	▶ Replace the bulb as soon as possible.
	Switch off lights	Headlamps have been turned on with the driver's door opened and the SmartKey removed from the starter switch.	▶ Switch off the headlamps.
	Taillamp left Substit. bulb on	The left tail lamp is malfunctioning. A substitute bulb is being used.	▶ Replace the bulb as soon as possible.
	Taillamp right Substit. bulb on	The right tail lamp is malfunctioning. A substitute bulb is being used.	▶ Replace the bulb as soon as possible.

### What to do if ...

Display symbol	Display message	Possible cause/consequence	Possible solution
	Turn signal left front	The left front turn signal lamp is malfunctioning.	► Replace the bulb as soon as possible.
	Turn signal right front	The right front turn signal lamp is malfunctioning.	► Replace the bulb as soon as possible.
	Turn signal left mirror	The left turn signal in the side mirror is malfunctioning. This message will only appear if all light emitting diodes have stopped working.	► Visit an authorized Mercedes-Benz Center as soon as possible.
	Turn signal right mirror	The right turn signal in the side mirror is malfunctioning. This message will only appear if all light emitting diodes have stopped working.	► Visit an authorized Mercedes-Benz Center as soon as possible.
	Turn signal left rear Substit. bulb on	The left rear turn signal lamp is malfunctioning. A substitute bulb is being used.	► Replace the bulb as soon as possible.
	Turn signal right rear Substit. bulb on	The right rear turn signal lamp is malfunctioning. A substitute bulb is being used.	► Replace the bulb as soon as possible.

Display symbol	Display message	Possible cause/consequence	Possible solution
	Belt system Drive to workshop	The seat belt system is malfunctioning.	▶ Visit an authorized Mercedes-Benz Center as soon as possible.
	Steering oil Visit workshop	The steering gear oil level is too low. There is a danger of steering gear damage.	▶ Have the system checked by an authorized Mercedes-Benz Center.

**Warning!**











If the level of steering gear oil in reservoir is too low, the steering power assistance could fail. Much greater effort will then be needed to turn the steering wheel.

Do not add steering oil without checking the steering system.

Do not drive the vehicle. Have the system checked at an authorized Mercedes-Benz Center as soon as possible.

### What to do if ...

Display symbol	Display message	Possible cause/consequence	Possible solution
	Close slid./pop-up sunroof	You have opened the driver's door with the SmartKey removed from the starter switch and the sliding portion of the tilt/sliding sunroof* open.	▶ Close the tilt/sliding sunroof* (▷ page 244).
	Close slid./pop-up sunroof	You have opened the driver's door with the SmartKey removed from the starter switch and the tilting portion of the tilt/sliding sunroof* open.	▶ Close the tilt/sliding sunroof* (▷ page 244).
	Tele Aid malfunction. Drive to workshop	One or more main functions of the Tele Aid system* are malfunctioning.	▶ Have the Tele Aid system* checked by an authorized Mercedes-Benz Center.
	Function unavailable	This display appears if button  or  on the multifunction steering wheel is pressed and the vehicle is not equipped with a telephone*.	
	Trunk open	You are attempting to drive with the trunk open.	▶ Close the trunk.
	Washer fluid please refill	The fluid level has dropped to about $\frac{1}{3}$ of total reservoir capacity.	▶ Add washer fluid (▷ page 303).

## ▼ Where will I find ...?

### First aid kit

The first aid kit is located in the trunk on the left side secured by a hook and loop fastener.



- ① First aid kit
- ② Hook and loop fastener

- ▶ Unfasten hook and loop fastener ②.
- ▶ Remove first aid kit ①.



Check expiration dates and contents for completeness at least once a year and replace missing/expired items.

### Vehicle tool kit

The vehicle tool kit is located in the storage compartment underneath the trunk floor.

The following is included:

- Towing eye bolt
- Wheel wrench
- Alignment bolt
- Vehicle jack
- Spare fuses
- Collapsible wheel chock
- A pair of gloves

### Removing the vehicle tool kit

- ▶ Lift up trunk floor cover and engage trunk floor handle in upper edge of trunk.



- ① Retaining screw
- ② Storage well casing

- ▶ Loosen retaining screw ① by turning it counterclockwise.
- ▶ Remove storage well casing ②. ▷▷



### Where will I find ...?

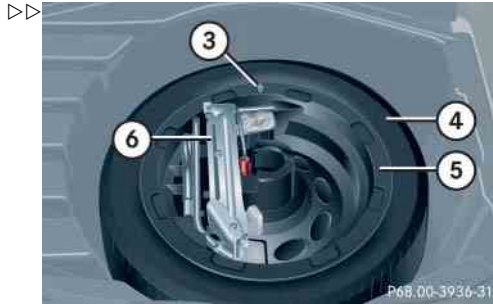

- ③ Arrow
  - ④ Minispare wheel with spare wheel bolts in container on wheel rim
  - ⑤ Vehicle tool kit storage well casing
  - ⑥ Vehicle tool kit
- ▶ Remove vehicle tool kit ⑥.

### Storing the vehicle tool kit

- ▶ Place vehicle tool kit ⑥ in vehicle tool kit storage well casing ⑤.
- ▶ Place storage well casing ② over the vehicle tool kit storage well casing ⑤ and turn retaining screw ① clockwise as far as it will go to secure the Minispare wheel.



Arrow ③ on vehicle tool kit storage well casing ⑤ must point in the direction of travel. Otherwise you cannot place the storage well casing ② on top and secure the Minispare wheel with retaining screw ①.



To prevent damage, always disengage trunk floor handle from upper edge of trunk and lower trunk floor before closing the trunk.

## Vehicle jack

### Warning!



The jack is designed exclusively for jacking up the vehicle at the jack take-up brackets built into both sides of the vehicle. To help avoid personal injury, use the jack only to lift the vehicle during a wheel change. Never get beneath the vehicle while it is supported by the jack. Keep hands and feet away from the area under the lifted vehicle. Always firmly set parking brake and block wheels before raising vehicle with jack.

Do not disengage parking brake while the vehicle is raised. Be certain that the jack is always vertical (plumb line) when in use, especially on hills. Always try to use the jack on level surface. Make sure the jack arm is fully seated in the jack take-up bracket. Always lower the vehicle onto sufficient capacity jackstands before working under the vehicle.

The vehicle jack is located in the storage compartment underneath the trunk floor.

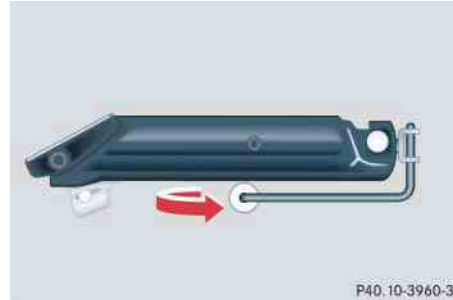

P40.10-3960-31

### Storage position

- ▶ Turn crank handle in direction of arrow as far as it will go.
- ▶ Push crank handle up.

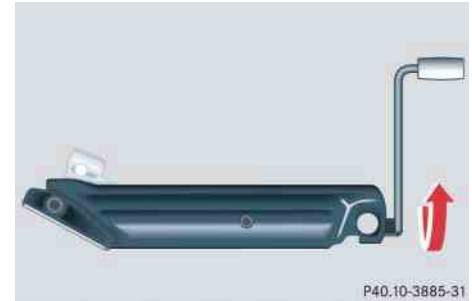

P40.10-3885-31

### Operational position

- ▶ Turn crank handle clockwise.

Before storing the vehicle jack in its compartment:

- It should be fully collapsed.
- The handle must be folded in (storage position).

### Where will I find ...?

#### Setting up the collapsible wheel chock

The collapsible wheel chock serves to additionally secure the vehicle, e.g. while changing the wheel.

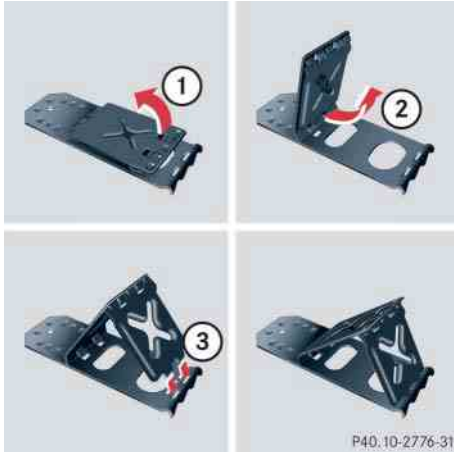

- ① Tilt the plate upward
- ② Fold the lower plate outward
- ③ Insert the plate

- ▶ Tilt both plates upward ①.
- ▶ Fold the lower plate outward ②.
- ▶ Guide the tabs of the lower plate all the way into the openings of the base plate ③.

#### Minispare wheel

The Minispare wheel is located in the storage compartment underneath the trunk floor.

#### Removing the Minispare wheel

- ▶ Lift up trunk floor cover and engage trunk floor handle in upper edge of trunk.
- ▶ Loosen the retaining screw (▷ page 383) in the middle of storage well casing.
- ▶ Remove the storage well casing (▷ page 383).

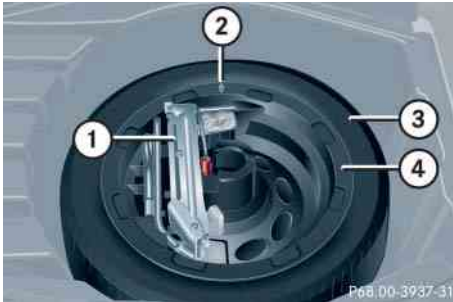

- ① Vehicle tool kit
  - ② Arrow
  - ③ Minispare wheel with spare wheel bolts in container on wheel rim
  - ④ Vehicle tool kit storage well casing
- ▶ Remove vehicle tool kit storage well casing ④.
  - ▶ Remove Minispare wheel ③.

### Storing the Minispare wheel

- ▶ Place Minispare wheel ③ in wheel well.
- ▶ Place vehicle tool kit storage well casing ④ over the Minispare wheel.  
Make sure arrow ② on vehicle tool kit storage well casing ④ points in the direction of travel.
- ▶ Place storage well casing (▷ page 383) over vehicle tool kit storage well casing ④ and turn the retaining screw (▷ page 383) clockwise as far it will go to secure the Minispare wheel.



Arrow ② on vehicle tool kit storage well casing ④ must point in the direction of travel. Otherwise you cannot place the storage well casing (▷ page 383) on top and secure the Minispare wheel with the retaining screw (▷ page 383).



To prevent damage, always disengage trunk floor handle from upper edge of trunk and lower trunk floor before closing the trunk lid.

### Warning!



The dimensions of the Minispare wheel are different from those of the road wheels. As a result, the vehicle handling characteristics change when driving with a Minispare wheel mounted.

The Minispare wheel should only be used temporarily, and should be replaced with a regular road wheel as quickly as possible.

### Where will I find ...?

In case of a flat tire, you may temporarily use the Minispare wheel when observing the following restrictions:

- Do not exceed a vehicle speed of 50 mph (80 km/h).
- Drive to the nearest tire repair facility to have the flat tire repaired or replaced as appropriate.
- Do not operate vehicle with more than one Minispare wheel mounted.

For more information, see “Rims and Tires” (> page 432).

### Spare wheel bolts

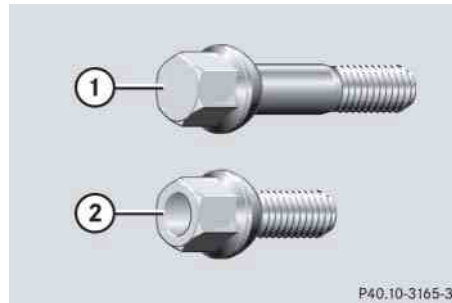

- ① Wheel bolt for light alloy rims
- ② Wheel bolt for Minispare wheel or other steel rims (located in trunk with spare wheel)



Wheel bolts ② must be used when mounting the Minispare wheel or other steel rims. The use of any wheel bolts other than wheel bolts ② for the Minispare wheel or other steel rims will physically damage the vehicle's brakes.

### Warning!



Make sure to use the original length wheel bolts when remounting the original wheel after it has been repaired.

Unlocking/locking in an emergency

▼ **Unlocking/locking in an emergency**

**Unlocking the vehicle**

If you are unable to unlock the vehicle with the SmartKey, open the driver's door and the trunk using the mechanical key.



Unlocking and opening the driver's door and/or the trunk with the mechanical key will trigger the anti-theft alarm system\*.

To cancel the alarm, do one of the following:

- Press button or on the SmartKey.
- Insert the SmartKey in the starter switch.

**Removing the mechanical key**



- ① Mechanical key locking tab
- ② Mechanical key

- ▶ Move locking tab ① in direction of arrow.
- ▶ Slide mechanical key ② out of the housing.

**Unlocking the driver's door**

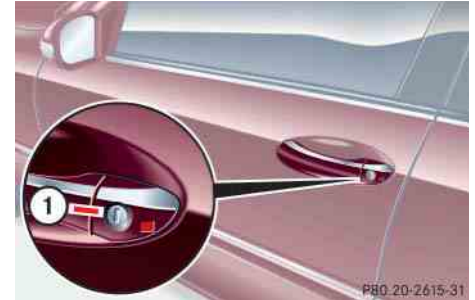

- ① Unlocking

- ▶ Insert the mechanical key into the driver's door lock until it stops.
- ▶ Turn the mechanical key counterclockwise to position ①.

The driver's door is unlocked.

### Unlocking/locking in an emergency

#### Unlocking and opening the trunk

A minimum height clearance of 5.71 ft (1.74 m) is required to open the trunk lid.

The trunk lid lock is located next to the handle above the rear license plate recess.

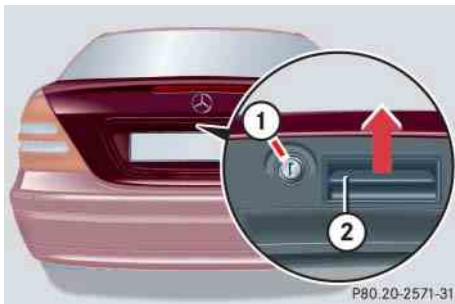

① Unlocking in an emergency

② Handle

▶ Insert the mechanical key into the trunk lid lock until it stops.

▶ Turn the mechanical key counterclockwise to position ①.

The trunk lid unlocks.

▶ Pull on handle ②.

The trunk opens.



The trunk lid swings open upwards automatically. Always make sure there is sufficient overhead clearance.

▶ Turn the mechanical key back and remove it from the trunk lid lock.

#### Locking the vehicle

If you can not lock the vehicle with the SmartKey, do the following:

▶ Close the passenger door, the rear doors and the trunk.

▶ Press the central locking switch in the center console (▷ page 107).

▶ Check to see whether the locking knobs on the doors have moved down.

▶ If necessary push them down manually.

▶ Remove the mechanical key out of the SmartKey (▷ page 389).

▶ Check whether the trunk is locked.

▶ If necessary, lock the trunk with the mechanical key (▷ page 106).

Except for the driver's door, the vehicle should now be locked.

Unlocking/locking in an emergency

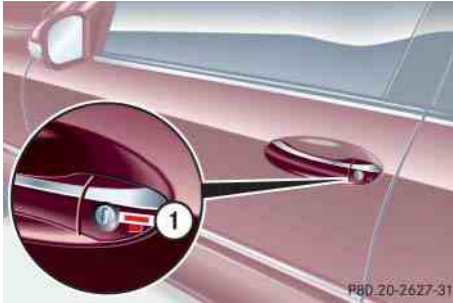

① Locking

- ▶ Insert the mechanical key into the driver's door lock until it stops.
  - ▶ Turn the mechanical key clockwise to position ①.
- The driver's door is locked.

Fuel filler flap

In case the central locking system does not release the fuel filler flap, you can open it manually.

**Warning!**



If you operate the emergency release button, be careful of the sharp edges so that you do not injure yourself.

The release button is on the right-hand side of the luggage compartment behind the side trim.

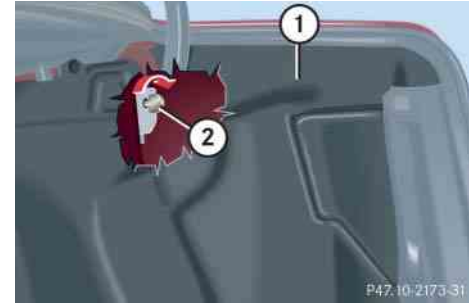

① Side trim

② Release button

- ▶ Open the trunk.
  - ▶ Remove the side trim ① from the right-hand side of the luggage compartment.
  - ▶ Turn release button ② clockwise as far as will go.
- The fuel filler flap is released.
- ▶ Open the fuel filler flap from outside.



### Unlocking/locking in an emergency

#### Manually unlocking the transmission gear selector lever

In case of power failure, the transmission gear selector lever can be manually unlocked, e.g. to tow the vehicle.

- ▶ Slide out the swiveling cup holder (▷ page 259).

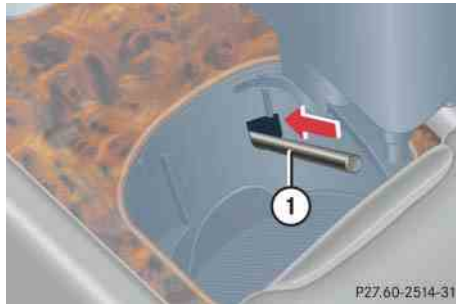

① Tool

- ▶ Insert a tool ① (e.g. flat blade screw driver) into the opening.
- ▶ Perform the following two steps simultaneously:
  - ▶ Press tool ① forward in the direction of the arrow.
  - ▶ Move gear selector lever from position **P**.
- ▶ Remove tool ① from the opening.



The gear selector lever is locked again when moving it to position **P**.

Opening/closing in an emergency

▼ Opening/closing in an emergency

Power tilt/sliding sunroof\*

You can open or close the tilt/sliding sunroof manually should an electrical malfunction occur.

The tilt/sliding sunroof drive is located behind the lens ① of the interior overhead light.



- ▶ Remove SmartKey from the starter switch.
- ▶ Pry off lens ① using a flat blade screwdriver.



- ▶ Slide both locking tabs ② in direction of the arrows.
- ▶ Lower the rear of the cover and remove.
- ▶ Remove the cover.
- ▶ Take the crank ③ out of the Operator's Manual pouch.



Do not disconnect electrical connectors.

- ▶ Insert crank ③ through hole on the left side.

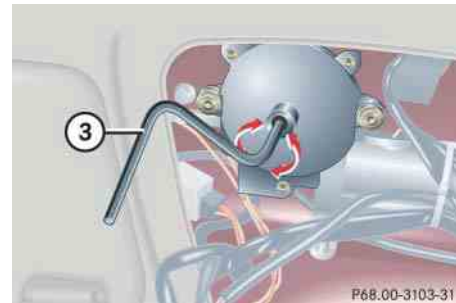

- ▶ Turn crank ③ clockwise to:
  - slide sunroof closed
  - raise sunroof at the rear
- ▶ Turn crank ③ counterclockwise to:
  - slide sunroof open
  - lower sunroof at the rear



Turn crank ③ slowly and smoothly.

The tilt/sliding sunroof must be synchronized after being operated manually (▷ page 246).

### Resetting activated head restraints

#### Resetting activated head restraints

If the active head restraints has been triggered in a rear-end collision, the active head restraints must be reset. Otherwise, the active head restraint cannot offer any additional protection in the event of another rear-end collision.



For your convenience, we recommend that you have this work carried out by an authorized Mercedes-Benz Center.

You will find the reset tool for manually operating the active head restraints in the Mercedes-Benz vehicle literature pouch.



- ▶ Take the reset tool out of the Mercedes-Benz vehicle literature pouch.
- ▶ Guide reset tool into center of head restraint between head restraint cushion and rear head restraint cover.



Take care to avoid damaging the upholstery.

- ▶ Press the reset tool forward in the direction of the arrow.

- ▶ Press reset tool downward until you hear the head restraint release mechanism audibly engage.
- ▶ Pull out reset tool.
- ▶ Firmly press the head restraint cushion back toward the rear head restraint cover until it engages.

#### Warning!



When pushing back the head restraint cushion, take care that your fingers do not become caught between the head restraint cushion and the cover. Failing to do so may lead to injury.

- ▶ Repeat this procedure on the active head restraint for the second seat.

For information on active head restraints, see “Active head restraint” (▷ page 73).

For information on head restraint adjustment, see “Seats” (▷ page 35).

## Replacing SmartKey batteries

## ▼ Replacing SmartKey batteries

If the batteries in the SmartKey are discharged, the vehicle can no longer be locked or unlocked. It is recommended to have the batteries replaced at an authorized Mercedes-Benz Center.

**Warning!**

Keep the batteries out of reach of children.

If a battery is swallowed, seek medical help immediately.

Batteries contain materials that can harm the environment if disposed of improperly. Recycling of batteries is the preferred method of disposal. Many states require sellers of batteries to accept old batteries for recycling.



When inserting the batteries, make sure they are clean and free of lint.



When replacing batteries, always replace both batteries.

The required replacement batteries are available at any Mercedes-Benz Center.

### Replacing SmartKey batteries

#### SmartKey

Replacement batteries: Lithium, type CR 2025 or equivalent.

- ▶ Remove the mechanical key (▷ page 389).

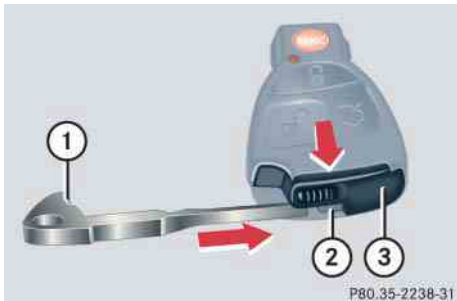

- ① Mechanical key
- ② Slide
- ③ Battery compartment

- ▶ Insert the mechanical key ① in direction of arrow in side opening.
- ▶ Using mechanical key ①, push gray slide ② to unlatch battery compartment ③.
- ▶ Pull battery compartment ③ out of the housing in direction of arrow.

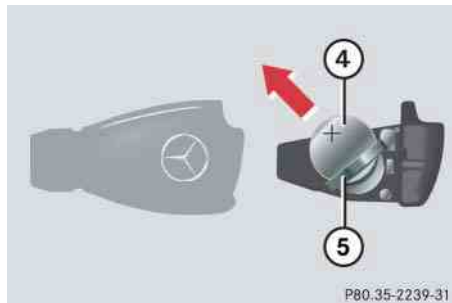

- ④ Battery
- ⑤ Contact spring

- ▶ Remove the batteries ④ in direction of arrow.

- ▶ Using a lint-free cloth, insert new batteries ④ under the contact spring ⑤ with the positive terminal (+) side facing up.
- ▶ Return battery compartment ③ into housing until it locks into place.
- ▶ Slide mechanical key ① back into the SmartKey.
- ▶ Check the operation of the SmartKey.

## ▼ Replacing bulbs

Safe vehicle operation depends on proper exterior lighting and signaling. It is therefore essential that all bulbs and lamp assemblies are in good working order at all times.

Correct headlamp adjustment is extremely important. Have headlamps checked and readjusted at regular intervals and when a bulb has been replaced. See an authorized Mercedes-Benz Center for headlamp adjustment.



If the headlamps or front fog lamps are fogged up on the inside as a result of high humidity, driving the vehicle a distance with the lights on should clear up the fogging.



Substitute bulbs will be brought into use when lamps malfunction. Observe the messages in the multifunction display (▷ page 377).

## Replacing bulbs

### Bulbs

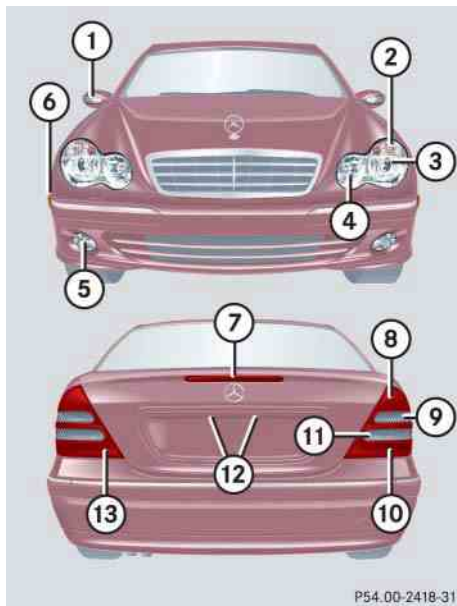

### Front lamps

	Lamp	Type
①	Additional turn signal lamp	LED
②	Halogen headlamp: Turn signal lamp	1156 A
	Bi-Xenon* headlamp: Turn signal lamp	2357 A
③	Halogen headlamp: Low beam	H7 (55 W)
	Bi-Xenon* headlamp: Low and high beam <sup>1</sup>	D2S-35 W

<sup>1</sup> Vehicles with Bi-Xenon\* headlamps: Low beam and high beam use the same D2S-35W lamp. Do not replace the Xenon bulbs yourself. Contact an authorized Mercedes-Benz Center.

	Lamp	Type
④	Halogen headlamp: High beam/high beam flasher	H7 (55 W)
	Bi-Xenon* headlamp: High beam flasher	H7 (55 W)
	Parking and standing lamp	W 5 W
⑤	Front fog lamp	HB4 (51 W)
	Front fog lamp with cornering fog lamp*	H7 (55 W)
⑥	Side marker lamp	W 5 W

Rear lamps

Lamp	Type
⑦ High mounted brake lamp	LED
⑧ Brake lamp	P 21 W
⑨ Turn signal lamp	PY 21 W
⑩ Parking and side marker lamp	P 21/5 W
⑪ Backup lamp	P 21 W
⑫ License plate lamps	C 5 W
⑬ Rear fog lamp (driver's side only), tail and standing lamp	P 21/4 W

**Warning!**



Bulbs and bulb sockets can be very hot. Allow the lamp to cool down before changing a bulb.

Keep bulbs out of reach of children.

Halogen lamps contain pressurized gas. A bulb can explode if you

- touch or move it when hot
- drop the bulb
- scratch the bulb

Wear eye and hand protection.

Because of high voltage in Xenon lamps, it is dangerous to replace the bulb or repair the lamp and its components. We recommend that you have such work done by a qualified technician.

Notes on bulb replacement

- Only use 12 volt bulbs of the same type and with the specified watt rating.
- Switch lights off before changing a bulb to prevent short circuits.
- Always use a clean lint-free cloth when handling bulbs.
- Your hands should be dry and free of oil and grease.
- If the newly installed bulb does not come on, visit an authorized Mercedes-Benz Center.



### Replacing bulbs

Have the LEDs and bulbs for the following lamps replaced by an authorized Mercedes-Benz Center:

- Additional turn signals in the exterior rear view mirrors
- High mounted brake lamp
- Xenon\* lamps
- Front fog lamps
- Front side marker lamps



Have the headlamp adjustment checked regularly.

### Replacing bulbs for front lamps

Before you start to replace a bulb for a front lamp, do the following first:

- ▶ Turn the exterior lamp switch to position **0** (▷ page 118).
- ▶ Open the hood (▷ page 297).

### Halogen headlamp

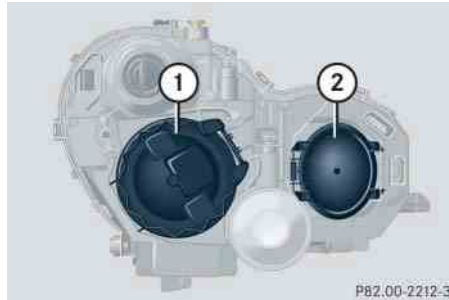

- ① Housing cover for low beam headlamp
- ② Housing cover for high beam headlamp, parking and standing lamp

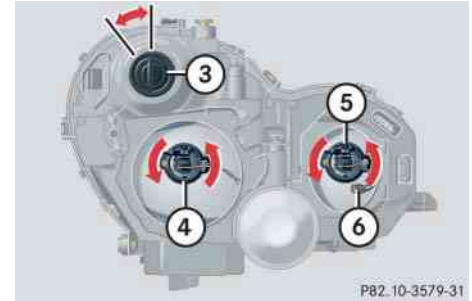

- ③ Bulb socket for turn signal lamp bulb
- ④ Bulb socket for low beam bulb
- ⑤ Bulb socket for high beam bulb
- ⑥ Bulb socket for parking and standing lamp bulb

***Low beam bulb***

- ▶ Press the clamp on housing cover ① and remove it.
- ▶ Pull the electrical connector off.
- ▶ Turn bulb socket ④ counterclockwise and take out the bulb.
- ▶ Insert the new bulb so that its socket locates in the recess of the lamp housing.
- ▶ Turn bulb socket ④ clockwise until it engages.
- ▶ Plug the electrical connector onto the bulb.
- ▶ Align housing cover ① and press until it engages.

***High beam bulb***

- ▶ Press the clamp on housing cover ② and remove it.
- ▶ Pull the electrical connector off.
- ▶ Turn bulb socket ⑤ counterclockwise and take out the bulb.
- ▶ Insert the new bulb so that its socket locates in the recess of the lamp housing.
- ▶ Turn bulb socket ⑤ clockwise until it engages.
- ▶ Plug the electrical connector onto the bulb.
- ▶ Align housing cover ② and press until it engages.

***Front turn signal lamp bulb***

- ▶ Turn bulb socket ③ with the bulb counterclockwise and remove it.
- ▶ Press gently onto the bulb and turn it counterclockwise out of bulb socket ③.
- ▶ Press new bulb gently into bulb socket ③ and turn clockwise until it engages.
- ▶ Place bulb socket ③ back into the lamp and turn it clockwise.

***Parking and standing lamp bulb***

- ▶ Press the clamp on housing cover ② and remove it.
- ▶ Pull out bulb socket ⑥ with the bulb.
- ▶ Pull the bulb out of bulb socket ⑥.
- ▶ Press the new bulb into bulb socket ⑥.
- ▶ Press bulb socket ⑥ back into the lamp.
- ▶ Align housing cover ② and press until it engages.

### Replacing bulbs

#### Bi-Xenon\* headlamp

##### Warning!



Do not remove the cover ① for the Bi-Xenon headlamp. Because of high voltage in Bi-Xenon lamps, it is dangerous to replace the bulb or repair the lamp and its components. We recommend that you have such work done by a qualified technician.

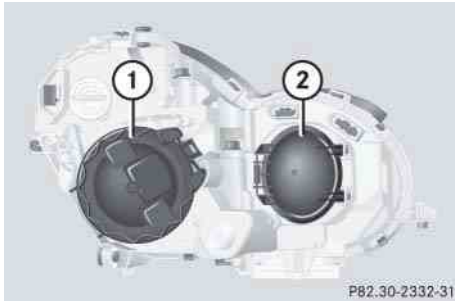

- ① Housing cover for Bi-Xenon headlamp
- ② Housing cover for high beam flasher, parking and standing lamp

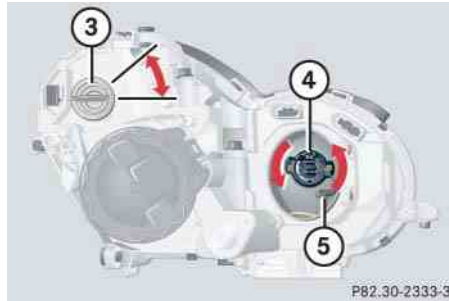

- ③ Bulb socket for turn signal lamp bulb
- ④ Bulb socket for high beam flasher bulb
- ⑤ Bulb socket for parking and standing lamp bulb

#### High beam flasher bulb

- ▶ Press the clamp on housing cover ② and remove it.
- ▶ Pull the electrical connector off.
- ▶ Turn bulb socket ④ counterclockwise and take out the bulb.
- ▶ Insert the new bulb so that its socket locates in the recess of the lamp housing.
- ▶ Turn bulb socket ④ clockwise until it engages.
- ▶ Plug the electrical connector onto the bulb.
- ▶ Align housing cover ② and press until it engages.

### Front turn signal lamp bulb

- ▶ Turn bulb socket ③ with the bulb counterclockwise and remove it.
- ▶ Press gently onto the bulb and turn it counterclockwise out of bulb socket ③.
- ▶ Press new bulb gently into bulb socket ③ and turn clockwise until it engages.
- ▶ Place bulb socket ③ back into the lamp and turn it clockwise.

### Parking and standing lamp bulb

- ▶ Press the clamp on housing cover ② and remove it.
- ▶ Pull out bulb socket ⑤ with the bulb.
- ▶ Pull the bulb out of bulb socket ⑤.
- ▶ Press the new bulb into bulb socket ⑤.
- ▶ Press bulb socket ⑤ back into the lamp.
- ▶ Align housing cover ② and press until it engages.

### Additional turn signal lamp bulbs

The additional turn signal lamps in the exterior rear view mirrors have LEDs.

If a malfunction occurs or LEDs fail to function, the entire turn signal unit must be replaced. Have the turn signal unit replaced by an authorized Mercedes-Benz Center.

### Front side marker lamp bulbs

Since replacing the side marker lamp bulbs is a technically highly demanding process, we recommend you have the side marker lamp bulbs replaced by an authorized Mercedes-Benz Center.

### Replacing bulbs for rear lamps

Before you start to replace a bulb for a rear lamp, do the following first:

- ▶ Turn the exterior lamp switch to position **0** (▷ page 118).
- ▶ Open the trunk (▷ page 103).

### Tail lamp unit



① Latch

### Replacing bulbs

- ▶ Fold the corresponding trim panel to the side.
- ▶ Turn latch ① to vertical position and remove the bulb carrier.

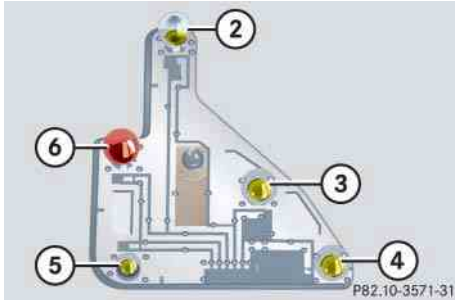

#### Bulb carrier

- ② Brake lamp bulb
- ③ Backup lamp bulb
- ④ Rear fog lamp (driver's side only), tail and standing lamp bulb
- ⑤ Parking and side marker lamp bulb
- ⑥ Turn signal lamp bulb

- ▶ Press gently onto the respective bulb and turn counterclockwise out of its bulb socket.
- ▶ Press the new bulb gently into its bulb socket and turn clockwise until it engages.
- ▶ Reinstall the bulb carrier and lock it again with latch ①.
- ▶ Reinstall the trim panel.

### License plate lamp

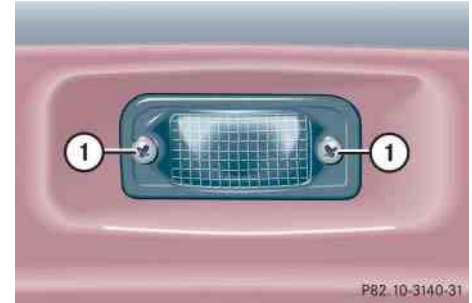

#### ① Screw

- ▶ Loosen both screws ①.
- ▶ Remove the license plate lamp.
- ▶ Replace the bulb.
- ▶ Reinstall the license plate lamp.
- ▶ Retighten screws ①.

## ▼ Replacing wiper blades

### Removing wiper blades

#### Warning!



For safety reasons, switch off wipers and remove SmartKey from starter switch before replacing a wiper blade. Otherwise, the wiper motor could suddenly turn on and cause injury.

- ▶ Remove SmartKey from starter switch.
- ▶ Fold wiper arm forward.

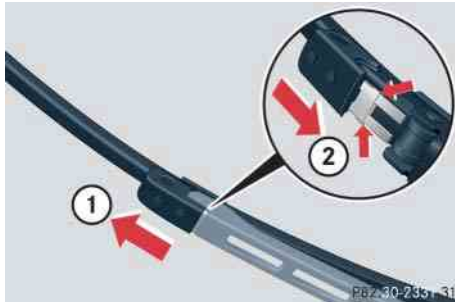

- ① Unlock
- ② Lock

- ▶ Pull the tab in direction of arrow ① and remove wiper blade.

### Installing wiper blades

- ▶ Slide the wiper blade into the cutout on the wiper arm (see arrows).
- ▶ Slide the tab back in the direction of arrow ② until it audibly engages.
- ▶ Fold the wiper arm backward to rest on the windshield. Make sure you hold on to the wiper when folding the wiper arm back.



Never open the hood when the wiper arms are folded forward.

Hold on to the wiper when folding the wiper arm back. If released, the force of the impact from the tensioning spring could crack the windshield.

Do not allow the wiper arms to contact the windshield glass without a wiper blade inserted.

Make certain that the wiper blades are properly installed. Improperly installed wiper blades may cause windshield damage.

For your convenience, we recommend that you have this work carried out by an authorized Mercedes-Benz Center.

### Flat tire

#### Warning!



The dimensions of the Minispare wheel are different from those of the road wheels. As a result, the vehicle handling characteristics change when driving with a Minispare wheel mounted. Adapt your driving style accordingly.

The Minispare wheel is for temporary use only. When driving with Minispare wheel mounted, ensure proper tire inflation pressure and do not exceed a vehicle speed of 50 mph (80 km/h).

Drive to the nearest Mercedes-Benz Center as soon as possible to have the Minispare wheel replaced with a regular road wheel.

Never operate the vehicle with more than one Minispare wheel mounted.

Do not switch off the ESP® when a Minispare wheel is mounted.

#### Preparing the vehicle

- ▶ Park the vehicle in a safe distance from moving traffic on a hard, flat surface when possible.
- ▶ Turn on the hazard warning flasher (▷ page 124).
- ▶ Turn the steering wheel so that the front wheels are in a straight ahead position.
- ▶ Set the parking brake (▷ page 58).
- ▶ Move the gear selector lever to **P** (manual transmission: to first or reverse gear).
- ▶ Turn off the engine (▷ page 59).
- ▶ Remove the SmartKey from the starter switch.
- ▶ Have any passenger exit the vehicle at a safe distance from the roadway.



Open doors only when conditions are safe to do so.

#### Mounting the Minispare wheel

##### Preparing the vehicle

Prepare the vehicle as described (▷ page 406).

- ▶ Take the wheel wrench, the wheel bolts, and the jack out of the trunk (▷ page 383).
- ▶ Take the Minispare wheel out of the trunk (▷ page 386).

## Lifting the vehicle

- ▶ Prevent the vehicle from rolling away by blocking wheels with wheel chocks or other sizable objects.

One wheel chock is included with the vehicle tool kit (▷ page 383).

When changing wheel on a level surface:

- ▶ Place the wheel chock in front of and another sizable object behind the wheel that is diagonally opposite to the wheel being changed.

Always try lifting the vehicle using the jack on a level surface. However, should circumstances require you to do so on a hill, place the wheel chock and the other sizeable object as follows:

- ▶ Place wheel chocks and another sizeable object on the downhill side blocking both wheels of the axle not being worked on.

### Warning!



The jack is designed exclusively for jacking up the vehicle at the jack take-up brackets built into both sides of the vehicle. To help avoid personal injury, use the jack only to lift the vehicle during a wheel change. Never get beneath the vehicle while it is supported by the jack. Keep hands and feet away from the area under the lifted vehicle. Always firmly set parking brake and block wheels before raising vehicle with jack.

Do not disengage parking brake while the vehicle is raised. Be certain that the jack is always vertical (plumb line) when in use, especially on hills. Always try to use the jack on level surface. Make sure the jack arm is fully seated in the jack take-up bracket. Always lower the vehicle onto sufficient capacity jackstands before working under the vehicle.



- ▶ On wheel to be changed, loosen but do not yet remove the wheel bolts (approximately one full turn with wrench).



### Flat tire

The jack take-up brackets are located directly behind the front wheel housings and in front of the rear wheel housings.

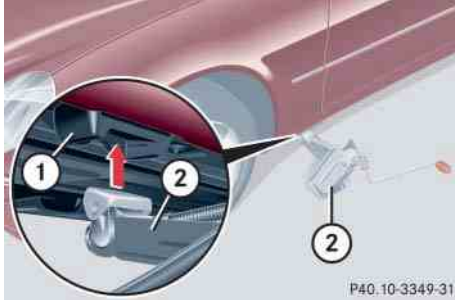

- ① Take-up bracket
- ② Jack

- ▶ Place jack ② on firm ground.
- ▶ Position jack ② under take-up bracket ① so that it is always vertical (plumb-line) as seen from the side, even if the vehicle is parked on an incline.

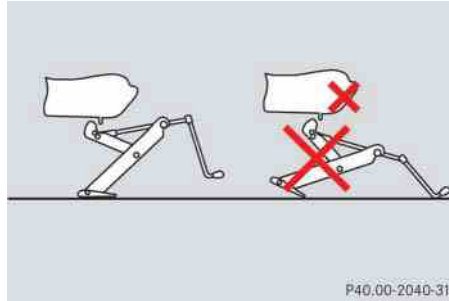

- ▶ Jack up the vehicle until the wheel is a maximum of 1.2 in (3 cm) from the ground. Never start engine while vehicle is raised.

#### Warning!



The jack is intended only for lifting the vehicle briefly for wheel changes. It is not suited for performing maintenance work under the vehicle.

- Never start the engine when the vehicle is raised.
- Never lie down under the raised vehicle.

### Removing the wheel



- ① Alignment bolt
- ▶ Unscrew upper-most wheel bolt and remove.
- ▶ Replace this wheel bolt with alignment bolt ① supplied in the tool kit.
- ▶ Remove the remaining bolts.
- ! Do not place wheel bolts in sand or dirt. This could result in damage to the bolts and wheel hub threads.
- ▶ Remove the wheel.

### Mounting the spare wheel

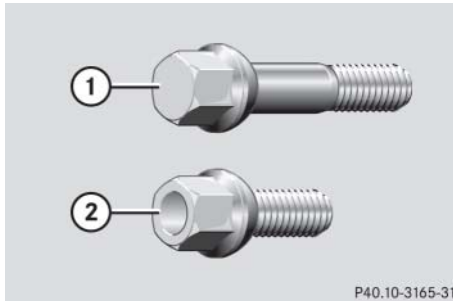

- ① Wheel bolt for light alloy rims
- ② Wheel bolt for Minispare wheel (located in trunk with spare wheel)



Wheel bolts ② must be used when mounting the Minispare wheel or other steel rims. The use of any wheel bolts other than wheel bolts ② for the Minispare wheel will physically damage the vehicle's brakes.

- ▶ Clean contact surfaces of wheel and wheel hub.



To avoid paint damage, place wheel flat against hub and hold it there while installing first wheel bolt.

### Warning!



Always replace wheel bolts that are damaged or rusted.

Never apply oil or grease to wheel bolts.

Damaged wheel hub threads should be repaired immediately. Do not continue to drive under these circumstances! Contact an authorized Mercedes-Benz Center or call Roadside Assistance.

Incorrect wheel bolts or improperly tightened wheel bolts can cause the wheel to come off. This could cause an accident. Make sure to use the correct wheel bolts.



- ▶ Guide spare wheel onto the alignment bolt and push it on.
- ▶ Insert wheel bolts and tighten them slightly.

### Flat tire



- ▶ Unscrew the alignment bolt, install last wheel bolt and tighten slightly.

#### Warning!



Only use genuine equipment Mercedes-Benz wheel bolts. Other wheel bolts may come loose.

Do not tighten the wheel bolts when the vehicle is raised. Otherwise the vehicle could fall off the jack.

#### Lowering the vehicle

- ▶ Lower vehicle by turning crank counterclockwise until vehicle is resting fully on its own weight.
- ▶ Remove the jack.

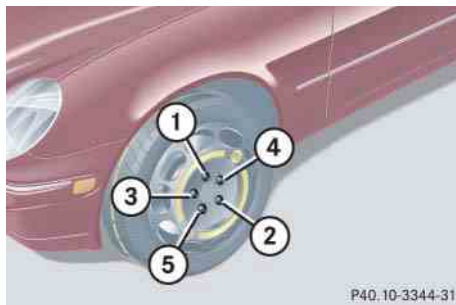

① - ⑤ Wheel bolts

- ▶ Tighten the five wheel bolts evenly, following the diagonal sequence illustrated (① to ⑤), until all bolts are tight. Observe a tightening torque of 80 lb-ft (110 Nm).

#### Warning!



Have the tightening torque checked after changing a wheel. The wheels could come loose if they are not tightened to a torque of 80 lb-ft (110 Nm).

Before storing the jack, it should be fully collapsed, with handle folded in (storage position) (▷ page 385).

- ▶ Store the jack and the other vehicle tools in the trunk.

### MOExtended system\*

The MOExtended system allows you to continue driving your vehicle even if there is a total loss of pressure in one or more tires.

You may only use the MOExtended system in conjunction with the Run Flat Indicator\*.



The maximum distance in emergency mode depends on the vehicle's load. It is 30 miles (50 km) if the vehicle is partially loaded and 18 miles (30 km) if the vehicle is fully loaded.

The point at which the maximum driving distance begins in emergency mode is when the warning message appears in the multifunction display indicating that there is a loss of tire inflation pressure.

Do not exceed the maximum speed of 50 mph (80 km/h).

### Warning!



In emergency mode, your vehicle's driving characteristics are diminished in such situations as:

- driving around curves
- while braking
- while accelerating rapidly

Therefore, your driving style must be adapted accordingly. Avoid abrupt steering and driving maneuvers, as well as driving over obstacles (road curbs, potholes, or off-road areas). This is especially important if the vehicle is heavily loaded.

The emergency driving distance that can be achieved greatly depends on the demands placed on the vehicle. Depending on speed, load, driving maneuvers, road conditions, outside temperature, etc., the distance can be significantly shorter or, if the vehicle is driven cautiously, somewhat longer.

Do not continue driving in emergency mode if

- you notice knocking sounds
- the vehicle starts to shake
- smoke develops and you smell rubber
- ESP<sup>®</sup> is intervening continuously
- you notice tears on the tire sidewalls

After driving in emergency mode, you must have the rims inspected by an authorized Mercedes-Benz Center to check if they are suitable for further use. The failed tire must be replaced in any case.



When replacing individual or all tires on the vehicle, make sure only matching tires marked with "MOExtended" are mounted in the size specified for your vehicle (▷ page 432).

### Battery

The battery is located in the engine compartment on the right hand side.

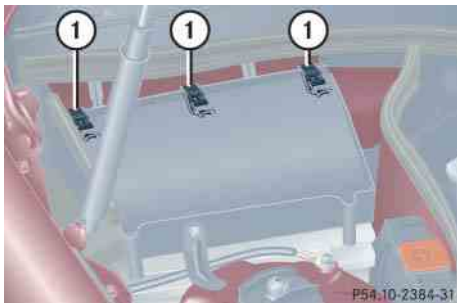

#### ① Clamps

Removing filter box:

- ▶ Release clamps ①.
- ▶ Remove filter box.

Installing filter box:

- ▶ Insert filter box properly.
- ▶ Secure it with clamps ①.

#### Warning!



Failure to follow these instructions can result in severe injury or death.

Observe all safety instructions and precautions when handling automotive batteries (▷ page 302).

Never lean over batteries while connecting, you might get injured.

Battery fluid contains sulfuric acid. Do not allow this fluid to come in contact with eyes, skin or clothing. In case it does, immediately flush affected area with water and seek medical help if necessary.

A battery will also produce hydrogen gas, which is flammable and explosive. Keep flames or sparks away from battery, avoid improper connection of jumper cables, smoking, etc.

#### Warning!



Do not place metal objects on the battery as this could result in a short circuit.

Use leak-proof battery only to avoid the risk of acid burns in the event of an accident.



Never loosen or detach battery terminal clamps while the engine is running or the SmartKey is in the starter switch. Otherwise the alternator and other electronic components could be severely damaged.

Have the battery checked regularly by an authorized Mercedes-Benz Center.

Refer to Maintenance Booklet for maintenance intervals or contact an authorized Mercedes-Benz Center for further information.

**Warning!**

With a disconnected battery

- you will no longer be able to turn the SmartKey in the starter switch
- the gear selector lever will remain locked in position **P**

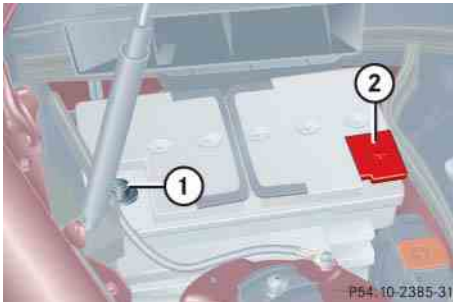

- ① Negative terminal
- ② Positive terminal cover

**Disconnecting the battery**

- ▶ Turn off the engine (▷ page 59).
- ▶ Turn off all electrical consumers.
- ▶ Remove SmartKey from starter switch.
- ▶ Open the hood (▷ page 297).
- ▶ Remove the filter box (▷ page 412).
- ▶ Disconnect the battery negative lead from negative terminal ①.
- ▶ Remove cover ② from the positive terminal.
- ▶ Disconnect the battery positive lead.

**Removing the battery**

- ▶ Remove the screw-nuts securing the battery.
- ▶ Remove the battery bracket.
- ▶ Pull out the battery ventilation tube from the battery (depending on battery arrangement in your vehicle model, the ventilation tube is located either on the left or right side of the battery).
- ▶ Take out the battery.

### Battery

#### Charging and reinstalling the battery

##### Warning!



Never charge a battery while still installed in the vehicle unless the accessory battery charge unit approved by Mercedes-Benz is being used. Gases may escape during charging and cause explosions that may result in paint damage, corrosion or personal injury.

An accessory battery charge unit specially adapted for Mercedes-Benz vehicles and tested and approved by Mercedes-Benz is available, permitting the charging of the battery in its installed position. Contact an authorized Mercedes-Benz Center for information and availability. Charge battery in accordance with the separate instructions for the accessory battery charger.

- ▶ Charge battery in accordance with the instructions of the battery charger manufacturer.
- ▶ Reinstall the charged battery. Follow the previously described steps in reverse order.



The battery, its filler caps and the battery ventilation tube must always be securely installed when the vehicle is in operation.

#### Reconnecting the battery

- ▶ Turn off all electrical consumers.
- ▶ Remove SmartKey from starter switch.
- ▶ Connect the battery positive lead and fasten its cover ②.
- ▶ Connect the battery negative lead.



NEVER invert the terminal connections!

- ▶ Reinstall the filter box (▷ page 412).



The following procedures must be carried out following any interruption of battery power (e.g. due to reconnection):

- Set the clock (▷ page 145).  
Vehicles with COMAND\*:  
See COMAND operator's manual.
- Synchronize side windows (▷ page 242).
- Synchronize tilt/sliding sunroof\* (▷ page 246).

Batteries contain materials that can harm the environment if disposed of improperly. Large 12 volt storage batteries contain lead. Recycling of batteries is the preferred method of disposal. Many states require sellers of batteries to accept old batteries for recycling.

## ▼ Jump starting

### Warning!



Failure to follow these directions will cause damage to the electronic components, and can lead to a battery explosion and severe injury or death.

Never lean over batteries while connecting or jump starting, you might get injured.

Battery fluid contains sulfuric acid. Do not allow this fluid to come in contact with eyes, skin or clothing. In case it does, immediately flush affected area with water, and seek medical help if necessary.

A battery will also produce hydrogen gas, which is flammable and very explosive. Keep flames or sparks away from battery, avoid improper connection of jumper cables, smoking, etc.

Attempting to jump start a frozen battery can result in it exploding, causing personal injury.

Read all instructions before proceeding.

If the battery is discharged, the engine can be started with jumper cables and the battery of another vehicle. Observe the following:

- Jump starting should only be performed when the engine and catalytic converter are cold.
- Do not start the engine if the battery is frozen. Let the battery thaw out first.
- Only jump start from batteries with the same voltage rating (12 V). Jump starting with a more powerful battery could damage the vehicle's electrical system, which will not be covered by the Mercedes-Benz Limited Warranty.
- Only use jumper cables with sufficient cross-section and insulated terminal clamps.
- Always make sure the jumper cables are not on or near pulleys, fans, or other parts that move when an engine is started or running.



Avoid repeated and lengthy starting attempts.

Do not attempt to start the engine using a battery quick charge unit.

If engine does not run after several unsuccessful starting attempts, have it checked at the nearest authorized Mercedes-Benz Center.

Excessive unburned fuel generated by repeated failed starting attempts may damage the catalytic converter and may present a fire risk.

Make sure the jumper cables do not have loose or missing insulation.

Make sure the cable clamps do not touch any other metal part while the other end is still attached to a battery.



### Jump starting

#### Warning!



Keep flames or sparks away from battery.  
Do not smoke.

Observe all safety instructions and precautions when handling automotive batteries (▷ page 302).

The battery is located in the engine compartment on the right hand side. The terminals for jump starting are located in front of the battery.

- ▶ Make sure the two vehicles do not touch.
- ▶ Turn off all electrical consumers.
- ▶ Apply parking brake.
- ▶ Shift gear selector lever to position **P** (manual transmission: to Neutral).
- ▶ Open the hood (▷ page 297).
- ▶ Flip up cover positive under hood terminal ② in front of the filter box (▷ page 412).

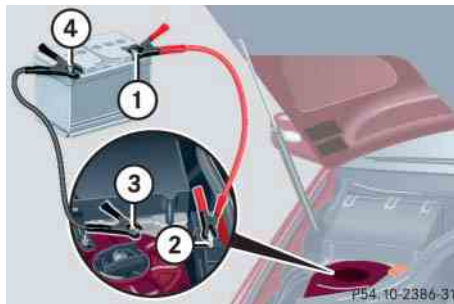

- ① Positive terminal of charged battery
  - ② Positive under hood terminal in front of discharged battery
  - ③ Negative under hood terminal in front of discharged battery
  - ④ Negative terminal of charged battery
- ▶ Connect positive terminal ① of the charged battery with positive under hood terminal ② in front of the filter box with the jumper cables. Clamp cable to charged battery ① first.



Never invert the terminal connections!

- ▶ Start engine of the vehicle with the charged battery and run at idle speed.
- ▶ Connect negative terminal ④ of the charged battery with negative under hood terminal ③ in front of the filter box with the jumper cables. Clamp cable to charged battery ④ first.
- ▶ Start the engine of the disabled vehicle.

You can now again turn on the electrical consumers. Do not turn on the lights under any circumstances.

- ▶ Remove the jumper cables first from negative terminals ③ and ④ and then from positive terminals ② and ①.

You can now turn on the lights.

- ▶ Have the battery checked at the nearest authorized Mercedes-Benz Center.



Vehicles with automatic transmission and/or 4MATIC:  
Do not tow-start the vehicle.

## ▼ Towing the vehicle

Mercedes-Benz recommends that the vehicle be transported with all wheels off the ground using flatbed or appropriate wheel lift/dolly equipment. This method is preferable to other types of towing.



Use flatbed or wheel lift/dolly equipment with the SmartKey in the starter switch turned to position **0**.

Do not tow with sling-type equipment. Towing with sling-type equipment over bumpy roads will damage radiator and supports.

To prevent damage during transport, do not tie down vehicle by its chassis or suspension parts.

Switch off the tow-away alarm\* (▷ page 95) and deactivate the automatic central locking (▷ page 152).

When circumstances do not permit the recommended towing methods, the vehicle may be towed with all wheels on the ground or front wheels raised (except vehicles with 4MATIC) only so far as necessary to have the vehicle moved to a safe location where the recommended towing methods can be employed.



Vehicles with automatic transmission and/or 4MATIC:  
Do not tow-start the vehicle.



Vehicles with 4MATIC:  
Do not tow with one axle raised. Doing so could damage the transfer case, which is not covered by the Mercedes-Benz Limited Warranty.

All wheels must be on or off the ground. Observe instructions for towing the vehicle with all wheels on the ground.



If the vehicle is towed with the front axle raised (not permissible for vehicles with 4MATIC), the engine must be shut off (SmartKey in starter switch position **0** or **1**). Otherwise the ESP® will immediately be engaged and will apply the rear wheel brakes.

When towing the vehicle with all wheels on the ground, the gear selector lever must be in position **N** (manual transmission: gears disengaged) and the SmartKey must be in starter switch position **2**.

When towing the vehicle with all wheels on the ground or the front axle raised, the vehicle may be towed only for distances up to 30 miles (50 km) and at a speed not to exceed 30 mph (50 km/h).

### Towing the vehicle



To be certain to avoid a possibility of damage to the drivetrain, however, we recommend the drive shaft be disconnected at the rear axle drive flange (vehicles with 4MATIC: disconnected at the front and rear axle drive flanges) for any towing beyond a short tow to a nearby garage.

#### Warning!



If circumstances require towing the vehicle with all wheels on the ground, always tow with a tow bar if:

- the engine will not run
- there is a malfunction in the power supply or in the vehicle's electrical system

as that will be necessary to adequately control the towed vehicle.

Prior to towing the vehicle with all wheels on the ground, make sure the SmartKey is in starter switch position **2**.

If the SmartKey is left in starter switch position **0** for an extended period of time, it can no longer be turned in the switch. In this case, the steering is locked. To unlock, remove SmartKey from starter switch and reinsert.



To signal turns while being towed with the hazard warning flasher in use, switch on the ignition and activate the combination switch for the left or right turn signal in the usual manner – only the selected turn signal will operate.

Upon canceling the turn signal, the hazard warning flasher will operate again.

**Warning!**

With the engine not running, there is no power assistance for the brake and steering systems. In this case, it is important to keep in mind that a considerably higher degree of effort is necessary to brake and steer the vehicle. Adapt your driving accordingly.



When towing the vehicle with all wheels on the ground, please note the following:

With the automatic central locking activated and the SmartKey in starter switch position **2**, the vehicle doors lock if the left front wheel as well as the right rear wheel are turning at vehicle speeds of approx. 9 mph (15 km/h) or more.

Switch off the tow-away alarm\* (▷ page 95).

To prevent the vehicle doors from locking, deactivate the automatic central locking (▷ page 152).

Towing of the vehicle should only be done using the properly installed towing eye bolt. Never attach tow cable, tow rope or tow rod to vehicle chassis, frame or suspension parts.



If the battery is disconnected or discharged

- the SmartKey will not turn in the starter switch. For more information, see “Battery” (▷ page 412) and “Jump starting” (▷ page 415).
- the gear selector lever will remain locked in position **P**. For information on manually unlocking the transmission gear selector lever see (▷ page 392).

### Towing the vehicle

#### Installing towing eye bolt

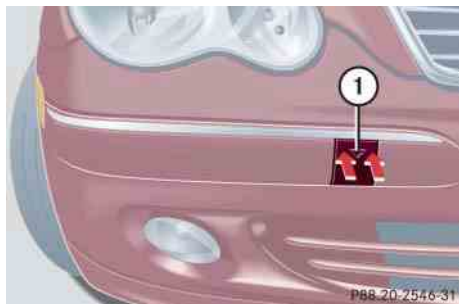

① Cover on right side of front bumper



② Cover on right side of rear bumper

#### Removing cover

- ▶ Press mark on cover ① or ② in direction of arrows.
- ▶ Lift cover off to reveal the threaded hole for towing eye bolt.

The towing eye bolt is supplied with the tool kit (located in the compartment underneath the trunk floor).

- ▶ Screw towing eye bolt in to its stop and tighten with lug wrench.

#### Reinstalling cover

- ▶ Fit cover ① or ② and snap into place.

## ▼ Fuses

Fuses are designed to protect the electrical circuits in your vehicle from a short circuit. If a fuse is blown, the component(s) and systems secured by that fuse will stop operating.

The following aids are available to help you replace fuses (▷ page 421):

- Fuse chart
- Spare fuses
- Fuse extractor

### Warning!



Only use fuses approved by Mercedes-Benz with the specified amperage for the system in question. Using other fuses may cause an overload leading to a fire, and/or cause damage to electrical components and/or systems.



Never attempt to repair or bridge a blown fuse. Have the cause determined and remedied by an authorized Mercedes-Benz Center.



Keep the fuse boxes free by contamination and wetness. Otherwise, electrical parts or systems could be damaged.

The electrical fuses are located in different fuse boxes:

- Main fuse box in passenger compartment (▷ page 422)
- Fuse box in engine compartment (▷ page 422)
- Fuse box in trunk (▷ page 423)

## Aids for replacing fuses

### Fuse chart

The fuse chart is located in the main fuse box in the passenger compartment (▷ page 422). The amperages of the fuses are also given there.

### Spare fuses

Spare fuses are located in the vehicle tool kit in the trunk (▷ page 383).

### Fuse extractor

The fuse extractor is located in the fuse box cover in the trunk (▷ page 423).

### Fuses

#### Main fuse box in passenger compartment

The main fuse box is located in the passenger compartment on the driver's side of the cockpit.



① Main fuse box cover

#### Opening fuse box

- ▶ Open the driver's door.
- ▶ Pull fuse box cover ① open with a screw driver or similar tool (see arrow).
- ▶ Remove fuse box cover ① rearward.

#### Closing fuse box

- ▶ Attach fuse box cover ① in the front.
- ▶ Fold fuse box cover ① in until it engages.

#### Fuse box in engine compartment

The fuse box is located in the engine compartment on the driver's side.

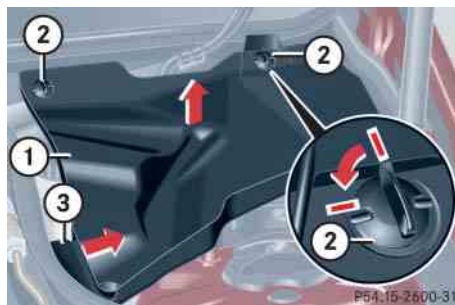

- ① Cover
- ② Screws
- ③ Retainer

#### Removing cover

- ▶ Twist screws ② 90° counterclockwise.
- ▶ Lift the rear of cover ①.
- ▶ Slide out retainer ③ and remove cover ① by pulling towards front.

#### Opening fuse box

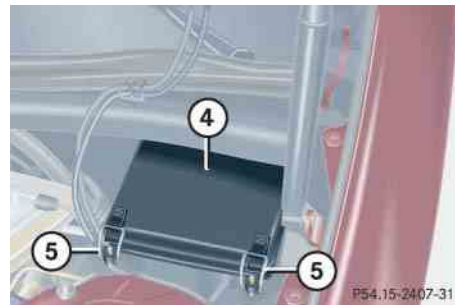

- ④ Fuse box cover
- ⑤ Clamps

- ▶ With a dry cloth, remove any moisture from the fuse box.
- ▶ Release clamps ⑤.
- ▶ Remove fuse box cover ④.

### Closing fuse box

- ▶ Make sure that the sealing rubber is properly positioned.
- ▶ Press fuse box cover ④ down and secure with clamps ⑤.

### Installing cover

- ▶ Insert cover ① sideways into retainer ③.
- ▶ Twist screws ② 90° clockwise.

### Fuse box in trunk

The fuse box is located in the trunk behind the left-hand trim panel.

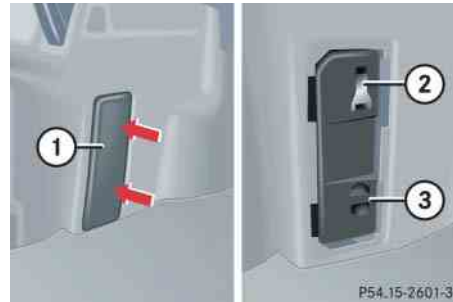

- ① Trim panel
- ② Fuse extractor
- ③ Fuse box cover

### Opening fuse box

- ▶ Pull away trim panel ①.
- ▶ Remove fuse box cover ③.

### Closing fuse box

- ▶ Insert fuse box cover ③.
- ▶ Insert trim panel ①.





**Parts service**

**Warranty coverage**

**Identification labels**

**Layout of poly-V-belt drive**

**Engine**

**Rims and Tires**

**Electrical system**

**Main dimensions**

**Weights**

**Fuels, coolants, lubricants, etc.**



### Parts service

The “Technical data” section provides the necessary technical data for your vehicle.

All authorized Mercedes-Benz Centers maintain a stock of Genuine Mercedes-Benz parts required for maintenance and repair work. In addition, strategically located parts distribution centers provide quick and reliable parts service.

More than 300 000 different parts for Mercedes-Benz models are available.

Genuine Mercedes-Benz parts are subject to stringent quality inspections. Each part has been specifically developed, manufactured or selected for and adapted to Mercedes-Benz vehicles.

Therefore, Genuine Mercedes-Benz parts should be installed.



The use of non-genuine Mercedes-Benz parts and accessories not authorized by Mercedes-Benz could damage the vehicle, which is not covered by the Mercedes-Benz Limited Warranty, or could compromise the vehicle's durability or safety.

### ▼ Warranty coverage

Your vehicle is covered under the terms of the warranties printed in the Service and Warranty Information booklet. Your authorized Mercedes-Benz Center will exchange or repair any defective parts originally installed in the vehicle in accordance with the terms of the following warranties:

- New Vehicle Limited Warranty
- Emission System Warranty
- Emission Performance Warranty
- California, Maine, Massachusetts, and Vermont Emission Control Systems Warranty

Replacement parts and accessories are covered by the Mercedes-Benz Parts and Accessories warranties, copies of which are available at any Mercedes-Benz Center.

### Loss of Service and Warranty Information Booklet

---

Should you lose your Service and Warranty Information booklet, have an authorized Mercedes-Benz Center arrange for a replacement. It will be mailed to you.

### Identification labels



① Certification label  
(includes Paintwork code)



② Vehicle Identification Number (VIN)

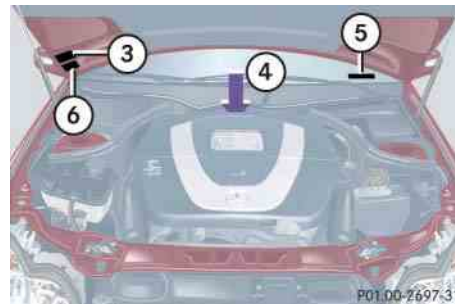

③ Vacuum line routing diagram label  
④ Engine number (engraved on engine)  
⑤ VIN, visible (lower edge of windshield)  
⑥ Emission control information label,  
includes both federal and California  
certification exhaust emission  
standards



When ordering parts, please specify vehicle identification and engine numbers.

▼ **Layout of poly-V-belt drive**

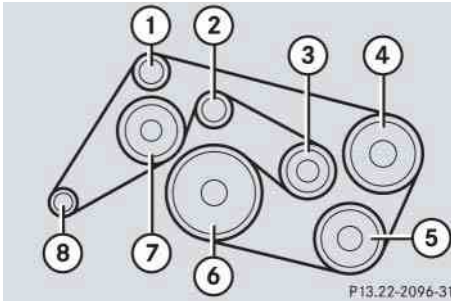

**All models**

- ① Idler pulley
- ② Idler pulley
- ③ Automatic belt tensioner
- ④ Power steering pump
- ⑤ Air conditioning compressor
- ⑥ Crankshaft
- ⑦ Coolant pump
- ⑧ Generator (alternator)

**Engine**

Model	C 230 (203.052) <sup>1</sup> C 230 Sport (203.052) <sup>1</sup>	C 280 (203.054) <sup>1</sup> C 280 4MATIC (203.092) <sup>1</sup>
Engine	272	272
Mode of operation	4-stroke engine, gasoline injection	4-stroke engine, gasoline injection
No. of cylinders	6	6
Bore	3.46 in (88.00 mm)	3.46 in (88.00 mm)
Stroke	2.69 in (68.40 mm)	3.23 in (82.10 mm)
Total piston displacement	152.3 cu in (2496 cm <sup>3</sup> )	182.8 cu in (2996 cm <sup>3</sup> )
Compression ratio	11.2:1	11.1:1
Output acc. to SAE J 1349	201 hp/6200 rpm <sup>2</sup> (150 kW/6200 rpm)	228 hp/6000 rpm <sup>2</sup> (170 kW/6000 rpm)
Maximum torque acc. to SAE J 1349	181 lb-ft/2700 – 5000 rpm (245 Nm/2700 – 5000 rpm)	221 lb-ft/2700 – 5000 rpm (300 Nm/2700 – 5000 rpm)
Maximum engine speed	6500 rpm	6500 rpm
Firing order	1-4-3-6-2-5	1-4-3-6-2-5
Poly-V-belt	2404 mm	2404 mm

<sup>1</sup> The quoted data apply only to the standard vehicle. See an authorized Mercedes-Benz Center for the corresponding data of all special bodies and special equipment.

<sup>2</sup> Premium fuel required. Performance may vary with fuel octane rating.

<b>Model</b>	<b>C 350 (203.056)<sup>1</sup></b> <b>C 350 Sport (203.056)<sup>1</sup></b> <b>C 350 4MATIC (203.087)<sup>1</sup></b>
<b>Engine</b>	272
<b>Mode of operation</b>	4-stroke engine, gasoline injection
<b>No. of cylinders</b>	6
<b>Bore</b>	3.65 in (92.90 mm)
<b>Stroke</b>	3.38 in (86.00 mm)
<b>Total piston displacement</b>	213.5 cu in (3498 cm <sup>3</sup> )
<b>Compression ratio</b>	10.5:1
<b>Output acc. to SAE J 1349</b>	268 hp/6000 rpm <sup>2</sup> (200 kW/6000 rpm)
<b>Maximum torque acc. to SAE J 1349</b>	258 lb-ft/3000 rpm (350 Nm/3000 rpm)
<b>Maximum engine speed</b>	6700 rpm
<b>Firing order</b>	1-4-3-6-2-5
<b>Poly-V-belt</b>	2404 mm

<sup>1</sup> The quoted data apply only to the standard vehicle. See an authorized Mercedes-Benz Center for the corresponding data of all special bodies and special equipment.

<sup>2</sup> Premium fuel required. Performance may vary with fuel octane rating.



### Rims and Tires



Only use tires which have been tested and approved for your vehicle by Mercedes-Benz. Tires approved by Mercedes-Benz are developed to provide best possible performance in conjunction with the driving safety systems on your vehicle such as ABS or ESP®. Tires specially developed for your vehicle and tested and approved by Mercedes-Benz can be identified by finding the following on the tire's sidewall:

- MO = Mercedes-Benz Original equipment tires
- MOE = Mercedes-Benz Original Extended (tires with limited run-flat characteristics) original equipment tires

Using tires other than those approved by Mercedes-Benz may result in damage that is not covered by the Mercedes-Benz Limited Warranty.



For information on driving with MOExtended tires, see “MOExtended system\*” (▷ page 411).



Using tires other than those approved by Mercedes-Benz can have detrimental effects, such as

- poor handling characteristics
- increased noise
- increased fuel consumption

Moreover, tires and rims not approved by Mercedes-Benz may, under load, exhibit dimensional variations and different tire deformation characteristics that could cause them to come into contact with the vehicle body or axle parts. Damage to the tires or the vehicle may be the result.



Further information on tires and rims is available at any authorized Mercedes-Benz Center. A placard with the recommended tire inflation pressures is located on the driver's door B-pillar. Some vehicles may have supplemental tire inflation pressure information for driving at high speeds (▷ page 315) or for vehicle loads less than the maximum loaded vehicle condition (▷ page 315). If such information is provided, it can be found on the placard located on the inside of the fuel filler flap. The tire inflation pressure should be checked regularly and should only be adjusted on cold tires. Follow tire manufacturer's maintenance recommendation included with vehicle.





The following pages also list the approved wheel rim and tire sizes for equipping your vehicles with winter tires. Winter tires are not available as standard or optional factory equipment, but can be purchased from an authorized Mercedes-Benz Center.

Depending on vehicle model and the standard or optional factory-equipped wheel rim/tire configuration on your vehicle (Appearance Package, Sport Package etc.), equipping your vehicle with winter tires approved for your vehicle model may also require the purchase of two or four wheel rims of the recommended size for use with these winter tires. See an authorized Mercedes-Benz Center for more information.

Rims and Tires

Same size tires

Model	C 230 <sup>1</sup> C 280 C 280 4MATIC C 350 C 350 4MATIC	C 230 Sport C 350 Sport
Rims (light alloy)	7 J x 16 H2	7.5 J x 17 H2
Wheel offset	1.22 in (31 mm)	1.42 in (36 mm)
All-season tires <sup>2</sup>	205/55 R16 91H M+S	-
Summer tires <sup>2</sup>	-	-
Winter tires <sup>2,3</sup>	205/55 R16 91H M+S 	225/45 R17 91H M+S  or 225/45 R17 91H M+S  MOExtended <sup>4</sup>

<sup>1</sup> Canada only

<sup>2</sup> Radial-ply tires

<sup>3</sup> Not available as factory equipment.

<sup>4</sup> Must be used in conjunction with Run Flat Indicator\* only.

Mixed size tires

<b>Model</b>	<b>C 230 Sport</b> <b>C 350 Sport</b>
--------------	--

**Front axle:**

<b>Rims (light alloy)</b>	7.5 J x 17 H2
<b>Wheel offset</b>	1.42 in (36 mm)
<b>Summer tires</b> <sup>1</sup>	225/45 R17 91W or 225/45 R17 91W MOExtended <sup>2</sup>

**Rear axle:**

<b>Rims</b>	8.5 J x 17 H2
<b>Wheel offset</b>	1.18 in (30 mm)
<b>Summer tires</b> <sup>1,3</sup>	245/40 R17 91W or 245/40 R17 91W MOExtended <sup>2</sup>

<sup>1</sup> Radial-ply tires

<sup>2</sup> Must be used in conjunction with Run Flat Indicator\* only.

<sup>3</sup> Must not be used with snow chains.

## Rims and Tires

### Minispare wheel

<b>Model</b>	<b>C 230<sup>1</sup></b> <b>C 280</b> <b>C 280 4MATIC</b> <b>C 350</b> <b>C 350 4MATIC</b>	<b>C 230 Sport</b> <b>C 350 Sport</b>
<b>Rim (steel)</b>	3.5 B x 16 H2	3.5 B x 17 H2
<b>Wheel offset</b>	0.67 in (17 mm)	0.67 in (17 mm)
<b>Tire</b>	T 125/90 R16 98M <sup>2</sup>	T 125/80 R17 99M <sup>2</sup>

<sup>1</sup> Canada only

<sup>2</sup> Must not be used with snow chains.



Please compare the recommended tire inflation pressure for your vehicle with the tire inflation pressure on the yellow label located on the spare wheel rim.

If the tire inflation pressure on the yellow label on the spare wheel rim differs from the values given in this Operator's Manual, inflate the Minispare wheel to the recommended tire inflation pressure given on the yellow label on the spare wheel rim.



Please note that the tire inflation pressure of the Minispare differs from the tire inflation pressure of the road tires.

Inflate the Minispare wheel to approximately 61 psi (4.2 bar).

▼ **Electrical system**

<b>Model</b>	<b>all models</b>
<b>Generator (alternator)</b>	14 V/150 A
<b>Starter motor</b>	12 V/1.4 kW
<b>Battery</b>	12 V/100 Ah
<b>Spark plugs</b>	Bosch Platin Y 7 MPP 33 NGK PLKR 6A
<b>Electrode gap</b>	0.031 in (0.8 mm)
<b>Tightening torque</b>	18 – 22 lb-ft (25 – 30 Nm)

**Main dimensions**

Model	C 230 C 230 Sport	C 280 C 350	C 280 4MATIC C 350 4MATIC	C 350 Sport
Overall vehicle length	178.4 in (4532 mm)	178.4 in (4532 mm)	178.4 in (4532 mm)	178.4 in (4532 mm)
Overall vehicle width (exterior rear view mirrors folded out)	77.8 in (1977 mm)	77.8 in (1977 mm)	77.8 in (1977 mm)	77.8 in (1977 mm)
Overall vehicle height	55.6 in (1413 mm)	56.1 in (1426 mm)	56.3 in (1429 mm)	55.5 in (1410 mm)
Wheelbase	106.9 in (2715 mm)	106.9 in (2715 mm)	106.9 in (2715 mm)	106.9 in (2715 mm)
Track, front	59.3 in (1505 mm)	59.3 in (1505 mm)	59.3 in (1505 mm)	59.3 in (1505 mm)
Track, rear	58.1 in (1476 mm)	58.1 in (1476 mm)	58.1 in (1476 mm)	58.1 in (1476 mm)

## ▼ Weights

Roof load max.	220 lb (100 kg)
Trunk load max.	220 lb (100 kg)



## Fuels, coolants, lubricants, etc.

### Capacities

Vehicle components and their respective lubricants must match. Therefore only use products tested and approved by Mercedes-Benz.

Please refer to the Factory Approved Service Products pamphlet, or inquire at your Mercedes-Benz Center.

	Model	Capacity	Fuels, coolants, lubricants, etc.
<b>Engine with oil filter</b>		8.5 US qt (8.0 l)	Approved engine oils
<b>Automatic transmission</b>	C 230 (all models) C 280 C 350 C 350 4MATIC C 350 4MATIC	9.0 US qt (8.5 l) 9.0 US qt (8.5 l) 9.0 US qt (8.5 l) 8.3 US qt (7.8 l) 8.3 US qt (7.8 l)	MB Automatic Transmission Fluid
<b>Manual transmission</b>	C 230 (all models) C 350	1.3 US qt (1.2 l) 1.6 US qt (1.5 l)	MB Manual Transmission Oil
<b>Rear axle</b>	C 230 (all models) C 280 (all models) C 350 C 350 Sport C 350 4MATIC	1.0 US qt (1.0 l) 1.2 US qt (1.1 l) 1.2 US qt (1.1 l) 1.2 US qt (1.1 l) 1.0 US qt (1.0 l)	Hypoid gear oil SAE 85 W 90
<b>Front axle</b>	C 280 4MATIC C 350 4MATIC	0.5 US qt (0.46 l)	Hypoid gear oil SAE 85 W 90
<b>Transfer case</b>	C 280 4MATIC C 350 4MATIC	approx. 0.62 US qt (0.59 l)	MB Transfer case fluid

**Fuels, coolants, lubricants, etc.**

	<b>Model</b>	<b>Capacity</b>	<b>Fuels, coolants, lubricants, etc.</b>
<b>Power steering</b>		approx. 1.1 US qt (1.0 l)	MB Power Steering Fluid (Pentosin CHF 11S)
<b>Front wheel hubs</b>		approx. 2.1 oz (60 g) each	High temperature roller bearing grease
<b>Brake system</b>		0.5 US qt (0.5 l)	MB Brake Fluid (DOT 4+)
<b>Cooling system</b>		approx. 7.5 US qt (7.1 l)	MB 325.0 Anticorrosion/antifreeze agent
<b>Fuel tank including a reserve of</b>		16.4 US gal (62.0 l) 2.1 US gal (8.0 l)	Premium unleaded gasoline: Minimum Posted Octane 91 (Avg. of 96 RON/86 MON)
<b>Air conditioning system</b>			R-134a refrigerant and special PAG lubricant oil (never R-12)
<b>Windshield washer</b>		3.2 US qt (3.0 l)	MB Windshield Washer Concentrate <sup>1</sup>
<b>Windshield washer and headlamp cleaning system*</b>		6.4 US qt (6.0 l)	

<sup>1</sup> Use MB Windshield Washer Concentrate “S” and water for temperatures above freezing point or MB Windshield Washer Concentrate “S” and commercially available premixed windshield washer solvent/antifreeze for temperatures below freezing point. Follow suggested mixing ratios (> page 448).

### Fuels, coolants, lubricants, etc.

#### Engine oils

Engine oils are specifically tested for their suitability in our engines and durability for our service intervals. Therefore, only use approved engine oils and oil filters required for vehicles with Maintenance System (U.S. vehicles) or FSS (Canada vehicles). For a listing of approved engine oils and oil filters, refer to the Factory Approved Service Products pamphlet, or contact an authorized Mercedes-Benz Center.



Using engine oils and oil filters of specification other than those expressly required for the Maintenance System (U.S. vehicles) or FSS (Canada vehicles), or changing of oil and oil filter at change intervals longer than those called for by the Maintenance System (U.S. vehicles) or FSS (Canada Vehicles) will result in engine damage not covered by the Mercedes-Benz Limited Warranty.

Please follow Maintenance System (U.S. vehicles) or FSS (Canada vehicles) recommendations for scheduled oil changes. Failure to do so will result in engine damage not covered by the Mercedes-Benz Limited Warranty.

#### Engine oil additives

Do not blend oil additives with engine oil. They may damage the engine.

Damage or malfunctions resulting from blending oil additives are not covered by the Mercedes-Benz Limited Warranty.

#### Air conditioning refrigerant

R-134a (HFC) refrigerant and special PAG lubricating oil are used in the air conditioning system.

Never use R-12 (CFC) or mineral-based lubricating oil. Otherwise damage to the system will occur.

#### Brake fluid

During vehicle operation, the boiling point of the brake fluid is continuously reduced through the absorption of moisture from the atmosphere.

#### Warning!



Under extremely strenuous operating conditions, this moisture content can lead to the formation of bubbles in the system, thus reducing the system's efficiency.

Therefore, the brake fluid must be replaced regularly. Refer to your vehicle's Maintenance Booklet for replacement interval.

Only brake fluid approved by Mercedes-Benz is recommended. An authorized Mercedes-Benz Center will provide you with additional information.

## Premium unleaded gasoline

### Warning!



Gasoline is highly flammable and poisonous. It burns violently and can cause serious injury. Whenever you are around gasoline, avoid inhaling fumes and skin contact, extinguish all smoking materials. Never allow sparks, flame or smoking materials near gasoline!



To maintain the engine's durability and performance, premium unleaded gasoline must be used. If premium unleaded is not available and low octane fuel is used, follow these precautions:

- Have the fuel tank only partially filled with unleaded regular and fill up with premium unleaded as soon as possible.
- Avoid full throttle driving and abrupt acceleration.
- Do not exceed an engine speed of 3000 rpm if the vehicle is loaded with a light load such as two persons and no luggage.
- Do not exceed  $\frac{2}{3}$  of maximum accelerator pedal position if the vehicle is fully loaded or operating in mountainous terrain.

## Gasoline additives

A major concern among engine manufacturers is carbon build-up caused by gasoline. Mercedes-Benz recommends only the use of quality gasoline containing additives that prevent the build-up of carbon deposits.

After an extended period of using fuels without such additives, carbon deposits can build up especially on the intake valves and in the combustion area, leading to engine performance problems such as:

- Warm-up hesitation
- Unstable idle
- Knocking/pinging
- Misfire
- Power loss

### Fuels, coolants, lubricants, etc.

In areas where carbon deposits may be encountered due to lack of availability of gasolines which contain these additives, Mercedes-Benz recommends the use of additives approved by us for use on Mercedes-Benz vehicles. Refer to Factory Approved Service Products pamphlet for a listing of approved product(s). Follow directions on product label.

Do not blend other fuel additives with fuel. This only results in unnecessary cost and may be harmful to engine operation.

Damage or malfunction resulting from poor fuel quality or from blending additional fuel additives other than those tested and approved by us for use on Mercedes-Benz vehicles listed in the Factory Approved Service Products pamphlet are not covered by the Mercedes-Benz Limited Warranty.

#### Fuel requirements

---

Only use premium unleaded fuel:

- The octane number (posted at the pump) must be 91 min. It is an average of both the Research (R) octane number and the Motor (M) octane number:  $(R+M)/2$ . This is also known as the ANTI-KNOCK INDEX.

Unleaded gasoline containing oxygenates such as ethanol, IPA, IBA and TBA can be used provided the ratio of any one of these oxygenates to gasoline does not exceed 10%; MTBE must not exceed 15%.

The ratio of methanol to gasoline must not exceed 3% plus additional cosolvents.

Using mixtures of ethanol and methanol is not allowed. Gasohol, which contains 10% ethanol and 90% unleaded gasoline, can be used.

These blends must also meet all other fuel requirements, such as resistance to spark knock, boiling range, vapor pressure, etc.

#### Coolants

---

The engine coolant is a mixture of water and anticorrosion/antifreeze, which provides:

- Corrosion protection
- Freeze protection
- Boiling protection (by increasing the boiling point)

The cooling system was filled at the factory with a coolant providing freeze protection to approximately  $-22^{\circ}\text{F}$  ( $-30^{\circ}\text{C}$ ) and corrosion protection.

If the antifreeze mixture is effective to  $-22^{\circ}\text{F}$  ( $-30^{\circ}\text{C}$ ), the boiling point of the coolant in the pressurized cooling system is reached at approx.  $266^{\circ}\text{F}$  ( $130^{\circ}\text{C}$ ).

### Fuels, coolants, lubricants, etc.

The coolant solution must be used year-round to provide the necessary corrosion protection and increase boil-over protection. Refer to Maintenance Booklet for replacement interval.

Coolant system design and coolant used determine the replacement interval. The replacement interval published in the Maintenance Booklet is only applicable if MB 325.0 anticorrosion/antifreeze solution or other Mercedes-Benz approved products of equal specification (see Factory Approved Service Products pamphlet) are used to renew the coolant concentration or bring it back up to the proper level.

To provide important corrosion protection, the solution must be at least 45% anticorrosion/antifreeze [equivalent to freeze protection to approx.  $-22^{\circ}\text{F}$  ( $-30^{\circ}\text{C}$ )].

If you use a solution that is more than 55% anticorrosion/antifreeze [freeze protection to approx.  $-49^{\circ}\text{F}$  ( $-45^{\circ}\text{C}$ )], the engine temperature will increase due to the lower heat transfer capability of the solution. Therefore, do not use more than this amount of anticorrosion/antifreeze.

If the coolant level is low, water and MB 325.0 anticorrosion/antifreeze should be used to bring it up to the proper level (have cooling system checked for signs of leakage). Please make sure the mixture is in accordance with label instructions.

The water in the cooling system must meet minimum requirements, which are usually satisfied by normal drinking water. If you are not sure about the water quality, consult an authorized Mercedes-Benz Center.

### Fuels, coolants, lubricants, etc.

#### Anticorrosion/antifreeze

Your vehicle contains a number of aluminum parts. The use of aluminum components in motor vehicle engines necessitates that anticorrosion/antifreeze coolant used in such engines be specifically formulated to protect the aluminum parts.

Failure to use such anticorrosion/antifreeze coolant will result in a significantly shortened service life.

Therefore, the following product is strongly recommended for use in your vehicle:

Mercedes-Benz 325.0

Anticorrosion/Antifreeze Agent.

Before the start of the winter season (or once a year in hot southern regions), you should have the anticorrosion/antifreeze concentration checked. The coolant is also regularly checked each time you bring your vehicle to an authorized Mercedes-Benz Center for service.

*Anticorrosion/antifreeze quantity*

Model	Approx. freeze protection	
	-35°F (-37°C)	-49°F (-45°C)
all models	3.8 US qt (3.6 l)	4.1 US qt (3.9 l)



### Fuels, coolants, lubricants, etc.

#### Windshield washer and headlamp cleaning system\*

Both the windshield washer and headlamp cleaning system\* are supplied from the windshield washer fluid reservoir.

The washer fluid reservoir has a capacity of approx.:

- 3.2 US qt (3.0 l) in vehicles without headlamp cleaning system\*
- 6.4 US qt (6.0 l) in vehicles with headlamp cleaning system\*

- ▶ Refill the reservoir with MB Windshield Washer Concentrate “S” and water (or concentrate and commercially available premixed windshield washer solvent/antifreeze, depending on ambient temperatures).

#### Warning!



Washer solvent/antifreeze is highly flammable. Do not spill washer solvent/antifreeze on hot engine parts, because it may ignite and burn. You could be seriously burned.

#### Windshield and headlamp washer fluid mixing ratio

For temperatures above freezing point, use MB Windshield Washer Concentrate “S” and water:

- 1 part “S” to 100 parts water (1.34 fl oz [40 ml] “S” to 1 gallon [4.0 l] water)

For temperatures below freezing point, use MB Windshield Washer Concentrate “S” and commercially available premixed windshield washer solvent/antifreeze:

- 1 part “S” to 100 parts solvent (1.34 fl oz [40 ml] “S” to 1 gallon [4.0 l] solvent)

**ABS**

(Antilock Brake System)

Prevents the wheels from locking up during braking so that the vehicle can continue to be steered.

**Accessory weight**

(▷ page 331)

**Air pressure**

(▷ page 331)

**Alignment bolt**

Metal pin with thread. The centering pin is an aid used when changing a tire to align the wheel with the wheel hub.

**Aspect ratio**

(▷ page 331)

**Bar**

(▷ page 331)

**BAS**

(Brake Assist System)

System for potentially reducing braking distances in emergency braking situations. The system is activated when it senses an emergency based on how fast the brake is applied.

**Bead**

(▷ page 331)

**Bi-Xenon headlamps\***

Headlamps which use an electric arc as the light source and produce a more intense light than filament headlamps. Bi-Xenon headlamps produce low beam and high beam.

**CAC**

(Customer Assistance Center)

Mercedes-Benz customer service center, which can help you with any questions about your vehicle and provide assistance in the event of a breakdown.

**CAN system**

(Controller Area Network)

Data bus network serving to control vehicle functions such as door locking or windshield wiping depending on vehicle settings and/or ambient conditions.

**Cockpit**

All instruments, switches, buttons and indicator/warning lamps in the passenger compartment needed for vehicle operation and monitoring.

**Cold tire inflation pressure**

(▷ page 331)

**COMAND\***

(Cockpit Management and Data System)

Information and operating center for vehicle sound and communications systems, including the radio and the navigation system, as well as other optional equipment (CD changer\*, telephone\*, etc.).

### Control system

The control system is used to call up vehicle information and to change component settings. Information and messages appear in the multifunction display. The driver uses the buttons on the multifunction steering wheel to navigate through the system and to adjust settings.

### Cruise control

Driving convenience system that automatically maintains the vehicle speed set by the driver.

### Curb weight

(▷ page 331)

### DOT

(Department of Transportation)

(▷ page 331)

### Engine number

The number set by the manufacturer and placed on the cylinder block to uniquely identify each engine produced.

### Engine oil viscosity

Measurement for the inner friction (viscosity) of the oil at different temperatures. The higher the temperature an oil can tolerate without becoming thin, or the lower the temperature it can tolerate without becoming viscous, the better the viscosity.

### ESP®

(Electronic Stability Program)  
Improves vehicle handling and directional stability.

### ETD

(Emergency Tensioning Device)  
Device which deploys in certain frontal and rear collisions exceeding the system's threshold to tighten the seat belts.  
->SRS

### FSS (Canada vehicles)

(Flexible Service System)

Maintenance service indicator in the multifunction display that informs the driver when the next vehicle maintenance service is due. FSS evaluates engine temperature, oil level, vehicle speed, engine speed, distance driven and the time elapsed since your last maintenance service, and calls for the next maintenance service accordingly.

### GAWR

(Gross Axle Weight Rating)

(▷ page 331)

### Gear range

Number of gears which are available to the automatic transmission for shifting. The automatic gear shifting process can be adapted to specific operating conditions using the gear selector lever.

**GPS**

(Global Positioning System)  
 Satellite-based system for relaying geographic location information to and from vehicles equipped with special receivers. Employs CD digital maps for navigation.

**GVW**

(Gross Vehicle Weight) (▷ page 332)

**GVWR**

(Gross Vehicle Weight Rating)  
 (▷ page 332)

**Instrument cluster**

The displays and indicator/warning lamps in the driver's field of vision, including the tachometer, speedometer, engine temperature display and fuel gauge.

**Kickdown**

Depressing the accelerator past the point of resistance shifts the transmission down to the lowest possible gear. This very quickly accelerates the vehicle and should not be used for normal acceleration needs.

**Kilopascal (kPa)**

(▷ page 332)

**Locking knob**

Knob on the door which indicates whether the door is locked or unlocked. Pushing the locking knob down on an individual door from inside will lock that door.

**Maintenance System (U.S. vehicles)**

Maintenance service indicator in the multifunction display that informs the driver when the next vehicle maintenance service is due. The Maintenance System in your vehicle tracks distance driven and the time elapsed since your last maintenance service, and calls for the next maintenance service accordingly.

**Maximum tire inflation pressure**

(▷ page 332)

**Maximum load rating**

(▷ page 332)

**Maximum loaded vehicle weight**

(▷ page 332)

**Memory function\***

Used to store three individual seat, steering wheel and mirror positions.

### **MON**

(Motor Octane Number)

The Motor Octane Number for gasoline as determined by a standardized method. It is an indication of a gasoline's ability to resist undesired detonation (knocking). The average of both the MON (Motor Octane Number) and →RON (Research Octane Number) is posted at the pump, also known as ANTI-KNOCK INDEX.

### **Multifunction display**

Display field in the instrument cluster used to present information provided by the control system.

### **Multifunction steering wheel**

Steering wheel with buttons for operating the control system.

### **Normal occupant weight**

(▷ page 332)

### **OCS**

(Occupant Classification System)

The system automatically turns the front passenger front air bag on or off based on the classified occupant size category determined by weight sensor readings from the seat.

### **Occupant distribution**

(▷ page 332)

### **Overspeed range**

Engine speeds within the red marking of the tachometer dial. Avoid this engine speed range, as it may result in serious engine damage that is not covered by the Mercedes-Benz Limited Warranty.

### **Poly-V-belt drive**

Drives engine-components (alternator, AC compressor, etc.) from the engine.

### **Power train**

Collective term designating all components used to generate and transmit motive power to the drive axles, including

- engine
- clutch/torque converter
- transmission
- transfer case
- drive shaft
- differential
- axle shafts/axles

### **Production options weight**

(▷ page 333)

### **Program mode selector switch**

Used to switch the automatic transmission\* between standard operation **S** and comfort operation **C**.

**PSI**

(Pounds per square inch) (▷ page 333)

**Recommended tire inflation pressure**

(▷ page 333)

**Restraint systems**

Seat belts, child restraints, lower anchors and tethers for children (LATCH). As independent systems, their protective functions complement one another.

**Rim**

(▷ page 333)

**RON**

(Research Octane Number)

The Research Octane Number for gasoline as determined by a standardized method. It is an indication of a gasoline's ability to resist undesired detonation (knocking). The average of both the →MON (Motor Octane Number) and RON (Research Octane Number) is posted at the pump, also known as ANTI-KNOCK INDEX.

**Shift lock**

When the vehicle is parked, this lock prevents the transmission gear selector lever from being moved out of position **P** without SmartKey turned and brake pedal depressed.

**Sidewall**

(▷ page 333)

**SRS**

(Supplemental Restraint System)

Air bags, air bag control unit (with crash sensor), emergency tensioning device. Though independent systems, they are closely interfaced to provide effective occupant protection.

**Tele Aid\* System**

(Telematic Alarm Identification on Demand)

The Tele Aid system consists of three types of response: automatic and manual emergency, roadside assistance and information. Tele Aid is initially activated by completing a subscriber agreement and placing an acquaintance call.

The Tele Aid system is operational provided that the vehicle's battery is charged, properly connected, not damaged and cellular and GPS coverage is available.

### **Telematics\***

A combination of the terms “telecommunications” and “informatics”.

### **Tightening torque**

Force times lever arm (e.g. a lug wrench) with which threaded fasteners such as wheel bolts are tightened.

### **TIN**

(Tire Identification Number)  
(▷ page 333)

### **Tire load rating**

(▷ page 333)

### **Tire ply composition and material used**

(▷ page 333)

### **Tire speed rating**

(▷ page 333)

### **Traction**

(▷ page 334)

### **Tread**

(▷ page 334)

### **Treadwear indicators**

(▷ page 334)

### **Uniform Tire Quality Grading Standards**

(▷ page 334)

### **Vehicle capacity weight**

(▷ page 334)

### **Vehicle maximum load on the tire**

(▷ page 334)

### **VIN**

(Vehicle Identification Number)  
The number set by the manufacturer and placed on the body to uniquely identify each vehicle produced.

- A**
- ABS 25, 87, 449
    - Indicator lamp 350
    - Messages in display 360
  - Accelerator position,
    - automatic transmission\* 165
  - Accessory weight 331
  - Accident
    - In case of 56
  - Active head restraints
    - see Head restraints
  - Additional turn signals 398
  - Air bags 63
    - Children 64
    - Front passenger front air bag off
      - indicator lamp 27, 80, 356
    - Front, Driver 67
    - Front, Passenger 67
    - Passenger 67
    - Safety guidelines 66
    - Side impact (front and rear\*) 68
    - Window curtain 68
  - Air conditioning refrigerant 442
  - Air conditioning system
    - Automatic climate control\*
      - (Canada only) 186
    - Climate control 176
  - Air conditioning, Cooling
    - Automatic climate control\*
      - (Canada only) 196
    - Climate control 183
  - Air distribution
    - Automatic climate control\*
      - (Canada only) 190
    - Climate control 180
  - Air pressure see Tire inflation pressure
  - Air recirculation mode
    - Automatic climate control\*
      - (Canada only) 192
    - Climate control 182
  - Air vents, Front
    - Automatic climate control\*
      - (Canada only) 187
    - Climate control 177
  - Air vents, Rear
    - Automatic climate control\*
      - (Canada only) 198
    - Climate control 185
  - Air volume
    - Automatic climate control\*
      - (Canada only) 191
    - Climate control 180
  - Alignment bolt (vehicle tool kit) 408, 449
  - Anticorrosion/antifreeze 446, 447
  - Antiglare, Rear view mirror 170
  - Anti-theft systems 93
    - Anti-theft alarm system\* 93
    - Immobilizer 93
    - Tow-away alarm\* 95
  - Aquaplaning see Hydroplaning
  - Armrest 258
  - Ashtrays 261
  - Aspect ratio 331
  - ATF (Automatic transmission fluid) 300
  - AUDIO menu (Control system) 136
  - Audio system 199
    - Audio and telephone, operation 199
    - Button and soft key operation 202
    - CD changer\* with MP3 218
    - CD operation 216



- Operating and display elements 200
  - Operating audio system 202
  - Operating safety 199
  - Radio operation 207
  - Telephone\* operation 225
  - Auto-dimming mirror\* 171
  - Automatic central locking
    - Activating/deactivating (Control system) 152
  - Automatic climate control\* (Canada only) 186
    - Control panel 187
    - Defrosting, front 191
    - Rear window defroster 175
  - Automatic headlamp mode 119
  - Automatic locking when driving 107
  - Automatic shift program
    - Program mode selector switch (Automatic transmission\*) 167
  - Automatic time change (Standard time, Daylight Saving time) 147
  - Automatic transmission\* 162
    - Accelerator position 165
    - Automatic shift program 167
    - Emergency operation (Limp Home Mode) 169
    - Fluid level (ATF) 300
    - Gear ranges 166
    - Gear selector lever 162
    - Gear shifting malfunctions 169
    - Kickdown 165
    - Manual shifting 168
    - One-touch gearshifting 168
    - Program mode selector switch 167
    - Starting engine 49
- B**
- Backrest
    - Driver's multicontour seat\* (Canada only) 113
    - Rear seat, folding 254
    - Seat, manual 36
    - Seat, power\* 38
  - Backup lamps
    - Messages in display 377
    - Replacing bulbs 399
  - Bar 331
  - BAS 88, 449
  - Batteries, SmartKey
    - Changing 396
    - Checking battery condition 101
  - Battery, Vehicle 302, 412
    - Charging 414
    - Disconnecting and connecting 413
    - Jump starting 415
    - Removing and installing 413
  - Bead 331
  - Bi-Xenon\* headlamps see headlamps
  - Block heater (Canada only) 337
  - Bolts, Spare wheel 388
  - Brake Assist System see BAS
  - Brake fluid 442
    - Checking 295
    - Message in display 370

- Brake lamps
  - Cleaning lenses 344
  - Messages in display 377
  - Replacing bulbs 403
- Brake pads
  - Message in display 370
- Brakes 284
  - Warning lamp 25, 351
- Break-in period 282
- Bulbs, replacing see Replacing bulbs
- C**
- CAC 449
- California retail buyers and lessees,
  - important notice 11
- CAN system 449
- Cargo area see Trunk
- Cargo tie-down rings\* 256
- Carpets, cleaning 347
- Catalytic converter 291
- CD changer\* 216
- CD player\* 137, 216
- Centigrade see Temperature display
  - mode 142
- Central locking
  - Automatic 107, 152
  - From inside 107
  - Locking/unlocking from inside 107
  - Switch 107
- Certification label 428
- Charcoal filter
  - Automatic climate control\*
    - (Canada only) 194
- Children in the vehicle 74
  - Air bags 64
  - Blocking rear door window
    - operation 85
  - Indicator lamp, front passenger
    - air bag 80, 356
  - Infant and child restraint systems 74
  - LATCH-type child seat anchors 83
  - Occupant Classification System
    - (OCS) 77
- Cigarette lighter 262
- Climate control system 176
  - Control panel 177
  - Defrosting, Front 181
  - Rear window defroster 175
- Clock 25, 130
  - Setting time 145, 146
- Cockpit 22, 449
- Cockpit Management and Data System
  - see COMAND
- Cold tire inflation pressure 331
- Collapsible wheel chock 386
- COMAND\* 449
- COMAND\* see separate COMAND
  - operating instructions
- Combination switch 52, 122
- Control system 130, 450
  - Multifunction display 130
  - Multifunction steering wheel 131
  - Resetting to factory default 140
- Control system menu 130, 450
  - AUDIO 136
  - Menus overview 133
  - NAV\* 138
  - Settings 140
  - Standard display 135
  - TEL\* 157
  - Trip computer 155
  - Vehicle status message
    - memory 138

- Control system submenus 132, 134
    - Convenience 153
    - Instrument cluster 143
    - Lighting 149
    - Time/Date 145
    - Vehicle 152
  - Controller Area Network see CAN system
  - Coolant 301, 444
    - Anticorrosion/antifreeze quantity 445
    - Capacities 440, 441
    - Checking coolant level 295, 301
    - Messages in display 371–373
    - Temperature 293
    - Temperature gauge 25, 128
  - Corner-illuminating front fog lamps\* 123
    - Replacing bulbs 398
  - Cruise control 247, 450
    - Message in display 374
  - Cup holder 259, 260
    - Cleaning 346
  - Curb weight 331
  - Customer Assistance Center see CAC
- D**
- Date display, setting 147, 148
  - Daytime running lamp mode 120
    - Setting 149
  - Deep water see Standing water
  - Defogging windshield
    - Automatic climate control\* (Canada only) 192
    - Climate control 181
  - Defrosting, Front
    - Automatic climate control\* (Canada only) 191
    - Climate control 181
  - Defrosting, Rear 175
  - Delayed shut-off
    - Exterior lamps 151
    - Interior lighting 152
  - Department of Transportation see DOT
  - Difficulties
    - While driving 56
    - With starting 50
  - Digital clock see clock
  - Digital speedometer 135
  - Dimensions, vehicle 438
  - Direction of rotation (tires) 307
  - Displays
    - Digital speedometer 135
    - Maintenance service indicator 338
    - Messages in display 374
    - Multifunction display 130
    - Outside temperature 135
    - Symbol messages 369
    - Text messages 360
    - Vehicle status messages memory 139, 358
  - Distance to empty (range), Trip computer 156
  - Door control panel 30
  - Doors
    - Entry lamps 126
    - Locking/unlocking, SmartKey 98
    - Message in display 374
    - Opening from inside/outside 100, 102
    - Remote door unlock (Tele Aid\*) 272
    - Unlocking, Mechanical key 389

DOT 331  
 Downhill driving  
   Cruise control 248  
 Drinking and driving 283  
 Driving  
   Abroad 290  
   Hydroplaning 287  
   In winter 289  
   Instructions 45, 283  
   Problems 56  
   Safety systems 87  
   Systems 247  
   Through standing water 290  
 Driving safety systems  
   4MATIC 92  
   ABS 87  
   BAS 88  
   ESP® 89

## E

Easy-entry/exit feature\* 42, 153  
 Electrical fuses see Fuses  
 Electrical outlet 263  
 Electrical system, Technical data 437  
 Electronic Stability Program see ESP®  
 Emergency calls  
   911 calls 237  
   Tele Aid\* calls 267, 268, 271  
 Emergency operation  
   (Limp Home Mode) 169  
 Emergency operations  
   Fuel filler flap 391  
   Gear selector lever, Unlocking 392  
   Locking/unlocking the vehicle 389  
   Power tilt/sliding sunroof\*,  
     Manual operation 393  
   Remote door unlock 272  
   Trunk lid, Releasing from inside 105  
   Trunk lid, Unlocking 390  
 Emergency Tensioning Device see ETD

Emergency, in case of  
   Battery, Jump starting 415  
   First aid kit 350, 383  
   Flat tire, Changing 406  
   Fuses 421  
   Hazard warning flasher 124  
   Instrument cluster,  
     Indicator lamps 350–355  
   Roadside Assistance 12, 268  
   Towing the vehicle 417  
 Emission control 292  
   Information label 428  
   System warranties 10  
 Engine  
   Belt layout 429  
   Block heater (Canada only) 337  
   Brake-in recommendations 282  
   Cleaning 343  
   Compartment 297  
   Malfunction indicator lamp 25, 352  
   Maximum engine speed 430

- Number 428
- Starting 49
- Tachometer 25
- Technical data 430
- Turning 59
- Engine coolant see coolant
- Engine number 450
- Engine oil 298, 442
  - Adding 300
  - Additives 442
  - Changing 440
  - Checking level (Dipstick) 299
  - Consumption 298
  - Filler neck 300
  - Recommended engine and oil filter 375
  - Viscosity 450
- ESP<sup>®</sup> 89, 450
  - Four wheel electronic traction system with ESP<sup>®</sup> 92
  - Messages in display 361–362
  - Warning lamp 25, 354
- ETD 72, 450
  - Safety guidelines 66
- Exterior lamp switch 52, 118
- Exterior rear view mirrors 43
  - Parking position\* 172
- F**
- Fahrenheit see Temperature display mode 142
- Filler neck, Engine oil 300
- First aid kit 383
- Flat tire 406
  - Jacking up the vehicle 407
  - Lowering the vehicle 410
  - Minispare wheel 386
  - Mounting the spare wheel 406
  - Preparing the vehicle 406
- Flexible Service System see FSS
- Fluids
  - Automatic transmission fluid 300, 440
  - Brake fluid 295, 442
  - Capacities 440
  - Engine coolant 295, 444
  - Engine oil 298, 442
  - Power steering fluid 441
  - Windshield washer and headlamp cleaning system\* 303, 448
- Fog lamps 121, 122
  - Message in display 377, 379
  - Replacing bulbs 398, 399
- Four wheel electronic traction system (4MATIC) with ESP<sup>®</sup> 92
- 4MATIC 92
- Front air bags 67
- Front lamps see Headlamps
- Front passenger front air bag 67
  - Messages in display 364–367
- Front passenger front air bag off indicator lamp 27, 80, 356, 357
- Front seat head restraints see Head restraints 109
- FSS (Flexible Service System) (Canada vehicles) 338, 450

- Fuel 294, 443
  - Additives 443
  - Capacities, Fuel tank 441
  - Filling the tank 294
  - Fuel filler flap and cap, Multifunction display messages 352, 353, 376
  - Fuel gauge 25
  - Fuel reserve warning lamp 354
  - Requirements, Octane rating 444
  - Technical data 441, 443
- Fuel consumption statistics
  - After start 155
  - Since last reset 156
- Fuel filler flap 294
  - Opening in an emergency 391
- Fuel reserve warning lamp 25
- Fuel tank
  - Capacity 441
  - Filler flap 294
- Fuels, coolants, lubricants etc.
  - Capacities 440
- Fuses 421
  - Aids for changing fuses 421
  - Fuse box (main) in passenger compartment 422
  - Fuse box in engine compartment 422
  - Fuse box in trunk 423
  - Fuse chart 421
  - Fuse extractor 421, 423
  - Replacing 421
  - Spare fuses 421
- G**
- Garage door opener\* 273
- Gasoline see Fuel
- GAWR 331
- Gear range 450
  - Automatic transmission\* 166
  - Limiting 166
  - Shifting into optimal 169
- Gear selector lever 48, 49, 161, 162
  - Cleaning 347
  - Lock 49
  - Position indicator 163
  - Position, Automatic transmission\* 130, 162, 164
  - Unlocking in an emergency 392
- Global locking/unlocking see Key
- Global Positioning System see GPS
- Glove box 257
- Good visibility 170
- GPS 451
- Gross Axle Weight Rating see GAWR
- Gross Vehicle Weight Rating see GVWR
- Gross Vehicle Weight see GVW
- GVW 332
- GVWR 332
- H**
- Halogen headlamp see Headlamps
- Hands-free microphone 29
- Hard plastic trim items, cleaning 347
- Hazard warning flasher 124
- Head restraints 37, 109
  - Active head restraint 73, 394
- Front seat,
  - Removing and installing 109
- Manual seat, Adjusting 37
- Power seat\*, Adjusting 39
- Rear seat, Folding back 110
- Rear seat, Removing and installing 111
- Resetting activated head restraints 394

- Head unit
  - Time synchronization\* with 145
- Headlamp cleaning system\* 170, 303, 441
- Headlamp shut-off delay see Delayed shut-off, Exterior lamps
- Headlamps
  - Automatic headlamp mode 119
  - Bi-Xenon\* 402, 449
  - Cleaning lenses 344
  - Halogen 400
  - High beam see High beam flasher
  - High beam see High beam headlamps
  - Low beam see Low beam headlamps
  - Manual headlamp mode 119
  - Messages in display 377, 378, 379
  - Replacing bulbs 397
  - Switch 52, 59
- Headliner and shelf below rear window
  - Cleaning and care of 347
- Heated seats\* 113
- High beam flasher 52, 122
- High beam headlamps 52, 122
- Indicator lamp 25
- Messages in display 378
- Replacing bulbs 398, 401
- High mounted brake lamp 399
- Hood 297
  - Message in display 376
- Horn 23
- HVAC see Climate control
- Hydroplaning 287
- I**
- Identification labels 428
- Identification number, Vehicle (VIN) 428
- Ignition 33, 49
- Immobilizer 93
- Indicator lamps see Lamps, indicator and warning
- Infant and child restraint systems see Children in the vehicle
- Inflation pressure see Tires, Inflation pressures
- Inside door handle 102
- Instrument and controls see Instrument cluster
- Instrument cluster 24, 127, 451
  - Cleaning 346
  - Illumination brightness 127
  - Lamps 350, 355
  - Messages in display see Malfunction display messages
  - Multifunction display 130
- Instrument lighting see Instrument cluster, Illumination brightness
- Instruments and controls see Cockpit
- Interior lighting 125
  - Delayed shut-off 152
- Interior rear view mirror 43
  - Antiglare positions 170
  - Auto-dimming mirrors\* 171
- Interior storage spaces see Storage compartment

- J**  
 Jack 383  
 Jacking up the vehicle 407  
 Jump starting 415
- K**  
 Key, mechanical 389  
 Key, SmartKey  
   Batteries 101  
   Battery check lamp 101  
   Changing batteries 396  
   Factory setting 100  
   Locking/unlocking 32, 100  
   Locking/unlocking, Global setting 100  
   Locking/unlocking, Selective setting 100  
   Loss of 102  
   Messages in display 376  
   Opening and closing the power windows 243  
   Opening and closing the tilt/sliding sunroof\* 243  
   Positions in starter switch 33  
   Remote control 98  
   Starting the engine 48, 49  
   Turning off the engine 59  
   Unlocking, Trunk lid 102  
   Valet locking 106
- Kickdown 165, 451  
 Kilopascal 332
- L**  
 Labels 428  
   Certification 428  
   Emission control information 428  
   Emission control vacuum line routing 428
- Lamp sensor  
   Message in display 378
- Lamps, exterior 398, 399  
   Light sensor 378  
   Messages in display 377, 378, 379, 380
- Lamps, indicator and warning  
   ABS 25, 350  
   Battery (SmartKey) 100  
   Brakes 25, 351

- Engine diagnostics 352, 355  
 Engine malfunction 25, 352–353  
 ESP® 25, 354  
 Fog lamps 118  
 Front passenger front air bag off 27, 68  
 Fuel reserve 25, 354  
 High beam headlamps 25  
 Instrument cluster 350, 355  
 Low beam headlamps 25  
 Maintenance service indicator 338  
 Rear fog lamp 118  
 Seat belt telltale 25  
 SRS 25, 63, 355  
 Turn signals 25
- Language, Setting 143  
 LATCH-type child seat anchors see Children in the vehicle  
 Leather upholstery, Cleaning and care of 348  
 License plate lamps  
   Messages in display 378  
   Replacing bulbs 399



- Light alloy wheels
    - Cleaning 346
    - Technical data 434, 435
  - Light sensor see Lamp sensor
  - Lighter see Cigarette lighter
  - Lighting
    - Parking lamps 118
  - Lighting, Exterior and interior 118
  - Limp Home Mode 169
  - Loading see Vehicle loading
  - Loading terminology 331
  - Loading the vehicle 307
  - Locator lighting 121, 150
  - Locking knob 451
  - Loss of keys 102
  - Loss of Service and Warranty Information
    - Booklet 427
  - Low beam headlamps
    - Indicator lamp 25
    - Messages in display 378, 379
    - Replacing bulbs 398, 401
    - Switching on 52
  - Lubricants 440
    - Technical data 440
  - Lumbar support\* 112
- M**
- Main dimensions 438
  - Main fuse box
    - In passenger compartment 422
  - Main odometer 130
  - Maintenance 12, 338
    - Calling up service indicator display 339
    - Clearing service indicator message 339
    - FSS (Canada vehicles) 338
    - Maintenance System (U.S. vehicles) 338
    - Resetting service indicator 340
    - Service indicator message 338
    - Service term exceeded 339
  - Maintenance System (U.S. vehicles) 338, 451
  - Manual headlamp mode see Headlamps
  - Manual seat see Seat, Manual 36
  - Manual transmission 160, 161
    - Gearshift lever 48, 161
    - Shift positions 161
    - Starting the engine 49
  - Maximum load rating, Tires 332
  - Maximum loaded vehicle weight 332
  - Maximum tire inflation pressure 332
  - MB Tex upholstery, Cleaning and care of 348
  - Mechanical key 389
  - Memory function\* see Steering wheel
  - Menus see Control system
  - Microphone, Hands-free 29
  - Minispare wheel see Spare wheel
  - Mirrors
    - Adjusting 43
    - Auto-dimming\* 171
    - Exterior rear view mirror 43
    - Exterior rear view mirror, Parking position\* 117, 154, 172
    - Interior rear view mirror 43, 170
  - MOE tires see *MOExtended* system\* (Canada only)
  - MOExtended* system\* 411
  - MOExtended* system\* (Canada only) 320
  - MON 452
  - Motor Octane Number see MON
  - Multicontour seats\* (Canada only) 113
  - Multifunction display 130, 452
    - Changing settings see Contro system menus and Control system submenus

## Multifunction display messages

- ABS 360
- Brake fluid 370
- Brake lamps 377
- Brake pads 370
- Coolant 371, 372, 373
- Cruise control 374
- Display 374
- Door 374
- Engine coolant 371, 372, 373
- Engine oil 375
- ESP® 361, 362
- Fog lamps 377, 379
- Front passenger front air bag 364, 367
- Fuel cap 352, 376
- Headlamps 378, 379
- Hood 376
- Key, SmartKey 376
- Lamps, exterior 377–380
- Parking brake 370
- Parking lamp 379
- Seat belt system 381
- SRS 363
- Steering gear oil 381

- Tele Aid\* 382
- Telephone\* 382
- Tilt/sliding sunroof\* 382
- Trunk 382
- Turn signals 380
- Windshield washer fluid 382
- Multifunction steering wheel 26, 131, 452
  - Button operation 131

**N**

- Navigation system\* 138
  - See separate COMAND\* operating instructions
- Net, parcel 258
- Neutral gear position, Automatic transmission\* 162
- Neutral gear position, Manual transmission 161
- New vehicle break-in 282
- Night security illumination 121
  - Setting 151
- Normal occupant weight 332
- Number, vehicle identification (VIN) 428

**O**

- Occupant Classification System see OCS
- Occupant distribution 332
- Occupant safety 62
  - Air bags 63
  - Children and air bags 64
  - Children in the vehicle 74
  - Fastening the seat belt 45
  - Front passenger front air bag off indicator lamp 80, 356
  - Infant and child restraint systems 74
  - LATCH-type child seat anchors 83
  - OCS 77
    - Seat belts 45, 66
- OCS 77, 452
  - Self-test 81
- Odometer 130
- Oil level see Engine oil level, Checking oil level
- Oil see Engine oil
- One-touch gearshifting (Automatic transmission\*) 168
  - Canceling gear range limit 169
  - Downshifting 169
  - Upshifting 169

- Operating safety 199
- Ornamental moldings, Cleaning 344
- Outside temperature see Displays
- Overhead control panel 29
- Overspeed range, engine 452
- P**
- Paintwork, Cleaning 342
- Panic alarm\* 86
- Parcel net
  - In front passenger footwell 258
- Parking 57, 285
- Parking brake 50, 58
  - Engaging 58
  - Message in display 370
  - Releasing 50
- Parking lamps
  - Messages in display 379
  - Replacing bulbs 398
- Parking position\*
  - Exterior rear view mirrors 117, 154, 172
- Parts service 426
- Passenger compartment 290
  - Interior lighting 125
  - Interior rear view mirror 43
  - Main fuse box in 422
  - Parcel net in front passenger footwell 258
- Passenger safety see Occupant safety
- Pedals 283
- Phone\* see Telephone\*
- Plastic and rubber parts, Cleaning and care of 346
- Poly-V-belt drive 452
  - Layout 429
- Positions (memory function\*) see Seats
- Power assistance 283
- Power outlet in rear passenger compartment 263
- Power seat\* see Seats, Power\* 38
- Power tilt/sliding sunroof\* 244
  - Messages in display 382
  - Opening/closing 244
  - Opening/closing in an emergency 393
  - Opening/closing, SmartKey 243
  - Stopping 246
  - Synchronizing 246
- Power train 452
- Power washer 342
- Power windows 240
  - Cleaning 345
  - Opening/closing 240
  - Rear door window,
    - Blocking operation 85
    - Stopping 242
    - Synchronizing 242
- Practical hints 350
- Premium unleaded gasoline 443
- Problems
  - While driving 56
  - With vehicle 17
- Product information 9
- Production options weight 333
- Program mode 130
- Program mode selector switch 452
  - Automatic shift program, automatic transmission\* 167
- PSI 333
- Push starting 415

- R**
- Radio
    - Operation 202, 207
    - Selecting stations (Control system) 136
  - Radio transmitters 291
  - Range (distance to empty) 156
  - Reading lamp 125
  - Rear bench seat, foldable\* 253
  - Rear door window
    - Blocking operation 85
  - Rear fog lamp see Fog lamps
  - Rear lamps see Tail lamps
  - Rear outer seats
    - Adjusting head restraint height 110
  - Rear passenger compartment
    - Adjustable air vents 184, 197
  - Rear seat ashtray see Ashtray
  - Rear seat head restraints see Head restraints
  - Rear view mirrors see Mirrors
  - Rear window defroster 175
  - Rear window sunshade\* 174
  - Recommended tire inflation pressure 333
  - Recovery services, Stolen vehicle (Tele Aid\*) 273
  - Refrigerant, Air conditioning 442
  - Refueling 294
  - Regular checks 295
  - Remote control, SmartKey 98
  - Remote door unlock (Tele Aid\*) 272
  - Replacing bulbs
    - Additional turn signal lamps 403
    - Backup lamp 404
    - Brake lamps 404
    - Corner-illuminating front fog lamps\* 398
    - Fog lamps 404
    - Headlamps 398, 400, 402
    - High beam headlamps 398, 400
    - License plate lamps 404
    - Low beam headlamps 400
    - Parking lamps 401, 403, 404
    - Side marker lamps 403
    - Standing lamps 401, 403
    - Tail lamps 399, 404
    - Turn signal lamps 401, 403, 404
  - Reporting safety defects 18
  - Research Octane Number see RON
  - Reset button, In the instrument cluster 127, 141
  - Reset tool
    - Location 394
  - Residual heat utilization 197
  - Residual ventilation 197
  - Restraint system
    - see Children in the vehicle
    - see Infant and child restraint systems
    - see SRS
  - Restraint system see Infant and child restraint systems
  - Reverse gear position, Automatic transmission\* 49
  - Reverse gear position, Manual transmission 48
  - Rims 333, 432
  - Roadside Assistance 12
  - RON 453
  - Roof rack\* 250
  - Rubber parts, Cleaning 346
  - Run Flat Indicator\* (Canada only) 317

## S

- Safety
  - Driving safety systems 87
  - Occupant 62
  - Reporting defects 18
- Safety belts see Seat belts
- Satellite radio\* 211
- Seat belt force limiter 72
- Seat belts 69
  - Children in the vehicle 74
  - Cleaning 347
  - Fastening 45
  - Height adjustment 47
  - Message in display 381
  - Proper use of 47, 70
  - Safety guidelines 66
  - Telltale 25, 381
- Seat heating\* 114
- Seating capacity 309
- Seats, 35, 109
  - Heating\* 113, 114
  - Lumbar support\* 112
  - Manual 36, 109
  - Memory function\*
    - (Power seats\*) 115
  - Multicontour seat\*
    - (Canada only) 113
  - Power\* 38, 109
  - Rear bench seat\* 253
- Securing cargo 256
- Selector lever see gear selector lever
- Self-test
  - OCS 81
  - Tele Aid\* 266
- Service and Warranty Booklet
  - Loss of 427
- Service and warranty information 10
- Service intervals see Maintenance service indicator 338
- Service life (tires) 305
- Service see Maintenance Service system
  - see FSS (Canada vehicles) or Maintenance System (U.S. vehicles) 338
- Service System see FSS
- Service, Parts 426
- Settings
  - Control system menus and submenus 133, 134
  - Date 147, 148
  - Factory, SmartKey 100
  - Individual, SmartKey 100
  - Individual, Vehicle 140
  - Lighting (control system) 149
  - Memory function\* 115
  - Menus and submenus 132
  - Resetting all (control system) 140
  - Selective, SmartKey 100
  - Time 145, 146
- Shelf below rear window, cleaning 347
- Shift lever position indicator 130, 163
- Shift lock 453
- Shift program mode, Automatic transmission\* 130
- Shifting
  - Automatic transmission\* 49, 162
  - Into optimal gear range
    - (automatic transmission\*) 169
  - Into reverse (manual transmission) 161
  - Manual transmission 48, 161
- Side impact air bags (front and rear\*) 68
- Side marker lamps
  - Cleaning lenses 344
  - Messages in display 377
  - Replacing bulbs 403
- Side windows see Power windows

- Sidewall 333
  - Ski sack\* (Canada only) 250, 252, 253
  - SmartKey see Key, SmartKey
  - Snow chains 337
  - Sound system\* 204
  - Spare fuses 421
  - Spare wheel 436
    - Bolts 388
    - Mounting 406
  - Speed settings
    - Cruise control 249
  - Speedometer 25, 143
  - Split rear bench seat\* 253
  - SRS 70, 453
    - Indicator lamp 25, 355
    - Message in display 363
  - Standing lamps
    - Replacing bulbs 398, 399
  - Standing water, Driving through 290
  - Starter switch 23, 33
    - Positions 33
  - Starting difficulties, Engine 50
  - Steering column 40, 41
    - Easy entry/exit feature\* 42
  - Steering gear oil
    - Message in display 381
  - Steering wheel 40
    - Buttons 26
    - Cleaning 347
    - Electrical adjustment\* 41
    - Manual adjustment 40
  - Stolen vehicle
    - Recovery services 273
  - Storage compartments
    - Armrest 258
    - Cup holder 259
    - Glove box 257
    - Parcel net in front passenger footwell 258
  - Storing (memory function\*)
    - Positions into memory 116
  - Storing tires 306
  - Submenus see Control system submenus
  - Substitute lamps
    - Bulbs 397
  - Summer opening feature 243
  - Sun visors 173
  - Sunshade\* 174
  - Supplemental Restraint System see SRS
  - Symbols used in this operator's manual 15
- T**
- Tachometer 25, 129
    - Overspeed range 129
  - Tail lamps
    - Cleaning 344
    - Messages in display 379
    - Replacing bulbs 399, 403
  - Tar stains 342
  - Technical data
    - Air conditioning refrigerant 442
    - Brake fluid 442
    - Coolant 440, 441, 444
    - Electrical system 437
    - Engine 430
    - Engine oil additives 442
    - Engine oils 442
    - Fuel requirements 444
    - Fuels 440, 441
    - Fuels, coolants, lubricants, etc 440
    - Gasoline additives 443
    - Lubricants 440
    - Premium unleaded gasoline 443
    - Rims and tires 432
    - Weights 439

- Windshield washer 441
- Windshield washer and headlamp cleaning\* system 441, 448
- Tele Aid\* 265, 271, 453
  - Emergency calls 267
  - Hands-free microphone 29
  - Information 270
  - Initiating an emergency call manually 268
  - Message in display 382
  - Remote door unlock 272
  - Roadside Assistance 268
  - SOS button 268
  - Stolen Vehicle Recovery services 273
  - System self-check 266
- Telematics\* 454
- Telephone\* 26, 264
  - Answering/ending a call 158
  - Hands-free microphone 29
  - Message in display 382
  - Operation 157, 225
  - Phone book 158
  - Redialing 159
- Temperature
  - Display mode 135
  - Interior temperature 180
- Temperature, Tires 315
- Tether attachment points, see Children in the vehicle
- Tie-down rings\*, Trunk 256
- Tightening torque, Wheel bolts 410, 454
- Tilt/sliding sunroof\* see Power tilt/sliding sunroof\*
- Time 145
- TIN 333
- Tire and Loading Information Placard 308
- Tire and loading Information Terminology 331
- Tires 304, 432
  - Air pressure 331
  - Care and maintenance 305
  - Chains 337
  - Cleaning 306, 342
  - Direction of rotation 307
  - Driving instructions 286
  - Important notes, Tire inflation pressure 315
  - Inflation pressure 296, 314, 316
- Information Placard 308
- Inspection 305
- Load rating 333
- MO*Extended* system\* (Canada only) 320, 411
- Ply composition and material used 333
- Problems under-/overinflation 319
- Retreads 304
- Rims and tires 432
- Rotating 335
- Run Flat Indicator\* (Canada only) 317
- Service life 305
- Sizes 432
- Speed rating 288, 323, 333
- Temperature 315, 330
- Terminology 331
- Tire Identification Number see TIN
- Traction 287
- Tread 334
- Tread depth 306, 336
- Treadwear indicators 334
- Vehicle maximum load on 334
- Wear pattern 335
- Winter 336

- Tools 383
- Top tether, see Children in the vehicle
- Tow-away alarm\* 95
- Towing eye bolt 420
- Towing the vehicle 417
- Traction 168, 334
- Transmission gear selector lever see Gear selector lever
- Transmission see Automatic\* or Manual transmission
- Traveling abroad 290
- Tread 334
- Tread depth 306, 336
- Treadwear indicators 334
- Trip computer 155
- Trip odometer 128
- Trunk
  - Closing the lid 104
  - Fuse box 423
  - Lamp 126
  - Message in display 382
  - Opening 102, 103, 104
  - Tie-down rings 256
  - Trunk emergency release 105
  - Unlocking in an emergency 105
- Turn signal lamps
  - Messages in display 380
  - Replacing bulbs 398, 399
- Turn signals 53
  - Additional in mirrors 398
  - Bulbs 398, 399
  - Cleaning lenses 344
  - Indicator lamps 25
- Turning off engine 59
- U**
- Uniform Tire Quality Grading Standards 334
- Units, Setting
  - Speedometer 143
- Upholstery, Cleaning 348
- Useful features 257
- V**
- Vacuum line routing diagram label 428
- Valet locking 106
- Vehicle
  - Battery 412
  - Breaking-in the vehicle 282
  - Care 341
  - Dimensions 438
  - Individual settings 140, 142
  - Locking/unlocking 108
  - Locking/unlocking in an emergency 389, 390
  - Lowering 410
  - Modifications and alterations, Operating safety 16
  - Towing 417
  - Washing 342, 343
  - Weights 439
- Vehicle capacity weight 334
- Vehicle Identification Number see VIN
- Vehicle jack 385
- Vehicle lighting 296
- Vehicle loading
  - Cargo tie-down rings\* 256
  - Instructions 255, 307
  - Load limit 439
  - Roof rack\* 250
  - Split rear bench seat\* 253
  - Terminology 331
- Vehicle maximum load on the tire 334
- Vehicle recovery services, Stolen (Tele Aid\*) 265
- Vehicle status message memory 138



Vehicle tool kit 383  
VIN 428, 454  
Voice control system\*,  
    Hands-free microphone 29  
    see separate operating instructions

**W**

Warning lamps see Lamps, indicator and warning  
Warning sounds  
    Driver's or passenger's seat belt 71  
    Parking brake 51  
    Seat belt telltale 355  
Warranty coverage 10, 427  
Washer fluid see Windshield washer fluid  
Washer reservoir level 296  
Washing the vehicle 341  
Wear pattern (tires) 335  
Weights, Vehicle 439  
Wheel  
    Bolts 388  
    Change 410  
    Removing 408  
    Spare 384, 386, 436  
    Tightening torque 410

Wheels, Tires 304  
Window curtain air bags 68  
Windows see Power windows  
Windshield  
    Cleaning 345  
    Defogging 181, 192  
    Replacing wiper blades 405  
    Washer fluid 303, 448  
    Washer system 448  
Windshield washer fluid 448  
    Message in display 382  
    Mixing ratio 448  
    Refilling 303  
    Wiping with 55  
Windshield washer system 448  
Windshield wipers 53  
    Cleaning 345  
    Replacing wiper blades 405  
Winter driving 336  
    Block heater (Canada only) 337  
    Snow chains 337  
    Tires 336  
Winter driving instructions 289  
Winter tires 336

Wiper blades  
    Cleaning 345  
    Replacing 405  
Wood trims, Cleaning 348

## X

Xenon headlamps\* see Headlamps

## Service and Literature

Your authorized Mercedes-Benz Center has trained technicians and original Mercedes-Benz parts to service your vehicle properly.  
For expert advice and quality service, see an authorized Mercedes-Benz Center.

If you are interested in obtaining service literature for your vehicle, please contact an authorized Mercedes-Benz Center.  
We consider this the best way for you to obtain accurate information for your vehicle.

For further information you can find us on the Mercedes-Benz web-site [www.mbusa.com](http://www.mbusa.com) or [www.mercedes-benz.ca](http://www.mercedes-benz.ca).

### Warning!



To help avoid personal injury, be extremely careful when performing any service work or repairs. Improper or incomplete service or the use of incorrect or inappropriate parts or materials may damage the vehicle or its equipment, which may in turn result in personal injury.

If you have questions about carrying out any type of service, turn to the advice of an authorized Mercedes-Benz Center.

We reserve the right to modify the technical details of the vehicle as given in the data and illustrations of this Operator's Manual.  
Reprinting, translation and copying, even of excerpts, is not permitted without our prior authorization in writing.

Title illustration no. P00.01-2840-31

Press time May 10, 2005

GSP/TIP

Printed in Germany