



Operator's Manual
M-Class



Mercedes-Benz



1635843396

Order No. 6515 4237 13 Part No. 163 584 33 96 USA Edition A 2005

ML 350

ML 500

Our company and staff congratulate you on the purchase of your new Mercedes-Benz.

Your selection of our product is a demonstration of your trust in our company name. Furthermore, it exemplifies your desire to own an automobile that will be as easy as possible to operate and provide years of service.

Your Mercedes-Benz represents the efforts of many skilled engineers and craftsmen. To help assure your driving pleasure, and also the safety of you and your passengers, we ask you to make a small investment of time:

- Please read this manual carefully, then return it to your vehicle where it will be handy for your reference.
- Please follow the recommendations contained in this manual. They are designed to acquaint you with the operation of your Mercedes-Benz.
- Please pay attention to the warnings and cautions contained in this manual. They are designed to help improve the safety of the vehicle operator and occupants.

We extend our best wishes for many miles of safe, pleasurable driving.

Mercedes-Benz USA, LLC
A DaimlerChrysler Company

Contents

Introduction	9	At a glance	21	Parking and locking	54
Product information	9	Cockpit	22	Parking brake	54
Operator's Manual	10	Instrument cluster	24	Switching off headlamps	55
Service and warranty information ..	10	Center console	27	Turning off engine	55
Important notice for California		Upper part	27	Locking	56
retail buyers and lessees of		Lower part	28		
Mercedes-Benz automobiles	11	Overhead control panel	29		
Maintenance	12				
Roadside Assistance	12				
Change of address or ownership	13	Getting started	31	Safety and Security	57
Operating your vehicle outside		Unlocking	32	Occupant safety	58
the USA or Canada	13	Remote control with folding key	32	Airbags	59
Where to find it	15	Adjusting	35	Seat belts	64
Symbols	16	Seats	35	Children in the vehicle	67
Operating safety	17	Steering wheel	40	Blocking of rear door	
Proper use of the vehicle	17	Mirrors	41	window operation	74
Problems with your vehicle	18	Driving	43	Panic alarm	75
Reporting safety defects	19	Fastening the seat belts	43	Activating	75
Reporting safety defects	19	Starting the engine	47	Deactivating	75
Vehicle data recording	20	Switching on headlamps	50	Driving safety systems	76
Information regarding		Turn signals and high beam	50	ABS	76
electronic		Windshield wipers	51	BAS	78
recording devices	20	Rear window wiper / washer	52	4-ETS	79
		Problems while driving	53	EBP	80
				ESP	80

Contents

Anti-theft systems.....	83	Seats	95	Automatic transmission.....	120
Immobilizer.....	83	Removing and installing		One-touch gearshifting	121
Anti-theft alarm system	83	front seat head restraints.....	95	Gear ranges	122
Tow-away alarm,		Rear seat head restraints	96	Gear selector lever position	123
glass breakage sensor.....	84	Heated seats*	98	Driving tips.....	124
		Rear seats	99	Towing a trailer	125
		Third row seats*	102	Emergency operation	
Controls in detail	87	Memory function*	105	(Limp Home Mode)	126
Locking and unlocking	88	Storing positions into memory	106	Transmission control -	
Remote control with folding key.....	88	Recalling positions		LOW RANGE mode	127
Opening the doors		from memory	106	Switching on LOW RANGE mode..	127
from the inside	90	Storing exterior rear		Switching off LOW RANGE mode .	127
Opening the liftgate.....	91	view mirror parking position.....	106	Good visibility	128
Closing the liftgate	92	Lighting.....	107	Rear view mirrors.....	128
Automatic central locking	93	Combination switch	107	Electrically folding	
Locking and unlocking		Fog lamps	111	exterior rear view mirrors.....	130
from the inside	94	Hazard warning flasher	113	Windshield wipers	131
		Interior lighting.....	114	Headlamp cleaning system*	133
		Instrument cluster	117	Rear window wiper.....	133
		Instrument cluster illumination	117	Sun visors	134
		Coolant temperature gauge	118	Rear window defroster	135
		Display in the speedometer	118		
		Resetting trip odometer	119		
		Tachometer	119		
		Outside temperature indicator	119		
		Setting the clock	119		

Contents

Automatic climate control	136	Driving systems	153	Operation	195
Automatic mode.....	139	Cruise control	153	The first 1000 miles (1500 km).....	196
Adjusting air volume and air distribution manually.....	139	Parktronic* system (Parking assist)	156	Driving instructions	197
Defrosting	140	Loading.....	160	Drive sensibly – save fuel	197
Air recirculation mode.....	140	Loading instructions	160	Drinking and driving.....	197
Air conditioning.....	141	Partition net*	162	Pedals.....	197
Residual heat and ventilation	142	Cargo compartment cover blind* .	164	Power assistance.....	197
Rear passenger compartment ventilation and rear automatic climate control	143	Cargo floor plates	165	Brakes	198
Front and rear air vents.....	144	Roof rack*	166	Driving off	199
Power windows.....	146	Useful features	167	Parking	200
Opening and closing the side windows	146	Storage compartments	167	Tires.....	200
Synchronizing power windows	148	Cup holders	169	Hydroplaning	201
Rear quarter windows*	148	Armrest in rear seat bench	170	Tire traction	201
Power tilt /sliding sunroof*	150	Ashtrays and cigarette lighter.....	171	Tire speed rating.....	202
Opening and closing the power tilt / sliding sunroof.....	150	Electrical outlet.....	173	Winter driving instructions.....	202
Synchronizing the power tilt / sliding sunroof.....	152	Telephone*	173	Standing water	204
		Tele Aid*	174	Off-road driving.....	204
		Garage door opener	183	Trailer towing.....	211
		Trip computer*	189	Passenger compartment.....	215
				Driving abroad	216
				Control and operation of radio transmitters.....	216
				Catalytic converter	217
				Emission control	217
				Coolant temperature	218

Contents

At the gas station.....	219	Maintenance.....	237	Unlocking / locking in an emergency.....	268
Refueling.....	219	Clearing the maintenance service indicator	237	Unlocking the vehicle.....	268
Check regularly and before a long trip.....	221	Maintenance service term exceeded	238	Locking the vehicle	269
Engine compartment.....	222	Calling up the maintenance service indicator	238	Fuel filler flap	269
Hood	222	Resetting the maintenance service indicator	238	Manually unlocking the transmission gear selector lever ..	270
Engine oil.....	223	Vehicle care.....	240	Opening / closing in an emergency.....	271
Transmission fluid level	227	Cleaning and care of the vehicle ..	240	Power tilt / sliding sunroof*	271
Coolant level	227			Replacing key batteries	272
Battery	228			Remote control	273
Windshield / rear window washer system and headlamp cleaning system*	230	Practical hints	247	Replacing bulbs	274
Tires and wheels.....	231	What to do if	248	Bulbs.....	274
Important guidelines	231	Lamps in instrument cluster	248	Replacing bulbs for front lamps ...	276
Life of tire.....	232	Additional indicators in the speedometer display.....	263	Replacing bulbs for rear lamps	279
Direction of rotation	232	Where will I find ...?	264	Adjusting headlamp aim	282
Checking tire inflation pressure ...	232	First aid kit	264	Replacing wiper blades.....	283
Rotating wheels.....	233	Vehicle tool kit	264	Removing	283
Winter driving.....	235	Spare wheel (space-saver tire).....	266	Installing	283
Winter tires.....	235			Flat tire	284
Block heater (Canada only)	236			Mounting the spare wheel	284
Snow chains	236				

Contents

Battery.....	288		
Disconnecting the battery.....	289		
Removing the battery.....	289		
Charging and reinstalling the battery.....	289		
Reconnecting the battery.....	289		
Jump starting.....	291		
Towing the vehicle.....	293		
Front towing eye.....	295		
Rear towing eye.....	295		
Stranded vehicle.....	296		
Fuses.....	297		
Aids for changing fuses.....	298		
Main fuse box.....	298		
Fuse box in front passenger footwell.....	299		
		Technical data	301
		Parts service.....	302
		Warranty coverage.....	303
		Loss of Service and Warranty Information Booklet.....	303
		Identification labels.....	304
		Layout of poly-V-belt drive.....	305
		Engine.....	306
		Rims and tires.....	307
		Rims and tires.....	307
		Spare wheel.....	308
		Electrical system.....	309
		Main Dimensions.....	310
		Weights.....	311
		Fuels, coolants, lubricants, etc.....	312
		Capacities.....	312
		Engine oils.....	314
		Engine oil additives.....	314
		Air conditioning refrigerant.....	314
		Brake fluid.....	314
		Premium unleaded gasoline.....	315
		Fuel requirements.....	315
		Gasoline additives.....	315
		Coolants.....	316
		Windshield washer and headlamp cleaning* system.....	319
		Windshield and headlamp washer fluid mixing ratio.....	319
		Consumer information.....	320
		Uniform tire quality grading.....	320
		Technical terms	323
		Index	329



▼ **Product information**

Please observe the following in your own best interest:

We recommend using genuine Mercedes-Benz parts as well as conversion parts and accessories explicitly approved by us for your vehicle model.

We have tested these parts to determine their reliability, safety and special suitability for Mercedes-Benz vehicles.

We are unable to make an assessment for other products and therefore cannot be held responsible for them, even if in individual cases an official approval or authorization by governmental or other agencies should exist. Use of such parts and accessories could adversely affect the safety, performance or reliability of your vehicle. Please do not use them.

Genuine Mercedes-Benz parts as well as conversion parts and accessories approved by us are available at your authorized Mercedes-Benz Light Truck Center where you will receive comprehensive information, also on permissible technical modifications, and where proper installation will be performed.

Introduction

Operator's Manual

This Operator's Manual contains a great deal of useful information. We urge you to read it carefully and familiarize yourself with the vehicle before driving.

For your own safety and longer service life of the vehicle, we urge you to follow the instructions and warnings contained in this manual. Ignoring them could result in damage to the vehicle or personal injury to you or others. Vehicle damage caused by failure to follow instructions is not covered by the Mercedes-Benz Limited Warranty.

Your vehicle may have some or all of the equipment described in this manual. Therefore, you may find explanations for optional equipment not installed in your vehicle. If you have any questions about the operation of any equipment, your authorized Mercedes-Benz Light Truck Center will be glad to demonstrate the proper procedures.

We continuously strive to improve our product, and ask for your understanding that we reserve the right to make changes in design and equipment. Therefore, information, illustrations and descriptions in this Operator's Manual might differ from your vehicle.

Optional equipment is also described in this manual, including operating instructions wherever necessary. Since they are special-order items, the descriptions and illustrations herein may vary slightly from the actual equipment of your vehicle.

If there are any equipment details that are not shown or described in this Operator's Manual, your authorized Mercedes-Benz Light Truck Center will be glad to inform you of correct care and operating procedures.

The Operator's Manual and Maintenance Booklet are important documents and should be kept with the vehicle.

Service and warranty information

The Service and Warranty Information Booklet contains detailed information about the warranties covering your Mercedes-Benz, including:

- New Light Truck Limited Warranty,
- Emission System Warranty,
- Emission Performance Warranty,
- California, Maine, Massachusetts, and Vermont Emission Control System Warranty (California, Maine, Massachusetts, and Vermont only),
- State Warranty Enforcement Laws (Lemon Laws).

Important notice for California retail buyers and lessees of Mercedes-Benz automobiles

Under California law you may be entitled to a replacement of your vehicle or a refund of the purchase price or lease price, if Mercedes-Benz USA, LLC and / or its authorized repair or service facilities fail to fix one or more substantial defects or malfunctions in the vehicle that are covered by its express warranty after a reasonable number of repair attempts. During the period of 18 months from original delivery of the vehicle or the accumulation of 18 000 miles (approx. 29 000 km) on the odometer of the vehicle, whichever occurs first, a reasonable number of repair attempts is presumed for a retail buyer or lessee if one or more of the following occurs:

- (1) the same substantial defect or malfunction results in a condition that is likely to cause death or serious bodily injury if the vehicle is driven, that defect or malfunction has been subject to repair two or more times, and you have directly notified Mercedes-Benz USA, LLC in writing of the need for its repair,
- (2) the same substantial defect or malfunction of a less serious nature than category (1) has been subject to repair four or more times and you have directly notified us in writing of the need for its repair, or
- (3) the vehicle is out of service by reason of repair of the same or different substantial defects or malfunctions for a cumulative total of more than 30 calendar days.

Written notification should be sent to us, not a dealer, at Mercedes-Benz USA, LLC, Customer Assistance Center, One Mercedes Drive, Montvale, NJ 07645-0350.

Introduction

Operator's Manual

Maintenance

The Maintenance Booklet describes all the necessary maintenance work which should be performed at regular intervals.

Always have the Maintenance Booklet with you when you take the vehicle to your authorized Mercedes-Benz Light Truck Center for service. The service advisor will record each service in the booklet for you.

Roadside Assistance

The Mercedes-Benz Roadside Assistance Program provides factory-trained technical help in the event of a breakdown. Calls to the toll-free Roadside Assistance number

1-800-FOR-MERCEdes (in the USA)
1-800-387-0100 (in Canada)

will be answered by Mercedes-Benz Customer Assistance Representatives 24 hours a day, 365 days a year.

Roadside Assistance will be provided in accordance with standard program guidelines which include providing service to the vehicle up to a reasonable distance from a paved roadway. We will make every effort to assist in a breakdown situation, however, the accessibility of your vehicle will be determined by our authorized Mercedes-Benz Light Truck Center technician or the tow service provider on a case-by-case basis and may be a factor in our ability to respond.

Additional charges may be applicable for a breakdown location determined not to be a reasonably accessible roadside location as determined by our authorized technician and tow service provider.

For additional information refer to the Mercedes-Benz Roadside Assistance Program Brochure in your glove box.

Change of address or ownership

If you change your address, be sure to send in the “Change of Address Notice” found in the Service and Warranty Information Booklet, or simply call the Mercedes-Benz Customer Assistance Center (in the USA) at 1-800-FOR-MERCEdes, or Customer Service (in Canada) at 1-800-387-0100. It is in your own interest that we can contact you should the need arise.

If you sell your Mercedes, please leave all literature with the vehicle to make it available to the next operator.

If you bought this vehicle used, be sure to send in the “Notice of Purchase of Used Truck” found in the Service and Warranty Information Booklet, or call the Mercedes-Benz Customer Assistance Center (in the USA) at 1-800-FOR-MERCEdes, or Customer Service (in Canada) at 1-800-387-0100.

Operating your vehicle outside the USA or Canada

If you plan to operate your vehicle in foreign countries, please be aware that:

- service facilities or replacement parts may not be readily available,
- unleaded gasoline for vehicles with catalytic converters may not be available; the use of leaded fuels will damage the catalyts,
- gasoline may have a considerably lower octane rating, and improper fuel can cause engine damage.

Introduction

Operator's Manual

Warning!



This Sport Utility Vehicle is designed for both on-road and off-road use. It can go places and perform tasks for which conventional 2-wheel drive passenger cars are not intended. This vehicle will handle and maneuver differently from conventional passenger cars in driving conditions which may occur on streets, highways and off-road use.

This vehicle has a higher ground clearance and a higher center of gravity than many passenger cars. As with other vehicles of this type, if you make sharp turns at excessive speeds or abrupt maneuvers, the vehicle may roll over or may go out of control and crash. Utility vehicles have a significantly higher rollover rate than other types of vehicles. Failure to operate this vehicle safely may result in an accident, rollover of the vehicle, and severe or fatal injury.

Before you start to drive this vehicle, read the Operator's Manual. Take time to become familiar with the driving characteristics of this vehicle. Be sure you are familiar with all vehicle controls. Learn how your vehicle handles on different road surfaces. Do not attempt sharp turns at excessive speeds or abrupt maneuvers or other unsafe driving actions that can cause loss of vehicle control. When driving off-road or working the vehicle hard, do not overload it. And, always wear your seat belts at all times. In a rollover crash, an unbelted person is significantly more likely to die than a person wearing a seat belt.

▼ Where to find it

This Operator's Manual is designed to provide comprehensive support information for you, the vehicle operator. Each section has its own reference color so you can find information quickly.

At a glance

Here you will find an overview of all the controls that can be operated from the driver's seat.

Getting started

Here you will find all the information you need for your first drive. You should read this section first if this is your first Mercedes-Benz vehicle or if you are renting or borrowing this vehicle.

Safety and Security

Here you will find descriptions of the safety features of your vehicle.

Controls in detail

Here you will find detailed information about the equipment installed on your vehicle. This section expands on the "Getting started" section and also describes technical innovations. If you are already familiar with the basic functions of your vehicle, this section will be of particular interest to you.

Operation

Here you will find all the information you need for the proper operation of your vehicle.

Practical hints

This section provides fast assistance for dealing with problems you may encounter.

Technical data

All important technical data for your vehicle can be found in this section.

Indexes

The glossary provides explanations of the most important technical terms.

The table of contents and the index are designed to help you find information quickly and easily.

The following publications are part of your vehicle documentation:

- this Operator's Manual
- the Maintenance Booklet

Separate operating instructions will be provided as required depending on the equipment options installed in your vehicle.

Introduction

Symbols

The following symbols are found in this Operator's Manual:

- * Optional equipment is identified with an asterisk. Since standard equipment varies between models, the descriptions and illustrations in this manual may differ slightly from the actual equipment of your vehicle.

Warning!



Warning notices draw your attention to hazards that may endanger your health or life, or the health or life of others.



Highlights hazards that may result in damage to your vehicle.



Helpful hints or further information you may find useful.

- ▶ This symbol points to instructions for you to follow.
- ▶ A number of these symbols appearing in succession indicates a multiple-step procedure.
- ▷ Page This symbol tells you where to look for further information on a topic.
- ▷▷ This continuation symbol marks an interrupted procedure which will be continued on the next page.
- > In the glossary of technical terms, this symbol is used to indicate cross-references to term definitions.
- Display Words appearing in the multi-function display are printed in the type shown here.

▼ Operating safety

Warning!



Work improperly carried out on electronic components and associated software could cause them to cease functioning. Because the vehicle's electronic components are interconnected, any modifications made may produce an undesired effect on other systems. Electronic malfunctions could seriously impair the operating safety of your vehicle.

See an authorized Mercedes-Benz Light Truck Center for repairs or modifications to electronic components.

Other improper work or modifications on the vehicle could also have a negative impact on the operating safety of the vehicle.

Some safety systems only function while the engine is running. You should therefore never turn off the engine while driving.

Warning!



Heavy blows against the vehicle underbody or tires / wheels, for example when running over an obstacle, road debris or a pothole, may cause serious damage and impair the operating safety of your vehicle. If you feel a sudden significant vibration or ride disturbance, or you suspect that damage to your vehicle has occurred, you should turn on your hazard warning flashers, carefully slow down, and drive with caution to an area which is a safe distance from the road.

Inspect the vehicle underbody and tires / wheels for possible damage. If the vehicle appears unsafe, have it towed to the nearest authorized Mercedes-Benz Light Truck Center or other qualified maintenance or repair facility for further inspection or repairs.

Proper use of the vehicle

Proper use of the vehicle requires that you are familiar with the following information and rules:

- the safety precautions in this manual
- the “Technical data” section in this manual
- traffic rules and regulations
- motor vehicle laws and safety standards

Warning!



Various warning labels are attached to your vehicle. These warning labels are intended to make you and others aware of various risks. You should not remove any of these warning labels unless explicitly instructed to do so by information on the label itself. Removal of any of these labels may cause you and others to be unaware of certain risks which may result in an accident and / or personal injury.

Introduction

Problems with your vehicle

If you should experience a problem with your vehicle, particularly one that you believe may affect its safe operation, we urge you to immediately contact an authorized Mercedes-Benz Light Truck Center to have the problem diagnosed and corrected if required. If the matter is not handled to your satisfaction, please discuss the problem with the Mercedes-Benz Light Truck Center management, or if necessary contact us at one of the following addresses:

In the USA:

Customer Assistance Center
Mercedes-Benz USA, LLC
One Mercedes Drive
Montvale, NJ 07645-0350

In Canada:

Customer Relations Department
Mercedes-Benz Canada, Inc.
98 Vanderhoof Avenue
Toronto, Ontario, M4G 4C9

▼ **Reporting safety defects**

For the USA only:

The following text is published as required of manufacturers under Title 49, Code of U.S. Federal Regulations, Part 575 pursuant to the “National Traffic and Motor Vehicle Safety Act of 1966”.

Reporting safety defects

If you believe that your vehicle has a defect which could cause a crash or could cause injury or death, you should immediately inform the National Highway Traffic Safety Administration (NHTSA) in addition to notifying Mercedes-Benz USA, LLC.

If NHTSA receives similar complaints, it may open an investigation, and if it finds that a safety defect exists in a group of vehicles, it may order a recall and remedy campaign. However, NHTSA cannot become involved in individual problems between you, your dealer, or Mercedes-Benz USA, LLC.

To contact NHTSA, you may either call the Auto Safety Hotline toll-free at 1-888-327-4236 (or 366-0123 in Washington, D.C. area) or write to: NHTSA, U.S. Department of Transportation, Washington, D.C. 20590. You can also obtain other information about motor vehicle safety from the Hotline.

▼ Vehicle data recording**Information regarding electronic recording devices**

(Including notice pursuant to California Code § 9951)

Please note that your vehicle is equipped with devices that can record vehicle systems data and, if equipped with the Tele Aid system, may transmit some data in certain accidents.

This information helps, for example, to diagnose vehicle systems after a collision and to continuously improve vehicle safety. DaimlerChrysler may access the information and share it with others

- for safety research or vehicle diagnosis purposes
- with the consent of the vehicle owner or lessee
- in response to an official request by law enforcement or other government agency
- for use in dispute resolution involving DaimlerChrysler, its affiliates or sales / service organization and / or
- as otherwise required or permitted by law.

Please check the Tele Aid subscription service agreement for details regarding the information that may be recorded or transmitted via that system.

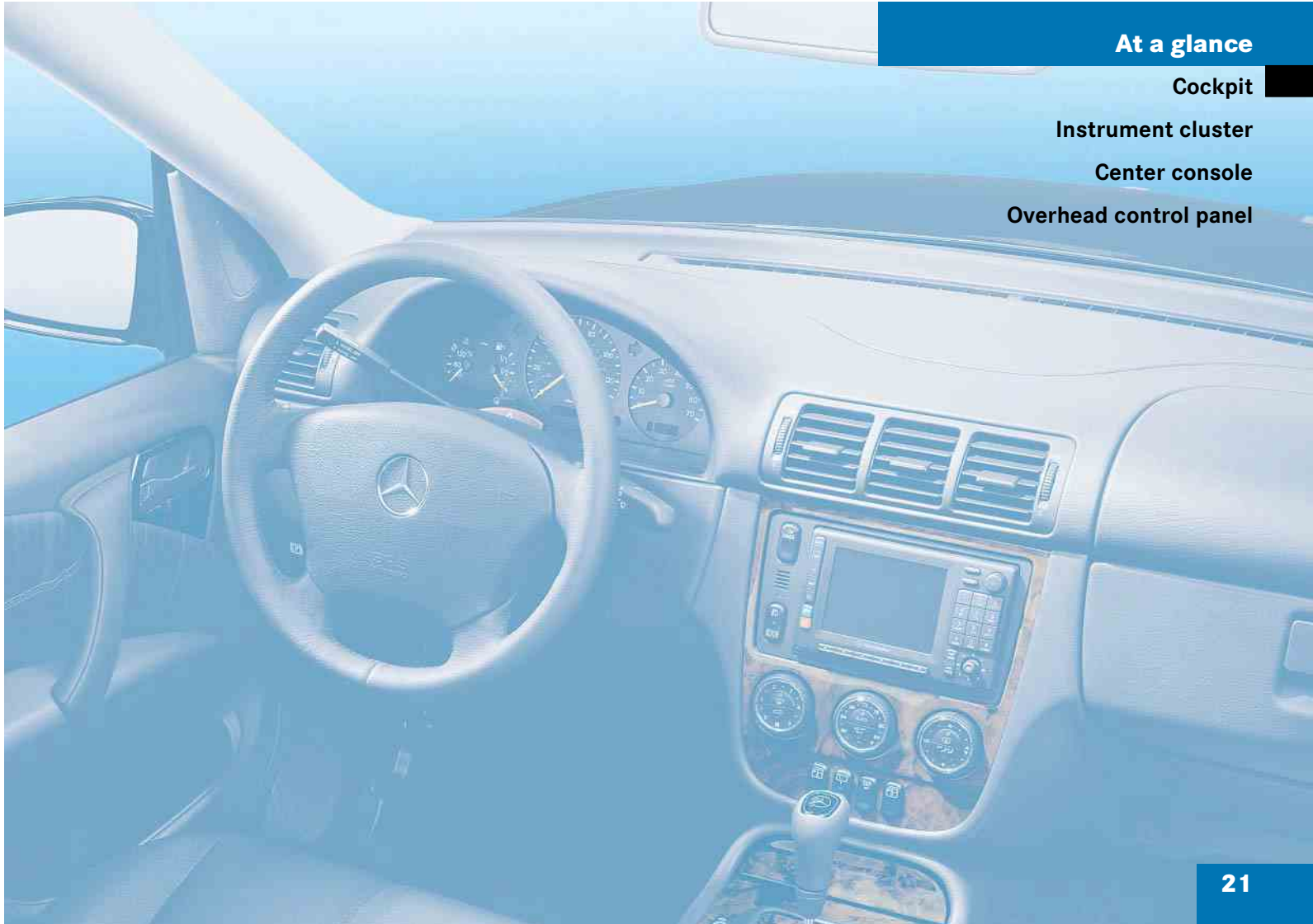

At a glance

Cockpit

Instrument cluster

Center console

Overhead control panel

At a glance

Cockpit

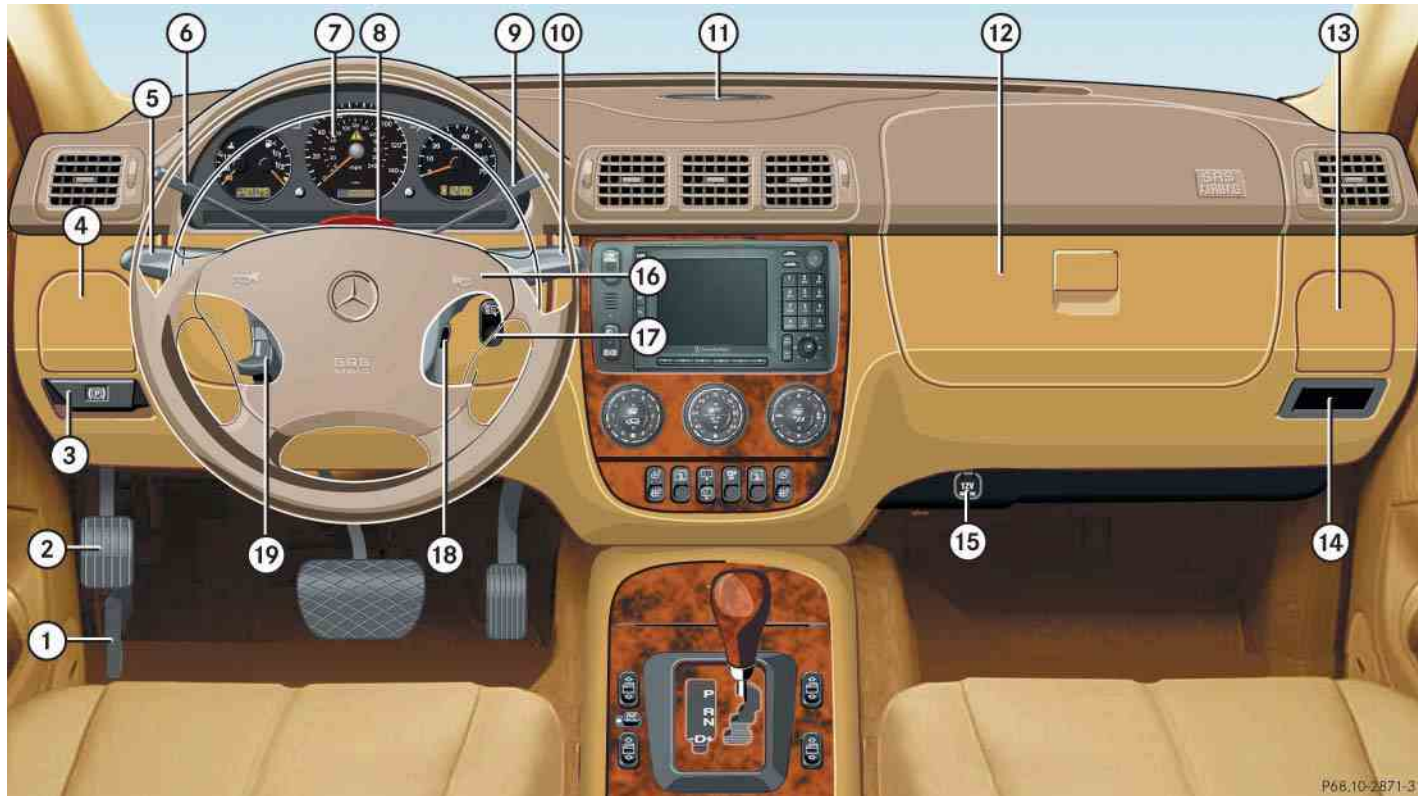

Item	Page
① Hood lock release	222
② Parking brake pedal	54
③ Parking brake release	54
④ Left cup holder	169
⑤ Combination switch	50
• Exterior lights	
• High beam	
• Turn signals	
⑥ Cruise control lever	153
⑦ Instrument cluster	117
⑧ Hazard warning flasher switch	113
⑨ Lever for voice control system*, see separate operating instructions	

Item	Page
⑩ Windshield wiper / washer switch	51
⑪ Front Parktronic* warning indicator	158
⑫ Glove box	167
⑬ Right cup holder	169
⑭ Storage compartment	
⑮ Electrical outlet	173
⑯ Horn	
⑰ Headlamp washer button*	133
⑱ Steering lock with ignition	33
⑲ Steering wheel lever	40

At a glance



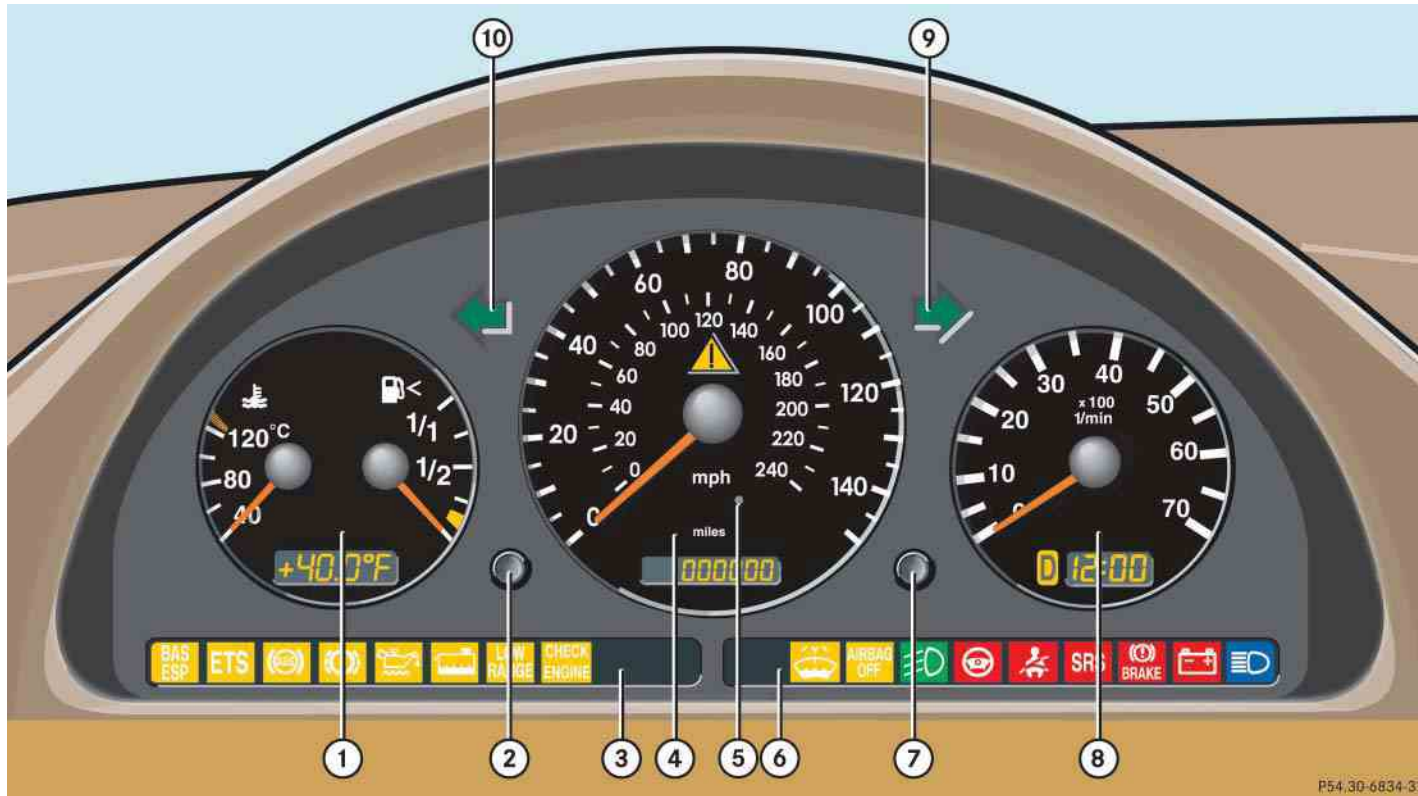



Instrument cluster







At a glance

Instrument cluster



	Item	Page
①	Gauge for	
	Coolant temperature	118
	Outside temperature	119
	Fuel reserve warning lamp	259
②	Knob for	
	Activating instrument cluster	117
	Adjusting intensity of instrument lamps	117
	Main odometer	118
	Trip odometer readout / reset	119
	Activating Maintenance System indicator	237







	Item	Page
③	Left indicator lamps with:	
	 Brake Assist System (BAS) / Electronic Stability Program (ESP) malfunction warning lamp	252
	 Electronic Traction System (4-ETS) malfunction indicator lamp	259
	 Antilock Brake System (ABS) malfunction indicator lamp	248
	 Brake pad wear indicator lamp	261
	 Low engine oil level warning lamp	260
	 Low engine coolant level warning lamp	256



	Item	Page
	 Low range indicator lamp	259
	 Engine malfunction indicator lamp, USA only	254
	 Engine malfunction indicator lamp, Canada only	254
④	Speedometer with:	
	 4-ETS (Electronic Traction System) / Electronic Stability Program (ESP) warning lamp	258
	Trip / main odometer	118
	Display for Maintenance System	237
	Engine oil level indicator	224

At a glance

Instrument cluster

	Item	Page
⑤	Photo sensor (adjusts the brightness of the digital displays located in 1, 4 and 8)	
⑥	Right indicator lamps with:	
	 Low windshield/headlamp washer system fluid level warning lamp	260
	 Front passenger airbag switched off	249
	 Front fog lamp switched on	112

	Item	Page
	 Steering wheel adjustment not locked	260
	 Seat belt telltale	260
	 Supplemental Restraint System (SRS) indicator lamp	262
	 Brake warning lamp	250
	 Charge indicator lamp	261
	 High beam headlamp indicator	50

	Item	Page
⑦	Knob for setting clock	119
⑧	Tachometer with:	
	Display for Selector lever position	122
	Clock	119
⑨	 Right turn signal indicator lamp	
⑩	 Left turn signal indicator lamp	

At a glance

Center console

▼ Center console

Upper part

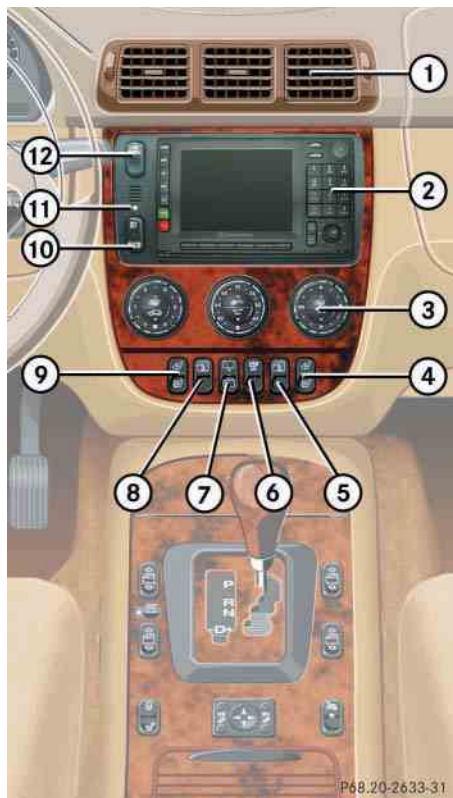

Item	Page
① Air vents, automatic climate control	144
② MCS, see separate operating instructions	
③ Automatic climate control	136
Rear window defroster switch	135
④ Seat heater switch*, passenger side	98
⑤ Rear quarter window switch*, right	148
⑥ ESP control switch	80

Item	Page
⑦ Rear window wiper / washer switch	52
⑧ Rear quarter window switch*, left	148
⑨ Seat heater switch*, driver's side	98
⑩ Front and rear fog lamp switch	111
⑪ Indicator lamp for antitheft alarm system	83
⑫ Transmission control switch, LOW RANGE mode	127

At a glance

Center console

Lower part

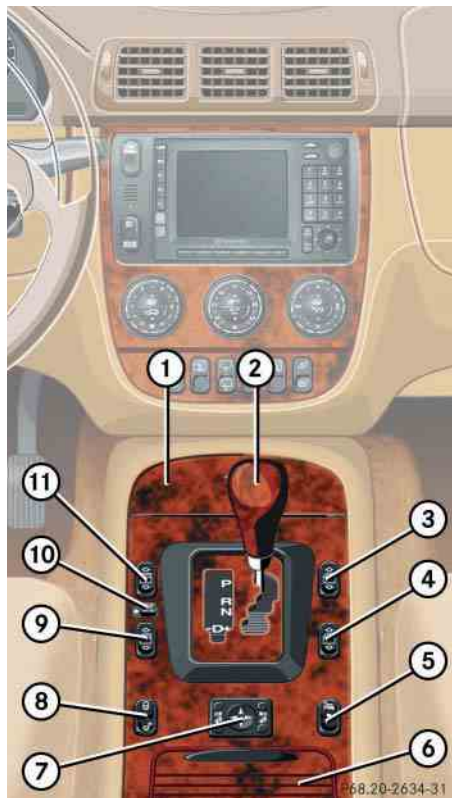

Item	Page
① Ashtray with cigarette lighter	171
② Gear selector lever for automatic transmission	47
③ Power window switch, right front door	146
④ Power window switch, right rear door	146
⑤ Parktronic system* deactivation switch	159
⑥ Storage compartment with cup holder	169

Item	Page
⑦ Exterior rear view mirror adjustment switch	41
Exterior rear view mirror electrically folding*	130
⑧ Central locking switch	93
⑨ Power window switch, left rear door	146
⑩ Switch for rear door window override	74
⑪ Power window switch, left front door	146

At a glance

Overhead control panel

▼ Overhead control panel

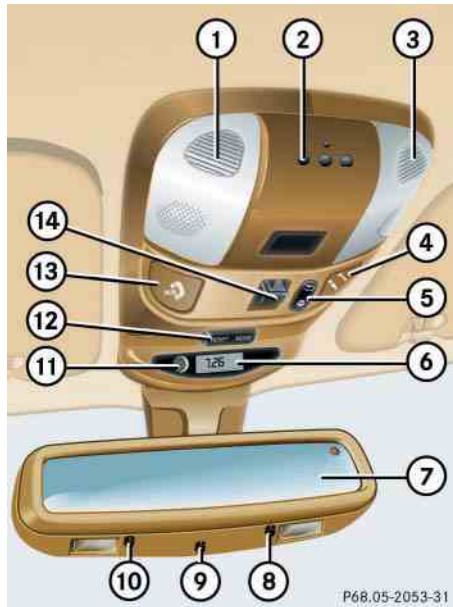

Item	Page
① Front left interior lighting	114
② Signal transmitter buttons for garage door opener	183
③ Front right interior lighting	114
④ Roadside Assistance button	178
Information button	180
⑤ Interior lighting control	114
⑥ Trip computer* display	189
⑦ Rear view mirror	128

Item	Page
⑧ Right reading lamp on/off	115
⑨ Automatic antiglare function* on/off	128
⑩ Left reading lamp on/off	115
⑪ Glass breakage sensor	84
⑫ Trip computer* control	189
Tow-away alarm switch	85
⑬ Tele Aid* (emergency call system) button	174
⑭ Tilt/sliding sunroof* switch	150



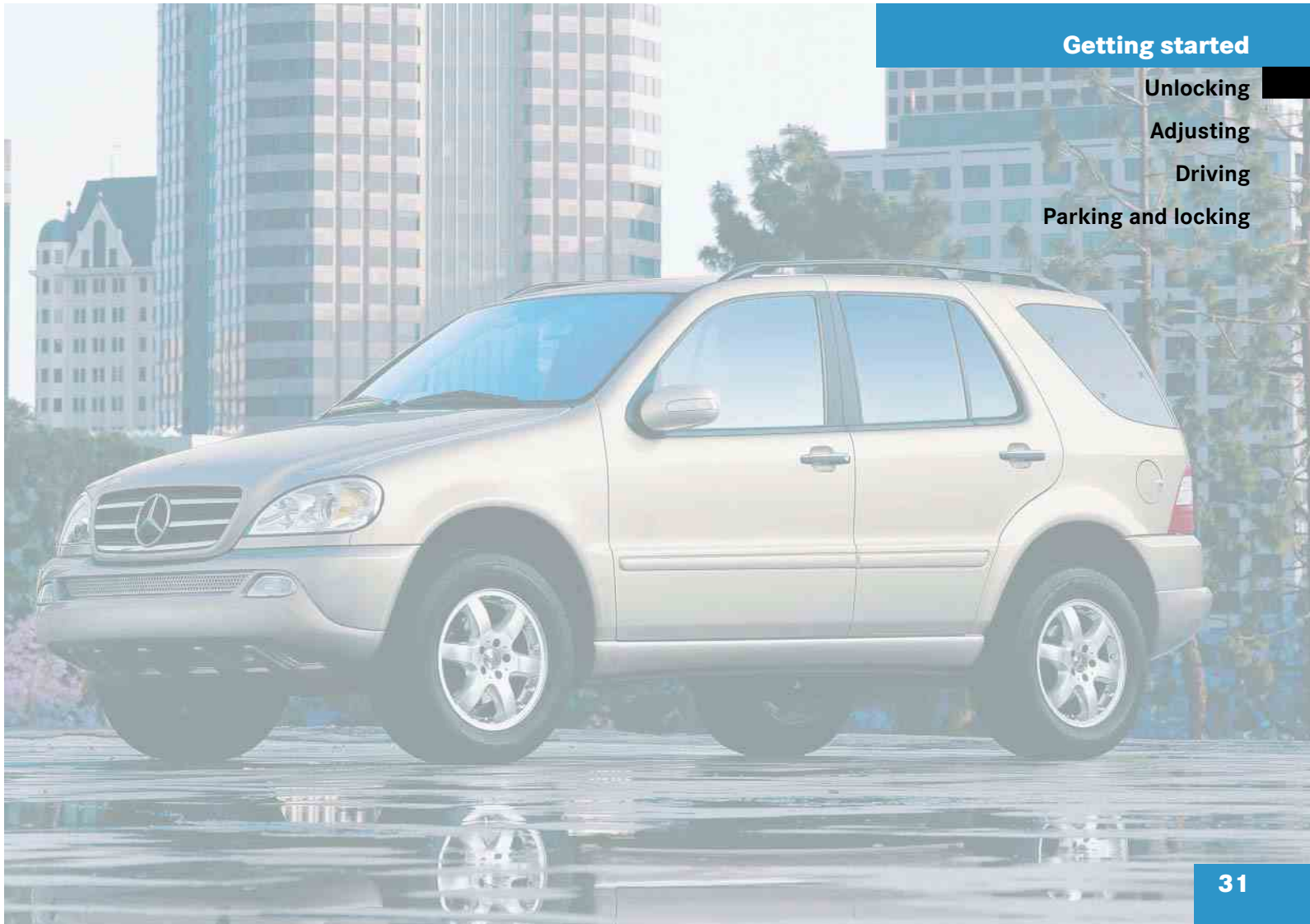

Getting started

Unlocking

Adjusting

Driving

Parking and locking

Getting started

Unlocking



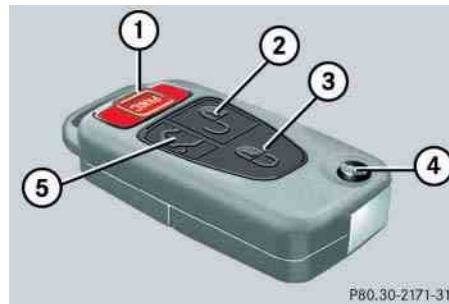

The “Getting started” section provides an overview of the vehicle’s most basic functions. First-time Mercedes-Benz owners should pay special attention to the information given here.

If you are already familiar with the basic functions described here, the “Controls in detail” section will provide you with further information. The corresponding page references are located at the end of each segment.

Remote control with folding key



Remote control with folding key

- ① **PANIC** Panic button (▷ page 75)
- ②  Unlock button
- ③  Lock button
- ④  Release button for key
- ⑤  Unlock button for liftgate

- ▶ Press unlock button  on the remote control.

All turn signal lamps flash once. The locking knobs in the doors move up.

- ▶ Press release button ④ on the remote control.

The key folds out.

- ▶ Get in the vehicle and insert the key in the steering lock (▷ page 33).

For more information, see “Locking and unlocking” (▷ page 88).

Steering lock positions

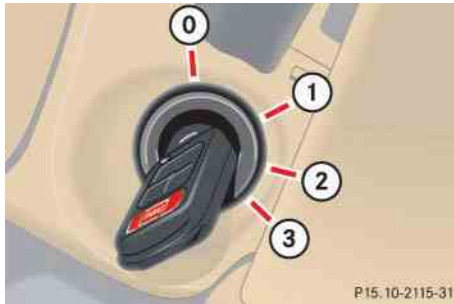

Steering lock

- 0** For removing key
The steering is locked when the key is removed from the steering lock. If necessary, move steering wheel slightly to allow the locking mechanism to engage.
- 1** Unlocking steering
Power supply to some electrical consumers, such as seat adjustment.

- 2** Ignition (power supply for all electrical consumers) and driving position
All lamps in the instrument cluster come on. If a lamp in the instrument cluster fails to come on when the ignition is switched on, have it checked and replaced if necessary. If a lamp in the instrument cluster remains on after starting the engine or comes on while driving, refer to “Lamps in instrument cluster” (▷ page 248).
- 3** Starting position

Warning!



When leaving the vehicle, always remove the key from the steering lock and lock the vehicle. Do not leave children unattended in the vehicle, or with access to an unlocked vehicle. Unsupervised use of vehicle equipment may cause an accident and / or serious personal injury.

i

When you switch on the ignition, the indicator and warning lamps in the instrument cluster come on. This indicates that the respective systems are operational. They should go out when the engine is running.

Getting started

Unlocking



The key can only be withdrawn in position **0**.

If necessary, move steering wheel slightly to allow the key to be turned clockwise to position **1**.

A warning sounds when the driver's door is opened and the key is in steering lock position **0** or **1**.

The key can only be removed from the steering lock with the gear selector lever in position **P**.



To prevent accelerated battery discharge and a possible dead battery, always remove the key from the steering lock when the engine is not in operation.

For more information, see "Remote control with folding key" (> page 88).

▼ Adjusting

Warning!

All seat, head restraint, steering wheel, and rear view mirror adjustments, as well as fastening of seat belts, must be done before the vehicle is put into motion.

Seats

The seats can be adjusted either manually or electrically, depending on the vehicle's equipment.

Warning!

Do not adjust the driver's seat while driving. Adjusting the seat while driving could cause the driver to lose control of the vehicle.

Never ride in a moving vehicle with the seat back in an excessively reclined position as this can be dangerous. You could slide under the seat belt in a collision. If you slide under it, the belt would apply force at the abdomen or neck.

That could cause serious or fatal injuries. The seat backrest and seat belts provide the best restraint when the wearer is in a nearly upright position and belts are properly positioned on the body. Your seat must be adjusted so that you can correctly fasten your seat belt (▷ page 43).

Never place hands under the seat or near any moving parts while a seat is being adjusted.

Warning!

When leaving the vehicle, always remove the key from the steering lock and lock your vehicle.

Even with the key removed from the steering lock, the power seats* can also be operated when the respective door is open. Therefore, do not leave children unattended in the vehicle, or with access to an unlocked vehicle. Unsupervised use of vehicle equipment may cause an accident and / or serious personal injury.

Warning!

Children 12 years old and under must never ride in the front seat, except in a Mercedes-Benz authorized BabySmart™¹ compatible child seat, which operates with the BabySmart™ system installed in the vehicle to deactivate the passenger front airbag when it is properly installed. Otherwise they will be struck by the airbag when it inflates in a crash. If this happens, serious or fatal injury will result.

According to accident statistics, children are safer when properly restrained in the rear seating positions than in the front seating positions. Infants and small children must ride in back seats and be seated in an appropriate infant or child restraint system, which is properly secured with the vehicle's seat belt and top tether strap, or secured via lower anchors and top tether strap, fully in accordance with the child seat manufacturer's instructions. ▷▷

¹ BabySmart™ is a trademark of Siemens Automotive Corp.

Getting started

Adjusting

- ▷▷ A child's risk of serious or fatal injuries is significantly increased if the child restraints are not properly secured in the vehicle and the child is not properly secured in the child restraint.

Manual seat adjustment



- ① Seat fore and aft adjustment
- ② Backrest tilt
- ③ Seat height

Seat fore and aft adjustment

- ▶ Lift handle ①.
- ▶ Slide seat to the desired position.
- ▶ Allow handle ① to reengage.
- ▶ Check for proper seat engagement before driving.

Adjust seat to a comfortable seating position that still allows you to reach the accelerator / brake pedal safely. The position should be as far rearward as possible, consistent with ability to properly operate controls.



When moving the seat, make sure there are no items in the footwell or behind the seats. Otherwise you could damage the seats.

Seat backrest tilt

- ▶ Switch on ignition (▷ page 33).
- ▶ Turn handwheel ② forward or backward until your hands are slightly angled when holding the steering wheel.

Seat height

- ▶ Switch on ignition (▷ page 33).
- ▶ Lift handle ③.
- ▶ Use your body weight to push the seat downwards.
- ▶ Lift your weight off the seat to obtain a higher seat position.
- ▶ Release lever ③.

Head restraint height

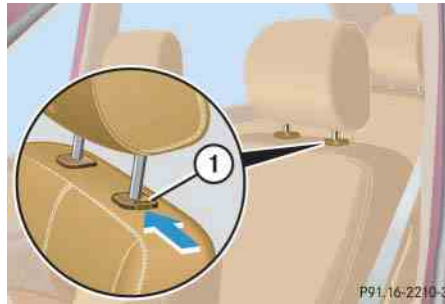

- ① Release button

Raising:

- ▶ Manually adjust the height of the head restraint by pulling it upward.

Lowering:

- ▶ To lower the head restraint, push release button ① and press down on the head restraint.

Warning!



For your protection, drive only with properly positioned head restraints.

Adjust head restraint so that the center of the head restraint supports the back of the head at eye level. This will reduce the potential for injury to the head and neck in the event of an accident or similar situation.

Do not drive the vehicle without the seat head restraints. Head restraints are intended to help reduce injuries during an accident.



Adjust the head restraint in such a way that it is as close to the head as possible.

Getting started

Adjusting

Head restraint tilt



Manually adjust the angle of the head restraint.

- ▶ Push or pull on the upper edge of the head restraint cushion.

For more information, see “Seats” (▷ page 95).

Power seat* adjustment

The seat adjustment switch is located on the entry side of each front seat base.

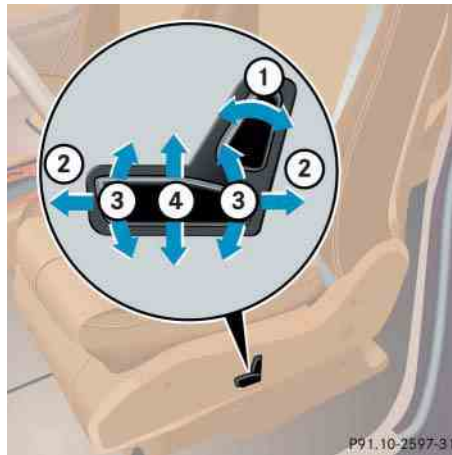

- ① Backrest tilt
- ② Seat fore and aft adjustment
- ③ Seat cushion tilt
- ④ Seat height

- ▶ Switch on ignition (▷ page 33).
or
- ▶ Open the respective door.

Seat fore and aft adjustment

- ▶ Press the switch forward or backward in the direction of arrow ①.

Adjust seat to a comfortable seating position that still allows you to reach the accelerator / brake pedal safely. The position should be as far to the rear as possible, consistent with ability to properly operate controls.



When moving the seat, make sure there are no items in the footwell or behind the seat. Otherwise you could damage the seat.

The memory function* (▷ page 105) lets you store the setting for the seat positions together with the setting for the exterior rear view mirrors.

Seat cushion tilt

- ▶ Press the switch up or down in the direction of arrow ③ until your upper legs are lightly supported.

Seat backrest tilt

- ▶ Press the switch forward or backward in the direction of arrow ① until your arms are slightly angled when holding the steering wheel.

Seat height

- ▶ Press the switch up or down in the direction of arrow ④.

Head restraint height

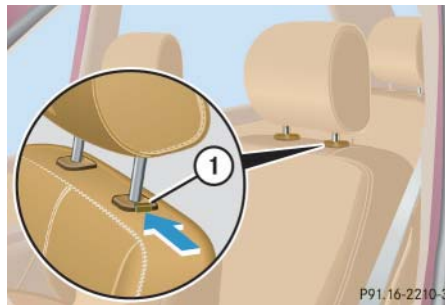

- ① Release button

Raising:

- ▶ Manually adjust the height of the head restraint by pulling it upward.

Lowering:

- ▶ To lower the head restraint, push release button ① and press down on the head restraint.

Warning!



For your protection, drive only with properly positioned head restraints.

Adjust head restraint so that the center of the head restraint supports the back of the head at eye level. This will reduce the potential for injury to the head and neck in the event of an accident or similar situation.

Do not drive the vehicle without the seat head restraints. Head restraints are intended to help reduce injuries during an accident.



Adjust the head restraint in such a way that it is as close to the head as possible.

Getting started

Adjusting

Head restraint tilt



Manually adjust the angle of the head restraint.

- ▶ Push or pull on the upper edge of the head restraint cushion.

For more information, see “Seats” (▷ page 95).

Steering wheel

Warning!



Do not adjust the steering wheel while driving. Adjusting the steering wheel while driving, or driving without the adjustment locked could cause the driver to lose control of the vehicle.

When leaving the vehicle, always remove the key from the steering lock and lock your vehicle.

Do not leave children unattended in the vehicle, or with access to an unlocked vehicle. Unsupervised use of vehicle equipment may cause an accident and / or serious personal injury.

Steering wheel adjustment

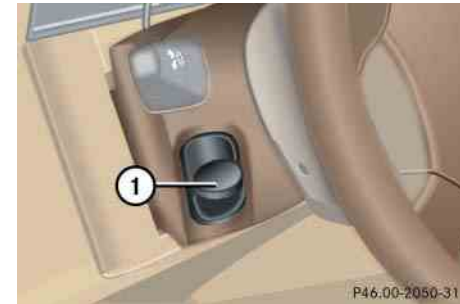

① Lever

- ▶ To unlock the steering column, move lever ① to its stop down.
- ▶ Move steering wheel to the desired position.
- ▶ To lock the steering column, move lever ① to its stop up.

The steering wheel is once again locked into position.



Do not drive the vehicle until you have properly locked the steering column.

If the indicator lamp  (> page 26) comes on while the engine is running, the steering column is not locked properly.

Mirrors

Adjust the interior and exterior rear view mirrors before driving so that you have a good view of the road and traffic conditions.

Warning!



In the case of an accident, liquid electrolyte may escape the mirror housing if the mirror glass breaks.

Electrolyte has an irritating effect. Do not allow the liquid to come into contact with eyes, skin, clothing, or respiratory system. In case it does, immediately flush affected area with water, and seek medical help if necessary.

Getting started

Adjusting

Interior rear view mirror

- ▶ Manually adjust the interior rear view mirror.

For more information, see “Rear view mirrors” (> page 128).

Exterior rear view mirrors

Warning!



Exercise care when using the passenger-side exterior rear view mirror. The mirror surface is convex (outwardly curved surface for a wider field of view). Objects in mirror are closer than they appear. Check your interior rear view mirror or glance over your shoulder before changing lanes.



Electrolyte drops coming into contact with the vehicle paint finish can only be completely removed while in their liquid state and by applying plenty of water.

Getting started

Adjusting

The buttons are located on the lower part of the center console.

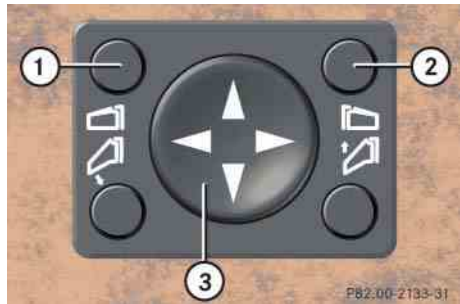

- ① Driver's side exterior rear view mirror button
- ② Passenger-side exterior rear view mirror button
- ③ Adjustment button

- ▶ Switch on ignition (▷ page 33).
- ▶ Press button ① for the driver's side exterior rear view mirror or button ② for the passenger-side exterior rear view mirror.
- ▶ Push adjustment button ③ up, down, left, or right according to the desired setting.



For information on how to reposition the exterior mirror housing when it was forcibly pushed forward (hit from the rear) or forcibly pushed rearward (hit from the front), see "Folding exterior mirrors in and out manually*" (▷ page 130).



With the front doors closed, the exterior rear view mirrors can still be adjusted for approximately 30 minutes after the ignition has been switched off.



The memory function* (▷ page 105) lets you save the exterior mirror settings together with the seat and steering wheel settings.



At low outside temperatures, the exterior mirrors will be automatically heated.

For more information, see "Rear view mirrors" (▷ page 128).

▼ Driving

Warning!

Do not lay any objects in the driver's footwell. Be careful that floor mats or carpets in the driver's footwell have sufficient clearance for the pedals.

During sudden driving or braking maneuvers, the objects could get caught between the pedals. You could then no longer brake or accelerate.

Fastening the seat belts**Warning!**

Always fasten your seat belt before driving off. Always make sure your passengers are properly restrained, even those sitting in the rear and pregnant women.

Failure to wear and properly fasten and position your seat belt greatly increases your risk of injuries and their likely severity in an accident. You and your passengers should always wear seat belts.

If you are ever in an accident, your injuries can be considerably more severe without your seat belt properly buckled. Without your seat belt buckled, you are much more likely to hit the interior of the vehicle or be ejected from it. You can be seriously injured or killed.

In the same crash, the possibility of injury or death is lessened if you are wearing your seat belt. The airbags can only provide the protection they were designed to afford if the occupants are using their seat belts (> page 58).

Warning!

Children 12 years old and under must never ride in the front seat, except in a Mercedes-Benz authorized BabySmart^{TM1} compatible child seat, which operates with the BabySmartTM system installed in the vehicle to deactivate the passenger front airbag when it is properly installed. Otherwise they will be struck by the airbag when it inflates in a crash. If this happens, serious or fatal injury will result.

According to accident statistics, children are safer when properly restrained in the rear seating positions than in the front seating positions. Infants and small children must ride in back seats and be seated in an appropriate infant or child restraint system, which is properly secured with the vehicle's seat belt and top tether strap, or secured via lower anchors and top tether strap, fully in accordance with the child seat manufacturer's instructions. >>

¹ BabySmartTM is a trademark of Siemens Automotive Corp.

Getting started

Driving

- ▷▷ A child's risk of serious or fatal injuries is significantly increased if the child restraints are not properly secured in the vehicle and the child is not properly secured in the child restraint.

Warning!



Never ride in a moving vehicle with the seat backrest in an excessively reclined position as this can be dangerous. You could slide under the seat belt in a collision. If you slide under it, the belt would apply force at the abdomen or neck. That could cause serious or even fatal injuries. The seat backrest and seat belt provide the best restraint when the wearer is in a nearly upright position and the belt is properly positioned on the body.

Warning!



Never let more people ride in the vehicle than there are seat belts available. Make sure everyone riding in the vehicle is correctly restrained with a separate seat belt. Never use a seat belt for more than one person at a time.

Warning!



Read and observe the additional warning notices printed in the "Safety and Security" section (▷ page 62) and (▷ page 64).



- ① Latch plate
- ② Buckle
- ③ Release button
- ④ Seat belt outlet

- ▶ With a smooth motion, pull the belt from seat belt outlet ④.
 - ▶ Place the shoulder portion of the belt across the top of your shoulder and the lap portion across your hips.
 - ▶ Push latch plate ① into buckle ② until it clicks.
 - ▶ If necessary, tighten the lap portion to a snug fit by pulling shoulder portion up.
 - ▶ If necessary, adjust the seat belt to the correct height (▷ page 46).
- Position the lap belt as low as possible on your hips (over hip joint) and not across the abdomen.
 - Place the seat backrest in a nearly upright position.
 - Never use a seat belt for more than one person at a time.
 - Do not fasten a seat belt around a person and another object at the same time. When using a seat belt to secure infant or toddler restraints or children in booster seats, always follow the child seat manufacturer's instructions.

Proper use of seat belts

- Do not twist the belt when fastening.
- Adjust seat belt so that the shoulder portion is located as close as possible to the middle of the shoulder (it should not touch the neck). Never pass the shoulder portion of the belt under your arm. For this purpose, you can adjust the height of the belt outlet (▷ page 46).
- Check your seat belt during travel to make sure it is properly positioned.
- Make sure the seat belt is always fitted snugly. Take special care of this when wearing loose clothing.

Warning!



Do not pass belts over sharp edges. They could tear.

Do not allow the belt to get caught in the door or in the seat adjustment mechanism. This could damage the belt.

Never attempt to make modifications to seat belts. This could impair the effectiveness of the belts.

Do not bleach or dye seat belts as this may severely weaken them. In a crash, they may not be able to provide adequate protection.

Damaged seat belts or belts that were highly stressed in an accident must be replaced. Contact an authorized Mercedes-Benz Light Truck Center.

Getting started

Driving

Seat belt height adjustment

Seat belt height can be adjusted for the following seats:

- Driver's seat
- Passenger seat
- Outer rear seats

Adjust seat belt so that the shoulder portion is located as close as possible to the middle of the shoulder (it should not touch the neck or pass under the arm).

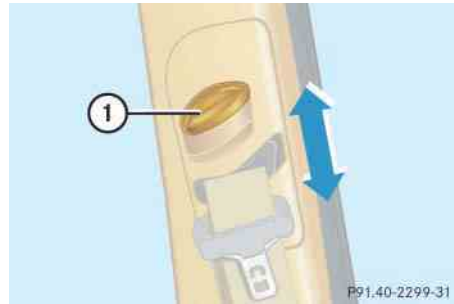

① Release button

Adjusting seat belt higher

- ▶ Slide belt outlet upward.

The belt outlet engages in various positions.

Adjusting seat belt lower

- ▶ Press and hold release button ①.
- ▶ Slide belt outlet in desired position.
- ▶ Let go of release button ①.

Starting the engine

Warning!



Inhalation of exhaust gas is hazardous to your health. All exhaust gas contains carbon monoxide, and inhaling it can cause unconsciousness and lead to death.

Do not run the engine in confined areas (such as a garage) which are not properly ventilated. If you think that exhaust gas fumes are entering the vehicle while driving, have the cause determined and corrected immediately. If you must drive under these conditions, drive only with at least one window fully open.

Automatic transmission

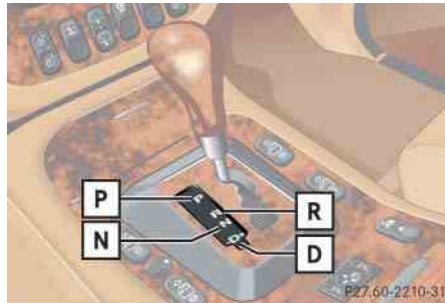

Gearshift pattern for automatic transmission

- P** Park position with gear selector lever lock
- R** Reverse gear
- N** Neutral
- D** Drive position

For more information, see “Automatic transmission” (▷ page 120).

Starting

- ▶ Make sure the gear selector lever is set to **P**.
- ▶ Do not depress accelerator.
- ▶ Turn the key in the steering lock to position **3** and hold until the engine starts (▷ page 33).
- ▶ Depress the brake pedal.

The gear selector lever lock is released.

For information on turning off the engine, see “Turning off engine” (▷ page 55).

Getting started

Driving

Starting difficulties

If the engine does not start as described, carry out the following steps:

- ▶ Turn key in steering lock to position **0** and repeat starting procedure.
Remember that extended starting attempts can drain the battery.
- ▶ Get a jump start (▷ page 29 1).

If the engine does not start after several starting attempts, there could be a malfunction in the engine electronics or in the fuel supply system.

- ▶ Notify an authorized Mercedes-Benz Light Truck Center.

Parking brake

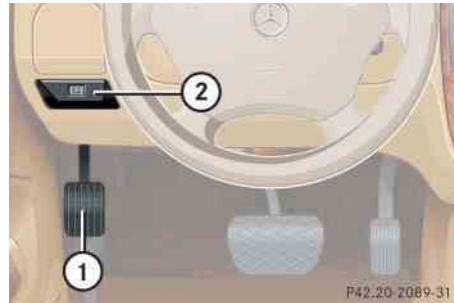

- ① Parking brake pedal
- ② Release handle

Warning!



When leaving the vehicle, always remove the key from the steering lock, and lock the vehicle.

Do not leave children unattended in the vehicle, or with access to an unlocked vehicle. Children could release the parking brake, which could result in an accident and / or serious personal injury.

- ▶ Release the parking brake by pulling on handle ②.

The warning lamp  in the instrument cluster goes out.

Driving

- ▶ Depress the brake pedal.
- ▶ Move gear selector lever to position **D** or **R**.



Wait for the gear selection process to complete before setting the vehicle in motion.

- ▶ Release the brake pedal.
- ▶ Carefully depress the accelerator pedal.

Once the vehicle is in motion, the automatic central locking system engages and the locking knobs drop down.



If you hear a warning signal when driving off, you have forgotten to release the parking brake.

Release the parking brake.

After a cold start, the automatic transmission shifts at a higher engine revolution. This allows the catalytic converter to reach its operating temperature earlier.

Warning!



It is dangerous to shift the gear selector lever out of **P** or **N** if the engine speed is higher than idle speed. If your foot is not firmly on the brake pedal, the vehicle could accelerate quickly forward or in reverse. You could lose control of the vehicle and hit someone or something. Only shift into gear when the engine is idling normally and when your right foot is firmly on the brake pedal.

Warning!



On slippery road surfaces, never downshift in order to obtain braking action. This could result in drive wheel slip and reduced vehicle control. Your vehicle's ABS will not prevent this type of loss of control.



Place the gear selector lever in position **R** only when the vehicle is stopped in order to avoid damaging the transmission.



Do not run cold engine at high engine speeds. Running a cold engine at high engine speeds may shorten the service life of the engine.



Simultaneously depressing the accelerator pedal and applying the brake reduces engine performance and causes premature brake and drivetrain wear.

For more information, see “Driving instructions” (▷ page 197).

For information on off-road driving, see “Off-road driving” (▷ page 204).

Getting started

Driving

Switching on headlamps

The combination switch is located on the left of the steering column.



Combination switch

- ① Off
- ② Low beam headlamps on

- ▶ Turn combination switch to position .

The low beam headlamps are switched on.

For more information, see “Lighting” (▷ page 107).

Turn signals and high beam

The combination switch is on the left of the steering column.

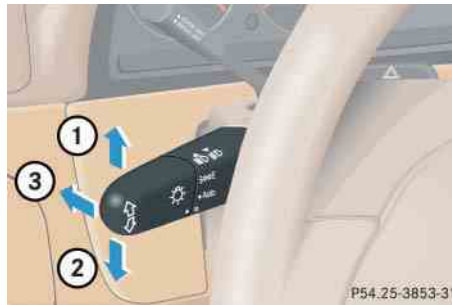



Combination switch

- ① Turn signals, right
- ② Turn signals, left
- ③ High beam

Turn signals

- ▶ Press combination switch in direction of arrow ① or ②.

The corresponding turn signal indicator lamp  or  in the instrument cluster flashes.

The combination switch resets automatically after major steering wheel movements.



To signal minor directional changes, move combination switch only to point of resistance and release. The corresponding turn signals will flash three times.

High beam

- ▶ Push combination switch forward in direction of arrow ③.

The high beam indicator lamp  in the instrument cluster comes on.

For more information, see “Lighting” (▷ page 107).

Windshield wipers

The wiper switch is located on the right of the steering column.



Wiper switch

- ① Windshield wipers off
 - ① Intermittent wiping
 - ② Normal wiper speed
 - ③ Fast wiper speed
 - ④ Wiping with windshield wiper fluid
- Switch on ignition (▷ page 33).



Vehicles with rain sensor*:

Do not leave windshield wipers in intermittent setting when the vehicle is taken to an automatic car wash or during windshield cleaning. Wipers will operate in the presence of water sprayed on the windshield, and wipers may be damaged as a result.

The switch should not be left in intermittent setting as the wipers will wipe the windshield once every time the engine is started. Dust that accumulates on the windshield might scratch the glass and / or damage the wiper blades when wiping occurs on a dry windshield.

Switching on windshield wipers

- Press the wiper switch to the desired position ①, ② or ③, depending on the intensity of the rain.

Single wipe

- Press wiper switch briefly in the direction of arrow ②.

The windshield wipers wipe one time without washer fluid.

Wiping with windshield washer fluid

- Pull and hold wiper switch in direction of arrow ④.

The windshield wiper operates with washer fluid.

For information on filling up the washer reservoir, see “Windshield washer system and headlamp cleaning system*” (▷ page 230).

Getting started

Driving



If anything blocks the windshield wipers (leaves, snow, etc.), switch them off immediately.

- For safety reasons, withdraw key from steering lock before attempting to remove any blockage.
- Remove blockage.
- Turn the windshield wipers on again.

If windshield wipers fail to function at all in switch position ①,

- set the combination switch to the next highest wiper speed
- have the windshield wipers checked at the nearest authorized Mercedes-Benz Light Truck Center

Rear window wiper/washer

The button is on the upper part on the center console.



- ① Intermittent wiping
- ② Indicator lamp
- ③ Wiping with washer fluid

- ▶ Switch on ignition (▷ page 33).

Activating intermittent wipe

- ▶ Press upper half ① of the button.
The indicator lamp ② comes on.

Deactivating intermittent wipe

- ▶ Press upper half ① of the button again.
The indicator lamp ② goes out.

Wiping with windshield washer fluid

- ▶ Press and hold lower half ③ of the button.

The wiper operates with washer fluid. After releasing the button the wiper operates for additional five seconds.

For more information, see “Windshield wipers” (▷ page 131).

Problems while driving

The engine runs erratically and misfires

- An ignition cable may be damaged.
- The engine electronics may not be operating properly.
- Unburned gasoline may have entered the catalytic converter and damaged it.
- ▶ Give very little gas.
- ▶ Have the problem repaired by an authorized Mercedes-Benz Light Truck Center as soon as possible.

The coolant temperature is above 248°F (120°C)

The coolant is too hot and is no longer cooling the engine.

- ▶ Stop the vehicle as soon as possible and turn off the engine. Allow engine and coolant to cool.
- ▶ Check the coolant level and add coolant if necessary (> page 227).

In case of accident

If the vehicle is leaking gasoline:

- ▶ Do not start the engine under any circumstances.
- ▶ Notify local fire and /or police authorities.

If the extent of the damage cannot be determined:

- ▶ Notify an authorized Mercedes-Benz Light Truck Center.

If no damage can be determined on the

- major assemblies
- fuel system
- engine mount:
- ▶ Start the engine in the usual manner.

Getting started

Parking and locking

You have now completed your first drive. You have properly stopped and parked your vehicle. End your drive as follows.

Warning!



Wait until the vehicle is stationary before removing the key from the steering lock. The vehicle cannot be steered when the key is removed.

Warning!



With the engine not running, there is no power assistance for the brake and steering system. In this case, it is important to keep in mind that a considerably higher degree of effort is necessary to brake and steer the vehicle.

Warning!



Do not park this vehicle in areas where combustible materials such as grass, hay or leaves can come into contact with the hot exhaust system, as these materials could be ignited and cause a vehicle fire.

To reduce the risk of personal injury as a result of vehicle movement, before turning off the engine and leaving the vehicle always:

- Keep right foot on brake pedal.
- Firmly depress parking brake pedal.
- Move the gear selector lever to position **P**.
- Slowly release brake pedal.
- When parked on an incline, turn front wheel towards the road curb.
- Turn the key to steering lock position **0** and remove.
- Take the key and lock vehicle when leaving.

Parking brake

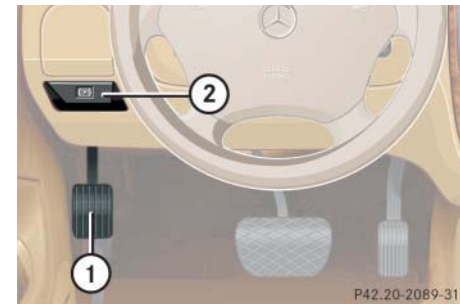

- ① Parking brake
- ② Release handle

- Step firmly on parking brake ①.

When the engine is running, the warning lamp  in the instrument cluster will be illuminated.

Getting started

Parking and locking

Warning!



When leaving the vehicle, always remove the key from the steering lock and lock the vehicle. Do not leave children unattended in the vehicle, or with access to an unlocked vehicle. Children could release the parking brake and / or move the gear selector lever from position **P**, either of which could result in an accident and / or serious personal injury.

Warning!



Getting out of your vehicle with the gear selector lever not fully engaged in position **P** is dangerous. Also, when parked on an incline, position **P** alone may not prevent your vehicle from moving, possibly hitting people or objects.

Always set the parking brake in addition to shifting to position **P** (▷ page 123).

When parked on an incline, also turn front wheel towards the road curb.

Switching off headlamps

- ▶ Turn the combination switch to ① (▷ page 50).

For more information, see “Lighting” (▷ page 107).

Turning off engine

- ▶ Place the gear selector lever in position **P**.



Always set the parking brake in addition to shifting to position **P**.

On steep slopes, turn the front wheels towards the road curb.

- ▶ Turn the key in the steering lock to position **0** (▷ page 33) and remove it.

The immobilizer is activated.



The key can only be removed from the steering lock with the gear selector lever in position **P**.

- ▶ Move the steering wheel slightly to allow the locking mechanism to engage. ▷▷

Getting started

Parking and locking

- ▷▷ Press the seat belt release button (▷ page 43).

Allow the retractor to completely rewind the seat belt by guiding the latch plate.



With the key removed and the driver's door open, a warning sounds if the vehicle's exterior lamps are not switched off.

Warning!



When leaving the vehicle, always remove the key from the steering lock, and lock your vehicle. Do not leave children unattended in the vehicle, or with access to an unlocked vehicle. Unsupervised use of vehicle equipment may cause an accident and / or serious personal injury.

For more information, see “Locking and unlocking” (▷ page 88).

Locking

Warning!



To prevent possible personal injury, always keep hands and fingers away from the door openings when closing the doors. Be especially careful when small children are around.

Before closing doors, make sure there is no possibility of someone getting caught in a door during closing.

- ▶ After exiting the vehicle, press the lock button  on the remote control (▷ page 32).

The turn signal lamps flash three times and the locking knobs on the doors move down.

Warning!



When leaving the vehicle, always remove the key from the steering lock, and lock your vehicle. Do not leave children unattended in the vehicle, or with access to an unlocked vehicle. Unsupervised use of vehicle equipment may cause an accident and / or serious personal injury.

For more information, see “Locking and unlocking” (▷ page 88).

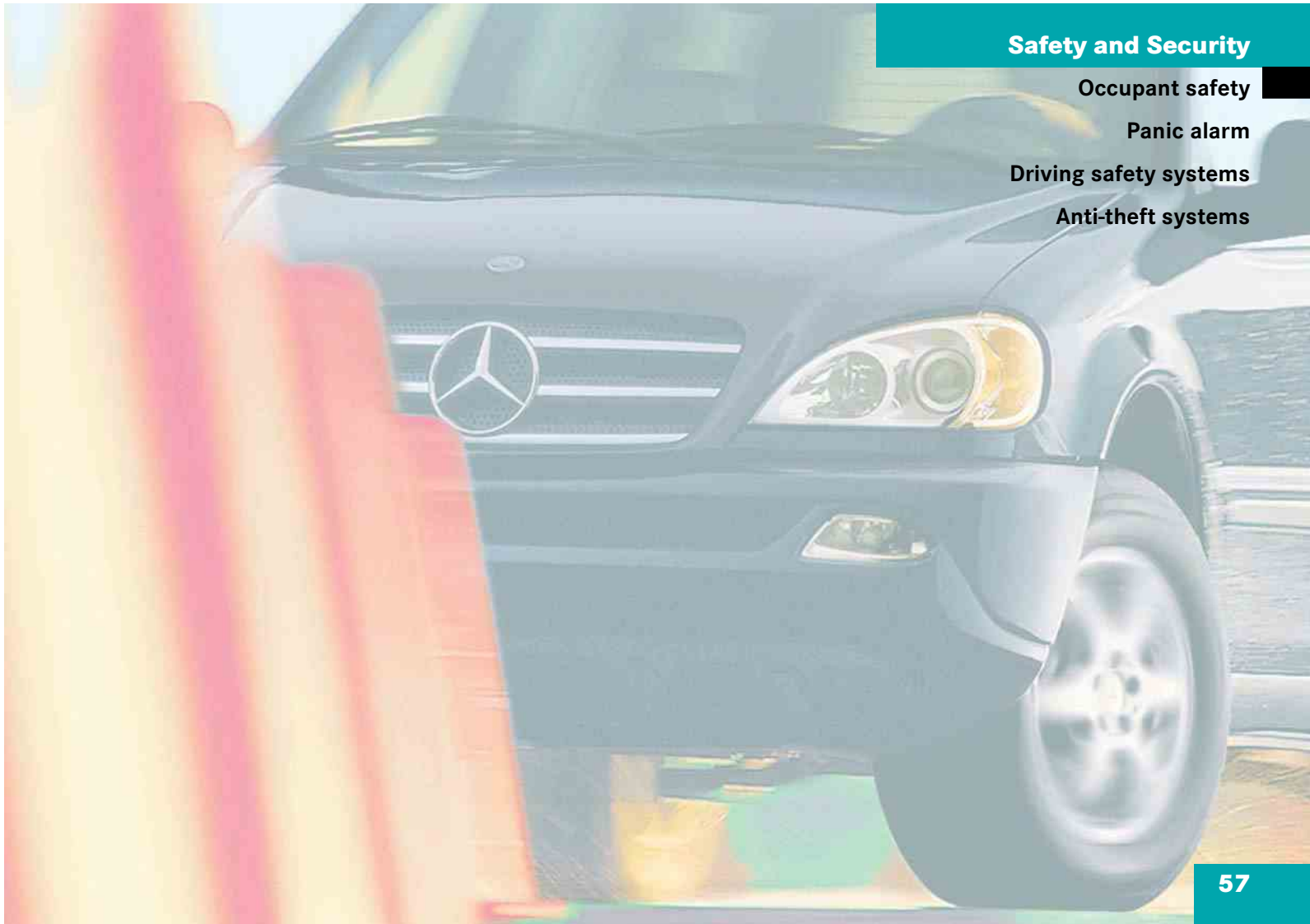

Safety and Security

Occupant safety

Panic alarm

Driving safety systems

Anti-theft systems

Safety and Security

Occupant safety

In this section you will learn the most important facts about the restraint systems of the vehicle.

The restraint systems are

- Seat belts
- Emergency tensioning device
- Airbags
- Child seats
- Child seat recognition
- Lower anchors and tethers for children (LATCH)

As independent systems, their protective effects work in conjunction with each other.



For information on infants and children traveling with you in the vehicle and restraint systems for infants and children, see “Children in the vehicle” (▷ page 67).

The **SRS** indicator lamp in the instrument cluster (▷ page 26) comes on for about four seconds when you turn the key in the steering lock to position **1**. It goes out when you start the engine. This shows that the restraint systems are operational.

If the lamp does not come on at all or if it fails to extinguish after approximately four seconds or if it comes on thereafter, a malfunction in the system has been detected.

For more information, see the “Practical hints” section (▷ page 262).

Warning!



In the event that the **SRS** indicator lamp comes on during driving or does not come at all, the SRS self-check has detected a malfunction.

For your safety, we strongly recommend that you visit an authorized Mercedes-Benz Light Truck Center immediately to have the system checked; otherwise the SRS may not be activated when needed in an accident, which could result in serious or fatal injury, or it might deploy unexpectedly and unnecessarily which could also result in injury.

In addition, improper work on the SRS creates a risk of rendering the SRS inoperative or causing unintended airbag deployment. Work on the SRS must therefore only be performed by qualified technicians. Contact an authorized Mercedes-Benz Light Truck Center.

Airbags

Warning!



Airbags are designed to reduce the potential of injury and fatality in certain frontal (front airbags) impacts, or side (side impact and head protection window curtain airbags) impacts which may cause significant injuries. However, no system available today can totally eliminate injuries and fatalities.

The activation of the airbags temporarily releases a small amount of dust from the airbags. This dust, however, is neither injurious to your health, nor does it indicate a fire in the vehicle. The dust might cause some temporary breathing difficulty for people with asthma or other breathing trouble. To avoid this, you may wish to get out of the vehicle as soon as it is safe to do so. If you have any breathing difficulty but cannot get out of the vehicle after the airbag inflates, then get fresh air by opening a window or door.

Warning!



To reduce the risk of injury when the front airbags inflate, it is very important for the driver and front passenger to always be in a properly seated position and to wear your seat belt.

For maximum protection in the event of a collision always be in normal seated position with your back against the backrest. Fasten your seat belt and make sure it is properly positioned on your body (▷ page 43).

Since the airbag inflates with considerable speed and force, a proper seating and hands on steering wheel position will help to keep you at a safe distance from the airbag. Occupants who are unbelted, out of position or too close to the airbag can be seriously injured by an airbag as it inflates with great force in the blink of an eye:

- Sit properly belted in a nearly upright position with your back against the seat backrest.

- Adjust the driver seat as far as possible rearward, still permitting proper operation of vehicle controls. The distance from the center of the driver's breastbone to the center of the airbag cover on the steering wheel must be at least ten inches (25 cm) or more. You should be able to accomplish this by a combination of adjustments to the seat and steering wheel. If you have any problems, please see an authorized Mercedes-Benz Light Truck Center.
- Airbags and emergency tensioning devices (ETDs) are designed to function on a one-time only basis. An airbag or ETD that was activated must be replaced.
- Do not lean with your head or chest close to the steering wheel or dashboard.
- Keep hands on the outside of steering wheel rim. Placing hands and arms inside the rim can increase the risk and potential severity of hand/arm injury when driver front airbag inflates.



Safety and Security

Occupant safety



- Adjust the passenger seat as far as possible rearward from the dashboard when the seat is occupied.
- Occupants, especially children, should never lean their heads in the area of the door where the side impact airbag inflates. This could result in serious injuries or death should the airbag be triggered. Always sit nearly upright, properly use the seat belts and appropriate size infant or child restraint system.
- Children 12 years old and under must never ride in the front seat, except in a Mercedes-Benz authorized BabySmart^{TM1} compatible child seat, which operates with the BabySmartTM system installed in the vehicle to deactivate the passenger front airbag when it is properly installed. Otherwise they will be struck by the airbag when it inflates in a crash. If this happens, serious or fatal injury will result.

¹ BabySmartTM is a trademark of Siemens Automotive Corp.

Failure to follow these instructions can result in severe injuries to you or other occupants.

If you sell your vehicle, it is important that you make the buyer aware of this safety information. Be sure to give the buyer this Operator's Manual.

Warning



Accident research shows that the safest place for children in an automobile is in the rear seat. Should you choose to place a child 12 years old or under in the front passenger seat of your vehicle, you must properly use a BabySmartTM child restraint which will turn off the passenger front airbag (▷ page 70). BabySmartTM will not, however, turn off any side impact airbag.

It should be noted that with respect to both front and rear side impact airbags there is a possibility for a side airbag related injury if occupants, especially children, are not properly seated or restrained when next to a side airbag which needs to deploy rapidly in a side impact in order to do its job.

Safety and Security

Occupant safety

To help avoid the possibility of injury, please follow these guidelines:

- (1) Occupants, especially children, should never place their bodies or lean their heads in the area of the door where the side airbag inflates. This could result in serious injuries or death should the side airbag be activated.
- (2) Always sit nearly upright, properly use the seat belts and use an appropriately sized infant or child restraint system for all children 12 years old or under.
- (3) Always wear seat belts properly.

If you believe that, even with the use of these guidelines, it would be safer for your rear seat occupants to have both rear door mounted side airbags deactivated, then deactivation can be accomplished upon your written request to do so at an authorized Mercedes-Benz Light Truck Center at an additional cost.

Please contact an authorized Mercedes-Benz Light Truck Center or call our Customer Assistance Center at 1-800-FOR-MERCEdes (1-800-367-6372) for details.



Airbags are designed to activate only in certain frontal impacts (front airbags) and in side impacts (side impact and head protection window curtain airbags) which exceed preset thresholds.

Only during these types of impacts, if of sufficient severity to meet the deployment thresholds, will they provide their supplemental protection.

The driver and passengers should always wear their seat belts. Otherwise it is not possible for airbags to provide their supplemental protection.

In cases of other frontal impacts, angled impacts, roll-overs, other side impacts, rear collisions, or other accidents, the airbags will not be activated. The driver and passengers will then be protected by the fastened seat belts.

We caution you not to rely on the presence of the airbags in order to avoid wearing your seat belt.

Your vehicle was originally equipped with airbags that are designed to activate in certain impacts exceeding a preset threshold to reduce the potential and severity of injury. It is important to your safety and that of your passengers that you replace deployed airbags and repair any malfunctioning airbags to make sure the vehicle will continue to provide supplemental crash protection for occupants.

Safety and Security

Occupant safety

Safety guidelines for the seat belt, emergency tensioning device and airbag

Warning



- Damaged seat belts or belts that were highly stressed in an accident must be replaced and their anchoring points must also be checked. Use only belts installed or supplied by an authorized Mercedes-Benz Light Truck Center.
- No modifications of any kind may be made to any components or wiring of the SRS. This includes changing or removing any component or part of the SRS, the installation of additional trim material, badges, etc. over the steering wheel hub, passenger front airbag cover, or door trim panels, and installation of additional electrical / electronic equipment on or near SRS components and wiring. Keep area between airbags and occupants free from objects (e.g. packages, purses, umbrellas, etc.).

- Airbags and emergency tensioning devices (ETDs) are designed to function on a one-time only basis. An airbag or ETD that was activated must be replaced.
 - Do not pass belts over sharp edges. They could tear.
 - Do not make any modification that could change the effectiveness of the belts.
 - Do not bleach or dye seat belts as this may severely weaken them. In a crash they may not be able to provide adequate protection.
 - Do not hang items such as coat hangers from the coat hooks or handles over the door. These items may turn into projectiles and cause head and other injuries when curtain airbag is deployed.
 - Never place your feet on the instrument panel, dashboard, or on the seat. Always keep both feet on the floor in front of the seat.
 - Airbag system components will be hot after an airbag has inflated. Do not touch.
- In addition, improper repair work on the SRS creates a risk of rendering the SRS inoperative or causing unintended airbag deployment. Work on the SRS must therefore only be performed by qualified technicians. Contact an authorized Mercedes-Benz Light Truck Center.
 - For your protection and the protection of others, when scrapping the airbag unit or emergency tensioning device, our safety instructions must be followed. These instructions are available from your authorized Mercedes-Benz Light Truck Center.
 - Given the considerable deployment speed and the textile structure of the airbags, there is the possibility of abrasions or other injuries resulting from airbag deployment.

Safety and Security

Occupant safety

When you sell your vehicle, we strongly urge you to give notice to the subsequent owner that it is equipped with an SRS by alerting them to the applicable section in the Operator's Manual.

Warning!



In the event that the **SRS** indicator lamp comes on while driving, the SRS may not be operational. For your safety, we strongly recommend that you visit an authorized Mercedes-Benz Light Truck Center immediately to have the system checked; otherwise the SRS may not be activated when needed in an accident, which could result in serious or fatal injury, or it might deploy unexpectedly and unnecessarily which could also result in injury.

Front airbags



- ① Driver airbag
- ② Passenger front airbag
- ③ Side impact airbag

Driver and front passenger airbags are deployed:

- in the event of a frontal impact
- if impact exceeds a preset deployment threshold
- independently of the side impact airbags

The airbags will not deploy in impacts which do not exceed the system's deployment thresholds. You will then be protected by the fastened seat belts.

The passenger front airbag will only be deployed if:

- the passenger seat is occupied
- the **AIRBAG OFF** indicator lamp in the instrument cluster is not lit (▷ page 26)
- the impact exceeds a preset deployment threshold



Do not place objects heavier than 20 lbs (9 kg) on the front passenger seat. This could cause the front or side impact airbag on the front passenger side to deploy in a crash which exceeds the system's deployment threshold.

Safety and Security

Occupant safety

Side impact airbags, window curtain airbags

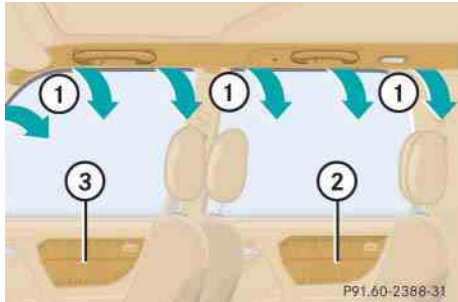

- ① Window curtain airbags
- ② Side impact airbag, rear
- ③ Side impact airbag, front



The side impact airbags and window curtain airbags are deployed:

- on the impacted side of the vehicle
- in impacts exceeding a preset deployment threshold
- independently of the front airbags

The front passenger side impact airbag will only deploy if the system senses that the front passenger seat is occupied.

The side impact airbags and window curtain airbags are not deployed in impacts which do not exceed the system's deployment threshold.

Seat belts

When the engine is started, the seat belt telltale  illuminates to remind you and your passengers to fasten your seat belts. If the driver's seat belt is not fastened before the engine is started, the seat belt telltale  illuminates and a warning chime sounds for approximately six seconds when the engine is started.

The use of seat belts and infant and child restraint systems is required by law in all 50 states, the District of Columbia, the U.S. territories and all Canadian provinces.

Even where this is not the case, all vehicle occupants should have their seat belts fastened whenever the vehicle is in motion.

For information on fastening seat belts, see the "Getting started" section ([▷ page 43](#)).



For information on infants and children traveling with you in the vehicle and restraint systems for infants and children, see "Children in the vehicle" ([▷ page 67](#)).

Safety and Security

Occupant safety

Warning!



Always fasten your seat belt before driving off. Always make sure your passengers are properly restrained, even those sitting in the rear and pregnant women.

Failure to wear and properly fasten and position your seat belt greatly increases your risk of injuries and their likely severity in an accident. You and your passengers should always wear seat belts.

If you are ever in an accident, your injuries can be considerably more severe without your seat belt properly buckled. Without your seat belt buckled, you are much more likely to hit the interior of the vehicle or be ejected from it. You can be seriously injured or killed.

In the same crash, the possibility of injury or death is lessened if you are properly wearing your seat belt. Airbags can only protect as they are designed if the occupants are properly wearing their seat belts.

Warning!



Never ride in a moving vehicle with the seat backrest in an excessively reclined position as this can be dangerous. You could slide under the seat belt in a collision. If you slide under it, the belt would apply force at the abdomen or neck. That could cause serious or even fatal injuries. The seat backrest and seat belt provide the best restraint when the wearer is in a nearly upright position and the belt is properly positioned on the body.

Warning!



Never let more people ride in the vehicle than there are seat belts available. Make sure everyone riding in the vehicle is correctly restrained with a separate seat belt. Never use a seat belt for more than one person at a time.

Warning!



Damaged seat belts or belts that were highly stressed in an accident must be replaced and their anchoring points must also be checked.

Only use seat belts which have been approved by Mercedes-Benz.

Do not make any modifications to the seat belts. This can lead to unintended activation or to failure.

Do not bleach or dye seat belts as this may severely weaken them. In a crash, they may not be able to provide adequate protection.

Have all work carried out only by qualified technicians. Contact an authorized Mercedes-Benz Light Truck Center.

Safety and Security

Occupant safety

Warning!



USE SEAT BELTS PROPERLY

- Seat belts can only work when used properly. Never wear seat belts in any other way than as described in this section, as that could result in serious injuries in case of an accident.
- Each occupant should wear their seat belt at all times, because seat belts help reduce the likelihood of and potential severity of injuries in accidents, including rollovers. The integrated restraint system includes SRS (driver airbag, passenger front airbag, front and rear door mounted side impact airbags and window curtain airbags), ETD (seat belt emergency tensioning device for the outboard passenger seats [except in the optional third row seats]), and front seat knee bolsters.

- The system is designed to enhance the protection offered to properly belted occupants in certain frontal (front airbags and ETD) and side (side impact, window curtain airbags and ETD) impacts which exceed preset deployment thresholds.
 - Never wear the shoulder belt under your arm, against your neck or off your shoulder. In a crash, your body would move too far forward. That would increase the chance of head and neck injuries. The belt would also apply too much force to the ribs or abdomen, which could severely injure internal organs such as your liver or spleen.
 - Never wear belts over rigid or breakable objects in or on your clothing, such as eyeglasses, pens, keys, etc., as these might cause injuries.
 - Position the lap belt as low as possible on your hips and not across the abdomen. If the belt is positioned across your abdomen, it could cause serious injuries in a crash.
- Never use a seat belt for more than one person at time. Do not fasten a seat belt around a person and another person or other objects.
 - Belts should not be worn twisted. In a crash, you wouldn't have the full width of the belt to manage impact forces. The twisted belt against your body could cause injuries.
 - Pregnant women should also use a lap-shoulder belt. The lap belt portion should be positioned as low as possible on the hips to avoid any possible pressure on the abdomen.
 - Never place your feet on the instrument panel, dashboard or on the seat. Always keep both feet on the floor in front of the seat.

Emergency tensioning device, seat belt force limiter

The seat belts for the front seats are equipped with emergency tensioning devices and belt force limiters. The outboard passenger seats belts (except in the third row seats*) are equipped with emergency tensioning devices.

The ETD is designed to activate in the following cases:

- in frontal or rear-end impacts exceeding a preset severity level
- if the restraint systems are operational and functioning correctly, see **SRS** indicator lamp (▷ page 58)



The ETDs for the front seats will only activate if the respective front seat belt is fastened (latch plate properly inserted into buckle).

The ETDs for the rear outer seats will activate with or without the respective seat belt fastened.

In an impact, emergency tensioning devices remove slack from the belts in such a way that the seat belts fit more snugly against the body. Belt force limiters reduce the force exerted by the seat belts on occupants during a crash.

Warning!



An emergency tensioning device (ETD) that was activated must be replaced.

When disposing of the emergency tensioning device, our safety instructions must be followed. These are available at your authorized Mercedes-Benz Light Truck Center.



Do not place objects heavier than 20 lbs (9 kg) on the front passenger seat. This could cause the front or side impact airbag on the front passenger side to deploy in a crash which exceeds the system's deployment threshold.

Children in the vehicle

If an infant or child is traveling with you in the vehicle:

- Secure the child using an infant or child restraint appropriate to the age and size of the child.
- Make sure the infant or child is properly secured by a belt at all times while the vehicle is in motion.

Infant and child restraint seats and information on choosing an appropriate restraint system can be obtained from any authorized Mercedes-Benz Light Truck Center.

Safety and Security

Occupant safety

Infant and child restraint systems

Use only a BabySmart^{TM1} compatible child restraint for the front passenger seat in this vehicle.

We recommend that all infants and children be properly restrained at all times while the vehicle is in motion. All lap-shoulder belts except the driver's seat belt have special seat belt retractors for secure fastening of child restraints.

To fasten a child restraint, follow child restraint instructions for mounting. Then pull shoulder belt out completely and let it retract. During the seat belt retraction a ratcheting sound can be heard to indicate that the special seat belt retractor is activated. The belt is now locked. Push down on child restraint to take up any slack.

To deactivate, release seat belt buckle and let seat belt retract completely. The seat belt can again be used in the usual manner.

¹ BabySmartTM is a trademark of Siemens Automotive Corp.



For information on child seats with anchor fittings for tether anchorages, see "Installation of infant and child restraint system" (▷ page 71).

For information on child seat anchors – LATCH type, see (▷ page 73).

Warning!



Never release the seat belt buckle while the vehicle is in motion, since the special seat belt retractor will be deactivated.



The use of infant or child restraints is required by law in all 50 states, the District of Columbia, the U.S. territories and all Canadian provinces.

Infants and small children should be seated in an appropriate infant or child restraint system properly secured by a lap-shoulder belt or, if so equipped, a child restraint lower anchorage system that complies with U.S. Federal Motor Vehicle Safety Standards 213 and 225 and Canadian Motor Vehicle Safety Standard 213 and 210.2.

A statement by the child restraint manufacturer of compliance with this standard can be found on the instruction label on the restraint and in the instruction manual provided with the restraint.

When using any infant or child restraint system, make sure to carefully read and follow all manufacturer's instructions for installation and use.

Please read and observe warning labels affixed to inside of vehicle and to infant or child restraints.

Warning!



Children 12 years old and under must never ride in the front seat, except in a Mercedes-Benz authorized BabySmart™ compatible child seat, which operates with the BabySmart™ System installed in the vehicle to deactivate the passenger front airbag when it is properly installed. Otherwise they will be struck by the airbag when it inflates in a crash. If this happens, serious or fatal injury can result.

According to accident statistics, children are safer when properly restrained in the rear seating positions than in the front seating positions. Infants and small children must ride in back seats and be seated in an appropriate infant or child restraint system, which is properly secured with the vehicle's seat belt and top tether strap, or secured via lower anchors and top tether strap, fully in accordance with the child seat manufacturer's instructions.

Safety and Security

Occupant safety

Infants and small children should never share a seat belt with another occupant. During an accident, they could be crushed between the occupant and seat belt.

A child's risk of serious or fatal injuries is significantly increased if the child restraints are not properly secured in the vehicle and the child is not properly secured in the child restraint.

Safety and Security

Occupant safety

Warning!



Children too big for child restraint systems must ride in back seats using regular seat belts. Position shoulder belt across chest and shoulder, not face or neck. A booster seat may be necessary to achieve proper belt positioning for children from 41 lbs until they reach a height where a lap / shoulder belt fits properly without a booster.

When the child restraint is not in use, remove it from the vehicle or secure it with the seat belt to prevent the child restraint from becoming a projectile in the event of an accident.

Do not leave children unattended in the vehicle, even if the children are secured in a child restraint system. Unsupervised children in a child restraint system may use vehicle equipment and may cause an accident and / or serious personal injury.

BabySmart™ airbag deactivation system

Special BabySmart™¹ compatible child seats, designed for use with the Mercedes-Benz system and available at any authorized Mercedes-Benz Light Truck Center, are required for use with the BabySmart™ airbag deactivation system. With the special seat properly installed, the passenger front airbag will not deploy.

The  indicator lamp located in the instrument cluster will be illuminated, except with the key removed or in steering lock position **0** (▷ page 33).



The system does not deactivate the door mounted side impact airbag, the window curtain airbags and the emergency tensioning device.

Self-test BabySmart™ without special child seat installed

After turning the key in the steering lock to position **1** or **2**, the  indicator lamp located in the instrument cluster comes on for approximately six seconds, extinguishes, then flashes once.

If the indicator lamp should not come on or is continuously lit, the system is not functioning. You must see an authorized Mercedes-Benz Light Truck Center before seating any child on the front passenger seat.

For more information, see the “Practical hints” section (▷ page 249).

¹ BabySmart™ is a trademark of Siemens Automotive Corp.

Warning!



The BabySmart™ airbag deactivation system will ONLY work with a special child seat designed to operate with it. It will not work with child seats which are not BabySmart™ compatible.

Never place anything between seat cushion and child seat (e.g. pillow), since it reduces the effectiveness of the deactivation system. The bottom of the child seat must make full contact with the passenger seat cushion. An incorrectly mounted child seat could cause injuries to the child in case of an accident, instead of protecting the child.

Follow the manufacturer's instructions for installation of special child seats.

When using a BabySmart™ compatible child seat on the front passenger seat, the passenger front airbag will not deploy only if the AIRBAG OFF indicator lamp remains illuminated.

Please make sure to check the indicator every time you use the special system child seat.

Should the light go out while the restraint is installed, please check installation. If the light remains out, do not use the BabySmart™ restraint to transport children on the passenger seat until the system has been repaired.

Warning!



Do not place powered-on laptops, cell phones and like electronic devices on the front passenger seat. Signals from such devices may interfere with the BabySmart™ system. Such signal interference may cause the AIRBAG OFF indicator lamp not to come on during self-test or be continuously lit, indicating that the system is not functioning.

Safety and Security

Occupant safety

Installation of infant and child restraint system

- ▶ Guide top tether strap between head restraint and top of seat back. Head restraint must be installed and positioned such that the top tether strap can pass freely between the head restraint and top of seat back.

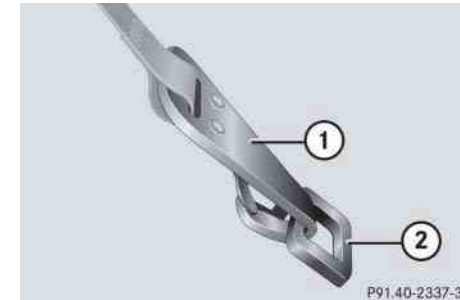

- ① Hook
- ② Anchorage ring

Safety and Security

Occupant safety

- ▶ Securely fasten the hook ① to the anchorage ring ②.

For safety, make sure the hook has attached to the ring beyond the safety catch, as illustrated.

Once the top tether anchorage hook is attached, the child restraint itself can be secured. Tighten the top tether strap according to the child restraint manufacturer's instructions.

Vehicle without third row seats

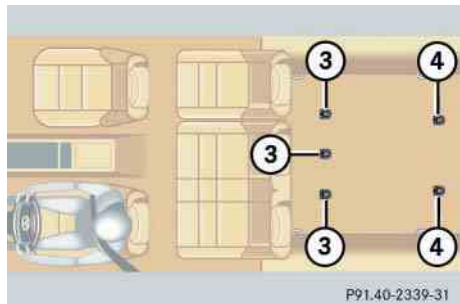

- ③ Anchorage rings for second row seats
- ④ Anchorage rings for third row seats*

This vehicle is provided with three tether anchorages ③ for a top tether strap behind the second row seats.



Do not use the tether anchorages ④ for a top tether strap on a second row seat.

Vehicle with third row seats*

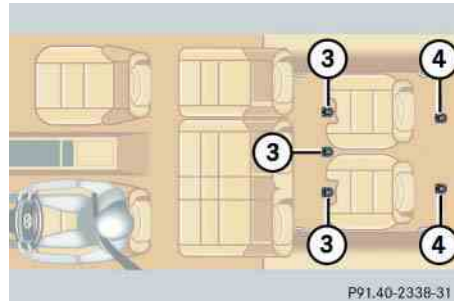

- ③ Anchorage rings for second row seats
- ④ Anchorage rings for third row seats*

This vehicle is provided with tether anchorages for a top tether strap behind the second row seats ③ and the third row seats ④.

When using the third row observe the following:

- Installation of infant and child restraint systems with a top tether strap is allowed only on both third row seats plus the center second row seat.
- When using the center second row seat for a top tether strap, the left third row seat should only be used for a child restraint system, since exiting the vehicle may not be possible in an emergency due to the routing of the top tether strap.
- When installing an infant or child restraint system with a top tether strap on the left second row seat, the left third row seat should not be occupied.

Safety and Security

Occupant safety



An infant and child restraint system must not be installed on the right second row seat while a passenger rides in a third row seat. An infant and child restraint system installed on the right second row seat will prevent the use of the easy-entry / exit feature (▷ page 101).

Child seat anchors – LATCH type

This vehicle is equipped with two LATCH (Lower Anchors and Tethers for Children) type anchors (at each of the rear seats) for the installation of a LATCH child seat with matching mounting fittings.

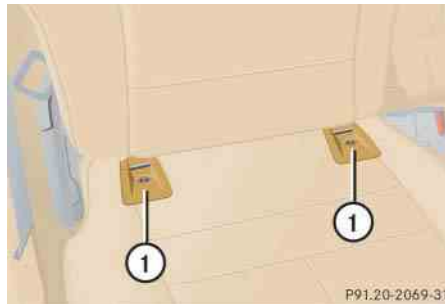

① Anchors

- ▶ Install a LATCH type child seat according to the manufacturer's instructions.



With a child seat installed in the left rear seat, the seat belt for the center seat occupied by a passenger must operate freely. Guide seat belt between its seat cushion mount and backrest mount along outside of right side child seat mount.

Non-LATCH type child seats may also be used and can be installed using the vehicle's seat belt system. Install child seat according to the manufacturer's instructions.

Safety and Security

Occupant safety

Warning!



Install child seat according to manufacturer's instructions.

The child seat must be firmly attached in the right and left side anchors.

An incorrectly mounted child seat may come loose during an accident.

Damaged or impact damaged child seats or child seat mounting fittings must be replaced.

Do not leave children unattended in the vehicle, even if the children are secured in a child restraint system.

Children too big for child restraint systems must ride in back seats using regular seat belts. Position shoulder belt across chest and shoulder, not face or neck. A booster seat may be necessary to achieve proper belt positioning for children from 41 lbs until they reach a height where a lap / shoulder belt fits properly without a booster.

Blocking of rear door window operation

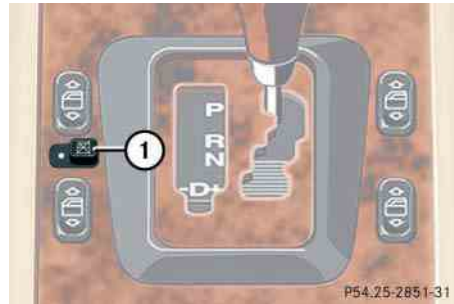

① Override switch

- ▶ Slide override switch ① to the right.

A dot becomes visible. The rear windows can no longer be operated using the switch in the rear doors.

Warning!



Activate the override switch when children are riding in the back seats of the vehicle. The children may otherwise injure themselves, e.g. by becoming trapped in the window opening.

When leaving the vehicle, always remove the key from the steering lock, and lock the vehicle. Do not leave children unattended in the vehicle, or with access to an unlocked vehicle. Unsupervised use of vehicle equipment may cause an accident and / or serious personal injury.

For more information on power windows, see "Power windows" (▷ page 146).

▼ Panic alarm

An audible alarm and flashing turn signal lamps will operate for approximately 2½ minutes.



① **PANIC** button

Activating

- ▶ Press and hold button ① for at least one second.

Deactivating

- ▶ Press button ① again.
- or
- ▶ Insert key in steering lock.

i

For operation in the USA only:
This device complies with Part 15 of the FCC Rules. Operation is subject to the following two conditions:

- (1) This device may not cause harmful interference, and
- (2) this device must accept any interference received, including interference that may cause undesired operation.

Any unauthorized modification to this device could void the user's authority to operate the equipment.

Safety and Security

Driving safety systems

In this section you will find information on the following driving safety systems:

- ABS (Antilock Brake System)
- BAS (Brake Assist System)
- 4-ETS (Electronic Traction System)
- EBP (Electronic Brake Proportioning)
- ESP (Electronic Stability Program)



In winter operation, the maximum effectiveness of the ABS, the BAS, the ESP, the EBP, and the 4-ETS is only achieved with winter tires (M+S tires) or snow chains as required.

Warning!



The following factors increase the risk of accidents:

- Excessive speed, especially in turns
- Wet and slippery road surfaces
- Following another vehicle too closely

The ABS, BAS, ESP and 4-ETS cannot reduce this risk.

Always adjust your driving style to the prevailing road and weather conditions.

ABS

Warning!



Do not pump the brake pedal. Use firm, steady brake pedal pressure instead. Pumping the brake pedal defeats the purpose of the ABS and significantly reduces braking effectiveness.

The Antilock Brake System (ABS) regulates the brake pressure so that the wheels do not lock during braking. This allows you to maintain the ability to steer your vehicle.

The ABS is functional above a speed of approximately 5 mph (8 km/h) independent of road surface conditions.

On slippery road surfaces, the ABS will respond even with light brake pressure.

The  indicator lamp in the instrument cluster (▷ page 25) comes on when you turn the key in the steering lock to position **2**. It goes out when the engine is running.

Braking

At the instant one of the wheels is about to lock up, a slight pulsation can be felt in the brake pedal, indicating that the ABS is in the regulating mode.

- ▶ Keep firm and steady pressure on the brake pedal while experiencing the pulsation.

Continuous, steady brake pedal pressure yields the advantages provided by the ABS, namely braking power and the ability to steer the vehicle.

The pulsating brake pedal can be an indication of hazardous road conditions and functions as a reminder to take extra care while driving.

Emergency brake maneuver

- ▶ Keep continuous full pressure on the brake pedal.



With the ABS malfunctioning, the BAS, the ESP, and the 4-ETS are also switched off.

Normal driving and braking functions are still available.

LOW RANGE- ABS

During off-road driving, a special low range system for the ABS is operational with transmission in LOW RANGE mode (▷ page 127).

When applying the service brakes at speeds below approximately 18 mph (30 km/h), the front wheels are locked cyclically to shorten the braking distance (dig-in effect). This affects steering the vehicle.

Safety and Security

Driving safety systems

Warning!



The ABS cannot prevent the natural laws of physics from acting on the vehicle, nor can it increase braking or steering efficiency beyond that afforded by the condition of the vehicle brakes and tires or the traction afforded. The ABS cannot prevent accidents, including those resulting from excessive speed in turns, following another vehicle too closely, or hydroplaning. Only a safe, attentive, and skillful driver can prevent accidents. The capabilities of an ABS equipped vehicle must never be exploited in a reckless or dangerous manner which could jeopardize the user's safety or the safety of others.

For more information, see "Practical Hints" (▷ page 248).

BAS

The Brake Assist System (BAS) operates in emergency situations. If you apply the brakes very quickly, the BAS automatically provides full brake boost, thereby potentially reducing braking distance. Apply continuous full braking pressure until the emergency braking situation is over. The ABS will prevent the wheels from locking.

When you release the brake pedal, the brakes function again as normal. The BAS is then deactivated.

The  indicator lamp in the instrument cluster (▷ page 25) comes on when you turn the key in the steering lock to position **2**. It goes out when the engine is running.

Warning!



The BAS cannot prevent the natural laws of physics from acting on the vehicle, nor can it increase braking efficiency beyond that afforded by the condition of the vehicle brakes and tires or the traction afforded. The BAS cannot prevent accidents, including those resulting from excessive speed in turns, following another vehicle too closely, or hydroplaning. Only a safe, attentive, and skillful driver can prevent accidents. The capabilities of a BAS equipped vehicle must never be exploited in a reckless or dangerous manner which could jeopardize the user's safety or the safety of others.

For more information, see "Practical hints" (▷ page 251).

4-ETS

The 4-Electronic Traction System (4-ETS) improves vehicle's ability to utilize available traction, especially under slippery road conditions. The brakes are applied to the spinning wheel and power is transferred to the wheel(s) with traction.

The traction control engages at vehicle speeds up to approximately 24 mph (40 km/h), and switches off at approximately 50 mph (80 km/h).

The **ETS** indicator lamp in the instrument cluster (> page 25) comes on when you turn the key to position **2**. It goes out when the engine is running.

The 4-ETS / ESP warning lamp , located in the speedometer dial, starts to flash at any vehicle speed, as soon as the tires lose traction and the wheels begin to spin.

Warning!



When you see the 4-ETS / ESP-warning lamp  flashing in the speedometer, then proceed as follows:

- While driving off, apply as little throttle as possible.
- While driving ease up on the accelerator.
- Adapt your speed and driving style to the prevailing road conditions.

Failure to observe these guidelines could cause the vehicle to skid.

The 4-ETS cannot prevent accidents resulting from excessive speed.



Because of the ESP's automatic operation, the engine must be shut off (Key in steering lock position **0** or **1**) when the parking brake is being tested on a brake test dynamometer.

Active braking action through ESP may otherwise seriously damage the front or rear axle brake system.

Operational tests with the engine running can only be conducted on a two-axle dynamometer.



If the yellow 4-ETS malfunction indicator lamp **ETS** comes on while the 4-ETS / ESP warning lamp  flashes, the electronic traction system is being switched off temporarily to prevent overheating of the drive wheel brakes.

Safety and Security

Driving safety systems

LOW RANGE 4-ETS

During off-road driving, a special low range system for the 4-ETS is operational with transmission in LOW RANGE mode.

For more information, see the “Practical hints” section (▷ page 248) and (▷ page 259).

EBP



The EBP enhances braking effectiveness by allowing the rear brakes to supply a greater proportion of the braking effort without a loss of vehicle stability.

ESP

The Electronic Stability Program (ESP) monitors the vehicle’s traction (force of adhesive friction between the tires and the road surface) and handling.

The ESP recognizes when a wheel is spinning or if the vehicle starts to skid. By applying brakes to the appropriate wheel and by limiting engine output, the ESP works to stabilize the vehicle. The ESP is especially useful while driving off and on wet or slippery road surfaces.

The 4-ETS / ESP warning lamp  in the speedometer flashes when the ESP is engaged.

The  indicator lamp in the instrument cluster (▷ page 25) and the 4-ETS / ESP warning lamp  in the speedometer come on when you turn the key to position **2**. They go out when the engine is running.

Warning!



Never switch off the ESP when you see the 4-ETS / ESP-warning lamp  flashing in the speedometer. In this case, proceed as follows:

- While driving off, apply as little throttle as possible.
- While driving ease up on the accelerator.
- Adapt your speed and driving style to the prevailing road conditions.

Failure to observe these guidelines could cause the vehicle to skid.

The ESP cannot prevent accidents resulting from excessive speed.

Warning!



The ESP cannot prevent the natural laws of physics from acting on the vehicle, nor can it increase the traction afforded. The ESP cannot prevent accidents, including those resulting from excessive speed in turns, following another vehicle too closely, or hydroplaning. Only a safe, attentive, and skillful driver can prevent accidents. The capabilities of an ESP equipped vehicle must never be exploited in a reckless or dangerous manner which could jeopardize the user's safety or the safety of others.



Because of the ESP's automatic operation, the engine must be shut off (Key in steering lock position **0** or **1**) when the parking brake is being tested on a brake test dynamometer.

Active braking action through ESP may otherwise seriously damage the front or rear axle brake system.

Operational tests with the engine running can only be conducted on a two-axle dynamometer.

LOW RANGE – ESP

During off-road driving, a special low range system for the ESP is operational with transmission in LOW RANGE mode (▷ page 127).

In the LOW RANGE mode, the ESP operates in a traction improving fashion specifically adapted for off-road driving. At speeds below 27 mph (45 km/h), the ESP assists in over-/understeering, thus improving vehicle traction.

Switching off the ESP

Warning!



The ESP should not be switched off during normal driving other than in the circumstances described below. Disabling of the system will reduce vehicle stability in standard driving maneuvers.

To improve the vehicle's traction, turn off the ESP in driving situations where it would be advantageous to have the drive wheels spin and thus cut into surfaces for better grip such as:

- starting out on slippery surfaces and in deep snow in conjunction with snow chains
- in sand or gravel
- when driving off-road

Safety and Security

Driving safety systems



Avoid spinning of a drive wheel for an extended period of time with the ESP switched off. This may cause serious damage to the drivetrain which is not covered by the Mercedes-Benz Limited Warranty.



Turn ESP on immediately if the aforementioned circumstances do not apply anymore.

The switch is located on the upper center console.



ESP on/off switch

- ▶ Press upper half of the ESP switch.

The 4-ETS / ESP warning lamp  in the speedometer comes on.

The ESP is deactivated.

If one or more drive wheels are spinning, the 4-ETS / ESP warning lamp  in the speedometer flashes, regardless of the speed.

Traction control brakes a spinning wheel even when the ESP is deactivated.

The ESP always operates when you are braking, even when it has been deactivated.

Warning!



When the 4-ETS / ESP warning lamp  is illuminated continuously, the ESP is switched off.

Adapt your speed and driving to the prevailing road conditions and to the non-operating status of the ESP.

Switching on the ESP

- ▶ Press lower half of the ESP switch until the 4-ETS / ESP warning lamp  in the speedometer goes out.

You are now again in normal driving mode.

For more information, see the “Practical hints” section (▶ page 247).

▼ Anti-theft systems

Immobilizer

The immobilizer prevents unauthorized persons from starting your vehicle.

Activating

Removing the key from the steering lock activates the immobilizer.

Deactivating

Turning the key in the steering lock to position **2** (▷ page 33) deactivates the immobilizer.



In case the engine cannot be started (yet the vehicle's battery is charged), the system is not operational. Contact an authorized Mercedes-Benz Light Truck Center or call 1-800-FOR-MERCEdes (in the USA), or 1-800-387-0100 (in Canada).

Anti-theft alarm system

Once the alarm system has been armed, a visual and audible alarm is triggered when someone:

- opens a door
- opens the liftgate
- opens the hood

The alarm will stay on even if the activating element (a door, for example) is immediately closed.

The alarm system will also be triggered when

- someone attempts to raise the vehicle
- unlocking and opening the driver's door with the mechanical key



If the alarm stays on for more than 30 seconds, a call to the Response Center is initiated automatically by the Tele Aid* system (▷ page 174) provided Tele Aid service was subscribed to and properly activated, and that necessary cellular service and GPS coverage are available.

Arming the alarm system

The alarm system is armed after locking the vehicle with the remote control. The turn signal lamps flash three times to indicate that the alarm system is activated. A red indicator lamp in the center console will flash after approximately 10 seconds when the alarm system is completely armed (▷ page 27).

Safety and Security

Anti-theft systems



If the turn signal lamps do not flash three times, the tow-away - glass breakage sensor is malfunctioning or one of the following elements may not be properly closed:

- a door
- the liftgate
- the hood

Close the respective element and lock the vehicle again.

Disarming the alarm system

The alarm system is disarmed when you unlock your vehicle with the remote control. The turn signal lamps flash once to indicate that the alarm system is deactivated.





The alarm system will rearm automatically again after approximately 40 seconds if one of the doors or the liftgate is not opened.

Canceling the alarm

To cancel the alarm:

- ▶ Switch on ignition (▷ page 33).

or

- ▶ Press the  or  button on the remote control.

The alarm is canceled.

Tow-away alarm, glass breakage sensor

The tow-away alarm and the glass breakage sensor are part of the anti-theft alarm system.

Once the tow-away alarm is armed, a visual and audible alarm will be triggered when someone:

- attempts to raise the vehicle
- breaks a window and reaches into the passenger compartment



The tow-away protection alarm is triggered, for example, if the vehicle is lifted on one side.

If the alarm stays on for more than 30 seconds, a call to the Response Center is initiated automatically by the Tele Aid* system (▷ page 174) provided Tele Aid service was subscribed to and properly activated, and that necessary cellular service and GPS coverage are available.

Safety and Security

Anti-theft systems

Arming tow-away alarm and glass breakage sensor

When you lock your vehicle, the tow-away and glass breakage sensor alarm is automatically armed.

Disarming tow-away alarm and glass breakage sensor

To prevent triggering the tow-away alarm feature, switch off the tow-away alarm and glass breakage sensor before towing the vehicle, or when parking on a surface subject to movement, such as a ferry or auto train.

Vehicles with trip computer*

The buttons are located in the overhead control panel.



- ① Reset button
- ② Mode button
- ③ Display
- ④ Glass breakage sensor

- ▶ Turn key in steering lock to position **2** (▷ page 33).
- ▶ Return key to position **0** and remove it from the steering lock.
- ▶ Within 30 seconds press button ① or ②.
The display shows OFF.
- ▶ Exit vehicle and lock vehicle with remote control (▷ page 32).

The tow-away alarm and glass breakage sensor remain switched off until the key is inserted in steering lock and turned to position **1**.

Safety and Security

Anti-theft systems

*Vehicles without trip computer**

The buttons are located in the overhead control panel.

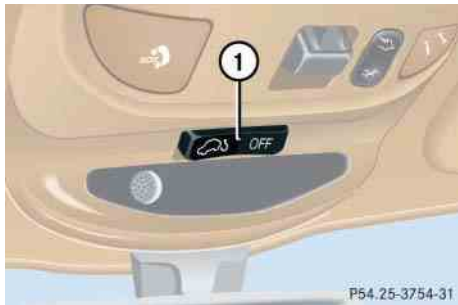

① Switching off tow-away alarm and glass breakage sensor

- ▶ Turn key in steering lock to position **2** (▷ page 33).
- ▶ Return key to position **0** and remove it from the steering lock.
- ▶ Within 30 seconds press button ① on the right or left side.
- ▶ Exit vehicle and lock vehicle with remote control (▷ page 32).



The tow-away alarm and glass breakage sensor remain switched off until the key is inserted in steering lock and turned to position **1**.

Canceling the alarm

To cancel the alarm:

- ▶ Switch on ignition (▷ page 33).

or

- ▶ Press the  or  button on the remote control.

The alarm is canceled.

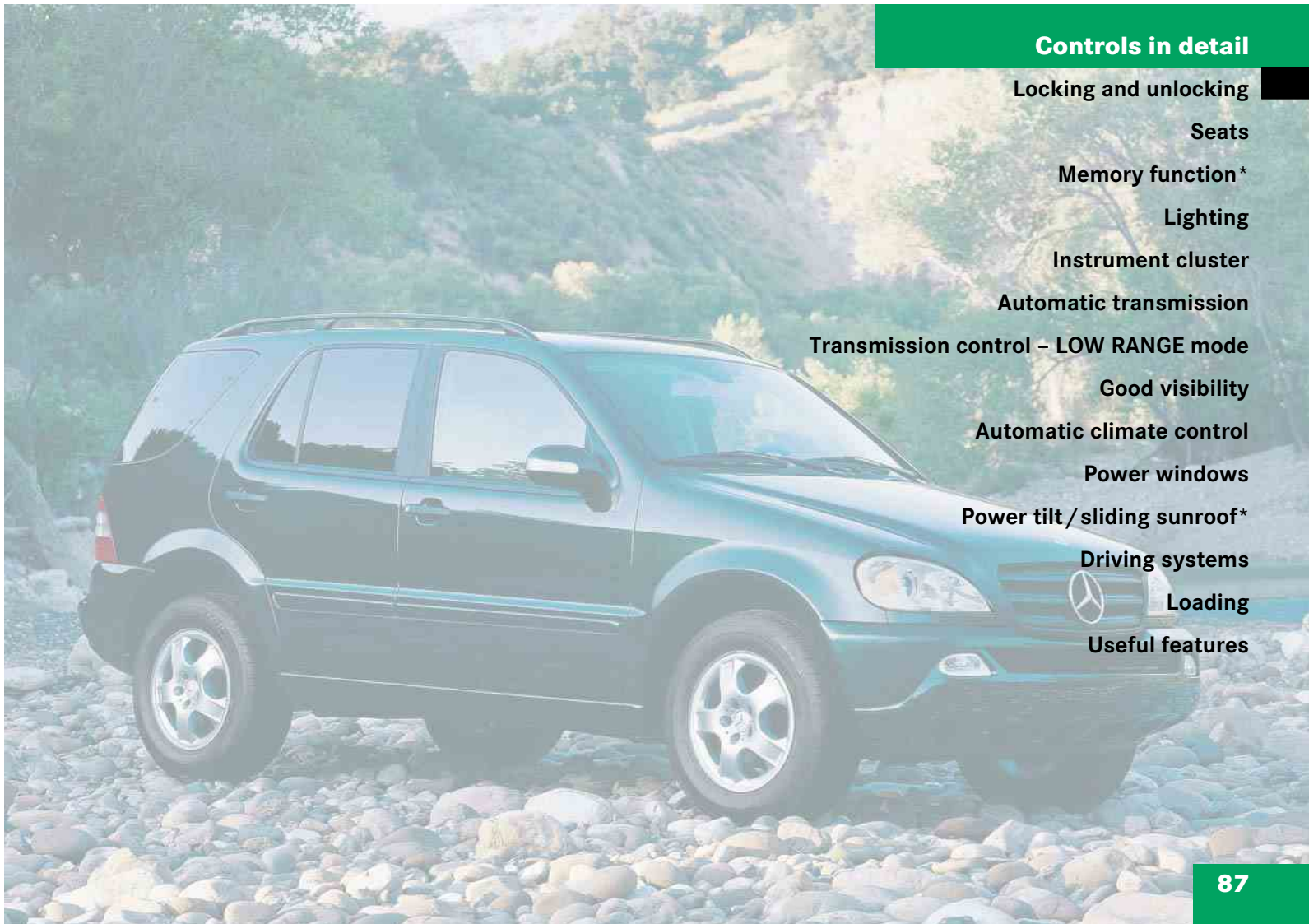

Controls in detail

Locking and unlocking

Seats

Memory function*

Lighting

Instrument cluster

Automatic transmission

Transmission control - LOW RANGE mode

Good visibility

Automatic climate control

Power windows

Power tilt/sliding sunroof*

Driving systems

Loading

Useful features

Controls in detail

Locking and unlocking

In the “Controls in detail” section you will find detailed information on how to operate the equipment installed in your vehicle. If you are already familiar with the basic functions of your vehicle, this section will be of particular interest to you.

To quickly familiarize yourself with the basic functions of the vehicle, refer to the “Getting started” section of this manual. The corresponding page numbers are given at the beginning of each segment.

For more information on locking and unlocking, see “Getting started” (▷ page 31) and (▷ page 55).

Remote control with folding key

Your vehicle comes supplied with two remote controls with folding key.



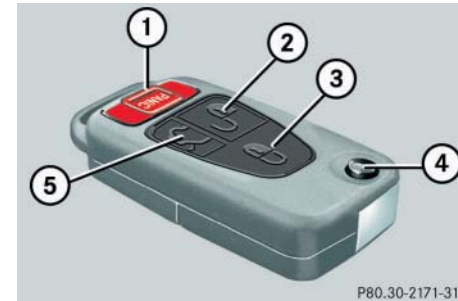

The remote control provides an extended operating range. To prevent theft, however, it is advisable to only unlock the vehicle when you are in close proximity to it.

The key centrally locks and unlocks:

- the doors
- the liftgate
- the fuel filler flap



Remote control with folding key

- ① **PANIC** Panic button (▷ page 75)
- ②  Unlock button
- ③  Lock button
- ④  Release button for key
- ⑤  Unlock button for liftgate

Warning!



When leaving the vehicle, always remove the key from the steering lock, and lock your vehicle. Do not leave children unattended in the vehicle, or with access to an unlocked vehicle. Unsupervised use of vehicle equipment may cause an accident and / or serious personal injury.



To prevent possible malfunction, avoid exposing the remote control to high levels of electromagnetic radiation.



If the key is inserted in the steering lock, the vehicle cannot be locked or unlocked with the remote control.

Unlocking

Global unlocking

- ▶ Press button  twice.

All turn signal lamps flash once. The locking knobs in the doors move up. The anti-theft alarm system is switched off.

The vehicle will lock again automatically and reactivate the anti-theft alarm system within approximately 40 seconds of unlocking if:

- neither door nor liftgate is opened
- the key is not inserted in the starter switch
- the central locking switch is not activated

Controls in detail

Locking and unlocking

Unlocking the driver's door and fuel filler flap

- ▶ Press button  once.

All turn signal lamps flash once. The locking knob in the driver's door moves up. The anti-theft alarm system is switched off.

Unlocking the liftgate

- ▶ Press button .

Only the liftgate unlocks.

Locking

- ▶ Press button  once.

All turn signal lamps flash three times to indicate that all doors, the liftgate and the fuel filler flap are locked. The anti-theft alarm system is activated.

Controls in detail

Locking and unlocking



If you can no longer lock or unlock the vehicle with the remote control, then the batteries in the remote control are discharged, the remote control is malfunctioning or the vehicle battery is drained.

- Check the batteries in the remote control and replace them if necessary (▷ page 273).
- Use the folding key to unlock or lock the driver's door as required (▷ page 268).
- Lock the liftgate if necessary from inside (▷ page 91).
- Check the vehicle battery (▷ page 272).
- Synchronize the remote control (▷ page 273).

If the remote control is malfunctioning, contact an authorized Mercedes-Benz Light Truck Center.

Loss of remote control with folding key

If you lose a remote control or the folding key, you should do the following:

- ▶ Have the remote control deactivated by an authorized Mercedes-Benz Light Truck Center.
- ▶ Report the loss of the remote control or the folding key immediately to your car insurance company.
- ▶ If necessary have the mechanical lock replaced.

Your authorized Mercedes-Benz Light Truck Center will be glad to supply you with a replacement.

Opening the doors from the inside

You can open a locked door from the inside. Open door only when conditions are safe to do so.

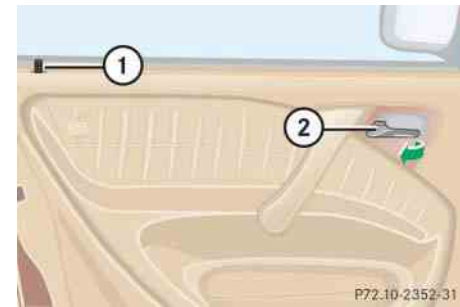

- ① Locking knob
- ② Inside door handle

Front doors

- ▶ Pull on door handle ② on the respective front door to open door.

If door was locked, locking knob ① will move up.

Rear doors

- ▶ Pull up locking knob ① on the respective rear door.
- ▶ Pull on door handle ② on the respective rear door to open door.



If the vehicle has previously been locked from the outside using the remote control, opening a door from the inside will trigger the alarm.

To cancel the alarm, do one of the following:

- Switch on the ignition by turning the key in the steering lock to position 2.
- Press the or button on the remote control.

Opening the liftgate

Opening the liftgate from outside

A minimum height clearance of 7 ft (2.15 m) is required to open the liftgate.

The handle is located above the rear license plate recess.

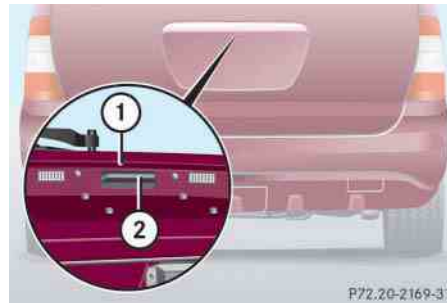

- ① Grip molding
- ② Handle

The vehicle must be unlocked.

- ▶ Pull on handle ②.
- ▶ Swing the liftgate upward by using the grip molding ①.

Controls in detail

Locking and unlocking



Always make sure that there is sufficient overhead clearance.

Opening the liftgate from inside

A minimum height clearance of 7 ft (2.15 m) is required to open the liftgate.

The release lever is located on the inside of the liftgate.

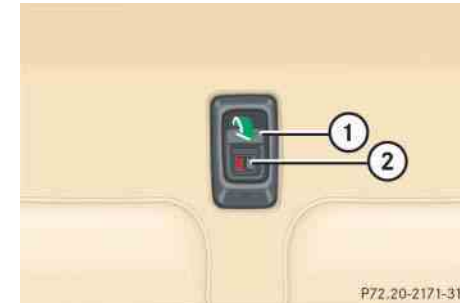

- ① Release lever
- ② Catch

- ▶ To unlock the liftgate, move the catch ② to the right.



Controls in detail

Locking and unlocking

- ▶▶ Pull release lever ① down and swing liftgate upward.



Always make sure that there is sufficient overhead clearance.



To lock the liftgate, move the catch ② to the left.

Closing the liftgate

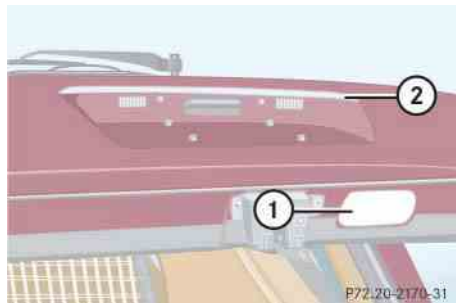

- ① Recessed grip
- ② Grip molding

- ▶ Pull down on recessed grip ①.
- ▶ Close liftgate by using grip molding ②.

Warning!



To prevent possible personal injury, always keep hands and fingers away from the liftgate opening when closing the liftgate. Be especially careful when small children are around.

Do not close the liftgate from the inside by pulling on the handle.

When leaving the vehicle, always remove the key from the steering lock and lock the vehicle. Do not leave children unattended in the vehicle. Children could open the liftgate from inside, which could result in an accident and / or serious personal injury.

Warning!



Only drive with the liftgate closed as exhaust fumes may enter the vehicle interior.



Do not place the key in the cargo compartment. You may lock yourself out.



If the vehicle was previously centrally locked, the liftgate lid will lock automatically when closed. The turn signals will flash three times to confirm locking.

Automatic central locking

The doors and the liftgate automatically lock when the ignition is switched on and the left front wheel turns at vehicle speeds of approximately 9 mph (15 km/h) or more.

You can open a locked door from the inside. Open door only when conditions are safe to do so.

If one of the front doors is then opened from the inside, the vehicle is unlocked centrally unless only the driver's door was previously unlocked.



The doors unlock automatically after an accident if the force of the impact exceeds a preset threshold.

To prevent the vehicle door locks from locking, deactivate the automatic central locking when the vehicle

- is pushed or towed
- is on a test stand
- during a wheel change

You can deactivate the automatic locking using the central locking switch.

Controls in detail

Locking and unlocking

The switch is located on the lower center console.



Central locking switch

- ① Locking
- ② Unlocking

► Switch on ignition (▷ page 33).

Controls in detail

Locking and unlocking

Activating

- ▶ Press and hold upper part ① of the central locking switch for approximately six seconds.

The automatic central locking is activated.

Deactivating

- ▶ Press and hold lower part ② of the central locking switch for approximately six seconds.

The automatic central locking is deactivated.

Locking and unlocking from the inside

You can lock or unlock the doors and the liftgate from inside using the central locking switch. This can be useful, for example, if you want to lock the vehicle before starting to drive.

The fuel filler flap cannot be locked or unlocked with the central locking switch.

Warning!



When leaving the vehicle, always remove the key from the steering lock and lock the vehicle. Do not leave children unattended in the vehicle, or with access to an unlocked vehicle. Unsupervised use of vehicle equipment may cause an accident and / or serious personal injury.

i

You can open a locked door from the inside. Open door only when conditions are safe to do so.

If the vehicle was previously centrally locked using the remote control, it will not unlock using the central locking switch.

The switch is located on the lower center console (▷ page 93).

Locking

- ▶ Press upper part ① of central locking switch.

If all the doors are closed, the vehicle locks.

Unlocking

- ▶ Press lower part ② of central locking switch.

The vehicle unlocks.

▼ Seats

For information on seat adjustment, see the “Getting started” section (▷ page 35).

Removing and installing front seat head restraints

For more information on head restraint adjustment, see the “Getting started” section (▷ page 35).



Adjust the head restraint in such a way that it is as close to the head as possible.

Warning!



For your protection, drive only with properly positioned head restraints.

Adjust head restraint so that the center of the head restraint supports the back of the head at eye level. This will reduce the potential for injury to the head and neck in the event of an accident or similar situation.

Do not drive the vehicle without the seat head restraints. Head restraints are intended to help reduce injuries during an accident.

Do not interchange head restraints from front and rear seat.

Controls in detail

Seats

Front seat head restraints

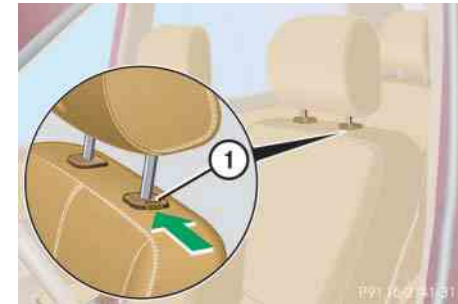

① Release button

Removing front seat head restraints

- ▶ Pull head restraint to its highest position.
- ▶ Push release button ① and pull out head restraint.

Controls in detail

Seats

Installing front seat head restraint

- ▶ Insert head restraint and push it down to the stop.
- ▶ Push release button ① and adjust head restraint to the desired position (▷ page 37).

Rear seat head restraints

Head restraint height

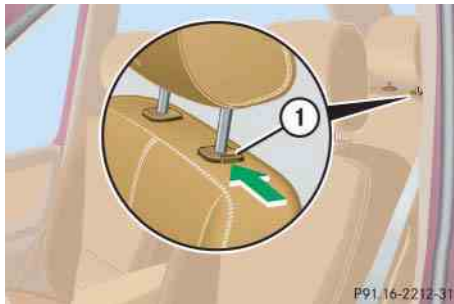

① Release button

Raising:

- ▶ Manually adjust the height of the head restraint by pulling it upward.

Lowering:

- ▶ To lower the head restraint, push release button ① and press down on the head restraint.



Adjust the head restraint in such a way that it is as close to the head as possible.

Warning!



For your protection, drive only with properly positioned head restraints.

Adjust head restraint so that the center of the head restraint supports the back of the head at eye level. This will reduce the potential for injury to the head and neck in the event of an accident or similar situation.

Do not drive the vehicle without the seat head restraints. Head restraints are intended to help reduce injuries during an accident.

Do not interchange head restraints from front and rear seat.

Head restraint tilt

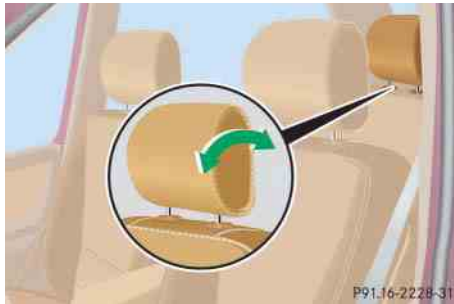

Manually adjust the angle of the head restraint.

- ▶ Push or pull on the upper edge of the head restraint cushion.

For more information on seats, see the “Getting started” section (▷ page 35).

Removing and installing rear seat head restraints

Warning!



For your protection, drive only with properly positioned head restraints.

Adjust head restraint so that the center of the head restraint supports the back of the head at eye level. This will reduce the potential for injury to the head and neck in the event of an accident or similar situation.

Do not drive the vehicle without the seat head restraints. Head restraints are intended to help reduce injuries during an accident.

Do not interchange head restraints from front and rear seat.

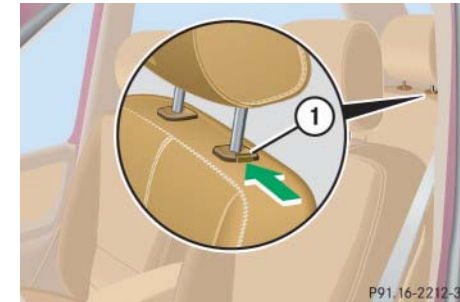

- ① Release button

Removing rear seat head restraints

- ▶ Pull head restraint to its highest position.
- ▶ Push release button ① and pull out head restraint.



For a better view toward the rear, you can store the rear center head restraint underneath the rear seat (▷ page 98).

Controls in detail

Seats

Installing rear seat head restraints

- ▶ Insert head restraint and push it down to the stop.
- ▶ Push release button ① and adjust head restraint to the desired position (▷ page 37).

Stowing rear center head restraint

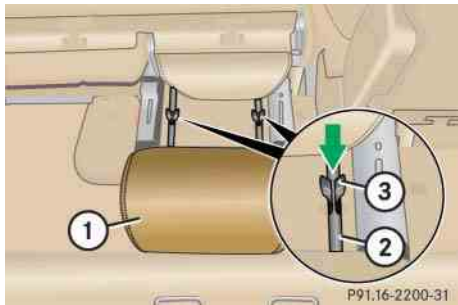

- ① Rear center head restraint
- ② Bar
- ③ Clip

- ▶ Remove rear center head restraint (▷ page 97).
- ▶ If necessary, remove cargo floor plates, see “Removing cargo floor plates” (▷ page 165).
- ▶ Slide rear seats forward, see “Adjusting rear seat fore and aft” (▷ page 100).
- ▶ Fold rear seat backrests down, see “Folding down the backrest” (▷ page 100).

- ▶ From cargo compartment, attach rear center head restraint ① to underside of rear center seat.

Make sure front side of head restraint ① is facing upward.

- ▶ Press bar ② on both sides into clips ③.

Heated seats*

Both switches for the front seats are located in the center console.



- ① Normal heating
- ② Rapid heating

- ▶ Start the engine.

Switching on seat heating

- ▶ Press upper switch position ①.

A red indicator lamp on the switch lights up.

Switching off seat heating

- ▶ Press upper switch position ① again.
The indicator lamp on the switch turns off.



The seat heater will be automatically switched off after approximately 20 minutes.

Switching on rapid seat heating

- ▶ Press lower switch position ②.
Both red indicator lamps on the switch turn on.



The system switches over to normal heating mode after approximately five minutes. Only one red indicator lamp remains on.

Switching off rapid seat heating

- ▶ Press lower switch position ② again.

Both red indicator lamps on the switch turn off.



If one or both of the lamps on the seat heater switch are flashing, there is insufficient voltage available since too many electrical consumers are turned on. The seat heater switches off automatically.

The seat heater will switch back on again automatically as soon as sufficient voltage is available.

Rear seats

Warning!



Do not adjust the rear seats while driving.

When using the rear seats, always make sure the seats are folded up and in the locked position, and the seat belts are properly positioned on the body. Your seat must be adjusted so that you can correctly fasten your seat belt.

Adjust head restraint so that the center of the head restraint supports the back of the head at eye level. This will reduce the potential for injury to the head and neck in the event of an accident or similar situation.

Never place hands under the seat or near any moving parts while a seat is being adjusted.

Controls in detail

Seats

The rear seats are divided asymmetrically. To enlarge the cargo compartment you can adjust the left and right part separately. The following changes are possible:

- moving the seat fore and aft
- folding down the backrest
- lowering the seat

Adjusting rear seat fore and aft

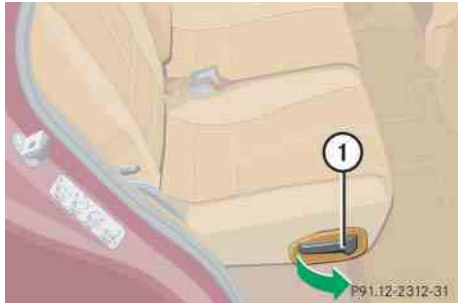

① Release lever

- ▶ Pull release lever ① in direction of arrow.

- ▶ Slide seat to the desired position until it locks in place.

Warning!



Failure to assure that seats are locked into place could result in an increased chance of injury in an accident.

Folding down the backrest



① Lock button

- ▶ Close cup holder (▷ page 170) and ashtray (▷ page 172) in rear center console (▷ page 170).

- ▶ Move front seats forward. Manual seat (▷ page 36) or power seat (▷ page 38).
- ▶ Slide seat forward.
- ▶ Remove head restraint(s) (▷ page 95).
- ▶ Pull lock button ① up and fold backrest forward until it locks in place.

The red backrest lock indicator at lock button ① is not visible in the locked position.

Folding up the backrest

- ▶ Close cup holder (▷ page 170) and ashtray (▷ page 172) in rear center console.
- ▶ Pull lock button ① up and unfold backrest until it locks in place.

Make sure the seat belt is not caught in the seat.

- ▶ Check for secure locking by pulling and pushing on the backrest.

The red backrest lock indicator at lock button ① is not visible in the locked position.

- ▶ Install head restraint (▷ page 96).
- ▶ Slide seat rearward to desired position (▷ page 100).
- ▶ Adjust front seats to desired position. Manual seats (▷ page 36) or power seats (▷ page 38).

Lowering the rear seat



- ① Release button
- ② Lever
- ③ Release lever

- ▶ Close cup holder in rear center console (▷ page 170).
- ▶ Move front seats forward. Manual seat (▷ page 36) or power seat (▷ page 38).
- ▶ Press and hold release button ① to unlock lever ②.
- ▶ Pull lever ② in direction of arrow.
- ▶ Pull release lever ③ and push down rear seat until it locks in place.
- ▶ Fold down the backrest (▷ page 100).
- ▶ Adjust front seats to desired position. Manual seats (▷ page 36) or power seats (▷ page 38).

Controls in detail

Seats

Folding up the rear seat

- ▶ Move front seats forward. Manual seat (▷ page 36) or power seat (▷ page 38).
- ▶ Pull release lever ③ and raise rear seat until it locks in place.

Warning!



Failure to assure that seats are locked into place could result in an increased chance of injury in an accident.

Easy entry / exit feature*

The easy entry / exit feature allows access to the third row seats*. The right cargo floor plate must be removed (▷ page 165).

Warning!



Never drive with the second row right seat folded forward (easy entry / exit feature). It could open and fold back unintentionally.

Controls in detail

Seats

Folding rear seat forward

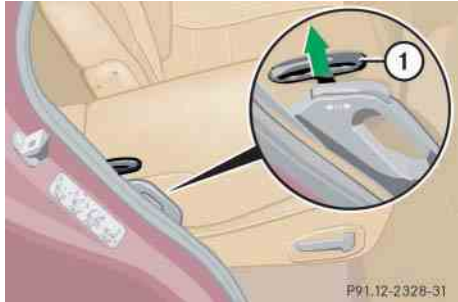

- ① Lever
- ▶ Move right seat forward. Manual seats (▷ page 36) or power seats (▷ page 38).
- ▶ Move rear seat forward (▷ page 100).
- ▶ Push head restraint fully down and tilt it forward.
- ▶ Fold backrest forward (▷ page 100).
- ▶ Pull lever ① up and fold the rear seat forward.

Resetting rear seat



- ▶ Pull down on seat bench until it locks into place.
- ▶ Pull lock button ① (▷ page 100) up and unfold backrest until it locks into place.
The red backrest lock indicator at lock button ① (▷ page 100) is not visible in the locked position.
- ▶ Check for secure locking by pulling and pushing on the backrest.

- ▶ Move the rear and front seats in desired position.
- ▶ Pull up and adjust head restraint (▷ page 37).

Third row seats*

Warning!



For your protection, drive only with properly positioned head restraints.

Adjust head restraint so that the center of the head restraint supports the back of the head at eye level. This will reduce the potential for injury to the head and neck in the event of an accident or similar situation.

Failure to assure that seats are locked into place could result in an increased chance of injury in an accident.

Never place hands under seat or near any moving parts while a seat is being adjusted.

Folding down single seat

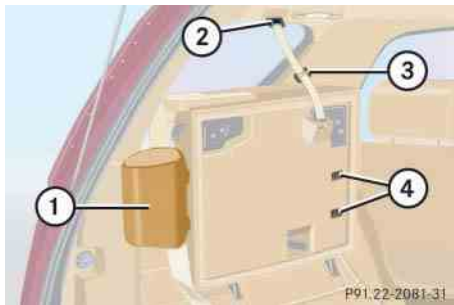

- ① Head restraint
- ② Hook
- ③ Tensioner
- ④ Hook and loop fastener strip

- ▶ Remove cargo floor plate (▷ page 165).
- ▶ Remove head restraint ① from seat cushion.
- ▶ Lift tensioner ③ upward to a horizontal position to release tension of the belt.
- ▶ Disengage hook ② while holding onto the seat firmly with one hand.

- ▶ Attach belt at hook and loop fastener strip ④ (▷ page 103) on underside of seat.

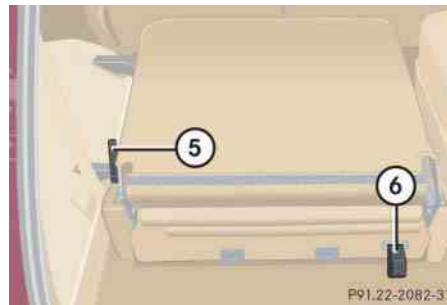

- ⑤ Backrest release
- ⑥ Seat release
- ▶ Fold seat down until it locks securely in place.
The red marking on the seat release ⑥ should not be visible.
- ▶ Store cargo floor plates inside the backrest (▷ page 165).
- ▶ Pull backrest release ⑤ and unfold backrest until it locks securely in place.

- ▶ Install head restraint ① in backrest (▷ page 103).

Storing single seat



- ▶ Remove head restraint from backrest (▷ page 103).
- ▶ Pull backrest release ⑤ and fold backrest forward until it locks securely in place.
- ▶ Remove cargo floor plates from the backrest.
- ▶ Pull seat release ⑥ (▷ page 103) and fold seat up.

▷▷

Controls in detail

Seats

- ▷▷ Disengage belt and engage hook ② (▷ page 103) in ceiling mount.
- ▶ Pull on free end of belt until tight.
- ▶ Install head restraint in openings provided in seat cushion.
- ▶ Install cargo floor plates (▷ page 165).

Warning!



After folding the seats up, manually place the lap belt portion of the seat belt behind the seat (arrow). Otherwise, the lap belt may be subject to damage and could rip.

Removing single seat

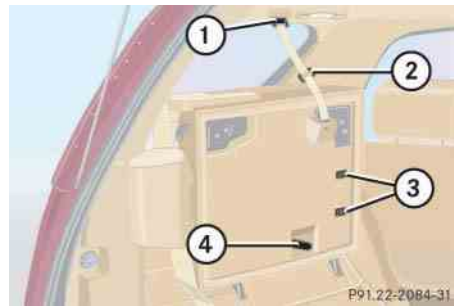

- ① Hook
- ② Tensioner
- ③ Hook and loop fastener strip
- ④ Release lever

- ▶ Lift tensioner ② upward to a horizontal position to release tension of the belt.
- ▶ Disengage hook ① while holding onto the seat firmly with one hand.
- ▶ Attach belt at hook and loop fastener strip ③ on underside of seat.
- ▶ Move release lever ④ upward and remove seat.

Installing single seat

- ▶ Place seat into the mounting clamps and click the seat into place.

▼ Memory function*



Prior to operating the vehicle, the driver should check and adjust the seat height, seat position fore and aft, and seat backrest angle if necessary, to ensure adequate control, reach and comfort. The head restraint should also be adjusted for proper height. See also the section on airbags (▷ page 59) for proper seat positioning.

In addition, adjust the steering wheel to ensure adequate control, reach, operation and comfort. Both the interior and exterior rear view mirrors should be adjusted for adequate rear vision.

Fasten seat belts. Infants and small children should be seated in a properly secured restraint system that complies with U.S. Federal Motor Vehicle Safety Standard 213 and 225 and Canadian Motor Vehicle Safety Standards 213 and 210.2.

With the memory button you can store up to three different settings for the driver- and passenger seat.

Together with the driver's seat you can store the exterior rear view mirrors.

For the front passenger seat you can store the seat position.

Warning!



Do not activate the memory function while driving. Activating the memory function while driving could cause the driver to lose control of the vehicle.

Controls in detail

Memory function*



- ① Position button
- ② Memory button

► Switch on ignition (▷ page 33).

Controls in detail

Memory function*

Storing positions into memory

- ▶ Adjust the seat (▷ page 38) and exterior rear view mirrors (▷ page 41) to the desired position.
- ▶ Push memory button ② (▷ page 105).
- ▶ Release memory button and press one of the position buttons ① within three seconds.

All the settings are stored at the selected position.

Recalling positions from memory



Do not operate the power seats using the memory button if the seat backrest is in an excessively reclined position. Doing so could cause damage to front or rear seats.

- ▶ Press and hold one of the position buttons ① until seat and rear view mirrors have fully moved to the stored positions.



Releasing the button immediately stops movement to the stored positions.

Storing exterior rear view mirror parking position

For easier parking, you can adjust the passenger-side exterior rear view mirror so that you can see the right rear wheel as soon as you engage reverse gear **R**.

For information on activating the parking position feature, see “Activating exterior rear view mirror parking position” (▷ page 129).

Storing parking position

- ▶ Stop the vehicle.
- ▶ Switch on ignition (▷ page 33).
- ▶ Press button ②.

The passenger-side exterior rear view mirror is selected.

- ▶ Adjust the exterior rear view mirror with button ③ so that you see the rear wheel and the road curb.
- ▶ Press memory button ② (▷ page 105).
- ▶ Within three seconds, press bottom of adjustment button ③.

The parking position is stored if the mirror does not move.



If the mirror does move, repeat the above steps. After the setting is stored you can move the mirror again.

The selected position will be stored relative to the position button ① (▷ page 105) pressed.

▼ Lighting

For information on how to switch on the headlamps and use the turn signals, see the “Getting started” section (▷ page 50).



If you drive in countries where vehicles drive on the other side of the road than the country in which the vehicle is registered, you must have the headlamps modified for symmetrical low beams. Relevant information can be obtained at your authorized Mercedes-Benz Light Truck Center.

Combination switch



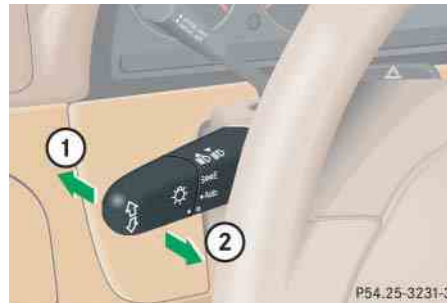

The combination switch is on the left of the steering column.



- ① High beam
- ② High beam flasher

Controls in detail

Lighting

-  Off
Daytime running lamp mode (Canada only) (▷ page 109)
-  **AUTO** Automatic headlamp mode
Daytime running lamp mode (Canada only) (▷ page 109)
-  Parking lamps (also tail lamps, license plate lamps, side marker lamps, instrument panel lamps)
-  Low beam headlamps (or high beam headlamps when the combination switch is pushed forward) and parking lamps
-  Left or right standing lamps (symbol on underside of switch)

Controls in detail

Lighting



With the key removed from the steering lock and the driver's door open, a warning sounds if the parking lamps or low beam headlamps are switched on (▷ page 107).

Manual headlamp mode

The low beam headlamps and the parking lamps can be switched on and off with the combination switch.

Automatic headlamp mode

The following lamps switch on and off automatically depending on the brightness of the ambient light.

- Low beam headlamps
- Tail and parking lamps
- License plate lamps
- Side marker lamps



Warning!



If the combination switch is set to **AUTO**

- the headlamps may switch off unexpectedly when the system senses bright ambient light, for example light from oncoming traffic.
- the headlamps will not be automatically switched on under foggy conditions.

To minimize risk to you and to others, activate headlamps by turning combination switch to  when driving or when traffic and / or ambient lighting conditions require you to do so.

In low ambient lighting conditions, only switch from position **AUTO** to  with the vehicle at a standstill. Switching from **AUTO** to  will briefly switch off the headlamps. Doing so while driving in low ambient lighting conditions may result in an accident.

The automatic headlamp feature is only an aid to the driver. The driver is responsible for the operation of the vehicle's lights at all times.

- ▶ Turn the combination switch to position **AUTO**.

With the key in steering lock position **1** only the parking lamps will switch on and off automatically.

With the engine is running, the low beam headlamps, the tail and parking lamps, the license plate lamps, and the side marker lamps will switch on and off automatically.

They will be switched on constantly, when you switch on the front fog lamps.

Daytime running lamp mode

Canada only:

- ▶ Turn combination switch to position  or **AUTO**.

When the engine is running, the low beam headlamps are switched on.



In low ambient light conditions, the following lamps will switch on additionally:

- Tail and parking lamps
- License plate lamps
- Side marker lamp

For nighttime driving you should turn the combination switch to position  to permit activation of the high beam headlamps.

When the engine is running, and you shift from a driving position to position **N** or **P**, the low beam headlamps will switch off with a three minutes delay.

When the engine is running, and you

- turn the combination switch to position , the parking lamps switch on additionally.
- turn the combination switch to position , the manual headlamp mode has priority over the daytime running lamp mode.

The corresponding exterior lamps switch on (▷ page 107).



With the daytime running lamp mode and the combination switch in position , the high beam headlamps cannot be switched on.

The high beam flasher is always available.

Night security illumination

Use this function to set whether and how long you would like the exterior lamps to illuminate during darkness after exiting the vehicle and all doors closed.

When a time is set for the night security illumination and the combination switch is set to position **AUTO** before turning off the engine, the following lamps will come on after you have removed the key from the steering lock:

- Tail and parking lamps
- License plate lamps
- Side marker lamps
- Front fog lamps



You can reactivate this function within ten minutes by opening a door.

If you do not open a door or do not close an opened door after turning off the engine, the lamps will automatically switch off after 60 seconds.

Controls in detail

Lighting

Setting illumination time



① Fog lamps switch

- ▶ Switch on ignition (▷ page 33).
- ▶ Turn combination switch to position **0**.
- ▶ Press and hold the upper part of fog lamps switch ① until the clock in the instrument cluster displays the actual illumination time.

- ▶ Release fog lamps switch ①.

- ▶ Press the upper part of fog lamps switch ① again.

Each time the switch is pressed, the illumination time increases by 15 seconds. You can set the illumination time between 0 (off) and 60 seconds.

The time is factory-set to 0 seconds.

Approximately five seconds after pressing the switch, the illumination time is adopted and the clock is displayed again.

- ▶ Turn the combination switch to position **AUTO** before turning off the engine (▷ page 107).

The night security illumination is activated.

Deactivating night security illumination temporarily

You can temporarily deactivate the delayed shut-off feature.

- ▶ Before exiting the vehicle, turn the key in the steering lock to position **0**.
- ▶ Then turn it to position **2** and back to position **0**.

The delayed shut-off feature is deactivated. It will reactivate as soon as you reinsert the key in the steering lock.

Locator lighting

With the locator lighting feature activated, the following lamps will switch on when the vehicle is unlocked by remote control during darkness:

- Tail and parking lamps
- License plate lamps
- Side marker lamps
- Front fog lamps
- Additional lamps in the exterior rear view mirrors.

The locator lighting switches off when the driver's door is opened.

If you do not open a door after unlocking by remote control the lamps will switch off automatically after of approximately 40 seconds.

- ▶ Turn the combination switch to position **AUTO** when exiting the vehicle (▷ page 107).

The locator lighting is activated.

High beam

- ▶ Turn the combination switch to position  or **AUTO** (▷ page 107).
- ▶ Push the combination switch in direction of arrow ① to switch on the high beam (▷ page 107).

The high beam headlamp indicator lamp  in the instrument cluster comes on.

- ▶ Pull the combination switch in direction of arrow ② to its original position to switch off the high beam.

The high beam indicator lamp  in the instrument cluster goes out.



High beam flasher

- ▶ Pull the combination switch briefly in direction of arrow ② (▷ page 107).

Fog lamps

Warning!



In low ambient lighting or foggy conditions, only switch from position **AUTO** to  with the vehicle at a standstill. Switching from **AUTO** to  will briefly switch off the headlamps. Doing so while driving in low ambient lighting conditions may result in an accident.



Fog lamps will operate with the parking lamps and / or low beam headlamps on. Fog lamps should only be used in conjunction with low beam headlamps. Consult your State or Province Motor Vehicle Regulations regarding permissible lamp operation.

Controls in detail

Lighting



- ① Front fog lamps
- ② Indicator lamp
- ③ Front fog lamps and rear fog lamp



When switching on the front fog lamps, the low beam headlamps, the tail and parking lamps, the license plate lamps and the side marker lamps are also switched on when

- the combination switch is set to position **AUTO**
- the ignition is switched on or the engine is running

Front fog lamps

- ▶ Switch the low beam headlamps on (▷ page 107).
- ▶ Press upper part ① of the fog lamps switch.

The front fog lamps are switched on.

The green indicator lamp  in the instrument cluster comes on.

- ▶ Press upper part ① of the fog lamps switch again.

The front fog lamps switch off.

The green indicator lamp  in the instrument cluster goes out.

Front and rear fog lamps

- ▶ Switch the low beam headlamps on (▷ page 107).
- ▶ Press lower part ③ of the fog lamps switch.

The front and rear fog lamps are switched on.

The green indicator lamp  in the instrument cluster and the yellow indicator lamp ② in the fog lamps switch come on.

- ▶ Press lower part ③ of the fog lamps switch again.

The front and rear fog lamps switch off.

The green indicator lamp  in the instrument cluster and the yellow indicator lamp ② in the fog lamps switch go out.

Switching off the rear fog lamp separately when both, the front and rear fog lamps are switched on:

- ▶ Press upper part ① of the fog lamps switch.

The rear fog lamp switches off.

The yellow indicator lamp ② in the fog lamp switch goes out.

The front fog lamps remain lit.

Hazard warning flasher

The hazard warning flasher can be switched on at all times, even with the key removed from the steering lock.

The hazard warning flasher switches on automatically when an airbag deploys.

The hazard warning flasher switch is located on the top of the steering column.



Hazard warning flasher switch

Controls in detail

Lighting

Switching on hazard warning flasher

- ▶ Press the hazard warning flasher switch.

All turn signals will flash.



With the hazard warning flasher activated and the combination switch set for either left or right turn, only the respective turn signals will operate when the ignition is switched on (▷ page 33).

Switching off hazard warning flasher

- ▶ Press the hazard warning flasher switch again.



If the hazard warning flasher has been activated automatically, press the hazard warning flasher switch once to switch it off.

Controls in detail

Lighting

Interior lighting

The controls are located in the overhead control panel.

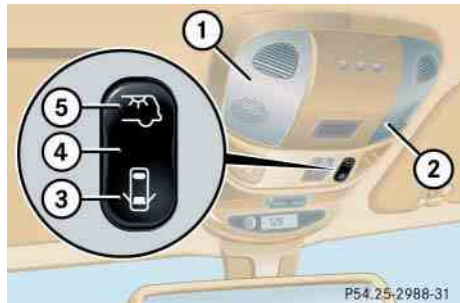

Interior lighting switch

- ① Left front interior lamp lens
- ② Right front interior lamp lens
- ③ Automatic control off
- ④ Automatic control on
- ⑤ Rear interior lighting



An interior lamp switched on manually does not go out automatically. This could cause the battery to become discharged.

Automatic control

Activating

- ▶ Press the interior lighting switch to center position ④.

The interior lighting (except cargo compartment lamps) switches on in darkness, when you:

- unlock the vehicle
- remove the key from the steering lock
- open a door

The interior lighting switches off automatically after a brief delay when all doors are closed and no key is inserted in the steering lock.



If the door remains open, the interior lighting switches off automatically after approximately 30 minutes.

Deactivating

- ▶ Press lower part ③ of the interior lighting switch.

The interior lighting remain switched off in darkness, even when you:

- unlock the vehicle
- remove the key from the steering lock
- open a door

Manual control



With the key in the steering lock position **0** or removed, the interior lighting can be switched on for up to 30 minutes.

Front interior lighting

- ▶ Press front interior lamp lens ① or ②. The corresponding front interior lamp switches on.
- ▶ Press respective front interior lamp lens ① or ② again. The corresponding front interior lamp switches off.

Rear interior lighting

- ▶ Press upper part ⑤ of the interior lighting switch to switch the rear interior lighting on or off.

Operating rear interior lighting with lamp lens



Rear interior lighting

- ▶ Press gently on lamp lens in direction of arrow to switch the rear interior lighting on or off.

Controls in detail

Lighting

Reading lamps



- ① Reading lamp
- ② Reading lamp on / off
- ▶ Press reading lamp button ② to switch the desired reading lamp on or off.

Controls in detail

Lighting

Cargo compartment lamp

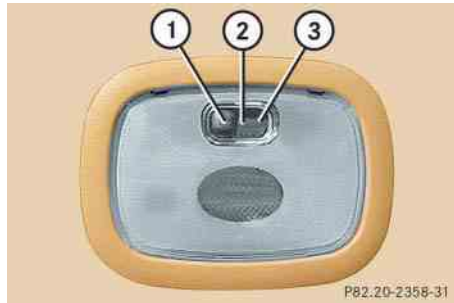

- ① Switched off
- ② Switched on
- ③ Automatic control

Switched off continuously

- ▶ Slide the cargo compartment lamp switch to position ①.
The cargo compartment lamp is switched off continuously.

Switched on continuously

- ▶ Slide the cargo compartment lamp switch to position ②.
The cargo compartment lamp is switched on continuously.



When leaving the vehicle, make sure the cargo compartment lamp switch is not in position ② to prevent the vehicle battery from being discharged.

Automatic control

- ▶ Slide the cargo compartment lamp switch to position ③.
The cargo compartment lamp switches on when you open the liftgate.
It switches off when you close the liftgate.

▼ Instrument cluster

For a full view illustration of the instrument cluster, see the “At a glance” section (▷ page 24).



- ① Left knob
- ② Right knob

The instrument cluster is activated when you:

- open the driver's door
- switch on ignition (▷ page 33)
- press the left knob ①

Controls in detail

Instrument cluster

Instrument cluster illumination



You can set the instrument cluster illumination with the following lamps on:

- parking lamps
- low beam headlamps
- high beam headlamps

To brighten illumination

- ▶ Turn knob ① clockwise.

The instrument cluster illumination will brighten.

To dim illumination

- ▶ Turn knob ① counterclockwise.

The instrument cluster illumination will dim.

Controls in detail

Instrument cluster

Coolant temperature gauge

Under normal driving conditions, the coolant temperature may rise to 248°F (120°C). The coolant temperature may climb to the red marking:

- at high outside temperatures
- during stop-and-go city traffic
- when driving on hilly terrain

The engine should not be operated with the coolant temperature in the red zone. Doing so may cause serious engine damage which is not covered by the Mercedes-Benz Limited Warranty.

Warning!



Driving when your engine is badly overheated can cause some fluids which may have leaked into the engine compartment to catch fire. You could be seriously burned.

Steam from an overheated engine can cause serious burns and can occur just by opening the engine hood. Stay away from the engine if you see or hear steam coming from it.

Turn off the engine, get out of the vehicle and do not stand near the vehicle until the engine has cooled down.

Display in the speedometer

Changing display

- ▶ Press the left knob  in the instrument cluster (▷ page 117).

The display changes between main odometer and trip odometer.

- ▶ Press the left knob  twice.

The next scheduled service is displayed (▷ page 237).

Resetting trip odometer

- ▶ Press the left knob ① (▷ page 117) repeatedly until you see the trip odometer display.
- ▶ Press and hold the left knob ① until the trip odometer is reset.

Tachometer

To help protect the engine, the fuel supply is interrupted if the engine is operated above its specified limit.

Outside temperature indicator

Warning!



The outside temperature indicator is not designed to serve as an ice-warning device and is therefore unsuitable for that purpose.

Indicated temperatures just above the freezing point do not guarantee that the road surface is free of ice. The road may still be icy, especially in wooded areas or on bridges.

The outside temperature is displayed in the instrument cluster (▷ page 24).

When moving the vehicle into colder ambient temperatures (e.g. when leaving your garage), you will notice a delay before the lower temperature is displayed.

A delay also occurs when ambient temperatures rise. This prevents inaccurate temperature indications caused by heat radiated from the engine during idling or slow driving.

Setting the clock

Hour

- ▶ Pull out the right knob ② in the instrument cluster (▷ page 117) and turn it counterclockwise.

Minutes

- ▶ Pull out the right knob ② in the instrument cluster (▷ page 117) and turn it clockwise.



To set the clock by a single hour or a few minutes, turn knob ② just a few degrees in the direction indicated for hours or minutes.

Controls in detail

Automatic transmission

For information on driving with an automatic transmission, see the “Getting started” section (▷ page 47).

Your vehicle’s transmission adapts its gear shifting process to your individual driving style by continually adjusting the shift points up or down. These shift point adjustments are performed based on current operating and driving conditions.

If the operating conditions change, the automatic transmission reacts by adjusting its gear shift program.



During the brief warm-up, transmission upshifting is delayed. This allows the catalytic converter to heat up more quickly to operating temperature.

The automatic transmission selects individual gears automatically, depending on:

- the gear selector lever position **D** with gear ranges **4, 3, 2, 1** (▷ page 122)
- the position of the accelerator pedal (▷ page 124)
- the vehicle speed

The current gear selector lever position appears in the tachometer display (▷ page 24).

Warning!



It is dangerous to shift the gear selector lever out of **P** or **N** if the engine speed is higher than idle speed. If your foot is not firmly on the brake pedal, the vehicle could accelerate quickly forward or reverse. You could lose control of the vehicle and hit someone or something. Only shift into gear when the engine is idling normally and when your right foot is firmly on the brake pedal.

When the gear selector lever is in position **D**, you can influence transmission shifting by

- limiting the gear range
- changing gears manually

One-touch gearshifting

Even with an automatic transmission you can change the gears manually when the gear selector lever is in position **D**.

Downshifting

- ▶ Briefly press the gear selector lever to the left in the **D-** direction.

The transmission will shift from the current gear to the next lower gear. This action simultaneously limits the gear range of the transmission (> page 122).

Warning!



On slippery road surfaces, never downshift in order to obtain braking action. This could result in drive wheel slip and reduced vehicle control. Your vehicle's ABS will not prevent this type of loss of control.



To avoid overrevving the engine when the gear selector lever is moved to the **D-** direction, the transmission will not shift to a lower gear if the engine's max. speed would be exceeded.

Upshifting

- ▶ Briefly press the gear selector lever to the right in the **D+** direction.

The transmission will shift from the current gear to the next higher gear as permitted by the shift program. This action simultaneously extends the gear range of the transmission.

Controls in detail

Automatic transmission

Canceling gear range limit

- ▶ Press and hold the gear selector lever in the **D+** direction until **D** reappears in the tachometer display.

The transmission will shift from the current gear range directly to gear range **D**.

Shifting into optimal gear range

- ▶ Press and hold the gear selector lever in the **D-** direction.

The transmission will automatically select the gear range suited for optimal acceleration and deceleration. This will involve shifting down one or more gears.

Controls in detail

Automatic transmission

Gear ranges

With the gear selector lever in position **D**, you can limit the transmission's gear range by pressing the gear selector lever to the left (**D-**), and reverse the gear range limit by pressing the gear selector lever to the right (**D+**).

The selected gear range appears in the tachometer display. If you press on the accelerator when the engine has reached its rpm limit, the transmission will upshift beyond any gear range limit selected.

	Effect
4	The transmission shifts through fourth gear only.
3	The transmission shifts through third gear only. With this selection you can use the braking effect of the engine.

	Effect
2	The transmission shifts through second gear only. Allows the use of engine's braking power when driving: <ul style="list-style-type: none">• on steep downgrades• in mountainous regions• under extreme operating conditions
1	The transmission operates in first gear only. For maximum use of engine's braking effect on very steep or lengthy downgrades.

Controls in detail

Automatic transmission

Gear selector lever position

	Effect
P	Park position Gear selector lever position when the vehicle is parked. Place gear selector lever in position P only when vehicle is stopped. The park position is not intended to serve as a brake when the vehicle is parked. Rather, the driver should always set the parking brake in addition to placing the gear selector lever in position P to secure the vehicle.

	Effect
	The key can only be removed from the steering lock with the gear selector lever in position P . With the key removed, the gear selector lever is locked in position P . If the vehicle's electrical system is malfunctioning, the gear selector lever could remain locked in position P (▷ page 270).
R	Reverse gear Place gear selector lever in position R only when vehicle is stopped.

	Effect
N	Neutral No power is transmitted from the engine to the drive axle. When the brakes are released, the vehicle can be moved freely (pushed or towed). To avoid damage to the transmission, never engage N while driving. If the ESP is deactivated or malfunctioning: Move gear selector lever to N only if the vehicle is in danger of skidding, e.g. on icy roads.
D	Drive The transmission shifts automatically. All five forward gears are available.

Controls in detail

Automatic transmission



Coasting the vehicle, or driving for any other reason with gear selector lever in **N** can result in transmission damage that is not covered by the Mercedes-Benz Limited Warranty.

Warning!



Getting out of your vehicle with the gear selector lever not fully engaged in position **P** is dangerous. Also, position **P** alone is not intended to or capable of preventing your vehicle from moving, possibly hitting people or objects.

Always set the parking brake in addition to shifting to position **P** (▷ page 54).

When parked on an incline, turn the front wheels towards the road curb.

Warning!



Do not park this vehicle in areas where combustible materials such as grass, hay or leaves can come into contact with the hot exhaust system, as these materials could be ignited and cause a vehicle fire.

Warning!



When leaving the vehicle, always remove the key from the steering lock, take it with you and lock the vehicle. Do not leave children unattended in the vehicle, or with access to an unlocked vehicle. Children could move the gear selector lever from position **P**, which could result in an accident and / or serious personal injury.

Driving tips

Accelerator position

Your driving style influences the transmission's shifting behavior:

Less throttle	Earlier upshifting
More throttle	Later upshifting

Kickdown

Use kickdown when you want maximum acceleration.

- ▶ Press the accelerator past the point of resistance.
The transmission shifts into a lower gear.
- ▶ Ease on the accelerator when you have reached the desired speed.
The transmission shifts up again.

Stopping

When you stop briefly, e.g. at traffic lights:

- ▶ Leave the transmission in gear.
- ▶ Hold the vehicle with the brake.

When you stop longer with the engine idling or on an uphill gradient:

- ▶ Move the gear selector lever to position **P**.
- ▶ Set the parking brake.

Maneuvering

When you maneuver in tight areas, e.g. when pulling into a parking space:

- ▶ Control the vehicle speed by gradually releasing the brakes.
- ▶ Accelerate gently.
- ▶ Never abruptly step on the accelerator.

Working on the vehicle

Warning!



When working on the vehicle, set the parking brake and move gear selector lever to position **P**. Otherwise the vehicle could roll away.

Towing a trailer

If you tow a trailer, note the following points:

- Manually shift to a lower gear range (**4, 3, 2, 1**), if the transmission hunts between gears on inclines (▷ page 122).

A lower gear range and reduction of speed reduces the change to overload or overheat the engine.

- At very steep inclines switch transfer case to LOW RANGE mode (▷ page 127).

For more information on trailer towing, see the “Operation” section (▷ page 211).

Controls in detail

Automatic transmission

Emergency operation (Limp Home Mode)

If vehicle acceleration worsens or the transmission no longer shifts, the transmission is most likely operating in limp home (emergency operation) mode. In this mode only second gear and reverse gear can be activated.

- ▶ Stop the vehicle.
- ▶ Move gear selector lever to position **P**.
- ▶ Turn off the engine.
- ▶ Wait at least ten seconds before restarting.
- ▶ Restart the engine.
- ▶ Move selector lever to position **D** (for second gear) or **R**.
- ▶ Have the transmission checked at an authorized Mercedes-Benz Light Truck Center as soon as possible.

Transmission control – LOW RANGE mode

▼ Transmission control – LOW RANGE mode

In the following situations you should switch to LOW RANGE mode:

- during off-road driving
- when crossing water
- when towing up or down on steep gradients



Only switch the LOW RANGE mode on or off, when the vehicle is

- at a complete standstill
- the engine speed is less than 1500 rpm

Failure to do so may result in transmission or engine damage which is not covered by the Mercedes-Benz Limited Warranty.



You should only operate the vehicle on a single axle dynamometer for briefly testing the brakes.

The key must be in steering lock position 1 (▷ page 33).

Switching on LOW RANGE mode



LOW RANGE mode switch

- ▶ Stop the vehicle.
- ▶ Move the gear selector lever to position **N**.

- ▶ Press on the upper part of the switch.

During the changeover the indicator lamp (▷ page 25) flashes three times.

Once the changeover is complete, the indicator lamp comes on continuously.

Switching off LOW RANGE mode

- ▶ Stop the vehicle.
 - ▶ Move the gear selector lever to position **N**.
 - ▶ Press on the upper part of the switch.
- During the changeover the indicator lamp (▷ page 25) flashes three times.
- Once the changeover is complete, the indicator lamp goes out.

For information on driving safety systems during LOW RANGE mode, see the “Safety and Security” section (▷ page 76).

Controls in detail

Good visibility

For more information, see “Windshield wipers” (▷ page 51) and “Mirrors” (▷ page 41).

Rear view mirrors

Interior rear view mirror, antiglare position

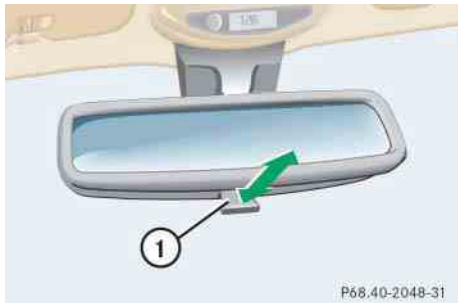

① Lever

- ▶ Tilt the mirror to the antiglare night position by moving lever ① towards the windshield.

The interior rear view mirror is dimmed.

Automatic antiglare rear view mirrors*

The reflection brightness of the exterior rear view mirror on the driver's side and the interior rear view mirror will respond automatically to glare when:

- the automatic antiglare function is activated (▷ page 129)
- the ignition is switched on
- incoming light from headlamps falls on the sensor in the interior rear view mirror

The rear view mirror will not react if

- reverse gear is engaged
- the interior light is turned on

Warning!



The automatic antiglare function does not react if incoming light is not aimed directly at sensors in the interior rear view mirror.

The interior rear view mirror and the exterior rear view mirror on the driver's side do not react, for example, if the cargo compartment is fully loaded.

Glare can endanger you and others.

Warning!



In the case of an accident, liquid electrolyte may escape from the mirror housing if the mirror glass breaks.

Electrolyte has an irritating effect. Do not allow the liquid to come into contact with eyes, skin, clothing, or respiratory system. In case it does, immediately flush affected area with water, and seek medical help if necessary.

Warning!



Exercise care when using the passenger-side exterior rear view mirror. The mirror surface is convex (outwardly curved surface for a wider field of view). Objects in mirror are closer than they appear. Check your interior rear view mirror or glance over your shoulder before changing lanes.



Electrolyte drops coming into contact with the vehicle paint finish can be completely removed only while in the liquid state and by applying plenty of water.

Activating



- ① Button
- ② Indicator lamp
- ▶ Press button ①.
Indicator lamp ② comes on.

Deactivating

- ▶ Press button ① again.
Indicator lamp ② goes out.

Controls in detail

Good visibility

Activating exterior rear view mirror parking position

The buttons are located on the lower part of the center console.

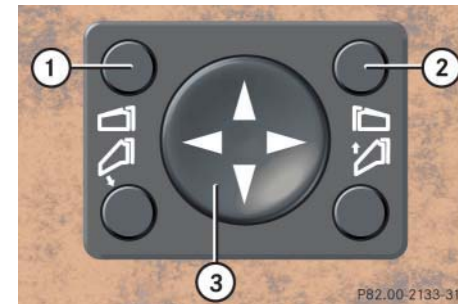

- ① Deactivating parking position
- ② Activating parking position
- ③ Adjustment button
- ▶ Make sure you have stored a parking position for the passenger-side exterior rear view mirror (▷ page 106).
- ▶ Switch on ignition (▷ page 33).
- ▶ Press button ② for the passenger-side exterior rear view mirror. ▷▷

Controls in detail

Good visibility

- ▷▷ Place the gear selector lever in reverse gear **R**.

The passenger-side exterior rear view mirror will be turned downward to the stored position.

The exterior rear view mirror returns to its previously stored driving position:

- ten seconds after you put the gear selector lever in position **D**
- immediately once you exceed a vehicle speed of approx. 6 mph (10 km/h)
- immediately when you press the button ① for driver's side mirror



If the button ① is pressed, the automatic passenger-side exterior rear view parking position is deactivated.

Electrically folding exterior rear view mirrors



Before driving the vehicle through an automatic car wash, fold the exterior mirrors in. Otherwise they may get damaged.

Folding exterior mirrors in and out manually*

The exterior rear view mirrors can vibrate if they are not completely folded out.

The buttons are located on the lower part of the center console.



- ① Folds the exterior mirrors in
- ② Folds the exterior mirrors out

- ▶ Switch on ignition (▷ page 33).



With the front doors closed, the exterior mirrors can still be folded in and out approximately 30 minutes after the ignition has been turned off.

Folding in

- ▶ Briefly press button ① (▷ page 130).
The mirrors fold in.



Before you drive the vehicle through an automatic car wash, fold the exterior mirrors in, otherwise they may get damaged.



If you are driving at more than approximately 9 mph (15 km/h), you will not be able to fold the exterior mirrors in.

Folding out

- ▶ Briefly press button ②.
The mirrors fold out.



If an exterior rear view mirror housing is forcibly pushed forward (hit from the rear), reposition it manually by applying firm pressure until it snaps back into place.

If an exterior rear view mirror is forcibly pushed rearward (hit from the front) press button ① to fold mirrors in, then press button ② to fold mirrors out. Do not force mirrors by hand as this may damage the adjustment mechanism.

The mirror housing is now properly positioned and you can adjust the mirror normally.

Windshield wipers

For more information on the windshield wipers, see the “Getting started” section (▷ page 51).



If leaves, snow, etc. block the windshield wipers, the wiper motor turns off.

- For safety reasons, withdraw key from steering lock. Remove blockage.
- Turn the windshield wipers on again.

If windshield wipers fail to function at all in switch position ①,

- set the wiper switch to the next highest wiper speed.
- have the windshield wipers checked at the nearest authorized Mercedes-Benz Light Truck Center.

Controls in detail

Good visibility

Intermittent wiping



Intermittent wiping is interrupted when the vehicle is at a standstill and a front door is opened.

*Windshield wipers without rain sensor**

At speeds of approximately 105 mph (170 km/h) the wiper switches automatically to continuous wiping. Always obey local speed limits.

*Windshield wipers with rain sensor**

A rain sensor automatically controls the windshield wipers depending on how wet the windshield is.

- ▶ Switch on ignition.
- ▶ Set the wiper switch to position ① (▷ page 51).

After the initial wipe, pauses between wipes are automatically controlled by the rain sensor which monitors the wetness of windshield.



When intermittent wiping is on and the key is turned from position **1** to position **2** in the steering lock (▷ page 33), and kept in that position for longer than two seconds, the wipe interval will be set to approximately five seconds.



Do not leave windshield wipers in intermittent setting when the vehicle is taken to an automatic car wash or during windshield cleaning. Wipers will operate in the presence of water sprayed on the windshield, and wipers may be damaged as a result.

The switch should not be left in intermittent setting as the wipers will wipe the windshield once every time the engine is started. Dust that accumulates on the windshield might scratch the glass and/or damage the wiper blades when wiping occurs on a dry windshield.

Headlamp cleaning system*

The button is located on the right side of the dashboard.



Headlamp washer button

- ▶ Switch on ignition.
- ▶ Briefly press the upper part of button.

The headlamps will be cleaned with a high-pressure water jet.

For information on filling up the washer reservoir, see the “Operation” section (▷ page 230).

Rear window wiper

For more information on Rear window wiper, see the “Getting started” section (▷ page 52).

The rear window wiper will also automatically engage if the windshield wiper is engaged and the gear selector lever is placed in reverse.

Rear window wiper with rain sensor*

Rear window wiper intervals are controlled automatically according to the amount of water on the windshield and the speed of the vehicle, if:

- rear window wiper is switched on
- front windshield wipers are switched to intermittent wiping

The interval for the rear window wiper remains constant when the windshield wiper interval is ten seconds or more.

Controls in detail

Good visibility

Sun visors

The sun visors protect you from sun glare while driving.

Warning!



Do not use the vanity mirror while driving. Keep the mirrors in the sun visors closed while vehicle is in motion. Reflected glare can endanger you and others.

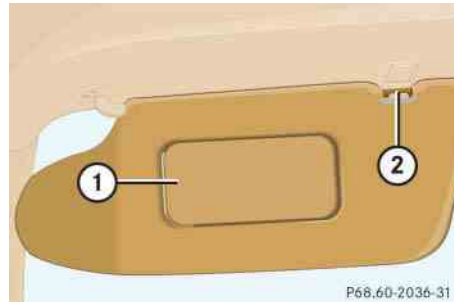

① Mirror cover

② Mounting

- ▶ Swing sun visors down when you experience glare.
- ▶ To use mirror, lift cover ① up.



If sunlight enters through a side window, disengage sun visor from mounting ② and pivot to the side.

Illuminated vanity mirrors

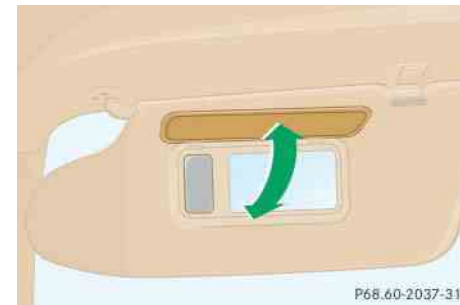

- ▶ Turn the key in steering lock to position 1 (▷ page 33).
- ▶ Lift cover up.
The lamp switches on.

Rear window defroster

The rear window defroster uses a large amount of power. To keep the battery drain to a minimum, switch off the defroster as soon as the rear window is clear. The defroster is automatically deactivated after approximately 6 to 17 minutes of operation depending on the outside temperature.

Activating

- ▶ Switch ignition on.
- ▶ Press button  (▷ page 137).
The indicator lamp on the button comes on.

Deactivating

- ▶ Press button  again.
The indicator lamp on the button goes out.

Warning!



Any accumulation of snow and ice should be removed from the rear window before driving. Visibility could otherwise be impaired, endangering you and others.



If the rear window defroster switches off too soon and the indicator lamp starts flashing, this means that too many electrical consumers are operating simultaneously and there is insufficient voltage in the battery. The system responds automatically by deactivating the rear window defroster.

As soon as the battery has sufficient voltage, the rear window defroster automatically turns itself back on.

Controls in detail

Automatic climate control

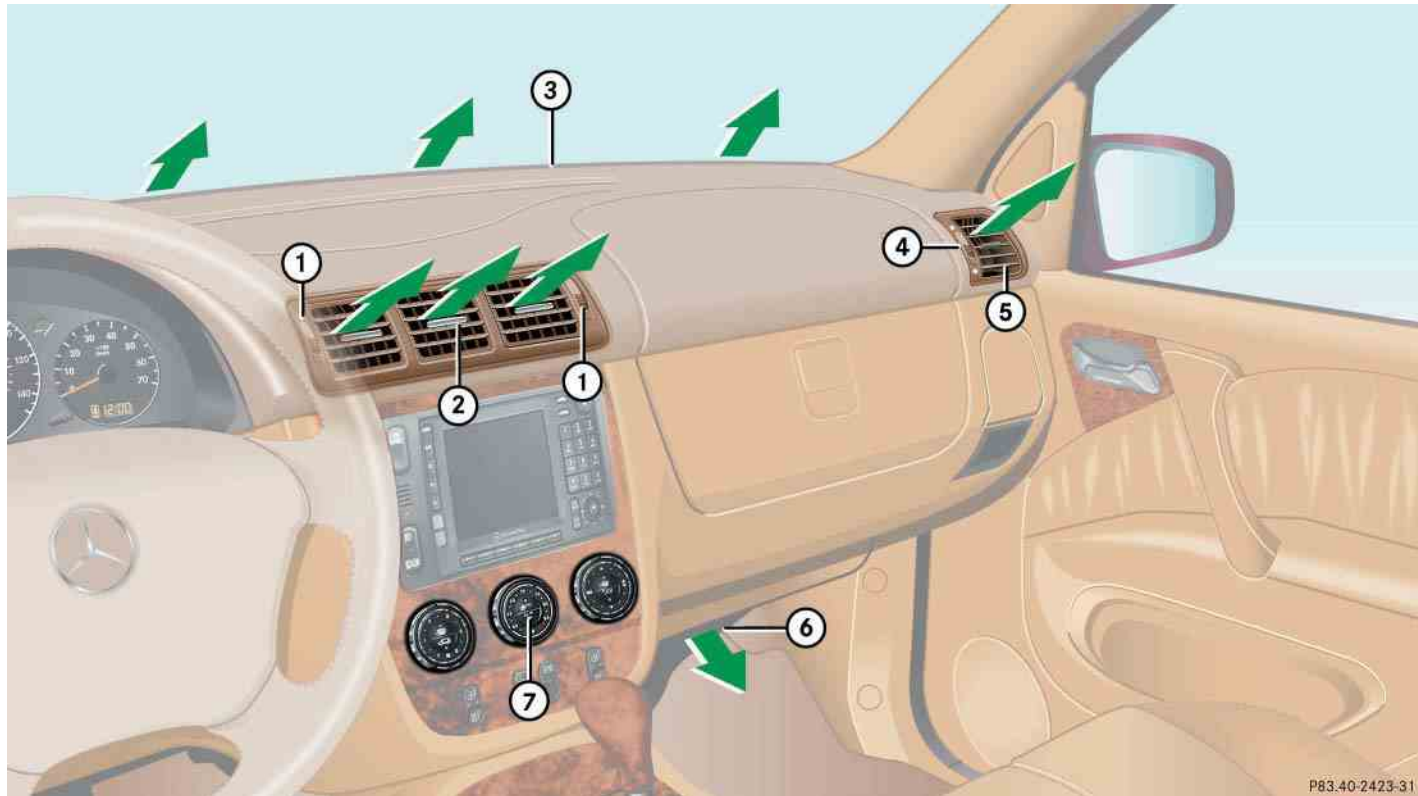

Item	
①	Thumbwheel for center air vent
②	Center air vent, adjustable
③	Defroster air vent windshield
④	Thumbwheels for side air vent
⑤	Side air vent, adjustable
⑥	Footwell air vent
⑦	Automatic climate control

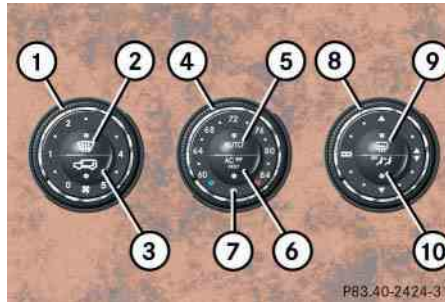

Automatic climate control panel in the front

Controls in detail

Automatic climate control

Item	
①	Air volume control
②	Defrosting
③	Air recirculation
④	Temperature control
⑤	Automatic control (temperature, air distribution, air volume)
⑥	AC cooling on / off (AC^{OFF}) Residual heat / ventilation (REST)
⑦	Interior temperature sensor
⑧	Air distribution control
⑨	Rear window defroster
⑩	Rear passenger compartment ventilation on / off

Controls in detail

Automatic climate control

The automatic climate control is operational whenever the engine is running. You can operate the climate control system in either the automatic or manual mode. The system cools or heats the interior depending on the selected interior temperature and the current outside temperature.

Nearly all dust particles, pollutants and odors are filtered out before outside air enters the passenger compartment through the air distribution system.

Warning!



When operating the automatic climate control, the air that enters the passenger compartment through the air vents in the footwell can be very hot or very cold (depending on the set temperature). This may cause burns or frostbite on unprotected skin in the immediate area of the air vents.

Always keep sufficient distance between unprotected parts of the body and the footwell air vents. If necessary, change the air flow using the air distribution controls to direct the air away from the footwell air vents (▷ page 140).

Warning!



Follow the recommended settings for heating and cooling given on the following pages. Otherwise the windows could fog up, impairing visibility and endangering you and others.

i

Severe conditions (e.g. strong air pollution) may require replacement of the filter before its scheduled interval. A clogged filter will reduce the air volume to the interior.

If the vehicle interior is hot, ventilate the interior before driving off.

Keep the air intake grille in front of the windshield free of snow and debris.

Do not touch the interior temperature sensor to maintain a precise temperature.

The set value is indicated by a lighted segment on the control wheels.

Automatic mode

Switching on

- ▶ Briefly press button **AUTO** (▷ page 137).
The indicator lamp comes on. The temperature, air volume and distribution are controlled automatically.
- ▶ Adjust the temperature with the temperature control ④ (▷ page 137).
Temperature control is switched off in the extreme position (blue or red dot).

Switching off

- ▶ Briefly press button **AUTO** (▷ page 137).
The indicator lamp goes out. The automatic mode is switched off.
Air volume control ① is set to fan speed 2 and air distribution is set to .

Activating basic setting

- ▶ Press button **AUTO** at least three seconds.
All functions are switched to automatic mode and temperature is set to 72°F (22°C).

Changing basic setting

- ▶ Set temperature control ④ (▷ page 137) to desired temperature.
- ▶ Press button **AUTO** for ten seconds.
The selected temperature value is stored and set.



Adjust temperature settings in small increments.

Controls in detail

Automatic climate control

Adjusting air volume and air distribution manually



If you turn air volume control ① or air distribution control ⑧ (▷ page 137), the automatic mode switches off. The indicator lamp in the button **AUTO** goes out. The temperature control will still be in automatic mode.

Adjusting air volume

- ▶ Turn air volume control ① to one of five air volume settings.







When set to 0 the system is fully deactivated and no fresh air is supplied. This setting should only be selected for short periods of time.

Controls in detail



Automatic climate control

Adjusting air distribution

- ▶ Turn air distribution control  (▷ page 137) to one the following symbols:

Symbol	Function
	Directs air to the center and side air vents
	Directs air to the windshield and side air vents
	Directs air into the entire vehicle interior
	Directs air to the footwells and side air vents

Windshield fogged on the outside

- ▶ Switch the windshield wipers on, (▷ page 51).
- ▶ Turn air distribution control  to  or .

Defrosting



These settings should only be selected for a short time.

When the defrost setting has been selected, only the rear window defroster can be switched on. No other settings are possible.

Activating

- ▶ Press button  (▷ page 137).

The indicator lamp on the button  comes on.

Deactivating

- ▶ Press button  again.

or

- ▶ Press button **AUTO** (▷ page 137).

The indicator lamp on the button  goes out.

Air recirculation mode

Switch to air recirculation mode to prevent unpleasant odors from entering the vehicle from the outside. This setting cuts off the intake of outside air and recirculates the air in the passenger compartment.

Warning!



When the outside temperature is below 41°F (5°C), only switch to air recirculation mode for short periods to prevent window fogging.

Controls in detail

Automatic climate control

Activating

- ▶ Press button  (▷ page 137).

The indicator lamp on the button  comes on.



To achieve the fastest possible cooling of the interior, the automatic climate control automatically switches to air recirculation. The indicator lamp in the button  is not illuminated when the system automatically switches to air recirculation.

Deactivating

- ▶ Press button  (▷ page 137).

The indicator lamp on the button  goes out.



The air recirculation mode is deactivated automatically

- after 30 minutes if the automatic climate control is switched on
- after five minutes if the air conditioning is switched off
- after five minutes if the outside temperature is above approximately 45°F (7°C)

Air conditioning

The air conditioning is operational while the engine is running and cools the interior air to the temperature set by the operator.



Condensation may drip out from underneath the vehicle. This is normal and not an indication of a malfunction.

Deactivating

It is possible to deactivate the air conditioning (cooling) function of the automatic climate control system. The air in the vehicle will then no longer be cooled or dehumidified.

- ▶ Press button  (▷ page 137).

The indicator lamp on the button  comes on.

Activating

Moist air can fog up the windows. You can dehumidify the air with the air conditioning.

- ▶ Press button  again.

The indicator lamp on the button  goes out.

The air conditioning system uses the refrigerant R-134a. This refrigerant is free of CFCs which are harmful to the ozone layer.

Controls in detail

Automatic climate control



If the  button on the automatic climate control panel starts to flash, this indicates that the air conditioning system is losing refrigerant. The compressor has turned itself off. The air conditioning cannot be turned on again.

Have the air conditioning system checked at the nearest authorized Mercedes-Benz Light Truck Center.

Residual heat and ventilation

With the engine switched off, it is possible to continue to heat or ventilate the interior for up to 30 minutes. This feature makes use of the residual heat produced by the engine.



How long the system will provide heating depends on the coolant temperature and the temperature set by the operator. The blower will run at lower speed regardless of the air volume control setting.

Activating

- ▶ Turn the key in the steering lock to position **0** or **1** (▷ page 33).
- ▶ Press button  (▷ page 137).

The indicator lamp on button  comes on.

Deactivating

- ▶ Press button .

The indicator lamp on button  goes out.



The residual heat is automatically turned off:

- when the ignition is switched on
- after about 30 minutes
- if the coolant temperature is too low
- if the battery voltage drops

Rear passenger compartment ventilation and rear automatic climate control

Deactivating

For an improved cooling or heating output in the front passenger compartment, you can switch off the rear passenger compartment ventilation.

- ▶ Press button  (▷ page 137).

The indicator lamp on the button  comes on.

The operation of the rear automatic climate control and the fresh air supply to the rear compartment is shut off.

Activating

- ▶ Press button  again.

The indicator lamp on the button  goes out.

The rear automatic climate control switches to automatic mode and fresh air enters the rear compartment.

Automatic mode

The automatic climate control panel for the rear is located on the rear center console.

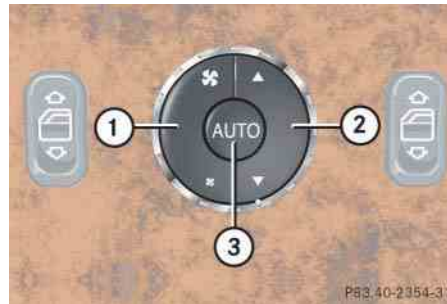

- ① Air volume control
- ② Air distribution control
- ③ Automatic control (air distribution, air volume)

- ▶ Press button **AUTO**.

The indicator lamp on the button **AUTO** comes on.

The automatic climate control cools or heats the interior depending on the temperature selected on the front climate control unit.

Controls in detail

Automatic climate control

Adjusting air volume and air distribution manually

i

When the air volume or air distribution control is pressed, the automatic mode is switched off. The indicator lamp in button **AUTO** is turned off. Temperature setting remains in automatic mode.

Adjusting air volume

- ▶ Press upper part of button .

The blower setting is increased each time the button is pressed.

- ▶ Press lower part of button .

The blower setting is decreased each time the button is pressed. ▷▷

Controls in detail



Automatic climate control



When in manual mode, the rear blower setting cannot be increased beyond the setting for the front blower setting. For example, if the driver or front passenger changes the blower setting to level 3, the rear blower will not go higher than level 3 as well.

The rear air volume control position indicator lights may not always reflect the actual fan speed.

Adjusting air distribution

- ▶ Press upper part of button . Air is directed upwards.
- ▶ Press lower part of button . Air is directed to the footwell.

Front and rear air vents





For draft-free ventilation, adjust the air vents upwards.

To allow unrestricted operation of the automatic climate control, the air vents should remain open.

Adjusting side air vents

- ▶ Turn thumbwheel  (▶ page 137) to one of the following positions:

Symbol	Function
	Open
	Ventilation of side windows in area of exterior mirror
	Closed

Center air vents

Opening

- ▶ Turn thumbwheel for center air vent ① (▷ page 137) upward to position .

Closing

- ▶ Turn thumbwheel for center air vent ① downward to position **0**.

Use the left thumbwheel to adjust the center air vents on the left and in the center. Use the right thumbwheel to adjust the right center air vent.

Rear passenger compartment air vents

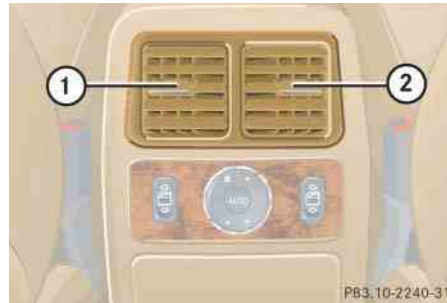

- ① Left center air vent, adjustable
- ② Right center air vent, adjustable



The temperature at the air vents for the rear passenger compartment is the same as at the dashboard center air vents.

Controls in detail

Power windows

Opening and closing the side windows

The side windows can be opened and closed electrically. The switches for all the side windows are on the driver's door. The switches for the respective windows are on the passenger door and on the rear center console.

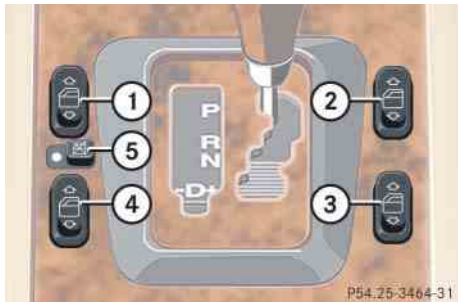

- ① Left front window
- ② Right front window
- ③ Right rear window
- ④ Left rear window
- ⑤ Rear window override switch (▷ page 74).

Additional switches for the rear windows are located on the rear center console.



- ⑥ Left rear window
- ⑦ Right rear window

Warning!



When closing the windows, make sure that there is no danger of anyone being harmed by the closing procedure.

The closing of the door windows can be immediately halted by releasing the switch or, if switch was pressed past the resistance point and released, by pressing the respective switch.

If the window encounters an obstruction that blocks its path in a circumstance where you pressed the switch past the resistance point and released it to close the window, the automatic reversal function will stop the window and open it slightly.

If the window encounters an obstruction that blocks its path in a circumstance where you are closing the window by pressing and holding the switch, the automatic reversal function will not operate.

When leaving the vehicle, always remove the key from the steering lock, and lock your vehicle. Do not leave children unattended in the vehicle, or with access to an unlocked vehicle. Unsupervised use of vehicle equipment can cause an accident and / or serious personal injury.

- Switch on ignition (▷ page 33).

Opening the windows

- ▶ Press switch ① to ④ at the symbol  to the resistance point.
The corresponding window will move downwards until you release the switch.

Closing the windows

- ▶ Press switch ① to ④ at the symbol  to the resistance point.
The corresponding window will move upwards until you release the switch.

Warning



If you press and hold the switch when closing the window, and upward movement of the window is blocked by some obstruction including but not limited to arms, hands, fingers, etc., the automatic reversal will not operate.

Fully opening the windows (Express-open)

- ▶ Press switch ① to ④ at the symbol  past the resistance point and release.
The corresponding window opens completely.

Fully closing the windows (Express-close)

- ▶ Press switch ① to ④ at symbol  past the resistance point and release.
The corresponding window closes completely.



If the upward movement of the window is blocked during the closing procedure, the window will stop and open slightly.

Remove the obstruction, press the switch  again past the resistance point and release.

Controls in detail

Power windows

If the window still does not close when there is no obstruction, then hold the switch  down. The side window will then close without the obstruction sensor function.

Warning!



Driver's door only:

If within five seconds switch  is again pressed past the resistance point and released, the automatic reversal will not operate.

Stopping windows

- ▶ Press respective switch again.

Controls in detail

Power windows

Synchronizing power windows

The power window must be resynchronized each time

- after the battery has been disconnected.
- if the power windows cannot be fully opened (Express-open) or closed (Express-close).

Synchronizing the power windows

- ▶ Switch on ignition.
- ▶ Press the power window switches at the symbol  until the side windows are closed.

Hold the switches for approximately one second.

The power window are synchronized.

Rear quarter windows*

The switches are on the upper part of the center console.



- ① Left side
- ② Right side

- ▶ Switch on ignition (▷ page 33).

Warning!



When closing the windows, make sure that there is no danger of anyone being harmed by the closing procedure. The closing of the windows can be immediately halted by releasing the switch.

When leaving the vehicle, always remove the key from the steering lock, and lock the vehicle. Do not leave children unattended in the vehicle, or with access to an unlocked vehicle. Unsupervised use of vehicle equipment may cause an accident and/or serious personal injury.

Opening the windows

- ▶ Press and hold the upper part of switches ① or ②.

The corresponding window will move downwards until you release the switch.

Closing the windows

- ▶ Press and hold the lower part of switches ① or ②.

The corresponding window will move upwards until you release the switch.

Controls in detail

Power tilt/sliding sunroof*

Opening and closing the power tilt/sliding sunroof

The tilt/sliding sunroof can be opened and closed electrically. The switch for the tilt/sliding sunroof is on the overhead control panel.

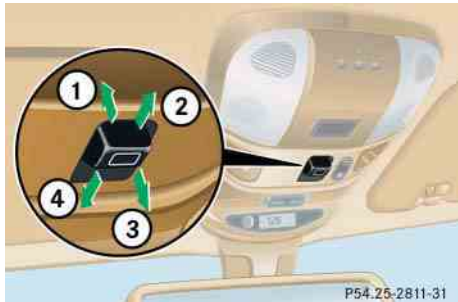

Sunroof switch

- ① Push up to raise sunroof at rear
- ② Push back to slide sunroof open
- ③ Push down to lower sunroof at rear
- ④ Push forward to slide sunroof closed

With the sunroof closed or tilted open, a screen can be slid into the roof opening to guard against sun rays. When sliding the sunroof open, the screen will also retract.

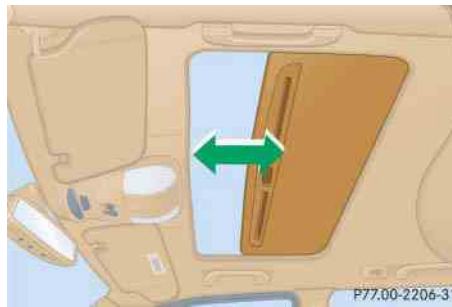

Warning!



When closing the tilt/sliding sunroof, make sure that there is no danger of anyone being harmed by the closing procedure.

The opening procedure of the tilt/sliding sunroof can be immediately halted by releasing the switch or, if the switch was moved past the resistance point and released, by moving the switch in any direction.

The closing procedure of the tilt/sliding sunroof can be immediately halted by releasing the switch.

The closing procedure of the tilt/sliding sunroof can be immediately reversed by moving the switch in direction ① or ②.

The tilt/sliding sunroof is made out of glass. In the event of an accident, the glass may shatter. This may result in an opening in the roof.

In a vehicle rollover, occupants not wearing their seat belts or not wearing them properly may be thrown out of the opening. Such an opening also presents a potential for injury for occupants wearing their seat belts properly as entire body parts or portions of them may protrude from the passenger compartment.

When leaving the vehicle, always remove the key from steering lock and lock your vehicle. Do not leave children unattended in the vehicle, or with access to an unlocked vehicle. Unsupervised use of vehicle equipment can cause an accident and / or serious personal injury.



To avoid damaging the seals, do not transport any objects with sharp edges which can stick out of the tilt / sliding sunroof.

Do not open the tilt / sliding sunroof if there is snow or ice on the roof, as this could result in malfunctions.

The tilt / sliding sunroof can be opened or closed manually should an electrical malfunction occur (▷ page 271).

- ▶ Switch on ignition (▷ page 33).

Controls in detail

Power tilt / sliding sunroof*

Opening and closing the power tilt / sliding sunroof

- ▶ To open, close, raise, or lower the tilt / sliding sunroof, move the sunroof switch to resistance point in the required direction of arrows ① to ④.

Release the sunroof switch when the tilt / sliding sunroof has reached the desired position.



If the movement of the tilt / sliding sunroof is blocked during the closing procedure, the tilt / sliding sunroof will stop and reopen slightly.

Controls in detail

Power tilt / sliding sunroof*

Fully opening (Express-open) the power tilt / sliding sunroof

- ▶ To open the tilt / sliding sunroof, move the sunroof switch past the resistance point in the direction of arrow ② and release.

The tilt / sliding sunroof almost opens completely.

- ▶ Move the sunroof switch again briefly in the direction of arrow ②.

The tilt / sliding sunroof almost opens completely.

Stopping the power tilt / sliding sunroof during Express-open

- ▶ Move the sunroof switch in any direction.

The movement of the tilt / sliding sunroof stops.

Synchronizing the power tilt / sliding sunroof

The tilt / sliding sunroof must be synchronized

- after the battery has been disconnected or discharged
- after the tilt / sliding sunroof has been closed manually (▷ page 271)
- after a malfunction
- the tilt / sliding sunroof does not open smoothly

- ▶ Remove the respective fuse from the fuse box (▷ page 297).

- ▶ Reinsert the fuse in the fuse box.

- ▶ Switch on ignition.

- ▶ Move and hold the sunroof switch in the direction of arrow ① or ④ until the tilt / sliding sunroof is fully raised at the rear or completely closed.

Keep holding the sunroof switch in the direction of arrow ① or ④ for approximately one second.

The tilt / sliding sunroof is synchronized.

▼ Driving systems

The driving systems of your vehicle are described on the following pages:

- Cruise control, with which the vehicle can maintain a preset speed.
- Parktronic*, with which you can assist your parking maneuvers.

The driving systems BAS, ABS, ESP, EBB and 4-ETS, are described in the “Safety and Security” section (▷ page 76).

Cruise control

Cruise control automatically maintains the speed you set for your vehicle.

Use of cruise control is recommended for driving at a constant speed for extended periods of time. You can set or resume cruise control at any speed over 20 mph (30 km / h).

The cruise control function is operated by means of the cruise control lever.

The cruise control lever is the uppermost lever found on the left-hand side of the steering column (▷ page 23).

Controls in detail

Driving systems

Warning!



Cruise control is a convenience system designed to assist the driver during vehicle operation. The driver is and must remain at all times responsible for the vehicle speed and for safe brake operation.

Only use cruise control if the road, traffic and weather conditions make it advisable to travel at a steady speed.

- The use of cruise control can be dangerous on winding roads or in heavy traffic because conditions do not allow safe driving at a steady speed.
- The use of cruise control can be dangerous on slippery roads. Rapid changes in tire traction can result in wheel spin and loss of control.
- Deactivate cruise control when driving in fog.

The “Resume” function should only be operated if the driver is fully aware of the previously set speed and wishes to resume this particular preset speed.

Controls in detail

Driving systems

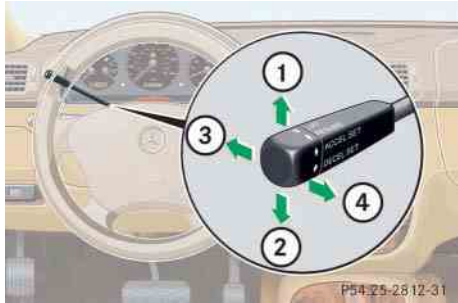

- ① Set current or higher speed
- ② Set current or lower speed
- ③ Cancel cruise control
- ④ Resume at last set speed

Setting current speed

- ▶ Accelerate or decelerate to the desired speed.
- ▶ Briefly lift ① or depress ② the cruise control lever.

The current speed is set.

- ▶ Remove your foot from the accelerator pedal.

Cruise control is activated.



On uphill or downhill grades, cruise control may not be able to maintain the set speed. Once the grade eases, the set speed will be resumed.

Canceling cruise control

There are several ways to cancel cruise control:

- ▶ Step on the brake pedal.
- or
- ▶ Briefly push the cruise control lever to position ③.

Cruise control will be canceled. The last speed set will be stored for later use.



Moving gear selector lever to position **N** while driving also cancels cruise control. However, the gear selector lever should not be moved to position **N** while driving except to coast when the vehicle is in danger of skidding (e.g. on icy roads).



The last stored speed is canceled when you turn off the engine.

Setting a higher speed

- ▶ Lift the cruise control lever to position ① and hold it up until the desired speed is reached.
- ▶ Release the cruise control lever.
The new speed is set.



Depressing the accelerator pedal does not deactivate the cruise control. After brief acceleration (e.g. for passing), cruise control will resume the last speed set.

Setting a lower speed

- ▶ Depress the cruise control lever to position ② and hold it down until the desired speed is reached.
- ▶ Release the cruise control lever.
The new speed is set.



When you use the cruise control lever to decelerate, the transmission will automatically downshift if the engine's braking power does not brake the vehicle sufficiently.

Fine adjustment in 1 mph (Canada: 1 km/h) increments

Faster

- ▶ Briefly tip the cruise control lever in the direction of arrow ①.

Slower

- ▶ Briefly tip the cruise control lever in the direction of arrow ②.

Controls in detail

Driving systems

Setting to last stored speed ("Resume" function)

Warning!



The speed stored in memory should only be set again if prevailing road conditions permit. Possible acceleration or deceleration differences arising from returning to preset speed could cause an accident and/or serious injury to you and others.

- ▶ Briefly push the cruise control lever to position ④.
The cruise control will resume the last set speed.
- ▶ Remove your foot from the accelerator pedal.

Transmission in LOW RANGE mode



The cruise control should not be used during off-road driving.

Controls in detail

Driving systems

Parktronic* system (Parking assist)

Warning!



The Parktronic is a supplemental system. It is not intended to, nor does it replace, the need for extreme care. The responsibility during parking and other critical maneuvers always rests with the driver.

Special attention must be paid to objects with smooth surfaces or low silhouettes (e.g. trailer couplings, painted posts, or road curbs). Such objects may not be detected by the system and can damage the vehicle.

The operational function of the Parktronic system can be affected by dirty sensors, especially at times of snow and ice. See “Cleaning the Parktronic system sensors” (> page 243).

Interference caused by other ultrasonic signals (e.g. working jackhammers, car wash, or the air brakes of trucks) can cause the system to send erratic indications, and should be taken into consideration.

Warning!



Make sure that no persons or animals are in the area in which you are maneuvering. You could otherwise injure them.

The Parktronic system is an electronic and designed to assist the driver during parking maneuvers. It visually and audibly indicates the relative distance between the vehicle and an obstacle.

The Parktronic system is automatically activated when you switch on the ignition. The Parktronic system deactivates at speeds over approximately 10 mph (15 km/h). At lower speeds the Parktronic system turns on again.

The Parktronic system monitors the surroundings of your vehicle with six sensors in the front bumper and four sensors in the rear bumper.

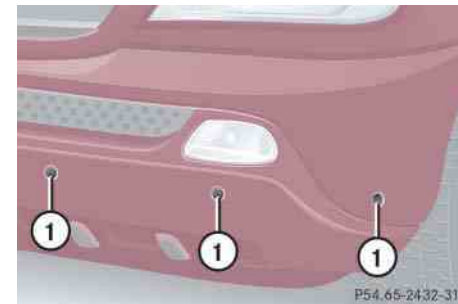

① Sensors located in front bumper

Controls in detail

Driving systems

Range of the sensors

To function properly, the sensors must be free of dirt, ice, snow and slush. Clean the sensors regularly, being careful not to scratch or damaging the sensors.

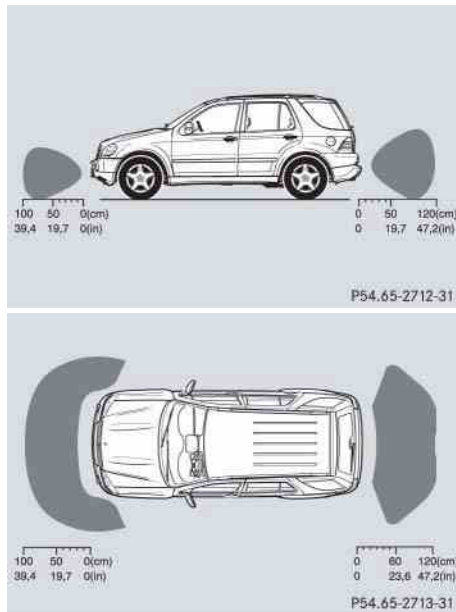

Front sensors

Center	approx. 39.4 in (100 cm)
Corners	approx. 23.6 in (60 cm)

Rear sensors

Center	approx. 47.2 in (120 cm)
Corners	approx. 31.5 in (80 cm)



During parking maneuvers, pay special attention to objects located above or below the height of the sensors (e.g. planters or trailer hitches). The Parktronic system will not detect such objects at close range and damage to your vehicle or the object may result.

Ultrasonic signals from outside sources (e.g. truck air brakes or jackhammers) may impair the operation of the Parktronic system.

Minimum distance

Center	approx. 8 in (20 cm)
Corners	approx. 6 in (15 cm)

When an obstacle is located in this area, all warning displays will light up and a warning tone will sound. If the vehicle moves closer than the minimum distance to an object, the distance may no longer be displayed.

Controls in detail

Driving systems

Warning indicators

The warning indicators show the distance between the sensor and the obstacle. The warning indicators for the front area are located above the center air vents in the dashboard. The warning indicator for the rear area is located in the rear passenger compartment lamp.

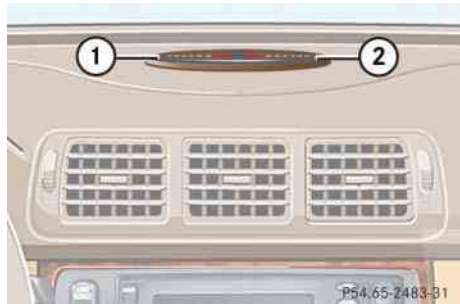

Front area warning indicator

- ① Segments, left side of vehicle
- ② Segments, right side of vehicle

Each warning indicator has six yellow and two red segments.

The gear selector lever position determines which warning indicator is activated.

Selector lever position	Warning indicator
D, R, N, P	Front area activated
R	Rear area activated

As soon as the sensors detect an obstacle, one or more segments light up, depending on the distance. An intermittent acoustic warning will also sound as the seventh segment comes on and a constant acoustic warning lasting a maximum of three seconds will sound for the eighth segment.



If all red segments light up in the warning indicators, a dirty sensor or a ultrasonic signal could be the reason.

- Clean the sensors (> page 243).
After cleaning the sensors, switch the ignition on.

Switching Parktronic system on / off

The Parktronic system can be switched on or off manually.

The Parktronic switch is located on the lower part of the center console.



- ① Parktronic off
- ② Indicator lamp
- ③ Parktronic on



If the Parktronic system is malfunctioning, all red segments of the warning indicators light up and an additional warning sounds.

Contact your Mercedes-Benz Light Truck Center as soon as possible.

Switching off the Parktronic system

- ▶ Press Parktronic switch on upper part ①.
- Indicator lamp ② comes on.

Switching on the Parktronic system

- ▶ Press Parktronic switch on lower part ③.
- The indicator lamp ② goes out.



If you switch the ignition on, the Parktronic system will be automatically switched on.

The rear Parktronic sensors will not automatically disengage when towing a trailer. Therefore switch the Parktronic system off.

Controls in detail

Loading

Loading instructions

Warning!



Always fasten items being carried as securely as possible using cargo tie-down rings and fastening materials appropriate for the weight and size of the load.

In an accident, during hard braking or sudden maneuvers, loose items will be thrown around inside the vehicle, and can cause injury to vehicle occupants unless the items are securely fastened in the vehicle.

To help avoid personal injury during a collision or sudden maneuver, always use partition net when transporting cargo.

Never drive vehicle with the liftgate open. Deadly carbon monoxide (CO) gases may enter vehicle interior resulting in unconsciousness and death.

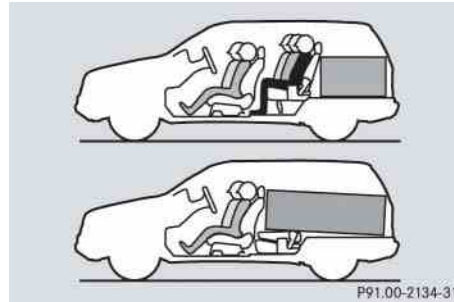

The gross vehicle weight which is the weight of the vehicle including fuel, tools, spare wheel, installed accessories, passengers and luggage / cargo must never exceed the Gross Vehicle Weight Rating (GVWR) for your vehicle. In addition, the load must be distributed in such a way so that the weight on each axle never exceeds the Gross Axle Weight Rating (GAWR) for the front and rear axle. The GVWR and GAWR for your vehicle are indicated on the certification label which can be found on the left door pillar.

The handling characteristics of a fully loaded vehicle depend greatly on the load distribution. It is therefore recommended to load the vehicle according to the illustrations shown, with the heaviest items being placed towards the front of the vehicle.

Please pay attention to and comply with the following instructions when loading the vehicle and transporting cargo:

- Always place items being carried against front or rear seat backrests, and fasten them as securely as possible.
- The heaviest portion of the cargo should always be kept as low as possible against front or rear seat backrests.



For additional safety when transporting cargo while the rear seats are unoccupied, fasten the outer seat belts crosswise into the opposite side buckles.



The cargo compartment is the preferred place to carry objects. The enlarged cargo compartment should only be used for items which do not fit in the cargo compartment alone.

Cargo tie-down rings

The cargo compartment is provided with four tie-down rings. Additional two rings are located at the rear of front seats.



Cargo tie-down ring

Carefully secure cargo by applying even load on all rings with rope of sufficient strength to hold down the cargo.



While the partition net* (▷ page 162) will help protect you from smaller objects, it cannot prevent the movement of large, heavier objects into the passenger compartment in an accident. Such items must be properly secured using the cargo tie-down rings in the cargo compartment floor.

Controls in detail

Loading

Hooks

Four hooks located on the rear compartment trim panels, two on each side.



Hooks

Use the hooks to secure light weight items. The maximum permissible weight per hook is 9 lbs (4 kg).

Partition net*

Warning!



Always lock backrest in its upright position when rear seat bench is occupied by passengers, or cargo is being carried behind the seat bench.

To help avoid personal injury from smaller objects flying in the occupant compartment during a collision or sudden maneuver, always use partition net when transporting cargo.

The partition net cannot prevent the movement of large, heavier objects into the passenger compartment in an accident. Such items must be properly secured using the cargo tie-down rings in the cargo compartment floor (▷ page 161).

Passenger use of seats behind installed partition net is restricted because of the footwell being taken up by the net.

Use of the partition net is a particularly important safety factor when the vehicle is loaded higher than the top of the seat backrests with smaller objects.

The partition net can be installed behind the backrests of the front or rear seats.

Engaging partition net

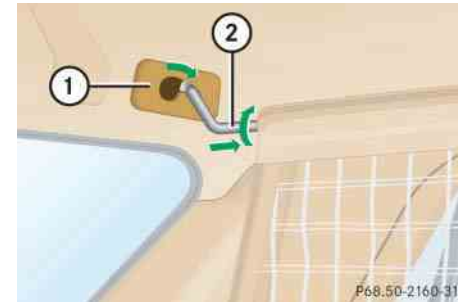

① Holder

② Mounting hook

- ▶ One after the other, press the two mounting hooks ② inward against the spring pressure and turn them.
The mounting hooks are locked in this position and you can move the net into position more easily.
- ▶ Turn one of the mounting hooks ② in the opposite direction.
The spring pressure will push it out.
- ▶ Engage mounting hook ② in holder ①.
- ▶ Turn the other mounting hook and engage it in the opposite holder.
- ▶ Push both mounting hooks ② forward into holder ①.

Tightening partition net



Before tightening the partition net, remove the cargo floor plates (▶ page 165).

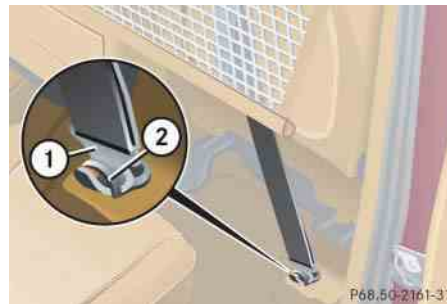

Installation behind the front seats

- ① Tie-down hook
- ② Ring

Controls in detail

Loading

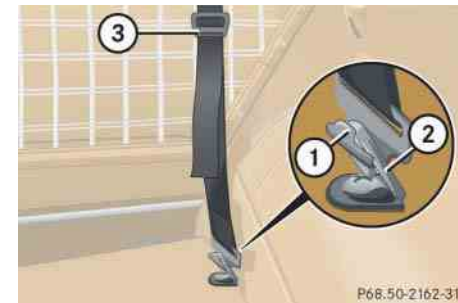

Installation behind the rear seats

- ① Tie-down hook
 - ② Ring
 - ③ Tensioner
- ▶ Insert tie-down hook ① in rings ②.
 - ▶ Pull on loose ends of tie-down straps until net is tight.
 - ▶ After driving a short distance, check the tension on the net and retighten if necessary.

Controls in detail

Loading

Removing partition net

- ▶ Lift tensioner ③ upward to a horizontal position to release tensioning of the strap.
- ▶ Disengage tie-down hooks ① from rings ②.
- ▶ Remove mounting hooks ② (▷ page 162) from holder ① (▷ page 162).
- ▶ Roll up and close the partition net.
- ▶ Store partition net behind rear seat bench.

Cargo compartment cover blind*

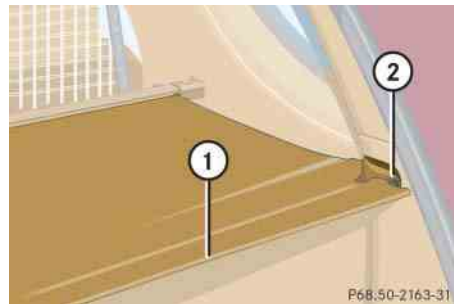

- ① Handle
- ② Holder

Warning!



Passenger use of third row seats with cargo compartment cover blind installed is restricted.

Closing blind

- ▶ Pull blind on handle ① across the cargo compartment.
- ▶ Guide blind into holders ②.

Opening blind

- ▶ Disengage blind and guide retraction by its handle ①.

Removing blind

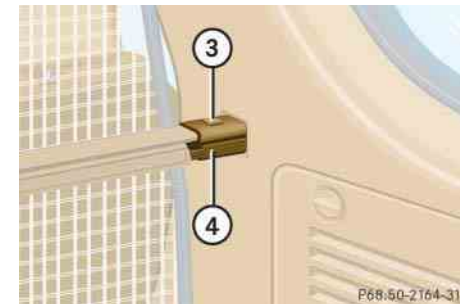

- ③ Button
- ④ Mounting sleeve

- ▶ Roll the blind up.
- ▶ Push mounting sleeve ④ inward against spring pressure until it engages.
- ▶ Remove blind from mounts.

Installing blind

- ▶ Place left side of blind in left mount.
- ▶ Position right side of blind over right mount.
- ▶ Push button ③, releasing mounting sleeve to slide into mount.

Cargo floor plates

Removing cargo floor plates



Before you can remove the cargo floor plates, it is possible that the third row seats* (▷ page 102) must be removed.



- ▶ Lift cargo floor plate at rear edge (arrow).
Cargo floor plate unhinges automatically.
- ▶ Remove cargo floor plate by pulling it rearwards.

Controls in detail

Loading

Storing cargo floor plates

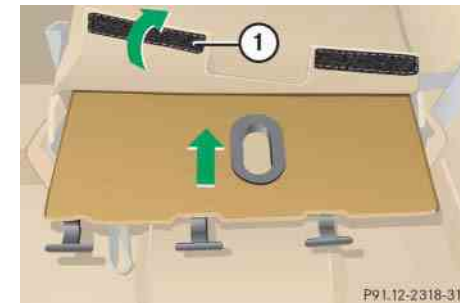

① Hook and loop strip

- ▶ Fold the left cargo floor plate together.
- ▶ Open the hook and loop strip at the bottom of backrest of the third row seats* and insert cargo floor plate.
- ▶ Close the hook and loop strip.

Controls in detail

Loading

Installing cargo floor plates

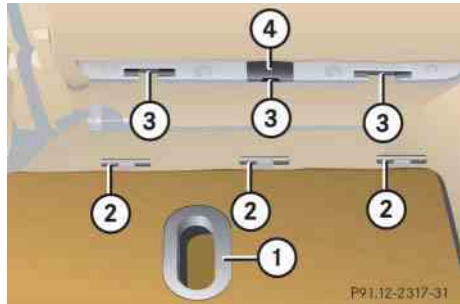

- ① Opening
- ② Pins
- ③ Attachment opening
- ④ Latch

- ▶ Grip into opening ① and guide pins ② into attachment opening ③.

The center pin must snap into place in latch ④.

Roof rack*

Warning!



Take into consideration that when the roof rack is loaded, the handling characteristics are different from those when operating the vehicles without the roof rack loaded.

The maximum roof load when using roof rack systems is 220 lb (100 kg).



Roof rails



Attach roof racks to the roof rails only.

Use only those roof racks approved by Mercedes-Benz for your vehicle model. Follow manufacturer's installation instructions.

The vehicle could otherwise be damaged.

For further information, inquire at your Mercedes-Benz Light Truck Center.

▼ Useful features

Storage compartments

Warning!



To help avoid personal injury during a collision or sudden maneuver, exercise care when stowing objects in the vehicle. Put luggage or cargo in the cargo compartment if possible. Do not pile luggage or cargo higher than the seat backs.

Always use partition net when transporting cargo. Partition net cannot secure hard or heavy objects.

Parcel nets cannot secure hard or heavy objects.

Keep compartment lids closed. This will help to prevent stored objects from being thrown about and injuring vehicle occupants during an accident.

Glove box

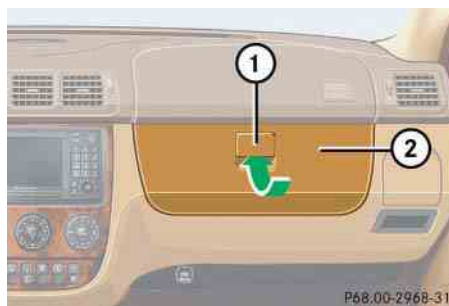

- ① Glove box lid release
- ② Glove box lid



The opened glove box is illuminated with the key in steering lock position 1 (► page 33).

Opening the glove box

- Grab in recess and pull lid release ①. The glove box lid ② opens downward.

Closing the glove box

- Push glove box lid up to close.

Controls in detail

Useful features

Storage compartment under front passenger seat*

The storage compartment is lockable with its separate key.

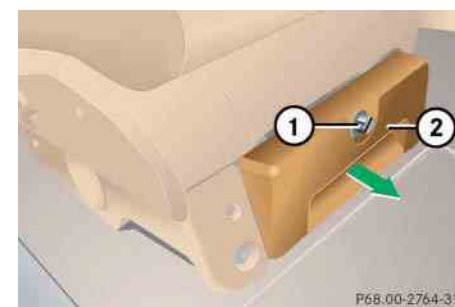

- ① Lock cylinder
- ② Handle

Locking and unlocking the storage compartment

- Turn the key clockwise. The storage compartment is locked.
- Turn the key counterclockwise. The storage compartment is unlocked.

Controls in detail

Useful features

Opening the storage compartment

- ▶ Press the lock cylinder in and pull storage compartment out using handle ②.

Closing the storage compartment

- ▶ Push the storage compartment in until the lock engages.

Armrest storage compartments

A flat storage tray with a deeper storage compartment underneath is located below the armrest. Both can be opened separately.

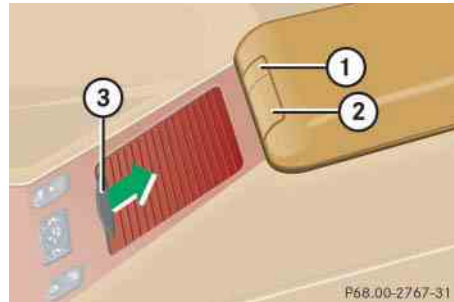

- ① Button to open storage tray
- ② Button to open storage compartment
- ③ Open cover



- ④ Storage tray
- ⑤ Coin holder

Opening the storage tray

- ▶ Press button ① and lift up armrest.
The armrest contains two coin holders.

Opening the storage compartment

- ▶ Press button ② and lift up armrest.

Opening the storage compartment in front of armrest

- ▶ Slide the cover ③ rearward.

The storage compartment below contains a cup holder (▷ page 170).

Cup holders

Warning!



When not in use, keep the cup holder closed. Place only containers that fit into the cup holder to prevent spills. Use lids on open containers and do not fill containers to a height where the contents, especially hot liquids, could spill during vehicle maneuvers.

Controls in detail

Useful features

Cup holder in instrument panel

A cup holder is located on both the right and left side of the instrument panel.



Opening the cup holder

- ▶ Briefly touch top of cover.
The cup holder opens automatically.

Closing the cup holder

- ▶ Fold the cup holder upwards and press on it until it engages.

Controls in detail

Useful features

Cup holder in front of armrest

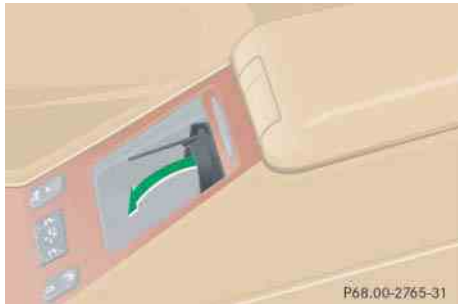

Opening the cup holder

- ▶ Slide cover rearward (▷ page 169).
- ▶ Fold the cup holder forward.

Closing the cup holder

- ▶ Fold the cup holder backward.
- ▶ Slide cover forward.

Cup holder in rear center console



Opening the cup holder

- ▶ Briefly touch the cover.
The cup holder opens automatically.

Closing the cup holder

- ▶ Press the cup holder forward and press on it until it engages.



Close the cup holder before folding the rear seat bench.

Armrest in rear seat bench



- ▶ Pull the armrest down by its top.

Ashtrays and cigarette lighter

Warning!



Never touch the heating element or sides of the cigarette lighter; they are extremely hot. Hold the knob only.

When leaving the vehicle always remove the key from the steering lock. Do not leave children unattended in the vehicle, or with access to an unlocked vehicle. Unsupervised use of vehicle equipment may cause an accident and / or serious personal injury.



The cigarette lighter socket can be used to accommodate electrical accessories up to a maximum of 50 W.

If the engine is off, the battery may become discharged when used for long periods of time.

Ashtray and cigarette lighter in the front center console

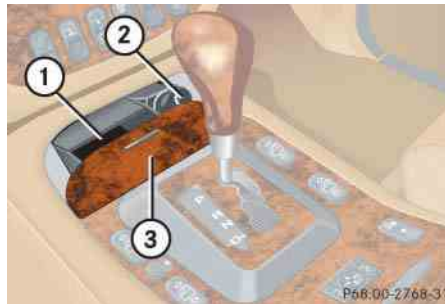

- ① Ashtray
- ② Cigarette lighter
- ③ Cover plate

Opening the ashtray

- ▶ Briefly touch cover plate ③.
The ashtray opens automatically.

Removing ashtray insert

Warning!



Remove ashtray only with vehicle standing still. Set the parking brake to secure vehicle from movement. Move gear selector lever to position **N**. With gear selector lever in position **N**, turn off the engine.

- ▶ Secure vehicle from movement by setting the parking brake. Move the gear selector lever to position **N**.
Now you have more room to take out the insert.
- ▶ Grip the insert on the sides and pull it out upwards.

Reinstalling ashtray insert

- ▶ Install ashtray insert.
- ▶ Close the ashtray.

Controls in detail

Useful features

Controls in detail

Useful features

Cigarette lighter

- ▶ Switch on the ignition.
- ▶ Push in cigarette lighter ② (▷ page 171).

The cigarette lighter will pop out automatically when hot.

Ashtray and cigarette lighter in the rear center console



Close the ashtray in the rear center console before folding the rear seat bench.



- ① Ashtray
- ② Cigarette lighter
- ③ Cover plate

Opening the ashtray

- ▶ Briefly touch cover plate ③.
The ashtray opens automatically.

Removing ashtray insert

- ▶ Grip the insert on the sides and pull it out upwards.

Reinstalling ashtray insert

- ▶ Install ashtray insert.
- ▶ Close the ashtray.

Cigarette lighter

- ▶ Switch on the ignition.
- ▶ Push in cigarette lighter ②.

The cigarette lighter will pop out automatically when hot.

Electrical outlet



Electrical outlet

One outlet is located in the front passenger footwell and another on the right-hand side of the luggage compartment.

- Flip up cover and insert electrical plug (cigarette lighter type).



The outlets function even if the key is not in the ignition.

The electrical outlet can be used to accommodate electrical consumers (e.g. air pump, auxiliary lamps) up to a maximum of 180 W.

If the engine is off, the battery may become discharged if used for long periods of time.

Telephone*

Warning!



Never operate radio transmitters equipped with a built-in or attached antenna (i.e. without being connected to an external antenna) from inside the vehicle while the engine is running. Doing so could lead to a malfunction of the vehicle's electronic system, possibly resulting in an accident and / or serious personal injury.

Radio transmitters, such as a portable telephone or a citizens band unit, should only be used inside the vehicle if they are connected to an antenna that is installed on the outside of the vehicle.

The external antenna must be approved by Mercedes-Benz. Please contact an authorized Mercedes-Benz Light Truck Center for information on the installation of an approved external antenna. Refer to the radio transmitter operation instructions regarding use of an external antenna.

Controls in detail

Useful features

Warning!



Please do not forget that your primary responsibility is to drive the vehicle. A driver's attention to the road must always be his / her primary focus when driving. For your safety and the safety of others, we recommend that you pull over to a safe location and stop before placing or taking a telephone call.

If you choose to use the telephone¹ while driving, please use the hands-free device and only use the telephone when road, weather and traffic conditions permit. Some jurisdictions prohibit the driver from using a cellular telephone while driving a vehicle.

Only operate the MCS (**M**odular **C**ontrol **S**ystem)¹ if road, weather and traffic conditions permit.

Bear in mind that at a speed of just 30 mph (approximately 50 km / h), your vehicle is covering a distance of 44 feet (approximately 14 m) every second.

¹ Observe all legal requirements

You can take and place telephone calls using the **MCS** unit.

See separate instruction manual for information on how to operate the telephone.

Warning!



Some jurisdictions prohibit the driver from using a cellular telephone while driving a vehicle. Whether or not prohibited by law, for safety reasons, the driver should not use the cellular telephone while the vehicle is in motion.

Stop the vehicle in a safe location before answering or placing a call.

Tele Aid*



The initial activation of the Tele Aid system may only be performed by:

- completing the subscriber agreement and
- placing an acquaintance call using the  button

Failure to complete either of these steps will result in a system that is not activated. If the system is not activated, the indicator lamp in the SOS button stays on after switching on ignition and the message **TELE AID - NOT ACTIVATED** will be shown in the MCS display for approximately 10 seconds.

If you have any questions regarding activation, please call the Response Center at 1-800-756-9018 (in the USA) or 1-888-923-8367 (in Canada).

The Tele Aid system



(Telematic Alarm Identification on Demand)

The Tele Aid system consists of three types of response:



- automatic and manual emergency
- roadside assistance and
- information

The Tele Aid system is operational providing that the vehicle's battery is charged, properly connected, not damaged and cellular and GPS coverage is available.

The speaker volume of a Tele Aid call can be adjusted using the volume control on the MCS unit.

- ▶ To activate, press the SOS button, the Roadside Assistance button  or the Information button , depending on the type of response required.





The SOS button, the Roadside Assistance button  and the Information button  are located in the overhead control panel.

Shortly after the completion of your acquaintance call, you will receive a user ID and password. By visiting www.mbusa.com and selecting "Tele Aid" (USA only), you will have access to account information, remote door unlock, profile and more.



The Tele Aid system utilizes the cellular network for communication and the GPS (Global Positioning System) satellites for vehicle location. If either of these signals are unavailable, the Tele Aid system may not function and if this occurs, assistance must be summoned by other means.

System self-check

Initially, after switching on ignition, malfunctions are detected and indicated (the indicator lamps in the SOS button, the Roadside Assistance button  and the Information button  stay on longer than 10 seconds or do not come on). The message TELE AID - VISIT WORKSHOP appears for approx. 10 seconds in the MCS display.

Controls in detail

Useful features

Warning!



The Tele Aid control unit is located under the front passenger seat. If there is accumulation of water or other liquid in this compartment, the Tele Aid control unit could suffer an electrical short circuit making the system inoperative. In this case the indicator lamp in the SOS button will not illuminate during or will remain illuminated after the system self-check. Have the system checked at the nearest Mercedes-Benz Light Truck Center as soon as possible.

If the indicator lamps in the SOS button, in the Roadside Assistance button and/or in the Information button do not come on during the system self-check or if any of these indicators remain illuminated constantly in red and/or the message TELE AID - VISIT WORKSHOP is displayed in the MCS display after the system self-check, a malfunction in the system has been detected.

If a malfunction is indicated as outlined above, the system may not operate as expected. Have the system checked at the nearest Mercedes-Benz Light Truck Center as soon as possible.

Emergency calls

An emergency call is initiated automatically:

- following an accident in which the emergency tensioning detractors (ETDs) or airbags deploy.

An emergency call can also be initiated manually by opening the cover next to the inside rear view mirror labeled SOS, then briefly pressing the button located under the cover. See (> page 178) for instructions on initiating an emergency call manually.

Once the emergency call is in progress, the indicator lamp in the SOS button will begin to flash. The message EMERGENCY CALL - CONNECTING CALL appears in the MCS display. When the connection is established, the message EMERGENCY CALL - CALL CONNECTED appears in the MCS display. All information relevant to the emergency, such as the location of the vehicle (determined by the GPS satellite location system), vehicle model, identification number and color are generated.

A voice connection between the Response Center and the occupants of the vehicle will be established automatically soon after the emergency call has been initiated. When a voice connection is established, the audio system mutes and the message TELE AID - EMERGENCY CALL ACTIVE appears in the MCS display. The Response Center will attempt to determine more precisely the nature of the accident provided they can speak to an occupant of the vehicle.

The Tele Aid system is available if:

- it has been activated and is operational. Activation requires a subscription for monitoring services, connection and cellular air time.
- the relevant cellular phone network and GPS signals are available and pass the information on to the response center.



Location of the vehicle on a map is only possible if the vehicle is able to receive signals from the GPS satellite network and pass the information on to the response center.

Controls in detail

Useful features

Warning!



If the indicator lamp in the SOS button is illuminated continuously and there was no voice connection to the Response Center established, then the Tele Aid system could not initiate an emergency call (e.g. the relevant cellular phone network is not available). The message EMERGENCY CALL - CALL FAILED appears in the MCS display for approx. ten seconds.

Should this occur, assistance must be summoned by other means.

Controls in detail

Useful features

Initiating an emergency call manually



- ① Cover
- ② SOS button

- ▶ Briefly press on cover ①.
The cover will open.
- ▶ Press SOS button ② briefly.
The indicator lamp in SOS button ② will flash until the emergency call is concluded.
- ▶ Wait for a voice connection to the Response Center.
- ▶ Close cover ① after the emergency call is concluded.

Warning!



If you feel at any way in jeopardy when in the vehicle (e.g. smoke or fire in the vehicle, vehicle in a dangerous road location), please do not wait for voice contact after you have pressed the emergency button. Carefully leave the vehicle and move to a safe location. The Response Center will automatically contact local emergency officials with the vehicle's approximate location if they receive an automatic SOS signal and cannot make voice contact with the vehicle occupants.

Roadside Assistance button

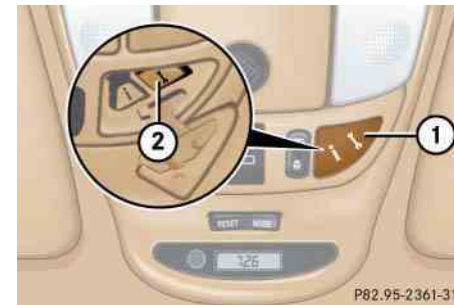

- ① Cover
- ② Roadside Assistance button 

- ▶ Briefly press on cover ①.
The cover will open.
- ▶ Press and hold the button ② (for longer than two seconds).
A call to a Mercedes-Benz Roadside Assistance dispatcher will be initiated. The button will flash while the call is in progress. The message **ROADSIDE ASSISTANCE - CONNECTING CALL** will appear in the MCS display.

When the connection is established, the message **ROADSIDE ASSISTANCE - CALL CONNECTED** appears in the MCS display. The Tele Aid system will transmit data generating the vehicle identification number, model, color and location (subject to availability of cellular and GPS signals).



While the call is connected you can change to navigation menu by pressing NAVI button on the MCS unit.

A voice connection between the Roadside Assistance dispatcher and the occupants of the vehicle will be established. When a voice connection is established the audio system mutes and the message **TELE AID - ROADSIDE ASSISTANCE CALL ACTIVE** appears in the MCS display.

- ▶ Describe the nature of the need for assistance.

The Mercedes-Benz Roadside assistance dispatcher will either dispatch a qualified Mercedes-Benz technician or arrange to tow your vehicle to the nearest Mercedes-Benz Light Truck Center. For services such as labor and / or towing, charges may apply. Refer to the Roadside Assistance manual for more information.



The following is only available in the USA:

- Sign and Drive services: Services such as jump start, a few gallons of fuel or the replacement of a flat tire with the vehicle spare tire are obtainable.

Controls in detail

Useful features



The indicator lamp in the Roadside Assistance button  remains illuminated in red for approx. ten seconds during the system self-check after turning the key in the steering lock to position **2** (together with the SOS button and the Information button .

See system self-check (▷ page 175) when the indicator lamp does not light up in red or stays on longer than approximately ten seconds.

Controls in detail

Useful features

If the indicator lamp in the Roadside Assistance button  is illuminated continuously and there was no voice connection to the Response Center established, then the Tele Aid system could not initiate a Roadside Assistance call (e.g. the relevant cellular phone network was not available). The message `ROADSIDE ASSISTANCE - CALL FAILED` appears in the MCS display.

Roadside Assistance calls can be terminated using the END Button on the MCS unit.

Information button



- ① Cover
- ② Information button 

- ▶ Briefly press on cover ①.
The cover will open.
- ▶ Press and hold the button (for longer than two seconds).

A call to the Customer Assistance Center will be initiated. The button will flash while the call is in progress. The message `INFO - CONNECTING CALL` will appear in the MCS display.

When the connection is established, the message `INFO - CALL CONNECTED` appears in the MCS display. The Tele Aid system will transmit data generating the vehicle identification number, model, color and location (subject to availability of cellular and GPS signals).

i

While the call is connected, you can change to navigation menu by pressing NAVI button on the MCS unit.



A voice connection between the Customer Assistance Center representative and the occupants of the vehicle will be established. When a voice connection is established the audio system mutes and the message `TELE AID - INFO CALL ACTIVE` appears in the MCS display. Information regarding the operation of your vehicle, the nearest Mercedes-Benz Light Truck Center or Mercedes-Benz USA products and services is available to you.

Controls in detail

Useful features

For more details concerning the Tele Aid system, please visit www.mbusa.com and use your ID and password (sent to you separately) to learn more (USA only).



The indicator lamp in the Information button  remains illuminated in red for approx. 10 seconds during the system self-check after turning key in the steering lock to position **2** (together with the SOS button and the Roadside Assistance button .

See system self-check (▷ page 175) when the indicator lamp does not light up in red or stays on longer than approximately ten seconds.

If the indicator lamp in the Information button  is illuminated continuously and there was no voice connection to the Response Center established, then the Tele Aid system could not initiate an Information call (e.g. the relevant cellular phone network is not available).

The message **INFO CALL FAILED** appears in the MCS display.

Information calls can be terminated using the **END** button on the MCS.



If the indicator lamps do not start flashing after pressing one of the buttons or remains illuminated (in red) at any time, the Tele Aid system has detected a fault or the service is not currently active, and may not initiate a call. Visit your Mercedes-Benz Light Truck Center and have the system checked or contact the Response Center at 1-800-756-9018 (in the USA) or 1-888-923-8367 (in Canada) as soon as possible.

Upgrade signals

The Tele Aid system processes calls using the following priority.

- Automatic emergency – First priority
- Manual emergency – Second priority
- Roadside assistance – Third priority
- Information – Fourth priority

Should a higher priority call be initiated while you are connected, an upgrade (alternating) tone will be heard and the appropriate indicator lamp will flash. If certain information such as vehicle identification number or customer information is not available, the operator may need to re-transmit.

During this time you will hear a beep and voice contact will be interrupted. Voice contact will resume once the retransmission is completed. Once a call is concluded, a beep will be heard and the respective indicator lamp will stop flashing. The MCS system operation will resume.

Controls in detail

Useful features



If the indicator lamp continues to flash or the system does not reset, contact the Response Center at 1-800-756-9018 (in the USA) or 1-888-923-8367 (in Canada), or Mercedes-Benz Customer Assistance at 1-800-FOR-MERCEdes (1-800-367-6372) in the USA or Customer Service at 1-800-387-0100 in Canada.



The indicator lamp on the corresponding button flashes until the call is concluded. Calls can only be terminated by a Response Center or Customer Assistance Center representative, except Roadside Assistance and Information calls, which can also be terminated by using the END button on the MCS unit.



When a Tele Aid call has been initiated, the MCS system audio is muted and the selected mode (radio, tape or CD) pauses. The optional cellular phone (if installed) switches off. If you must use this phone, the vehicle must be parked. Disconnect the coiled cord and place the call. The navigation system (if engaged) will continue to run. A pop-up window will appear in the MCS display to indicate that a Tele Aid call is in progress.

Remote door unlock

In case you have locked your vehicle unintentionally (e.g. key inside vehicle), and no other key is available:

- ▶ Contact the Mercedes-Benz Response Center at 1-800-756-9018 (in the USA) or 1-888-923-8367 (in Canada).

You will be asked to provide your password which you provided when you completed the subscriber agreement.

- ▶ Then return to your vehicle and pull outside handle of the liftgate for minimum of 20 seconds until the SOS button is flashing.

The message EMERGENCY CALL - CALL CONNECTED appears in the MCS display.

As an alternative, you may unlock the vehicle via Internet using the ID and password sent to you shortly after the completion of your acquaintance call.

The Response Center will then unlock your vehicle with the remote door unlocking feature.



The remote door unlock feature is available if the relevant cellular phone network is available.

The SOS button will flash and the message **EMERGENCY CALL - CALL CONNECTED** will appear in the MCS display to indicate receipt of the door unlock command.

Once the vehicle is unlocked, a Response Center specialist will attempt to establish voice contact with the vehicle occupants.

If the outside liftgate handle was pulled for more than 20 seconds before door unlock authorization was received by the Response Center, you must wait 15 minutes before pressing the outside liftgate handle again.

Stolen Vehicle Recovery services

In the event your vehicle was stolen:

- ▶ Report the incident to the police.
The police will issue a numbered incident report.
- ▶ Pass this number on to the Mercedes-Benz Response Center along with your password issued to you when you subscribed to the service.

The Response Center will then attempt to covertly contact the vehicle's Tele Aid system. Once the vehicle is located, the Response Center will contact the local law enforcement and you. The vehicle's location will only be provided to law enforcement.



When the anti-theft alarm or the tow-away alarm stays on for more than 30 seconds, a call is initiated automatically to the Response Center. See anti-theft alarm system (▷ page 83) and tow-away alarm (▷ page 84).

Controls in detail

Useful features

Garage door opener

The built-in remote control is capable of operating up to three separately controlled devices, for example garage door openers, gate openers, or other devices compatible with HomeLink® or some other systems.

You can program the signal transmitter buttons.

Controls in detail

Useful features



Remote control integrated into the overhead control panel

- ① Hand-held remote control transmitter (not part of the vehicle equipment)
- ② Hand-held transmitter button
- ③,④,⑤ Signal transmitter button
- ⑥ Indicator lamp

Warning!



Before programming the integrated remote control to a garage door opener or gate operator, make sure people and objects are out of the way of the device to prevent potential harm or damage. When programming a garage door opener, the door moves up or down. When programming a gate operator, the gate opens or closes.

Do not use the integrated remote control with any garage door opener that lacks safety stop and reverse features as required by U.S. federal safety standards (this includes any garage door opener model manufactured before April 1, 1982). A garage door that cannot detect an object - signaling the door to stop and reverse - does not meet current U.S. federal safety standards.

i

Certain types of garage door openers are incompatible with the integrated opener. If you should experience difficulties with programming the transmitter, contact an authorized Mercedes-Benz Light Truck Center, or call Mercedes-Benz Customer Assistance Center (in the USA only) at 1-800-FOR-MERCEdes, or Customer Service (in Canada) at 1-800-387-0100.



For operation in the USA only:
This device complies with Part 15 of the FCC Rules. Operation is subject to the following two conditions:

- (1) This device may not cause harmful interference, and
- (2) this device must accept any interference received, including interference that may cause undesired operation.

Any unauthorized modification to this device could void the user's authority to operate the equipment.

Programming or reprogramming the integrated remote control

Step 1:

- ▶ Switch on ignition.

Step 2:

- ▶ If you have previously programmed an integrated signal transmitter button and wish to retain its programming, proceed to step 3. Otherwise, press and hold the two outer signal transmitter buttons ③ and ⑤ and release them only when the indicator lamp ⑥ begins to flash after approximately 20 seconds (do not hold the button for longer than 30 seconds). This procedure erases any previous settings for all three channels and initializes the memory. If you later wish to program a second and/or third hand-held transmitter to the remaining two signal transmitter buttons, do not repeat this step and begin directly with step 3.

Controls in detail

Useful features

Step 3:

- ▶ Hold the end of the hand-held remote control transmitter ① of the device you wish to train approximately 2 to 5 in (5 to 12 cm) away from the surface of the integrated remote control located on the interior rear view mirror, keeping the indicator lamp ⑥ in view.

Step 4:

- ▶ Using both hands, simultaneously press the hand-held transmitter button ② and the desired integrated signal transmitter button (③, ④ or ⑤). Do not release the buttons until completing step 5.

The indicator lamp ⑥ on the integrated remote control will flash, first slowly and then rapidly. >>

Controls in detail

Useful features



The indicator lamp ⑥ flashes the first time the signal transmitter button is programmed. If this button has already been programmed, the indicator lamp will only start flashing after 20 seconds.

Step 5:

- ▶ When the indicator lamp ⑥ flashes rapidly, release both buttons.

Step 6:

- ▶ Press and hold the just-trained integrated signal transmitter button and observe the indicator lamp ⑥.

If the indicator lamp ⑥ stays on constantly, programming is complete and your device should activate when the integrated signal transmitter button is pressed and released.



If the indicator lamp ⑥ flashes rapidly for about two seconds and then turns to a constant light, continue with programming steps 8 through 12 as your garage door opener may be equipped with the “rolling code” feature.

Step 7:

- ▶ To program the remaining two buttons, repeat the steps above starting with step 3.

Rolling code programming

To train a garage door opener (or other rolling code devices) with the rolling code feature, follow these instructions after completing the “Programming” portion (steps 1 through 6) of this text. (A second person may make the following training procedures quicker and easier.)

Step 8:

- ▶ Locate “training” button on the garage door opener motor head unit.

Exact location and color of the button may vary by garage door opener brand. Depending on manufacturer, the “training” button may also be referred to as “learn” or “smart” button. If there is difficulty locating the transmitting button, refer to the garage door opener operator’s manual.

Controls in detail

Useful features

Step 9:

- ▶ Press “training” button on the garage door opener motor head unit.

The “training light” is activated.

You have 30 seconds to initiate the following step.

Step 10:

- ▶ Firmly press, hold for two seconds and release the programmed integrated signal transmitter button (③, ④ or ⑤).

Step 11:

- ▶ Press, hold for two seconds and release same button a second time to complete the training process.

Some garage door openers (or other rolling code equipped devices) may require you to perform this procedure a third time to complete the training.

Step 12:

- ▶ Confirm the garage door operation by pressing the programmed integrated signal transmitter button (③, ④ or ⑤).

Step 13:

- ▶ To program the remaining two buttons, repeat the steps above starting with step 3.

Gate operator / Canadian programming

Canadian radio-frequency laws require transmitter signals to “time-out” (or quit) after several seconds of transmission which may not be long enough for the integrated signal transmitter to pick up the signal during programming. Similar to this Canadian law, some U.S. gate operators are designed to “time-out” in the same manner.

If you live in Canada or if you are having difficulties programming a gate operator (regardless of where you live) by using the programming procedures, replace step 4 with the following:

Controls in detail

Useful features

Step 4:

- ▶ Continue to press and hold the integrated signal transmitter button (③, ④ or ⑤) while you press and re-press (“cycle”) your hand-held remote control transmitter ① every two seconds until the frequency signal has been learned. Upon successful training, the indicator lamp ⑥ will flash slowly and then rapidly after several seconds.
- ▶ Proceed with programming step 5 and step 6 to complete.

Operation of remote control

- ▶ Switch on ignition.
- ▶ Select and press the appropriate integrated signal transmitter button (③, ④ or ⑤) to activate the remote controlled device.

The integrated remote control transmitter continues to send the signal as long as the button is pressed – up to 20 seconds.

Erasing the remote control memory

- ▶ Switch on ignition.
- ▶ Simultaneously hold down the signal transmitter buttons ③ and ⑤, for approximately 20 seconds, or until the indicator lamp ⑥ flashes rapidly. Do not hold for longer than 30 seconds.

The codes of all three channels are erased.



If you sell your vehicle, erase the codes of all three channels.

Reprogramming a single integrated signal transmitter button

To program a device using a signal transmitter button previously trained, follow these steps:

- ▶ Press and hold the desired signal transmitter button (③, ④ or ⑤). Do not release the button.
- ▶ The indicator lamp will begin to flash after 20 seconds. Without releasing the integrated signal transmitter button, proceed with programming starting with step 3.

Trip computer*

The trip computer is located in the overhead console.



- ① RESET
- ② MODE
- ③ Display

Switching on the trip computer

- ▶ Switch on ignition.
Display ③ shows one of the available functions.
- ▶ If a function display does not appear, press MODE ②.



With engine not running, the display switches off automatically 30 seconds after the last entry.

Selecting functions

- ▶ Press MODE ② repeatedly until the desired display appears.

The functions are displayed in the following order:

- Date
- Compass
- Stop watch
- Present fuel consumption
- Average fuel consumption
- Distance remaining
- Country
- Switching off trip computer

Setting the date

- ▶ Press MODE ② repeatedly until the date appears.
- ▶ Press RESET ①.
The month shown flashes.
- ▶ Press MODE ② to advance to selected month.
- ▶ Press RESET ①.
The day shown flashes.
- ▶ Press MODE ② to advance to selected day.
- ▶ Press RESET ①.
The year shown flashes.
- ▶ Press MODE ② to advance to selected year.
- ▶ Press RESET ①.
The display stops flashing and the date is set.

Controls in detail

Useful features

Compass

The compass displays the direction the vehicle is traveling. The display ③ will show you N, NE, E, SE, S, SW, W or NW.



The presence of buildings, bridges, power lines and large antenna masts can influence the displayed values. Metallic or magnetic objects in or on the vehicle can influence the accuracy of the compass.

To make sure the display is correct, the compass must be set to the proper geographic zone (▷ page 191). It may also be necessary to calibrate the compass (▷ page 191).

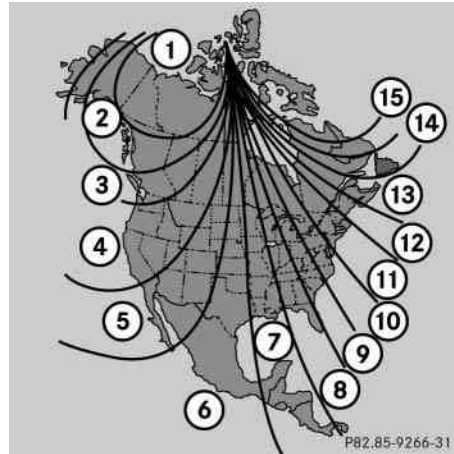

Zone map North America

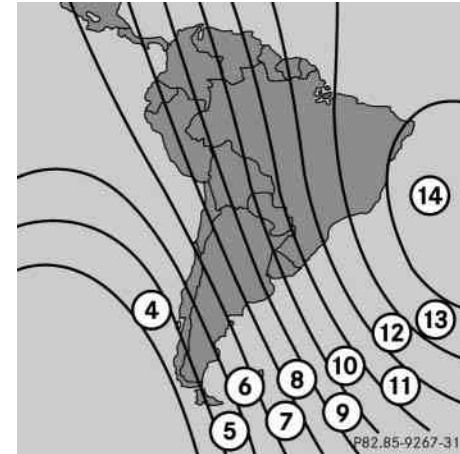

Zone map South America

Setting the compass zone

- ▶ Determine the geographical point of the vehicle with the aid of the zone maps.
- ▶ Switch on the ignition.
- ▶ Press MODE ② (▷ page 189) repeatedly until the compass display appears in the trip computer display ③.
- ▶ Press RESET ① (▷ page 189) to select the compass zone mode.

The zone selected last is shown in the display.

- ▶ Press RESET ① repeatedly until the correct compass zone, as determined from the zone map, is shown in the display.
- ▶ Press MODE ② twice.

The new compass zone is activated and the compass display will be shown.

Calibrating the compass

If the vehicle was exposed to a significant magnetic zone, such as high voltage power lines, the compass may have to be calibrated.

To calibrate the compass correctly, observe the following:

- Calibrate the compass in an area free of steel superstructures and power lines.
- Switch off all electrical consumers (e.g. exterior lamps, climate control, rear window defroster etc.).
- Do not open or close the tilt/sliding sunroof.
- Close doors and liftgate.



An open liftgate triggers the display - - -.

- ▶ Start and run the engine.
- ▶ Press MODE ② (▷ page 189) repeatedly until the compass display appears in the trip computer display ③.

- ▶ Press RESET ① and afterwards press MODE ②.

In the display appears CAL-.

- ▶ Press and hold RESET ① for approximately two seconds.

The calibration mode is activated and the display shows CAL.

- ▶ Drive without interruption two full circles at a speed between 3 mph (5 km/h) and 7 mph (10 km/h).

The message CAL goes out after a short time. The calibration is now complete.

Controls in detail

Useful features



If CAL remains in the display, calibration was not successfully completed. You have to recalibrate:

- Remove the key from the steering lock.
- Start the vehicle and start the calibration procedure described previously.

We recommend that you have the compass calibrated at a Mercedes-Benz Light Truck Center.

Stop watch

- ▶ Press MODE ② (▷ page 189) repeatedly until the stop watch display appears in the trip computer display ③.

Counting

- ▶ Press RESET ① (▷ page 189) to start counting.

Stopping

- ▶ Press RESET ① again to stop counting.

Resetting

- ▶ Press and hold RESET ① until the display shows "0:00".

Average fuel consumption

- ▶ Press MODE ② (▷ page 189) repeatedly until the average fuel consumption display appears in the trip computer display ③.

Distance remaining with fuel presently in tank

- ▶ Press MODE ② (▷ page 189) repeatedly until the distance remaining display appears in the trip computer display ③.



When the fuel supply drops to reserve level the display flashes distance remaining.

- USA only:
The display alternates between FUEL and distance remaining until supply is consistently below the reserve level. When the fuel supply is very low (approximately 1.5 gal [5.5 l]) FUEL is displayed continuously.

Country

- ▶ Press MODE ② (▷ page 189) repeatedly until the country display appears in the trip computer display ③.
- ▶ Press and hold RESET ① a minimum of five seconds to change the country unit system.

Canada units system selection

You can choose between CAN-English or CAN-French.

Setting CAN-English

- ▶ Press RESET ① repeatedly until CAN is displayed.
- ▶ Press MODE ② to select -ENG.
- ▶ Press MODE ② again to set CAN-English.

Setting CAN-French

- ▶ Press RESET ① repeatedly until CAN is displayed.
- ▶ Press MODE ②.
-ENG is displayed.
- ▶ Press RESET ① to select -Fr.
- ▶ Press MODE ② to set CAN-French.

The language selected determines how the various displays are presented, see table.

Display	Language	Date	Cardinal points	Fuel consumption	Distance remaining
GEr	German	DD.MM	Süd, Nord, Ost, West	l / 100 km	Kilometer
Gb	English	MM.DD	South, North, East, West	mi / gal (Imperial)	Miles
ESP	Spain	DD.MM	Sur, Norte, Este, Oeste	l / 100 km	Kilometer
Fr	French	DD.MM	Sud, Nord, Est, Ouest	l / 100 km	Kilometer
USA	American	MM.DD	South, North, East, West	mi / gal (US)	Miles
CAN-ENG	American	MM.DD	South, North, East, West	l / 100 km	Kilometer
CAN-Fr	French	DD.MM	Sud, Nord, Est, Ouest	l / 100 km	Kilometer



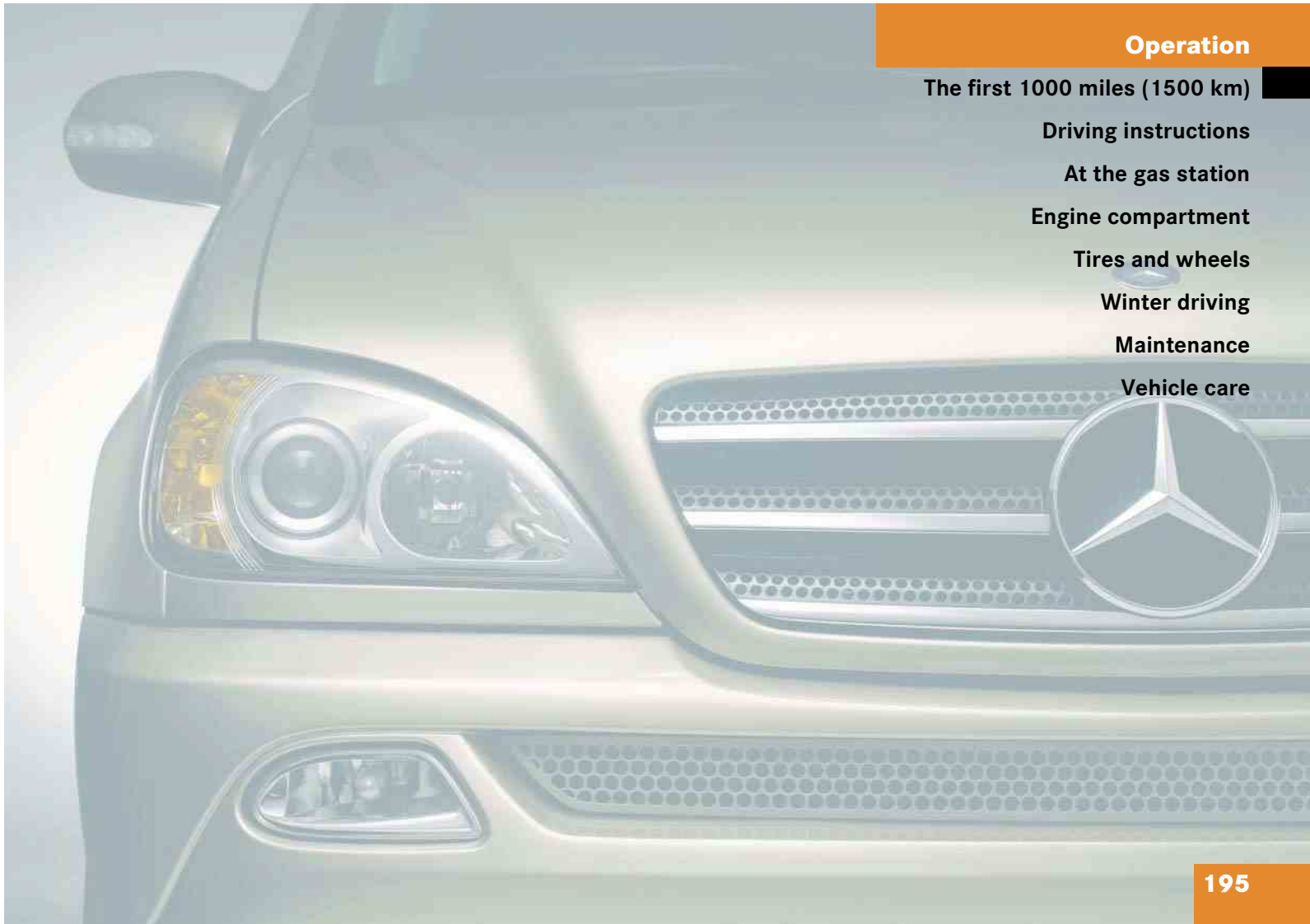

Operation

The first 1000 miles (1500 km)

Driving instructions

At the gas station

Engine compartment

Tires and wheels

Winter driving

Maintenance

Vehicle care

Operation

The first 1000 miles (1500 km)

In the “Operation” section you will find detailed information on operating, maintaining and caring for your vehicle.

The more cautiously you treat your vehicle during the break-in period, the more satisfied you will be with its performance later on.

- Drive your vehicle during the first 1000 miles (1500 km) at varying but moderate vehicle and engine speeds.
- During this period, avoid heavy loads (full throttle driving) and excessive engine speeds (no more than $\frac{2}{3}$ of maximum rpm in each gear).
- Avoid accelerating by kick-down.
- Do not attempt to slow the vehicle down by shifting to a lower gear using the gear selector lever.
- Select positions **3**, **2** or **1** only when driving at moderate speeds (for hill driving).

After 1000 miles (1500 km) you may gradually increase vehicle and engine speeds to the permissible maximum.

All of the above instructions, as may apply to your vehicle type, also apply when the first 1000 miles (1500 km) after the engine, the transfer case, the front differential or the rear differential has been replaced.



Always obey applicable speed limits.

▼ **Driving instructions**

Drive sensibly – save fuel

Fuel consumption, to a great extent, depends on driving habits and operating conditions.

To save fuel you should:

- Keep tires at the recommended inflation pressures.
- Remove unnecessary loads.
- Allow engine to warm up under low load use.
- Avoid frequent acceleration and deceleration.
- Have all maintenance work performed at the intervals specified in the Maintenance Booklet and as required by the maintenance service indicator. Contact an authorized Mercedes-Benz Light Truck Center.

Fuel consumption is also increased by driving in cold weather, in stop-and-go traffic, on short trips and in hilly country.

Drinking and driving

Warning!



Drinking and driving and / or taking drugs and driving are a very dangerous combination. Even a small amount of alcohol or drugs can affect your reflexes, perceptions and judgement.

The possibility of a serious or even fatal accident are greatly increased when you drink or take drugs and drive.

Do not drink or take drugs and drive or allow anyone to drive who has been drinking or taking drugs.

Pedals

Warning!



Keep driver's foot area clear at all times. Objects stored in this area may impair pedal movement.

Power assistance

Warning!



With the engine is not running, there is no power assistance for the brake and steering systems. In this case, it is important to keep in mind that a considerably higher degree of effort is necessary to brake and steer the vehicle.

Operation

Driving instructions

Brakes

Warning!



After driving in heavy rain for some time without applying the brakes or through water deep enough to wet brake components, the first braking action may be somewhat reduced and increased pedal pressure may be necessary to obtain expected braking effect. Maintain a safe distance from vehicles in front.

Resting your foot on the brake pedal will cause excessive and premature wear of the brake pads.

It can also result in the brakes overheating, thereby significantly reducing their effectiveness. It may not be possible to stop the vehicle in sufficient time to avoid an accident.

To help prevent brake disk corrosion after driving on wet road surfaces (particularly salted roads), it is advisable to brake the vehicle with considerable force prior to parking. The heat generated serves to dry the brakes.

If your brake system is normally only subjected to moderate loads, you should occasionally test the effectiveness of the brakes by applying above-normal braking pressure at higher speeds. This will also enhance the grip of the brake pads.



Be very careful not to endanger other road users when you apply the brakes.

Refer to the description of the Brake Assist System (BAS) (▷ page 78).

If the parking brake is released and the brake warning lamp in the instrument cluster stays on and there is no audible warning (EBP), the brake fluid level in the reservoir is too low.

Brake pad wear or a leak in the system may be the reason for low brake fluid in the reservoir.

Have the brake system inspected immediately. Contact an authorized Mercedes-Benz Light Truck Center.

All checks and service work on the brake system should be carried out by qualified technicians only. Contact an authorized Mercedes-Benz Light Truck Center.

Only install brake pads and brake fluid recommended by Mercedes-Benz.

Warning!



If other than recommended brake pads are installed, or other than recommended brake fluid is used, the braking properties of the vehicle can be degraded to an extent that safe braking is substantially impaired. This could result in an accident.



When driving down long and steep grades, relieve the load on the brakes by shifting into a lower gear to use the engine's braking power. This helps prevent overheating of the brakes and reduces brake pad wear.

After hard braking, it is advisable to drive on for some time, rather than immediately parking, so the air stream will cool down the brakes faster.

Operation

Driving instructions

Driving off

Apply the brakes to test them briefly after driving off. Perform this procedure only when the road is clear of other traffic.

Warm up the engine smoothly. Do not place full load on the engine until the operating temperature has been reached.

When starting off on a slippery surface, do not allow a drive wheel to spin for an extended period with the ESP switched off. Doing so may cause serious damage to the drivetrain which is not covered by the Mercedes-Benz Limited Warranty.

Operation

Driving instructions

Parking



Set the parking brake whenever parking or leaving the vehicle. In addition, move gear selector lever to position **P**.

When parking on hills, always turn front wheels towards the curb.

Warning!



To reduce the risk of personal injury, or damage to the vehicle powertrain, as a result of vehicle / trailer movement, always:

- Keep right foot on brake pedal.
- Shift gear selector lever to position **N**.
- Have a second person place wheel chocks on downhill side of left and right trailer wheels.
- Slowly release brake pedal and let vehicle and trailer roll into chocks until stopped.
- Firmly depress parking brake pedal.
- Move gear selector lever to position **P**.
- When parked on an incline, turn front wheel towards the road curb.

Tires

Warning!



If you feel a sudden significant vibration or ride disturbance, or you suspect that possible damage to your vehicle has occurred, you should turn on the hazard warning flashers, carefully slow down, and drive with caution to an area which is a safe distance from the road.

Inspect the tires and the vehicle underbody for possible damage. If the vehicle or tires appear unsafe, have it towed to the nearest Mercedes-Benz Light Truck Center or tire dealer for repairs.

Treadwear indicators (TWI) are required by law. These indicators are located in six places on the tread circumference and become visible at a tread depth of approximately $\frac{1}{16}$ in (1.6 mm), at which point the tire is considered worn and should be replaced.

The treadwear indicator appears as a solid band across the tread.

Warning!



Although the applicable federal motor vehicle safety laws consider a tire to be worn when the treadwear indicators (TWI) become visible at approximately $\frac{1}{16}$ in (1.6 mm), we recommend that you do not allow your tires to wear down to that level. As tread depth approaches $\frac{1}{8}$ in (3 mm), the adhesion properties on a wet road are sharply reduced.

Depending upon the weather and /or road surface (conditions), the tire traction varies widely.

Specified tire pressures must be maintained. This applies particularly if the tires are subjected to high loads (e.g. high speeds, heavy loads, high ambient temperatures).

Warning!



Do not drive with a flat tire. A flat tire affects the ability to steer or brake the vehicle. You may lose control of the vehicle. Continued driving with a flat tire or driving at high speed with a flat tire will cause excessive heat build-up and possibly a fire.

Hydroplaning

Depending on the depth of the water on the road, hydroplaning may occur even at low speeds and with new tires. Reduce vehicle speed, avoid track grooves in the road and apply brakes cautiously in the rain.

Tire traction

The safe speed on a wet, snow covered or icy road is always lower than on a dry road.

Operation

Driving instructions

You should pay particular attention to the condition of the road whenever the outside temperatures are close to the freezing point.

Warning!



If ice has formed on the road, tire traction will be substantially reduced. Under such weather conditions, drive, steer and brake with extreme caution.

Mercedes-Benz recommends M+S rated radial-ply tires with a minimum tread depth of approximately $\frac{1}{6}$ in (4 mm) on all four wheels for the winter season to make sure normal balanced handling characteristics. On packed snow, they can reduce your stopping distance as compared with summer tires.

Stopping distance, however, is still considerably greater than when the road is not covered with snow or ice. Exercise appropriate caution.

Operation

Driving instructions



Avoid spinning of one drive wheel. This may cause serious damage to the drivetrain which is not covered by the Mercedes-Benz Limited Warranty.

Tire speed rating

Regardless of the tire speed rating, local speed limits should be obeyed. Use prudent driving speeds appropriate to prevailing conditions.

Warning!



Even when permitted by law, never operate a vehicle at speeds greater than the maximum speed rating of the tires.

Exceeding the maximum speed for which tires are rated can lead to sudden tire failure, causing loss of vehicle control and possibly resulting in an accident and/or serious injury and possible death, for you and for others.

ML 350

Your vehicle is factory equipped with “H”-rated tires, which have a speed rating of 130 mph (210 km/h).

An electronic speed limiter prevents your vehicle from exceeding a speed of 130 mph (210 km/h).

ML 500

Your vehicle is factory equipped with “V”-rated tires, which have a speed rating of 149 mph (240 km/h).

An electronic speed limiter prevents your vehicle from exceeding a speed of 130 mph (210 km/h).



For information on speed ratings for winter tires, see “Winter tires” (▷ page 235).

Winter driving instructions

The most important rule for slippery or icy roads is to drive sensibly and to avoid abrupt acceleration, braking and steering maneuvers. Do not use the cruise control system under such conditions.

When the vehicle is in danger of skidding, move gear selector lever to position **N**. Try to keep the vehicle under control by corrective steering action.



For information on driving with snow chains, see “Snow chains” (▷ page 236).

Warning!



On slippery road surfaces, never downshift in order to obtain braking action. This could result in drive wheel slip and reduced vehicle control. Your vehicle's ABS will not prevent this type of control loss.

Do not engage the transfer case in position **LOW** when driving on ice or packed snow. At speeds below 18 mph (30 km / h) vehicle steering is adversely affected by the LOW RANGE - ABS (▷ page 77).

Road salts and chemicals can adversely affect braking efficiency. Increased pedal force may become necessary to produce the normal brake effect.

Depressing the brake pedal periodically when traveling at length on salt-strewn roads can bring road-salt-impaired braking efficiency back to normal.

If the vehicle is parked after being driven on salt-treated roads, the braking efficiency should be tested as soon as possible after driving is resumed.

Warning!



Make sure not to endanger any other road users when carrying out these braking maneuvers.

Warning!



If the vehicle becomes stuck in snow, make sure that snow is kept clear of the exhaust pipe and from around the vehicle with the engine running. Otherwise, deadly carbon monoxide (CO) gases may enter vehicle interior resulting in unconsciousness and death.

To assure sufficient fresh air ventilation, open a window slightly on the side of the vehicle not facing the wind.

Warning!



The outside temperature indicator is not designed to serve as an ice-warning device and is therefore unsuitable for that purpose. Indicated temperatures just above the freezing point do not guarantee that the road surface is free of ice.

For more information, see “Winter driving” (▷ page 235).

Operation

Driving instructions

Standing water



Do not drive through flooded areas or water of unknown depth. Before driving through water, determine its depth. Never accelerate before driving into water. The bow wave could force water into the engine and auxiliary equipment, thus damaging them.

If you must drive through standing water, drive slowly to prevent water from entering the passenger compartment or the engine compartment. Water in these areas could cause damage to electrical components or wiring of the engine or transmission, or could result in water being ingested by the engine through the air intake, causing severe internal engine damage. Any such damage is not covered by the Mercedes-Benz Limited Warranty.

Off-road driving

Warning!



Drive slowly in unknown terrain. This will make it easier to recognize unexpected obstacles and avoid damage to the vehicle.

To help avoid the vehicle rolling over, never turn it around on steep inclines. If the vehicle cannot complete the attempted climb, back it down in reverse gear.

Do not drive along the side of a slope (danger of vehicle rollover). The vehicle might otherwise rollover. If in doing so the vehicle begins to show a tendency to roll, immediately steer into a line of gravity (straight up or downhill).

Never let the vehicle roll backwards in idle. You may lose control of the vehicle if you use only the service brake.

Warning!



Sand, dirt, mud and other material having friction property can cause exceptional wear and tear as well as brake failure.

Have the brakes checked for dirt build-up and cleaned. There is otherwise a risk that full braking power may not be available in an emergency.

Read this chapter carefully before you begin off-road travel.

Familiarize yourself with the vehicle characteristics and gear changing before you attempt any difficult terrain off-road driving. We recommend that you start out with easy off-road travel.

Special driving features for off-road driving

The following driving features are available for specific kind of operation:

- LOW RANGE mode (▷ page 127)
- LOW RANGE – ABS (▷ page 77)
- LOW RANGE – 4-ETS (▷ page 80)
- LOW RANGE – ESP (▷ page 81)

Off-road driving rules

Engage the LOW RANGE mode before driving under off-road conditions (▷ page 127).

Fasten items being carried as securely as possible (▷ page 160).



We recommend keeping doors, liftgate, windows, and tilt / sliding sunroof* closed whenever driving in off-road mode.



Observe the following during off-road driving:

- Adjust vehicle speed to condition of terrain. The more uneven, rutty and steeper the terrain, the lower the speed should be.
- Watch out for obstacles, such as rocks, holes, tree stumps and ruts.
- Be especially careful when driving in unknown territory. It may be necessary to get out of the vehicle and scout the path you intend to take.
- Before driving through water, determine its depth.
- Do not stop vehicle while immersed in water, and do not shut off the engine.

- In sandy soil, please drive at a steady speed as allowed by conditions. This helps overcome the vehicle rolling resistance and reduces the likelihood of the vehicle sinking into the ground.
- Do not initiate jumps with the vehicle. It interrupts the forward momentum of the vehicle.
- Always drive onto slopes with the engine running and the vehicle in gear.

Checklist before off-road driving

Engine oil level

- Check the engine oil level (▷ page 224). The display OIL i.0 must appear via display in the speedometer.

Only then can the vehicle obtain a trouble-free oil supply, even on steep gradients.

Operation

Driving instructions

Tires

- Check the tread depth and maintain specified tire pressure (see tire pressure label inside the fuel filler flap).
- Check tires for possible damage and remove foreign objects.
- Replace missing valve caps.

Rims

- Dented or bent rims can cause tire pressure loss and damage the tire beads. For this reason, check and, if necessary, change rims before driving off-road.

Vehicle tool kit

- Check if the vehicle jack is functional.
- In all cases take the vehicle tool kit, a strong tow rope, a shovel and a small plank (to put under the vehicle jack on sandy soil) with you.

Driving in steep terrain

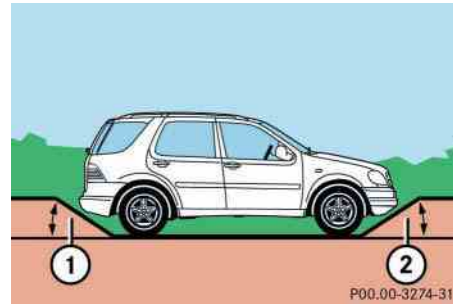

Slope angle

- ① 25°
- ② 26°
- Switch to LOW RANGE mode before starting to drive up or down steep inclines (> page 127).
- Driving on embankments, slopes and other steep inclines should only be done straight up or downhill, i.e. in the line of gravity. Maximum vehicle climbing ability is a 60% grade.

- Do not drive along the side of a slope (danger of vehicle rollover). If in doing so the vehicle begins to show a tendency to roll, immediately steer into a line of gravity (straight up or downhill).
- To help avoid the vehicle rolling over, never turn it around on steep inclines. If the vehicle cannot complete the attempted climb, back it down in reverse gear.
- Utilize the engine's braking power when descending a slope, observe the engine speed (do not overrev the engine). Apply the service brake as needed.
- Check the brakes after a lengthy down-grade drive.



Avoid excessive engine speeds – drive with moderate engine speeds (max. 3000 RPM).

Select gear range **2** or **1** on the automatic transmission (> page 122).

Traction in steep terrain

- Be easy on the accelerator and watch for continuous wheel traction when driving in steep terrain.

The 4-ETS helps greatly when starting out on a steep incline when the front wheels have then the tendency to slip due to the weight shifting away the front axle.

The 4-ETS recognizes the situation and limits the torque for the front wheels by braking them. Simultaneously the torque for the rear wheels is increased.

Driving across a hilltop

- Decelerate just ahead of a hilltop (do not select gear range **N**), to prevent the vehicle from speeding up too much after climbing a hill.

Use the momentum of the vehicle to drive across the hilltop.

Driving in this manner prevents the vehicle from jumping across the hilltop and thus losing its forward momentum.

Driving downhill

- Select gear range **1** on the automatic transmission (▷ page 122).
- Drive downhill observing the same rules as driving uphill (▷ page 206).
- The special LOW RANGE – ABS setting allows for precise and brief (cyclical) blocking of the front wheels, permitting them to dig into loose ground.

Remember that the front wheels when stopped, slide across a surface, thus lose their ability to steer the vehicle.

Operation

Driving instructions

Driving through water

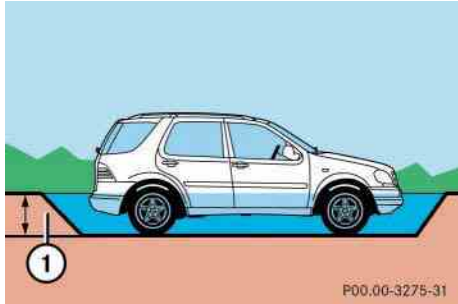

① 20 in (50 cm)

- Before driving through water, determine its depth.

It should not be deeper than approximately 20 inches (50 cm).

Make sure you check the water bed. The ground surface may not be firm which may result in deeper waters than expected when driving the vehicle through it.

- Switch to LOW RANGE mode before driving through water (▷ page 127).
- Switch off the exterior lamps as well as the automatic climate control.
- Select gear range **1** on the automatic transmission (▷ page 122).
- Enter the water only at a shallow spot, driving at walking speed.



Never accelerate before driving into the water. The bow wave could force water into the engine and auxiliary equipment, thus damaging them.

- Do not stop vehicle while immersed in water, and do not shut off the engine.

There is a very high level of driving resistance in water. The surface is slippery and may not be firm, making pulling away in water difficult and dangerous.

- Clean mud off the tire tread after driving through water.
- To dry the brakes, apply pressure to the brake pedal several times after leaving the water.

Crossing obstacles



Obstacles can damage the vehicle undercarriage or suspension components. If possible use the assistance of a second person outside the vehicle to scout the path you intend to take and check for adequate ground clearance when you cross obstacles with your vehicle. The person assisting you outside the vehicle should always be a safe distance away from the vehicle and positioned so that he or she cannot get hurt in case of any unexpected vehicle movement.

After off-road driving or crossing obstacles, inspect vehicle for any damage, especially vehicle undercarriage and suspension components. Failure to do so can adversely affect the vehicle's future performance, including increased chance of an accident.

- Check the vehicle clearance before crossing obstacles.
- Select gear range **1** on the automatic transmission (▷ page 122).
- Cross obstacles (e.g. tree stumps or big rocks) very slowly by aiming one of the front wheels at the center of the obstacle, and repeat same with the rear wheel.



Special attention is needed when you cross obstacles on a steep incline.

The vehicle could slide sideways as a result of its possible slanted position which in turn may result in the vehicle tipping or rolling over.

Operation

Driving instructions

Ruts

A number of off-road tracks or other by-ways have deep ruts which can cause the undercarriage to come in contact with the ground.

- Select gear range **1** on the automatic transmission (▷ page 122).
- Drive next to the ruts rather than through them if at all possible.

Returning from off-road driving

Warning!



If you feel a sudden significant vibration or ride disturbance, or you suspect that possible damage to your vehicle has occurred, you should turn on the hazard warning flashers, carefully slow down, and drive with caution to an area which is a safe distance from the roadway.

Inspect the tires and under the vehicle for possible damage. If the vehicle or tires appear unsafe, have it towed to the nearest Mercedes-Benz Light Truck Center or tire dealer for repairs.

Off-road driving increases strain on the vehicle.

We recommend that you inspect the vehicle for possible damage after each off-road trip. Recognizing any damage and a subsequent timely repair reduces the chance of a possible breakdown or accident later on.

Proceed as follows:

- Switch off the LOW RANGE mode (▷ page 127).
- Remove excessive dirt from tires, wheels, wheel housings, and underbody.

For instance, after driving in mud, clean the radiator, chassis, engine, brakes, and wheels from extreme dirt using a strong jet of water.

- Inspect frame, oil pan, brake hoses, etc., as well as vehicle underbody for possible damage.
- Check tires for possible damage, clean all exterior lamps, and conduct a brake test.
- Check for brush or branches caught in the undercarriage.
They could increase the possibility of a fire, as well as cut fuel and / or brake lines, puncture rubber bellows of the axles or drive shafts.
- After continued operation in mud, sand, water or other dirty conditions clean the brake discs, wheels, brake pads and check and clean axle joints.

Trailer towing

Warning!



Failure to use proper equipment and driving technique can result in a loss of vehicle control when towing a trailer.

Improper towing or failure to follow the instructions contained in this guide can result in serious injury. Follow the guidelines below carefully to assure safe trailer operation.

Ask an authorized Mercedes-Benz Light Truck Center should you require an explanation of information contained in this guide.

Operation

Driving instructions

Trailer hitches

- Only install a trailer hitch receiver approved for your vehicle.

For information on availability and installation, see an authorized Mercedes-Benz Light Truck Center.

- The bumpers on your vehicle are not designed for use with clamp-type hitches.

Do not attach rental hitches or other bumper-type hitches to them.

- To reduce the possibility of damage, remove the hitch ball adaptor from the receiver when not in use.

Operation

Driving instructions

Electrical connections

The vehicle is prewired to accept the seven-wire harness included in the Mercedes-Benz approved trailer hitch receiver kit.

An additional four-pole conversion plug is included in the Mercedes-Benz supplied trailer hitch receiver kit.

For further information, see an authorized Mercedes-Benz Light Truck Center.

Vehicle and trailer weights and ratings

Gross Vehicle Weight Rating (GVWR) is the maximum permissible vehicle weight: 6614 lbs (3000 kg).

Gross Vehicle Weight (GVW): Comprises weight of vehicle including fuel, tools, spare wheel, installed accessories, passengers, cargo and trailer tongue. It must never exceed the GVWR.

Gross Axle Weight Rating (GAWR) is the maximum permissible axle weight:

front	2976 lbs	(1350 kg)
rear	3858 lbs	(1750 kg)

Gross Trailer Weight (GTW) is the maximum permissible trailer weight to be towed: 5000 lbs (2260 kg).

Trailer Tongue Weight Rating (TWR) is the maximum permissible weight on the trailer tongue: 500 lbs (225 kg) limit for Mercedes-Benz approved hitch receiver.

Loading a trailer

- When loading a trailer, you should observe that neither the permissible GTW, nor the GVWR are exceeded.

Maximum permissible values are listed on the safety compliance certification labels for the vehicle and for the trailer to be towed.

The lowest value listed must be selected when determining how the vehicle and trailer are loaded.

- The tongue weight at the hitch ball must be added to the GVW to prevent exceeding your Mercedes-Benz tow vehicle's rear GAWR.



We recommend loading the trailer in such a manner that it has a tongue weight (TW) between 10% and 15% of the GTW.

Checking weights of vehicle and trailer

- To assure that the tow vehicle and trailer are in compliance with the maximum permissible weight limits have the loaded rig (tow vehicle including driver, passengers and cargo, trailer fully loaded) weighed on a commercial scale.
- Check the vehicle's front and rear Gross Axle Weight (GAW), the GTW and TW.

The values as measured must not be exceeded, according to the weight listed under "Vehicle and trailer weight and ratings".

Attaching a trailer

Observe maximum permitted trailer dimensions (width and length).

Most states and all Canadian provinces require

- safety chains between your tow vehicle and the trailer.

The chains should be crisscrossed under the trailer tongue. They must be attached to the hitch receiver, and not to the vehicle's bumper or axle.

Make sure to leave enough slack in the chains to permit turning corners.

- a separate brake system at various trailer weights.
- a break-away switch on trailers with a separate brake system.

The switch activates the trailer brakes in the possible event that the trailer might separate from the tow vehicle.



Do not connect a trailer brake system (if trailer is so equipped) directly to the vehicle's hydraulic brake system, as your vehicle is equipped with antilock brakes. If you do, neither the vehicle's brakes nor the trailer's brakes will function properly.



The provided vehicle electrical wiring harness for trailer towing has a brake signal wire (color orange) for hook-up to a brake controller.

You should consider using a trailer sway control system. For further information see an authorized Mercedes-Benz Light Truck Center.

Operation

Driving instructions

Towing a trailer

There are many different laws, including speed limit restrictions, having to do with trailer towing. Make sure your rig will be legal, not only for where you reside, but also for where you will be driving. A good source for this information can be the police or local authorities.

Note the following points, when driving with the trailer:

- In order to gain skill and an understanding of the vehicle's behavior, you should practice turning, stopping and backing up in an area which is free from traffic.
- Before you start driving check the
 - trailer hitch
 - break-away switch
 - safety chains
 - electrical connections
 - lighting and tires

Adjust the mirrors to permit unobstructed view beyond rear of trailer.

- If the trailer has electric brakes, start your vehicle and trailer moving slowly, and then apply only the trailer brake controller by hand to make sure the brakes are working properly.
- Always secure items in the trailer to prevent load shifts while driving.
- When towing a trailer, check occasionally to make sure the load is secure, and that lighting and trailer brakes (if so equipped) are functioning properly.
- Take into consideration that when towing a trailer, the handling characteristics are different and less stable from those when operating the vehicle without a trailer.

It is important to avoid sudden maneuvers.

- The vehicle and trailer combination is heavier, and therefore is limited in acceleration and climbing ability, and requires longer stopping distances.

It is more prone to reacting to side wind gusts, and requires more sensitive steering input.

- If possible, do not brake abruptly, but rather engage the brake slightly at first to permit the trailer to activate its brake. Then increase the braking force.



If the trailer should begin to sway, reduce the vehicle's speed and use the brake controller by hand to straighten out the vehicle and trailer.

In no case should you attempt to straighten out the tow vehicle and trailer by increasing the speed or oversteering and stepping on the brakes.

- If the transmission hunts between gears on inclines, manually shift to a lower gear (select **4, 3, 2** or **1**).
A lower gear and reduction of speed reduces the chance of engine overloading and/or overheating.
- On very steep inclines, not manageable with gear selector lever in position **1**, switch transfer case to LOW RANGE mode (▷ page 127).
- When going down a long hill, shift into a lower gear and use the engine's braking effect.
Avoid riding the brakes, thus overheating the vehicle and trailer brakes.
- If the engine coolant rises to an extremely high temperature (coolant temperature needle approaching the red zone) when the air conditioning is on, turn off the air conditioning system.
Engine coolant heat can be additionally vented by opening the windows, switching the climate control fan speed to high and setting the temperature control to the maximum hot position.
- Extreme care must be exercised since your vehicle with a trailer will require additional passing distance ahead than when driving without a trailer.
Because your vehicle and trailer is longer than your vehicle alone, you will also need to go much farther ahead of the passed vehicle before you can return to your lane.

Passenger compartment

Warning!



Always fasten items being carried as securely as possible.

In an accident, during hard braking or sudden maneuvers, loose items will be thrown around inside the vehicle, and cause injury to vehicle occupants unless the items are securely fastened in the vehicle.

The rear cargo compartment is the preferred place to carry objects. Always use the partition net when transporting cargo. Partition net cannot secure hard or heavy objects. Always fasten items being carried as securely as possible using the cargo tie-down rings in the cargo floor area and fastening materials.

Operation

Driving instructions

Driving abroad

Abroad, there is an extensive Mercedes-Benz service network at your disposal. If you plan to drive into areas which are not listed in the index of your Mercedes-Benz Light Truck Center directory, you should request pertinent information from an authorized Mercedes-Benz Light Truck Center.

Control and operation of radio transmitters

MCS, radio and telephone*

Warning!



Do not forget that your primary responsibility is to drive the vehicle. Only operate the MCS, radio or telephone¹ if road, weather and traffic conditions permit.

Bear in mind that at a speed of just 30 mph (approximately 50 km/h), your vehicle is covering a distance of 44 feet (approximately 14 m) every second.

¹ Observe all legal requirements.

Telephones and two-way radios

Warning!



Never operate radio transmitters equipped with a built-in or attached antenna (i.e. without being connected to an external antenna) from inside the vehicle while the engine is running. Doing so could lead to a malfunction of the vehicle's electronic system, possibly resulting in an accident and/or personal injury.

Radio transmitters, such as a portable telephone or a citizens band unit should only be used inside the vehicle if they are connected to an antenna that is installed on the outside of the vehicle.

Refer to the radio transmitter operation instructions regarding use of an external antenna.

Catalytic converter

Your Mercedes-Benz is equipped with monolithic-type catalytic converters, an important element in conjunction with the oxygen sensors to achieve substantial control of the pollutants in the exhaust emissions. Keep your vehicle in proper operating condition by following our recommended maintenance instructions as outlined in your Maintenance Booklet.



To prevent damage to the catalytic converters, use only premium unleaded gasoline in this vehicle.

Any noticeable irregularities in engine operation should be repaired promptly. Otherwise, excessive unburned fuel may reach the catalytic converter, causing it to overheat and start a fire.

Warning!



As with any vehicle, do not idle, park or operate this vehicle in areas where combustible materials such as grass, hay or leaves can come into contact with the hot exhaust system, as these materials could be ignited and cause a vehicle fire.

Emission control

Certain engine systems serve to keep the toxic components of the exhaust gases within permissible legal limits.

These systems, of course, will function properly only when maintained strictly according to factory specifications. Any adjustments on the engine should, therefore, be carried out only by qualified Mercedes-Benz Light Truck Center authorized technicians. Engine adjustments should not be altered in any way. Moreover, the specified service jobs must be carried out regularly according to

Mercedes-Benz servicing requirements. For details refer to the Maintenance Booklet.

Warning!



Inhalation of exhaust gas is hazardous to your health. All exhaust gas contains carbon monoxide, and inhaling it can cause unconsciousness and lead to death.

Do not run the engine in confined areas (such as a garage) which are not properly ventilated. If you think that exhaust gas fumes are entering the vehicle while driving, have the cause determined and corrected immediately. If you must drive under these conditions, drive only with at least one window fully open at all times.

Operation

Driving instructions

Coolant temperature

During severe operating conditions and stop-and-go city traffic, the coolant temperature may rise to approx. 248°F (120°C).

The engine should not be operated with the coolant temperature in the red zone. Doing so may cause serious engine damage which is not covered by the Mercedes-Benz Limited Warranty.

Warning!



- Driving when your engine is badly overheated can cause some fluids which may have leaked into the engine compartment to catch fire. You could be seriously burned.
- Steam from an overheated engine can cause serious burns and can occur just by opening the engine hood. Stay away from the engine if you see or hear steam coming from it.

Turn off the engine, get out of the vehicle and do not stand near the vehicle until the engine has cooled down.

▼ At the gas station

Refueling

Warning!



Gasoline is highly flammable and poisonous. It burns violently and can cause serious injury. Whenever you are around gasoline, avoid inhaling fumes and skin contact, extinguish all smoking materials. Never allow sparks, flame or smoking materials near gasoline!

The fuel filler flap is located on the left-hand side of the vehicle towards the rear. Locking/unlocking the vehicle with the remote control automatically locks/unlocks the fuel filler flap.

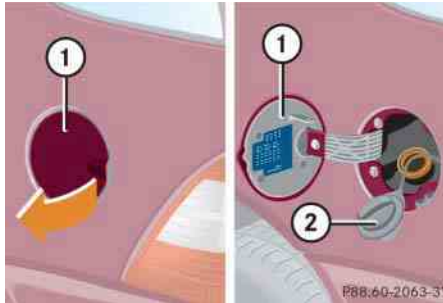

- ① Fuel filler flap
- ② Fuel cap

- ▶ Remove the key from the steering lock.
- ▶ Open the fuel filler flap ① by pulling in direction of the arrow.
- ▶ Turn the fuel cap ② to the left and hold on to it until possible pressure is released.
- ▶ Take off the cap.

Operation

At the gas station



The fuel filler cap is tethered to the fuel filler neck. Do not drop the cap. It could damage the vehicle paint finish.

- ▶ Only fill your tank until the filler nozzle unit cuts out – do not top up or overfill.



To prevent damaging the lens of the plastic tail lamp, make certain that no gasoline comes into contact with it.

Warning!



Overfilling of the fuel tank may create pressure in the system which could cause a gas discharge. This could cause the gas to spray back out when removing the fuel pump nozzle, which could cause personal injury. ▷▷

Operation

At the gas station



- ▷▷ Replace the fuel cap by turning it to the right.
You will hear when the fuel cap is tightened.
- ▶ Close the fuel filler flap.



Only use premium unleaded gasoline with a minimum Posted Octane Rating of 91 (average of 96 RON / 86 MON). Information on gasoline quality can normally be found on the fuel pump.

For more information on gasoline, see the Factory Approved Service Products pamphlet.



Leaving the engine running and the fuel cap open can cause the yellow fuel tank reserve warning lamp to flash and the  malfunction indicator lamp (USA only) or the  malfunction indicator lamp (Canada only) to illuminate.

For more information, see “Practical hints” (> page 254).

Check regularly and before a long trip

- Open the hood (▷ page 222).

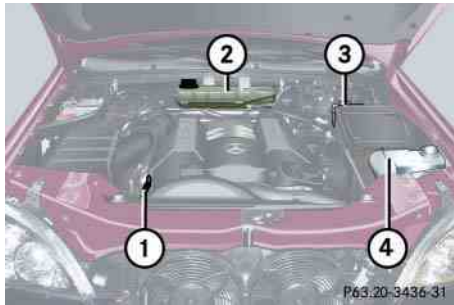

- ① Engine oil level
- ② Coolant level
- ③ Brake fluid
- ④ Windshield washer system and headlamp cleaning system*

Engine oil level

For more information on engine oil, see “Engine oil” (▷ page 223).

Coolant

For normal replenishing, use water (potable water quality). For more information, see “Coolant level” (▷ page 227) and see “Fuels, coolants, lubricants, etc.” (▷ page 312).

Brake fluid



If you find that the brake fluid in the brake fluid reservoir has fallen to the minimum mark or below, have the brake system checked for brake pad thickness and leaks immediately. Notify an authorized Mercedes-Benz Light Truck Center immediately. Do not add brake fluid as this will not solve the problem. For more information, see “Practical Hints” (▷ page 251).

Windshield / rear window washer system and headlamp cleaning system*

For more information on refilling the reservoir, see “Windshield / rear window washer system and headlamp cleaning system*” (▷ page 230).

Vehicle lighting

Check function and cleanliness. For information on replacing light bulbs, see “Replacing bulbs” (▷ page 274).

For more information, see “Combination switch” (▷ page 107).

Tire inflation pressure

For more information, see “Checking tire inflation pressure” (▷ page 232).

Operation

Engine compartment

Hood

Warning!



Do not pull the release lever while the vehicle is in motion. Otherwise the hood could be forced open by passing air flow.

Opening

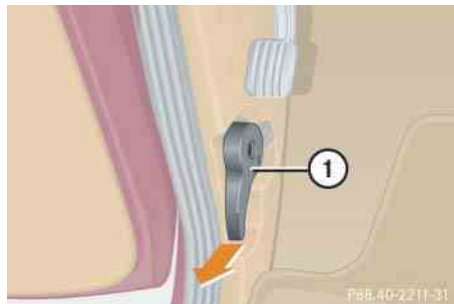

① Release lever

- ▶ Pull release lever ① downwards.

The hood is unlocked. Handle ② protrudes slightly from the radiator-grille. If not, lift the hood slightly.



To avoid damage to the windshield wipers or hood, never open the hood if the wiper arms are folded forward away from the windshield.

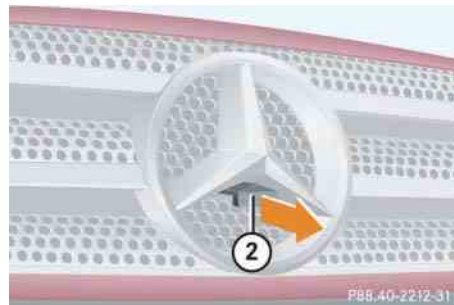

② Handle for opening the hood

- ▶ Pull handle ② to its stop out of the radiator-grille.

- ▶ Pull up on the hood and then release it.

The hood will be automatically held open at shoulder height by gas-filled struts.

Warning!



To help prevent personal injury, stay clear of moving parts when the hood is open and the engine is running. Make sure the hood is properly closed before driving. When closing the hood, use extreme caution not to catch hands or fingers.

The radiator fan may continue to run for approximately 30 seconds or even restart after the engine has been turned off. Stay clear of fan blades.

Warning!



If you see flames or smoke coming from the engine compartment, or if the coolant temperature gauge indicates that the engine is overheated, do not open the hood. Move away from vehicle and do not open the hood until the engine has cooled. If necessary, call the fire department.

Warning!



The engine is equipped with a transistorized ignition system. Because of the high voltage it is dangerous to touch any components (ignition coils, spark plug sockets, diagnostic socket) of the ignition system

- with the engine running
- while starting the engine
- if ignition is “on” and the engine is turned manually

Closing

Warning!



Be careful that you do not close the hood on anyone.

- ▶ Let the hood drop from a height of approximately 1 ft (30 cm).

The hood will lock audibly.

- ▶ Check to make sure the hood is fully closed.

If you can raise the hood at a point above the headlamps, then it is not properly closed. Open it again and let it drop with somewhat greater force.



Do not push the hood closed manually, as this could damage it.

Engine oil

The amount of oil your engine needs will depend on a number of factors, including driving style. Higher oil consumption can occur when

- the vehicle is new
- the vehicle is driven frequently at higher engine speeds

Engine oil consumption checks should only be made after the vehicle break-in period.



Do not use any special lubricant additives, as these may damage the drive assemblies. Using special additives not approved by Mercedes-Benz will restrict your warranty entitlement. More information on this subject is available at any Mercedes-Benz Light Truck Center.

Operation

Engine compartment

Checking engine oil level via display

When checking the oil level the vehicle must

- be parked on level ground
- be at normal operating temperature
- have been stationary for at least five minutes with the engine turned off

To check the engine oil level via the display in the speedometer, do the following:

- ▶ Turn the key in the steering lock to position **2**.



① Button

② Display in speedometer

- ▶ Wait until the display ----- appears in the speedometer display ②.

- ▶ Within one second press button ① twice.

One of the following messages will subsequently appear in the display:

- OIL i.0

The oil level is correct. Engine oil does not to be added.

- - 1.0 L
 - ▶ Add 1.0 liter of engine oil.
- - 1.5 L
 - ▶ Add 1.5 liters of engine oil.
- - 2.0 L
 - ▶ Add 2.0 liters of engine oil.

For adding engine oil see (▷ page 314).

For more information on engine oil, see the “Technical data” section (▷ page 312) and (▷ page 314).

Other display messages

If there is excess engine oil with the engine at normal operating temperature, the following message will appear in the display:

OIL HI

The oil level is too high.

- ▶ Have excess oil siphoned.



Excess oil must be siphoned or drained off. It could cause damage to the engine and catalytic converter not covered by the Mercedes-Benz Limited Warranty.

The display ----- flashes in the speedometer display, if a proper oil level check cannot be performed.

- ▶ If engine is at normal operating temperature, wait five minutes before repeating check procedure.
- ▶ If engine is not yet at normal operating temperature, wait 30 minutes before repeating check procedure.



Perform the engine oil level check with the dipstick if it cannot be completed via the speedometer display (▷ page 225).

In this case we recommend that you have the system checked at a Mercedes-Benz Light Truck Center.

See the “Practical hints” section (▷ page 260) if the low engine oil level warning lamp in the instrument cluster flashes.

Checking engine oil level with the oil dipstick

When checking the oil level the vehicle must

- be parked on level ground
- be at normal operating temperature
- have been stationary for at least five minutes with the engine turned off



The engine oil level can be checked by either the oil dipstick or via the speedometer display in the instrument cluster (▷ page 224). The amount of engine oil needed is shown more precisely in the speedometer display.

To check the engine oil level with the oil dipstick, do the following:

- ▶ Open the hood (▷ page 222).
- ▶ Pull out oil dipstick ① (▷ page 226).

Operation

Engine compartment

- ▶ Wipe oil dipstick ① clean.
- ▶ Fully insert oil dipstick ① into the dipstick guide tube.
- ▶ Pull out oil dipstick ① again after approximately three seconds to obtain accurate reading.

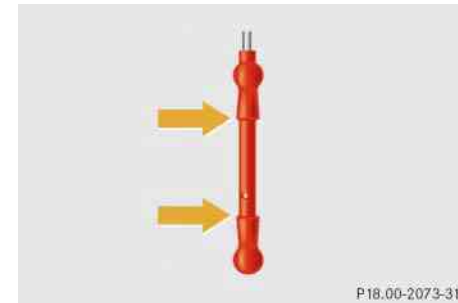

Oil dipstick

The oil level is correct when it is between the lower (min) and upper (max) mark of the oil dipstick.

Operation

Engine compartment



The filling quantity between the upper and lower marks on the oil dipstick is approximately 2.1 US qt. (2.0 l).

- ▶ If necessary, add engine oil.

For adding engine oil see (▷ page 226).

For more information on engine oil, see “Technical data” section (▷ page 312) and (▷ page 314).

See the “Practical hints” section (▷ page 260) if the low engine oil level warning lamp in the instrument cluster flashes.

Adding engine oil

Only use approved engine oils and oil filters required for vehicles with Maintenance System (U.S. vehicles) or FSS (Canada vehicles). For a listing of approved engine oils and oil filters, refer to the Factory Approved Service Products pamphlet in your vehicle literature portfolio, or contact an authorized Mercedes-Benz Light Truck Center.

Using engine oils and oil filters of specification other than those expressly required for the Maintenance System (U.S. vehicles) or FSS (Canada vehicles), or changing of oil and oil filter at change intervals longer than those called for by the Maintenance System (U.S. vehicles) or FSS (Canada Vehicles) will result in engine damage not covered by the Mercedes-Benz Limited Warranty.

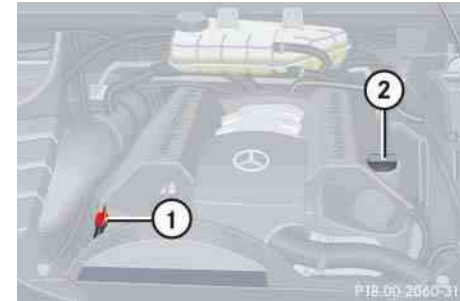

① Oil dipstick

② Filler cap

- ▶ Unscrew filler cap ② from filler neck.
- ▶ Add engine oil as required. Be careful not to overfill with oil.

Be careful not to spill any oil when adding. Avoid environmental damage caused by oil entering the ground or water.



Excess oil must be siphoned or drained off. It could cause damage to the engine and catalytic converter not covered by the Mercedes-Benz Limited Warranty.

- ▶ Screw filler cap ② back on filler neck.

For more information on engine oil, see the “Technical data” section (▷ page 312) and (▷ page 314).

Transmission fluid level

The transmission fluid level does not need to be checked. If you notice transmission fluid loss or gear shifting malfunctions, have an authorized Mercedes-Benz Light Truck Center check the automatic transmission.

Coolant level

The engine coolant is a mixture of water and anticorrosion / antifreeze. To check the coolant level, the vehicle must be parked on level ground and the engine must be cool.

Operation

Engine compartment

Warning!



In order to avoid any possibly serious burns:

- Use extreme caution when opening the hood if there are any signs of steam or coolant leaking from the cooling system, or if the coolant temperature gauge indicates that the coolant is overheated.
- Do not remove pressure cap on coolant reservoir if coolant temperature is above 158°F (70°C). Allow engine to cool down before removing cap. The coolant reservoir contains hot fluid and is under pressure.
- Using a rag, slowly open the cap approximately $\frac{1}{2}$ turn to relieve excess pressure. If opened immediately, scalding hot fluid and steam will be blown out under pressure.
- Do not spill antifreeze on hot engine parts. Antifreeze contains ethylene glycol which may burn if it comes into contact with hot engine parts.

Operation

Engine compartment

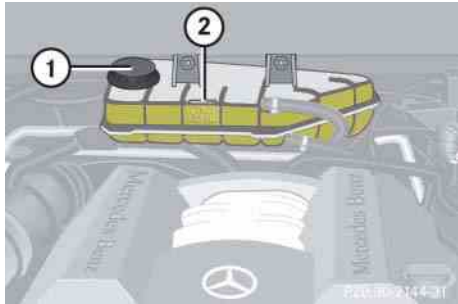

- ① Cap
- ② COLD LEVEL mark

The coolant level should reach the COLD LEVEL mark ② in the reservoir.



If the engine is already at its regular operating temperature, the coolant may be approximately 0.6 in (1.5 cm) above the COLD LEVEL mark.

- ▶ Using a rag, turn the cap slowly approximately one half turn to the left to release any excess pressure.
- ▶ Continue turning the cap to the left and remove it.
- ▶ Add coolant as required.
- ▶ Replace and tighten cap.

For more information on coolant, see the “Technical data” section (▷ page 316).

Battery





The battery is located in the engine compartment.



The battery should always be sufficiently charged in order to achieve its rated service life. Refer to Maintenance Booklet for battery maintenance intervals.

If you use your vehicle mostly for short-distance trips, you will need to have the battery charge checked more frequently.

When replacing batteries, always use batteries approved by Mercedes-Benz.

If you do not intend to operate your vehicle for an extended period of time, consult an authorized Mercedes-Benz Light Truck Center about steps you need to observe.

	Observe all safety instructions and precautions when handling automotive batteries.
	Risk of explosion
	Keep flames or sparks away from battery. Do not smoke.
	Battery acid is caustic. Do not allow it to come into contact with skin, eyes or clothing. In case it does, immediately flush affected area with clear water and seek medical help if necessary.

	Wear eye protection.
	Keep children away.
	Follow the instructions in this Operator's Manual.

Batteries contain materials that can harm the environment if disposed of improperly. Recycling of batteries is the preferred method of disposal. Many states require sellers of batteries to accept old batteries for recycling.

Operation

Engine compartment

Windshield/rear window washer system and headlamp cleaning system*

The windshield washer reservoir is located in the engine compartment.

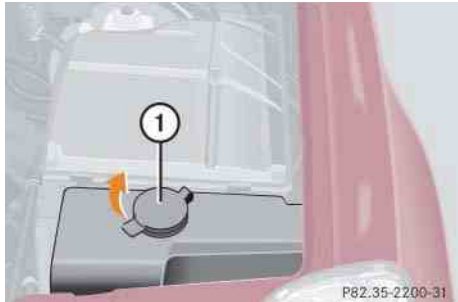

① Cap

Fluid for the windshield washer system and the headlamp cleaning system* is supplied from the windshield washer reservoir. It has a capacity of 8.0 US qt (7.6 l).

During all seasons, add MB Windshield Washer Concentrate "S" to water. Premix the windshield washer fluid in a suitable container.

- ▶ Use the tab to pull cap ① upwards (arrow).
- ▶ Refill the reservoir with MB Windshield Washer Concentrate "S" and water (or commercially available premixed windshield washer solvent / antifreeze, depending on ambient temperatures).

Always use washer solvent / antifreeze where temperatures may fall below freezing point. Failure to do so could result in damage to the washer system / reservoir.



Only use washer fluid which is suitable for plastic lenses. Improper washer fluid can damage the plastic lenses of the headlamps.

Warning!



Washer solvent / antifreeze is highly flammable. Do not spill washer solvent / antifreeze on hot engine parts, because it may ignite and burn. You could be seriously burned.

For more information, see the "Technical data" section (▷ page 319).

▼ Tires and wheels

See an authorized Mercedes-Benz Light Truck Center for information on tested and recommended rims and tires for summer and winter operation. They can also offer advice concerning tire service and purchase.

Warning!



Replace rims or tires with the same designation, manufacturer and type as shown on the original part. See an authorized Mercedes-Benz Light Truck Center for further information. If incorrectly sized rims and tires are mounted:

- The wheel brakes or suspension components can be damaged.
- The correct operating clearance of the wheels and the tires are no longer guaranteed.

Warning!



Worn, old tires can cause accidents. If the tire tread is badly worn, or if the tires have sustained damage, replace them.

When replacing rims, use only genuine Mercedes-Benz wheel bolts specified for the particular rim type. Failure to do so can result in the bolts loosening and possibly an accident.

Retreaded tires are not tested or recommended by Mercedes-Benz, since previous damage cannot always be recognized on retreads. Mercedes-Benz can therefore not assure the operating safety of the vehicle when such tires are used.

See an authorized Mercedes-Benz Light Truck Center for information on tested and recommended rims and tires for summer and winter operation.

Operation

Tires and wheels

Important guidelines

- Only use sets of tires and rims of the same type and make.
- Tires must be of the correct size for the rim.
- Break in new tires for approximately 60 miles (100 km) at moderate speeds.
- Regularly check the tires and rims for damage. Dented or bent rims can cause tire pressure loss or damage to the tire beads.
- If vehicle is heavily loaded, check tire pressure and correct as required.
- Do not allow your tires to wear down too far. Adhesion properties on wet roads are sharply reduced at tread depths under $\frac{1}{8}$ in (3 mm).
- When replacing individual tires, you should mount new tires on the front wheels first.

Operation

Tires and wheels



When the wheels are heavily soiled, e.g. after driving through mud, clean the inside of the wheels with a jet of water.

Life of tire

The service life of a tire is dependent upon varying factors including but not limited to:

- Driving style
- Tire pressure
- Distance driven

Warning!



Tires and spare tire should be replaced after six years, regardless of the remaining tread.



Keep unmounted tires in a cool, dry place with as little exposure to light as possible. Protect tires from contact with oil, grease and gasoline.

Direction of rotation

Unidirectional tires offer added advantages, such as better hydroplaning performance. To benefit, however, you must make sure the tires rotate in the direction specified.

An arrow on the sidewall indicates the intended direction of rotation of the tire.

Checking tire inflation pressure

Warning!



If the tire pressure drops repeatedly:

- Check the tires for punctures from foreign objects.
- Check to see whether air is leaking from the valves or from around the rim.

Correct the tire pressure only when tires are cold.

Regularly check your tire pressure at intervals of no more than 14 days.

If the tires are warm, you should only correct the tire pressure if it is too low for current operating conditions.

A table on the fuel filler flap lists the specified tire inflation pressures for warm and cold tires as well as for various operating conditions.



The pressures listed for light loads are minimum values offering high driving comfort.

Increased inflation pressures listed for heavier loads may also be used for light loads. These higher pressures produce favorable handling characteristics. The ride of the vehicle, however, will be somewhat harder. Never exceed the max. values or inflate tires below the min. values listed in the fuel filler flap.

Tire pressure changes by approximately 1.5 psi (0.1 bar) per 18°F (10°C) of air temperature change. Keep this in mind when checking tire pressure where the temperature is different from the outside temperature.

Tire temperature and tire pressure are also increased while driving, depending on the driving speed and the tire load.

Warning!



Follow recommended inflation pressures.

Do not overinflate tires. Overinflated tires can result in sudden deflation (blowout) because they are more likely to become punctured or damaged by road debris, potholes, etc.

Do not underinflate tires. Underinflated tires wear unevenly, adversely affect handling and fuel economy, and are more likely to fail from being overheated.

Do not overload the tires by exceeding the Gross Vehicle Weight Rating (GVWR) and the Gross Axle Weight Rating (GAWR) as indicated on the certification label on the driver's door pillar. Overloading the tires can overheat them, possibly causing a blowout.

Check the spare tire periodically for condition and inflation. Spare tire will age and become worn over time even if never used, and thus should be inspected and replaced when necessary.

Operation

Tires and wheels

Rotating wheels

Warning!



Rotate front and rear wheels only if they are of the same size,

The wheels can be rotated every 3000 to 6000 miles (5000 to 10000 km) or sooner if necessary, according to the degree of tire wear. The same direction of tire rotation must be retained.

Rotate the wheels before the characteristic tire wear pattern becomes visible (shoulder wear on front wheels and tread center wear on rear wheels).

Thoroughly clean the inner side of the wheels after each rotation. Check and make sure proper tire inflation pressure.

Operation

Tires and wheels

Warning!



Have the tightening torque checked after changing a wheel. Wheels could become loose if not tightened with a torque of 110 lb-ft (150 Nm).

Use only genuine Mercedes-Benz wheel bolts specified for your vehicle's rims.

▼ Winter driving

Before the onset of winter, have your vehicle winterized at an authorized Mercedes-Benz Light Truck Center. This service includes:

- Check of anticorrosion and antifreeze concentration.
- Addition of cleaning concentrate to the water of the windshield and headlamp cleaning system. Add MB Concentrate "S" to a premixed windshield washer solvent / antifreeze which is formulated for temperatures below freezing point (▷ page 319).
- Battery test. Battery capacity drops with decreasing ambient temperature. A well charged battery helps to make sure that the engine can be started even at low ambient temperatures.
- Tire change. Mercedes-Benz recommends M+S rated radial-ply tires with a minimum tread depth of approximately $\frac{1}{6}$ in (4 mm) on all four wheels for the winter season.

Winter tires

Always use winter tires at temperatures below 45°F (7°C) and whenever wintry road conditions prevail. Use of winter tires is the only way to achieve the maximum effectiveness of the ABS, ESP, 4-ETS, and EBP in winter operation.

For safe handling, make sure all winter tires mounted are of the same make and have the same tread design.

Warning!



Winter tires with a tread depth under $\frac{1}{6}$ in (4 mm) must be replaced. They are no longer suitable for winter operation.

Always observe the speed rating of the winter tires installed on your vehicle. If the maximum speed for which your tires are rated is below the speed rating of your vehicle, you must place a notice to this effect where it will be seen by the driver. Such notices are available at your tire dealer or any authorized Mercedes-Benz Light Truck Center.

Warning!



If you use your spare tire when winter tires are fitted on the other wheels, be aware that the difference in tire characteristics may very well impair turning stability and that overall driving stability may be reduced. Adapt your driving style accordingly.

Have the spare tire replaced with a winter tire at the nearest authorized Mercedes-Benz Light Truck Center.

Operation

Winter driving

Block heater (Canada only)

The engine is equipped with a block heater.

The electrical cable may be installed at an authorized Mercedes-Benz Light Truck Center.

Snow chains

Snow chains should only be driven on snow-covered roads at speeds not to exceed 30 mph (50 km/h). Remove chains as soon as possible when driving on roads without snow.



When driving with snow chains, you may wish to deactivate the ESP (▷ page 81) before setting the vehicle in motion. This will improve the vehicle's traction.

Please observe the following guidelines when using snow chains:

- Use of snow chains is not permissible with all wheel / tire combinations.
- Snow chains should only be used on all four wheels. With only two chains available, they should be mounted on the rear wheels. Follow the manufacturer's mounting instructions.
- Only use snow chains that are approved by Mercedes-Benz. Your authorized Mercedes-Benz Light Truck Center will be glad to advise you on this subject.
- Use of snow chains may be prohibited depending on location. Always check local and state laws before installing snow chains.

▼ Maintenance

We strongly recommend that you have your vehicle serviced by an authorized Mercedes-Benz Light Truck Center, in accordance with the Maintenance Booklet at the times called for by the maintenance service indicator display.



Failure to have the vehicle maintained in accordance with the Maintenance Booklet and maintenance service indicator at the designated times / mileage will result in vehicle damage not covered by the Mercedes-Benz Limited Warranty.

The maintenance service indicator will notify you when your next service is due.



- ① Knob
- ② Display in the speedometer

Starting approximately one month before your maintenance service is due, the type of maintenance service is indicated in the speedometer display ②:

-  Minor service (A)
-  Major service (B)

Operation

Maintenance

The following information, depending on operating conditions throughout the year, is also shown:

- calculated distance remaining
- calculated remaining time in days



Vehicles equipped with FSS (Flexible Service System) only (Canada vehicles): The interval between maintenance services depends on your driving habits. A gentle driving style, moderate engine speeds and the avoidance of short-distance trips will lengthen the interval between services.

Clearing the maintenance service indicator

The maintenance service indicator is automatically cleared after ten seconds when you switch on the ignition or when reaching the service threshold while driving. You can also clear it yourself.



- ▶ Press knob ①.

Operation

Maintenance

Maintenance service term exceeded

If you have exceeded the suggested maintenance service term:

- the  or  symbol appears in the display ② for 30 seconds and a signal sounds after switching on the ignition.
- it is preceded by a “-” (minus symbol).

The Mercedes-Benz Light Truck Center will reset the maintenance service indicator following a completed maintenance service.

Calling up the maintenance service indicator

- ▶ Within one second press knob ① twice.

The maintenance service indicator display will appear for ten seconds.



If the battery is disconnected, the days of disconnection will not be included in the count shown by the service indicator. To arrive at the true maintenance service deadline, you will need to subtract these days from the days shown in the maintenance service indicator.

Do not confuse the maintenance service indicator with the engine oil level indicator .

Resetting the maintenance service indicator

In the event that the maintenance service on your vehicle is not carried out by an authorized Mercedes-Benz Light Truck Center, you can reset the maintenance service indicator yourself.

- ▶ Switch ignition on and immediately press knob ① twice within one second.
The present status for days or distance is displayed.
- ▶ Within ten seconds turn the key in steering lock to position **0** (▷ page 33).
- ▶ Press and hold knob ① while switching the ignition on.
The present status for days or distance is displayed once more.

- ▶ Continue to hold knob ①.

After approximately ten seconds a signal sounds, and the display shows the distance to the next maintenance service due for approximately ten seconds.

- ▶ Release knob ①.



If the maintenance service indicator was inadvertently reset, have a Mercedes-Benz Light Truck Center correct it.

Only reset if the proper maintenance service has been performed. Resetting the system without performing the proper service as called for by the maintenance service indicator will result in engine damage and / or other vehicle damage not covered by the Mercedes-Benz Limited Warranty.

Operation

Vehicle care

Cleaning and care of the vehicle

Warning!



Many cleaning products can be hazardous. Some are poisonous, others are flammable. Always follow the instructions on the particular container. Always open your vehicle's doors or windows when cleaning the inside. Never use fluids or solvents that are not designed for cleaning your vehicle.

While in operation, even while parked, your vehicle is subjected to varying external influences which, if gone unchecked, can attack the paintwork as well as the underbody and cause lasting damage.

Such damage is caused not only by extreme and varying climatic conditions, but also by:

- Air pollution
- Road salt
- Tar
- Gravel and stone chipping

To avoid paint damage, you should immediately remove:

- Grease and oil
- Fuel
- Coolant
- Brake fluid
- Bird droppings
- Insects
- Tree resins, etc.

Frequent washing reduces and /or eliminates the aggressiveness and potency of the above adverse influences.

More frequent washings are necessary to deal with unfavorable conditions:

- near the ocean
- in industrial areas (smoke, exhaust emissions)
- during winter operation

You should check your vehicle from time to time for stone chipping or other damage. Any damage should be repaired as soon as possible to prevent corrosion.

In doing so, do not neglect the underbody of the vehicle. A prerequisite for a thorough check is a washing of the underbody followed by a thorough inspection. Damaged areas need to be re-undercoated.

Your vehicle has been treated at the factory with a wax-base rustproofing in the body cavities which will last for the lifetime of the vehicle. Post-production treatment is neither necessary nor recommended by Mercedes-Benz because of the possibility of incompatibility between materials used in the production process and others applied later.

We have selected car-care products and compiled recommendations which are specially matched to our vehicles and which always reflect the latest technology. You can obtain Mercedes-Benz approved car-care products at an authorized Mercedes-Benz Light Truck Center.

Scratches, corrosive deposits, corrosion or damage due to negligent or incorrect care cannot always be removed or repaired with the car-care products recommended here. In such cases it is best to seek aid at an authorized Mercedes-Benz Light Truck Center.

The following topics deal with the cleaning and care of your vehicle and give important “how-to” information as well as references to Mercedes-Benz approved car-care products.

For more information, see the booklet entitled “Vehicle Care Guide”.

Power washer

When using a power washer for cleaning the vehicle, always observe manufacturer’s operating instructions.



Never use a round nozzle to power-wash tires. The intense jet of water can result in damage to the tire.

Always replace a damaged tire.

Always keep the jet of water moving across the surface. Do not aim directly at electrical parts, electrical connectors, seals, or other rubber parts.

Tar stains

Quickly remove tar stains before they dry and become more difficult to remove. A tar remover is recommended.

Paintwork, painted body components

Mercedes-Benz approved Paint Care should be applied when water drops on the paint surface do not “bead up”, normally every three to five months, depending on climate and washing detergent used.

Mercedes-Benz approved Paint Cleaner should be applied if the paint surface shows signs of dirt embedding (i.e. loss of gloss).

Do not apply any of these products or wax if your vehicle is parked in the sun or if the hood is still hot.

Use the appropriate MB-Touch-Up Stick for quick and provisional repairs of minor paint damage (i.e. chips from stones, vehicle doors, etc.).

Operation

Vehicle care

Engine cleaning

Prior to cleaning the engine compartment make sure to protect electrical components and connectors from the intrusion of water and cleaning agents.

Corrosion protection, such as MB Anticorrosion Wax, should be applied to the engine compartment after every engine cleaning. Before applying, all control linkage bushings and joints should be lubricated. The poly-V-belt and all pulleys should be protected from any wax.

Vehicle washing

Do not use hot water or wash your vehicle in direct sunlight. Use only a mild car wash detergent, such as Mercedes-Benz approved Car Shampoo.

Thoroughly spray the vehicle with a diffused jet of water. Direct only a very weak spray towards the ventilation intake. Use plenty of water and rinse the sponge and chamois frequently.

Rinse with clear water and thoroughly dry with a chamois. Do not allow cleaning agents to dry on the finish.

Due to the width of the vehicle, fold in exterior rear view mirrors prior to running the vehicle through an automatic car wash to prevent damage to the mirrors.

In the winter, thoroughly remove all traces of road salt as soon as possible.

When washing the underbody, do not forget to clean the inner sides of the wheels.

Ornamental moldings

For regular cleaning and care of very dirty chrome-plated parts, use a chrome cleaner.

Headlamps, tail lamps, side markers, turn signal lenses

Use a mild car wash detergent, such as Mercedes-Benz approved Car Shampoo, with plenty of water.

To prevent scratches, never apply strong force and only use a soft, non-scratchy cloth when cleaning the lenses. Do not attempt to wipe dirty lenses with a dry cloth or sponge.

Cleaning the Parktronic* system sensors

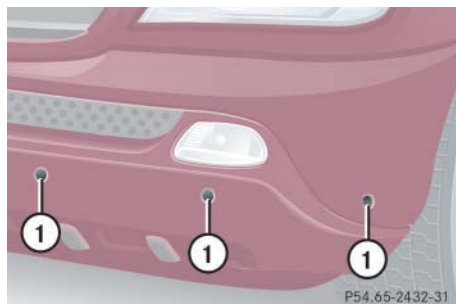

① Parktronic* system sensors

- ▶ Use a mild car wash detergent, such as Mercedes-Benz approved Car Shampoo, with plenty of water to clean the sensors ①.

When using a steam cleaner or power washer, aim nozzle only briefly from a minimum distance of 12 in (30 cm) at sensors ①.

To prevent scratches, never apply strong force and only use a soft, non-scratchy cloth when cleaning the sensor. Do not attempt to wipe dirty sensors with a dry cloth or sponge.

Wiper blades

- ▶ Fold wiper arms forward.

Warning!



For safety reasons, switch off wipers and remove key from steering lock before cleaning the wiper blades, otherwise the wiper motor might suddenly turn on and cause injury.

- ▶ Clean the wiper blades inserts with a clean cloth and detergent solution.



Fold the windshield wiper arms back onto the windshield before turning the key in the steering lock.

Hold on to the wiper when folding the wiper arm back. If released, the force of the impact from the tensioning spring could crack the windshield.

Window cleaning

- ▶ Fold wiper arms forward.

Warning!



For safety reasons, switch off wipers and remove key from steering lock before cleaning the windshield, otherwise the wiper motor might suddenly turn on and cause injury.

- ▶ Use a window cleaning solution on all glass surfaces.

An automotive glass cleaner is recommended.

Operation

Vehicle care



Fold the windshield wiper arms back onto the windshield before turning the key in the steering lock.

Hold on to the wiper when folding the wiper arm back. If released, the force of the impact from the tensioning spring could crack the windshield.

Light alloy wheels

Mercedes-Benz approved Wheel Care should be used for regular cleaning of the light alloy wheels.

If possible, clean wheels once a week with Mercedes-Benz approved Wheel Care, using a soft bristle brush and a strong spray of water.

Follow instructions on container.



Only use acid-free cleaning materials. Acid may cause corrosion or damage the clear coat.

Instrument cluster

Use a gentle dishwashing detergent or mild detergent for delicate fabrics as a washing solution. Wipe with a cloth moistened in lukewarm solution. Do not use scouring agents.

Steering wheel and gear selector lever

Wipe with a damp cloth and dry thoroughly or clean with Mercedes-Benz approved Leather Care.

Cup holder

Use a gentle dishwashing detergent or mild detergent for delicate fabrics as a washing solution. Wipe with a cloth moistened in lukewarm solution. Do not use scouring agents.

Hard plastic trim items

Pour Mercedes-Benz approved Interior Care onto soft lint-free cloth and apply with light pressure.

Headliner and rear window shelf

Clean with soft bristle brush, or use a dry-shampoo cleaner in case of excessive dirt.

Seat belts

The webbing must not be treated with chemical cleaning agents. Only use clear, lukewarm water and soap. Do not dry the webbing at temperatures above 176°F (80°C) or in direct sunlight.

Warning!



Do not bleach or dye seat belts as this may severely weaken them. In a crash they may not be able to provide adequate protection.

Upholstery

Using aftermarket seat covers or wearing clothing that has the tendency to give off coloring (e.g. when wet, etc.) may cause the upholstery to become permanently discolored. By lining the seats with a proper intermediate cover, contact-discoloration will be prevented.

Leather upholstery*

Wipe leather upholstery with a damp cloth and dry thoroughly or clean with Mercedes-Benz approved Leather Care. Exercise particular care when cleaning perforated leather as its underside should not become wet.

MB Tex upholstery

Pour Mercedes-Benz approved Interior Care onto soft lint-free cloth and apply with light pressure.

Plastic and rubber parts

Do not use oil or wax on these parts.

Wood trims

Dampen cloth using water and use damp cloth to clean wood trims in your vehicle. Do not use solvents like tar remover or wheel cleaner nor polishes or waxes as these may be abrasive.



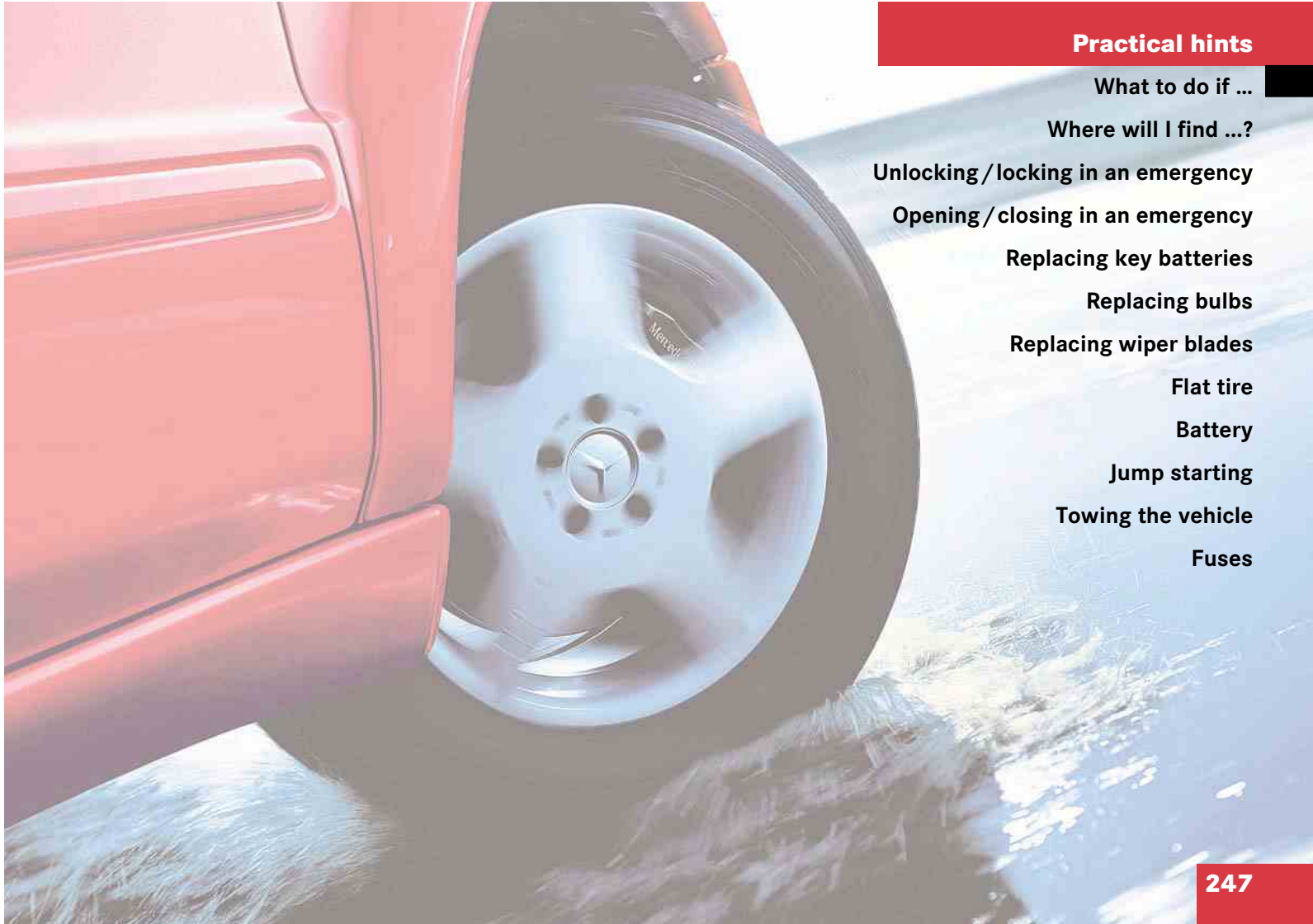

Practical hints

What to do if ...

Where will I find ...?

Unlocking/locking in an emergency

Opening/closing in an emergency

Replacing key batteries

Replacing bulbs

Replacing wiper blades

Flat tire

Battery

Jump starting

Towing the vehicle

Fuses

Practical hints

What to do if ...

Lamps in instrument cluster



General information:
If a bulb in the instrument cluster fails to come on during the bulb self-check when

switching on ignition, have it checked and replaced if necessary.

Problem	Possible cause	Suggested solution
 The yellow ABS malfunction indicator lamp comes on while driving.	ABS has detected a malfunction and has switched off. The BAS, ESP, and 4-ETS are also switched off.	▶ Continue driving with added caution. Wheels may lock during hard braking reducing steering capability.
	The brake system is still functioning normally but without ABS available.	▶ Have the system checked at an authorized Mercedes-Benz Light Truck Center as soon as possible. Failure to follow these instructions increases the risk of an accident.
	The charging voltage has fallen below 10 volts. The ABS has switched off.	When the voltage is above this value again, the ABS is operational again. ▶ If necessary, have the generator (alternator) and the battery checked.

Practical hints



What to do if ...

Problem	Possible cause	Suggested solution
 The yellow indicator lamp comes on.	A BabySmart ^{TM1} child seat is installed on the front passenger seat. The front passenger front airbag is therefore switched off. The system is malfunctioning when there is no BabySmart TM child seat installed on the front passenger seat.	<ul style="list-style-type: none">▶ Have the system checked as soon as possible by an authorized Mercedes-Benz Light Truck Center.
 The yellow indicator lamp does not light up with a BabySmart TM child seat properly installed on the front passenger seat.	The system is malfunctioning.	<ul style="list-style-type: none">▶ Make sure there is nothing between seat cushion and child seat and check installation of the child seat (▷ page 67).▶ If the light remains out, have the system checked as soon as possible by an authorized Mercedes-Benz Light Truck Center. <p>Do not use the BabySmartTM restraint to transport children on the front passenger seat until the system has been repaired.</p>

¹ Baby SmartTM is trademark of Siemens Automotive Corp.

Practical hints

What to do if ...

Problem	Possible cause	Suggested solution
 The red brake warning lamp comes on while driving.	There is insufficient brake fluid in the reservoir.	► Risk of accident! Carefully stop the vehicle and notify an authorized Mercedes-Benz Light Truck Center. Do not add brake fluid! This will not solve the problem.
 The red brake warning lamp comes on while driving and you hear a warning sound.	You are driving with the parking brake set.	► Release the parking brake (▷ page 48).

Warning!





Driving with the brake warning lamp illuminated can result in an accident. Have your brake system checked immediately if the brake warning lamp stays on. Don't add brake fluid before checking the brake system. Overfilling the brake fluid reservoir can result in spilling brake fluid on hot engine parts and the brake fluid catching fire. You can be seriously burned.



If you find that the brake fluid in the brake fluid reservoir has fallen to the minimum mark or below, have the brake system checked for brake pad thickness and leaks.

Practical hints

What to do if ...

Problem	Possible cause	Suggested solution
 BRAKE  ABS The red brake warning lamp comes on in addition to the yellow ABS indicator lamp and you hear a warning sound.	There is a malfunction in the Electronic Brake Proportioning (EBP) system. The enhanced braking effect is not available.	► Have the system checked immediately at an authorized Mercedes-Benz Light Truck Center. Failure to follow these instructions increases the risk of accidents.
 BAS ESP The yellow BAS / ESP indicator lamp comes on while driving.	The self-diagnosis has not been completed.	The BAS / ESP indicator lamp will go out after driving a short distance at more than approx. 12 mph (20 km/h).

Practical hints

What to do if ...



Problem	Possible cause	Suggested solution
 The yellow BAS / ESP malfunction indicator lamp comes on while driving.	The ESP is no longer synchronized following a voltage supply interruption (e.g. battery disconnected or discharged).	<p>Synchronize the ESP:</p> <ul style="list-style-type: none">▶ With vehicle stationary and the engine running, turn the steering wheel completely to the left and then to the right. <p>If the BAS / ESP indicator lamp does not go out:</p> <ul style="list-style-type: none">▶ Continue driving with added caution.▶ Visit an authorized Mercedes-Benz Light Truck Center as soon as possible. <p>Failure to follow these instructions increases the risk of an accident.</p>



When synchronizing the ESP, make sure you can turn the steering wheel in both directions as far as it will go without the wheels hitting any objects, e.g. a road curb.



Practical hints

What to do if ...

Problem	Possible cause	Suggested solution
 The yellow BAS / ESP malfunction indicator lamp comes on while driving.	The charging voltage has fallen below 10 volts. The BAS and the ESP have switched off.	When the voltage is above this value again, the BAS and ESP are operational again. <ul style="list-style-type: none">▶ If necessary, have the generator and the battery checked.
 The yellow BAS / ESP malfunction indicator lamp comes on while driving.	The BAS or the ESP is malfunctioning.	<ul style="list-style-type: none">▶ Continue driving with added caution.▶ Have the BAS / ESP checked at an authorized Mercedes-Benz Light Truck Center as soon as possible. Failure to follow these instructions increases the risk of an accident.



Practical hints

What to do if ...

Problem	Possible cause	Suggested solution
 (USA only)  (Canada only) The yellow engine malfunction indicator lamp comes on while driving.	<p>There is a malfunction of:</p> <ul style="list-style-type: none">• The fuel management system• The ignition system• The emission control system• Systems which affect emissions <p>Such malfunctions may result in excessive emissions values and may switch the engine to its limp-home (emergency operation) mode.</p>	<p>► Have the vehicle checked as soon as possible by an authorized Mercedes-Benz Light Truck Center. An on-board diagnostic connector is used by the service station to link the vehicle to the shop diagnostics system. It allows the accurate identification of system malfunctions through the readout of diagnostic trouble codes. It is located in the front left area of the footwell next to the parking brake pedal.</p>

Practical hints

What to do if ...

Problem	Possible cause	Suggested solution
 (USA only) The yellow engine malfunction indicator lamp comes on while driving.	A loss of pressure has been detected in the fuel system. The fuel cap may not be closed properly or the fuel system may be leaky.	<ul style="list-style-type: none">▶ Check the fuel cap (▷ page 219). If it is not closed properly: <ul style="list-style-type: none">▶ Close the fuel cap. If it is closed properly: <ul style="list-style-type: none">▶ Have the fuel system checked by an authorized Mercedes-Benz Light Truck Center.
 (Canada only) The yellow engine malfunction indicator lamp comes on while driving.	Your fuel tank is empty.	<ul style="list-style-type: none">▶ After refuelling start the engine three or four times in succession. The limp-home mode is canceled. You do not need to have your vehicle checked.

Practical hints

What to do if ...

Problem	Possible cause	Suggested solution
 The yellow coolant warning lamp comes on when the engine is running.	<p>The coolant is too hot.</p> <p>The coolant level is too low.</p>	<ul style="list-style-type: none"> ▶ Stop as soon as possible and allow the engine and coolant to cool down. ▶ Check the coolant level and add coolant if necessary (▷ page 227).
	<p>If the warning lamp comes on frequently, there is a leak in the cooling system.</p>	<ul style="list-style-type: none"> ▶ Have the cooling system checked by an authorized Mercedes-Benz Light Truck Center.
<p>The coolant temperature gauge is above 248°F (120°C).</p>	<p>The coolant level is too low.</p>	<ul style="list-style-type: none"> ▶ Stop as soon as possible and allow the engine and coolant to cool down. ▶ Add coolant to prevent engine from overheating (▷ page 227).
	<p>If the coolant level is correct, the electrical radiator fan may be broken.</p>	<ul style="list-style-type: none"> ▶ If the coolant temperature is below the red zone, immediately to the nearest authorized Mercedes-Benz Light Truck Center. <p>Avoid high engine loads (e.g. driving uphill) and stop-and-go driving.</p>

Practical hints

What to do if ...

Warning!



Driving when your engine is badly overheated can cause some fluids which may have leaked into the engine compartment to catch fire. You could be seriously burned.

Steam from an overheated engine can cause serious burns and can occur just by opening the engine hood. Stay away from the engine if you see or hear steam coming from it.

Turn off the engine, get out of the vehicle and do not stand near the vehicle until the engine has cooled down.

Warning!



Do not spill antifreeze on hot engine parts. Antifreeze contains ethylene glycol which may burn if it comes into contact with hot engine parts. You can be seriously burned.





Do not ignore the coolant warning lamps. Extended driving with the symbol displayed may cause serious engine damage not covered by the Mercedes-Benz Limited Warranty.

Do not drive without sufficient amount of coolant. The engine will overheat, causing major engine damage.

Practical hints

What to do if ...

Problem	Possible cause	Suggested solution
 The yellow 4-ETS / ESP warning lamp comes on steady while driving.	The ESP is deactivated. Risk of accident! Adapt your speed and driving to the prevailing road and weather conditions.	<ul style="list-style-type: none">▶ Switch the ESP back on (▷ page 82). If the ESP cannot be switched back on, have the system checked at an authorized Mercedes-Benz Light Truck Center as soon as possible.
 The yellow 4-ETS / ESP warning lamp flashes while driving.	The ESP or 4-ETS has come into operation because of detected traction loss in at least one tire.	<ul style="list-style-type: none">▶ During take-off, apply as little throttle as possible.▶ While driving, ease up on the accelerator.▶ Adapt your speed and driving to the prevailing road and weather conditions.▶ Do not deactivate the ESP. Exceptions: (▷ page 81). Failure to follow these instructions increases the risk of accidents.





Practical hints

What to do if ...

Problem	Possible cause	Suggested solution
ETS The yellow ETS malfunction indicator lamp comes on while the 4-ETS / ESP warning lamp  flashes.	4-ETS has switched off to prevent overheating of the brakes. Also see 4-ETS / ESP warning lamp (▷ page 258). 4-ETS is malfunctioning and has switched off.	As soon as the brakes have cooled off, 4-ETS switches on again. The indicator lamp goes out. ► Have the 4-ETS checked at an authorized Mercedes-Benz Light Truck Center as soon as possible.
LOW RANGE The yellow LOW RANGE indicator lamp flashes after one or more switching conditions.	The gear selection conditions have not been adhered to.	► Repeat the gear selection process (▷ page 127).
LOW RANGE The yellow LOW RANGE indicator lamp flashes after switching the ignition on.	LOW RANGE mode is malfunctioning.	Have the LOW RANGE mode checked at an authorized Mercedes-Benz Light Truck Center.
The yellow fuel tank reserve warning lamp comes on while driving.	The fuel level has gone below the reserve mark.	► Refuel at the next gas station (▷ page 219).
The yellow fuel tank reserve warning lamp flashes when leaving the engine running.	The fuel cap is not closed tightly.	► Check the fuel cap (▷ page 219).



Practical hints

What to do if ...

Problem	Possible cause	Suggested solution
 The yellow warning lamp flashes after starting the engine or while driving.	The engine oil level has sunk to the minimum level. If the engine oil level continues to sink, the warning lamp will light up.	<ul style="list-style-type: none"> ▶ Add approved oil at the next gas station (▷ page 314). ▶ If oil loss is visible on the engine, have the malfunction corrected as soon as possible at a Mercedes-Benz Light Truck Center.
 The red indicator lamp does not go out after starting the engine.	The adjustable telescoping steering column is not properly locked.	<ul style="list-style-type: none"> ▶ Lock the adjustable steering column (▷ page 40).
 The green front fog lamp indicator lamp lights up when ignition is turned on.	The front fog lamps are switched on.	<ul style="list-style-type: none"> ▶ Fog lamps (▷ page 111).
 The red seat belt telltale illuminates for a brief period after starting the engine.	The telltale reminds you to fasten seat belts.	<ul style="list-style-type: none"> ▶ Fasten your seat belt (▷ page 64). The telltale goes out.
 The yellow low washer system fluid level lamp comes on after starting the engine or while driving.	<p>There is approximately 1.3 US qt. (1.25 l) of washer fluid remaining in the reservoir.</p> <p>The washer fluid may have frozen.</p>	<ul style="list-style-type: none"> ▶ Add washer fluid (▷ page 230). ▶ Move the vehicle to a warmer environment so that the washer fluid will thaw. ▶ Correct the concentration level after the washer fluid in the reservoir thaws.

Practical hints

What to do if ...

Problem	Possible cause	Suggested solution
 The red charge indicator lamp comes on when the engine is running.	The battery is no longer charging. Possible causes: <ul style="list-style-type: none">• alternator malfunctioning• broken poly-V-belt	▶ Stop immediately and check the poly-V-belt. If it is broken ▶ Do not continue to drive, before the poly-V-belt is replaced. Notify an authorized Mercedes-Benz Light Truck Center.
 The yellow brake indicator lamp comes on during braking or after starting the engine.	The brake pads are worn down.	▶ Have the system checked at an authorized Mercedes-Benz Light Truck Center.



Brake pad thickness must be visually checked by a qualified technician at the intervals specified in the Maintenance Booklet.

Practical hints

What to do if ...

Problem	Possible cause	Suggested solution
SRS The red SRS indicator lamp lights up while driving.	There is a malfunction in the restraint systems. The airbags or emergency tensioning device (ETDs) could deploy unexpectedly or fail to activate in an accident.	► Drive with added caution to the nearest authorized Mercedes-Benz Light Truck Center.

Warning!







In the event a malfunction of the SRS is indicated as outlined above, the SRS may not be operational. For your safety, we strongly recommend that you visit an authorized Mercedes-Benz Light Truck Center immediately to have the system checked, otherwise the SRS may not be activated when needed in an accident, which could result in serious or fatal injury, or it might deploy unexpectedly and unnecessarily which could result in an accident /or injury to you or to others.

Practical hints

What to do if ...

Additional indicators in the speedometer display

Display	Possible cause	Suggested solution
	Perform minor service (A) (▷ page 237).	▶ Visit an authorized Mercedes-Benz Light Truck Center to perform service.
	Perform major service (B) (▷ page 237).	▶ Visit an authorized Mercedes-Benz Light Truck Center to perform service.
  The StArt message comes on in addition to the Error message.	The immobilizer is not operational.	▶ Contact an authorized Mercedes-Benz Light Truck Center or call 1-800-FOR-MERCEdes (in the USA), or 1-800-387-0100 (in Canada).

Practical hints

Where will I find ...?

First aid kit



Check expiration dates and contents for completeness at least once a year and replace missing/expired items.

The first aid kit is stored in the liftgate.

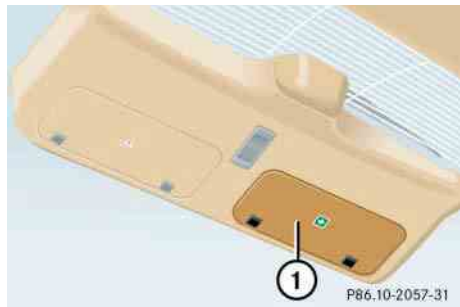

- ▶ Open and fold down panel ①.
The first aid kit can be removed.

Vehicle tool kit

The vehicle tool kit is stored in the cargo compartment behind the right trim panel.

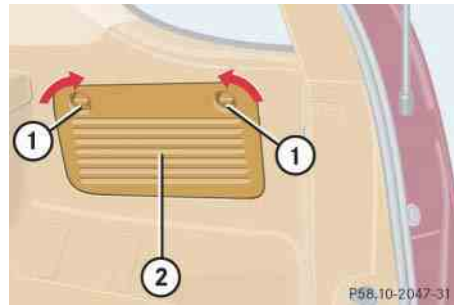

- ① Handles
- ② Panel
- ▶ Turn handles ① 90° in direction of arrows.
- ▶ Fold down the panel ②.

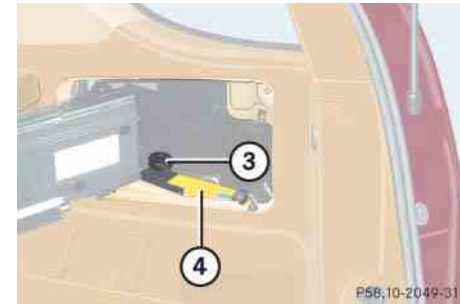

- ③ Screw
- ④ Vehicle jack with tool kit

- ▶ Turn screw ③ counterclockwise.
- ▶ Remove vehicle jack.

Vehicles with CD-changer*
(▷ page 265).

The jack is exclusively designed for lifting the vehicle during a wheel change. Always lower the vehicle on sufficient capacity jackstands before working under the vehicle.

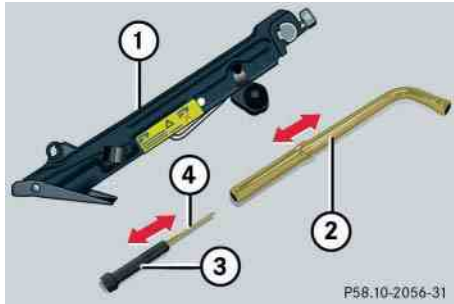

- ① Vehicle jack
- ② Wheel bolt wrench
- ③ Screwdriver
- ④ Interchangeable slot

Screwdriver ③ is placed inside the wheel-bolt wrench handle.

Vehicle jack

Please also observe the safety guidelines in the “Flat tire” section (▷ page 284) when using the jack.

Warning!



The jack is designed exclusively for jacking up the vehicle at the jack take-up brackets built into both sides of the vehicle. To help avoid personal injury, use the jack only to lift the vehicle during a wheel change. Never get beneath the vehicle while it is supported by the jack. Keep hands and feet away from the area under the lifted vehicle. Always firmly set parking brake and block wheels before raising vehicle with jack.

Do not disengage parking brake while the vehicle is raised. Be certain that the jack is always vertical (plumb line) when in use, especially on hills. Always try to use the jack on level surface.

Practical hints

Where will I find ...?

Make sure that the jack arm is fully seated in the jack take-up bracket. Always lower the vehicle onto sufficient capacity jack-stands before working under the vehicle.

Vehicle with CD-changer*

To access the vehicle tool kit, swing the CD-changer out of the panel.

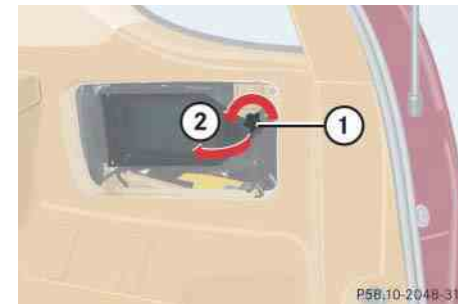

- ① Screw
- ② CD-changer

- ▶ Turn screw ① counterclockwise.
- ▶ Swing the CD-changer ② out of the panel.

Practical hints

Where will I find ...?

Spare wheel (space-saver tire)

Use the spare wheel only temporarily, while observing the following restrictions:

- Do not exceed vehicle speed of 50 mph (80 km/h).
- Drive to the nearest repair facility to have the flat tire repaired or replaced as appropriate.
- Do not operate vehicle with more than one spare wheel mounted.

Warning!



The dimensions of the spare wheel are different from those of the road wheels. As a result, the vehicle handling characteristics change when driving with a mounted spare wheel.



Please comply with the instructions for “Mounting the spare wheel” (▷ page 284).

Removing spare wheel

Warning!



Exercise care when removing or installing spare wheel to prevent personal injury.

The spare wheel is located behind the rear bumper.

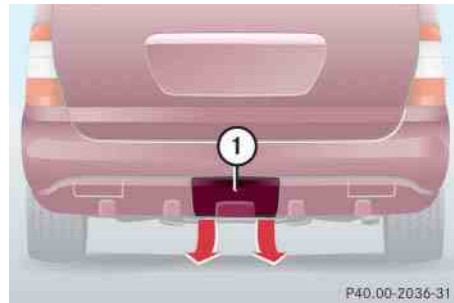

① Cover

- ▶ Hold left and right side of cover ① and pull away from bumper.

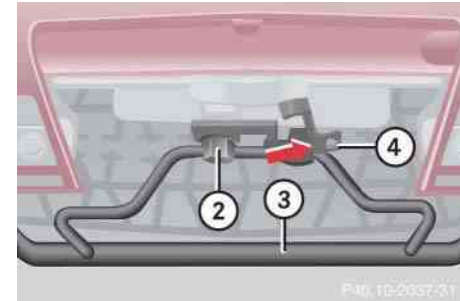

② Screw

③ Spare wheel carrier

④ Lever

- ▶ Turn screw ② counterclockwise using the wrench (▷ page 265).

Screw ② remains in spare wheel carrier ③.

- ▶ Lift spare wheel carrier slightly and push lever ④ to the right using screwdriver (▷ page 264).

- ▶ Swing spare wheel carrier ③ down and pull it out from under the bumper.

Practical hints

Where will I find ...?

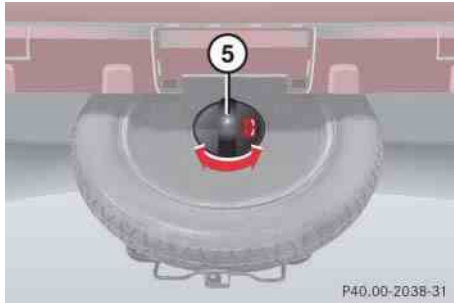

When storing the space-saver spare wheel in its holder, secure it using the bayonet lock.

⑤ Bayonet lock

- ▶ Turn the bayonet lock ⑤ 90° to the left.
- ▶ Pull off bayonet lock ⑤.
- ▶ Remove the spare wheel cover and the spare wheel.
- ▶ Store bayonet lock ⑤ and spare wheel cover in cargo compartment.
- ▶ Replace the spare wheel carrier and secure it in place.
- ▶ Install cover ① to the bumper.

Practical hints

Unlocking/locking in an emergency



Unlocking the vehicle

If you are unable to unlock the driver's door using the remote control, open the door using the folding key.



Unlocking the driver's door with the folding key will trigger the anti-theft alarm system.

To cancel the alarm, do one of the following:

- Press button  or  on the remote control.
- Insert the key in the steering lock.

Remote control with folding key

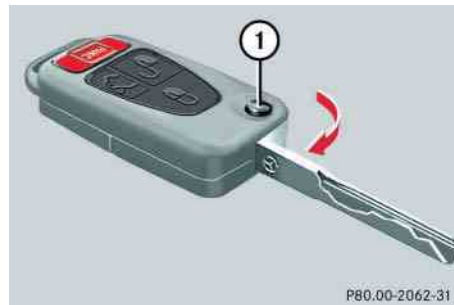

① Release button

- ▶ Press release button ① on the remote control.

The key folds out.

Unlocking the driver's door

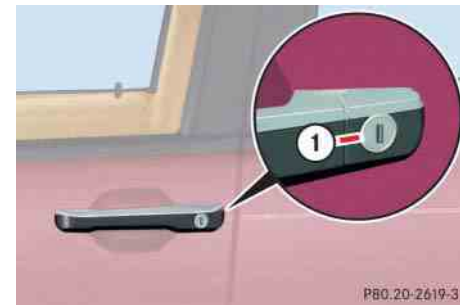

① Unlocking

- ▶ Insert the key into the driver's door lock until it stops.
- ▶ Turn the key counterclockwise to position ①.

The driver's door is unlocked.

Locking the vehicle

If you are unable to lock the vehicle with the remote control, lock it with the folding key as follows:

- ▶ Close the passenger doors and the liftgate.
- ▶ Press the upper part of the central locking switch in the cockpit (▷ page 93).
- ▶ Check to see whether the locking knobs on the passenger doors have moved down. If necessary push them down manually.
- ▶ Lock the liftgate if necessary from inside (▷ page 91).

Except for the driver's door, the vehicle should now be locked.

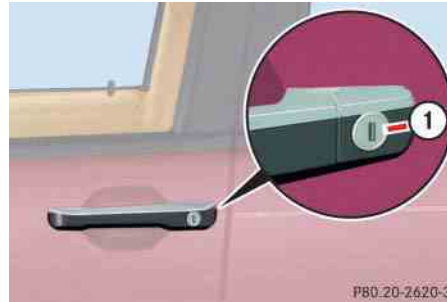

① Locking

- ▶ Insert the key into the driver's door lock until it stops.
 - ▶ Turn the key clockwise to position ①.
- The driver's door is locked.

Fuel filler flap

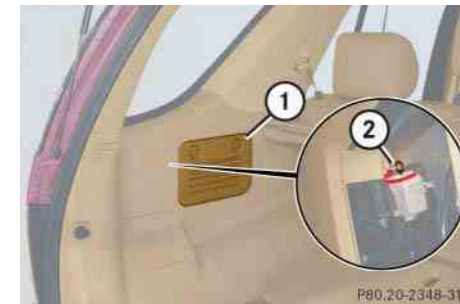

① Cover

② Lock rod

- ▶ Open the liftgate.
- ▶ Open cover ① in cargo compartment behind the left trim panel.
- ▶ Turn lock rod ② clockwise (arrow) to the end stop.

The fuel filler flap can now be opened.

Practical hints

Unlocking/locking in an emergency

Manually unlocking the transmission gear selector lever

In the case of power failure the transmission gear selector lever can be manually unlocked, e.g. to tow the vehicle.



① Pin

- ▶ Insert a pin ①, e.g. ball point pen, into the covered opening below the position **D** of the shift pattern.
- ▶ Perform the following two steps simultaneously:
 - ▶ Push the pin down.
 - ▶ Move gear selector lever from position **P**.
- ▶ Remove pin ①.

The cover returns to its closed position after moving the gear selector lever to position **D**.



The gear selector lever is locked again when moving it to position **P**.

▼ **Opening/closing in an emergency**

Power tilt/sliding sunroof*

You can open or close the tilt/sliding sunroof manually should an electrical malfunction occur.

The tilt/sliding sunroof drive is located behind cover ③ between the front interior lamps.

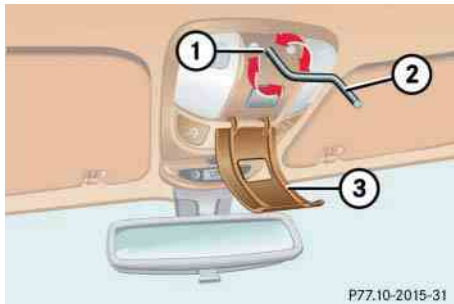

- ① Hexagon drive hole
- ② Crank
- ③ Cover

- ▶ Remove the key from the steering lock.
- ▶ Pry off cover ③ using a flat blade screwdriver.

- ▶ Take crank ② out of the Operator's Manual pouch.
- ▶ Insert crank ② through hole ①.



Push crank ② upward while turning to disengage the electric motor.

- ▶ Turn crank ② clockwise to:
 - slide sunroof closed
 - raise sunroof at the rear
- ▶ Turn crank ② counterclockwise to:
 - slide sunroof open
 - lower sunroof at the rear



Turn crank ② slowly and smoothly.

The tilt/sliding sunroof must be synchronized if it has been operated manually (▷ page 152).

Practical hints

Replacing key batteries

If the batteries in the remote control are discharged, the vehicle can no longer be locked or unlocked. It is recommended to have the batteries replaced at an authorized Mercedes-Benz Light Truck Center.

Warning!



Keep the batteries out of reach of children.

If a battery is swallowed, seek medical help immediately.

Batteries contain materials that can harm the environment if disposed of improperly. Recycling of batteries is the preferred method of disposal. Many states require sellers of batteries to accept old batteries for recycling.



When replacing batteries, always replace both batteries.

The required replacement batteries are available at any Mercedes-Benz Light Truck Center.

Remote control

Replacement batteries: Lithium, type CR 2025 or equivalent.

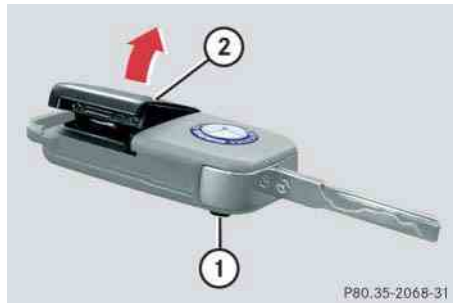

- ① Release button
- ② Battery cover
- ▶ Unfold the key by pressing release button ①.
- ▶ Pull off battery cover ② in direction of arrow.
- ▶ Remove the batteries.



When inserting the batteries, make sure they are clean and free of lint.





- ▶ Using a lint-free cloth, insert new batteries under the contact spring with the plus (+) side facing up.
- ▶ Press battery cover ② onto housing until locked in place.
- ▶ Push each button to assure proper operation of the remote control.

If remote control does not function correctly after replacing the batteries, the system may have to be resynchronized.

Practical hints

Replacing key batteries

Synchronizing remote control

- ▶ Turn key in steering lock to position **2** (▷ page 33), then to position **0** and remove.
 - ▶ Within ten seconds, push and hold button  while pushing button  five times.
 - ▶ Release the button, and press ,  or  once.
- The remote control is resynchronized.
- ▶ Recheck all of the remote control functions.



If it is not possible to resynchronize the remote control, have the system checked at an authorized Mercedes-Benz Light Truck Center.

Practical hints

Replacing bulbs

Bulbs

Safe vehicle operation depends on proper exterior lighting and signaling. It is therefore essential that all bulbs and lamp assemblies are in good working order at all times.

Correct headlamp adjustment is extremely important. Have headlamps checked and readjusted at regular intervals and when a bulb has been replaced. See an authorized Mercedes-Benz Light Truck Center for headlamp adjustment.



Backup bulbs will be brought into use when the following lamps malfunction:

- Turn signal lamps
- Parking lamps
- Tail lamps

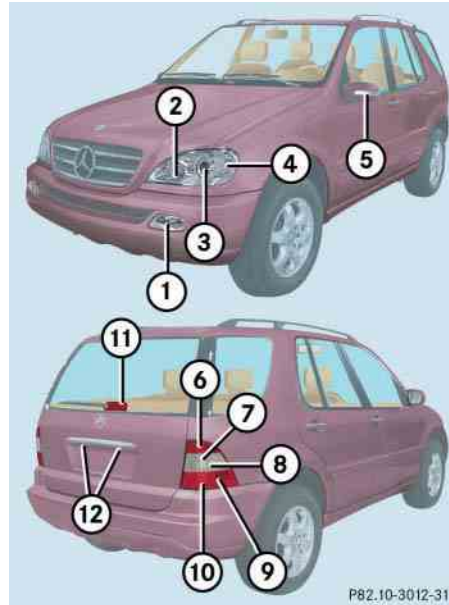

If the headlamps or front fog lamps are fogged up on the inside as a result of high humidity, driving the vehicle a distance with the lights on should clear up the fogging.

Front lamps

Lamp	Type
① Front Fog lamp	H8 (35 W)
② High beam	H7 (55 W)
Parking, standing lamp	5 W 5
③ Low beam ¹	H7 (55 W) Xenon*: D2S-35 W
④ Turn signal and side marker lamp	1 157 NA (32 / 3 cp bulb)
⑤ Additional turn signal lamp	LED

¹ Vehicles with Xenon* headlamps: Do not replace the Xenon bulbs yourself. See your authorized Mercedes-Benz Light Truck Center.

Rear lamps

	Lamp	Type
⑥	Brake lamp	1073 (32 cp bulb)
⑦	Backup lamp	1073 (32 cp bulb)
⑧	Turn signal lamp	PY 21 W
⑨	Side marker lamp	W 5 W
⑩	Tail, parking, standing lamp, rear fog lamp (only driver's side)	P 21 / 4 W
⑪	High mounted brake lamp	1073 (32 cp bulb)
⑫	License plate lamps	C 5 W

Warning!



Bulbs and bulb sockets can be very hot. Allow the lamp to cool down before changing a bulb.

Keep bulbs out of reach of children.

Halogen lamps contain pressurized gas. A bulb can explode if you:

- touch or move it when hot
- drop the bulb
- scratch the bulb

Wear eye and hand protection.

Because of high voltage in Xenon lamps, it is dangerous to replace the bulb or repair the lamp and its components. We recommend that you have such work done by a qualified technician.

Practical hints

Replacing bulbs

Notes on bulb replacement

- Only use 12 volt bulbs of the same type and with the specified watt rating.
- Switch lights off before changing a bulb to prevent short circuits.
- Always use a clean lint-free cloth when handling bulbs.
- Your hands should be dry and free of oil and grease.
- If the newly installed bulb does not come on, visit an authorized Mercedes-Benz Light Truck Center.

Practical hints

Replacing bulbs

Have the LEDs and bulbs for the following lamps replaced by an authorized Mercedes-Benz Light Truck Center:

- Additional turn signals in the exterior rear view mirrors
- Xenon*-lamps
- Front fog lamps (vehicles with sport package*)
- High mounted brake lamp (only vehicles with an exterior spare-wheel rack*)

Replacing bulbs for front lamps

Before you start to replace a bulb for a front lamp, do the following first:

- ▶ Turn the combination switch to position  (▷ page 107).
- ▶ Open the hood (▷ page 222).

Replacing low beam bulbs

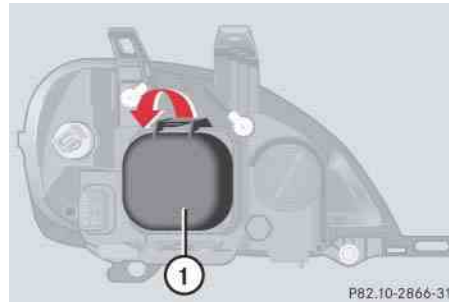

- ① Low beam halogen or Bi-Xenon* housing cover with locking tab

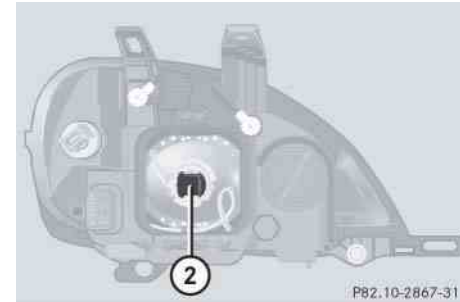

- ② Electrical connector

Bi-Xenon* headlamp

Warning!



Do not remove the cover ① for the Bi-Xenon* headlamp. Because of high voltage in Xenon* lamps, it is dangerous to replace the bulb or repair the lamp and its components. We recommend that you have such work done by a qualified technician.

Low beam halogen headlamp

- ▶ Press down the tab on top end of housing cover ① and remove it in direction of arrow.
- ▶ Pull electrical connector ② off.
- ▶ Unclip the retainer spring on the bulb socket and take out of the bulb.
- ▶ Insert the new bulb so that its socket locates in the recess of the lamp housing.
- ▶ Clip on the retainer spring.
- ▶ Plug electrical connector ② onto the bulb.
- ▶ Align housing cover ① and press until it engages.

High beam halogen bulb (vehicles with halogen bulbs: high beam and high beam flasher; vehicles with Xenon* headlamps: high beam flasher only), parking and standing lamp

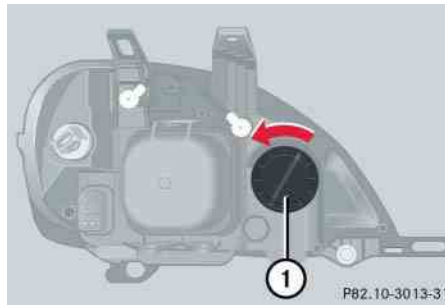

- ① Housing cover for high beam halogen bulb (vehicles with halogen bulbs: high beam and high beam flasher; vehicles with Xenon* headlamps: high beam flasher only), parking and standing lamp

Practical hints

Replacing bulbs

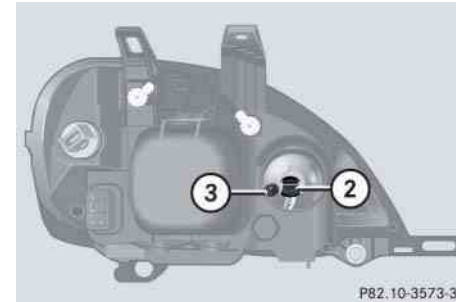

- ② Electrical connector for high beam halogen bulb (vehicles with halogen bulbs: high beam and high beam flasher; vehicles with Xenon* headlamps: high beam flasher only)
- ③ Bulb socket for parking and standing lamp bulb

Practical hints

Replacing bulbs

High beam halogen bulb (vehicles with halogen bulbs: high beam and high beam flasher; vehicles with Xenon* headlamps: high beam flasher only)

- ▶ Turn housing cover ① counterclockwise and remove it.
- ▶ Pull electrical connector ② off.
- ▶ Unclip the retainer spring on the bulb socket and take out the bulb.
- ▶ Insert the new bulb so that its socket locates in the recess of the lamp housing.
- ▶ Clip on the retainer spring.
- ▶ Plug electrical connector ② onto the bulb.
- ▶ Align housing cover ① and turn it clockwise.

Parking/standing lamp bulb

- ▶ Turn housing cover ① counterclockwise and remove it.
- ▶ Pull out bulb socket ③ with the bulb.
- ▶ Press gently onto the bulb and turn counterclockwise out of bulb socket ③.
- ▶ Press the new bulb gently into bulb socket ③ and turn clockwise until it engages.
- ▶ Press bulb socket ③ back into the lamp.
- ▶ Align housing cover ① and turn it clockwise.

Turn signal bulb/side marker bulb

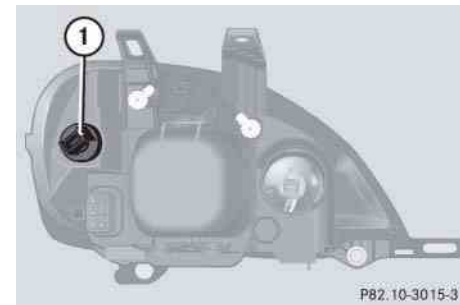

- ① Bulb socket
- ▶ Twist bulb socket ① counterclockwise and pull out.
- ▶ Push bulb into socket, turn counterclockwise and remove.
- ▶ Insert new bulb in socket, push in and twist clockwise.
- ▶ Reinstall the bulb socket ①.

Practical hints

Replacing bulbs

Front fog lamp

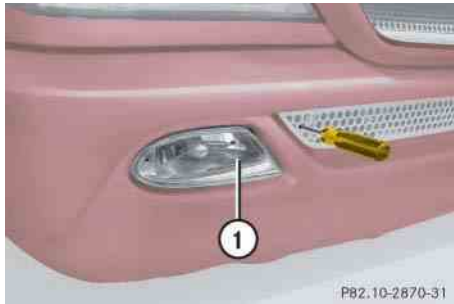

① Front fog lamp

- ▶ Use a suitable object (e.g. screwdriver) to press on the release lever behind the front panel.

Front fog lamp ① releases.

- ▶ Pull front fog lamp ① out of the bumper.

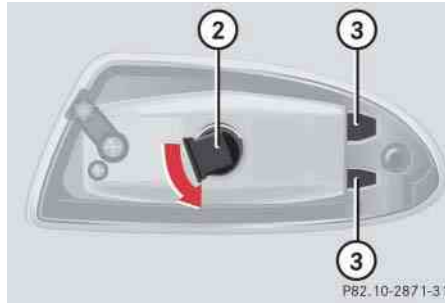

② Bulb socket of front fog lamp bulb

③ Tabs

- ▶ Turn bulb socket ② with the bulb counterclockwise and remove it.
- ▶ Insert new bulb socket ② with the bulb into the lamp and turn it clockwise.
- ▶ Reinstall front fog lamp ① into the bumper.

Let tabs ③ engage in the bumper.

Replacing bulbs for rear lamps

Before you start to replace a bulb for a rear lamp, do the following first:

- ▶ Turn the combination switch to position  (▷ page 107).

Tail lamp unit

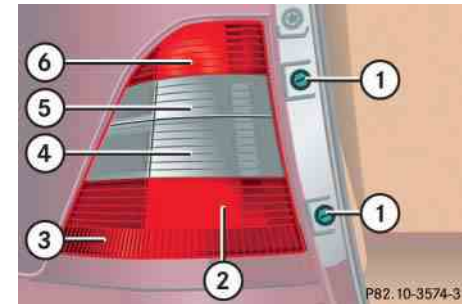

- ① Hexagon cap nut (with washer)
- ② Rear fog lamp (only driver's side), tail lamp, parking and standing lamp
- ③ Side marker lamp
- ④ Turn signal lamp
- ⑤ Backup lamp
- ⑥ Brake lamp

▷▷

Practical hints

Replacing bulbs

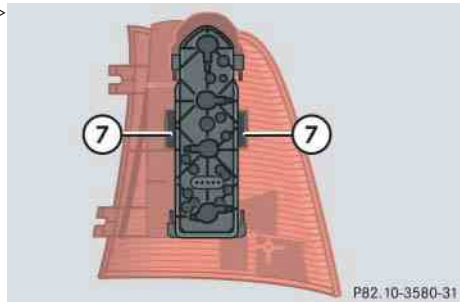

⑦ Tab

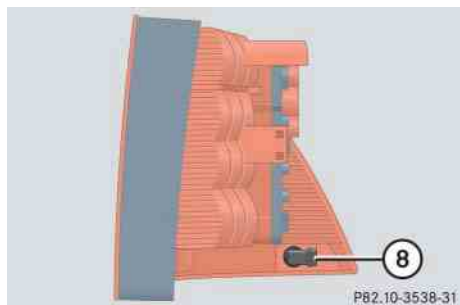

⑧ Bulb socket for rear side marker bulb

- ▶ Open the liftgate.
- ▶ Remove hexagon cap nuts ① with washers on them.
- ▶ Remove tail lamp unit.
- ▶ Press tabs ⑦ together.
- ▶ Remove the bulb carrier.
- ▶ Press gently onto the respective bulb and turn counterclockwise out of its bulb socket.
- ▶ Press the new bulb gently into its bulb socket and turn clockwise until it engages.
- ▶ Reinstall the bulb carrier.
Let tabs ⑦ engage.
- ▶ Insert the tail lamp unit in the body, lower edge first.
Let the tail lamp unit engage.
- ▶ Retighten hexagon cap nuts ① with washers on them.

Rear side marker

- ▶ Open the liftgate.
- ▶ Remove hexagon cap nuts ① with washers on them.
- ▶ Remove tail lamp unit.
- ▶ Turn bulb socket ⑧ with the bulb counterclockwise and remove it.
- ▶ Pull the bulb out of bulb socket ⑧.
- ▶ Press the new bulb into bulb socket ⑧.
- ▶ Insert bulb socket ⑧ back into the lamp and turn it clockwise.
- ▶ Insert the tail lamp unit in the body, lower edge first.
Let the tail lamp unit engage.
- ▶ Retighten hexagon cap nuts ① with washers on them.

Practical hints

Replacing bulbs

License plate lamp

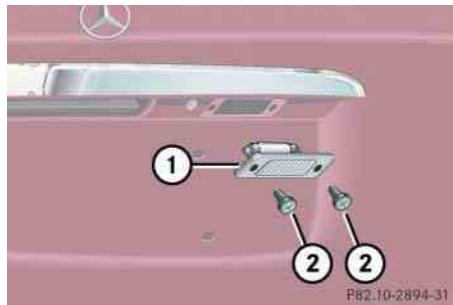

- ① License plate lamp
- ② Screw

- ▶ Loosen both screws ②.
- ▶ Remove license plate lamp ①.
- ▶ Replace the tubular bulb.
- ▶ Reinstall license plate lamp ①.
- ▶ Retighten screws ②.

High mounted brake lamp

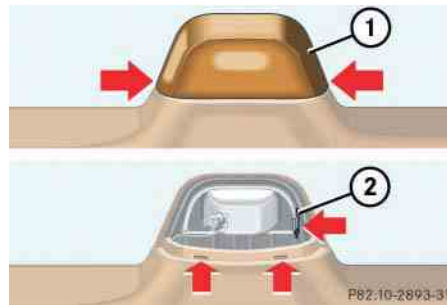

- ① Cover
- ② Tab

- ▶ Press gently on both sides of cover ① in direction of arrows.
- ▶ Fold it backwards and remove.
- ▶ Press tab ② on the reflector and remove it.

- ▶ Press gently onto the bulb and turn counterclockwise out of the bulb socket.
- ▶ Press the new bulb gently into the bulb socket and turn clockwise until it engages.
- ▶ Reinstall the reflector on the left side first and let it engage on the right side.
- ▶ Align cover ① with its tabs in the slots and press gently onto cover ① until it engages.



Vehicles with an exterior spare-wheel rack*:

You cannot replace the LEDs of the high mounted brake light with an exterior spare-wheel rack installed. Have therefore the high mounted brake light checked and, if necessary, the LEDs replaced by an authorized Mercedes-Benz Light Truck Center.

Practical hints

Replacing bulbs

Adjusting headlamp aim

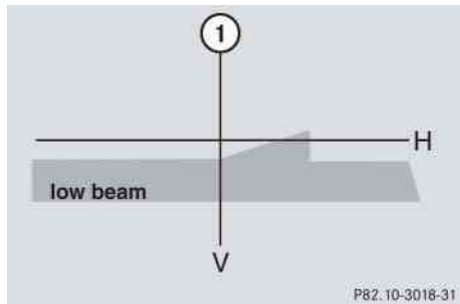

V Vertical centerline

H Headlamp mounting high, measured from the center



High beam adjustments simultaneously aim the low beam.

Vehicle should have a normal trunk load.

Correct headlamp adjustment is extremely important. To check and readjust a headlamp, follow the steps described:

- ▶ Park the vehicle on a level surface 25 feet (7.6 m) from a vertical test screen or wall.
- ▶ Switch the headlamps on (▷ page 107).

If the beam does not show a beam pattern as indicated in the figure left, then follow the steps below:

- ▶ Open hood (▷ page 222).

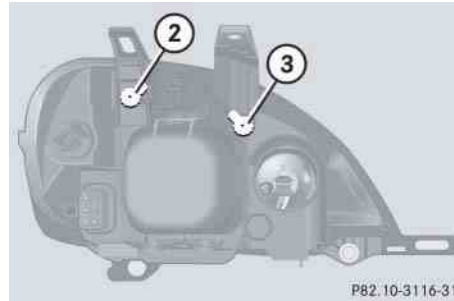

② Headlamp vertical adjustment screw

③ Headlamp vertical adjustment screw

- ▶ Always turn adjustment screws ② and ③ simultaneously for vertical adjustment until the headlamp is adjusted as shown ①. Turn clockwise for upward movement and counterclockwise for downward movement.

Graduations:

screw ②: 0.50° pitch

screw ③: 0.67° pitch

The left and right headlamps must be adjusted individually.



If it is not possible to obtain a proper headlamp adjustment, have the system checked at an authorized Mercedes-Benz Light Truck Center.

▼ Replacing wiper blades

Removing

Warning!



For safety reasons, remove key from steering lock before replacing a wiper blade. Otherwise the motor could suddenly turn on and cause injury.

- ▶ Fold the wiper arm forward.
- ▶ Turn wiper blade at a right angle to wiper arm.

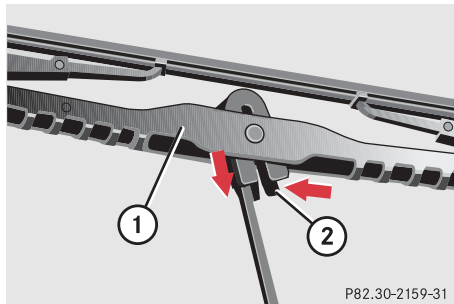

- ① Wiper blade
- ② Safety tab

- ▶ Press safety tab down ②.
- ▶ Push wiper blade downward ① and remove.

Installing

- ▶ Slide the wiper blade into end of wiper arm until it locks in place.
- ▶ Fold the wiper arm back to rest on the windshield. Make sure you hold onto the wiper when folding the wiper arm back.

Practical hints

Replacing wiper blades



Never open the hood when the wiper arms are folded forward.

Hold on to the wiper when folding the wiper arm back. If released, the force of the impact from the tensioning spring could crack the windshield.

Do not allow the wiper arms to contact the windshield glass without a wiper blade inserted.

Make certain that the wiper blades are properly installed. Improperly installed wiper blades may cause windshield damage.

For your convenience, we recommend that you have this work carried out by an authorized Mercedes-Benz Center.

Practical hints

Flat tire

Mounting the spare wheel

Warning!



The dimensions of the spare wheel are different from those of the road wheels. As a result, the vehicle handling characteristics change when driving with a mounted spare wheel. Adapt your driving style accordingly.

The spare wheel is for temporary use only. When driving with spare wheel mounted, make sure proper tire pressure and do not exceed vehicle speed of 50 mph (80 km/h).

Drive to the nearest Mercedes-Benz Light Truck Center as soon as possible to have the spare wheel replaced with a regular road wheel.

Never operate the vehicle with more than one spare wheel mounted.

Preparing the vehicle

- ▶ Park the vehicle as far as possible from moving traffic on a hard surface.
- ▶ Turn on the hazard warning flashers.
- ▶ Engage the steering wheel lock in the straight ahead position.
- ▶ Set the parking brake.
- ▶ Move the gear selector lever to **P**.
- ▶ Have any passenger exit the vehicle at a safe distance from the roadway.



Open door only when conditions are safe to do so.

- ▶ Take the spare wheel out of its carrier (▷ page 266).

Lifting the vehicle

- ▶ Prevent the vehicle from rolling away by blocking wheels with wheel chocks (not included) or other sizable objects.

When changing wheel on a level surface:

- ▶ Place one chock in front of and one behind the wheel that is diagonally opposite to the wheel being changed.

When changing wheel on a hill:

- ▶ Place chocks on the downhill side blocking both wheels of the other axle.
- ▶ Take the two-piece wheel wrench and the jack out of the rear cargo compartment (▷ page 264). Assemble wheel wrench.

Warning!



The jack is designed exclusively for jacking up the vehicle at the jack take-up brackets built into both sides of the vehicle. To help avoid personal injury, use the jack only to lift the vehicle during a wheel change. Never get beneath the vehicle while it is supported by the jack. Keep hands and feet away from the area under the lifted vehicle. Always firmly set parking brake and block wheels before raising vehicle with jack.

Do not disengage parking brake while the vehicle is raised. Be certain that the jack is always vertical (plumb line) when in use, especially on hills. Always try to use the jack on level surface. Make sure that the jack arm is fully seated in the jack take-up bracket. Always lower the vehicle onto sufficient capacity jackstands before working under the vehicle.



- ▶ On wheel to be changed, loosen but do not yet remove the wheel bolts (approximately one full turn with wrench).

The jack take-up brackets are located directly behind the front wheel housings and in front of the rear wheel housings.



Do not position the jack on the body of the vehicle, as this may cause damage to the vehicle.



- ① Take-up bracket
- ② Jack

- ▶ Place jack ② on firm ground.
- ▶ Position jack ② under the take-up bracket ① so that it is always vertical (plumb-line) as seen from the side, even if the vehicle is parked on an incline.
- ▶ Jack up the vehicle until the wheel is a maximum of 1.2 in (3 cm) from the ground. Never start engine while vehicle is raised.

Practical hints

Flat tire

Practical hints

Flat tire

Removing the wheel

- ▶ Unscrew and remove all wheel bolts.
- ▶ Remove the remaining bolts.



Do not place wheel bolts in sand or dirt. This could result in damage to the bolt and wheel hub threads.

- ▶ Grip the wheel from the sides and remove it.

Mounting the new wheel

- ▶ Clean contact surfaces of wheel and wheel hub.
- ▶ Install spare wheel on wheel hub.
- ▶ Insert wheel bolts and tighten them slightly.



To avoid paint damage, place wheel flat against hub and hold it there while installing first wheel bolt.

Warning!



Always replace wheel bolts that are damaged or rusted.

Never apply oil or grease to wheel bolts.

Damaged wheel hub threads should be repaired immediately. Do not continue to drive under these circumstances! Contact an authorized Mercedes-Benz Light Truck Center or call Roadside Assistance.

Incorrect wheel bolts or improperly tightened wheel bolts can cause the wheel to come off. This could cause an accident. Make sure to use the correct wheel bolts.

Warning!



Use only genuine equipment Mercedes-Benz wheel bolts. Other wheel bolts may come loose.

Do not tighten the wheel bolts when the vehicle is raised. Otherwise the vehicle could tip over.

Practical hints

Flat tire

Lowering the vehicle

- ▶ Lower vehicle by turning crank counterclockwise until vehicle is resting fully on its own weight.
- ▶ Remove the jack.

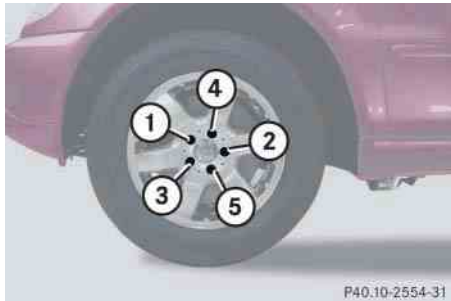

①-⑤ Wheel bolts

- ▶ Tighten the five wheel bolts evenly, following the diagonal sequence illustrated (1 to 5), until all bolts are tight. Observe a tightening torque of 110 lb-ft (150 Nm).

Warning!



Have the tightening torque checked after changing a wheel. The wheels could come loose if they are not tightened to a torque of 110 lb-ft (150 Nm).

- ▶ Store jack and tool kit.

i

The removed road wheel cannot be stored in the spare wheel carrier, but should be transported in the rear cargo compartment wrapped in a protective cover supplied with the vehicle.

The protective cover is located in the rear cargo compartment behind the cover in the right side trim panel.

Practical hints

Battery

The battery is located on the passenger side of the engine compartment.

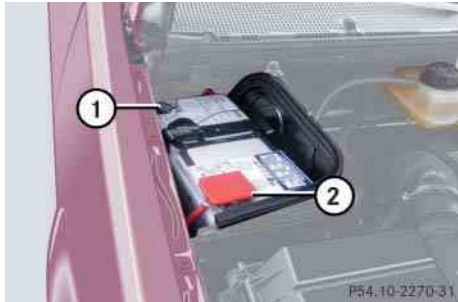

- ① Negative terminal
- ② Positive terminal

Warning!



Failure to follow these instructions can result in severe injury or death.

Observe all safety instructions and precautions when handling automotive batteries (▷ page 228).

Never lean over batteries while connecting, you might get injured.

Battery fluid contains sulfuric acid. Do not allow this fluid to come in contact with eyes, skin or clothing. In case it does, immediately flush affected area with water and seek medical help if necessary.

A battery will also produce hydrogen gas, which is flammable and explosive. Keep flames or sparks away from battery, avoid improper connection of jumper cables, smoking etc.



Never loosen or detach battery terminal clamps while the engine is running or the key is in the steering lock. Otherwise the alternator and other electronic components could be severely damaged.

Have the battery checked regularly by an authorized Mercedes-Benz Light Truck Center.

Refer to Maintenance Booklet for maintenance intervals or contact an authorized Mercedes-Benz Light Truck Center for further information.

Warning!



Do not place metal objects on the battery as this could result in a short circuit.

Use leak-proof battery only to avoid the risk of acid burns in the event of an accident.

Disconnecting the battery

Warning!



With a disconnected battery

- you will no longer be able to turn the key in the steering lock
- the gear selector lever will remain locked in position **P**

- ▶ Depress parking brake firmly or move gear selector lever to position **P**.
- ▶ Turn off all electrical consumers.
- ▶ Remove key from the steering lock.
- ▶ Open the hood (▷ page 222).
- ▶ Disconnect the battery negative lead.
- ▶ Remove the cover from the positive terminal.
- ▶ Disconnect the battery positive lead.

Removing the battery

- ▶ Remove the screw securing the battery.
- ▶ Remove the battery support and bracket.
- ▶ Take out the battery.

Charging and reinstalling the battery

Warning!



Never charge a battery while still installed in the vehicle. Gases may escape during charging and cause explosions that may result in paint damage, corrosion or personal injury.

- ▶ Charge battery in accordance with the instructions of the battery charger manufacturer.
- ▶ Reinstall the charged battery. Follow the previously described steps in reverse order.

Reconnecting the battery

- ▶ Turn off all electrical consumers.
- ▶ Connect the positive lead and fasten its cover.
- ▶ Connect the negative lead.



Never invert the terminal connections!



The battery, its filler caps and the vent tube must always be securely installed when the vehicle is in operation.

Practical hints

Battery



The following procedures must be carried out following any interruption of battery power (e.g. due to reconnection):

- Set the clock (▷ page 119).
- Set the date in trip computer (▷ page 189).
- Calibrate the compass (▷ page 191).
- Resynchronize the ESP (▷ page 252).
- Resynchronize side power windows (▷ page 148).
- Resynchronize tilt/sliding sunroof* (▷ page 152).

Batteries contain materials that can harm the environment if disposed of improperly. Large 12 volt storage batteries contain lead. Recycling of batteries is the preferred method of disposal. Many states require sellers of batteries to accept old batteries for recycling.

▼ Jump starting

Warning!



Failure to follow these directions will cause damage to the electronic components, and can lead to a battery explosion and severe injury or death.

Never lean over batteries while connecting or jump starting, you might get injured.

Battery fluid contains sulfuric acid. Do not allow this fluid to come in contact with eyes, skin or clothing. In case it does, immediately flush affected area with water, and seek medical help if necessary.

A battery will also produce hydrogen gas, which is flammable and very explosive. Keep flames or sparks away from battery, avoid improper connection of jumper cables, smoking, etc.

Attempting to jump start a frozen battery can result in it exploding, causing personal injury.

Read all instructions before proceeding.

If the battery is discharged, the engine can be started with jumper cables and the battery of another vehicle. Observe the following:

- Jump starting should only be performed when the engine and catalytic converter are cold.
- Do not start the engine if the battery is frozen. Let the battery thaw out first.
- Only jump start from batteries with the same voltage rating (12 V). Jump starting with a more powerful battery could damage the vehicle's electrical system, which will not be covered by the Mercedes-Benz Limited Warranty.
- Only use jumper cables with sufficient cross-section and insulated terminal clamps.
- Always make sure the jumper cables are not on or near pulleys, fans, or other parts that move when the engine is started or running.

Practical hints

Jump starting



Avoid repeated and lengthy starting attempts.

Do not attempt to start the engine using a battery quick charge unit.

If engine does not run after several unsuccessful starting attempts, have it checked at the nearest authorized Mercedes-Benz Light Truck Center.

Excessive unburned fuel generated by repeated failed starting attempts may damage the catalytic converter and may present a fire risk.

Make sure the jumper cables do not have loose or missing insulation.

Make sure the cable clamps do not touch any other metal part while the other end is still attached to a battery.

Practical hints

Jump starting

Warning!



Keep flames or sparks away from battery. Do not smoke.

Observe all safety instructions and precautions when handling automotive batteries (> page 228).

The battery is located on the passenger side of the engine compartment.

- ▶ Make sure the two vehicles do not touch.
- ▶ Turn off all electrical consumers.
- ▶ Apply parking brake.
- ▶ Shift gear selector lever to position **P**.
- ▶ Open the hood.

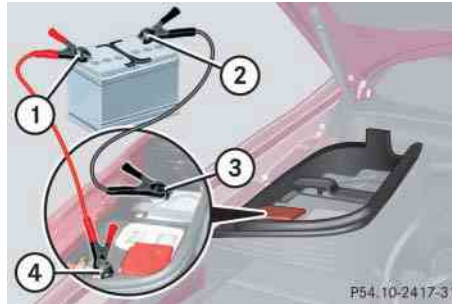

- ① Positive terminal of charged battery
 - ② Negative terminal of charged battery
 - ③ Negative terminal of discharged battery
 - ④ Positive terminal of discharged battery
- ▶ Connect positive terminals ① and ④ of the batteries with the jumper cable. Clamp cable to positive terminal ① of charged battery first.



Never invert the terminal connections!

- ▶ Start engine of the vehicle with the charged battery and run at idle speed.
- ▶ Connect negative terminals ② and ③ of the batteries with the jumper cable. Clamp cable to negative terminal ② of charged battery first.
- ▶ Start the engine of the disabled vehicle.

Now you can turn on the electrical consumers. Do not turn on the lights under any circumstances.

- ▶ Remove the jumper cables first from the negative terminals ③ and ② and then from positive terminals ④ and ①.

You can now turn on the lights.

- ▶ Have the battery checked at the nearest authorized Mercedes-Benz Light Truck Center.



Do not tow-start the vehicle.

▼ Towing the vehicle

Mercedes-Benz recommends that the vehicle be transported with all wheels off the ground using flatbed or appropriate wheel lift / dolly equipment. This method is preferable to other types of towing.



Use flatbed or wheel lift / dolly equipment, with key in steering lock turned to position **0**.

Do not tow with sling-type equipment. Towing with sling-type equipment over bumpy roads will damage radiator and supports.

To prevent damage during transport, do not tie down vehicle by its chassis or suspension parts. Use the towing eyes.

Switch off the ESP (▷ page 81), tow-away alarm (▷ page 85) and the automatic central locking (▷ page 93).

When circumstances do not permit the recommended towing methods, the vehicle may be towed with all wheels on the ground only so far as necessary to have the vehicle moved to a safe location where the recommended towing methods can be employed.



When towing the vehicle with all wheels on the ground, the gear selector lever must be in position **N** and the key must be in steering lock position **2**.

When towing the vehicle with all wheels on the ground, the vehicle may be towed only for distances up to 30 miles (50 km) and at a speed not to exceed 30 mph (50 km / h).

If the vehicle is towed with the front axle raised (observe instructions regarding flexible drive shaft), the engine must be shut off (key in steering lock position **1**). Otherwise, the 4-ETS may become engaged which may cause loss of towing control.

Practical hints

Towing the vehicle



To be certain to avoid additional damage to the vehicle powertrain, however you should observe the following:

- With damage to the front axle
 - raise front axle
 - remove flexible drive shaft between rear axle and transfer case
- With damage to the rear axle
 - raise rear axle
 - tow vehicle with wheel lift or dolly placed under front wheels
- With damage to the transfer case
 - remove flexible drive shaft to the drive axles

Always install new self-locking nuts when reinstalling flexible drive shaft.

Practical hints

Towing the vehicle

Warning!



If circumstances require towing the vehicle with all wheels on the ground, always tow with a tow bar if:

- the engine will not run
- there is a malfunction in the power supply or in the vehicle's electrical system

Prior to towing the vehicle with all wheels on the ground, make sure the key is in steering lock position **2**.

If the key is left in steering lock position **0** for an extended period of time, it can no longer be turned in the switch. In this case, the steering is locked. To unlock, remove key from steering lock and reinsert.

Warning!



With the engine not running, there is no power assistance for the brake and steering systems. In this case, it is important to keep in mind that a considerably higher degree of effort is necessary to brake and steer the vehicle. Adapt your driving accordingly.



To signal turns while being towed with hazard warning flasher in use, turn key in steering lock to position **2** and activate combination switch for left or right turn signal in usual manner – only the selected turn signal will operate.

Upon canceling the turn signal, the hazard warning flasher will operate again.



The vehicle cannot be started via tow-start.



If the battery is disconnected or discharged, the gear selector lever will remain locked in position **P** and the key will not turn in the steering lock. For more information, see “Battery” (▷ page 272) and “Jump starting” (▷ page 291).

For information on manual unlocking transmission gear selector lever, see (▷ page 270).



When towing the vehicle with all wheels on the ground, note the following:

With the automatic central locking activated and the key in steering lock position **2**, the vehicle doors lock if the left front wheel is turning at vehicle speeds of approx. 9 mph (15 km/h) or more.

To prevent the vehicle doors from locking, deactivate the automatic central locking (▷ page 93).

Towing of the vehicle should only be done using the towing eye. Never attach tow cable, tow rope or tow rod to vehicle chassis, frame or suspension parts.

Front towing eye

The front towing eye is located on the passenger side below the bumper.

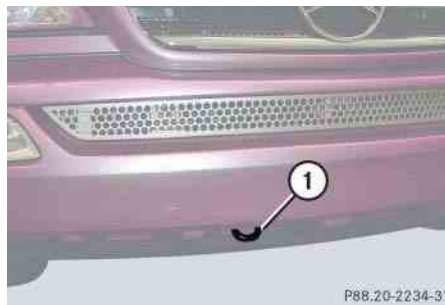

① Towing eye

Rear towing eye

Warning!



In order to avoid possible serious burns or injury, use extreme caution when removing the cover, because the rear exhaust pipe is extremely hot.

Practical hints

Towing the vehicle

The rear towing eye is located behind the right side cover in the bumper panel.

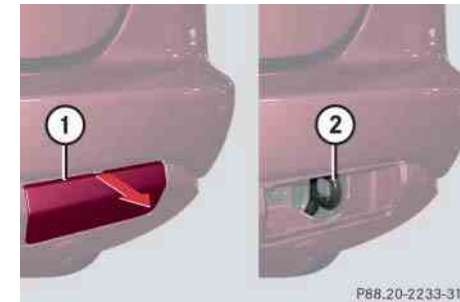

① Cover

② Towing eye

To remove cover:

- ▶ Pry out the cover ① using a flat blade screwdriver (▷ page 264).

To reinstall cover:

- ▶ Engage cover at bottom and press in top securely.

Practical hints

Towing the vehicle

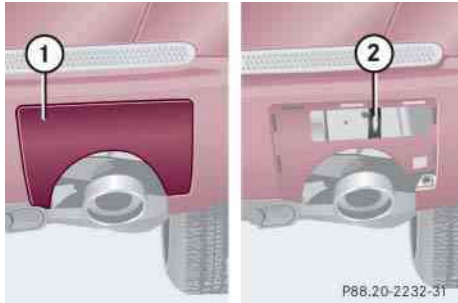

Vehicles with sport package*

- ① Cover
- ② Towing eye

To remove cover:

- ▶ Grip cover ① at bottom and securely pull out.

To reinstall cover:

- ▶ Engage cover and press in securely.

Stranded vehicle

Freeing a stranded vehicle, on which the wheels are dug into sand or mud, should be done with the greatest of care, especially if the vehicle is heavily loaded.

Avoid pulling the vehicle jerkily or diagonally, since it could result in damage to the chassis alignment.

Never try to free a vehicle that is still coupled to a trailer.

If possible, a vehicle equipped with trailer hitch receiver should be pulled backward in its own previously made tracks.

▼ **Fuses**

The electrical fuses in your vehicle serve to stop the supply of electricity to a device that is malfunctioning. This helps to prevent damage to the other vehicle electronics.

The following aids are available to help you change fuses (▷ page 298):

- Fuse chart
- Spare fuses
- Fuse extractor

Warning!



Only use fuses approved for Mercedes-Benz with the specified amperage for the system in question. Otherwise, a short circuit could result and cause a fire.



Only install fuses that have been tested and approved by Mercedes-Benz and that have the specified amperage rating.

Otherwise, electrical parts or systems could be damaged.

Never attempt to repair or bridge a blown fuse. Have the cause determined and remedied by an authorized Mercedes-Benz Light Truck Center.

The electrical fuses are located in different fuse boxes:

- Main fuse box in engine compartment (▷ page 298)
- Fuse box in front passenger footwell (▷ page 299)

Practical hints

Fuses

Aids for changing fuses

Fuse chart

A chart explaining fuse allocation and fuse amperages can be found in the main fuse box in the engine compartment (▷ page 298).

Spare fuses

Spare fuses are found in the main fuse box in the engine compartment (▷ page 298).

Fuse extractor

The fuse extractor is found in the main fuse box in the engine compartment (▷ page 298).

Main fuse box

The main fuse box is located in the engine compartment on the driver's side.

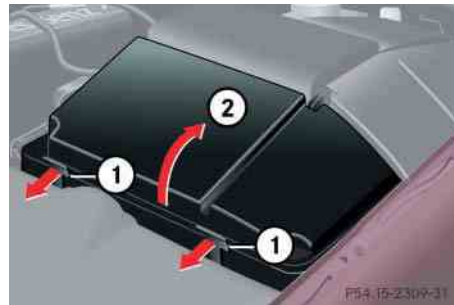

- ① Clamps
- ② Main fuse box cover

Removing/installing main fuse box cover

- ▶ Opening the hood.
- ▶ Release clamps ①.
- ▶ Lift fuse box cover ② up.
- ▶ Install main fuse box cover in reverse order.



- ③ Fuse chart
- ④ Fuse extractor
- ⑤ Spare fuses

Fuse box in front passenger footwell

The fuse box is located in the front passenger compartment.

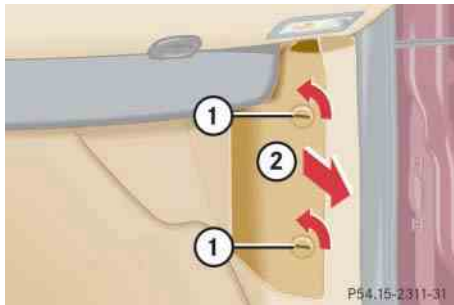

- ① Lock
- ② Cover

Removing / installing cover

- ▶ Open passenger-side door.
- ▶ Turn both locks ① 90° counterclockwise.
- ▶ Remove cover ② in direction of arrow.
- ▶ Install cover ② in reverse order.



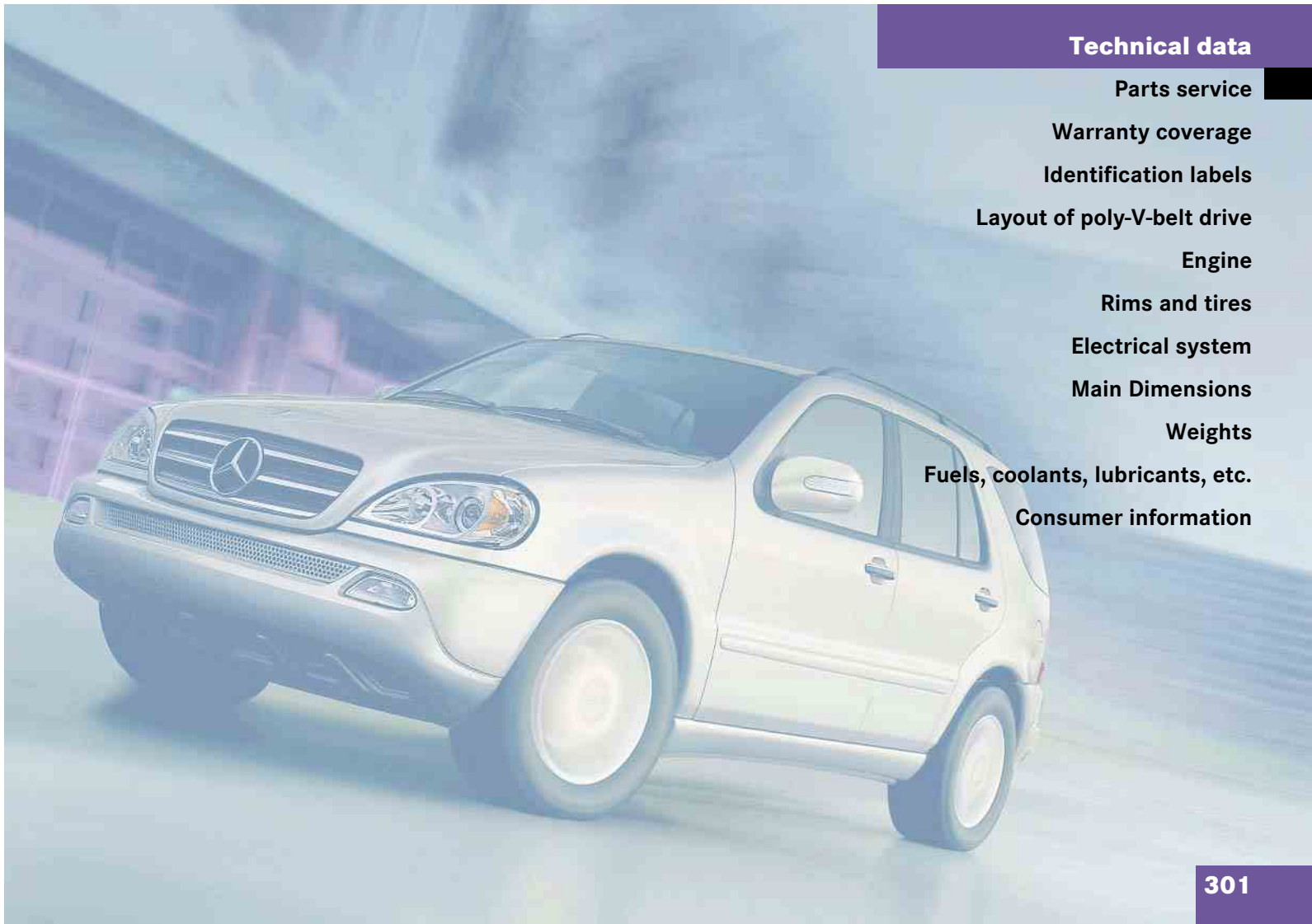

Technical data

Parts service

Warranty coverage

Identification labels

Layout of poly-V-belt drive

Engine

Rims and tires

Electrical system

Main Dimensions

Weights

Fuels, coolants, lubricants, etc.

Consumer information

Technical data

Parts service

The “Technical data” section provides the necessary technical data for your vehicle.

All authorized Mercedes-Benz Centers maintain a stock of genuine Mercedes-Benz parts required for maintenance and repair work. In addition, strategically located parts distribution centers provide quick and reliable parts service.

More than 300 000 different parts for Mercedes-Benz models are available.

Genuine Mercedes-Benz parts are subjected to stringent quality inspections. Each part has been specifically developed, manufactured or selected for and adapted to Mercedes-Benz vehicles.

Therefore, genuine Mercedes-Benz parts should be installed.



The use of non-genuine Mercedes-Benz parts and accessories not authorized by Mercedes-Benz could damage the vehicle, which is not covered by the Mercedes-Benz Limited Warranty, or could compromise the vehicle’s durability or safety.

▼ **Warranty coverage**

Your vehicle is covered under the terms of the warranties printed in the Service and Warranty Information booklet. Your authorized Mercedes-Benz Light Truck Center will exchange or repair any defective parts originally installed on the vehicle in accordance with the terms of the following warranties:

- New Vehicle Limited Warranty
- Emission System Warranty
- Emission Performance Warranty
- California, Maine, Massachusetts, and Vermont Emission Control Systems Warranty

Replacement parts and accessories are covered by the Mercedes-Benz Parts and Accessories warranties, copies of which are available at any Mercedes-Benz Light Truck Center.

Loss of Service and Warranty Information Booklet

Should you lose your Service and Warranty Information booklet, have an authorized Mercedes-Benz Light Truck Center arrange for a replacement. It will be mailed to you.

Technical data

Identification labels

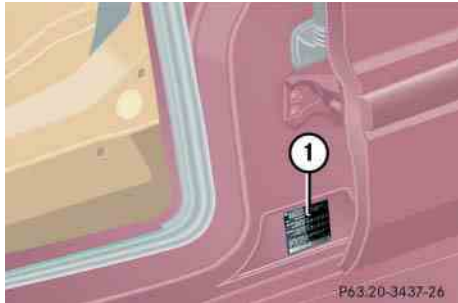

① Certification label (includes Paintwork code)

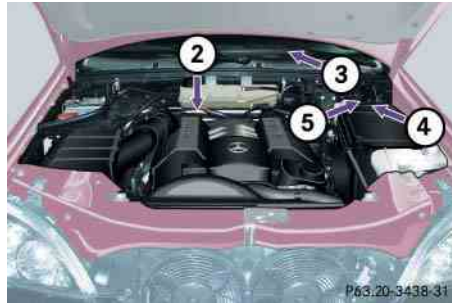

- ② Engine number (engraved on engine)
- ③ VIN, visible (lower edge of windshield)
- ④ Emission control information label, includes both federal and California certification exhaust emission standards
- ⑤ Vacuum line routing diagram label for emission control system

i

When ordering parts, please specify vehicle identification and engine numbers.

▼ Layout of poly-V-belt drive

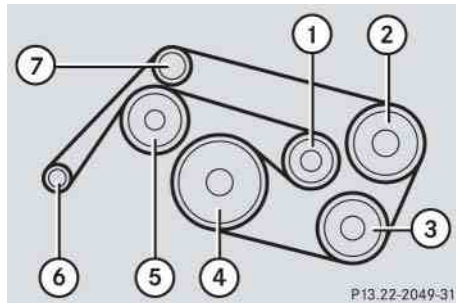

- ① Automatic belt tensioner
- ② Power steering pump
- ③ Air conditioning compressor
- ④ Crankshaft
- ⑤ Coolant pump
- ⑥ Generator (alternator)
- ⑦ Idler pulley

Technical data

Engine

Model	ML 350 (163.157 ¹)	ML 500 (163.175) ¹
Engine	112	113
Mode of operation	4-stroke engine, gasoline injection	4-stroke engine, gasoline injection
No. of cylinders	6	8
Bore	3.81 in (97.00 mm)	3.81 in (97.00 mm)
Stroke	3.31 in (84.00 mm)	3.31 in (84.00 mm)
Total piston displacement	227 cu in (3724 cm ³)	303 cu in (4966 cm ³)
Compression ratio	10:1	10:1
Output acc. to SAE J 1349	232 hp / 5750 rpm ² (173 kW / 5750 rpm)	288 hp / 5600 rpm ² (215 kW / 5600 rpm)
Maximum torque acc. to SAE J 1349	254 lb-ft / 3000-4500 rpm (345 Nm / 3000-4500 rpm)	325 lb-ft / 2700 rpm (440 Nm / 2700 rpm)
Maximum engine speed	6000 rpm	6000 rpm
Firing order	1-4-3-6-2-5	1-5-4-2-6-3-7-8
Poly-V-belt	2370 mm	2370 mm

¹ The quoted data apply only to the standard vehicle. See an authorized Mercedes-Benz Light Truck Center for the corresponding data of all special bodies and special equipment.

² Premium fuel required. Performance may vary with fuel octane rating.

Technical data

Rims and tires

▼ Rims and tires

Only use tires and rims which have been specifically developed for your vehicle and tested and approved by Mercedes-Benz. Other tires and rims can have detrimental effects, such as

- poor handling characteristics
- increased noise
- increased fuel consumption



Moreover, tires and rims not approved by Mercedes-Benz may, under load, exhibit dimensional variations and different tire deformation characteristics that could cause them to come into contact with the vehicle body or axle parts. This may result in damage to the tires or the vehicle.



Further information on tires and rims is available at any authorized Mercedes-Benz Light Truck Center. A tire inflation pressure table is located on the fuel filler cap of the vehicle. The tire pressure should be checked regularly and should only be adjusted on cold tires. Follow tire manufacturer's maintenance recommendation included with vehicle.

Rims and tires

Model	ML 350	ML 500
Rims (light alloy)	8 J x 17 H2	8 1/2 J x 17 H2
Wheel offset	2.0 in (52 mm)	2.0 in (52 mm)
All-season tires (radial-ply tires)	255 / 60 R17 106 H	275 / 55 R17 109 V
Rims* (light alloy)	8 1/2 J x 17 H2	8 1/2 J x 17 H2
Wheel offset*	1.85 in (47 mm)	1.85 in (47 mm)
All-season tires (radial-ply tires)*	275 / 55 R17 109 V	275 / 55 R17 109 V

Technical data

Rims and tires

Spare wheel

Model	ML 350, ML 500
Rim	4 Jx18 H2 ET0
Wheel offset	0 in (0 mm)
Space-saver tire	T155/90 D18 113M ¹

¹ Must not be used with snow chains.

▼ **Electrical system**

Model	ML 350	ML 500
Generator (alternator)	14 V / 120 A	14 V / 150 A
Starter motor	12 V / 1.7 kW	12 V / 1.7 kW
Battery	12 V / 100 Ah	12 V / 100 Ah
Spark plugs	Bosch F 8 DPP332 Bosch F 8 DPER	Bosch F 8 DPP332 Bosch F 8 DPER
Electrode gap	0.039 in (1.0 mm)	0.039 in (1.0 mm)
Tightening torque	15 – 22 lb-ft (20 – 30 Nm)	15 – 22 lb-ft (20 – 30 Nm)

Technical data

Main Dimensions

Model	ML 350, ML 500
Overall vehicle length	182.6 in (4638 mm)
Overall vehicle width	83.7 in (2126 mm)
Overall vehicle height	71.7 in (1820 mm)
Wheelbase	111.0 in (2820 mm)
Track, front	61.2 in (1555 mm)
Track, rear	61.2 in (1555 mm)
Ground clearance	8.03 in (204 mm)
Turning radius	468.5 in (11.9 m)

▼ Weights

Roof load max.	220 lb (100 kg)
----------------	-----------------

Technical data

Fuels, coolants, lubricants, etc.

Capacities

Vehicle components and their respective lubricants must match.

Therefore only use products tested and approved by Mercedes-Benz.

Please refer to the Factory Approved Service Products pamphlet, or inquire at your Mercedes-Benz Light Truck Center.

	Model	Capacity	Fuels, coolants, lubricants, etc.
Engine with oil filter	ML 350, ML 500	8.5 US qt (8.0 l)	Approved engine oils
Automatic transmission		9.0 US qt (8.5 l)	MB Automatic Transmission Oil
Transfer case		1.6 US qt (1.5 l)	(Dexron 3 or Dexron 2E)
Rear axle		1.3 US qt (1.25 l)	(Hypoid gear oil SAE 90, 85 W 90)
Front axle		1.2 US qt (1.1 l)	(Hypoid gear oil SAE 90)
Power steering		approx. 0.65 US qt (0.6 l)	MB Power Steering Fluid
Front wheel hubs		approx. 1.5 oz (43 g) each	High temperature roller bearing grease

Technical data

Fuels, coolants, lubricants, etc.

	Model	Capacity	Fuels, coolants, lubricants, etc.
Cooling system		approx. 12.7 US qt (12.0 l)	MB Anticorrosion / Antifreeze
Fuel Tank including a reserve of	ML 350, ML 500	22.0 US gal (83.0 l) approx. 3.2 US gal (12.0 l)	Premium unleaded gasoline: Minimum Posted Octane 91 (Avg. of 96 RON / 86 MON)
Air conditioning system			R-134a refrigerant and special PAG lubricant oil (never R-12)
Windshield washer and headlamp cleaning system*		8.0 US qt (7.6 l)	MB Windshield Washer Concentrate ¹

¹ Use MB Windshield Washer Concentrate "S" and water for temperatures above freezing or MB Windshield Washer Concentrate "S" and commercially available premixed windshield washer solvent / antifreeze for temperatures below freezing. Follow suggested mixing ratios (▷ page 319).

Technical data

Fuels, coolants, lubricants, etc.

Engine oils

Engine oils are specifically tested for their suitability in our engines and durability for our service intervals. Therefore, only use approved engine oils and oil filters required for vehicles with Maintenance System (U.S. vehicles) or FSS (Canada vehicles). For a listing of approved engine oils and oil filters, refer to the Factory Approved Service Products pamphlet, or contact an authorized Mercedes-Benz Light Truck Center.

Using engine oils and oil filters of specification other than those expressly required for the Maintenance System (U.S. vehicles) or FSS (Canada vehicles), or changing of oil and oil filter at change intervals longer than those called for by the Maintenance System (U.S. vehicles) or FSS (Canada vehicles) will result in engine damage not covered by the Mercedes-Benz Limited Warranty.

Please follow Maintenance System (U.S. vehicles) or FSS (Canada vehicles) recommendations for scheduled oil changes. Failure to do so could result in engine damage not covered by the Mercedes-Benz Limited Warranty.

Engine oil additives

Do not blend oil additives with engine oil. They may damage the engine.

Damage or malfunctions resulting from blending oil additives are not covered by the Mercedes-Benz Limited Warranty.

Air conditioning refrigerant

R-134a (HFC) refrigerant and special PAG lubricating oil are used in the air conditioning system.

Never use R-12 (CFC) or mineral-based lubricating oil. Otherwise damage to the system will occur.

Brake fluid

During vehicle operation, the boiling point of the brake fluid is continuously reduced through the absorption of moisture from the atmosphere. Under extremely strenuous operating conditions, this moisture content can lead to the formation of bubbles in the system, thus reducing the system's efficiency.

Therefore, the brake fluid must be replaced every two years, preferably in the spring.

Only brake fluid approved by Mercedes-Benz is recommended. Your authorized Mercedes-Benz Light Truck Center will provide you with additional information.

Premium unleaded gasoline



To maintain the engine's durability and performance, premium unleaded gasoline must be used. If premium unleaded is not available and low octane fuel is used, follow these precautions:

- Have the fuel tank only partially filled with unleaded regular and fill up with premium unleaded as soon as possible.
- Avoid full throttle driving and abrupt acceleration.
- Do not exceed an engine speed of 3000 rpm if the vehicle is loaded with a light load such as two persons and no luggage.
- Do not exceed $\frac{2}{3}$ of maximum accelerator pedal position if the vehicle is fully loaded or operating in mountainous terrain.

Fuel requirements

Only use premium unleaded fuel.

- The octane number (posted at the pump) must be 91 min. It is an average of both the Research (R) octane number and the Motor (M) octane number: $(R+M) / 2$. This is also known as the ANTI-KNOCK INDEX.

Unleaded gasoline containing oxygenates such as ethanol, IPA, IBA and TBA can be used provided the ratio of any one of these oxygenates to gasoline does not exceed 10%; MTBE must not exceed 15%.

The ratio of methanol to gasoline must not exceed 3% plus additional cosolvents.

Using mixtures of ethanol and methanol is not allowed. Gasohol, which contains 10% ethanol and 90% unleaded gasoline, can be used.

These blends must also meet all other fuel requirements, such as resistance to spark knock, boiling range, vapor pressure, etc.

Gasoline additives

A major concern among engine manufacturers is carbon build-up caused by gasoline. Mercedes-Benz recommends only the use of quality gasoline containing additives that prevent the build-up of carbon deposits.

After an extended period of using fuels without such additives carbon deposits can build up, especially on the intake valves and in the combustion area, leading to engine performance problems such as:

- Warm-up hesitation
- Unstable idle
- Knocking / pinging
- Misfire
- Power loss

Technical data

Fuels, coolants, lubricants, etc.

In areas where carbon deposits may be encountered due to lack of availability of gasolines which contain these additives, Mercedes-Benz recommends the use of additives approved by us for use on Mercedes-Benz vehicles. Refer to Factory Approved Service Products Pamphlet for a listing of approved product(s). Follow directions on product label.

Do not blend other specific fuel additives with fuel. This only results in unnecessary costs and may be harmful to the engine operation.

Damage or malfunction resulting from poor fuel quality or from blending additional fuel additives other than those tested and approved by us for use on Mercedes-Benz vehicles listed in the Factory Approved Service Products Pamphlet are not covered by the Mercedes-Benz Limited Warranty.

Coolants

The engine coolant is a mixture of water and anticorrosion / antifreeze, which provides:

- Corrosion protection
- Freeze protection
- Boiling protection (by increasing the boiling point)

The cooling system was filled at the factory with a coolant providing freeze protection to approximately -35°F (-37°C) and corrosion protection.

If the antifreeze mixture is effective to -22°F (-30°C), the boiling point of the coolant in the pressurized cooling system is reached at approximately 266°F (130°C).

The coolant solution must be used year round to provide the necessary corrosion protection and increase boil-over protection. Refer to Maintenance Booklet for replacement interval.

To provide important corrosion protection, the solution must be at least 45% anticorrosion / antifreeze (equivalent to freeze protection to approx. - 22°F [-30°C]). If you use a solution that is more than 55% anticorrosion / antifreeze (freeze protection to approx. - 49°F [-45°C]), the engine temperature will increase due to the lower heat transfer capability of the solution. Therefore, do not use more than this amount of anticorrosion / antifreeze.

Technical data

Fuels, coolants, lubricants, etc.

If the coolant level is low, water and MB 325.0 anticorrosion / antifreeze should be used to bring it up to the proper level (have cooling system checked for signs of leakage). Please make sure the mixture is in accordance with label instructions.

The water in the cooling system must meet minimum requirements, which are usually satisfied by normal drinking water. If you are not sure about the water quality, consult an authorized Mercedes-Benz Light Truck Center.

Technical data

Fuels, coolants, lubricants, etc.

Anticorrosion / antifreeze

Your vehicle contains a number of aluminum parts. The use of aluminum components in motor vehicle engines necessitates that anticorrosion / antifreeze coolant used in such engines be specifically formulated to protect the aluminum parts. (Failure to use such

anticorrosion / antifreeze coolant will result in a significantly shortened service life.)

Therefore, the following product is strongly recommended for use in your vehicle:
Mercedes-Benz 325.0
anticorrosion / antifreeze agent.

Before the start of the winter season (or once a year in hot southern regions), you should have the anticorrosion / antifreeze concentration checked. The coolant is also regularly checked each time you bring your vehicle to an authorized Mercedes-Benz Light Truck Center for service.

Anticorrosion / antifreeze quantity

Model	Approx. freeze protection	
	- 35°F (- 37°C)	- 49°F (- 45°C)
ML 350, ML 500,	6.4 US qt (6.0 l)	7.0 US qt (6.6 l)

Windshield washer and headlamp cleaning* system

Both the windshield washer and headlamp cleaning* system are supplied from the windshield washer fluid reservoir.

The windshield and headlamp washer fluid reservoir has a capacity of approx. 8.0 US qt (7.6 l).

- ▶ Refill the reservoir with MB Windshield Washer Concentrate “S” and water (or concentrate and commercially available premixed windshield washer solvent / antifreeze, depending on ambient temperatures).

Warning!



Washer solvent / antifreeze is highly flammable. Do not spill washer solvent / antifreeze on hot engine parts, because it may ignite and burn. You could be seriously burned.

Technical data

Fuels, coolants, lubricants, etc.

Windshield and headlamp washer fluid mixing ratio

For temperatures above freezing point, use MB Windshield Washer Concentrate “S” and water:

- 1 part “S” to 100 parts water
(1.34 fl oz [40 ml] “S” to 1 gallon [4.0 l] water)

For temperatures below freezing point, use MB Windshield Washer Concentrate “S” and commercially available premixed windshield washer solvent / antifreeze:

- 1 part “S” to 100 parts solvent
(1.34 fl oz [40 ml] “S” to 1 gallon [4.0 l] solvent)

Technical data

Consumer information

The following text is published as required of all manufacturers of passenger cars under Title 49, Code of U.S. Federal Regulations, Part 575 pursuant to the “National Traffic and Motor Vehicle Safety Act of 1966”.

Uniform tire quality grading

Quality grades can be found, where applicable, on the tire sidewall between tread shoulder and maximum section width. For example:

Treadwear	Traction	Temperature
200	AA	A

All passenger car tires must conform to federal safety requirements in addition to these grades.

Treadwear

The treadwear grade is a comparative rating based on the wear rate of the tire when tested under controlled conditions on a specified government test course. For example, a tire graded 150 would wear one and one-half ($1\frac{1}{2}$) times as well on the government course as a tire graded 100. The relative performance of tires depends upon the actual conditions of their use, however, and may depart significantly from the norm due to variations in driving habits, service practices and differences in road characteristics and climate.

Traction

The traction grades, from highest to lowest are AA, A, B, and C. Those grades represent the tire’s ability to stop on wet pavement as measured under controlled conditions on specified government test surfaces of asphalt and concrete. A tire marked C may have poor traction performance.

Warning!



The traction grade assigned to this tire is based on straight ahead braking traction tests, and does not include acceleration, cornering, hydroplaning, or peak traction characteristics.

Temperature

The temperature grades are A (the highest), B, and C, representing the tire's resistance to the generation of heat and its ability to dissipate heat when tested under controlled conditions on a specified indoor laboratory test wheel. Sustained high temperature can cause the material of the tire to degenerate and reduce tire life, and excessive temperature can lead to sudden tire failure. The grade C corresponds to a level of performance which all passenger car tires must meet under the Federal Motor Vehicle Safety Standard No. 109. Grades B and A represent higher levels of performance on the laboratory test wheel than the minimum required by law.

Warning!



The temperature grade for this tire is established for a tire that is properly inflated and not overloaded. Excessive speed, underinflation, or excessive loading, either separately or in combination, can cause excessive heat build-up and possible tire failure.



ABS

(Antilock Brake System)

Prevents the wheels from locking up during braking so that the vehicle can continue to be steered.

BabySmart™ airbag deactivation system

This system detects if a special system compatible child restraint seat is installed on the front passenger seat. The system will automatically deactivate the passenger front airbag when such a seat is properly installed (indicator lamp  in the instrument cluster lights up). See an authorized Mercedes-Benz Light Truck Center for availability.

BabySmart™ compatible child seats

Special restraint system for children. The sensor system for the passenger seat prevents deployment of the passenger front airbag if a BabySmart™ compatible child seat is installed.

BAS

(Brake Assist System)

System for potentially reducing braking distances in emergency braking situations. The system is activated when it senses an emergency based on how fast the brake is applied.

Bi-Xenon headlamps*

Headlamps which use an electric arc as the light source and produce a more intense light than filament headlamps. Bi-Xenon headlamps produce low beam and high beam.

CAC

(Customer Assistance Center)
Mercedes-Benz customer service center, which can help you with any questions about your vehicle and provide assistance in the event of a breakdown.

CAN system

(Controller Area Network)

Data bus network serving to control vehicle functions such as door locking or windshield wiping.

Cockpit

All instruments, switches, buttons and indicator / warning lamps in the passenger compartment needed for vehicle operation and monitoring.

Cruise control

Driving convenience system for automatically maintaining the vehicle speed set by the driver.

Engine number

The number set by the manufacturer and placed on the cylinder block to uniquely identify each engine produced.

Technical terms

Engine oil viscosity

Measurement for the inner friction (viscosity) of the oil at different temperatures. The higher the temperature an oil can tolerate without becoming thin, or the lower the temperature it can tolerate without becoming viscous, the better the viscosity.

ESP

(Electronic Stability Program)
Improves vehicle handling and directional stability.

ETD

(Emergency Tensioning Device)
Device which deploys in certain frontal and rear collisions exceeding the system's threshold to tighten the seat belts.
->SRS

FSS (Canada vehicles)

(Flexible Service System)
Maintenance service indicator in the speedometer display that informs the driver when the next vehicle maintenance service is due. FSS evaluates engine temperature, oil level, vehicle speed, engine speed, distance driven and the time elapsed since your last service, and calls for the next maintenance service accordingly.

GAWR

(Gross Axle Weight Rating)
The GAWR is the maximum permissible axle weight. The gross vehicle weight on each axle must never exceed the GAWR for the front and rear axle indicated on the certification label located on the driver's door pillar.

GVW

(Gross Vehicle Weight)
The GVW comprises the weight of the vehicle including fuel, tools, spare wheel, installed accessories, passengers and cargo. The GVW must never exceed the GVWR, indicated on the certification label located on the driver's door pillar.

GVWR

(Gross Vehicle Weight Rating)
This is the maximum permissible vehicle weight. It is indicated on certification label located on the driver's door pillar.

Gear range

Number of gears which are available to the automatic transmission for shifting. The automatic gear shifting process can be adapted to specific operating conditions using the gear selector lever.

GPS

(Global Positioning System)
Satellite-based system for relaying geographic location information to and from vehicles equipped with special receivers. Employs CD or DVD digital maps for navigation.

Instrument cluster

The displays and indicator / warning lamps in the driver's field of vision, including the tachometer, speedometer, engine temperature and fuel gauge.

Kickdown

Depressing the accelerator past the point of resistance shifts the transmission down to the lowest possible gear. This very quickly accelerates the vehicle and should not be used for normal acceleration needs.

Line of fall

The direct line that an object moves downhill when influenced by the force of gravity alone.

Lock button

Button on the door which indicates whether the door is locked or unlocked. Pushing the lock button down on an individual door from inside will lock that door.

MCS

(Modular Control System)
Information and operating center for vehicle sound and communications systems, including the radio and the radio and navigation system, as well as for other optional equipment (CD changer, telephone, etc.).

Memory function*

Used to store three individual seat, steering wheel and mirror positions.

MON

(Motor Octane Number)
The Motor Octane Number for gasoline as determined by a standardized method. It is an indication of a gasoline's ability to resist undesired detonation (knocking). The average of both the MON (Motor Octane Number) and ->RON (Research Octane Number) is posted at the pump, also known as ANTI-KNOCK INDEX.

Multifunction display

A display field in the instrument cluster used to present information provided by the control system.

Technical terms

Parktronic (Parking assist)*

System which uses visual and acoustic signals to assist the driver during parking maneuvers.

Poly-V-belt drive

Drives engine-components (alternator, AC compressor, etc.) from the engine.

Power train

Collective term designating all components used to generate and transmit motive power to the drive axles, including

- engine
- clutch / torque converter
- transmission
- transfer case
- drive shaft
- differential
- axle shafts / axles

Remote Vehicle Diagnostics

Transmission of vehicle data and current location to the Mercedes-Benz Customer Assistance Center for subscribers to Tele Aid service.

REST

(Residual engine heat utilization)
Feature that uses the engine heat stored in the coolant to heat the vehicle interior for a short time after the engine has been turned off.

Restraint system

Seat belts, belt tensioner, airbags and child seat restraint systems. As independent systems, their protective functions complement one another.

RON

(Research Octane Number)

The Research Octane Number for gasoline as determined by a standardized method. It is an indication of a gasoline's ability to resist undesired detonation (knocking). The average of both the →MON (Motor Octane Number) and RON (Research Octane Number) is posted at the pump, also known as ANTI-KNOCK INDEX.

Shift lock

When the vehicle is parked, this lock prevents the transmission selector lever from being moved out of position **P** without key turned and brake pedal depressed.

SRS

(Supplemental Restraint System)

Seat belts, emergency tensioning device and airbags. Though independent systems, they are closely interfaced to provide effective occupant protection.

Tele Aid System*

(Telematic Alarm Identification on Demand)

The Tele Aid system consists of three types of response: automatic and manual emergency, roadside assistance and information. Tele Aid is initially activated by completing a subscriber agreement and placing an acquaintance call.

The Tele Aid system is operational provided that the vehicle's battery is charged, properly connected, not damaged and cellular and GPS coverage is available.

Telematics*

A combination of the terms "telecommunications" and "informatics".

Tightening torque

Force times lever arm (e.g. a lug wrench) with which threaded fasteners such as wheel bolts are tightened.

Tire speed rating

Part of tire designation; indicates the speed range for which a tire is approved.

Traction

Force exerted by the vehicle on the road via the tires.

Transfer case

Speed of rotation / torque converter that works together with the ->automatic transmission. In the LOW mode off-road position, the transfer case decreases the output rotational speed of the ->automatic transmission by approximately half. This results in a corresponding increase of torque on the drive axles.

The vehicle then has nearly double the driving force but drives only approximately half as fast.

TWR

(Tongue Weight Rating)

The TWR is the maximum permissible weight on the trailer tongue.

Maintenance System (U.S. vehicles)

Maintenance service indicator in the speedometer display that informs the driver when the next vehicle maintenance service is due. The Maintenance System tracks distance driven and the time elapsed since your last maintenance service, and calls for the next maintenance service accordingly.

VIN

(Vehicle Identification Number)

The number set by the manufacturer and placed on the body to uniquely identify each vehicle produced.

Voice control system*

Voice control system for car phones, portable cell phones and audio systems (radio, CD, etc.).



A

- ABS 25, 76, 323
 - ABS control 76
 - LOW RANGE mode 77
 - Malfunction indicator lamp 248
 - Warning lamp 248
- Accelerator position,
 - automatic transmission 124
- Accident
 - In case of 53
- Activating
 - Air circulation mode 141
 - Air recirculation mode 141
 - Anti-theft alarm system 83
 - Automatic climate control 137
 - ESP 82
 - Exterior headlamps 50
 - Hazard warning flasher 113
 - Headlamps 50
 - Ignition 33
 - Immobilizer 55, 83
- Rear passenger compartment
 - ventilation and climate control 143
- Rear window defroster 135
- Rear window wiper 52
- Residual heat 142
- Seat heater* 98
- Tow-away alarm 85
- Warning indicators (Parktronic*) 158
- Windshield wipers 51
- Activating automatic central locking 94
- Adding
 - Coolant 228
 - Engine oil 226
- Additional turn signals 274
- Adjustable steering column
 - Indicator lamp 260
- Adjusting 35
 - Backrest tilt 37, 39
 - Exterior rear view mirror 41
 - Head restraint height 37, 39
 - Head restraint tilt 38, 40
- Headlamp aim 282
- Instrument cluster illumination 117
- Interior rear view mirror 41
- Manual seat 36
- Mirrors 41
- Seat cushion tilt 39
- Seat fore and aft 36
- Seat fore and aft adjustment 38
- Seat height 37, 39
- Seats 35
- Steering wheel 40
- Adjusting air distribution
 - Automatic climate control 139
- Adjusting air volume
 - Automatic climate control 139
- Air conditioning
 - Cooling 141
- Air conditioning refrigerant 314
- Air pressure see Tire inflation pressure

Index

- Air recirculation mode 140
 - Activating 141
 - Deactivating 141
- Air vents
 - Automatic climate control 144
- AIRBAG OFF
 - Warning lamp 249
- Airbags 59
 - BabySmart™ airbag deactivation system 323
 - BabySmart™ deactivation system 70
 - Children 60
 - Front 63
 - Passenger 63
 - Safety guidelines 62
 - Side impact 64
 - Window curtain 64
- Alarm
 - Audible 75, 84, 86
 - Canceling 84, 86
 - Visual 83
- Alarm system
 - Anti-theft 83
- Anticorrosion/antifreeze 318
- Antiglare
 - Automatic 128
- Antilock brake system (ABS) 323
- Anti-theft alarm system
 - Arming 83
 - Canceling alarm 84, 86
 - Disarming 84
- Anti-theft systems
 - Anti-theft alarm system 83
 - Immobilizer 83
 - Tow-away alarm,
 - glass breakage sensor 84
- Aquaplaning see Hydroplaning
- Armrest
 - Storage compartment in front of 168
 - Storage compartments 168
- Armrest in rear seat bench 170
- Ashtray
 - Front center console 171
- ATF (automatic transmission fluid) 227
- Attaching a trailer 213
- Automatic antiglare for rear view mirror 128
- Automatic central locking
 - Activating 94
 - Deactivating 94
- Automatic climate control 136
 - Adjusting air distribution 139
 - Adjusting air volume 139
- Air conditioning 141
- Air vents 144
- Basic setting 139
- Changing basic setting 139
- Defrosting 140
- Economy mode 137
- Rear passenger compartment 143
- Rear window defroster 135
- Residual heat utilization 142
- Residual ventilation 142
- Switching off 139
- Switching on 139

- Automatic headlamp mode 108
- Automatic interior lighting control
 - Activating 114
 - Deactivating 114
- Automatic locking when driving 93
- Automatic transmission
 - Accelerator position 124
 - Emergency operation (Limp Home Mode) 126
 - Gear ranges 122
 - Gear selector lever position 123
 - Gear shifting malfunctions 126
 - Kickdown 124
 - Manual shifting 121
 - One-touch gearshifting 121
 - Selector lever position 120
 - Towing a trailer 125
 - Transmission fluid 227
- B**
- BabySmart™
 - Airbag deactivation system 70
 - Compatible child seats 70, 323
 - Self-test 70
- BabySmart™ airbag deactivation system 323
- Backrest tilt 36
- Backup lamps 275, 279
 - Bulbs 275
- BAS 78, 323
 - Malfunction indicator lamp 251, 252, 253
 - Warning lamp 251
- Batteries, remote control
 - Replacing 273
- Battery discharged
 - Jump starting 291
- Battery indicator lamp
 - Indicator lamp 261
- Battery, vehicle 228, 272
 - Charging 289
 - Disconnecting 289
 - Reconnecting 289
 - Reinstalling 289
 - Removing 289
- Bi-Xenon headlamps* 323
- Block heater (Canada only) 236
- Blocking
 - Rear door window operation 74
- Brake assist system (BAS) 323
- Brake fluid 314
- Brake lamp bulbs 275
- Brake pad wear
 - Indicator lamp 261
- Brakes 198
 - Warning lamp 250
- Break-in period 196
- Bulbs, replacing 274
 - Additional turn signals 274
 - Backup lamps 275
 - Brake lamps 275
 - Fog lamps 274
 - Front fog lamp 279
 - Front lamps 274
 - High beam 274
 - High mounted brake lamp 281
 - License plate lamps 275, 281
 - Low beam 274
 - Parking, standing lamp 274
 - Rear fog lamps 279
 - Rear side marker lamp bulbs 279
 - Side marker lamps 274, 275
 - Standing lamps 274
 - Tail lamp assemblies 279
 - Turn signal lamps 274, 275
 - Turn signal, side marker lamp 274

Index

C

- CAC (Customer Assistance Center) 323
- Calibrating compass 191
- California
 - Important notice 11
- Calling up
 - Service indicator 238
- CAN system 323
- Capacities
 - Fuels, coolants, lubricants, etc. 312
- Cargo area see Cargo compartment
- Cargo compartment
 - Liftgate 89
 - Lighting 116
 - Tie-down rings 161
- Cargo compartment cover blind* 164
 - Closing 164
 - Installing 165
 - Opening 164
 - Removing 164
- Cargo floor plates 165
 - Installing 166
 - Removing 165
 - Storing 165
- Cargo tie-down rings 161
- Catalytic converter 217
- CD-changer* 265
- Center console 27
 - Lower part 28
 - Upper part 27
- Central locking
 - Automatic 93
 - From inside 94
 - Switch 94
 - Unlocking from inside 94
- Central locking switch 94
- Certification label 304
- Charge indicator lamp 261
- Charging
 - Vehicle battery 289
- Chart
 - Fuses 298
- CHECK ENGINE malfunction indicator lamp 254, 255
- Checking
 - Coolant level 227
 - Oil level 223
 - Tire inflate pressure 221
 - Vehicle lighting 221
- Checking weights
 - Trailer and vehicle 213
- Checklist
 - Off-road driving 205
 - Returning from off-road driving 210
- Child safety 67
 - Airbags 60
 - Infant and child restraint systems 64, 68
 - LATCH child seat mounts 73
- Child safety switch see Blocking of rear door window operation
- Cigarette lighter
 - Front center console 171

- Cleaning
 - Cup holder 244
 - Gear selector lever 244
 - Hard plastic trim items 244
 - Headlamps 133
 - Headliner 244
 - Instrument cluster 244
 - Leather upholstery 245
 - Light alloy wheels 244
 - MB Tex upholstery 245
 - Plastic and rubber parts 245
 - Seat belts 244
 - Steering wheel 244
 - Windows 243
 - Windshield 51
 - Wiper blades 243
- Clock 26, 119
- Closing
 - Glove box 167
 - Hood 223
 - Liftgate 92
 - Power tilt/sliding sunroof* 271
 - Rear quarter windows* 149
 - Side windows 147
 - Tilt/sliding sunroof* 150
- Closing tilt/sliding sunroof*
 - In an emergency 271
- Cockpit 22, 323
- Combination switch
 - High beam flasher 50
 - Turn signals 50
 - Windshield wipers 51
- Compass 190
 - Calibrating 191
 - Setting compass zone 191
- Compass zone 191
- Consumer information 320
- Control and operation of radio transmitters 216
- Coolant 227, 316
 - Adding 228
 - Anticorrosion/antifreeze quantity 316
 - Checking level 227
 - Indicator lamp 256
 - Temperature 218
 - Temperature gauge 118
- Coolant level
 - Checking 227
- Crossing obstacles 209
- Cruise control 153, 323
 - Canceling 154
 - Driving downhill 154
 - Driving uphill 154
 - Fine adjustment 155
 - LOW RANGE mode 155
 - Saving current speed 154
 - Setting speeds 155
- Cruise control lever 153
- Cup holder 169
 - Cleaning 244
 - In front seat armrest 170
 - In instrument panel 169
 - In rear center console 170
- Customer Assistance Center (CAC) 323

Index

D

Daytime running lamp mode 109

Deactivating

Air conditioning (cooling) 141

Air recirculation mode 141

Alarm 84

Anti-theft alarm system 84

Automatic climate control 137, 139

Cruise control 154

Defrost 140

Engine 55

ESP 81

Hazard warning flasher 113

Headlamps 55

Immobilizer 83

Rear passenger compartment
ventilation and climate control 143

Rear window defroster 135

Rear window wiper 52

Residual heat 142

Seat heater* 99

Tow-away alarm 85

Tow-away alarm

(vehicles with trip computer*) 85

Tow-away alarm (vehicles without trip
computer*) 86

Deactivating automatic central
locking 94

Deep water see Standing water

Defogging

Windshield 140

Defrosting 140

Difficulties

While driving see Problems
while driving

With starting 48

Direction of rotation (tires) 232

Discharged battery

Jump starting 291

Disconnecting

Vehicle battery 289

Display in the speedometer 118

Display messages

Error 263

Service indicator (FSS) 263

StArt 263

Displays

Messages 224

Service indicator 237

Distance remaining 192

Door unlock

With Tele Aid* 182

Doors

Opening from inside vehicle 90

Opening from outside 89

Downhill driving

Cruise control 154

Downshifting 121

Drink holder see Cup holder

Drinking and driving 197

Drive sensibly-save fuel 197

Driving 43, 48

Abroad 216

In winter 202

Problems 53

Safety systems 76

Through standing water 204

- Driving abroad 216
- Driving instructions
 - Towing a trailer 214
- Driving off 199
- Driving safety systems
 - 4-ETS 79
 - ABS 76
 - BAS 78
 - ESP 80
- Driving systems 153
 - Cruise control 153
 - Driving safety systems 76
 - EBP 80
 - Parktronic* 156
- Driving through water 208
- Driving tips 124
 - Accelerator position 124
 - Kickdown 124
- E**
- Easy entry/exit feature* 101
- EBP 80
 - Indicator lamp 251
- Economy mode
 - Automatic climate control 137
- Electrical connections
 - Trailer 212
- Electrical fuses 297
- Electrical outlet 173
- Electrical system
 - Technical data 309
- Electrically folding exterior
 - rear view mirrors 130
- Electronic Brake Proportioning see EBP
- Electronic Stability Program see ESP
- Electronic stability program see ESP
- Electronic Traction System see 4-ETS
- Emergency call system
 - Requirements 175
- Emergency call system* 175
- Emergency calls
 - Initiating an emergency call 178
 - With Tele Aid* 176
- Emergency operation
 - (Limp Home Mode) 126
- Emergency operations
 - Closing tilt/sliding sunroof* 271
 - Locking the vehicle 269
 - Opening tilt/sliding sunroof* 271
 - Remote door unlock 182
 - Unlocking the vehicle 268
- Emergency tensioning device see ETD
- Emission control 217
- Emission control label 304
- Engine
 - Starting 47
 - Technical data 306
 - Turning off 55
- Engine cleaning 242
- Engine compartment
 - Hood 222
 - Main fuse box 298
- Engine malfunction indicator lamp 254
- Engine malfunction indicator lamp
 - (Canada only) 25
 - (USA only) 25
- Engine number 323

Index

- Engine oil 223, 314
 - Adding 226
 - Additives 314
 - Checking level 223
 - Consumption 223
 - Messages in display 224
 - Oil dipstick 226
 - Viscosity 324
- Enlarged cargo compartment 100
- Error
 - Display messages 263
- ESP 25, 80, 324
 - Indicator lamp 251
 - LOW RANGE mode 81
 - Malfunction indicator lamp 251, 252, 253
 - Switching off 81
 - Switching on 82
 - Synchronizing 252
 - Warning lamp 258
- ETD 324
 - Safety guidelines 62
- ETD (Emergency tensioning device) 67
- Exterior mirrors
 - Folding 130
- Exterior rear view mirrors
 - Adjusting 41
 - Folding electrically 130
- F**
- Fastening the seat belts 43
- Fine adjustment
 - Cruise control 155
- First aid kit 264
- Flat tire 284
 - Lowering the vehicle 287
 - Preparing the vehicle 284
 - Spare wheel 266
- Flexible Service System (FSS) 237, 324
- Fluid level
 - Automatic transmission 227
- Fog lamps 111
 - Replacing bulbs 274
- Fog lamps, front
 - Replacing bulbs 276
 - Switching on 112
- Folding
 - Exterior mirrors 130
- Folding electrically
 - Exterior rear view mirrors 130
- 4-ETS 25, 79
 - Indicator lamp 259
 - LOW RANGE mode 80
 - Malfunction indicator lamp 259
 - Warning lamp 258
- Front airbags 63
- Front fog lamps
 - Indicator lamp 260
- Front lamps
 - Replacing bulbs 274, 276
- Front towing eye 295
- Front turn signal bulbs
 - Replacing 278
- FSS (Flexible Service System) 237, 324
- Fuel 220
 - Additives 315
 - Fuel reserve warning lamp 259
 - Gasoline additives 315
 - Premium unleaded gasoline 220, 315
 - Requirements 315
 - Reserve warning 25

Fuel additives 315
 Fuel filler flap 219
 Locking 219
 Opening 269
 Unlocking 219
 Fuel requirements 315
 Fuel tank
 Filler flap 219
 Fuels, coolants, lubricants etc. 312
 Functions
 Trip computer* 189
 Fuse box 299
 Fuse chart 298
 Fuse extractor 298
 Fuses 297
 Fuse box in passenger footwell 299
 Fuse chart 298
 Fuse extractor 298
 Main fuse box 298
 Spare fuses 298

G

Garage door opener 29, 183
 Erasing in remote control 188
 Gasoline additives 315
 Gasoline see Fuel
 Gauge for
 Coolant temperature 25
 Fuel 25
 Outside temperature 25
 GAWR (Gross Axle Weight Rating) 324
 Gear range 324
 Automatic transmission 122
 Limiting 122
 Shifting into optimal 121
 Gear range limit
 Canceling 121
 Gear selector lever
 Cleaning 244
 Position 123
 Glass breakage sensor 84
 Global Positioning System (GPS) 325

Glove box 23, 167
 Closing 167
 Opening 167
 Good visibility 128
 GPS 325
 GVW (Gross Vehicle Weight) 324
 GVWR (Gross Vehicle Weight
 Rating) 324

H

Hard plastic trim items
 Cleaning 244
 Hazard warning flasher 113
 Switching off 113
 Switching on 113
 Head restraints
 Manual seats 37
 Power seats* 39
 Headlamp aim
 Adjusting 282

Index

Headlamp cleaning system* 230
Headlamps
 Automatic control 108
 Bi-Xenon* 323
 Cleaning 242
 Cleaning system* 133, 230
 Refilling washer fluid 230
 Switching off 55
 Switching on 50
 Washer fluid 319
 Washer system 319
Headliner
 Cleaning 244
Heated seats* 98
Height adjustment
 Head restraints 37, 39
 Seat belts 46
 Steering wheel 40
High beam 111
High beam flasher 50, 111
High beam halogen headlamps
 Replacing bulbs 277
High beam headlamps
 Replacing bulbs 274
High mounted brake lamp
 Replacing bulbs 281

Hood 222
 Closing 223
 Opening 222
Hooks
 Loading 162
Hydroplaning 201
I
Identification labels 304
 Certification label 304
 Vehicle identification number (VIN) 304
Ignition 33
Immobilizer 83
 Activating 83
 Deactivating 83
Indicator lamp
 Adjustable steering column 260
 Brake pad wear 261
 Coolant 256
 Front fog lamps 260
 Low engine oil level 260
Infant and child restraint systems 68
 Installing 71
 LATCH child seat mounts 73

Information
 About service and warranty 10
 Button for Tele Aid* 180
Inside rear view mirror
 Antiglare 128
Installing
 Infant and child restraint systems 71
 Wiper blades 283
Instrument cluster 24, 117, 325
 Cleaning 244
 Coolant temperature gauge 118
 Display in the speedometer 118
 Illumination 117
 Lamps in 259
 Outside temperature indicator 119
Instruments and controls see Cockpit
Integrated remote control
 Erasing memory 188
 Operating 188
Interior lighting 114
 Activating automatic control 114
 Deactivating automatic control 114
 Manual control 115
 Reading lamps 115
Interior rear view mirror
 Adjusting 41

Intermittent wiping 132

J

Jack 265

Jump starting 291

K

Key

Global locking 89

Global unlocking 89

Loss of 90

Positions in steering lock 33

Remote control with folding key 88

Unlocking liftgate 89

Unlocking the driver's door,
fuel filler flap 89

Key, Mechanical 268

Key, Remote control

Unlocking with 32

Kickdown 124, 325

L

Labels, identification 304

Lamp bulbs, exterior 274

Lamps, exterior

Front 274

Rear 275

Lamps, indicator and warning

4-ETS 258, 259

ABS 248

Adjustable steering column 260

AIRBAG OFF 63, 249

BAS 78, 251, 252

Battery indicator lamp 261

Brake pad wear 261

Brakes 250

CHECK ENGINE 254, 255

CHECK Engine malfunction indicator
lamp 255

Coolant 256

EBP 251

Engine diagnostics 254, 255

ESP 251, 252, 258

Front fog lamps 260

Fuel reserve 259

Low engine oil level 260

LOW RANGE 259

Low washer system fluid level 260

Seat belts 260

Service indicator 237

SRS 262

Turn signals 25

LATCH child seat anchors 73

LATCH child seat mounts 73

Layout of poly-V-belt drive 305

Leather upholstery

Cleaning 245

Lever

For cruise control 153

License plate lamps

Replacing bulbs 275, 281

Liftgate

Closing 92

Opening 89, 91

Opening from inside 91

Opening from outside 91

Light alloy wheels

Cleaning 244

Lighter see cigarette lighter

Index

- Lighting 107
 - Automatic headlamp mode 108
 - Cargo compartment 116
 - Daytime running lamp mode 109
 - Fog lamps 111
 - Front fog lamps 112
 - High beam 111
 - High beam flasher 111
 - Instrument cluster illumination 117
 - Interior 114
 - Locator lighting 111
 - Night security illumination 109
 - Limiting the gear range 122
 - Limp Home Mode 126
 - Line of fall 325
 - Loading 160
 - Cargo compartment cover blind* 164
 - Cargo floor plates 165
 - Cargo tie-down rings 161
 - Hooks 162
 - Instructions 160
 - Partition net* 162
 - Roof rack 166
 - Split rear bench seat 100
 - Trailer 212
 - Locator lighting 111
 - Lock button 325
 - Locking 88
 - Automatic while driving 93
 - Centrally from inside 94
 - Fuel filler flap 219
 - Global 89
 - Vehicle in an emergency 269
 - Locking knobs 32
 - Loss of keys 90
 - Loss of Service and Warranty Information Booklet 303
 - Low beam bulbs
 - Replacing bulbs 276
 - Low beam headlamps
 - Replacing bulbs 274
 - Switching on 50
 - Low engine oil level
 - Indicator lamp 260
 - LOW RANGE - 4-ETS 80
 - LOW RANGE - ABS 77
 - LOW RANGE - ESP 81
 - LOW RANGE mode 127
 - Low washer system fluid level
 - Indicator lamp 260
 - Lowering
 - Vehicle 287
- M**
- Main dimensions 310
 - Main fuse box 298
 - Maintenance 12
 - Display messages 263
 - Maintenance System (U.S. vehicles) 327
 - Manual operations
 - Fuel filler flap 269
 - Interior lighting control 115
 - Locking the vehicle 269
 - Power tilt/sliding sunroof* 271
 - Unlocking the driver's door 268
 - Unlocking transmission selector lever 270
 - Manual seat
 - Adjusting 36
 - Adjusting backrest tilt 37
 - Adjusting head restraint height 37
 - Adjusting head restraint tilt 38, 40
 - Seat fore and aft adjustment 36
 - Seat height 37
 - MB Tex upholstery
 - Cleaning 245

- MCS
 Modular Control System 325
- Mechanical key 268
- Memory function 105, 325
- Memory function* 106
 Recalling positions from
 memory 106
- Mirrors
 Activating exterior mirror parking
 position 129
 Adjusting 41
 Automatic antiglare for rear view
 mirror 128
 Exterior rear view mirror 41
 Storing exterior rear view mirror
 parking position 106
- MON 220
- MON (Motor Octane Number) 325
- Multifunction display 325
- N**
- Night security illumination 109
 Deactivation temporarily 110
- O**
- Occupant safety 58
 Children and airbags 60
 Children in the vehicle 67
 Fastening the seat belt 43
 Infant and child restraint systems 68
 LATCH child seat mounts 73
 Seat belts 43, 62
- Odometer display 118
- Odometer, main 25
- Off-road driving
 Checklist 205, 210
 Crossing obstacles 209
 Driving instructions off-road
 driving 204
 Driving through water 208
 Returning 210
 Rules 205
 Special driving features 205
 Steep terrain 206
- Oil
 Adding 226
 Consumption 223
 Dipstick 223
 Oil dipstick 226
 Viscosity 324
- One-touch gearshifting 121
 Canceling gear range limit 121
 Downshifting 121
 Upshifting 121
- Opening
 Doors from the inside 90
 Fuel filler flap 219
 Fuel filler flap manually 269
 Glove box 167
 Hood 222
 Liftgate 89, 91
 Liftgate from inside 91
 Liftgate from outside 91
 Power tilt/sliding sunroof* 271
 Rear quarter windows* 148
 Side windows 147
 Storage compartment in front of
 armrest 169
 Storage compartment under passenger
 seat 168
 Tilt/sliding sunroof* 150
 Tilt/Sliding sunroof* in an
 emergency 271
 Windows 147

Index

- Opening and closing
 - Side windows 146
- Operating
 - Garage door opener 188
 - Integrated remote control 188
 - Radio transmitters 216
 - Vehicle outside the USA or Canada 13
- Operating safety 17
- Operator's Manual 10
- Ornamental moldings 242
- Outside temperature indicator 119
- Overdue service 238
- Overhead control panel 29
- P**
- Paintwork 241
- Panic alarm 75
 - Panic button on remote control 75
- Parking 200
- Parking and locking 54
- Parking brake 48, 54
 - Engaging 54
 - Releasing 48
- Parking lamps
 - Switching on 107
- Parking, standing lamp
 - Replacing bulbs 274
- Parktronic (Parking assist)* 326
- Parktronic system*
 - Switching off 159
 - Switching on 159
- Parktronic* 156
 - Cleaning system sensor 243
 - Range of the sensors 157
 - Sensor cover 243
 - Switching off 159
 - Switching on 159
 - Warning indicators 158
- Partition net* 162
 - Engaging 162
 - Removing 164
 - Tightening 163
- Parts see Parts service
- Parts service 302
- Passenger compartment 215
 - Interior lighting 114
- Passenger footwell
 - Fuse box in 299
- Passenger safety see Occupant safety
- Pedals 197
- Plastic and rubber parts
 - Cleaning 245
- Poly-V-belt drive 326
 - Layout 305
- Positions (Memory function*)
 - Recalling from memory 106
 - Storing into memory 106
- Power assistance 197
- Power seat*
 - Adjusting backrest tilt 39
 - Adjusting head restraint height 39
 - Adjusting seat cushion tilt 39
 - Adjusting seat height 39
 - Seat fore and aft adjustment 38
- Power tilt/sliding sunroof* 150
 - Closing 271
 - Opening 271
- Power train 326
- Power washer 241
- Power windows
 - Blocking of rear door window operation 74
 - Side windows 146
 - Synchronizing 148

- Practical hints
 - First aid kit 264
 - Fuses 297
 - Lamps in instrument cluster 248
 - Spare wheel 266
 - Towing the vehicle 293
 - Vehicle jack 265
 - Vehicle tool kit 264
- Premium unleaded gasoline 315
- Problems
 - While driving 53
 - With vehicle 18
- Product information 9
- R**
- Radio transmitters, control and operation 216
- Rain sensor* 132, 133
- Range of the sensors
 - Parktronic* 157
- Rapid seat heating
 - Switching off 99
- Rapid seat heating*
 - Switching on 99
- Reading lamp 29
- Reading lamps 115
- Rear automatic climate control 143
 - Adjusting air volume and air distribution manually 143
 - Automatic mode 143
- Rear bench seat
 - Foldable 100
- Rear door window
 - Blocking operation 74
- Rear fog lamp
 - Switching on 112
- Rear lamp bulbs
 - Replacing 279
- Rear passenger compartment ventilation and climate control
 - Activating 143
 - Deactivating 143
- Rear passenger compartment ventilation and rear automatic climate control 143
- Rear quarter windows* 148
 - Closing 149
 - Opening 148
- Rear seats 99
 - Easy entry/exit feature* 101
 - Enlarging cargo compartment 100
 - Folding down backrest 100
 - Folding up 101
 - Folding up backrest 100
 - Fore and aft 100
 - Lowering 101
 - Third row* 102
- Rear towing eye 295
- Rear view mirror automatic antiglare 128
- Rear view mirrors see Mirrors
- Rear window defroster 135
 - Activating 135
 - Deactivating 135
- Rear window wiper 133
 - Rain sensor* 133
- Rear window wiper/washer 52
- Reconnecting
 - Vehicle battery 289
- Refrigerant
 - Air conditioning 314
- Regular checks 221
- Reinstalling vehicle battery 289

Index

- Remote control
 - Global locking 89
 - Global unlocking 89
 - Replacing batteries 273
 - Synchronizing 273
 - Unlocking liftgate 89
 - Unlocking the driver's door,
 - fuel filler flap 89
 - Unlocking with 32
 - Remote control with folding key 88
 - Remote door unlock
 - With Tele Aid* 182
 - Remote Vehicle Diagnostics 326
 - Removing
 - Vehicle battery 289
 - Wheel 286
 - Wiper blades 283
 - Removing spare wheel 266
 - Replacing
 - Backup lamp bulbs 279
 - Brake lamp bulbs 279
 - Bulbs 274
 - Front lamp bulbs 276
 - Front turn signal bulbs 278
 - Fuses 298
 - High beam halogen bulbs 277
 - High mounted brake lamp 281
 - License plate lamp bulbs 281
 - Low beam bulbs 276
 - Rear fog lamp bulbs 279
 - Rear lamp bulbs 275, 279
 - Rear side marker lamp bulbs 279
 - Rear turn signal bulbs 279
 - Side marker bulb 278
 - Wiper blades 283
 - Replacing front fog lamp bulb 279
 - Reporting
 - Safety defects 19
 - Resetting
 - Service indicator (FSS) 238
 - Trip odometer 119
 - Residual heat utilization 142, 326
 - Residual ventilation 142
 - REST (Residual engine heat utilization) 326
 - Restraint system 326
 - Restraint system see Infant and child restraint systems
 - Returning from off-road driving 210
 - Rims 307
 - Roadside assistance 12
 - Tele Aid* 178
 - RON 220
 - RON (Research Octane Number) 326
 - Roof rack 166
 - Rotating wheels 233
 - Rubber parts
 - Cleaning 245
- ### S
- Safety
 - Occupant 58
 - Safety belts see Seat belts
 - Safety defects
 - Reporting 19
 - Safety systems
 - Driving 76

- Saving current speed 154
- Seat belt force limiter 67
- Seat belt height adjustment 46
- Seat belts 64
 - Cleaning 244
 - Fastening 43
 - Height adjustment 46
 - Proper use of 45, 66
 - Safety guidelines 62
 - Warning lamp 260
- Seat heater*
 - Switching off 99
 - Switching on 98
- Seats 95
 - Adjusting 35
 - Heater* 98
 - Manual 36
 - Rapid seat heating* 99
 - Rear 99
 - Split rear bench seat 100
- Securing cargo
 - Cargo tie-down rings 161
- Selector lever 26
 - Lock 47
 - Position 26, 120
- Self-test
 - BabySmart™ airbag deactivation system 70
 - Tele Aid* 175
- Service
 - Calling up the service indicator 238
 - Major service (Service B) 237
 - Minor service (Service A) 237
 - Overdue 238
 - Parts 302
 - Types 238
 - When due 237
- Service and Warranty Booklet
 - Loss of 303
- Service and warranty information 10
- Service indicator 237
 - Calling up 238
 - Clearing 237, 238
- Service indicator (FSS)
 - Display messages 263
- Service life (tires) 232
- Service System see FSS
- Setting
 - Cruise control 154
 - Higher speed in cruise control 155
 - Hours (clock) 119
 - Lower speed in cruise control 155
 - Minutes (clock) 119
 - Slower speed in cruise control 155
 - Speed in cruise control 155
- Setting date
 - Trip computer* 189
- Setting illumination time 110
- Setting language
 - Trip computer* 193
- Shift lock 326
- Shifting
 - Gear selector lever positions 123
 - Into optimal gear range (automatic transmission) 121
- Side impact airbags 64
- Side marker bulb
 - Replacing 278
- Side marker lamps
 - Replacing bulbs 274, 275

Index

- Side windows 146
 - Automatic closing 147
 - Automatic opening 147
 - Cleaning 243
 - Closing 147
 - Closing fully (Express-close) 147
 - Opening 147
 - Opening and closing 146
 - Opening fully (Express-open) 147
 - Rear quarter window* 148
 - Stopping 147
 - Synchronizing power windows 148
- Simultaneous wiping and washing
 - Rear window wiper/washer 52
 - Windshield wipers 51
- Single wipe 51
- Snow chains 236
- Spare fuses 298
- Spare wheel 266
 - Removing 266
- Speed
 - Saving current 154
- Speed settings
 - Cruise control 155
- Speedometer 25
- Split rear bench seat 100
- SRS 66, 326
 - Indicator lamp 262
- Standing lamps 107
- Standing water
 - Driving instructions 204
- StArt
 - Display messages 263
- Starting difficulties 48
- Starting position 33
- Starting the engine 47
- Steep terrain
 - Driving 206
- Steering column
 - Height adjustment 40
 - Length adjustment 40
- Steering lock 23, 33
 - Positions 33
- Steering wheel
 - Adjusting 40
 - Adjustment 40
 - Cleaning 244
- Stolen vehicle
 - Tracking services 183
- Stop watch 192
- Stopping
 - Windows 147
- Storage compartments 167
 - Armrest 168
 - Cup holder 170
 - Glove box 167
 - Storage compartment in front of armrest 168
 - Storage compartment under front passenger seat* 167
 - Under front passenger seat* 167
- Storing (Memory function*)
 - Positions into memory 106
- Stranded vehicle 296
- Sun visor 134
- Supplemental Restraint System (SRS) 326

- Switching off
 - Automatic climate control 139
 - ESP 81
 - Hazard warning flasher 113
 - Headlamps 55
 - Rapid seat heating 99
 - Transmission control – LOW RANGE mode 127
 - Switching on
 - Automatic climate control 139
 - ESP 82
 - Front fog lamps 112
 - Front fog lamps, rear fog lamp 112
 - Hazard warning flasher 113
 - Headlamps 50
 - Rapid seat heating* 99
 - Seat heating* 98
 - Transmission control – LOW RANGE mode 127
 - Trip computer* 189
 - Windshield wipers 51
 - Synchronizing
 - ESP 252
 - Power windows 148
 - Remote control 273
 - Tilt/sliding sunroof* 152
- T**
- Tachometer 26, 119
 - Displaying gear range 122
 - Tail lamps 279
 - Cleaning 242
 - Tar stains 241
 - Technical data 314
 - Brake fluid 314
 - Coolants 316
 - Electrical system 309
 - Engine 306
 - Engine oil 314
 - Engine oil additives 314
 - Fuel requirements 315
 - Gasoline additives 315
 - Main dimensions 310
 - Premium unleaded gasoline 315
 - Rims and tires 307
 - Weights 311
 - Windshield washer and headlamp cleaning* system 319
 - Tele Aid System* 327
- Tele Aid* 174
 - Emergency calls 176
 - Information 180
 - Initiating an emergency call manually 178
 - Remote door unlock 182
 - Roadside assistance 178
 - Stolen vehicle tracking services 183
 - System self-check 175
 - Tele Aid System* 175
 - Upgrade signals 181
 - Telematics* 327
 - Telephone* 173
 - Temperature
 - Grades of tires 321
 - Tires 233
 - Third row seats* 102
 - Folding down single seat 103
 - Installing single seat 104
 - Removing single seat 104
 - Storing single seat 103
 - Tie-down rings
 - (Cargo compartment) 161

Index

- Tightening torque 327
- Tightening torque (Wheel bolts) 287
- Tilt
 - Head restraint 38, 40
- Tilt/sliding sunroof*
 - Closing 150
 - Opening 150
 - Synchronizing 152
- Time
 - Setting hours 119
 - Setting minutes 119
- Tire inflation pressure
 - Checking 221, 232
- Tire speed rating 202, 327
- Tire traction 201
- Tires 307
 - Direction of rotation 232
 - Driving instructions 200
 - Retreads 231
 - Rims and tires 307
 - Service life 232
 - Temperature 233
 - Temperature grades 321
 - Tread depth 235
 - Wear pattern 233
 - Winter 235
- Tools 264
 - Vehicle jack 265
 - Vehicles with CD-changer* 265
 - Wheel bolt wrench 265
- Tow-away alarm 29, 84
 - Arming 84
 - Disarming 84
 - Disarming for transport 84
- Towing
 - Trailer 211
- Towing a trailer 214
 - Automatic transmission 125
- Towing eye
 - Front 295
 - Rear 295
- Towing the vehicle 293
 - Stranded vehicle 296
- Tracking services
 - For stolen vehicle 183
- Traction 320, 327
- Trailer
 - Attaching 213
 - Loading 212
 - Towing 214
- Trailer hitches 211
- Trailer towing 211
 - Attaching a trailer 213
 - Checking weights 213
 - Electrical connections 212
 - Hitches 211
 - Loading 212
 - Weights and ratings 212
- Trailer weights and ratings 212
- Transfer case 327
- Transmission control - LOW RANGE mode 127
 - Switching off 127
 - Switching on 127
- Transmission selector lever 270
 - Unlocking manually 270
- Tread depth (tires) 235
- Treadwear 320

- Trip computer* 29, 189
 - Average fuel consumption 192
 - Compass 190
 - Country 193
 - Distance remaining 192
 - Language 193
 - Selecting functions 189
 - Setting date 189
 - Stop watch 192
 - Switching on 189
- Trip odometer
 - Resetting 119
- Trip odometer display 118
- Trunk see Cargo compartment
- Turn signal lamps
 - Replacing bulbs 274, 275
- Turn signal, side marker lamp
 - Replacing bulbs 274
- Turn signals 50
 - Additional in mirrors 274
 - Cleaning lenses 242
 - Front bulbs 274
 - Indicator lamps 25
 - Rear bulbs 275, 279
- Turning off
 - Engine 55
- TWR (Tongue Weight Rating) 327
- U**
- Unlocking 32, 88
 - Centrally from inside 94
 - Driver's door in an emergency 268
 - Driver's door, fuel filler flap 89
 - Fuel filler flap 219
 - In an emergency 268
 - Transmission selector lever
 - manually 270
 - Vehicle in an emergency 182
 - With the remote control 32
- Upgrade signals
 - Tele Aid* 181
- Uphill driving
 - Cruise control 154
- Upholstery
 - Cleaning 245
- Upshifting 121
- Useful features 167
 - Ashtrays and cigarette lighter 171
 - Cup holder 169
 - Electrical outlet 173
 - Garage door opener 183
 - Storage compartments 167
 - Tele Aid* 174
 - Telephone* 173
 - Trip computer* 189
- V**
- Vehicle
 - Data recording 20
 - Locking 28
 - Locking in an emergency 269
 - Lowering 287
 - Proper use of 17
 - Service battery 272
 - Towing 293
 - Unlocking 28
 - Unlocking in an emergency 268
- Vehicle and trailer weights and ratings 212
- Vehicle battery 272

Index

- Vehicle care
 - Cup holder 244
 - Engine cleaning 242
 - Gear selector lever 244
 - Hard plastic trim items 244
 - Headlamps 242
 - Instrument cluster 244
 - Leather upholstery 245
 - Light alloy wheels 244
 - MB Tex upholstery 245
 - Ornamental moldings 242
 - Paintwork 241
 - Parktronic* system sensor 243
 - Plastic and rubber parts 245
 - Power washer 241
 - Seat belts 244
 - Steering wheel 244
 - Tail lamps 242
 - Tar stains 241
 - Turn signals 242
 - Upholstery 245
 - Vehicle washing 242
 - Window cleaning 243
 - Wiper blades 243
- Vehicle identification number (VIN) 304
- Vehicle jack 265
- Vehicle lighting
 - Checking 221
- Vehicle tool kit 264
 - Vehicle with CD-changer* 265
- Vehicle washing 242
- VIN (Vehicle Identification Number) 304, 327
- Voice control system* 327
- W**
- Warning indicators
 - Parktronic* 158
- Warning sounds
 - Drivers seat belts 64
 - Parking brake 49
- Warranty coverage 303
- Washer fluid see Windshield washer fluid
- Washing the vehicle 240
- Wear pattern (tires) 233
- Weights 311
- Wheel bolt wrench 265
- Wheel change
 - Tightening torque 287
- Wheels
 - Rotating 233
- Window curtain airbags 64
- Windows see Side windows
- Windshield
 - Defogging 140
 - Refilling washer fluid 230
 - Replacing wiper blades 283
 - Washer fluid 230, 319
 - Washer system 319
- Windshield washer fluid 319
 - Mixing ratio 319
 - Refilling 230
 - Wiping with 51
- Windshield washer system 319

- Windshield wipers 51, 131
 - Intermittent 51
 - Interval wiping 132
 - Normal wiper speed 51
 - Rain sensor* 132
 - Rear window wiper/washer 52
 - Replacing wiper blades 283
 - Simultaneous wiping and washing 52
 - Single wipe 51
 - Switching on 51
 - Wiping with windshield washer fluid 51
 - Winter driving
 - Snow chains 236
 - Tires 235
 - Winter driving instructions 202
 - Winter tires 235
 - Wiper blades
 - Cleaning 243
 - Installing 283
 - Removing 283
 - Replacing 283
 - Wiper switch 51
 - Wiper/washer
 - Rear window 52
 - Wiping
 - And washing simultaneously 51
 - Intermittent 51, 132
 - With windshield washer fluid 51
 - Wiping and washing simultaneously 52
- X**
- Xenon headlamps*
 - Bi-Xenon* 323

Service and Literature

Your authorized Mercedes-Benz Center has trained technicians and original Mercedes-Benz parts to service your vehicle properly. For expert advice and quality service, see your authorized Mercedes-Benz Light Truck Center.

If you are interested in obtaining service literature for your vehicle, please contact your authorized Mercedes-Benz Light Truck Center. We consider this the best way for you to obtain accurate information for your vehicle.

For further information you can find us on the Mercedes-Benz web-site *www.mbusa.com* or *www.mercedes-benz.ca*.

Warning!



To help avoid personal injury, be extremely careful when performing any service work or repairs. Improper or incomplete service or the use of incorrect or inappropriate parts or materials may damage the vehicle or its equipment, which may in turn result in personal injury.

If you have questions about carrying out any type of service, turn to the advice of an authorized Mercedes-Benz Light Truck Center.

We reserve the right to modify the technical details of the vehicle as given in the data and illustrations of this Operator's Manual. Reprinting, translation and copying, even of excerpts, is not permitted without our prior authorization in writing.

Title illustration no. P00.01-2273-31

Press time 02 / 16 / 04

GSP / TIP

Printed in Germany

