



Operator's Manual  
E-Class Sedan



Mercedes-Benz



2115848483

Order No. 6515 1117 13 Part No. 211 584 84 83 USA Edition B 2005

E 320  
E 320 4MATIC  
E 320 CDI  
E 500  
E 500 4MATIC  
E 55 AMG

Our company and staff congratulate you on the purchase of your new Mercedes-Benz.

Your selection of our product is a demonstration of your trust in our company name. Furthermore, it exemplifies your desire to own an automobile that will be as easy as possible to operate and provide years of service.

Your Mercedes-Benz represents the efforts of many skilled engineers and craftsmen. To help assure your driving pleasure, as well as your and your passengers' safety, we ask you to make a small investment of time:

- Please read this manual carefully, then return it to your vehicle where it will be handy for your reference.
- Please follow the recommendations contained in this manual. They are designed to assist you with the operation of your Mercedes-Benz.
- Please pay attention to the warnings and cautions contained in this manual. They are designed to help improve the safety of the vehicle operator and occupants.

We extend our best wishes for many miles of safe, pleasurable driving.

Mercedes-Benz USA, LLC  
A DaimlerChrysler Company

## Contents

<b>Introduction</b> .....	9	<b>At a glance</b> .....	21	<b>Getting started</b> .....	31
Product information .....	9	Cockpit .....	22	Unlocking .....	32
Operator's Manual .....	10	Instrument cluster .....	24	Unlocking with the SmartKey .....	32
Service and warranty information ..	10	Multifunction steering wheel .....	26	Unlocking with KEYLESS-GO* .....	33
Important notice for California		Center console .....	27	Starter switch positions .....	33
retail buyers and lessees of		Upper part .....	27	Adjusting .....	37
Mercedes-Benz automobiles .....	11	Lower part .....	28	Seats .....	37
Maintenance .....	12	Overhead control panel .....	29	Steering wheel .....	39
Roadside Assistance .....	12	Door control panel .....	30	Mirrors .....	40
Change of address or ownership....	12			Driving .....	43
Operating your vehicle outside				Fastening the seat belts .....	43
the USA or Canada .....	13			Starting the engine .....	46
Where to find it .....	14			Switching on headlamps .....	50
Symbols .....	15			Turn signals .....	51
Operating safety .....	16			Windshield wipers .....	51
Proper use of the vehicle .....	16			Problems while driving .....	53
Problems with your vehicle .....	17			Parking and locking .....	55
Reporting safety defects .....	18			Parking brake .....	55
Reporting safety defects .....	18			Switching off headlamps .....	56
Vehicle data recording .....	19			Turning off engine .....	56
Information regarding electronic					
recording devices .....	19				

## Contents

<b>Safety and Security</b> .....	59	<b>Controls in detail</b> .....	97	Memory function .....	130
Occupant safety.....	60	Locking and unlocking.....	98	Storing positions into memory .....	131
Air bags .....	61	SmartKey .....	98	Recalling positions from memory.....	131
Seat belts .....	67	SmartKey with KEYLESS-GO* .....	102	Storing exterior rear view mirror	
Children in the vehicle.....	71	Opening the doors from		parking position .....	132
Blocking of rear door window		the inside .....	109	Lighting .....	133
operation.....	83	Opening the trunk .....	110	Exterior lamp switch .....	133
Panic alarm .....	84	Closing the trunk.....	112	Combination switch .....	137
Activating .....	84	Trunk lid emergency release .....	117	Hazard warning flasher .....	138
Deactivating .....	84	Automatic central locking .....	118	Interior lighting in the front.....	139
Driving safety systems.....	85	Locking and unlocking from		Door entry lamps .....	140
ABS .....	85	the inside .....	119	Interior lighting in the rear .....	141
BAS .....	87	Seats .....	121	Trunk lamp.....	141
ESP.....	87	Easy-entry/exit feature .....	121	Instrument cluster .....	142
SBC brake system .....	90	Removing and installing front		Instrument cluster illumination ....	142
Four wheel electronic traction		seat head restraints .....	123	Coolant temperature indicator .....	143
system (4MATIC) with the ESP .....	93	Rear seat head restraints .....	124	Trip odometer .....	143
Anti-theft systems.....	94	Drive-Dynamic seat* with		Tachometer.....	144
Immobilizer.....	94	multicontour features.....	126	Outside temperature indicator .....	144
Anti-theft alarm system .....	94	Seat heating* .....	127		
Tow-away alarm .....	95	Seat ventilation* .....	128		

## Contents

Control system .....	145	Good visibility .....	186	4-zone automatic climate control* .....	204
Multifunction display .....	145	Headlamp cleaning system* .....	186	Deactivating the 4-zone	
Multifunction steering wheel.....	146	Rear view mirrors.....	186	automatic climate control system	209
Menus .....	148	Sun visors .....	188	Setting the temperature .....	210
Standard display menu .....	150	Rear window sunshade* .....	189	Adjusting air distribution .....	210
AUDIO menu .....	150	Roller sunblind* in the rear doors.	190	Adjusting air volume .....	211
NAV* menu.....	152	Rear window defroster.....	191	Defrosting.....	211
Distronic* menu.....	152	Dual-zone automatic climate control..	192	Maximum cooling MAX COOL.....	212
Vehicle status message memory		Deactivating the dual-zone		Air recirculation mode .....	212
menu.....	153	automatic climate control system.	197	Air conditioning .....	214
Settings menu.....	154	Setting the temperature.....	197	Residual heat and ventilation	
Trip computer menu.....	170	Adjusting air distribution.....	198	(available on climate control	
TEL menu* .....	171	Adjusting air volume .....	198	panel design A only) .....	215
Automatic transmission.....	174	Defrosting .....	199	Rear air conditioning.....	216
One-touch gearshifting.....	176	Air recirculation mode .....	199	Heater booster system	
Gear ranges .....	177	Air conditioning.....	201	(Diesel engine).....	217
Gear selector lever position .....	178	Residual heat and ventilation*		Power windows .....	218
Automatic shift programm .....	179	(available on climate control		Opening and closing the windows	218
Driving tips.....	180	panel design A only).....	202	Synchronizing power windows.....	220
Steering wheel gearshift control		Heater booster system		Summer opening feature .....	220
(Speedshift) E 55 AMG.....	181	(Diesel engine) .....	203	Convenience closing feature.....	221
Manual shift program E 55 AMG..	183			Power tilt /sliding sunroof* .....	223
Emergency operation				Opening and closing the power	
(Limp Home Mode) .....	185			tilt/sliding sunroof.....	223
				Synchronizing the power tilt/	
				sliding sunroof .....	225

## Contents

Panorama roof with power tilt/ sliding panel* ..... 226	Useful features ..... 262	<b>Operation</b> ..... 285
Opening and closing the roller sunblinds for the panorama roof with power tilt/sliding panel. 226	Storage compartments ..... 262	The first 1000 miles (1500 km) ..... 286
Opening and closing the panorama roof with power tilt/sliding panel. 227	Cup holders ..... 265	Driving instructions ..... 287
Synchronizing the panorama roof with power tilt/sliding panel. 229	Ashtrays ..... 268	Drive sensibly – save fuel ..... 287
Solar panel* ..... 230	Cigarette lighter ..... 269	Drinking and driving ..... 287
Driving systems ..... 231	12-V socket* ..... 269	Pedals ..... 287
Cruise control ..... 231	Heated steering wheel* ..... 270	Power assistance ..... 288
Distronic* ..... 235	Telephone* ..... 270	Brakes ..... 288
Airmatic DC (Dual Control)* ..... 247	Tele Aid* ..... 271	Driving off ..... 290
Parktronic system (Parking assist)* ..... 250	Garage door opener ..... 279	Parking ..... 290
Loading ..... 254		Tires ..... 290
Roof rack* ..... 254		Hydroplaning ..... 291
Ski sack* ..... 254		Tire traction ..... 292
Split rear bench seat* ..... 257		Tire speed rating ..... 292
Expanding the cargo area* ..... 259		Winter driving instructions ..... 294
Loading instructions ..... 260		Standing water ..... 295
Cargo tie-down rings* ..... 261		Passenger compartment ..... 295
		Driving abroad ..... 295
		Control and operation of radio transmitter ..... 295
		Catalytic converter (Gasoline engine) ..... 296
		Oxidation catalyst (Diesel engine) 297
		Emission control ..... 297
		Coolant temperature ..... 298



## Contents

At the gas station .....	299	Uniform Tire Quality Grading	
Refueling .....	299	Standards (U.S. vehicles).....	334
Check regularly and before a		Tire ply material .....	336
long trip.....	301	Tire and loading terminology.....	337
Engine compartment .....	303	Rotating tires .....	340
Hood .....	303	Winter driving .....	341
Engine oil .....	304	Winter tires .....	341
Transmission fluid level.....	308	Block heater* (Canada only).....	342
Coolant level .....	308	Snow chains.....	342
Battery .....	309	Maintenance.....	343
Windshield washer system and		Clearing the maintenance service	
headlamp cleaning system* .....	310	indicator.....	344
Tires and wheels.....	311	Maintenance service term	
Important guidelines .....	311	exceeded .....	344
Tire care and maintenance.....	312	Calling up the maintenance	
Direction of rotation.....	314	service indicator .....	345
Loading the vehicle .....	314	Resetting the maintenance	
Recommended tire inflation		service indicator .....	345
pressure.....	320	Setting the date for special	
Checking tire inflation pressure ...	322	works .....	346
Tire labeling.....	327	Calling up the maintenance	
Load identification .....	331	service data information .....	347
DOT, Tire Identification Number		Vehicle care.....	348
(TIN) .....	332	Cleaning and care of vehicle .....	348
Maximum tire load .....	333		
Maximum tire inflation pressure ..	334		
		<b>Practical hints</b> .....	355
		What to do if .....	356
		Lamps in instrument cluster .....	356
		Lamp in center console .....	365
		Vehicle status messages in the	
		multifunction display .....	367
		Where will I find ...? .....	407
		First aid kit.....	407
		Spare wheel.....	407
		Luggage box .....	408
		Vehicle tool kit.....	409
		Unlocking/locking in an emergency ..	410
		Unlocking the vehicle .....	410
		Locking the vehicle .....	411
		Fuel filler flap emergency release .	412
		Manually unlocking the	
		transmission selector lever.....	412
		Opening/closing in an emergency ....	414
		Power tilt/sliding sunroof* or	
		panorama roof with power tilt/s	
		liding panel* .....	414
		Replacing SmartKey batteries .....	415
		SmartKey .....	415
		SmartKey with KEYLESS-GO* .....	416



▼ **Product information**

Please observe the following in your own best interest:

We recommend using genuine Mercedes-Benz parts as well as conversion parts and accessories explicitly approved by us for your vehicle model.

We have tested these parts to determine their reliability, safety and special suitability for Mercedes-Benz vehicles.

We are unable to make an assessment for other products and therefore cannot be held responsible for them, even if in individual cases an official approval or authorization by governmental or other agencies should exist. Use of such parts and accessories could adversely affect the safety, performance or reliability of your vehicle. Please do not use them.

Genuine Mercedes-Benz parts as well as conversion parts and accessories approved by us are available at your authorized Mercedes-Benz Center where you will receive comprehensive information, also on permissible technical modifications, and where proper installation will be performed.

## Introduction

### Operator's Manual

This Operator's Manual contains a great deal of useful information. We urge you to read it carefully and familiarize yourself with the vehicle before driving.

For your own safety and longer service life of the vehicle, we urge you to follow the instructions and warnings contained in this manual. Ignoring them could result in damage to the vehicle or personal injury to you or others. Vehicle damage caused by failure to follow instructions is not covered by the Mercedes-Benz Limited Warranty.

Your vehicle may have some or all of the equipment described in this manual. Therefore, you may find explanations for optional equipment not installed in your vehicle. If you have any questions about the operation of any equipment, your authorized Mercedes-Benz Center will be glad to demonstrate the proper procedures.

We continuously strive to improve our product, and ask for your understanding that we reserve the right to make changes in design and equipment. Therefore, information, illustrations and descriptions in this Operator's Manual might differ from your vehicle.

Optional equipment is also described in this manual, including operating instructions wherever necessary. Since they are special-order items, the descriptions and illustrations herein may vary slightly from the actual equipment of your vehicle.

If there are any equipment details that are not shown or described in this Operator's Manual, your authorized Mercedes-Benz Center will be glad to inform you of correct care and operating procedures. The Operator's Manual and Maintenance Booklet are important documents and should be kept with the vehicle.

### Service and warranty information

The Service and Warranty Information Booklet contains detailed information about the warranties covering your Mercedes-Benz, including:

- New Car Limited Warranty
- Emission System Warranty
- Emission Performance Warranty
- California, Maine, Massachusetts, and Vermont Emission Control System Warranty (California, Maine, Massachusetts, and Vermont only)<sup>1</sup>
- State Warranty Enforcement Laws (Lemon Laws)

<sup>1</sup> Applicable to vehicles with gasoline engine only.

**Important notice for California retail buyers and lessees of Mercedes-Benz automobiles**

Under California law you may be entitled to a replacement of your vehicle or a refund of the purchase price or lease price, if Mercedes-Benz USA, LLC and /or its authorized repair or service facilities fail to fix one or more substantial defects or malfunctions in the vehicle that are covered by its express warranty after a reasonable number of repair attempts. During the period of 18 months from original delivery of the vehicle or the accumulation of 18000 miles (approximately 29000 km) on the odometer of the vehicle, whichever occurs first, a reasonable number of repair attempts is presumed for a retail buyer or lessee if one or more of the following occurs:

- (1) the same substantial defect or malfunction results in a condition that is likely to cause death or serious bodily injury if the vehicle is driven, that defect or malfunction has been subject to repair two or more times, and you have directly notified Mercedes-Benz USA, LLC in writing of the need for its repair,
- (2) the same substantial defect or malfunction of a less serious nature than category (1) has been subject to repair four or more times and you have directly notified us in writing of the need for its repair, or
- (3) the vehicle is out of service by reason of repair of the same or different substantial defects or malfunctions for a cumulative total of more than 30 calendar days.

Written notification should be sent to us, not a dealer, at Mercedes-Benz USA, LLC, Customer Assistance Center, One Mercedes Drive, Montvale, NJ 07645-0350.

## Introduction

### Operator's Manual

#### Maintenance

---

The Maintenance Booklet describes all the necessary maintenance work which should be performed at regular intervals.

Always have the Maintenance Booklet with you when you take the vehicle to your authorized Mercedes-Benz Center for service. The service advisor will record each service in the booklet for you.

#### Roadside Assistance

---

The Mercedes-Benz Roadside Assistance Program provides factory trained technical help in the event of a breakdown. Calls to the toll-free Roadside Assistance number

**1-800-FOR-MERCEdes (in the USA)**  
**1-800-387-0100 (in Canada)**

will be answered by Mercedes-Benz Customer Assistance Representatives 24 hours a day, 365 days a year.

For additional information refer to the Mercedes-Benz Roadside Assistance Program brochure in your vehicle literature portfolio.

#### Change of address or ownership

---

If you change your address, be sure to send in the "Change of Address Notice" found in the Service and Warranty Information Booklet, or simply call the Mercedes-Benz Customer Assistance Center (in the USA) at 1-800-FOR-MERCEdes, or Customer Service (in Canada) at 1-800-387-0100. It is in your own interest that we can contact you should the need arise.

If you sell your Mercedes, please leave all literature with the vehicle to make it available to the next operator.

If you bought this vehicle used, be sure to send in the "Notice of Purchase of Used Car" found in the Service and Warranty Information Booklet, or call the Mercedes-Benz Customer Assistance Center (in the USA) at 1-800-FOR-MERCEdes, or Customer Service (in Canada) at 1-800-387-0100.

**Operating your vehicle outside the USA or Canada**

---

If you plan to operate your vehicle in foreign countries, please be aware that:

- service facilities or replacement parts may not be readily available,
- unleaded gasoline for vehicles with catalytic converters may not be available; the use of leaded fuels will damage the catalyts,
- gasoline may have a considerably lower octane rating, and improper fuel can cause engine damage.

Certain Mercedes-Benz models are available for delivery in Europe under our European Delivery Program. For details, consult your authorized Mercedes-Benz Center or write to:

In the USA:

Mercedes-Benz USA, LLC  
European Delivery Department  
One Mercedes Drive  
Montvale, NJ 07645-0350

In Canada:

Mercedes-Benz Canada, Inc.  
European Delivery Department  
98 Vanderhoof Avenue  
Toronto, Ontario M4G 4C9

## Introduction

### Where to find it

This Operator's Manual is designed to provide comprehensive support information for you, the vehicle operator. For easy access, each section has its own reference color:

#### At a glance

Here you will find an overview of all the controls that can be operated from the driver's seat.

#### Getting started

Here you will find all the information you need for your first drive. You should read this section first if this is your first Mercedes-Benz vehicle or if you are renting or borrowing this vehicle.

#### Safety and Security

Here you will find descriptions of the safety features of your vehicle.

#### Controls in detail

Here you will find detailed information about the equipment installed in your vehicle. This section expands on the "Getting started" section and also describes technical innovations. If you are already familiar with the basic functions of your vehicle, this section will be of particular interest to you.

#### Operation

Here you will find all the information you need for the proper operation of your vehicle.

#### Practical hints

This section provides fast assistance for dealing with problems you may encounter.

#### Technical data

All important technical data for your vehicle can be found in this section.

#### Indexes

The glossary provides explanations of the most important technical terms.

The table of contents and the index are designed to help you find information quickly and easily.

The following publications are part of your vehicle documentation:

- this Operator's Manual
- the Maintenance Booklet

Separate operating instructions will be provided as required depending on the equipment options installed in your vehicle.



## ▼ Symbols

The following symbols are found in this Operator's Manual:

- \* Optional equipment is identified with an asterisk. Since standard equipment varies between models, the descriptions and illustrations in this manual may differ slightly from the actual equipment of your vehicle.

### Warning!



Warning notices draw your attention to hazards that may endanger your health or life, or the health or life of others.



Highlights hazards that may result in damage to your vehicle.



Helpful hints or further information you may find useful.

- ▶ This symbol points to instructions for you to follow.
- ▶ A number of these symbols appearing in succession indicates a multiple-step procedure.
  - ▷ Page This symbol tells you where to look for further information on a topic.
  - ▷▷ This continuation symbol marks an interrupted procedure which will be continued on the next page.
  - > In the glossary of technical terms, this symbol is used to indicate cross-references to term definitions.
  - DISPLAY Words appearing in the multi-function display are printed in the type shown here.

## Introduction

### Operating safety

#### Warning!



Work improperly carried out on electronic components and associated software could cause them to cease functioning. Because the vehicle's electronic components are interconnected, any modifications made may produce an undesired effect on other systems. Electronic malfunctions could seriously impair the operating safety of your vehicle.

See your authorized Mercedes-Benz Center for repairs or modifications to electronic components.

Other improper work or modifications on the vehicle could also have a negative impact on the operating safety of the vehicle.

Some safety systems only function while the engine is running. You should therefore never turn off the engine while driving.

#### Warning!



Heavy blows against the vehicle underbody or tires / wheels, for example when running over an obstacle, road debris or a pothole, may cause serious damage to and impair the operating safety of your vehicle. If you feel a sudden strong vibration or ride disturbance, or you suspect that damage to your vehicle has occurred, you should turn on your hazard warning flashers, carefully slow down, and drive with caution to an area which is a safe distance from the road.

Inspect the vehicle underbody and tires / wheels for possible damage. If the vehicle appears unsafe, have it towed to the nearest authorized Mercedes-Benz Center or other qualified maintenance or repair facility for further inspection or repairs.

#### Proper use of the vehicle

Proper use of the vehicle requires that you are familiar with the following information and rules:

- the safety precautions in this manual
- the “Technical data” section in this manual
- traffic rules and regulations
- motor vehicle laws and safety standards

#### Warning!



Various warning labels are attached to your vehicle. These warning labels are intended to make you and others aware of various risks. You should not remove any of these warning labels unless explicitly instructed to do so by information on the label itself. Removal of any of these labels may cause you and others to be unaware of certain risks which may result in an accident and/or personal injury.

▼ **Problems with your vehicle**

If you should experience a problem with your vehicle, particularly one that you believe may affect its safe operation, we urge you to immediately contact an authorized Mercedes-Benz Center to have the problem diagnosed and corrected if required. If the matter is not handled to your satisfaction, please discuss the problem with the Mercedes-Benz Center management, or if necessary contact us at one of the following addresses:

In the USA:

Customer Assistance Center  
Mercedes-Benz USA, LLC  
One Mercedes Drive  
Montvale, NJ 07645-0350

In Canada:

Customer Relations Department  
Mercedes-Benz Canada, Inc.  
98 Vanderhoof Avenue  
Toronto, Ontario M4G 4C9

## Introduction

### Reporting safety defects

For the USA only:

The following text is published as required of manufacturers under Title 49, Code of U.S. Federal Regulations, Part 575 pursuant to the “National Traffic and Motor Vehicle Safety Act of 1966.”

#### **Reporting safety defects**

---

If you believe that your vehicle has a defect which could cause a crash or could cause injury or death, you should immediately inform the National Highway Traffic Safety Administration (NHTSA) in addition to notifying Mercedes-Benz USA, LLC.

If NHTSA receives similar complaints, it may open an investigation, and if it finds that a safety defect exists in a group of vehicles, it may order a recall and remedy campaign. However, NHTSA cannot become involved in individual problems between you, your dealer, or Mercedes-Benz USA, LLC.

To contact NHTSA, you may either call the Auto Safety Hotline toll-free at 1-888-327-4236 (or 366-0123 in Washington, D.C. area) or write to: NHTSA, U.S. Department of Transportation, Washington, D.C. 20590. You can also obtain other information about motor vehicle safety from the Hotline.

**▼ Vehicle data recording****Information regarding electronic recording devices**

---

(Including notice pursuant to California Code § 9951)

Please note that your vehicle is equipped with devices that can record vehicle systems data and, if equipped with the Tele Aid system, may transmit some data in certain accidents.

This information helps, for example, to diagnose vehicle systems after a collision and to continuously improve vehicle safety. DaimlerChrysler may access the information and share it with others

- for safety research or vehicle diagnosis purposes
- with the consent of the vehicle owner or lessee
- in response to an official request by law enforcement or other government agency
- for use in dispute resolution involving DaimlerChrysler, its affiliates or sales/service organization and/or
- as otherwise required or permitted by law.

Please check the Tele Aid subscription service agreement for details regarding the information that may be recorded or transmitted via that system.



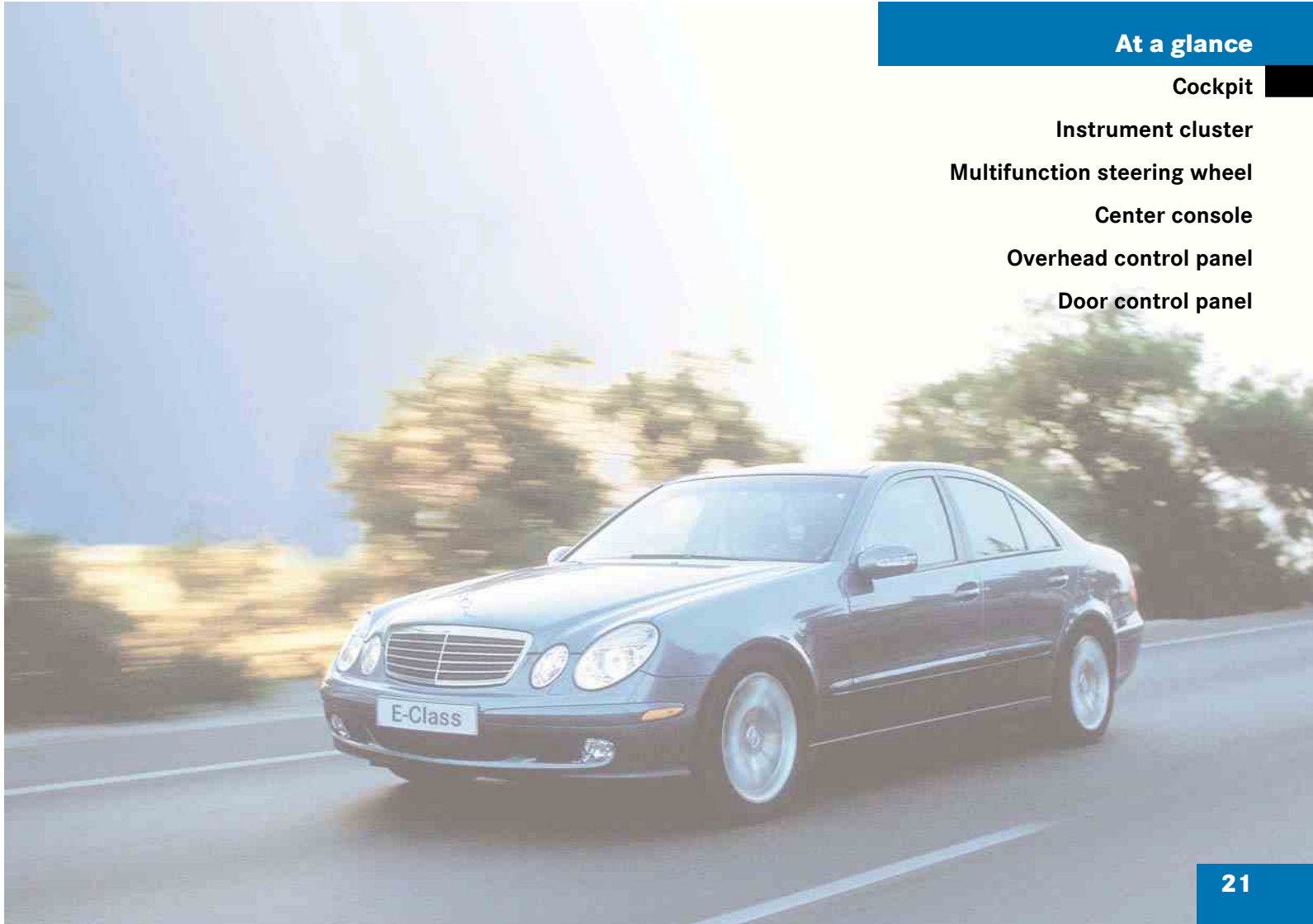

## **At a glance**

**Cockpit**

**Instrument cluster**

**Multifunction steering wheel**

**Center console**

**Overhead control panel**

**Door control panel**

## At a glance

### Cockpit





## At a glance

### Cockpit

Item	Page
① Parking brake pedal	48, 55
② Hood lock release	303
③ Steering wheel adjustment stalk	40
Heated steering wheel*	270
④ Parking brake release	48
⑤ Combination switch	
• Turn signals	51
• Windshield wipers	51
• High beam	50
⑥ Door control panel	30
⑦ Exterior lamp switch	133

Item	Page
⑧ Headlamp washer button*	186
⑨ Steering wheel gearshift control (E55 AMG only)	181
⑩ Cruise control lever	
• Cruise control	239
• Distronic*	235
⑪ Instrument cluster	24, 142
⑫ Multifunction steering wheel	26, 146
⑬ Horn	
⑭ Lever for voice control system*, see separate operating instructions	

Item	Page
⑮ Starter switch	34
⑯ Front Parktronic* warning indicator	250
⑰ Overhead control panel	29
⑱ Mobile phone/Glasses box	262
⑲ Glove box lid release, glove box lock	262
⑳ Glove box	262
㉑ Center console	27

## At a glance





### Instrument cluster















P54.30-7786-31

## At a glance

### Instrument cluster

Item	Page
①  Left turn signal indicator lamp	
②  ABS/ ESP warning lamp	357
③ <b>Speedometer</b>	
④ <b>Multifunction display</b>	145
⑤  Distance warning lamp	361
Vehicles without DISTRONIC*: Warning lamp without function. It illuminates with the ignition on. It should go out when the engine is running.	
⑥  Right turn signal indicator lamp	
⑦ <b>Coolant temperature indicator with:</b>	
 Coolant temperature warning lamp	361





Item	Page
⑧ <b>Tachometer with:</b>	
 Supplemental Restraint System indicator lamp	364
 Antilock Brake System (ABS) indicator lamp	356
 Seat belt telltale	362
 Low beam headlamp indicator lamp	50
 High beam headlamp indicator lamp	137
⑨ <b>Main odometer with:</b>	
• Selector lever position	46
• Program mode	179
⑩ <b>Clock with:</b>	159
 Brake warning lamp, USA only	358
 Brake warning lamp, Canada only	358



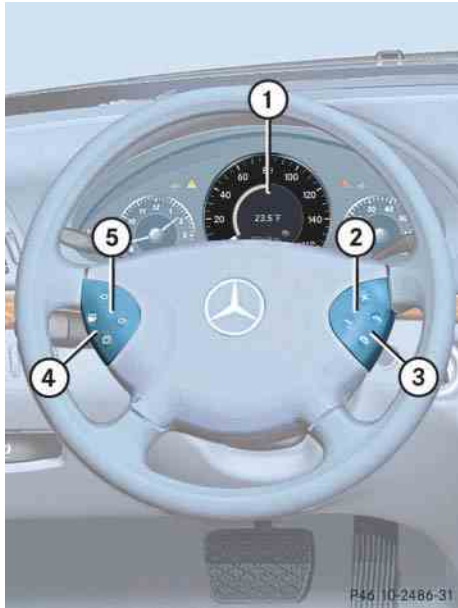

Item	Page
 Engine malfunction indicator lamp, USA only	359
 Engine malfunction indicator lamp, Canada only	359
 Tire inflation pressure warning lamp*	363
 Preglow indicator lamp, Diesel engine only	47
⑪ <b>Fuel display with:</b>	
 Fuel reserve warning lamp	362
⑫ <b>Reset button for:</b>	
• Resetting trip odometer	143
• Adjusting instrument cluster illumination	142
• Confirming new time settings	159

## At a glance

### Multifunction steering wheel



Item	Page
① Multifunction display in speedometer	145
<b>Operating control system</b>	146
② Selecting the submenu or setting the volume: Press button	
 up/to increase  down/to decrease	
③ Telephone*: Press button	
 to take a call to dial a call  to end a call to reject an incoming call	

Item	Page
④ Menu systems: Press button	
 for next menu  for previous menu	
⑤ Moving within a menu: Press button	
 for next display  for previous display	

## At a glance

### Center console

#### ▼ Center console

##### Upper part



Item	Page
① Dual-zone automatic climate control	192
4-zone automatic climate control*	204
② COMAND system, see separate operating instructions	
③ Seat heating*, front passenger side	127
Seat ventilation*, front passenger side	128
④ Electronic Stability Program (ESP) control switch	89
⑤ Central locking switch	119

Item	Page
⑥ Opening/closing button for storage tray or CD changer*, see separate operating instructions	263
⑦ Rear seat head restraints switch, folding down	124
⑧ Rear window sunshade switch*	89
⑨ Seat heating*, driver's side	127
Seat ventilation*, driver's side	128
⑩ Hazard warning flasher switch	138
⑪ Front passenger front air bag off indicator lamp	78

## At a glance

### Center console

#### Lower part

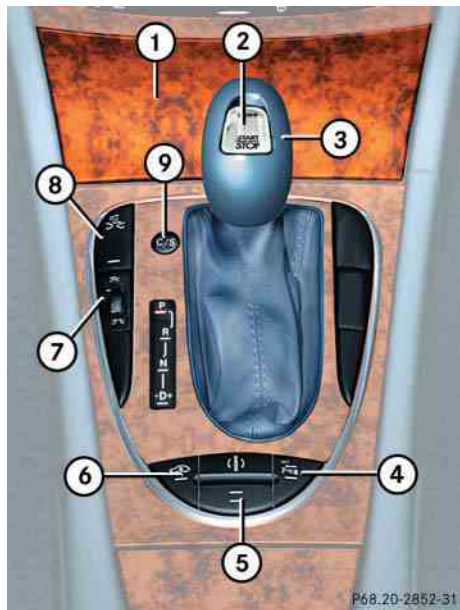

Item	Page
① Ashtray	268
② KEYLESS-GO* start/stop button	35
③ Selector lever for automatic transmission	46, 178
④ Parking assist (Parktronic system)* deactivation switch	250
⑤ Adaptive damping system (ADS)* switch	247

Item	Page
⑥ Vehicle level control switch*	248
⑦ Thumbwheel for setting distance in DISTRONIC*	242
⑧ Distance warning function* on/off switch	243
⑨ Program mode selector switch for automatic transmission	179

## At a glance

### Overhead control panel

#### ▼ Overhead control panel

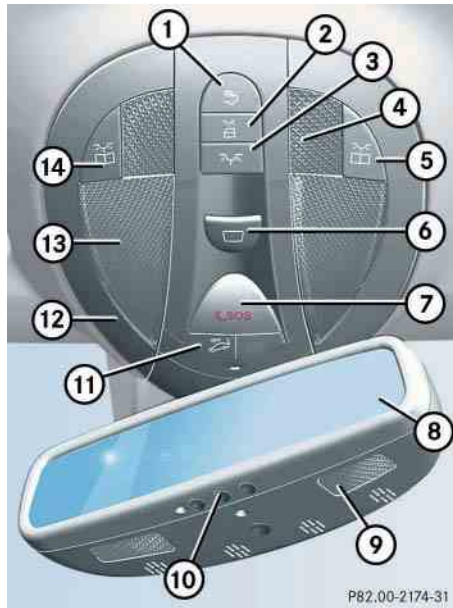

Item	Page
① Rear interior lighting on/off	139
② Automatic interior lighting	139
③ Front interior lighting on/off	139
④ Temperature sensor	
⑤ Right reading lamp on/off	139
⑥ Tilt/sliding sunroof* or tilt/sliding panel*	223, 226

Item	Page
⑦ Tele Aid (emergency call system) button	271
⑧ Rear view mirror	186
⑨ Reading lamps	139
⑩ Garage door opener	279
⑪ Tow-away alarm button	95
⑫ Ambient lighting	165
⑬ Interior lighting	
⑭ Left reading lamp on/off	139

## At a glance

### Door control panel

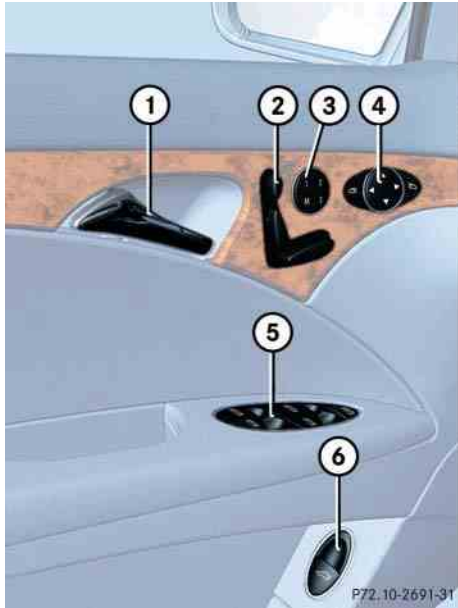

	Item	Page
①	Door handle	109
②	Seat adjustment	38
③	Memory function (for storing seat, exterior mirror and steering wheel settings)	130
④	Exterior rear view mirror adjustment	41
⑤	Switches for opening/closing front and rear side windows, rear window override switch	218
⑥	Remote trunk lid release switch, Trunk lid opening/closing system*	111



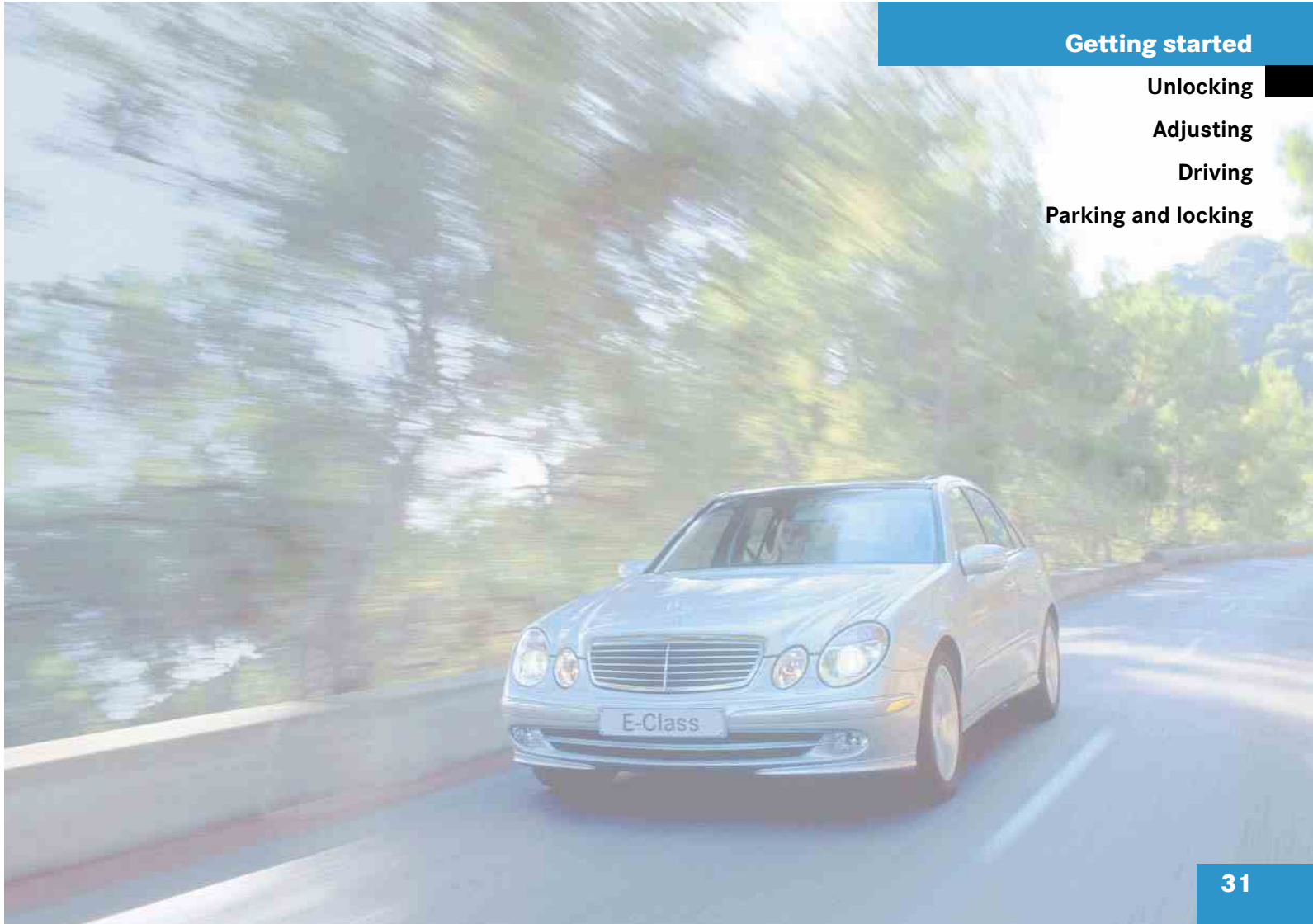

**Getting started**

**Unlocking**

**Adjusting**

**Driving**

**Parking and locking**

## Getting started

### Unlocking





The “Getting started” section provides an overview of the vehicle’s most basic functions.

If you are already familiar with the basic functions described here, the “Controls in detail” section will provide you with further information. The corresponding page references are located at the end of each segment.

#### Unlocking with the SmartKey



#### SmartKey with remote control

- ①  Lock button
- ②  Unlock button for trunk lid
- ③  Unlock button
- ④  Panic button (▷ page 84)

#### Warning!



When leaving the vehicle, always remove the SmartKey from the starter switch, take it with you, and lock the vehicle. Do not leave children unattended in the vehicle, or with access to an unlocked vehicle. Unsupervised use of vehicle equipment may cause an accident and/or serious personal injury.

- ▶ Press unlock button  on the SmartKey.

All turn signal lamps flash once. The vehicle unlocks. The locking knobs in the doors move up. The anti-theft alarm system is disarmed.



The SBC brake system is activated (▷ page 90).

- ▶ Get in the vehicle and insert the SmartKey in the starter switch.

For more information, see “Locking and unlocking” (▷ page 98).

#### Unlocking with KEYLESS-GO\*

With KEYLESS-GO you can open and start your vehicle without using the buttons on the SmartKey.



To unlock the vehicle, the SmartKey with KEYLESS-GO must be outside the vehicle, no further than approximately 3 feet (1 meter) away from the door.

#### Warning!



When leaving the vehicle, always take the SmartKey with KEYLESS-GO with you, and lock the vehicle. Do not leave children unattended in the vehicle, or with access to an unlocked vehicle. Unsupervised use of vehicle equipment may cause an accident and/or serious personal injury.

- ▶ Pull the outside door handle.

All turn signal lamps flash once. The vehicle unlocks. The locking knobs on the doors move up. The anti-theft alarm system is disarmed.



The SBC brake system is activated (▷ page 90).

- ▶ Get in the vehicle.

For more information, see “SmartKey with KEYLESS-GO\*” (▷ page 102).

#### Starter switch positions

#### Warning!



When leaving the vehicle, always remove the SmartKey or the SmartKey with KEYLESS-GO\* from the starter switch, take it with you, and lock the vehicle. Do not leave children unattended in the vehicle, or with access to an unlocked vehicle. Unsupervised use of vehicle equipment may cause an accident and/or serious personal injury.

## Getting started

### Unlocking

#### SmartKey



#### Starter switch

- 0 For removing SmartKey
- 1 Power supply to some electrical consumers, such as seat adjustment
- 2 Ignition (power supply for all electrical consumers) and driving position. All lamps (except low beam headlamp indicator lamp, high beam headlamp indicator lamp, and turn signal indicator lamps unless activated) in the instrument cluster come on. If a lamp in the instrument cluster fails to come on when the ignition is switched on, have it checked and replaced if necessary. If a lamp in the instrument cluster re-

mains on after starting the engine or comes on while driving, refer to “Lamps in instrument cluster” (▷ page 356).

#### 3 Starting position



When you switch on the ignition, the indicator and warning lamps (except low beam headlamp indicator lamp, high beam headlamp indicator lamp, and turn signal indicator lamps unless activated) in the instrument cluster come on. This indicates that the respective systems are operational. The indicator and warning lamps (except low beam headlamp indicator lamp, high beam headlamp indicator lamp, and turn signal indicator lamps if activated) should go out when the engine is running.



The SmartKey can only be removed from the starter switch with the gear selector lever in position **P**.



If the SmartKey can still not be turned, the battery may not be sufficiently charged.

- Check the battery and charge it if necessary (▷ page 435).
- Get a jump start (▷ page 436).

To prevent accelerated battery discharge or a completely discharged battery, always remove the SmartKey from the starter switch when the engine is not in operation.

For information on starting the engine using the SmartKey, see “Starting with the SmartKey” (▷ page 46).

#### SmartKey with KEYLESS-GO\*

Pressing the KEYLESS-GO start/stop button on the gear selector lever corresponds to turning the SmartKey to the various starter switch positions.

If you firmly depress the brake pedal during pressing KEYLESS-GO start/stop button, the engine starts automatically.



The function of the SmartKey overrides the KEYLESS-GO function.



#### KEYLESS-GO start/stop button

- ① USA only
- ② Canada only

The SmartKey with KEYLESS-GO must be located in the vehicle.

- ▶ Make sure the gear selector lever is set to **P**.
- ▶ Do not depress the brake pedal.

#### Position 0

Before you press the KEYLESS-GO start/stop button, the vehicle's on-board electronics have status **0** (as with SmartKey removed).

#### Position 1

- ▶ Press KEYLESS-GO start/stop button once.

This supplies power to some electrical consumers, such as seat adjustment.



If you now press the KEYLESS-GO start/stop button

- once again, the ignition (position **2**) is switched on.
- twice, the power supply is again switched off.

## Getting started

### Unlocking

#### *Ignition (or position 2)*

- ▶ Press KEYLESS-GO start/stop button twice.

This supplies power to all electrical consumers. All lamps (except low beam headlamp indicator lamp, high beam headlamp indicator lamp, and turn signal indicator lamps unless activated) in the instrument cluster come on. If a lamp in the instrument cluster fails to come on when the ignition is switched on, have it checked and replaced if necessary. If a lamp in the instrument cluster remains on after starting the engine or comes on while driving, see “Lamps in instrument cluster” (▷ page 356).



If you now press the KEYLESS-GO start/stop button once, the power supply is again switched off.



When you switch on the ignition, the indicator and warning lamps (except low beam headlamp indicator lamp, high beam headlamp indicator lamp, and turn signal indicator lamps unless activated) in the instrument cluster come on. This indicates that the respective systems are operational. The indicator and warning lamps (except low beam headlamp indicator lamp, high beam headlamp indicator lamp, and turn signal indicator lamps if activated) should go out when the engine is running.

For information on starting the engine using the KEYLESS-GO start/stop button, see “Starting with KEYLESS-GO\*” (▷ page 47).

## ▼ Adjusting

### Warning!



All seat, head restraint, steering wheel, and rear view mirror adjustments, as well as fastening of seat belts, must be done before the vehicle is put into motion.

## Seats

### Warning!



Do not adjust the driver's seat while driving. Adjusting the seat while driving could cause the driver to lose control of the vehicle.

Never ride in a moving vehicle with the seat backrest in an excessively reclined position as this can be dangerous. You could slide under the seat belt in a collision. If you slide under it, the belt would apply force at the abdomen or neck. That could cause serious or fatal injuries. The seat back and seat belts provide the best restraint when the wearer is in a nearly upright position and belts are properly positioned on the body.

Your seat must be adjusted so that you can correctly fasten your seat belt (▷ page 43).

Never place hands under the seat or near any moving parts while a seat is being adjusted.

### Warning!



When leaving the vehicle, always remove the SmartKey or the SmartKey with KEYLESS-GO\* from the starter switch, take it with you, and lock the vehicle.

Even with the SmartKey or the SmartKey with KEYLESS-GO\* removed from the starter switch or the SmartKey with KEYLESS-GO\* removed from the vehicle, the power seats can be operated when the respective door is open. Therefore, do not leave children unattended in the vehicle, or with access to an unlocked vehicle. Unsupervised use of vehicle equipment may cause an accident and / or serious personal injury.

## Getting started

### Adjusting

### Warning!



According to accident statistics, children are safer when properly restrained in the rear seating positions than in the front seating position. Thus, we strongly recommend that children be placed in the rear seats. Regardless of seating position, children 12 years old and under must be seated and properly secured in an appropriate infant or toddler restraint, or booster seat recommended for the size and weight of the child. For additional information, see "Children in the vehicle" (▷ page 71).

A child's risk of serious or fatal injuries is significantly increased if the child restraints are not properly secured in the vehicle and the child is not properly secured in the child restraint.

## Getting started

### Adjusting

#### Seat adjustment

The seat adjustment switches are located on the front doors.

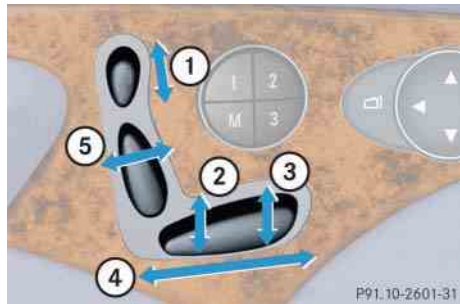

- ① Head restraint height
- ② Seat height
- ③ Seat cushion tilt
- ④ Seat fore and aft adjustment
- ⑤ Backrest tilt

- ▶ Switch on the ignition (▷ page 33).  
or
- ▶ Open the respective door.

#### Seat fore and aft adjustment

- ▶ Press the switch forward or backward in the direction of arrow ④.

Adjust a comfortable seating position that still allows you to reach the accelerator/brake pedal safely. The position should be as far to the rear as possible, consistent with ability to properly operate controls.



When moving the seat, be sure there are no items in the footwell or behind the seats. Otherwise you could damage the seats.

The memory function (▷ page 130) lets you store the setting for the seat position together with the setting for the steering wheel and the exterior rear view mirrors.

#### Seat cushion tilt

- ▶ Press the switch up or down in the direction of arrow ③ until your upper legs are lightly supported.

#### Backrest tilt

- ▶ Press the switch forward or backward in the direction of arrow ⑤ until your arms are slightly angled when holding the steering wheel.

#### Seat height

- ▶ Press the switch up or down in the direction of arrow ②.



### Head restraint height

- ▶ Press the switch up or down in the direction of arrow ⑤.



Adjust the head restraint in such a way that it is as close to the head as possible.

#### Warning!



For your protection, drive only with properly positioned head restraints.

Adjust head restraint so that the center of the head restraint supports the back of the head at eye level. This will reduce the potential for injury to the head and neck in the event of an accident or similar situation.

Do not drive the vehicle without the seat head restraints. Head restraints are intended to help reduce injuries during an accident.

### Head restraint tilt

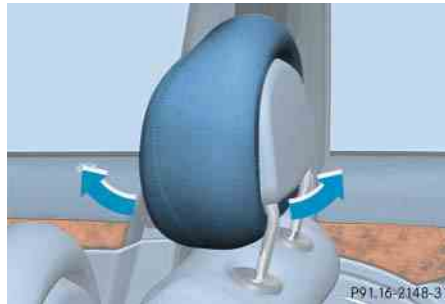

Manually adjust the angle of the head restraint.

- ▶ Push or pull on the lower edge of the head restraint cushion.



Adjust the head restraint in such a way that it is as close to the head as possible.

For more information on seats, see the “Controls in detail” section (▶ page 121).

### Steering wheel

#### Warning!



Do not adjust the steering wheel while driving. Adjusting the steering wheel while driving could cause the driver to lose control of the vehicle.

When leaving the vehicle, always remove the SmartKey or the SmartKey with KEYLESS-GO\* from the starter switch, take it with you, and lock your vehicle.

Even with the SmartKey removed from the starter switch or the SmartKey with KEYLESS-GO\* removed from the vehicle, the steering wheel adjustment feature can be operated when the driver’s door is open. Therefore, do not leave children unattended in the vehicle, or with access to an unlocked vehicle. Unsupervised use of vehicle equipment may cause an accident and/or serious personal injury.

## Getting started

### Adjusting

#### Steering wheel adjustment

The stalk for steering wheel adjustment is located on the steering column (lower left).



- ① Adjusting steering column, in or out
- ② Adjusting steering column, up or down

- ▶ Switch on the ignition (▷ page 33).  
or
- ▶ Open the driver's door.

#### Adjusting steering column in or out

- ▶ Move stalk forward or back in the direction of arrow ① until a comfortable steering wheel position is reached with your arms slightly bent at the elbow.

#### Adjusting steering column up or down

- ▶ Move stalk up or down in the direction of arrow ②.

Make sure your legs can move freely and that all the displays (incl. malfunction and indicator lamps) on the instrument cluster are clearly visible.



The memory function (▷ page 130) lets you store the setting for the seat position together with the setting for the steering wheel and the exterior rear view mirrors.

For more information, see “Heated steering wheel\*” (▷ page 270).

#### Mirrors

Adjust the interior and exterior rear view mirrors before driving so that you have a good view of the road and traffic conditions.

#### Warning!



In the case of an accident liquid electrolyte may escape the mirror housing if the mirror glass breaks.

Electrolyte has an irritating effect. Do not allow the liquid to come into contact with eyes, skin, clothing, or respiratory system. In case it does, immediately flush affected area with water, and seek medical help if necessary.



Electrolyte drops coming into contact with the vehicle paint finish can only be completely removed while in their liquid state and by applying plenty of water.

**Interior rear view mirror**

- ▶ Manually adjust the interior rear view mirror.

For more information, see “Rear view mirrors” (▷ page 186).

**Exterior rear view mirrors****Warning!**

Exercise care when using the passenger-side exterior rear view mirror. The mirror surface is convex (outwardly curved surface for a wider field of view). Objects in mirror are closer than they appear. Check your interior rear view mirror or glance over your shoulder before changing lanes.

The buttons are located on the driver's door.

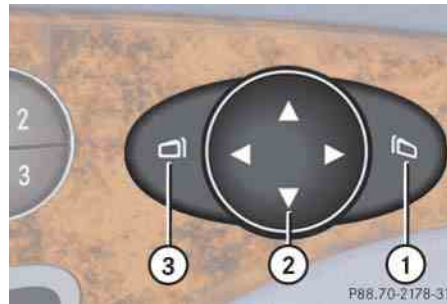

- ① Passenger-side exterior rear view mirror button
- ② Adjustment button
- ③ Driver's side exterior rear view mirror button

- ▶ Switch on the ignition (▷ page 33).
- ▶ Press button ③ for the driver's side exterior rear view mirror or button ① for the passenger-side exterior rear view mirror.
- ▶ Push adjustment button ② up, down, left or right according to the desired setting.

## Getting started

### Adjusting



If an exterior rear view mirror was forcibly pushed forward (hit from the rear) or forcibly pushed rearward (hit from the front), reposition it by applying firm pressure until it snaps into place. The mirror housing is now properly positioned and you can adjust the mirror normally.



The memory function (▷ page 130) lets you store the setting for the seat position together with the setting for the steering wheel and the exterior rear view mirrors.

At low ambient temperatures, the mirrors will be heated automatically.

For more information, see “Activating exterior rear view mirror parking position” (▷ page 187).



At low ambient temperatures, the exterior rear view mirrors will be heated automatically.

For more information, see “Rear view mirrors” (▷ page 186).

#### ▼ Driving

##### Warning!



Do not lay any objects in the driver's footwell. Be careful that floor mats or carpets in the driver's footwell have sufficient clearance for the pedals.

During sudden driving or braking maneuvers the objects could get caught between the pedals. You could then no longer brake or accelerate.

#### Fastening the seat belts

##### Warning!



Always fasten your seat belt before driving off. Always make sure all of your passengers are properly restrained, even those sitting in the rear and pregnant women.

Failure to wear and properly fasten and position your seat belt greatly increases your risk of injuries and their likely severity in an accident. You and your passengers should always wear seat belts.

If you are ever in an accident, your injuries can be considerably more severe without your seat belt properly buckled. Without your seat belt buckled, you are much more likely to hit the interior of the vehicle or be ejected from it. You can be seriously injured or killed.

In the same crash, the possibility of injury or death is lessened if you are wearing your seat belt. The air bags can only provide the protection they were designed to afford if the occupants are using their seat belts (> page 67).

##### Warning!



According to accident statistics, children are safer when properly restrained in the rear seating positions than in the front seating position. Thus, we strongly recommend that children be placed in the rear seats. Regardless of seating position, children 12 years old and under must be seated and properly secured in an appropriate infant or toddler restraint, or booster seat recommended for the size and weight of the child. For additional information, see "Children in the vehicle" (> page 71).

A child's risk of serious or fatal injuries is significantly increased if the child restraints are not properly secured in the vehicle and the child is not properly secured in the child restraint.

## Getting started

### Driving

#### Warning!



Never let more people ride in the vehicle than there are seat belts available. Be sure everyone riding in the vehicle is correctly restrained with a separate seat belt. Never use a seat belt for more than one person at a time.

#### Warning!



Never ride in a moving vehicle with the seat backrest in an excessively reclined position as this can be dangerous. You could slide under the seat belt in a collision. If you slide under it, the belt would apply force at the abdomen or neck. That could cause serious or even fatal injuries. The seat backrest and seat belt provide the best restraint when the wearer is in a nearly upright position and the belt is properly positioned on the body.

#### Warning!



Read and observe the additional warning notices printed in the “Safety and security” section (▷ page 67).



- ① Retractor
- ② Latch plate
- ③ Buckle
- ④ Release button

- ▶ Place the shoulder portion of the belt across the top of your shoulder and the lap portion across your hips.
- ▶ Push latch plate ② into buckle ③ until it clicks.
- ▶ If necessary, tighten the lap portion to a snug fit by pulling shoulder portion up.

#### Belt outlet height adjustment

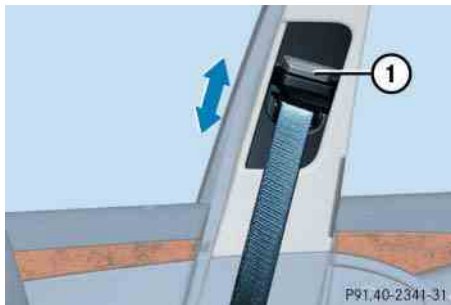

- ① Release button
- ▶ Press release button ① and move the seat belt height adjuster upward or downward.

#### Proper use of seat belts

- Do not twist the belt when fastening.
- Adjust seat belt so that the shoulder portion is located as close as possible to the middle of the shoulder (it should not touch the neck). Never pass the shoulder portion of the belt under your arm.
- Position the lap belt as low as possible on your hips (over hip joint) and not across the abdomen.
- Place the seat backrest in a nearly upright position.
- Never use a seat belt for more than one person at a time.
- Do not fasten a seat belt around a person and another object at the same time. When using a seat belt to secure infant or toddler restraints or children in booster seats, always follow the child seat manufacturer's instructions.

## Getting started

### Driving

- Check your seat belt periodically during travel to make sure that it is properly positioned.
- Make sure that the seat belt is always fitted snugly. Take special care of this when wearing loose clothing.

#### Warning!



Do not pass belts over sharp edges. They could tear.

Do not allow the belt to get caught in the door or in the seat adjustment mechanism. This could damage the belt.

Never attempt to make modifications to seat belts. This could impair the effectiveness of the belts.

Do not bleach or dye seat belts as this may severely weaken them. In a crash they may not be able to provide adequate protection.

Damaged seat belts or belts that were highly stressed in an accident must be replaced. Contact an authorized Mercedes-Benz Center.

## Getting started

### Driving

#### Starting the engine

##### Warning!



Inhalation of exhaust gas is hazardous to your health. All exhaust gas contains carbon monoxide, and inhaling it can cause unconsciousness and lead to death.

Do not run the engine in confined areas (such as a garage) which are not properly ventilated. If you think that exhaust gas fumes are entering the vehicle while driving, have the cause determined and corrected immediately. If you must drive under these conditions, drive only with at least one window fully open.

#### Automatic transmission

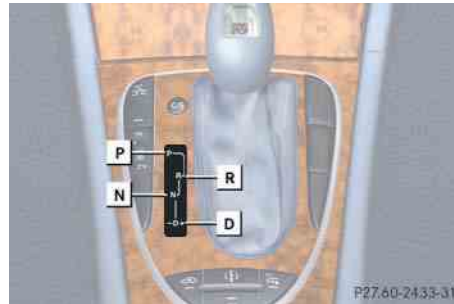

##### Gearshift pattern for automatic transmission

- P** Park position with gear selector lever lock
- R** Reverse gear
- N** Neutral
- D** Drive position

For more information, see the “Controls in detail” section (▷ page 177).

#### Starting with the SmartKey

For information on turning off the engine with the SmartKey, see “Turning off engine” (▷ page 56).

##### Gasoline engine:

- ▶ Make sure the gear selector lever is set to **P**.
- ▶ Do not depress the accelerator.
- ▶ Turn the SmartKey in the starter switch to position **3** and hold until the engine starts (▷ page 34).



You can also use the “touch-start” function. Turn the SmartKey to position **3** and release it again immediately. The engine then starts automatically.

- ▶ Depress the brake pedal.  
The selector lever lock is released.



**Diesel engine:**

- ▶ Make sure the gear selector lever is set to **P**.
- ▶ Do not depress the accelerator.
- ▶ Turn the SmartKey in the starter switch to position **2** (▷ page 34).

The preglow indicator lamp  in the instrument cluster comes on.

- ▶ As soon as the preglow indicator lamp  goes out, turn the SmartKey in the starter switch to position **3** (▷ page 34) and release it.

The engine starts automatically.



If the engine is at operating temperature, the preglow indicator lamp  may not stay on and you can start the engine without preglowing.

- ▶ Depress the brake pedal.  
The selector lever lock is released.

**Starting with KEYLESS-GO\***

You can start your vehicle without the SmartKey in the starter switch using the KEYLESS-GO start/stop button on the gear selector lever.

For information on turning off the engine with KEYLESS-GO, see “Turning off with KEYLESS-GO\*” (▷ page 57).

The SmartKey with KEYLESS-GO must be located in the vehicle.

**KEYLESS-GO start/stop button**

- ① USA only
- ② Canada only

**Gasoline engine:**

- ▶ Make sure the gear selector lever is set to **P**.
- ▶ Depress the brake pedal during the starting procedure. Do not depress accelerator.

The selector lever lock is released.

- ▶ Press KEYLESS-GO start/stop button ① once.

The engine starts automatically if the SmartKey with KEYLESS-GO is in the vehicle.

**Diesel engine:**

- ▶ Make sure the gear selector lever is set to **P**.
- ▶ Depress the brake pedal during the starting procedure. Do not depress accelerator.

The selector lever lock is released.

- ▶ Press KEYLESS-GO start/stop button ① once.

▷▷

## Getting started

### Driving

- ▷▷ The engine begins to preglow and will start automatically.

If the engine is at operating temperature, the preglow indicator lamp  may not stay on and you can start the engine without preglowing:

- ▶ Press KEYLESS-GO start/stop button ① until the engine is running.

### Starting difficulties

If the engine does not start as described, carry out the following steps:

- ▶ If you are starting the engine with the SmartKey, turn SmartKey in starter switch to position **0** and repeat starting procedure.
- ▶ If you are starting the engine with KEYLESS-GO: Close any doors that may be open to allow for better detection of the SmartKey with KEYLESS-GO.  
Or:  
Start the engine with the SmartKey as radio signals from another source may be interfering with the SmartKey with KEYLESS-GO.
- ▶ Repeat the starting procedure (▷ page 46). Remember that extended starting attempts can drain the battery.
- ▶ Get a jump start (▷ page 436).

If the engine does not start after several starting attempts, there could be a malfunction in the engine electronics or in the fuel supply system.

- ▶ Notify an authorized Mercedes-Benz Center.

### Parking brake



- ① Parking brake pedal
- ② Parking brake release handle

**Warning!**

When leaving the vehicle, always remove the SmartKey or the SmartKey with KEYLESS-GO\* from the starter switch, take it with you and lock the vehicle. Do not leave children unattended in the vehicle, or with access to an unlocked vehicle. Children could release the parking brake, which could result in an accident and/or serious injury.

- ▶ Release the parking brake by pulling on handle ②.

The warning lamp **BRAKE** (USA only) or **(P)** (Canada only) in the instrument cluster goes out.

**Driving**

- ▶ Depress the brake pedal.
- ▶ Move selector lever to position **D** or **R**.



Wait for the gear selection process to complete before setting the vehicle in motion.

- ▶ Release the brake pedal.
- ▶ Carefully depress the accelerator pedal.

Once the vehicle is in motion, the automatic central locking system engages and the locking knobs drop down.



You can open a locked door from the inside. Open door only when conditions are safe to do so.



If you hear a warning signal and a message appears in the multifunction display when driving off, you have forgotten to release the parking brake.

Release the parking brake.

After a cold start, the automatic transmission engages at a higher revolution. This allows the catalytic converter (gasoline engine) or the oxidation catalyst (Diesel engine) to reach its operating temperature earlier.

**Warning!**

On slippery road surfaces, never downshift in order to obtain braking action. This could result in drive wheel slip and reduced vehicle control. Your vehicle's ABS will not prevent this type of loss of control.

## Getting started

### Driving

#### Warning!



It is dangerous to shift the gear selector lever out of **P** or **N** if the engine speed is higher than idle speed. If your foot is not firmly on the brake pedal, the vehicle could accelerate quickly forward or in reverse. You could lose control of the vehicle and hit someone or something. Only shift into gear when the engine is idling normally and when your right foot is firmly on the brake pedal.

For more information on driving, see “Driving instructions” (▷ page 287).



Simultaneously depressing the accelerator pedal and applying the brake reduces engine performance and causes premature brake and drivetrain wear.



#### Switching on headlamps

##### Low beam headlamps

The exterior lamp switch is located on the dashboard to the left of the steering wheel.



##### Exterior lamp switch

- ① Off
  - ② Low beam headlamps on
- Turn the exterior lamp switch to position .
- The low beam headlamp indicator lamp  in the instrument cluster comes on (▷ page 24).

##### High beam

The combination switch is located on the left of the steering column.

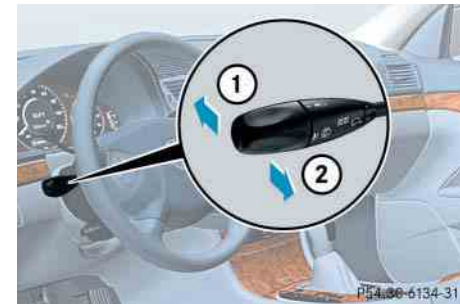

##### Combination switch

- ① High beam
  - ② High beam flasher
- Push combination switch in direction of arrow ①.

The high beam headlamp indicator lamp  in the instrument cluster comes on (▷ page 137).

For more information on headlamps, see “Lighting” (▷ page 133).

### Turn signals

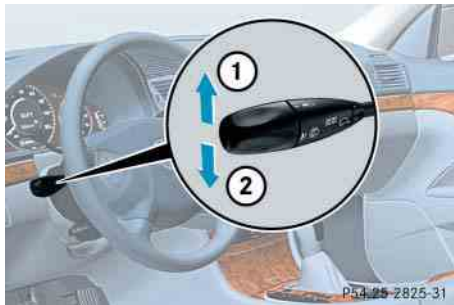

The combination switch is located on the left of the steering column.



#### Combination switch

- ① Turn signals, right
- ② Turn signals, left

- ▶ Press combination switch in direction of arrow ① or ②.

The corresponding turn signal indicator lamp  or  in the instrument cluster flashes.

The combination switch resets automatically after major steering wheel movements.



To signal minor directional changes such as changing lanes, press combination switch only to point of resistance and release. The corresponding turn signals will flash three times.

### Windshield wipers

The combination switch is located on the left of the steering column.



#### Combination switch

- ① Single wipe
- ② Switching on windshield wipers

- ▶ Switch on the ignition (> page 33).

## Getting started

### Driving

#### Switching on windshield wipers

- ▶ Turn the combination switch to the desired position depending on the intensity of the rain.

0 Windshield wipers off

I Intermittent wiping (interval dependent on wetness of windshield)

II Normal wiper speed

III Fast wiper speed



Intermittent wiping interval is dependent on wetness of windshield. After the initial wipe, pauses between wipes are automatically controlled by the rain sensor.



Do not leave windshield wipers in intermittent setting when the vehicle is taken to an automatic car wash or during windshield cleaning. Wipers will operate in the presence of water sprayed on the windshield, and wipers may be damaged as a result.

The combination switch should not be left in intermittent setting as the wipers will wipe the windshield once every time the engine is started. Dust that accumulates on the windshield might scratch the glass and / or damage the wiper blades when wiping occurs on a dry windshield.

#### Intermittent wiping

- ▶ Turn the combination switch to position I.



Intermittent wiping is interrupted when the vehicle is at a standstill and a front door is opened.

#### Single wipe

- ▶ Press combination switch briefly in direction of arrow ①.

The windshield wipers wipe one time without washer fluid.

#### Wiping with windshield washer fluid

- ▶ Push combination switch in direction of arrow ① past the resistance point.

The windshield wipers operate with washer fluid.

For information on filling up the washer reservoir, see “Windshield washer system and headlamp cleaning system\*”

(▷ page 310).



If anything blocks the windshield wipers (leaves, snow, etc.), switch them off immediately.

- For safety reasons,
  - turn off the engine by turning the SmartKey to position **0** and withdraw SmartKey from starter switch

or

- turn off the engine by pressing the KEYLESS-GO\* start/stop button and open the driver's door (with the driver's door open, starter switch is in position **0**, same as with SmartKey removed from starter switch)

before attempting to remove any blockage.

- Remove blockage.
- Turn the windshield wipers on again.

If windshield wipers fail to function at all in combination switch position **I**,

- set the combination switch to the next highest wiper speed
- have the windshield wipers checked at the nearest authorized Mercedes-Benz Center

### Problems while driving

#### The engine runs erratically and misfires

- An ignition cable may be damaged.
- The engine electronics may not be operating properly.
- Unburned gasoline may have entered the catalytic converter and damaged it (Gasoline engine only).
- ▶ Give very little gas.
- ▶ Have the problem repaired by an authorized Mercedes-Benz Center as soon as possible.

## Getting started

### Driving

#### **The coolant temperature is above 248°F (120°C)**

The coolant is too hot and is no longer cooling the engine.

- ▶ Stop the vehicle as soon as possible and turn off the engine. Allow engine and coolant to cool.
- ▶ Check the coolant level and add coolant if necessary (▷ page 308).

#### **In case of accident**

If the vehicle is leaking fuel:

- ▶ Do not start the engine under any circumstances.
- ▶ Notify local fire and/or police authorities.

If the extent of the damage cannot be determined:

- ▶ Notify an authorized Mercedes-Benz Center.

If no damage can be determined on the

- major assemblies
  - fuel system
  - engine mount:
- ▶ Start the engine in the usual manner.



## ▼ Parking and locking

You have now completed your first drive. You have properly stopped and parked your vehicle. End your drive as follows.

### Warning!



With the engine not running, there is no power assistance for the brake and steering systems. In this case, it is important to keep in mind that a considerably higher degree of effort is necessary to brake and steer the vehicle.

## Parking brake



- ① Parking brake
- ② Release handle

- ▶ Step firmly on parking brake ①.

When the engine is running, the warning lamp **BRAKE** (USA only) or **(P)** (Canada only) in the instrument cluster will be illuminated.

## Getting started

### Parking and locking

### Warning!



When leaving the vehicle, always remove the SmartKey or SmartKey with KEYLESS-GO\* from the starter switch, take it with you and lock the vehicle. Do not leave children unattended in the vehicle, or with access to an unlocked vehicle. Children could release the parking brake and/or move the gear selector lever from position **P**, either of which could result in an accident and/or serious injury.

## Getting started

### Parking and locking

#### Warning!



Getting out of your vehicle with the gear selector lever not fully engaged in position **P** is dangerous. Also, when parked on an incline, position **P** alone may not prevent your vehicle from moving, possibly hitting people or objects.

Always set the parking brake in addition to shifting to position **P**.

When parked on an incline, turn front wheels towards the road curb.

#### Switching off headlamps

- ▶ Turn the exterior lamp switch to **0** (▷ page 50).

For more information, see the “Controls in detail” section (▷ page 133).

#### Turning off engine

- ▶ Place the gear selector lever in position **P**.



Always set the parking brake in addition to shifting to position **P**.

On slopes, turn the front wheels towards the road curb.

#### Turning off with the SmartKey

- ▶ Turn the SmartKey in the starter switch (▷ page 34) to position **0** and remove it.

The immobilizer is activated.



The SmartKey can only be removed from the starter switch with the gear selector lever in position **P**.

- ▶ Press the seat belt release button (▷ page 44).

Allow the retractor to completely rewind the seat belt by guiding the latch plate.



With the SmartKey removed and the driver's door open, a warning sounds and the message *Switch off lights* appears in the multifunction display if the vehicle's exterior lamps are not switched off.

#### Warning!



To prevent possible personal injury, always keep hands and fingers away from the door openings when closing the doors. Be especially careful when small children are around.

Before closing doors, make sure that there is no possibility of someone getting caught in a door during closing.

- ▶ After exiting the vehicle press the lock button  on the SmartKey (▷ page 32).

All turn signal lamps flash three times. The locking knobs on the doors move down. The anti-theft alarm system is armed.

#### Warning!



When leaving the vehicle, always remove the SmartKey from the starter switch, take it with you, and lock the vehicle. Do not leave children unattended in the vehicle, or with access to an unlocked vehicle. Unsupervised use of vehicle may cause an accident and/or serious personal injury.

For more information, see the “Controls in detail” section (▷ page 98).

#### Turning off with KEYLESS-GO\*

- ▶ Place the gear selector lever in **P**.
- ▶ Press the KEYLESS-GO start/stop button to shut off the engine.

With the driver's door closed, the starter switch is now in position **1**. With the driver's door opened, the starter switch is set to position **0**, same as SmartKey removed from starter switch (▷ page 33).

- ▶ Press the seat belt release button (▷ page 44).



If you hear a warning signal, you have either

- forgotten to switch off the vehicle's exterior lamps before opening the driver's door,
- or
- tried to turn off the engine while the gear selector lever is not in **P**.

Turn off the lights or place the gear selector lever in **P**. ▷▷

## Getting started

### Parking and locking



#### Warning!



To prevent possible personal injury, always keep hands and fingers away from the door openings when closing the doors. Be especially careful when small children are around.

Before closing doors, make sure that there is no possibility of someone getting caught in a door during closing.

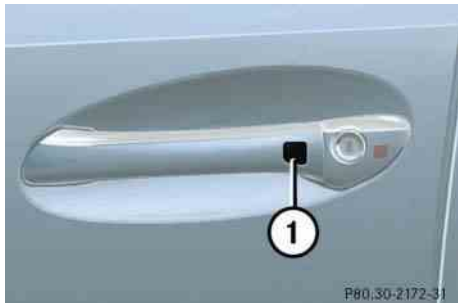

① Lock button on the door handle

- ▶ After exiting the vehicle, press lock button ① on the door handle or on the trunk lid.

All turn signal lamps flash three times. The locking knobs on the doors move down. The anti-theft alarm system is armed.

#### Warning!



When leaving the vehicle, always take the SmartKey with KEYLESS-GO\* with you, and lock the vehicle. Do not leave children unattended in the vehicle, or with access to an unlocked vehicle. Unsupervised use of vehicle equipment may cause an accident and/or serious personal injury.

For more information, see the “Controls in detail” section (▷ page 102).



**Safety and Security**

**Occupant safety**

**Panic alarm**

**Driving safety systems**

**Anti-theft systems**

## Safety and Security

### Occupant safety

In this section you will learn the most important facts about the restraint system components of the vehicle.

- Seat belts (▷ page 67)
- Child restraints (▷ page 80)
- Lower anchors and tethers for children (LATCH) (▷ page 81)

Supplemental Restraint System (SRS) with

- Air bags (▷ page 61)
- Air bag control unit (with crash sensors)
- Emergency tensioning device (ETD) for seat belts (▷ page 70)

Air bag system components with

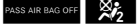
-  indicator lamp (▷ page 78)
- Front passenger seat with Occupant Classification System (OCS) (▷ page 74)

As independent systems, their protective functions work in conjunction with each other.



For information on infants and children traveling with you in the vehicle and restraint systems for infants and children, see “Children in the vehicle” (▷ page 71).

The SRS system conducts a self-test when the ignition is switched on and in regular intervals while the engine is running. This facilitates early detection of malfunctions. The **SRS** indicator lamp in the instrument cluster lights up when the ignition is switched on and goes out no later than a few seconds after the engine has been started.

The SRS components are in operational readiness if the **SRS** indicator lamp is not lit when the engine is running.

A malfunction in the system has been detected if the **SRS** indicator lamp:

- fails to go out after approximately four seconds after the engine was started
- does not come on at all
- comes on after the engine was started or while driving

## Safety and Security

### Occupant safety

#### Warning!



In the event that the **SRS** indicator lamp comes on during driving or does not come on at all, the SRS self-check has detected a malfunction. For your safety, we strongly recommend that you visit an authorized Mercedes-Benz Center immediately to have the system checked; otherwise the SRS may not be activated when needed in an accident, which could result in serious or fatal injury, or it might deploy unexpectedly and unnecessarily which could also result in injury.

In addition, improper repair work on the SRS creates a risk of rendering the SRS inoperative or causing unintended air bag deployment. Work on the SRS must therefore only be performed by qualified technicians. Contact an authorized Mercedes-Benz Center.

If it is necessary to modify an air bag system to accommodate a person with disabilities, contact your local authorized Mercedes-Benz Center or call our Customer Assistance Center at 1-800-FOR-MERcedes (1-800-367-6372) for details.

#### Air bags

#### Warning!



Air bags are designed to reduce the potential of injury and fatality in certain frontal impacts (front air bags), side impacts (side impact air bags and head protection window curtain air bags) or rollovers (head protection window curtain air bags). However, no system available today can totally eliminate injuries and fatalities.

The activation of the air bags temporarily releases a small amount of dust from the air bags. This dust, however, is neither injurious to your health, nor does it indicate a fire in the vehicle. The dust might cause some temporary breathing difficulty for people with asthma or other breathing trouble. To avoid this, you may wish to get out of the vehicle as soon as it is safe to do so. If you have any breathing difficulty but cannot get out of the vehicle after the air bag inflates, then get fresh air by opening a window or door.

## Safety and Security

### Occupant safety

#### Warning!



To reduce the risk of injury when the front air bags inflate, it is very important for the driver and front passenger to always be in a properly seated position and to wear their respective seat belts.

For maximum protection in the event of a collision always be in normal seated position with your back against the backrest. Fasten your seat belt and make sure that it is properly positioned on your body.

Since the air bag inflates with considerable speed and force, a proper seating and hands on steering wheel position will help to keep you at a safe distance from the air bag. Occupants who are unbelted, out of position or too close to the air bag can be seriously injured by an air bag as it inflates with great force in the blink of an eye:

- Sit properly belted in a nearly upright position with your back against the seat backrest.

- Adjust the driver seat as far as possible rearward, still permitting proper operation of vehicle controls. The distance from the center of the driver's breastbone to the center of the air bag cover on the steering wheel must be at least 10 in (25 cm) or more. You should be able to accomplish this by a combination of adjustments to the seat and steering wheel. If you have any problems, please see your authorized Mercedes-Benz Center.
- Do not lean your head or chest close to the steering wheel or dashboard.
- Keep hands on the outside of steering wheel rim. Placing hands and arms inside the rim can increase the risk and potential severity of hand/arm injury when driver front air bag inflates.
- Adjust the front passenger seat as far as possible rearward from the dashboard when the seat is occupied.

- Occupants, especially children, should never place their bodies or lean their heads in the area of the door where the side impact air bag inflates. This could result in serious injuries or death should the air bag be triggered. Always sit nearly upright, properly use the seat belts and use an appropriately sized infant or toddler restraint or booster seat recommended for the size and weight of the child.

Failure to follow these instructions can result in severe injuries to you or other occupants.

If you sell your vehicle, it is important that you make the buyer aware of this safety information. Be sure to give the buyer this Operator's Manual.



## Safety and Security

### Occupant safety

#### Warning!



Accident research shows that the safest place for children in an automobile is in the rear seat.

It should be noted that with respect to both front and rear side impact air bags there is a possibility for a side impact air bag related injury if occupants, especially children, are not properly seated or restrained when next to a side impact air bag which needs to deploy rapidly in a side impact in order to do its job.

To help avoid the possibility of injury, please follow these guidelines:

- (1) Occupants, especially children, should never place their bodies or lean their heads in the area of the door where the side impact air bag inflates. This could result in serious injuries or death should the side impact air bag be deployed.

- (2) Always sit nearly upright, properly use the seat belts and for children 12 years old and under, use an appropriately sized infant or toddler restraint or booster seat recommended for the size and weight of the child.

- (3) Always wear seat belts properly.

If you believe that, even with the use of these guidelines, it would be safer for your rear seat occupants to have the rear mounted side impact air bags deactivated, then deactivation can be accomplished upon your written request to do so at your authorized Mercedes-Benz Center at an additional cost.

Please contact your local authorized Mercedes-Benz Center or call our Customer Assistance Center at 1-800-FOR-MERCEdes (1-800-367-6372) for details.



Air bags are designed to deploy only in certain frontal impacts (front air bags), side impacts (side impact and head protection window curtain air bags) which exceed preset thresholds and in certain rollovers (head protection window curtain air bags). Only during these events will they provide their supplemental protection.

The driver and passengers should always wear their seat belts. Otherwise it is not possible for air bags to provide their supplemental protection.

## Safety and Security

### Occupant safety

In case of other types of impacts and impacts below air bag deployment thresholds, air bags will not be deployed. The driver and passenger will then be protected to the extent possible by a properly fastened seat belt. A properly fastened seat belt is also needed to provide the best possible protection in a rollover.

We caution you not to rely on the presence of the air bags in order to avoid wearing your seat belt.

It is important to your safety and that of your passengers that you replace deployed air bags and repair any malfunctioning air bags to make sure that the vehicle will continue to provide supplemental crash protection for occupants.

#### Safety guidelines for the seat belt, emergency tensioning device and air bag

##### Warning!



- Damaged seat belts or belts that were highly stressed in an accident must be replaced and their anchoring points must also be checked. Use only belts installed or supplied by an authorized Mercedes-Benz Center.
- Air bags and emergency tensioning devices (ETDs) are designed to function on a one-time-only basis. An air bag or ETD that was activated must be replaced.
- No modifications of any kind may be made to any components or wiring of the SRS. This includes changing or removing any component or part of the SRS, the installation of additional trim material, badges etc. over the steering wheel hub, passenger front air bag cover, door trim panels, or door frame trims, and installation of additional electrical/electronic equipment on or near SRS components and wiring. Keep area between air bags and occupants free from objects (e.g. packages, purses, umbrellas, etc.).
- Do not pass belts over sharp edges. They could tear.
- Do not make any modification that could change the effectiveness of the belts.
- Do not bleach or dye seat belts as this may severely weaken them. In a crash they may not be able to provide adequate protection.
- Do not hang items such as coat hangers from the coat hooks or handles over the door. These items may turn into projectiles and cause head and other injuries when curtain air bag is deployed.
- Never place your feet on the instrument panel, dashboard, or on the seat. Always keep both feet on the floor in front of the seat.

- Air bag system components will be hot after an air bag has inflated. Do not touch.
- In addition, improper repair work on the SRS creates a risk of rendering the SRS inoperative or causing unintended air bag deployment. Work on the SRS must therefore only be performed by qualified technicians. Contact an authorized Mercedes-Benz Center.
- For your protection and the protection of others, when scrapping the air bag unit or emergency tensioning device, our safety instructions must be followed. These instructions are available from your authorized Mercedes-Benz Center.
- Given the considerable deployment speed, required inflation volume, and the textile structure of the air bags, there is the possibility of abrasions or other more significant injuries resulting from air bag deployment.

### Warning!



Only use seat covers which have been tested and approved by Mercedes-Benz for your vehicle model. Using other seat covers may interfere with or prevent the deployment of the front side impact air bags. Contact your authorized Mercedes-Benz Center for availability.

When you sell your vehicle we strongly urge you to give notice to the subsequent owner that it is equipped with an SRS by alerting them to the applicable section in the Operator's Manual.

## Safety and Security

### Occupant safety

#### Front air bags



- ① Driver air bag
- ② Passenger air bag

Driver and front passenger air bags are deployed:

- in the event of certain frontal impacts
- if impact exceeds a preset deployment threshold
- independently of the side impact air bags

## Safety and Security

### Occupant safety



The front air bags in this vehicle have been designed to inflate in two stages. This allows the air bag to have different rates of inflation that are based on the rate of relevant vehicle deceleration as assessed by the air bag control unit.

On the front passenger side, the front air bag deployment is additionally influenced by the passenger's weight category as identified by the Occupant Classification System (OCS) (> page 74).

The lighter the front passenger side occupant, the higher the vehicle deceleration rate required for the second stage inflation of the air bag.

The air bags will not deploy in impacts which do not exceed the system's deployment thresholds. You will then be protected by the fastened seat belts.

The passenger front air bag will only be deployed if:

- the system, based on OCS weight sensor readings, senses that the front passenger seat is occupied
- the  indicator lamp in the center console is not lit (> page 78)
- the impact exceeds a preset deployment threshold

### Side impact air bags, window curtain air bags

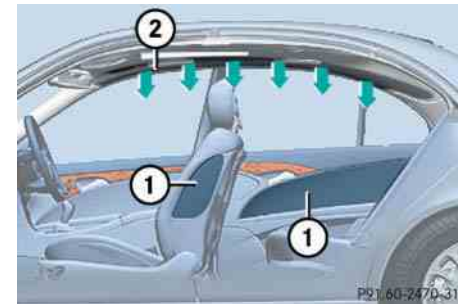

- ① Side impact air bags
- ② Window curtain air bag

The side impact air bags and window curtain air bags are deployed:

- on the impacted side of the vehicle
- in impacts exceeding a preset deployment threshold
- independently of the front air bags

## Safety and Security

### Occupant safety

In addition, the window curtain air bags ② are deployed:

- in certain vehicle rollovers



The front passenger side impact air bags ① will only deploy if the system senses that the front passenger seat is occupied.



The side impact air bags and window curtain air bags are not deployed in impacts which do not exceed the system's deployment threshold.

#### Seat belts

When the engine is started the seat belt telltale  illuminates for a maximum of six seconds and a warning chime sounds to remind you and your passengers to fasten your seat belts.

If after these six seconds, the driver's or the front passenger's seat belt (with the front passenger seat occupied) are not fastened with all doors closed,

- and the vehicle speed does not exceed 15 mph (25 km/h), the seat belt telltale  remains illuminated for as long as either the driver's or front passenger's seat belt are not fastened.
- and the vehicle speed exceeds 15 mph (25 km/h), the seat belt telltale  starts flashing and a warning chime sounds with increasing intensity until both the driver's and front passenger's seat belt are fastened, or for a maximum of 60 seconds from the time the vehicle speed exceeded 15 mph (25 km/h) if either the driver's or front passenger's seat belt remains unfastened.

If the driver's or front passenger's seat belt remains unfastened after 60 seconds, the seat belt telltale  stops flashing and the warning chime stops sounding. The seat belt telltale 

then continues to be illuminated for as long as either the driver's or front passenger's seat belt are not fastened.

The seat belt telltale will only go out if both the driver and front passenger's seat belt (with the front passenger seat occupied) are fastened, or the vehicle is standing still and a front door is opened.

For more information, see "Practical hints" (▷ page 362)

The use of seat belts and infant and child restraint systems is required by law in all 50 states, the District of Columbia, the U.S. territories and all Canadian provinces.

Even where this is not the case, all vehicle occupants should have their seat belts fastened whenever the vehicle is in motion.

For more information, see "Fastening the seat belts" (▷ page 43).

## Safety and Security

### Occupant safety



For information on infants and children traveling with you in the vehicle and restraint systems for infants and children, see “Children in the vehicle” (▷ page 71).

#### Warning!



Always fasten your seat belt before driving off. Always make sure all of your passengers are properly restrained, even those sitting in the rear and pregnant women.

Failure to wear and properly fasten and position your seat belt greatly increases your risk of injuries and their likely severity in an accident. You and your passengers should always wear seat belts.

If you are ever in an accident, your injuries can be considerably more severe without your seat belt properly buckled. Without your seat belt buckled, you are much more likely to hit the interior of the vehicle or be ejected from it. You can be seriously injured or killed.

In the same crash, the possibility of injury or death is lessened if you are properly wearing your seat belt. Air bags can only protect as they are designed if the occupants are properly wearing their seat belts.

#### Warning!



Never ride in a moving vehicle with the seat backrest in an excessively reclined position as this can be dangerous. You could slide under the seat belt in a collision. If you slide under it, the belt would apply force at the abdomen or neck. That could cause serious or even fatal injuries. The seat backrest and seat belt provide the best restraint when the wearer is in a nearly upright position and the belt is properly positioned on the body.

#### Warning!



Never let more people ride in the vehicle than there are seat belts available. Be sure everyone riding in the vehicle is correctly restrained with a separate seat belt. Never use a seat belt for more than one person at a time.

## Safety and Security

### Occupant safety

#### Warning!



Damaged seat belts or belts that were highly stressed in an accident must be replaced and their anchoring points must also be checked.

Only use seat belts which have been approved by Mercedes-Benz.

Do not make any modifications to the seat belts. This can lead to unintended activation or to failure.

Do not bleach or dye seat belts as this may severely weaken them. In a crash they may not be able to provide adequate protection.

Have all work carried out only by qualified technicians. Contact an authorized Mercedes-Benz Center.

#### Warning!



#### USE SEAT BELTS PROPERLY

- Seat belts can only work when used properly. Never wear seat belts in any other way than as described in this section, as that could result in serious injuries in case of an accident.
- Each occupant should wear their seat belt at all times, because seat belts help reduce the likelihood of and potential severity of injuries in accidents, including rollovers. The integrated restraint system includes SRS (driver air bag, passenger front air bag, side impact air bags, head protection window curtain air bags for side windows), ETD (seat belt emergency tensioning device), and front seat knee bolsters.

The system is designed to enhance the protection offered to properly belted occupants in certain frontal (front air bags and ETD) and side (side impact and window curtain air bags and ETD) impacts which exceed preset deployment thresholds and in certain rollovers (window curtain air bags and ETD).

- Never wear the shoulder belt under your arm, against your neck or off your shoulder. In a frontal crash, your body would move too far forward. That would increase the chance of head and neck injuries. The belt would also apply too much force to the ribs or abdomen, which could severely injure internal organs such as your liver or spleen. ▷▷

## Safety and Security

### Occupant safety



- Never wear belts over rigid or breakable objects in or on your clothing, such as eyeglasses, pens, SmartKeys etc., as these might cause injuries.
- Position the lap belt as low as possible on your hips and not across the abdomen. If the belt is positioned across your abdomen, it could cause serious injuries in a crash.
- Never use a seat belt for more than one person at a time. Do not fasten a seat belt around a person and another person or other objects.
- Belts should not be worn twisted. In a crash, you wouldn't have the full width of the belt to distribute impact forces. The twisted belt against your body could cause injuries.

- Pregnant women should also use a lap-shoulder belt. The lap belt portion should be positioned as low as possible on the hips to avoid any possible pressure on the abdomen.
- Never place your feet on the instrument panel, dashboard, or on the seat. Always keep both feet on the floor in front of the seat.
- When using a seat belt to secure infant or toddler restraints or children in booster seats, always follow the child seat manufacturer's instructions.

### Emergency tensioning device (ETD), seat belt force limiter

The seat belts for the front and rear outer seats are equipped with emergency tensioning devices and belt force limiters.

The ETD is designed to activate in the following cases:

- in frontal or rear-end impacts exceeding a preset severity level
- in certain vehicle rollovers
- if the restraint systems are operational and functioning correctly, see **SRS** indicator lamp (▷ page 60)



The ETDs for the front seats will only activate if the front seat belts are fastened (latch plate properly inserted into buckle).

The ETDs for the rear outer seats will activate with or without the respective seat belts fastened.



In an impact, emergency tensioning devices remove slack from the belts. Belt force limiters reduce the force exerted by the seat belts on occupants during a crash.

#### Warning!



An emergency tensioning device (ETD) that was activated must be replaced.

When disposing of the emergency tensioning device, our safety instructions must be followed. These are available at your authorized Mercedes-Benz Center.

#### Automatic comfort-fit feature seat belt

An automatic comfort-fit feature for front seats reduces the retracting force of the seat belts when they are in normal use.

#### Children in the vehicle

If an infant or child is traveling with you in the vehicle:

- Secure the child using an infant or child restraint appropriate to the age and size of the child.
- Make sure that the infant or child is properly secured at all times while the vehicle is in motion.

Infant and child restraint seats and information on choosing an appropriate restraint system can be obtained from any Mercedes-Benz Center.

#### Infant and child restraint systems

We recommend all infants and children be properly restrained at all times while the vehicle is in motion.

All lap-shoulder belts except the driver's seat belt have special seat belt retractors for secure fastening of child restraints.

To fasten a child restraint, follow child restraint instructions for mounting. Then pull the shoulder belt out completely and let it retract. During seat belt retraction, a ratcheting sound can be heard to indicate that the special seat belt retractor is activated. The belt is now locked. Push down on child restraint to take up any slack.

To deactivate, release seat belt buckle and let seat belt retract completely. The seat belt can again be used in the usual manner.

## Safety and Security

### Occupant safety



Information on child seats with mounting fittings for tether anchorages (▷ page 80).

For information on LATCH-type child seat mounts (▷ page 81).



The use of infant or child restraints is required by law in all 50 states, the District of Columbia, the U.S. territories and all Canadian provinces.

Infants and small children should be seated in an appropriate infant or child restraint system properly secured by a lap/shoulder belt or, if so equipped, a top tether anchorage point and a child restraint lower anchorage system that complies with U.S. Federal Motor Vehicle Safety Standards 213 and 225 and Canadian Motor Vehicle Safety Standards 213 and 210.2.

#### Warning!



Never release the seat belt buckle while the vehicle is in motion, since the special seat belt retractor will be deactivated.



A statement by the child restraint manufacturer of compliance with this standard can be found on the instruction label on the restraint and in the instruction manual provided with the restraint.

When using any infant or child restraint system, be sure to carefully read and follow all manufacturer's instructions for installation and use.

Please read and observe warning labels affixed to the inside of the vehicle and to infant or child restraints.

#### Warning!





According to accident statistics, children are safer when properly restrained in the rear seating positions than in the front seating position. Thus, we strongly recommend that children be placed in the rear seats whenever possible. Regardless of seating position, children 12 years old and under must be seated and properly secured in an appropriate infant or child restraint recommended for the size and weight of the child.

The infant or child restraint must be properly secured with the vehicle's seat belt, the seat belt and top tether strap, or lower anchors and top tether strap, fully in accordance with the child seat manufacturer's instructions.

## Safety and Security

### Occupant safety

Children can be killed or seriously injured by an inflating air bag. Note the following important information when circumstances require you to place a child in the front passenger seat:

- Your vehicle is equipped with air bag technology designed to turn off the front passenger front air bag in your vehicle when the OCS senses the weight of a typical 12-month-old child or less along with the weight of a standard appropriate child restraint on the front passenger seat.
  - A child in a rear-facing child restraint on the front passenger seat will be seriously injured or even killed if the front passenger front air bag inflates in a collision which could occur under some circumstances, even with the air bag technology installed in your vehicle. The only means to completely eliminate this risk is to never place a child in a rear-facing child restraint in the front seat. We therefore strongly recommend that you always place a child in a rear-facing child restraint in the back seat.
- If you must install a rear-facing child restraint on the front passenger seat because circumstances require you to do so, make sure that the  indicator lamp is illuminated, indicating that the front passenger air bag is deactivated. Should the light not illuminate or go out while the restraint is installed, please check installation. Periodically check the indicator lamp while driving to make sure the lamp is illuminated. If the  indicator lamp goes out or remains out, do not transport a child on the front passenger seat until the system has been repaired. A child in a rear-facing child restraint on the front passenger seat will be seriously injured or even killed if the front passenger front air bag inflates.
  - If you have to place a child in a forward-facing child restraint on the front passenger seat, move the seat as far back as possible, use the proper child restraint recommended for the age, size and weight of the child, and secure child restraint with the vehicle's seat belt according to the child seat manufacturer's instructions. For children larger than the typical 12-month-old child, the front passenger air bag may or may not be activated (▷ page 76).

## Safety and Security

### Occupant safety

#### Warning!



Infants and small children should never share a seat belt with another occupant. During an accident, they could be crushed between the occupant and seat belt.

A child's risk of serious or fatal injuries is significantly increased if the child restraints are not properly secured in the vehicle and the child is not properly secured in the child restraint.

Children too big for a toddler restraint must ride in seats using regular seat belts. Position shoulder belt across chest and shoulder, not face or neck. A booster seat may be necessary to achieve proper belt positioning for children from 41 lbs until they reach a height where a lap/shoulder belt fits properly without a booster.

When the child restraint is not in use, remove it from the vehicle or secure it with the seat belt to prevent the child restraint from becoming a projectile in the event of an accident.

Do not leave children unattended in the vehicle, even if the children are secured in a child restraint system. Unsupervised children in a child restraint system may use vehicle equipment and may cause an accident and/or serious personal injury.

#### Occupant Classification System

The Occupant Classification System (OCS) automatically turns the front passenger front air bag on or off based on the classified occupant weight category determined by weight sensor readings from the front passenger seat.



The system does not deactivate the front passenger side impact air bag, the window curtain air bag and the emergency tensioning device.

Occupants must sit properly belted in a nearly upright position with their back against the seat backrest and feet on the floor to be correctly classified. If the occupant's weight is transferred to another object in the vehicle (e.g. by leaning on armrests), the OCS may not be able to properly approximate the occupant's weight category.

## Safety and Security

### Occupant safety

Furthermore, the occupant weight may appear to increase or decrease due to objects hanging on the seat, other passengers pushing on the seat, objects lodged underneath the seat or stuffed between seat and middle console or between seat and door or due to objects applying pressure on the back of the seat. Always make sure that the seat has clearance in all directions at all times.



If your seat, including your trim cover and cushion needs to be serviced in any way, take the vehicle to your authorized Mercedes-Benz Center.

Only seat accessories approved by Mercedes-Benz may be used.

Both driver and the front passenger should always use the  indicator lamp as an indication of whether or not the front passenger is properly positioned.

#### Warning!



If the  indicator lamp illuminates when an adult or someone larger than a small individual is in the front passenger seat, have the front passenger re-position himself or herself in the seat until the light goes out, or check whether objects are caught under or around the seat.

More information about air bag display messages (> page 374).



In the event of a collision, the air bag control unit will not allow front passenger front air bag deployment when the OCS classified the front passenger seat occupant as being up to or less than the weight of a typical 12-month-old child in a standard child restraint or if the front passenger seat is sensed as being empty.

When the OCS senses that the front passenger seat occupant is classified as being up to or less than the weight of a typical 12-month-old child in a standard child restraint, the  indicator lamp will illuminate when the engine is started and remain illuminated, indicating that the front passenger front air bag is deactivated.

When the OCS senses that the front passenger seat is classified as being empty, the  indicator lamp will illuminate when the engine is started and remain illuminated, indicating that the front passenger front air bag is deactivated. >>

## Safety and Security

### Occupant safety

▷▷ When the OCS senses that the front passenger seat occupant is classified as being heavier than the weight of a typical 12-month-old child seated in a standard child restraint or as being a small individual (such as a young teenager or a small adult), the  indicator lamp will illuminate for approximately six seconds when the engine is started and then, depending on occupant weight sensor readings from the seat, remain illuminated or go out. With the  indicator lamp illuminated, the front passenger front air bag is deactivated. With the  indicator lamp out, the front passenger front air bag is activated.

When the OCS senses that the front passenger seat occupant is classified as an adult or someone larger than a small individual, the  indicator lamp will illuminate for approximately six seconds when the engine is started and then go out, indicating that the front passenger front air bag is activated.

If the  indicator lamp is illuminated, the front passenger front air bag is deactivated and will not be deployed.

If the  indicator lamp is not illuminated, the front passenger front air bag is activated and will be deployed:

- in the event of certain frontal impacts
- if impact exceeds a preset deployment threshold
- independently of the side impact air bags.

If the front passenger front air bag is deployed, the rate of inflation will be influenced by:

- the rate of relevant vehicle deceleration as assessed by the air bag control unit
- front passenger's weight category as identified by the Occupant Classification System (OCS).

### Warning!





According to accident statistics, children are safer when properly restrained in the rear seating positions than in the front seating position. Thus, we strongly recommend that children be placed in the rear seats whenever possible. Regardless of seating position, children 12 years old and under must be seated and properly secured in an appropriate infant or child restraint recommended for the size and weight of the child.

The infant or child restraint must be properly secured with the vehicle's seat belt, the seat belt and top tether strap, or lower anchors and top tether strap, fully in accordance with the child seat manufacturer's instructions.

## Safety and Security

### Occupant safety

Children can be killed or seriously injured by an inflating air bag. Note the following important information when circumstances require you to place a child in the front passenger seat:

- Your vehicle is equipped with air bag technology designed to turn off the front passenger front air bag in your vehicle when the system senses the weight of a typical 12-month-old child or less along with the weight of a standard appropriate child restraint on the front passenger seat.
  - A child in a rear-facing child restraint on the front passenger seat will be seriously injured or even killed if the front passenger front air bag inflates in a collision which could occur under some circumstances, even with the air bag technology installed in your vehicle. The only means to completely eliminate this risk is to never place a child in a rear-facing child restraint in the front seat. We therefore strongly recommend that you always place a child in a rear-facing child restraint in the back seat.
- If you must install a rear-facing child restraint on the front passenger seat because circumstances require you to do so, make sure that the  indicator lamp is illuminated, indicating that the front passenger air bag is deactivated. Should the light not illuminate or go out while the restraint is installed, please check installation. Periodically check the indicator lamp while driving to make sure the lamp is illuminated. If the  indicator lamp goes out or remains out, do not transport a child on the front passenger seat until the system has been repaired. A child in a rear-facing child restraint on the front passenger seat will be seriously injured or even killed if the front passenger front air bag inflates.
  - If you have to place a child in a forward-facing child restraint on the front passenger seat, move the seat as far back as possible, use the proper child restraint recommended for the age, size and weight of the child, and secure child restraint with the vehicle's seat belt according to the child seat manufacturer's instructions. For children larger than the typical 12-month-old child, the front passenger air bag may or may not be activated (▷ page 76).

## Safety and Security

### Occupant safety



Deployment of the driver front air bag does not mean that the front passenger front air bag also should have deployed.

The Occupant Classification System (▷ page 74) may have determined:

- that the seat was empty or occupied by the weight up to or less than that of a typical 12-month-old child seated in a standard child restraint - both instances where the system suppresses deployment of the passenger front air bag even though the impact met the criteria and was of sufficient severity to deploy the driver front air bag.

- that the seat was occupied by a small individual (such as a young teenager or a small adult) or a child weighing more than the weight of a typical 12-month-old child in a standard child restraint - instances where the system may suppress deployment of the passenger front air bag even though the impact met the criteria and was of sufficient severity to deploy the driver front air bag.

The indicator lamp is located in the center console.



① Indicator lamp

The indicator lamp ① will be illuminated, except with the SmartKey removed or in starter switch position 0.

### Warning!



If the indicator lamp and the indicator lamp are lit at the same time, there is a malfunction in the Occupant Classification System. The front passenger front air bag will be deactivated in this case.





In order to ensure proper operation of the air bag system and OCS:



- Have the system checked as soon as possible by qualified technicians. Contact an authorized Mercedes-Benz Center.
- Do not place more than 4.4 lbs (2 kg) into the ruffled storage bag on the back of the front passenger seat. Otherwise, the OCS may not be able to properly approximate the occupant weight category.



- Do not place objects under and / or around the front passenger seat.
- Do not hang anything from or attach any items to the seats.
- Do not stuff objects such as books between the middle console and the front passenger seat.
- Do not move the front passenger seat backwards against stiff objects.
- Sit properly belted in a nearly upright position with your back against the seat backrest.
- Do not lean on the armrests or lift yourself from the seat by using the handle over the door as this may cause the OCS to be unable to correctly approximate the occupant weight category.
- Only have the seat repaired or replaced by an authorized Mercedes-Benz Center.
- Read and observe all warnings in this chapter.

### Self-test Occupant Classification System

After turning the SmartKey in the starter switch to position **1** or **2** or pressing the KEYLESS-GO\* start/stop button once or twice, the   indicator lamp ① located in the center console illuminates. If an adult occupant is properly sitting on the front passenger seat and the system senses the occupant as being an adult, the   indicator lamp will illuminate and go out after approximately six seconds.

If the seat is not occupied and the system senses the front passenger seat as being empty, the   indicator lamp will illuminate and not go out.

## Safety and Security

### Occupant safety

#### Warning!



If the indicator lamp should not illuminate, the system is not functioning. You must see an authorized Mercedes-Benz Center before seating any child on the front passenger seat.

For more information, see the “Practical hints” section (▷ page 374).

#### Warning!



Never place anything between seat cushion and child seat (e.g. pillow), since it reduces the effectiveness of the Occupant Classification System. The bottom of the child seat must make full contact with the passenger seat cushion. An incorrectly mounted child seat could cause injuries to the child in case of an accident, instead of increasing protection for the child.

Follow the manufacturer’s instructions for installation of child seats.

## Safety and Security

### Occupant safety

#### Installation of infant and child restraint systems

This vehicle is equipped with tether anchorages for a top tether strap at each of the rear seating positions.

#### Not foldable rear seat backrest

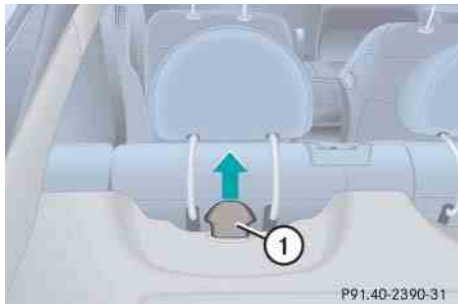

① Cover

- ▶ Remove cover ① from anchorage ring.
- ▶ Guide tether strap between head restraint and top of the seat back.

- ▶ Head restraint must be installed (if removable) and positioned such that the top tether strap can pass freely between the head restraint and the top of the seat back.

Make sure the tether strap is not twisted.

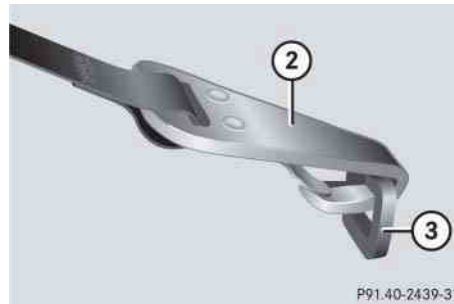

② Hook

③ Anchorage ring

- ▶ Securely fasten the hook ② to the anchorage ring ③.

**i**

For safety, make sure the hook ② has attached to the ring ③ beyond the safety catch, as illustrated.

Once the top tether anchorage hook is attached, the child restraint itself can be secured. Tighten the top tether strap according to the child restraint manufacturer's instructions.

#### Foldable rear seat backrest\*

- ▶ Fold rear seat backrest slightly forward.
- ▶ Remove cover from anchorage ring.
- ▶ Guide tether strap between head restraint and top of the seat back.
- ▶ Head restraint must be positioned such that the top tether strap can pass freely between the head restraint and the top of the seat back.

Make sure the tether strap is not twisted.

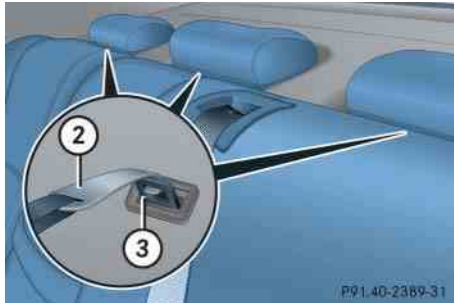

- ② Hook
- ③ Anchorage ring

- ▶ Securely fasten the hook ② to the anchorage ring ③.



For safety, make sure the hook ② has attached to the ring ③ beyond the safety catch, as illustrated below.

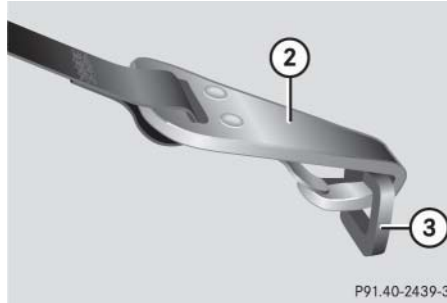

- ② Hook
- ③ Anchorage ring

- ▶ Swing rear seat backrest to the rear until it engages.
- ▶ Check the rear seat backrest to be locked in its upright position (▷ page 379).

Once the top tether anchorage hook is attached, the child restraint itself can be secured. Tighten the top tether strap according to the child restraint manufacturer's instructions.

#### Child seat anchors - LATCH type

This vehicle is equipped with two LATCH (Lower Anchors and Tethers for Children) type anchors (at each of the outer rear seats) for the installation of a “LATCH” child seat with the matching mounting fittings.

The anchors are located behind an upholstery blend.

## Safety and Security

### Occupant safety

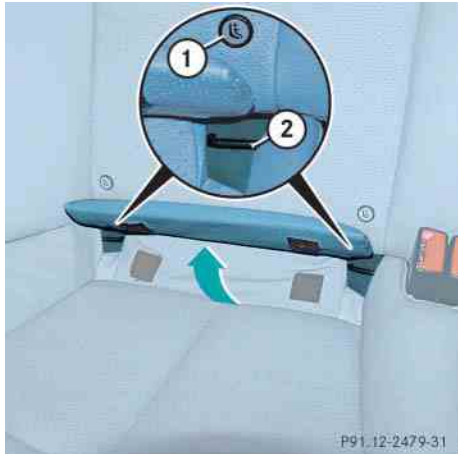

① Indicates the position of the anchors

② Anchors

- ▶ Install child seat according to the manufacturer's instructions.



Make sure the seat belt for the center seat can operate freely with a child seat installed.



Non-LATCH type child seats may also be used and can be installed using the vehicle's seat belt system. Install child seat according to the manufacturer's instructions.

### Warning!



Children too big for a toddler restraint must ride in seats using regular seat belts. Position shoulder belt across chest and shoulder, not face or neck. A booster seat may be necessary to achieve proper belt positioning for children from 41 lbs until they reach a height where a lap/shoulder belt fits properly without a booster.

Install child seat according to manufacturer's instructions.

The child seat must be firmly attached in the right and left side anchors ②.

An incorrectly mounted child seat may come loose during an accident which could result in serious injury or death to the child.

Damaged or impact damaged child seats or child seat mounting fittings must be replaced.

Do not leave children unattended in the vehicle, even if the children are secured in a child restraint system.

#### Blocking of rear door window operation



- ① Override switch
- ② Indicator lamp

- ▶ Press override switch ①.

Indicator lamp ② comes on. The rear door windows can no longer be operated using the switches located in the rear doors.



Operation of the rear door windows with the switches located on the door control panel of the driver's door is still possible.

#### Warning!



Activate the override switch when children are riding in the back seats of the vehicle. The children may otherwise injure themselves, e.g. by becoming trapped in the window opening.

When leaving the vehicle, always remove the SmartKey or SmartKey with KEYLESS-GO\* from the starter switch, take it with you, and lock the vehicle. Do not leave children unattended in the vehicle, or with access to an unlocked vehicle. Unsupervised use of vehicle equipment can cause an accident and/or serious personal injury.

For more information on power windows, see the "Controls in detail" section (▷ page 218).

## Safety and Security

### Panic alarm

An audible alarm and flashing exterior lamps will operate for approximately 2½ minutes.



① PANIC button

#### Activating

- ▶ Press and hold button ① for at least one second.

#### Deactivating

- ▶ Press button ① again.
- or
- ▶ Insert SmartKey in starter switch.



USA only:

This device complies with Part 15 of the FCC Rules. Operation is subject to the following two conditions:

- (1) This device may not cause harmful interference, and
- (2) this device must accept any interference received, including interference that may cause undesired operation.

Any unauthorized modification to this device could void the user's authority to operate the equipment.



Canada only:

This device complies with RSS-210 of Industry Canada. Operation is subject to the following two conditions:

- (1) This device may not cause interference, and
- (2) this device must accept any interference received, including interference that may cause undesired operation of the device.

Any unauthorized modification to this device could void the user's authority to operate the equipment.

#### ▼ Driving safety systems

In this section you will find information on the following driving safety systems:

- ABS (Antilock Brake System)
- BAS (Brake Assist System)
- ESP (Electronic Stability Program)
- SBC (Sensotronic Brake Control)
- 4MATIC (Four Wheel Electronic Traction System)



In winter operation, the maximum effectiveness of the ABS, the BAS, the ESP, SBC and 4MATIC is only achieved with winter tires (M+S tires), or snow chains as required.

#### Warning!



The following factors increase the risk of accidents:

- Excessive speed, especially in turns
- Wet and slippery road surfaces
- Following another vehicle too closely

The ABS, BAS, ESP, SBC and 4MATIC cannot reduce this risk.

Always adjust your driving style to the prevailing road and weather conditions.

#### ABS

#### Warning!



Do not pump the brake pedal. Use firm, steady brake pedal pressure instead. Pumping the brake pedal defeats the purpose of the ABS and significantly reduces braking effectiveness.

The Antilock Brake System (ABS) regulates the brake pressure so that the wheels do not lock during braking. This allows you to maintain the ability to steer your vehicle.

The ABS is functional above a speed of approximately 5 mph (8 km/h) independent of road surface conditions.

On slippery road surfaces, the ABS will respond even with light brake pressure.

## Safety and Security

### Driving safety systems

The  malfunction warning lamp in the instrument cluster comes on when you switch on the ignition. It goes out when the engine is running.

#### Braking

If the ABS activates during braking, the ABS/ESP warning lamp  in the instrument cluster dial flashes. Because of the SBC brake system, you will not feel any pulsation in the brake pedal.

- ▶ Keep firm and steady pressure on the brake pedal.

Continuous, steady brake pedal pressure yields the advantages provided by the ABS, namely braking power and the ability to steer the vehicle.

The ABS/ESP warning lamp  flashes whenever the ABS is activated which can be an indication of hazardous road conditions and functions as a reminder to take extra care while driving.

#### Emergency brake maneuver

- ▶ Keep continuous full pressure on the brake pedal.

#### Warning!



When the ABS is malfunctioning, the BAS and the ESP are also switched off.

When the ABS is malfunctioning, the wheels may lock during hard braking, reducing steering capability and extending the braking distance.

#### Warning!



The ABS cannot prevent the natural laws of physics from acting on the vehicle, nor can it increase braking or steering efficiency beyond that afforded by the condition of the vehicle brakes and tires or the traction afforded. The ABS cannot prevent accidents, including those resulting from excessive speed in turns, following another vehicle too closely, or hydroplaning. Only a safe, attentive, and skillful driver can prevent accidents. The capabilities of an ABS equipped vehicle must never be exploited in a reckless or dangerous manner which could jeopardize the user's safety or the safety of others.

For more information, see the "Practical hints" section (▷ page 357).



## Safety and Security

### Driving safety systems

#### BAS

The Brake Assist System (BAS) operates in emergency situations. If you apply the brakes very quickly, the BAS automatically provides full brake boost, thereby potentially reducing the braking distance. Apply continuous full braking pressure until the emergency braking situation is over. The ABS will prevent the wheels from locking.

When you release the brake pedal, the brakes function again as normal. The BAS is then deactivated.

#### Warning!



If the BAS is malfunctioning, the brake system is still functioning normally, but without the additional brake boost available that BAS would normally provide in an emergency braking maneuver. Therefore, the braking distance may increase.

#### Warning!





The BAS cannot prevent the natural laws of physics from acting on the vehicle, nor can it increase braking efficiency beyond that afforded by the condition of the vehicle brakes and tires or the traction. The BAS cannot prevent accidents, including those resulting from excessive speed in turns, following another vehicle too closely, or hydroplaning. Only a safe, attentive, and skillful driver can prevent accidents. The capabilities of a BAS equipped vehicle must never be exploited in a reckless or dangerous manner which could jeopardize the user's safety or the safety of others.

#### ESP

The Electronic Stability Program (ESP) monitors the vehicle's traction (force of adhesive friction between the tires and the road surface) and handling.

The ESP recognizes when a wheel is spinning or if the vehicle starts to skid. By applying brakes to the appropriate wheel and by limiting engine output, the ESP works to stabilize the vehicle. The ESP is especially useful while driving off and on wet or slippery road surfaces.

The ABS/ESP warning lamp  in the instrument cluster flashes when the ESP is engaged.

The ABS/ESP warning lamp  in the instrument cluster comes on when you switch on the ignition. It goes out when the engine is running.

## Safety and Security

### Driving safety systems

#### Warning!



Never switch off the ESP when you see the ABS/ESP warning lamp  flashing in the instrument cluster. In this case proceed as follows:

- While driving off, apply as little throttle as possible.
- While driving, ease up on the accelerator.
- Adapt your speed and driving style to the prevailing road conditions.

Failure to observe these guidelines could cause the vehicle to skid.

The ESP cannot prevent accidents resulting from excessive speed.

#### Warning!



The ESP cannot prevent the natural laws of physics from acting on the vehicle, nor can it increase the traction afforded. The ESP cannot prevent accidents, including those resulting from excessive speed in turns, or hydroplaning. Only a safe, attentive, and skillful driver can prevent accidents. The capabilities of an ESP equipped vehicle must never be exploited in a reckless or dangerous manner which could jeopardize the user's safety or the safety of others.



The ESP will only function properly if you use wheels of the recommended tire size (▷ page 453).



Vehicles without 4MATIC:

Because of the ESP's automatic operation, the engine and the ignition must be shut off (SmartKey in starter switch position **0** or **1** or KEYLESS-GO start/stop button\* in position **0** or **1**) when:

- the parking brake is being tested on a brake test dynamometer
- the vehicle is being towed with the front axle raised

Active braking action through the ESP may otherwise seriously damage the brake system.

For information on vehicles with 4MATIC, see "Four wheel electronic traction system (4MATIC) with the ESP" (▷ page 93).

For more information, see the "Practical hints" section (▷ page 357).

#### Switching off the ESP

##### Warning!



The ESP should not be switched off during normal driving other than in the circumstances described below. Disabling of the system will reduce vehicle stability in driving maneuvers.

To improve the vehicle's traction, turn off the ESP in driving situations where it would be advantageous to have drive wheels spin and thus cut into surfaces for better grip such as:

- starting out on slippery surfaces and in deep snow in conjunction with snow chains
- in sand or gravel



Turn on the ESP immediately if the aforementioned circumstances do not apply anymore.

When you switch off the ESP

- the ESP does not stabilize the vehicle
- the engine output is not limited, which allows the drive wheels to spin and thus cut into surfaces for better grip
- the traction control will still brake a spinning wheel
- the ESP continues to operate when you are braking
- you cannot activate DISTRONIC\*



When the ESP is switched off and one or more drive wheels are spinning, the ABS/ESP warning lamp  in the speedometer flashes. However, the ESP will then not stabilize the vehicle.

The switch is located on the center console.



① ESP switch

- ▶ Press ESP switch ① until the ABS/ESP warning lamp  in the instrument cluster comes on.

The ESP is deactivated.

## Safety and Security

### Driving safety systems

#### Warning!



When the ABS/ESP warning lamp  is illuminated continuously, the ESP is switched off.

Adapt your speed and driving to the prevailing road conditions and to the non-operating status of the ESP.



Avoid spinning of a drive wheel for an extended period with the ESP switched off. This may cause serious damage to the drivetrain which is not covered by the Mercedes-Benz Limited Warranty.

#### Switching on the ESP

- ▶ Press ESP button .

The ABS/ESP warning lamp  in the instrument cluster goes out.

You are now again in normal driving mode.





Turn on the ESP immediately if the aforementioned circumstances do not apply anymore.

#### SBC brake system

The SBC brake system combines a hydraulic brake circuit with electronically controlled brake servo assistance. You have increased braking safety and improved braking comfort.

#### Warning!



Never ignore a brake malfunction indicated in the speedometer display, for example by the  (USA only) or  (Canada only) warning lamp. Refer to the “Practical hints” section (▷ page 358). Also read and observe the messages in the instrument cluster display (▷ page 367).

#### Warning!



The SBC brake system requires electrical power to operate.

A malfunction in the vehicle's power supply or electrical system may impair brake system operation and switch it into its emergency operation mode. In such a case, the red brake warning lamp (▷ page 358) and warning messages in the instrument cluster (▷ page 367) come on while driving. To brake, the driver must then apply significantly greater brake pedal pressure and depress the pedal much further to obtain the expected braking effect. If necessary, apply full pressure to the brake pedal. Brakes may only be applied to the front wheels. Stopping distance is increased!

If there is a malfunction in the SBC brake system, we recommend that the vehicle be transported with all wheels off the ground using flatbed or appropriate wheel lift/dolly equipment.

A tow bar must be used if circumstances do not permit the use of the recommended towing methods and the vehicle requires towing with all four wheels on the ground. Towing the vehicle with all four wheels on the ground is only permissible for distances up to 30 miles (50 km) and at a speed not to exceed 30 mph (50 km/h). For more information, refer to "Towing the vehicle" (▷ page 439).

The SBC brake system is automatically activated when you

- unlock the vehicle with the SmartKey or the KEYLESS-GO\*
- open the driver's or passenger door
- turn the SmartKey in the starter switch to position **1**
- in vehicles with KEYLESS-GO\*, press the start/stop button on the gear selector lever once
- depress the brake pedal
- release the parking brake



If the SBC brake system is activated as the brake pedal is first depressed, you may feel a reduced pedal resistance and longer pedal travel than normal. When releasing the pedal, you may also feel the brake pedal pulsate and you may hear a sound which is caused by the activation of the SBC brake system pump. This is normal and not an indication of a malfunction. Pedal travel returns to normal when you release the brake pedal and the sound soon ceases.

If you experience the above while driving and the red brake warning lamp (▷ page 358) illuminates and/or warning messages appear in the instrument cluster (▷ page 367), the brake system is malfunctioning. Follow the instructions of the warning message(s) and have the brake system checked immediately.

## Safety and Security

### Driving safety systems

#### Warning!



Have brake pad replacement and other work on the SBC brake system carried out by qualified technicians only. Contact an authorized Mercedes-Benz Center for further information. The SBC brake system must be deactivated prior to working on the system. High pressure is intermittently built up in the system as part of its automatic self-test. In addition, the system is automatically activated when the vehicle is unlocked by SmartKey, when the driver or passenger door is opened, when the starter switch is turned to position **1**, when the brake pedal is depressed or when the parking brake is released. Failure to deactivate the system prior to maintenance will cause brake pistons to extend and brake fluid to leak, which may result in injuries (contusions and acid burns). Extended brake pistons may also cause injury.

The SBC brake servo assistance switches off automatically

- approximately two minutes after you turned the SmartKey in the starter switch to position **0** or removed the SmartKey
- approximately two minutes after you pressed the KEYLESS-GO\* start/stop button to turn off the engine or power supply and opened the driver's door (with driver's door open, the starter switch is set to position **0**, same as SmartKey removed from starter switch)
- approximately 20 seconds after you locked the vehicle from outside

#### Note on driving with the SBC

- Following extended periods of only minor loads to your brake system, you should occasionally apply the brakes when traveling at high speeds. This improves the grip of the brake pads.

#### Warning!



Be very careful not to endanger other road users when you apply the brakes.

- After driving on wet or snow-covered roads, you should apply your brakes firmly before parking your vehicle. This produces heat which serves to dry the brake disks and help prevent corrosion.
- On long and steep grades, shift to a lower gear (gear range **1**, **2**, or **3**) to prevent the brakes from overheating and to reduce brake wear.
- After hard braking, it is advisable to drive on for some time so that the air stream will cool down the brakes faster.
- Only Mercedes-Benz approved components (e.g. brake pads) should be installed on your vehicle. Brake pads not approved by Mercedes-Benz may impair the safety of your vehicle.

#### Four wheel electronic traction system (4MATIC) with the ESP

Models with all-wheel-drive only.

The 4MATIC improves vehicle's ability to use available traction, e.g. during winter operation in mountains under snowy conditions, by applying power to all four wheels.

#### Warning!



If you see the ESP warning lamp  flashing in the speedometer, proceed as follows:

- While driving off, apply as little throttle as possible
- While driving, ease up on the accelerator
- Adapt your speed and driving style to the prevailing road conditions

Failure to observe these guidelines could cause the vehicle to skid.

The ESP cannot prevent accidents resulting from excessive speed.



Do not tow with one axle raised.

Otherwise the transfer case can be damaged, which is not covered by the Mercedes-Benz Limited Warranty.



Performance testing must only be conducted on a two-axle dynamometer.

Otherwise the transfer case can be damaged, which is not covered by the Mercedes-Benz Limited Warranty.



Because of the ESP's automatic operation, the engine and the ignition must be shut off (SmartKey in starter switch position **0** or **1** or KEYLESS-GO start/stop button\* in position **0** or **1**) when the parking brake is being tested on a brake test dynamometer.

Active braking action through ESP may otherwise seriously damage the front or rear axle brake system.

Operational tests with the engine running can only be conducted on a two-axle dynamometer.

## Safety and Security

### Anti-theft systems

#### Immobilizer

The immobilizer prevents unauthorized persons from starting your vehicle.

#### Activating

- With the SmartKey: Removing the SmartKey from the starter switch activates the immobilizer.
- With KEYLESS-GO\*: Turning off the engine by means of the KEYLESS-GO start/stop button on the gear selector lever activates the immobilizer.

#### Deactivating

- With the SmartKey: Inserting the SmartKey in the starter switch deactivates the immobilizer.
- With KEYLESS-GO\*: Starting the engine by means of the start/stop button on the gear selector lever deactivates the immobilizer.



In case the engine cannot be started (yet the vehicle's battery is charged), the system is not operational. Contact an authorized Mercedes-Benz Center or call 1-800-FOR-MERCEdes (in the USA), or 1-800-387-0100 (in Canada).

#### Anti-theft alarm system

Once the alarm system has been armed, a visual and audible alarm is triggered when someone opens

- a door
- the trunk
- the hood.

The alarm will stay on, even if the activating element (a door, for example) is immediately closed.

The alarm system will also be triggered when

- someone attempts to raise the vehicle.



If the alarm stays on for more than 30 seconds, a call to the Response Center is initiated automatically by the Tele Aid system\* (▷ page 271) provided Tele Aid service was subscribed to and properly activated, and that necessary cellular service and GPS coverage are available.

#### Arming the alarm system

The alarm system is armed within approximately ten seconds after locking the vehicle with the SmartKey or KEYLESS-GO\*. The turn signal lamps flash three times to indicate that the alarm system is activated. The indicator lamp in the central locking switch (▷ page 27) begins to flash after arming the alarm system.





If the turn signal lamps do not flash three times, one of the following elements may not be properly closed:

- a door
- the trunk lid

Close the respective element and lock the vehicle again.

#### Disarming the alarm system



The alarm system is disarmed when you unlock your vehicle with the SmartKey or KEYLESS-GO\*. The turn signal lamps flash once to indicate that the alarm system is deactivated.

#### Canceling the alarm

##### *With the SmartKey*

- ▶ Insert the SmartKey in the starter switch.

or

- ▶ Press the  or  button on the SmartKey.

The alarm is canceled.

##### *With KEYLESS-GO\**

- ▶ Grasp the outside door handle.

or

- ▶ Press the KEYLESS-GO\* start/stop button.

The alarm is canceled.

#### Tow-away alarm

Once the tow-away alarm is armed, a visual and audible alarm will be triggered when someone attempts to raise the vehicle.



The tow-away protection alarm is triggered, for example, if the vehicle is lifted on one side.

If the alarm stays on for more than 30 seconds, a call to the Response Center is initiated automatically by the Tele Aid system\* (> page 271), provided that the Tele Aid service was subscribed to and properly activated, and that necessary cellular service and GPS coverage are available.

#### Arming the tow-away alarm

When you lock your vehicle, the tow-away alarm is automatically armed after about 30 seconds.

When you unlock your vehicle, the tow-away protection disarms automatically.

## Safety and Security

### Anti-theft systems

#### Disarming the tow-away alarm

To prevent triggering the tow-away alarm feature, switch off the tow-away alarm before towing the vehicle, or when parking on a surface subject to movement, such as a ferry or auto train.

The button is located on the overhead control panel.



① Tow-away alarm off button

- ▶ Switch off the ignition and remove the SmartKey from the starter switch.



You cannot disarm the tow-away alarm when the ignition is switched on.

- ▶ Press button ①.

The indicator lamp in the button comes on briefly.

- ▶ Exit and lock your vehicle with the SmartKey or (vehicles with KEYLESS-GO\*) the lock button at each door handle.

The tow-away alarm remains disarmed until you lock your vehicle again.



#### Canceling tow-away alarm

To cancel the alarm:

##### *With the SmartKey*

- ▶ Insert the SmartKey in the starter switch.

or

- ▶ Press the  or  button on the SmartKey.

##### *With KEYLESS-GO\**

- ▶ Grasp the outside door handle.

or

- ▶ Press the KEYLESS-GO start/stop button.



**Controls in detail**

**Locking and unlocking**

**Seats**

**Memory function**

**Lighting**

**Instrument cluster**

**Control system**

**Automatic transmission**

**Good visibility**

**Dual-zone automatic climate control**

**4-zone automatic climate control\***

**Power windows**

**Power tilt /sliding sunroof\***

**Panorama roof with power tilt/sliding panel\***

**Driving systems**

**Loading**

**Useful features**

## Controls in detail

### Locking and unlocking

In the “Controls in detail” section you will find detailed information on how to operate the equipment installed on your vehicle. If you are already familiar with the basic functions of your vehicle, this section will be of particular interest to you.

To quickly familiarize yourself with the basic functions of the vehicle, refer to the “Getting started” section of this manual. The corresponding page numbers are given at the beginning of each segment.

For more information on locking and unlocking, see “Getting started” (▷ page 32) and (▷ page 56).

#### SmartKey

Your vehicle comes supplied with two SmartKeys, each with remote control and a removable mechanical key. The locking tabs for the mechanical key portion of the two SmartKeys are a different color to help distinguish each key unit.





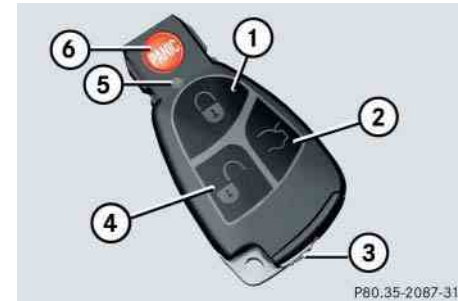

The SmartKey provides an extended operating range. To prevent theft, however, it is advisable to only unlock the vehicle when you are in close proximity to it.

The SmartKey centrally locks and unlocks

- the doors
- the trunk
- the fuel filler flap



#### SmartKey with remote control

- ①  Lock button
- ②  Unlock button for the trunk lid
- ③  Mechanical key locking tab
- ④  Unlock button
- ⑤  Battery check lamp
- ⑥  PANIC button (▷ page 84)

### Warning!



When leaving the vehicle, always remove the SmartKey from the starter switch, take it with you and lock the vehicle. Do not leave children unattended in the vehicle, or with access to an unlocked vehicle. It is possible for children to open a locked door from the inside, which could result in an accident and/or serious personal injury.



To prevent possible malfunction, avoid exposing the SmartKey to high levels of electromagnetic radiation.



USA only:

This device complies with Part 15 of the FCC Rules. Operation is subject to the following two conditions:

- (1) This device may not cause harmful interference, and

- (2) this device must accept any interference received, including interference that may cause undesired operation.

Any unauthorized modification to this device could void the user's authority to operate the equipment.



Canada only:

This device complies with RSS-210 of Industry Canada. Operation is subject to the following two conditions:

- (1) This device may not cause interference, and
- (2) this device must accept any interference received, including interference that may cause undesired operation of the device.

Any unauthorized modification to this device could void the user's authority to operate the equipment.

## Controls in detail

### Locking and unlocking



The SBC brake system is activated (▷ page 90).



You can also open and close the power windows (▷ page 218) and tilt/sliding sunroof\* (▷ page 223) or tilt/sliding panel\* (▷ page 229) using the SmartKey.

### Factory setting

#### Global unlocking

- ▶ Press button

All turn signal lamps flash once. The locking knobs in the doors move up. The anti-theft alarm system is disarmed.

## Controls in detail

### Locking and unlocking

The vehicle will lock again automatically and reactivate the anti-theft alarm system within approximately 40 seconds of unlocking if:

- neither door nor trunk is opened
- the SmartKey is not inserted in the starter switch
- the central locking switch is not activated



#### **Global locking**

- ▶ Press button .

All turn signal lamps flash three times. The locking knobs in the doors move down. The anti-theft alarm system is armed.

#### **Selective setting**

If you frequently travel alone, you may wish to reprogram the SmartKey so that pressing  only unlocks the driver's door and the fuel filler flap.

- ▶ Press and hold buttons  and  simultaneously for about five seconds until battery check lamp  flashes twice.

The SmartKey will then function as follows:

#### **Unlocking driver's door and fuel filler flap**

- ▶ Press button  once.

All turn signal lamps flash once. The locking knob in the driver's door moves up. The anti-theft alarm system is disarmed.

#### **Global unlocking**

- ▶ Press button  twice.



All turn signal lamps flash once. The locking knobs in the doors move up. The anti-theft alarm system is disarmed.

#### **Global locking**

- ▶ Press button .

All turn signal lamps flash three times. The locking knobs in the doors move down. The anti-theft alarm system is armed.

#### **Restoring to factory setting**

- ▶ Press and hold buttons  and  simultaneously for about six seconds until battery check lamp  flashes twice.





If you can no longer lock or unlock the vehicle with the SmartKey, then either the batteries in the SmartKey are discharged, the SmartKey is malfunctioning or the vehicle battery is drained.

- Check the batteries in the SmartKey (▷ page 101) and replace them if necessary (▷ page 415).
- Use the mechanical key to unlock the driver's door (▷ page 410).
- Have the vehicle batteries and their connections checked.
- Use the mechanical key to lock the driver's door (▷ page 410).

If the SmartKey is malfunctioning, contact an authorized Mercedes-Benz Center.

### Checking the batteries

- ▶ Press button  or .

Battery check lamp  comes on briefly to indicate that the SmartKey batteries are in order.





If battery check lamp  does not come on briefly during check, then the SmartKey batteries are discharged.

Replace the batteries (▷ page 415).

You can obtain the required batteries at any authorized Mercedes-Benz Center.



If the batteries are checked within signal range of the vehicle, pressing the button  or  will lock or unlock the vehicle accordingly.

## Controls in detail

### Locking and unlocking

#### Unlocking and opening the trunk lid

You can unlock and open the trunk separately.

A minimum height clearance of 5.90 ft (1.80 m) is required to open the trunk lid.

- ▶ Press and hold button  until trunk unlocks and begins to open.



The trunk lid swings open upwards automatically. Always make sure there is sufficient overhead clearance.

Vehicles with trunk lid opening/closing system\*: to stop the opening procedure, press button  on the SmartKey. The trunk lid stops moving.

The trunk can also be opened from its inside in an emergency, see "Trunk lid emergency release" (▷ page 117).

## Controls in detail

### Locking and unlocking



If the vehicle was previously centrally locked, the trunk will lock automatically after closing it. The turn signals flash three times to confirm locking.

#### Loss of SmartKey or mechanical key

If you lose a SmartKey or mechanical key, you should do the following:

- ▶ Have the SmartKey deactivated by an authorized Mercedes-Benz Center.
- ▶ Report the loss of the SmartKey or the mechanical key immediately to your car insurance company.
- ▶ If necessary, have the mechanical lock replaced.

Your authorized Mercedes-Benz Center will be glad to supply you with a replacement.

#### SmartKey with KEYLESS-GO\*

Specially equipped vehicles come with two SmartKeys with KEYLESS-GO, each with remote control and a removable mechanical key. The locking tabs for the mechanical key portion of the two SmartKeys with KEYLESS-GO are a different color to help distinguish each SmartKey with KEYLESS-GO unit.

The function of the SmartKey overrides the KEYLESS-GO function.

The KEYLESS-GO function is integrated into the SmartKey. On these vehicles, the validity of the SmartKey with KEYLESS-GO is checked every time you grasp a door handle.

If the SmartKey with KEYLESS-GO is valid, your vehicle unlocks

- the doors
- the trunk lid
- the fuel filler flap

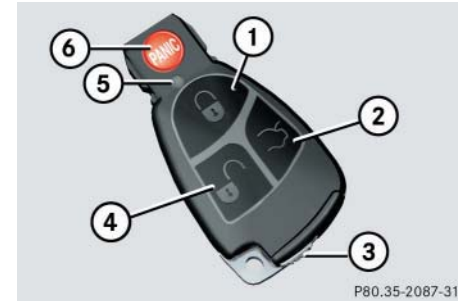

P80.35-2087-31

#### SmartKey with KEYLESS-GO

- ① Lock button
- ② Unlock button for the trunk lid
- ③ Mechanical key locking tab
- ④ Unlock button
- ⑤ Battery check lamp
- ⑥ PANIC button (▷ page 84)



When any outside door handle other than the driver's outside door handle is grasped, the vehicle is centrally unlocked.



### Warning!



When leaving the vehicle, always take the SmartKey with KEYLESS-GO with you, and lock the vehicle. Do not leave children unattended in the vehicle, or with access to an unlocked vehicle. It is possible for children to open a locked door from the inside, which could result in an accident and/or serious personal injury.



To prevent possible malfunction, avoid exposing the SmartKey with KEYLESS-GO to high levels of electromagnetic radiation.



USA only:

This device complies with Part 15 of the FCC Rules. Operation is subject to the following two conditions:

- (1) This device may not cause harmful interference, and
- (2) this device must accept any interference received, including interference that may cause undesired operation.

Any unauthorized modification to this device could void the user's authority to operate the equipment.



Canada only:

This device complies with RSS-210 of Industry Canada. Operation is subject to the following two conditions:

- (1) This device may not cause interference, and
- (2) this device must accept any interference received, including interference that may cause undesired operation of the device.

Any unauthorized modification to this device could void the user's authority to operate the equipment.



If the vehicle has been parked for a longer period of time, you must grasp the outside door handle in order to activate the KEYLESS-GO function.

## Controls in detail

### Locking and unlocking

## Controls in detail

### Locking and unlocking



You can also open and close the power windows (▷ page 218) and tilt/sliding sunroof\* (▷ page 223) or tilt/sliding panel\* (▷ page 229) using the SmartKey.



When you unlock the vehicle, the SBC brake system is activated (▷ page 90).

#### Important notes on using KEYLESS-GO

- You can also use the SmartKey with KEYLESS-GO like a normal SmartKey (▷ page 98).
- You can combine KEYLESS-GO functions with normal SmartKey functions (e.g. unlocking with KEYLESS-GO and locking with the  button).
- Always carry the SmartKey with KEYLESS-GO with you.
- Never store the SmartKey with KEYLESS-GO together with:
  - electronic items such as a cellular phone or another SmartKey with KEYLESS-GO
  - metallic objects such as coins or metal foil

Doing so could impair the function of the KEYLESS-GO system.

- To lock or unlock the vehicle, the SmartKey with KEYLESS-GO must be located outside the vehicle within approximately 3 ft (1 m) of a door or the trunk.
- In order to start the engine with the SmartKey with KEYLESS-GO:
  - The SmartKey with KEYLESS-GO must be located in the vehicle.
  - All the doors must be closed.
  - The brake pedal must be firmly depressed. Do not depress the accelerator.
- If you have started the engine with the KEYLESS-GO start/stop button (▷ page 36), you can only turn it off again with this button, even if you have put the SmartKey in the starter switch in the meantime.

This does not apply if, after starting, the selector lever is still in position **P** and then the SmartKey is inserted in the starter switch. The SmartKey will then have priority over the KEYLESS-GO

function and the vehicle's electrical system will operate according to the position of the SmartKey in the starter switch, even stopping the engine.

- If the SmartKey with KEYLESS-GO is positioned farther away from the vehicle, the system may no longer recognize the SmartKey with KEYLESS-GO. The vehicle cannot be locked or the engine started via the KEYLESS-GO system.
- If the SmartKey with KEYLESS-GO is removed from the vehicle while the ignition is switched on (e.g. if passenger exits the vehicle with the SmartKey with KEYLESS-GO), the message *Key not recognized* will appear in the multifunction display while driving off.

Find the SmartKey or change its present location immediately (e.g. place it on the front passenger seat or insert it in shirt pocket).

- Remember that the engine can be started by anyone with a SmartKey with KEYLESS-GO that is left inside the vehicle. If you leave the SmartKey with KEYLESS-GO behind when exiting and locking the vehicle, the message *Key still in vehicle* will appear in the multifunction display.

#### Factory setting

#### Global unlocking

- ▶ Grasp the outside door handle.

All turn signal lamps flash once. The locking knobs in the doors move up. The anti-theft alarm system is disarmed.

The vehicle will lock again automatically and reactivate the anti-theft alarm system within approximately 40 seconds if:

- neither door nor trunk is opened
- the central locking switch is not activated.

## Controls in detail

### Locking and unlocking



The vehicle could be inadvertently unlocked if the SmartKey with KEYLESS-GO is within 3 ft (1 m) of the vehicle and

- the outside door handle is splashed with water, or
- you attempt to clean the outside door handle.

#### Global locking

- ▶ Press lock button at the outside door handle (▷ page 58) or trunk lid (▷ page 107).



All turn signal lamps flash three times. The locking knobs in the doors move down. The anti-theft alarm system is armed.

## Controls in detail

### Locking and unlocking

#### Selective setting

If you frequently travel alone, you may wish to reprogram the SmartKey with KEYLESS-GO so when you grasp the driver's door handle only the driver's door and the fuel filler flap unlocks.

- ▶ Press and hold buttons  and  simultaneously for about five seconds until battery check lamp  flashes twice.

The SmartKey with KEYLESS-GO will then function as follows:

#### *Unlocking driver's door and fuel filler flap*

- ▶ Press button  once.  
All turn signal lamps flash once. The locking knob in the driver's door moves up. The anti-theft alarm system is disarmed.



#### *Global unlocking*

- ▶ Press button  twice.  
All turn signal lamps flash once. The locking knobs in the doors move up. The anti-theft alarm system is disarmed.

#### *Global locking*

- ▶ Press button .  
All turn signal lamps flash three times. The locking knobs in the doors move down. The anti-theft alarm system is armed.

#### *Restoring to factory setting*

- ▶ Press and hold buttons  and  simultaneously for about six seconds until battery check lamp  flashes twice.





If you can no longer lock or unlock the vehicle with the SmartKey with KEYLESS-GO, then the batteries in the SmartKey are discharged, the SmartKey with KEYLESS-GO is malfunctioning or the vehicle battery is drained.

- Check the batteries in the SmartKey with KEYLESS-GO (▷ page 107) and replace them if necessary (▷ page 415).
- Use the mechanical key to unlock the driver's door (▷ page 410).
- Have the vehicle battery checked by an authorized Mercedes-Benz Center.
- Use the mechanical key to lock the driver's door (▷ page 410).

If the SmartKey with KEYLESS-GO is malfunctioning, contact an authorized Mercedes-Benz Center.

### Checking the batteries

- ▶ Press button  or .

Battery check lamp  comes on briefly to indicate that the SmartKey batteries are in order.





If battery check lamp  does not come on briefly during check, then the SmartKey batteries are discharged.

Replace the batteries (▷ page 415).

You can obtain the required batteries at any authorized Mercedes-Benz Center.



If the batteries are checked within signal range of the vehicle, pressing the button  or  will lock or unlock the vehicle accordingly.

### Global locking using the lock button at trunk lid



To prevent a possible inadvertent lock-out, the trunk will open automatically if a SmartKey with KEYLESS-GO is recognized inside the vehicle or in the trunk.



 Lock button at trunk lid

- ▶ Press lock button at trunk lid .

All turn signal lamps flash three times. The locking knobs in the doors move down. The anti-theft alarm system is armed.

## Controls in detail

### Locking and unlocking



If the vehicle was previously centrally locked with KEYLESS-GO, the trunk will lock automatically after closing it. The turn signals flash three times to confirm locking.



You can also lock the vehicle using the lock button at outside door handle (▷ page 105) or KEYLESS-GO locking/closing switch (▷ page 116).

## Controls in detail

### Locking and unlocking

#### Unlocking and opening the trunk lid

You can unlock and open the trunk lid separately.

A minimum height clearance of 5.90 ft (1.80 m) is required to open the trunk lid.

The handle is located in the rear license plate recess.



- ▶ Pull on the handle  
or
- ▶ Press and hold button  until the trunk lid unlocks and opens.



The trunk lid swings open upwards automatically. Always make sure there is sufficient overhead clearance.

Vehicles with trunk lid opening/closing system\*: to stop the opening procedure, press button  on the SmartKey with KEYLESS-GO. The trunk lid stops moving.



If the vehicle was previously centrally locked with KEYLESS-GO, the trunk will lock automatically after closing it. The turn signals flash three times to confirm locking.

#### Loss of the SmartKey with KEYLESS-GO

If you lose your SmartKey with KEYLESS-GO, you should do the following:

- ▶ Have the SmartKey with KEYLESS-GO deactivated by an authorized Mercedes-Benz Center.
- ▶ Report the loss immediately to your car insurance company.
- ▶ Have the mechanical lock replaced if necessary.

Your authorized Mercedes-Benz Center will be glad to supply you with a replacement.

## Controls in detail

### Locking and unlocking

#### Opening the doors from the inside

You can open a locked door from the inside. Open door only when conditions are safe to do so.

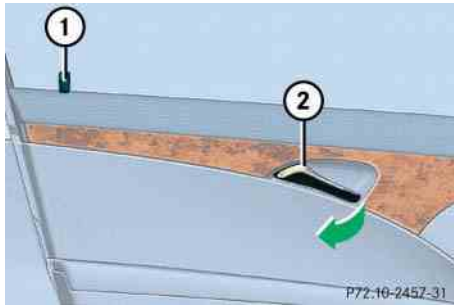

- ① Locking knob
- ② Inside door handle

#### Front doors

- ▶ Pull on door handle ② on the respective front or rear door to open door.

If door was locked, locking knob ① will move up.



#### Rear doors

- ▶ Pull up locking knob ① on the respective rear door to unlock door.
- ▶ Pull on door handle ② on the respective rear door to open door.

#### i

If the vehicle has previously been locked from the outside with the SmartKey, opening a door from the inside will trigger the anti-theft alarm system.

To cancel the alarm, do one of the following:

- Press button  or  on the SmartKey.
- Insert the SmartKey in the starter switch.

In vehicles with KEYLESS-GO\*

- Press the KEYLESS-GO\* start/stop button (▷ page 35).

The SmartKey with KEYLESS-GO must be inside the vehicle.

- Grasp the outside door handle.

The SmartKey with KEYLESS-GO must be within 3 ft (1 m) of the vehicle.

## Controls in detail

### Locking and unlocking

#### Opening the trunk

##### Opening the trunk from the outside

A minimum height clearance of 5.90 ft (1.80 m) is required to open the trunk lid.

The handle is located above the rear license plate recess.

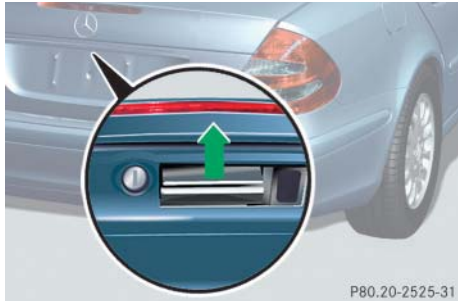

In vehicles without KEYLESS-GO\*: The vehicle must be unlocked.

- Pull on the handle.  
The trunk lid opens.



The trunk lid swings open upwards automatically. Always make sure there is sufficient overhead clearance.



The trunk can also be opened using the button  on the SmartKey or SmartKey with KEYLESS-GO\* or from its inside in an emergency, see “Trunk lid emergency release” (▷ page 117).



If the vehicle was previously centrally locked, the trunk will lock automatically after closing it. The turn signals flash three times to confirm locking.

#### Opening the trunk from the inside

You can open the trunk from the inside if the vehicle is stationary.

A minimum height clearance of 5.90 ft (1.80 m) is required to open the trunk lid.

The switch is located on the driver's door.

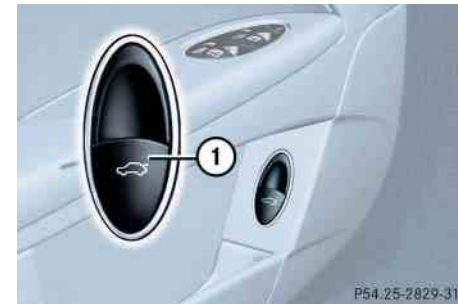

- ① Remote trunk lid switch with indicator lamp



## Controls in detail

### Locking and unlocking

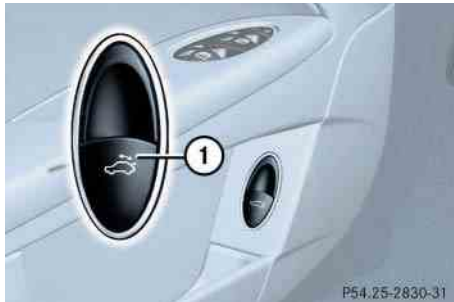

① Remote trunk lid switch with indicator lamp (vehicles with trunk lid opening/closing system\*)

- ▶ Pull remote trunk lid switch ① until the trunk begins to open.

The trunk lid opens. The indicator lamp in the switch comes on and remains lit until the trunk is closed.



The trunk lid swings open upwards automatically. Always make sure there is sufficient overhead clearance.

Vehicles with trunk lid opening/closing system\*: To stop the opening procedure, press or pull remote trunk lid switch ①.



The trunk can also be opened using the button  on the SmartKey or SmartKey with KEYLESS-GO\* or from its inside in an emergency, see “Trunk lid emergency release” (▷ page 117).

#### Limiting opening height of trunk lid\*

Vehicles with trunk lid opening/closing system\*:

The trunk lid opening height can be limited when transporting goods on a roof rack (e.g. presence of an optional MB sport luggage container). When activated, the trunk lid opens to approximately the height of the roof edge.

- ▶ Activate the limiting opening height of trunk lid using the control system (▷ page 166).

## Controls in detail

### Locking and unlocking

#### Closing the trunk

##### Closing the trunk from the inside automatically\*

In vehicles with trunk lid opening/closing system\* you can close the trunk from the inside using the remote trunk lid switch.

- ▶ Press remote trunk lid switch (▷ page 111) until the indicator lamp in the switch goes out and the trunk lid is closed.

To interrupt the closing procedure:

- ▶ Release the remote trunk lid switch.



You can also close the trunk by hand.

#### Warning!



Maintain sight of trunk area while operating the door mounted switch. Monitor the closing procedure carefully to make sure that no one is in danger of being injured.

To interrupt the closing procedure, release the door mounted remote trunk lid switch.

Even with the SmartKey or SmartKey with KEYLESS-GO\* removed from the starter switch or the SmartKey with KEYLESS-GO\* removed from the vehicle, the remote trunk lid switch can be operated. Therefore, do not leave children unattended in the vehicle, or with access to an unlocked vehicle. Unsupervised use of vehicle equipment may cause an accident and/or serious personal injury.

#### Warning!



Only drive with the trunk closed as, among other dangers such as visibility blockage, exhaust fumes may enter the vehicle interior.

If the trunk lid comes into contact with an object while closing (e.g. luggage that has been piled too high), the closing procedure is stopped and the trunk reopens slightly.

### Closing the trunk from the outside manually

Depending on production date, your vehicle is equipped with either trunk design A or B.



#### Trunk design A

- ① Handle
- ▶ Lower trunk lid by pulling firmly on handle ①.
- ▶ Close trunk lid with hands placed flat on trunk lid.

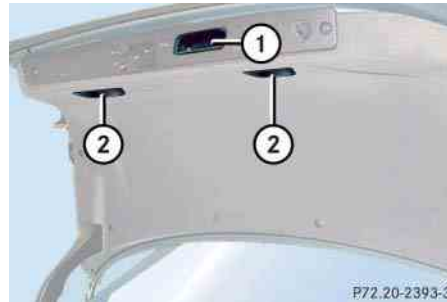

#### Trunk design B

- ① Handle
- ② Handles
- ▶ Lower trunk lid by pulling firmly on handle ① or handles ②.
- ▶ Close trunk lid with hands placed flat on trunk lid.

## Controls in detail

### Locking and unlocking

#### Warning!



To prevent possible personal injury, always keep hands and fingers away from the trunk opening when closing the trunk. Be especially careful when small children are around.

When leaving the vehicle, always remove the SmartKey or SmartKey with KEYLESS-GO\* from the starter switch, take it with you, and lock the vehicle. Do not leave children unattended in the vehicle, or with access to an unlocked vehicle. Unsupervised use of vehicle equipment may cause an accident and/or serious personal injury.

#### Warning!



Only drive with the trunk closed as, among other dangers such as visibility blockage, exhaust fumes may enter the vehicle interior.

## Controls in detail

### Locking and unlocking



Do not place the SmartKey in the open trunk. You may lock yourself out.

Vehicles with KEYLESS-GO\*:  
To prevent a possible inadvertent lock-out, the trunk lid will open automatically if a SmartKey with KEYLESS-GO is recognized inside the vehicle or in the trunk.



If the vehicle was previously centrally locked, the trunk lid will lock automatically after closing it (▷ page 112). The turn signals will flash three times to confirm locking.

#### Closing the trunk from the outside (vehicles without KEYLESS-GO\*)

In vehicles with trunk lid opening/closing system\* you can close the trunk separately from the outside using the trunk lid closing switch.



① Trunk lid closing switch

- ▶ Press trunk lid closing switch ① briefly.

The trunk lid closes.



You can also close the trunk by hand.

If the trunk lid comes into contact with an object while closing (e.g. luggage that has been piled too high), the closing procedure is stopped and the trunk lid reopens slightly.

#### Warning!



Monitor the closing procedure carefully to make sure no one is in danger of being injured. To prevent possible personal injury, always keep hands and fingers away from the trunk opening when closing the trunk. Be especially careful when small children are around. To stop the closing procedure, do one of the following:

- press the trunk lid closing switch ①
- press the  button on the SmartKey
- press the remote trunk lid switch (on the driver's door)

Even with the SmartKey removed from the starter switch, the remote trunk lid switch can be operated. Therefore, do not leave children unattended in the vehicle, or

with access to an unlocked vehicle. Unsupervised use of vehicle equipment may cause an accident and/or serious personal injury.

### Warning!



Only drive with the trunk closed as, among other dangers such as visibility blockage, exhaust fumes may enter the vehicle interior.



Do not place the SmartKey in the open trunk. You may lock yourself out.



If the vehicle was previously centrally locked, the trunk lid will lock automatically after closing it (▷ page 112). The turn signals will flash three times to confirm locking.

### Closing the trunk from the outside (vehicles with KEYLESS-GO\*)

In vehicles with trunk lid opening/closing system\* you can close the trunk separately from the outside using the trunk lid closing switch.



① Trunk lid closing switch

- ▶ Make sure you have the SmartKey with KEYLESS-GO with you.
- ▶ Press trunk lid closing switch ① briefly.  
The trunk lid closes.

## Controls in detail

### Locking and unlocking



You can also close the trunk by hand.

If the trunk lid comes into contact with an object while closing (e.g. luggage that has been piled too high), the closing procedure is stopped and the trunk reopens slightly.



To prevent a possible inadvertent lock-out, the trunk lid will open automatically if a SmartKey with KEYLESS-GO is recognized inside the vehicle or in the trunk.

## Controls in detail

### Locking and unlocking

#### Warning!



Monitor the closing procedure carefully to make sure no one is in danger of being injured. To prevent possible personal injury, always keep hands and fingers away from the trunk opening when closing the trunk. Be especially careful when small children are around. To stop the closing procedure, do one of the following:

- press the trunk lid closing switch ①
- press the  button on the SmartKey with KEYLESS-GO
- press the remote trunk lid switch (on the driver's door)

Even with the SmartKey with KEYLESS-GO removed from the vehicle, the trunk lid closing switch can be operated. Therefore, do not leave children unattended in the vehicle, or with access to an unlocked vehicle. Unsupervised use of vehicle equipment may cause an accident and/or serious personal injury.

#### Warning!



Only drive with the trunk closed as, among other dangers such as visibility blockage, exhaust fumes may enter the vehicle interior.



If the vehicle was previously centrally locked, the trunk lid will lock automatically after closing it (▷ page 112). The turn signals will flash three times to confirm locking.

#### Closing the trunk and locking the vehicle from the outside (vehicles with KEYLESS-GO\*)

In vehicles with trunk lid opening/closing system\* and KEYLESS-GO, you can close the trunk lid and lock the vehicle simultaneously from the outside using the KEYLESS-GO locking/closing switch.



#### ① KEYLESS-GO locking/closing switch

You can close the trunk lid and lock the vehicle simultaneously.

- Make sure you have the SmartKey with KEYLESS-GO with you.

- Press switch ① briefly.

The vehicle is locked and the trunk lid closes automatically. The turn signals flash three times to confirm locking. The locking knobs in the doors move down. The anti-theft alarm system is armed.



You can also close the trunk by hand.

If the trunk lid comes into contact with an object while closing (e.g. luggage that has been piled too high), the closing procedure is stopped and the trunk reopens slightly.



To prevent a possible inadvertent lock-out, the trunk lid will open automatically if a SmartKey with KEYLESS-GO is recognized inside the vehicle or in the trunk.

### Warning!



Monitor the closing procedure carefully to make sure no one is in danger of being injured. To prevent possible personal injury, always keep hands and fingers away from the trunk opening when closing the trunk. Be especially careful when small children are around. To stop the closing procedure, do one of the following:

- press KEYLESS-GO locking/closing switch ①
- press the  button on the SmartKey with KEYLESS-GO
- press the remote trunk lid switch (on the driver's door)

Even with the SmartKey with KEYLESS-GO removed from the vehicle, the KEYLESS-GO locking/closing switch can be operated. Therefore do not leave children unattended in the vehicle, or with access to an unlocked vehicle. Unsupervised use of vehicle equipment may cause an accident and/or serious personal injury.

## Controls in detail

### Locking and unlocking

### Warning!



Only drive with the trunk closed as, among other dangers such as visibility blockage, exhaust fumes may enter the vehicle interior.

### Trunk lid emergency release

The emergency release button is located on the inside of the trunk lid.



① Emergency release button

## Controls in detail

### Locking and unlocking

- ▶ Briefly press emergency release button ①.

The trunk unlocks and the trunk lid opens.



The emergency release button unlocks and opens the trunk while the vehicle is standing still or in motion.

Illumination of the emergency release button:

- The button will flash for 30 minutes after opening the trunk.
- The button will flash for 60 minutes after closing the trunk.





The emergency release button does not open the trunk lid, if the vehicle battery is discharged or disconnected.



If the emergency release button is pressed and the vehicle was centrally locked from the outside using the SmartKey, the exterior lamps will flash and the alarm will sound as the trunk lid opens.

To cancel the alarm, do one of the following:

- Insert the SmartKey in the starter switch.
- Press button  or  on the SmartKey.

In vehicles with KEYLESS-GO\*

- Grasp the outside door handle.

The SmartKey with KEYLESS-GO must be within 3 ft (1 m) of the vehicle.

- Press the KEYLESS-GO\* start/stop button (▷ page 35).

The SmartKey with KEYLESS-GO must be inside the vehicle.

### Automatic central locking

The doors and the trunk automatically lock when the ignition is switched on and the wheels are turning at vehicle speeds of approximately 9 mph (15 km/h) or more.

You can open a locked door from the inside. Open door only when conditions are safe to do so.



The doors unlock automatically after an accident if the force of the impact exceeds a preset threshold.

The vehicle automatically locks when the ignition is switched on and the wheels are turning at vehicle speeds of approximately 9 mph (15 km/h) or more. You could therefore lock yourself out when the vehicle

- is pushed or towed
- is on a test stand



For more information on towing the vehicle, see the “Practical hints” section (▷ page 439).

You can deactivate the automatic locking mode using the control system (▷ page 166).

### Locking and unlocking from the inside

You can lock or unlock the doors and the trunk from inside using the central locking switch. This can be useful, for example, if you want to lock the vehicle before starting to drive.

The fuel filler flap cannot be locked or unlocked with the central locking switch.

#### Warning!



When leaving the vehicle, always remove the SmartKey or the SmartKey with KEYLESS-GO\* from the starter switch, take it with you, and lock the vehicle. Do not leave children unattended in the vehicle, or with access to an unlocked vehicle. Unsupervised use of vehicle equipment may cause an accident and/or serious personal injury.

## Controls in detail

### Locking and unlocking

The switch is located in the center console.



#### Central locking switch

- ① Locking
- ② Unlocking

#### Locking

- ▶ Press upper half ① of the central locking switch.

If all doors are closed, the vehicle locks.

## Controls in detail

### Locking and unlocking

#### Unlocking

- ▶ Press lower half ② of the central locking switch.

The vehicle unlocks.



You can open a locked door from the inside. Open door only when conditions are safe to do so.

If the vehicle was previously centrally locked using the SmartKey, it will not unlock using the central locking switch.

If the vehicle was previously locked with the central locking switch

- while in the selective remote control mode, only the front door opened from the inside is unlocked.
- while in the global remote control mode, the vehicle is unlocked completely when a front door is opened from the inside.

## ▼ Seats

For more information on seat adjustment, see the “Getting started” section (▷ page 38).

### Easy-entry/exit feature

This feature allows for easier entry into and exit from the vehicle.

The easy-entry/exit feature can be activated or deactivated in the Convenience sub-menu of the control system (▷ page 167).

#### Warning!



You must make sure no one can become trapped or injured by the moving steering wheel and driver's seat when the easy-entry/exit feature is activated.

To cancel seat/steering wheel movement, do one of the following:

- Press seat adjustment switch (▷ page 30).
- Move steering column stalk (▷ page 40).
- Press one of the memory position buttons (▷ page 131).

Do not leave children unattended in the vehicle, or with access to an unlocked vehicle. Children could open the driver's door and unintentionally activate the easy-entry/exit feature, which could result in an accident and/or serious personal injury.

## Controls in detail

### Seats

When exiting the vehicle, with the easy-entry/exit feature activated and depending on your selection, the steering wheel tilts upwards and/or the driver's seat moves a few inches to the rear when you:

- remove the SmartKey from the starter switch,  
or
- open the driver's door with the SmartKey in starter switch position **0** or **1** or the KEYLESS-GO\* start/stop button (▷ page 35) in position **1**.

## Controls in detail

### Seats



If the current position for the steering wheel is in the uppermost tilt position, the steering wheel will no longer be able to move upward when the easy-entry/exit feature is activated.

If the current seat position falls into a factory-set position range and the system recognizes the current seat position to be rearward enough for easy entry and exit, the driver's seat will not move to the rear when the easy-entry/exit feature is activated.

When entering the vehicle, with the easy-entry/exit feature activated, the steering wheel or, depending on your selection, the steering wheel and driver's seat will return to their last set memory position or a factory-set maximum forward position when you:

- close the driver's door with the ignition switched on
- insert the SmartKey in starter switch or press the KEYLESS-GO\* start/stop button (▷ page 35) once with the driver's door closed.



For safety reasons, the driver's seat will not return to its last set position with the easy-entry/exit feature activated if the system recognizes the last set position as an extreme forward position. Instead, the driver's seat will remain at or move to a factory-set maximum forward position. To again fully return the driver's seat to your last set position or to memory position, adjust the seat to the desired position or press and hold the respective memory position button (▷ page 131).

### Removing and installing front seat head restraints

For more information on head restraint adjustment, see the “Getting started” section (▷ page 39).

#### Warning!



For your protection, drive only with properly positioned head restraints.

Adjust head restraint so that the center of the head restraint supports the back of the head at eye level. This will reduce the potential for injury to the head and neck in the event of an accident or similar situation.

Do not drive the vehicle without the seat head restraints. Head restraints are intended to help reduce injuries during an accident.



Tilt the backrest to the rear for easier removal and installation of the head restraints.

#### Front seat head restraints

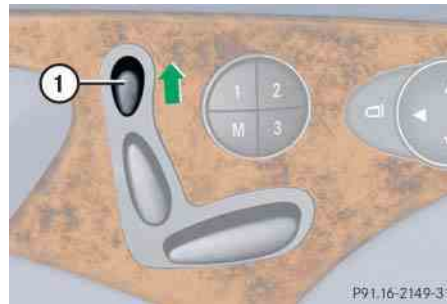

#### Removing front head restraints

- ▶ Press switch ① upwards and hold until the head restraint is fully extended.
- ▶ Pull out head restraint.

#### Installing front head restraints:

- ▶ Press switch ① upwards and hold for about five seconds.
- ▶ Push the head restraint down until it engages.
- ▶ Adjust head restraint to desired position (▷ page 39).

## Controls in detail

### Seats

#### Rear seat head restraints



The rear seat head restraints cannot be adjusted.

#### Folding head restraints back with switch in the center console

The rear seat head restraints can be folded backward for increased visibility.



① Head restraint release switch

► Switch on the ignition (▷ page 33).

► Press the symbol-side on rocker switch ① to release the head restraints.

The head restraints will fold backward.

#### Warning!



For safety reasons, always drive with the rear head restraints in the upright position when the rear seats are occupied.

Keep the area around head restraints clear of articles (e.g. clothing) to not obstruct the folding operation of the head restraints.

#### Placing head restraints upright



► Pull the head restraint forward until it locks into position.



Make sure the head restraints engage when placing them upright. Otherwise their protective function cannot be assured.

### Removing and installing rear seat head restraints

**Warning!**



For your protection, drive only with properly positioned head restraints.

Adjust head restraint so that the head restraint supports the back of the head at eye level. This will reduce the potential for injury to the head and neck in the event of an accident or similar situation.

Do not drive the vehicle without the seat head restraints. Head restraints are intended to help reduce injuries during an accident.

Do not interchange head restraints from front and rear seat.

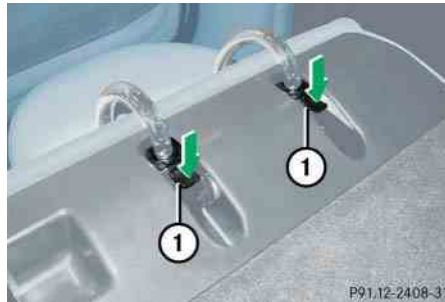

① Release catch

#### Removing rear seat head restraints

- ▶ Fold the backrest forward (▷ page 257).
- ▶ Fold back head restraint (▷ page 124).
- ▶ Press head restraint release catch ① and pull the head restraints out of the guides.
- ▶ Fold the backrest back to its original position.

#### Installing rear seat head restraints



When installing the head restraints, make sure that:

- you place the correct head restraint on the middle seat. It is marked with the letter “M” on the outside of the metal bars.
- the head restraints engage fully.

## Controls in detail

### Seats

#### Drive-Dynamic seat\* with multicontour features

The Drive-Dynamic seat automatically adjusts the lateral support provided by the backrest to your driving style.

The Drive-Dynamic seat electronically controls the air pressure in the air chambers of the backrest side bolsters. This function improves driving comfort and pleasure.

Additional the Drive-Dynamic seat has a movable seat cushion and inflatable air cushions built into the backrest to provide additional lumbar and side support.

The seat cushion movement, backrest cushion height and curvature can be continuously varied with switches on the right side of the seat after turning the SmartKey in the starter switch to position **2** or pressing the KEYLESS-GO\* start/stop button twice.

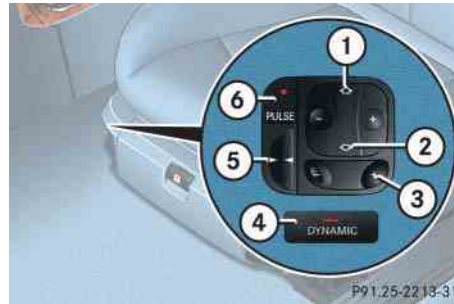

- ① Backrest center
- ② Backrest bottom
- ③ Seat cushion depth
- ④ Activate drive dynamic function
- ⑤ Backrest side bolsters
- ⑥ Massage function

► Switch on the ignition (▷ page 33).

#### Multicontour features

##### Seat cushion depth

- Adjust the seat cushion depth to the length of your upper leg using switch ③.

##### Backrest contour

- Adjust the contour of the backrest to the desired position using **+** or **-**.
- Move the backrest support to the bottom by using button ② or to the center by using button ①.

##### Backrest side bolsters

- Adjust the side bolsters so that they provide good lateral support using switch ⑤.



#### Drive-dynamic features

##### Activating

- ▶ Press button ④ (▷ page 126).

The indicator lamp in the button comes on for five seconds and the following display appears in the multi-function display for about five seconds.



You can adjust the characteristics of the Drive-Dynamic seat using the control system (▷ page 169).

##### Deactivating

- ▶ Press button ④ (▷ page 126) again.

The indicator lamp in the button goes out.



When the engine is turned off, the last cushion setting is retained in memory. The cushion is automatically adjusted to this setting when the engine is restarted.

##### Massage function (PULSE)

The massage function can help prevent muscle tension during long drives.

- ▶ Press button ⑥ (▷ page 126).

The indicator lamp in button ② comes on. The air cushions in the lumbar area pulsate.



The massage function turns off automatically after approximately five minutes.

#### Seat heating\*

Both switches for the front seats are located in the center console. The red indicator lamps in the switch come on to show which heating level you have selected.

Level	
off	No indicator lamps on
1	One indicator lamp on
2	Two indicator lamps on The seat heater automatically switches to level 1 after approximately ten minutes.
3	Three indicator lamps on The seat heater automatically switches to level 2 after approximately five minutes.

## Controls in detail

### Seats



① Seat heating switch

- ▶ Switch on the ignition (▷ page 33).

#### Switching seat heating on

- ▶ Press button ① repeatedly until the desired heating level is set.

One or more red indicator lamps on the switch show the selected heater level.

#### Switching seat heating off

- ▶ Press button ① repeatedly until all indicator lamps go out.



The seat heating will be automatically switched off after approximately 20 minutes.



If one or more of the lamps on the seat heater switch are flashing, there is insufficient voltage available since too many electrical consumers are turned on. The seat heater switches off automatically.

The seat heater will switch back on again automatically as soon as sufficient voltage is available.

#### Seat ventilation\*

The switch is located on the center console. Seat ventilation can be activated manually with the ignition on, or by the summer opening feature (▷ page 220).

The blue indicator lamps on the switch show the ventilation level selected:

Level	
3	Three indicator lamps on
2	Two indicator lamps on
1	One indicator lamp on
off	No indicator lamp on



① Seat ventilation switch

- ▶ Switch on the ignition (▷ page 33).

#### Switching seat ventilation on

- ▶ Press button ① repeatedly until the desired ventilation level is set.

#### Switching seat ventilation off

- ▶ Press button ① repeatedly until all indicator lamps go out.



The seat ventilation is automatically set to the highest level if activated via summer opening feature (▷ page 220).



If one or all of the lamps flash on the seat ventilation switch, there is insufficient voltage due to too many electrical consumers being switched on. The seat ventilation switches off automatically.

The seat ventilation will switch back on again automatically as soon as sufficient voltage is available.

## Controls in detail

### Memory function



Prior to operating the vehicle, the driver should check and adjust the seat height, seat position fore and aft, and seat backrest angle if necessary, to ensure adequate control, reach and comfort. The head restraint should also be adjusted for proper height. See also the section on air bags (> page 61) for more information on proper seat positioning.

In addition, adjust the steering wheel to ensure adequate control, reach, operation and comfort. Both the interior and exterior rear view mirrors should be adjusted for adequate rear vision.

Fasten seat belts. Infants and small children should be seated in a properly secured restraint system that complies with U.S. Federal Motor Vehicle Safety Standards 213 and 225 and Canadian Motor Vehicle Safety Standards 213 and 210.2.

You can store up to three different settings for each SmartKey or SmartKey with KEYLESS-GO\*.

The following settings are stored when using the buttons on the driver's door:

- Driver's seat, backrest, head restraint position and settings for multicontour seat
- Steering wheel position
- Exterior rear view mirror positions

These SmartKey-dependent memory settings can be deactivated if desired. For information on SmartKey-dependent memory settings, see "Setting SmartKey-dependency" (> page 168).

The following settings are not SmartKey-dependent. They are stored when using the buttons on the front passenger door:

- Front passenger seat, backrest, head restraint position and settings for multicontour seat

#### Warning!



Do not activate the memory function while driving. Activating the memory function while driving could cause the driver to lose control of the vehicle.

## Controls in detail

### Memory function

The memory button and stored position button are located on the door.



**M** Memory button

**1, 2, 3** Stored position button

▶ Switch on the ignition (▷ page 33).

or

▶ Open the respective door and insert the SmartKey in the starter switch.

#### Storing positions into memory

- ▶ Adjust the seats, steering wheel and exterior rear view mirrors to the desired position (▷ page 37).
- ▶ Press memory button **M**.
- ▶ Release memory button **M** and press stored position button **1**, **2** or **3** within three seconds.

All the settings are stored to the selected position.

#### Recalling positions from memory



Do not operate the power seats using the memory button if the seat backrest is in an excessively reclined position. Doing so could cause damage to front or rear seats.

- ▶ Press and hold stored position button **1**, **2** or **3** until the seat, steering wheel and exterior rear view mirrors have completely moved to the stored positions.



Releasing the stored position button stops movement to the stored positions immediately.

## Controls in detail

### Memory function

#### Storing exterior rear view mirror parking position

For easier parking, you can adjust the passenger-side exterior rear view mirror so that you can see the right rear wheel as soon as you engage reverse gear **R**.

For information on activating the parking position, see “Activating exterior rear view mirror parking position” (▷ page 187).



You can store a parking position for the passenger side exterior rear view mirror for each SmartKey or SmartKey with KEYLESS-GO\*.

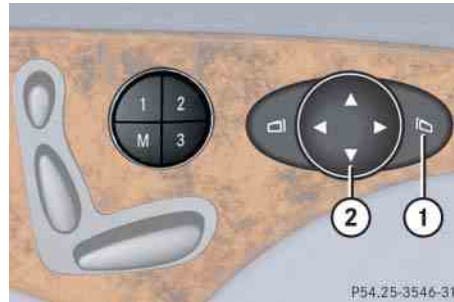

① Passenger side, exterior rear view mirror

② Adjustment button

- ▶ Stop the vehicle.
- ▶ Switch on the ignition (▷ page 33).
- ▶ Press button ①.

The passenger-side exterior rear view mirror is selected.

- ▶ Adjust the exterior rear view mirror with button ② so that you see the rear wheel and the road curb.
- ▶ Press memory button **M**.
- ▶ Within three seconds, press bottom of adjustment button ②.

The parking position is stored if the mirror does not move.



If the mirror does move, repeat the above steps. After the setting is stored, you can move the mirror again.

## ▼ Lighting

For information on how to switch on the headlamps and use the turn signals, see “Switching on headlamps” (▷ page 50) and see “Turn signals” (▷ page 51).



If you drive in countries where vehicles drive on the other side of the road than the country where the vehicle is registered, you must have the headlamps modified for symmetrical low beams. Relevant information can be obtained at your authorized Mercedes-Benz Center.

### Exterior lamp switch

The exterior lamp switch is located on the dashboard to the left of the steering wheel.



### Exterior lamp switch

- 0** Off  
Daytime running lamp mode  
(▷ page 134)
- AUTO** Automatic headlamp mode  
Daytime running lamp mode  
(▷ page 134)
- P** Parking lamps (also tail lamps, license plate lamps, side marker lamps, instrument panel lamps)

## Controls in detail

### Lighting

- Low beam headlamps (or high beam headlamps when the combination switch is pushed forward) and parking lamps.
- Standing lamps, right (turn left one stop)
- Standing lamps, left (turn left two stops)
- Indicator lamp for front fog lamps
- Indicator lamp for rear fog lamp



With the SmartKey removed from the starter switch or the engine turned off with KEYLESS-GO\* and the driver's door open a warning sounds if the parking lamps or low beam headlamps are switched on.

The message *Switch off lamps* appears in the multifunction display.

## Controls in detail

### Lighting

#### Manual headlamp mode

The low beam headlamps and the parking lamps can be switched on and off with the exterior lamp switch.

#### Automatic headlamp mode

The following lamps switch on and off automatically depending on the brightness of the ambient light:

- Low beam headlamps
- Tail and parking lamps
- License plate lamps
- Side marker lamps



#### Warning!



If the exterior lamp switch is set to **AUTO**,

- the headlamps may switch off unexpectedly when the system senses bright ambient light, for example light from oncoming traffic.
- the headlamps will not be automatically switched on under foggy conditions.

To minimize risk to you and to others, activate headlamps by turning exterior lamp switch to  when driving or when traffic and/or ambient lighting conditions require you to do so.

In low ambient lighting conditions, only switch from position **AUTO** to  with the vehicle at a standstill. Switching from **AUTO** to  will briefly switch off the headlamps. Doing so while driving in low ambient lighting conditions may result in an accident.

The automatic headlamp feature is only an aid to the driver. The driver is responsible for the operation of the vehicle's lights at all times.

- ▶ Turn the exterior lamp switch to position **AUTO**.

With the SmartKey in starter switch position **1** or the KEYLESS-GO\* start/stop button once, only the parking lamps will switch on and off automatically.

When the engine is running, the low beam headlamps, the tail and parking lamps, the license plate lamps, and the side marker lamps will switch on and off automatically.

#### Daytime running lamp mode

- ▶ Turn the exterior lamp switch to position **0** or **AUTO**.

When the engine is running, the low beam headlamps are automatically switched on.

In low ambient light conditions the parking lamps will also switch on:

- Tail and parking lamps
- License plate lamps
- Side marker lamps

For nighttime driving you should turn the exterior lamp switch to position  to permit activation of the high beam headlamps.





With the daytime running lamp mode activated and the exterior lamp switch in position **0**, the high beam headlamps cannot be switched on.



The high beam flasher is available at all times.

#### **Canada only:**

The daytime running lamp mode is mandatory and therefore in a constant mode.

When the engine is running, and you shift from a driving position to position **N** or **P**, the low beam headlamps will switch off with a three-minute delay.

When the engine is running, and you

- turn the exterior lamp switch to position , the parking lamps switch on additionally.
- turn the exterior lamp switch to position , the manual headlamp mode has priority over the daytime running lamp mode.



The corresponding exterior lamps switch on (▷ page 50).

## Controls in detail

### Lighting

#### **USA only:**

By default, the daytime running lamp mode is deactivated. Activate the daytime running lamp mode using the control system, see “Setting daytime running lamp mode (USA only)” (▷ page 162).

When the engine is running, and you turn the exterior lamp switch to position  or , the manual headlamp mode has priority over the daytime running lamp mode.

The corresponding exterior lamps switch on (▷ page 50).

## Controls in detail

### Lighting



#### Locator lighting and night security illumination

Locator lighting and night security illumination are described in the “Control system” section, see (▷ page 163) and (▷ page 164).

#### Fog lamps

##### Warning!



In low ambient lighting or foggy conditions, only switch from position **AUTO** to  with the vehicle at a standstill. Switching from **AUTO** to  will briefly switch off the headlamps. Doing so while driving in low ambient lighting conditions may result in an accident.



Fog lamps will operate with the parking lamps and/or the low beam headlamps on. Fog lamps should only be used in conjunction with low beam headlamps. Consult your State or Province Motor Vehicle Regulations regarding permissible lamp operation.



Fog lamps cannot be switched on with the exterior lamp switch in position **AUTO**. For switching on the fog lamps, turn the exterior lamp switch to position .

#### Front fog lamps

▶ Switch on the low beam headlamps (▷ page 50).

▶ Pull out exterior lamp switch to first stop.

The front fog lamps are switched on.

The green indicator lamp  in the exterior lamp switch comes on (▷ page 133).

▶ Push in the exterior lamp switch.

The front fog lamps are switched off.

The green indicator lamp  in the exterior lamp switch goes out.

#### Rear fog lamp (driver's side only)

- ▶ Switch on the low beam headlamps (▷ page 50).
- ▶ Pull out exterior lamp switch to second stop.

The yellow indicator lamp  in the exterior lamp switch comes on (▷ page 133).

- ▶ Push in the exterior lamp switch to first stop.

The rear fog lamp switches off.

The yellow indicator lamp  in the exterior lamp switch goes out.

The front fog lamps remain lit.

#### Combination switch

The combination switch is located on the left side of the steering column.

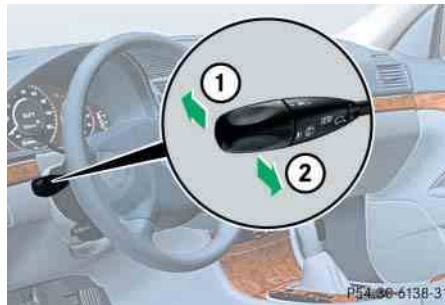

#### Combination switch

- ① High beam
- ② High beam flasher

#### High beam

- ▶ Turn the exterior lamp switch to position  or **AUTO** (▷ page 133).
- ▶ Push the combination switch in direction of arrow ① to switch on the high beam.

The high beam headlamp indicator lamp  in the instrument cluster comes on (▷ page 24).

- ▶ Pull the combination switch in direction of arrow ② to its original position to switch off the high beam.

The high beam headlamp indicator lamp  in the instrument cluster goes out.

#### High beam flasher

- ▶ Pull the combination switch briefly in direction of arrow ②.

## Controls in detail

### Lighting

#### Hazard warning flasher

The hazard warning flasher can be switched on at all times, even with the SmartKey removed from the starter switch or with the SmartKey with KEYLESS-GO\* removed from the vehicle.

The hazard warning flasher switches on automatically when an air bag deploys.

The hazard warning flasher switch is located on the center console.



① Hazard warning flasher switch

#### Switching on hazard warning flasher

- ▶ Press the hazard warning flasher switch ①.

All turn signals are flashing.



With the hazard warning flasher activated and the combination switch set for either left or right turn, only the respective left or right turn signals will operate when the ignition is switched on.

#### Switching off hazard warning flasher

- ▶ Press hazard warning flasher switch ① again.



If the hazard warning flasher has been activated automatically, press hazard warning flasher switch ① once to switch off.

#### Interior lighting in the front



- ① Left front reading lamp on/off
- ② Rear interior lighting on/off
- ③ Automatic control on/off
- ④ Front interior lighting on/off
- ⑤ Right front reading lamp on/off
- ⑥ Ambient lighting
- ⑦ Interior lighting
- ⑧ Front reading lamp

The controls are located in the overhead control panel.



Leaving an interior light switch in the ON position for extended periods of time with the engine turned off could result in a discharged battery.

#### Automatic control

##### Activating

- ▶ Press automatic control switch ③.

The Interior lighting switches on in darkness, when you:

- unlock the vehicle
- remove the SmartKey from the starter switch
- open a door
- open the trunk

The interior lighting switches off automatically following an adjustable time delay.

For more information, see “Setting interior lighting delayed shut-off” (▷ page 165).



If the door remains open, the interior lamps switch off automatically after approximately five minutes.

##### Deactivating

- ▶ Press automatic control switch ③ again.

The interior lighting remains switched off in darkness, even when you:

- unlock the vehicle
- remove the SmartKey from the starter switch
- open a door
- open the trunk

## Controls in detail

### Lighting

#### Manual control

##### *Front interior lighting*

- ▶ Press front interior lighting switch ④.  
The front interior lighting switches on.
- ▶ Press front interior lighting switch ④ again.  
The front interior lighting switches off.

##### *Rear interior lighting*

- ▶ Press rear interior lighting switch ②.  
The rear interior lighting switches on.
- ▶ Press rear interior lighting switch ② again.  
The rear interior lighting switches off.



The setting selected for the interior lighting is used for the trunk lighting as well.

If the trunk lid remains open, the trunk lighting switches off automatically after approximately ten minutes.

#### Front reading lamps

The front reading lamps are located in lower edge of the interior rear view mirror.

- ▶ Press front reading lamp switch ① or ⑤ to switch on the desired front reading lamp.
- ▶ Press front reading lamp switch ① or ⑤ again to switch off the respective front reading lamp.

#### Door entry lamps

For better orientation in the dark, the corresponding door entry lamps will switch on in darkness when you open a door and the automatic control is activated.

The door entry lamps will switch off when the corresponding door is closed.



If you turn the SmartKey in the starter switch to position **0** and switch off the headlamps, the door entry lamps will remain lit for approximately five minutes.

#### Interior lighting in the rear

The overhead control panel is located above the rear seat bench.

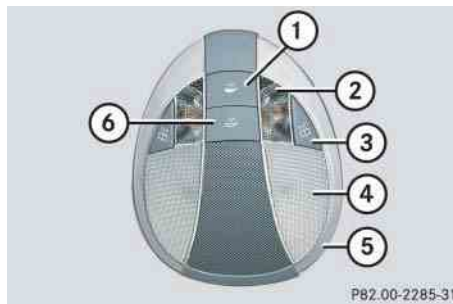

- ① Ambient lighting switch, to brighten
- ② Rear reading lamp
- ③ Rear reading lamp on/off
- ④ Rear interior lamp
- ⑤ Ambient lighting
- ⑥ Ambient lighting switch, to dim

#### Rear reading lamps

- ▶ Press desired rear reading lamp switch ③ to switch on the corresponding rear reading lamp.
- ▶ Press respective rear reading lamp switch ③ again to switch off the corresponding rear reading lamp.

#### Ambient lighting

- ▶ Press ambient lighting switch ① or ⑥ repeatedly until ambient lighting ⑤ has reached the desired intensity.

You can switch the ambient lighting on and off, using the Control system (▷ page 165).

#### Trunk lamp

The trunk lamp switches on if the trunk lid is opened.

If the trunk lid remains open, the trunk lighting switches off automatically after approximately ten minutes.

## Controls in detail

### Instrument cluster

A full view illustration of the instrument cluster can be found in the “At a glance” section of this manual (▷ page 24).

The instrument cluster is activated when you

- open a door
- turn on the ignition
- press the reset button (▷ page 24)
- switch on the exterior lamps

You can change the instrument cluster settings in the instrument cluster submenu of the control system (▷ page 157).

#### Instrument cluster illumination

Use the reset button (▷ page 24) to adjust the illumination brightness for the instrument cluster.



The instrument cluster illumination is dimmed or brightened automatically to suit ambient light conditions.

The instrument cluster illumination will also be adjusted automatically when you switch on the vehicle’s exterior lamps.

#### To brighten illumination

- ▶ Turn the reset button in the instrument cluster clockwise (▷ page 24).

The instrument cluster illumination will brighten.

#### To dim illumination

- ▶ Turn the reset button in the instrument cluster counterclockwise (▷ page 24).

The instrument cluster illumination will dim.



#### Coolant temperature indicator

##### Warning!



- Driving when your engine is overheated can cause some fluids which may have leaked into the engine compartment to catch fire. You could be seriously burned.
- Steam from an overheated engine can cause serious burns and can occur just by opening the hood. Stay away from the engine if you see or hear steam coming from it.

Turn off the engine, get out of the vehicle and do not stand near the vehicle until the engine has cooled down.





Excessive coolant temperature trigger a warning in the multifunction display (▷ page 361).

During severe operating conditions, e.g. stop-and-go traffic, the coolant temperature may rise close to 248°F (120°C).

The engine should not be operated with the coolant temperature above 248°F (120°C). Doing so may cause serious engine damage which is not covered by the Mercedes-Benz Limited Warranty.

#### Trip odometer

Make sure you are viewing the trip odometer display (▷ page 145).

- ▶ If it is not displayed, press the  or  repeatedly until the trip odometer appears.
- ▶ Press and hold the reset button on the instrument cluster (▷ page 24) until the trip odometer is reset.

## Controls in detail

### Instrument cluster

#### Tachometer

The red marking on the tachometer denotes excessive engine speed.



Avoid driving at excessive engine speeds, as it may result in serious engine damage that is not covered by the Mercedes-Benz Limited Warranty.

To help protect the engine, the fuel supply is interrupted if the engine is operated within the red marking.

#### Outside temperature indicator

##### Warning!



The outside temperature indicator is not designed to serve as an ice-warning device and is therefore unsuitable for that purpose.

Indicated temperatures just above the freezing point do not guarantee that the road surface is free of ice. The road may still be icy, especially in wooded areas or on bridges.

The outside temperature is displayed in the instrument cluster (▷ page 24). For information on how to select the unit of the displayed temperature, i.e. degrees Celsius (°C) or degrees Fahrenheit (°F), see “Selecting temperature display mode” (▷ page 157).

The temperature sensor is located in the front bumper area. Due to its location, the sensor can be affected by road or engine heat during idling or slow driving. This means that the accuracy of the displayed temperature can only be verified by comparison to a thermometer placed next to the sensor, not by comparison to external displays (e.g. bank signs etc.).

When moving the vehicle into colder ambient temperatures (e.g. when leaving your garage), you will notice a delay before the lower temperature is displayed.

A delay also occurs when ambient temperatures rise. This prevents inaccurate temperature indications caused by heat radiated from the engine during idling or slow driving.

## Controls in detail

### Control system

#### ▼ Control system

The control system is activated as soon as the SmartKey in the starter switch is turned to position **1** or as soon as the KEYLESS-GO start/stop button\* is in position **1**. The control system enables you to:

- call up information about your vehicle
- change vehicle settings.

For example, you can use the control system to find out when your vehicle is next due for service, to set the language for messages in the instrument cluster display, and much more.



The displays for the audio systems (radio, CD player) will appear in English, regardless of the language selected.

#### Warning!



A driver's attention to the road and traffic conditions must always be his/her primary focus when driving.

For your safety and the safety of others, selecting features through the multifunction steering wheel should only be done by the driver when traffic and road conditions permit it to be done safely.

Bear in mind that at a speed of just 30 mph (approximately 50 km/h), your vehicle is covering a distance of 44 feet (approximately 14 m) every second.

The control system relays information to the multifunction display.

#### Multifunction display



- ① Outside temperature
- ② Trip odometer
- ③ Automatic transmission program mode
- ④ Main odometer
- ⑤ Current gear selector lever position

Above illustration shows the standard display.

For more information on menus displayed in the multifunction display, see “Menus” (▷ page 148).

## Controls in detail

### Control system

#### Multifunction steering wheel

The displays in the multifunction display and the settings in the control system (▷ page 145) are controlled by the buttons on the multifunction steering wheel.

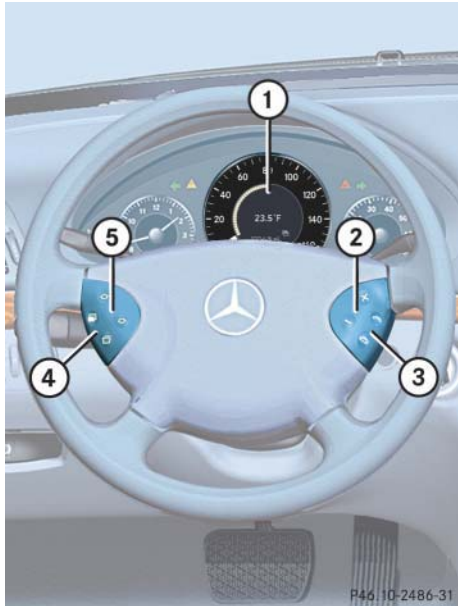

- ① Multifunction display in the speedometer

#### Operating the control system

- ② Selecting the submenu or setting the volume:  
Press button

 up/to increase

 down/to decrease

- ③ Telephone\*:  
Press button

 to take a call

 to end a call

- ④ Menu systems:  
Press button

 for next menu

 for previous menu

- ⑤ Moving within a menu:  
Press button

 for next display





 for previous display

Pressing any of the buttons on the multifunction steering wheel will alter what is shown in the multifunction display.

The information available in the multifunction display is arranged in menus, each containing a number of functions or sub-menus.

The individual functions are then found within the relevant menu (radio or CD operations under *Audio*, for example). These functions serve to call up relevant information or to customize the settings for your vehicle.

It is helpful to think of the menus, and the functions within each menu, as being arranged in a circular pattern.

- If you press button  or  repeatedly, you will pass through each menu one after the other.
- If you press button  or  repeatedly, you will pass through each function display, one after the other, in the current menu.

In the *Settings* menu, instead of functions you will find a number of submenus for calling up and changing settings. For instructions on using these submenus, see the “Settings menu” section (▷ page 154).

The number of menus available in the system depends on which optional equipment is installed in your vehicle.

The menus are described on the following pages.

## Controls in detail

### Control system

#### Menus

This is what you will see when you scroll through the menus.

The table on the next page provides an overview of the individual menus.

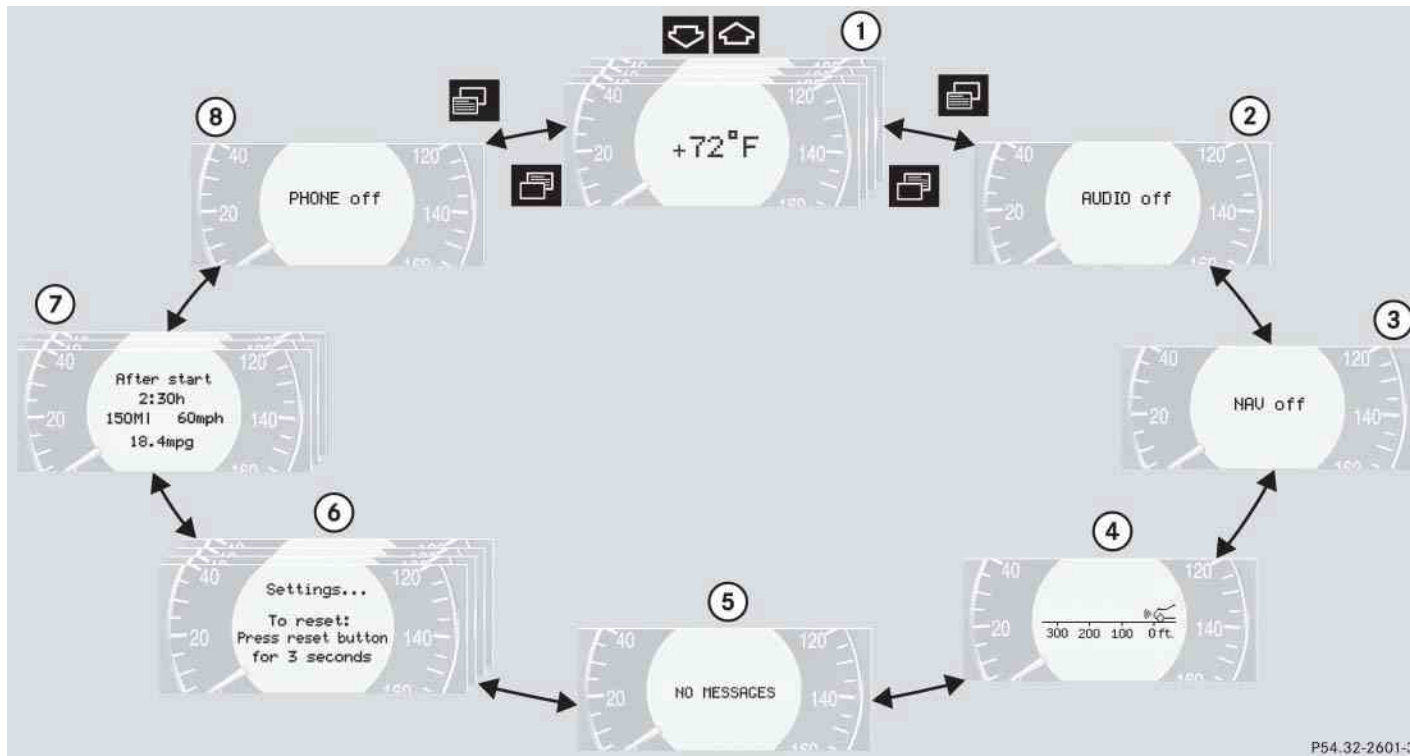

**Menus, submenus and functions**

	<b>Menu ①</b>	<b>Menu ②</b>	<b>Menu ③</b>	<b>Menu ④</b>	<b>Menu ⑤</b>	<b>Menu ⑥</b>	<b>Menu ⑦</b>	<b>Menu ⑧</b>
	<b>Standard display</b>	<b>AUDIO</b>	<b>NAV*</b>	<b>Distronic*</b>	<b>Vehicle status message memory</b>	<b>Settings</b>	<b>Trip computer</b>	<b>Telephone</b>
	(▷ page 150)	(▷ page 150)	(▷ page 152)	(▷ page 152)	(▷ page 153)	(▷ page 154)	(▷ page 170)	(▷ page 171)
<b>Commands/submenus</b>	Digital speedometer	Select radio station	Activate route guidance	Call up settings	Call up vehicle malfunction, warning and system status messages stored in memory	Reset to factory settings	Fuel consumption statistics after start	Load phone book
	Call up maintenance system display	Operate CD player				Instrument cluster submenu	Fuel consumption statistics since the last reset	Search for name in phone book
	Check tire pressure*					Time/Date submenu	Call up range	
	Check engine oil level					Lighting submenu Vehicle submenu Convenience submenu Dynamic seat* submenu		

## Controls in detail

### Control system



The headings used in the menus table are designed to facilitate navigation within the system and are not necessarily identical to those shown in the control system displays.

The first function displayed in each menu will automatically show you which part of the system you are in.

#### Standard display menu

You can select the functions in the standard display menu with button or .

The following functions are available:

Function	Page
Call up digital speedometer	150
Call up maintenance display	343
Check tire pressure*	322
Check engine oil level	305

#### Display digital speedometer

- ▶ Press button twice.

The current vehicle speed is shown in the multifunction display.

#### AUDIO menu

The functions in the Audio menu operate the audio equipment which you currently have turned on.

If no audio equipment is currently turned on, the message AUDIO off is shown in the display.

The following functions are available:

Function	Page
Select radio station	150
Select satellite radio station*	151
Operate CD player	151

#### Select radio station

- ▶ Turn on the radio. Refer to separate operating instructions.
- ▶ Press button or repeatedly until you see the currently tuned station in the display.

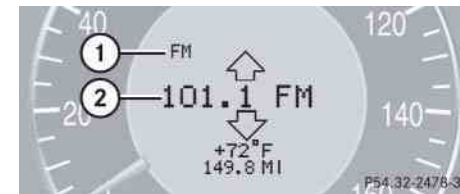

- ① Waveband setting
- ② Station frequency

- ▶ Press button or repeatedly until the desired station is found.





You can only store new stations using the corresponding feature on the radio, see separate operating instructions.

You can also operate the radio in the usual manner.

#### Select satellite radio station\*

The satellite radio is treated as a radio application.

- ▶ Select SAT radio with the corresponding softkey in the radio menu.



- ① SAT mode and preset number
- ② Setting for station selection using memory
- ③ Channel name or number

- ▶ Press button or repeatedly until the desired channel is found.



Additional optional satellite radio equipment and a subscription to satellite radio service provider are required for satellite radio operation. Contact an authorized Mercedes-Benz Center for details and availability for your vehicle.

For more information, refer to separate COMAND operating instructions.

## Controls in detail

### Control system

#### Operate the CD player

- ▶ Turn on the radio and select the CD player. Refer to separate operating instructions.
- ▶ Press button or repeatedly until the settings for the CD currently being played are shown in the display.

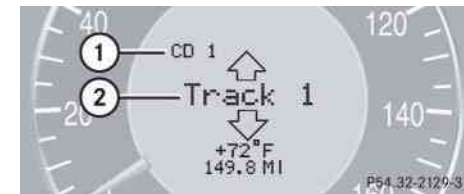

- ① Current CD (for CD changer\*)
- ② Current track

- ▶ Press button or repeatedly until the desired track is selected.





To select a CD from the magazine, press a number on the COMAND system SmartKey pad located in the center console.

## Controls in detail

### Control system

#### NAV\* menu

The Nav menu contains the functions needed to operate your navigation system.

- ▶ Press button  or  repeatedly until you see the message NAV in the display.
- If the navigation system is switched off, the message NAV off is shown in the display.
- If the navigation system is switched on, the message NAV Active is shown in the display.



Please refer to the COMAND manual for instructions on how to activate the route guidance system.

#### Distronic\* menu

Use the Distronic menu to display the current settings for your Distronic system.

What information is shown in the display depends on whether the Distronic system is active or inactive.

Please refer to the “Driving systems” section of this manual (▷ page 235) for instructions on how to activate Distronic.

- ▶ Press button  or  repeatedly until you see one of the following two pictures in the display.

#### Distronic deactivated

When Distronic is deactivated, you will see the standard display in the display.

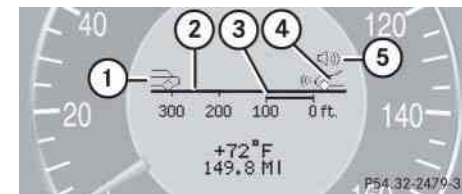

- ① Vehicle ahead, if detected
- ② Actual distance to vehicle ahead
- ③ Preset distance threshold to vehicle ahead
- ④ Your vehicle
- ⑤ Symbol for activated distance warning function

### Distronic activated

When Distronic is activated, Distronic and the set speed are seen in the display.

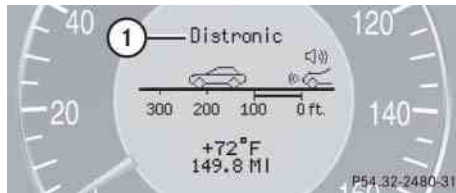

① Distronic activated

### Vehicle status message memory menu

Use the vehicle status message memory menu to scan malfunction and warning messages that may be stored in the system. Such messages appear in the multifunction display and are based on conditions or system status the vehicle's system has recorded.



#### Warning!



Malfunction and warning messages are only indicated for certain systems and are intentionally not very detailed. The malfunction and warning messages are simply a reminder with respect to the operation of certain systems and do not replace the owner's and/or driver's responsibility to maintain the vehicle's operating safety by having all required maintenance and safety checks performed on the vehicle and by bringing the vehicle to an authorized Mercedes-Benz Center to address the malfunction and warning messages (▷ page 367).

## Controls in detail

### Control system

- ▶ Press button  or  repeatedly until the vehicle status message memory appears in the multifunction display.

#### No vehicle status messages

If no conditions are recorded in memory, the message in the multifunction display is:

NO MESSAGES



#### Vehicle status messages have been recorded

If conditions have occurred, causing status messages to be recorded the number of messages appears in the multifunction display:



## Controls in detail

### Control system

- ▶ Press button  or .

The stored messages will now be displayed in the order in which they have occurred. For malfunction and warning messages, see “Vehicle status messages in the multifunction display” (▷ page 367).



Should the vehicle’s system record any conditions while driving, the number of messages will reappear in the multifunction display when the SmartKey in the starter switch is turned to position **0** or removed from the starter switch.



The vehicle status message memory will be cleared when you turn the SmartKey in the starter switch to position **1** or **2**. You will then only see high priority messages in the multifunction display (▷ page 367).

### Settings menu

In the Settings menu there are two functions:

- The function To reset: Press reset button for 3 seconds, with which you can reset all the settings to the original factory settings.
  - A collection of submenus with which you can make individual settings for your vehicle.
- ▶ Press button  or  repeatedly until the Settings menu is seen in the display.



### Resetting all settings

You can reset all the functions of all submenus to the factory settings.

- ▶ Press the reset button in the instrument cluster (▷ page 24) for approximately three seconds.

In the display you will see the request to press the reset button again to confirm.

- ▶ Press the reset button again.

The functions of all the submenus will reset to factory settings.



The settings you have changed will not be reset unless you confirm the action by pressing the reset button a second time.

#### Submenus in the Settings menu



- ▶ Press button  or .



In the display you see the collection of the submenus.





- ▶ Press button .

The selection marker moves to the next submenu.

The submenus are arranged by hierarchy. Scroll down with the  button, scroll up with the  button.

Move within the submenus with the  or  button to the individual functions.

The settings themselves are made with button  or .

#### Resetting the functions of a submenu

For each submenu you can reset all the functions to the factory settings.

- ▶ Move to a function in the submenu.
- ▶ Press the reset button (▷ page 24) in the instrument cluster for approximately three seconds.

In the display you will see the request to press the reset button again to confirm.

- ▶ Press the reset button again.

All functions of the submenu will reset to factory settings.

## Controls in detail

### Control system

The table below shows what settings can be changed within the various menus. Detailed instructions on making individual settings can be found on the following pages.

INSTRUMENT CLUSTER	TIME/DATE	LIGHTING	VEHICLE	CONVENIENCE	DYNAMIC SEAT*
Select temperature display mode	Synchronizing the time	Set daytime running lamp mode (USA only)	Set automatic locking	Activate easy-entry/exit feature	Set level for dynamic seat, driver
Select speedometer display mode	Set time (hours)	Set locator lighting	Limiting opening height of trunk lid*	Set SmartKey-dependency	Set level for dynamic seat, passenger
Select language	Set time (minutes)	Ambient lighting		Set parking position for exterior rear view mirror	
Select display (speed display or outside temperature) for status line	Set date (month)	Exterior lamps delayed shut-off			
Select display (speed display or outside temperature) for basic display	Set date (day)	Interior lighting delayed shut-off			
Tire pressure unit display*	Set date (year)				

## Controls in detail

### Control system

#### Instrument cluster submenu

Access the Instr. cluster submenu via the Settings menu. Use the Instr. cluster submenu to change the instrument cluster display settings. The following functions are available:

Function	Page
Select temperature display mode	157
Select speedometer display mode	157
Select language	158
Select display (speed display or outside temperature) for status display	158
Select display (speed display or outside temperature) for basic display	159
Tire pressure display*	159

#### Selecting temperature display mode

- ▶ Move the selection marker with the **+** or **-** button to the Instr. cluster submenu.
- ▶ Press button **↶** or **↷** repeatedly until you see this message in the display: Temp. indicator.

The selection marker is on the current setting.

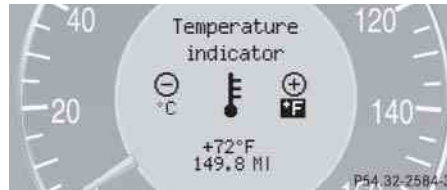

- ▶ Press button **+** or **-** to set the temperature unit to degrees Celsius (°C) or degrees Fahrenheit (°F).

#### Selecting speedometer display mode

- ▶ Move the selection marker with the **+** or **-** button to the Instr. cluster submenu.
- ▶ Press button **↶** or **↷** repeatedly until you see this message in the display: Display unit Speed-/odometer.

The selection marker is on the current setting.



- ▶ Press button **+** or **-** to set speedometer unit to km or miles.

## Controls in detail

### Control system

#### Selecting language

- ▶ Move the selection marker with the **+** or **-** button to the Instr. cluster submenu.
- ▶ Press button **▲** or **▼** repeatedly until you see this message in the display: Language.

The selection marker is on the current setting.



- ▶ Press button **+** or **-** to select the language to be used for the multi-function display messages.

Available languages:

- German
- English
- French
- Italian
- Spanish

#### Selecting display (speed display or outside temperature) for status display

- ▶ Move the selection marker with the **+** or **-** button to the Instr. cluster submenu.
- ▶ Press button **▲** or **▼** repeatedly until you see this message in the display: Status line display.

The selection marker is on the current setting.



- ▶ Press button **+** or **-** to select the status line to degrees Fahrenheit (°F) or miles.



You will see the status indicator when you have called up a different display from the standard display.



#### Selecting display (speed display or outside temperature) for basic display

- ▶ Move the selection marker with the **+** or **-** button to the Instr. cluster submenu.
- ▶ Press button **↕** or **↙** repeatedly until you see this message in the display: Basic display.

The selection marker is on the current setting.



- ▶ Press button **+** or **-** to select the display permanently shown in the multifunction display.

#### Tire pressure display\*

Use this function to set the unit for the tire pressure display.

- ▶ Move the selection marker with the **+** or **-** button to the Instr. cluster submenu.
- ▶ Press button **↕** or **↙** repeatedly until you see this message in the display: Display unit Tire pressure.

The selection marker is on the current setting.



- ▶ Press button **+** or **-** to select the desired tire pressure unit.

#### Time/Date submenu

Access the Time/Date submenu via the Settings menu. Use the Time/Date submenu to change the time and date display settings. The following functions are available:

Function	Page
Synchronizing the time	160
Set time (hours)	160
Set time (minutes)	160
Set date (month)	161
Set date (day)	161
Set date (year)	161



Information on setting the time, refer to separate COMAND instructions.

## Controls in detail

### Control system

#### *Synchronizing the time*

This function can only be seen on vehicles with COMAND and navigation module\*.

- ▶ Move the selection marker with the **+** or **-** button to the Time/Date submenu.
- ▶ Press button **↕** or **↴** repeatedly until you see this message in the display: Time sync. with head unit.

The selection marker is on the current setting.



- ▶ Press button **+** or **-** to select the desired setting.

#### *Set time (hours)*

This function can only be seen when time synchronization is switched off.

- ▶ Move the selection marker with the **+** or **-** button to the Time/Date submenu.
- ▶ Press button **↕** or **↴** repeatedly until you see this message in the display: Clock, hours.

The selection marker is on the hour setting.



- ▶ Press button **+** or **-** to set the hour.
- ▶ Confirm by pressing reset button.

#### *Set time (minutes)*

This function can only be seen when time synchronization is switched off.

- ▶ Move the selection marker with the **+** or **-** button to the Time/Date submenu.
- ▶ Press button **↕** or **↴** repeatedly until you see this message in the display: Clock, minutes.

The selection marker is on the minute setting.



- ▶ Press button **+** or **-** to set the minutes.
- ▶ Confirm by pressing reset button.

#### Set date (month)

- ▶ Move the selection marker with the **+** or **-** button to the Time/Date submenu.
- ▶ Press button **▲** or **▼** repeatedly until you see this message in the display: Set date month.

The selection marker is on the month setting.



- ▶ Press button **+** or **-** to set the month.

#### Set date (day)

- ▶ Move the selection marker with the **+** or **-** button to the Time/Date submenu.
- ▶ Press button **▲** or **▼** repeatedly until you see this message in the display: Set date day.

The selection marker is on the day setting.



- ▶ Press button **+** or **-** to set the day.

#### Set date (year)

- ▶ Move the selection marker with the **+** or **-** button to the Time/Date submenu.
- ▶ Press button **▲** or **▼** repeatedly until you see this message in the display: Set date year.

The selection marker is on the year setting.



- ▶ Press button **+** or **-** to set the year.

## Controls in detail

### Control system

#### Lighting submenu

Access the Lighting submenu via the Settings menu. Use the Lighting submenu to change the lamp and lighting settings on your vehicle. The following functions are available:

Function	Page
Set daytime running lamp mode (USA only)	162
Setting locator lighting	163
Setting night security illumination	164
Setting interior lighting delayed shut-off	165
Setting ambient lighting	165

#### Setting daytime running lamp mode (USA only)



This function is not available in countries where the daytime running lamp mode is mandatory and therefore in a constant mode.

- ▶ Move the selection marker with button **+** or **-** to the Lighting submenu.
- ▶ Press button **↶** or **↷** repeatedly until you see Lamp circuit headlamp in the multifunction display.

The selection marker is on the current setting.



- ▶ Press button **+** or **-** to select manual operation (manual) or daytime running lamp mode (constant) activated.

With daytime running lamp mode activated and the exterior lamp switch at position **0** or **AUTO** the low beam headlamps are switched on when the engine is running.

In low ambient light conditions the following lamps will switch on additionally:

- Parking lamps
- Tail lamps
- License plate lamps
- Side marker lamps

For more information on the daytime running lamp mode, see “Lighting” (▷ page 133).



For safety reasons, resetting the Lighting submenu to factory settings while driving (▷ page 154) will not deactivate the daytime running lamp mode.

The following message appears in the multifunction display: Lighting - Cannot be completely reset to factory settings while driving.

### Setting locator lighting

With the locator lighting feature activated and the exterior lamp switch in position **AUTO**, the following lamps will switch on when the vehicle is unlocked with the SmartKey or KEYLESS-GO\* during darkness:

- Parking lamps
- Tail lamps
- License plate lamps
- Side marker lamps
- Front fog lamps

The locator lighting switches off when the driver's door is opened.

If you do not open a door after unlocking with the SmartKey the lamps will switch off automatically after approximately 40 seconds.

- ▶ Move the selection marker with button **+** or **-** to the Lighting submenu.

## Controls in detail

### Control system

- ▶ Press button or repeatedly until you see Function Surround lighting in the multifunction display.

The selection marker is on the current setting.

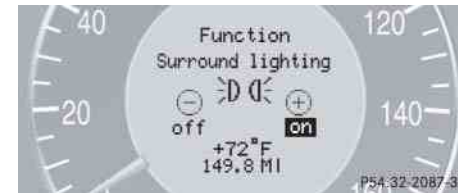

- ▶ Press button **+** or **-** to switch the locator lighting function on.
- ▶ Turn the exterior lamp switch to position **AUTO** when exiting the vehicle. The locator lighting feature is activated.

## Controls in detail

### Control system

#### Setting night security illumination (Headlamps delayed shut-off)

Use this function to set whether and how long you would like the exterior lamps to illuminate during darkness after exiting the vehicle and all doors closed.

With the delayed shut-off feature activated and the exterior lamp switch in position **AUTO** before the engine is turned off, the following lamps will switch on after you have removed the SmartKey from the starter switch or, when using KEYLESS-GO\*, open the driver's door:

- Parking lamps
- Tail lamps
- License plate lamps
- Side marker lamps
- Front fog lamps

If you do not open a door after removing the SmartKey from the starter switch, the lamps will switch off automatically after approximately 60 seconds.



You can reactivate this function within ten minutes by opening a door.

- ▶ Move the selection marker with button **+** or **-** to the Lighting submenu.
- ▶ Press button or repeatedly until you see Headlamps delayed shut-off in the multifunction display.

The selection marker is on the current setting.



- ▶ Press button **+** or **-** to select the desired lamp-on period.

- 0 sec., the delayed shut-off feature is deactivated.
- 15 sec., 30 sec., 45 sec. or 60 sec., select the desired lamp-on period.

- ▶ Turn the exterior lamp switch to position **AUTO** before turning off the engine.

The headlamps delayed shut-off feature is activated.

You can temporarily deactivate the delayed shut-off feature:

- ▶ Before exiting the vehicle, turn the SmartKey in the starter switch to position **0**.
- ▶ Then turn it to position **2** and back to position **0**.

The delayed shut-off feature is deactivated. It will reactivate as soon as you reinsert the SmartKey in the starter switch.

Vehicles with KEYLESS-GO\*:

- ▶ Press the KEYLESS-GO start/stop button on the gear selector lever (▷ page 35).

### **Setting interior lighting delayed shut-off**

Use this function to set whether and how long you would like the interior lighting to remain lit during darkness after you have removed the SmartKey from the starter switch.

- ▶ Move the selection marker with button **+** or **-** to the Lighting submenu.
- ▶ Press button **↶** or **↷** repeatedly until you see Interior lamp delayed shut-off in the multifunction display.

The selection marker is on the current setting.



- ▶ Press button **+** or **-** to select the desired lamp-on period.

You can select:

- 0 sec., the delayed shut-off feature is deactivated.
- 5 sec., 10 sec., 15 sec. or 20 sec., the interior lighting delayed shut-off feature is activated with the desired lamp-on period.

### **Setting ambient lighting**

Using this function to adjust the brightness of the ambient lighting.

- ▶ Move the selection marker with button **+** or **-** to the Lighting submenu.

## **Controls in detail**

### **Control system**

- ▶ Press button **↶** or **↷** repeatedly until you see Ambient light Level in the multifunction display.

The selection marker is on the current setting.

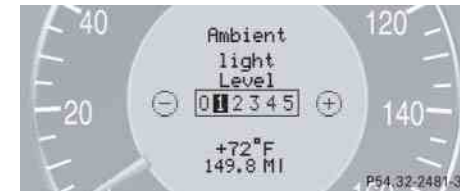

- ▶ Press button **+** or **-** to select the desired brightness of the ambient lighting.

The setting 1 represents the darkest level and setting 5 the brightest level.

The ambient light is switched off at setting 0.

## Controls in detail

### Control system

#### Vehicle submenu

Access the Vehicle submenu via the Settings menu. Use the Vehicle submenu to make general vehicle settings. The following functions are available:

Function	Page
Set automatic locking	166
Limiting opening height of trunk lid*	166

#### Setting automatic locking

Use this function to activate or deactivate the automatic central locking. With the automatic central locking system activated, the vehicle is centrally locked at vehicle speeds of approximately 9 mph (15 km/h).

- ▶ Move the selection marker with the **+** or **-** button to the Vehicle submenu.
- ▶ Press button **↕** or **↴** repeatedly until you see this message in the display: Automatic door lock.

The selection marker is on the current setting.



- ▶ Press button **+** or **-** to switch Automatic door lock on or off.

#### Limiting opening height of trunk lid\*

Use this function to activate or deactivate the limiting opening height of trunk lid.

- ▶ Move the selection marker with the **+** or **-** button to the Vehicle submenu.
- ▶ Press button **↕** or **↴** repeatedly until you see this message in the display: Opening limiter Trunk lid.

The selection marker is on the current setting.



- ▶ Press button **+** or **-** to switch Opening limiter Trunk lid On or Off.



## Convenience submenu

Access the Convenience submenu via the Settings menu. Use the Convenience submenu to change the settings for a number of convenience features. The following functions are available:

Function	Page
Activate easy-entry/exit feature	167
Set SmartKey-dependency	168
Set parking position for exterior rear view mirror	168

### Activating easy-entry/exit feature

Use this function to activate and deactivate the easy-entry/exit feature (▷ page 121).

### Warning!



You must make sure no one can become trapped or injured by the moving steering wheel and driver's seat when the easy-entry/exit feature is activated.



To cancel seat/steering wheel movement, do one of the following:

- Press seat adjustment switch (▷ page 30).
- Move steering column stalk (▷ page 40).
- Press one of the memory position buttons or the memory button **M** (▷ page 131).

Do not leave children unattended in the vehicle, or with access to an unlocked vehicle. Children could open the driver's door and unintentionally activate the easy-entry/exit feature, which could result in an accident and/or serious personal injury.

## Controls in detail

### Control system

- ▶ Move the selection marker with the **+** or **-** button to the Convenience submenu.
- ▶ Press button  or  repeatedly until you see this message in the display: Function Easy-entry feature.

The selection marker is on the current setting.

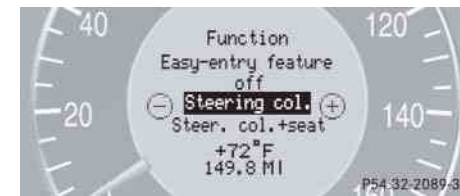

- ▶ Press button **+** or **-** to change the easy-entry/exit setting.

## Controls in detail

### Control system

The following settings are available for the easy-entry/exit feature:

off	The easy-entry/exit feature is deactivated.
Steering col.	Only the steering column is moved.
Steering col. + seat	Both the steering column and the seat are moved.

### Setting SmartKey-dependency

Use this function to set whether the memory settings for the seats, the steering wheel, the mirrors and other settings of the control system should be stored separately for each SmartKey (▷ page 98).

- ▶ Move the selection marker with the **+** or **-** button to the Convenience submenu.
- ▶ Press button **↶** or **↷** repeatedly until you see this message in the display: Key-dependent.

The selection marker is on the current setting.



- ▶ Press button **+** or **-** to set SmartKey-dependency to on or off.

### Setting parking position for exterior rear view mirror

Use the Mirror adjustment parking aid function to select whether the passenger-side exterior rear view mirror should be turned downward during parking maneuvers when reverse gear **R** is engaged. For additional information, see “Activating exterior rear view mirror parking position” (▷ page 187).

- ▶ Move the selection marker to the Convenience submenu using the **+** or **-** button.
- ▶ Press button **↶** or **↷** repeatedly until you see this message in the display: Mirror adjustment parking aid.

The selection marker is on the current setting.



- ▶ Press button **+** or **-** to switch function on or off.

#### Dynamic seat\* submenu

Access the Dynamic Seat submenu via the Settings menu. Use the Dynamic Seat submenu to change the settings for the dynamic seats. The following functions are available:

Function	Page
Adjust driver seat	169
Adjust passenger seat	169

#### Adjusting the dynamic seat

The function dynamic seat adjustment lets you determine the way the seat adjusts while driving.

- ▶ Move the selection marker with the **+** or **-** button to the Dynamic Seat submenu.
- ▶ Press button **▲** or **▼** repeatedly until you see this message in the display: Dyn. Multi-cont. Seat, driver for the driver seat or Dyn. Multi-cont. Seat, fr. pass. for the passenger seat.

The selection marker is on the current setting.



- ▶ Press button **+** or **-** to switch function Level 1 or Level 2.

## Controls in detail

### Control system

The following settings are available:

Level 1	(Comfort) Less lateral support and slow air pressure build-up in the air chambers of the backrest side bolsters
Level 2	(Sporty) Strong lateral support and fast air pressure build-up in the air chambers of the backrest side bolsters

## Controls in detail





### Control system

#### Trip computer menu

Use the trip computer menu to call up statistical data on your vehicle. The following information is available:

Function	Page
Fuel consumption statistics after start	170
Fuel consumption statistics since last reset	170
Call up range (distance to empty)	171





#### Fuel consumption statistics after start

- ▶ Press button  or  repeatedly until you see the first function of the Trip computer menu.
- ▶ Press button  or  repeatedly until you see this message in the left display: After start.



- ① Distance driven since start
- ② Time elapsed since start
- ③ Average speed since start
- ④ Average fuel consumption since start

#### Fuel consumption since last reset

- ▶ Press button  or  repeatedly until you see the first function of the Trip computer menu.
- ▶ Press button  or  repeatedly until you see this message in the display: After reset.







- ① Distance driven since last reset
- ② Time elapsed since last reset
- ③ Average speed since last reset
- ④ Average fuel consumption since last reset

#### i





All statistics stored since the last engine start will be reset approximately four hours after the SmartKey in the starter switch is turned to position **0** or removed from the starter switch.

Resetting will not occur if you turn the SmartKey back to position **1** or **2** within this time period.

### Resetting fuel consumption statistics

- ▶ Press button  or  repeatedly until you see the first function of the Trip computer menu.
- ▶ Press button  or  repeatedly until you see the reading that you want to reset in the display.
- ▶ Press and hold the reset button in the instrument cluster (▷ page 24) until the value is reset to 0.

### Call up range (distance to empty)

- ▶ Press button  or  repeatedly until you see the first function of the Trip computer menu.
- ▶ Press button  or  repeatedly until you see this message in the display: Range:

In the display you will see the calculated range based on the current fuel tank level.



### TEL menu\*

#### Warning!



A driver's attention to the road must always be his/her primary focus when driving. For your safety and the safety of others, we recommend that you pull over to a safe location and stop before placing or taking a telephone call. If you choose to use the telephone while driving, please use the hands-free device and only use the telephone when weather, road and traffic conditions permit.

## Controls in detail



### Control system

Some jurisdictions prohibit the driver from using a cellular telephone while driving a vehicle.

Bear in mind that at a speed of just 30 mph (approximately 50 km/h), your vehicle is covering a distance of 44 feet (approximately 14 m) every second.

Never operate radio transmitters equipped with a built-in or attached antenna (i.e. without being connected to an external antenna) from inside the vehicle while the engine is running. Doing so could lead to a malfunction of the vehicle's electronic system, possibly resulting in an accident and/or personal injury.

You can use the functions in the TEL menu to operate your telephone, provided it is connected to a hands-free system and switched on.

- ▶ Switch on the telephone and COMAND.
- ▶ Press button  or  on the steering wheel repeatedly until you see the Tel menu in the display.

## Controls in detail

### Control system

Which messages will appear in the display field depends on whether your telephone is switched on or off:

- If the telephone is off, the message in the multifunction display is: PHONE off.
- If the telephone is on:

The telephone will then search for a network. During this time the display is empty.

As soon as the telephone has found a network, READY appears in the display.

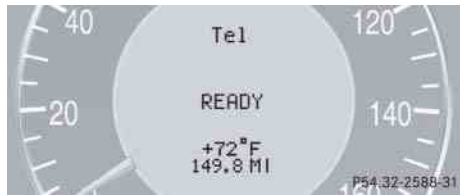

This standby message indicates that your telephone is ready for use and you can operate it using the control system.

### Answering a call

When your telephone is ready to receive calls, you can answer a call at any time. In the display you will then see the message:



- ▶ Press button .

You have answered the call. In the display you see the length of the call.



If you do not wish to accept a call, press button .



### Ending a call

- ▶ Press button .

You have ended the call. In the display you will again see the standby message.

### Dialing a number from the phone book



If your telephone is ready to receive calls, you may select and dial a number from the phone book at any time.

- ▶ Press button  or  repeatedly until you see the Tel menu in the display.

- ▶ Press button  or .



The control system reads the phone book which is stored in the telephone. This may take up to 30 seconds. In the display you will see the message Please wait.

When the message Please wait disappears, the phone book has been loaded.

- ▶ Press button  or  repeatedly until the desired name appears in the display.

The stored names are displayed in ascending or descending alphabetical order.



If you press and hold  or  for longer than one second, the system scrolls rapidly through the list of names until you release the button again.

Cancel the quick search mode by pressing .

- ▶ Press button .

The system dials the selected phone number.

- If the connection is successful, the name of the party you called and the duration of the call will appear in the display.

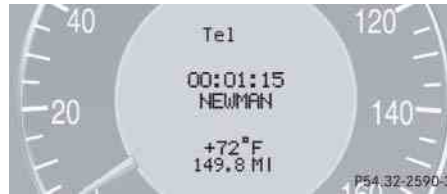



- If no connection is made, the control system stores the dialed number in the redial memory.

### Redialing

The control system stores the most recently dialed phone numbers. This eliminates the need to search through your entire phone book.



## Controls in detail

### Control system

- ▶ Press button  or  repeatedly until you see the Tel menu in the display.

- ▶ Press button .

In the display you see the first number in the redial memory.

- ▶ Press button  or  repeatedly until the desired name appears in the display.

- ▶ Press button .

The control system dials the selected phone number.

## Controls in detail

### Automatic transmission

For more information on driving with an automatic transmission, see the “Getting started” section (▷ page 46).

Your vehicle’s transmission adapts its gear shifting process to your individual driving style by continually adjusting the shift points up or down. These shift point adjustments are performed based on current operating and driving conditions.

If the operating conditions change, the automatic transmission reacts by adjusting its gear shift program.



During the brief warm-up, transmission upshifting is delayed. This allows the catalytic converter (gasoline engine) or the oxidation catalyst (Diesel engine) to reach its operating temperature earlier.

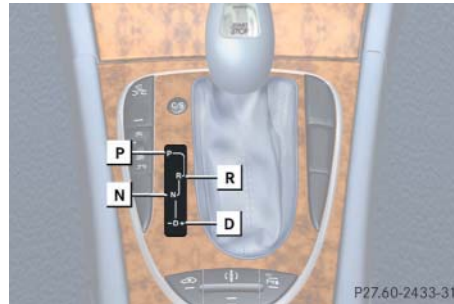

#### Gearshift pattern for automatic transmission

The automatic transmission selects individual gears automatically, depending on:

- the gear selector lever position **D** with gear ranges (▷ page 177)
- the selected program mode: **(C/S)** (▷ page 179)  
or  
**(M/C/S)** (E 55 AMG only) (▷ page 183)
- the position of the accelerator pedal (▷ page 180)
- the vehicle speed

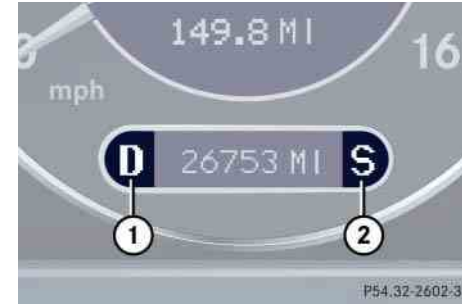

- ① Current gear range/gear selector lever position
- ② Current program mode

The current gear range/gear selector lever position and program mode (C/S) or (M/C/S) appear in the multifunction display.

An additional indication of the current gear selector lever position can be found on the cover of the shifting-gate.

The indicators come on when you activate a switch (e.g. unlocking the vehicle or opening a door) and go out after approximately 15 minutes.



### Warning!



It is dangerous to shift the gear selector lever out of **P** or **N** if the engine speed is higher than idle speed. If your foot is not firmly on the brake pedal, the vehicle could accelerate quickly forward or reverse. You could lose control of the vehicle and hit someone or something. Only shift into gear when the engine is idling normally and when your right foot is firmly on the brake pedal.



Allow engine to warm up under low load use. Do not place full load on the engine until the operating temperature has been reached.

Shift into reverse gear **R** or parking position **P** only when the vehicle is stopped.

Avoid spinning of a drive wheel for an extended period when driving off on slippery road surfaces. This may cause serious damage to the drivetrain which is not covered by the Mercedes-Benz Limited Warranty.

## Controls in detail

### Automatic transmission

When the gear selector lever is in position **D**, you can influence transmission shifting by:

- limiting the gear range
- changing gears manually

## Controls in detail

### Automatic transmission

#### One-touch gearshifting

Even with an automatic transmission you can change the gears manually when the gear selector lever is in position **D**.

#### Downshifting

- ▶ Briefly press the gear selector lever to the left in the **D-** direction.

The transmission will shift from the current gear to the next lower gear as permitted by the shift program. This action simultaneously limits the gear range of the transmission (▷ page 177).

#### Warning!



On slippery road surfaces, never downshift in order to obtain braking action. This could result in drive wheel slip and reduced vehicle control. Your vehicle's ABS will not prevent this type of loss of control.



To avoid overrevving the engine when the gear selector lever is moved to the **D-** direction, the transmission will not shift to a lower gear if the engine's max. speed would be exceeded.

#### Upshifting

- ▶ Briefly press the gear selector lever to the right in the **D+** direction.

The transmission will shift from the current gear to the next higher gear as permitted by the shift program. This action simultaneously extends the gear range of the transmission.

#### Canceling gear range limit

- ▶ Press and hold the gear selector lever in the **D+** direction until **D** reappears in the multifunction display.

The transmission will shift from the current gear range directly to gear range **D**.

#### Shifting into optimal gear range

- ▶ Press and hold the gear selector lever in the **D-** direction.

The transmission will automatically select the gear range suited for optimal acceleration and deceleration. This will involve shifting down one or more gears.

### Gear ranges

With the gear selector lever in position **D**, you can limit the transmission's gear range by pressing the gear selector lever to the left (**D-**), and reverse the gear range limit by pressing the gear selector lever to the right (**D+**).

The selected gear range appears in the multifunction display. If you press on the accelerator when the engine has reached its rpm limit, the transmission will upshift beyond any gear range limit selected.

	Effect
<b>6</b>	The transmission shifts through sixth gear only (applies only to vehicles with 7-speed automatic transmission).
<b>5</b>	The transmission shifts through fifth gear only (applies only to vehicles with 7-speed automatic transmission).
<b>4</b>	The transmission shifts through fourth gear only.
<b>3</b>	The transmission shifts through third gear only.  With this selection you can use the braking effect of the engine.

## Controls in detail

### Automatic transmission

	Effect
<b>2</b>	The transmission shifts through second gear only.  Allows the use of engine's braking power when driving <ul style="list-style-type: none"><li>• on steep downgrades</li><li>• in mountainous regions</li><li>• under extreme operating conditions</li></ul>
<b>1</b>	The transmission operates in first gear only.  For maximum use of engine's braking effect on very steep or lengthy downgrades.

## Controls in detail

### Automatic transmission

#### Gear selector lever position

	Effect
<b>P</b>	<b>Park position</b> Gear selector lever position when the vehicle is parked. Place gear selector lever in position <b>P</b> only when vehicle is stopped. The park position is not intended to serve as a brake when the vehicle is parked. Rather, the driver should always set the parking brake in addition to placing the gear selector lever in position <b>P</b> to secure the vehicle.

	Effect
	The SmartKey can only be removed from the starter switch with the gear selector lever in position <b>P</b> . With the SmartKey removed, the gear selector lever is locked in position <b>P</b> .  If the vehicle's electrical system is malfunctioning, the gear selector lever could remain locked in position <b>P</b> (▷ page 412).
<b>R</b>	<b>Reverse gear</b> Place gear selector lever in position <b>R</b> only when vehicle is stopped.

	Effect
<b>N</b>	<b>Neutral</b> No power is transmitted from the engine to the drive axle. When the brakes are released, the vehicle can be moved freely (pushed or towed).  To avoid damage to the transmission, never engage <b>N</b> while driving.  If the ESP is deactivated or malfunctioning: Move gear selector lever to <b>N</b> only if the vehicle is in danger of skidding, e.g. on icy roads.
<b>D</b>	<b>Drive</b> The transmission shifts automatically. All forward gears are available.



Coasting the vehicle, or driving for any other reason with gear selector lever in **N** can result in transmission damage that is not covered by the Mercedes-Benz Limited Warranty.

### Warning!



Getting out of your vehicle with the gear selector lever not fully engaged in position **P** is dangerous. Also, position **P** alone is not intended to or capable of preventing your vehicle from moving, possibly hitting people or objects.

Always set the parking brake in addition to shifting to position **P** (▷ page 55).

When parked on an incline, turn the front wheels towards the road curb.

Do not park this vehicle in areas where combustible materials such as grass, hay or leaves can come into contact with the hot exhaust system, as these materials could be ignited and cause a vehicle fire.

### Warning!



When leaving the vehicle, always remove the SmartKey or the SmartKey with KEYLESS-GO\* from the starter switch, take it with you, and lock the vehicle. Do not leave children unattended in the vehicle, or with access to an unlocked vehicle. Children could move the gear selector lever from position **P**, which could result in an accident and/or serious personal injury.

## Controls in detail

### Automatic transmission

#### Automatic shift programm

The program mode selector switch is located on the lower part of the center console.



① Program mode selector switch

**C** Comfort For comfort driving

**S** Sport For standard driving

The current gear selector lever position and the selected program mode (C/S) are indicated in the multifunction display (▷ page 174).

## Controls in detail

### Automatic transmission



Never change the program mode when the gear selector lever is out of position **P**. This could result in a change of driving characteristics for which you may not be prepared.



The last selected program mode (**C** or **S**) is switched on when the engine is restarted.

- ▶ Press program mode selector switch  repeatedly until the letter of the desired shift program appears in the multifunction display.

Select **C** for comfort driving:

- The vehicle starts out in second gear (both forward and reverse) for gentler starts. This does not apply if full throttle is applied or gear range **1** is selected.
- Traction and driving stability are improved on icy roads.

- Upshifts occur earlier even when you give more gas. The engine then operates at lower rpms and the wheels are less likely to spin.

### Driving tips

#### Accelerator position

Your driving style influences the transmission's shifting behavior:

- |               |                    |
|---------------|--------------------|
| Less throttle | Earlier upshifting |
| More throttle | Later upshifting   |

#### Kickdown

Use kickdown when you want maximum acceleration.

- ▶ Press the accelerator past the point of resistance.  
The transmission shifts into a lower gear.

- ▶ Ease on the accelerator when you have reached the desired speed.  
The transmission shifts up again.

### Stopping

When you stop briefly, e.g. at traffic lights:

- ▶ Leave the transmission in gear.
- ▶ Hold the vehicle with the brake.

When you stop longer with the engine idling or on an uphill gradient:

- ▶ Move the gear selector lever to position **P**.
- ▶ Set the parking brake.

### Maneuvering

When you maneuver in tight areas, e.g. when pulling into a parking space:

- ▶ Control the vehicle speed by gradually releasing the brakes.
- ▶ Accelerate gently.
- ▶ Never abruptly step on the accelerator.

## Working on the vehicle

### Warning!



When working on the vehicle, set the parking brake and move gear selector lever to position **P**. Otherwise the vehicle could roll away.

## Steering wheel gearshift control (Speedshift) E 55 AMG

When driving in the automatic program modes **C**, **S** or in the manual program mode **M** you can change the gears manually on the steering wheel or by using the gear selector lever (▷ page 176).



To avoid overrevving the engine when downshifting with steering wheel gearshift buttons, the transmission will not shift to a lower gear if the engine's max. speed would be exceeded.



Allow engine to warm up under low load use. Do not place full load on the engine until the operating temperature has been reached.

Shift into reverse gear **R** or parking position **P** only when the vehicle is stopped.

Avoid spinning of a drive wheel for an extended period when driving off on slippery road surfaces. This may cause serious damage to the drivetrain which is not covered by the Mercedes-Benz Limited Warranty.

## Controls in detail

### Automatic transmission

The steering wheel gearshift buttons are located to the left and right of the steering wheel.

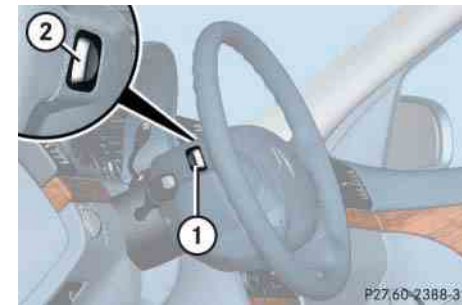

- ① Left button: downshift
- ② Right button: upshift

## Controls in detail

### Automatic transmission



You cannot shift with the steering wheel gearshift buttons when the gear selector lever is in position **P**, **N** or **R**.

The manual program mode **M** will not be stored. When the engine is turned off with the manual program mode **M** selected, the transmission will go to the automatic program mode (**C** or **S**) when the engine is restarted.

The last selected program mode (**C** or **S**) is switched on when the engine is restarted in the automatic program mode.

#### Downshifting

##### Warning!



On slippery road surfaces, never downshift in order to obtain braking action. This could result in drive wheel slip and reduced vehicle control. Your vehicle's ABS will not prevent this type of loss of control.

- ▶ Press button ① on the left side of the steering wheel.

The transmission will shift to the next lower gear as permitted by the shift program. This action simultaneously limits the gear range of the transmission (▷ page 177) when you are driving in the automatic program mode (**C** or **S**).

#### Upshifting

- ▶ Press button ② on the right side of the steering wheel.

The transmission will shift to the next higher gear as permitted by the shift program. This action simultaneously extends the gear range of the transmission when you are driving in the automatic program mode (**C** or **S**).



## Manual shift program E 55 AMG

In the manual program mode **M** you can change the gears manually on the steering wheel (▷ page 181) or by using the gear selector lever (▷ page 176).



Allow engine to warm up under low load use. Do not place full load on the engine until the operating temperature has been reached.

Shift into reverse gear **R** or parking position **P** only when the vehicle is stopped.

Avoid spinning of a drive wheel for an extended period when driving off on slippery road surfaces. This may cause serious damage to the drive train which is not covered by the Mercedes-Benz Limited Warranty.

The program mode selector switch is located on the lower part of the center console.

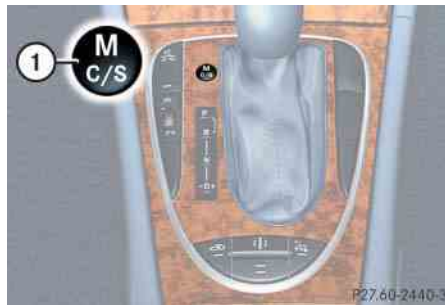

① Program mode selector switch

<b>M</b> Manual	For manual gear shifting
<b>C</b> Comfort	For comfort driving
<b>S</b> Sport	For standard driving

The current gear selector lever position and the selected program mode (M/C/S) are indicated in the multifunction display (▷ page 174).

## Controls in detail

### Automatic transmission

#### Activating manual shift program

- ▶ Press program mode selector switch ① repeatedly until the **M** for manual shift program mode **M** appears in the multifunction display.

The transmission switches to the manual program mode **M**. Automatic shifting is switched off. The gear range is not limited.

You can change the gears manually when the gear selector lever is in position **D**. You can upshift or downshift through the gears in succession.

## Controls in detail

### Automatic transmission

#### Downshifting

##### Warning!



On slippery road surfaces, never downshift in order to obtain braking action. This could result in drive wheel slip and reduced vehicle control. Your vehicle's ABS will not prevent this type of loss of control.

- ▶ Briefly press the gear selector lever to the left in the **D-** direction (▷ page 176).

or

- ▶ Press button ① on the left side of the steering wheel (▷ page 181).

The transmission shifts to the next lower gear.



When you brake or stop, the transmission shifts down to a gear from which you can easily accelerate or take off.

#### Upshifting



In the manual program mode **M**, the transmission will not upshift, even if the engine has reached its overrevving range. Shift up to the next gear before the engine has reached its overrevving range. Make absolutely certain that the engine speed does not reach the red marking on the tachometer (▷ page 24). Otherwise the engine could be damaged which is not covered by the Mercedes-Benz Limited Warranty.

- ▶ Briefly press the gear selector lever to the right in the **D+** direction (▷ page 176).

or

- ▶ Press button ② on the right side of the steering wheel (▷ page 181).

The transmission shifts to the next higher gear.

If, instead of the manual program mode symbol **M**, the  symbol appears in the multifunction display (▷ page 174), shift to the next higher gear. The fuel supply will otherwise be interrupted to prevent the engine from overrevving.

**Kickdown**

Using the kickdown when driving in the manual program mode **M** is not possible.

**Deactivating manual shift program**

- ▶ Press the program mode selector switch (▷ page 179) repeatedly until **C** or **S** appears in the multifunction display.

or

- ▶ Restart the engine.

The transmission will go to the automatic program mode (**C** or **S**).

The manual program mode **M** is not stored.

**Emergency operation  
(Limp Home Mode)**

If vehicle acceleration worsens or the transmission no longer shifts, the transmission is most likely operating in limp home (emergency operation) mode. In this mode only second gear and reverse gear can be activated.

- ▶ Stop the vehicle.
- ▶ Move gear selector lever to **P**.
- ▶ Turn off the engine.
- ▶ Wait at least ten seconds before restarting.
- ▶ Restart the engine.
- ▶ Move gear selector lever to position **D** (for second gear) or **R**.
- ▶ Have the transmission checked at an authorized Mercedes-Benz Center as soon as possible.

## Controls in detail

### Good visibility

For information on windshield wipers, see “Windshield wipers” (▷ page 51).

#### Headlamp cleaning system\*

The button is located on the left side of the dashboard.



- ① Headlamp washer button
- ▶ Switch on the ignition (▷ page 33).
  - ▶ Press button ①.

The headlamps are cleaned with a high-pressure water jet.

For more information on filling up the washer reservoir, see the “Operation” section (▷ page 310).

#### Rear view mirrors

For more information on setting the rear view mirrors, see “Mirrors” (▷ page 40).

#### Auto-dimming mirrors

The reflection brightness of the exterior rear view mirror on the driver’s side and the interior rear view mirror will respond automatically to glare when

- the ignition is switched on and
- incoming light from headlamps falls on the sensor in the interior rear view mirror.

The rear view mirrors will not react if

- reverse gear is engaged
- the interior lighting is turned on

#### Warning!



The auto-dimming function does not react if incoming light is not aimed directly at sensors in the interior rear view mirror.

The interior rear view mirror and the exterior rear view mirror on the driver’s side do not react, for example, if the rear window sunshade\* is in raised position.

Glare can endanger you and others.

#### Warning!



In the case of an accident liquid electrolyte may escape from the mirror housing if the mirror glass breaks.

Electrolyte has an irritating effect. Do not allow the liquid to come into contact with eyes, skin, clothing, or respiratory system. In case it does, immediately flush affected area with water, and seek medical help if necessary.



Electrolyte drops coming into contact with the vehicle paint finish can be completely removed only while in the liquid state by applying plenty of water.

### Warning!



Exercise care when using the passenger-side exterior rear view mirror. The mirror surface is convex (outwardly curved surface for a wider field of view). Objects in mirror are closer than they appear. Check your interior rear view mirror or glance over your shoulder before changing lanes.

### Activating exterior rear view mirror parking position

Follow these steps to activate the mirror parking position so that the passenger-side exterior rear view mirror will be turned downward to the stored position.

The buttons are located on the driver's door.

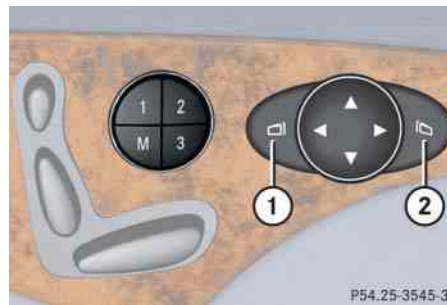

- ① Driver's side exterior rear view mirror button
  - ② Passenger-side exterior rear view mirror button
- ▶ Make sure you have stored a parking position for the passenger-side exterior rear view mirror (▷ page 132).

## Controls in detail

### Good visibility

- ▶ Make sure the Mirror adjustment parking aid function in the Convenience submenu of the control system is switched to on (▷ page 168).
- ▶ Switch on the ignition (▷ page 33).
- ▶ Press button ② for the passenger-side exterior rear view mirror.
- ▶ Place the gear selector lever in reverse gear **R**.

The passenger-side exterior rear view mirror will be turned downward to the stored position.

The exterior rear view mirror returns to its previously stored driving position:

- ten seconds after you put the gear selector lever out of position **R**
- immediately once you exceed a vehicle speed of approx. 6 mph (10 km/h)
- immediately when you press button ① for driver's side mirror.

## Controls in detail

### Good visibility

#### Sun visors

The sun visors protect you from sun glare while driving.

#### Warning!



Do not use the vanity mirror while driving. Keep the mirrors in the sun visors closed while vehicle is in motion. Reflected glare can endanger you and others.

- ▶ Swing sun visors down when you experience glare.

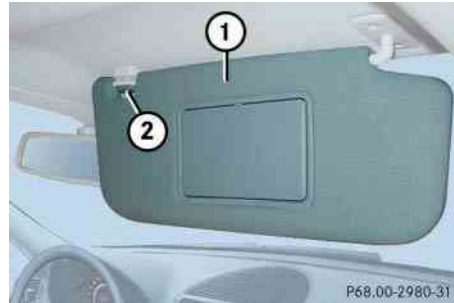

- ① Sun visor
- ② Mounting

- ▶ Swing sun visor ① down when you experience glare.

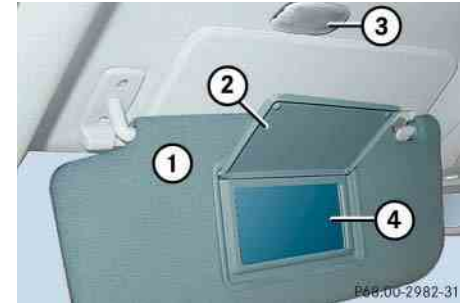

- ① Sun visor
- ② Mirror cover
- ③ Mirror lamp
- ④ Vanity mirror

- ▶ Make sure the sun visor is properly engaged in the mounting.
- ▶ Lift the mirror cover to access the mirror.
- Lamp ③ switches on.

## Controls in detail

### Good visibility

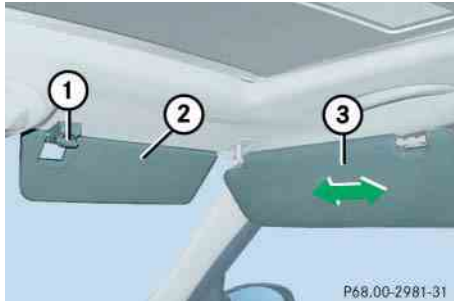

- ① Mounting
- ② Additional visor\*
- ③ Sun visor

If sunlight enters through a side window:

- ▶ Disengage sun visor from mounting ①.
- ▶ Pivot sun visor to the side.

The sun visors are extendable.

- ▶ Adjust the sun visors by pushing or pulling in the direction of the arrows.



If sunlight enters through a side window, disengage sun visor from mounting ① and pivot to the side.

Mirror lamp ③ will switch off.

#### Rear window sunshade\*

The switch is located in the center console.



- ▶ Switch on the ignition (▷ page 33).
- ▶ Press the switch briefly at ① to raise the sunshade.
- ▶ Press the switch briefly at ① to lower the sunshade.

Always raise the sunshade fully for its support against the window frame.

#### Warning!



When operating the rear window sunshade, be sure that there is no danger of anyone being harmed by the raising or lowering procedure.

The raising or lowering procedure can be immediately halted by briefly pressing switch ①. To reverse direction of movement, press switch ① again. ▷▷

## Controls in detail

### Good visibility



#### Warning!



When leaving the vehicle, always remove the SmartKey or the SmartKey with KEYLESS-GO\* from the starter switch, take it with you, and lock the vehicle. Do not leave children unattended in the vehicle, or with access to an unlocked vehicle. Unsupervised use of vehicle equipment can cause an accident and/or serious personal injury.

#### Roller sunblind\* in the rear doors

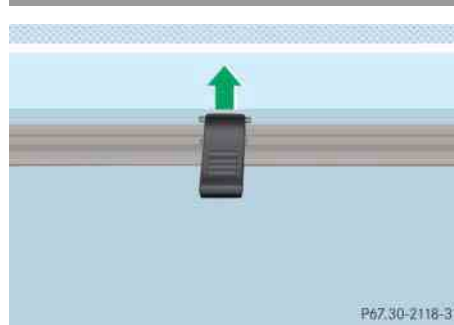

- ▶ Pull the roller sunblind out using the hooks.
- ▶ Attach the hooks at the top.





Always guide the sunblind by hand. Do not let it snap back, as the retractor could be damaged.



## Rear window defroster

The rear window defroster uses a large amount of power. To keep the battery drain to a minimum, switch off the defroster as soon as the rear window is clear. The defroster is automatically deactivated after approximately 6 to 17 minutes of operation depending on the outside temperature.

### Activating

- ▶ Press button  (▷ page 194) or (▷ page 195) or button  (▷ page 206) or (▷ page 207) on the respective climate control panel.

The indicator lamp on the button comes on.

### Deactivating

- ▶ Press button  or button  again.

The indicator lamp on the button goes out.

### Warning!



Any accumulation of snow and ice should be removed from the rear window before driving. Visibility could otherwise be impaired, endangering you and others.

## Controls in detail

### Good visibility



If the rear window defroster switches off too soon and the indicator lamp starts flashing, this means that too many electrical consumers are operating simultaneously and there is insufficient voltage in the battery. The system responds automatically by deactivating the rear window defroster.

As soon as the battery has sufficient voltage, the rear window defroster automatically turns itself back on.

## Controls in detail

### Dual-zone automatic climate control

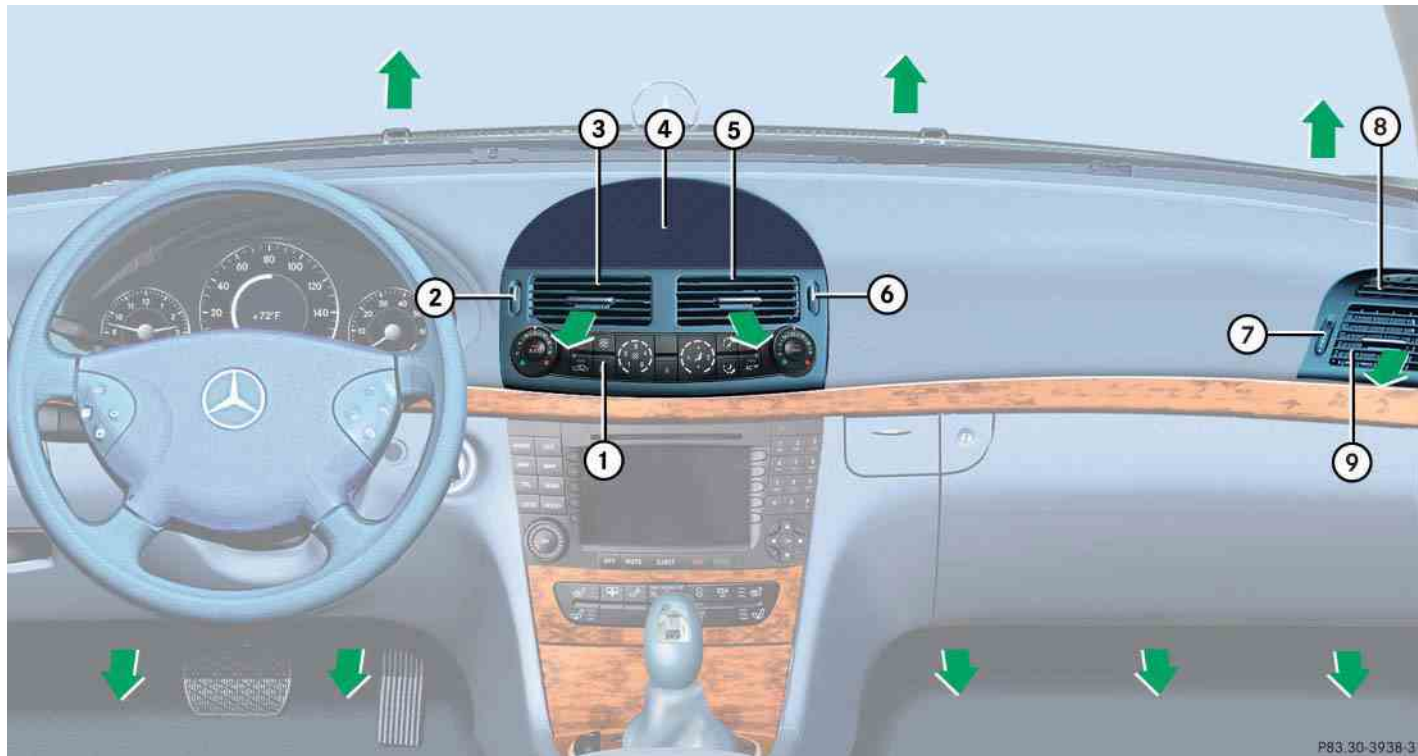

## Controls in detail

### Dual-zone automatic climate control

- ① Climate control panel
- ② Thumbwheel for air volume control for left center air vent
- ③ Left center air vent, adjustable
- ④ Center air vent, fixed
- ⑤ Right center air vent, adjustable
- ⑥ Thumbwheel for air volume control for right center air vent
- ⑦ Thumbwheel for air volume control for side air vent
- ⑧ Side defroster vent, fixed
- ⑨ Side air vent, adjustable



For draft-free ventilation, move the sliders for the center vents ③ and ⑤ to the middle position.

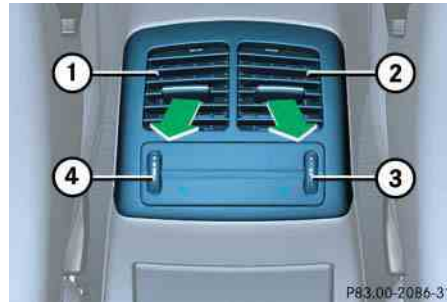

Rear air vents

- ① Left rear center air vent, adjustable
- ② Right rear center air vent, adjustable
- ③ Thumbwheel for air volume control for right rear center air vent
- ④ Thumbwheel for air volume control for left rear center air vent

## Controls in detail

### Dual-zone automatic climate control

Depending on production date, your vehicle is equipped with either climate control panel design A or B.

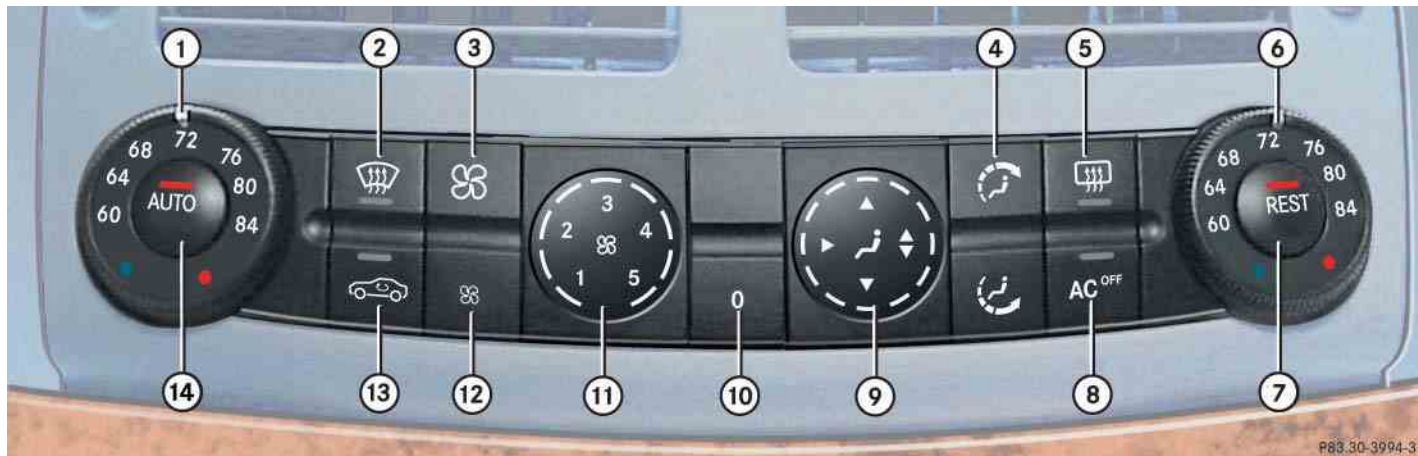

Climate control panel design A

- ① Left-side temperature control
- ② Windshield defroster
- ③ Increase air volume
- ④ Air distribution
- ⑤ Rear window defroster

- ⑥ Right-side temperature control
- ⑦ Residual heat/ventilation
- ⑧ AC cooling on/off
- ⑨ Air distribution display
- ⑩ Climate control on/off

- ⑪ Air volume display
- ⑫ Decrease air volume
- ⑬ Air recirculation
- ⑭ Air distribution and air volume (automatic, manual)

## Controls in detail

### Dual-zone automatic climate control

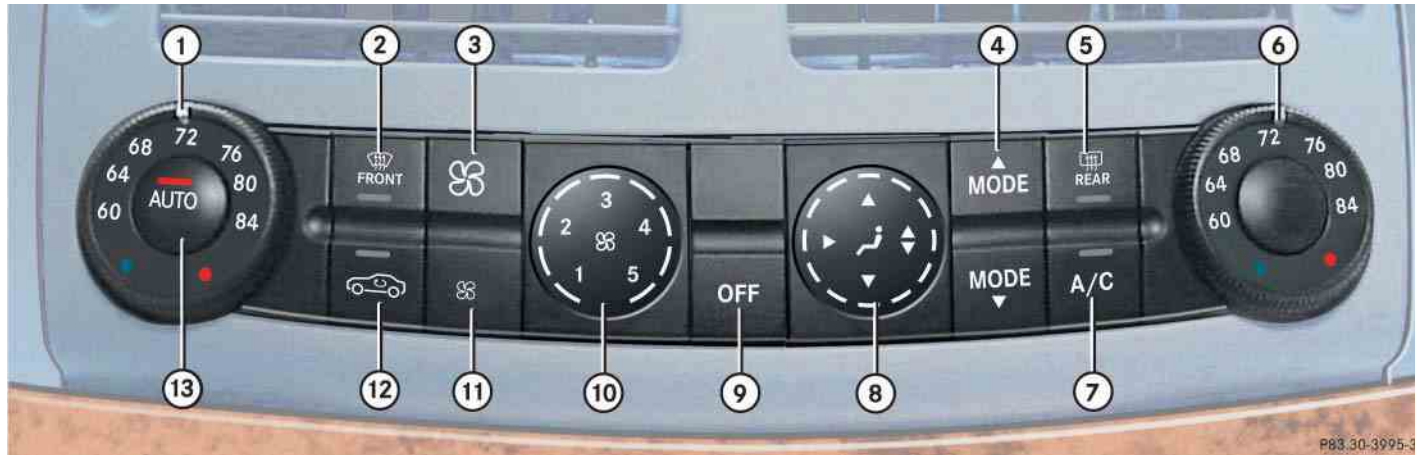

Climate control panel design B

- ① Left-side temperature control
- ② Windshield defroster
- ③ Increase air volume
- ④ Air distribution
- ⑤ Rear window defroster
- ⑥ Right-side temperature control

- ⑦ AC cooling on/off
- ⑧ Air distribution display
- ⑨ Climate control on/off
- ⑩ Air volume display
- ⑪ Decrease air volume

- ⑫ Air recirculation
- ⑬ Air distribution and air volume (automatic, manual)

## Controls in detail

### Dual-zone automatic climate control

The climate control is operational whenever the engine is running. You can operate the climate control system in either the automatic or manual mode. The system cools or heats the interior depending on the selected interior temperature and the current outside temperature.

#### Warning!



When operating the climate control, the air that enters the passenger compartment through the air vents in the footwell can be very hot or very cold (depending on the set temperature). This may cause burns or frostbite to unprotected skin in the immediate area of the air vents. Always keep sufficient distance between unprotected parts of the body and the footwell air vents. If necessary change the air flow using the air distribution controls (▷ page 194) to direct the air away from the footwell air vents.

Nearly all dust particles, pollutants and odors are filtered out before outside air enters the passenger compartment through the air distribution system.

The air conditioning will not engage (no cooling) if the **AC<sup>OFF</sup>** mode is activated or **AC** mode is deactivated (▷ page 201).

#### Warning!



Follow the recommended settings for heating and cooling given on the following pages. Otherwise the windows could fog up, impairing visibility and endangering you and others.



Severe conditions (e.g. strong air pollution) may require replacement of the filter before its scheduled interval. A clogged filter will reduce the air volume to the interior.

If the vehicle interior is hot, ventilate the interior before driving off.

Keep the air intake grille in front of the windshield free of snow and debris.

Do not obstruct air flow by placing objects on the air flow-through exhaust slots below the rear window.

#### Deactivating the dual-zone automatic climate control system

##### Deactivating

- ▶ Press button **0** (▷ page 194) or button **OFF** (▷ page 195).



When the air conditioning is switched off, the outside air supply and circulation are also switched off. Only choose this setting for a short time. Otherwise the windows could fog up.

##### Reactivating

- ▶ Press button **0** (▷ page 194) or button **OFF** (▷ page 195) again.
- or
- ▶ Press any button on the climate control panel (▷ page 194) or (▷ page 195).

#### Setting the temperature

Use temperature controls ① and ⑥ (▷ page 194) or (▷ page 195) to separately adjust the air temperature on each side of the passenger compartment. You should raise or lower the temperature setting in small increments, preferably starting at 72°F (22°C).



When operating the climate control system in automatic mode, you will only rarely need to adjust the temperature, air volume and air distribution.

#### Increasing

- ▶ Turn the temperature control ① or ⑥ (▷ page 194) or (▷ page 195) slightly to the right.

The climate control system will correspondingly adjust the interior air temperature.

#### Decreasing

- ▶ Turn the temperature control ① or ⑥ (▷ page 194) or (▷ page 195) slightly to the left.

The climate control system will correspondingly adjust the interior air temperature.





## Controls in detail

### Dual-zone automatic climate control

#### Adjusting air distribution

##### Adjusting manually

Use air distribution control ④ (▷ page 194) or (▷ page 195) to adjust the air distribution.

Symbol	Function
	Directs air through the center, side and rear passenger compartment air vents
	Directs air to the windows
	Directs air into the entire vehicle interior
	Directs air to the footwells

- ▶ Press air distribution rocker switch ④ (▷ page 194) or (▷ page 195) until the display shows the desired setting.

The indicator lamp on the button **AUTO** goes out and the current air distribution appears in the air distribution display ⑨ (▷ page 194) or ⑧ (▷ page 195).

##### Adjusting automatically

- ▶ Press button **AUTO** (▷ page 194) or (▷ page 195).

The indicator lamp on the button comes on. The air distribution is adjusted automatically.

Adjusting center air vents:

The thumbwheels for left ② and right ⑥ (▷ page 192) center air vents are automatically positioned for optimum interior air-flow. In this position, center air vent ④ (▷ page 192) and adjustable left and right center vents ③ and ⑤ (▷ page 192) are fully opened.

##### Windshield fogged on the outside



- ▶ Switch the windshield wipers on (▷ page 52).
- ▶ Press button **AUTO** (▷ page 194) or (▷ page 195).

The indicator lamp on the button comes on.

#### Adjusting air volume

##### Adjusting manually

Five blower speeds are available.

- ▶ Press  to decrease or  to increase air volume (▷ page 194) or (▷ page 195) to the desired level.

The indicator lamp on the **AUTO** button (▷ page 194) or (▷ page 195) goes out. The selected blower speed is shown in the display.

##### Adjusting automatically

- ▶ Press the **AUTO** button (▷ page 194) or (▷ page 195).

The indicator lamp on the **AUTO** button comes on. The air volume is adjusted automatically.



#### Defrosting



These settings should only be selected for a short time.

#### Activating

- ▶ Press button (▷ page 194) or button (▷ page 195).

The indicator lamp on the button comes on.

The air conditioning switches automatically to the following functions:

- maximum blowing and heating power
- air flows onto the windshield and the front side windows
- the air recirculation mode is switched off

#### Deactivating

- ▶ Press button (▷ page 194) or button (▷ page 195).

The indicator lamp on the button goes out. Defrosting is turned off.

#### Air recirculation mode

Switch to air recirculation mode to prevent unpleasant odors from entering the vehicle from the outside. This setting cuts off the intake of outside air and recirculates the air in the passenger compartment.

#### Warning!



When the outside temperature is below 41°F (5°C), only switch to air recirculation mode for short periods to prevent window fogging.

Window fogging may impair visibility and endanger you and others.

#### Activating

- ▶ Press button (▷ page 194) or (▷ page 195).

The indicator lamp on the button comes on.



If you keep button pressed, the side windows and tilt/sliding sunroof\* or tilt/sliding panel\* will close.

## Controls in detail

### Dual-zone automatic climate control

#### Warning!



Never operate the windows and tilt/sliding sunroof\* or tilt/sliding panel\* if there is the possibility of anyone being harmed by the opening or closing procedure.

In case the procedure causes potential danger:

Vehicles with tilt/sliding sunroof: The closing of the side windows can be immediately halted by pressing or pulling the respective window switch. The closing of the tilt/sliding sunroof can be immediately halted by moving the switch for the tilt/sliding sunroof in any direction.

The closing of the side windows and the tilt/sliding sunroof can be reversed by again pressing and holding the  button.

Vehicles with panorama roof: The closing of the side windows and tilt/sliding panel can be immediately halted by releasing the  button.



The air recirculation mode is activated automatically at high outside temperatures.

If you have turned off the air conditioning (> page 201) or the outside temperature is below 41°F (5°C), the air recirculation mode will not switch on automatically.

#### Deactivating

- ▶ Press button  (> page 194) or (> page 195).

The indicator lamp on the button goes out.



If you keep button  pressed, the side windows and tilt/sliding sunroof\* or tilt/sliding panel\* will return to their previous position.

The air recirculation mode is deactivated automatically:

- after five minutes if the outside temperature is below approximately 41°F (5°C)
- after five minutes if the air conditioning is turned off
- after 30 minutes if the outside temperature is above approximately 41°F (5°C)

At outside temperatures above 79°F (26°C), the system will not automatically switch back to outside air. A quantity of outside air is added after approximately 30 minutes.

#### Air conditioning

The air conditioning is operational while the engine is running and cools the interior air to the temperature set by the operator.



Condensation may drip out from underneath the vehicle. This is normal and not an indication of a malfunction.

#### Warning!



If you turn off the cooling function, the vehicle will not be cooled when weather conditions are warm. The windows can fog up more quickly. Window fogging may impair visibility and endanger you and others.

#### Deactivating

It is possible to deactivate the air conditioning (cooling) function of the climate control system. The air in the vehicle will then no longer be cooled or dehumidified.

##### *Climate control panel design A*

- ▶ Press button **AC<sup>OFF</sup>** (▷ page 194).  
The indicator lamp on the button comes on.

The cooling function and heater booster system (Diesel engine) (▷ page 203) are switched off.

##### *Climate control panel design B*

- ▶ Press button **A/C** (▷ page 195).

The indicator lamp on the button goes out.

The cooling function (▷ page 203) is switched off.

#### Activating

Moist air can fog up the windows. You can dehumidify the air with the air conditioning.

##### *Climate control panel design A*

- ▶ Press button **AC<sup>OFF</sup>** (▷ page 194) again.  
The indicator lamp on the button goes out.

##### *Climate control panel design B*

- ▶ Press button **A/C** (▷ page 195) again.  
The indicator lamp on the button comes on.

The air conditioning uses the refrigerant R134a. This refrigerant is free of CFCs which are harmful to the ozone layer. ▷▷

## Controls in detail

### Dual-zone automatic climate control



If the air conditioning cannot be turned on again, this indicates that the air conditioning is losing refrigerant. The compressor has turned itself off.

Have the air conditioning checked at the nearest authorized Mercedes-Benz Center.

#### Residual heat and ventilation\* (available on climate control panel design A only)

With the engine switched off, it is possible to continue to heat or ventilate the interior for up to 30 minutes. This feature makes use of the residual heat produced by the engine.

#### Activating

- ▶ Turn the SmartKey in the starter switch to position **0** or **1**, or remove it from the starter switch.
- ▶ Press button **REST** (▷ page 194).

The indicator lamp on button comes on.



How long the system will provide heating depends on the coolant temperature and the temperature set by the operator. The blower will run at speed setting 1 regardless of the air distribution control setting.

#### Deactivating

- ▶ Press button **REST** (▷ page 194).

The indicator lamp on button goes out.

The residual heat is automatically turned off:

- when the ignition is switched on
- after about 30 minutes
- if the battery voltage drops

#### Heater booster system (Diesel engine)

Your vehicle is equipped with a heater booster system. A PTC heating element (▷ page 475) ensures that the vehicle interior is warmed up as quickly as possible when the engine has not reached its normal operating temperature yet.

The heater booster system switches on automatically if required.



If the cooling function for the air conditioning is switched off with the **AC<sup>OFF</sup>** button, the heater booster system is deactivated too (Climate control panel design A only).

## Controls in detail

### 4-zone automatic climate control\*

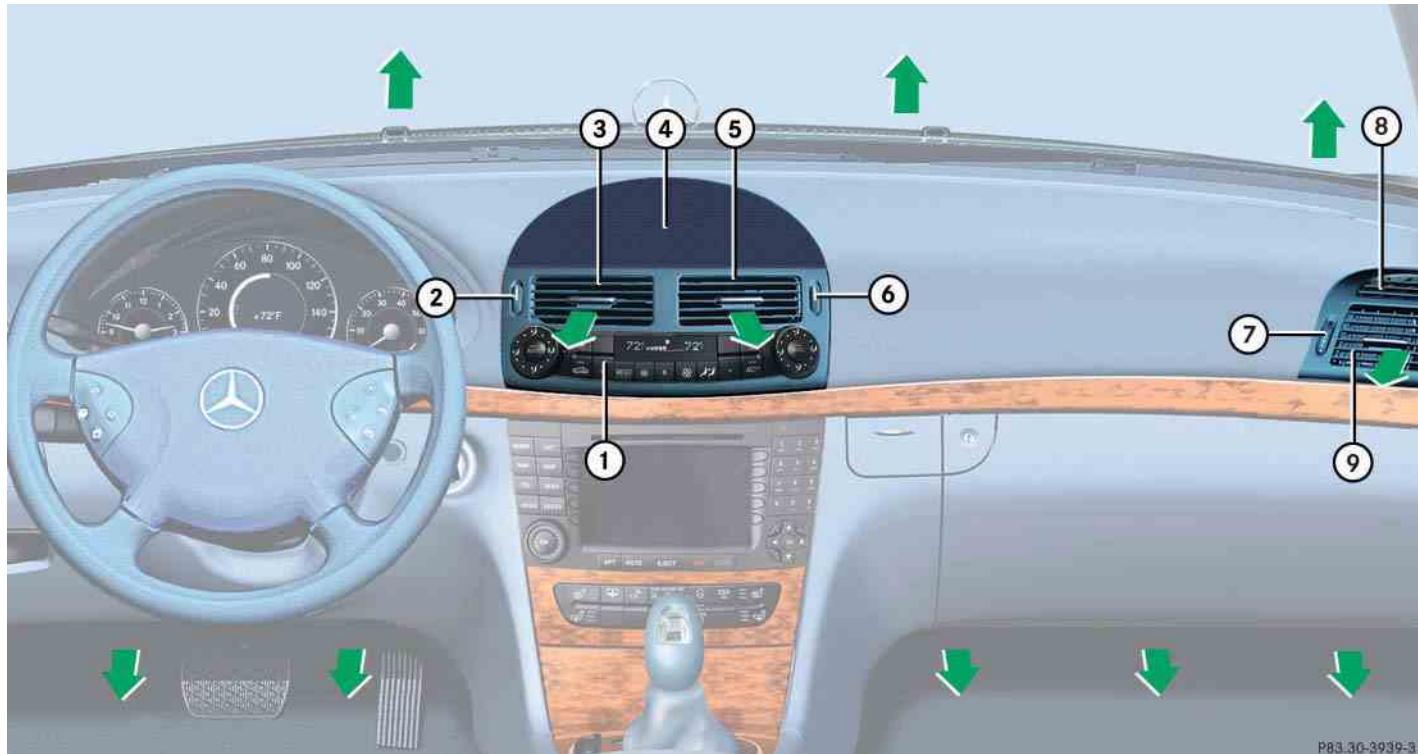

## Controls in detail

### 4-zone automatic climate control\*

- ① Climate control panel
- ② Thumbwheel for air volume control for left center air vent
- ③ Left center air vent, adjustable
- ④ Air vent, fixed
- ⑤ Right center air vent, adjustable
- ⑥ Thumbwheel for air volume control for right center air vent
- ⑦ Thumbwheel for air volume control for side air vent
- ⑧ Side defroster vent, fixed
- ⑨ Side air vent, adjustable

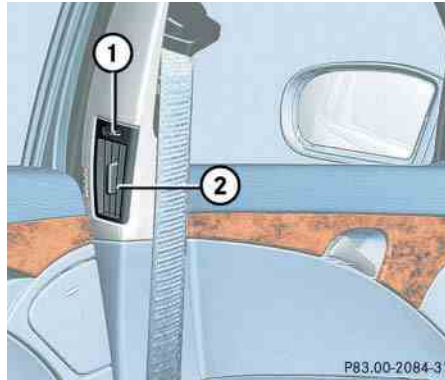

- ① Thumbwheel for air volume control for side air vent
- ② Side air vent, adjustable

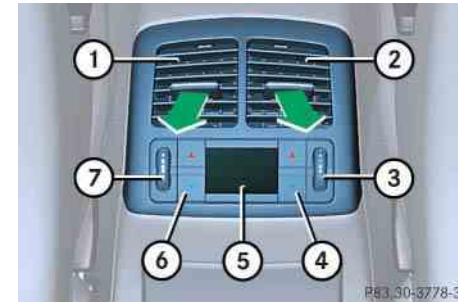

- ① Left rear center air vent, adjustable
- ② Right rear center air vent, adjustable
- ③ Thumbwheel for air volume control for right rear center air vent
- ④ Temperature rocker switch, right
- ⑤ Display
- ⑥ Temperature rocker switch, left
- ⑦ Thumbwheel for air volume control for left rear center air vent

## Controls in detail

### 4-zone automatic climate control\*

Depending on production date, your vehicle is equipped with either climate control panel design A or B.

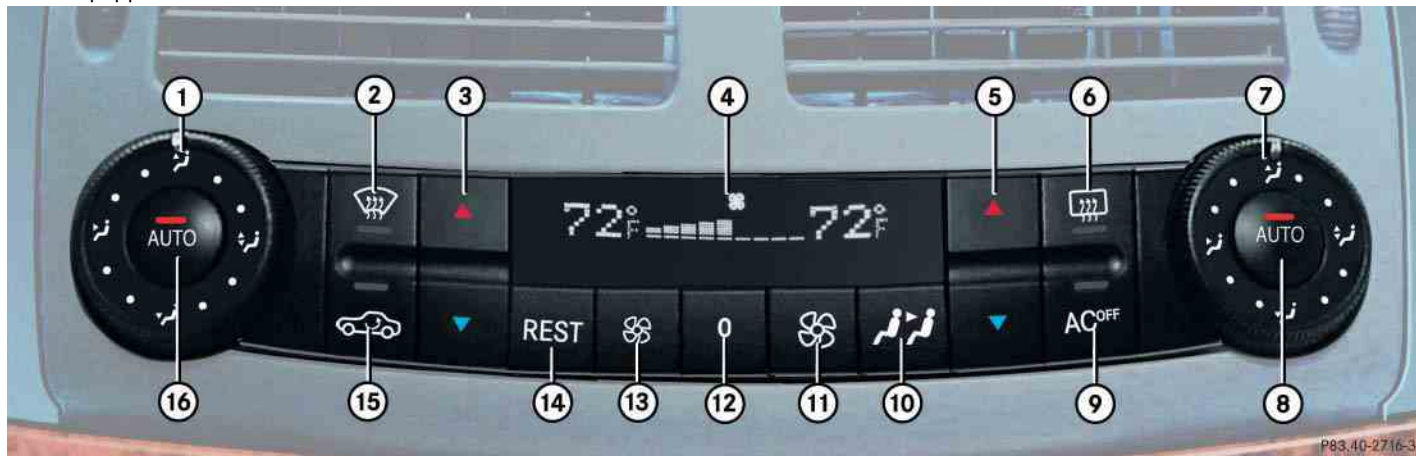

Climate control panel design A

① Air distribution, left	⑦ Air distribution, right	⑫ Climate control on/off
② Defrosting	⑧ Air distribution and air volume, right (automatic, manual)	⑬ Decrease air volume
③ Temperature rocker switch, left	⑨ AC cooling on/off	⑭ Residual heat/ventilation
④ Display	⑩ Rear air-conditioning remote control	⑮ Air recirculation
⑤ Temperature rocker switch, right	⑪ Increase air volume	⑯ Air distribution and air volume, left (automatic, manual)
⑥ Rear window defroster		



## Controls in detail

### 4-zone automatic climate control\*

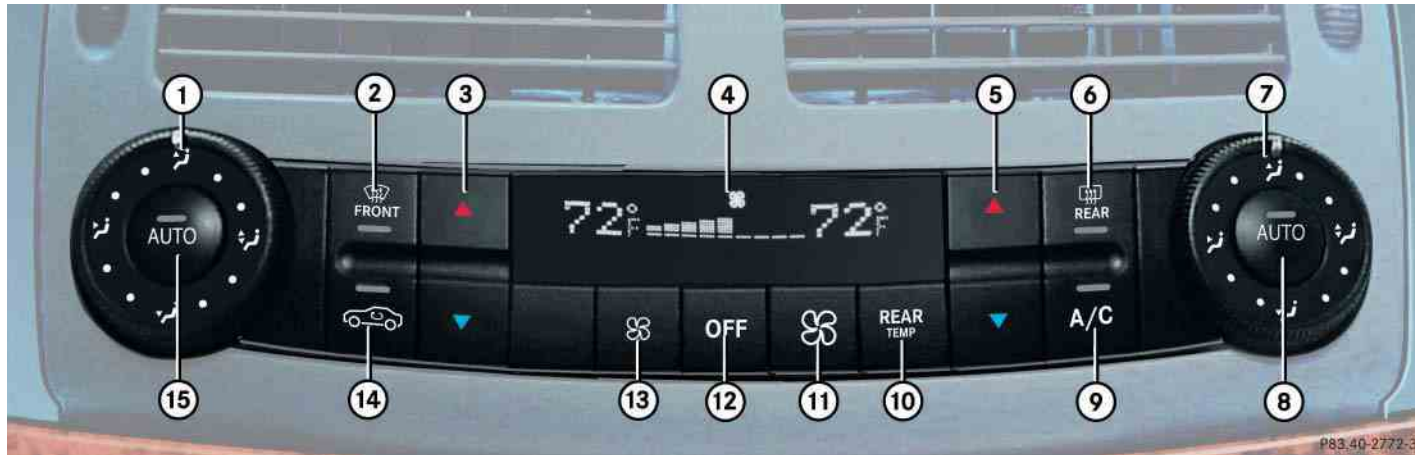

Climate control panel design B

- |                                    |  |   |
|------------------------------------|--|---|
| ① Air distribution, left           | ⑦ Air distribution, right                                    | ⑫ Climate control on/off                                    |
| ② Defrosting                       | ⑧ Air distribution and air volume, right (automatic, manual) | ⑬ Decrease air volume                                       |
| ③ Temperature rocker switch, left  | ⑨ AC cooling on/off  | ⑭ Air recirculation   |
| ④ Display                          | ⑩ Rear air-conditioning remote control                       | ⑮ Air distribution and air volume, left (automatic, manual) |
| ⑤ Temperature rocker switch, right | ⑪ Increase air volume  |   |
| ⑥ Rear window defroster            |  |   |

## Controls in detail

### 4-zone automatic climate control\*

#### Warning!



When operating the climate control, the air that enters the passenger compartment through the air vents in the footwell can be very hot or very cold (depending on the set temperature). This may cause burn or frostbite to unprotected skin in the immediate area of the air vents. Always keep sufficient distance between unprotected parts of the body and the footwell air vents. If necessary change the air flow using the air distribution controls (▷ page 206) to direct the air away from the footwell air vents.

The climate control is a 4-zone intelligent climate control system. Your vehicle interior is divided into 4 zones.

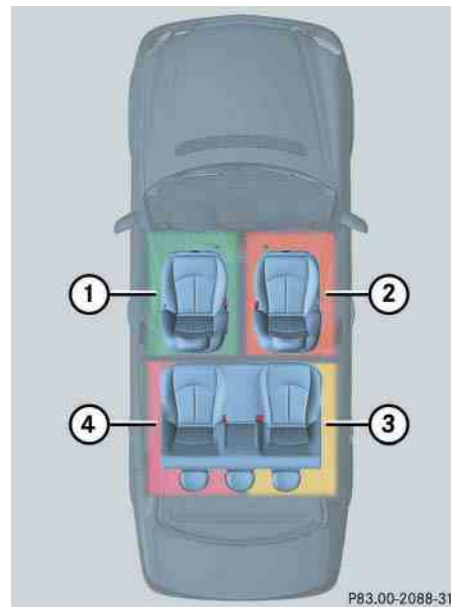

With the help of a sun sensor, the climate control determines the relation of the sun to the vehicle and automatically adjusts the inside temperature for every individual zone.

You can set the temperature for each of the 4 zones separately. These settings can be assigned to a SmartKey and stored in memory (▷ page 168).

The climate control is operational whenever the engine is running. It cools the vehicle's interior according to the angle and intensity of the sun's rays, the outside temperature and the selected temperature. You can operate the climate control system in either the automatic or manual mode.

Nearly all dust particles, pollutants and odors are filtered out before outside air enters the passenger compartment through the air distribution system.

The air conditioning will not engage (no cooling) if the **AC<sup>OFF</sup>** mode is activated or **AC** mode is deactivated (▷ page 206).

### Warning!



Follow the recommended settings for heating and cooling given on the following pages. Otherwise the windows could fog up, impairing visibility and endangering you and others.



Severe conditions (e.g. strong air pollution) may require replacement of the filter before its scheduled interval. A clogged filter will reduce the air volume to the interior.

If the vehicle interior is hot, ventilate the interior before driving off.

Keep the air intake grille in front of the windshield free of snow and debris.

Do not obstruct air flow by placing objects on the air flow-through exhaust slots below the rear window.

## Controls in detail

### 4-zone automatic climate control\*

#### Deactivating the 4-zone automatic climate control system

##### Deactivating

It is possible to deactivate the climate control system.

- ▶ Press button **0** (▷ page 206) or button **OFF** (▷ page 207) until the display is cleared.

The climate control system is deactivated.



When the air conditioning is switched off, the outside air supply and circulation are also switched off. Only choose this setting for a short time. Otherwise the windows could fog up.

##### Reactivating

- ▶ Press button **0** (▷ page 206) or button **OFF** (▷ page 207) again.

## Controls in detail

### 4-zone automatic climate control\*

#### Setting the temperature

Use temperature control rocker switches ③ and ⑤ (▷ page 206) or (▷ page 207) to separately adjust the air temperature on each side of the passenger compartment. You should raise or lower the temperature setting in small increments, preferably starting at 72°F (22°C).



When operating the climate control system in automatic mode, you will only rarely need to adjust the temperature, air volume and air distribution.

#### Increasing

- ▶ Push top of temperature control rocker switch ③ and/or ⑤ (▷ page 206) or (▷ page 207).

The climate control system will correspondingly adjust the interior air temperature.

#### Decreasing

- ▶ Push bottom of temperature control rocker switch ③ and/or ⑤ (▷ page 206) or (▷ page 207).

The climate control system will correspondingly adjust the interior air temperature.

#### Adjusting air distribution

Use the air distribution controls ① and ⑦ (▷ page 206) or (▷ page 207) or to separately adjust the air distribution on each side of the passenger compartment. The following symbols are found on the controls:

Symbol	Function
	Directs air through the center, side and rear passenger compartment air vents
	Directs air to the windows
	Directs air into the entire vehicle interior
	Directs air to the footwells

#### Adjusting manually

- ▶ Turn air distribution controls on each side of the passenger compartment to the desired symbol.

The indicator lamp in the **AUTO** button goes out.

#### Adjusting automatically

- ▶ Press left or right **AUTO** button (▷ page 206) or (▷ page 207).

The indicator lamp in the **AUTO** button illuminates. The air distribution is adjusted automatically.



#### Windshield fogged on the outside

- ▶ Switch the windshield wipers on.
- ▶ Press the left or right **AUTO** button (▷ page 206) or (▷ page 207).

#### Adjusting air volume

##### Adjusting manually

Nine blower speeds are available.

- ▶ Press  to decrease or  (▷ page 206) or (▷ page 207) to increase air volume to the desired level.

The AUTO display disappears and the automatic mode is switched off. The selected blower speed is shown in the display.

##### Adjusting automatically

- ▶ Press left or right **AUTO** button (▷ page 206) or (▷ page 207).

The AUTO display appears and the air volume is adjusted automatically.

#### Defrosting



These settings should only be selected for a short time.

##### Activating

- ▶ Press button  (▷ page 206) or button  (▷ page 207).

The indicator lamp on the button comes on.

The air conditioning switches automatically to the following functions:

- maximum blowing and heating power
- air flows onto the windshield and the front side windows
- the air recirculation mode is switched off

## Controls in detail

### 4-zone automatic climate control\*

#### Deactivating

- ▶ Press button  (▷ page 206) or button  (▷ page 207).

The indicator lamp on the button goes out. Defrosting is turned off.

#### Maximum cooling MAX COOL

If the left and right air distribution controls as well as the airflow volume control are set to **AUTO** and there is a high need for cooling, the display “MAX COOL” appears in the front and rear display.

This provides the fastest possible cooling of the vehicle interior (when windows and tilt/sliding sunroof\* or tilt/sliding panel\* are closed).

#### Air recirculation mode

Switch to air recirculation mode to prevent unpleasant odors from entering the vehicle from the outside. This setting cuts off the intake of outside air and recirculates the air in the passenger compartment.

#### Warning!



When the outside temperature is below 41°F (5°C), only switch to air recirculation mode for short periods to prevent window fogging.

Window fogging may impair visibility and endanger you and others.

#### Activating

- ▶ Press button  (▷ page 206) or (▷ page 207).

The indicator lamp on the button comes on.



If you keep button  pressed, the side windows and the tilt/sliding sunroof\* or tilt/sliding panel\* will close.

#### Warning!



Never operate the side windows and tilt/sliding sunroof\* or tilt/sliding panel\* if there is the possibility of anyone being harmed by the opening or closing procedure.

In case the procedure causes potential danger:

Vehicles with tilt/sliding sunroof: The closing of the side windows can be immediately halted by pressing or pulling the respective window switch. The closing of the tilt/sliding sunroof can be immediately halted by moving the switch for the tilt/sliding sunroof in any direction.

The closing of the side windows and the tilt/sliding sunroof can be reversed by again pressing and holding the  button.

Vehicles with panorama roof: The closing of the side windows and tilt/sliding panel can be immediately halted by releasing the  button.



The air recirculation mode is activated automatically:

- at high outside temperatures
- if the concentration of carbon monoxide and nitrogen oxide in the outside air increases, for example in a tunnel

If you have turned off the air conditioning (▷ page 206) or (▷ page 207) or the outside temperature is below 41°F (5°C), the air recirculation mode will not switch on automatically.

#### Deactivating

- ▶ Press button  (▷ page 206) or (▷ page 207).

The indicator lamp on the button goes out.



If you keep button  pressed, the side windows and the tilt/sliding sunroof\* or tilt/sliding panel\* will return to their previous position.

The air recirculation mode is deactivated automatically:

- after five minutes if the outside temperature is below approximately 41°F (5°C)
- after five minutes if the air conditioning is turned off
- after 30 minutes if the outside temperature is above approximately 41°F (5°C)

At outside temperatures above 79°F (26°C) the system will not automatically switch back to outside air. A quantity of outside air is added after approximately 30 minutes.

## Controls in detail

### 4-zone automatic climate control\*

#### Air conditioning

The air conditioning is operational while the engine is running and cools the interior air to the temperature set by the operator.



Condensation may drip out from underneath the vehicle. This is normal and not an indication of a malfunction.

#### Warning!



If you turn off the cooling function, the vehicle will not be cooled when weather conditions are warm. The windows can fog up more quickly. Window fogging may impair visibility and endanger you and others.

#### Deactivating

It is possible to deactivate the air conditioning (cooling) function of the climate control system. The air in the vehicle will then no longer be cooled or dehumidified.

##### Climate control design A

- ▶ Press button **AC<sup>OFF</sup>** (▷ page 206).

The indicator lamp on the button comes on.

**AC<sup>OFF</sup>** in the display comes on.

The cooling function and heater booster system (Diesel engine) (▷ page 217) are switched off.

##### Climate control design B

- ▶ Press button **A/C** (▷ page 207).

The indicator lamp on the button goes out.

The cooling function (▷ page 217) is switched off.

#### Activating

Moist air can fog up the windows. You can dehumidify the air with the air conditioning.

##### Climate control design A

- ▶ Press button **AC<sup>OFF</sup>** (▷ page 206) again.

The indicator lamp on the button goes out.

**AC<sup>OFF</sup>** in the display goes out.

##### Climate control design B

- ▶ Press button **A/C** (▷ page 207) again.

The indicator lamp on the button comes on.

The air conditioning uses the refrigerant R134a. This refrigerant is free of CFCs which are harmful to the ozone layer.





If the air conditioning cannot be turned on again, this indicates that the air conditioning is losing refrigerant. The compressor has turned itself off.

Have the air conditioning checked at the nearest authorized Mercedes-Benz Center.

#### **Residual heat and ventilation (available on climate control panel design A only)**

With the engine switched off, it is possible to continue to heat or ventilate the interior for up to 30 minutes. This feature makes use of the residual heat produced by the engine.

#### **Activating**

- ▶ Turn the SmartKey in the starter switch to position **0** or **1**, or remove it from the starter switch.
- ▶ Press button **REST** (> page 206).  
**REST** in the display comes on.

#### **Deactivating**

- ▶ Press button **REST** (> page 206).  
**REST** in the display goes out.

The residual heat is automatically turned off

- when the ignition is switched on
- after about 30 minutes
- if the battery voltage drops



How long the system will provide heating depends on the coolant temperature and the temperature set by the operator. The blower will run at speed setting 1 regardless of the air distribution control setting.

## Controls in detail

### 4-zone automatic climate control\*

#### Rear air conditioning

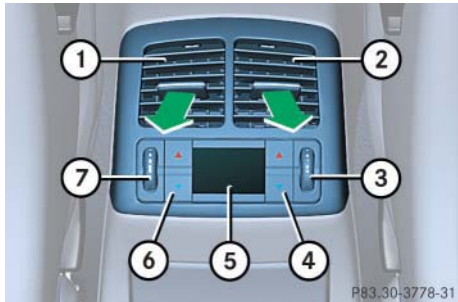

- ① Left rear center air vent, adjustable
- ② Right rear center air vent, adjustable
- ③ Thumbwheel for air volume control for right rear center air vent
- ④ Temperature rocker switch, right
- ⑤ Display
- ⑥ Temperature rocker switch, left
- ⑦ Thumbwheel for air volume control for left rear center air vent

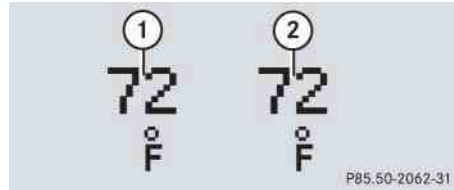

#### Display

- ① Temperature, left
- ② Temperature, right

#### Basic settings



We recommend setting the temperature on both the left- and right-hand sides to 72°F (22°C). This ensures a pleasant temperature in the rear of the vehicle.

The temperatures for the left- and right-hand sides can be set using temperature rocker switches ④ and ⑥.

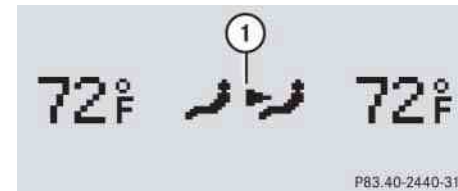
#### Adjusting the rear settings with the front control panel



#### Display



- ▶ Press the  button (▷ page 206) or the  button (▷ page 207).

The display switches over.

The temperature for the rear left- and right-hand sides of the vehicle can be set with temperature rocker switches ③ and ⑤.

The temperature display disappears approximately five seconds after the last SmartKey confirmation and switches back to the normal display.



The normal display will appear when the  button or the button  is pressed again.

#### **Heater booster system (Diesel engine)**

Your vehicle is equipped with a heater booster system. A PTC heating element (▷ page 475) ensures that the vehicle interior is warmed up as quickly as possible when the engine has not reached its normal operating temperature yet.

The heater booster system switches on automatically if required.



If the cooling function for the air conditioning is switched off with the  button (▷ page 206), the heater booster system is deactivated too.

## Controls in detail

### Power windows

#### Opening and closing the windows

The side windows are opened and closed electrically. The switches for all of the side windows are on the driver's door. The switches for the respective windows are on the front passenger door and the rear doors.



- ① Rear window override switch  
(▷ page 83)
- ② Right front window
- ③ Right rear window
- ④ Left rear window
- ⑤ Left front window

#### Warning!



When closing the windows, make sure that there is no danger of anyone being harmed by the closing procedure.

The closing of the door windows can be immediately halted by releasing the switch or, if switch was pulled past the resistance point and released, by either pressing or pulling the respective switch.

The door windows are equipped with the express-close and automatic reversal function. If the window encounters an obstruction that blocks its path in a circumstance where you pulled the switch past the resistance point and released it to close the window, the automatic reversal function will stop the window and open it slightly.

If the window encounters an obstruction that blocks its path in a circumstance where you are closing the window by pulling and holding the switch, by pressing and holding button  on the SmartKey,

or by pressing and holding the lock button (vehicles with KEYLESS-GO\*) on the door handle, the automatic reversal function will not operate.

When leaving the vehicle, always remove the SmartKey or SmartKey with KEYLESS-GO\* from the starter switch, take it with you, and lock the vehicle. Do not leave children unattended in the vehicle, or with access to an unlocked vehicle. Unsupervised use of vehicle equipment can cause an accident and/or serious personal injury.



You can also open or close the windows using the SmartKey, see “Summer opening feature” (▷ page 220) and “Convenience closing feature” (▷ page 221).

You can close and reopen the windows using the air recirculation button  in the control panel of the climate control (▷ page 194) or (▷ page 206).



Operating the windows from the rear is not possible if you activate the override switch (▷ page 83).



With the SmartKey in starter switch position **0** or removed from the starter switch, the power windows can be operated:

- until you open the driver's or front passenger's door
- for at least five minutes.

- ▶ Switch on the ignition (▷ page 33).

#### Opening the windows

- ▶ Press switch ② to ⑤ to the resistance point.

The corresponding window will move downwards until you release the switch.

#### Closing the windows

- ▶ Pull switch ② to ⑤ to the resistance point.

The corresponding window will move upwards until you release the switch.

#### Warning



If you pull and hold the switch up when closing the window, and upward movement of the window is blocked by some obstruction including but not limited to arms, hands, fingers, etc., the automatic reversal will not operate.

#### Fully opening the windows (Express-open)

- ▶ Press switch ② to ⑤ past the resistance point and release.

The corresponding window opens completely.

#### Fully closing the windows (Express-close)

- ▶ Pull switch ② to ⑤ past the resistance point and release.

The corresponding window closes completely.

#### Warning!



Driver's door only:

If within five seconds switch is again pulled past the resistance point and released, the automatic reversal will not operate.

## Controls in detail

### Power windows



If the upward movement of the window is blocked during the closing procedure, the window will stop and open slightly.

Remove the obstruction, pull the respective power window switch again past the resistance point and release.

If the window still does not close when there is no obstruction, pull and hold the respective power window switch.

The side window will then close without the obstruction sensor function.

#### Stopping windows during Express-operation

- ▶ Press or pull the respective power window switch again.

#### Synchronizing power windows

The power windows must be synchronized

- after the battery has been disconnected
- if the power windows cannot be fully opened (Express-open) or closed (Express-close)

#### Synchronizing

- ▶ Close all doors.
- ▶ Switch on the ignition (▷ page 33).
- ▶ Pull switch ② to ⑤ until the side windows are completely closed.
- ▶ Hold on to switches ② to ⑤ for approximately one second.

The power windows are synchronized.

#### Summer opening feature

If the weather is warm, you can ventilate the vehicle before driving off by simultaneously:

- opening the side windows
- opening the tilt/sliding sunroof\* or tilt/sliding panel\*
- turning on the seat ventilation\* for the driver's seat



The seat ventilation\* for the driver's seat is automatically set to the highest level if activated via summer opening feature.



## Controls in detail

### Power windows





- ▶ With the vehicle unlocked, aim transmitter eye of the SmartKey or SmartKey with KEYLESS-GO\* at the driver's outside door handle.

#### Vehicles without panorama roof\*



- ▶ Press and hold button  until the windows and the tilt/sliding sunroof\* have reached the desired position.
- ▶ Release button  to interrupt procedure.

#### Vehicles with panorama roof\*

If roller sunblinds are closed:

- ▶ Press and hold button . The windows and roller blinds begin to open after approximately one second.
- ▶ With the windows and roller blinds fully opened, press and hold button  again. The tilt/sliding panel of the panorama roof\* tilts and opens.

If roller sunblinds are open:



- ▶ Press and hold button . The windows move down and the tilt/sliding panel tilts and opens after approximately one second.
- ▶ Release button  to interrupt procedure.

#### Convenience closing feature

When you lock the vehicle, you can close the windows, tilt/sliding sunroof\* or tilt/sliding panel\* simultaneously.

- ▶ Aim transmitter eye of the SmartKey or SmartKey with KEYLESS-GO\* at the driver's outside door handle (▷ page 220).
- ▶ Press and hold button  until the windows, the tilt/sliding sunroof\* or tilt/sliding panel\* are completely closed.



Vehicles with panorama roof\*:

- ▶ Press and hold button  again. The roller sunblinds close.
- ▶ Release button  to interrupt procedure. ▷▷

## Controls in detail

### Power windows

▷▷ Vehicles with KEYLESS-GO\*:



- ▶ Press and hold button  or the lock button at the outside door handle (▷ page 58) until the windows, the tilt/sliding sunroof\* or tilt/sliding panel\* are completely closed.
- ▶ Release button  or the lock button at the outside door handle to interrupt procedure.

#### Warning!



When closing the windows and the tilt/sliding sunroof\* or the tilt/sliding panel\*, be sure that there is no danger of anyone being harmed by the closing procedure.

If potential danger exists, proceed as follows:

- Release button . To reverse in direction of movement, press button  for opening or button  for closing.

Vehicles with KEYLESS-GO\*:

- Pull on the door handle and hold firmly. The side windows and the tilt/sliding sunroof\* or the tilt/sliding panel\* will open for as long as the door handle is held but the door not opened.



## ▼ Power tilt /sliding sunroof\*

### Opening and closing the power tilt/sliding sunroof

The tilt/sliding sunroof can be opened and closed electrically. The switch for the tilt/sliding sunroof is on the overhead control panel.



#### Sunroof switch

- ① Push back to slide sunroof open
- ② Push forward to slide sunroof closed
- ③ Push up to raise sunroof at rear
- ④ Pull down to lower sunroof at rear

With the sunroof closed or tilted open, a screen can be slid into the sunroof opening to guard against sun rays. When sliding the sunroof open, the screen will also retract.



## Controls in detail

### Power tilt /sliding sunroof\*

#### Warning!



When closing the tilt/sliding sunroof, make sure there is no danger of anyone being harmed by the closing procedure.

The opening/closing procedure of the tilt/sliding sunroof can be immediately halted by releasing the switch or, if the switch was moved past the resistance point and released, by moving the switch in any direction.

The tilt/sliding sunroof is made out of glass. In the event of an accident, the glass may shatter. This may result in an opening in the roof.

In a vehicle rollover, occupants not wearing their seat belts or not wearing them properly may be thrown out of the opening. Such an opening also presents a potential for injury for occupants wearing their seat belts properly as entire body parts or portions of them may protrude from the passenger compartment.



## Controls in detail

### Power tilt /sliding sunroof\*

▷▷ When leaving the vehicle, always remove the SmartKey or the SmartKey with KEYLESS-GO\* from the starter switch, take it with you, and lock the vehicle. Do not leave children unattended in the vehicle, or with access to an unlocked vehicle. Unsupervised use of vehicle equipment can cause an accident and/or serious personal injury.



To avoid damaging the seals, do not transport any objects with sharp edges which can stick out of the tilt/sliding sunroof.

Do not open the tilt/sliding sunroof if there is snow or ice on the roof, as this could result in malfunctions.

The tilt/sliding sunroof can be opened or closed manually should an electrical malfunction occur (▷ page 414).



You can also open or close the tilt/sliding sunroof using the SmartKey (summer opening/convenience closing feature) (▷ page 220) or (▷ page 221).

You can close and reopen the tilt/sliding sunroof using the air recirculation switch  in the control panel of the climate control (▷ page 194) or (▷ page 206).

- ▶ Switch on the ignition (▷ page 46).

#### Opening and closing the power tilt/sliding sunroof

- ▶ To open, close, raise or lower the tilt/sliding sunroof, move the sunroof switch to resistance point in the required direction of arrows ① to ④. Release the sunroof switch when the tilt/sliding sunroof has reached the desired position.

#### Fully opening (Express-open) and closing (Express-close) the power tilt/sliding sunroof

- ▶ To open or close the tilt/sliding sunroof, move the sunroof switch past the resistance point in the direction of arrow ① to ② and release. The tilt/pop up roof opens or closes completely.

### **Stopping the power tilt/sliding sunroof during Express-operation**

- ▶ Move the sunroof switch in any direction.



If the movement of the tilt/sliding sunroof is blocked during the closing procedure, the tilt/sliding sunroof will stop and reopen slightly.

### **Synchronizing the power tilt/sliding sunroof**

The tilt/sliding sunroof must be synchronized

- after the battery has been disconnected or discharged
- after the tilt/sliding sunroof has been closed manually (▷ page 414)
- after a malfunction
- if the tilt/sliding sunroof does not open smoothly

## **Controls in detail**

### **Power tilt /sliding sunroof\***

- ▶ Remove the respective fuse from the main fuse box (▷ page 443).
- ▶ Reinsert the fuse in the main fuse box.
- ▶ Switch on the ignition (▷ page 33).
- ▶ Move and hold the sunroof switch in the direction of arrow ③ until the tilt/sliding sunroof is fully raised at the rear.

Keep holding the sunroof switch in the direction of arrow ③ for approximately one second.

- ▶ Check the Express-open feature (▷ page 224).

If the tilt/sliding sunroof opens completely, the roof is synchronized. Otherwise repeat the above steps.

## Controls in detail

### Panorama roof with power tilt/sliding panel\*

#### Opening and closing the roller sunblinds for the panorama roof with power tilt/sliding panel

The tilt/sliding panel and the front and rear roller sunblinds can be opened and closed electrically. The switch for the tilt/sliding panel and the roller sunblinds is on the overhead control panel. An additional switch for the roller sunblinds is in the rear passenger compartment.

The roller sunblinds only operate with the tilt/sliding panel closed. The front and rear roller sunblind cannot be operated individually.



#### Roof panel switch

- ① Open roller sunblinds
- ② Close roller sunblinds

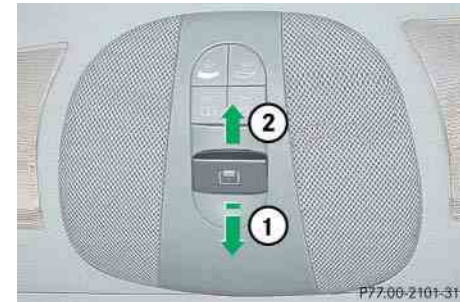

#### Roller sunblinds switch, rear

- ① Open roller sunblinds
- ② Close roller sunblinds

► Switch on the ignition (▷ page 33).

#### Opening and closing the roller sunblinds

► To open or close the roller sunblinds, move the roof panel/roller sunblinds switch to the resistance point in the required direction of arrow ① or ②.

Release the roof panel/roller sunblinds switch when the roller sunblinds have reached the desired position.

### Panorama roof with power tilt/sliding panel\*

#### Warning!



When closing the roller sunblinds, make sure that no one is in danger of being injured by the closing procedure. The closing of the roller sunblinds can be immediately halted by releasing the switch.

#### Fully opening the roller sunblinds (Express-open)

- ▶ Move the roof panel/roller sunblinds switch past the resistance point in direction of arrow ① and release.  
The roller sunblinds opens completely.

#### Stopping the roller sunblinds during Express-operation

- ▶ Move the roof panel/roller sunblinds switch in any direction.

#### Opening and closing the panorama roof with power tilt/sliding panel

The tilt/sliding panel can be opened and closed electrically. The switch for the tilt/sliding panel is on the overhead control panel.

The tilt/sliding panel only operates with the roller sunblinds opened.



#### Roof panel switch

- ① Push back to slide roof panel open
- ② Push forward to slide roof panel closed
- ③ Push up to raise roof panel
- ④ Pull down to lower roof panel

#### Warning!



When opening or closing the tilt/sliding panel, make sure that there is no danger of anyone being harmed by the opening or closing procedure.

The opening procedure of the tilt/sliding panel can be immediately halted by releasing the switch or, if the switch was moved past the resistance point and released, by moving the switch in any direction.

The closing procedure of the tilt/sliding panel can be immediately halted by releasing the switch.

The panorama roof with power tilt/sliding panel is made out of glass. In the event of an accident, the glass may shatter. This may result in an opening in the roof.



## Controls in detail

### Panorama roof with power tilt/sliding panel\*



In a vehicle rollover, occupants not wearing their seat belts or not wearing them properly may be thrown out of the opening. Such an opening also presents a potential for injury for occupants wearing their seat belts properly as entire body parts or portions of them may protrude from the passenger compartment.

When leaving the vehicle, always remove the SmartKey or the SmartKey with KEYLESS-GO\* from the starter switch, take it with you, and lock the vehicle. Do not leave children unattended in the vehicle, or with access to an unlocked vehicle. Unsupervised use of vehicle equipment can cause an accident and/or serious personal injury.



To avoid damaging the seals, do not transport any objects with sharp edges which can stick out of the tilt/sliding panel.

Do not open the tilt/sliding panel if there is snow or ice on the roof, as this could result in malfunctions.

The tilt/sliding panel can be opened or closed manually should an electrical malfunction occur (▷ page 414).



You can also open or close the tilt/sliding panel using the SmartKey (summer opening/convenience closing feature) (▷ page 220) or (▷ page 221).

You can close and reopen the tilt/sliding panel using the air recirculation switch  in the control panel of the climate control (▷ page 194) or (▷ page 206).

- ▶ Switch on the ignition (▷ page 33).

**Panorama roof with power tilt/sliding panel\***

**Opening and closing the panorama roof with tilt/sliding panel**

- ▶ To open, close, raise, or lower the tilt/sliding panel, move the roof panel switch to resistance point in the required direction of arrows ① to ④.

Release the roof panel switch when the tilt/sliding panel has reached the desired position.

**Fully opening (Express-open) the panorama roof with tilt/sliding panel**

- ▶ Move the roof panel switch past the resistance point in the direction of arrow ① and release.

The tilt/sliding panel opens completely.

**Stopping the panorama roof with tilt/sliding panel during Express-open**

- ▶ Move the roof panel switch in any direction.

**Synchronizing the panorama roof with power tilt/sliding panel**

The tilt/sliding panel must be synchronized

- after the battery has been disconnected or discharged
- after the tilt/sliding panel has been closed manually (▷ page 414)
- after a malfunction
- if the tilt/sliding panel does not open smoothly

- ▶ Remove the fuse from the main fuse box (▷ page 443).
- ▶ Reinsert the fuse in the main fuse box.
- ▶ Switch on the ignition (▷ page 33).
- ▶ Move and hold the roof panel switch in the direction of arrow ② until the roller sunblinds are fully closed.
- ▶ Keep holding the roof panel switch in the direction of arrow ② for approximately one second.
- ▶ Move and hold the roof panel switch in the direction of arrow ① until the roller sunblinds are fully opened.
- ▶ Keep holding the roof panel switch in the direction of arrow ① for approximately one second. ▷▷

## Controls in detail

### Panorama roof with power tilt/sliding panel\*

- ▷▷▶ Move and hold the roof panel switch in the direction of arrow ③ until the tilt/sliding panel is fully raised.
- ▶ Keep holding the roof panel switch in the direction of arrow ③ for approximately one second.
- ▶ Move and hold the roof panel switch in the direction of arrow ② until the tilt/sliding panel is fully closed.
- ▶ Keep holding the roof panel switch in the direction of arrow ② for approximately one second.
- ▶ Check the Express-open feature of the tilt/sliding panel (▷ page 229).

If the tilt/sliding panel opens completely, the roof is synchronized. Otherwise repeat the above steps.

### Solar panel\*

A solar panel is available in combination with the panorama roof with tilt/sliding panel. The solar cells convert natural light into electrical energy. When the engine is switched off, the energy generated automatically switches on the ventilation fan. The constant air flow creates a cooler temperature for cars parked in the sunlight.

The air flow depends on the intensity of the solar radiation. The ventilation starts two minutes after switching off the engine.



## ▼ Driving systems

The following driving systems are explained on the following pages:

- Cruise control and Distronic\*, with which the vehicle can maintain a preset speed
- Airmatic\* adjusts the vehicle suspension characteristics automatically and controls the vehicle level
- Parktronic system\*, which assists the driver during parking maneuvers

The BAS, ABS, ESP and SBC are described in the “Safety and Security” section (▷ page 85).

### Cruise control

The cruise control automatically maintains the speed you set for your vehicle.

Use of cruise control is recommended for driving at a constant speed for extended periods of time. You can set or resume cruise control at any speed above 25 mph (40 km/h).

E 320 4MATIC, E 500 4MATIC:  
You can set or resume cruise control at any speed above 20 mph (30 km/h).

The cruise control function is operated by means of the cruise control lever.

The cruise control lever is the uppermost lever found on the left-hand side of the steering column (▷ page 22).

## Controls in detail

### Driving systems

#### Warning!



Cruise control is a convenience system designed to assist the driver during vehicle operation. The driver is and must always remain responsible for the vehicle speed and for safe brake operation.

Only use cruise control if the road, traffic and weather conditions make it advisable to travel at a steady speed.

- The use of cruise control can be dangerous on winding roads or in heavy traffic because conditions do not allow safe driving at a steady speed.
- The use of cruise control can be dangerous on slippery roads. Rapid changes in tire traction can result in wheel spin and loss of control.
- Deactivate cruise control when driving in fog.

The “Resume” function should only be operated if the driver is fully aware of the previously set speed and wishes to resume this particular preset speed.

## Controls in detail

### Driving systems

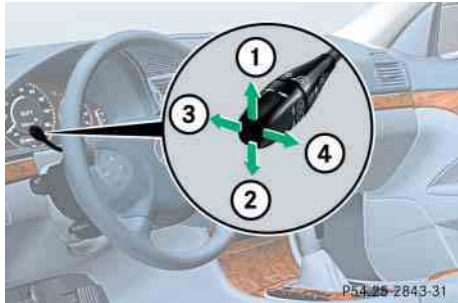

- ① Set current or higher speed
- ② Set current or lower speed
- ③ Cancel cruise control
- ④ Resume at previously set speed

#### Setting current speed

- ▶ Accelerate or decelerate to the desired speed.
- ▶ Briefly lift ① or depress ② the cruise control lever.

The current speed is set.

- ▶ Remove your foot from the accelerator pedal.

Cruise control is activated.

The selected speed appears in the multi-function display for approximately five seconds, and the corresponding speedometer segments from the selected speed to the vehicle maximum speed are illuminated.

#### i

On uphill or downhill grades, cruise control may not be able to maintain the set speed. Once the grade eases, the set speed will be resumed.

E 320 CDI, E 320, E 500, E 55 AMG:  
On downhill grades, the cruise control will hold the set speed with active braking action.

In addition, on longer downhill grades the automatic transmission will automatically downshift.

E 320 4MATIC, E 500 4MATIC:  
If the engine's braking power does not brake the vehicle sufficiently on downhill grades, the automatic transmission will automatically downshift.

#### Canceling cruise control

There are several ways to cancel cruise control:

- ▶ Step on the brake pedal.

Cruise control will be canceled. The last speed set will be stored for later use.

or

- ▶ Briefly push the cruise control lever to position ③.

Cruise control will be canceled. The last speed set will be stored for later use.



The last stored speed is canceled when you turn off the engine.



Cruise control automatically switched off, if

E 320 CDI, E 320, E 500, E 55 AMG:

- you step on the brake pedal.
- you depress the parking brake pedal.

In this case the segments in the multifunction display (▷ page 232) go out and no warning sounds.

- the vehicle speed is below 25 mph (40 km/h).
- the ESP is in operation or switched off with the ESP switch (▷ page 89).
- you move the gear selector lever to position **N** while driving.

The segments in the multifunction display (▷ page 232) go out, and an acoustic warning sounds.

E 320 4MATIC, E 500 4MATIC:

- you step on the brake pedal.
- you move the gear selector lever to position **N** while driving.
- the vehicle speed is below 20 mph (30 km/h).
- ESP is in operation.

The segments in the multifunction display are flashing.



Moving gear selector lever to position **N** while driving also cancels cruise control. However, the gear selector lever should not be moved to position **N** while driving except to coast when the vehicle is in danger of skidding (e.g. on icy roads).

## Controls in detail

### Driving systems

#### Setting a higher speed

- ▶ Lift cruise control lever to position ① and hold it up until the desired speed is reached.
- ▶ Release cruise control lever.  
The new speed is set.



Depressing the accelerator pedal does not deactivate cruise control. After brief acceleration (e.g. for passing), cruise control will resume the last speed set.

#### Setting a lower speed

- ▶ Depress cruise control lever to position ② and hold it down until the desired speed is reached.
- ▶ Release cruise control lever.  
The new speed is set.



E 320 CDI, E 320, E 500, E 55 AMG:  
When you use the cruise control lever to decelerate, the brake system will automatically brake the vehicle if the engine's braking power does not brake the vehicle sufficiently.

E 320 4MATIC, E 500 4MATIC:  
When you use the cruise control lever to decelerate, the transmission will automatically downshift if the engine's braking power does not brake the vehicle sufficiently.

#### Fine adjustment in 1 mph (Canada: 1 km/h) increments

##### *Faster*

- ▶ Briefly tip cruise control lever in direction of arrow ①.

##### *Slower*

- ▶ Briefly tip cruise control lever in direction of arrow ②.

#### Setting to last stored speed ("Resume" function)

##### Warning!



The speed stored in memory should only be set again if prevailing road conditions permit. Possible acceleration or deceleration differences arising from returning to the pre-set speed could cause an accident and/or serious injury to you and others.

- ▶ Briefly pull cruise control lever to position ④.  
The cruise control resume the last set speed.
- ▶ Remove your foot from the accelerator pedal.

The selected speed appears in the multi-function display for approximately five seconds, and the corresponding speedometer segments from the selected speed to the vehicle maximum speed are illuminated.

## Distronic\*

When activated, the Distronic adaptive cruise control system increases driving convenience afforded by the cruise control during travel on expressways and other major roads.

- If the Distronic distance sensor detects a slower moving vehicle directly ahead, your vehicle speed will be reduced so that you follow that vehicle at a preset distance.
- If there is no vehicle directly ahead of you, Distronic will function in the same way as cruise control (> page 239).

### Warning!



Distronic adaptive cruise control is no substitute for active driving involvement. It does not react to stationary objects, nor recognize or predict the curvature and lane layout or the movement of vehicles ahead. Distronic can only apply a maximum of 20% of the vehicle's braking power.

It is the driver's responsibility at all times to be attentive to traffic and road conditions and to provide the steering, braking and other driving inputs necessary to retain control of the vehicle.

### Warning!



Distronic is a convenience system. Its speed adjustment reduction capability is intended to make cruise control more effective and usable when traffic speeds vary. However, it is not intended to, nor does it, replace the need for extreme care. The responsibility for the vehicle speed and the distance to the vehicle ahead, including most importantly brake operation to assure safe stopping distance, always rests with the driver.

Distronic cannot take street and traffic conditions into account.

## Controls in detail

### Driving systems

### Warning!



Distronic requires familiarity with its operational characteristics. We strongly recommend that you review the following information carefully before operating the system.



USA only:

This device complies with Part 15 of the FCC Rules. Operation is subject to the following two conditions:

- (1) This device may not cause harmful interference, and
- (2) this device must accept any interference received, including interference that may cause undesired operation.

Any unauthorized modification to this device could void the user's authority to operate the equipment.

## Controls in detail

### Driving systems



Canada only:

This device complies with RSS-210 of Industry Canada. Operation is subject to the following two conditions:

- (1) This device may not cause interference, and
- (2) this device must accept any interference received, including interference that may cause undesired operation of the device.

Any unauthorized modification to this device could void the user's authority to operate the equipment.

#### Warning!



Distronic cannot take street and traffic conditions into account. Only use Distronic if the road, weather and traffic conditions make it advisable to travel at a steady speed.

#### Warning!



Use of Distronic can be dangerous on slippery roads. Rapid changes in tire traction can result in wheel spin and loss of control.

Distronic does not act upon adverse sight distance conditions. Do not use Distronic during conditions of fog and heavy rain, snow or sleet.

#### Warning!



Close attention to road and traffic conditions is imperative at all times, regardless of whether or not Distronic is activated.

Use of Distronic can be dangerous on winding roads or in heavy traffic because conditions do not allow safe driving at a steady speed.

Distronic will not react to stationary objects in the roadway (e.g. a stopped vehicle in a traffic jam or a disabled vehicle). Distronic will also not respond to oncoming vehicles.

Switch off Distronic:

- when changing from the left to the right lane if vehicles are moving more slowly in the left lane
- when entering a turn lane or highway off ramp
- in complex driving situations, such as in highway construction zones

In these situations, Distronic will continue to maintain the set speed unless deactivated.

Distronic is designed and intended only to maintain a set speed and keep a set distance from moving objects in front of it.

#### Warning!



The "Resume" function should only be operated if the driver is fully aware of the previously set speed and wishes to resume this particular preset speed.

## Controls in detail

### Driving systems

#### Distronic displays in the speedometer dial



#### ① Set speed

If Disticronic is activated, one or two segments come on around the set speed.



The vehicle speed displayed on the speedometer can briefly vary from the speed setting on the Disticronic system.



#### ① Segments

If Disticronic detects a vehicle directly ahead, the segments from the speed of the vehicle ahead to the set speed come on.

If Disticronic calculates that there is a danger of collision:

- The DTR warning lamp  in the instrument cluster comes on red.
- An intermittent warning sounds.
- ▶ Immediately brake the vehicle to avoid a collision.

Under no circumstances should the driver await the intermittent warning sound before braking. See the following warning note.

The intermittent warning sound ceases and the red DTR warning lamp  goes out when the necessary distance to the vehicle ahead is again established.

## Controls in detail

### Driving systems

#### Warning!



An intermittent warning sounds and the DTR warning lamp in the instrument cluster is illuminated if the Distronic system calculates that the distance to the vehicle ahead and your vehicle's current speed indicate that Distronic will not be capable of slowing the vehicle sufficiently to maintain the preset following distance, which creates a danger of a collision.

Immediately brake the vehicle to increase the distance to the vehicle in front of you. The warning sound is intended as a final caution that you have not interceded with your own braking inputs to avoid a potentially dangerous situation. Do not wait for the operation of the warning signal to intercede with your own braking, as that will result in potentially dangerous emergency braking which will not always result in an impact being avoided.

Tailgating increases the risk of an accident.

#### Warning!



Distronic brakes your vehicle with a maximum deceleration of  $6.5 \text{ ft/s}^2$  ( $2 \text{ m/s}^2$ ). This corresponds to about 20% of the maximum deceleration ability of your vehicle.



Distronic brakes the vehicle in an effort to restore the preset distance or to maintain the speed. The brake pedal is automatically applied as this happens which results in the brake pedal moving.

Keep driver's foot area clear at all times, including the area under the brake pedal. Objects stored in this area may impair pedal movement which could interfere with the braking ability of the Distronic system.

Do not place your foot under the brake pedal – your foot could become caught.

#### Distronic menu in the control system

In the Distronic menu you can read the current settings for Distronic. What appears in the display depends on whether Distronic and the distance warning function are turned on or off.

- ▶ Press button  or  repeatedly until you see one of the following displays.



## Controls in detail

### Driving systems

#### Distronic deactivated

If DISTRONIC is deactivated you can see the standard display of DISTRONIC in the multifunction display.

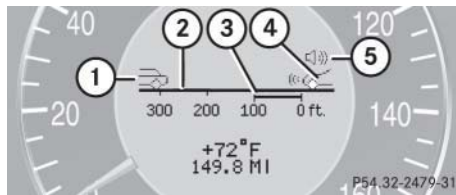

- ① Vehicle ahead, if detected
- ② Actual distance to vehicle ahead
- ③ Preset distance threshold to vehicle ahead
- ④ Your vehicle
- ⑤ Symbol for activated distance warning function

#### Distronic activated

If you turn DISTRONIC on, you will see the set speed in the multifunction display for about five seconds. If DISTRONIC is activated, you can see the following display in the multifunction display.

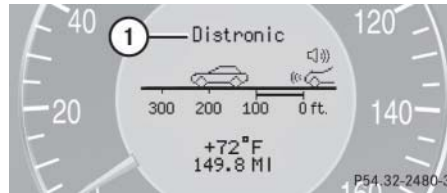

- ① DISTRONIC activated

#### Cruise control lever

The DISTRONIC system is operated by means of the cruise control lever.

The cruise control lever is the uppermost lever found on the left-hand side of the steering column.

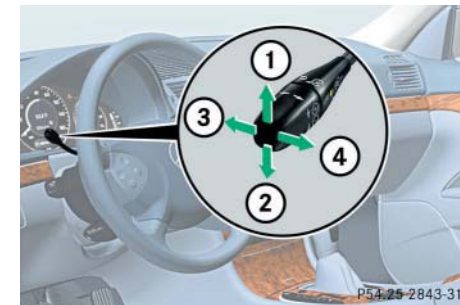

- ① Set current or higher speed
- ② Set current or lower speed
- ③ Deactivate DISTRONIC
- ④ Resume at previously set speed

## Controls in detail

### Driving systems

#### Activating Distronic

You can activate Distronic if:

- you are driving between 25 mph (40 km/h) and 110 mph (180 km/h)
- the ESP is activated (▷ page 87)

If Distronic has not been activated after pressing the cruise control lever you will see the message --- in the multifunction display.

In the following cases you cannot activate Distronic:

- Up to two minutes after starting the engine
- When you brake
- If you have set the parking brake
- If the gear selector lever is in position **P**, **R** or **N**
- If the ESP is switched off

#### Setting the current speed

- ▶ Accelerate or decelerate to the desired speed.
- ▶ Briefly lift or depress the cruise control lever.

Distronic is activated and the current speed is set.

- ▶ Remove your foot from the accelerator pedal.



If you do not take your foot off the accelerator completely, the following message will appear in the multifunction display:  
*Distronic override.* The distance to a slower moving vehicles in front of you will not be set. Your vehicle speed will then be determined only by the accelerator pedal position.

#### Setting a higher speed

- ▶ Briefly tip the cruise control lever in the direction of arrow ① (▷ page 239) to increase vehicle speed in increments of 5 mph (Canada: 10 km/h).

The new speed is set.

The stored speed is displayed in the multifunction display for approximately five seconds (▷ page 239), and one or two segments around the stored speed come on, on the speedometer (▷ page 237).



Depressing the accelerator pedal does not deactivate Distronic. After brief acceleration (e.g. for passing), cruise control will resume the last speed set.

### Setting a lower speed

- ▶ Briefly tip the cruise control lever in the direction of arrow ② (▷ page 239) to decrease vehicle speed in increments of 5 mph (Canada: 10 km/h).

The new speed is set.

The stored speed is displayed in the multifunction display for approximately five seconds (▷ page 239), and one or two segments around the stored speed come on, on the speedometer (▷ page 237).



When you use the cruise control lever to decelerate, the transmission will automatically downshift if the rate of deceleration is too low.

### Fine adjustment in 1 mph (Canada: 1 km/h) increments

#### *Faster*

- ▶ Briefly tip the cruise control lever in the direction of arrow ④ (▷ page 239).

## Controls in detail

### Driving systems

### Setting stored speed ("Resume" function)

#### **Warning!**



The speed stored in memory should only be set again if prevailing road conditions permit. Possible acceleration or deceleration differences arising from returning to preset speed could cause an accident and/or serious injury to you and others.

- ▶ Briefly tip the cruise control lever in the direction of arrow ④ (▷ page 239).  
Distronic is activated and set to the last stored speed.
- ▶ Remove your foot from the accelerator pedal.

## Controls in detail

### Driving systems

#### Deactivating Distronic

There are several ways to deactivate the Distronic system:

- ▶ Briefly tip the cruise control lever in the direction of arrow ③ (▷ page 239).

or

- ▶ Step on the brake pedal.

Distronic will be deactivated. The last speed set will be stored in memory.



The following message will appear in the multifunction display for approximately five seconds: *Distronic off*.

The last stored speed is deleted when you turn off the engine.

Distronic deactivates automatically when:

- you set the parking brake
- you drive slower than 25 mph (40 km/h)
- the ESP is active (▷ page 87) or you deactivate the ESP
- you move the transmission selector lever into position **N**

A signal will sound. The *Distronic off* message appears in the multifunction display for approximately five seconds.

#### Warning!



Distronic switches off and releases the brakes when the vehicle decelerates below the minimum speed of approximately 25 mph (40 km/h) by operation of the system. At that time the driver must apply the brakes in order to reduce vehicle speed further or bring it to a stop.

#### Setting the following distance in Distronic

You can set the specified following distance for Distronic by varying the time setting between 1.0 and 2.0 seconds. Using this time setting and the current speed of your vehicle, Distronic calculates and sets the required following distance to the vehicle ahead. The set distance will be shown in the multifunction display field.

The thumbwheel for making the time setting is located on the lower section of the center console.

#### Warning!



It is up to the driver to exercise discretion to select the appropriate setting given road conditions, traffic, driver's preferred driving style and applicable laws and driving recommendations for safe following distance.

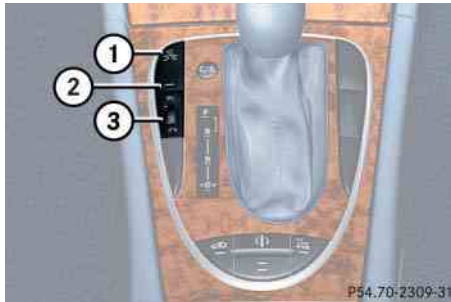

- ① Distance warning function on/off switch
- ② Control lamp
- ③ Thumbwheel for setting distance

#### **Increasing distance**

Increasing the distance setting tells Distronic to maintain a greater following distance to the vehicle ahead.

- Turn thumbwheel ③ towards .

#### **Decreasing distance**

Decreasing the distance setting tells Distronic to maintain a shorter following distance to the vehicle ahead.

- Turn thumbwheel ③ towards .

#### **Distance warning function**

When Distronic is deactivated, this function will continue to warn you when recognizing a stationary obstacle or a slower vehicle moving in the vehicle's path and the danger of a collision exists:

- The distance warning lamp  in the instrument cluster comes on.
- An intermittent warning sounds.

If these warnings are issued, you must brake manually to maintain a safe distance and avoid a collision with the vehicle ahead.

When pressing the brake pedal, the warning sound stops. The warning sound also stops when the distance to the vehicle

ahead is sufficient again without applying the brake pedal. In this case the distance warning lamp also extinguishes.

#### **Warning!**



If the DTR warning lamp  in the instrument cluster comes on while driving and/or an intermittent warning sounds, immediate attention on the part of the driver is required. As required by the traffic situation, apply the brakes and navigate around a possible obstacle. However, do not drive by relying on the distance warning function, as this will result in an emergency braking application. Especially depending on road surface conditions and driver reaction, this will not always enable you to avoid a collision.



Complex driving situations are not always fully recognized by Distronic. This could result in wrong or missing distance warnings.

## Controls in detail

### Driving systems

#### Activating

- ▶ Press button ①.

Indicator lamp ② on the button comes on. A loudspeaker symbol appears in the multifunction display (▷ page 239).

#### Deactivating

- ▶ Press button ①.

Indicator lamp ② on the button goes out. No loudspeaker symbol appears in the multifunction display.

#### Driving with DISTRONIC

This section describes a number of driving situations where special precaution is required on the part of the driver. Be prepared to brake in such situations. This will deactivate the DISTRONIC system.

#### Warning!



DISTRONIC works to maintain the speed selected by the driver unless a moving obstacle proceeding directly ahead of it in the same travel direction is detected (e.g. following another vehicle ahead of you at a distance set by DISTRONIC). This means that:

- Your vehicle can pass another vehicle after you change lanes
- While in a sharp turn or if the vehicle in front is in a sharp turn, DISTRONIC could lose sight of a vehicle traveling in front of it, then your vehicle could accelerate to the previously selected speed.

DISTRONIC regulates only the distance between your vehicle and those directly ahead of it, but does not register stationary objects in the road, e.g.:

- A stopped vehicle in a traffic jam
- A disabled vehicle
- An oncoming vehicle

The driver must always be on the alert, observe all traffic and intercede as required by steering or braking the vehicle.

#### Warning!



DISTRONIC should not be used in snowy or icy road conditions.

## Controls in detail

### Driving systems

The most likely cause for a malfunctioning system is a dirty sensor (located behind the hood grille), especially at times of snow and ice or heavy rain. In such a case, Distronic will switch off, and the message *Currently unavailable See Operator's Manual* appears in the multifunction display.

For cleaning and care of the Distronic sensor, see "Cleaning the Distronic system sensor" (▷ page 351).



If the message *Currently unavailable See Operator's Manual* disappears during driving and the last speed stored flashes for approximately five seconds, the dirt (e.g. slush) has dissolved; Distronic works again.

#### *Turns and bends*

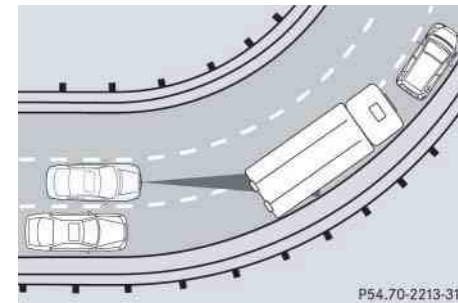

In turns or bends, Distronic may not detect a moving vehicle in front, or it may detect one too soon. This may cause your vehicle to brake late or unexpectedly.

## Controls in detail

### Driving systems

#### Offset driving

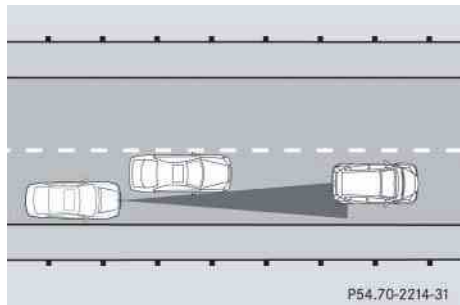

A vehicle traveling in your lane but offset from your direct line of travel may not be detected by Distronic. There will be insufficient distance to the vehicle ahead.

#### Lane changing

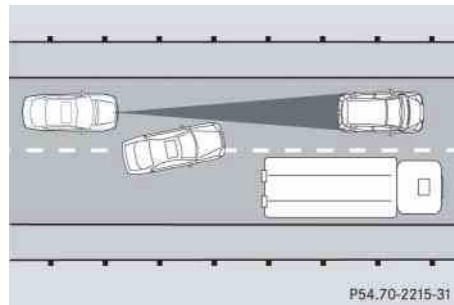

Distronic has not yet detected the vehicle changing lanes. There will be insufficient distance to the lane-changing vehicle.

#### Narrow vehicles

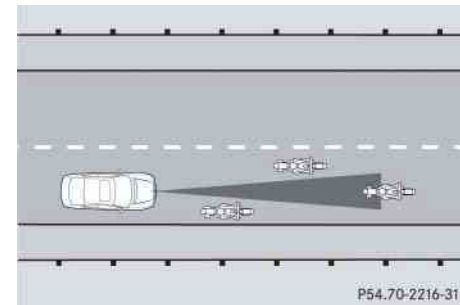

Because of its narrow profile, the vehicle traveling near the edge of the roadway has not yet been detected by Distronic. There will be insufficient distance to the vehicle ahead.



### Airmatic DC (Dual Control)\*

Airmatic automatically selects the optimum suspension tuning and ride height for your vehicle. The Airmatic consists of two components:

- Adaptive Damping System (ADS)
- Vehicle level control

The ADS automatically selects the optimum damping for the respective driving conditions. At the same time the suspension is set to either sporty or comfort.

### Suspension tuning

The suspension tuning is set according to:

- Your driving style
- Road surface conditions
- Your choice of suspension style, “sporty I”, “sporty II” or “comfortable”, which you select using the damping button.

The following suspension styles are available:

- Comfortable  
Both indicator lamps ② are off.
- Sporty I  
One indicator lamp ② is on.
- Sporty II  
Both indicator lamps ② are on.

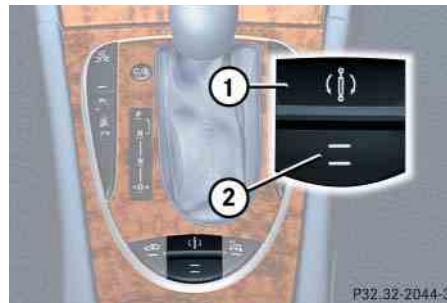

- ① Damping button
- ② Indicator lamps

## Controls in detail

### Driving systems

- ▶ Start the engine.
- ▶ Press the damping button ① until the desired suspension style is set.



The selected suspension style is stored in memory, even after the SmartKey is removed from the starter switch.



In the sporty suspension style the vehicle is lowered up to 0.6 in (15 mm).

## Controls in detail

### Driving systems

#### Vehicle level control

Your vehicle automatically adjusts its ride height to

- reduce fuel consumption
- increase vehicle safety

The following vehicle chassis ride heights can be selected:

- Normal
- Raised

The vehicle chassis ride height is raised or lowered according to the selected level setting and to the vehicle speed:

- At a speed above approximately above 68 mph (110 km/h) and the sporty suspension style selected (▷ page 247), ride height is reduced automatically by up to approximately 0.6 in (15 mm).
- With decreasing speed, the ride height is again raised to the “Normal” level.



These height adjustments are so small that you may not notice any change.

Select the “Raised” level only when required by current driving conditions. Otherwise

- fuel consumption may increase
- handling may be impaired

#### Warning!



To help avoid personal injury, keep hands and feet away from wheel housing area, and stay away from under the vehicle when lowering the vehicle chassis.

The following vehicle level settings can be selected when the vehicle is stationary and the engine is running:

Vehicle level when stationary	Use for	Ride height increase over normal	Automatic lowering	Indicator lamp (▷ page 249)
Normal	Normal operation	None	Max. approx. 0.6 in (15 mm)	Lamp off
Raised	Driving with snow chains or very rough road surface conditions	Approx. 0.8 in (20 mm)	Max. approx. 1.4 in (35 mm)	Lamp on

The button is located in the lower section of the center console.

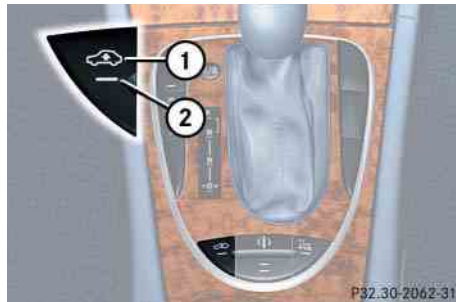

- ① Vehicle level control button
- ② Indicator lamp

- ▶ Briefly press button ① to change from “Normal” level to “Raised” level. When vehicle is at “Raised” level, pressing the switch will return the vehicle to “Normal” level.



At a speed of approximately above 75 mph (120 km/h) or if the speed amounts to between 50 mph (80 km/h) and 75 mph (120 km/h)

for approximately five minutes, the setting “Raised” is canceled. The message *Leveling cancelled* appears in the multifunction display.

If you do not drive in this speed range, the “Raised” level remains stored even if the SmartKey is removed from the starter switch.

## Controls in detail

### Driving systems

#### Parktronic system (Parking assist)\*

##### Warning!



Parktronic is a supplemental system. It is not intended to, nor does it replace, the need for extreme care. The responsibility during parking and other critical maneuvers always rests with the driver.

Special attention must be paid to objects with smooth surfaces or low silhouettes (e.g. trailer couplings, painted posts, or road curbs). Such objects may not be detected by the system and can damage the vehicle.

The operational function of the Parktronic system can be affected by dirty sensors, especially at times of snow and ice, see “Cleaning the Parktronic system\* sensors” (▷ page 351).

Interference caused by other ultrasonic signals (e.g. working jackhammers, car wash or the air brakes of trucks) can cause the system to send erratic indications, and should be taken into consideration.

##### Warning!



Make sure no persons or animals are in the area in which you are maneuvering. You could otherwise injure them.

The Parktronic system is an electronic aid designed to assist the driver during parking maneuvers. It visually and audibly indicates the relative distance between the vehicle and an obstacle.

The Parktronic system is automatically activated when you switch on the ignition, release the parking brake, and placed the gear selector lever in position **D**, **R**, or **N**. The Parktronic system deactivates at speeds over approximately 11 mph (18 km/h). At lower speeds the Parktronic system turns on again.

The Parktronic system also deactivates when you place the gear selector lever in position **P** or depress the parking brake pedal.

The Parktronic system monitors the surroundings of your vehicle with six sensors in the front bumper and four sensors in the rear bumper.



① Sensors in the front bumper

#### Range of the sensors

To function properly, the sensors must be free of dirt, ice, snow and slush. Clean the sensors regularly, being careful not to scratch or damage the sensors, see “Cleaning the Parktronic system\* sensors” (▷ page 351).

## Controls in detail

### Driving systems

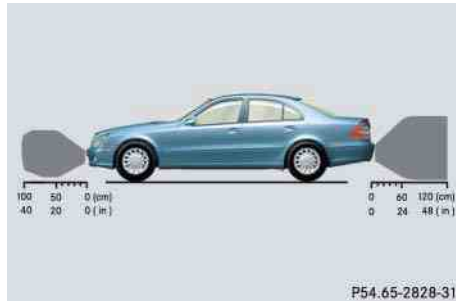

#### Front sensors

Center	<b>approx. 40 in (100 cm)</b>
Corners	<b>approx. 24 in (60 cm)</b>

#### Rear sensors

Center	<b>approx. 48 in (120 cm)</b>
Corners	<b>approx. 32 in (80 cm)</b>

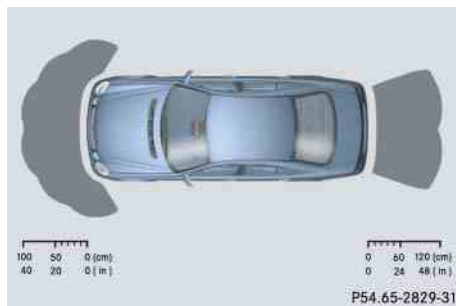

During parking maneuvers, pay special attention to objects located above or below the height of the sensors (e.g. planters or trailer hitches). The Parktronic system will not detect such objects at close range and damage to your vehicle or the object may result.

Ultrasonic signals from outside sources (e.g. truck air brakes, car wash or jackhammers) may impair the operation of the Parktronic system.

#### Minimum distance

Center	<b>approx. 8 in (20 cm)</b>
Corners	<b>approx. 6 in (15 cm)</b>

If the system detects an obstacle in this range, all the distance warning segments illuminate and you hear a warning signal. If the obstacle is closer than the minimum distance, the actual distance might no longer be indicated by the system.

## Controls in detail

### Driving systems

#### Warning indicators

Visual signals indicate to the driver the relative distance between the sensors and an obstacle. The warning indicator for the front area is located above the center air vents in the dashboard. The warning indicator for the rear area is integrated in the rear trim.

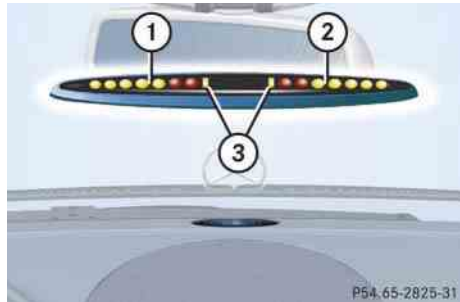

#### Front area warning indicator

- ① Left side of the vehicle
- ② Right side of the vehicle
- ③ Readiness indicators

Each warning indicator is divided into five yellow and two red segments for either side of the vehicle. The Parktronic system is operational when the yellow readiness indicators ③ are illuminated.

The position of the gear selector lever determines which warning indicators will be activated.

Gear selector lever position	Warning indicator
<b>D</b>	Front area activated
<b>R or N</b>	Front and rear area activated
<b>P</b>	Neither activated

As your vehicle approaches an object, one or more segments will come on, depending on the distance. When the seventh segment illuminates, you have reached the minimum distance.

- Front area: An intermittent acoustic warning will sound as the first red distance segment illuminates and a constant acoustic warning lasting a maximum of two seconds will sound for the second red distance segment. The signal is canceled when the gear selector lever is placed in position **P** or the parking brake is activated.
- Rear area: An intermittent acoustic warning will sound as the first red distance segment illuminates and a constant acoustic warning lasting a maximum of two seconds will sound for the second red distance segment. The signal is canceled when the gear selector lever is placed in position **D**, **P** or the parking brake is activated.

#### Switching the Parktronic system on/off

The Parktronic system can be switched off manually.

The Parktronic switch is located in the lower part of the center console (▷ page 28).

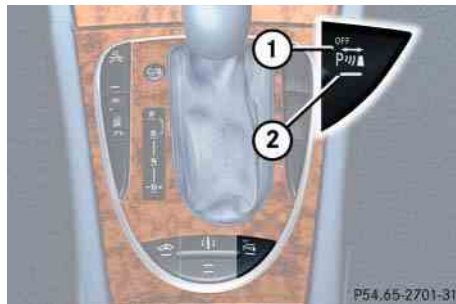

- ① Parktronic switch
- ② Indicator lamp

#### Switching off the Parktronic system

- ▶ Press Parktronic switch ①.
- Indicator lamp ② comes on.

#### Switching on the Parktronic system

- ▶ Press Parktronic switch ① again.
- Indicator lamp ② goes out.



The Parktronic system is automatically switched on when the ignition is switched on (▷ page 33).

#### Parktronic system malfunction

If only the red distance segments illuminate and an acoustic warning sounds, there is a malfunction in the Parktronic system. The Parktronic system will automatically switch off after 20 seconds and the indicator lamp in the Parktronic switch comes on.

- ▶ Have the Parktronic system checked by an authorized Mercedes-Benz Center as soon as possible.

If only the red distance segments illuminate and no acoustic warning sounds, the Parktronic system sensors are dirty or there is an interference from other radio or ultrasonic signals. The Parktronic system will automatically switch off after 20 seconds and the indicator lamp in the Parktronic switch comes on.

- ▶ Switch off the ignition (▷ page 33).
- ▶ Clean the Parktronic system sensors (▷ page 351).
- ▶ Switch on the ignition.
- or
- ▶ Check the Parktronic system operation at another location to rule out interference from outside radio or ultrasonic signals.

## Controls in detail

### Loading

#### Roof rack\*

##### Warning!



Only use roof racks approved by Mercedes-Benz for your vehicle model to avoid damage to the vehicle. Follow manufacturer's installation instructions.

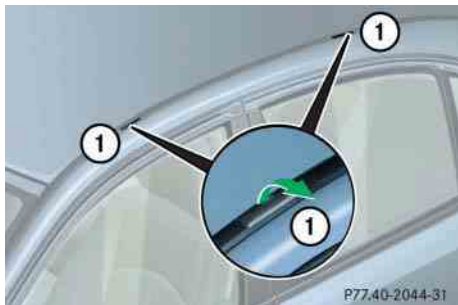

① Trim

#### Preparing roof rack installation

- ▶ Open trim ① at the trim strips in the roof.
- ▶ Secure the roof rack according to manufacturer's instructions for installation.



Load the roof rack in such a way that the vehicle cannot be damaged while driving.

Make sure

- you can fully raise the tilt/sliding sunroof\* or tilt/sliding panel\*
- you can fully open the trunk

#### Ski sack\*

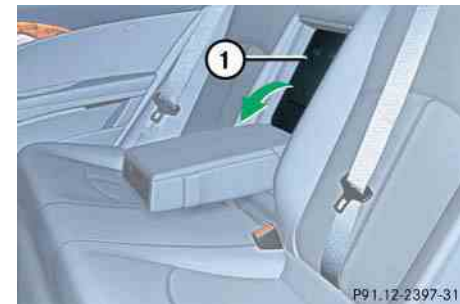

#### Unfolding and loading

- ▶ Fold rear armrest down (arrow).
- ▶ Swing cover ① down.



## Controls in detail

### Loading



- ▶ Open hook and loop strap ①.
- ▶ Pull ski sack into passenger compartment and unfold.



- ▶ From trunk, slide skis into ski sack.



- ▶ Wrap strap around ski sack and rear armrest.
- ▶ Close clasp (arrows) and pull strap tight to firmly secure skis. ▷▷

#### Warning!



The ski sack is designed for up to four pairs of skis. Do not load the ski sack with other objects.

Always fasten the ski sack securely. In an accident, an unfastened ski sack can cause injury to vehicle occupants.

## Controls in detail

### Loading

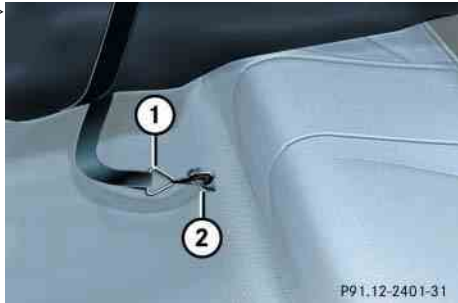

- ▶ Connect snap hook ① of front strap to eye ② located on center tunnel in front of rear seat bench.

### Unloading and folding



- ▶ Loosen strap, open clasp by pressing tabs together (arrows).
- ▶ Unload skis.
- ▶ Close flap in trunk.
- ▶ Fold and flatten ski sack lengthwise and place folded ski sack inside recess of backrest.



- ▶ Close ski sack compartment cover.

### Removal of ski sack

For removal of the ski sack, we recommend that you contact an authorized Mercedes-Benz Center.

#### Warning!



Never drive vehicle with trunk open while the ski sack is removed. Deadly carbon monoxide (CO) gases may enter vehicle interior, resulting in unconsciousness and death.



To prevent unauthorized persons from access to the trunk, always close the cover.

### Split rear bench seat\*

To expand the trunk, you can fold down the left and right rear seat backrests.

The two sections can be folded down separately to enlarge the trunk.

#### Warning!



When expanding the luggage compartment, always fold the seat cushions fully forward.

Unless you are transporting cargo, the backrests must remain properly locked in the upright position.

In an accident, during hard braking or sudden maneuvers, loose items will be thrown around inside the vehicle, and cause injury to vehicle occupants unless the items are securely fastened in the vehicle.

Always use the cargo tie down rings (▷ page 261).

## Controls in detail

### Loading

### Folding the backrest forward



You must always release the seat cushion and fold it up before folding the seat backrests forward. The upholstery on the seat backrest may otherwise be damaged.



① Release handle

## Controls in detail

### Loading



If tall persons have occupied the driver's and front passenger seats, it may be necessary to move these seats forward slightly in order to fold the rear seat backrests forward.

- ▶ Pull release handle ①.

The seat cushion automatically springs upward slightly.

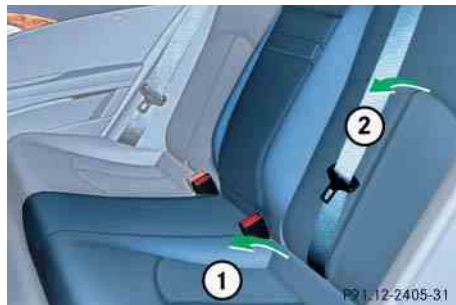

- ① Seat cushion
- ② Seat backrest

- ▶ Grip the back of seat cushion ① and fold forward.

- ▶ Push the rear seat head restraints all the way in.



If the rear center seat is to be occupied while driving, it may be necessary to fold the seat belt buckle up again.



- ▶ Pull the handle in the trunk.  
The seat backrest is released and the head restraints fold back.
- ▶ Fold the seat backrest forward.



Make sure the head restraints fit all the way into the seat cushion pockets. This will prevent the backrests from being damaged during loading.

### Returning seat backrest to original position

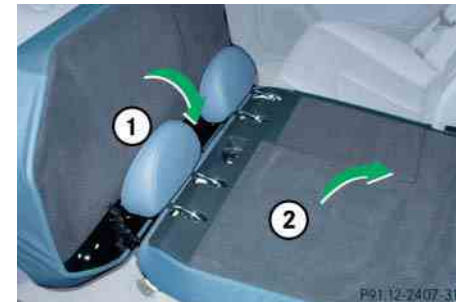

- ① Seat cushion
- ② Seat backrest

- ▶ Swing seat backrest ② to the rear until it engages.
- ▶ Swing seat cushion ① to the rear and press the center front of the cushion until it audibly engages.

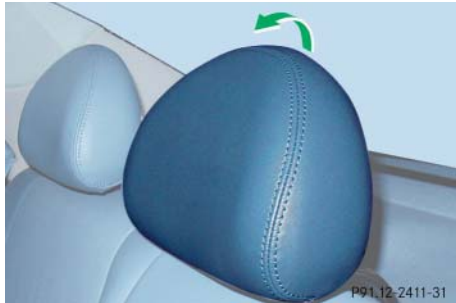

- ▶ Swing the head restraint forward by hand until it engages.

### Warning!



Always lock backrest in its upright position when rear seat bench is occupied, or the extended trunk compartment is not in use. Check for secure locking by pushing and pulling on the backrest.

In an accident, during hard braking or sudden maneuvers, loose items will be thrown around inside the vehicle, and cause injury to vehicle occupants unless the items are securely fastened in the vehicle.

To help avoid personal injury during a collision or sudden maneuver, exercise care when transporting cargo.

## Controls in detail

### Loading

#### Expanding the cargo area\*

Removing the rear seat cushions will provide you with a larger, flat cargo area.

- ▶ Fold the seat cushions and the backrests forward (▷ page 257).
- ▶ Remove the head restraints (▷ page 125).
- ▶ Fold the backrest into the vertical position.

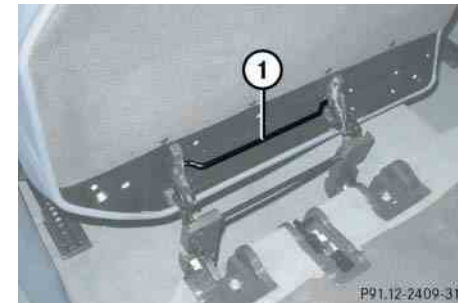

① Release lever

- ▶ Pull seat cushion release lever ① and remove the seat cushion by pulling it upward.

## Controls in detail

### Loading



Leave the seat cushion hinge in this position. The upholstery could be damaged if you fold the hinge back.



- Fold the seat backrest forward.

### Loading instructions

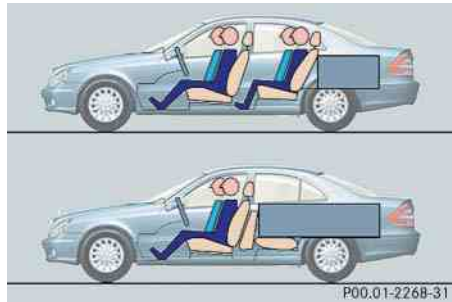

The total load weight including vehicle occupants and luggage/cargo should not exceed the load limit or vehicle capacity weight indicated on the corresponding placard located on the driver's door B-pillar.

The handling characteristics of a fully loaded vehicle depend greatly on the load distribution. It is therefore recommended to load the vehicle according to the illustrations shown, with the heaviest items being placed towards the front of the vehicle.

Always place items being carried against front or rear seat backrests, and fasten them as securely as possible.

The heaviest portion of the cargo should always be kept as low as possible since it influences the handling characteristics of the vehicle.

#### Warning!



Always fasten items being carried as securely as possible.

In an accident, during hard braking or sudden maneuvers, loose items will be thrown around inside the vehicle and can cause injury to vehicle occupants unless the items are securely fastened in the vehicle.

To help avoid personal injury during a collision or sudden maneuver, exercise care when transporting cargo. Put luggage or cargo in the trunk if possible. Do not pile luggage or cargo higher than the seat backs. Do not place anything on the rear-window shelf.

Never drive vehicle with trunk open. Deadly carbon monoxide (CO) gases may enter vehicle interior resulting in unconsciousness and death.

#### Cargo tie-down rings\*

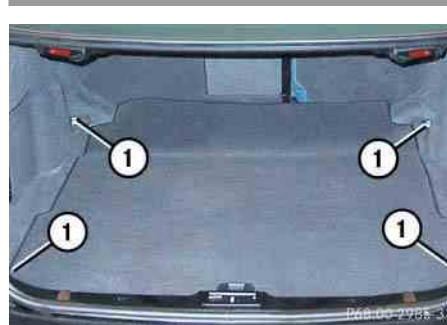

Four rings ① are located in the trunk.

- Carefully secure cargo by applying even load on all rings with rope of sufficient strength to hold down the cargo.

Always follow loading instructions (► page 260).

#### Rear seat

There is a cargo tie-down ring located on each side of the footwell under the rear seat.

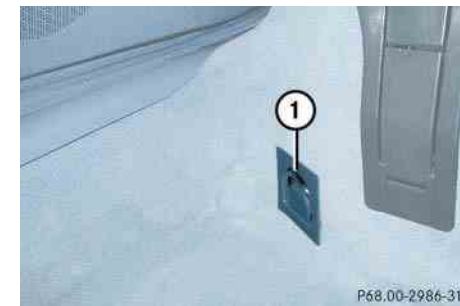

## Controls in detail

### Useful features

#### Storage compartments

##### Warning!



To help avoid personal injury during a collision or sudden maneuver, exercise care when stowing objects in the vehicle. Put luggage or cargo in the trunk if possible. Do not pile luggage or cargo higher than the seat backs. Do not place anything on the shelf below the rear window.

Luggage nets cannot secure hard or heavy objects.

Keep compartment lids closed. This will help to prevent stored objects from being thrown about and injuring vehicle occupants during an accident.

#### Parcel net in front passenger footwell

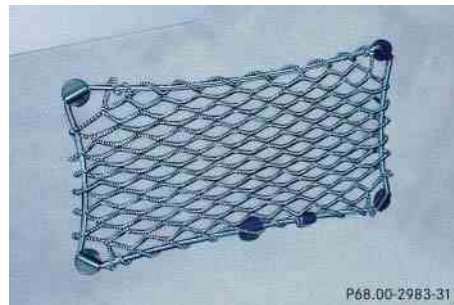

A small convenience parcel net is located in the front passenger footwell. It is for small and light items, such as road maps, mail, etc.

##### Warning!



The parcel net is intended for storing light-weight items only.

Heavy objects, objects with sharp edges or fragile objects may not be transported in the parcel net.

The parcel net cannot protect transported goods in the event of an accident.

#### Glove box

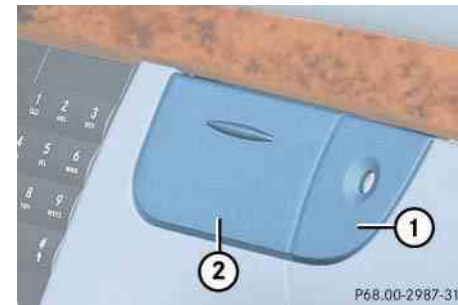

① Glove box lid release

② Compartment for mobile phone/glasses

##### Opening the glove box

- ▶ Push lid release ①.

The glove box lid opens downward.

##### Closing the glove box

- ▶ Push lid up to close.



## Controls in detail

### Useful features



Prior to closing the glove box, close the compartment for glasses first.

#### Storage compartment in the center console (no CD changer\* installed)



① Opening/closing button

► Press button ① to open.

The control panel swings out upward and the storage compartment extends out.



Never place any medications in the storage compartment. If there is a power failure, the storage compartment cannot be opened.

► Press button ① to close.

#### Storage space under center armrest (Vehicles with cup holders in the center console)

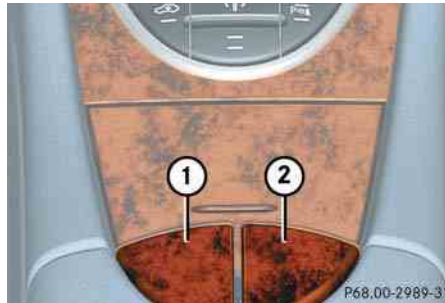

① Storage compartment

② Storage tray

#### Opening storage tray

► Pull handle ②.

#### Opening storage compartment

► Pull handle ①.

## Controls in detail

### Useful features

#### Storage compartment in the rear center console



- ▶ Briefly press the top of the compartment.

It extends automatically.

#### Ruffled storage bags



Ruffled storage bags are located on the back of the front seats.

#### Warning!



The ruffled storage bag is intended for storing light-weight items only.

Heavy objects, objects with sharp edges or fragile objects may not be transported in the ruffled storage bag.

The ruffled storage bag cannot protect transported goods in the event of an accident.

#### Storage compartment in the rear armrest

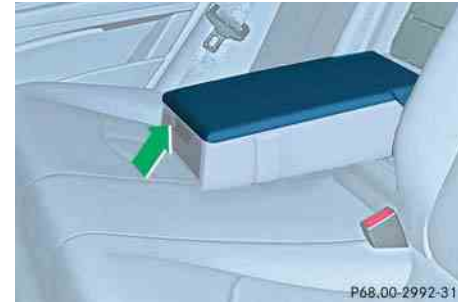

- ▶ Press the handle upward and fold the rear armrest up.

## Cup holders

Depending on production date, your vehicle is equipped with cup holders in either the center console (▷ page 265) or in the center armrest (▷ page 266).

### Warning!



In order to help prevent spilling liquids on vehicle occupants, only use containers that fit into the cup holder. Use lids on open containers and do not fill containers to a height where the contents, especially hot liquids, could spill during braking, vehicle maneuvers, or in an accident.

When not in use, keep the cup holder closed. An open cup holder may cause injury to you or others when contacted during braking, vehicle maneuvers, or in an accident.

Keep in mind that objects placed in the cup holder may come loose during braking, vehicle maneuvers, or in an accident and be thrown around in the vehicle interior. Objects thrown around in the vehicle interior may cause an accident and/or serious personal injury.

### Cup holder in the center console



- ▶ Briefly press the marking in the back of the cover.

The cover opens.

## Controls in detail

### Useful features

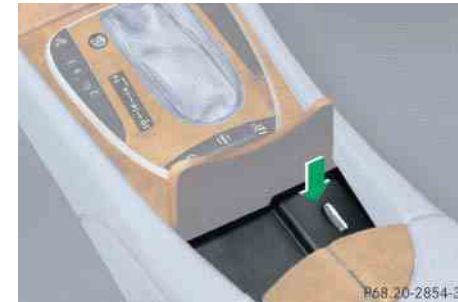

- ▶ Briefly press marking on the cup holder.  
The cup holder extends automatically.



The cup holder can be removed for cleaning. Clean the cup holder only with clear, lukewarm water. Make sure to insert the cup holder in the guides when reinstalling it. ▷▷

## Controls in detail

### Useful features

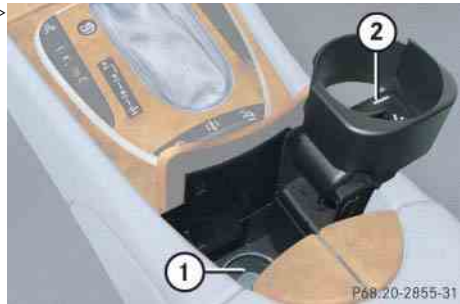

- ① Left cup holder
- ② Right cup holder

#### Removing cup holder

- ▶ Take out the cup holder.

Using two fingers in the horizontal slot at the upper rear side of the cup holder, lift cup holder upwards to remove.

#### Storage compartment with cup holder in the center armrest

The storage compartment in the center armrest contains a removable dual cup holder.

#### Opening storage compartment

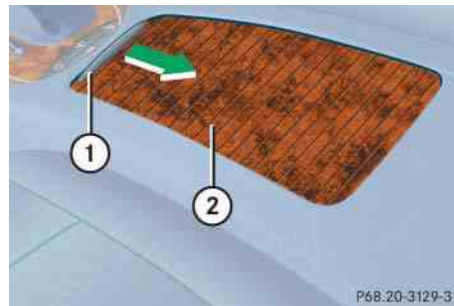

- ① Cover
- ▶ Slide cover ① in direction of arrow ②.

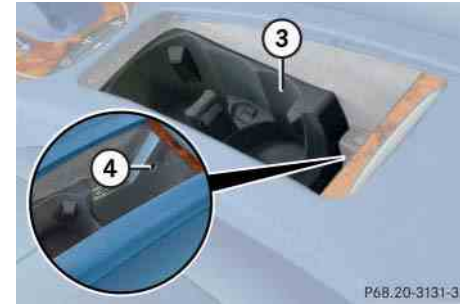

#### Cup holder in the center armrest

- ③ Dual cup holder
- ④ Telephone\* compartment

#### Closing storage compartment

- ▶ Slide cover ① back.



The cup holder can be removed to increase storage space and for cleaning. Clean the cup holder only with clear, lukewarm water. Make sure to insert the cup holder in the guides when reinstalling it (▷ page 267).

**Removing cup holder**

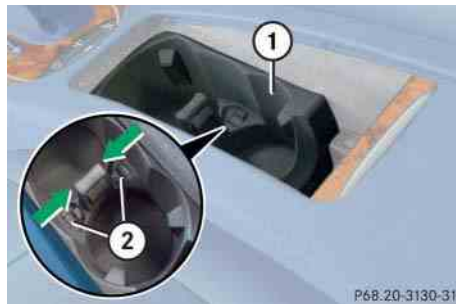

- ① Cup holder
- ② Locking pins
- ▶ Move both locking pins ② in direction of arrow.
- ▶ Take cup holder out upward.

**Reinstalling cup holder**



- ③ Locking pins
- ▶ Insert cup holder.
- ▶ Move both locking pins ③ in direction of arrow.

**Rear cup holder**

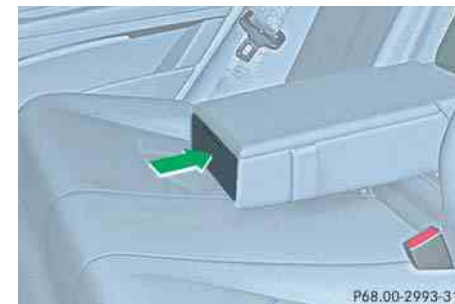

- ▶ Briefly press the front of the rear armrest.
- The cup holder extends automatically.

## Controls in detail

### Useful features

#### Ashtrays

##### Center console ashtray



##### Opening ashtray

- ▶ Briefly press the marking on the bottom of cover ①.  
The ashtray opens automatically.

##### Removing ashtray insert

##### Warning!



Remove front ashtray only with vehicle standing still. Set the parking brake to secure vehicle from movement. Move gear selector lever to position **N**. With gear selector lever in position **N**, turn off the engine.

- ▶ Secure vehicle from movement by setting the parking brake. Move the gear selector lever to position **N**.  
Now you have more room to take out the insert.
- ▶ Push sliding button ② to the right and hold.
- ▶ Grip and remove insert from ashtray frame.

##### Reinstalling ashtray insert

- ▶ Install insert by pushing it back into frame until it engages again.

##### Rear seat ashtray



##### Opening rear seat ashtray

- ▶ Briefly press the top of the ashtray.  
The ashtray opens.

#### Cigarette lighter

The cigarette lighter is located in the center console compartment in front of the center armrest (▷ page 28).

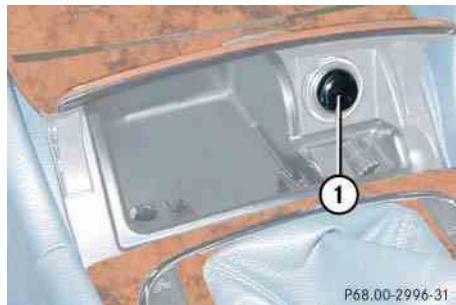

#### ① Cigarette lighter

- ▶ Switch on the ignition (▷ page 33).
- ▶ Push in cigarette lighter ①.  
The lighter will pop out automatically when hot.

#### Warning!



Never touch the heating element or sides of the lighter; they are extremely hot. Hold the knob only.

When leaving the vehicle, always remove the SmartKey or the SmartKey with KEYLESS-GO\* from the starter switch, take it with you, and lock the vehicle. Do not leave children unattended in the vehicle, or with access to an unlocked vehicle. Unsupervised use of vehicle equipment may cause an accident and/or serious personal injury.



The lighter socket can be used to accommodate electrical accessories up to a maximum 85 W.

#### 12-V socket\*



The socket is located in the rear of the center console storage compartment.

The socket can be used for accessories up to a maximum of 180 W.



An additional socket is located in the trunk.

## Controls in detail

### Useful features

#### Heated steering wheel\*

The steering wheel heating warms up the leather area of the steering wheel.

The stalk with the heated steering wheel switch is on the lower left-hand side of the steering wheel.

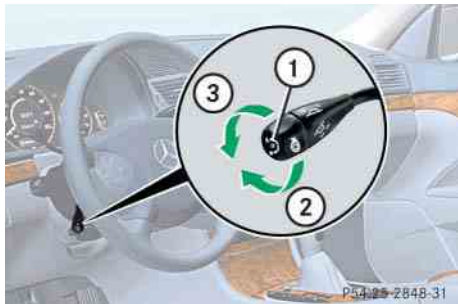

- ① Indicator lamp
- ② Switching off
- ③ Switching on

#### Switching on

- ▶ Switch on the ignition (▷ page 33).
- ▶ Turn switch at the tip of stalk in the direction of arrow ③.

The steering wheel is heated. Indicator lamp ① comes on.

#### Switching off

- ▶ Turn switch at the tip of stalk in direction of arrow ②.

The heated steering wheel is turned off. Indicator lamp ① goes out.



The steering wheel heating does not turn off automatically.

#### Telephone\*

##### Warning!



Never operate radio transmitters equipped with a built-in or attached antenna (i.e. without being connected to an external antenna) from inside the vehicle while the engine is running. Doing so could lead to a malfunction of the vehicle's electronic system, possibly resulting in an accident and/or serious personal injury.

Radio transmitters, such as a portable telephone or a citizens band unit, should only be used inside the vehicle if they are connected to an antenna that is installed on the outside of the vehicle.

The external antenna must be approved by Mercedes-Benz. Please contact an authorized Mercedes-Benz Center for information on the installation of an approved external antenna. Refer to the radio transmitter operation instructions regarding use of an external antenna.



## Controls in detail

### Useful features

#### Warning!





Please do not forget that your primary responsibility is to drive the vehicle. A driver's attention to the road must always be his/her primary focus when driving. For your safety and the safety of others, we recommend that you pull over to a safe location and stop before placing or taking a telephone call.

If you choose to use the telephone<sup>1</sup> while driving, please use the hands-free device and only use the telephone when road, weather and traffic conditions permit. Some jurisdictions prohibit the driver from using a cellular telephone while driving a vehicle.

Only operate the COMAND (Cockpit Management and Data System) if road, weather and traffic conditions permit.

<sup>1</sup> Observe all legal requirements.

Bear in mind that at a speed of just 30 mph (approximately 50 km/h), your vehicle is covering a distance of 44 feet (approximately 14 m) every second.

You can take and place telephone calls using the  and  buttons on the steering wheel. To carry out other telephone functions, use the control system (▷ page 171).

See separate operating manual for instructions on how to use the telephone.

#### Warning!



Some jurisdictions prohibit the driver from using a cellular telephone while driving a vehicle. Whether or not prohibited by law, for safety reasons, the driver should not use the cellular telephone while the vehicle is in motion.

Stop the vehicle in a safe location before answering or placing a call.

#### Tele Aid\*



The initial activation of the Tele Aid system may only be performed by completing the subscriber agreement and placing an acquaintance call using the  button. Failure to complete either of these steps will result in a system that is not activated.

If you have any questions regarding activation, please call the Response Center at 1-800-756-9018 (in the USA) or 1-888-923-8367 (in Canada).

#### The Tele Aid system

(Telematic Alarm Identification on Demand)



The Tele Aid system consists of three types of response:



- automatic and manual emergency
- roadside assistance and
- information

## Controls in detail

### Useful features



The Tele Aid system is operational providing that the vehicle's battery is charged, properly connected, not damaged and cellular and GPS coverage is available.

The speaker volume of a Tele Aid call can be adjusted when using the volume control on the multifunction steering wheel. To raise, press button  and to lower, press button  or use the volume knob on your COMAND headunit.

- ▶ To activate, press the SOS button, the Roadside Assistance button  or the Information button , depending on the type of response required.



The SOS button is located above the interior rear view mirror.



The Roadside Assistance button  and the Information button  are located below the center armrest cover.

Shortly after the completion of your Tele Aid acquaintance call, you will receive a user ID and password. By visiting [www.mbusa.com](http://www.mbusa.com) and selecting "Tele Aid" (USA only), you will have access to account information, remote door unlock and more.



The Tele Aid system utilizes the cellular network for communication and the GPS (Global Positioning System) satellites for vehicle location. If either of these signals are unavailable, the Tele Aid system may not function and if this occurs, assistance must be summoned by other means.

#### System self-check

Initially, after switching on the ignition, malfunctions are detected and indicated (the indicator lamps in the SOS button, the Roadside Assistance button  and the Information button  stay on longer than ten seconds or do not come on). The

message TELE AID malfunction - Drive to workshop appears in the multifunction display.

#### Warning!



If the indicator lamps in the SOS button, in the Roadside Assistance button and/or in the Information button remain illuminated constantly in red and/or the message TELE AID malfunction - Drive to workshop is displayed in the multifunction display after the system self-check, a malfunction in the system has been detected.

If a malfunction is indicated as outlined above, the system may not operate as expected. Have the system checked at the nearest Mercedes-Benz Center as soon as possible.

### Emergency calls

An emergency call is initiated automatically following an accident in which the emergency tensioning devices (ETDs) or air bags deploy.

An emergency call can also be initiated manually by opening the cover next to the interior rear view mirror labeled SOS, then briefly pressing the button located under the cover. See (▷ page 274) for instructions on initiating an emergency call manually.

Once the emergency call is in progress, the indicator lamp in the SOS button will begin to flash. The message *Connecting call* appears in the multifunction display and the audio system is muted. When the connection is established, the message *Call connected* appears in the multifunction display. All information relevant to the emergency, such as the location of the vehicle (determined by the GPS satellite location system), vehicle model, identification number and color are generated.

A voice connection between the Response Center and the occupants of the vehicle will be established automatically soon after the emergency call has been initiated. The Response Center will attempt to determine more precisely the nature of the emergency provided they can speak to an occupant of the vehicle.

The Tele Aid system is available if

- it has been activated and is operational. Activation requires a subscription for monitoring services, connection and cellular air time
- the relevant cellular phone network and GPS signals are available and pass the information on to the Response Center



Location of the vehicle on a map is only possible if the vehicle is able to receive signals from the GPS satellite network and pass the information on to the Response Center.

## Controls in detail

### Useful features

## Controls in detail

### Useful features

#### Warning!



If the indicator lamp in the SOS button is flashing continuously and there was no voice connection to the Response Center established, then the Tele Aid system could not initiate an emergency call (e.g. the relevant cellular phone network is not available). The message *Call failed* appears in the multifunction display for approximately ten seconds.

Should this occur, assistance must be summoned by other means.

#### Initiating an emergency call manually



① Cover

② SOS button

- ▶ Briefly press on cover ①.  
The cover will open.
- ▶ Press SOS button ② briefly.  
The indicator lamp in SOS button ② will flash until the emergency call is concluded.
- ▶ Wait for a voice connection to the Response Center.
- ▶ Close cover after the emergency call is concluded.

#### Warning!



If you feel at any way in jeopardy when in the vehicle (e.g. smoke or fire in the vehicle, vehicle in a dangerous road location), please do not wait for voice contact after you have pressed the emergency button. Carefully leave the vehicle and move to a safe location. The Response Center will automatically contact local emergency officials with the vehicle's approximate location if they receive an automatic SOS signal and cannot make voice contact with the vehicle occupants.

### Roadside Assistance button

Located below the center armrest cover is the Roadside Assistance button .

- ▶ Press and hold the button (for longer than two seconds).

A call to a Mercedes-Benz Roadside Assistance dispatcher will be initiated. The button will flash while the call is in progress. The message *Connecting call* will appear in the multifunction display and the audio system is muted.

When the connection is established, the message *Call connected* appears in the multifunction display. The Tele Aid system will transmit data generating the vehicle identification number, model, color and location (subject to availability of cellular and GPS signals).

A voice connection between the Roadside Assistance dispatcher and the occupants of the vehicle will be established.

- ▶ Describe the nature of the need for assistance.

The Mercedes-Benz Roadside Assistance dispatcher will either dispatch a qualified Mercedes-Benz technician or arrange to tow your vehicle to the nearest authorized Mercedes-Benz Center. For services such as labor and/or towing, charges may apply. Refer to the Roadside Assistance manual for more information.



The following is only available in the USA:

- Sign and Drive services: Services such as a jump start, a few gallons of fuel or the replacement of a flat tire with the vehicle spare tire are obtainable.

## Controls in detail

### Useful features



The indicator lamp on the Roadside Assistance button  remains illuminated in red for approximately ten seconds during the system self-check after switching on the ignition (together with the SOS button and the Information button .

See system self-check (▷ page 272) when the indicator lamp does not come on in red or stays on longer than approximately ten seconds.

If the indicator lamp on the Roadside Assistance button  is flashing continuously and there was no voice connection to the Response Center established, then the Tele Aid system could not initiate a Roadside Assistance call (e.g. the relevant cellular phone network is not available). The message *Call failed* appears in the multifunction display.

## Controls in detail

### Useful features

Roadside Assistance calls can be terminated using the  button on the multifunction steering wheel or the respective button for ending a telephone call on the COMAND headunit.

#### Information button

The Information button  is located below the center armrest cover.

- ▶ Press and hold button (for longer than two seconds).



A call to the Customer Assistance Center will be initiated. The button will flash while the call is in progress. The message *Connecting call* will appear in the multifunction display and the audio system is muted.

When the connection is established, the message *Call connected* appears in the multifunction display. The Tele Aid system will transmit data generating the vehicle identification number, model, color and location (subject to availability of cellular and GPS signals).

A voice connection between the Customer Assistance Center representative and the occupants of the vehicle will be established. Information regarding the operation of your vehicle, the nearest authorized Mercedes-Benz Center or Mercedes-Benz USA products and services is available to you.

For more details concerning the Tele Aid system, please visit [www.mbusa.com](http://www.mbusa.com) and use your ID and password (sent to you separately) to learn more (USA only).



The indicator lamp on the Information button  remains illuminated in red for approximately ten seconds during the system self-check after switching on the ignition (together with the SOS button and the Roadside Assistance button ).

See system self-check (▷ page 272) when the indicator lamp does not come on in red or stays on longer than approximately ten seconds.

If the indicator lamp on the Information button  is flashing continuously and there was no voice connection to the Response Center established, then the Tele Aid system could not initiate an Information call (e.g. the relevant cellular phone network is not available). The message *Call failed* appears in the multifunction display.

Information calls can be terminated using the  button on the multifunction steering wheel or the respective button for ending a telephone call on the COMAND headunit.



If the indicator lamps do not start flashing after pressing one of the buttons or remain illuminated (in red) at any time, the Tele Aid system has detected a malfunction or the service is not currently active, and may not initiate a call. Visit an Mercedes-Benz Center and have the system checked or contact the Response Center at 1-800-756-9018 (in the USA) or 1-888-923-8367 (in Canada) as soon as possible.

#### Upgrade scenario

An emergency call is possible even if other services are active.



If the indicator lamp continues to flash or the system does not reset, contact the Response Center at 1-800-756-9018 (in the USA) or 1-888-923-8367 (in Canada), or Mercedes-Benz Customer Assistance at 1-800-FOR-MERCEdes (1-800-367-6372) in the USA or Customer Service at 1-800-387-0100 in Canada.

## Controls in detail

### Useful features



The indicator lamp in the respective button flashes until the call is concluded. Calls can only be terminated by a Response Center or Customer Assistance Center representative except Roadside Assistance and Information calls, which can also be terminated by pressing button  on the multifunction steering wheel or the respective button for ending a telephone call on the COMAND headunit.

## Controls in detail

### Useful features



When a Tele Aid call has been initiated, the COMAND system audio is muted and the selected mode (radio or CD) pauses. The optional cellular phone (if installed) switches off. If you must use this phone, the vehicle must be parked. Disconnect the coiled cord and place the call. The COMAND navigation\* system (if engaged) will continue to run. The display in the instrument cluster is available for use, and spoken commands are only available by pressing the RPT button on the COMAND unit. A pop-up window will appear in the COMAND display to indicate that a Tele Aid call is in progress.

#### Remote door unlock

In case you have locked your vehicle unintentionally (e.g. SmartKey inside vehicle), and the reserve SmartKey is not handy:

- ▶ Contact the Mercedes-Benz Response Center at 1-800-756-9018 (in the USA) or 1-888-923-8367 (in Canada).

You will be asked to provide your password which you provided when you completed the subscriber agreement.

- ▶ Then return to your vehicle and pull the trunk recessed handle for a minimum of 20 seconds until the SOS button is flashing.

The message *Call connected* appears in the multifunction display.

As an alternative, you may unlock the vehicle via Internet using the ID and password sent to you shortly after the completion of your acquaintance call.

The Response Center will then unlock your vehicle with the remote door unlocking feature.



The remote door unlock feature is available if the relevant cellular phone network is available.

The SOS button will flash and the message *Call connected* will appear in the multifunction display to indicate receipt of the door unlock command.

Once the vehicle is unlocked, a Response Center specialist will attempt to establish voice contact with the vehicle occupants.

If the trunk recessed handle was pulled for more than 20 seconds before door unlock authorization was received by the Response Center, you must wait 15 minutes before pulling the trunk recessed handle again.



### Stolen Vehicle Recovery services

In the event your vehicle was stolen:

- ▶ Report the incident to the police.  
The police will issue a numbered incident report.
- ▶ Pass this number on to the Mercedes-Benz Response Center along with your password issued to you when you subscribed to the service.

The Response Center will then attempt to covertly contact the vehicle's Tele Aid system. Once the vehicle is located, the Response Center will contact the local law enforcement and you. The vehicle's location will only be provided to law enforcement.



When the anti-theft alarm or the tow-away alarm stays on for more than 30 seconds, a call is initiated automatically to the Response Center. See anti-theft alarm system (▷ page 94) and tow-away alarm (▷ page 95).

### Garage door opener

The built-in remote control is capable of operating up to three separately controlled devices, for example garage door openers, gate openers, or other devices compatible with HomeLink® or some other systems.

You can program the signal transmitter buttons.

## Controls in detail

### Useful features

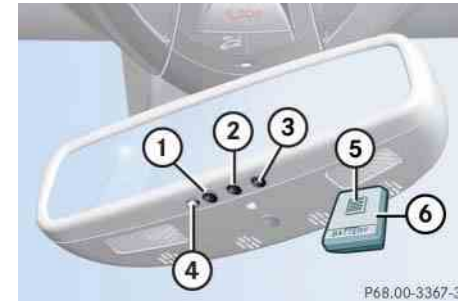

#### Remote control integrated into the overhead control panel

- ① ② ③ Signal transmitter button
- ④ Indicator lamp
- ⑤ Hand-held transmitter button
- ⑥ Hand-held remote control transmitter (not part of the vehicle equipment)

## Controls in detail

### Useful features

#### Warning!



Before programming the integrated remote control to a garage door opener or gate operator, make sure that people and objects are out of the way of the device to prevent potential harm or damage. When programming a garage door opener, the door moves up or down. When programming a gate operator, the gate opens or closes.

Do not use the integrated remote control with any garage door opener that lacks safety stop and reverse features as required by U.S. federal safety standards (this includes any garage door opener model manufactured before April 1, 1982). A garage door that cannot detect an object - signaling the door to stop and reverse - does not meet current U.S. federal safety standards.



Certain types of garage door openers are incompatible with the integrated opener. If you should experience difficulties with programming the transmitter, contact an authorized Mercedes-Benz Center, or call Mercedes-Benz Customer Assistance Center (in the USA only) at 1-800-FOR-MERCEdes, or Customer Service (in Canada) at 1-800-387-0100.



USA only:

This device complies with Part 15 of the FCC Rules. Operation is subject to the following two conditions:

- (1) This device may not cause harmful interference, and
- (2) this device must accept any interference received, including interference that may cause undesired operation.

Any unauthorized modification to this device could void the user's authority to operate the equipment.



Canada only:

This device complies with RSS-210 of Industry Canada. Operation is subject to the following two conditions:

- (1) This device may not cause interference, and
- (2) this device must accept any interference received, including interference that may cause undesired operation of the device.

Any unauthorized modification to this device could void the user's authority to operate the equipment.

### Programming or reprogramming the integrated remote control

Step 1:

- ▶ Switch on the ignition (▷ page 33).

Step 2:

- ▶ If you have previously programmed an integrated signal transmitter button and wish to retain its programming, proceed to step 3. Otherwise, press and hold the two outer signal transmitter buttons ① and ③ and release them only when the indicator lamp ④ begins to flash after approximately 20 seconds (do not hold the button for longer than 30 seconds). This procedure erases any previous settings for all three channels and initializes the memory. If you later wish to program a second and/or third hand-held transmitter to the remaining two signal transmitter buttons, do not repeat this step and begin directly with step 3.

## Controls in detail

### Useful features

Step 3:

- ▶ Hold the end of the hand-held remote control transmitter ⑥ of the device you wish to train approximately 2 to 5 in (5 to 12 cm) away from the surface of the integrated remote control located on the interior rear view mirror, keeping the indicator lamp ④ in view.

Step 4:

- ▶ Using both hands, simultaneously press the hand-held transmitter button ⑤ and the desired integrated signal transmitter button (①, ② or ③). Do not release the buttons until completing step 5.

The indicator lamp ④ on the integrated remote control will flash, first slowly and then rapidly. ▷▷

## Controls in detail

### Useful features



The indicator lamp ④ flashes the first time the signal transmitter button is programmed. If this button has already been programmed, the indicator lamp will only start flashing after 20 seconds.

Step 5:

- ▶ When the indicator lamp ④ flashes rapidly, release both buttons.

Step 6:

- ▶ Press and hold the just-trained integrated signal transmitter button and observe the indicator lamp ④.

If the indicator lamp ④ stays on constantly, programming is complete and your device should activate when the integrated signal transmitter button is pressed and released.



If the indicator lamp ④ blinks rapidly for about two seconds and then turns to a constant light, continue with programming steps 8 through 12 as your garage door opener may be equipped with the “rolling code” feature.

Step 7:

- ▶ To program the remaining two buttons, repeat the steps above starting with step 3.

### ***Rolling code programming***

To train a garage door opener (or other rolling code devices) with the rolling code feature, follow these instructions after completing the “Programming” portion (steps 1 through 6) of this text. (A second person may make the following training procedures quicker and easier.)

Step 8:

- ▶ Locate “training” button on the garage door opener motor head unit.

Exact location and color of the button may vary by garage door opener brand. Depending on manufacturer, the “training” button may also be referred to as “learn” or “smart” button. If there is difficulty locating the transmitting button, refer to the garage door opener operator’s manual.

## Controls in detail

### Useful features

Step 9:

- ▶ Press “training” button on the garage door opener motor head unit.

The “training light” is activated.

You have 30 seconds to initiate the following step.

Step 10:

- ▶ Firmly press, hold for two seconds and release the programmed integrated signal transmitter button (①, ② or ③).

Step 11:

- ▶ Press, hold for two seconds and release same button a second time to complete the training process.

Some garage door openers (or other rolling code equipped devices) may require you to perform this procedure a third time to complete the training.

Step 12:

- ▶ Confirm the garage door operation by pressing the programmed integrated signal transmitter button (①, ② or ③).

Step 13:

- ▶ To program the remaining two buttons, repeat the steps above starting with step 3.

#### ***Gate operator/Canadian programming***

Canadian radio-frequency laws require transmitter signals to “time-out” (or quit) after several seconds of transmission which may not be long enough for the integrated signal transmitter to pick up the signal during programming. Similar to this Canadian law, some U.S. gate operators are designed to “time-out” in the same manner.

If you live in Canada or if you are having difficulties programming a gate operator (regardless of where you live) by using the programming procedures, replace step 4 with the following:

Step 4:

- ▶ Continue to press and hold the integrated signal transmitter button (①, ② or ③) while you press and re-press (“cycle”) your hand-held remote control transmitter ⑥ every two seconds until the frequency signal has been learned. Upon successful training, the indicator lamp ④ will flash slowly and then rapidly after several seconds.
- ▶ Proceed with programming step 5 and step 6 to complete.

## Controls in detail

### Useful features

#### Operation of integrated remote control

- ▶ Switch on the ignition (▷ page 33).
- ▶ Select and press the appropriate integrated signal transmitter button (①, ② or ③) to activate the remote controlled device.

The integrated remote control transmitter continues to send the signal as long as the button is pressed – up to 20 seconds.

#### Erasing the integrated remote control memory

- ▶ Switch on the ignition (▷ page 33).
- ▶ Simultaneously hold down the signal transmitter buttons ① and ③, for approximately 20 seconds, until the indicator lamp ④ blinks rapidly. Do not hold for longer than 30 seconds.

The codes of all three channels are erased.



If you sell your vehicle, erase the codes of all three channels.

#### Reprogramming a single integrated signal transmitter button

To program a device using a signal transmitter button previously trained, follow these steps:

- ▶ Press and hold the desired signal transmitter button (①, ② or ③). Do not release the button.
- ▶ The indicator lamp will begin to flash after 20 seconds. Without releasing the integrated signal transmitter button, proceed with programming starting with step 3.

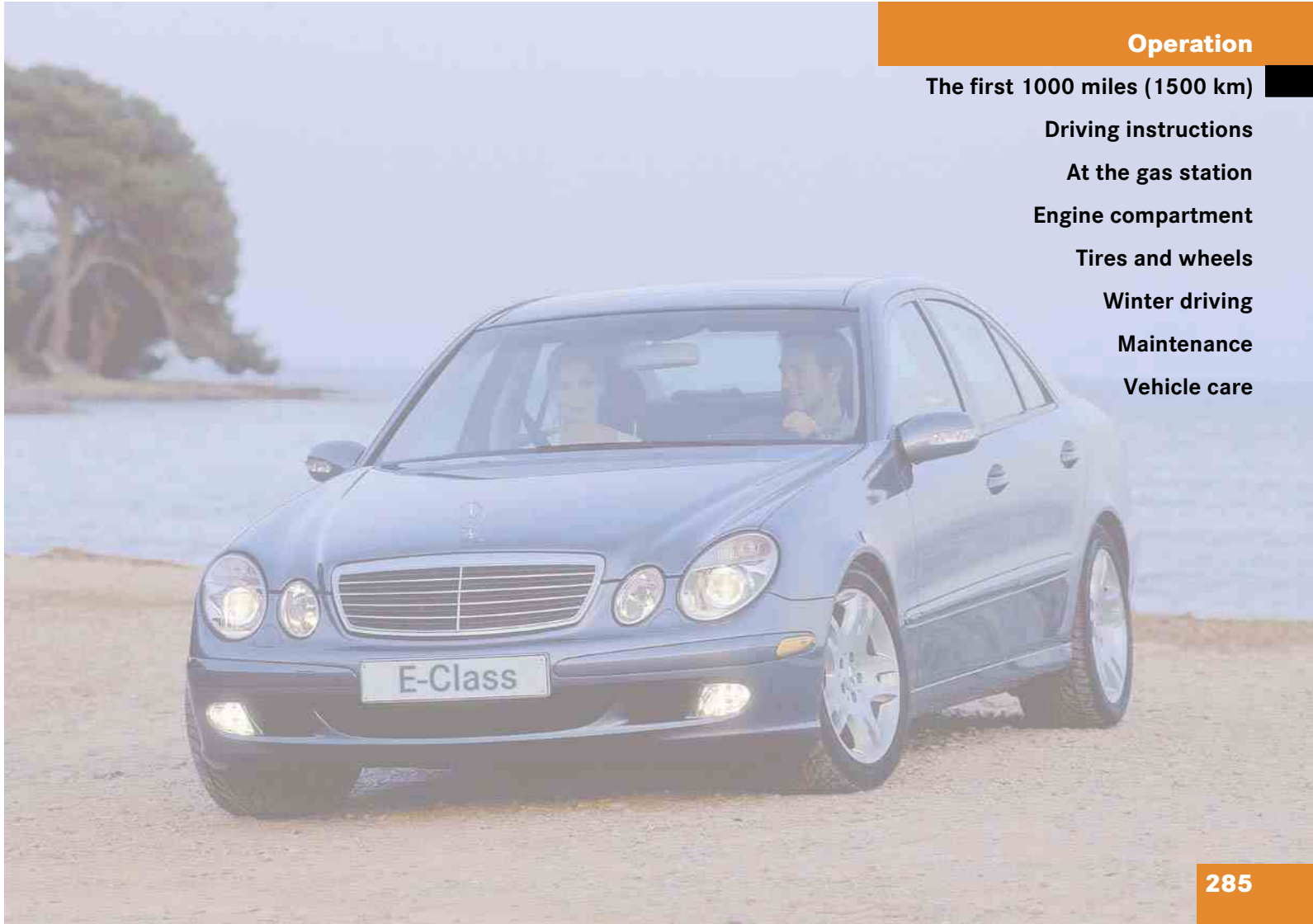

## **Operation**

**The first 1000 miles (1500 km)**

**Driving instructions**

**At the gas station**

**Engine compartment**

**Tires and wheels**

**Winter driving**

**Maintenance**

**Vehicle care**

## Operation

### The first 1000 miles (1500 km)

In the “Operation” section you will find detailed information on operating, maintaining and caring for your vehicle.

The more cautiously you treat your vehicle during the break-in period, the more satisfied you will be with its performance later on.

- Drive your vehicle during the first 1000 miles (1500 km) at varying but moderate vehicle and engine speeds.
- During this period, avoid heavy loads (full throttle driving) and excessive engine speeds (no more than  $\frac{2}{3}$  of maximum rpm in each gear).
- Avoid accelerating by kick-down.
- Do not attempt to slow the vehicle down by shifting to a lower gear using the selector lever.
- Select positions **3**, **2** or **1** only when driving at moderate speeds (for hill driving).
- Select **C** as the preferred shift program (▷ page 179) for the first 1000 miles (1500 km).

After 1000 miles (1500 km) you may gradually increase vehicle and engine speeds to the permissible maximum.



Additional instructions for AMG vehicles:

- During the first 1000 miles (1500 km), do not exceed a speed of 85 mph (140 km/h).
- During this period, avoid engine speeds above 4500 rpm in each gear.

All of the above, as may apply to your vehicle type, also apply when driving the first 1000 miles (1500 km) after the engine or the rear differential has been replaced.



Always obey applicable speed limits.



▼ **Driving instructions**

**Drive sensibly – save fuel**

Fuel consumption, to a great extent, depends on driving habits and operating conditions.

To save fuel you should:

- Keep tires at the recommended inflation pressures.
- Remove unnecessary loads.
- Remove roof rack when not in use.
- Allow engine to warm up under low load use.
- Avoid frequent acceleration and deceleration.
- Have all maintenance work performed at the intervals specified in the Maintenance Booklet and as required by the Maintenance System. Contact an authorized Mercedes-Benz Center.

Fuel consumption is also increased by driving in cold weather, in stop-and-go traffic, on short trips and in hilly area.

**Drinking and driving**

**Warning!**



Drinking and driving and / or taking drugs and driving are very dangerous combinations. Even a small amount of alcohol or drugs can affect your reflexes, perceptions and judgement.

The possibility of a serious or even fatal accident are greatly increased when you drink or take drugs and drive.

Do not drink or take drugs and drive or allow anyone to drive who has been drinking or taking drugs.

**Pedals**

**Warning!**



Keep driver's foot area clear at all times. Objects stored in this area may impair pedal movement.

## Operation

### Driving instructions

#### Power assistance

##### Warning!



The brake system requires electrical energy for operation.

A malfunction in the vehicle's power supply or electrical system may impair brake system operation and switch it into its emergency operation mode. In such a case, the red brake warning lamp (▷ page 358) and warning messages in the instrument cluster (▷ page 367) come on while driving. To brake, the driver must then apply significantly greater brake pedal pressure and depress the pedal much further to obtain the expected braking effect. If necessary, apply full pressure to the brake pedal. Brakes may only be applied to the front wheels. Stopping distance is increased!

If there is a malfunction in the SBC brake system, we recommend that the vehicle be transported with all wheels off the ground using flatbed or appropriate wheel lift/dolly equipment. A tow bar must be used if circumstances do not permit the use of the recommended towing methods and the vehicle requires towing with all four wheels on the ground. Towing the vehicle with all four wheels on the ground is only permissible for distances up to 30 miles (50 km) and at a speed not to exceed 30 mph (50 km/h). For more information, refer to "Towing the vehicle" (▷ page 439). For more information, see "SBC brake system" (▷ page 90).

With the engine not running, there is no power assistance for the brake and steering systems. In this case, it is important to keep in mind that a considerably higher degree of effort is necessary to brake and steer the vehicle.

#### Brakes

##### Warning!



After driving in heavy rain for some time without applying the brakes or through water deep enough to wet brake components, the first braking action may be somewhat reduced and increased pedal pressure may be necessary to obtain expected braking effect. Maintain a safe distance from vehicles in front.

Resting your foot on the brake pedal will cause excessive and premature wear of the brake pads.

It can also result in the brakes overheating, thereby significantly reducing their effectiveness. It may not be possible to stop the vehicle in sufficient time to avoid an accident.

To help prevent brake disk corrosion after driving on wet road surfaces (particularly salted roads), it is advisable to brake the vehicle with considerable force prior to parking. The heat generated serves to dry the brakes.

If your brake system is normally only subjected to moderate loads, you should occasionally test the effectiveness of the brakes by applying above-normal braking pressure at higher speeds. This will also enhance the grip of the brake pads.



Be very careful not to endanger other road users when you apply the brakes.

Refer to the description of the Brake Assist System (BAS) (▷ page 87).

If the parking brake is released and the brake warning lamp in the instrument cluster stays on, there is a malfunction in the SBC brake system (▷ page 90) or the brake fluid level in the reservoir is too low.

Brake pad wear or a leak in the system may be the reason for low brake fluid in the reservoir.

Have the brake system inspected by qualified technicians immediately. Contact an authorized Mercedes-Benz Center.

All checks and service work on the brake system should be carried out by qualified technicians only. Contact an authorized Mercedes-Benz Center.

Only install brake pads and brake fluid recommended by Mercedes-Benz.

**Warning!**



If other than recommended brake pads are installed, or other than recommended brake fluid is used, the braking properties of the vehicle can be degraded to an extent that safe braking is substantially impaired. This could result in an accident.

Be certain to read and observe the warning notices on brake pad replacement (▷ page 380).



When driving down long and steep grades, relieve the load on the brakes by shifting into a lower gear to use the engine's braking power. This helps prevent overheating of the brakes and reduces brake pad wear.

After hard braking, it is advisable to drive on for some time, rather than immediately parking, so that the air stream will cool down the brakes faster.

## Operation

### Driving instructions

#### Driving off

Apply the brakes to test them briefly after driving off. Perform this procedure only when the road is clear of other traffic.

Warm up the engine smoothly. Do not place full load on the engine until the operating temperature has been reached.

When starting off on a slippery surface, do not allow a drive wheel to spin for an extended period with the ESP switched off. Doing so may cause serious damage to the drive train which is not covered by the Mercedes-Benz Limited Warranty.



Simultaneously depressing the accelerator pedal and applying the brake reduces engine performance and causes premature brake and drivetrain wear.

#### Parking



Set the parking brake whenever parking or leaving the vehicle. In addition, move gear selector lever to position **P**. When parking on hills, always set the parking brake and turn front wheel against road curb.

#### Warning!



Do not park this vehicle in areas where combustible materials such as grass, hay or leaves can come into contact with the hot exhaust system, as these materials could be ignited and cause a vehicle fire.

To reduce the risk of personal injury as a result of vehicle movement, before turning off the engine and leaving the vehicle always:

- Keep right foot on brake pedal.
- Firmly depress parking brake pedal.
- Move the selector lever to position **P**.

- Slowly release brake pedal.
- When parked on an incline, turn front wheel towards the road curb.
- Turn the SmartKey in the starter switch to position **0** and remove the SmartKey from the starter switch, or press KEYLESS-GO\* start/stop button (vehicles with KEYLESS-GO\*).
- Take the SmartKey or the SmartKey with KEYLESS-GO\* with you and lock vehicle when leaving.

#### Tires

#### Warning!



If you feel a sudden significant vibration or ride disturbance, or you suspect that possible damage to your vehicle has occurred, you should turn on the hazard warning flashers, carefully slow down, and drive with caution to an area which is a safe distance from the road.

Inspect the tires and the vehicle underbody for possible damage. If the vehicle or tires appear unsafe, have it towed to the nearest Mercedes-Benz Center or tire dealer for repairs.

Treadwear indicators (TWI) are required by law. These indicators are located in six places on the tread circumference and become visible at a tread depth of approximately  $\frac{1}{16}$  in (1.6 mm), at which point the tire is considered worn and should be replaced.

The treadwear indicator appears as a solid band across the tread.

### Warning!



Although the applicable federal motor vehicle safety laws consider a tire to be worn when the treadwear indicators (TWI) become visible at approximately  $\frac{1}{16}$  in (1.6 mm), we recommend that you do not allow your tires to wear down to that level. As tread depth approaches  $\frac{1}{8}$  in (3 mm), the adhesion properties on a wet road are sharply reduced.

Depending upon the weather and/or road surface (conditions), the tire traction varies widely.

Specified tire inflation pressures must be maintained. This applies particularly if the tires are subjected to high loads (e.g. high speeds, heavy loads, high ambient temperatures).

## Operation

### Driving instructions

### Warning!



Do not drive with a flat tire. A flat tire affects the ability to steer or brake the vehicle. You may lose control of the vehicle. Continued driving with a flat tire or driving at high speed with a flat tire will cause excessive heat build-up and possibly a fire.

### Hydroplaning

Depending on the depth of the water layer on the road, hydroplaning may occur, even at low speeds and with new tires. Reduce vehicle speed, avoid track grooves in the road and apply brakes cautiously in the rain.

## Operation

### Driving instructions

#### Tire traction

The safe speed on a wet, snow covered or icy road is always lower than on a dry road.

You should pay particular attention to the condition of the road whenever the outside temperatures are close to the freezing point.

#### Warning!



If ice has formed on the road, tire traction will be substantially reduced. Under such weather conditions, drive, steer and brake with extreme caution.

Mercedes-Benz recommends M+S rated radial-ply tires with a minimum tread depth of approximately  $\frac{1}{8}$  in (4 mm) on all four wheels for the winter season to make sure normal balanced handling characteristics. On packed snow, they can reduce your stopping distance compared to summer tires. Stopping distance, however, is still

considerably greater than when the road is not covered with snow or ice. Exercise appropriate caution.



Avoid spinning of a drive wheel. This may cause serious damage to the drivetrain which is not covered by the Mercedes-Benz Limited Warranty.

#### Tire speed rating

Regardless of the tire speed rating, local speed limits should be obeyed. Use prudent driving speeds appropriate to prevailing conditions.

#### Warning!



Even when permitted by law, never operate a vehicle at speeds greater than the maximum speed rating of the tires.

Exceeding the maximum speed for which tires are rated can lead to sudden tire failure, causing loss of vehicle control and possibly resulting in an accident and/or personal injury and possible death, for you and for others.

**E 320 CDI**  
**E 320, E 320 4MATIC**  
**E 500, E 500 4MATIC**  
**E 320 4MATIC (Appearance Package\*)**  
**E 500 4MATIC (Appearance Package\*)**

Your vehicle is factory equipped with “H”-rated tires, which have a speed rating of 130 mph (210 km/h).

An electronic speed limiter prevents your vehicle from exceeding a speed of 130 mph (210 km/h).

**E 320 (Appearance Package\*)**  
**E 500 (Appearance Package\*)**

Your vehicle is factory equipped with “H”-rated tires, which have a speed rating of 130 mph (210 km/h).

An electronic speed limiter prevents your vehicle from exceeding a speed of 130 mph (210 km/h).

**E 320 (Sport Package\*)**  
**E 500 (Sport Package\*)**

Your vehicle is factory equipped with “Z”-rated tires, which have a speed rating of above 149 mph (240 km/h).

An electronic speed limiter prevents your vehicle from exceeding a speed of 130 mph (210 km/h).

**E 320 4MATIC (Sport Package\*)**  
**E 500 4MATIC (Sport Package\*)**

Your vehicle is factory equipped with min. “Y”-rated tires, which have a speed rating of 186 mph (300 km/h).

An electronic speed limiter prevents your vehicle from exceeding a speed of 130 mph (210 km/h).

**E 55 AMG**

Your vehicle is factory equipped with “Z”-rated tires, which have a speed rating of above 149 mph (240 km/h).

An electronic speed limiter prevents your vehicle from exceeding a speed of 155 mph (250 km/h).



For additional general information on tire speed markings on tire sidewall, see “Tire speed rating” (▷ page 329).

## Operation

### Driving instructions

#### Winter driving instructions

The most important rule for slippery or icy roads is to drive sensibly and to avoid abrupt acceleration, braking and steering maneuvers. Do not use the cruise control system under such conditions.

When the vehicle is in danger of skidding, move gear selector lever to position **N**. Try to keep the vehicle under control by corrective steering action.



For more information on driving with snow chains, see “Snow chains” (▷ page 342).

#### Warning!



On slippery road surfaces, never downshift in order to obtain braking action. This could result in drive wheel slip and reduced vehicle control. Your vehicle’s ABS will not prevent this type of control loss.

Road salts and chemicals can adversely affect braking efficiency. Increased pedal force may become necessary to produce the normal braking effect.

Depressing the brake pedal periodically when traveling at length on salt-strewn roads can bring road-salt-impaired braking efficiency back to normal.

If the vehicle is parked after being driven on salt-treated roads, the braking efficiency should be tested as soon as possible after driving is resumed.

#### Warning!



Make sure not to endanger any other road users when carrying out these braking maneuvers.

#### Warning!



If the vehicle becomes stuck in snow, make sure that snow is kept clear of the exhaust pipe and from around the vehicle with the engine running. Otherwise, deadly carbon monoxide (CO) gases may enter vehicle interior resulting in unconsciousness and death.

To assure sufficient fresh air ventilation, open a window slightly on the side of the vehicle not facing the wind.

#### Warning!



The outside temperature indicator is not designed to serve as an ice-warning device and is therefore unsuitable for that purpose. Indicated temperatures just above the freezing point do not guarantee that the road surface is free of ice.

For more information, see “Winter driving” (▷ page 341)



### Standing water



Do not drive through flooded areas or water of unknown depth. Before driving through water, determine its depth. Never accelerate before driving into water. The bow wave could force water into the engine and auxiliary equipment, thus damaging them.

If you must drive through standing water, drive slowly to prevent water from entering the passenger compartment or the engine compartment. Water in these areas could cause damage to electrical components or wiring of the engine or transmission, or could result in water being ingested by the engine through the air intake causing severe internal engine damage. Any such damage is not covered by the Mercedes-Benz Limited Warranty.

### Passenger compartment

#### Warning!



Always fasten items being carried as securely as possible.

In an accident, during hard braking or sudden maneuvers, loose items will be thrown around inside the vehicle, and cause injury to vehicle occupants unless the items are securely fastened in the vehicle.

The trunk is the preferred place to carry objects.

### Driving abroad

Abroad, there is an extensive Mercedes-Benz service network at your disposal. If you plan to drive into areas which are not listed in the index of your Mercedes-Benz Center directory, you should request pertinent information from your authorized Mercedes-Benz Center.

### Control and operation of radio transmitter

#### COMAND, radio and telephone\*

#### Warning!



Please do not forget that your primary responsibility is to drive the vehicle safely. Only operate the COMAND (Cockpit Management and Data System), radio or telephone<sup>1</sup> if road, weather and traffic conditions permit.

Bear in mind that at a speed of just 30 mph (approximately 50 km / h), your vehicle is covering a distance of 44 feet (approximately 14 m) every second.

<sup>1</sup> Observe all legal requirements

## Operation

### Driving instructions

#### Telephones and two-way radios

##### Warning!



Never operate radio transmitters equipped with a built-in or attached antenna (i.e. without being connected to an external antenna) from inside the vehicle while the engine is running. Doing so could lead to a malfunction of the vehicle's electronic system, possibly resulting in an accident and/or personal injury.

Radio transmitters, such as a portable telephone or a citizens band unit should only be used inside the vehicle if they are connected to an antenna that is installed on the outside of the vehicle.

Refer to the radio transmitter operation instructions regarding use of an external antenna.

#### Catalytic converter (Gasoline engine)

Your Mercedes-Benz is equipped with monolithic-type catalytic converters, an important element in conjunction with the oxygen sensors to achieve substantial control of the pollutants in the exhaust emissions. Keep your vehicle in proper operating condition by following our recommended maintenance instructions as outlined in your Maintenance Booklet.



To prevent damage to the catalytic converters, only use premium unleaded gasoline in this vehicle.

Any noticeable irregularities in engine operation should be repaired promptly. Otherwise, excessive unburned fuel may reach the catalytic converter, causing it to overheat, which could potentially start a fire.

##### Warning!



As with any vehicle, do not idle, park or operate this vehicle in areas where combustible materials such as grass, hay or leaves can come into contact with the hot exhaust system, as these materials could be ignited and cause a vehicle fire.

**Oxidation catalyst (Diesel engine)**

Your Mercedes-Benz is equipped with an oxidation catalyst, an important element in conjunction with the oxygen sensors to achieve substantial control of the pollutants in the exhaust emissions. Keep your vehicle in proper operating condition by following our recommended maintenance instructions as outlined in your Maintenance Booklet.

**Warning!**



As with any vehicle, do not idle, park or operate this vehicle in areas where combustible materials such as grass, hay or leaves can come into contact with the hot exhaust system, as these materials could be ignited and cause a vehicle fire.

**Emission control**

Certain systems of the engine serve to keep the toxic components of the exhaust gases within permissible limits required by law.

These systems, of course, will function properly only when maintained strictly according to factory specifications. Any adjustments on the engine should, therefore, be carried out only by qualified Mercedes-Benz Center authorized technicians. Engine adjustments should not be altered in any way. Moreover, the specified service jobs must be carried out regularly according to Mercedes-Benz servicing requirements. For details refer to the Maintenance Booklet.

**Warning!**



Inhalation of exhaust gas is hazardous to your health. All exhaust gas contains carbon monoxide, and inhaling it can cause unconsciousness and lead to death.

Do not run the engine in confined areas (such as a garage) which are not properly ventilated. If you think that exhaust gas fumes are entering the vehicle while driving, have the cause determined and corrected immediately. If you must drive under these conditions, drive only with at least one window fully open at all times.

## Operation

### Driving instructions

#### Coolant temperature

During severe operating conditions and stop-and-go city traffic, the coolant temperature may rise close to approximately 248°F (120°C).

The engine should not be operated with the coolant temperature over 248°F (120°C). Doing so may cause serious engine damage which is not covered by the Mercedes-Benz Limited Warranty.

#### Warning!



- Driving when your engine is badly overheated can cause some fluids, which may have leaked into the engine compartment, to catch fire. You could be seriously burned.
- Steam from an overheated engine can cause serious burns and can occur just by opening the engine hood. Stay away from the engine if you see or hear steam coming from it.

Turn off the engine, get out of the vehicle and do not stand near the vehicle until the engine has cooled down.

## ▼ At the gas station

### Refueling

#### Warning!



Gasoline and diesel fuel are highly flammable and poisonous. They burn violently and can cause serious injury. Whenever you are around gasoline or diesel fuel, avoid inhaling fumes and skin contact, extinguish all smoking materials. Never allow sparks, flame or smoking materials near gasoline or diesel fuel!

The fuel filler flap is located on the right-hand side of the vehicle towards the rear. Locking/unlocking the vehicle with the remote control automatically locks/unlocks the fuel filler flap.



Diesel engine:

When filling the diesel fuel tank using fuel containers, place a filling filter, a suede cloth or a clean flannel cloth into the filler neck to filter the diesel fuel. Otherwise, you could clog the fuel lines.



- ▶ Turn the engine off
  - by turning the SmartKey to position **0**.

## Operation

### At the gas station

- by pressing the KEYLESS-GO\* start/stop button. Open the driver's door (with the driver's door open, starter switch is now in position **0**, same as SmartKey removed from starter switch).
- ▶ Remove the SmartKey from the starter switch.
- ▶ Open the fuel filler flap by pushing at the point indicated by the arrow. The fuel filler flap springs open.
- ▶ Turn the fuel cap to the left and hold on to it until possible pressure is released.
- ▶ Take off the cap and set it in the recess on the fuel filler flap. To prevent fuel vapors from escaping into open air, fully insert filler nozzle unit.
- ▶ Only fill your tank until the filler nozzle unit cuts out – **do not top up or overfill**. ▷▷

## Operation

### At the gas station





#### Warning!



Overfilling of the fuel tank may create pressure in the system which could cause a gas or diesel fuel discharge. This could cause the gasoline or diesel fuel to spray back out when removing the fuel pump nozzle, which could cause personal injury.

- ▶ Replace the fuel cap by turning it to the right.  
You will hear when the fuel cap is tightened.
- ▶ Close the fuel filler flap.



Leaving the engine running and the fuel cap open can cause the yellow fuel tank reserve warning lamp to flash and the  malfunction indicator lamp (USA only) or the  malfunction indicator lamp (Canada only) to illuminate.

See also “Practical hints” section (▷ page 362).



Gasoline engine:

Only use premium unleaded gasoline with a minimum Posted Octane Rating of 91 (average of 96 RON/86 MON). Information on gasoline quality can normally be found on the fuel pump.

For more information on gasoline, see the Factory Approved Service Products pamphlet.



Diesel engine:

Only use commercially available vehicular diesel fuels No. 2 or No. 1 (ASTM D975 No. 2-D or No. 1-D). Information on diesel quality can normally be found on the fuel pump.

For more information on diesel fuels, refer to the Factory Approved Service Products pamphlet.



Diesel engine:

If you have driven the vehicle until the tank is empty, the fuel system needs to be bled (▷ page 432).



Diesel engine:

The engine is more susceptible to wear and damage if you use

- marine diesel fuel
- heating oil

If you use such non-approved fuels and/or special additives, your warranty rights will be limited.

#### Low outside temperatures (Diesel engine)

To prevent malfunctions, diesel fuel with better cold flow characteristics is offered in the winter months. Check with your fuel retailer.



Do not fill the tank with gasoline. Do not mix diesel fuel with gasoline or kerosene. The fuel system and engine will otherwise be damaged.

#### Check regularly and before a long trip



- ① Windshield washer and headlamp cleaning system\*  
For more information on refilling the reservoir, see “Windshield washer system and headlamp cleaning system\*” (▷ page 310).
- ② Brake fluid  
For more information on brake fluid, see “Brake fluid” (▷ page 464).
- ③ Coolant level  
For more information on the coolant level, see “Coolant level” (▷ page 308).



If you find that the brake fluid in the brake fluid reservoir has fallen to the minimum mark or below, have the brake system checked for brake pad thickness and leaks immediately. Notify an authorized Mercedes-Benz Center immediately. Do not add brake fluid as this will not solve the problem. For more information, see “Practical hints” (▷ page 358).

## Operation

### At the gas station

#### Engine oil level

For more information on engine oil level, see “Engine oil” (▷ page 304).

#### Vehicle lighting

Check function and cleanliness. For more information on replacing light bulbs, see the “Practical hints” section (▷ page 417).

For more information, see “Exterior lamp switch” (▷ page 133).

#### Tire inflation pressure

For more information, see “Checking tire inflation pressure” (▷ page 322).



## ▼ Engine compartment

### Hood

#### Warning!



Do not pull the release lever while the vehicle is in motion. Otherwise the hood could be forced open by passing air flow.

### Opening



① Hood release

- ▶ Pull lever ① downwards.

The hood is unlocked and handle ② will extend out of the radiator grille.



To avoid damage to the windshield wipers or hood, never open the hood if the wiper arms are folded forward away from the windshield.



② Handle for opening the hood

## Operation

### Engine compartment

- ▶ Pull handle ② to its stop out of radiator grille.
- ▶ Pull up on the hood (do not pull up on the handle) and then release it.

The hood will be automatically held open at shoulder height by gas-filled struts.

#### Warning!



To help prevent personal injury, stay clear of moving parts when the hood is open and the engine is running. Make sure the hood is properly closed before driving. When closing the hood, use extreme caution not to catch hands or fingers.

The radiator fan may continue to run for approximately 30 seconds or even restart after the engine has been turned off. Stay clear of fan blades.

## Operation

### Engine compartment

#### Warning!



If you see flames or smoke coming from the engine compartment, or if the coolant temperature gauge indicates that the engine is overheated, do not open the hood. Move away from vehicle and do not open the hood until the engine has cooled. If necessary, call the fire department.

#### Warning!



Gasoline engine: The engine is equipped with a transistorized ignition system. Because of the high voltage it is dangerous to touch any components (ignition coils, spark plug sockets, diagnostic socket) of the ignition system

- with the engine running
- while starting the engine
- if ignition is “on” and the engine is turned manually

### Closing

#### Warning!



Be careful that you do not close the hood on anyone.

- ▶ Let the hood drop from a height of approximately 1 ft (30 cm).

The hood will lock audibly.

- ▶ Check to make sure the hood is fully closed.

If you can raise the hood at a point above the headlamps, then it is not properly closed. Open it again and let it drop with somewhat greater force.

### Engine oil

The amount of oil your engine needs will depend on a number of factors, including driving style. Higher oil consumption can occur when

- the vehicle is new
- the vehicle is driven frequently at higher engine speeds

Engine oil consumption checks should only be made after the vehicle break-in period.



Do not use any special lubricant additives, as these may damage the drive assemblies. Using special additives not approved by Mercedes-Benz may cause damage not covered by the Mercedes-Benz Limited Warranty. More information on this subject is available at any Mercedes-Benz Center.

### Checking engine oil level with the control system



When checking the oil level

- the vehicle must be parked on level ground
- with the engine at operating temperature, the vehicle must have been stationary for at least five minutes with the engine turned off
- with the engine not at operating temperature yet, the vehicle must have been stationary for at least 30 minutes with the engine turned off

To check the engine oil level via the multifunction display, do the following:

- ▶ Switch on the ignition (▷ page 33).

The standard display (▷ page 145) should appear in the multifunction display.



- ▶ Press button  or , on the steering wheel until the following message is seen in the multifunction display:



One of the following messages will subsequently appear in the indicator:

- Engine oil level ok
- Add 1.0 Qt. to reach max. oil level (Canada: 1.0 Liter)
- Add 1.5 Qts. to reach max. oil level (Canada: 1.5 Liters)
- Add 2.0 Qts. to reach max. oil level (Canada: 2.0 Liters)



If you want to interrupt the checking procedure, press the  or  button on the multifunction steering wheel.

- ▶ If necessary, add engine oil.

For adding engine oil, see (▷ page 306).

For more information on engine oil, see the “Technical data” section (▷ page 461) and (▷ page 464).

#### Other display messages

If the SmartKey or KEYLESS-GO start/stop button\* is not in position **2**, the following message will appear:

Switch on ignition to check engine oil level

- ▶ Switch on the ignition (▷ page 33).

If you see the message:

Observe waiting period

## Operation

### Engine compartment

- ▶ If engine is at normal operating temperature, wait five minutes before repeating check procedure.
- ▶ If engine is not at operating temperature yet, wait 30 minutes before repeating check procedure.

If you see the message:

Engine oil level  
Not when engine on

- ▶ Turn off the engine.
- ▶ If the engine is at normal operating temperature, wait five minutes before checking oil.
- ▶ If the engine is not yet at normal operating temperature, you must wait 30 minutes before checking oil.

If there is excess engine oil with the engine at normal operating temperature, the following message will appear:

Engine oil level  
Reduce oil level

- ▶ Have excess oil siphoned or drained off. Contact an authorized Mercedes-Benz Center.



Excess oil must be siphoned or drained off. It could cause damage to the engine and catalytic converter not covered by the Mercedes-Benz Limited Warranty.

For more information on messages in the display concerning engine oil, see the “Practical hints” section (▷ page 387).

### Adding engine oil



Only use approved engine oils and oil filters required for vehicles with Maintenance System (U.S. vehicles) or FSS PLUS (Canada vehicles). For a listing of approved engine oils and oil filters, refer to the Factory Approved Service Products pamphlet in your vehicle literature portfolio, or contact an authorized Mercedes-Benz Center.

Using engine oils and oil filters of specification other than those expressly required for the Maintenance System (U.S. vehicles) or FSS PLUS (Canada vehicles), or changing of oil and oil filter at change intervals longer than those called for by the Maintenance System (U.S. vehicles) or FSS PLUS (Canada vehicles) will result in engine damage not covered by the Mercedes-Benz Limited Warranty.

## Operation

### Engine compartment



① Filler cap (Gasoline engine)



① Filler cap (Diesel engine)

- ▶ Unscrew filler cap ① from filler neck.
- ▶ Add engine oil as required. Be careful not to overfill with oil.

Be careful not to spill any oil when adding. Avoid environmental damage caused by oil entering the ground or water.



Excess oil must be siphoned or drained off. It could cause damage to the engine and catalytic converter (Gasoline engine) or oxidation catalyst (Diesel engine) not covered by the Mercedes-Benz Limited Warranty.

- ▶ Screw filler cap ① back on filler neck.

For more information on engine oil, see the “Technical data” section (▷ page 461) and (▷ page 464).

## Operation

### Engine compartment

#### Transmission fluid level

The transmission fluid level does not need to be checked. If you notice transmission fluid loss or gear shifting malfunctions, have an authorized Mercedes-Benz Center check the transmission.

#### Coolant level

The engine coolant is a mixture of water and anticorrosion/antifreeze. To check the coolant level, the vehicle must be parked on level ground and the engine must be cool.

The coolant expansion tank is located on the driver's side of the engine compartment.

#### Warning!



In order to avoid any possibly serious burns:

- Use extreme caution when opening the hood if there are any signs of steam or coolant leaking from the cooling system, or if the coolant temperature gauge indicates that the coolant is overheated.
- Do not remove pressure cap on coolant reservoir if coolant temperature is above 158°F (70°C). Allow engine to cool down before removing cap. The coolant reservoir contains hot fluid and is under pressure.
- Using a rag, slowly open the cap approximately  $\frac{1}{2}$  turn to relieve excess pressure. If opened immediately, scalding hot fluid and steam will be blown out under pressure.
- Do not spill antifreeze on hot engine parts. Antifreeze contains ethylene glycol which may burn if it comes into contact with hot engine parts.



#### ① Coolant expansion tank

- ▶ Using a rag, turn the cap slowly approximately one half turn to the left to release any excess pressure.
- ▶ Continue turning the cap to the left and remove it.

The coolant level is correct if the level:

- for cold coolant: reaches the black top part of the reservoir
  - for warm coolant: is approximately 0.6 in (1.5 cm) higher
- ▶ Add coolant as required.

- Replace and tighten cap.

For more information on coolant, see the “Technical data” section (▷ page 466).

### Battery

Your vehicle is equipped with two batteries:

- Auxiliary battery (located in the engine compartment).
- Main battery (starter and electrical consumers; located in the trunk).

These batteries should always be sufficiently charged in order to achieve their rated service life. Refer to Maintenance Booklet for battery maintenance intervals.

If you use your vehicle mostly for short-distance trips, you will need to have the battery charge checked more frequently.

When replacing batteries, always use batteries approved by Mercedes-Benz.

If you do not intend to operate your vehicle for an extended period of time, consult an authorized Mercedes-Benz Center about steps you need to observe.



Observe all safety instructions and precautions when handling automotive batteries.



Risk of explosion.



Keep flames or sparks away from battery. Do not smoke.



Battery acid is caustic. Do not allow it to come into contact with skin, eyes or clothing.

In case it does, immediately flush affected area with clear water and seek medical help if necessary.

## Operation

### Engine compartment



Wear eye protection.



Keep children away.



Follow the instructions in this Operator's Manual.

Batteries contain materials that can harm the environment if disposed of improperly. Recycling of batteries is the preferred method of disposal. Many states require sellers of batteries to accept old batteries for recycling.

## Operation

### Engine compartment

#### Windshield washer system and headlamp cleaning system\*

The windshield washer reservoir is located in the engine compartment.



#### ① Washer fluid reservoir

Fluid for the windshield washer system and the headlamp cleaning system is supplied from the windshield washer reservoir. It has a capacity of:

- Vehicles without headlamp cleaning system: approximately 4.8 US qt (4.5 l).
- Vehicles with headlamp cleaning system: approximately 7.4 US qt (7 l).

During all seasons, add MB Windshield Washer Concentrate “S” to water. Premix the windshield washer fluid in a suitable container.

- ▶ Refill the reservoir with MB Windshield Washer Concentrate and water (or commercially available premixed windshield washer solvent / antifreeze, depending on ambient temperatures).

Always use washer solvent/antifreeze where temperatures may fall below freezing point. Failure to do so could result in damage to the washer system/reservoir.

#### Warning!



Washer solvent / antifreeze is highly flammable. Do not spill washer solvent / antifreeze on hot engine parts, because it may ignite and burn. You could be seriously burned.



Only use washer fluid which is suitable for plastic lenses. Improper washer fluid can damage the plastic lenses of the headlamps.

For more information, see “Windshield and headlamp washer fluid mixing ratio” (▷ page 469).



## ▼ Tires and wheels

See an authorized Mercedes-Benz Center for information on tested and recommended rims and tires for summer and winter operation. They can also offer advice concerning tire service and purchase.

### Warning!



Replace rims or tires with the same designation, manufacturer and type as shown on the original part. See an authorized Mercedes-Benz Center for further information. If incorrectly sized rims and tires are mounted:

- The wheel brakes or suspension components can be damaged
- The correct operating clearance of the wheels and the tires are no longer guaranteed

### Warning!



Worn, old tires can cause accidents. If the tire tread is badly worn, or if the tires have sustained damage, replace them.

When replacing rims, only use genuine Mercedes-Benz wheel bolts specified for the particular rim type. Failure to do so can result in the bolts loosening and possibly an accident.

Retreaded tires are not tested or recommended by Mercedes-Benz, since previous damage cannot always be recognized on retreads. Mercedes-Benz can therefore not assure the operating safety of the vehicle when such tires are used.

See an authorized Mercedes-Benz Center for information on tested and recommended rims and tires for summer and winter operation.

## Operation

### Tires and wheels

#### Important guidelines

- Only use sets of tires and rims of the same type and make.
- Tires must be of the correct size for the rim.
- Break in new tires for approximately 60 miles (100 km) at moderate speeds.
- Regularly check the tires and rims for damage. Dented or bent rims can cause tire inflation pressure loss and damage to the tire beads.
- If vehicle is heavily loaded, check tire inflation pressure and correct as required.
- Do not allow your tires to wear down too far. Adhesion properties on wet roads are sharply reduced at tread depths under  $\frac{1}{8}$  in (3 mm).
- When replacing individual tires, you should mount new tires on the front wheels first (on vehicles with same-sized wheels all around).

## Operation

### Tires and wheels

#### Tire care and maintenance

##### Warning!



Regularly check the tires for damage. Damaged tires can cause tire inflation pressure loss. As a result, you could lose control of your vehicle.

Worn, old tires can cause accidents. If the tire tread is badly worn, or if the tires have sustained damage, replace them.

Regularly check your tire inflation pressure at least once a month. For more information on checking tire inflation pressure see “Recommended tire inflation pressure” (▷ page 320).

#### Tire inspection

Every time you check your tire inflation pressure, you should also inspect your tires for the following:

- excessive tread wear (▷ page 313)
- cord or fabric showing through the tire’s rubber
- bumps, bulges, cuts, cracks or splits in the tread or side of the tire

Replace the tire if you find any of the above conditions.

Make sure you also inspect the spare tire periodically for condition and inflation. Spare tires will age and become worn over time even if never used, and thus should be inspected and replaced when necessary.

#### Life of tire

The service life of a tire is dependent upon varying factors including but not limited to:

- Driving style
- Tire inflation pressure
- Distance driven

##### Warning!



Tires and spare tire should be replaced after six years, regardless of the remaining tread.

#### Tread depth

Do not allow your tires to wear down too far. Adhesion properties on wet roads are sharply reduced at tread depths under  $\frac{1}{8}$  in (3 mm).

Tread wear indicators (TWI) are required by law. These indicators are located in six places on the tread circumference and become visible at a tread depth of approximately  $\frac{1}{16}$  in (1.6 mm), at which point the tire is considered worn and should be replaced.

Recommended minimum tire tread depth:

- Summer tires  $\frac{1}{8}$  in (3 mm)
- Winter tires  $\frac{1}{6}$  in (4 mm)

#### Warning!



Although the applicable federal motor safety laws consider a tire to be worn when the tread wear indicators (TWI) become visible at approximately  $\frac{1}{16}$  in (1.6 mm), we recommend that you do not allow your tires

to wear down to that level. As tread depth approaches  $\frac{1}{8}$  in (3 mm), the adhesion properties on a wet road are sharply reduced.

Depending upon the weather and/or road surface (conditions), the tire traction varies widely.

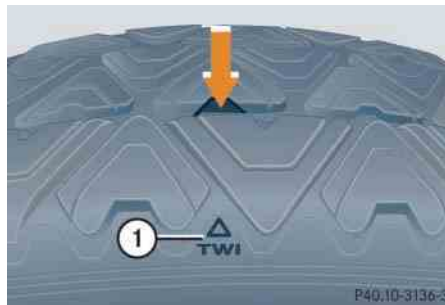

① TWI (Tread Wear Indicator)

The tread wear indicator appears as a solid band across the tread.

#### Storing tires



Keep unmounted tires in a cool, dry place with as little exposure to light as possible. Protect tires from contact with oil, grease and gasoline.

#### Cleaning tires



Never use a round nozzle to power wash tires. The intense jet of water can result in damage to the tire.

Always replace a damaged tire.

## Operation

### Tires and wheels

#### Direction of rotation

Unidirectional tires offer added advantages, such as better hydroplaning performance. To benefit, however, you must make sure the tires rotate in the direction specified.

An arrow on the sidewall indicates the intended direction of rotation (spinning) of the tire.



Spare wheels may be mounted against the direction of rotation (spinning) even with a unidirectional tire for temporary use only until the regular drive wheel has been repaired or replaced. Always observe and follow applicable temporary use restrictions and speed limitations indicated on the spare wheel.

#### Loading the vehicle

Two labels on your vehicle show how much weight it may properly carry.

- The Tire and Loading Information placard (Example A) or the Vehicle Tire Information placard (Example B) can be found on the driver's door B-pillar. This placard tells you important information about the number of people that can be in the vehicle and the total weight that can be carried in the vehicle. It also contains information on the proper size and recommended tire inflation pressures for the original equipment tires on your vehicle.
- The Certification label, also found on the driver's door B-pillar tells you about the gross weight capacity of your vehicle, called the Gross Vehicle Weight Rating (GVWR). The GVWR includes the weight of the vehicle, all occupants, fuel and cargo. The Certification label also tells you about the front and rear axle weight capacity, called the Gross Axle Weight Rating (GAWR). The GAWR is the total allowable weight that can be carried by a single axle (front or rear). Never exceed the GVWR or GAWR for either the front axle or rear axle.

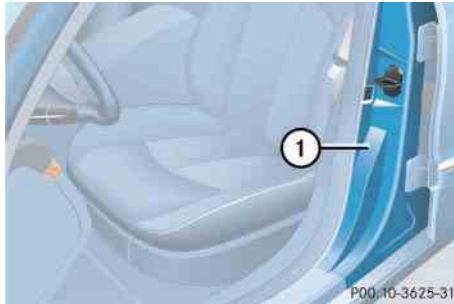

① Driver's door B-pillar

Following is a discussion on how to work with the information contained on the two placards with regards to loading your vehicle.

#### Tire and Loading Information

##### Warning!



Do not overload the tires by exceeding the specified load limit or vehicle capacity weight as indicated on the placard on the driver's door B-pillar. Overloading the tires can overheat them, possibly causing a blowout. Overloading the tires can also result in handling or steering problems, or brake failure.

Your vehicle is equipped with either the Tire and Loading Information placard (Example A) or the Vehicle Tire Information placard (Example B).



Data shown on placard examples is for illustration purposes only. Load limit data is specific to each vehicle and may vary from data shown in the illustrations below. Refer to placard on vehicle for actual data specific to your vehicle.

#### Placard (Example A)

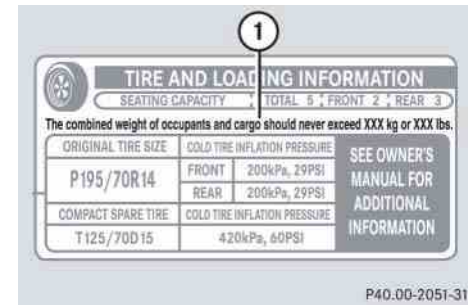

① Load limit information on the Tire and Loading Information placard

The placard showing the load limit information is located on the driver's door B-pillar. If your vehicle is equipped with the Tire and Loading Information placard (Example A), locate the statement "The combined weight of occupants and cargo should never exceed XXX kilograms or XXX lbs." on this placard. The combined weight of all occupants, cargo / luggage and trailer tongue load (if applicable) should never exceed the weight referenced in that statement.

## Operation

### Tires and wheels

#### Placard (Example B)



- ① Load limit information on the Vehicle Tire Information placard

The placard showing the load limit information is located on the driver's door B-pillar. If your vehicle is equipped with the Vehicle Tire Information placard (Example B), locate the heading "Vehicle Capacity Weight" on this placard. The combined weight of all occupants, cargo/luggage and trailer tongue (if applicable) should never exceed the weight listed next to vehicle capacity weight.

#### Seating capacity

The seating capacity gives you important information on the number of occupants that can be in the vehicle. Observe front and rear seating capacity. Your vehicle is equipped with either placard Example A or placard Example B located on the driver's door B-pillar (▷ page 315).



Data shown on placard examples is for illustration purposes only. Seating data is specific to each vehicle and may vary from data shown in the illustrations below. Refer to placard on vehicle for actual data specific to your vehicle.

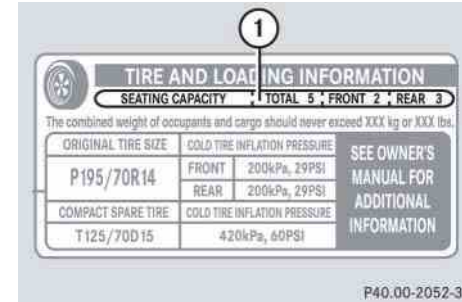

#### Placard (Example A)

- ① Seating capacity



#### Placard (Example B)

- ① Seating capacity

**Steps for determining correct load limit**

The following steps have been developed as required of all manufacturers under Title 49, Code of U.S. Federal Regulations, Part 575 pursuant to the “National Traffic and Motor Vehicle Safety Act of 1966”.

**Step 1** (Vehicles equipped with placard Example A)

- ▶ Locate the statement “The combined weight of occupants and cargo should never exceed XXX kg or XXX lbs.” on your vehicle’s placard.

**Step 1** (Vehicles equipped with placard Example B)

- ▶ Locate the heading “Vehicle Capacity Weight” on your vehicle’s placard.

**Step 2**

- ▶ Determine the combined weight of the driver and passengers that will be riding in your vehicle.

**Step 3**

- ▶ Subtract the combined weight of the driver and passengers from XXX kilograms or XXX lbs.

**Step 4**

- ▶ The resulting figure equals the available amount of cargo and luggage load capacity. For example, if the “XXX” amount equals 1400 lbs. and there will be five 150 lbs. passengers in your vehicle, the amount of available cargo and luggage load capacity is 650 lbs. (1400-750 (5 x150) = 650 lbs.)

**Step 5**

- ▶ Determine the combined weight of luggage and cargo being loaded on the vehicle. That weight may not safely exceed the available cargo and luggage load capacity calculated in step 4.

**Step 6** (if applicable)

- ▶ If your vehicle will be towing a trailer, load from your trailer will be transferred to your vehicle. Consult this manual to determine how this reduces the available cargo and luggage load capacity of your vehicle (▷ page 319).

The following table shows examples on how to calculate total and cargo load capacities with varying seating configurations and number and size of occupants. The following examples use a load limit of 1500 lbs. **This is for illustration purposes only.** Make sure you are using the actual load limit for your vehicle stated on the vehicle’s placard (▷ page 315).

## Operation

### Tires and wheels

Example	Combined weight limit of occupants and cargo from placard	Number of occupants (driver and passengers)	Seating configuration	Occupants weight	Combined weight of all occupants	Available cargo/luggage and trailer tongue weight (total load limit or vehicle capacity weight from placard minus combined weight of all occupants)
1	1500 lbs	5	front: 2 rear: 3	Occupant 1: 150 lbs Occupant 2: 180 lbs Occupant 3: 160 lbs Occupant 4: 140 lbs Occupant 5: 120 lbs	750 lbs	1500 lbs - 750 lbs = 750 lbs
2	1500 lbs	3	front: 1 rear: 2	Occupant 1: 200 lbs Occupant 2: 190 lbs Occupant 3: 150 lbs	540 lbs	1500 lbs - 540 lbs = 960 lbs
3	1500 lbs	1	front:1	Occupant 1: 150 lbs	150 lbs	1500 lbs - 150 lbs = 1350 lbs

The higher the weight of all occupants, the less cargo and luggage load capacity is available.

For more information, see “Trailer tongue load” (> page 319).



#### ***Certification label***

Even after careful determination of the combined weight of all occupants, cargo and the trailer tongue load (if applicable) (▷ page 319) as to not exceed the permissible load limit, you must make sure that your vehicle never exceeds the Gross Vehicle Weight Rating (GVWR) and the Gross Axle Weight Rating (GAWR) for either the front or rear axle. You can obtain the GVWR and GAWR from the Certification label. The Certification Label can be found on the driver's door B-pillar, see "Technical data" (▷ page 448).

**Gross Vehicle Weight Rating (GVWR):** The total weight of the vehicle, all occupants, all cargo, and the trailer tongue load (▷ page 319) must never exceed the GVWR.

**Gross Axle Weight Rating (GAWR):** The total allowable weight that can be carried by a single axle (front or rear).

To assure that your vehicle does not exceed the maximum permissible weight limits (GVWR and GAWR for front and rear axle), have the loaded vehicle (including driver, passengers and all cargo and, if applicable, trailer fully loaded) weighed on a suitable commercial scale.

#### ***Trailer tongue load***

The tongue load of any trailer is an important weight to measure because it affects the load you can carry in your vehicle. If a trailer is towed, the tongue load must be added to the weight of all occupants riding and any cargo you are carrying in the vehicle. The tongue load typically is ten percent of the trailer weight and everything loaded in it.

Your Mercedes-Benz has been designed primarily to carry passengers and their cargo. Mercedes-Benz does not recommend trailer towing with your vehicle.

## Operation

### Tires and wheels

#### Recommended tire inflation pressure

##### Warning!



Follow recommended tire inflation pressures.

Do not underinflate tires. Underinflated tires wear excessively and /or unevenly, adversely affect handling and fuel economy, and are more likely to fail from being overheated.

Do not overinflate tires. Overinflated tires can adversely affect handling and ride comfort, wear unevenly, increase stopping distance, and result in sudden deflation (blowout) because they are more likely to become punctured or damaged by road debris, potholes etc.

Your vehicle is equipped with either the Tire and Loading Information placard (Example A) or the Vehicle Tire Information placard (Example B) located on the driver's door B-pillar (> page 315).

The tire inflation pressure should be checked regularly and should only be adjusted on cold tires. The tires can be considered cold if the vehicle has been parked for at least three hours or driven less than one mile (1.6 km).

Follow recommended cold tire inflation pressures listed on placard.

Keeping the tires properly inflated provides the best handling, tread life and riding comfort.

In addition to the tire placard on the driver's door B-pillar, also consult the fuel filler flap for any additional information pertaining to special driving situations. For more information, see "Important notes on tire inflation pressure" (> page 321).



Data shown on placard examples is for illustration purposes only. Tire data is specific to each vehicle and may vary from data shown in the illustrations below. Refer to placard on vehicle for actual data specific to your vehicle.

#### Placard (Example A)

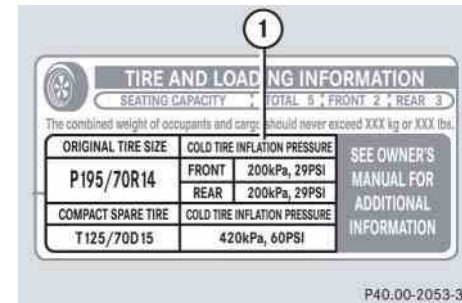

- ① Tire and Loading Information placard with recommended cold tire inflation pressures

Placard (Example A) lists the recommended cold tire inflation pressures for maximum loaded vehicle weight. The tire inflation pressures listed apply to the tires installed as original equipment.

#### Placard (Example B)

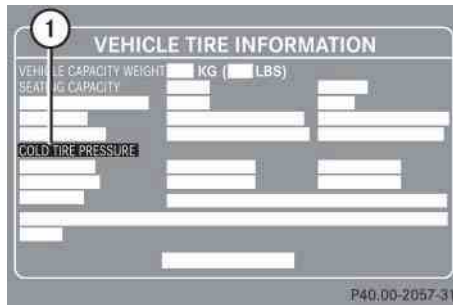

- ① Vehicle Tire Information placard with recommended cold tire inflation pressures

Placard (Example B) lists the recommended cold tire inflation pressures for maximum loaded vehicle weight. The tire inflation pressures listed apply to the tires installed as original equipment.



Placard (Example B) may list recommended cold tire inflation pressures for different vehicle loads.

#### Important notes on tire inflation pressure

##### Warning!



If the tire inflation pressure repeatedly drops:

- Check the tires for punctures from foreign objects.
- Check to see whether air is leaking from the valves or from around the rim.

Tire temperature and tire inflation pressure are also increased while driving, depending on the driving speed and the tire load.

If you will be driving your vehicle at high speeds of 100 mph (160 km/h) or higher, where it is legal and conditions allow, consult the placard on the inside of the fuel filler flap on how to adjust the cold tire inflation pressure. If you do not adjust the tire inflation pressure, excessive heat can build up and result in sudden tire failure.

Be sure to readjust the tire inflation pressure for normal driving speeds. You should wait until the tires are cold before adjusting the tire inflation pressure.

Some vehicles may have supplemental tire pressure information for vehicle loads less than the maximum loaded vehicle condition. If such information is provided, it can be found on the placard located on the inside of the fuel filler flap.

Tire inflation pressure changes by approximately 1.5 psi (0.1 bar) per 18°F (10°C) of air temperature change. Keep this in mind when checking tire inflation pressure where the temperature is different from the outside temperature.

## Operation

### Tires and wheels

#### Checking tire inflation pressure

Regularly check your tire inflation pressure at least once a month.

Check and adjust the tire inflation pressure when the tires are cold. The tires can be considered cold if the vehicle has been parked for at least three hours or driven less than one mile (1.6 km).

If you check the tire inflation pressure when the tires are warm (the vehicle has been driven for several miles or sitting less than three hours), the reading will be approximately 4 psi (0.3 bar) higher than the cold reading. This is normal. Do not let air out to match the specified cold tire inflation pressure. Otherwise, the tire will be underinflated.

#### Checking tire inflation pressure manually

Follow the steps below to achieve correct tire inflation pressure:

- ▶ Remove the cap from the valve on one tire.

- ▶ Firmly press a tire gauge onto the valve.
- ▶ Read tire inflation pressure on tire gauge and check against the recommended tire inflation pressure on the placard on the driver's door B-pillar (▷ page 315). If necessary, add air to achieve the recommended tire inflation pressure.



If you have overfilled the tire, release tire inflation pressure by pushing the metal stem of the valve with e.g. a tip of a pen. Then recheck the tire inflation pressure with the tire gauge.

- ▶ Install the valve cap.
- ▶ Repeat this procedure for each tire.

#### Checking tire inflation pressure electronically\*

The tire pressure monitoring system only functions on wheels that are equipped with the proper electronic sensors. It monitors the tire inflation pressure, as selected by the driver, in all four tires. A warning is issued to alert you to a decrease in pressure in one or more of the tires.

You can call up the tire inflation pressure using the control system (▷ page 150).







After you have reactivated the tire pressure monitoring system, the current tire inflation pressures will only be shown after a few minutes' driving time.

During this time, you will see the following message in the display:

Tire pressure  
displayed only  
after driving  
a few mins.



Possible differences between the readings of a tire inflation pressure gauge of an air hose, e.g. gas station equipment, and the vehicle's control system can occur. The readings issued by the control system are more precise.

- ▶ Switch on the ignition (▷ page 33).
- ▶ Press button  or  on the multifunction steering wheel repeatedly until the standard display menu appears in the multifunction display (▷ page 150).
- ▶ Press the  or  button until the current inflation pressures for each tire appear in the multifunction display.



### Warning!



When the tire pressure monitoring system warning light is lit, one or more of your tires is significantly under-inflated. You should stop and check your tires as soon as possible, and inflate them to the proper pressure as indicated on the vehicle's tire information placard. Driving on a significantly under-inflated tire causes the tire to overheat and can lead to tire failure. Under-inflation also reduces fuel efficiency and tire tread life, and may affect the vehicle's handling and stopping ability. Each tire, including the spare, should be checked monthly when cold and set to the recommended inflation pressure as specified in the vehicle placard and owner's manual.



The recommended tire inflation pressures for your vehicle can be found on the placard on the driver's door B-pillar or the inside of the fuel filler flap, not in the owner's manual.

## Operation

### Tires and wheels

### Warning!



The tire pressure monitoring system does not indicate a warning for wrongly selected inflation pressures. Always adjust tire inflation pressure according to the placard located on the driver's door B-pillar or the inside of the fuel filler flap.

The tire pressure monitoring system is not able to issue a warning due to a sudden dramatic loss of pressure (e.g. tire blowout caused by a foreign object). In this case bring the vehicle to a halt by carefully applying the brakes and avoiding abrupt steering maneuvers.



Operating radio transmission equipment (e.g. wireless headsets, two-way radios) in or near the vehicle could cause the tire pressure monitoring system to malfunction.

## Operation

### Tires and wheels

#### Warning!



Follow recommended tire inflation pressures.



Do not overinflate tires. Overinflating tires can result in sudden deflation (blowout) because they are more likely to become punctured or damaged by road debris, potholes, etc.

Do not underinflate tires. Underinflated tires wear unevenly, adversely affect handling and fuel economy, and are more likely to fail from being overheated.

Do not overload the tires by exceeding the specified vehicle capacity weight (as indicated by the label on the pillar in the driver's door opening). Overloading the tires can overheat them, possibly causing a blowout.

#### Reactivating the tire pressure monitoring system

The tire pressure monitoring system must be reactivated in the following situations:

- If you have changed the tire inflation pressure
  - If you have replaced the wheels or tires
  - If you have installed new wheels or tires
- ▶ Using the tire placard on the driver's door B-pillar or, if available, the inside of the fuel filler flap, make sure the tire inflation pressure of all four tires is correct.
- ▶ Press button  or  repeatedly until you see the current inflation pressures for each tire appear in the multifunction display or the following message appears in the multifunction display:
- Tire pressure  
displayed only  
after driving  
a few mins.



If you are transporting a deflated tire in the vehicle, do not activate the tire pressure monitoring system until

- the deflated tire is no longer in the vehicle
- you have inflated the tire to the correct pressure

- ▶ Press the reset button on the instrument cluster (▷ page 24).

The following message will appear in the multifunction display:

Check current  
tire pres.?

- ▶ Press the **+** button.

The following message will appear in the multifunction display field:

Tire pres. monitor  
reactivated

The tire pressure monitoring system will now monitor the tire inflation pressure values of all four tires.

The following message will appear in the multifunction display field:

Tire pressure  
displayed only  
after driving  
a few mins.

This display appears until the individual inflation pressure values are matched with the tires. The individual values are then displayed (▶ page 396).

If you wish to cancel activation:

- ▶ Press the **-** button.

If one of the following messages appears in the multifunction display:

- reactivate tire pressure monitor after rectifying pressure
- Tire pressure  
Please rectify
- ▶ Check the tire inflation pressures and correct them if necessary.
- ▶ Reactivate the tire pressure monitoring system.

## Operation

### Tires and wheels



After you have reactivated the tire pressure monitoring system, the current tire inflation pressure values will only be shown after several minutes of driving. During this time, the following message appears in the display:

Tire pressure  
displayed only  
after driving  
a few mins.

The time before the tire inflation pressures are shown depends on whether or not

- you have mounted new tires
- the old tires are still on the vehicle

If you have mounted new tires, it will take slightly longer before the tire inflation pressures are shown in the display.

## Operation

### Tires and wheels



If the positions of the wheels have not been changed on the vehicle, the tire inflation pressures are shown correctly after a short period. If the positions of the wheels have been switched, however, it is possible that the tire inflation pressures are temporarily shown for the wrong wheel positions. They are corrected after a few minutes of driving, and the tire inflation pressures are shown for the correct wheel positions.

#### Potential problems associated with underinflated and overinflated tires

##### *Underinflated tire inflation pressure*

Underinflated tires can:

- cause excessive and uneven tire wear
- adversely affect fuel economy
- lead to tire failure from being overheated
- adversely affect handling characteristics

#### Warning!



Follow recommended tire inflation pressures.

Do not underinflate tires. Underinflated tires wear excessively and / or unevenly, adversely affect handling and fuel economy, and are more likely to fail from being overheated.

##### *Overinflated tire inflation pressure*

Overinflated tires can:

- adversely affect handling characteristics
- cause uneven tire wear
- be more prone to damage from road hazards
- adversely affect ride comfort
- increase stopping distance

#### Warning!



Follow recommended tire inflation pressures.

Do not overinflate tires. Overinflated tires can adversely affect handling and ride comfort, wear unevenly, increase stopping distance, and result in sudden deflation (blowout) because they are more likely to become punctured or damaged by road debris, potholes etc.



### Tire labeling

Besides tire name (sales designation) and manufacturer name, a number of markings can be found on a tire.

Following are some explanations for the markings on your vehicle's tires:

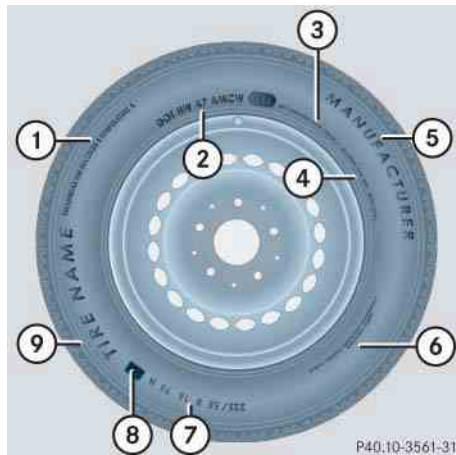

- ① Uniform Quality Grading Standards (▷ page 334)
- ② DOT, Tire Identification Number (TIN) (▷ page 332)
- ③ Maximum tire load (▷ page 333)
- ④ Maximum tire inflation pressure (▷ page 334)
- ⑤ Manufacturer
- ⑥ Tire ply material (▷ page 336)
- ⑦ Tire size designation, load and speed rating (▷ page 327)
- ⑧ Load identification (▷ page 331)
- ⑨ Tire name



For illustration purposes only. Actual data on tires is specific to each vehicle and may vary from data shown in above illustration.

For more information, see “Rims and tires” (▷ page 453).

### Tire size designation, load and speed rating

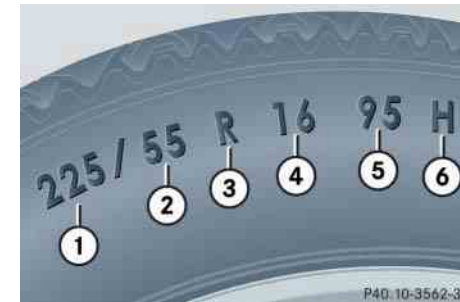

- ① Tire width
- ② Aspect ratio in %
- ③ Radial tire code
- ④ Rim diameter
- ⑤ Tire load rating
- ⑥ Tire speed rating



For illustration purposes only. Actual data on tires is specific to each vehicle and may vary from data shown in above illustration.

## Operation

### Tires and wheels

#### General:

Depending on the design standards used, the tire size molded into the sidewall may have no letter or a letter preceding the tire size designation.

No letter preceding the size designation (as illustrated above): Passenger car tire based on European design standards.

Letter “P” preceding the size designation: Passenger car tire based on U.S. design standards.

Letter “LT” preceding the size designation: Light Truck tire based on U.S. design standards.

Letter “T” preceding the size designation: Temporary spare tires which are high pressure compact spares designed for temporary emergency use only.

#### **Tire width**

The tire width ① (▷ page 327) indicates the nominal tire width in mm.

#### **Aspect ratio**

The aspect ratio ② (▷ page 327) is the dimensional relationship between tire section height and section width and is expressed in percentage. The aspect ratio is arrived at by dividing section height by section width.

#### **Tire code**

The tire code ③ (▷ page 327) indicates the tire construction type. The “R” stands for radial tire type. Letter “D” means diagonal or bias ply construction; letter “B” means belted-bias ply construction.

At the tire manufacturer's option, any tire with a speed capability above 149 mph (240 km/h) can include a “ZR” in the size designation (for example: 245/40 ZR 18). For additional information, see “Tire speed rating” (▷ page 329).

#### **Rim diameter**

The rim diameter ④ (▷ page 327) is the diameter of the bead seat, not the diameter of the rim edge. Rim diameter is indicated in inches (in).

#### **Tire load rating**

The tire load rating ⑤ (▷ page 327) is a numerical code associated with the maximum load a tire can support.

For example, a load rating of 91 corresponds to a maximum load of 1356 lbs (615 kg) the tire is designed to support. See also “Maximum tire load” (▷ page 333) where the maximum load associated with the load index is indicated in kilograms and lbs.

#### Warning



The tire load rating must always be at least half of the GAWR (▷ page 337) of your vehicle. Otherwise, tire failure may be the result which may cause an accident and/or serious personal injury to you or others.

Always replace rims and tires with the same designation, manufacturer and type as shown on the original part.

#### Warning!



Do not overload the tires by exceeding the specified load limit or vehicle capacity weight as indicated on the placard located on the driver's door B-pillar. Overloading the tires can overheat them, possibly causing a blowout. Overloading the tires can also result in handling or steering problems, or brake failure.

For additional information on tire load rating, see “Load identification” (▷ page 331).



Tire load rating ⑤ (▷ page 327) and Tire speed rating ⑥ (▷ page 327) are also referred to as “service description”.

#### *Tire speed rating*

The tire speed rating ⑥ (▷ page 327) indicates the approved maximum speed for the tire.

#### Warning!



Even when permitted by law, never operate a vehicle at speeds greater than the maximum speed rating of the tires.

Exceeding the maximum speed for which tires are rated can lead to sudden tire failure, causing loss of vehicle control and possibly resulting in an accident and/or personal injury and possible death, for you and for others.



Tire load rating ⑤ (▷ page 327) and Tire speed rating ⑥ (▷ page 327) are also referred to as “service description”.

## Operation

### Tires and wheels

#### Summer tires

Index	Speed rating
Q	up to 100 mph (160 km/h)
R	up to 106 mph (170 km/h)
S	up to 112 mph (180 km/h)
T	up to 118 mph (190 km/h)
H	up to 130 mph (210 km/h)
V	up to 149 mph (240 km/h)
W	up to 168 mph (270 km/h)
Y	up to 186 mph (300 km/h)
(Y)	above 186 mph (300 km/h)
ZR	above 149 mph (240 km/h)

- At the tire manufacturer's option, any tire with a speed capability above 149 mph (240 km/h) can include a "ZR" in the size designation (for example: 245/40 ZR18). To determine the maximum speed capability of the tire, the service description for the tire must be referred to. The service description

is comprised of the tire load rating ⑤ (▷ page 327) and the tire speed rating ⑥ (▷ page 327).

If your tire includes "ZR" in the size designation and no service description ⑤ and ⑥ (▷ page 327) is given, the tire manufacturer must be consulted for the maximum speed capability.

If a service description ⑤ and ⑥ (▷ page 327) is given, the speed capability is limited by the speed symbol in the service description.

Example: 245/40 ZR18 97Y.

In this example, "97Y" is the service description. The letter "Y" designates the speed rating and the speed capability of the tire is limited to 186 mph (300 km/h).

- Any tire with a speed capability above 186 mph (300 km/h) must include a "ZR" in the size designation AND the service description must be placed in parenthesis. Example: 275/40 ZR 18 (99Y). The "(Y)" speed rating in parenthesis designates the maximum speed capability of the tire as being above 186 mph (300 km/h). Consult the tire manufacturer for the actual maximum permissible speed of the tire.

All-season and winter tires

Index	Speed rating
Q M+S	up to 100 mph (160 km/h)
T M+S	up to 118 mph (190 km/h)
H M+S	up to 130 mph (210 km/h)
V M+S	up to 149 mph (240 km/h)



The marking “M+S” next to the service description designates tires with mud and snow capabilities.

Load identification



① Load identification



For illustration purposes only. Actual data on tires is specific to each vehicle and may vary from data shown in above illustration.

In addition to tire load rating, special load information may be molded into the tire sidewall following the letter designating the tire speed rating ① (▷ page 331).

No specification given: absence of any text (like in above example) indicates a standard load (SL) tire.

XL or Extra Load: designates an extra load (or reinforced) tire.

Light Load: designates a light load tire.

C, D, E: designates load range associated with the maximum load a tire can carry at a specified pressure.

## Operation

### Tires and wheels

#### DOT, Tire Identification Number (TIN)

U.S. tire regulations require each new tire manufacturer or tire retreader to mold a TIN into or onto a sidewall of each tire produced.

The TIN is a unique identifier which facilitates efforts by tire manufacturers to notify purchasers in recall situations or other safety matters concerning tires and gives purchasers the means to easily identify such tires.

The TIN is comprised of “Manufacturer’s identification mark”, “Tire size”, “Tire type code” and “Date of manufacture”.



- ① DOT
- ② Manufacturer’s identification mark
- ③ Tire size
- ④ Tire type code (at the option of the tire manufacturer)
- ⑤ Date of manufacture



For illustration purposes only. Actual data on tires is specific to each vehicle and may vary from data shown in above illustration.

#### DOT (Department of Transportation)

A tire branding symbol ① (▷ page 332) which denotes the tire meets requirements of the U.S. Department of Transportation.

#### Manufacturer’s identification mark

The manufacturer’s identification mark ② (▷ page 332) denotes the tire manufacturer.

New tires have a mark with two symbols.

Retreaded tires have a mark with four symbols. For more information on retreaded tires, see (▷ page 311).

#### Tire size

The code ③ (▷ page 332) indicates the tire size.

**Tire type code**

The code ④ (▷ page 332) may, at the option of the manufacturer, be used as a descriptive code for identifying significant characteristics of the tire.

**Date of manufacture**

The date of manufacture ⑤ (▷ page 332) identifies the week and year of manufacture.

The first two figures identify the week, starting with “01” to represent the first full week of the calendar year. The second two figures represent the year.

For example, “3202” represents the 32nd week of 2002.

**Maximum tire load**



① Maximum tire load rating



For illustration purposes only. Actual data on tires is specific to each vehicle and may vary from data shown in above illustration.

The maximum tire load is the maximum weight the tires are designed to support.

**Warning!**



Do not overload the tires by exceeding the specified load limit or vehicle capacity weight as indicated on the placard located on the driver’s door B-pillar. Overloading the tires can overheat them, possibly causing a blowout. Overloading the tires can also result in handling or steering problems, or brake failure.

For more information on tire load rating (▷ page 328)

For information on calculating total and cargo load capacities (▷ page 317).

## Operation

### Tires and wheels

#### Maximum tire inflation pressure

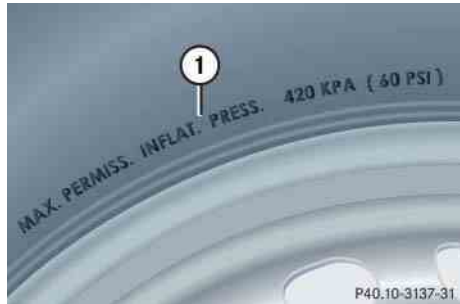

- ① Maximum permissible tire inflation pressure



For illustration purposes only. Actual data on tires is specific to each vehicle and may vary from data shown in above illustration.

This is the maximum permissible tire inflation pressure for the tire.

Always follow the recommended tire inflation pressure (▷ page 320) for proper tire inflation.

#### Warning!



Never exceed the max. tire inflation pressure. Follow recommended tire inflation pressures.

Do not underinflate tires. Underinflated tires wear excessively and / or unevenly, adversely affect handling and fuel economy, and are more likely to fail from being overheated.

Do not overinflate tires. Overinflated tires can adversely affect handling and ride comfort, wear unevenly, increase stopping distance, and result in sudden deflation (blowout) because they are more likely to become punctured or damaged by road debris, potholes etc.

#### Uniform Tire Quality Grading Standards (U.S. vehicles)

Tire manufacturers are required to grade tires based on three performance factors: treadwear, traction and temperature resistance.

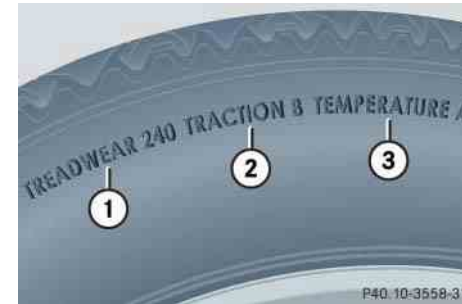

- ① Treadwear
- ② Traction
- ③ Temperature resistance



For illustration purposes only. Actual data on tires is specific to each vehicle and may vary from data shown in above illustration.



Quality grades can be found, where applicable, on the tire sidewall between tread shoulder and maximum section width. For example:

Treadwear	Traction	Temperature
200	AA	A

All passenger car tires must conform to federal safety requirements in addition to these grades.

**Treadwear**

The treadwear grade is a comparative rating based on the wear rate of the tire when tested under controlled conditions on a specified government test course. For example, a tire graded 150 would wear one and one-half (1 1/2) times as well on the government course as a tire graded 100. The relative performance of tires depends upon the actual conditions of their use, however, and may depart significantly from the norm due to variations in driving habits, service practices and differences in road characteristics and climate.

**Traction**

The traction grades, from highest to lowest, are AA, A, B, and C. Those grades represent the tire’s ability to stop on wet pavement as measured under controlled conditions on specified government test surfaces of asphalt and concrete. A tire marked C may have poor traction performance.

**Warning!**



The traction grade assigned to this tire is based on straight-ahead braking traction tests, and does not include acceleration, cornering, hydroplaning, or peak traction characteristics.

## Operation

### Tires and wheels

#### Temperature

The temperature grades are A (the highest), B, and C, representing the tire's resistance to the generation of heat and its ability to dissipate heat when tested under controlled conditions on a specified indoor laboratory test wheel. Sustained high temperature can cause the material of the tire to degenerate and reduce tire life, and excessive temperature can lead to sudden tire failure. The grade C corresponds to a level of performance which all passenger car tires must meet under the Federal Motor Vehicle Safety Standard No. 109. Grades B and A represent higher levels of performance on the laboratory test wheel than the minimum required by law.

#### Warning!



The temperature grade for this tire is established for a tire that is properly inflated and not overloaded. Excessive speed, underinflation, or excessive loading, either separately or in combination, can cause excessive heat build-up and possible tire failure.

#### Tire ply material

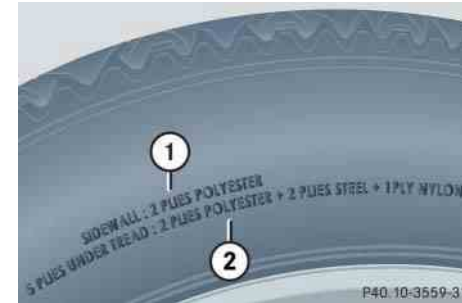

- ① Plies in sidewall
- ② Plies under tread



For illustration purposes only. Actual data on tires is specific to each vehicle and may vary from data shown in above illustration.

This marking tells you about the type of cord and number of plies in the sidewall and under the tread.

## Tire and loading terminology

### Accessory weight

The combined weight (in excess of those standard items which may be replaced) of automatic transmission, power steering, power brakes, power windows, power seats, radio, and heater, to the extent that these items are available as factory-installed equipment (whether installed or not).

### Air pressure

The amount of air inside the tire pressing outward on each square inch of the tire. Air pressure is expressed in pounds per square inch (psi), or kilopascal (kPa) or bars.

### Aspect ratio

Dimensional relationship between tire section height and section width expressed in percentage.

### Bar

Another metric unit for air pressure. There are 14.5038 pounds per square inch (psi) to 1 bar; there are 100 kilopascals (kPa) to 1 bar.

### Bead

The tire bead contains steel wires wrapped by steel cords that hold the tire onto the rim.

### Cold tire inflation pressure

Tire inflation pressure when your vehicle has been sitting for at least three hours or driven no more than one mile (1.6 km).

### Curb weight

The weight of a motor vehicle with standard equipment including the maximum capacity of fuel, oil, and coolant, and, if so equipped, air conditioning and additional optional equipment, but without passengers and cargo.

### DOT (Department of Transportation)

A tire branding symbol which denotes the tire meets requirements of the U.S. Department of Transportation.

### GAWR (Gross Axle Weight Rating)

The GAWR is the maximum permissible axle weight. The gross vehicle weight on each axle must never exceed the GAWR for the front and rear axle indicated on the certification label located on the driver's door B-pillar.

### GVW (Gross Vehicle Weight)

The GVW comprises the weight of the vehicle including fuel, tools, spare wheel, installed accessories, passengers and cargo and, if applicable, trailer tongue load. The GVW must never exceed the GVWR indicated on the certification label located on the driver's door B-pillar.

## Operation

### Tires and wheels

#### **GVWR (Gross Vehicle Weight Rating)**

This is the maximum permissible vehicle weight of the fully loaded vehicle (weight of the vehicle including all options, passengers, fuel, and cargo and, if applicable, trailer tongue load). It is indicated on certification label located on the driver's door B-pillar.

#### **Kilopascal (kPa)**

The metric unit for air pressure. There are 6.9 kPa to one psi; another metric unit for air pressure is bars. There are 100 kilopascals (kPa) to one bar.

#### **Maximum load rating**

The maximum load in kilograms and pounds that can be carried by the tire.

#### **Maximum loaded vehicle weight**

The sum of curb weight, accessory weight, vehicle capacity weight and production options weight.

#### **Maximum tire inflation pressure**

This number is the greatest amount of air pressure that should ever be put in the tire under normal driving conditions.

#### **Normal occupant weight**

The number of occupants the vehicle is designed to seat, multiplied by 68 kilograms (150 lbs).

#### **Occupant distribution**

The distribution of occupants in a vehicle at their designated seating positions.

#### **Production options weight**

The combined weight of those installed regular production options weighing over 5 lbs (2.3 kilograms) in excess of those standard items which they replace, not previously considered in curb weight or accessory weight, including heavy duty brakes, ride levelers, roof rack, heavy duty battery, and special trim.

#### **PSI (Pounds per square inch)**

A standard unit of measure for air pressure -> bar, kilopascal (kPa).

#### **Recommended tire inflation pressure**

Recommended tire inflation pressure listed on placard located on driver's door B-pillar for normal driving conditions. Provides best handling, tread life and riding comfort.

#### **Rim**

A metal support for a tire or a tire and tube assembly upon which the tire beads are seated.

#### **Sidewall**

The portion of a tire between the tread and the bead.

**TIN (Tire Identification Number)**

Unique identifier which facilitates efforts by tire manufacturers to notify purchasers in recall situations or other safety matters concerning tires and gives purchases the means to easily identify such tires. The TIN is comprised of “Manufacturer's identification mark”, “Tire size”, “Tire type code” and “Date of manufacture”.

**Tire load rating**

Numerical code associated with the maximum load a tire can support.

**Tire ply composition and material used**

This indicates the number of plies or the number of layers of rubber-coated fabric in the tire tread and sidewall. Tire manufacturers also must indicate the ply materials in the tire and sidewall, which include steel, nylon, polyester, and others.

**Tire speed rating**

Part of tire designation; indicates the speed range for which a tire is approved.

**Traction**

Force exerted by the vehicle on the road via the tires. The amount of grip provided.

**Tread**

The portion of a tire that comes into contact with the road.

**Treadwear indicators**

Narrow bands, sometimes called “wear bars” that show across the tread of a tire when only  $\frac{1}{6}$  in (1.6 mm) of tread remains.

**Uniform Tire Quality Grading Standards**

A tire information system that provides consumers with ratings for a tire's traction, temperature and treadwear. Ratings are determined by tire manufacturers using government testing procedures. The ratings are molded into the sidewall of the tire.

**Vehicle capacity weight**

Rated cargo and luggage load plus 68 kilograms (150 lbs) times the vehicle's designated seating capacity.

**Vehicle maximum load on the tire**

Load on an individual tire that is determined by distributing to each axle its share of the maximum loaded vehicle weight and dividing it by two.

## Operation

### Tires and wheels

#### Rotating tires

##### Warning!



Rotate front and rear wheels only if they are of the same size.

If your vehicle is equipped with mixed-size tires (different tire dimensions front vs. rear), tire rotation is not possible.

Tire rotation can be performed on vehicles with tires of the same dimension all around. If your vehicle is equipped with tires of the same dimension all around, tires can be rotated, observing a front-to-rear rotation pattern that will maintain the intended rotation (spinning) direction of the tire (▷ page 314).

In some cases, such as when your vehicle is equipped with mixed-size tires (different tire dimension front vs. rear), tire rotation is not possible.

If applicable to your vehicle's tire configuration, tires can be rotated according to the tire manufacturer's recommended intervals in the tire manufacturer's warranty pamphlet located in your vehicle literature portfolio. If none is available, tires should be rotated every 3000 to 6 000 miles (5000 to 10 000 km), or sooner if necessary, according to the degree of tire wear. The same rotation (spinning) direction must be maintained (▷ page 314).

Rotate tires before the characteristic tire wear pattern becomes visible (shoulder wear on front tires and tread center wear on rear tires).

Thoroughly clean the mounting face of wheels and brake disks, i.e. the inner side of the wheels/tires, during each rotation. Check for and ensure proper tire inflation pressure, activating the tire pressure monitoring system\* if necessary.



If your vehicle is equipped with a tire pressure monitoring system\*, there are electronic components built into the wheel.

Do not use mounting tools in the area of the valve as they could damage the electronic components.

To prevent damage or incorrect installation, have the tires changed at an authorized Mercedes-Benz Center.

##### Warning!



Have the tightening torque checked after changing a wheel. Wheels could become loose if not tightened with a torque of 96 lb-ft (130 Nm).

Only use genuine Mercedes-Benz wheel bolts specified for your vehicle's rims.

For information on wheel change, see the "Practical hints" section (▷ page 407) and (▷ page 425).

▼ **Winter driving**

Before the onset of winter, have your vehicle winterized at an authorized Mercedes-Benz Center. This service includes:

- Check of anticorrosion and antifreeze concentration
- Addition of cleaning concentrate to the water of the windshield and headlamp cleaning system

Add MB Concentrate “S” to a premixed windshield washer solvent / antifreeze which is formulated for temperatures below freezing point (▷ page 467).

- Battery test

Battery capacity drops with decreasing ambient temperature. A well charged battery helps to make sure that the engine can be started and the SBC brake system will be fully operational, even at low ambient temperatures.

- Tire change

Mercedes-Benz recommends M+S rated radial-ply tires with a minimum tread depth of approximately  $\frac{1}{6}$  in (4 mm) on all four wheels for the winter season.

**Winter tires**

Always use winter tires at temperatures below 45°F (7°C) and whenever wintry road conditions prevail. Use of winter tires is the only way to achieve the maximum effectiveness of the ABS, ESP and 4MATIC in winter operation.

For safe handling, make sure that all mounted winter tires are of the same make and have the same tread design.

**Warning!**



Winter tires with a tread depth of less than  $\frac{1}{6}$  in (4 mm) must be replaced. They are no longer suitable for winter operation.

Always observe the speed rating of the winter tires installed on your vehicle. If the maximum speed for which your tires are rated is below the speed rating of your vehicle, you must place a notice to this effect where it will be seen by the driver. Such notices are available at your tire dealer or any authorized Mercedes-Benz Center.

**Warning!**



If you use your spare tire when winter tires are fitted on the other wheels, be aware that the difference in tire characteristics may very well impair turning stability and that overall driving stability may be reduced. Adapt your driving style accordingly.

Have the spare tire replaced with a winter tire at the nearest authorized Mercedes-Benz Center.

## Operation

### Winter driving

#### Block heater\* (Canada only)

The engine is equipped with a block heater.

The electrical cable may be installed at an authorized Mercedes-Benz Center.

#### Snow chains



When driving with snow chains, always select the raised level of the level control system Airmatic\* (▷ page 248). Other settings may result in damage to your vehicle.

Snow chains should only be driven on snow-covered roads at speeds not to exceed 30 mph (50 km/h). Remove chains as soon as possible when driving on roads without snow.



When driving with snow chains, you may wish to deactivate the ESP (▷ page 89) before setting the vehicle in motion. This will improve the vehicle's traction.

Please observe the following guidelines when using snow chains:

- Use of snow chains is not permissible with all wheel/tire combinations.
- Snow chains should only be used on the rear wheels. Follow the manufacturer's mounting instructions.
- Only use snow chains that are approved by Mercedes-Benz. Your authorized Mercedes-Benz Center will be glad to advise you on this subject.
- Use of snow chains may be prohibited depending on location. Always check local and state laws before installing snow chains.



Even on vehicles with all-wheel-drive, use snow chains on rear tires only.

Use of snow chains is not permissible with tire sizes:

- 265/35 ZR18
- T 155/70 R17 110M
- T 175/55-18 95P



▼ Maintenance

We strongly recommend that you have your vehicle serviced by an authorized Mercedes-Benz Center, in accordance with the Maintenance Booklet at the times called for by the maintenance service indicator display.

Failure to have the vehicle maintained in accordance with the Maintenance Booklet and maintenance service indicator at the designated times /mileage will result in vehicle damage not covered by the Mercedes-Benz Limited Warranty.

The maintenance service indicator will notify you when your next maintenance service is due.

Starting approximately one month before maintenance service is due, one of the following messages will appear in the multifunction display while you are driving or when you switch on the ignition (example service A):

Service A in XXXX miles (km)  
 Service A in XX days  
 Service A in X day  
 Service A due now!

The maintenance services will be indicated by showing a service type A through type H in the multifunction display. Types A through H are classified based on estimated time needed to perform the maintenance service, ranging:

from Service A  
 (approx. one hour)  
 to Service H  
 (approx. eight hours)



When the service type appears, you can use the vehicle's control system to view a list of the service items (1-14) that need to be performed at the called for service type (▷ page 347).



The additional + after the type of service indicates the degree of wear of the brake pads.

The brake pads may reach their wear limit in the time period up to the next service interval.

Have the brake pads checked and, if necessary, replaced by an authorized Mercedes-Benz Center during your next service appointment.

## Operation

### Maintenance



Vehicles equipped with FSS PLUS (Flexible Service System PLUS) only (Canada vehicles): The interval between maintenance services depends on your driving habits. A gentle driving style, moderate engine speeds and the avoidance of short-distance trips will lengthen the interval between services.

#### Clearing the maintenance service indicator

You can clear the maintenance service indicator.

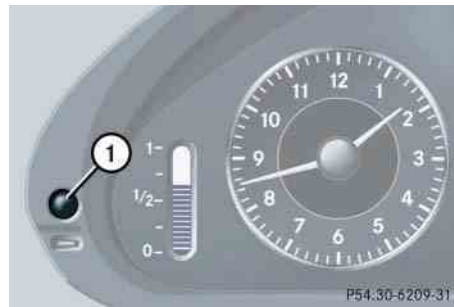

- ▶ Press the reset button ① on the left side of the instrument cluster.

The maintenance service indicator is cleared and the standard display appears in the multifunction display.

#### Maintenance service term exceeded





If you have exceeded the suggested maintenance service term, you will see the following message in the multifunction display:

Service A exceeded by XXXXX miles (km)  
Service A exceeded by XXX days  
Service A exceeded by X day

In addition, a signal sounds when the message appears.

Any authorized Mercedes-Benz Center will reset the maintenance service indicator following a completed maintenance service.

### Calling up the maintenance service indicator

- ▶ Switch on the ignition (▷ page 33).  
The standard display of the control system appears (▷ page 145).
- ▶ Press button  or  on the multifunction steering wheel until the maintenance service indicator with the service symbol  or  and the service deadline appears in the multifunction display.



If the battery is disconnected, the days of disconnection will not be included in the count shown by the maintenance service indicator. To arrive at the true maintenance service deadline, you will need to subtract these days from the days shown in the maintenance service indicator.

Do not confuse the maintenance service indicator with the engine oil level indicator .

### Resetting the maintenance service indicator

In the event that the maintenance service on your vehicle is not carried out by an authorized Mercedes-Benz Center, you can have the maintenance service indicator reset. The automotive maintenance facility carrying out the maintenance service will find the information for resetting the maintenance service indicator in the maintenance-relevant information for your vehicle. Such information is available from either your authorized Mercedes-Benz Center or directly from Mercedes-Benz.



If the maintenance service indicator was inadvertently reset, have an authorized Mercedes-Benz Center correct it.

Only reset if the proper maintenance service has been performed. Resetting the system without performing the proper service as called for by the maintenance service indicator will result in engine damage and/or other vehicle damage not covered by the Mercedes-Benz Limited Warranty.

## Operation



### Maintenance

#### Setting the date for special works



You can enter appointments for exhaust gas analysis and general inspection using the maintenance system.

- ▶ Switch on the ignition (▷ page 33).

The standard display of the control system appears (▷ page 145).



- ▶ Press button  or  on the multifunction steering wheel until the maintenance indicator appears in the multifunction display.
- ▶ Press the reset button (▷ page 24) for about five seconds.

The Service menu appears in the multifunction display.

- ▶ Select the Addit. Work menu with the  or  button.
- ▶ Press the  button.

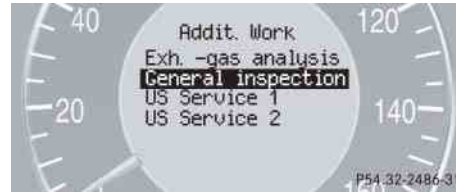
The service indicator now displays the Addit. Work menu.











- ▶ Select the Exh.-gas analysis or General inspection menu with the  or  button.

- ▶ Press the  button.

The service indicator now displays the Next due date menu.



- ▶ Select the Month and Year with the  or  button.
  - ▶ Press button  or  on the multifunction steering wheel to set the month and year.
  - ▶ Select Confirm with the  or  button.
  - ▶ Press the  button.
- The new date is set.

- ▶ Press the  button on the multifunction steering wheel until the standard display appears in the multifunction display.

The maintenance service system now recalculates the values. You cannot call up the maintenance service display or the service menu during this time.





#### Calling up the maintenance service data information

The maintenance service indicator shows the maintenance service type (letters A-H) in the multifunction display approximately one month before the service appointment is due in miles (distance criterion) or in days (time criterion).

This maintenance service type is based on the service items to be carried out. The service items are described in the Maintenance Booklet.

The service items to be carried out under the corresponding service type can be displayed in the multifunction display.

#### Calling up the service item menu

- ▶ Switch on the ignition (▷ page 33).  
The standard display of the control system appears (▷ page 145).
- ▶ Press button  or  on the multifunction steering wheel until the maintenance service indicator appears in the multifunction display.
- ▶ Press the reset button (▷ page 24) for about five seconds.  
The *Service* menu appears in the multifunction display (▷ page 145).
- ▶ Select the *Items* menu with the  or  button.
- ▶ Press the  button.

## Operation

### Maintenance

The service indicator now displays the *Items* menu.



The maintenance service items to be carried out are shown in this menu.

Please refer to the Maintenance Booklet for a description of each maintenance service item.

- ▶ Press button  on the multifunction steering wheel until the standard display appears in the multifunction display.

## Operation

### Vehicle care

#### Cleaning and care of vehicle

##### Warning!



Many cleaning products can be hazardous. Some are poisonous, others are flammable. Always follow the instructions on the particular container. Always open your vehicle's doors or windows when cleaning the inside. Never use fluids or solvents that are not designed for cleaning your vehicle.

While in operation, even while parked, your vehicle is subjected to varying external influences which, if gone unchecked, can attack the paintwork as well as the underbody and cause lasting damage.

Such damage is caused not only by extreme and varying climatic conditions, but also by:

- Air pollution
- Road salt
- Tar
- Gravel and stone chipping

To avoid paint damage, you should immediately remove:

- Grease and oil
- Fuel
- Coolant
- Brake fluid
- Bird droppings
- Insects
- Tree resins etc.

Frequent washing reduces and/or eliminates the aggressiveness and potency of the above adverse influences.

More frequent washings are necessary to deal with unfavorable conditions:

- near the ocean
- in industrial areas (smoke, exhaust emissions)
- during winter operation

You should check your vehicle from time to time for stone chipping or other damage. Any damage should be repaired as soon as possible to prevent corrosion.

In doing so, do not neglect the underbody of the vehicle. A prerequisite for a thorough check is a washing of the underbody followed by a thorough inspection. Damaged areas need to be re-undercoated.

Your vehicle has been treated at the factory with a wax-base rustproofing in the body cavities which will last for the lifetime of the vehicle. Post-production treatment is neither necessary nor recommended by Mercedes-Benz because of the possibility of incompatibility between materials used in the production process and others applied later.

We have selected car-care products and compiled recommendations which are specially matched to our vehicles and which always reflect the latest technology. You can obtain Mercedes-Benz approved car-care products at an authorized Mercedes-Benz Center.

Scratches, corrosive deposits, corrosion or damage due to negligent or incorrect care cannot always be removed or repaired with the car-care products recommended here. In such cases it is best to seek aid at an authorized Mercedes-Benz Center.

The following topics deal with the cleaning and care of your vehicle and give important “how-to” information as well as references to Mercedes-Benz approved car-care products.

### Power washer

When using a power wash for cleaning the vehicle, always observe the manufacturer’s operating instructions.



Vehicles with KEYLESS-GO\*:

If a door handle is hit by a strong jet of water, and a SmartKey with KEYLESS-GO\* is in close proximity, i.e. within approximately 3 ft (approximately 1 m), the vehicle could be inadvertently locked or unlocked.



Never use a round nozzle to power-wash tires. The intense jet of water can result in damage to the tire.

Always replace a damaged tire.

Always keep the jet of water moving across the surface. Do not aim directly at electrical parts, electrical connectors, seals, or other rubber parts.

### Tar stains

Quickly remove tar stains before they dry and become more difficult to remove. A tar remover is recommended.

### Paintwork, painted body components

Mercedes-Benz approved Paint Care should be applied when water drops on the paint surface do not “bead up”, normally every three to five months, depending on climate and washing detergent used.

Mercedes-Benz approved Paint Cleaner should be applied if the paint surface shows signs of embedded dirt (i.e. loss of gloss).

Do not apply any of these products or wax if your vehicle is parked in the sun or if the hood is still hot.

Use the appropriate MB-Touch-Up Stick for quick and provisional repairs of minor paint damage (i.e. chips from stones, vehicle doors, etc.).

## Operation

### Vehicle care

#### Engine cleaning

Prior to cleaning the engine compartment, make sure to protect electrical components and connectors from contact with water and cleaning agents.

Corrosion protection, such as MB Anticorrosion Wax should be applied to the engine compartment after every engine cleaning. Before applying, all control linkage bushings and joints should be lubricated. The poly-V-belt and all pulleys should be protected from any wax.

#### Vehicle washing

Do not use hot water or wash your vehicle in direct sunlight. Only use a mild car wash detergent, such as Mercedes-Benz approved Car Shampoo.

Thoroughly spray the vehicle with a diffused jet of water. Direct only a very weak spray towards the ventilation intake. Use plenty of water and rinse the sponge and chamois frequently.

Rinse with clear water and thoroughly dry with a chamois. Do not allow cleaning agents to dry on the finish.

Due to the width of the vehicle, fold in exterior rear view mirrors prior to running the vehicle through an automatic car wash to prevent damage to the mirrors.

In the winter, thoroughly remove all traces of road salt as soon as possible.

When washing the underbody, do not forget to clean the inner sides of the wheels.



Vehicles with KEYLESS-GO\*:  
If a door handle is hit by a strong jet of water, and a SmartKey with KEYLESS-GO\* is in close proximity, i.e. within approximately 3 ft (approximately 1 m), the vehicle could be inadvertently locked or unlocked.

#### Ornamental moldings

For regular cleaning and care of very dirty chrome-plated parts, use a chrome cleaner.

#### Headlamps, tail lamps, side markers, turn signal lenses

Use a mild car wash detergent, such as Mercedes-Benz approved Car Shampoo, with plenty of water.

To prevent scratches, never apply strong force and only use a soft, non-scratchy cloth when cleaning the lenses. Do not attempt to wipe dirty lenses with a dry cloth or sponge.



#### Cleaning the DISTRONIC\* system sensor cover

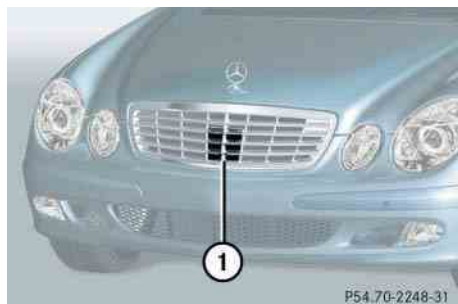

#### ① DISTRONIC system sensor cover

Use a mild car wash detergent, such as Mercedes-Benz approved Car Shampoo, with plenty of water to clean sensor cover ①.

To prevent scratches, never apply strong force and use only a soft, non-scratchy cloth when cleaning the sensor cover. Do not attempt to wipe dirty sensors with a dry cloth or sponge.

#### Cleaning the Parktronic system\* sensors



#### ① Parktronic system\* sensors

- Clean the sensors ① on the bumpers using a mild car wash detergent, such as Mercedes-Benz approved Car Shampoo, with plenty of water and a soft, non-scratchy cloth.

When using a steam cleaner or power washer, aim nozzle only briefly from a minimum distance of 12 in (30 cm) at sensors ①.

Do not apply strong pressure to the sensor cover, applying strong pressure may damage the sensor cover.

To prevent scratches, never apply strong force and use only a soft, non-scratchy cloth when cleaning the sensor. Do not attempt to wipe dirty sensors with a dry cloth or sponge.

#### Wiper blades



The windshield wipers must be in a vertical position before folding them away from the windshield. They could otherwise damage the hood.

- Turn on the wipers and place it in a vertical position.

For information on placing the wipers in a vertical position, see "Replacing wiper blades" (▷ page 423).



## Operation

### Vehicle care



#### Warning!



For safety reasons, switch off wipers and remove SmartKey from starter switch (vehicles with KEYLESS-GO\*): Make sure the vehicle's on-board electronics have status 0) before cleaning the wiper blades. Otherwise, the wiper motor could suddenly turn on and cause injury.

- ▶ Clean the wiper blade inserts with a clean cloth and detergent solution.



Fold the windshield wiper arms back onto the windshield before turning the SmartKey in the starter switch.

Hold on to the wiper when folding the wiper arm back. If released, the force of the impact from the tensioning spring could crack the windshield.

### Window cleaning



The windshield wipers must be in a vertical position before folding them away from the windshield. They could otherwise damage the hood.

- ▶ Turn on the wipers and place it in a vertical position.

For information on placing the wipers in a vertical position, see “Replacing wiper blades” (▷ page 423).

#### Warning!



For safety reasons, switch off wipers and remove SmartKey from starter switch (vehicles with KEYLESS-GO\*): Make sure the vehicle's on-board electronics have status 0) before cleaning the windshield. Otherwise, the wiper motor could suddenly turn on and cause injury.

Use a window cleaning solution on all glass surfaces. An automotive glass cleaner is recommended.



Fold the windshield wiper arms back onto the windshield before turning the SmartKey in the starter switch.

Hold on to the wiper when folding the wiper arm back. If released, the force of the impact from the tensioning spring could crack the windshield.

**Light alloy wheels**

Mercedes-Benz approved Wheel Care should be used for regular cleaning of the light alloy wheels.

If possible, clean wheels once a week with Mercedes-Benz approved Wheel Care, using a soft bristle brush and a strong spray of water.

Follow the instructions on the container.



Only use acid-free cleaning materials. Acid could lead to corrosion.

**Instrument cluster**

Use a gentle dishwashing detergent or mild detergent for delicate fabrics as a washing solution. Wipe with a cloth moistened in a lukewarm solution. Do not use scouring agents.

**Steering wheel and gear selector lever**

Wipe with a damp cloth and dry thoroughly or clean with Mercedes-Benz approved Leather Care.

**Cup holder**

Use a gentle dishwashing detergent or mild detergent for delicate fabrics as a washing solution. Wipe with a cloth moistened in lukewarm solution. Do not use scouring agents.

**Hard plastic trim items**

Pour Mercedes-Benz approved Interior Care onto a soft, lint-free cloth and apply with light pressure.

**Headliner and shelf below rear window**

Clean with a soft bristle brush, or use a dry-shampoo cleaner in case of excessive dirt.

**Seat belts**

The webbing must not be treated with chemical cleaning agents. Use only clear, lukewarm water and soap. Do not dry the webbing at temperatures above 176°F (80°C) or in direct sunlight.

**Warning!**

Do not bleach or dye seat belts as this may severely weaken them. In a crash they may not be able to provide adequate protection.

## Operation

### Vehicle care

#### Leather upholstery

Using aftermarket seat covers or wearing clothing that has the tendency to give off coloring (e.g. when wet, etc.) may cause the upholstery to become permanently discolored. By lining the seats with a proper intermediate cover, contact-discoloration will be prevented.

Wipe leather upholstery with a damp cloth and dry thoroughly or clean with Mercedes-Benz approved Leather Care. Exercise particular care when cleaning perforated leather as its underside should not become wet.

#### ***Nubuck leather upholstery (E 55 AMG)***

The nubuck leather upholstery is treated with a protective coating. Wipe nubuck leather upholstery with damp microfiber cloth to remove dust and other light stains. Carefully dab nubuck leather upholstery with a dry microfiber cloth to remove oil stains.



Do not use Mercedes-Benz approved Leather Care or any solvents to clean nubuck leather upholstery.

Avoid hard scrubbing on nubuck leather upholstery.

#### **MB Tex upholstery**

Pour Mercedes-Benz approved Interior Care onto a soft, lint-free cloth and apply with light pressure.

#### **Plastic and rubber parts**

Do not use oil or wax on these parts.

#### **Wood trims**

Dampen cloth using water and use damp cloth to clean wood trims in your vehicle. Do not use solvents like tar remover or wheel cleaner nor polishes or waxes as these may be abrasive.

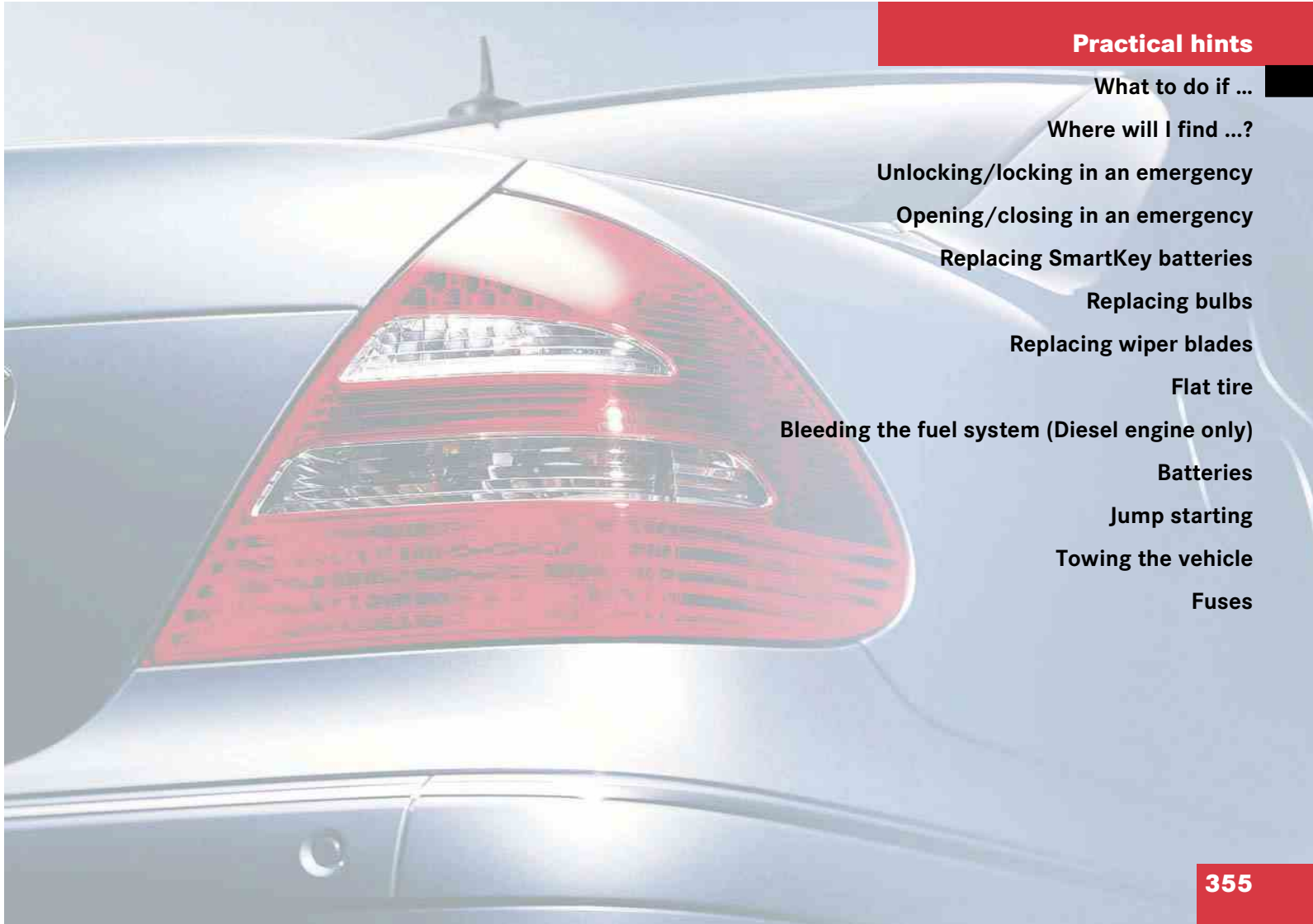

## **Practical hints**

**What to do if ...**

**Where will I find ...?**

**Unlocking/locking in an emergency**

**Opening/closing in an emergency**

**Replacing SmartKey batteries**

**Replacing bulbs**

**Replacing wiper blades**

**Flat tire**

**Bleeding the fuel system (Diesel engine only)**

**Batteries**

**Jump starting**

**Towing the vehicle**

**Fuses**

## Practical hints

### What to do if ...

#### Lamps in instrument cluster

General information:



If any of the following lamps in the instrument cluster fails to come on during the

bulb self-check when switching on the ignition, have the respective bulb checked and replaced if necessary.

Problem	Possible cause	Suggested solution
 The yellow ABS malfunction indicator lamp comes on while driving.	<p>The ABS has detected a malfunction and has switched off. The BAS and the ESP are also switched off (see messages in display).</p> <p>The SBC brake system is still functioning normally but without the ABS available.</p> <p>If the ABS control unit is malfunctioning, other systems such as the Parktronic system*, DISTRONIC*, or the automatic transmission may also be malfunctioning.</p>	<ul style="list-style-type: none"> <li>▶ Continue driving with added caution. Wheels may lock during hard braking, reducing steering capability.</li> <li>▶ Read and observe messages in the display (▷ page 367).</li> <li>▶ Have the system checked at an authorized Mercedes-Benz Center as soon as possible.</li> </ul> <p>Failure to follow these instructions increases the risk of an accident.</p>
	<p>The charging voltage has fallen below 10 volts. The ABS has switched off.</p> <p>The battery may not be sufficiently charged.</p>	<ul style="list-style-type: none"> <li>▶ Switch off electrical consumers that are currently not needed, e.g. seat heating.</li> <li>▶ If necessary, have the generator and battery checked.</li> </ul> <p>When the voltage is above this value again, the ABS is operational again.</p>



## Practical hints

### What to do if ...

Problem	Possible cause	Suggested solution
 The yellow ABS/ESP warning lamp comes on while driving.	The ESP is deactivated. Risk of accident! Adapt your speed and driving to the prevailing road, weather, and traffic conditions.	▶ Switch the ESP back on (▷ page 90). If the ESP cannot be switched back on, have the system checked at an authorized Mercedes-Benz Center as soon as possible.
 The yellow ABS/ESP warning lamp flashes while driving.	The ABS, ESP or traction control has come into operation because of detected traction loss in at least one tire. Distronic* is deactivated.	▶ When driving off, apply as little throttle as possible. ▶ While driving, ease up on the accelerator. ▶ Adapt your speed and driving to the prevailing road and weather conditions. ▶ Do not deactivate the ESP. Exceptions: (▷ page 90). Failure to follow these instructions increases the risk of accidents.

## Practical hints

### What to do if ...

Problem	Possible cause	Suggested solution
<b>BRAKE</b> (USA only)  (Canada only) The red brake warning lamp comes on while driving and you hear a warning sound.	You are driving with the parking brake set.	<ul style="list-style-type: none"> <li>▶ Release the parking brake.</li> <li>▶ Observe the additional message in the display.</li> </ul>
<b>BRAKE</b> (USA only)  (Canada only) The red brake warning lamp comes on while driving.	<ul style="list-style-type: none"> <li>• There is a malfunction in the SBC brake system.</li> <li>• There is insufficient brake fluid in the reservoir.</li> </ul>	<ul style="list-style-type: none"> <li>▶ Risk of accident! Do not drive any further. Consult a Mercedes-Benz Service Center. Under no circumstances should you top up the brake fluid. This will not solve the problem.</li> </ul>

#### Warning!



Driving with the brake warning lamp illuminated can result in an accident. Have your brake system checked immediately if the brake warning lamp stays on. Do not add brake fluid before checking the brake system.

Overfilling the brake fluid reservoir can result in spilling brake fluid on hot engine parts and the brake fluid catching fire. You can be seriously burned.



If you find that the brake fluid in the brake fluid reservoir has fallen to the minimum mark or below, have the brake system checked for brake pad thickness and leaks.





## Practical hints

### What to do if ...

Problem	Possible cause	Suggested solution
<p><b>CHECK ENGINE</b></p> <p>(USA only)</p> <p> (Canada only)</p> <p>The yellow engine malfunction indicator lamp comes on while driving.</p>	<p>There is a malfunction in:</p> <ul style="list-style-type: none"> <li>• The fuel management system</li> <li>• The ignition system (Gasoline engine)</li> <li>• The emission control system</li> <li>• Systems which affect emissions</li> </ul> <p>Such malfunctions may result in excessive emissions values and may switch the engine to its limp-home (emergency operation) mode.</p>	<p>▶ Have the vehicle checked as soon as possible by an authorized Mercedes-Benz Center. An on-board diagnostic connector is used by the service station to link the vehicle to the shop diagnostics system. It allows the accurate identification of system malfunctions through the read-out of diagnostic trouble codes. It is located in the front left area of the footwell next to the parking brake.</p>
	<p>A loss of pressure has been detected in the fuel system. The fuel cap may not be closed properly or the fuel system may be leaky.</p>	<p>▶ Check the fuel cap.</p> <p>If it is not closed properly:</p> <p>▶ Close the fuel cap.</p> <p>If it is closed properly:</p> <p>▶ Have the fuel system checked by an authorized Mercedes-Benz Center.</p>



## Practical hints

### What to do if ...

Problem	Possible cause	Suggested solution
 (USA only)  (Canada only) The yellow engine malfunction indicator lamp comes on while driving.	Your fuel tank is empty.	<ul style="list-style-type: none"> <li>▶ After refuelling start, turn off and re-start the engine three or four times in succession.</li> </ul> The limp-home mode is canceled. You do not need to have your vehicle checked.
	Diesel engine: The fuel tank is empty. The engine is running in emergency operation mode.	<ul style="list-style-type: none"> <li>▶ Bleed the fuel system (▷ page 432).</li> </ul> The limp-home mode is canceled. You do not need to have your vehicle checked.
	Diesel engine: The diesel engine electronics are malfunctioning. Full engine performance is not available.	<ul style="list-style-type: none"> <li>▶ Have the fuel system checked by an authorized Mercedes-Benz Center.</li> </ul>

## Practical hints

### What to do if ...

Problem	Possible cause	Suggested solution
 The red coolant warning lamp comes on when the engine is running.	<p>There is insufficient coolant in the reservoir.</p> <p>If this warning lamp comes on frequently, there is a leak in the cooling system.</p> <p>If the coolant level is correct, the electric radiator fan may be broken.</p>	<ul style="list-style-type: none"> <li>▶ Immediately add coolant to prevent engine from overheating (▷ page 308).</li> <li>▶ Have the cooling system checked.</li> <li>▶ If the coolant temperature is below 257°F (125°C), you can continue driving to the nearest authorized Mercedes-Benz Center.</li> <li>▶ Avoid high engine loads (e.g. driving uphill) and stop-and-go driving.</li> </ul>
 The red coolant warning lamp comes on while driving and you hear a warning sound.	<p>The coolant temperature has exceeded 257°F (125°C).</p>	<ul style="list-style-type: none"> <li>▶ Stop as soon as possible and allow the engine and coolant to cool down.</li> </ul>
 The red DTR warning lamp comes on while driving.	<p>You are too close to the vehicle in front of you to maintain selected speed.</p>	<ul style="list-style-type: none"> <li>▶ Apply the brakes immediately to increase the following distance.</li> </ul>

### Warning!





Driving when your engine is badly overheated can cause some fluids which may have leaked into the engine compartment to

catch fire. You could be seriously burned. Steam from an overheated engine can cause serious burns and can occur just by opening the engine hood. Stay away from the engine if you see or hear steam coming from it.

Turn off the engine, get out of the vehicle and do not stand near the vehicle until the engine has cooled down.

## Practical hints

### What to do if ...

Problem	Possible cause	Suggested solution
 The red DTR warning lamp comes on while driving and you hear a warning chime sound.	<ul style="list-style-type: none"> <li>You are gaining too rapidly on the vehicle ahead of you.</li> <li>The distance warning system has recognized a stationary obstacle on your probable line of travel.</li> </ul>	<ul style="list-style-type: none"> <li>▶ Apply the brakes immediately.</li> <li>▶ Carefully observe the traffic situation. You may need to brake or maneuver to avoid hitting an obstacle.</li> </ul>
 The yellow fuel tank reserve warning lamp comes on while driving.	The fuel level has gone below the reserve mark.	▶ Refuel at the next gas station (▷ page 299).
 The red seat belt telltale comes on after starting the engine with all doors closed.  The red seat belt telltale flashes and you additionally hear an intermittent warning signal with increasing intensity for a maximum of 60 seconds when the vehicle's speed exceeds 15 mph (25 km/h).	<p>The seat belt telltale reminds you and your front passenger to fasten your seat belts before driving off.</p> <p>You and/or your front passenger have forgotten to fasten your seat belts.</p> <p>There are items placed on the front passenger seat and therefore the system senses the front passenger seat as being occupied.</p>	<ul style="list-style-type: none"> <li>▶ Fasten your seat belts.</li> <li>▶ Fasten your seat belts.</li> <li>▶ Remove the items from the front passenger seat and put them in a safe place.</li> </ul>

## Practical hints

### What to do if ...

Problem	Possible cause	Suggested solution
 The yellow warning lamp for the tire pressure monitoring system comes on.	The tire pressure monitoring system detects a loss of pressure in at least one tire.	<ul style="list-style-type: none"><li>▶ Bring the vehicle to a halt, avoiding abrupt steering and braking maneuvers. Observe the traffic situation around you.</li><li>▶ Take note of the messages in the multi-function display.</li></ul> <p>The warning lamp goes out once the tire pressure monitoring system has been reactivated after the tire inflation pressures have been corrected.</p>

### Warning!



When the tire pressure monitoring system warning light is lit, one or more of your tires is significantly under-inflated. You should stop and check your tires as soon as possible, and inflate them to the proper pressure as indicated on the vehicle's tire information placard. Driving on a significantly under-inflated tire causes the tire to overheat and can lead to tire failure.

Under-inflation also reduces fuel efficiency and tire tread life, and may affect the vehicle's handling and stopping ability. Each tire, including the spare, should be checked monthly when cold and set to the recommended inflation pressure as specified in the vehicle placard and owner's manual.



The recommended tire inflation pressures for your vehicle can be found on the placard on the driver's door B-pillar or the inside of the fuel filler flap, not in the owner's manual.

## Practical hints

### What to do if ...



Problem	Possible cause	Suggested solution
<b>SRS</b> The red SRS indicator lamp comes on while driving.	There is a malfunction in the restraint systems. The air bags or emergency tensioning devices (ETDs) could deploy unexpectedly or fail to activate in an accident.	► Drive with added caution to the nearest authorized Mercedes-Benz Center.

### Warning!





In the event a malfunction of the SRS is indicated as outlined above, the SRS may not be operational. For your safety, we strongly recommend that you visit an authorized Mercedes-Benz Center immediately to have the system checked; otherwise the SRS may not be activated when needed in an accident, which could result in serious or fatal injury, or it might deploy unexpectedly and unnecessarily which could also result in an accident and/or injury to you or to others.

**Lamp in center console**

Problem	Possible cause	Suggested solution
<p> </p> <p>The indicator lamp illuminates and remains illuminated with the weight of a typical adult or someone larger than a small individual on the front passenger seat.</p>	<p>The system is malfunctioning.</p>	<ul style="list-style-type: none"> <li>▶ Have the system checked as soon as possible by an authorized Mercedes-Benz Center.</li> <li>▶ Also note any messages in the multifunction display and follow corrective steps (▷ page 374).</li> </ul>



**Warning!**



If the   indicator lamp illuminates and remains illuminated with the weight of a typical adult or someone larger than a small individual on the front passenger seat, do not have any passenger use the front passenger seat until the system has been repaired.



## Practical hints

### What to do if ...

Problem	Possible cause	Suggested solution
<p> </p> <p>The indicator lamp does not illuminate and/or does not remain illuminated with the weight of a typical 12-month-old child in a standard child restraint or less on the front passenger seat.</p>	<p>The system is malfunctioning.</p>	<ul style="list-style-type: none"><li>▶ Make sure that there is nothing between seat cushion and child seat and check installation of the child seat.</li><li>▶ Make sure that no objects applying supplemental weight onto the seat are present.</li><li>▶ Make sure that no objects which apply forces to the seat are present (e.g. objects such as books, brief-cases etc. lodged behind or around the seat, head restraints pushing against roof etc.). The system may recognize such forces as supplemental weight.</li><li>▶ If the light remains out, have the system checked as soon as possible by an authorized Mercedes-Benz Center. Do not transport a child on the front passenger seat until the system has been repaired.</li><li>▶ Also note any messages in the multifunction display and follow corrective steps (▷ page 374).</li></ul>

### Warning!



If the   indicator lamp does not illuminate or remains out with the

weight of a typical 12-month-old child in a standard child restraint or less on the front passenger seat, do not transport a child on the front passenger seat until the system has been repaired.



### Vehicle status messages in the multifunction display





Warning and malfunction messages appear in the multifunction display located in the instrument cluster.





Certain warning and malfunction messages are accompanied by an audible signal.

Address these messages accordingly and follow the additional instructions given in this Operator's Manual.

Selecting the vehicle status message memory menu in the control system (▷ page 145) displays both cleared and uncleared messages.

High-priority messages appear in the multifunction display in red color.

Certain messages of high priority cannot be cleared from the multifunction display using the reset button (▷ page 24) or button , ,  or  on the multifunction steering wheel.

Other messages of high priority and messages of less immediate priority can be cleared from the multifunction display using the reset button or button , ,  or  on the multifunction steering wheel. They are then stored in the vehicle status message memory (▷ page 153). Remember that clearing a message will only make the message disappear. Clearing a message will not correct the condition that caused the message to appear.

## Practical hints

### What to do if ...

#### Warning!



All categories of messages contain important information which should be taken note of and, where a malfunction is indicated, addressed as soon as possible at an authorized Mercedes-Benz Center.

Failure to repair condition noted may cause damage not covered by the Mercedes-Benz Limited Warranty, or result in property damage or personal injury.

#### Warning!



No messages will be displayed if either the instrument cluster or the multifunction display is inoperative.

Contact the nearest authorized Mercedes-Benz Center.

## Practical hints

### What to do if ...



Switching on the ignition causes all instrument cluster lamps (except low beam headlamp indicator lamp, high beam headlamp indicator lamp, and turn signal indicator lamps unless activated) as well as the multifunction display to come on. Make sure the lamps and multifunction display are in working order before starting your journey.

On the pages that follow, you will find a compilation of the most important warning and malfunction messages that may appear in the multifunction display.

For your convenience the messages are divided into two sections:

- Text messages (> page 369)
- Symbol messages (> page 378)

**Text messages**

<b>Display</b>	<b>Display message</b>	<b>Possible cause</b>	<b>Possible solution</b>
ABS	Malfunction Visit workshop	<p>The ABS has detected a malfunction and has switched off.</p> <p>The ESP and the BAS are also deactivated.</p> <p>The SBC brake system is still functioning normally but without the ABS available.</p>	<ul style="list-style-type: none"> <li>▶ Continue driving with added caution. Wheels will lock during hard braking, reducing steering capability.</li> <li>▶ Have the system checked at an authorized Mercedes-Benz Center as soon as possible.</li> </ul> <p>Failure to follow these instructions increases the risk of an accident.</p>
	Display malfunction Visit workshop	The ABS or the ABS display is malfunctioning.	<ul style="list-style-type: none"> <li>▶ Continue driving with added caution. Wheels will lock during hard braking, reducing steering capability.</li> <li>▶ Visit an authorized Mercedes-Benz Center as soon as possible.</li> </ul> <p>Failure to follow these instructions increases the risk of an accident.</p>

## Practical hints

### What to do if ...

Display	Display message	Possible cause	Possible solution
Low Battery	Conven. functions temporarily unavailable	The battery has insufficient voltage and can no longer supply convenience functions such as the rear window defroster.	As soon as the on-board voltage is sufficient, the consumers will switch on again.
Please note:	Conven. functions available again	On-board voltage is sufficient; the consumers will switch on again.	
Cruise control	Drive to workshop	Cruise control or Distronic* is malfunctioning.	► Have the cruise control or Distronic* checked by an authorized Mercedes-Benz Center.
Distronic	External interference Reactivate	The Distronic* is switched off and is temporarily unavailable.	► Try activating the Distronic* again later.
	Drive to workshop	The Distronic* is malfunctioning or the display is malfunctioning.	► Visit an authorized Mercedes-Benz Center as soon as possible.

## Practical hints

### What to do if ...

Display	Display message	Possible cause	Possible solution
Distrionic	Currently unavailable See Operator's Manual	DISTRONIC* is switched off if: <ul style="list-style-type: none"><li>the DISTRONIC cover in the area of the radiator grille is dirty</li><li>the functionality is impaired by heavy rain or thick fog</li></ul>	<ul style="list-style-type: none"><li>▶ If necessary, clean the DISTRONIC cover in the area of the radiator grille.</li><li>▶ Restart the vehicle.</li></ul> or DISTRONIC* becomes operational again without the engine being restarted when: <ul style="list-style-type: none"><li>dirt on the grille falls off while driving (e.g. slush or snow)</li><li>the system recognizes full sensor availability (due to lessening rain or the road surface drying)</li><li>the message in the multifunction display disappears</li><li>the speed last stored flashes in the display for five seconds.</li></ul> You can operate DISTRONIC* as usual again.

## Practical hints

### What to do if ...

Display	Display message	Possible cause	Possible solution
ESP	Malfunction Visit workshop	<p>The ESP has detected a malfunction and switched off.</p> <p>The ABS may not be operational.</p> <p>The SBC brake system is still functioning normally but without the ESP available.</p>	<ul style="list-style-type: none"> <li>▶ Continue driving with added caution.</li> <li>▶ Have the system checked at an authorized Mercedes-Benz Center as soon as possible.</li> </ul> <p>Failure to follow these instructions increases the risk of an accident.</p>
	unavailable See Operator's Manual	<p>The ESP is deactivated because the power supply was interrupted.</p> <p>The SBC brake system is still functioning normally but without the ESP available.</p>	<ul style="list-style-type: none"> <li>▶ Synchronize the ESP. With the vehicle stationary, turn the steering wheel completely to the left and then to the right to synchronize the ESP.</li> </ul> <p>If the ESP message does not go out:</p> <ul style="list-style-type: none"> <li>▶ Continue driving with added caution.</li> <li>▶ Have the system checked at an authorized Mercedes-Benz Center as soon as possible.</li> </ul> <p>Failure to follow these instructions increases the risk of an accident.</p>



When synchronizing the ESP, make sure you can turn the steering wheel in

both directions as far as it will go without the wheels hitting any objects, e.g. a road curb.

## Practical hints

### What to do if ...

Display	Display message	Possible cause	Possible solution
ESP	Display malfunction Visit workshop	The ESP or the ESP display is malfunctioning.	<ul style="list-style-type: none"><li>▶ Continue driving with added caution.</li><li>▶ Have the system checked at an authorized Mercedes-Benz Center as soon as possible.</li></ul> Failure to follow these instructions increases the risk of an accident.
P	Gear selector lever in Park	You have attempted to turn off the engine with the KEYLESS-GO* start/stop button with the gear selector lever not in <b>P</b> . You have opened the driver's door with the gear selector lever not in <b>P</b> .	<ul style="list-style-type: none"><li>▶ Place the gear selector lever in position <b>P</b>.</li></ul>
P/N	Shift to Neutral or Park	You have attempted to start the engine with the KEYLESS-GO* start/stop button while the gear selector lever was in position <b>R</b> or <b>D</b> .	<ul style="list-style-type: none"><li>▶ Place the gear selector lever in position <b>P</b> or <b>N</b>. Make sure the brake pedal is depressed.</li></ul>

## Practical hints

### What to do if ...

Display symbol	Display messages	Possible cause	Possible solution
	Front passenger airbag activated See Operator's Manual	Air bag is activated while driving even though a child, small individual, or object below the system's weight threshold is on the front passenger seat, or the front passenger seat is empty. Objects on the seat or forces acting on the seat may make the system sense supplemental weight.	Stop the vehicle in a safe location as soon as possible and check the following: <ul style="list-style-type: none"><li>▶ Make sure that there is nothing between seat cushion and child seat and check installation of the child seat.</li><li>▶ Make sure that no objects applying supplemental weight onto the seat are present.</li><li>▶ Make sure that no objects which apply forces to the seat are present (e.g. objects such as books, brief-cases etc. lodged behind or around the seat, head restraints pushing against roof etc.). The system may recognize such forces as supplemental weight and sense that an occupant on the front passenger seat is of a heavier weight than actually present.</li></ul> (Continued on next page)



## Practical hints

### What to do if ...

Display symbol	Display messages	Possible cause	Possible solution
	Front passenger airbag activated See Operator's Manual		<p>If performing any of the above corrective steps is successful, the message Front passenger airbag deactivated will appear in the multifunction display, confirming the situation has been remedied. Note that after performing the corrective steps, it may take up to 60 seconds for the message Front passenger airbag deactivated to appear.</p> <p>If the message Front passenger airbag activated remains on in the multifunction display and/or the  indicator lamp remains out even after performing the above corrective steps, have the system checked as soon as possible by an authorized Mercedes-Benz Center.</p>

### Warning!

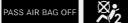

If the message Front passenger airbag activated remains on in the multifunction display and/or the  indicator lamp remains out even after performing the above corrective steps, do not have any

children 12 years old and under and other small individuals use the front passenger seat until the system has been repaired.



## Practical hints

### What to do if ...

Display symbol	Display messages	Possible cause	Possible solution
	<p>Front passenger airbag deactivated See Operator's Manual</p>	<p>Air bag is deactivated while driving even though an adult or someone larger than a small individual is occupying the front passenger seat. Forces acting on the seat may make the system sense a decrease in weight.</p>	<p>Stop the vehicle in a safe location as soon as possible and check the following:</p> <ul style="list-style-type: none"> <li>▶ Do not lean on armrests or lift yourself up using handle over the door.</li> <li>▶ Adjust the seat in a height position (▷ page 38).</li> <li>▶ Make sure that no objects which apply forces to the seat are present (e.g. objects such as books, brief-cases etc. lodged underneath, behind or around the seat). Such forces may cause the system to sense that an occupant of a lesser weight than actually present is on the front passenger seat.</li> <li>▶ Re-position yourself.</li> <li>▶ Sit properly belted in a nearly upright position with your back against the seat backrest.</li> </ul> <p>If performing any of the above corrective steps is successful, the message <i>Front passenger airbag activated</i> will appear in the multifunction display, confirming the situation has been remedied.</p> <p>(Continued on next page)</p>



## Practical hints

### What to do if ...

Display symbol	Display messages	Possible cause	Possible solution
	Front passenger airbag deactivated See Operator's Manual		<p>Note that after performing the corrective steps, it may take up to 60 seconds for the message Front passenger airbag activated to appear.</p> <p>If the message Front passenger airbag deactivated remains on in the multifunction display and/or the   indicator lamp remains on even after performing the above corrective steps, have the system checked as soon as possible by an authorized Mercedes-Benz Center.</p> <p>Do not have any passenger use the front passenger seat until the system has been repaired.</p>

### Warning!



If the message Front passenger airbag deactivated remains on in the multifunction display and/or the   indicator lamp remains illuminated even after performing the above corrective steps, do not have any passenger use the front passenger seat until the system has been repaired.

## Practical hints



### What to do if ...

#### Symbol messages

Display symbol	Display messages	Possible cause	Possible solution
	Undervoltage Switch off consumers	The battery has insufficient voltage.	▶ Turn off unnecessary electrical consumers.
	Visit workshop	<p>The battery is no longer charging. Possible causes:</p> <ul style="list-style-type: none"> <li>• alternator malfunctioning</li> <li>• broken poly-V-belt</li> </ul> <p>Do not forget that the brake system requires electrical energy and may be operating with restricted capability. Considerably greater brake pedal force is required and the stopping distance is increased.</p>	<p>▶ Stop immediately and check the poly-V-belt.</p> <p>If it is broken:</p> <p>▶ Do not continue to drive. Otherwise the engine will overheat due to an inoperative water pump which may result in damage to the engine. Notify an authorized Mercedes-Benz Center.</p> <p>If it is intact:</p> <p>▶ Drive immediately to the nearest authorized Mercedes-Benz Center. Adjust driving to be consistent with reduced braking responsiveness.</p>





## Practical hints

### What to do if ...

Display symbol	Display messages	Possible cause	Possible solution
	Battery/Alternator Stop vehicle	The battery is malfunctioning.  The SBC brake system requires electrical energy and therefore has only limited operation. Considerably greater brake pedal force is required and the stopping distance is increased.	<ul style="list-style-type: none"> <li>▶ Stop the vehicle as soon as it is safe to do so. Adjust driving to be consistent with reduced braking responsiveness.</li> <li>▶ Notify an authorized Mercedes-Benz Center.</li> </ul>
	Low voltage Start engine	The battery has insufficient voltage.	▶ Start the engine (▷ page 46).
	Malfunction Electrical consumers switched off	The consumer battery has insufficient voltage and can no longer supply the convenience functions such as seat ventilation*.	The electrical consumers will come back online as soon as on-board voltage is sufficient.
	Backrest, right rear not locked	The rear seat backrest is not engaged.	▶ Adjust the rear seat backrest until it is fully engaged in position.
	Backrest, left rear not locked	The rear seat backrest is not engaged.	▶ Adjust the rear seat backrest until it is fully engaged in position.



## Practical hints

### What to do if ...

Display symbol	Display messages	Possible cause	Possible solution
	Brake wear Visit workshop	The brake pads have reached their wear limit.	<ul style="list-style-type: none"> <li>▶ Brake pad thickness must be visually inspected at the intervals specified in the Maintenance Booklet.</li> <li>▶ Have the brake pads replaced as soon as possible.</li> </ul>
	Reduced braking power Depress brake pedal fully	<p>The SBC brake system is in emergency operation mode. Considerably greater brake pedal force is required and the stopping distance is increased.</p> <p>The maximum speed is limited to 55 mph (90 km/h).</p>	<ul style="list-style-type: none"> <li>▶ Do <b>not</b> drive any further.</li> <li>▶ Stop the vehicle and notify an authorized Mercedes-Benz Center.</li> <li>▶ Prevent the vehicle from rolling away by blocking the wheels with wheel chocks or other sizable objects.</li> <li>▶ Call for Roadside Assistance.</li> </ul>
(USA only)  (Canada only) 	Reduced braking power Start engine	The battery has insufficient voltage and cannot supply sufficient power to the SBC brake system.	<ul style="list-style-type: none"> <li>▶ Start the engine.</li> </ul> <p>The message disappears when sufficient voltage is available.</p>



## Practical hints

### What to do if ...

Display symbol	Display messages	Possible cause	Possible solution
(USA only)  (Canada only) 	Reduced braking power Visit workshop	The SBC brake system is in emergency operation mode. Considerable brake pedal force is required and the stopping distance is increased.	<ul style="list-style-type: none"> <li>▶ Continue driving with added caution.</li> <li>▶ Adjust driving to be consistent with reduced braking responsiveness.</li> <li>▶ Visit an authorized Mercedes-Benz Center as soon as possible.</li> </ul>
	Service brake Visit workshop	There are malfunctions, but the SBC brake system is operating normally.	<ul style="list-style-type: none"> <li>▶ Visit an authorized Mercedes-Benz Center as soon as possible.</li> </ul>
	Brake overheated Drive carefully	The brake system is overheated due to an excessive load on the brakes.	<ul style="list-style-type: none"> <li>▶ Relieve the load on the brake system.</li> <li>▶ Drive more smoothly and think ahead to avoid unnecessary braking.</li> <li>▶ When driving down slopes, shift into a lower gear to use the engine's braking power (▷ page 176).</li> <li>▶ Cautiously continue driving so that the air stream will cool down the brakes.</li> </ul>
	Release parking brake	You are driving with the parking brake set.	<ul style="list-style-type: none"> <li>▶ Release the parking brake (▷ page 48).</li> </ul>

## Practical hints

### What to do if ...

Display symbol	Display messages	Possible cause	Possible solution
(USA only)  (Canada only) 	Brake fluid Visit workshop	There is insufficient brake fluid in the reservoir.	► Risk of accident! Stop the vehicle and notify an authorized Mercedes-Benz Center. Do not add brake fluid! This will not solve the problem.

#### Warning!



Driving while these messages are displayed can result in an accident. Have your brake system checked immediately.

If there is a malfunction in the SBC brake system, we recommend that the vehicle be transported with all wheels off the ground using flatbed or appropriate wheel lift/dolly equipment.

A tow bar must be used if circumstances do not permit the use of the recommended towing methods and the vehicle requires towing with all four wheels on the ground.

Towing the vehicle with all four wheels on the ground is only permissible for distances up to 30 miles (50 km) and at a speed not to exceed 30 mph (50 km/h). For more information, refer to "Towing the vehicle" (▷ page 439).

If the SBC brake system enters its emergency operation mode, the driver must apply significantly greater brake pedal pressure and depress the pedal much further than normal to obtain braking effect. If necessary, apply full pressure to the brake pedal. Brakes may only be applied to the front wheels. Stopping distance is increased!

Do not add brake fluid before checking the brake system. Overfilling the brake fluid reservoir can result in spilling brake fluid on hot engine parts and the brake fluid catching fire. You can be seriously burned.



If you find that the brake fluid in the brake fluid reservoir has fallen to the minimum mark or below, have the brake system checked for brake pad thickness and leaks.





Brake pad thickness must be visually inspected by a qualified technician at the intervals specified in the Maintenance Booklet.



## Practical hints

### What to do if ...

Display symbol	Display messages	Possible cause	Possible solution
 (USA only)  (Canada only)	Visit workshop	There may be a malfunction in the: <ul style="list-style-type: none"><li>• fuel injection system</li><li>• ignition system</li><li>• exhaust system</li><li>• fuel system</li></ul>	▶ Have the measuring system checked by an authorized Mercedes-Benz Center.
	Coolant Check level	The coolant level is too low.	▶ Add coolant (▷ page 308). ▶ If you have to add coolant frequently, have the cooling system checked by an authorized Mercedes-Benz Center.

### Warning!



Do not spill antifreeze on hot engine parts. Antifreeze contains ethylene glycol which may burn if it comes into contact with hot engine parts. You can be seriously burned.



Do not ignore the low engine coolant level warning. Extended driving with the message and symbol displayed may cause serious engine damage not covered by the Mercedes-Benz Limited Warranty.

Do not drive without sufficient amount of coolant in the cooling system. The engine will overheat causing major engine damage.

## Practical hints

### What to do if ...

Display symbol	Display messages	Possible cause	Possible solution
	Coolant Stop, engine off	The coolant is too hot.	<ul style="list-style-type: none"><li>▶ Stop the vehicle.</li><li>▶ Only start the engine again after the message disappears. You could otherwise damage the engine.</li></ul>

#### Warning!



Driving when your engine is badly overheated can cause some fluids which may have leaked into the engine compartment to catch fire. You could be seriously burned.

Steam from an overheated engine can cause serious burns and can occur just by opening the engine hood. Stay away from the engine if you see or hear steam coming from it.

Turn off the engine, get out of the vehicle and do not stand near the vehicle until the engine has cooled down.

During severe operation conditions and stop-and-go city traffic, the coolant temperature may rise close to 248°F (120°C).



The engine should not be operated with the coolant temperature above 248°F (120°C). Doing so may cause serious damage which is not covered by the Mercedes-Benz Limited Warranty.



## Practical hints

### What to do if ...

Display symbol	Display messages	Possible cause	Possible solution
	Coolant Stop, engine off	The poly-V-belt could be broken.	<ul style="list-style-type: none"> <li>▶ Stop immediately and check the poly-V-belt.</li> </ul> <p>If it is broken:</p> <ul style="list-style-type: none"> <li>▶ Do not continue to drive. Otherwise the engine will overheat due to an inoperative water pump which may result in damage to the engine. Notify an authorized Mercedes-Benz Center.</li> </ul> <p>If it is intact:</p> <ul style="list-style-type: none"> <li>▶ Do not continue to drive the vehicle with this message displayed. Doing so could result in serious engine damage that is not covered by the Mercedes-Benz Warranty.</li> <li>▶ Drive immediately to the nearest authorized Mercedes-Benz Center.</li> </ul>
	Coolant Visit workshop	The cooling fan for the coolant is malfunctioning.	<ul style="list-style-type: none"> <li>▶ Observe the coolant temperature display.</li> <li>▶ Have the fan replaced as soon as possible.</li> </ul>

## Practical hints

### What to do if ...

Display symbol	Display messages	Possible cause	Possible solution
	Display malfunction Visit workshop	The displays for several systems have malfunctioned. Some systems themselves may also have malfunctioned.	<ul style="list-style-type: none"><li>▶ Continue driving with added caution. When the display is malfunctioning, warnings and malfunction messages might not be displayed.</li><li>▶ Have the electronic systems checked by an authorized Mercedes-Benz Center.</li></ul>
	Display malfunction Visit workshop	Certain electronic systems are unable to relay information to the control system. The following systems may have failed: <ul style="list-style-type: none"><li>• Coolant temperature display</li><li>• Tachometer</li><li>• Cruise control display</li></ul>	<ul style="list-style-type: none"><li>▶ Have the electronic systems checked by an authorized Mercedes-Benz Center.</li></ul>
	Doors open	You are attempting to drive with one or more doors open.	<ul style="list-style-type: none"><li>▶ Close the doors.</li></ul>

## Practical hints

### What to do if ...

Display symbol	Display messages	Possible cause	Possible solution
	<p>USA only: Add 1 Qt. engine oil at next refueling</p> <p>Canada only: Add 1 Liter engine oil at next refueling</p>	The engine oil level is too low.	<ul style="list-style-type: none"> <li>▶ Add engine oil (▷ page 306) and check the engine oil level (▷ page 305).</li> </ul>
	<p>Engine oil level Stop, engine off</p>	There is no oil in the engine. There is a danger of engine damage.	<ul style="list-style-type: none"> <li>▶ Carefully bring the vehicle to a halt as soon as possible.</li> <li>▶ Turn off the engine.</li> <li>▶ Add engine oil (▷ page 306) and check the engine oil level (▷ page 305).</li> </ul>
	<p>Engine oil level Reduce oil level</p>	<p>You have added too much engine oil.</p> <p>There is a risk of damaging:</p> <ul style="list-style-type: none"> <li>• the engine</li> <li>• the catalytic converter (Gasoline engine)</li> <li>• the oxidation catalyst (Diesel engine)</li> </ul>	<ul style="list-style-type: none"> <li>▶ Have oil siphoned or drained off. Observe all legal requirements with respect to its disposal.</li> </ul>

## Practical hints

### What to do if ...

Display symbol	Display messages	Possible cause	Possible solution
	Engine oil Visit workshop	The engine oil has dropped to a critical level.	<ul style="list-style-type: none"> <li>▶ Check the engine oil level (▷ page 305) and add oil as required (▷ page 306).</li> <li>▶ If you must add engine oil frequently, have the engine checked for possible leaks.</li> </ul>
	Engine oil level Visit workshop	It may be that there is water in the engine oil.	▶ Have the engine oil checked.
	Engine oil level Visit workshop	The measuring system is malfunctioning.	▶ Have the measuring system checked by an authorized Mercedes-Benz Center.

When the Engine oil - Visit workshop message appears while the engine is running and at operating temperature, the engine oil level has dropped to approximately the minimum level.

When this occurs, the warning will first come on intermittently and then stay on if the oil level drops further.



If no oil leaks are noted, continue to drive to the nearest service station where the engine oil should be topped to the required level with an approved oil specified in the Factory Approved Service Products pamphlet.



The engine oil level warnings should not be ignored. Extended driving with the symbol displayed could result in serious engine damage that is not covered by the Mercedes-Benz Limited Warranty.

## Practical hints

### What to do if ...

Display symbol	Display messages	Possible cause	Possible solution
	Reserve fuel	The fuel level has dropped below the reserve mark.	▶ Refuel at the next gas station (▷ page 299).
	Check gas cap See Operator's Manual	A loss of pressure has been detected in the fuel system. The fuel cap may not be closed properly or the fuel system may be leaky.	▶ Check the fuel cap (▷ page 299). If it is not closed properly: ▶ Close the fuel cap. If it is closed properly: ▶ Have the fuel system checked by an authorized Mercedes-Benz Center.
	Hood open	You are driving with the hood open.	▶ Close the hood (▷ page 303).

## Practical hints

### What to do if ...

Display symbol	Display messages	Possible cause	Possible solution
	Key still in vehicle	A SmartKey with KEYLESS-GO* left in the vehicle was recognized while locking the vehicle from the outside.	▶ Take the SmartKey out of the vehicle.
	Keyless Go Check system	The KEYLESS-GO* system is malfunctioning.	▶ Visit an authorized Mercedes-Benz Center as soon as possible.
	Do not forget key	This display appears (for a maximum of 60 seconds) if the driver's door is opened with the engine shut off and no SmartKey in the starter switch. This message is only a reminder.	▶ Insert SmartKey in the starter switch. ▶ Take the SmartKey with KEYLESS-GO* with you when leaving the vehicle.
	Remove key	You have forgotten to remove the SmartKey.	▶ Remove the SmartKey from the starter switch.
	Replace key	There is no additional code available for SmartKey or SmartKey with KEYLESS-GO*.	▶ Visit an authorized Mercedes-Benz Center as soon as possible.



## Practical hints

### What to do if ...

Display symbol	Display messages	Possible cause	Possible solution
	Key Check battery	The SmartKey with KEYLESS-GO* batteries are discharged.	<ul style="list-style-type: none"> <li>▶ Change the batteries (&gt; page 415).</li> </ul>
	Key not recognized	<p>The SmartKey with KEYLESS-GO* is not recognized while the engine is running because</p> <ul style="list-style-type: none"> <li>• the SmartKey with KEYLESS-GO* is not in the vehicle</li> <li>• there is strong radio-frequency interference</li> </ul>	<ul style="list-style-type: none"> <li>▶ Stop the vehicle as soon as it is safe to do so.</li> <li>▶ Search for the SmartKey.</li> </ul> <p>Otherwise the vehicle cannot be centrally locked nor can the engine be started again after the engine is stopped.</p>
		The SmartKey with KEYLESS-GO* is momentarily not recognized.	<ul style="list-style-type: none"> <li>▶ Change the position of the SmartKey in the vehicle.</li> <li>▶ Operate the vehicle with the SmartKey in the starter switch if necessary.</li> </ul>

## Practical hints

### What to do if ...

Display symbol	Display messages	Possible cause	Possible solution
	Brake lamp Drive to workshop	Brake lamp illumination is delayed or lamp is permanently on.	► Visit an authorized Mercedes-Benz Center as soon as possible.
	Brake lamp, left Substitute bulb on	The left brake lamp is malfunctioning. A substitute bulb is being used.	► Visit an authorized Mercedes-Benz Center as soon as possible.
	Brake lamp, right Substitute bulb on	The right brake lamp is malfunctioning. A substitute bulb is being used.	► Visit an authorized Mercedes-Benz Center as soon as possible.
	Display malfunction Visit workshop	The display for the lamps or the system is malfunctioning.	► Visit an authorized Mercedes-Benz Center as soon as possible.
	Front foglamp, left	The left front fog lamp is malfunctioning.	► Replace the bulb as soon as possible.
	Front foglamp, right	The right front fog lamp is malfunctioning.	► Replace the bulb as soon as possible.
	Active Hdmp. currently unavailable	The Bi-Xenon cornering lamps system is malfunctioning.	► Visit an authorized Mercedes-Benz Center as soon as possible.
	Active Hdmp. malfunction Drive to workshop	The Bi-Xenon cornering lamps system is malfunctioning.	► Visit an authorized Mercedes-Benz Center as soon as possible.

## Practical hints

### What to do if ...

Display symbol	Display messages	Possible cause	Possible solution
	Low beam, right	The right low beam lamp is malfunctioning.	Halogen headlamp: ▶ Replace the bulb as soon as possible. Bi-Xenon* headlamp: ▶ Visit an authorized Mercedes-Benz Center as soon as possible.
	Front Marker light, left	The front left side marker lamp is malfunctioning.	▶ Replace the bulb as soon as possible.
	Front Marker light right	The front right side marker lamp is malfunctioning.	▶ Replace the bulb as soon as possible.
	Fr. Park. lamp, left	The left parking lamps are malfunctioning.	▶ Visit an authorized Mercedes-Benz Center as soon as possible.
	Fr. Park. lamp, right	The right parking lamps are malfunctioning.	▶ Visit an authorized Mercedes-Benz Center as soon as possible.
	Rear foglamp Substitute bulb on	The rear fog lamp is malfunctioning. A substitute bulb is being used.	▶ Replace the bulb as soon as possible.
	Backup lamp, left	The left reverse lamp is malfunctioning.	▶ Replace the bulb as soon as possible.
	Backup lamp, right	The right reverse lamp is malfunctioning.	▶ Replace the bulb as soon as possible.
	Switch off lamps	Lamps have been turned on although the SmartKey in the starter switch is in position <b>0</b> .	▶ Switch off the headlights.

## Practical hints

### What to do if ...

Display symbol	Display messages	Possible cause	Possible solution
	High beam, left	The left high beam lamp is malfunctioning.	▶ Replace the bulb as soon as possible.
	High beam, right	The right high beam lamp is malfunctioning.	▶ Replace the bulb as soon as possible.
	License plate lamp, left	The left license plate lamp is malfunctioning.	▶ Replace the bulb as soon as possible.
	License plate lamp, right	The right license plate lamp is malfunctioning.	▶ Replace the bulb as soon as possible.
	Light sensor Drive to workshop	The lamp sensor is malfunctioning. The headlamps switch on automatically.	<ul style="list-style-type: none"> <li>▶ In the control system, set lamp operation to manual mode (▷ page 162).</li> <li>▶ Switch on headlamps using the exterior lamp switch.</li> </ul>
	Low beam, left	The left low beam lamp is malfunctioning.	Halogen headlamp: <ul style="list-style-type: none"> <li>▶ Replace the bulb as soon as possible.</li> </ul> Bi-Xenon* headlamp: <ul style="list-style-type: none"> <li>▶ Visit an authorized Mercedes-Benz Center as soon as possible.</li> </ul>

## Practical hints

### What to do if ...

Display symbol	Display messages	Possible cause	Possible solution
	Taillamp, left Substitute bulb on	The left tail lamp is malfunctioning. A substitute bulb is being used.	► Visit an authorized Mercedes-Benz Center as soon as possible.
	Taillamp, right Substitute bulb on	The right tail lamp is malfunctioning. A substitute bulb is being used.	► Visit an authorized Mercedes-Benz Center as soon as possible.
	Turn sig., left rear Substitute bulb on	The left rear turn signal lamp is malfunctioning. A substitute bulb is being used.	► Replace the bulb as soon as possible.
	Turn sig., right rear Substitute bulb on	The right rear turn signal lamp is malfunctioning. A substitute bulb is being used.	► Replace the bulb as soon as possible.
	Turn sig., left front	The left front turn signal lamp is malfunctioning.	► Replace the bulb as soon as possible.
	Turn sig., right front	The right front turn signal lamp is malfunctioning.	► Replace the bulb as soon as possible.
	Turn signal, left mirror	The left turn signal in the side mirror is malfunctioning. This message will only appear if all light emitting diodes have stopped working.	► Have the LEDs replaced as soon as possible.
	Turn signal, right mirror	The right turn signal in the side mirror is malfunctioning. This message will only appear if all light emitting diodes have stopped working.	► Have the LEDs replaced as soon as possible.

## Practical hints

### What to do if ...

Display symbol	Display messages	Possible cause	Possible solution
	Tire pres. monitor reactivated	The tire pressure monitoring system is using the current pressure values as the basis for monitoring.	
	Tire pressure displayed only after driving a few mins.	The tire inflation pressure is being checked.	
	Tire pres. monitor temporarily unavailable	<p>The tire pressure monitoring system* is unable to monitor the tire inflation pressure due to</p> <ul style="list-style-type: none"> <li>the presence of several wheel sensors in the vehicle.</li> <li>excessive wheel sensor temperatures.</li> <li>a nearby radio interference source.</li> <li>unrecognized wheel sensors mounted.</li> </ul>	<p>► Remove any extra wheel sensors from the vehicle.</p> <p>As soon as the causes of the malfunction have been removed, the tire pressure monitoring system automatically becomes active again.</p>

#### Warning!



Do not drive with a flat tire. A flat tire affects

the ability to steer or brake the vehicle.

You may lose control of the vehicle. Continued driving with a flat tire will cause

excessive heat build-up and possibly a fire.

## Practical hints

### What to do if ...

Display symbol	Display messages	Possible cause	Possible solution
	Tire pres. monitor reactivated	The tire pressure monitoring system is using the current pressure values as the basis for monitoring.	
	Tire pressure displayed only after driving a few mins.	The tire inflation pressure is being checked.	
	Tire pres. monitor temporarily unavailable	<p>The tire pressure monitoring system* is unable to monitor the tire inflation pressure due to</p> <ul style="list-style-type: none"> <li>the presence of several wheel sensors in the vehicle.</li> <li>excessive wheel sensor temperatures.</li> <li>a nearby radio interference source.</li> <li>unrecognized wheel sensors mounted.</li> </ul>	<p>► Remove any extra wheel sensors from the vehicle.</p> <p>As soon as the causes of the malfunction have been removed, the tire pressure monitoring system automatically becomes active again.</p>

### Warning!



Do not drive with a flat tire. A flat tire affects

the ability to steer or brake the vehicle.

You may lose control of the vehicle. Continued driving with a flat tire will cause

excessive heat build-up and possibly a fire.

## Practical hints

### What to do if ...

Display symbol	Display messages	Possible cause	Possible solution
	Reactivate tire pres. monitor after corr. pres.	There was a tire pressure warning message. The yellow warning lamp for the tire pressure monitoring system comes on and you have not reactivated the system since the last tire pressure warning message.	▶ Reactivate the tire pressure monitoring system after correcting the tire pressure values (▷ page 324).
	Tire pres. monitor deactivated Drive to workshop	The tire pressure monitoring system is malfunctioning.  A wheel without proper sensor was installed.	▶ Have the tire pressure monitoring system checked by an authorized Mercedes-Benz Center.  ▶ Change the wheel (▷ page 425).

### Warning!



Do not drive with a flat tire. A flat tire affects the ability to steer or brake the vehicle.

You may lose control of the vehicle. Continued driving with a flat tire will cause excessive heat build-up and possibly a fire.



## Practical hints

### What to do if ...

Display symbol	Display messages	Possible cause	Possible solution
	Tire pres. Please rectify	The pressure is too low in one or more tires.	▶ Check and correct tire inflation pressure as required (▷ page 322).
	Caution Tire pressure	One or more tires is deflating.	▶ Carefully bring the vehicle to a halt, avoiding abrupt steering and braking maneuvers. Observe the traffic situation around you. ▶ Change the wheel (▷ page 425). ▶ Have the damaged wheel repaired or replaced at an authorized Mercedes-Benz Center.
	Tire pres. Check tire	The tire inflation pressure in one or more tires is already below the minimum value. The tire inflation pressure in one or more tires is low.	▶ Carefully bring the vehicle to a halt, avoiding abrupt steering and braking maneuvers. ▶ Check the tire. ▶ Check and correct the tire pressure as required. ▶ If necessary change the wheel (▷ page 425).

### Warning!



Do not drive with a flat tire. A flat tire affects

the ability to steer or brake the vehicle.

You may lose control of the vehicle. Continued driving with a flat tire will cause

excessive heat build-up and possibly a fire.

## Practical hints

### What to do if ...

Display symbol	Display messages	Possible cause	Possible solution
	Caution Tire pres., RL	The left rear tire is deflating.	<ul style="list-style-type: none"> <li>▶ Carefully bring the vehicle to a halt, avoiding abrupt steering and braking maneuvers. Observe the traffic situation around you.</li> <li>▶ Change the wheel (▷ page 425).</li> <li>▶ Have the damaged wheel repaired or replaced at an authorized Mercedes-Benz Center.</li> </ul>
	Tire pressure, RL Check tire	The left rear tire inflation pressure is low.	<ul style="list-style-type: none"> <li>▶ Carefully bring the vehicle to a halt.</li> <li>▶ Check the tire.</li> <li>▶ Check and adjust the tire inflation pressure.</li> <li>▶ If necessary, change the wheel (▷ page 425).</li> </ul>
	Caution Tire pres., RR	The right rear tire is deflating.	<ul style="list-style-type: none"> <li>▶ Carefully bring the vehicle to a halt, avoiding abrupt steering and braking maneuvers. Observe the traffic situation around you.</li> <li>▶ Change the wheel (▷ page 425).</li> <li>▶ Have the damaged wheel repaired or replaced at an authorized Mercedes-Benz Center.</li> </ul>

#### Warning!



Do not drive with a flat tire. A flat tire affects

the ability to steer or brake the vehicle.

You may lose control of the vehicle. Continued driving with a flat tire will cause

excessive heat build-up and possibly a fire.

## Practical hints

### What to do if ...

Display symbol	Display messages	Possible cause	Possible solution
	Tire pressure, RR Check tire	The right rear tire inflation pressure is low.	<ul style="list-style-type: none"> <li>▶ Carefully bring the vehicle to a halt.</li> <li>▶ Check the tire.</li> <li>▶ Check and adjust the tire inflation pressure.</li> <li>▶ If necessary, change the wheel (▷ page 425).</li> </ul>
	Caution Tire pres., FL	The left front tire is deflating.	<ul style="list-style-type: none"> <li>▶ Carefully bring the vehicle to a halt, avoiding abrupt steering and braking maneuvers. Observe the traffic situation around you.</li> <li>▶ Change the wheel (▷ page 425).</li> <li>▶ Have the damaged wheel repaired or replaced at an authorized Mercedes-Benz Center.</li> </ul>
	Tire pressure, FL Check tire	The left front tire inflation pressure is low.	<ul style="list-style-type: none"> <li>▶ Carefully bring the vehicle to a halt.</li> <li>▶ Check and adjust the tire inflation pressure.</li> <li>▶ If necessary, change the wheel (▷ page 425).</li> </ul>

### Warning!



Do not drive with a flat tire. A flat tire affects

the ability to steer or brake the vehicle.

You may lose control of the vehicle. Continued driving with a flat tire will cause

excessive heat build-up and possibly a fire.

## Practical hints

### What to do if ...

Display symbol	Display messages	Possible cause	Possible solution
	Caution Tire pres., FR	The right front tire is deflating.	<ul style="list-style-type: none"> <li>▶ Carefully bring the vehicle to a halt, avoiding abrupt steering and braking maneuvers. Observe the traffic situation around you.</li> <li>▶ Change the wheel (&gt; page 425).</li> <li>▶ Have the damaged wheel repaired or replaced at an authorized Mercedes-Benz Center.</li> </ul>
	Tire pressure, FR Check tire	The right front tire inflation pressure is low.	<ul style="list-style-type: none"> <li>▶ Carefully bring the vehicle to a halt.</li> <li>▶ Check the tire.</li> <li>▶ Check and adjust the tire inflation pressure.</li> <li>▶ If necessary change the wheel (&gt; page 425).</li> </ul>

### Warning!







Do not drive with a flat tire. A flat tire affects the ability to steer or brake the vehicle.

You may lose control of the vehicle. Continued driving with a flat tire will cause excessive heat build-up and possibly a fire.



## Practical hints

### What to do if ...

Display symbol	Display messages	Possible cause	Possible solution
	Seat belt system Drive to workshop	The seat belt system is malfunctioning.	▶ Visit an authorized Mercedes-Benz Center as soon as possible.
	Service memory full See Operator's Manual	The maintenance service system memory cannot save any more data.	▶ Have the service memory checked by an authorized Mercedes-Benz Center.
	Close Sunroof	You have opened the driver's door with the SmartKey removed from the starter switch and the tilt/sliding sunroof open.	▶ Close the tilt/sliding sunroof (▷ page 224).
	Close Sunroof	You have opened the driver's door with the SmartKey removed from the starter switch and the tilt/sliding sunroof open.	▶ Close the tilt/sliding sunroof (▷ page 224).

## Practical hints

### What to do if ...

Display symbol	Display messages	Possible cause	Possible solution
	Tele Aid malfunction Drive to workshop	One or more main functions of the Tele Aid system are malfunctioning.	▶ Have the Tele Aid system checked by an authorized Mercedes-Benz Center.
	Tele Aid battery Drive to workshop	The emergency power battery for the Tele Aid system is malfunctioning. If the vehicle battery is also dead, Tele Aid will not be operational.	▶ Have the Tele Aid system checked by an authorized Mercedes-Benz Center.
	Restraint system malfunction Drive to workshop	The system is malfunctioning.	▶ Drive with added caution to the nearest authorized Mercedes-Benz Center.

### Warning!







In the event a malfunction of the SRS is indicated as outlined above, the SRS may not be operational.

For your safety, we strongly recommend that you visit an authorized Mercedes-Benz

Center immediately to have the system checked; otherwise the SRS may not be activated when needed in an accident, which could result in serious or fatal injury, or it might deploy unexpectedly and unnecessarily which could also result in injury.

## Practical hints

### What to do if ...

Display symbol	Display messages	Possible cause	Possible solution
	Function unavailable	This display appears if button  or  on the multifunction steering wheel is pressed and the vehicle is not equipped with a telephone.	
	Trunk open	This message will appear whenever the trunk lid is open.	▶ Close the trunk lid.
	Washer fluid, please refill	The fluid level has dropped to about $\frac{1}{3}$ of total reservoir capacity.	▶ Add washer fluid (▷ page 310).

## Practical hints

### What to do if ...

Display symbol	Display messages	Possible cause	Possible solution
	Vehicle rising	Your vehicle is adjusting to your level selection.	
	Leveling cancelled	The “Raised” level setting is canceled at vehicle speeds of over 75 mph (120 km/h).	▶ Reactivate the “Raised” level setting.
	Stop, car too low	The vehicle level control is malfunctioning.	Avoid excessive steering input. The fender or tires could otherwise be damaged. Listen for scraping noises. Do not drive faster than 50 mph (80 km/h).  ▶ Drive to the side of the road and select a higher vehicle level. Depending on the type of malfunction, this may raise the vehicle’s level.  There is otherwise danger of an accident.
	Visit workshop	The system is functional only to a limited extent.  The system display or the system is malfunctioning.	▶ Do not drive faster than 50 mph (80 km/h).  ▶ Have the vehicle checked at an authorized Mercedes-Benz Center.



## ▼ Where will I find ...?

### First aid kit

The first aid kit is in the storage compartment at the front edge of the front passenger seat.

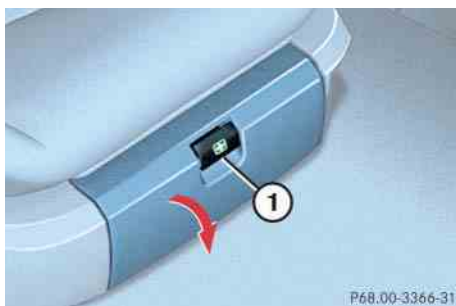

#### ① Tab

- ▶ Pull tab ① upward.
- ▶ Fold the covering forward.
- ▶ Remove the first aid kit.



Check expiration dates and contents for completeness at least once a year and replace missing/expired items.

### Spare wheel

The spare wheel is located under the trunk floor.

- ▶ Lift the trunk floor and engage the handle in the upper edge of trunk.
- ▶ Remove the luggage box (▶ page 408).

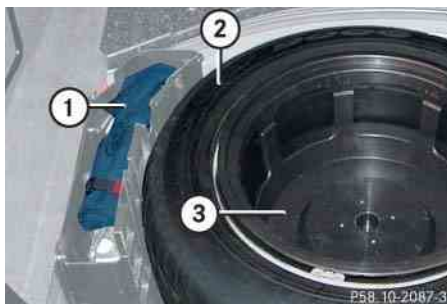

- ① Vehicle tool kit  
Wheel bolt wrench and Jack
- ② Spare wheel
- ③ Luggage bowl

## Practical hints

### Where will I find ...?

#### Removing the spare wheel

- ▶ Turn luggage bowl counterclockwise.
- ▶ Remove spare wheel ②.

#### Storing the spare wheel

- ▶ Place spare wheel ② in wheel well.
- ▶ Turn luggage bowl clockwise to its stop to secure the spare wheel.



Always lower trunk floor before closing trunk lid.



Vehicles with collapsible tire:  
The electrical air pump is located under luggage bowl ③.

## Practical hints

### Where will I find ...?

#### Warning!



The dimensions of the spare wheel (Minispare wheel or collapsible tire) are different from those of the road wheels. As a result, the vehicle handling characteristics change when driving with a spare wheel mounted.

The spare wheel should only be used temporarily, and replaced with a regular road wheel as quickly as possible.

In the case of a flat tire, you may temporarily use the spare wheel when observing the following restrictions:

- Do not exceed a vehicle speed of 50 mph (80 km / h).
- Drive to the nearest tire repair facility to have the flat tire repaired or replaced as appropriate.
- Do not operate vehicle with more than one spare wheel mounted.

For more information, see “Spare wheel” (▷ page 457).

### Luggage box

#### Remove luggage box

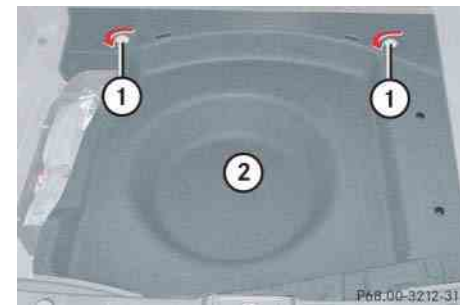

① Fastening clip

② Luggage box

- ▶ Turn fastening clips ① to the left upwards from fastening bolts.
- ▶ Lift luggage box in the area of the fastening bolts and remove it from trunk.

### Install luggage box



- ▶ Insert luggage box into trunk so that fastening clips are in line with fastening bolts.
- ▶ Push front edge of luggage box in direction of arrow under cover of trunk sill.
- ▶ Press fastening clips onto fastening bolts until they lock into place.

### Vehicle tool kit

The vehicle tool kit is stored in the compartment underneath the trunk floor (▷ page 407).

The vehicle tool kit includes:

- One pair of universal pliers
- One towing eye bolt
- One wheel wrench
- One alignment bolt
- One fuse extractor
- Spare fuses

## Practical hints



### Unlocking/locking in an emergency

#### Unlocking the vehicle

If you are unable to unlock the vehicle with the SmartKey, open the driver's door and the trunk using the mechanical key.



Unlocking your vehicle with the mechanical key will trigger the anti-theft alarm system. To cancel the alarm, do one of the following:

- Press button  or  on the SmartKey.
- Insert the SmartKey in the starter switch.
- Press the KEYLESS-GO\* start/stop button (▷ page 35).



① Mechanical key locking tab

② Mechanical key

- ▶ Move locking tab ① in the direction of the arrow and slide mechanical key ② out of the housing.

#### Unlocking the driver's door

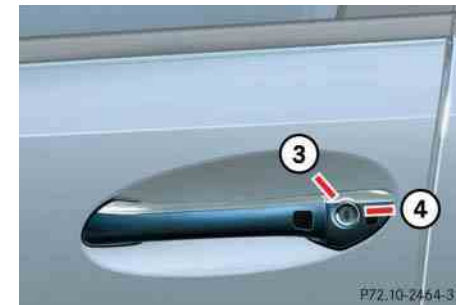

③ Unlocking

④ Locking

- ▶ Unlock the door with the mechanical key. To do so, push the mechanical key in the lock until it stops and turn it to the left.

Unlocking/locking in an emergency

Unlocking the trunk

A minimum height clearance of 5.90 ft (1.80 m) is required to open the trunk lid.

If you are unable to unlock the trunk with the SmartKey or KEYLESS-GO\*, open the trunk with the mechanical key.

The handle is located above the rear license plate recess.

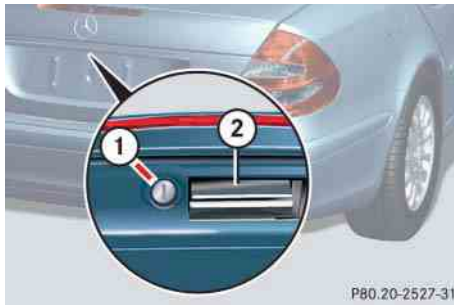

- ① Unlocking in an emergency
- ② Handle

- ▶ Insert the mechanical key into the trunk lid lock.

- ▶ Turn the mechanical key counterclockwise to position ① and hold it in this position.
- ▶ Pull trunk lid handle ② and lift the trunk lid.



Always make sure there is sufficient overhead clearance.



Unlocking your vehicle with the mechanical key will trigger the anti-theft alarm system. To cancel the alarm, do one of the following:

- Press button or on the SmartKey.
- Insert the SmartKey in the starter switch.

Vehicles with KEYLESS-GO\*:

- Grasp the outside door handle.
- Press the start/stop button.

Locking the vehicle

If you are unable to lock the vehicle with the SmartKey, lock it with the mechanical key as follows:

- ▶ Close the passenger doors and the trunk.
- ▶ Press the central locking switch in the cockpit (▷ page 119).
- ▶ Check to see whether the locking knobs on the passenger doors are still visible. If necessary, push them down manually.
- ▶ Slide mechanical key ② out of the SmartKey.
- ▶ Lock the driver's door with the mechanical key (▷ page 411).
- ▶ Check if the trunk is locked.

## Practical hints

### Unlocking/locking in an emergency

#### Fuel filler flap emergency release

In case the central locking system does not release the fuel filler flap, you can open it manually.

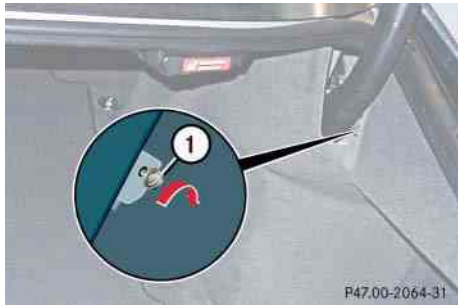

① Release knob

- ▶ Open trunk lid.
- ▶ Remove right-side tail trim.
- ▶ Turn release knob ① clockwise (arrow).

The fuel filler flap can now be opened.

#### Manually unlocking the transmission selector lever

In the case of power failure, the transmission selector lever can be manually unlocked, e.g. to tow the vehicle.

Depending on production date, your vehicle is equipped with cup holders in either the center console or in the center armrest.

#### Cup holder in the center console



① Pin

- ▶ Open the storage compartment in the center console (▷ page 265).

- ▶ Take out the cup holder (▷ page 266).
- ▶ Hold the cover at a 45° angle.
- ▶ Insert a suitable object ① (e.g. a pin) through the hole and press the pin downward.
- ▶ Remove pin ①.



The selector lever is locked again when moving it to position **P**.

Cup holder in the center armrest

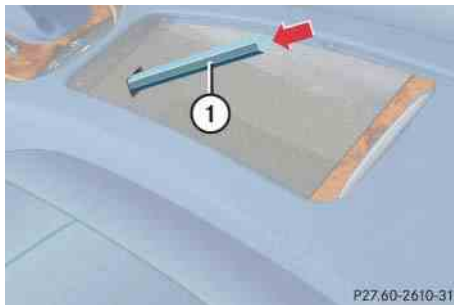

① Pin

- ▶ Open the storage compartment in the center armrest (▷ page 266).
- ▶ Take out the cup holder (▷ page 266).
- ▶ Insert a suitable object ① (e.g. a pin) through the hole and press the pin downward.
- ▶ Remove pin ①.



The selector lever is locked again when moving it to position **P**.

## Practical hints

### Opening/closing in an emergency

#### Power tilt/sliding sunroof\* or panorama roof with power tilt/sliding panel\*

You can open or close the tilt/sliding sunroof or tilt/sliding panel manually should an electrical malfunction occur.

The tilt/sliding sunroof or tilt/sliding panel drive is located behind lens ① of the interior overhead light.

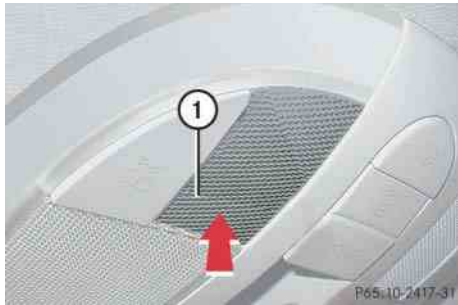

① Cover

- ▶ Remove the SmartKey from the starter switch.
- ▶ Press on cover ① in direction of the arrow to release it.

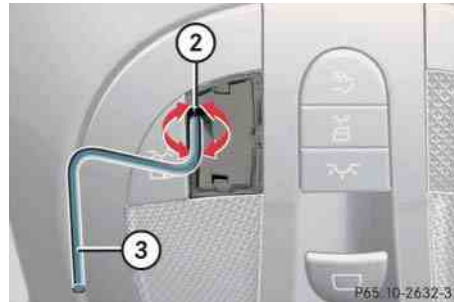

② Hole

③ Crank

- ▶ Take crank ③ out of the glove box.
- ▶ Insert crank ③ through hole ②.
- ▶ Turn crank ③ clockwise to:
  - slide roof panel/sunroof closed
  - raise roof panel/sunroof at the rear
- ▶ Turn crank ③ counterclockwise to:
  - slide roof panel/sunroof open
  - lower roof panel/sunroof at the rear

①

Turn crank ③ slowly and smoothly.

The tilt/sliding sunroof or tilt/sliding panel must be synchronized after being operated manually (▷ page 225) or (▷ page 229).



### ▼ Replacing SmartKey batteries

If the batteries in the SmartKey are discharged, the vehicle can no longer be locked or unlocked. It is recommended to have the batteries replaced at an authorized Mercedes-Benz Center.

#### Warning!



Keep the batteries out of reach of children.  
If a battery is swallowed, seek medical help immediately.

Batteries contain materials that can harm the environment if disposed of improperly. Recycling of batteries is the preferred method of disposal. Many states require sellers of batteries to accept old batteries for recycling.



When inserting the batteries, make sure they are clean and free of lint.



When replacing batteries, always replace both batteries.

The required replacement batteries are available at any Mercedes-Benz Center.

## Practical hints

### Replacing SmartKey batteries

#### SmartKey

Replacement batteries: Lithium, type CR 2025 or equivalent.

- ▶ Remove the mechanical key ① (▷ page 410).

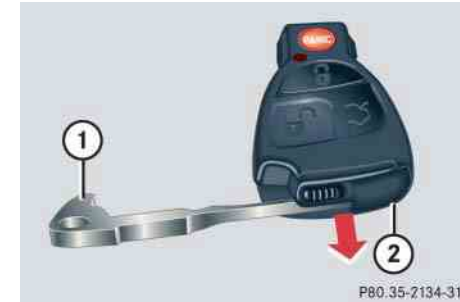

- ① Mechanical key
- ② Battery compartment

- ▶ Insert the mechanical key ① in side opening and push gray slide. Battery compartment ② is unlatched.
- ▶ Pull battery compartment ② out of the housing in direction of arrow.
- ▶ Remove the batteries.

## Practical hints

### Replacing SmartKey batteries

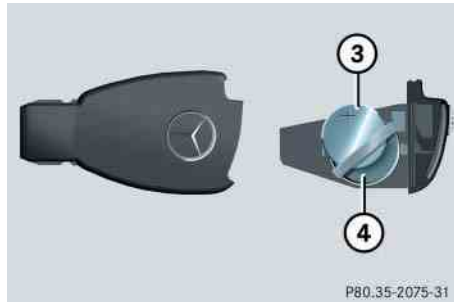

③ Battery

④ Contact spring

- ▶ Using a lint-free cloth, insert new batteries under the contact spring with the plus (+) side facing up.
- ▶ Return battery compartment into housing until it locks into place.

### SmartKey with KEYLESS-GO\*

Replacement batteries: Lithium, type CR 2025 or equivalent.

- ▶ Remove mechanical key (▷ page 410).

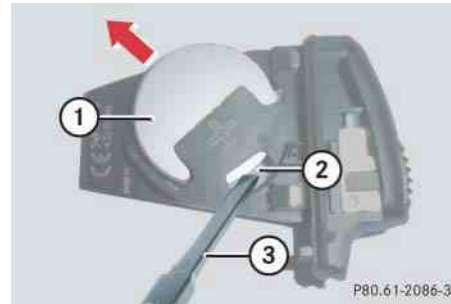

① Battery

② Tilt battery up

③ Mechanical key

- ▶ Insert the mechanical key ③ in side opening and push grey slide.

Battery compartment is unlatched.

- ▶ Pull battery compartment out of the housing in direction of arrow.
- ▶ Using mechanical key ③ apply pressure to position ②. Battery ① tilts up slightly.
- ▶ Pull out batteries ① in direction of arrow.
- ▶ Using a lint-free cloth, insert new batteries with the plus (+) side facing up.
- ▶ Return battery compartment into housing until it locks into place.

## ▼ Replacing bulbs

### Bulbs

---

Safe vehicle operation depends on proper exterior lighting and signaling. It is therefore essential that all bulbs and lamp assemblies are in good working order at all times.

Correct headlamp adjustment is extremely important. Have headlamps checked and readjusted at regular intervals and when a bulb has been replaced. See your authorized Mercedes-Benz Center for headlamp adjustment.



If the headlamps or front fog lamps are fogged up on the inside as a result of high humidity, driving the vehicle a distance with the lights on should clear up the fogging.



Substitute bulbs will be brought into use when lamps malfunction. Observe the messages in the multifunction display (▷ page 392).

## Practical hints

### Replacing bulbs

## Practical hints

### Replacing bulbs

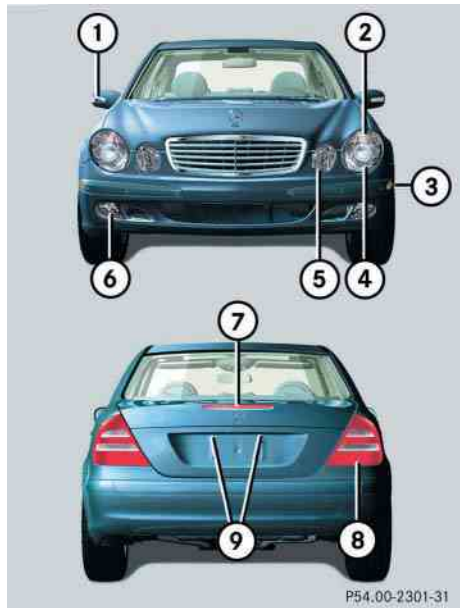

#### Front lamps

Lamp	Type
① Additional turn signal lamps	LED
② Turn signal lamp	1156 NA
③ Side marker lamp	W 5 W
④ Halogen headlamps: Low beam	H7 (55 W)
Bi-Xenon* headlamps: Low and high beam <sup>1</sup>	D2S-35 W
⑤ Halogen headlamps: High beam/high beam flasher	H7 (55 W)
Bi-Xenon* headlamps: High beam flasher	H7 (55 W)
Parking and standing lamps	W 5 W
⑥ Front fog lamp	HB4 (51 W)

<sup>1</sup> Vehicles with Bi-Xenon\* headlamps: Low beam and high beam use the same D2S-35W lamp. Do not replace the Bi-Xenon bulbs yourself. See your authorized Mercedes-Benz Center.

#### Rear lamps

Lamp	Type
⑦ High mounted brake lamp	LED
⑧ Brake, tail, parking, standing, backup lamps and turn signal lamps. Rear fog lamp (only driver's side)	HiP LED*
⑨ License plate lamps	C 5 W

### Warning!



Bulbs and bulb sockets can be very hot. Allow the lamp to cool down before changing a bulb.

Keep bulbs out of reach of children.

Halogen lamps contain pressurized gas.

A bulb can explode if you:

- touch or move it when hot
- drop the bulb
- scratch the bulb

Wear eye and hand protection.

Because of high voltage in Xenon lamps, it is dangerous to replace the bulb or repair the lamp and its components. We recommend that you have such work done by a qualified technician.

### Notes on bulb replacement

- Use only 12 volt bulbs of the same type and with the specified watt rating.
- Switch lights off before changing a bulb to prevent short circuits.
- Always use a clean lint-free cloth when handling bulbs.
- Your hands should be dry and free of oil and grease.
- If the newly installed bulb does not light up, visit an authorized Mercedes-Benz Center.

## Practical hints

### Replacing bulbs

Have the LEDs and bulbs for the following lamps replaced by an authorized Mercedes-Benz Center:

- Additional turn signals in the exterior rear view mirrors
- High mounted brake lamp
- Xenon\* lamps
- Front fog lamps
- Rear lamps (except license plate lamps)



Have the headlamp adjustment checked regularly.

## Practical hints

### Replacing bulbs

#### Replacing bulbs for front lamps

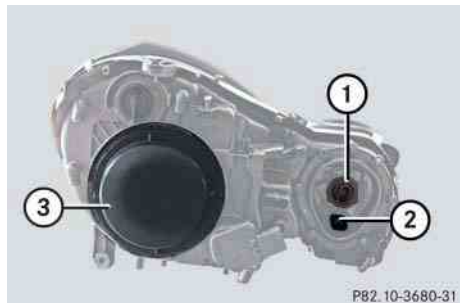

- ① Bulb socket for high beam headlamp/high beam flasher bulb
- ② Bulb socket for parking and standing lamp bulb
- ③ Housing cover for low beam/Bi-Xenon\* headlamp

#### Warning!



Do not remove the cover ③ for the Bi-Xenon\* headlamp. Because of high voltage in Xenon\* lamps, it is dangerous to replace the bulb or repair the lamp and its components. We recommend that you have such work done by a qualified technician.

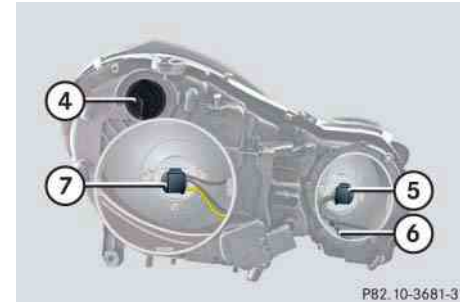

- ④ Bulb socket for turn signal lamp bulb
- ⑤ Electrical connector for high beam headlamp/high beam flasher bulb
- ⑥ Bulb socket for parking and standing lamp bulb
- ⑦ Electrical connector for low beam headlamp bulb (halogen headlamps only)

Before you start to replace a bulb for a front lamp, do the following first:

- ▶ Turn the exterior lamp switch to position **0** (▷ page 133).
- ▶ Open the hood (▷ page 303) (except for side marker lamps).

### Low beam bulb (halogen headlamps only)

- ▶ Turn housing cover ③ counterclockwise and remove it.
- ▶ Pull electrical connector ⑦ off.
- ▶ Unclip the retainer spring on the bulb socket and take out the bulb.
- ▶ Insert the new bulb so that its base locates in the recess on the lower left and is level to it.
- ▶ Clip on the retainer spring.
- ▶ Plug electrical connector ⑦ onto the bulb.
- ▶ Align housing cover ③ and turn it clockwise.

### High beam bulb/high beam flasher bulb (halogen headlamps)/high beam flasher bulb (Bi-Xenon\* headlamps)

- ▶ Turn bulb socket ① with the bulb counterclockwise and remove it.
- ▶ Pull electrical connector ⑤ off.

- ▶ Press gently onto the bulb and turn counterclockwise out of bulb socket ①.
- ▶ Press the new bulb gently into bulb socket ① and turn clockwise until it engages.
- ▶ Plug electrical connector ⑤ onto the bulb.
- ▶ Place bulb socket ① back into the lamp and turn it clockwise.

### Front turn signal lamp bulb

- ▶ Turn bulb socket ④ with the bulb counterclockwise and remove it.
- ▶ Press gently onto the bulb and turn counterclockwise out of bulb socket ④.
- ▶ Press the new bulb gently into bulb socket ④ and turn clockwise until it engages.
- ▶ Place bulb socket ④ back into the lamp and turn it clockwise.

## Practical hints

### Replacing bulbs

#### Parking and standing lamp bulb

- ▶ Pull out bulb socket ⑥ with the bulb.
- ▶ Press gently onto the bulb and turn counterclockwise out of bulb socket ⑥.
- ▶ Press the new bulb gently into bulb socket ⑥ and turn clockwise until it engages.
- ▶ Press bulb socket ⑥ back into the lamp.

## Practical hints

### Replacing bulbs

#### Side marker lamp bulb



- ▶ Carefully slide the lamp towards the front in direction of arrows.
- ▶ Remove the rear end first.
- ▶ Turn the bulb socket with the bulb counterclockwise and remove it.
- ▶ Pull the bulb out of the bulb socket.
- ▶ Insert the new bulb into the bulb socket.
- ▶ Place the bulb socket back into the lamp and turn it clockwise.
- ▶ To reinstall the lamp, set the front end in the bumper and let the rear end engage.

#### Replacing bulbs for rear lamps

##### Tail lamp unit

The tail lamps are equipped with HiP bulbs.

##### Warning!



The bulbs in the tail lamps cannot be replaced individually. The tail lamp bulbs are under pressure and could explode during an attempt to replace them.

If the tail lamps are malfunctioning, have them exchanged at an authorized Mercedes-Benz Center.

#### License plate lamp

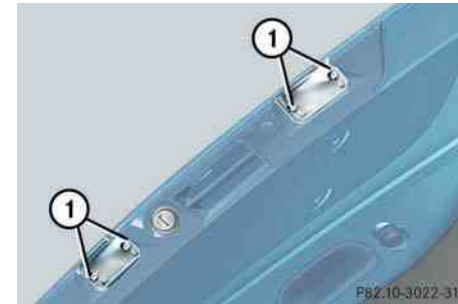

##### ① Screw

- ▶ Turn the exterior lamp switch to position **0** (▷ page 133).
- ▶ Loosen both screws ①.
- ▶ Remove the license plate lamp.
- ▶ Replace the bulb.
- ▶ Reinstall the license plate lamp.
- ▶ Retighten screws ①.



## ▼ Replacing wiper blades



The windshield wipers must be in a vertical position before folding them away from the windshield. They could otherwise damage the hood.



## Removing wiper blades

### Warning!



For safety reasons, switch off wipers and remove SmartKey from starter switch (vehicles with KEYLESS-GO\*: make sure the vehicle's on-board electronics have status 0) before replacing a wiper blade. Otherwise, the wiper motor could suddenly turn on and cause injury.

- ▶ Turn SmartKey in starter switch to position **1**.
- ▶ Turn combination switch to wiper setting **II** (▷ page 51).
- ▶ With wiper arm in the vertical position, turn SmartKey in starter switch to position **0**.
- ▶ Fold the wiper arm forward until it snaps into place.

## Practical hints

### Replacing wiper blades

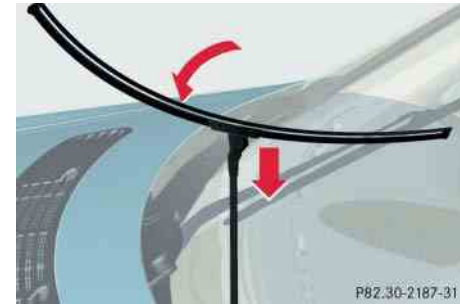

- ▶ Turn the wiper blade at a right angle to wiper arm.
- ▶ Slide the wiper blade sideways out of the retainer.

## Practical hints

### Replacing wiper blades

#### Installing wiper blades

- ▶ Slide wiper blade onto wiper arm until it locks in place.
- ▶ Rotate wiper blade into position parallel to wiper arm.
- ▶ Fold the wiper arm backward to rest on the windshield. Make sure you hold on to the wiper when folding the wiper arm back.



Never open the hood when the wiper arm is folded forward.

Hold on to the wiper when folding the wiper arm back. If released, the force of the impact from the tensioning spring could crack the windshield.

Do not allow the wiper arms to contact the windshield glass without a wiper blade inserted.

Make certain that the wiper blades are properly installed. Improperly installed wiper blades may cause windshield damage.

For your convenience, we recommend that you have this work carried out by an authorized Mercedes-Benz Center.

▼ Flat tire

**Warning!**



The dimensions of the Minispare wheel and the collapsible tire are different from those of the road wheels. As a result, the vehicle handling characteristics change when driving with a spare wheel mounted.

The spare wheel should only be used temporarily, and replaced with a regular road wheel as quickly as possible.

In the case of a flat tire, you may temporarily use the spare wheel when observing the following restrictions:

- Do not exceed a vehicle speed of 50 mph (80 km/h).
- Drive to the nearest tire repair facility to have the flat tire repaired or replaced as appropriate.
- Do not operate vehicle with more than one spare wheel mounted.

**Preparing the vehicle**

- ▶ Park the vehicle as far as possible from moving traffic on a hard surface.
- ▶ Turn on the hazard warning flashers.
- ▶ Engage the steering wheel lock in the straight-ahead position and set the parking brake.
- ▶ Move the selector lever to **P**.
- ▶ Have any passenger exit the vehicle at a safe distance from the roadway.

**Mounting the spare wheel**

**Preparing the vehicle**

Prepare the vehicle as described under “Preparing the vehicle” on this page.

- ▶ Take the spare wheel out of the trunk (▷ page 407).
- ▶ Take the wheel wrench and the jack out of the trunk (▷ page 407).

**Lifting the vehicle**

- ▶ Prevent the vehicle from rolling away by blocking wheels with wheel chocks (not included) or other sizable objects.

When changing wheel on a level surface:

- ▶ Place one chock in front of and one behind the wheel that is diagonally opposite to the wheel being changed.

## Practical hints

### Flat tire

When changing wheel on a hill:

- ▶ Place chocks on the downhill side blocking both wheels of the other axle.

#### Warning!



The jack is designed exclusively for jacking up the vehicle at the jack take-up brackets built into either side of the vehicle. To help avoid personal injury, use the jack only to lift the vehicle during a wheel change. Never get beneath the vehicle while it is supported by the jack. Keep hands and feet away from the area under the lifted vehicle. Always firmly set parking brake and block wheels before raising vehicle with jack.

Do not disengage parking brake while the vehicle is raised. Be certain that the jack is

always vertical (plumb line) when in use, especially on hills. Always try to use the jack on level surface. Be sure that the jack arm is fully seated in the jack take-up bracket. Always lower the vehicle onto sufficient capacity jackstands before working under the vehicle.



- ▶ On wheel to be changed, loosen but do not yet remove the wheel bolts (approximately one full turn with wrench).

The jack take-up brackets are located directly behind the front wheel housing and in front of the rear wheel housing.

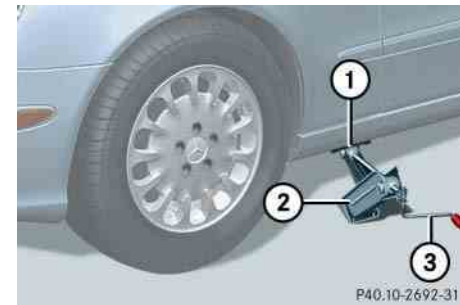

- ① Jack take-up bracket
- ② Jack
- ③ Crank

- ▶ Position jack ② on firm ground under the respective jack take-up bracket ①.

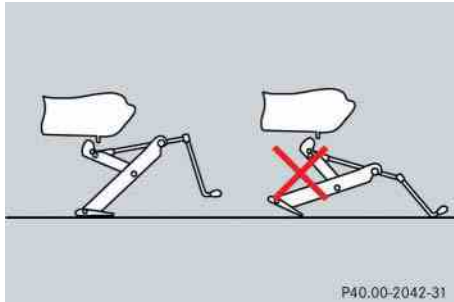

Make sure the foot of the jack is directly under the take-up bracket so that it is always vertical (plumb-line) as seen from the side, even if the vehicle is parked on an incline

- ▶ Turn crank ③ until the tire is a maximum of 1.2 in (3 cm) off the ground. Never start engine while vehicle is raised.

### Warning!



Position the jack only on the jack take-up brackets designed for this purpose. If the jack is not properly positioned, the vehicle may slip off of the jack.

### Warning!



The jack is intended only for lifting the vehicle briefly for wheel changes. It is not suited for performing maintenance work under the vehicle. Never lie down under the raised vehicle. Do not start the engine when the vehicle is raised.

## Practical hints

### Flat tire

#### Removing the wheel



#### ① Alignment bolt

- ▶ Unscrew the upper-most wheel bolt and remove.
- ▶ Replace this wheel bolt with alignment bolt ① supplied in the tool kit.
- ▶ Remove the remaining bolts.



Do not place wheel bolts in sand or dirt. This could result in damage to the bolt and wheel hub threads.

- ▶ Remove the wheel.

## Practical hints

### Flat tire

#### Mounting the spare wheel

##### Warning!



Vehicles with collapsible tire:

Inflate collapsible tire only after the wheel is properly mounted.

Inflate the collapsible tire using the electric pump (▷ page 429) before lowering the vehicle.

- ▶ Clean contact surfaces of wheel and wheel hub.
- ▶ Guide the spare wheel onto the alignment bolt and push it on.
- ▶ Insert wheel bolts and tighten them slightly.



To avoid paint damage, place wheel flat against hub and hold it there while installing first wheel bolt.

##### Warning!



Always replace wheel bolts that are damaged or rusted.

Never apply oil or grease to wheel bolts.

Damaged wheel hub threads should be repaired immediately. Do not continue to drive under these circumstances! Contact an authorized Mercedes-Benz Center or call Roadside Assistance.

Incorrect wheel bolts or improperly tightened wheel bolts can cause the wheel to come off. This could cause an accident. Be sure to use the correct wheel bolts.

##### Warning!



Use only genuine equipment Mercedes-Benz wheel bolts. They are identified by the Mercedes star. Other wheel bolts may come loose.

Do not tighten the wheel bolts when the vehicle is raised. Otherwise the vehicle could tip over.



- ▶ Unscrew the alignment bolt, install last wheel bolt and tighten slightly.

### Warning!



The dimensions of the Minispare wheel and the collapsible tire are different from those of the road wheels. As a result, the vehicle handling characteristics change when driving with a Minispare wheel mounted.

The spare wheel should only be used temporarily, and replaced with a regular road wheel as quickly as possible.

In the case of a flat tire, you may temporarily use the Minispare wheel when observing the following restrictions:

- Do not exceed a vehicle speed of 50 mph (80 km/h).
- Drive to the nearest tire repair facility to have the flat tire repaired or replaced as appropriate.
- Do not operate vehicle with more than one spare wheel mounted.

### Inflating the collapsible tire



Do not lower the vehicle before inflating the collapsible tire. Otherwise the rim may be damaged.

- ▶ Take the electric air pump out of the trunk (▷ page 407).

### Warning!



Observe instructions on air pump label.

## Practical hints

### Flat tire

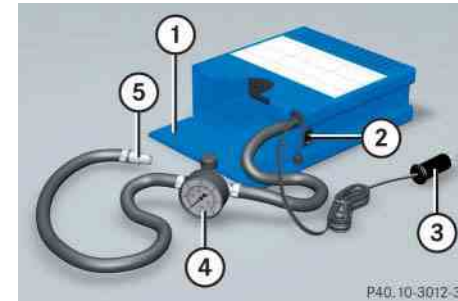

P40.10.3012-31

- ① Flap
  - ② Air pump switch
  - ③ Electrical plug
  - ④ Air hose with pressure gauge and vent screw
  - ⑤ Union nut
- ▶ Open flap ① on the air pump.
  - ▶ Pull out electrical plug ③ and air hose with pressure gauge ④.
  - ▶ Make sure the vent screw on air hose is closed.
  - ▶ Remove the valve cap from the tire valve.



## Practical hints

### Flat tire

- ▷▷ Screw air hose ④ onto the tire valve.
  - ▶ Insert electrical plug ③ into vehicle cigar lighter socket.
  - ▶ Turn the SmartKey in the ignition to position 1.  
or
  - ▶ Press the KEYLESS-GO\* start/stop button on the gear selector lever once without depressing the brake pedal.
  - ▶ Press I on electric air pump switch ②.  
The electric air pump should now switch on and inflate the tire.
  - ▶ Inflate the tire to approx. 51 psi (3.5 bar).  
This takes about five minutes for the collapsible tire. Air hose ④ and union nut ⑤ can become hot duration inflation. Exercise proper caution to avoid burning yourself when using the equipment.



- Do not operate the air pump longer than eight minutes without interruption. Otherwise it may overheat.  
You may operate the air pump again after it has cooled off.
- ▶ Press 0 on electric air pump switch ②.
  - ▶ Turn the SmartKey in the ignition to position 0.  
or
  - ▶ Press KEYLESS-GO\* start/stop button on the gear selector lever twice without depressing the brake pedal.  
The electric air pump should now be switched off.
  - ▶ If the tire inflation pressure is above 51 psi (3.5 bar), release excess tire inflation pressure using the vent screw.

### Warning!



- Follow recommend inflation pressures.
- Do not overinflate tires. Overinflating tires can result in sudden deflation (blowout) because they are more likely to become punctured or damaged by road debris, potholes, etc.
- Do not underinflate tires. Underinflated tires wear unevenly, adversely affect handling and fuel economy, and are more likely to fail from being overheated.
- ▶ Detach the electric air pump.
  - ▶ Stow electrical plug ③ and air hose ④ behind flap ① and place the air pump back in the trunk.



## Practical hints

### Flat tire

#### Lowering the vehicle

- ▶ Lower vehicle by turning crank counterclockwise until vehicle is resting fully on its own weight.
- ▶ Remove the jack.

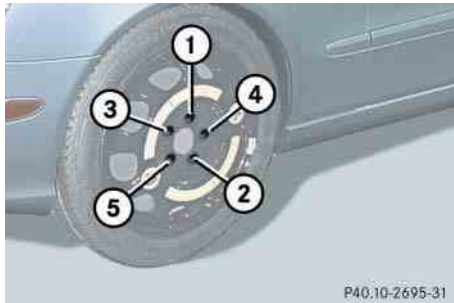

① - ⑤ Wheel bolts

- ▶ Tighten the five wheel bolts evenly, following the diagonal sequence illustrated (① to ⑤), until all bolts are tight. Observe a tightening torque of 96 lb-ft (130 Nm).

#### Warning!



Have the tightening torque checked after changing a wheel. The wheels could come loose if they are not tightened to a torque of 96 lb-ft (130 Nm).

- ▶ Before storing the jack in the trunk, it should be fully collapsed.





Wrap the damaged wheel in the protective film that comes with the spare wheel and put the wheel in the trunk.

You can also place the damaged wheel down into the spare wheel well. In this case, you must stow the holder from the spare wheel well in the trunk.

Do not activate the tire pressure monitoring system until the depressurized tire is no longer in the vehicle.

## Practical hints

### Bleeding the fuel system (Diesel engine only)

Allowing the vehicle to be driven until the fuel tank is empty is not recommended. If this occurs, air may be pulled into the fuel system. If this happens, the  malfunction indicator lamp (USA only) or the  malfunction indicator lamp (Canada only) comes and it may be possible that the engine will not start immediately after you refuel the vehicle.

After refueling:



- ▶ Turn the SmartKey in the starter switch to position **2** for at least 30 seconds.
- ▶ Return the SmartKey in the starter switch to position **0**.
- ▶ Turn the SmartKey in the starter switch to position **3** and hold it there for up to 60 seconds, i.e. until the engine is running surge-free.

If the engine does not start:

- ▶ Try to start the engine again without interruption for a maximum of 60 seconds until it is running smoothly.

If the engine still does not start even after this attempt, do not make any further attempts to start the engine. Contact an authorized Mercedes-Benz Center.



Where the  malfunction indicator lamp (USA only) or the  malfunction indicator lamp (Canada only) in the instrument cluster has been illuminated for the above condition, it will remain illuminated until the engine was cycled on and off four times in a row.

## ▼ Batteries

Your vehicle is equipped with two batteries:

- Main battery (battery for starter and electrical consumers; located in the trunk).
- Auxiliary battery (back-up battery; stabilizes the electrical system if the main battery is discharged; located in the engine compartment)

The main battery is in the trunk under the luggage box. Remove the luggage box (> page 408).



### Vehicles with spare wheel

- ① Negative terminal
- ② Positive terminal

### Warning!



Jump starting must only be done using the main battery in the trunk.

## Practical hints

### Batteries

### Warning!



Failure to follow these instructions can result in severe injury or death.

Observe all safety instructions and precautions when handling automotive batteries (> page 309).

Never lean over batteries while connecting, you might get injured.

Battery fluid contains sulfuric acid. Do not allow this fluid to come in contact with eyes, skin or clothing. In case it does, immediately flush affected area with water and seek medical help if necessary.

A battery will also produce hydrogen gas, which is flammable and explosive. Keep flames or sparks away from battery, avoid improper connection of jumper cables, smoking etc.

## Practical hints

### Batteries



Never loosen or detach battery terminal clamps while the engine is running or the SmartKey is in the starter switch. Otherwise the alternator and other electronic components could be severely damaged.

Have the battery checked regularly by an authorized Mercedes-Benz Center.

Refer to Maintenance Booklet for maintenance intervals or contact your authorized Mercedes-Benz Center for further information.

#### Warning!



Do not place metal objects on the battery as this could result in a short circuit.

Use leak-proof battery only to avoid the risk of acid burns in the event of an accident.

#### Warning!



The SBC brake system requires electrical power to operate.

A malfunction in the vehicle's power supply or electrical system may impair brake system operation and switch it into its emergency operation mode. The same applies if battery is disconnected. To brake, the driver must then apply significantly greater brake pedal pressure and depress the pedal much further to obtain the expected braking effect. If necessary, apply full pressure to the brake pedal. Brakes may only be applied to the front wheels. Stopping distance is increased! Adjust your driving style accordingly. For more information, refer to "SBC brake system" (> page 90).

### Disconnecting the battery

#### Warning!



With a disconnected battery

- you will no longer be able to turn the SmartKey in the starter switch and pressing the KEYLESS-GO\* start/stop button on the gear selector lever will have no effect
- the gear selector lever will remain locked in position **P**

- ▶ Depress parking brake firmly or move gear selector lever to position **P**.
  - ▶ Turn off all electrical consumers.
  - ▶ Remove SmartKey from starter switch.
- Vehicles with KEYLESS-GO\*:
- ▶ Press the start/stop button until the engine shuts off.
  - ▶ Open the driver's door.
  - ▶ Open the trunk.

- ▶ Remove the luggage box (▷ page 408).
- ▶ Disconnect battery negative lead ①.
- ▶ Remove cover ② from the positive terminal.
- ▶ Disconnect the battery positive lead.
- ▶ Charge battery in accordance with the instructions of the battery charger manufacturer.
- ▶ Reinstall the charged battery. Follow the previously described steps in reverse order.

#### Removing the battery

- ▶ Remove the screw-nuts securing the battery.
- ▶ Remove the battery bracket.
- ▶ Take out the battery.

#### Charging and reinstalling the battery

##### Warning!



Never charge a battery while still installed in the vehicle. Gases may escape during charging and cause explosions that may result in paint damage, corrosion or personal injury.

#### Reconnecting the battery

- ▶ Turn off all electrical consumers.
- ▶ Connect the positive lead and fasten its cover.
- ▶ Connect the negative lead.



Never invert the terminal connections!

- ▶ Install the luggage box (▷ page 408).



The battery, its filler caps and the vent tube must always be securely installed when the vehicle is in operation.

## Practical hints

### Batteries



The following procedures must be carried out following any interruption of battery power (e.g. due to reconnection):

- Set the clock (▷ page 159) (see COMAND operator's manual).
- Resynchronize the ESP (▷ page 372).
- Resynchronize the side windows (▷ page 220).
- Resynchronize the tilt/sliding sunroof\* (▷ page 225) or the tilt/sliding panel\* (▷ page 229).

Batteries contain materials that can harm the environment if disposed of improperly. Large 12 volt storage batteries contain lead. Recycling of batteries is the preferred method of disposal. Many states require sellers of batteries to accept old batteries for recycling.

## Practical hints

### Jump starting

#### Warning!



Failure to follow these directions will cause damage to the electronic components, and can lead to a battery explosion and severe injury or death.

Never lean over batteries while connecting or jump starting, you might get injured.

Battery fluid contains sulfuric acid. Do not allow this fluid to come in contact with eyes, skin or clothing. In case it does, immediately flush affected area with water, and seek medical help if necessary.

A battery will also produce hydrogen gas, which is flammable and very explosive. Keep flames or sparks away from battery, avoid improper connection of jumper cables, smoking, etc.

Attempting to jump start a frozen battery can result in it exploding, causing personal injury.

Read all instructions before proceeding.

If the battery is discharged, the engine can be started with jumper cables and the battery of another vehicle. Observe the following:

- Jump starting should only be performed when the engine and catalytic converter<sup>1</sup> are cold.
- Do not start the engine if the battery is frozen. Let the battery thaw out first.
- Only jump start from batteries with the same voltage rating (12 V). Jump starting with a more powerful battery could damage the vehicle's electrical system, which will not be covered by the Mercedes-Benz Limited Warranty.
- Use only jumper cables with sufficient cross-section and insulated terminal clamps.
- Always make sure the jumper cables are not on or near pulleys, fans or other parts that move when the engine is started or running.



Jump starting may only be performed on the main battery installed in the trunk.

Avoid repeated and lengthy starting attempts.

Do not attempt to start the engine using a battery quick charge unit.

If the engine does not run after several unsuccessful starting attempts, have it checked at the nearest authorized Mercedes-Benz Center.

Excessive unburned fuel generated by repeated failed starting attempts may damage the catalytic converter<sup>1</sup>.

Make sure the jumper cables do not have loose or missing insulation.

Make sure the cable clamps do not touch any other metal part while the other end is still attached to a battery.

<sup>1</sup> Vehicles with gasoline engine only

### Warning!



Keep flames or sparks away from battery.  
Do not smoke.

Observe all safety instructions and precautions when handling automotive batteries (▷ page 309).

The battery is located in the trunk underneath the luggage box (▷ page 408). Only jump start the vehicle from the battery in the trunk.

- ▶ Make sure the two vehicles do not touch.
- ▶ Turn off all electrical consumers.
- ▶ Apply parking brake.
- ▶ Shift gear selector lever to position **P**.
- ▶ Connect positive terminals ① and ③ of the batteries with the jumper cable. Clamp cable to charged battery ③ first.



Never invert the terminal connections!

## Practical hints

### Jump starting

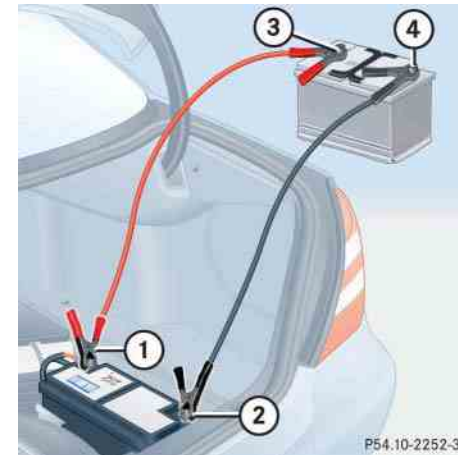

- ① Positive terminal of discharged battery
- ② Negative terminal of discharged battery
- ③ Positive terminal of charged battery
- ④ Negative terminal of charged battery

## Practical hints

### Jump starting

- ▶ Start engine of the vehicle with the charged battery and run at idle speed.
- ▶ Connect negative terminals ④ and ② of the batteries with the jumper cable. Clamp cable to charged battery ④ first.
- ▶ Start the engine of the disabled vehicle.



The message Malfunction - electric consumers switched off may appear in the instrument cluster. It will disappear as soon as the battery is sufficiently charged.

Now you can again turn on the electrical consumers. Do not turn on the lights under any circumstances.

- ▶ Remove the jumper cables first from negative terminals ② and ④ and then from positive terminals ① and ③.

Now you can turn on the lights.

- ▶ Have the battery checked at the nearest authorized Mercedes-Benz Center.



Do not tow-start the vehicle.



## ▼ Towing the vehicle

Mercedes-Benz recommends that the vehicle be transported with all wheels off the ground using flatbed or appropriate wheel lift/dolly equipment. This method is preferable to other types of towing.



Use flatbed or wheel lift/dolly equipment with SmartKey in starter switch turned to position **0**.

Do not tow with sling-type equipment. Towing with sling-type equipment over bumpy roads will damage radiator and supports.

To prevent damage during transport, do not tie down vehicle by its chassis or suspension parts.

Switch off the tow-away alarm and the automatic central locking

Do not tow-start the vehicle.

When circumstances do not permit the recommended towing methods, the vehicle may be towed with all wheels on the ground or front wheels raised (except vehicles with 4MATIC) only so far as necessary to have the vehicle moved to a safe location where the recommended towing methods can be employed.



Vehicles with 4MATIC:  
Do not tow with one axle raised. Doing so could damage the transfer case, which is not covered by the Mercedes-Benz Limited Warranty.

All wheels must be on or off the ground. Observe instructions for towing the vehicle with all wheels on the ground.

## Practical hints

### Towing the vehicle



If the vehicle is towed with the front axle raised (not permissible for vehicles with 4MATIC), the engine must be shut off (SmartKey in starter switch position **0** or **1**). Otherwise the ESP will immediately be engaged and will apply the rear wheel brakes.

When towing the vehicle with all wheels on the ground, the selector lever must be in position **N** and the SmartKey must be in starter switch position **2**.

When towing the vehicle with all wheels on the ground or the front axle raised, the vehicle may be towed only for distances up to 30 miles (50 km) and at a speed not to exceed 30 mph (50 km/h).

## Practical hints

### Towing the vehicle



To be certain to avoid a possibility of damage to the drive train, however, we recommend the drive shaft be disconnected at the rear axle drive flange (vehicles with 4MATIC: disconnected at the front and rear axle drive flanges) for any towing beyond a short tow to a nearby garage.

#### Warning!



If circumstances require towing the vehicle with all wheels on the ground, always tow with a tow bar if:

- the engine will not run
- there is a malfunction in the SBC brake system
- there is a malfunction in the power supply or in the vehicle's electrical system

as that will be necessary to adequately control the towed vehicle.

Prior to towing the vehicle with all wheels on the ground, make certain that the SmartKey is in starter switch position **2**.

If the SmartKey is left in the starter switch position **0** for an extended period of time, it can no longer be turned in the switch. In this case, the steering is locked. To unlock, remove SmartKey from starter switch and reinsert.

#### Warning!



The brake system requires electrical power to operate.

A malfunction in the vehicle's power supply or electrical system may impair brake system operation and switch it into its emergency operation mode. To brake, the driver must then apply significantly greater brake pedal pressure and depress the pedal much further to obtain the expected braking effect. If necessary, apply full pressure to the brake pedal. Brakes may only be applied to the front wheels. Stopping distance is increased! Adapt your driving style accordingly. For more information, refer to "SBC brake system" (▷ page 90).

With the engine not running, there is no power assistance for the steering system. In this case, it is important to keep in mind that a considerably higher degree of effort is necessary to steer the vehicle. Adapt your driving accordingly.



To signal turns while being towed with the hazard warning flasher in use, turn SmartKey in starter switch to position **2** and activate the combination switch for the left or right turn signal in the usual manner – only the selected turn signal will operate.

Upon canceling the turn signal, the hazard warning flasher will operate again.



When towing the vehicle with all wheels on the ground, please note the following:

With the automatic central locking activated and the SmartKey in starter switch position **2**, or KEYLESS-GO\* start/stop button in position **2**, the vehicle doors lock if the left front wheel as well as the right rear wheel are turning at vehicle speeds of approximately 9 mph (15 km/h) or more.

Switch off the tow-away alarm (▷ page 95).

To prevent the vehicle door locks from locking, deactivate the automatic central locking (▷ page 118).

Towing of the vehicle should only be done using the properly installed towing eye bolt. Never attach tow cable, tow rope or tow rod to the vehicle chassis, frame or suspension parts.

## Practical hints

### Towing the vehicle



The selector lever will remain locked in position **P** and the SmartKey will not turn in the starter switch if the battery is disconnected or discharged. For more information see “Battery” (▷ page 433) or “Jump starting” (▷ page 436).

Manual unlocking of the transmission selector lever (▷ page 412).

## Practical hints

### Towing the vehicle

#### Installing towing eye bolt

##### Front of vehicle

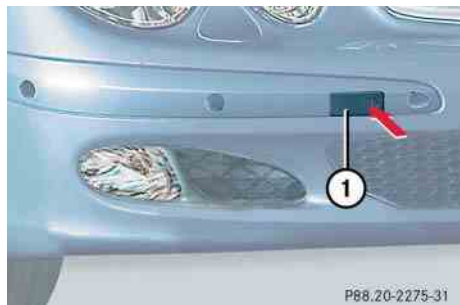

① Cover on right side of front bumper

To remove cover:

- ▶ Press mark on cover in direction of arrow.
- ▶ Lift cover off to reveal threaded hole for towing eye bolt.

The towing eye bolt is supplied with the tool kit (located in the storage compartment under the trunk floor).

- ▶ Screw towing eye bolt in to its stop and tighten with lug wrench.

To reinstall cover:

- ▶ Fit cover and snap into place.

##### Rear of vehicle

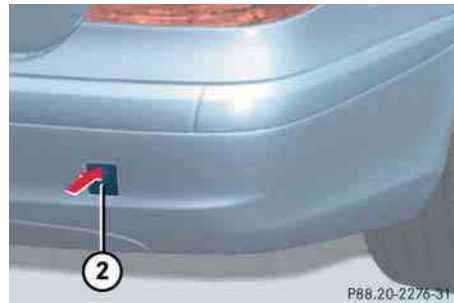

② Cover on right side of rear bumper

To remove cover:

- ▶ Pull cover in the direction of the arrow.
- ▶ Fold cover down to reveal threaded hole for the towing eye bolt.

The towing eye bolt is supplied with the tool kit (located in the storage compartment under the trunk floor).

- ▶ Screw towing eye bolt in to its stop and tighten with lug wrench.

To reinstall cover:

- ▶ Fit cover and snap into place.

▼ Fuses



Only install fuses that have been tested and approved by Mercedes-Benz and that have the specified amperage rating.

Never attempt to repair or bridge a blown fuse. Have the cause determined and remedied by an authorized Mercedes-Benz Center.

Fuse box in passenger compartment

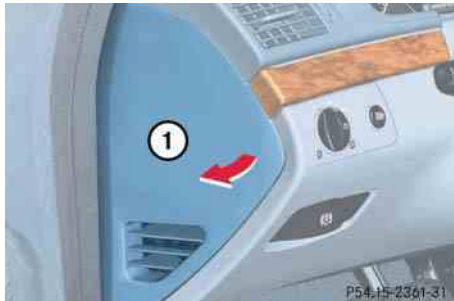

① Cover

Opening

- ▶ Pull cover ① open with a screwdriver or similar tool.
- ▶ Remove cover ① rearward.

Closing

- ▶ Attach cover ① in the front.
- ▶ Fold cover ① in until it engages.

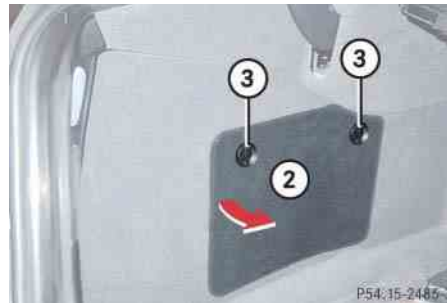

② Cover  
③ Catches

- ▶ Turn catches ③ counter-clockwise and remove cover ②.

Fuse chart

The fuse chart is found in the fuse box in the passenger compartment. The amperages of the fuses are also given there.

Spare fuses

Spare fuses are found in the vehicle tool kit in the trunk.

Fuse extractor

The fuse extractor is found in the vehicle tool kit in the trunk.



Only install fuses that have been tested and approved by Mercedes-Benz and that have the specified amperage rating.

Never attempt to repair or bridge a blown fuse. Have the cause determined and remedied by an authorized Mercedes-Benz Center.



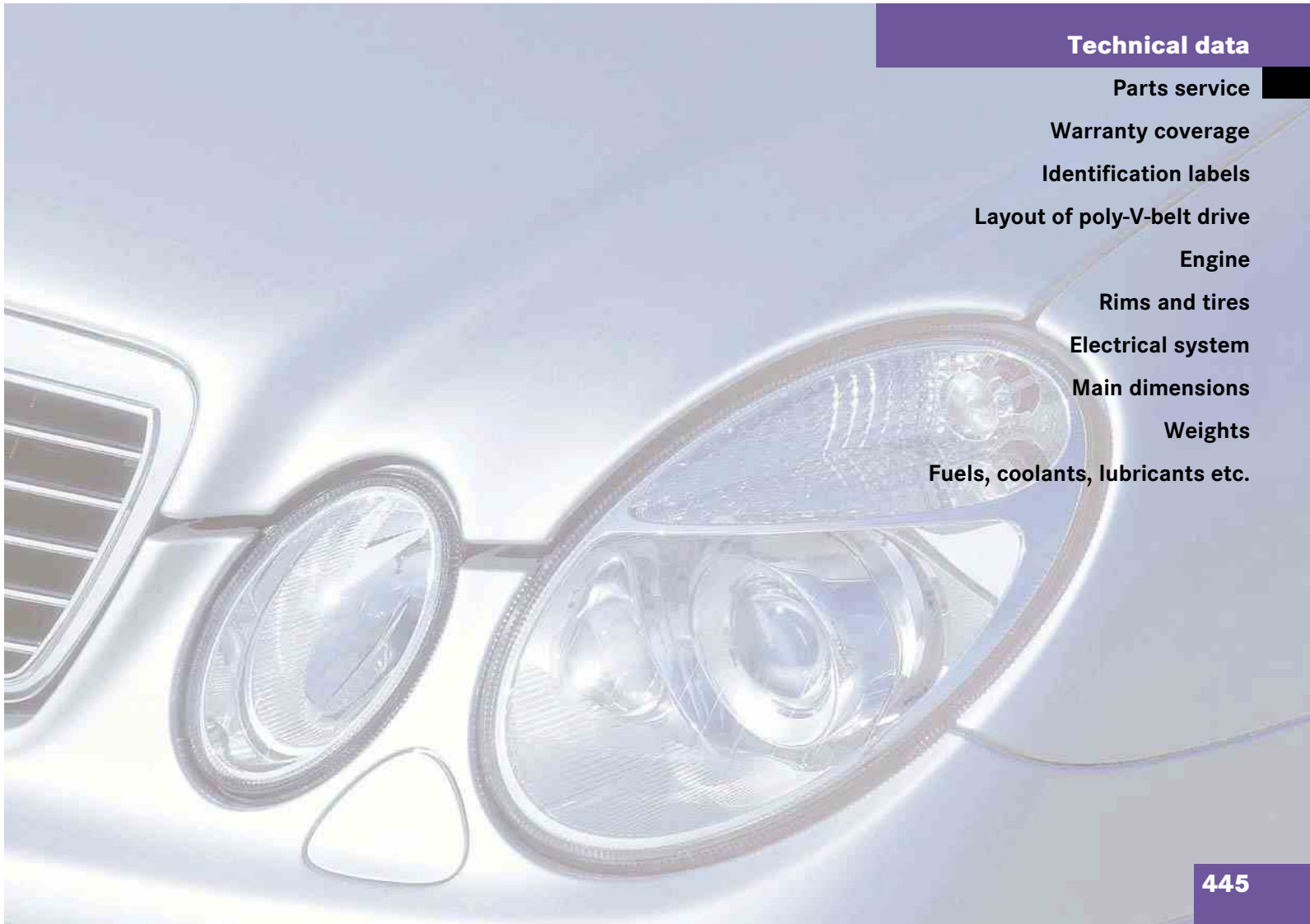

**Technical data**

**Parts service**

**Warranty coverage**

**Identification labels**

**Layout of poly-V-belt drive**

**Engine**

**Rims and tires**

**Electrical system**

**Main dimensions**

**Weights**

**Fuels, coolants, lubricants etc.**

## Technical data

### Parts service

The “Technical data” section provides the necessary technical data for your vehicle.

All authorized Mercedes-Benz Centers maintain a stock of genuine Mercedes-Benz parts required for maintenance and repair work. In addition, strategically located parts distribution centers provide quick and reliable parts service.

More than 300 000 different parts for Mercedes-Benz models are available.

Genuine Mercedes-Benz parts are subjected to stringent quality inspections. Each part has been specifically developed, manufactured or selected for and adapted to Mercedes-Benz vehicles.

Therefore, genuine Mercedes-Benz parts should be installed.



The use of non-genuine Mercedes-Benz parts and accessories not authorized by Mercedes-Benz could damage the vehicle, which is not covered by the Mercedes-Benz Limited Warranty, or could compromise the vehicle’s durability or safety.



▼ **Warranty coverage**

Your vehicle is covered under the terms of the warranties printed in the Service and Warranty Information Booklet. Your authorized Mercedes-Benz Center will exchange or repair any defective parts originally installed in the vehicle in accordance with the terms of the following warranties:

- New Car Limited Warranty
- Emission System Warranty
- Emission Performance Warranty
- California, Maine, Massachusetts, and Vermont Emission Control System Warranty<sup>1</sup>

Replacement parts and accessories are covered by the Mercedes-Benz Parts and Accessories Warranties, copies of which are available at any authorized Mercedes-Benz Center.

**Loss of Service and Warranty Information Booklet**

---

Should you lose your Service and Warranty Information Booklet, have your authorized Mercedes-Benz Center arrange for a replacement. It will be mailed to you.

<sup>1</sup> Applicable to vehicles with gasoline engines only.

## Technical data

### Identification labels



① Certification label (includes Paintwork code)



② Vehicle Identification Number (VIN)

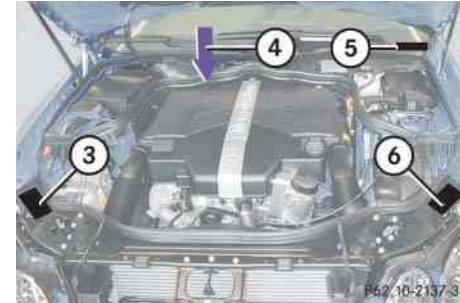

- ③ Vacuum line routing diagram label
- ④ Engine number (engraved on engine)
- ⑤ Vehicle Identification Number (VIN) (lower edge of windshield)
- ⑥ Gasoline engine: Emission control information label, includes both federal and California certification exhaust emission standards  
Diesel engine: Emission control information label

#### **i**

When ordering parts, please specify vehicle identification and engine numbers.

▼ Layout of poly-V-belt drive

E 320/E 500

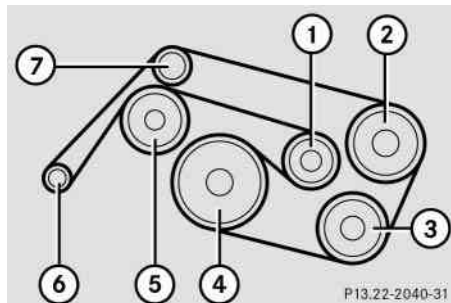

- ① Automatic belt tensioner
- ② Power steering pump
- ③ Air conditioning compressor
- ④ Crankshaft
- ⑤ Coolant pump
- ⑥ Generator (alternator)
- ⑦ Idler pulley

E 55 AMG

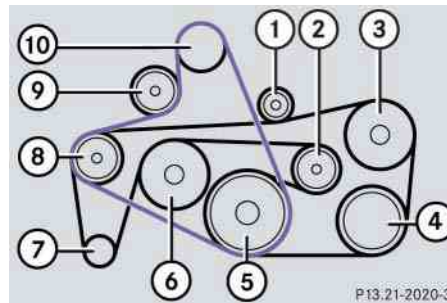

The E 55 AMG has two poly-V-belts (belt one shown in purple/belt two shown in black).

- ① Idler pulley
- ② Automatic belt tensioner
- ③ Power steering pump
- ④ Air conditioning compressor
- ⑤ Crankshaft
- ⑥ Coolant pump
- ⑦ Generator (alternator)
- ⑧ Idler pulley
- ⑨ Automatic belt tensioner
- ⑩ Super charger

E 320 CDI

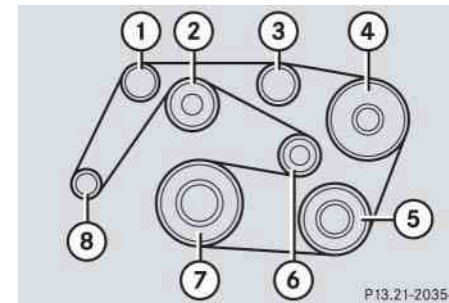

- ① Idler pulley
- ② Coolant pump
- ③ Idler pulley
- ④ Power steering pump
- ⑤ Air conditioning compressor
- ⑥ Automatic belt tensioner
- ⑦ Crankshaft
- ⑧ Generator (alternator)

## Technical data

### Engine

Model	E 320 (211.065 <sup>1</sup> ) E 320 4MATIC (211.082 <sup>1</sup> )	E 500 (211.070 <sup>1</sup> ) E 500 4MATIC (211.083 <sup>1</sup> )
Engine	112	113
Mode of operation	4-stroke engine, gasoline injection	4-stroke engine, gasoline injection
No. of cylinders	6	8
Bore	3.54 in (89.90 mm)	3.82 in (97.00 mm)
Stroke	3.31 in (84.00 mm)	3.31 in (84.00 mm)
Total piston displacement	195.2 cu in (3 199 cm <sup>3</sup> )	303.0 cu in (4 966 cm <sup>3</sup> )
Compression ratio	10:1	10:1
Output acc. to SAE J 1349	221 hp/5 600 rpm <sup>2</sup> (165 kW/5 600 rpm)	302 hp/5 600 rpm <sup>2</sup> (225 kW/5 600 rpm)
Maximum torque acc. to SAE J 1349	232 lb-ft/3000 rpm - 4 800 rpm (315 Nm/3000 rpm - 4 800 rpm)	339 lb-ft/2700 rpm - 4 250 rpm (460 Nm/2700 rpm - 4 250 rpm)
Maximum engine speed	6 000 rpm	6 000 rpm
Firing order	1-4-3-6-2-5	1-5-4-2-6-3-7-8
Poly-V-belt	2 390 mm	2 390 mm

<sup>1</sup> The quoted data apply only to the standard vehicle. See an authorized Mercedes-Benz Center for the corresponding data of all special bodies and special equipment.

<sup>2</sup> Premium fuel required. Performance may vary with fuel octane rating.

## Technical data

### Engine

<b>Model</b>	<b>E 55 AMG (211.076<sup>1</sup>)</b>
<b>Engine</b>	113
<b>Mode of operation</b>	4-stroke engine, gasoline injection
<b>No. of cylinders</b>	8
<b>Bore</b>	3.82 in (97.00 mm)
<b>Stroke</b>	3.60 in (92.00 mm)
<b>Total piston displacement</b>	331.8 cu in (5439 cm <sup>3</sup> )
<b>Compression ratio</b>	9:1
<b>Output acc. to SAE J 1349</b>	469 hp/6 100 rpm <sup>2</sup> (350 kW/6 100 rpm)
<b>Maximum torque acc. to SAE J 1349</b>	516 lb-ft/2 650 rpm (700 Nm/2 650 rpm - 4 500 rpm)
<b>Maximum engine speed</b>	6 500 rpm
<b>Firing order</b>	1-5-4-2-6-3-7-8
<b>Poly-V-belts</b>	Belt one: 1 289 mm Belt two: 2 449 mm

<sup>1</sup> The quoted data apply only to the standard vehicle. See an authorized Mercedes-Benz Center for the corresponding data of all special bodies and special equipment.

<sup>2</sup> Premium fuel required. Performance may vary with fuel octane rating.

## Technical data

### Engine

<b>Model</b>	<b>E 320 CDI (211.026<sup>1</sup>)</b>
<b>Engine</b>	OM 648
<b>Mode of operation</b>	Diesel 4-stroke
<b>No. of cylinders</b>	6
<b>Bore</b>	3.46 in (88.00 mm)
<b>Stroke</b>	3.48 in (88.30 mm)
<b>Total piston displacement</b>	196.6 cu in (3222 cm <sup>3</sup> )
<b>Compression ratio</b>	18:1
<b>Output acc. to SAE J 1349</b>	201 hp/4200 rpm (150 kW/4200 rpm)
<b>Maximum torque acc. to SAE J 1349</b>	369 lb-ft/1800 rpm - 2600 rpm (500 Nm/1800 rpm - 2600 rpm)
<b>Maximum engine speed</b>	4600 rpm
<b>Firing order</b>	1-5-3-6-2-4
<b>Poly-V-belt</b>	2260 mm

<sup>1</sup> The quoted data apply only to the standard vehicle. See an authorized Mercedes-Benz Center for the corresponding data of all special bodies and special equipment.

#### ▼ Rims and tires

Only use tires and rims which have been specifically developed for your vehicle and tested and approved by Mercedes-Benz. Other tires and rims can have detrimental effects, such as:

- Poor handling characteristics
- Increased noise
- Increased fuel consumption



Moreover, tires and rims not approved by Mercedes-Benz may, under load, exhibit dimensional variations and different tire deformation characteristics that could cause them to come into contact with the vehicle body or axle parts. This may result in damage to the tires or the vehicle.



Further information on tires and rims is available at any authorized Mercedes-Benz Center. A placard with the recommended tire inflation pressures is located on the driver's door B-pillar. Some vehicles may have supplemental tire pressure information for driving at high speeds (▷ page 321) or for vehicle loads less than the maximum loaded vehicle condition. If such information is provided, it can be found on the placard located on the inside of the fuel filler flap. The tire pressure should be checked regularly and should only be adjusted on cold tires. Follow tire manufacturer's maintenance recommendation included with vehicle.

## Technical data

### Rims and tires

#### Same size tires

##### 16" tires

	<b>E320 CDI E320, E320 4MATIC</b>
<b>Rims (light alloy)</b>	8 J x 16 H2
<b>Wheel offset</b>	1.4 in (36 mm)
<b>Summer tires (radial-ply tires)</b>	-
<b>All-season tires (radial-ply tires)</b>	225/55 R16 95H M+S
<b>Winter tires (radial-ply tires)</b>	-

##### 17" tires

	<b>E 320 E 500 (Appearance Package*)</b>	<b>E 500, E 500 4MATIC</b>	<b>E 320 4MATIC E 500 4MATIC (Appearance Package*)</b>
<b>Rims (light alloy)</b>	8 J x 17 H2	8 J x 17 H2	8 J x 17 H2
<b>Wheel offset</b>	1.5 in (38 mm)	1.5 in (38 mm)	1.5 in (38 mm)
<b>Summer tires (radial-ply tires)</b>	245/45 R17 95H	-	-
<b>All-season tires (radial-ply tires)</b>	-	245/45 R17 95H M+S	245/45 R17 95H M+S
<b>Winter tires (radial-ply tires)</b>	245/45 R17 95H M+S	245/45 R17 95H M+S	245/45 R17 95H M+S



## Technical data

### Rims and tires

#### 18" tires

	<b>E 55 AMG</b>	<b>E 320 4MATIC (Sport Package*) E 500 4MATIC (Sport Package*)</b>
<b>AMG light alloy rims</b>	8 J x 18 EH2	8 J x 18 EH2
<b>Wheel offset</b>	1.18 in (30 mm)	1.18 in (30 mm)
<b>Summer tires (radial-ply tires)</b>	-	245/40 R18 97Y XL or Extra Load
<b>All-season tires (radial-ply tires)</b>	-	-
<b>Winter tires (radial-ply tires)</b>	245/40 R18 93H M+S or 245/40 R18 97V XL or Extra Load M+S	-

## Technical data

### Rims and tires

#### Mixed size tires

		<b>E 55 AMG E 320 (Sport Package*) E 500 (Sport Package*)</b>
<b>Front axle:</b>	<b>AMG light alloy rims</b>	8 J x 18 EH2
	<b>Wheel offset</b>	1.18 in (30 mm)
	<b>Summer tires (radial-ply tires)</b>	245/40 ZR18
<b>Rear axle:</b>	<b>AMG light alloy rims</b>	9 J x 18 EH2
	<b>Wheel offset</b>	1.54 in (39 mm)
	<b>Summer tires (radial-ply tires)</b>	265/35 ZR18 XL or Extra Load M0 <sup>1</sup>

<sup>1</sup> Must not be used with snow chains

## Technical data

### Rims and tires

#### Spare wheel



Please note that the tire inflation pressure of the Minispare and the collapsible tire differs from the tire inflation pressure of the road tires.

Make sure the Minispare wheel is inflated to approx. 61 psi (4.2 bar).

Inflate the collapsible tire (▷ page 429) to approximately 51 psi (3.5 bar).

#### Minispare wheel (except E 55 AMG)

<b>Rim</b>	4 B x 17
<b>Wheel offset</b>	1.34 (34 mm)
<b>Tire</b>	T 155/70 R17 110 M <sup>1</sup>

<sup>1</sup> Must not be used with snow chains.

#### Collapsible tire (E 55 AMG only)

<b>Rim</b>	6 B x 18
<b>Wheel offset</b>	0.98 (25 mm)
<b>Tire</b>	175/55-18 95P <sup>1</sup>

<sup>1</sup> Must not be used with snow chains.

## Technical data

### Electrical system

Model	E 320, E 320 4MATIC	E 500, E 500 4MATIC	E 55 AMG
Generator (alternator)	14 V/150 A	14 V/150 A	14 V/180 A
Starter motor	14 V/1.4 kW	14 V/1.7 kW	14 V/1.7 kW
Battery (auxiliary)	12 V/12 Ah	12 V/12 Ah	12 V/12 Ah
Battery (main)	12 V/95 Ah	12 V/95 Ah	12 V/95 Ah
Spark plugs	Bosch F8 DPP 332U NGK PFR 5R-11	Bosch F8 DPP 332U NGK PFR 5R-11	NGK IL FR 6 A
Electrode gap	0.039 in (1.00 mm)	0.039 in (1.00 mm)	0.031 in (0.8 mm)
Tightening torque	18.5 - 22 lb-ft (25 - 30 Nm)	18.5 - 22 lb-ft (25 - 30 Nm)	18.5 - 22 lb-ft (25 - 30 Nm)

Model	E 320 CDI
Generator (alternator)	14 V/200 A
Starter motor	14 V/2.2 kW
Battery (auxiliary)	12 V/12 Ah
Battery (main)	12 V/95 Ah

## Technical data

### Main dimensions

#### ▼ Main dimensions

Model	E 320 CDI/E 320	E 500	E 55 AMG
<b>Overall vehicle length</b>	190.3 in (4833 mm)	190.3 in (4833 mm)	190.9 in (4849 mm)
<b>Overall vehicle width</b>	71.7 in (1822 mm)	71.7 in (1822 mm)	71.7 in (1822 mm)
<b>Overall vehicle height</b>	57.1 in (1449 mm)		
<b>Overall vehicle height (Airmatic DC*)</b> (optional with E320 Appearance Package; standard on E500/E55 AMG)	56.2 in (1429 mm)	56.3 in (1431 mm)	55.6 in (1412 mm)
<b>Wheelbase</b>	112.4 in (2854 mm)	112.4 in (2854 mm)	112.4 in (2854 mm)
<b>Track, front</b>	61.4 in (1559 mm)	61.7 in (1567 mm)	62.3 in (1583 mm)
<b>Track, rear</b>	61.1 in (1552 mm)	61.4 in (1560 mm)	61.3 in (1558 mm)

Model	E 320 4MATIC	E 500 4MATIC
<b>Overall vehicle length</b>	190.3 in (4833 mm)	190.3 in (4833 mm)
<b>Overall vehicle width</b>	71.7 in (1822 mm)	71.7 in (1822 mm)
<b>Overall vehicle height</b>	57.6 in (1463 mm)	
<b>Overall vehicle height (Airmatic DC*)</b> (optional on E320; standard on E500)	56.7 in (1439 mm)	57.7 in (1441 mm)
<b>Wheelbase</b>	112.4 in (2854 mm)	112.4 in (2854 mm)
<b>Track, front</b>	61.4 in (1559 mm)	61.7 in (1567 mm)
<b>Track, rear</b>	61.1 in (1552 mm)	61.4 in (1560 mm)

## Technical data

### Weights

Roof load max.	220 lb (100 kg)
----------------	-----------------

Trunk load max.	220 lb (100 kg)
-----------------	-----------------

▼ Fuels, coolants, lubricants etc.

Capacities

Vehicle components and their respective lubricants must match. Therefore only use products tested and approved by Mercedes-Benz.

Please refer to the Factory Approved Service Products Pamphlet, or inquire at your authorized Mercedes-Benz Center.

	Model	Capacity	Fuels, coolants, lubricants etc.
<b>Engine with oil filter</b>	E 320 E 320 4MATIC	8.5 US qt (8.0 l)	Approved engine oils
	E 500 E 500 4MATIC	8.0 US qt (7.5 l)	
	E 55 AMG	9.0 US qt (8.5 l)	
	E 320 CDI	6.87 US qt (6.5 l)	
<b>Automatic transmission</b>		8.0 US qt (7.5 l)	MB Automatic Transmission Fluid
<b>Front axle</b>	E 320 4MATIC E 500 4MATIC	0.63 US qt (0.6 l)	Hypoid gear oil SAE 85 W 90
<b>Rear axle</b>	E 320 E 320 4MATIC	1.06 US qt (1.0 l)	Hypoid gear oil SAE 85 W 90
	E 320 CDI E 500 E 500 4MATIC E 55 AMG	1.37 US qt (1.3 l)	
<b>Transfer case</b>	E 320 4MATIC E 500 4MATIC	0.62 US qt (0.585 l)	MB Transfer Case Fluid

## Technical data

### Fuels, coolants, lubricants etc.

	Model	Capacity	Fuels, coolants, lubricants etc.
<b>Power steering</b>	E 320 CDI	approx. 0.95 US qt (0.9 l)	MB Power Steering Fluid (Pentosin CHF 11S)
		approx. 1.1 US qt (1.0 l)	
<b>Front wheel hubs</b>		approx. 3.0 oz (85 g) each	High temperature roller bearing grease
<b>Brake system</b>		1.1 US qt (1.05 l)	MB Brake Fluid (DOT 4+)
<b>Cooling system</b>	E 320 CDI	13.3 US qt (12.6 l)	MB 325.0 Anticorrosion/Antifreeze
	E 320 E 320 4MATIC	10.7 US qt (10.0 l)	
	E 500 E 500 4MATIC	11.9 US qt (11.3 l)	
	E 55 AMG	13.8 US qt (13.2 l)	
<b>Fuel tank</b>		21.12 US gal (80.0 l)	Gasoline engines: Premium unleaded gasoline Minimum Posted Octane 91 (Avg. of 96 RON/86 MON)
	<b>including a reserve of</b>	2.38 US gal (9.0 l)	
	<b>including a reserve of</b> E 55 AMG	3.7 US gal (14.0 l)	
			Diesel engine: Diesel fuels according to ASTM D 975 grades 1-D and 2-D



## Technical data

### Fuels, coolants, lubricants etc.

	Model	Capacity	Fuels, coolants, lubricants etc.
<b>Air conditioning system</b>			R-134a refrigerant and special PAG lubricant oil (never R-12)
<b>Windshield washer</b>		4.8 US qt (4.5 l)	MB Windshield Washer Concentrate <sup>1</sup>
<b>Windshield washer and head-lamp cleaning system</b>		7.4 US qt (7.0 l)	MB Windshield Washer Concentrate <sup>1</sup>

<sup>1</sup> Use MB Windshield Washer Concentrate "S" and water for temperatures above freezing or MB Windshield Washer Concentrate "S" and commercially available pre-mixed windshield washer solvent/antifreeze for temperatures below freezing point. Follow suggested mixing ratios (▷ page 469).

## Technical data

### Fuels, coolants, lubricants etc.

#### Engine oils

Engine oils are specifically tested for their suitability in our engines and durability for our service intervals. Therefore, only use approved engine oils and oil filters required for vehicles with Maintenance System (U.S. vehicles) or FSS PLUS (Canada vehicles). For a listing of approved engine oils and oil filters, refer to the Factory Approved Service Products pamphlet, or contact an authorized Mercedes-Benz Center.

Using engine oils and oil filters of specification other than those expressly required for the Maintenance System (U.S. vehicles) or FSS PLUS (Canada vehicles), or changing of oil and oil filter at change intervals longer than those called for by the Maintenance System (U.S. vehicles) or FSS PLUS (Canada vehicles) will result in engine damage not covered by the Mercedes-Benz Limited Warranty.

Please follow Maintenance System (U.S. vehicles) or FSS PLUS (Canada vehicles) recommendations for scheduled oil changes. Failure to do so could result in engine damage not covered by the Mercedes-Benz Limited Warranty.

#### Engine oil additives

Do not blend oil additives with engine oil. They may damage the engine.

Damage or malfunctions resulting from blending oil additives are not covered by the Mercedes-Benz Limited Warranty.

#### Air conditioning refrigerant

R-134a (HFC) refrigerant and special PAG lubricating oil are used in the air conditioning system.

Never use R-12 (CFC) or mineral-based lubricating oil. Otherwise damage to the system will occur.

#### Brake fluid

During vehicle operation, the boiling point of the brake fluid is continuously reduced through the absorption of moisture from the atmosphere. Under extremely strenuous operating conditions, this moisture content can lead to the formation of bubbles in the system, thus reducing the system's efficiency. Therefore, the brake fluid must be replaced every two years, preferably in the spring. Only brake fluid approved by Mercedes-Benz is recommended. Your authorized Mercedes-Benz Center will provide you with additional information.

#### Premium unleaded gasoline (Gasoline engine)



To maintain the engine's durability and performance, premium unleaded gasoline must be used. If premium unleaded gasoline is not available and low octane fuel is used, follow these precautions:

- Have the fuel tank only partially filled with unleaded regular and fill up with premium unleaded as soon as possible
- Avoid full throttle driving and abrupt acceleration
- Do not exceed an engine speed of 3000 rpm if the vehicle is loaded with a light load such as two persons and no luggage
- Do not exceed 2/3 of maximum accelerator pedal position if the vehicle is fully loaded or operating in mountainous terrain

#### Gasoline additives (Gasoline engine)

A major concern among engine manufacturers is carbon build-up caused by gasoline. Mercedes-Benz recommends only the use of quality gasoline containing additives that prevent the build-up of carbon deposits.

After an extended period of using fuels without such additives, carbon deposits can build up especially on the intake valves and in the combustion area, leading to engine performance problems such as:

- Warm-up hesitation
- Unstable idle
- Knocking/pinging
- Misfire
- Power loss

In areas where carbon deposits may be encountered due to lack of availability of gasolines which contain these additives, Mercedes-Benz recommends the use of additives approved by us for use on Mercedes-Benz vehicles. Refer to Factory Approved Service Products Pamphlet for a listing of approved product(s). Follow directions on product label.

Do not blend any specific fuel additives with fuel. This only results in unnecessary costs and may be harmful to the engine operation.

Damage or malfunction resulting from poor fuel quality or from blending additional fuel additives other than those tested and approved by us for use on Mercedes-Benz vehicles listed in the Factory Approved Service Products pamphlet are not covered by the Mercedes-Benz Limited Warranty.

## Technical data

### Fuels, coolants, lubricants etc.

#### Fuel requirements

##### Gasoline engine

Only use premium unleaded gasoline meeting ASTM standard D 439.

The octane number (posted at the pump) must be 91 “min”. It is an average of both the Research (R) Octane Number and the Motor (M) Octane Number:  $(R+M)/2$ . This is also known as the ANTI-KNOCK INDEX.

Unleaded gasoline containing oxygenates such as ethanol, IPA, IBA and TBA can be used provided the ratio of any one of these oxygenates to gasoline does not exceed 10%; MTBE must not exceed 15%.

The ratio of methanol to gasoline must not exceed 3% plus additional cosolvents.

Using mixtures of ethanol and methanol is not allowed. Gasohol, which contains 10% ethanol and 90% unleaded gasoline, can be used.

These blends must also meet all other fuel requirements, such as resistance to spark knock, boiling range, vapor pressure, etc.

##### Diesel engine

Only use commercially available vehicular diesel fuels No. 2 or No. 1 (ASTM D975 No.2-D or No.1-D).

To prevent malfunctions, diesel fuel with better cold flow quality is offered in the winter months. Check with your fuel retailer.



Do not fill the tank with gasoline. Do not mix diesel fuel with gasoline or kerosene. The fuel system and engine will otherwise be damaged, which is not covered by the Mercedes-Benz Limited Warranty.

##### Coolants

The engine coolant is a mixture of water and anticorrosion/antifreeze, which provides:

- Corrosion protection
- Freeze protection
- Boiling protection (by increasing the boiling point)

The cooling system was filled at the factory with a coolant providing freeze protection to approximately  $-22^{\circ}\text{F}$  ( $-30^{\circ}\text{C}$ ) and corrosion protection.

## Technical data

### Fuels, coolants, lubricants etc.

If the antifreeze mixture is effective to  $-22^{\circ}\text{F}$  ( $-30^{\circ}\text{C}$ ), the boiling point of the coolant in the pressurized cooling system is reached at approximately  $266^{\circ}\text{F}$  ( $130^{\circ}\text{C}$ ).

The coolant solution must be used year-round to provide the necessary corrosion protection and increase boil-over protection. Refer to Maintenance Booklet for replacement interval.

Coolant system design and coolant used determine the replacement interval. The replacement interval published in the Maintenance Booklet is only applicable if MB 325.0 anticorrosion/antifreeze solution or other Mercedes-Benz approved products of equal specification (see Factory Approved Service Products pamphlet) are used to renew the coolant concentration or bring it back up to the proper level.

To provide important corrosion protection, the solution must be at least 45% anticorrosion/antifreeze [equivalent to freeze protection to approximately  $-22^{\circ}\text{F}$  ( $-30^{\circ}\text{C}$ )]. If you use a solution that is more than 55% anticorrosion/antifreeze [freeze protection to approximately  $-49^{\circ}\text{F}$  ( $-45^{\circ}\text{C}$ )], the engine temperature will increase due to the lower heat transfer capability of the solution. Therefore, do not use more than this amount of anticorrosion/antifreeze.

If the coolant level is low, water and MB 325.0 anticorrosion/antifreeze should be used to bring it up to the proper level (have cooling system checked for signs of leakage). Please make sure the mixture is in accordance with label instructions.

The water in the cooling system must meet minimum requirements, which are usually satisfied by normal drinking water. If you are not sure about the water quality, consult your authorized Mercedes-Benz Center.

#### Anticorrosion/antifreeze

Your vehicle contains a number of aluminum parts. The use of aluminum components in motor vehicle engines necessitates that anticorrosion/antifreeze coolant used in such engines be specifically formulated to protect the aluminum parts. (Failure to use such anticorrosion/antifreeze coolant will result in a significantly shortened service life.)

## Technical data

### Fuels, coolants, lubricants etc.

Therefore, the following product is strongly recommended for use in your vehicle:  
MB 325.0 anticorrosion/antifreeze agent.

Before the start of the winter season (or once a year in hot southern regions), you should have the anticorrosion/antifreeze concentration checked. The coolant is also

regularly checked each time you bring your vehicle to your authorized Mercedes-Benz Center for service.

#### *Anticorrosion/antifreeze quantity*

Model	Approx. freeze protection	
	- 35°F (- 37°C)	- 49°F (- 45°C)
E 320 CDI	6.7 US qt (6.3 l)	7.3 US qt (6.9 l)
E 320/E 320 4MATIC	5.3 US qt (5.0 l)	5.9 US qt (5.5 l)
E 500/E 500 4MATIC	6.0 US qt (5.65 l)	6.6 US qt (6.2 l)
E 55 AMG	7.0 US qt (6.6 l)	7.7 US qt (7.3 l)

### Windshield and headlamp washer system

Both the windshield and headlamp washer systems are supplied from the windshield washer fluid reservoir.

The washer fluid reservoir has a capacity of approximately:

- 7.4 US qt. (7.0 l) in vehicles with a headlamp cleaning system\* or heated reservoir
- 4.8 US qt. (4.5 l) in vehicles without a headlamp cleaning system

- ▶ Refill the reservoir with MB Windshield Washer Concentrate and water (or concentrate and commercially available premixed windshield washer solvent/antifreeze, depending on ambient temperatures).

#### Warning



Washer solvent/antifreeze is highly flammable. Do not spill washer solvent/antifreeze on hot engine parts, because it may ignite and burn. You can be seriously burned.

## Technical data

### Fuels, coolants, lubricants etc.

#### Windshield and headlamp washer fluid mixing ratio

For temperatures above “freezing point”, use MB Windshield Washer Concentrate “S” and water:

- 1 part “S” to 100 parts water (1.34 floz [40 ml] “S” to 1 gallon [4.0 l] water).

For temperatures below “freezing point” use MB Windshield Washer Concentrate “S” and commercially available premixed windshield washer solvent/antifreeze:

- 1 part “S” to 100 parts solvent (1.34 floz [40 ml] “S” to 1 gallon [4.0 l] solvent).





**ABS**

(Antilock Brake System)

Prevents the wheels from locking up during braking so that the vehicle can continue to be steered.

**ADS**

(Adaptive Damping System)

Automatically adapts the optimum suspension damping to prevailing driving conditions.

**Airmatic DC**

(Airmatic Dual Control)

Automatically selects the optimum suspension tuning and ride height for your vehicle. Airmatic consists of two components:

- Adaptive Damping System
- Vehicle level control

**Alignment bolt**

Metal pin with thread. The centering pin is an aid used when changing a tire to align the wheel with the wheel hub.

**BAS**

(Brake Assist System)

System for potentially reducing braking distances in emergency braking situations. The system is activated when it senses an emergency based on how fast the brake is applied.

**Bi-Xenon headlamps\***

Headlamps which use an electric arc as a light source and produce a more intense light than filament headlamps. Bi-Xenon headlamps produce low beam and high beam.

**CAC**

(Customer Assistance Center)

Mercedes-Benz customer service center which can help you with any questions about your vehicle and provide assistance in the event of a breakdown.

**CAN system**

(Controller Area Network)

Data bus network serving to control vehicle functions such as door locking or windshield wiping.

**CDI**

(Common-Rail Direct Injection)

Diesel fuel injection technology where all cylinders share a common diesel fuel supply line. Fine injection nozzles provide for highly accurate metering that reduces diesel fuel consumption.

**Cockpit**

All instruments, switches, buttons and indicator/warning lamps in the passenger compartment needed for vehicle operation and monitoring.

## Technical terms

### COMAND

(Cockpit Management and Data System)

Information and operating center for vehicle sound and communications systems, including the radio and navigation system, as well as other optional equipment (CD changer, telephone, etc.).

### Control system

The control system is used to call up vehicle information and to change component settings. Information and messages appear in the multifunction display. The driver uses the buttons on the multifunction steering wheel to navigate through the system and to adjust settings.

### Cruise control

Driving convenience system for automatically maintaining the vehicle speed set by the driver.

### Distronic\*

A driving convenience cruise control system which helps the driver maintain a pre-selected speed:

- If there is no vehicle directly ahead, the system operates in the same way as conventional ->cruise control.
- If a slower moving vehicle is ahead, Distronic will reduce your vehicle speed to the extent permitted by reduced throttle and up to 20% braking power to maintain the preset minimum following distance.

### DTR

(->Distronic\*)

### Engine number

The number set by the manufacturer and placed on the cylinder block to uniquely identify each engine produced.

### Engine oil viscosity

Measurement for the inner friction (viscosity) of the oil at different temperatures. The higher the temperature an oil can tolerate without becoming thin, or the lower the temperature it can tolerate without becoming viscous, the better the viscosity.

### ESP

(Electronic Stability Program)

Improves vehicle handling and directional stability.

### ETD

(Emergency Tensioning Device)

Device which deploys in certain frontal and rear collisions exceeding the system's threshold to tighten the seat belts.

->SRS

**FSS PLUS (Canada vehicles)**

(Flexible Service System PLUS)  
Maintenance service indicator in the multifunction display that informs the driver when the next vehicle maintenance service is due. FSS evaluates engine temperature, oil level, vehicle speed, engine speed, distance driven and the time elapsed since your last service, calculates other maintenance service work required, and calls for the next maintenance service accordingly.

**Gear range**

Number of gears which are available to the automatic transmission for shifting. The automatic gear shifting process can be adapted to specific operating conditions using the selector lever.

**GPS**

(Global Positioning System)  
Satellite-based system for relaying geographic location information to and from vehicles equipped with special receivers. Employs DVD digital maps for navigation.

**Heater booster system**

Provides for additional heat in the vehicle interior in vehicle models with diesel engines.

**Instrument cluster**

The displays and indicator/warning lamps in the driver's field of vision, including the tachometer, speedometer and fuel gauge.

**KEYLESS-GO\***

System for entering and operating the vehicle without the use of a SmartKey.

**Kickdown**

Depressing the accelerator past the point of resistance shifts the transmission down to the lowest possible gear. This very quickly accelerates the vehicle and should not be used for normal acceleration needs.

**Lock button**

Button on the door which indicates whether the door is locked or unlocked. Pushing the lock button down on an individual door from inside will lock that door.

**Maintenance System (U.S. vehicles)**

Maintenance service indicator in the multifunction display that informs the driver when the next vehicle maintenance service is due. The Vehicle Maintenance System in your vehicle tracks distance driven and the time elapsed since your last maintenance service, calculates other maintenance service work required, and calls for the next maintenance service accordingly.

## Technical terms

### Memory function\*

Used to store three individual seat, steering wheel and exterior mirror positions for each SmartKey.

### MON

(Motor Octane Number)

The Motor Octane Number for gasoline as determined by a standardized method. It is an indication of a gasoline's ability to resist undesired detonation (knocking). The average of both the MON (Motor Octane Number) and →RON (Research Octane Number) is posted at the pump, also known as ANTI-KNOCK INDEX.

### Multifunction display

The display field in the instrument cluster used to present information provided by the control system.

### Multifunction steering wheel

Steering wheel with buttons for operating the control system.

### Overspeed range

Engine speeds within the red marking on the tachometer dial. Avoid this engine speed range, as it may result in serious engine damage that is not covered by the Mercedes-Benz Limited Warranty.

### Parktronic (Parking assist)\*

System which uses visual and acoustic signals to assist the driver during parking maneuvers.

### Poly-V-belt drive

Drives engine-components (alternator, AC compressor, etc.) from the engine.

### Power train

Collective term designating all components used to generate and transmit motive power to the drive axles, including:

- Engine
- Clutch/torque converter
- Transmission
- Transfer case\*
- Drive shaft
- Axle shafts/axles

### Program mode selector switch

Used to switch the automatic transmission between standard operation **S** and operation **C**.

E 55 AMG with steering wheel gearshift control and manual shift program: in addition to **S** and **C** (for sporty **S** or comfortable **C** operation), you can use **M** for manual shift program.

### **PTC heating element**

(Positive Temperature Coefficient)  
Electronic component that warms up quickly as electricity is supplied to it and is used as a ->heater booster system in diesel vehicles.

### **Restraint systems**

Seat belts, belt tensioners, air bags and child restraint systems. As independent systems, their protective functions complement one another.

### **RON**

(Research Octane Number)  
The Research Octane Number for gasoline as determined by a standardized method. It is an indication of a gasoline's ability to resist undesired detonation (knocking). The average of both the ->MON (Motor Octane Number) and RON (Research Octane Number) is posted at the pump, also known as ANTI-KNOCK INDEX.

### **SBC**

(Sensotronic Brake Control)  
Electronically controlled hydraulic braking system for increased braking safety and comfort.

### **Shift lock**

When the vehicle is parked, this lock prevents the transmission selector lever from being moved out of position **P** without the ignition or engine on and brake pedal depressed.

### **SRS**

(Supplemental Restraint System)  
Seat belts, emergency tensioning device and air bags. Though independent systems, they are closely interfaced to provide effective occupant protection.

### **Tele Aid System**

(Telematic Alarm Identification on Demand)  
The Tele Aid system consists of three types of response: automatic and manual emergency, roadside assistance and information. Tele Aid is initially activated by completing a subscriber agreement and placing an acquaintance call.  
The Tele Aid system is operational provided that the vehicle's battery is charged, properly connected, not damaged and cellular and GPS coverage is available.

### **Telematics\***

A combination of the terms "telecommunications" and "informatics".

### **Tightening torque**

Force times lever arm (e.g. a lug wrench) with which threaded fasteners such as wheel bolts are tightened.

## Technical terms

### **Tire speed rating**

Part of a tire designation; indicates the speed range for which a tire is approved.

### **Traction**

Force exerted by the vehicle on the road via the tires.

### **Vehicle level control**

The ground clearance of the vehicle is automatically controlled according to a selected setting and speed. The driver can set the ground clearance manually for example on very rough roads.

### **VIN**

(Vehicle Identification Number)

The number set by the manufacturer and placed on the body to uniquely identify each vehicle produced.

### **Voice control system\***

Voice control system for car phones, portable cell phones and audio systems (radio, CD, etc.).

**A**

- ABS 85, 471
    - ABS control 86
    - Malfunction indicator lamp 356
    - Messages in display 369
    - Warning lamp 356
  - Accelerator position, automatic transmission\* 180
  - Accessory weight 337
  - Accident
    - In case of 54
  - Activating
    - Air conditioning (cooling) 201, 214
    - Air recirculation mode 199, 212
    - Anti-theft alarm system 94
    - Automatic climate control (Dual-zone) 194, 195
    - Central locking (control system) 166
    - Defrosting 199
    - Distance warning function\* 244
    - DISTRONIC\* 240
    - Easy-entry/exit feature\* 167
  - ESP 90
  - Exterior headlamps 50
  - Exterior lamps 134
  - Front fog lamps 136
  - Hazard warning flasher 138
  - Headlamps 50
  - High beams 137
  - Ignition 34
  - Ignition with KEYLESS-GO\* 36
  - Immobilizer 56, 94
  - Rear fog lamp 136
  - Rear window defroster 191
  - Residual heat 202, 215
  - Seat heater\* 128
  - Tow-away alarm 95
  - Windshield wipers 52
- Adding
    - Engine oil 306
  - Additional turn signal 418
  - Adjustable air vents, rear passenger compartment 216
- Adjusting 37
    - Air distribution 198, 210
    - Air volume 198, 211
    - Backrest tilt 38
    - Drive-dynamic seat\* with multicontour features 126
    - Exterior rear view mirror 41
    - Head restraint height 39
    - Head restraint tilt 39
    - Instrument cluster illumination 142
    - Interior rear view mirror 41
    - Mirrors 40
    - Seat cushion tilt 38
    - Seat fore and aft adjustment 38
    - Seat height 38
    - Seats 37
    - Steering column height 40
    - Steering wheel 39
  - Adjusting steering column in or out 40
  - Adjusting steering column up or down 40
  - Adjusting the dynamic seat 169

## Index

- Air conditioning (cooling)
  - Turning off 201, 214
  - Turning on 201, 214
- Air distribution
  - Adjusting 198, 210
- Air pressure 337
- Air pressure see Tire inflation pressure 322
- Air pump, electric 430
- Air recirculation mode 199, 212
  - Activating 199, 212
  - Deactivating 200, 213
- Air vents, rear passenger compartment
  - Adjustable 216
- Air volume
  - Adjusting 198, 211
- Airbags 61
  - Children 62
  - Front 65
  - Passenger 65
  - Safety guidelines 64
  - Side impact 66
  - Window curtain 66
- Airmatic DC (Dual Control)\* 247
- Alarm
  - Audible 84, 95
  - Canceling 95
  - Visual 94
- Alarm system
  - Anti-theft 94
- Alignment bolt (vehicle tool kit) 409, 427, 471
- Antilock brake system (ABS) 471
- Anti-theft alarm system
  - Arming 94
  - Canceling alarm 95
  - Disarming 95
- Anti-theft systems 94
  - Anti-theft alarm system 94
  - Immobilizer 94
  - Tow-away alarm 95
- Aquaplaning see Hydroplaning 291
- Ashtray 268
- Aspect ratio 337
- At the gas station 299
- AUDIO menu 150
  - Selecting radio station 150
  - Selecting satellite radio\* station 151
- Audio system
  - CD mode 151
- Auto-dimming
  - Automatic 186
- Auto-dimming for rear view mirrors 186
- Automatic central locking
  - Activating/deactivating (control system) 166
- Automatic climate control
  - 4-zone automatic climate control\* 204
  - Dual-zone automatic climate control 192
  - Temperature sensor 29



- Automatic climate control (4-zone\*) 204
    - Adjusting air distribution 210
    - Adjusting air volume 211
    - Air conditioning 214
    - Air recirculation mode 212
    - Deactivating 209
    - Defrosting 211
    - Maximum cooling MAX COOL 212
    - Rear air conditioning 216
    - Residual heat and ventilation 215
    - Setting the temperature 210
  - Automatic climate control (Dual-zone)
    - Adjusting air distribution 198
    - Adjusting air volume 198
    - Air conditioning 201
    - Air recirculation mode 199
    - Defrosting 199
    - Heater booster system 203
    - Residual ventilation 202
    - Setting the temperature 197
  - Automatic climate control\*
    - Rear window defroster 191
  - Automatic headlamp mode 134
  - Automatic lighting control
    - Activating 139
  - Automatic locking when driving 118
  - Automatic transmission 174
    - Emergency operation (Limp Home Mode) 185
    - Gear ranges 177
    - Gear selector lever position 178
    - Gear shifting malfunctions 185
    - Manual shift program mode (E 55 AMG) 183
    - Manual shifting 176
    - One-touch gearshifting 176
    - Program mode selector switch 179
    - Selector lever position 174
    - Starting the engine 46
    - Winter program mode 179
  - Automatic transmission\*
    - Accelerator position 180
    - Kickdown 180
    - Kickdown, manual shift program (E 55 AMG only) 185
- B**
- Backrest
    - Folding forward 257
    - Folding rearward 258
  - Bar 337
  - BAS 87, 471
  - Batteries, SmartKey
    - Changing 415, 416
    - Check lamp 100, 106
    - Checking 101, 107
  - Batteries, SmartKey with KEYLESS-GO\*
    - Changing 415, 416
    - Checking 101, 107
  - Batteries, vehicle
    - Charging 435
    - Disconnecting 434
    - Messages in display 370, 378, 379
    - Reconnecting 435
    - Removing 435
    - Service 433

## Index

- Battery discharged
  - Jump starting 436
- Bead 337
- Bi-Xenon headlamps\* 471
- Bleeding the fuel system 432
- Block heater\* 342
- Blocking
  - Rear window operation 83
- Brake assist system (BAS) 471
- Brake fluid 301, 382
- Brake pads
  - Message in display 380
- Brakes
  - Warning lamp 358
- Break-in period 286
- Bulbs, replacing
  - Additional turn signals 417
  - Fog lamps 417
  - Front lamps 417, 420
  - High beam 418
  - High mounted brake lamp 418
  - License plate lamps 418, 422
  - Low beam 418
  - Parking lamps 418
  - Side marker lamps 417, 422
  - Standing lamps 418
  - Tail lamp 418
  - Tail lamp assemblies 422
  - Turn signal lamp 417
- C**
- CAC (Customer Assistance Center) 471
- Calling up
  - Distronic\* settings 152
  - Maintenance service indicator 345
  - Range (distance to empty) 171
- CAN system 471
- Cargo tie-down rings 261
- CD player
  - Operating 151
- Center console
  - Lower part 28
  - PASS AIR BAG OFF indicator lamp 365
  - Upper part 27
- Centigrade
  - Setting temperature units 157
- Central locking
  - From inside 119
  - Switch 119
  - Switching on/off (control system) 166
  - Unlocking from inside 119
- Central locking switch 119
- Changing
  - Batteries (SmartKey with KEYLESS-GO\*) 415, 416
  - Batteries (SmartKey) 415, 416
  - SmartKey setting 167
  - Vehicle level 249
- Charging
  - Vehicle batteries 435
- CHECK ENGINE malfunction indicator lamp 359, 360

- Checking
  - Coolant level 308
  - Oil level 301, 304
  - Tire inflation pressure 301
  - Vehicle lighting 301
- Child safety 71
  - Airbags 62
  - Infant and child restraint systems 67, 71
  - LATCH child seat anchors 81
- Child safety switch see Blocking of rear window operation 83
- Cigarette lighter 269
- Cleaning
  - Headlamps 186, 350
  - Light alloy wheels 351
  - Parktronic\* system sensor 351
  - side markers 350
  - tail lamps 350
  - turn signal lenses 350
  - Windshield 52
  - Wood trims 354
- Cleaning tires 313
- Clock 160
- Closing
  - Glove box 262
  - Panorama sliding/pop-up roof 227
  - Roller sunblinds 226
  - Side windows 219
  - Sliding/pop-up roof\* 223
  - Trunk
    - Vehicle with KEYLESS-GO\* 115, 116
    - Trunk lid 112
    - Windows 218
- Closing the trunk lid 115, 116
- Cockpit 22, 471
- Cockpit management and data system (COMAND) 472
- Cold tire inflation pressure 337
- Collapsible tire 457
  - Tire inflation pressure 429
- COMAND 472
- COMAND\* see separate operating instructions
- Combination switch 137
  - Turn signals 51
  - Windshield wipers 51
- Control system 145, 472
  - AUDIO menu 150
  - Convenience submenu 167
  - Display digital speedometer 150
  - Distronic\* menu 152
  - Functions 149
  - Instrument cluster submenu 157, 159
  - Lighting submenu 162
  - Menus 148, 149
  - Multifunction display 145
  - Multifunction steering wheel 146
  - Selecting radio system 150
  - Selecting satellite radio\* system 151
  - Settings menu 154
  - Standard display menu 150
  - Submenus 147, 149
  - TEL\* menu 171
  - Trip computer menu 170
  - Vehicle status message memory menu 153
  - Vehicle submenu 166

## Index

- Convenience submenu 167
  - Activating easy-entry/exit feature\* 167
  - Setting parking position for exterior rear view mirror 168
  - Setting SmartKey-dependency 168
- Coolant
  - Checking level 308
  - Messages in display 383, 384, 385
  - Temperature gauge 143
  - Warning lamp 361
- Coolant temperature 298
- Cruise control 231, 472
  - Canceling 233
  - Driving downhill 232
  - Driving uphill 232
  - Fine adjustment 234
  - Lever 239
  - Saving current speed 232
  - Setting speeds 234
- Cruise control lever 231
- Cup holder in the center console 265
- Cup holders 265
- Curb weight 337
- Customer Assistance Center (CAC) 471
- D**
- Daytime running lamp mode 134
  - Setting 162
- Deactivating
  - Air conditioning 201
  - Air recirculation mode 200, 213
  - Alarm 95
  - Anti-theft alarm system 95
  - Automatic climate control (Dual-zone) 194, 195, 197
  - Central locking (control system) 166
  - Cruise control 233
  - Defrost 199, 211, 212
  - Distance warning function\* 244
  - Distronic\* 242
  - Engine with KEYLESS-GO\* 57
- ESP 89
- Exterior lamps 134
- Hazard warning flasher 138
- Headlamps 56
- Immobilizer 94
- Interior lighting delayed switch-off 165
- Manual shift program (E 55 AMG only) 185
- Rear window defroster 191
- Residual heat 202
- Seat heater\* 127
- Seat ventilation\* 128
- SmartKey
  - Turning off the engine 56
  - Tow-away alarm 96
- Deceleration
  - With Distronic\* 238
- Defogging
  - Windshield 198, 211
- Defrosting 199, 211

- Delayed switch-off
  - Interior lighting 165
- Department of Transportation see DOT
- Dialing
  - A number (telephone) 172
- Diesel fuel 300
- Difficulties
  - While driving see Problems while driving 53
  - With starting 48
- Digital speedometer 150
- Direction of rotation (tires) 314
- Discharged battery
  - Jump starting 436
- Disconnecting
  - Vehicle battery 434
- Display
  - Selecting 158, 159
- Displays
  - Digital speedometer 150
  - Distronic\* 237
  - Maintenance service indicator 343
  - Messages 305
  - Selecting 158
  - Showing malfunctions 153
- Distance
  - Decreasing in DISTRONIC\* 243
  - Increasing in DISTRONIC\* 243
  - Warning function 243
- Distance to empty (range)
  - Calling up 170
- Distance warning function\* 243
  - Activating 244
  - Deactivating 244
  - DTR\* warning lamp 243
  - Intermittent warning sound 243
  - Symbol in multifunction display 152
- Distronic\* 235, 472
  - Activated 239
  - Activating 240
  - Calling up settings 152, 238
  - Cleaning system sensor 351
  - Cruise control lever 239
  - Deactivated 239
  - Deactivating 242
  - Deceleration 238
  - Decreasing distance 243
  - Displays in the speedometer dial 237
  - Distance warning function 243
  - Driving hints 244
  - Increasing distance 243
  - Intermittent signal tone 237
  - Menu 238
  - Messages in display 370
  - Sensor cover 351
  - Setting a higher speed 240
  - Setting a slower speed 241
  - Setting the current speed 240
  - Setting the following distance in DISTRONIC 242
  - Warning and indicator lamps 237
- Door control panel 30
- Door entry lamps 140

## Index

Door handle 30  
Door unlock  
    With Tele Aid\* 278  
Doors  
    Message in display 386  
    Opening from inside vehicle 109  
    Opening from outside 105  
DOT 337  
Downhill driving  
    Cruise control 232  
Downshifting 176  
Drive-dynamic seat\* with multicontour features 126  
Driving  
    General instructions 43  
    Hydroplaning 291  
    In winter 294  
    Problems 53  
    Safety systems 85  
    With Distronic\* 244

Driving hints  
    SBC brake system 92  
Driving instructions 287  
Driving off 290  
Driving safety systems  
    4MATIC 93  
    ABS 85  
    BAS 87  
    ESP 87, 472  
    SBC brake system 90  
Driving systems 231  
    Airmatic DC\* 247  
    Cruise control 231  
    Distronic\* 235  
    Driving safety systems 85  
    Vehicle level control 248  
DTR see Distronic\* 472  
Dual control\*  
    Airmatic DC\* 247

**E**  
E 55 AMG  
    MANUAL shift program mode 183  
Easy-entry/exit  
    Message in display 381  
Easy-entry/exit feature\* 121  
    Activating 167  
    Interrupting movement 121, 167  
Electric air pump 429  
Electrical fuses 443  
Electrical system 458  
Electronic Stability Program see ESP 87, 472  
Emergency call system\* 271  
Emergency calls  
    Initiating an emergency call 274  
    With Tele Aid\* 273  
Emergency operation (Limp Home Mode) 185

- Emergency operations
  - Opening/closing sliding/pop-up roof\* or panorama sliding/pop-up roof\* 414
  - Releasing trunk lid from inside 117
  - Remote door unlock 278
  - Unlocking the trunk lid 411
  - Unlocking the vehicle 410
- Emergency tensioning device see ETD 70, 472
- Emission control 297
- Ending
  - A call (telephone) 172
- Engine 450
  - Compartment 303
  - Message in the display 359, 360, 383
  - Starting 46
  - Starting with KEYLESS-GO\* 47
  - Starting with the SmartKey 46, 47
  - Turning off with the key 56
- Engine compartment
  - Hood 303
- Engine malfunction indicator lamp 359, 360, 383
- Engine number 472
- Engine oil
  - Adding 306
  - Checking level 304
  - Consumption 304
  - Display messages 387
  - Messages in display 305
  - Viscosity 472
- ESP 87, 472
  - Four wheel electronic traction system with ESP 93
  - Switching off 89
  - Switching on 90
  - Synchronizing 372
  - Warning lamp 357
- ETD 472
  - Safety guidelines 64
- Exterior lamp switch 133
- Exterior rear view mirrors
  - Adjusting 41
  - Parking position for 168
- F**
- Fahrenheit
  - Setting temperature units 157
- Fastening the seat belts 43
- Fine adjustment
  - Cruise control 234
- First aid kit 407
- Flat tire 425
  - Collapsible tire 429
  - Mounting the spare wheel 425, 428
  - Spare wheel 425
- Flexible Service System (Canada vehicles) 343
- Flexible Service System (FSS) 473
- Fog lamp, rear 137
- Fog lamps, front
  - Messages in display 392
  - Switching on 136
- Following distance in DISTRONIC\* 242
- Four wheel electronic traction system (4MATIC) with ESP 93
- 4MATIC 93

## Index

Front airbags 65  
Front fog lamp  
    Replacing bulb 418  
Front lamps 418  
    Messages in display 394  
    Replacing bulbs 420  
    Switching on 133  
Front seat head restraints  
    Power seat 123  
    Removing and installing 123  
Front seats  
    Heater\* 127  
FSS (Canada vehicles) 343  
FSS (Flexible Service System) 473  
Fuel 300  
    Fuel tank reserve warning lamp 362  
    Premium unleaded gasoline 300  
Fuel consumption statistics  
    After start 170  
    Since last reset 170

Fuel filler flap 299  
    Locking 299  
    Unlocking 299  
Fuel requirements 466  
Fuel reserve tank  
    Message in display 389  
Fuel tank  
    Filler flap 299  
Fuels, coolants, lubricants etc. 461  
Functions (control system) 149  
    Resetting 155  
Fuse chart 443  
Fuses 443  
    Fuse chart 443  
    Fuse extractor 443  
    Spare fuses 443

**G**  
Garage door opener 29, 279  
    Erasing the integrated remote control 284  
    Integrated remote control 281  
    Rolling code programming 282  
Gasoline see Fuel 300  
GAWR 337  
Gear range 473  
    Automatic transmission 177  
    Limiting 177  
    Shifting into optimal 176  
Gear range limit  
    Canceling 176  
Gear selector lever  
    Position 178  
Global  
    Locking 100  
    Locking with KEYLESS-GO\* 105  
    Unlocking 99  
    Unlocking with KEYLESS-GO\* 105  
Global Positioning System (GPS) 473  
Glove box 262  
    Closing 262  
    Opening 262



Good visibility 186  
 GPS 473  
 GPS see COMAND 272  
 Gross Axle Weight Rating see GAWR  
 Gross Vehicle Weight Rating see GVWR  
 Gross Vehicle Weight see GVW  
 GVW 337  
 GVWR 338

**H**

Hand-held transmitter  
   Programming integrated remote control 281  
   Reprogramming integrated remote control 284  
 Hazard warning flasher 138  
   Switching off 138  
   Switching on 138

Headlamps  
   Automatic control 134  
   Bi-Xenon\* 471  
   Cleaning system\* 186  
   Switching off 56  
   Switching on 50  
 Heated seats\* 127  
 Heated steering wheel\* 270  
 Heater booster system 203, 473  
 Height adjustment  
   Head restraints 39  
   Steering wheel 39  
   Vehicle level 248  
 High beam flasher 50, 137  
 High beam headlamps  
   Messages in display 394  
   Replacing bulbs 418  
   Switching on 50, 137  
 High mounted brake lamp 418  
 Hood 303  
   Closing 303  
   Message in display 389  
   Opening 303  
 Hydroplaning 291

**I**

Identification labels 448  
 Ignition 34, 36  
   Switching on 46, 47  
 Immobilizer 94  
   Activating 94  
   Deactivating 94  
 Indicator lamps see Lamps, indicator and warning  
 Infant and child restraint systems 71  
   Installing 80  
   LATCH child seat anchors 81  
 Information  
   About service and warranty 10  
   Button for Tele Aid\* 276  
 Inside rear view mirror  
   Antiglare 186  
 Installing  
   Infant and child restraint systems 80  
   Towing eye bolt 442  
   Wiper blades 424

## Index

Instrument cluster 24, 142, 353, 473  
Coolant temperature gauge 143  
Illumination 142  
Multifunction display 145  
Outside temperature indicator 144  
Selecting language 158  
Integrated remote control  
Canadian programming 283  
Erasing memory 284  
Gate operator 283  
Hand-held transmitter 281  
Operation 284  
Rolling code programming 282  
Interior lighting 139  
Activating automatic control 139  
Delayed switch-off 165  
Interior rear view mirror  
Adjusting 41

**J**  
Jack 407  
Jump starting 436  
**K**  
Key, Mechanical 410  
Key, SmartKey  
Changing the batteries 415, 416  
Key, SmartKey with KEYLESS-GO\*  
Changing the batteries 415, 416  
KEYLESS-GO\* 473  
Activating ignition with 36  
Closing  
Trunk 115, 116  
Factory setting 105  
Global locking 105  
Global unlocking 105  
Important notes 104  
Remote controls 102  
Starting the engine 47  
Turning off engine 57  
Unlocking and opening, trunk lid 108  
Unlocking with 33  
Kickdown 180, 473  
Kilometers/miles in speedometer 157  
Kilopascal 338  
Km/h or mph in speedometer 157

**L**  
Lamp bulbs, exterior 417  
Lamps, exterior  
Front 418  
Light sensor 394  
Messages in display 394  
Replacing bulbs for rear 418, 422  
Lamps, indicator and warning  
ABS 356  
Airbag Off 66  
Battery (SmartKey) 100, 106  
Brakes 358  
CHECK ENGINE 359, 360  
Coolant 361  
DTR\* 237  
Engine diagnostics 359, 360  
ESP 357  
Fuel reserve 359, 360  
Maintenance service indicator 343  
SBC 90  
Seat belts 359, 360, 362  
SRS 61  
Language  
Multifunction display 158  
Setting 158  
LATCH child seat anchors 81

- Layout of poly-V-belt drive 449
  - Leather upholstery
    - Cleaning 354
  - Level control system\*
    - Airmatic DC\* 247
  - Lever
    - For cruise control 239
  - License plate lamps 418
    - Messages in display 394
    - Replacing bulbs 422
  - Light alloy wheels
    - Cleaning 353
  - Light sensor 394
  - Lighter see Cigarette lighter 269
  - Lighting 133
    - Automatic headlamp mode 134
    - Combination switch 137
    - Daytime running lamp mode 134
    - Door entry lamps 140
    - Exterior lamp switch 133
    - Front fog lamps 136
    - High beams 137
    - Instrument cluster illumination 142
    - Interior 139
    - Locator lighting 136
    - Low beam 133
    - Manual headlamp mode 134
    - Night security illumination 136
    - Parking lamps 133
    - Rear fog lamp 137
    - Settings (control system) 162
    - Trunk lamp 141
  - Limiting the gear range 177
  - Limp Home Mode 185
  - Loading 254
    - Cargo tie-down rings 261
    - Instructions 260
    - Roof rack\* 254
    - Ski sack\* 254
    - Split rear bench seat\* 257
  - Loading terminology 337
  - Loading the vehicle 314
  - Locator lighting 136
    - Setting 163
  - Lock button 473
    - Door handle (KEYLESS-GO\*) 58
  - Locking 55, 98
    - Fuel filler flap 299
    - Global with KEYLESS-GO\* 105
    - Global, SmartKey 100
    - Vehicle in an emergency 411
  - Loss of SmartKeys 102, 108
  - Low beam headlamps 50
    - Messages in display 394
    - Replacing bulbs 418
    - Switching on 50
  - Lowering
    - Vehicle 431
- M**
- Main Dimensions 459
  - Maintenance 12

## Index

- Maintenance service
  - Calling up the maintenance service indicator 345
  - Maintenance service data information 347
  - Overdue 343, 344
  - Resetting maintenance service indicator 345
  - Service type A - H 343
  - Types 343
  - When due 343
- Maintenance service indicator 343
  - Calling up 345
  - Clearing 344
  - Resetting 345
- Maintenance Service System 343
- Maintenance System (U.S. vehicles) 473
- Malfunction
  - Displaying 153
- MANUAL
  - Shift program mode (E 55 AMG) 183
- Manual headlamp mode 134
- Manual operations
  - Fuel filler flap 412
  - Sliding/pop-up roof\* or panorama sliding/pop-up roof\* 414
  - Unlocking the driver's door 410
  - Unlocking the transmission lever 412
  - Unlocking the trunk lid 411
- Manual shift program (E 55 AMG only)
  - Deactivating 185
- Massage function 127
- MAXCOOL maximum cooling 212
- Maximum inflation pressure 338
- Maximum load rating 338
- Maximum loaded vehicle weight 338
- Mechanical key 410
- Memory function 130, 474
  - Recalling positions from memory 131
  - Storing exterior rear view mirror parking positions 132
  - Storing SmartKey dependent settings 131
- Menus 148
  - AUDIO 150
  - Distronic\* 152, 238
  - In control system 148, 149
  - Settings menu 154
  - Standard display 150
  - Submenus 147
  - TEL\* 171
  - Trip computer 170
  - Vehicle status message memory 153
- Miles/kilometers in speedometer
  - Setting 157
- Mirrors
  - Adjusting 40
  - Auto-dimming for rear view mirrors 186
  - Exterior rear view mirror 41
  - Exterior rear view mirror parking positions 168, 187
  - Interior rear view mirror 41
  - Storing exterior mirror parking position 132
- MON 300
- MON (Motor Octane Number) 474
- Mph or km/h in speedometer 157
- Multifunction display 145, 474
  - Selecting language 158
  - Standard display 149

Multifunction display messages  
 ABS 369  
 Batteries 370, 378, 379  
 Brake fluid 382  
 Brake pads 380  
 Check engine 359, 360  
 Coolant 384, 385  
 Coolant level 383  
 Distronic\* 370  
 Doors 386  
 Easy-entry/exit feature 381  
 Fuel reserve tank 389  
 Hood 389  
 Lamps 394  
 Parking brake 381  
 SBC brake system 380, 381  
 SmartKey 390  
 SmartKey with KEYLESS-GO\* 391  
 Tele Aid 403, 404  
 Telephone\* 405  
 Tires 399  
 Trunk 405  
 Washer fluid 405  
 Multifunction steering wheel 26, 146,  
 474  
 Buttons 146

**N**

Navigation system  
 See separate COMAND operating  
 instructions 152  
 Night security illumination 136  
 Normal occupant weight 338

**O**

Occupant Classification System 74  
 Self-test 79  
 Occupant distribution 338  
 Occupant safety 60  
 Airbags 61  
 Children and airbags 62  
 Children in the vehicle 71  
 Fastening the seat belt 43  
 Infant and child restraint systems 71  
 LATCH child seat anchors 81  
 Seat belts 43, 64

**Oil**

Adding 306  
 Checking level 305  
 Consumption 304  
 Filler neck 306  
 Viscosity 472

**Oil level**

Checking 305

One-touch gearshifting 176  
 Canceling gear range limit 176  
 Downshifting 176  
 Upshifting 176

**Opening 414**

Ashtray 268  
 Doors from the inside 109  
 Fuel filler flap 299  
 Fuel filler flap manually 412  
 Glove box 262  
 Panorama sliding/pop-up roof 227  
 Panorama sliding/pop-up roof\* in an  
 emergency 414  
 Roller sunblinds 226  
 Side windows 219  
 Sliding/pop-up roof\* 223  
 Sliding/pop-up roof\* in an  
 emergency 414  
 Trunk 110  
 Trunk from the inside 110  
 Trunk lid with SmartKey 101  
 Windows 218

Opening the trunk from the outside 110

## Index

- Operating
  - CD player 151
  - Radio 150
  - Safety 16
  - Telephone\* 171
  - Vehicle outside the USA and Canada 13
- Operating safety 16
- Operation
  - Garage door opener 284
  - Integrated remote control 284
- Operator's Manual 10
- Ornamental moldings 350
- Outside temperature indicator 144
- Overdue maintenance service 343
- Overhead control panel 29
  - Garage door opener 279
- Overspeed range 474
- P**
- Paintwork 349
- Panic alarm 84
  - Panic button on SmartKey 84
- Panorama sliding/pop-up roof\* 226
- Parcel net in front passenger footwell 262
- Parking 55
  - Parking brake 48, 55
    - Engaging 55
    - Message in display 381
    - Releasing 48
  - Parking lamps 418
    - Switching on 133
  - Parking position
    - Exterior rear view mirrors 132, 168, 187
  - Parktronic system\* 474
    - Warning sounds 253
  - Parktronic\*
    - Malfunctioning 253
    - Sensor 351
  - Parts service 446
  - PASS AIR BAG OFF indicator lamp 365
  - Passenger compartment
    - Fuse box 443
    - Interior lighting 139
    - Interior rear view mirror 41
  - Passenger safety see Occupant safety 60
  - Pedals 287
  - Phone book\*
    - Loading 172
    - Quick search 173
  - Phone number\*
    - Dialing 172
    - Redialing 173
  - Plastic and rubber parts
    - Cleaning 354
  - Pliers, universal (vehicle tool kit) 409
  - Poly-V-belt drive 474
  - Positions (Memory function)
    - Recalling from memory 131
  - Positions (Memory function\*)
    - Storing into memory 131
  - Potential problems associated with under-inflated and overinflated tires 326
  - Power assistance 288
  - Power seat
    - Adjusting backrest tilt 38
    - Adjusting head restraint height 39
    - Adjusting head restraint tilt 39
    - Adjusting seat cushion tilt 38
    - Adjusting seat height 38
    - Memory function 130
    - Removing/installing head restraints 123
    - Seat fore and aft adjustment 38
  - Power train 474
  - Power washer 349

- Power windows 218
  - Blocking of rear window operation 83
  - Convenience closing feature 221
  - Side windows 218
  - Summer opening feature 220
  - Synchronizing 220
- Practical hints
  - First aid kit 407
  - Jump starting 436
  - Lamp in center console 365
  - Lamps in instrument cluster 356
  - Messages in the display 367
  - Spare wheel 407
  - Vehicle tool kit 409
- Problems
  - While driving 53
  - With vehicle 17
- Product information 9
- Production options weight 338
- Program mode selector switch 474
  - Automatic transmission 179
- PSI 338
- PTC heating element 475
- PULSE function (Massage function) 127
- Q**
- Quick search
  - Phone book\* 173
- R**
- Radio
  - Selecting stations 150
  - Selecting stations (satellite\*) 151
- Radio transmitters, control and operation 295
- Range (distance to empty)
  - Calling up 171
- Rear bench seat
  - Foldable 257
- Rear fog lamp
  - Switching on 137
- Rear lamp bulbs 418
- Rear lamps see Tail lamps
- Rear passenger compartment
  - Adjustable air vents 216
- Rear seat head restraints
  - Installing 125
  - Removing 125
- Rear view mirrors auto-dimming 186
- Rear view mirrors see Mirrors 186
- Rear window
  - Blocking operation 83
- Rear window defroster 191
  - Activating 191
  - Deactivating 191
- Rear window sunshade\* 189, 190
- Recommended inflation pressure 338
- Reconnecting
  - Vehicle battery 435
- Regular checks 301
- Reinstalling the battery 435
- Remote controls
  - Integrated 281
  - SmartKey 98, 102
  - SmartKey with KEYLESS-GO\* 102

## Index

- Remote door unlock
  - With Tele Aid\* 278
- Removing
  - Ski sack 257
  - Vehicle battery 435
  - Wheel 427
  - Wiper blades 424
- Removing and installing
  - Front seat head restraints 123
- Replacing
  - Bulbs 417
  - Front lamp bulbs 420
  - Fuses 443
  - License plate lamp bulbs 422
  - Rear lamp bulbs 418, 422
  - Side marker lamp bulb 422
  - Wiper blades 423
- Reporting
  - Safety defects 18
- Reprogramming
  - integrated remote control 284
- Reset button in the instrument cluster 154
- Resetting
  - All functions (control system) 154
  - All functions of a submenu 155
  - Fuel consumption 170
  - Maintenance service indicator 345
  - Service indicator (FSS) 346
  - Trip odometer 143
- Residual heat and ventilation 215
- Residual heat utilization 202
- Residual ventilation 202
- Restraint system see Infant and child restraint systems 71
- Rim 338
- Rims and Tires 453
- Roadside Assistance
  - Tele Aid\* 271
- Roadside assistance 12
- Rolling code programming 282
- RON 300
- RON (Research Octane Number) 475
- Roof rack\* 254
- Rotating tires 340
- Rubber parts
  - Cleaning 354
- S**
- Safety
  - Occupant 60
  - Safety belts see Seat belts 43
  - Safety defects
    - Reporting 18
  - Safety systems
    - Driving 85
  - Saving current speed 232
  - SBC 90
  - SBC brake system 475
    - Activation 91
    - Deactivation 92
    - Driving hints 92
    - Messages in display 380, 381
    - Self-check 92
    - Warning lamp 90
  - Seat belt force limiter 70



- Seat belts 67
  - Cleaning 353
  - Fastening 43
  - Proper use of 45, 69
  - Safety guidelines 64
  - Warning lamp 362
- Seat heater\*
  - Switching off 128
  - Switching on 128
- Seat ventilation\*
  - Switching off 128
  - Switching on 128
- Seating capacity 316
- Seats 121
  - Adjusting 37
  - Drive-dynamic seat\* with multicontour features 126
  - Easy entry/exit feature\* 121
  - Heater\* 127
  - Split rear bench seat\* 257
  - Ventilation 128
- Securing cargo
  - Cargo tie-down rings 261
- Selecting display 158, 159
- Selector lever
  - Lock 46, 174
- Message in the display 373
- Position (automatic transmission) 174
- Self-test
  - Occupant Classification System 79
  - Tele Aid\* 272
- Service
  - Batteries 433
- Service and warranty information 10
- Service life (tires) 312
- Setting
  - Convenience functions 156, 167
  - Cruise control 232
  - Daytime running lamp mode 162
  - Distronic\* time interval 242
  - Exterior rear view mirror parking position 132
  - Higher speed in cruise control 234
  - Higher speed in DISTRONIC\* 240
  - Hours (clock) 160
  - Individual vehicle settings 154
  - Interior lighting delayed switch-off 165
  - Lamps and lighting (control system) 162
  - Language, multifunction display 158
- Locator lighting 163
- Lower speed in cruise control 234
- Lower speed in DISTRONIC\* 241
- Miles/kilometers in speedometer 157
- Minutes (clock) 160, 161
- Parking position for exterior rear view mirrors 168
- Slower speed in cruise control 234
- Slower speed in DISTRONIC\* 241
- SmartKey dependent memory 168
- Speed in cruise control 234
- Speed in DISTRONIC\* 240
- Speedometer display mode 157
- Suspension tuning 247
- Synchronizing the time 160
- Temperature (interior) 197, 210
- Temperature indicator 157
- Tire inflation pressure 159
- Units
  - Speedometer 157
  - Temperature 157
  - Tire inflation pressure 159
- Vehicle level control 248

## Index

### Settings

- Calling up Distronic\* 152, 238
  - Convenience functions 167
  - Factory, KEYLESS-GO\* 105
  - Factory, SmartKey 99
  - Individual 168
  - Lighting (control system) 162
  - Menus and submenus 147
  - Resetting all (control system) 154
  - Resetting in the submenu 155
  - Selective 100, 106
- ### Settings menu
- Functions in 154
  - Individual vehicle settings 154
  - Submenus 155
- ### Shift lock 475
- ### Shifting
- Gear selector lever positions 178
  - Into optimal gear range (automatic transmission) 176
- ### Side impact airbags 66
- ### Side marker lamps 418, 422

### Side windows

- Automatic opening 219
  - Cleaning 352
  - Closing 218, 219
  - Opening 218
  - Opening fully (Express-open) 219
  - Stopping 220
  - Synchronizing power windows 220
- ### Sidewall 338
- ### Simultaneous wiping and washing
- Windshield wipers 52
- ### Single wipe 52
- ### Ski sack\* 254
- Removing 257
  - Unfolding and loading 254
  - Unloading and folding 256
- ### Sliding/pop-up roof\* 223
- Closing 223
  - Opening 223
  - Stopping 225, 229
  - Synchronizing 225
- ### Sliding/pop-up roof\* or panorama sliding/pop-up roof\*
- Emergency operations 414

### SmartKey 98

- Battery check lamp 100, 106
  - Checking the batteries 101, 107
  - Factory setting 99
  - Global locking 100
  - Global locking and unlocking 99
  - Global unlocking 99
  - Locking and unlocking 98
  - Loss of 102
  - positions in starter switch 33
  - Remote controls 98, 102
  - Restoring to factory setting 100, 106
  - Selective setting 100, 106
  - Starting the engine 46, 47
  - Unlocking with 32
- ### SmartKey with KEYLESS-GO\* 102
- Global locking and unlocking 105
  - Loss of 108
  - Messages in display 391
  - Remote controls 102
  - Turning off the engine 57
  - Unlocking with 33
- ### SmartKey-dependent memory
- Settings 168

- Snow chains 342
- Solar panel\* 230
- Spare fuses 443
- Spare wheel 407
- Speed
  - Saving current 232
- Speed settings
  - Cruise control 234
  - Distronic\* 240, 241
- Speedometer
  - Displays 237
  - Settings units 157
- Speedometer display mode
  - Selecting 157
- Split rear bench seat\* 257
- Sporty driving style 247
- SRS 475
- SRS indicator lamp 25, 364
- Standing lamps 133
- Standing water 295
- Starter switch 33
  - Positions 33
- Starting difficulties 48
- Starting position 33
- Starting the engine 46
- Steering column
  - Height adjustment 40
  - Length adjustment 40
- Steering wheel
  - Adjusting 39
  - Cleaning 354
  - Electrical adjustment 40
- Stolen vehicle
  - Tracking services 279
- Stopping
  - Sliding/pop-up roof\* 225, 229
  - Windows 220
- Storage compartment with cup holder in the armrest 266
- Storage compartments 262
  - Glove box 262
- Storage space under center armrest 263
- Storing (Memory function\*)
  - Positions into memory 131
- Storing tires 313
- Submenus
  - Convenience 167
  - For settings 147
  - In control system 149
  - Instrument cluster 157, 159
  - Lighting 162
  - Resetting functions in Control system 155
  - Selecting 155
  - Settings menu 155
  - Vehicle 166
- Sun visors 188
- Supplemental Restraint System (SRS) 475
- Suspension tuning
  - For comfortable driving style 247
  - For sporty driving style 247

## Index

- Switching off
  - Automatic central locking (control system) 166
  - Engine 56
  - ESP 89
  - Hazard warning flasher 138
  - Headlamps 56
  - Seat heating\* 128
- Switching on
  - Automatic central locking (control system) 166
  - ESP 90
  - Front fog lamps 136
  - Hazard warning flasher 138
  - Headlamps 50
  - High beams 137
  - Parking lamps 133
  - Rear fog lamp 137
  - Seat heating\* 128
  - Windshield wipers 51
- Symbol (Distronic\*)
  - Distance warning function\* 152
- Synchronizing
  - ESP 372
  - Panorama sliding/pop-up roof\* 229
  - Power windows 220
  - Sliding/pop-up roof\* 225
  - Time 160
- T**
- Tachometer 144
  - Displaying gear range 177
  - Overspeed range 144
- Tail lamps 422
- Tar stains 349
- Tele Aid
  - Messages in display 403, 404
- Tele Aid System 475
- Tele Aid\* 271
  - Emergency calls 273
  - Information 276
  - Initiating an emergency call manually 274
  - Remote door unlock 278
  - Roadside Assistance 275
  - Stolen vehicle tracking services 279
  - System self-check 272
  - Tele Aid System 271
  - Upgrade signals 277
- Telematics\* 475
- Telephone\* 26, 270
  - Answering a call 172
  - Dialing a number from the phone book 172
  - Ending a call 172
  - Loading phone book\* 172
  - Messages in the display 405
  - Operating 171
  - Redialing 173

- Temperature
  - Display mode 157
  - Sensor 29
  - Setting interior temperature 197
  - Setting units in display 157
  - Tires 321
- The coolant level is correct if the level 308
- Tie-down rings (trunk) 261
- Tightening torque 431, 475
- Time
  - Setting hours 160
  - Setting minutes 160, 161
- TIN 339
- Tire
  - Vehicle maximum load on 339
- Tire and Loading Information 315
- Tire and loading terminology 337
- Tire care and maintenance 312
- Tire Identification Number see TIN
- Tire inflation pressure
  - Checking 320
  - Setting units 159
- Tire inflation pressure see the placard on the fuel filler flap
- Tire inspection 312
- Tire load rating 339
- Tire ply composition and material used 339
- Tire speed rating 329, 339, 476
- Tire terminology 337
- Tire traction 292
- Tires
  - Direction of rotation 314
  - Driving instructions 290
  - Messages in display 399
  - Messages in the display 396, 397, 398
  - Retreads 311
  - Rotating 340
  - Service life 312
  - Temperature 321, 336
  - Tire pressure monitor warning lamp\* 363
  - Tread depth 313, 341
  - Wear pattern 340
  - Winter 341
- Tires and wheels
  - Tire inflation pressure 322
- Tools 409
- Tow-away alarm 95
  - Arming 95
  - Disarming 95
  - Disarming for transport 95
- Towing eye bolt (vehicle tool kit)
  - Installing 442
- Towing the vehicle 439
- Tracking services
  - For stolen vehicle 279
- Traction 180, 339, 476
- Transmission fluid level 308
- Tread 339
- Tread depth 313
- Tread depth (tires 341
- Treadwear indicators 339
- Trip computer 170
- Trip odometer
  - Resetting 143

## Index

Trunk  
Lamp 141  
Message in display 405  
Opening 110  
Opening from inside 110  
Tie-down rings 261  
Trunk lid emergency release 117  
Unlocking and opening with  
KEYLESS-GO\* 108  
Unlocking and opening with  
SmartKey 101  
Unlocking in an emergency 411  
Trunk lid  
Closing 112  
Turn signals 51  
Additional in mirrors 418  
Front bulbs 418  
Turning off  
Engine 56

**U**  
Uniform Tire Quality Grading  
Standards 339  
Units  
Setting speedometer units 157  
Setting temperature units 157  
Setting tire inflation pressure  
units 159  
Unlocking 32, 98, 410  
Driver's door in an emergency 410  
Fuel filler flap 299  
Global 99  
Global with KEYLESS-GO\* 105  
Selective settings 100, 106  
Trunk in an emergency 411  
Trunk lid with KEYLESS-GO\* 108  
Trunk lid with SmartKey 101  
Vehicle in an emergency 278  
With KEYLESS-GO\* 33  
With the SmartKey 32  
Upgrade signals  
Tele Aid\* 277  
Uphill driving  
Cruise control 232  
Upshifting 176

Useful features 262  
Ashtrays 268  
Cigarette lighter 269  
Garage door opener 279  
Heated steering wheel\* 270  
Tele Aid\* 271  
Telephone\* 270  
**V**  
Vehicle  
Individual settings 154, 156  
Locking in an emergency 411  
Lowering 431  
Towing 439  
Unlocking in an emergency 410  
Vehicle capacity weight 339

- Vehicle care
    - Cup holder 353
    - Distronic\* system sensor cover 351
    - Engine cleaning 350
    - Gear selector lever 353
    - Hard plastic trim items 353
    - Leather upholstery 354
    - Light alloy wheels 353
    - Ornamental moldings 350
    - Paintwork 349
    - Parktronic\* system sensor 351
    - Plastic and rubber parts 354
    - Power washer 349
    - Seat belts 353
    - Steering wheel 353
    - Tar stains 349
    - Vehicle washing 350
    - Window cleaning 352
    - Wood trims 354
  - Vehicle level
    - Changing 249
    - Setting 249
      - Automatic 249
      - Manual 249
  - Vehicle level control system\*
    - Airmatic DC\* 247
  - Vehicle loading terminology 337
  - Vehicle maximum load on the tire 339
  - Vehicle status message memory 153
    - Calling up 153
  - Vehicle tool kit 409
    - Alignment bolt 409
    - Fuse extractor 409
    - Hex-socket wrench 409
    - Open-end wrench 409
    - Screwdriver 409
    - Spare fuses 409
    - Towing eye bolt 409
    - Universal pliers 409
    - Wheel wrench 409
  - Vehicle washing 350
  - VIN (Vehicle Identification Number) 476
  - Voice control system\* 476
- W**
- Warning lamps see Lamps, indicator and warning
  - Warning sounds
    - Distance warning function\* 243
    - Distronic\* 237
    - Drivers seat belts 67
    - Parking brake 49
    - Parktronic system\* 253
  - Warranty coverage 447
  - Washing the vehicle 348
  - Wear pattern (tires) 340
  - Weights 460
  - Wheel change 425
    - Tightening torque 431
  - Wheels
    - Tires and wheels 311
  - Window curtain airbags 66
  - Windows see Side windows 218
  - Windshield
    - Defogging 198, 211
    - Refilling washer fluid 310
    - Replacing wiper blades 424
    - Washer fluid 310

## Index

- Windshield washer fluid
    - Message in display 405
    - Refilling 310
    - Wiping with 52
  - Windshield wipers 51
    - Fast wiper speed 52
    - Intermittent wiping 52
    - Replacing wiper blades 423, 424
    - Single wipe 52
    - Switching on 51
    - Wiping with windshield washer fluid 52
  - Winter driving
    - Block heater\* 342
    - Snow chains 342
    - Tires 341
    - Transmission program mode 179
    - Winter tires 341
  - Winter driving instructions 294
  - Winter tires 341
  - Wiper blades 351
    - Installing 424
    - Removing 424
    - Replacing 424
  - Wiping
    - And washing simultaneously 52
    - Interval 52
    - With windshield washer fluid 52
  - Wood trims
    - Cleaning 354
- X**
- Xenon headlamps\*
    - Bi-Xenon\* 471



### Service and Literature

Your authorized Mercedes-Benz Center has trained technicians and original Mercedes-Benz parts to service your vehicle properly. For expert advice and quality service, see your authorized Mercedes-Benz Center.

If you are interested in obtaining service literature for your vehicle, please contact your authorized Mercedes-Benz Center. We consider this the best way for you to obtain accurate information for your vehicle.

For further information you can find us on the Mercedes-Benz web-site [www.mbusa.com](http://www.mbusa.com) or [www.mercedes-benz.ca](http://www.mercedes-benz.ca).

#### Warning



To help avoid personal injury, be extremely careful when performing any service work or repairs. Improper or incomplete service or the use of incorrect or inappropriate parts or materials may damage the vehicle or its equipment, which may in turn result in personal injury.

If you have any questions about carrying out any type of service, turn to the advice of an authorized Mercedes-Benz Center.

We reserve the right to modify the technical details of the vehicle as given in the data and illustrations of this Operator's Manual. Re-printing, translation and copying, even of excerpts, is not permitted without our prior authorization in writing.

Title illustration no. P00.01-2282-31

Press time May 7, 2004

GSP/TIP

Printed in Germany

