

ML 350

ML 500

Our company and staff congratulate you on the purchase of your new Mercedes-Benz.

Your selection of our product is a demonstration of your trust in our company name. Furthermore, it exemplifies your desire to own an automobile that will be as easy as possible to operate and provide years of service.

Your Mercedes-Benz represents the efforts of many skilled engineers and craftsmen. To help assure your driving pleasure, and also the safety of you and your passengers, we ask you to make a small investment of time:

- Please read this manual carefully, then return it to your vehicle where it will be handy for your reference.
- Please follow the recommendations contained in this manual. They are designed to acquaint you with the operation of your Mercedes-Benz.
- Please pay attention to the warnings and cautions contained in this manual. They are designed to help improve the safety of the vehicle operator and occupants.

We extend our best wishes for many miles of safe, pleasurable driving.

Mercedes-Benz USA, LLC  
A DaimlerChrysler Company

## Contents

<b>Introduction</b> .....	9	<b>At a glance</b> .....	21	Driving.....	42
Product information.....	9	Cockpit.....	22	Fastening the seat belts .....	42
Operator's Manual.....	10	Instrument cluster .....	24	Starting the engine .....	46
Service and warranty information ..	10	Center console .....	27	Switching on headlamps.....	48
Important notice for California		Upper part .....	27	Turn signals .....	49
retail buyers and lessees		Lower part .....	28	Windshield wipers.....	49
of Mercedes-Benz automobiles .....	11	Overhead control panel .....	29	Rear window wiper .....	51
Maintenance .....	12			Problems while driving.....	51
Roadside Assistance .....	12			Parking and locking.....	53
Change of address or ownership....	13	<b>Getting started</b> .....	31	Parking brake .....	53
Operating your vehicle outside		Unlocking .....	32	Switching off headlamps.....	54
the USA or Canada.....	13	Remote control with folding key .....	32	Turning off engine.....	54
Where to find it.....	15	Adjusting .....	34		
Symbols.....	16	Seats.....	34		
Operating safety .....	17	Steering wheel .....	39		
Proper use of the vehicle .....	17	Mirrors.....	40		
Problems with your vehicle.....	18				
Reporting safety defects.....	19				
Reporting safety defects .....	19				

## Contents

<b>Safety and Security</b> .....	57	<b>Controls in detail</b> .....	87	Lighting .....	107
Occupant safety.....	58	Locking and unlocking.....	88	Combination switch .....	107
Airbags.....	59	Remote control with folding key.....	88	Fog lamps .....	111
Seat belts.....	64	Opening the doors		Hazard warning flasher .....	112
Children in the vehicle.....	67	from the inside.....	90	Interior lighting .....	112
Blocking of rear door		Opening the liftgate .....	91	Instrument cluster .....	116
window operation.....	73	Closing the liftgate.....	92	Instrument cluster illumination ....	116
Panic alarm.....	75	Automatic central locking .....	93	Coolant temperature gauge .....	117
Activating.....	75	Locking and unlocking		Display in the speedometer .....	117
Deactivating.....	75	from the inside.....	94	Resetting trip odometer.....	118
Driving and safety systems .....	76	Seats .....	95	Tachometer.....	118
ABS .....	76	Removing and installing		Outside temperature indicator .....	118
BAS .....	78	front seat head restraints.....	95	Setting the clock.....	118
4-ETS.....	79	Rear seat head restraints .....	96	Automatic transmission.....	119
EBP.....	80	Heated seats* .....	98	One-touch gearshifting .....	120
ESP.....	80	Rear seats .....	99	Gear ranges .....	121
Anti-theft systems.....	83	Third row seats* .....	102	Gear selector lever position .....	122
Immobilizer.....	83	Memory function* .....	105	Accelerator position.....	123
Anti-theft alarm .....	83	Storing exterior rear view mirror		Towing a trailer .....	124
Tow-away alarm,		parking position .....	105	Emergency operation	
glass breakage sensor.....	84	Storing positions in memory .....	106	(Limp Home Mode) .....	124
		Recalling positions from memory.	106		

## Contents

Transmission control –			
LOW RANGE mode.....	125	Power windows .....	144
Switching on LOW RANGE mode..	125	Opening and closing	
Switching off LOW RANGE mode .	125	the side windows .....	144
Good visibility .....	126	Synchronizing power windows.....	146
Rear view mirror.....	126	Rear quarter windows* .....	146
Electrically folding exterior		Sliding / pop-up roof* .....	148
rear view mirrors.....	128	Opening and closing the	
Windshield wipers .....	129	sliding / pop-up roof .....	148
Headlamp cleaning system* .....	131	Synchronizing the	
Rear window wiper.....	131	sliding / pop-up roof .....	149
Sun visor .....	132	Driving systems .....	150
Rear window defroster .....	133	Cruise control .....	150
Automatic climate control .....	134	Parktronic system*	
Automatic mode.....	137	(Parking assist) .....	153
Adjusting air volume and		Loading.....	157
air distribution manually.....	137	Loading instructions .....	157
Defrosting .....	138	Partition net* .....	159
Air recirculation mode.....	138	Cargo area cover blind* .....	161
Air conditioning.....	139	Cargo floor plates .....	162
Residual heat and ventilation .....	140	Roof rack* .....	163
Rear passenger compartment			
ventilation and rear automatic			
climate control.....	141		
Front and rear air vents.....	142	Useful features.....	164
		Interior storage spaces.....	164
		Cup holders .....	166
		Armrest in rear seat bench .....	167
		Ashtrays and cigarette lighter.....	168
		Electrical outlet.....	170
		Telephone* .....	170
		Tele Aid* .....	171
		Garage door opener.....	180
		Trip computer* .....	186

## Contents

<b>Operation</b> .....	191	At the gas station .....	214	Maintenance.....	232
The first 1000 miles (1500 km) .....	192	Refueling .....	214	Clearing the service indicator .....	232
Driving instructions.....	193	Check regularly and before a long trip.....	215	Service term exceeded .....	233
Drive sensibly – save fuel.....	193	Engine compartment .....	217	Calling up the service indicator....	233
Drinking and driving .....	193	Hood .....	217	Resetting the service indicator ....	233
Pedals .....	193	Engine oil .....	218	Vehicle care.....	234
Power assistance .....	193	Transmission fluid level.....	222	Cleaning and care of the vehicle..	234
Brakes .....	194	Coolant .....	222		
Driving off.....	195	Battery .....	223	<b>Practical hints</b> .....	241
Parking .....	196	Windshield washer system and headlamp cleaning system* .....	224	What to do if ... ..	242
Tires .....	196	Tires and wheels.....	226	Lamps in instrument cluster .....	242
Hydroplaning.....	197	Important guidelines .....	226	Additional indicators in the speedometer display.....	256
Tire traction.....	197	Life of tire.....	227	Where will I find ...? .....	257
Tire speed rating .....	198	Direction of rotation .....	227	First aid kit.....	257
Winter driving instructions .....	198	Checking tire inflation pressure ...	227	Vehicle tool kit.....	257
Standing water .....	200	Rotating wheels .....	228	Spare wheel (space-saver tire)....	259
Off-road driving .....	200	Winter driving .....	230	Unlocking/locking in an emergency.	261
Trailer towing .....	206	Winter tires .....	230	Unlocking the vehicle.....	261
Passenger compartment .....	211	Block heater (Canada only) .....	231	Locking the vehicle .....	262
Driving abroad.....	211	Snow chains.....	231	Changing batteries in the remote control .....	262
Control and operation of radio transmitters.....	211			Fuel filler flap .....	263
Catalytic converter .....	212			Manually unlocking the transmission gear selector lever ..	264
Emission control.....	212				
Coolant temperature .....	213				

## Contents

Opening /closing in an emergency ....	265	Fuses.....	287	Fuels, coolants, lubricants etc.....	300
Sliding / pop-up roof* .....	265	Fuse box in engine		Capacities.....	300
Replacing bulbs .....	266	compartment .....	287	Engine oils .....	302
Bulbs .....	266	Auxiliary fuse box in front		Engine oil additives.....	302
Replacing bulbs for front lamps ...	268	passenger footwell.....	288	Air conditioning refrigerant.....	302
Replacing bulbs for rear lamps.....	270			Brake fluid .....	302
Adjusting headlamp aim.....	272			Premium unleaded gasoline.....	303
Replacing wiper blades.....	273	<b>Technical data</b> .....	289	Fuel requirements.....	303
Removing .....	273	Spare parts service.....	290	Gasoline additives.....	303
Installing .....	273	Warranty coverage .....	291	Coolants .....	304
Flat tire .....	274	Loss of Service and Warranty		Anticorrosion / antifreeze.....	305
Mounting the spare wheel.....	274	Information Booklet .....	291	Windshield washer system and	
Battery.....	278	Identification labels .....	292	headlamp cleaning system* .....	307
Disconnecting the battery.....	279	Layout of poly-V-belt drive.....	293	Windshield and headlamp	
Removing the batteries .....	279	Engine .....	294	washer fluid mixing ratio.....	307
Charging and reinstalling		Rims and tires .....	295	Consumer information.....	308
batteries.....	279	Rims and tires.....	295	Uniform tire quality grading .....	308
Reconnecting the batteries .....	279	Spare wheel.....	296	Temperature .....	309
Jump starting .....	281	Electrical system .....	297		
Towing the vehicle .....	283	Main Dimensions .....	298		
Front towing eye .....	285	Weights .....	299	<b>Technical terms</b> .....	311
Rear towing eye .....	285				
Stranded vehicle .....	286			<b>Index</b> .....	317





▼ **Product information**

Please observe the following in your own best interest:

We recommend using genuine Mercedes-Benz parts as well as conversion parts and accessories explicitly approved by us for your vehicle model.

We have tested these parts to determine their reliability, safety and special suitability for Mercedes-Benz vehicles.

We are unable to make an assessment for other products and therefore cannot be held responsible for them, even if in individual cases an official approval or authorization by governmental or other agencies should exist. Use of such parts and accessories could adversely affect the safety, performance or reliability of your vehicle. Please do not use them.

Genuine Mercedes-Benz parts as well as conversion parts and accessories approved by us are available at your authorized Mercedes-Benz Light Truck Center where you will receive comprehensive information, also on permissible technical modifications, and where proper installation will be performed.

## Introduction

### Operator's Manual

#### ▼ Operator's Manual

This Operator's Manual contains a great deal of useful information. We urge you to read it carefully and familiarize yourself with the vehicle before driving.

For your own safety and longer service life of the vehicle, we urge you to follow the instructions and warnings contained in this manual. Ignoring them could result in damage to the vehicle or personal injury to you or others. Vehicle damage caused by failure to follow instructions is not covered by the Mercedes-Benz Limited Warranty.

Your vehicle may have some or all of the equipment described in this manual. Therefore, you may find explanations for optional equipment not installed in your vehicle. If you have any questions about the operation of any equipment, your authorized Mercedes-Benz Light Truck Center will be glad to demonstrate the proper procedures.

We continuously strive to improve our product, and ask for your understanding that we reserve the right to make changes in design and equipment. Therefore, information, illustrations and descriptions in this Operator's Manual might differ from your vehicle.

Optional equipment is also described in this manual, including operating instructions wherever necessary. Since they are special-order items, the descriptions and illustrations herein may vary slightly from the actual equipment of your vehicle.

If there are any equipment details that are not shown or described in this Operator's Manual, your authorized Mercedes-Benz Light Truck Center will be glad to inform you of correct care and operating procedures.

The Operator's Manual and Service Booklet are important documents and should be kept with the vehicle.

#### Service and warranty information

The Service and Warranty Information Booklet contains detailed information about the warranties covering your Mercedes-Benz, including:

- New Light Truck Limited Warranty,
- Emission System Warranty,
- Emission Performance Warranty,
- California, Maine, Massachusetts, and Vermont Emission Control System Warranty (California, Maine, Massachusetts, and Vermont only),
- State Warranty Enforcement Laws (Lemon Laws).

**Important notice for California retail buyers and lessees of Mercedes-Benz automobiles**

Under California law you may be entitled to a replacement of your vehicle or a refund of the purchase price or lease price, if Mercedes-Benz USA, LLC and / or its authorized repair or service facilities fail to fix one or more substantial defects or malfunctions in the vehicle that are covered by its express warranty after a reasonable number of repair attempts. During the period of 18 months from original delivery of the vehicle or the accumulation of 18 000 miles (approx. 29 000 km) on the odometer of the vehicle, whichever occurs first, a reasonable number of repair attempts is presumed for a retail buyer or lessee if one or more of the following occurs:

- (1) the same substantial defect or malfunction results in a condition that is likely to cause death or serious bodily injury if the vehicle is driven, that defect or malfunction has been subject to repair two or more times, and you have directly notified Mercedes-Benz USA, LLC in writing of the need for its repair,
- (2) the same substantial defect or malfunction of a less serious nature than category (1) has been subject to repair four or more times and you have directly notified us in writing of the need for its repair, or
- (3) the vehicle is out of service by reason of repair of the same or different substantial defects or malfunctions for a cumulative total of more than 30 calendar days. Written notification should be sent to us, not a dealer, at Mercedes-Benz USA, LLC, Customer Assistance Center, One Mercedes Drive, Montvale, NJ 07645-0350.

## Introduction

### Operator's Manual

#### Maintenance

---

The Service Booklet describes all the necessary maintenance work which should be performed at regular intervals.

Always have the Service Booklet with you when you take the vehicle to your authorized Mercedes-Benz Light Truck Center for service. The service advisor will record each service in the booklet for you.

#### Roadside Assistance

---

The Mercedes-Benz Roadside Assistance Program provides factory-trained technical help in the event of a breakdown. Calls to the toll-free Roadside Assistance number

**1-800-FOR-MERCEdes (in the USA)**  
**1-800-387-0100 (in Canada)**

will be answered by Mercedes-Benz Customer Assistance Representatives 24 hours a day, 365 days a year.

Roadside Assistance will be provided in accordance with standard program guidelines which include providing service to the vehicle up to a reasonable distance from a paved roadway. We will make every effort to assist in a breakdown situation, however, the accessibility of your vehicle will be determined by our authorized Mercedes-Benz Light Truck Center technician or the tow service provider on a case-by-case basis and may be a factor in our ability to respond.

Additional charges may be applicable for a breakdown location determined not to be a reasonably accessible roadside location as determined by our authorized technician and tow service provider.

For additional information refer to the Mercedes-Benz Roadside Assistance Program Brochure in your glove box.

### Change of address or ownership

---

If you change your address, be sure to send in the "Change of Address Notice" found in the Service and Warranty Information Booklet, or simply call the Mercedes-Benz Customer Assistance Center (in the USA) at 1-800-FOR-MERCEdes, or Customer Service (in Canada) at 1-800-387-0100. It is in your own interest that we can contact you should the need arise.

If you sell your Mercedes, please leave all literature with the vehicle to make it available to the next operator.

If you bought this vehicle used, be sure to send in the "Notice of Purchase of Used Truck" found in the Service and Warranty Information Booklet, or call the Mercedes-Benz Customer Assistance Center (in the USA) at 1-800-FOR-MERCEdes, or Customer Service (in Canada) at 1-800-387-0100.

### Operating your vehicle outside the USA or Canada

---

If you plan to operate your vehicle in foreign countries, please be aware that:

- service facilities or replacement parts may not be readily available,
- unleaded gasoline for vehicles with catalytic converters may not be available; the use of leaded fuels will damage the catalyts,
- gasoline may have a considerably lower octane rating, and improper fuel can cause engine damage.

## Introduction

### Operator's Manual

#### Warning!



This Sport Utility Vehicle is designed for both on-road and off-road use. It can go places and perform tasks for which conventional 2-wheel drive passenger cars are not intended. This vehicle will handle and maneuver differently from conventional passenger cars in driving conditions which may occur on streets, highways and off-road use.

This vehicle has a higher ground clearance and a higher center of gravity than many passenger cars. As with other vehicles of this type, if you make sharp turns at excessive speeds or abrupt maneuvers, the vehicle may roll over or may go out of control and crash. Utility vehicles have a significantly higher rollover rate than other types of vehicles. Failure to operate this vehicle safely may result in an accident, rollover of the vehicle, and severe or fatal injury.

Before you start to drive this vehicle, read the Operator's Manual. Take time to become familiar with the driving characteristics of this vehicle. Be sure you are familiar with all vehicle controls. Learn how your vehicle handles on different road surfaces. Do not attempt sharp turns at excessive speeds or abrupt maneuvers or other unsafe driving actions that can cause loss of vehicle control. When driving off-road or working the vehicle hard, do not overload it. And, always wear your seat belts at all times. In a rollover crash, an unbelted person is significantly more likely to die than a person wearing a seat belt.

#### ▼ Where to find it

This Operator's Manual is designed to provide comprehensive support information for you, the vehicle operator. Each section has its own reference color so you can find information quickly.

#### At a glance

Here you will find an overview of all the controls that can be operated from the driver's seat.

#### Getting started

Here you will find all the information you need for your first drive. You should read this section first if this is your first Mercedes-Benz vehicle or if you are renting or borrowing this vehicle.

#### Safety and Security

Here you will find descriptions of the safety features of your vehicle.

#### Controls in detail

Here you will find detailed information about the equipment installed on your vehicle. This section expands on the "Getting started" section and also describes technical innovations. If you are already familiar with the basic functions of your vehicle, this section will be of particular interest to you.

#### Operation

Here you will find all the information you need for the proper operation of your vehicle.

#### Practical hints

This section provides fast assistance for dealing with problems you may encounter.

#### Technical data

All important technical data for your vehicle can be found in this section.

#### Indexes

The glossary provides explanations of the most important technical terms.

The table of contents and the index are designed to help you find information quickly and easily.

The following publications are part of your vehicle documentation:

- this Operator's Manual
- the Service Booklet

Separate operating instructions will be provided as required depending on the equipment options installed in your vehicle.

## Introduction

### Symbols

#### ▼ Symbols

The following symbols are found in this Operator's Manual:

- \* Optional equipment is identified with an asterisk. Since standard equipment varies between models, the descriptions and illustrations in this manual may differ slightly from the actual equipment of your vehicle.

#### Warning!



Warning notices draw your attention to hazards that may endanger your health or life, or the health or life of others.



Highlights hazards that may result in damage to your vehicle.



Helpful hints or further information you may find useful.

- ▶ This symbol points to instructions for you to follow.
- ▶ A number of these symbols appearing in succession indicates a multiple-step procedure.
- ▷ Page This symbol tells you where to look for further information on a topic.
- ▷▷ This continuation symbol marks an interrupted procedure which will be continued on the next page.
- > In the glossary of technical terms, this symbol is used to indicate cross-references to term definitions.
- Display Words appearing in the multi-function display are printed in the type shown here.



#### ▼ Operating safety

##### Warning!



Work improperly carried out on electronic components and associated software could cause them to cease functioning. Because the vehicle's electronic components are interconnected, any modifications made may produce an undesired effect on other systems. Electronic malfunctions could seriously impair the operating safety of your vehicle.

See your authorized Mercedes-Benz Light Truck Center for repairs or modifications to electronic components.

Other improper work or modifications on the vehicle could also have a negative impact on the operating safety of the vehicle.

Some safety systems only function while the engine is running. You should therefore never turn off the engine while driving.

##### Warning!



Heavy blows against the vehicle underbody or tires / wheels, for example when running over an obstacle, road debris or a pothole, may cause serious damage and impair the operating safety of your vehicle. If you feel a sudden significant vibration or ride disturbance, or you suspect that damage to your vehicle has occurred, you should turn on your hazard warning flashers, carefully slow down, and drive with caution to an area which is a safe distance from the road.

Inspect the vehicle underbody and tires / wheels for possible damage. If the vehicle appears unsafe, have it towed to the nearest authorized Mercedes-Benz Light Truck Center or other qualified maintenance or repair facility for further inspection or repairs.

#### Proper use of the vehicle

Proper use of the vehicle requires that you are familiar with the following information and rules:

- the safety precautions in this manual
- the “Technical data” section in this manual
- traffic rules and regulations
- motor vehicle laws and safety standards

##### Warning!



Various warning labels are attached to your vehicle. These warning labels are intended to make you and others aware of various risks. You should not remove any of these warning labels unless explicitly instructed to do so by information on the label itself. Removal of any of these labels may cause you and others to be unaware of certain risks which may result in an accident and / or personal injury.

## Introduction

### Problems with your vehicle

#### ▼ Problems with your vehicle

If you should experience a problem with your vehicle, particularly one that you believe may affect its safe operation, we urge you to immediately contact your authorized Mercedes-Benz Light Truck Center to have the problem diagnosed and corrected if required. If the matter is not handled to your satisfaction, please discuss the problem with the Mercedes-Benz Light Truck Center management, or if necessary contact us at one of the following addresses:

In the USA:

Customer Assistance Center  
Mercedes-Benz USA, LLC  
One Mercedes Drive  
Montvale, NJ 07645-0350

In Canada:

Customer Relations Department  
Mercedes-Benz Canada, Inc.  
849 Eglinton Avenue East  
Toronto, Ontario, M4G 2L5

▼ **Reporting safety defects**

For the USA only:

The following text is published as required of manufacturers under Title 49, Code of U.S. Federal Regulations, Part 575 pursuant to the “National Traffic and Motor Vehicle Safety Act of 1966”.

**Reporting safety defects**

---

If you believe that your vehicle has a defect which could cause a crash or could cause injury or death, you should immediately inform the National Highway Traffic Safety Administration (NHTSA) in addition to notifying Mercedes-Benz USA, LLC.

If NHTSA receives similar complaints, it may open an investigation, and if it finds that a safety defect exists in a group of vehicles, it may order a recall and remedy campaign. However, NHTSA cannot become involved in individual problems between you, your dealer, or Mercedes-Benz USA, LLC.

To contact NHTSA, you may either call the Auto Safety Hotline toll-free at 1-888-327-4236 (or 366-0123 in Washington, D.C. area) or write to: NHTSA, U.S. Department of Transportation, Washington, D.C. 20590. You can also obtain other information about motor vehicle safety from the Hotline.



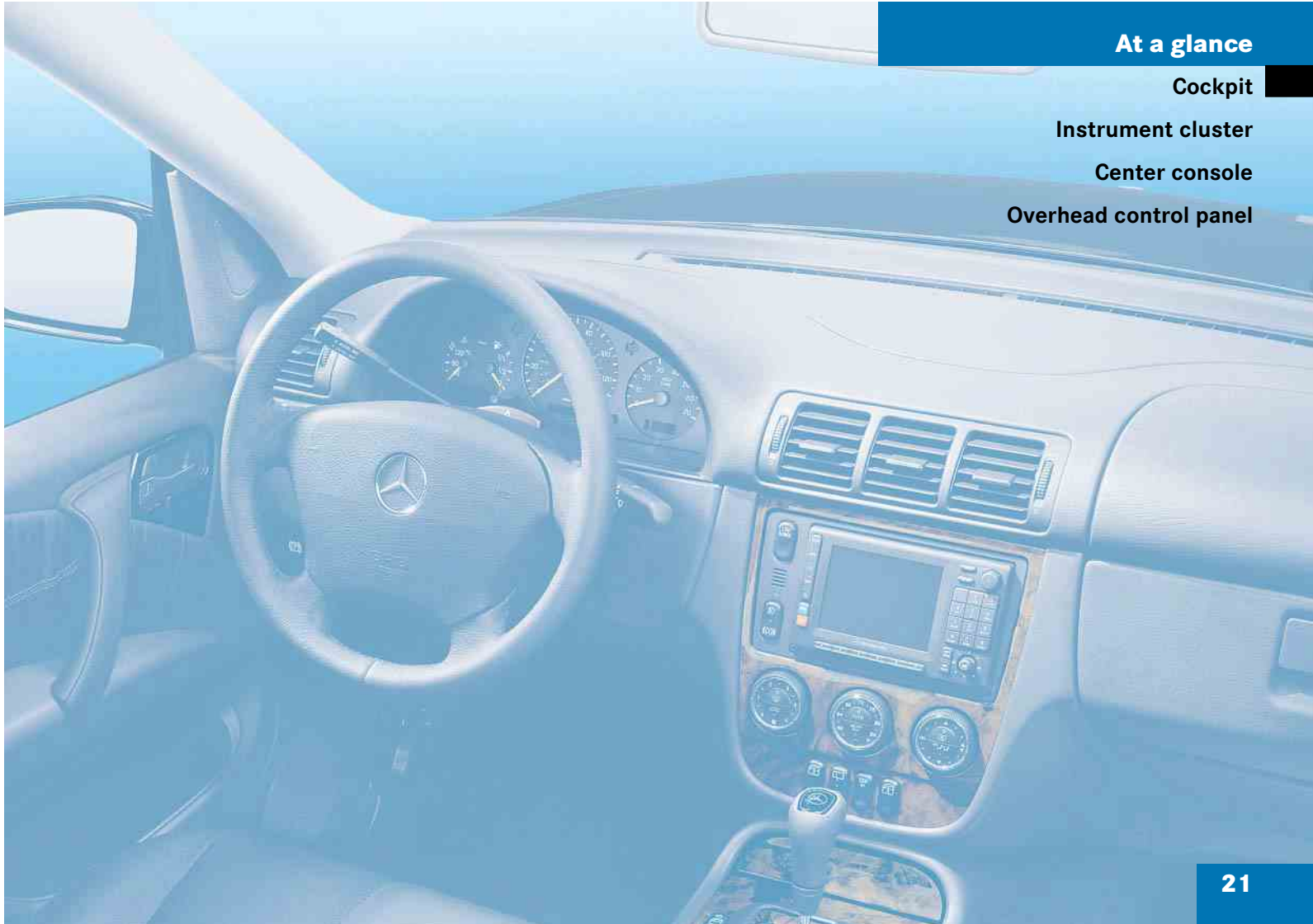

**At a glance**

**Cockpit**

**Instrument cluster**

**Center console**

**Overhead control panel**

## At a glance

### Cockpit

#### ▼ Cockpit

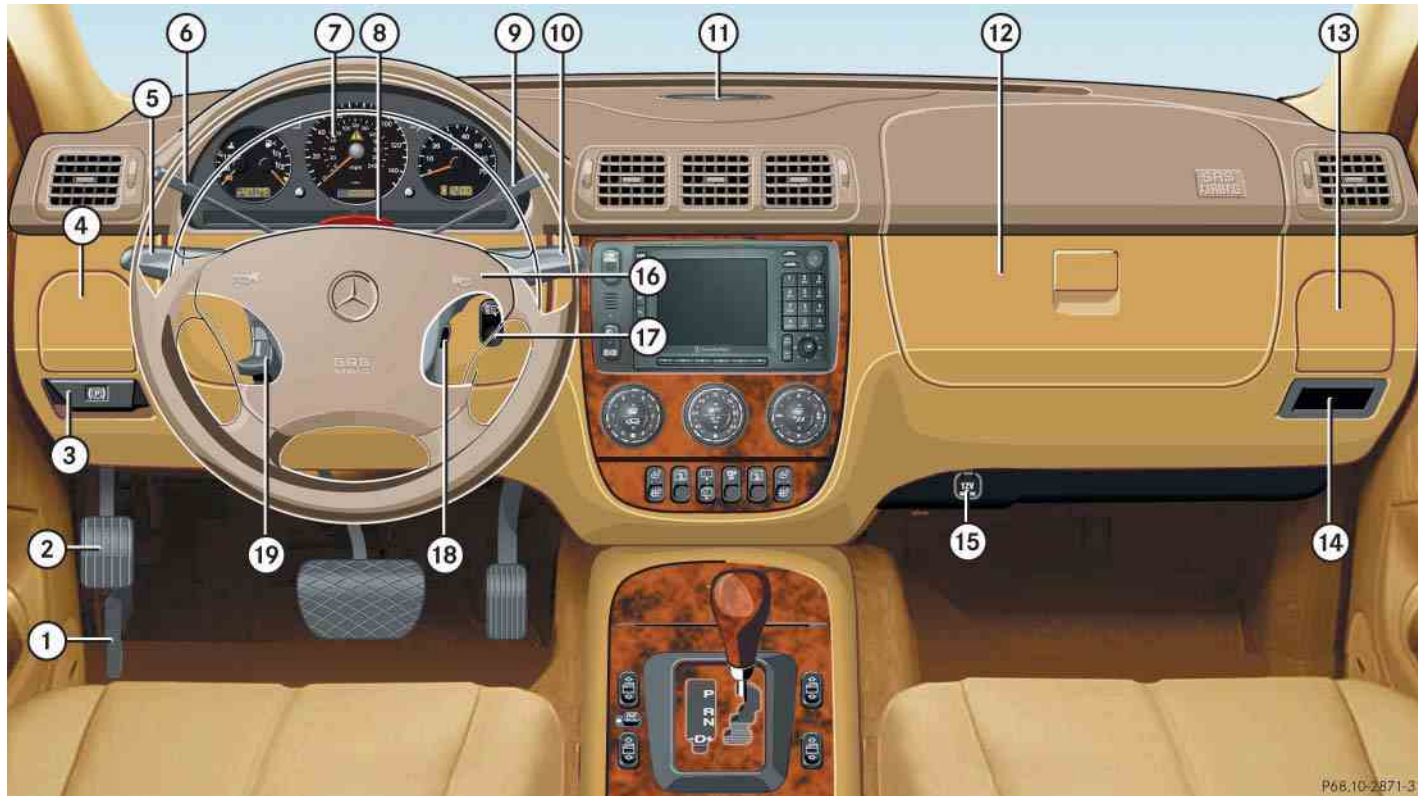

	Item	Page
①	Hood lock release	217
②	Parking brake pedal	53
③	Parking brake release	53
④	Left cup holder	166
⑤	Combination switch <ul style="list-style-type: none"> <li>• Exterior lights</li> <li>• High beam</li> <li>• Turn signals</li> </ul>	49
⑥	Cruise control lever	150
⑦	Instrument cluster	116
⑧	Hazard warning flasher switch	112
⑨	Lever for voice control system*, see separate operating instructions	

	Item	Page
⑩	Windshield wiper / washer switch	49
⑪	Front Parktronic* warning indicator	155
⑫	Glove box	164
⑬	Right cup holder	166
⑭	Storage compartment	
⑮	Electrical outlet	170
⑯	Horn	
⑰	Headlamp washer button*	131
⑱	Steering lock with ignition	33
⑲	Steering wheel lever	39

## At a glance

### Instrument cluster

#### ▼ Instrument cluster

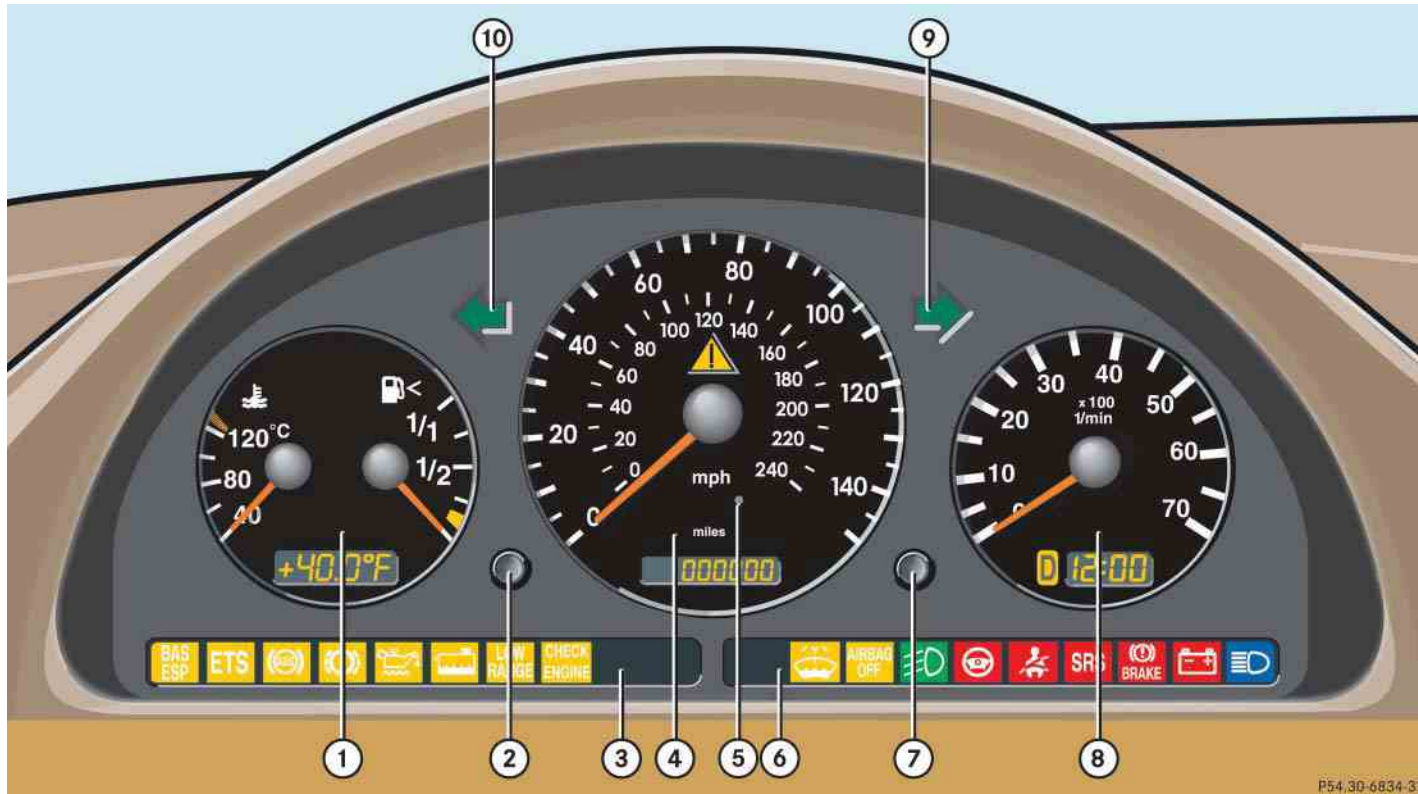





P54.30-6834-31







## At a glance

### Instrument cluster



	Item	Page
①	<b>Gauge for</b>	
	Coolant temperature	117
	Outside temperature	118
	Fuel reserve warning lamp	252
②	<b>Knob for</b>	
	Activating instrument cluster	116
	Adjusting intensity of instrument lamps	116
	Main odometer	117
	Trip odometer readout / reset	118
	Activating Flexible Service System (FSS) indicator	232







	Item	Page
③	<b>Left indicator lamps with:</b>	
	 Brake Assist System (BAS) / Electronic Stability Program (ESP) malfunction warning lamp	246
	 Electronic Traction System (4-ETS) malfunction indicator lamp	252
	 Antilock Brake System (ABS) malfunction warning lamp	242
	 Brake pad wear indicator lamp	254
	 Low engine oil level warning lamp	253



	Item	Page
	 Low engine coolant level warning lamp	249
	 Low range indicator lamp	252
	 Engine malfunction indicator lamp	248
④	<b>Speedometer with:</b>	
	 4-ETS (Electronic Traction System)/Electronic Stability Program (ESP) warning lamp	251
	Trip / main odometer	117
	Display for Flexible Service System (FSS)	232
	Engine oil level indicator	219

## At a glance

### Instrument cluster

	Item	Page
⑤	<b>Photo sensor</b> (adjusts the brightness of the digital displays located in 1, 4 and 8)	
⑥	<b>Right indicator lamps with:</b>	
	 Low wind-shield/headlamp washer system fluid level warning lamp	253
	 Front passenger air-bag switched off	243
	 Front fog lamp switched on	111

	Item	Page
	 Steering wheel adjustment not locked	253
	 Seat belt non-usage warning lamp	253
	 Supplemental Restraint System (SRS) indicator lamp	255
	 Brake warning lamp	244
	 Charge indicator lamp	254
	 High beam headlamp indicator	49

	Item	Page
⑦	<b>Knob for setting clock</b>	118
⑧	<b>Tachometer with:</b>	
	Display for Selector lever position	121
	Clock	118
⑨	 Right turn signal indicator lamp	
⑩	 Left turn signal indicator lamp	

## At a glance

### Center console

#### ▼ Center console

##### Upper part

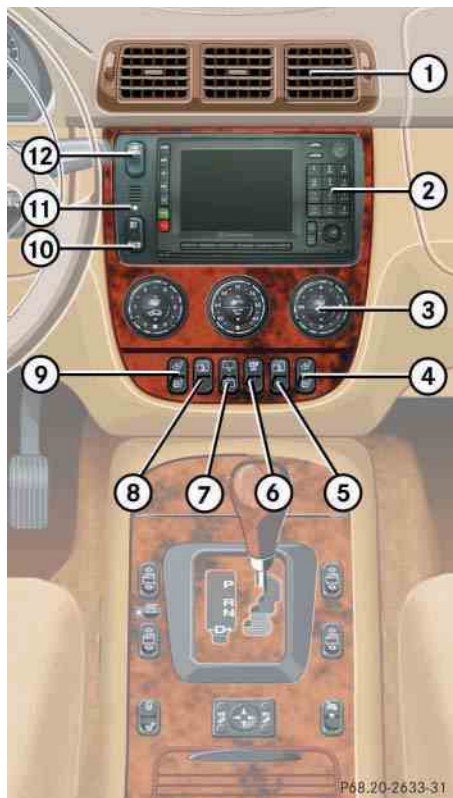

Item	Page
① Air vents, automatic climate control	142
② MCS, see separate operating instructions	
③ Automatic climate control	134
Rear window defroster switch	133
④ Seat heater switch*, passenger side	98
⑤ Rear quarter window switch*, right	146
⑥ ESP control switch	80

Item	Page
⑦ Rear window wiper/washer switch	51
⑧ Rear quarter window switch*, left	146
⑨ Seat heater switch*, driver's side	98
⑩ Front and rear fog lamp switch	111
⑪ Indicator lamp for antitheft alarm system	83
⑫ Transmission control switch, LOW RANGE mode	125

## At a glance

### Center console

#### Lower part

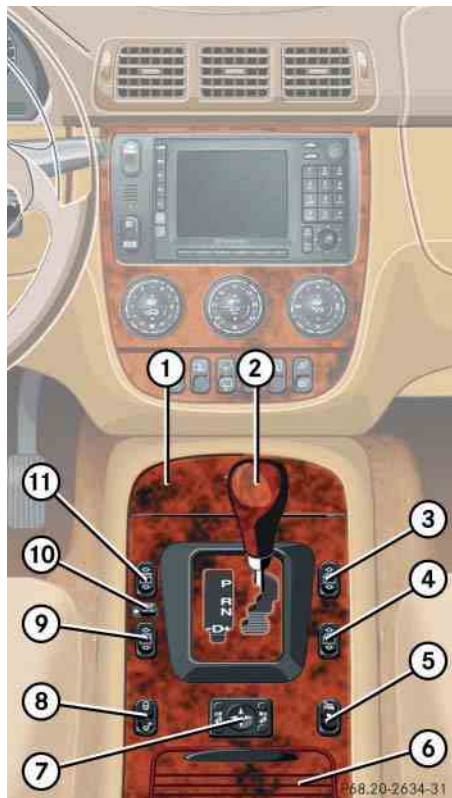

	Item	Page
①	Ashtray with cigarette lighter	168
②	Gear selector lever for automatic transmission	46
③	Power window switch, right front door	144
④	Power window switch, right rear door	144
⑤	Parktronic system* deactivation switch	156
⑥	Storage compartment with cup holder	166

	Item	Page
⑦	Exterior rear view mirror adjustment switch	40
	Exterior rear view mirror electrically folding*	128
⑧	Central locking switch	93
⑨	Power window switch, left rear door	144
⑩	Switch for rear door window override	73
⑪	Power window switch, left front door	144

## At a glance

### Overhead control panel

#### ▼ Overhead control panel

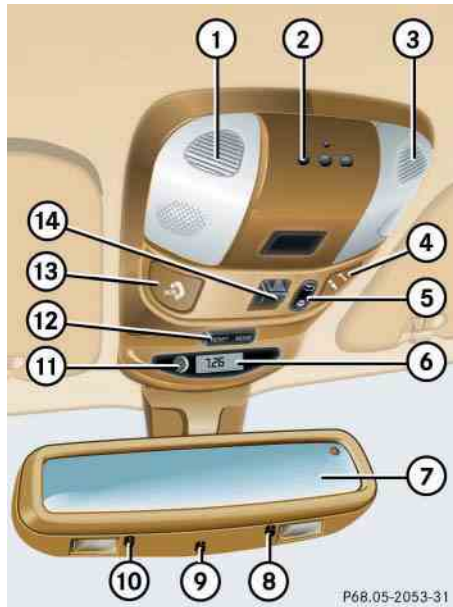

Item	Page
① Front left interior lighting	112
② Signal transmitter buttons for garage door opener	180
③ Front right interior lighting	112
④ Roadside Assistance button	175
Information button	177
⑤ Interior lighting control	112
⑥ Trip computer* display	186
⑦ Rear view mirror	126

Item	Page
⑧ Right reading lamp on / off	114
⑨ Automatic antiglare function* on / off	126
⑩ Left reading lamp on / off	114
⑪ Glass breakage sensor	84
⑫ Trip computer* control	186
Tow-away alarm switch	85
⑬ Tele Aid* (emergency call system) button	171
⑭ Sliding / pop-up roof* switch	148



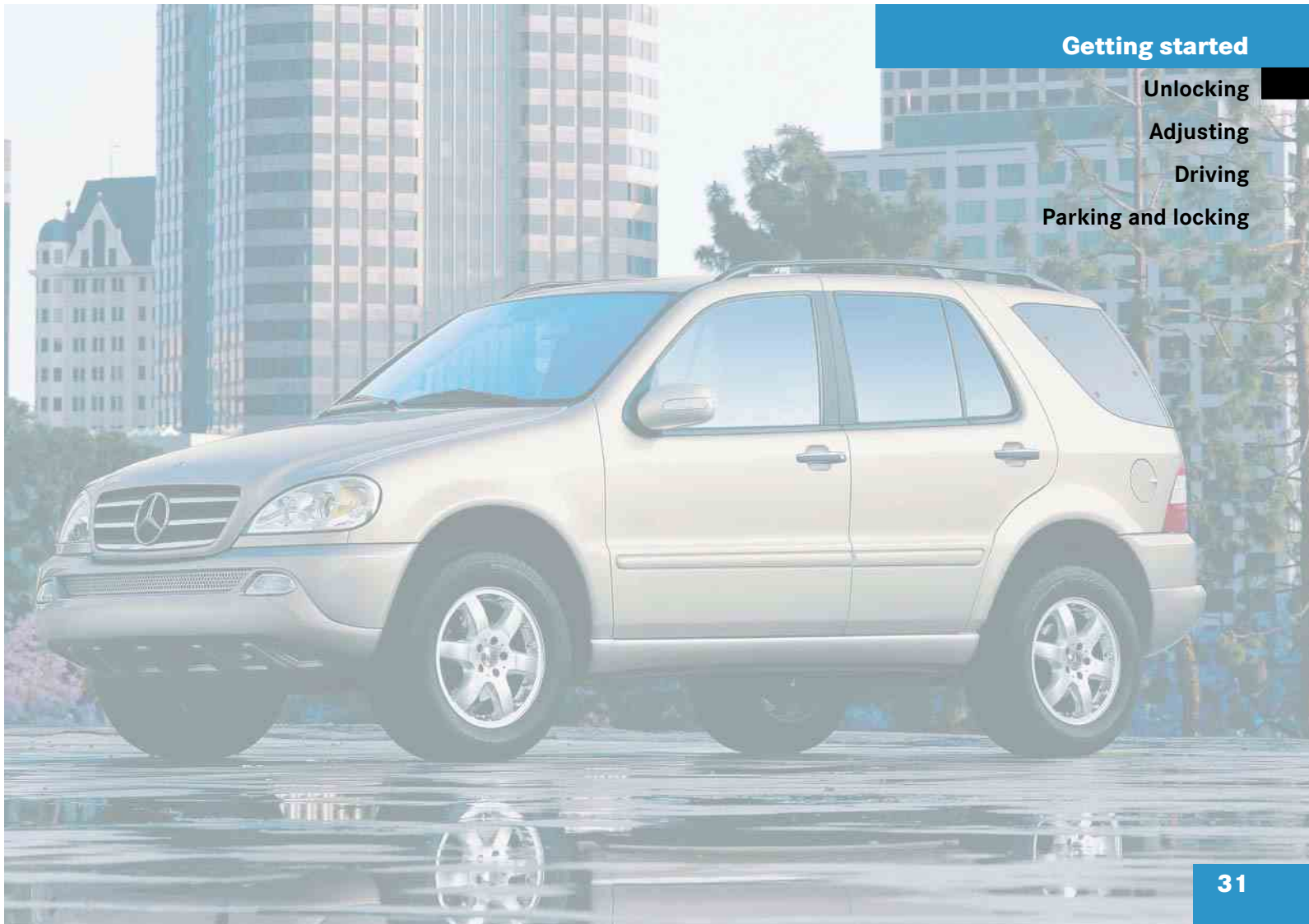

**Getting started**

**Unlocking**

**Adjusting**

**Driving**

**Parking and locking**

## Getting started

### Unlocking

The “Getting started” section provides an overview of the vehicle’s most basic functions. First-time Mercedes-Benz owners should pay special attention to the information given here.



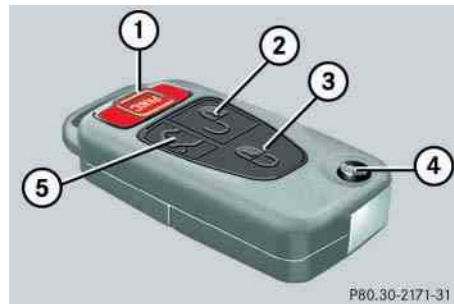

If you are already familiar with the basic functions described here, the “Controls in detail” section will provide you with further information. The corresponding page references are located at the end of each segment.

### ▼ Unlocking

#### Remote control with folding key



#### Remote control with folding key

- ① **PANIC** Panic button (▷ page 75)
- ②  Unlock button
- ③  Lock button
- ④  Release button for key
- ⑤  Unlock button for liftgate

- ▶ Press unlock button  on the remote control.

All turn signal lamps flash once. The locking knobs in the doors move up.

- ▶ Press release button ④ on the remote control.

The key folds out.

- ▶ Get in the vehicle and insert the key in the steering lock (▷ page 33).

More information can be found in the “Controls in detail” section (▷ page 88).



#### Steering lock positions

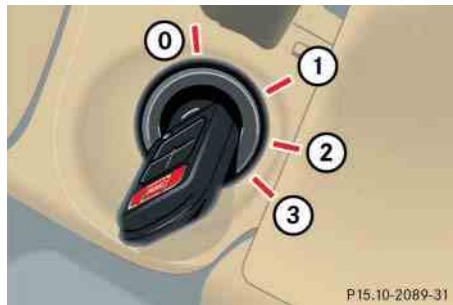

- 0** For removing key  
The steering is locked when the key is removed from the steering lock. If necessary, move steering wheel slightly to allow the locking mechanism to engage.
- 1** Unlocking steering  
Power supply to some electrical consumers, such as seat adjustment.
- 2** Ignition (power supply for all electrical consumers) and driving position
- 3** Starting position

#### Warning!



When leaving the vehicle, always remove the key from the steering lock and lock the vehicle. Do not leave children unattended in the vehicle, or with access to an unlocked vehicle. Unsupervised use of vehicle equipment may cause an accident and / or serious personal injury.



The key can only be withdrawn in position **0**.

If necessary, move steering wheel slightly to allow the key to be turned clockwise to position **1**.

A warning sounds when the driver's door is opened and the key is in steering lock position **0** or **1**.

The key can only be removed from the steering lock with the gear selector lever in position **P**.



To prevent accelerated battery discharge and a possible dead battery, always remove the key from the steering lock when the engine is not in operation.

## Getting started

### Adjusting

#### ▼ Adjusting

##### Warning!



All seat, head restraint, steering wheel, and rear view mirror adjustments, as well as fastening of seat belts, must be done before the vehicle is put into motion.

#### Seats

The seats can be adjusted either manually or electrically, depending on the vehicle's equipment.

##### Warning!



Do not adjust the driver's seat while driving. Adjusting the seat while driving could cause the driver to lose control of the vehicle.

Never ride in a moving vehicle with the seat back reclined. Sitting in an excessively reclined position can be dangerous. You could slide under the seat belt in a collision. If you slide under it, the belt would apply force at the abdomen or neck.

That could cause serious or fatal injuries. The seat back and seat belts provide the best restraint when the wearer is in an upright position and belts are properly positioned on the body. Your seat must be adjusted so that you can correctly fasten your seat belt (▷ page 42).

Never place hands under the seat or near any moving parts while a seat is being adjusted.

##### Warning!



When leaving the vehicle, always remove the key from the steering lock and lock your vehicle.

The power seats\* can also be operated with the appropriate door open. Do not leave children unattended in the vehicle or with access to an unlocked vehicle. Unsupervised use of vehicle equipment may cause an accident and /or serious personal injury.

##### Warning!



Children 12 years old and under must never ride in the front seat, except in a Mercedes-Benz authorized BabySmart<sup>TM</sup><sup>1</sup> compatible child seat, which operates with the BabySmart<sup>TM</sup> system installed in the vehicle to deactivate the passenger front airbag when it is properly installed. Otherwise they will be struck by the airbag when it inflates in a crash. If this happens, serious or fatal injury will result.

According to accident statistics, children are safer when properly restrained in the rear seating positions than in the front seating positions. Infants and small children must ride in back seats and be seated in an appropriate infant or child restraint system, which is properly secured with the vehicle's seat belt and top tether strap, or secured via lower anchors and top tether strap, fully in accordance with the child seat manufacturer's instructions.

<sup>1</sup> BabySmart<sup>TM</sup> is a trademark of Siemens Automotive Corp.

A child's risk of serious or fatal injuries is significantly increased if the child restraints are not properly secured in the vehicle and the child is not properly secured in the child restraint.

### Manual seat adjustment



- ① Seat fore and aft adjustment
- ② Backrest tilt
- ③ Seat height

## Getting started

### Adjusting

#### Seat fore and aft adjustment

- ▶ Lift handle ①.
- ▶ Slide seat to the desired position.
- ▶ Allow handle ① to reengage.
- ▶ Check for proper seat engagement before driving.

Adjust seat to a comfortable seating position that still allows you to reach the accelerator / brake pedal safely. The position should be as far rearward as possible, consistent with ability to properly operate controls.



When moving the seat, be sure that there are no items in the footwell or behind the seats. Otherwise you could damage the seats.

## Getting started

### Adjusting

#### Seat backrest tilt

- ▶ Turn handwheel ② forward or backward until your hands are slightly angled when holding the steering wheel.

#### Seat height

- ▶ Lift handle ③.
- ▶ Use your body weight to push the seat downwards.
- ▶ Lift your weight off the seat to obtain a higher seat position.
- ▶ Release lever ③.

#### Head restraint height

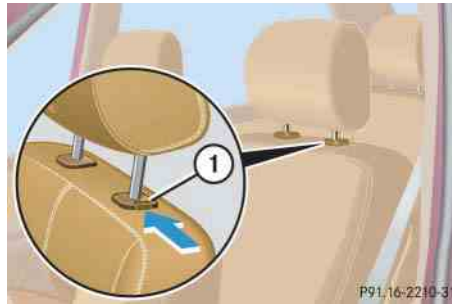

- ① Release button

#### Raising:

- ▶ Manually adjust the height of the head restraint by pulling it upward.

#### Lowering:

- ▶ To lower the head restraint, push release button ① and press down on the head restraint.

#### Warning!



For your protection, drive only with properly positioned head restraints.

Adjust head restraint so that the head restraint supports the back of the head at eye level. This will reduce the potential for injury to the head and neck in the event of an accident or similar situation.

Do not drive the vehicle without the seat head restraints. Head restraints are intended to help reduce injuries during an accident.

**Head restraint tilt**

Manually adjust the angle of the head restraint.

- ▶ Push or pull on the upper edge of the head restraint cushion.

More information on seats can be found in the “Controls in detail” section (▷ page 95).

**Power seat\* adjustment**

The seat adjustment switch is located on the entry side of each front seat base.

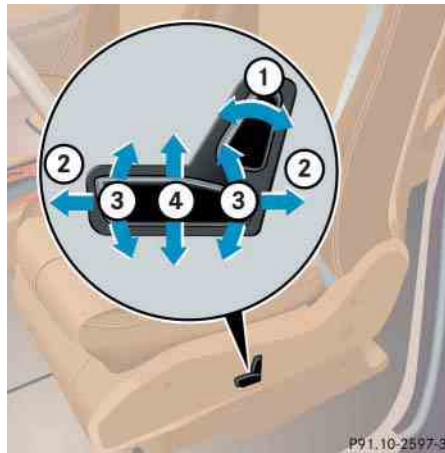

- ① Backrest tilt
- ② Seat fore and aft adjustment
- ③ Seat cushion tilt
- ④ Seat height

- ▶ Turn the key in the steering lock to position **1** or **2** (▷ page 33).

or

- ▶ Open the driver’s or passenger door.

**Seat fore and aft adjustment**

- ▶ Press the switch forward or backward in the direction of arrow ①.

Adjust seat to a comfortable seating position that still allows you to reach the accelerator / brake pedal safely. The position should be as far to the rear as possible, consistent with ability to properly operate controls.

**i**

When moving the seat, be sure that there are no items in the footwell or behind the seat. Otherwise you could damage the seat.

The memory function\* (▷ page 105) lets you store the setting for the seat positions together with the setting for the exterior rear view mirrors.

## Getting started

### Adjusting

#### Seat cushion tilt

- ▶ Press the switch up or down in the direction of arrow ③ until your upper legs are lightly supported.

#### Seat backrest tilt

- ▶ Press the switch forward or backward in the direction of arrow ① until your arms are slightly angled when holding the steering wheel.

#### Seat height

- ▶ Press the switch up or down in the direction of arrow ④.

#### Head restraint height

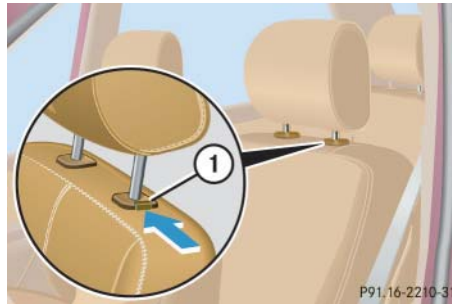

- ① Release button

#### Raising:

- ▶ Manually adjust the height of the head restraint by pulling it upward.

#### Lowering:

- ▶ To lower the head restraint, push release button ① and press down on the head restraint.

#### Warning!



For your protection, drive only with properly positioned head restraints.

Adjust head restraint so that the head restraint supports the back of the head at eye level. This will reduce the potential for injury to the head and neck in the event of an accident or similar situation.

Do not drive the vehicle without the seat head restraints. Head restraints are intended to help reduce injuries during an accident.

**Head restraint tilt**

Manually adjust the angle of the head restraint.

- ▶ Push or pull on the upper edge of the head restraint cushion.

More informations on seats can be found in the “Controls in detail” section (▷ page 95).

**Steering wheel****Warning!**

Do not adjust the steering wheel while driving. Adjusting the steering wheel while driving, or driving without the adjustment locked could cause the driver to lose control of the vehicle.

When leaving the vehicle, always remove the key from the steering lock and lock your vehicle.

Do not leave children unattended in the vehicle, or with access to an unlocked vehicle. Unsupervised use of vehicle equipment may cause an accident and / or serious personal injury.

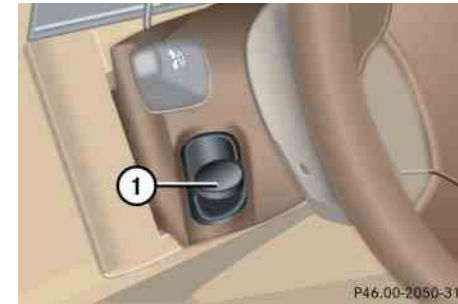
**Steering wheel adjustment**

## ① Lever

- ▶ To unlock the steering column, move lever ① to its stop down.
- ▶ Move steering wheel to the desired position.
- ▶ To lock the steering column, move lever ① to its stop up.

The steering wheel is once again locked into position.

## Getting started

### Adjusting



Do not drive the vehicle until you have properly locked the steering column.

If the indicator lamp  (▷ page 26) comes on while the engine is running, the steering column is not locked properly.

### Mirrors

Adjust the interior and exterior rear view mirrors before driving so that you have a good view of the road and traffic conditions.

#### Warning!



In the case of an accident, liquid electrolyte may escape the mirror housing if the mirror glass breaks.

Electrolyte has an irritating effect. Do not allow the liquid to come into contact with eyes, skin, clothing, or the respiratory system. In case it does, immediately flush affected area with water, and seek medical help if necessary.

### Interior rear view mirror

- ▶ Manually adjust the interior rear view mirror.

### Exterior rear view mirrors

#### Warning!



Exercise care when using the passenger side exterior rear view mirror. The mirror surface is convex (outwardly curved surface for a wider field of view). Objects in mirror are closer than they appear. Check your inside rear view mirror or glance over your shoulder before changing lanes.



Electrolyte drops coming into contact with the vehicle paint finish can only be completely removed while in their liquid state and by applying plenty of water.



The buttons are on the lower part of the center console.



- ① Driver's side exterior rear view mirror
- ② Passenger-side exterior rear view mirror
- ③ Adjustment button

- ▶ Switch on the ignition by turning the key in the steering lock to position 2 (▷ page 33).

All lamps in the instrument cluster come on.

- ▶ Press button ① for the left mirror or button ② for the right mirror.
- ▶ Push adjustment button ③ up, down, left, or right according to the desired setting.



For information on how to reposition the exterior mirror housing when it was forcibly pushed forward (hit from the rear) or forcibly pushed rearward (hit from the front), see “Folding exterior mirrors in and out manually\*” (▷ page 128).



With the front doors closed, the exterior mirrors can still be adjusted for approximately 30 minutes after the ignition has been switched off.



The memory function\* (▷ page 105) lets you save the exterior mirror settings together with the seat and steering wheel settings.



At low outside temperatures, the exterior mirrors will be automatically heated.

For more information, see “Electrically folding exterior rear view mirrors” (▷ page 128).

## Getting started

### Driving

#### ▼ Driving

##### Warning!



Do not lay any objects in the driver's footwell. Be careful that floor mats or carpets in the driver's footwell have sufficient clearance for the pedals.

During sudden driving or braking maneuvers the objects could get caught between the pedals. You could then no longer brake or accelerate.

#### Fastening the seat belts

##### Warning!



Always fasten your seat belt before driving off. Always make sure your passengers are properly restrained, even those sitting in the rear and pregnant women.

Failure to wear and properly fasten and position your seat belt greatly increases your risk of injuries and their likely severity in an accident. You and your passengers should always wear seat belts.

If you are ever in an accident, your injuries can be considerably more severe without your seat belt properly buckled. Without your seat belt buckled, you are much more likely to hit the interior of the vehicle or be ejected from it. You can be seriously injured or killed.

In the same crash, the possibility of injury or death is lessened if you are wearing your seat belt. The airbags can only protect as expected if the occupants are using their seat belts (> page 58).

##### Warning!



Children 12 years old and under must never ride in the front seat, except in a Mercedes-Benz authorized BabySmart<sup>TM</sup><sup>1</sup> compatible child seat, which operates with the BabySmart<sup>TM</sup> system installed in the vehicle to deactivate the passenger front airbag when it is properly installed. Otherwise they will be struck by the airbag when it inflates in a crash. If this happens, serious or fatal injury will result.

According to accident statistics, children are safer when properly restrained in the rear seating positions than in the front seating positions. Infants and small children must ride in back seats and be seated in an appropriate infant or child restraint system, which is properly secured with the vehicle's seat belt and top tether strap, or secured via lower anchors and top tether strap, fully in accordance with the child seat manufacturer's instructions.

<sup>1</sup> BabySmart<sup>TM</sup> is a trademark of Siemens Automotive Corp.

A child's risk of serious or fatal injuries is significantly increased if the child restraints are not properly secured in the vehicle and the child is not properly secured in the child restraint.

**Warning!**



Never ride in a moving vehicle with the backrest reclined. Sitting in an excessively reclined position can be dangerous. You could slide under the seat belt in a collision. If you slide under it, the belt would apply force at the abdomen or neck. That could cause serious or even fatal injuries. The backrest and seat belt provide the best restraint when the wearer is in an upright position and the belt is properly positioned on the body.

**Warning!**



Never let more people ride in the vehicle than there are seat belts available. Be sure everyone riding in the vehicle is correctly restrained with a separate seat belt.

**Warning!**



Read and observe the additional warning notices printed in the "Safety and Security" section (▷ page 62) and (▷ page 64).

## Getting started

### Driving



- ① Latch plate
- ② Buckle
- ③ Release button
- ④ Seat belt outlet

## Getting started

### Driving

- ▶ With a smooth motion, pull the belt from seat belt outlet ④.
  - ▶ Place the belt over your shoulder.
  - ▶ Push latch plate ① into buckle ② until it clicks.
  - ▶ If necessary, tighten the lap portion to a snug fit by pulling shoulder portion up.
  - ▶ If necessary, adjust the seat belt to the correct height (▷ page 45).
- Position the lap belt as low as possible on your hips (over hip joint) and not across the abdomen.
  - Place the seat backrest in a nearly upright position.
  - Never use a seat belt for more than one person at a time.
  - Do not fasten a seat belt around a person and another object at the same time.
  - Check your seat belt during travel to ensure that it is properly positioned.
  - Ensure that the seat belt is always fitted snugly. You should avoid wearing bulky clothing, such as winter coats, when traveling in the vehicle.

#### Proper use of seat belts:

- Do not twist the belt when fastening.
- Adjust the seat belt so that the shoulder portion is located as close as possible to the middle of the shoulder (it should not touch the neck or pass under the arm).

#### Warning!



Do not pass belts over sharp edges. They could tear.

Do not allow the belt to get caught in the door or in the seat adjustment mechanism. This could damage the belt.

Never attempt to make modifications to seat belts. This could impair the effectiveness of the belts.

Damaged seat belts or belts that were highly stressed in an accident must be replaced. Contact an authorized Mercedes-Benz Light Truck Center.

### Seat belt height adjustment

Seat belt height can be adjusted for the following seats:

- Driver's seat
- Passenger seat
- Outer rear seats

Adjust seat belt so that the shoulder portion is located as close as possible to the middle of the shoulder (it should not touch the neck or pass under the arm).

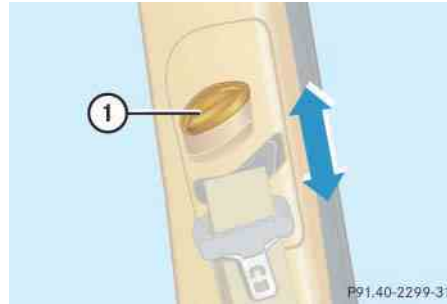

① Release button

### Adjusting seat belt higher

- ▶ Slide belt outlet upward.

The belt outlet engages in various positions.

### Adjusting seat belt lower

- ▶ Press and hold release button ①.
- ▶ Slide belt outlet in desired position and let go of release button ①.

## Getting started

### Driving

#### Starting the engine

##### Warning!



Inhalation of exhaust gas is hazardous to your health. All exhaust gas contains carbon monoxide, and inhaling it can cause unconsciousness and lead to death.

Do not run the engine in confined areas (such as a garage) which are not properly ventilated. If you think that exhaust gas fumes are entering the vehicle while driving, have the cause determined and corrected immediately. If you must drive under these conditions, drive only with at least one window fully open.

#### Automatic transmission

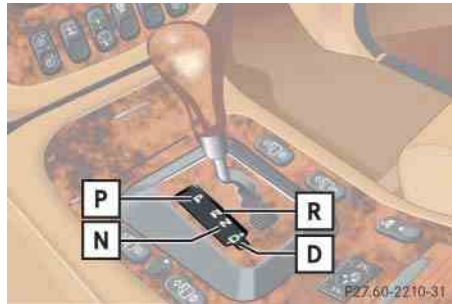

##### Gearshift pattern for automatic transmission

- P** Park position with gear selector lever lock
- R** Reverse gear
- N** Neutral
- D** Drive position

More information can be found in the “Controls in detail” section (▷ page 119).

#### Starting

- ▶ Make sure the gear selector lever is set to **P**.
- ▶ Do not depress the accelerator.
- ▶ Turn the key in the steering lock to position **3** and hold until the engine starts (▷ page 33).
- ▶ Depress the brake pedal.

The gear selector lever lock is released.

For information on turning off the engine, see “Turning off engine” (▷ page 54).

### Starting difficulties

If the engine does not start as described, carry out the following steps:

- ▶ Turn key in starter to position **0** and repeat starting procedure.  
Remember that extended starting attempts can drain the battery.
- ▶ Get a jump start (▷ page 281).

If the engine does not start after several starting attempts, there could be a malfunction in the engine electronics or in the fuel supply system.

- ▶ Notify an authorized Mercedes-Benz Light Truck Center.

### Parking brake

#### Warning!



When leaving the vehicle, always remove the key from the steering lock and lock the vehicle. Do not leave children unattended in the vehicle, or with access to an unlocked vehicle. Children could release the parking brake, which could result in an accident and / or serious personal injury.

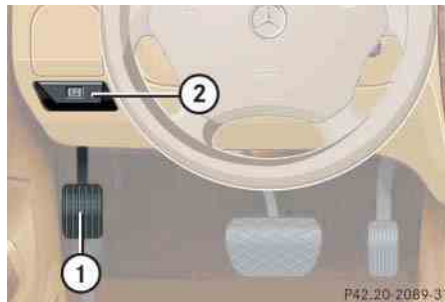

- ① Parking brake pedal
- ② Release handle

## Getting started

### Driving

- ▶ Release the parking brake by pulling on handle ②.

The indicator lamp  in the instrument cluster goes out.

### Driving

- ▶ Depress the brake pedal.
- ▶ Place the gear selector lever in position **D** or **R**.



Wait for the gear selection process to complete before setting the vehicle in motion.

- ▶ Release the brake pedal.
- ▶ Carefully depress the accelerator pedal.

## Getting started

### Driving



If you hear a warning signal when driving off, you have forgotten to release the parking brake.

Release the parking brake.

After a cold start, the automatic transmission shifts at a higher engine revolution. This allows the catalytic converter to reach its operating temperature earlier.

#### Warning!



It is dangerous to shift the gear selector lever out of **P** or **N** if the engine speed is higher than idle speed. If your foot is not firmly on the brake pedal, the vehicle could accelerate quickly forward or in reverse. You could lose control of the vehicle and hit someone or something. Only shift into gear when the engine is idling normally and when your right foot is firmly on the brake pedal.

#### Warning!



On slippery road surfaces, never downshift in order to obtain braking action. This could result in drive wheel slip and reduced vehicle control. Your vehicle's ABS will not prevent this type of loss of control.



Place the gear selector lever in position **R** only when the vehicle is stopped in order to avoid damaging the transmission.



Do not run cold engine at high engine speeds. Running a cold engine at high engine speeds may shorten the service life of the engine.

More information can be found in the “Operation” section (▷ page 191).

For information on off-road driving, see “Driving instructions” (▷ page 200).

### Switching on headlamps

The combination switch is located on the left of the steering column.

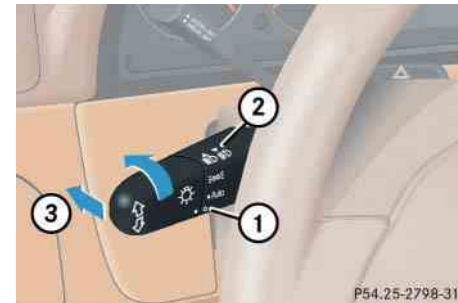

#### Combination switch

- ① Off
  - ② Low beam headlamps on
  - ③ High beam lamps on
- Turn the switch to . Low beam headlamps on.



**High beam**

- ▶ Push the combination switch forward.

The high beam indicator  in the instrument cluster comes on.

More information can be found in the “Controls in detail” section (▶ page 110).

**Turn signals**

The combination switch is on the left of the steering column.

**Combination switch**

- ① Turn signals, right
- ② Turn signals, left

- ▶ Press the combination switch up ① or down ②.

The switch is automatically cancelled when the steering wheel is turned to a large enough degree.



To signal minor directional changes, move combination switch to point of resistance only and release. The turn signal flashes three times.

**Windshield wipers**

The wiper switch is located on the right of the steering column.

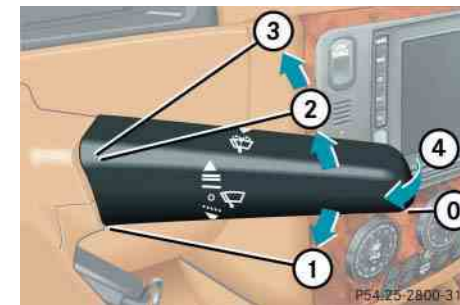
**Wiper switch**

- ① Windshield wipers off
- ① Intermittent wiping
- ② Normal wiper speed
- ③ Fast wiper speed
- ④ Wiping with windshield wiper fluid

## Getting started

### Driving



Vehicles with rain sensor\*:

Do not leave windshield wipers in intermittent setting when the vehicle is taken to an automatic car wash or during windshield cleaning. Wipers will operate in the presence of water sprayed on the windshield, and wipers may be damaged as a result.

The switch should not be left in intermittent setting as the wipers will wipe the windshield once every time the engine is started. Dust that accumulates on the windshield might scratch the glass and / or damage the wiper blades when wiping occurs on a dry windshield.

#### Switching on windshield wipers

- ▶ Make sure the ignition is switched on.
- ▶ Turn the wiper switch to the desired position ①, ② or ③, depending on the intensity of the rain.

#### Single wipe

- ▶ Press wiper switch briefly in the direction of arrow ②.

The windshield wipers wipe one time without washer fluid.

#### Wiping with windshield washer fluid

- ▶ Pull and hold wiper switch in direction of arrow ④.

The windshield wiper operates with washer fluid.

Information on filling up the washer reservoir can be found in the “Operation” section (▷ page 224).



If anything blocks the windshield wipers (leaves, snow, etc.), switch them off immediately.

- For safety reasons, withdraw key from steering lock before attempting to remove any blockage.
- Remove blockage.
- Turn the windshield wipers on again.

If windshield wipers fail to function at all in switch position ①,

- set the combination switch to the next highest wiper speed
- have the windshield wipers checked at the nearest authorized Mercedes-Benz Light Truck Center

### Rear window wiper

The button is on the upper part on the center console.



- ① Intermittent wiping
- ② Indicator lamp
- ③ Wiping with washer fluid

### Switching on intermittent wiping

Make sure the ignition is switched on.

- ▶ Press upper half ① of the button.

### Switching off intermittent wiping

- ▶ Press upper half ① of the button again.

### Wiping with washer fluid

- ▶ Press and hold lower half ③ of the button.

After releasing the button the wiper operates for additional five seconds.

More information on windshield wipers can be found in the “Controls in detail” section (▷ page 129).

### Problems while driving

#### The engine runs erratically and misfires

- An ignition cable may be damaged.
- The engine electronics may not be operating properly.
- Unburned gasoline may have entered the catalytic converter and damaged it.
- ▶ Give very little gas.
- ▶ Have the problem repaired by an authorized Mercedes-Benz Light Truck Center as soon as possible.

## Getting started

### Driving

#### **The coolant temperature is over 248°F (120°C)**

The coolant is too hot and is no longer cooling the engine.

- ▶ Stop the vehicle as soon as possible and turn off the engine. Allow engine and coolant to cool.
- ▶ Check the coolant level and add coolant if necessary (▷ page 222).

#### **In case of accident**

If the vehicle is leaking gasoline:

- ▶ Do not start the engine under any circumstances.
- ▶ Notify local fire and / or police authorities.

If the extent of the damage cannot be determined:

- ▶ Notify an authorized Mercedes-Benz Light Truck Center.

If no damage can be determined on the

- major assemblies
  - fuel system
  - engine mount:
- ▶ Start the engine in the usual manner.

## ▼ Parking and locking

You have now completed your first drive. You have properly stopped and parked your vehicle. End your drive as follows.

### Warning!



Wait until the vehicle is stationary before removing the key from the steering lock. The vehicle cannot be steered when the key is removed.

### Warning!



With the engine not running, there is no power assistance for the brake and steering system. In this case, it is important to keep in mind that a considerably higher degree of effort is necessary to brake and steer the vehicle.

### Warning!



Do not park this vehicle in areas where combustible materials such as grass, hay or leaves can come into contact with the hot exhaust system, as these materials could be ignited and cause a vehicle fire.

To reduce the risk of personal injury as a result of vehicle movement, before turning off the engine and leaving the vehicle always:

- Keep right foot on brake pedal.
- Firmly depress parking brake pedal.
- Move the gear selector lever to position **P**.
- Slowly release brake pedal.
- When parked on an incline, turn front wheel towards the road curb.
- Turn the key to starter switch position **0** and remove.
- Take the key and lock vehicle when leaving.

## Getting started

### Parking and locking

#### Parking brake

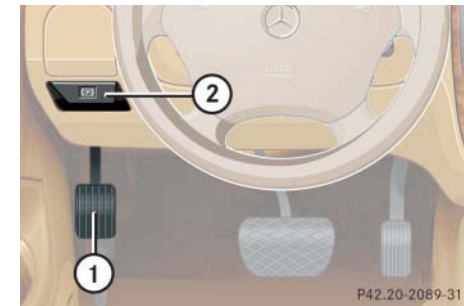

- ① Parking brake
- ② Release handle

- Step firmly on parking brake ①.

When the engine is running, the indicator lamp  in the instrument cluster will be illuminated.

## Getting started

### Parking and locking

#### Warning!



When leaving the vehicle, always remove the key from the steering lock and lock the vehicle. Do not leave children unattended in the vehicle, or with access to an unlocked vehicle. Children could release the parking brake and / or move the gear selector lever from position **P**, either of which could result in an accident and / or serious personal injury.

#### Warning!



Getting out of your vehicle with the gear selector lever not fully engaged in position **P** is dangerous. Also, when parked on an incline, position **P** alone may not prevent your vehicle from moving, possibly hitting people or objects.

Always set the parking brake in addition to shifting to position **P** (▷ page 53).

When parked on an incline, also turn front wheel towards the road curb.

#### Switching off headlamps

- ▶ Turn the combination switch to ① (▷ page 48).

More information can be found in the “Controls in detail” section (▷ page 107).

#### Turning off engine

- ▶ Place the gear selector lever in position **P**.



Always set the parking brake in addition to shifting to position **P**.

On steep slopes, turn the front wheels towards the road curb.

- ▶ Turn the key in the steering lock (▷ page 33) to position **0** and remove it.

The immobilizer is activated.



The key can only be removed from the steering lock with the gear selector lever in position **P**.

- ▶ Move the steering wheel slightly to allow the locking mechanism to engage.

- ▶ Press the seat belt release button (▷ page 42).

Allow the retractor to completely re-wind the seat belt by guiding the latch plate.



With the key removed and the driver's door open, a warning sounds if the vehicle's exterior lamps are not switched off.

#### Warning!



To prevent possible personal injury, always keep hands and fingers away from the door openings when closing the doors. Be especially careful when small children are around.

Before closing doors, ensure that there is no possibility of someone getting caught in a door during closing.

- ▶ After exiting the vehicle, press the lock button  on the remote control (▷ page 32).

The turn signal lamps flash three times and the locking knobs on the doors move down.

#### Warning!



When leaving the vehicle, always remove the key from the starter switch, and lock your vehicle. Do not leave children unattended in the vehicle, or with access to an unlocked vehicle. Unsupervised use of vehicle equipment may cause an accident and / or serious personal injury.

More information on parking and locking can be found in the "Controls in detail" section (▷ page 88).





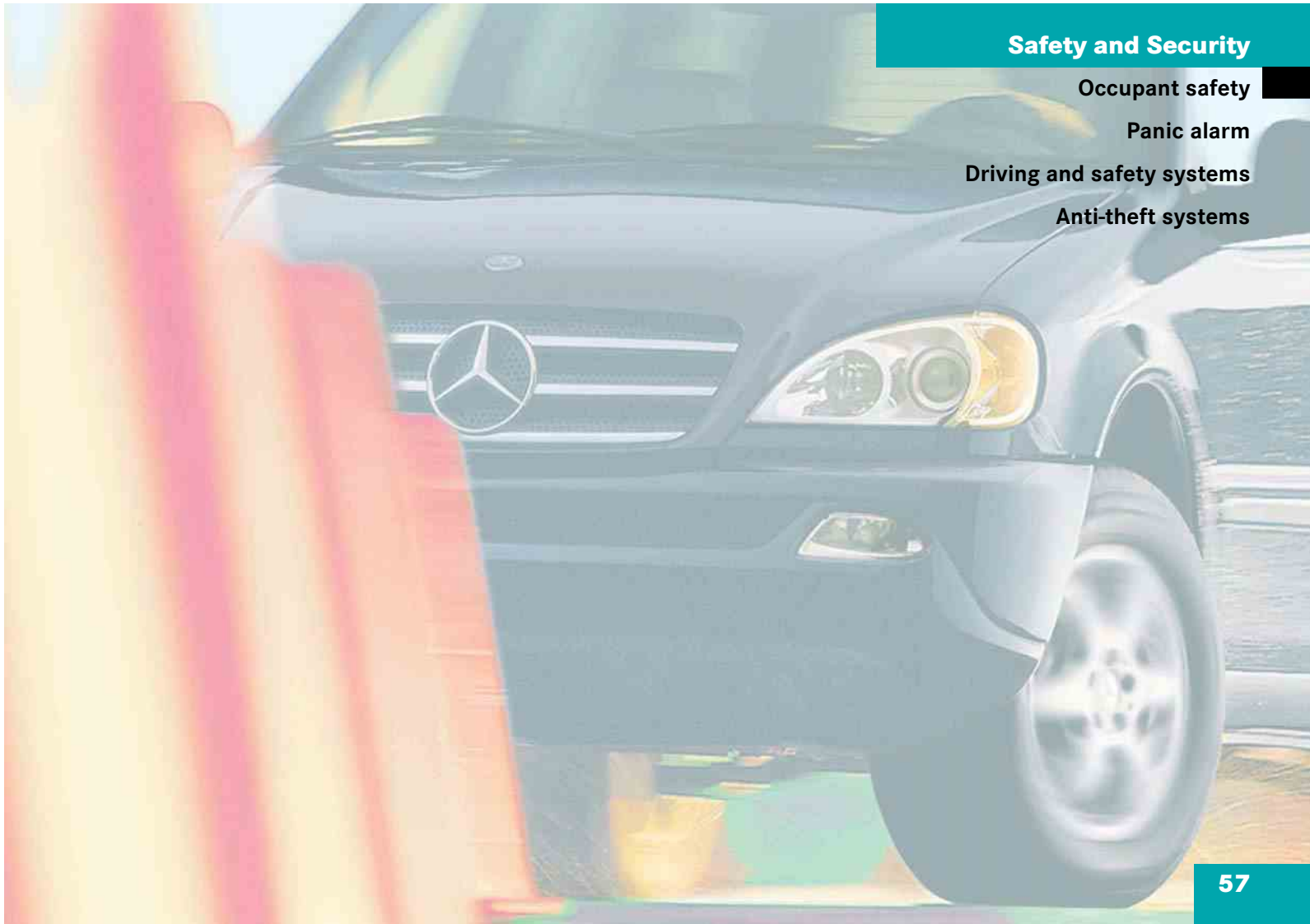

## Safety and Security

Occupant safety

Panic alarm

Driving and safety systems

Anti-theft systems

## Safety and Security

### Occupant safety

#### ▼ Occupant safety

In this section you will learn the most important facts about the restraint systems of the vehicle.

The restraint systems are

- Seat belts
- Emergency tensioning device
- Airbags
- Child seat
- Child seat recognition
- Lower anchors and tethers for children (LATCH)

As independent systems, their protective effects work in conjunction with each other.



For information on infants and children traveling with you in the vehicle and restraint systems for infants and children, see “Children in the vehicle” (▷ page 67).

The **SRS** indicator lamp in the instrument cluster (▷ page 26) comes on for about four seconds when you turn the key in the steering lock to position **2**. It goes out when you start the engine. This shows that the restraint systems are operational.

If the lamp does not come on at all or if it fails to extinguish after approximately four seconds or if it comes on thereafter, a malfunction in the system has been detected.

More information can be found in the “Practical hints” section (▷ page 255).

#### Warning!



In the event that the **SRS** malfunction indicator lamp comes on during driving or does not come at all, the SRS may not be operational.

For your safety, we strongly recommend that you visit an authorized Mercedes-Benz Light Truck Center immediately to have the system checked; otherwise the SRS may not be activated when needed in an accident, which could result in serious or fatal injury, or it might deploy unexpectedly and unnecessarily which could also result in injury.

Improper work on the restraint systems, including incorrect installation and removal, can lead to possible injury through an unintended activation of the SRS.

In addition, through improper work there is a risk of rendering the SRS inoperative or causing unintended airbag deployment. Work on the SRS must therefore only be performed by qualified technicians. Contact your authorized Mercedes-Benz Light Truck Center.

#### Airbags

##### Warning!



Airbags are designed to reduce the potential of injury and fatality in certain frontal (front airbags) impacts, or side (side impact and head protection window curtain airbags) impacts which may cause significant injuries. However, no system available today can totally eliminate injuries and fatalities.

The activation of the SRS temporarily releases a small amount of dust from the airbags. This dust, however, is neither injurious to your health, nor does it indicate a fire in the vehicle. The dust might cause some temporary breathing difficulty for people with asthma or other breathing trouble. To avoid this, you may wish to get out of the vehicle as soon as it is safe to do so. If you have any breathing difficulty but cannot get out of the vehicle after the airbag inflates, then get fresh air by opening a window or door.

##### Warning!



To reduce the risk of injury when the front airbags inflate, it is very important for the driver and passenger to always be in a properly seated position and to wear your seat belt.

For maximum protection in the event of a collision always be in normal seated position with your back against the backrest. Fasten your seat belt and ensure that it is properly positioned on your body (▷ page 42).

Since the airbag inflates with considerable speed and force, a proper seating and hands on steering wheel position will help to keep you at a safe distance from the airbag. Occupants who are unbelted, out of position or too close to the airbag can be seriously injured by an airbag as it inflates with great force in the blink of an eye:

- Sit properly belted in an upright position with your back against the seat backrest.

- Adjust the driver seat as far as possible rearward, still permitting proper operation of vehicle controls. The distance from the center of the driver's breastbone to the center of the airbag cover on the steering wheel must be at least ten inches (25 cm) or more. You should be able to accomplish this by a combination of adjustments to the seat and steering wheel. If you have any problems, please see your authorized Mercedes-Benz Light Truck Center.
- Airbags and emergency tensioning devices (ETDs) are designed to function on a one-time only basis. An airbag or ETD that was activated must be replaced.
- Do not lean with your head or chest close to the steering wheel or dashboard.
- Keep hands on the outside of steering wheel rim. Placing hands and arms inside the rim can increase the risk and potential severity of hand/arm injury when driver front airbag inflates.



## Safety and Security

### Occupant safety



- Adjust the passenger seat as far as possible rearward from the dashboard when the seat is occupied.
- Occupants, especially children, should never lean their heads in the area of the door where the side impact airbag inflates. This could result in serious injuries or death should the airbag be triggered. Always sit upright, properly use the seat belts and appropriate size infant or child restraint system.
- Children 12 years old and under must never ride in the front seat, except in a Mercedes-Benz authorized BabySmart<sup>TM1</sup> compatible child seat, which operates with the BabySmart<sup>TM</sup> system installed in the vehicle to deactivate the passenger front airbag when it is properly installed. Otherwise they will be struck by the airbag when it inflates in a crash. If this happens, serious or fatal injury will result.

<sup>1</sup> BabySmart<sup>TM</sup> is a trademark of Siemens Automotive Corp.

Failure to follow these instructions can result in severe injuries to you or other occupants.

If you sell your vehicle you are responsible to make the buyer aware of these points. Be sure to give the buyer this Operator's Manual.

### Warning



Accident research shows that the safest place for children in an automobile is in the rear seat. Should you choose to place a child 12 years old or under in the front passenger seat of your vehicle, you must properly use a BabySmart<sup>TM</sup> child restraint which will turn off the passenger front airbag (▷ page 70). BabySmart<sup>TM</sup> will not, however, turn off any side impact airbag.

It should be noted that with respect to both front and rear side impact airbags there is a possibility for a side airbag related injury if occupants, especially children, are not properly seated or restrained when next to a side airbag which needs to deploy rapidly in a side impact in order to do its job.

## Safety and Security

### Occupant safety

To help avoid the possibility of injury, please follow these guidelines: (1) occupants, especially children, should never place their bodies or lean their heads in the area of the door where the side airbag inflates. This could result in serious injuries or death should the side airbag be activated; (2) always sit upright, properly use the seat belts and use an appropriately sized infant or child restraint system for all children 12 years old or under; and (3) always wear seat belts properly.

If you believe that, even with the use of these guidelines, it would be safer for your rear seat occupants to have both rear door mounted side airbags deactivated, then deactivation can be accomplished upon your written election to do so at your authorized Mercedes-Benz Light Truck Center at an additional cost. Please contact your local authorized Mercedes-Benz Light Truck Center or call our Customer Assistance Center at 1-800-FOR-MERCEDES (1-800-367-6372) for details.



Airbags are designed to activate only in certain frontal (front airbags) impacts, or side (side impact and head protection window curtain airbags) impacts which exceed preset thresholds.

Only during these types of impacts, if of sufficient severity to meet the deployment thresholds, will they provide their supplemental protection.

The driver and passenger should always wear their seat belts. Otherwise it is not possible for the airbags to provide their supplemental protection.

In cases of other frontal impacts, angled impacts, roll-overs, other side impacts, rear collisions, or other accidents, the airbags will not be activated. The driver and passengers will then be protected by the fastened seat belts.

We caution you not to rely on the presence of the airbags in order to avoid wearing your seat belt.

Your vehicle was originally equipped with airbags that are designed to activate in certain impacts exceeding a preset threshold to reduce the potential and severity of injury. It is important to your safety and that of your passenger that you replace deployed airbags and repair any malfunctioning airbags to ensure that the vehicle will continue to provide supplemental crash protection for occupants.

## Safety and Security

### Occupant safety

#### Safety guidelines for the seat belt, emergency tensioning device and airbag

##### Warning



- Damaged seat belts or belts that were highly stressed in an accident must be replaced and their anchoring points must also be checked. Use only belts installed or supplied by an authorized Mercedes-Benz Light Truck Center.
- No modifications of any kind may be made to any components or wiring of the SRS. This includes changing or removing any component or part of the SRS, the installation of additional trim material, badges, etc. over the steering wheel hub, passenger front airbag cover, or door trim panels, and installation of additional electrical /electronic equipment on or near SRS components and wiring. Keep area between airbags and occupants free from objects (e.g. packages, purses, umbrellas, etc.).

- Airbags and emergency tensioning devices (ETDs) are designed to function on a one-time only basis. An airbag or ETD that was activated must be replaced.
  - Do not pass belts over sharp edges. They could tear.
  - Do not make any modification that could change the effectiveness of the belts.
  - Do not hang items such as coat hangers from the coat hooks or handles over the door. These items may turn into projectiles and cause head and other injuries when curtain airbag is deployed.
  - An airbag system component within the steering wheel gets hot after the airbag has inflated. Do not touch.
  - Improper work on the system, including incorrect installation and removal, can lead to possible injury through an unintended activation of the SRS.
- In addition, through improper work there is a risk of rendering the SRS inoperative or causing unintended airbag deployment. Work on the SRS must therefore only be performed by qualified technicians. Contact your authorized Mercedes-Benz Light Truck Center.
  - For your protection and the protection of others, when scrapping the airbag unit or emergency tensioning device, our safety instructions must be followed. These instructions are available from your authorized Mercedes-Benz Light Truck Center.
  - Given the considerable deployment speed and the textile structure of the airbags, there is the possibility of abrasions or other injuries resulting from airbag deployment.

When you sell your vehicle, we strongly urge you to give notice to the subsequent owner that it is equipped with an SRS by alerting them to the applicable section in the Operator's Manual.

#### Warning!



In the event that the **SRS** malfunction indicator lamp comes on while driving, the SRS may not be operational. For your safety, we strongly recommend that you visit an authorized Mercedes-Benz Light Truck Center immediately to have the system checked; otherwise the SRS may not be activated when needed in an accident, which could result in serious or fatal injury, or it might deploy unexpectedly and unnecessarily which could also result in injury.

#### Front airbags



- ① Driver airbag
- ② Passenger front airbag
- ③ Side impact airbag

Driver and passenger front airbags are deployed:

- in the event of a frontal impact
- if impact exceeds a preset deployment threshold
- independently of the side impact airbags

The airbags will not deploy in impacts which do not exceed the system's deployment thresholds. You will then be protected by the fastened seat belts.

The passenger front airbag will only be deployed if:

- the passenger seat is occupied
- the **AIRBAG OFF** indicator lamp in the instrument cluster is not lit (▷ page 26)
- the impact exceeds a preset deployment threshold



Do not place objects heavier than 20 lbs (9 kg) on the front passenger seat. This could cause the front or side impact airbag on the front passenger side to deploy in a crash which exceeds the system's deployment threshold.

## Safety and Security

### Occupant safety

#### Side impact airbags, window curtain airbags

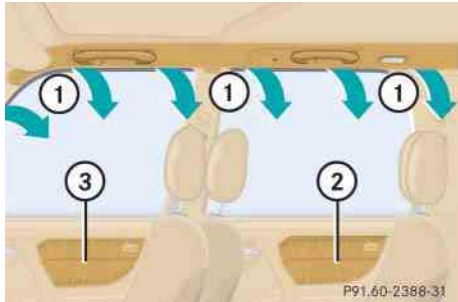

- ① Window curtain airbags
- ② Side impact airbag, rear
- ③ Side impact airbag, front



The side impact airbags and window curtain airbags are deployed:

- on the impacted side of the vehicle
- in impacts exceeding a preset deployment threshold
- independently of the front airbags

The front passenger side impact airbag will only deploy if the system senses that the front passenger seat is occupied.

The side impact airbags and window curtain airbags are not deployed in impacts which do not exceed the system's deployment threshold.

#### Seat belts

When the engine is started, the seat belt non-usage warning lamp  illuminates to remind you and your passengers to fasten your seat belts. If the driver's seat belt is not fastened before the engine is started, the seat belt non-usage warning lamp  illuminates and a warning chime sounds for approximately six seconds when the engine is started.

The use of seat belts and infant and child restraint systems is required by law in all 50 states and all Canadian provinces. Even where this is not the case, all vehicle occupants should have their seat belts fastened whenever the vehicle is in motion.

Information on fastening seat belts is found in the "Getting started" section (▷ page 42).

#### i

For information on infants and children traveling with you in the vehicle and restraint systems for infants and children, see "Children in the vehicle" (▷ page 67).



## Safety and Security

### Occupant safety

#### Warning!



Always fasten your seat belt before driving off. Always make sure your passengers are properly restrained, even those sitting in the rear and pregnant women.

Failure to wear and properly fasten and position your seat belt greatly increases your risk of injuries and their likely severity in an accident. You and your passengers should always wear seat belts.

If you are ever in an accident, your injuries can be considerably more severe without your seat belt properly buckled. Without your seat belt buckled, you are much more likely to hit the interior of the vehicle or be ejected from it. You can be seriously injured or killed.

In the same crash, the possibility of injury or death is lessened if you are properly wearing your seat belt. Airbags can only protect as they are designed if the occupants are properly wearing their seat belts.

#### Warning!



Never ride in a moving vehicle with the backrest reclined. Sitting in an excessively reclined position can be dangerous. You could slide under the seat belt in a collision. If you slide under it, the belt would apply force at the abdomen or neck. That could cause serious or even fatal injuries. The backrest and seat belt provide the best restraint when the wearer is in an upright position and the belt is properly positioned on the body.

#### Warning!



Never let more people ride in the vehicle than there are seat belts available. Be sure everyone riding in the vehicle is correctly restrained with a separate seat belt.

#### Warning!



Damaged seat belts or belts that were highly stressed in an accident must be replaced and their anchoring points must also be checked.

Only use seat belts which have been approved by Mercedes-Benz.

Do not make any modifications to the seat belts. This can lead to unintended activation or to failure.

Have all work carried out only by qualified technicians. Contact an authorized Mercedes-Benz Light Truck Center.

## Safety and Security

### Occupant safety

#### Warning!



#### USE SEAT BELTS PROPERLY

- Seat belts can only work when used properly. Never wear seat belts in any other way than as described in this section, as that could result in serious injuries in case of an accident.
- Each occupant should wear their seat belt at all times, because seat belts help reduce the likelihood of and potential severity of injuries in accidents, including rollovers. The integrated restraint system includes SRS (driver airbag, front passenger airbag, front and rear door mounted side impact airbags and window curtain airbags), ETB (seat belt emergency tensioning device for the outboard passenger seats [except in the optional third row seats]), and front seat knee bolsters.

The system is designed to enhance the protection offered to properly belted occupants in certain frontal (front airbags) and side (side impact airbags and window curtain airbags) impacts which exceed preset deployment thresholds.

- Never wear the shoulder belt under your arm, against your neck or off your shoulder. In a crash, your body would move too far forward. That would increase the chance of head and neck injuries. The belt would also apply too much force to the ribs or abdomen, which could severely injure internal organs such as your liver or spleen.
- Never wear belts over rigid or breakable objects in or on your clothing, such as eyeglasses, pens, keys, etc., as these might cause injuries.
- Position the lap belt as low as possible on your hips and not across the abdomen. If the belt is positioned across your abdomen, it could cause serious injuries in a crash.

- Never use a seat belt for more than one person at time. Do not fasten a seat belt around a person and another person or other objects.
- Belts should not be worn twisted. In a crash, you wouldn't have the full width of the belt to manage impact forces. The twisted belt against your body could cause injuries.
- Pregnant women should also use a lap-shoulder belt. The lap belt portion should be positioned as low as possible on the hips to avoid any possible pressure on the abdomen.
- Never place your feet on the instrument panel or on the seat. Always keep both feet on the floor in front of the seat.

#### Emergency tensioning device, seat belt force limiter

The seat belts for the front seats are equipped with emergency tensioning devices and belt force limiters. The outboard passenger seats belts (except in the third row seats\*) are equipped with emergency tensioning devices.

The ETD is designed to activate only when the seat belt is fastened and in the following cases:

- in frontal or rear-end impacts exceeding a preset severity level
- if the restraint systems are operational and functioning correctly, see **SRS** indicator lamp (▷ page 58)

In an impact, emergency tensioning devices remove slack from the belts in such a way that the seat belts fit more snugly against the body. Belt force limiters reduce the force exerted by the seat belts on occupants during a crash.

#### Warning!



An emergency tensioning device (ETD) that was activated must be replaced.

When disposing of the emergency tensioning device, our safety instructions must be followed. These are available at your authorized Mercedes-Benz Light Truck Center.



Do not place objects heavier than 20 lbs (9 kg) on the front passenger seat. This could cause the front or side impact airbag on the front passenger side to deploy in a crash which exceeds the system's deployment threshold.

#### Children in the vehicle

If an infant or child is traveling with you in the vehicle:

- Secure the child using an infant or child restraint appropriate to the age and size of the child and recommended for use by Mercedes-Benz.
- Ensure that the infant or child is properly secured by a belt at all times while the vehicle is in motion.

Infant and child restraint seats and information on choosing an appropriate restraint system can be obtained from any Mercedes-Benz Light Truck Center.

## Safety and Security

### Occupant safety

#### Infant and child restraint systems

Use only a BabySmart<sup>TM1</sup> compatible child restraint for the front passenger seat in this vehicle.

We recommend that all infants and children be properly restrained at all times while the vehicle is in motion. All lap-shoulder belts except the driver's seat belt have special seat belt retractors for secure fastening of child restraints.

To fasten a child restraint, follow child restraint instructions for mounting. Then pull shoulder belt out completely and let it retract. During the seat belt retraction a ratcheting sound can be heard to indicate that the special seat belt retractor is activated. The belt is now locked. Push down on child restraint to take up any slack.

To deactivate, release seat belt buckle and let seat belt retract completely. The seat belt can again be used in the usual manner.

<sup>1</sup> BabySmart<sup>TM</sup> is a trademark of Siemens Automotive Corp.



Information on child seats with mounting fittings for tether anchorages (▷ page 71).

For information on child seat anchors – LATCH type (▷ page 72).

#### Warning!



Never release the seat belt buckle while the vehicle is in motion, since the special seat belt retractor will be deactivated.



The use of infant or child restraints is required by law in all 50 states, the District of Columbia, the U.S. territories and all Canadian provinces.

Infants and small children should be seated in an appropriate infant or child restraint system properly secured by a lap-shoulder belt or, if so equipped, a child restraint lower anchorage system that complies with U.S. Federal Motor Vehicle Safety Standards 213 and 225 and Canadian Motor Vehicle Safety Standard 213 and 210.2. A statement by the child restraint manufacturer of compliance with this standard can be found on the instruction label on the restraint and in the instruction manual provided with the restraint.

When using any infant or child restraint system, be sure to carefully read and follow all manufacturer's instructions for installation and use.

Please read and observe warning labels affixed to inside of vehicle and to infant or child restraints.

## Safety and Security

### Occupant safety

#### Warning!



Children 12 years old and under must never ride in the front seat, except in a Mercedes-Benz authorized BabySmart™ compatible child seat, which operates with the BabySmart™ System installed in the vehicle to deactivate the passenger front airbag when it is properly installed. Otherwise they will be struck by the airbag when it inflates in a crash. If this happens, serious or fatal injury can result.

According to accident statistics, children are safer when properly restrained in the rear seating positions than in the front seating positions. Infants and small children must ride in back seats and be seated in an appropriate infant or child restraint system, which is properly secured with the vehicle's seat belt and top tether strap, or secured via lower anchors and top tether strap, fully in accordance with the child seat manufacturer's instructions.

Infants and small children should never share a seat belt with another occupant. During an accident, they could be crushed between the occupant and seat belt.

A child's risk of serious or fatal injuries is significantly increased if the child restraints are not properly secured in the vehicle and the child is not properly secured in the child restraint.

#### Warning!



Children too big for child restraint systems must ride in back seats using regular seat belts. Position shoulder belt across chest and shoulder, not face or neck. A booster seat may be necessary to achieve proper belt positioning for children from 41 lbs until they reach a height where a lap / shoulder belt fits properly without a booster.

When the child restraint is not in use, remove it from the vehicle or secure it with the seat belt to prevent the child restraint from becoming a projectile in the event of an accident.

Do not leave children unattended in the vehicle, even if the children are secured in a child restraint system. Unsupervised children in a child restraint system may use vehicle equipment and may cause an accident and / or serious personal injury.

## Safety and Security

### Occupant safety

#### BabySmart™ airbag deactivation system

Special BabySmart™<sup>1</sup> compatible child seats, designed for use with the Mercedes-Benz system and available at any authorized Mercedes-Benz Light Truck Center, are required for use with the BabySmart™ airbag deactivation system. With the special seat properly installed, the passenger front airbag will not deploy.

The  indicator lamp located in the instrument cluster will be illuminated, except with the key removed or in steering lock position **0** (▷ page 33).



The system does not deactivate the door mounted side impact airbag, the window curtain airbags and the emergency tensioning device.

<sup>1</sup> BabySmart™ is a trademark of Siemens Automotive Corp.

#### Self-test BabySmart™ without special child seat installed

After turning the key in the steering lock to position **1** or **2**, the  indicator lamp located in the instrument cluster comes on for approximately six seconds, extinguishes, then flashes once.

If the indicator lamp should not come on or is continuously lit, the system is not functioning. You must see an authorized Mercedes-Benz Light Truck Center before seating any child on the front passenger seat.

More information can be found in the “Practical hints” section (▷ page 243).

#### Warning!



The BabySmart™ airbag deactivation system will **ONLY** work with a special child seat designed to operate with it. It will not work with child seats which are not BabySmart™ compatible.

Never place anything between seat cushion and child seat (e.g. pillow), since it reduces the effectiveness of the deactivation system. The bottom of the child seat must make full contact with the passenger seat cushion. An incorrectly mounted child seat could cause injuries to the child in case of an accident, instead of protecting the child.

Follow the manufacturer’s instructions for installation of special child seats.

When using a BabySmart™ compatible child seat on the front passenger seat, the passenger front airbag will not deploy only if the  indicator lamp remains illuminated.

## Safety and Security

### Occupant safety

Please be sure to check the indicator every time you use the special system child seat.

Should the light go out while the restraint is installed, please check installation. If the light remains out, do not use the BabySmart™ restraint to transport children on the passenger seat until the system has been repaired.

#### Warning!



Do not place powered-on laptops, cell phones and like electronic devices on the passenger seat. Signals from such devices may interfere with the BabySmart™ system. Such signal interference may cause the  indicator lamp not to come on during self-test or be continuously lit, indicating that the system is not functioning.

#### Installation of infant and child restraint system

- ▶ Guide top tether strap between head restraint and top of seat back. Head restraint must be installed and positioned such that the top tether strap can pass freely between the head restraint and top of seat back.

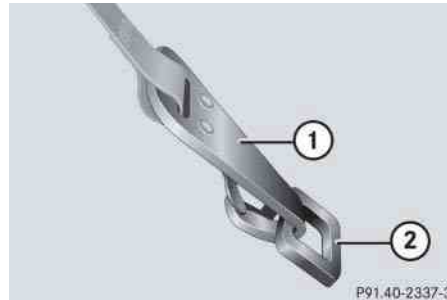

- ① Hook
- ② Anchorage ring

- ▶ Securely fasten the hook ① to the anchorage ring ②.

For safety, make sure the hook has attached to the ring beyond the safety catch, as illustrated.

#### Vehicle without third row seats

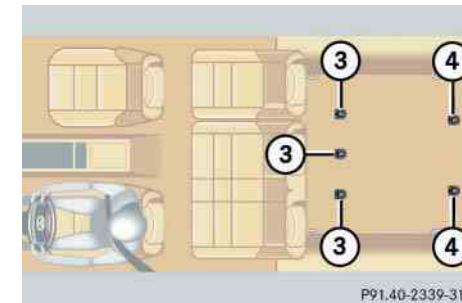

- ③ Anchorage rings for second row seats
- ④ Anchorage rings for third row seats\*

This vehicle is provided with three tether anchorages ③ for a top tether strap behind the second row seats.



Do not use the tether anchorages ④ for a top tether strap on a second row seat.

## Safety and Security

### Occupant safety

#### Vehicle with third row seats\*

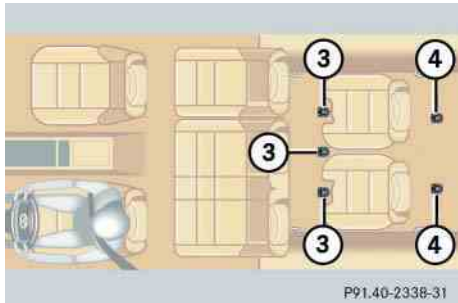

③ Anchorage rings for second row seats

④ Anchorage rings for third row seats\*

This vehicle is provided with tether anchorages for a top tether strap behind the second row seats ③ and the third row seats ④.

When using the third row observe the following:

- Installation of infant and child restraint systems with a top tether strap is allowed only on both third row seats plus the center second row seat.

- When using the center second row seat for a top tether strap, the left third row seat should only be used for a child restraint system, since exiting the vehicle may not be possible in an emergency due to the routing of the top tether strap.
- When installing an infant or child restraint system with a top tether strap on the left second row seat, the left third row seat should not be occupied.



An infant and child restraint system must not be installed on the right second row seat while a passenger rides in a third row seat. An infant and child restraint system installed on the right second row seat will prevent the use of the easy-entry / exit feature (▷ page 101).

#### Child seat anchors – LATCH type

This vehicle is equipped with two LATCH (Lower Anchors and Tethers for Children) type anchors (at each of the rear seats) for the installation of a LATCH child seat with matching anchor fittings.



① Anchors

- ▶ Install a LATCH type child seat according to the manufacturer's instructions.





With a child seat installed in the left rear seat, the seat belt for the center seat occupied by a passenger must operate freely. Guide seat belt between its seat cushion mount and backrest mount along outside of right side child seat mount.

Non-LATCH type child seats may also be used and can be installed using the vehicle's seat belt system. Install child seat according to the manufacturer's instructions.

### Warning!



Install child seat according to manufacturer's instructions.

The child seat must be firmly attached in the right and left side anchors ① (▷ page 72).

An incorrectly mounted child seat may come loose during an accident.

Damaged or impact damaged child seats or child seat mounting fittings must be replaced.

Do not leave children unattended in the vehicle, even if the children are secured in a child restraint system.

Children too big for child restraint systems must ride in back seats using regular seat belts. Position shoulder belt across chest and shoulder, not face or neck. A booster seat may be necessary to achieve proper belt positioning for children from 41 lbs until they reach a height where a lap / shoulder belt fits properly without a booster.

## Safety and Security

### Occupant safety

#### Blocking of rear door window operation

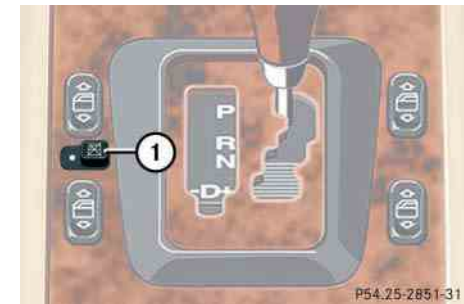

① Switch for rear door window override

- ▶ Slide the switch to the right.

A dot becomes visible. The rear windows can no longer be operated using the switch in the rear doors.

## Safety and Security

### Occupant safety

#### Warning!



Activate the override switch when children are riding in the back seats of the vehicle. The children may otherwise injure themselves, e.g. by becoming trapped in the window opening.

When leaving the vehicle, always remove the key from the steering lock, and lock the vehicle. Do not leave children unattended in the vehicle, or with access to an unlocked vehicle. Unsupervised use of vehicle equipment may cause an accident and / or serious personal injury.

For more information on power windows, see the “Controls in detail” section (▷ page 144).

#### ▼ Panic alarm

An audible alarm and flashing turn signal lamps will operate for approximately 2½ minutes.



① PANIC button

#### Activating

- ▶ Press and hold button ① for at least one second.

#### Deactivating

- ▶ Press button ① again.
- or
- ▶ Insert key in steering lock.

#### i

For operation in the USA only: This device complies with Part 15 of the FCC Rules. Operation is subject to the following two conditions:

- This device may not cause harmful interference, and
- this device must accept any interference received, including interference that may cause undesired operation.

Any unauthorized modification to this device could void the user's authority to operate the equipment.

## Safety and Security

### Driving and safety systems

#### ▼ Driving and safety systems

In this section you will find information on the following driving safety systems:

- ABS (Antilock Brake System)
- BAS (Brake Assist System)
- 4-ETS (Electronic Traction System)
- EBP (Electronic Brake Proportioning)
- ESP (Electronic Stability Program)



In winter operation, the maximum effectiveness of the ABS, the BAS, the ESP, the EBP, and the 4-ETS is only achieved with winter tires (M+S tires) or snow chains as required.

#### Warning!



The following factors increase the risk of accidents:

- Excessive speed, especially in turns
- Wet and slippery road surfaces
- Following another vehicle too closely

ABS, BAS, ESP and 4-ETS cannot reduce this risk.

Always adjust your driving style to the prevailing road and weather conditions.

### ABS

#### Warning!



Do not pump the brake pedal. Use firm, steady brake pedal pressure instead. Pumping the brake pedal defeats the purpose of the ABS and significantly reduces braking effectiveness.

The Antilock Brake System (ABS) regulates the brake pressure so that the wheels do not lock during braking. This allows you to maintain the ability to steer your vehicle.

The ABS is functional above a speed of approximately 5 mph (8 km/h) independent of road surface conditions.

On slippery road surfaces, the ABS will respond even with light brake pressure.

The  indicator lamp in the instrument cluster (▷ page 25) comes on when you turn the key to position **2**. It goes out when the engine is running.

#### Braking

At the instant one of the wheels is about to lock up, a slight pulsation can be felt in the brake pedal, indicating that the ABS is in the regulating mode.

- ▶ Keep firm and steady pressure on the brake pedal while experiencing the pulsation.

Continuous, steady brake pedal pressure yields the advantages provided by the ABS, namely braking power and the ability to steer the vehicle.

The pulsating brake pedal can be an indication of hazardous road conditions and functions as a reminder to take extra care while driving.

#### Emergency brake maneuver

- ▶ Keep continuous full pressure on the brake pedal.



With the ABS malfunctioning, the BAS, the EBP, ESP, and the 4-ETS are also switched off.

Normal driving and braking functions are still available.

#### LOW RANGE– ABS

During off-road driving, a special low range system for the ABS is operational with transmission in LOW RANGE mode (▷ page 125).

When applying the service brakes at speeds below approximately 18 mph (30 km/h), the front wheels are locked cyclically to shorten the braking distance (dig-in effect). This affects steering the vehicle.

## Safety and Security

### Driving and safety systems

#### Warning!



The ABS cannot prevent the natural laws of physics from acting on the vehicle, nor can it increase braking or steering efficiency beyond that afforded by the condition of the vehicle brakes and tires or the traction afforded. The ABS cannot prevent accidents, including those resulting from excessive speed in turns, following another vehicle too closely, or hydroplaning. Only a safe, attentive, and skillful driver can prevent accidents. The capabilities of an ABS equipped vehicle must never be exploited in a reckless or dangerous manner which could jeopardize the user's safety or the safety of others.

For more information, see “The yellow ABS warning lamp comes on while driving.” (▷ page 242).

#### BAS

The Brake Assist System (BAS) operates in emergency situations. If you apply the brakes very quickly, the BAS automatically provides full brake boost, thereby potentially reducing braking distance. Apply continuous full braking pressure until the emergency braking situation is over. The ABS will prevent the wheels from locking.

When you release the brake pedal, the brakes function again as normal. The BAS is then deactivated.

The  indicator lamp in the instrument cluster (▷ page 25) comes on when you turn the key to position **2**. It goes out when the engine is running.

#### Warning!



The BAS cannot prevent the natural laws of physics from acting on the vehicle, nor can it increase braking efficiency beyond that afforded by the condition of the vehicle brakes and tires or the traction afforded. The BAS cannot prevent accidents, including those resulting from excessive speed in turns, following another vehicle too closely, or hydroplaning. Only a safe, attentive, and skillful driver can prevent accidents. The capabilities of a BAS equipped vehicle must never be exploited in a reckless or dangerous manner which could jeopardize the user's safety or the safety of others.

For more information, see “The yellow BAS/ESP malfunction indicator lamp comes on while driving.” (▷ page 246).

## 4-ETS

The 4-Electronic Traction System (4-ETS) improves vehicle's ability to utilize available traction, especially under slippery road conditions. The brakes are applied to the spinning wheel and power is transferred to the wheel(s) with traction.

The traction control engages at vehicle speeds up to approximately 24 mph (40 km/h), and switches off at approximately 50 mph (80 km/h).

The **ETS** indicator lamp in the instrument cluster (> page 25) comes on when you turn the key to position **2**. It goes out when the engine is running.

The 4-ETS / ESP warning lamp , located in the speedometer dial, starts to flash at any vehicle speed, as soon as the tires lose traction and the wheels begin to spin.

### Warning!



When you see the 4-ETS / ESP-warning lamp  flashing in the speedometer, then proceed as follows:

- While driving off, apply as little throttle as possible.
- While driving ease up on the accelerator.
- Adapt your speed and driving style to the prevailing road conditions.

Failure to observe these guidelines could cause the vehicle to skid.

The 4-ETS cannot prevent accidents resulting from excessive speed.

## Safety and Security

### Driving and safety systems



Because of the ESP's automatic operation, the engine must be shut off (SmartKey in starter switch position **0** or **1**) when the parking brake is being tested on a brake test dynamometer.

Active braking action through ESP may otherwise seriously damage the front or rear axle brake system.

Operational tests with the engine running can only be conducted on a two-axle dynamometer.



If the yellow 4-ETS malfunction indicator lamp **ETS** comes on while the 4-ETS / ESP warning lamp  flashes, the electronic traction system is being switched off temporarily to prevent overheating of the drive wheel brakes.

## Safety and Security

### Driving and safety systems

#### LOW RANGE 4-ETS

During off-road driving, a special low range system for the 4-ETS is operational with transmission in LOW RANGE mode.

More information can be found in the “Practical hints” section (▷ page 242) and (▷ page 252).

#### EBP



The EBP enhances braking effectiveness by allowing the rear brakes to supply a greater proportion of the braking effort without a loss of vehicle stability.

#### ESP

The Electronic Stability Program (ESP) monitors the vehicle’s traction (force of adhesive friction between the tires and the road surface) and handling.

The ESP recognizes when a wheel is spinning or if the vehicle starts to skid. By applying brakes to the appropriate wheel and by limiting engine output, the ESP works to stabilize the vehicle. The ESP is especially useful while driving off and on wet or slippery road surfaces.

The 4-ETS / ESP warning lamp  in the speedometer flashes when the ESP is engaged.

The  indicator lamp in the instrument cluster (▷ page 25) and the 4-ETS / ESP warning lamp  in the speedometer come on when you turn the key to position **2**. They go out when the engine is running.

#### Warning!



Never switch off the ESP when you see the 4-ETS / ESP-warning lamp  flashing in the speedometer. In this case, proceed as follows:

- While driving off, apply as little throttle as possible.
- While driving, ease up on the accelerator.
- Adapt your speed and driving style to the prevailing road conditions.

Failure to observe these guidelines could cause the vehicle to skid.

The ESP cannot prevent accidents resulting from excessive speed.



#### Warning!



The ESP cannot prevent the natural laws of physics from acting on the vehicle, nor can it increase the traction afforded. The ESP cannot prevent accidents, including those resulting from excessive speed in turns, following another vehicle too closely, or hydroplaning. Only a safe, attentive, and skillful driver can prevent accidents. The capabilities of an ESP equipped vehicle must never be exploited in a reckless or dangerous manner which could jeopardize the user's safety or the safety of others.



Because of the ESP's automatic operation, the engine must be shut off (SmartKey in starter switch position **0** or **1**) when the parking brake is being tested on a brake test dynamometer.

Active braking action through ESP may otherwise seriously damage the front or rear axle brake system.

Operational tests with the engine running can only be conducted on a two-axle dynamometer.

#### LOW RANGE – ESP

During off-road driving, a special low range system for the ESP is operational with transmission in LOW RANGE mode (▷ page 125).

In the LOW RANGE mode, the ESP operates in a traction improving fashion specifically adapted for off-road driving. At speeds below 27 mph (45 km/h), the ESP assists in over-/understeering, thus improving vehicle traction.

#### Switching off the ESP

#### Warning!



The ESP should not be switched off during normal driving other than in the circumstances described below. Disabling of the system will reduce vehicle stability in standard driving maneuvers.

To improve the vehicle's traction, turn off the ESP in driving situations where it would be advantageous to have the drive wheels spin and thus cut into surfaces for better grip such as:

- starting out on slippery surfaces and in deep snow in conjunction with snow chains
- in sand or gravel
- when driving off-road

## Safety and Security

### Driving and safety systems



Avoid spinning of a drive wheel for an extended period with the ESP switched off. This may cause serious damage to the drivetrain which is not covered by the Mercedes-Benz Limited Warranty.



Turn ESP on immediately if the aforementioned circumstances do not apply anymore.

The switch is located in the upper center console.



#### ESP on/off switch

- ▶ Press upper half of the ESP switch.

The 4-ETS/ESP warning lamp  in the speedometer comes on.

The ESP is deactivated.

If one or more drive wheels are spinning, the 4-ETS/ESP warning lamp  in the speedometer flashes, regardless of the speed.

Traction control brakes a spinning wheel even when the ESP is deactivated.

The ESP always operates when you are braking, even when it has been deactivated.

#### Warning!



When the 4-ETS/ESP warning lamp  is illuminated continuously, the ESP is switched off.

Adapt your speed and driving to the prevailing road conditions and to the non-operating status of the ESP.

#### Switching on the ESP

- ▶ Press lower half of the ESP switch until the 4-ETS/ESP warning lamp  in the speedometer goes out.

You are now again in normal driving mode.

For more information, see “Practical hints” (▷ page 241).

#### ▼ Anti-theft systems

##### Immobilizer

The immobilizer prevents unauthorized persons from starting your vehicle.

##### Activating

Removing the key from the steering lock activates the immobilizer.

##### Deactivating

Turning the key in the steering lock to position **2** (▷ page 33) deactivates the immobilizer.



In case the engine cannot be started (vehicle's battery is in order), the system is not operational. Contact an authorized Mercedes-Benz Light Truck Center or call 1-800-FOR-MERCEdes (in the USA), or 1-800-387-0100 (in Canada).

##### Anti-theft alarm

Once the alarm system has been armed, a visual and audible alarm is triggered when someone:

- opens a door
- opens the liftgate
- opens the hood

The alarm will stay on even if the activating element (a door, for example) is immediately closed.

The alarm system will also be triggered when

- someone attempts to raise the vehicle
- unlocking and opening the driver's door with the mechanical key



If the alarm stays on for more than 20 seconds, an emergency call is initiated automatically by the Tele Aid\* system (▷ page 171) provided Tele Aid service was subscribed to and properly activated, and that necessary cellular service and GPS coverage are available.

##### Arming the alarm system

The alarm system is armed after locking the vehicle with the remote control. The turn signal lamps flash three times to indicate that the alarm system is activated. A red lamp in the center console will flash after approximately 10 seconds when the alarm system is completely armed (▷ page 27).

## Safety and Security

### Anti-theft systems



If the turn signal lamps do not flash three times, the tow-away - glass breakage sensor is malfunctioning or one of the following elements may not be properly closed:

- a door
- the liftgate
- the hood

Close the respective element and lock the vehicle again.

#### Disarming the alarm system

The alarm system is disarmed when you unlock your vehicle with the remote control. The turn signal lamps flash once to indicate that the alarm system is deactivated.





The alarm system will rearm automatically again after approximately 40 seconds if one of the doors or the liftgate is not opened.

#### Canceling the alarm

To cancel the alarm:

- ▶ Switch on the ignition by turning the key in the steering lock to position **2**.

or

- ▶ Press the  or  button on the remote control.

The alarm is canceled.

#### Tow-away alarm, glass breakage sensor

The tow-away alarm and the glass breakage sensor are part of the anti-theft alarm system.

Once the tow-away alarm is armed, a visual and audible alarm will be triggered when someone:

- attempts to raise the vehicle
- breaks a window and reaches into the passenger compartment



The tow-away protection alarm is triggered, for example, if the vehicle is lifted on one side.

If the alarm stays on for more than 20 seconds, an emergency call is initiated automatically by the Tele Aid\* system (▷ page 171) provided Tele Aid service was subscribed to and properly activated, and that necessary cellular service and GPS coverage are available.

## Safety and Security

### Anti-theft systems

#### Arming tow-away alarm and glass breakage sensor

When you lock your vehicle, the tow-away and glass breakage sensor alarm is automatically armed.

#### Disarming tow-away alarm and glass breakage sensor

To prevent triggering the tow-away alarm feature, switch off the tow-away alarm and glass breakage sensor before towing the vehicle, or when parking on a surface subject to movement, such as a ferry or auto train.

#### Vehicles with trip computer\*

The buttons are located in the overhead control panel.



- ① Reset button
- ② Mode button
- ③ Display
- ④ Glass breakage sensor

- ▶ Turn key in steering lock to position **2** (▷ page 33).
- ▶ Return key to position **0** and remove it from the steering lock.
- ▶ Within 30 seconds press button ① or ②.  
The display shows OFF.
- ▶ Exit vehicle and lock vehicle with remote control (▷ page 32).

The tow-away alarm and glass breakage sensor remain switched off until the key is inserted in steering lock and turned to position **1**.

## Safety and Security

### Anti-theft systems

#### *Vehicles without trip computer*

The buttons are located in the overhead control panel.





- ① Switching off tow-away alarm and glass breakage sensor

- ▶ Turn key in steering lock to position **2** (▷ page 33).
- ▶ Return key to position **0** and remove it from the steering lock.
- ▶ Within 30 seconds press button ① on the right or left side.
- ▶ Exit vehicle and lock vehicle with remote control (▷ page 32).

The tow-away alarm and glass breakage sensor remain switched off until the key is inserted in steering lock and turned to position **1**.

#### **Canceling the alarm**

To cancel the alarm:

- ▶ Switch on the ignition by turning the key in the steering lock to position **2**.
- or
- ▶ Press the  or  button on the remote control.

The alarm is canceled.



**Controls in detail**

**Locking and unlocking**

**Seats**

**Memory function\***

**Lighting**

**Instrument cluster**

**Automatic transmission**

**Transmission control - LOW RANGE mode**

**Good visibility**

**Automatic climate control**

**Power windows**

**Sliding / pop-up roof\***

**Driving systems**

**Loading**

**Useful features**

## Controls in detail

### Locking and unlocking

In the “Controls in detail” section you will find detailed information on how to operate the equipment installed in your vehicle. If you are already familiar with the basic functions of your vehicle, this section will be of particular interest to you.

To quickly familiarize yourself with the basic functions of the vehicle, refer to the “Getting started” section of this manual. The corresponding page numbers are given at the beginning of each segment.

### ▼ Locking and unlocking

#### Remote control with folding key

Your vehicle comes supplied with two remote controls with folding key.

The remote control provides an extended operating range. To prevent theft, however, it is advisable to only unlock the vehicle when you are in close proximity to it.

The key centrally locks and unlocks:

- the doors
- the liftgate
- the fuel filler flap



If the key is inserted in the steering lock, the vehicle cannot be locked or unlocked with the remote control.

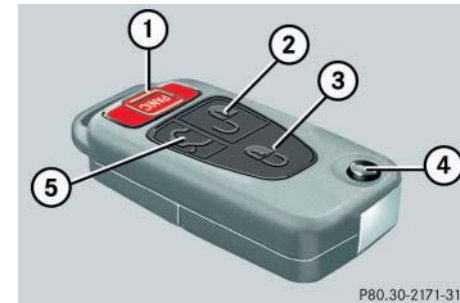

P80.30-2171-31

- ① **PANIC** Panic button (▷ page 75)
- ② Unlock button
- ③ Lock button
- ④ Release button for key
- ⑤ Unlock button for liftgate



To prevent possible malfunction, avoid exposing the remote control to high levels of electromagnetic radiation.



## Unlocking



Unlocking the vehicle with the remote control deactivates the anti-theft alarm.

The vehicle will lock again automatically and reactivate the anti-theft system within approximately 40 seconds of unlocking if neither door nor liftgate is opened.

### **Unlocking the driver's door and fuel filler flap**

- ▶ Press button once.  
All turn signal lamps flash once to indicate that the driver's door and the fuel filler flap are unlocked.

### **Global unlocking**

- ▶ Press button twice.  
All turn signal lamps flash once to indicate that all doors, fuel filler flap and liftgate are unlocked.

### **Unlocking the liftgate**

- ▶ Press button .  
Only the liftgate unlocks.

## Locking



Locking the vehicle with the remote control activates the anti-theft alarm.

- ▶ Press button once.  
All turn signal lamps flash three times to indicate that all doors, the liftgate and the fuel filler flap are locked.

## Controls in detail

### Locking and unlocking



If the turn signal lamps do not flash three times, one of the following elements may not be properly closed:

- a door
- the liftgate
- the hood

Close the respective element and lock the vehicle again.

### Warning!



When leaving the vehicle, always remove the key from the steering lock, and lock your vehicle. Do not leave children unattended in the vehicle, or with access to an unlocked vehicle. Unsupervised use of vehicle equipment may cause an accident and / or serious personal injury.

## Controls in detail

### Locking and unlocking



If you can no longer lock or unlock the vehicle with the remote control, then the batteries in the remote control are discharged, the remote control is malfunctioning or the vehicle battery is drained.

- Check the batteries in the remote control and replace them if necessary (▷ page 262).
- Use the folding key to unlock or lock the doors and the liftgate.
- Check the vehicle battery (▷ page 278).
- Synchronize the remote control (▷ page 263).

If the remote control is malfunctioning, contact an authorized Mercedes-Benz Light Truck Center.

#### Loss of remote control with folding key

If you lose a remote control or the folding key, you should do the following:

- ▶ Have the remote control deactivated by an authorized Mercedes-Benz Light Truck Center.
- ▶ Report the loss of the remote control or the folding key immediately to your car insurance company.
- ▶ If necessary have the mechanical lock replaced.

Your authorized Mercedes-Benz Light Truck Center will be glad to supply you with a replacement.

#### Opening the doors from the inside

You can open a locked door from the inside. Open door only when conditions are safe to do so.

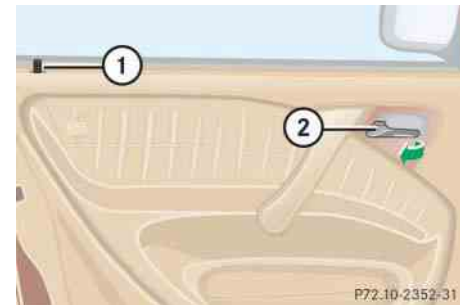

- ① Locking knob
- ② Inside door handle

- ▶ Pull on door handle ②.

If a door was locked, locking knob ① will move up.





If the vehicle has previously been locked from the outside with the remote control, opening a door from the inside will trigger the alarm.

To cancel the alarm, do one of the following:

Switch on the ignition by turning the key in the steering lock to position **2**.

or

Press the  or  button on the remote control.

The alarm is cancelled.

## Opening the liftgate

### Opening the liftgate from outside

A minimum height clearance of 7 ft (2.15 m) is required to open the liftgate.

The handle is located above the rear license plate recess.

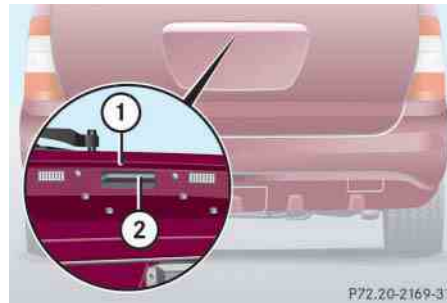

- ① Grip molding
- ② Handle

- ▶ Pull on handle ②.
- ▶ Swing the liftgate upward by using the grip molding.

## Controls in detail

### Locking and unlocking



Always make sure that there is sufficient overhead clearance.



The vehicle must be unlocked.

### Opening the liftgate from inside

A minimum height clearance of 7 ft (2.15 m) is required to open the liftgate.

The release lever is located on the inside of the liftgate.

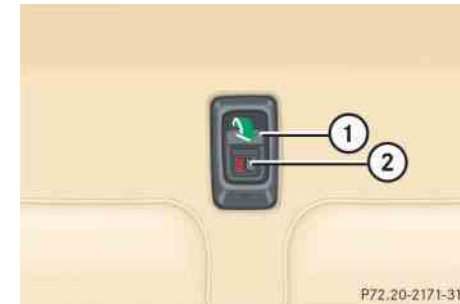

- ① Handle
- ② Catch

## Controls in detail

### Locking and unlocking

- ▶ To unlock the liftgate, move the catch ② to the right.
- ▶ Pull handle ① down and swing liftgate upward.



Always make sure that there is sufficient overhead clearance.



To lock the liftgate, move the catch ② to the left.

#### Warning!



When leaving the vehicle, always remove the key from the steering lock and lock the vehicle. Do not leave children unattended in the vehicle. Children could open the liftgate from inside, which could result in an accident and / or serious personal injury.

### Closing the liftgate

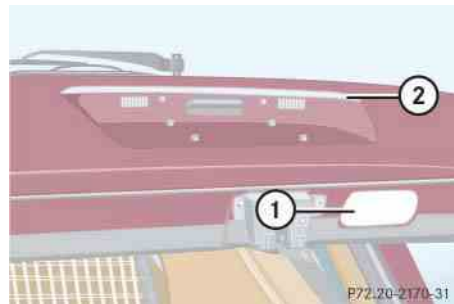

- ① Recessed grip
- ② Grip molding

- ▶ Pull down on recessed grip ①.
- ▶ Close liftgate by using grip molding ②.

#### Warning!



To prevent possible personal injury, always keep hands and fingers away from the liftgate opening when closing the liftgate. Be especially careful when small children are around.

Do not close the liftgate from the inside by pulling on the handle.

#### Warning!



Only drive with the liftgate closed as exhaust fumes may enter the vehicle interior.



To prevent an inadvertent lockout, do not place the key in the cargo compartment.

### Automatic central locking

The doors and the liftgate automatically lock when the ignition is switched on and the left front wheel turns at vehicle speeds of approximately 9 mph (15 km/h) or more.

If one of the front doors is then opened from the inside, the vehicle is unlocked centrally unless only the driver's door was previously unlocked.



The doors unlock automatically after an accident if the force of the impact exceeds a preset threshold.

To prevent the vehicle door locks from locking, deactivate the automatic central locking when the vehicle

- is pushed or towed
- is on a test stand

Information on towing the vehicle can be found in the "Practical hints" section (▷ page 241).

The switch is located on the lower center console.



#### Central locking switch

- ① Locking
- ② Unlocking

## Controls in detail

### Locking and unlocking

#### Activating

- ▶ Make sure the ignition is switched on.  
All the lamps in the instrument cluster light up.
- ▶ Press and hold upper part ① of the central locking button for approximately six seconds.  
The automatic central locking is activated.

#### Deactivating

- ▶ Make sure the ignition is switched on.  
All the lamps in the instrument cluster light up.
- ▶ Press and hold lower part ② of the central locking button for approximately six seconds.  
The automatic central locking is deactivated.

## Controls in detail

### Locking and unlocking

#### Locking and unlocking from the inside

You can lock or unlock the doors and the tailgate from inside using the central locking switch. This can be useful, for example, if you want to lock the vehicle before starting to drive.

#### Warning!



When leaving the vehicle, always remove the key from the steering lock and lock the vehicle. Do not leave children unattended in the vehicle, or with access to an unlocked vehicle. Unsupervised use of vehicle equipment may cause an accident and / or serious personal injury.

#### Locking

- ▶ Press upper part ① of central locking button (▷ page 93).

If all the doors are closed, the vehicle locks.

#### Unlocking

- ▶ Press lower part ② of central locking button (▷ page 93).

The vehicle unlocks.



You can open a locked door from the inside. Open door only when conditions are safe to do so.

If the vehicle was previously centrally locked using the remote control, it will not unlock using the central locking switch.

## ▼ Seats

Information on seat adjustment can be found in the “Getting started” section (▷ page 34).

### Removing and installing front seat head restraints

Information on head restraint adjustment can be found in the “Getting started” section (▷ page 34).

#### Warning!



For your protection, drive only with properly positioned head restraints.

Adjust head restraint so that the head restraint supports the back of the head at eye level. This will reduce the potential for injury to the head and neck in the event of an accident or similar situation.

Do not drive the vehicle without the seat head restraints. Head restraints are intended to help reduce injuries during an accident.

Do not interchange head restraints from front and rear seat.

## Controls in detail

### Seats

#### Front seat head restraints

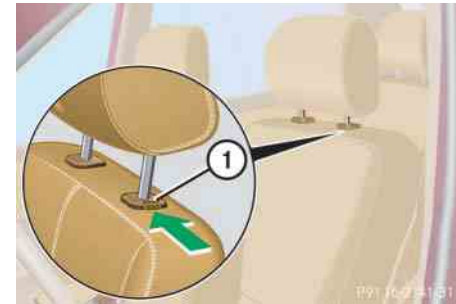

#### Removing head restraints

- ▶ Pull head restraint to its highest position.
- ▶ Push button ① and pull out head restraint.

## Controls in detail

### Seats

#### Installing head restraint

- ▶ Insert head restraint and push it down to the stop.
- ▶ Push button ① and adjust head restraint to the desired position (▷ page 36).

#### Rear seat head restraints

#### Head restraint height

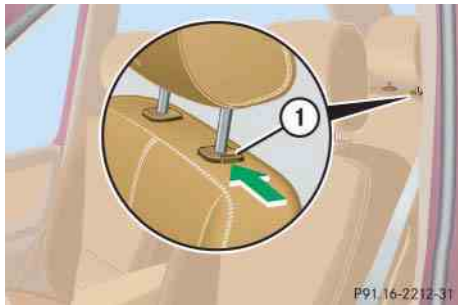

#### Raising:

- ▶ Manually adjust the height of the head restraint by pulling it upward.

#### Lowering:

- ▶ To lower the head restraint, push button ① and press down on the head restraint.

#### Warning!



For your protection, drive only with properly positioned head restraints.

Adjust head restraint so that the head restraint supports the back of the head at eye level. This will reduce the potential for injury to the head and neck in the event of an accident or similar situation.

Do not drive the vehicle without the seat head restraints. Head restraints are intended to help reduce injuries during an accident.

#### Head restraint tilt

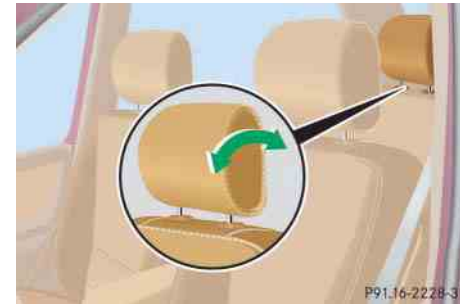

Manually adjust the angle of the head restraint.

- ▶ Push or pull on the upper edge of the head restraint cushion.

More information on seats can be found in the “Getting started” section (▷ page 34).



### Removing and installing rear seat head restraints

**Warning!**



For your protection, drive only with properly positioned head restraints.

Adjust head restraint so that the head restraint supports the back of the head at eye level. This will reduce the potential for injury to the head and neck in the event of an accident or similar situation.

Do not drive the vehicle without the seat head restraints. Head restraints are intended to help reduce injuries during an accident.

Do not interchange head restraints from front and rear seat.

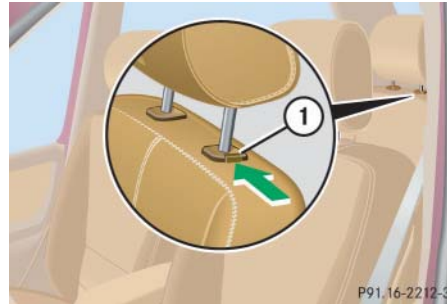

#### Removing rear seat head restraints

- ▶ Pull head restraint to its highest position.
- ▶ Push button ① and pull out head restraint.



For a better view toward the rear, you can store the rear center head restraint underneath the rear seat (▷ page 97).

#### Installing rear seat head restraints

- ▶ Insert head restraint and push it down to the stop.
- ▶ Push button ① and adjust head restraint to the desired position (▷ page 36).

#### Stowing rear center head restraint

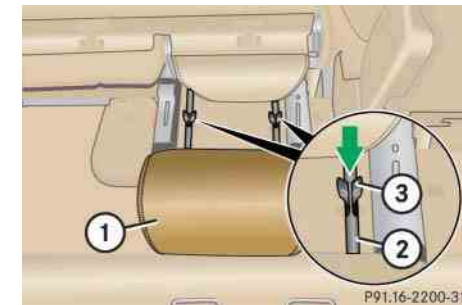

- ① Rear center head restraint
- ② Bar
- ③ Clip



## Controls in detail

### Seats

- ▷▷▶ Remove rear center head restraint (▷ page 96).
- ▶ If necessary, remove cargo floor plates, see “Removing cargo floor plates” (▷ page 162).
- ▶ Slide rear seats forward, see “Adjusting rear seat fore and aft” (▷ page 99).
- ▶ Fold rear seat backrests down, see “Folding down the backrest” (▷ page 100).
- ▶ From cargo compartment, attach rear center head restraint ① to underside of rear center seat.  
Make sure front side of head restraint ① is facing upward.
- ▶ Press bar ② on both sides into clips ③.

### Heated seats\*

Both switches for the front seats are located in the center console.



- ① Normal heating
- ② Rapid heating

- ▶ Start the engine.

### Switching on seat heating

- ▶ Press upper switch position ①.  
A red indicator lamp on the switch lights up.

### Switching off seat heating

- ▶ Press upper switch position ① again.  
The indicator lamp on the switch turns off.



The seat heater will be automatically switched off after approximately 20 minutes.

### Switching on rapid seat heating

- ▶ Press lower switch position ②.  
Both red indicator lamps on the switch turn on.



The system switches over to normal heating mode after approximately five minutes. Only one red indicator lamp remains on.

### Switching off rapid seat heating

- ▶ Press lower switch position ② again.

Both red indicator lamps on the switch turn off.



If one or both of the lamps on the seat heater switch are flashing, there is insufficient voltage available since too many electrical consumers are turned on. The seat heater switches off automatically.

The seat heater will switch back on again automatically as soon as sufficient voltage is available.

### Rear seats

#### Warning!



Do not adjust the rear seats while driving.

Always seat in an upright position and the seat belts are properly positioned on the body. Your seat must be adjusted so that you can correctly fasten your seat belt.

Adjust head restraint to support the back of the head approximately at ear level.

Never place hands under the seat or near any moving parts while a seat is being adjusted.

The rear seats are divided asymmetrically. To enlarge the cargo area you can adjust the left and right part separately. The following changes are possible:

- moving the seat fore and aft
- folding down the backrest
- lowering the seat

## Controls in detail

### Seats

### Adjusting rear seat fore and aft

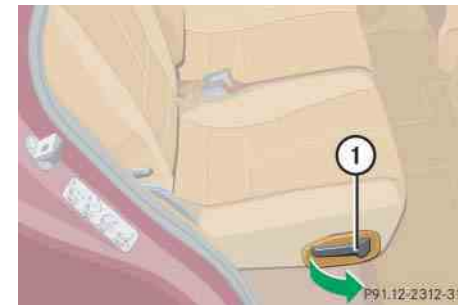

#### ① Release lever

- ▶ Pull release lever ① in direction of arrow.
- ▶ Slide seat to the desired position until it locks in place.

#### Warning!



Failure to assure that seats are locked into place could result in an increased chance of injury in an accident.

## Controls in detail

### Seats

#### Folding down the backrest

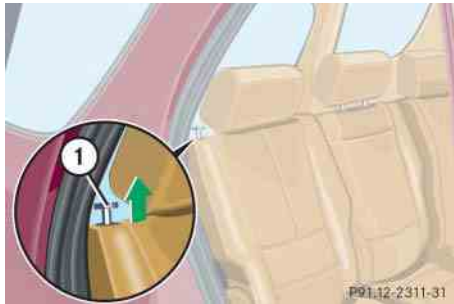

##### ① Lock button

- ▶ Close cup holder (▷ page 167) and ashtray (▷ page 169) in rear center console (▷ page 167).
- ▶ Move front seats forward. Manual seat (▷ page 35) or power seat (▷ page 37).
- ▶ Slide seat forward.
- ▶ Remove head restraint(s) (▷ page 95).
- ▶ Pull lock button ① up and fold backrest forward until it locks in place.

The red backrest lock indicator at lock button ① is not visible in the locked position.

#### Folding up the backrest

- ▶ Close cup holder (▷ page 167) and ashtray (▷ page 169) in rear center console.
- ▶ Pull lock button ① up and unfold backrest until it locks in place.

Make sure the seat belt is not caught in the seat.

- ▶ Check for secure locking by pulling and pushing on the backrest.

The red backrest lock indicator at lock button ① is not visible in the locked position.

- ▶ Install head restraint (▷ page 96).

- ▶ Slide seat rearward to desired position (▷ page 99).
- ▶ Adjust front seats to desired position. Manual seats (▷ page 35) or power seats (▷ page 37).

#### Lowering the rear seat

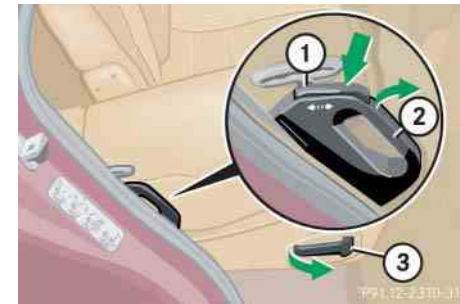

- ① Release button
- ② Lever
- ③ Release lever

- ▶ Close cup holder in rear center console (▷ page 167).
- ▶ Move front seats forward. Manual seat (▷ page 35) or power seat (▷ page 37).
- ▶ Press and hold release button ① to unlock lever ②.
- ▶ Pull lever ② in direction of arrow.
- ▶ Pull release lever ③ and push down rear seat until it locks in place.
- ▶ Fold down the backrest (▷ page 100).
- ▶ Adjust front seats to desired position. Manual seats (▷ page 35) or power seats (▷ page 37).

### Folding up the rear seat

- ▶ Move front seats forward. Manual seat (▷ page 35) or power seat (▷ page 37).
- ▶ Pull release lever ③ and raise rear seat until it locks in place.

#### Warning!



Failure to assure that seats are locked into place could result in an increased chance of injury in an accident.

### Easy entry / exit feature\*

The easy entry / exit feature allows access to the third row seats\*. The right cargo floor plate must be removed (▷ page 162).

#### Warning!



Never drive with the second row right seat folded forward (easy entry / exit feature). It could open and fold back unintentionally.

## Controls in detail

### Seats

### Folding rear seat forward

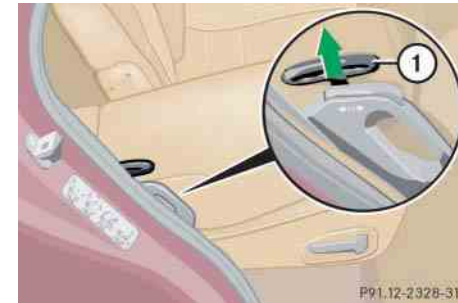

#### ① Lever

- ▶ Move right seat forward. Manual seats (▷ page 35) or power seats (▷ page 37).
- ▶ Move rear seat forward (▷ page 99).
- ▶ Push head restraint fully down and tilt it forward.
- ▶ Fold backrest forward (▷ page 100).
- ▶ Pull lever ① up and fold the rear seat forward.

## Controls in detail

### Seats

#### Resetting rear seat

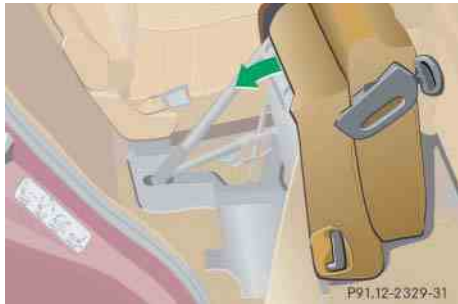

- ▶ Pull down on seat bench until it locks into place.
- ▶ Pull lock button ① (▷ page 100) up and unfold backrest until it locks into place.
- ▶ Check for secure locking by pulling and pushing on the backrest.

The red backrest lock indicator at lock button ① (▷ page 100) is not visible in the locked position.

- ▶ Move the rear and front seats in desired position.
- ▶ Pull up and adjust head restraint (▷ page 36).

#### Third row seats\*

##### Warning!



For your protection, drive only with properly positioned head restraints.

Adjust head restraint so that head restraint supports the back of the head at eye level. This will reduce the potential for injury to the head and neck in the event of an accident or similar situation.

Failure to assure that seats are locked into place could result in an increased chance of injury in an accident.

Never place hands under seat or near any moving parts while a seat is being adjusted.

#### Folding down single seat

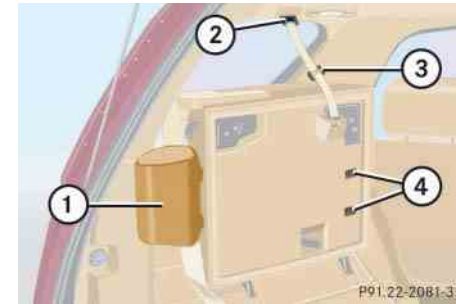

- ① Head restraint
- ② Hook
- ③ Tensioner
- ④ Hook and loop velcro strip

- ▶ Remove cargo floor plate (▷ page 162).
- ▶ Remove head restraint ① from seat cushion.
- ▶ Lift tensioner ③ upward to a horizontal position to release tension of the belt.
- ▶ Disengage hook ② while holding onto the seat firmly with one hand.

- ▶ Attach belt at hook and loop velcro strip ④ (▷ page 102) on underside of seat.

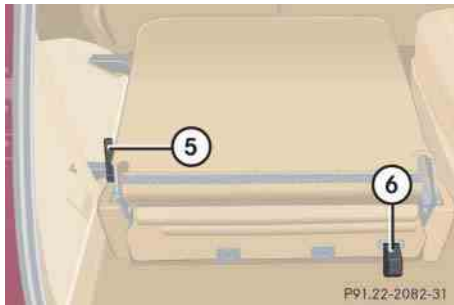

- ⑤ Backrest release
- ⑥ Seat release
- ▶ Fold seat down until it locks securely in place.  
The red marking on the seat release ⑥ should not be visible.
- ▶ Store cargo floor plates inside the backrest (▷ page 162).
- ▶ Pull backrest release ⑤ and unfold backrest until it locks securely in place.

- ▶ Install head restraint ① in backrest (▷ page 102).

#### Storing single seat



- ▶ Remove head restraint from backrest (▷ page 102).
- ▶ Pull backrest release ⑤ and fold backrest forward until it locks securely in place.
- ▶ Remove cargo floor plates from the backrest.
- ▶ Pull seat release ⑥ (▷ page 103) and fold seat up.

## Controls in detail

### Seats

- ▶ Disengage belt and engage hook ② (▷ page 102) in ceiling mount.
- ▶ Pull on free end of belt until tight.
- ▶ Install head restraint in openings provided in seat cushion.
- ▶ Install cargo floor plates (▷ page 162).

#### Warning!



After folding the seats up, manually place the lap belt portion of the seat belt behind the seat (arrow). Otherwise, the lap belt may be subject to damage and could rip.

## Controls in detail

### Seats

#### Removing single seat

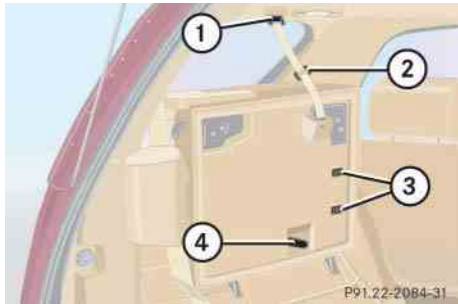

- ① Hook
- ② Tensioner
- ③ Hook and loop velcro strip
- ④ Release lever

- ▶ Lift tensioner ② upward to a horizontal position to release tension of the belt.
- ▶ Disengage hook ① while holding onto the seat firmly with one hand.
- ▶ Attach belt at hook and loop strip ③ on underside of seat.
- ▶ Move release lever ④ upward and remove seat.

#### Installing single seat

- ▶ Place seat into the mounting clamps and click the seat into place.



## ▼ Memory function\*



Prior to operating the vehicle the driver should check and adjust the seat height, seat position fore and aft, and seat backrest angle if necessary, to ensure adequate control, reach and comfort. The head restraint should also be adjusted for proper height. See also the section on airbags (▷ page 59) for proper seat positioning.

In addition, adjust the steering wheel to ensure adequate control, reach, operation and comfort. Both the inside and outside rear view mirrors should be adjusted for adequate rear vision.

Fasten seat belts. Infants and small children should be seated in a properly secured restraint system that complies with U.S. Federal Motor Vehicle Safety Standard 213 and 225 and Canadian Motor Vehicle Safety Standard 213 and 210.2.

With the memory button you can store up to three different settings for the driver- and passenger seat.

Together with the driver's seat you can store the exterior rear view mirrors.

For the front passenger seat you can store the seat position.

### Warning!



Do not activate the memory function while driving. Activating the memory function while driving could cause the driver to lose control of the vehicle.

### Storing exterior rear view mirror parking position

For easier parking, you can adjust the passenger-side exterior rear view mirror so that you can see the right rear wheel as soon as you engage reverse gear **R**.

## Controls in detail

### Memory function\*

For information on activating the parking position feature, see “Activating exterior rear view mirror parking position” (▷ page 127).



- ① Position buttons
- ② Memory button

## Controls in detail

### Memory function\*

#### Storing parking position

- ▶ Stop the vehicle.
- ▶ Switch on ignition (if not already on).
- ▶ Press button ②.  
The passenger-side exterior rear view mirror is selected.
- ▶ Adjust the exterior rear view mirror with button ③ so that you see the rear wheel and the road curb.
- ▶ Press memory button ② (▷ page 105).
- ▶ Within three seconds, press bottom of adjustment button ③.  
The parking position is stored if the mirror does not move.



If the mirror does move, repeat the above steps. After the setting is stored you can move the mirror again.

The selected position will be stored relative to the position button ① (▷ page 105) pressed.

#### Storing positions in memory

- ▶ Adjust the seat (▷ page 37) and exterior rear view mirrors (▷ page 40) to the desired position.
- ▶ Push memory button ② (▷ page 105).
- ▶ Release memory button and press one of the position buttons ① within three seconds.

All the settings are stored at the selected position.

#### Recalling positions from memory



Do not operate the power seats using the memory button if the seat backrest is in an excessively reclined position. Doing so could cause damage to front or rear seats.

- ▶ Press and hold one of the position buttons ① until seat and rear view mirrors have fully moved to the stored positions.



Releasing the button immediately stops movement to the stored positions.

## ▼ Lighting

For notes on how to switch on the headlamps (▷ page 48) and use the turn signals (▷ page 49), see the “Getting started” section.



If you drive in countries where vehicles drive on the other side of the road than the country where the vehicle is registered, you must have the headlamps modified for symmetrical low beams. Relevant information can be obtained at your authorized Mercedes-Benz Light Truck Center.

### Combination switch



The combination switch is on the left of the steering column.



- ① High beam
- ② High beam flasher

## Controls in detail

### Lighting

- 0** Off
- AUTO** Automatic headlamp mode
-  Parking lamps, license plate lamps and instrument panel lamps  
Canada only: With the engine running, the low beam headlamps additionally switched on.
-  Low beam or high beam headlamps
-  Left or right standing lamps (symbol on underside of switch)

## Controls in detail

### Lighting



If you remove the key and open the driver's door while the parking lamps or low beam headlamps are switched on, then a warning sounds.

#### Manual headlamp mode

The low beam headlamps and parking lamps can be switched on and off with the combination switch. For combination switch, see (▷ page 107).

#### Automatic headlamp mode

The parking lamps, low beam headlamps and license plate lamps switch on and off automatically depending on the brightness of the ambient light.

- ▶ Turn the combination switch to **AUTO**.

#### Warning!



If the combination switch is set to **AUTO**,

- the headlamps may switch off unexpectedly when the system senses bright ambient light, for example light from oncoming traffic.
- the headlamps will not be automatically switched on under foggy conditions.

To minimize risk to you and to others, activate headlamps by turning combination switch to **LED** when driving or when traffic and /or ambient lighting conditions require you to do so.

In low ambient lighting conditions, only switch from position **AUTO** to **LED** with the vehicle at a standstill. Switching from **AUTO** to **LED** will briefly switch off the headlamps. Doing so while driving in low ambient lighting conditions may result in an accident.

The automatic headlamp feature is only an aid to the driver. The driver is responsible for the operation of the vehicle's lights at all times.



If the automatic headlamp mode is activated, the fog lamps can also be switched on (▷ page 111). The low beam headlamp and parking lamps are activated simultaneously.

#### Daytime running lamp mode

##### Canada only:

- ▶ Turn combination switch to position **0** or **AUTO**.

When the engine is running, the low beam headlamps are automatically switched on. In low ambient light conditions, the parking lamps will also switch on.

When you shift from a driving position to position **N** or **P**, the low beam switches off (three minutes delay).

For nighttime driving you should turn the combination switch to position  to permit activation of the high beam headlamps.



The high beam flasher is always available.

#### Night security illumination

When you turn off the engine and the last door has been closed, the following lamps will remain lit:

- Parking lamps
- Tail lamps
- License plate lamps
- Front fog lamps

The combination switch must be set to position **AUTO** (▷ page 107).



You can reactivate this function within ten minutes by opening a door or the liftgate.

If you do not open a door or the liftgate after turning off the engine, the lamps will automatically switch off after 60 seconds.

#### Deactivating night security illumination temporarily

- ▶ Before leaving the vehicle, turn the key in the steering lock to position **0** (▷ page 33) then turn it to position **2** and back to **0**.

The night security illumination is deactivated. It will reactivate as soon as you start the engine.

#### Setting illumination time



① Switch for fog lamps

## Controls in detail

### Lighting

- ▶ Stop the vehicle.
- ▶ Make sure the ignition is switched on.  
All the lamps in the instrument cluster light up.
- ▶ Turn combination switch to position **0**.
- ▶ Press upper part ① of switch until the clock, located in the instrument cluster, displays the actual illumination time.
- ▶ Press upper part ① of switch again.  
Each time the switch is pressed, the illumination time increases by 15 seconds. You can set the illumination time between 0 (off) and 60 seconds.

Approximately five seconds after pressing the switch, the illumination time is set and the clock is displayed again.

#### Locator lighting



During darkness, the following lamps will come on when the vehicle is unlocked by remote control:

- Parking lamps
- Tail lamps
- License plate lamps
- Front fog lamps

The combination switch must be set to position **AUTO** (▷ page 107).

The locator lighting switches off when the driver's door is opened. It switches off automatically after a period of approximately 40 seconds.

#### Switching on high beams

- ▶ Turn the combination switch to  (▷ page 107).
- ▶ Push the combination switch forward.  
The high beam indicator  in the instrument cluster comes on.



#### High beam flasher

- ▶ Pull the combination switch briefly in direction ②.

## Fog lamps

### Warning!



In low ambient lighting or foggy conditions, only switch from position **AUTO** to  with the vehicle at a standstill. Switching from **AUTO** to  will briefly switch off the headlamps. Doing so while driving in low ambient lighting conditions may result in an accident.





The fog lamps can be switched on with combination switch in position  or **AUTO**. Consult your state Motor Regulations regarding allowable lamp operation.

The switch is located on the upper center console.



- ① Front fog lamps
- ② Indicator lamp
- ③ Front fog lamps and rear fog lamp

### Switching front fog lamps on and off

- ▶ Make sure the low beam headlamps are switched on.
- ▶ Press upper part ① of switch.  
The green indicator lamp  in the instrument cluster comes on.
- ▶ Press upper part ① of switch again.  
The green indicator lamp  in the instrument cluster goes out.

## Controls in detail

### Lighting

### Switching front fog lamps and rear fog lamps on and off

- ▶ Make sure the low beam headlamps are switched on.

- ▶ Press lower part ③ of switch.

The green indicator lamp  in the instrument cluster comes on in addition to the yellow indicator lamp ② in the switch.

- ▶ Press lower part ③ of switch again.

The green indicator lamp  in the instrument cluster and the yellow indicator lamp ② in the switch go out.

### Switching rear fog lamp on and off

- ▶ Press upper part ① of switch.

The yellow indicator lamp ② in the switch goes out.

- ▶ Press upper part ① of switch.

The green indicator lamp  in the instrument cluster goes out.

## Controls in detail

### Lighting

#### Hazard warning flasher

The hazard warning flasher can be activated with the ignition switched on or off. It is activated automatically when an airbag is deployed.

The switch is located on top of the steering column.



Hazard warning flasher switch

#### Switching on hazard warning flasher

- ▶ Press the hazard warning flasher switch.

All the turn signals will flash.

#### Switching off hazard warning flasher

- ▶ Press hazard warning flasher switch again.



If the hazard warning flasher was activated automatically, press the hazard warning flasher switch twice to deactivate.

#### Interior lighting

The controls are located in the overhead control panel.



- ① Left front interior lamp lens
- ② Right front interior lamp lens
- ③ Automatic function off
- ④ Automatic function on
- ⑤ Rear interior lighting



#### Automatic control

##### **Activating automatic control**

- ▶ Bring the rocker switch to center position ④.

Interior lamps (except cargo compartment lamp) are switched on in darkness, when you

- unlock the vehicle
- open a door
- remove the key from the steering lock

In addition, the entry / exit lamps in the door trays will come on when you open a door.

When all doors are closed and no key is inserted in the steering lock, the interior lamps are switched off after a brief delay.



If the door remains open, the interior lamps (except cargo compartment lamp) switch off automatically after approximately 30 minutes.

##### **Deactivating automatic control**

- ▶ Press lower part ③ of rocker switch.

The interior lighting and the entry / exit lamps remain switched off in darkness, even when you

- unlock the vehicle
- open a door
- remove the key from the steering lock

#### Manual control



If a lamp is switched on manually, it will not go out automatically. This could cause the battery to become discharged.

##### **Switching on front interior lamps**

- ▶ Press on lamp lens ① or ②.  
The respective lamp switches on.

##### **Switching off front interior lamps**

- ▶ Press on lamp lens ① or ② again.  
The respective lamp switches off.

##### **Operating rear interior lighting with rocker switch**

- ▶ Press on upper part ⑤ of rocker switch.

The rear interior lighting goes on. >>

## Controls in detail

### Lighting

- ▶▶ Press on upper part ⑤ of rocker switch again.  
The rear interior lighting goes off.  
If the switch is pressed while the rear interior lighting is on, the function is reversed.

#### *Operating rear interior lighting with lamp lens*



#### **Rear interior lighting**

- ▶ Push on lamp lens (arrow) to switch rear interior lighting on or off.

#### **Reading lamps in inside rear view mirror**

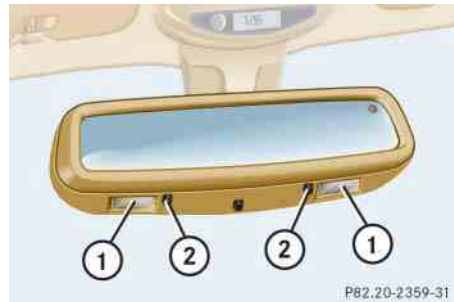

- ① Reading lamps
- ② Reading lamps on / off

#### **Switching reading lamp on and off**

- ▶ Press button ②.  
The lamp switches on.
- ▶ Press button ② again.  
The lamp switches off.

#### **Cargo compartment lamp**

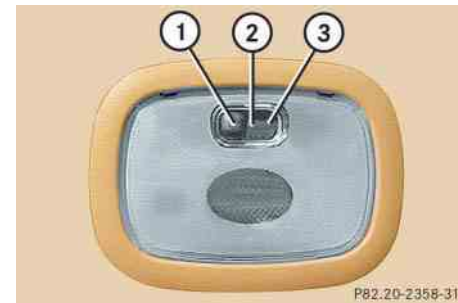

- ① Switched off
- ② Switched on continuously
- ③ Automatic control

#### **Switching off cargo compartment lamp**

- ▶ Slide the switch to position ①.  
The cargo compartment lamp is switched off, even when the liftgate is opened.

**Switching on continuous cargo compartment lamp**

- ▶ Slide the switch to position ②.

The cargo compartment lamp is switched on continuously.



To prevent the vehicle battery from being discharged, make sure the switch is not in position ② when leaving the vehicle.

**Automatic control**

- ▶ Slide the switch to position ③.

The cargo compartment lamp is switched on and off by opening or closing the liftgate.

## Controls in detail

### Instrument cluster

#### ▼ Instrument cluster

A full view illustration of the instrument cluster can be found in the “At a glance” section of this manual (▷ page 24).



- ① Left knob
- ② Right knob

The instrument cluster is activated when you:

- open the driver's door
- turn the key in steering lock to position **1** or **2** (▷ page 33)
- press the left knob ①

### Instrument cluster illumination



You can set the instrument cluster illumination with the following lamps on:

- parking lamps
- low beam headlamps
- high beam headlamps

#### To brighten illumination

- ▶ Turn knob ① clockwise.

The instrument cluster illumination will brighten.

#### To dim illumination

- ▶ Turn knob ① counterclockwise.

The instrument cluster illumination will dim.

### Coolant temperature gauge

Under normal driving conditions, the coolant temperature may rise to 248°F (120°C). The coolant temperature may climb to the red marking:

- at high outside temperatures
- during stop-and-go city traffic
- when driving on hilly terrain

The engine should not be operated with the coolant temperature in the red zone. Doing so may cause serious engine damage which is not covered by the Mercedes-Benz Limited Warranty.

### Warning!



Driving when your engine is badly overheated can cause some fluids which may have leaked into the engine compartment to catch fire. You could be seriously burned.

Steam from an overheated engine can cause serious burns and can occur just by opening the engine hood. Stay away from the engine if you see or hear steam coming from it.

Turn off the engine, get out of the vehicle and do not stand near the vehicle until the engine has cooled down.

### Display in the speedometer

#### Changing display

- ▶ Press the left knob ① in the instrument cluster (▷ page 116).

The display changes between main odometer and trip odometer.

- ▶ Press the left knob ① twice.

The next scheduled service is displayed (▷ page 232).

## Controls in detail

### Instrument cluster

#### Resetting trip odometer

- ▶ Press the left knob ① (▷ page 116) repeatedly until you see the trip odometer display.
- ▶ Press and hold the left knob ① until the trip odometer is reset.

#### Tachometer

To help protect the engine, the fuel supply is interrupted if the engine is operated above its specified limit.

#### Outside temperature indicator

##### Warning!



The outside temperature indicator is not designed to serve as an ice-warning device and is therefore unsuitable for that purpose.

Indicated temperatures just above the freezing point do not guarantee that the road surface is free of ice. The road may still be icy, especially in wooded areas or on bridges.

The outside temperature is displayed in the instrument cluster (▷ page 24).

When moving the vehicle into colder ambient temperatures (e.g. when leaving your garage), you will notice a delay before the lower temperature is displayed.

A delay also occurs when ambient temperatures rise. This prevents inaccurate temperature indications caused by heat radiated from the engine during idling or slow driving.

#### Setting the clock

##### Hour

- ▶ Pull out the right knob ② in the instrument cluster (▷ page 116) and turn it counterclockwise.

##### Minutes

- ▶ Pull out the right knob ② in the instrument cluster (▷ page 116) and turn it clockwise.



To set the clock by a single hour or a few minutes, turn knob ② just a few degrees in the direction indicated for hours or minutes.

## ▼ Automatic transmission

Information on driving with an automatic transmission is found in the “Getting started” section (▷ page 46).

Your vehicle’s transmission adapts its gear shifting process to your individual driving style by continually adjusting the shift points up or down. These shift point adjustments are performed based on current operating and driving conditions.

If the operating conditions change, the automatic transmission reacts by adjusting its gear shift program.



During the brief warm-up, transmission upshifting is delayed. This allows the catalytic converter to heat up more quickly to operating temperature.

The automatic transmission selects individual gears automatically, depending on:

- the gear selector lever position **D** with gear ranges **4, 3, 2, 1** (▷ page 121)
- the position of the accelerator pedal (▷ page 123)
- the vehicle speed

The current gear selector lever position appears in the tachometer display (▷ page 24).

## Controls in detail

### Automatic transmission

#### Warning!



It is dangerous to shift the gear selector lever out of **P** or **N** if the engine speed is higher than idle speed. If your foot is not firmly on the brake pedal, the vehicle could accelerate quickly forward or reverse. You could lose control of the vehicle and hit someone or something. Only shift into gear when the engine is idling normally and when your right foot is firmly on the brake pedal.

When the gear selector lever is in position **D**, you can influence transmission shifting by

- limiting the gear range
- changing gears manually

## Controls in detail

### Automatic transmission

#### One-touch gearshifting

Even with an automatic transmission you can change the gears manually when the gear selector lever is in position **D**.

#### Downshifting

- ▶ Briefly press the gear selector lever to the left in the **D-** direction.

The transmission will shift from the current gear to the next lower gear. This action simultaneously limits the gear range of the transmission (▷ page 121).

#### Warning!



On slippery road surfaces, never downshift in order to obtain braking action. This could result in drive wheel slip and reduced vehicle control. Your vehicle's ABS will not prevent this type of loss of control.



To avoid overrevving the engine when the gear selector lever is moved to the **D-** direction, the transmission will not shift to a lower gear if the engine's max. speed would be exceeded.

#### Upshifting

- ▶ Briefly press the gear selector lever to the right in the **D+** direction.

The transmission will shift from the current gear to the next higher gear as permitted by the shift program. This action simultaneously extends the gear range of the transmission.

#### Canceling gear range limit

- ▶ Press and hold the gear selector lever in the **D+** direction until **D** reappears in the tachometer display.

The transmission will shift from the current gear range directly to gear range **D**.

#### Shifting into optimal gear range

- ▶ Press and hold the gear selector lever in the **D-** direction.

The transmission will automatically select the gear range suited for optimal acceleration and deceleration. This will involve shifting down one or more gears.



### Gear ranges

With the gear selector lever in position **D**, you can limit the transmission's gear range by pressing the gear selector lever to the left (**D-**), and reverse the gear range limit by pressing the gear selector lever to the right (**D+**).

The selected gear range appears in the tachometer display. If you press on the accelerator when the engine has reached its rpm limit, the transmission will upshift beyond any gear range limit selected.

	Effect
<b>4</b>	The transmission shifts through fourth gear only.
<b>3</b>	The transmission shifts through third gear only.  With this selection you can use the braking effect of the engine.

## Controls in detail

### Automatic transmission

	Effect
<b>2</b>	The transmission shifts through second gear only.  Allows the use of engine's braking power when driving: <ul style="list-style-type: none"><li>• on steep downgrades</li><li>• in mountainous regions</li><li>• under extreme operating conditions</li></ul>
<b>1</b>	The transmission operates in first gear only.  For maximum use of engine's braking effect on very steep or lengthy downgrades.

## Controls in detail

### Automatic transmission

#### Gear selector lever position

	Effect
<b>P</b>	<b>Park position</b> Gear selector lever position when the vehicle is parked. Place gear selector lever in position <b>P</b> only when vehicle is stopped. The park position is not intended to serve as a brake when the vehicle is parked. Rather, the driver should always set the parking brake in addition to placing the gear selector lever in position <b>P</b> to secure the vehicle.

	Effect
	The key can only be removed from the steering lock with the gear selector lever in position <b>P</b> . With the key removed, the gear selector lever is locked in position <b>P</b> .  If the vehicle's electrical system is malfunctioning, the gear selector lever could remain locked in position <b>P</b> (▷ page 264).
<b>R</b>	<b>Reverse gear</b> Place gear selector lever in position <b>R</b> only when vehicle is stopped.

	Effect
<b>N</b>	<b>Neutral</b> No power is transmitted from the engine to the drive axle. When the brakes are released, the vehicle can be moved freely (pushed or towed).  To avoid damage to the transmission, never engage <b>N</b> while driving.  If the ESP is deactivated or malfunctioning: Move gear selector lever to <b>N</b> only if the vehicle is in danger of skidding, e.g. on icy roads.
<b>D</b>	<b>Drive</b> The transmission shifts automatically. All five forward gears are available.



Coasting the vehicle, or driving for any other reason with gear selector lever in **N** can result in transmission damage that is not covered by the Mercedes-Benz Limited Warranty.

### Warning!



Getting out of your vehicle with the gear selector lever not fully engaged in position **P** is dangerous. Also, position **P** alone is not intended to or capable of preventing your vehicle from moving, possibly hitting people or objects.

Always set the parking brake in addition to shifting to position **P** (▷ page 53).

When parked on an incline, turn the front wheels towards the road curb.

### Warning!



Do not park this vehicle in areas where combustible materials such as grass, hay or leaves can come into contact with the hot exhaust system, as these materials could be ignited and cause a vehicle fire.

### Warning!



When leaving the vehicle, always remove the key from the steering lock, take it with you and lock the vehicle. Do not leave children unattended in the vehicle, or with access to an unlocked vehicle. Children could move the gear selector lever from position **P**, which could result in an accident and / or serious personal injury.

## Controls in detail

### Automatic transmission

#### Accelerator position

Your driving style influences the transmission's shifting behavior:

Less throttle	Earlier upshifting
More throttle	Later upshifting

#### Kickdown

Use kickdown when you want maximum acceleration.

- ▶ Press the accelerator past the point of resistance.  
The transmission shifts into a lower gear.
- ▶ Ease on the accelerator when you have reached the desired speed.  
The transmission shifts up again.

## Controls in detail

### Automatic transmission

#### Towing a trailer

---

If you tow a trailer, note the following points:

- Manually shift to a lower gear range (**4, 3, 2, 1**), if the transmission hunts between gears on inclines (▷ page 121).

A lower gear range and reduction of speed reduces the change to overload or overheat the engine.

- At very steep inclines switch transfer case to LOW RANGE mode (▷ page 125).

For more information on trailer towing, see the “Operation” section (▷ page 206).

#### Emergency operation (Limp Home Mode)

---

If vehicle acceleration worsens or the transmission no longer shifts, the transmission is most likely operating in limp home (emergency operation) mode. In this mode only second gear and reverse gear can be activated.

- ▶ Stop the vehicle.
- ▶ Move gear selector lever to position **P**.
- ▶ Turn off the engine.
- ▶ Wait at least ten seconds before restarting.
- ▶ Restart the engine.
- ▶ Move selector lever to position **D** (for second gear) or **R**.
- ▶ Have the transmission checked at an authorized Mercedes-Benz Light Truck Center as soon as possible.

### Transmission control – LOW RANGE mode

#### ▼ Transmission control – LOW RANGE mode

In the following situations you should switch to LOW RANGE mode:

- during off-road driving
- when crossing water
- when towing up or down on steep gradients



Only switch the LOW RANGE mode on or off, when the vehicle is

- at a complete standstill
- the engine speed is less than 1500 rpm

Failure to do so may result in transmission or engine damage which is not covered by the Mercedes-Benz Limited Warranty.



You should only operate the vehicle on a single axle dynamometer for briefly testing the brakes.

The key must be in steering lock position 1 (▷ page 33).

#### Switching on LOW RANGE mode



#### LOW RANGE mode switch

- ▶ Stop the vehicle.
- ▶ Move the gear selector lever to position **N**.

- ▶ Press on the upper part of the switch. During the changeover the indicator lamp (▷ page 25) flashes three times. Once the changeover is complete, the indicator lamp comes on continuously.

#### Switching off LOW RANGE mode

- ▶ Stop the vehicle.
- ▶ Move the gear selector lever to position **N**.
- ▶ Press on the upper part of the switch. During the changeover the indicator lamp (▷ page 25) flashes three times. Once the changeover is complete, the indicator lamp goes out.

For information on driving safety systems during LOW RANGE mode see the “Safety and Security” section (▷ page 76).

## Controls in detail

### Good visibility

#### ▼ Good visibility

Information on the windshield wipers (▷ page 49) and for setting the rear view mirrors (▷ page 40) is found in the “Getting started” section.

#### Rear view mirror

##### Interior rear view mirror, antiglare position

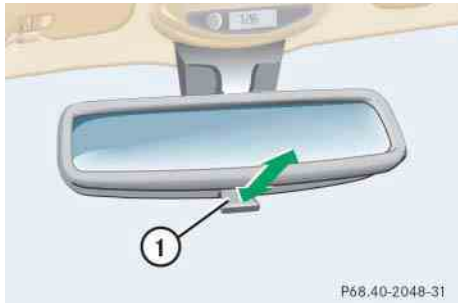

① Lever

- ▶ Tilt the mirror to the antiglare night position by moving lever ① towards the windshield.

The interior rear view mirror is dimmed.

##### Automatic antiglare rear view mirror\*

The reflection brightness of the exterior rear view mirror on the driver's side and the interior rear view mirror will respond automatically to glare when:

- the automatic antiglare function is activated (▷ page 127)
- the ignition is switched on
- incoming light from headlamps falls on the sensor in the interior rear view mirror

The rear view mirror will not react if

- reverse gear is engaged
- the interior light is turned on

#### Warning!



The automatic antiglare function does not react if incoming light is not aimed directly at sensors in the inside rear view mirror.

The interior rear view mirror and the exterior rear view mirror on the driver's side do not react, for example, if the cargo area is fully loaded.

Glare can endanger you and others.

#### Warning!



In the case of an accident, liquid electrolyte may escape the mirror housing if the mirror glass breaks.

Electrolyte has an irritating effect. Do not allow the liquid to come into contact with eyes, skin, clothing, or the respiratory system. In case it does, immediately flush affected area with water, and seek medical help if necessary.

### Warning!



Exercise care when using the passenger-side exterior rear view mirror. The mirror surface is convex (outwardly curved surface for a wider field of view). Objects in mirror are closer than they appear. Check your interior rear view mirror or glance over your shoulder before changing lanes.



Electrolyte drops coming into contact with the vehicle paint finish can only be completely removed while in their liquid state and by applying plenty of water.

### Activating



- ① Button
- ② Indicator lamp
- ▶ Press button ①.  
Indicator lamp ② comes on.

### Deactivating

- ▶ Press button ① again.  
Indicator lamp ② goes out.

## Controls in detail

### Good visibility

### Activating exterior rear view mirror parking position

The buttons are on the lower part of the center console.

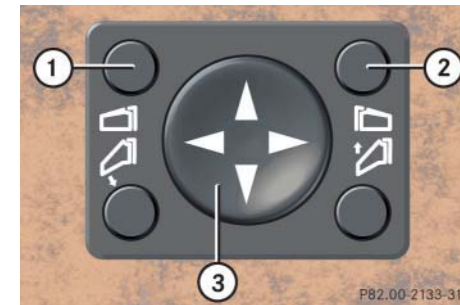

- ① Deactivating parking position
- ② Activating parking position
- ③ Adjustment button
- ▶ Make sure you have stored a parking position for the passenger-side exterior rear view mirror (▷ page 106).
- ▶ Switch on ignition (if not already on).
- ▶ Press button ②.

The passenger-side exterior rear view mirror is selected. ▷▷

## Controls in detail

### Good visibility

#### ▷▷▶ Engage reverse gear **R**.

The passenger-side exterior rear view mirror moves automatically to the stored parking position.

The exterior rear view mirror returns to its stored driving position:

- ten seconds after you put the gear selector lever in position **D**
- immediately once your vehicle exceeds a speed of approx. 6 mph (10 km/h)
- immediately when you press the button ① for driver's side mirror



If the button ① is pressed, the automatic passenger-side exterior rear view parking position is deactivated.

#### Electrically folding exterior rear view mirrors



Before driving the vehicle through an automatic car wash, fold the exterior mirrors in. Otherwise they may get damaged.

#### Folding exterior mirrors in and out manually\*

The exterior rear view mirrors can vibrate if they are not completely folded out.

The buttons are located on the upper center console.



- ① Folds the exterior mirrors in
- ② Folds the exterior mirrors out

▶ Check that the ignition is switched on.  
All the lamps in the instrument cluster come on.



With the front doors closed, the exterior mirrors can still be folded in and out approximately 30 minutes after the ignition has been turned off.



#### Folding in

- ▶ Briefly press button ① (▷ page 127).  
The mirrors fold in.



Before you drive the vehicle through an automatic car wash, fold the exterior mirrors in, otherwise they may get damaged.



If you are driving at more than approximately 9 mph (15 km/h), you will not be able to fold the exterior mirrors in.

#### Folding out

- ▶ Briefly press button ②.  
The mirrors fold out.



If an exterior rear view mirror housing is forcibly pushed forward (hit from the rear), reposition it manually by applying firm pressure until it snaps back into place.

If an exterior rear view mirror is forcibly pushed rearward (hit from the front) press button ① to fold mirrors in, then press button ② to fold mirrors out. Do not force mirrors by hand as this may damage the adjustment mechanism.

The mirror housing is now properly positioned and you can adjust the mirror normally.

#### Windshield wipers

Information on the windshield wipers is found in the “Getting started” section (▷ page 49).



If leaves, snow, etc. block the windshield wipers, the wiper motor turns off.

- For safety reasons, withdraw key from steering lock. Remove blockage.
- Turn the windshield wipers on again.

If windshield wipers fail to function at all in switch position ①,

- set the wiper switch to the next highest wiper speed.
- have the windshield wipers checked at the nearest authorized Mercedes-Benz Light Truck Center.

## Controls in detail

### Good visibility

#### Intermittent wiping



Intermittent wiping is interrupted when the vehicle is at a standstill and a front door is opened.

#### *Windshield wipers without rain sensor\**

At speeds of approximately 105 mph (170 km/h) the wiper switches automatically to continuous wiping. Always obey local speed limits.

#### *Windshield wipers with rain sensor\**

A rain sensor automatically controls the windshield wipers depending on how wet the windshield is.

- ▶ Switch on ignition.
- ▶ Set the wiper switch to position ① (▷ page 49).

After the initial wipe, pauses between wipes are automatically controlled by the rain sensor which monitors the wetness of windshield.



When intermittent wiping is on and the key is turned from position **1** to position **2** in the steering lock (▷ page 33), and kept in that position for longer than two seconds, the wipe interval will be set to approximately five seconds.



Do not leave windshield wipers in intermittent setting when the vehicle is taken to an automatic car wash or during windshield cleaning. Wipers will operate in the presence of water sprayed on the windshield, and wipers may be damaged as a result.

The switch should not be left in intermittent setting as the wipers will wipe the windshield once every time the engine is started. Dust that accumulates on the windshield might scratch the glass and/or damage the wiper blades when wiping occurs on a dry windshield.

#### Headlamp cleaning system\*

The button is located on the right side of the dashboard.



#### Headlamp washer button

- ▶ Switch on ignition.
- ▶ Briefly press the upper part of button.

The headlamps will be cleaned with a high-pressure water jet.

Information on filling up the washer reservoir can be found in the “Operation” section (▷ page 224).

#### Rear window wiper

The rear window wiper will also automatically engage if the windshield wiper is engaged and the gear selector lever is placed in reverse.

#### Rear window wiper with rain sensor\*

Rear window wiper intervals are controlled automatically according to the amount of water on the windshield and the speed of the vehicle, if:

- rear window wiper is switched on
- front windshield wipers are switched to intermittent wiping

The interval for the rear window wiper remains constant when the windshield wiper interval is ten seconds or more.

## Controls in detail

### Good visibility

#### Sun visor

The sun visors protect you from sun glare while driving.

#### Warning!



Do not use the vanity mirror while driving. Keep the mirrors in the sun visors closed while vehicle is in motion. Reflected glare can endanger you and others.

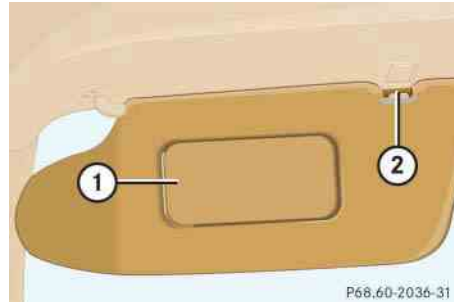

① Mirror cover

② Mounting

- ▶ Swing sun visors down when you experience glare.
- ▶ To use mirror, lift cover ① up.



If sunlight enters through a side window, disengage sun visor from mounting ② and pivot to the side.

#### Illuminated vanity mirrors



- ▶ Turn the key in steering lock to position 1 (▷ page 33).
- ▶ Lift cover up.  
The lamp switches on.

### Rear window defroster

The rear window defroster uses a large amount of power. To keep the battery drain to a minimum, switch off the defroster as soon as the rear window is clear. The defroster is automatically deactivated after approximately 6 to 17 minutes of operation depending on the outside temperature.

#### Activating

- ▶ Switch ignition on.
- ▶ Press button  (▷ page 135).  
The indicator lamp on the button comes on.

#### Deactivating

- ▶ Press button  again.  
The indicator lamp on the button goes out.

#### Warning!



Any accumulation of snow and ice should be removed from the rear window before driving. Visibility could otherwise be impaired, endangering you and others.



If the rear window defroster switches off too soon and the indicator lamp starts flashing, this means that too many electrical consumers are operating simultaneously and there is insufficient voltage in the battery. The system responds automatically by deactivating the rear window defroster.

As soon as the battery has sufficient voltage, the rear window defroster automatically turns itself back on.

## Controls in detail

### Automatic climate control

#### ▼ Automatic climate control

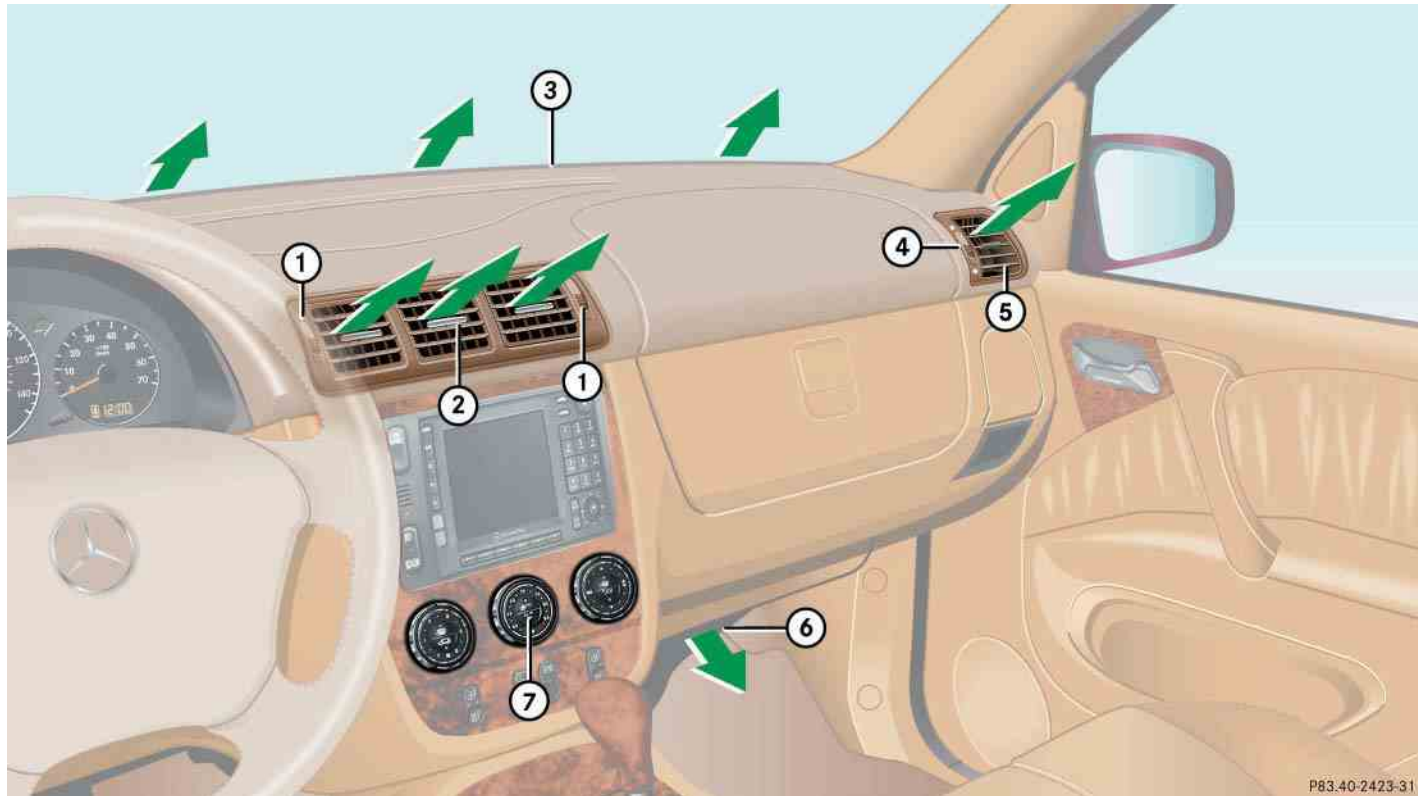

Item	
①	Thumbwheel for center air vent
②	Center air vent, adjustable
③	Defroster air vent windshield
④	Thumbwheels for side air vent
⑤	Side air vent, adjustable
⑥	Footwell air vent
⑦	Automatic climate control

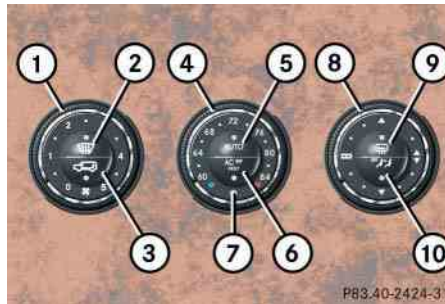

Automatic climate control panel in the front

## Controls in detail

### Automatic climate control

Item	
①	Air volume control
②	Defrosting
③	Air recirculation
④	Temperature control
⑤	Automatic control (temperature, air distribution, air volume)
⑥	AC cooling on / off ( <b>AC<sup>OFF</sup></b> ) Residual heat / ventilation ( <b>REST</b> )
⑦	Interior temperature sensor
⑧	Air distribution control
⑨	Rear window defroster
⑩	Rear passenger compartment ventilation on / off

## Controls in detail

### Automatic climate control

The automatic climate control is operational whenever the engine is running. You can operate the climate control system in either the automatic or manual mode. The system cools or heats the interior depending on the selected interior temperature and the current outside temperature.

Nearly all dust particles, pollutants and odors are filtered out before outside air enters the passenger compartment through the air distribution system.

#### Warning!



When operating the automatic climate control, the air that enters the passenger compartment through the air vents in the footwell can be very hot or very cold (depending on the set temperature). This may cause burns or frostbite on unprotected skin in the immediate area of the air vents.

Always keep sufficient distance between unprotected parts of the body and the footwell air vents. If necessary, change the air flow using the air distribution controls to direct the air away from the footwell air vents (▷ page 138).

#### Warning!



Follow the recommended settings for heating and cooling given on the following pages. Otherwise the windows could fog up, impairing visibility and endangering you and others.

#### i

Severe conditions (e.g. strong air pollution) may require replacement of the filter before its scheduled interval. A clogged filter will reduce the air volume to the interior.

If the vehicle interior is hot, ventilate the interior before driving off.

Keep the air intake grille in front of the windshield free of snow and debris.

Do not touch the interior temperature sensor to maintain a precise temperature.

The set value is indicated by a lighted segment on the control wheels.



## Automatic mode

---

### Switching on

- ▶ Briefly press button **AUTO** (▷ page 135).  
The indicator lamp comes on. The temperature, air volume and distribution are controlled automatically.
- ▶ Adjust the temperature with the temperature control ④ (▷ page 135).  
Temperature control is switched off in the extreme position (blue or red dot).

### Switching off

- ▶ Briefly press button **AUTO** (▷ page 135).  
The indicator lamp goes out. The automatic mode is switched off.  
Air volume control ① is set to fan speed 2 and air distribution is set to .

### Activating basic setting

- ▶ Press button **AUTO** at least three seconds.

All functions are switched to automatic mode and temperature is set to 72°F (22°C).

### Changing basic setting

- ▶ Set temperature control ④ (▷ page 135) to desired temperature.
- ▶ Press button **AUTO** for ten seconds.  
The selected temperature value is stored and set.



Adjust temperature settings in small increments.

## Controls in detail

### Automatic climate control

### Adjusting air volume and air distribution manually

---



If you turn air volume control ① or air distribution control ⑧ (▷ page 135), the automatic mode switches off. The indicator lamp in the button **AUTO** goes out. The temperature control will still be in automatic mode.

### Adjusting air volume

- ▶ Turn air volume control ① to one of five air volume settings.







When set to 0 the system is fully deactivated and no fresh air is supplied. This setting should only be selected for short periods of time.

## Controls in detail



### Automatic climate control

#### Adjusting air distribution

- ▶ Turn air distribution control  (▷ page 135) to one the following symbols:

Symbol	Function
	Directs air to the center and side air vents
	Directs air to the windshield and side air vents
	Directs air into the entire vehicle interior
	Directs air to the footwells and side air vents

#### Windshield fogged on the outside

- ▶ Switch the windshield wipers on, (▷ page 50).
- ▶ Turn air distribution control  to  or .

#### Defrosting



These settings should only be selected for a short time.

When the defrost setting has been selected, only the rear window defroster can be switched on. No other settings are possible.

#### Activating

- ▶ Press button  (▷ page 135).  
The indicator lamp on the button comes on.

#### Deactivating

- ▶ Press button  again.

or

- ▶ Press button **AUTO** (▷ page 135).

The indicator lamp on the button  goes out.

#### Air recirculation mode

Switch to air recirculation mode to prevent unpleasant odors from entering the vehicle from the outside. This setting cuts off the intake of outside air and recirculates the air in the passenger compartment.

#### Warning!



When the outside temperature is below 41°F (5°C), only switch to air recirculation mode for short periods to prevent window fogging.

## Controls in detail

### Automatic climate control

#### Activating

- ▶ Press button  (▷ page 135).

The indicator lamp on the button comes on.



To achieve the fastest possible cooling of the interior, the automatic climate control automatically switches to air recirculation. The indicator lamp in the button  is not illuminated when the system automatically switches to air recirculation.

#### Deactivating

- ▶ Press button  (▷ page 135).

The indicator lamp on the button goes out.



The air recirculation mode is deactivated automatically

- after 30 minutes if the automatic climate control is switched on
- after five minutes if the air conditioning is switched off
- after five minutes if the outside temperature is above approximately 45°F (7°C)

#### Air conditioning

The air conditioning is operational while the engine is running and cools the interior air to the temperature set by the operator.



Condensation may drip out from underneath the vehicle. This is normal and not an indication of a malfunction.

#### Deactivating

It is possible to deactivate the air conditioning (cooling) function of the automatic climate control system. The air in the vehicle will then no longer be cooled or dehumidified.

- ▶ Press button  (▷ page 135).

The indicator lamp on the button  comes on.

#### Activating

Moist air can fog up the windows. You can dehumidify the air with the air conditioning.

- ▶ Press button  again.

The indicator lamp on the button  goes out.

The air conditioning system uses the refrigerant R-134a. This refrigerant is free of CFCs which are harmful to the ozone layer.

## Controls in detail

### Automatic climate control



If the  button on the automatic climate control panel starts to flash, this indicates that the air conditioning system is losing refrigerant. The compressor has turned itself off. The air conditioning cannot be turned on again.

Have the air conditioning system checked at the nearest authorized Mercedes-Benz Light Truck Center.

### Residual heat and ventilation

With the engine switched off, it is possible to continue to heat or ventilate the interior for up to 30 minutes. This feature makes use of the residual heat produced by the engine.



How long the system will provide heating depends on the coolant temperature and the temperature set in the climate control. The blower will run at lower speed regardless of the air volume control setting.

### Activating

- ▶ Turn the key in the steering lock to position **0** or **1** (▷ page 33).
- ▶ Press button  (▷ page 135).

The indicator lamp on button  comes on.

### Deactivating

- ▶ Press button .

The indicator lamp on button  goes out.



The residual heat is automatically turned off:

- when the ignition is switched on
- after about 30 minutes
- if the coolant temperature is too low
- if the battery voltage drops

## Rear passenger compartment ventilation and rear automatic climate control

### Deactivating

For an improved cooling or heating output in the front passenger compartment, you can switch off the rear passenger compartment ventilation.

- ▶ Press button  (▷ page 135).

The indicator lamp on the button comes on.

The operation of the rear automatic climate control and the fresh air supply to the rear compartment is shut off.

### Activating

- ▶ Press button  again.

The indicator lamp on the button goes out.

The rear automatic climate control switches to automatic mode and fresh air enters the rear compartment.

### Automatic mode

The automatic climate control panel for the rear is located on the rear center console.

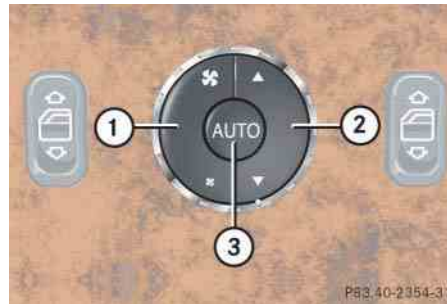

- ① Air volume control
- ② Air distribution control
- ③ Automatic control (air distribution, air volume)

- ▶ Press button **AUTO**.

The indicator lamp on the button comes on.

The automatic climate control cools or heats the interior depending on the temperature selected on the front climate control unit.

## Controls in detail

### Automatic climate control

### Adjusting air volume and air distribution manually

#### i

When the air volume or air distribution control is pressed, the automatic mode is switched off. The indicator lamp in button **AUTO** is turned off. Temperature setting remains in automatic mode.

### Adjusting air volume

- ▶ Press upper part of button .

The blower setting is increased each time the button is pressed.

- ▶ Press lower part of button .

The blower setting is decreased each time the button is pressed. ▷▷



## Controls in detail

### Automatic climate control



When in manual mode, the rear blower setting cannot be increased beyond the setting for the front blower setting. For example, if the driver or front passenger changes the blower setting to level 3, the rear blower will not go higher than level 3 as well.

#### Adjusting air distribution

- ▶ Press upper part of button . Air is directed upwards.
- ▶ Press lower part of button . Air is directed to the footwell.

#### Front and rear air vents





For draft-free ventilation, adjust the air vents upwards.

To allow unrestricted operation of the automatic climate control, the air vents should remain open.

#### Adjusting side air vents

- ▶ Turn thumbwheel  (▶ page 135) to one of the following positions:

Symbol	Function
	Open
	Ventilation of side windows in area of exterior mirror
	Closed

#### Center air vents

##### Opening

- ▶ Turn thumbwheel for center air vent ① (▷ page 135) upward to position .

##### Closing

- ▶ Turn thumbwheel for center air vent ① downward to position **0**.

Use the left thumbwheel to adjust the center air vents on the left and in the center. Use the right thumbwheel to adjust the right center air vent.

#### Rear passenger compartment air vents

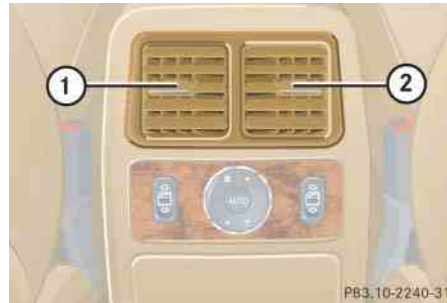

- ① Left center air vent, adjustable
- ② Right center air vent, adjustable



The temperature at the air vents for the rear passenger compartment is the same as at the dashboard center air vents.

## Controls in detail

### Power windows

#### ▼ Power windows

##### Opening and closing the side windows

The side windows can be opened and closed electrically. The switches for all the side windows are on the driver's door. The switches for the respective windows are on the passenger door and on the rear center console.

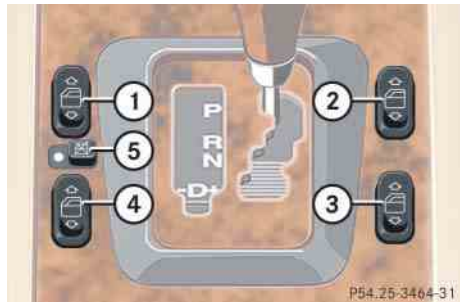

- ① Left front window
- ② Right front window
- ③ Right rear window
- ④ Left rear window
- ⑤ Rear window override switch  
(▷ page 73).

Additional switches for the rear windows are located on the rear center console.



- ⑥ Left rear window
- ⑦ Right rear window

#### Warning!



When closing the windows, make sure that there is no danger of anyone being harmed by the closing procedure.

The closing of the door windows can be immediately halted by releasing the switch or, if switch was pressed past the resistance point and released, by pressing the respective switch.

If the window encounters an obstruction that blocks its path in a circumstance where you pressed the switch past the resistance point and released it to close the window, the automatic reversal function will stop the window and open it slightly.

If the window encounters an obstruction that blocks its path in a circumstance where you are closing the window by pressing the switch and holding it there, the automatic reversal function will not operate.

When leaving the vehicle, always remove the key from the steering lock, and lock your vehicle. Do not leave children unattended in the vehicle, or with access to an unlocked vehicle. Unsupervised use of vehicle equipment can cause an accident and / or serious personal injury.

- ▶ Turn key in the steering lock to position **1** or **2**.



### Opening the windows

- ▶ Press switch ① to ④ at the symbol  to the resistance point.  
The corresponding window will move downwards until you release the switch.

### Closing the windows

- ▶ Press switch ① to ④ at the symbol  to the resistance point.  
The corresponding window will move upwards until you release the switch.

#### Warning



If you pull and hold the switch up when closing the window, and upward movement of the window is blocked by some obstruction including but not limited to arms, hands, fingers, etc., the automatic reversal will not operate.

### Fully opening the windows (Express-open)

- ▶ Press switch ① to ④ at the symbol  past the resistance point and release.  
The corresponding window opens completely.

### Fully closing the windows (Express-close)

- ▶ Press switch ① to ④ at symbol  past the resistance point and release.  
The corresponding window closes completely.



If the upward movement of the window is blocked during the closing procedure, the window will stop and open slightly.

Remove the obstruction, press the switch  again past the resistance point and release.

## Controls in detail

### Power windows

If the window still does not close when there is no obstruction, then hold the switch  down. The side window will then close without the obstruction sensor function.

#### Warning!



Driver's door only:

If within five seconds switch  is again pressed past the resistance point and released, the automatic reversal will not operate.

### Stopping windows

- ▶ Press respective switch again.

## Controls in detail

### Power windows

#### Synchronizing power windows

The power window must be resynchronized each time

- after the battery has been disconnected.
- if the power windows cannot be fully opened (Express-open) or closed (Express-close).

#### Synchronizing the power windows

- ▶ Switch on ignition.
- ▶ Press the power window switches at the symbol  until the side windows are closed.

Hold the switches for approximately one second.

The power window are synchronized.

#### Rear quarter windows\*

The switches are on the upper part of the center console.



- ① Left side
- ② Right side

- ▶ Turn key in the steering lock to position **1** or **2**.

#### Warning!



When closing the windows, make sure that there is no danger of anyone being harmed by the closing procedure. The closing of the windows can be immediately halted by releasing the switch.

When leaving the vehicle, always remove the key from the steering lock, and lock the vehicle. Do not leave children unattended in the vehicle, or with access to an unlocked vehicle. Unsupervised use of vehicle equipment may cause an accident and/or serious personal injury.

#### Opening the windows

- ▶ Press and hold the upper part of switches ① or ②.

The corresponding window will move downwards until you release the switch.

**Closing the windows**

- ▶ Press and hold the lower part of switches ① or ②.

The corresponding window will move upwards until you release the switch.

## Controls in detail

### Sliding / pop-up roof\*

#### ▼ Sliding / pop-up roof\*

#### Opening and closing the sliding / pop-up roof

The sliding / pop-up roof can be opened and closed electrically. The switch for the sliding / pop-roof is on the overhead control panel.

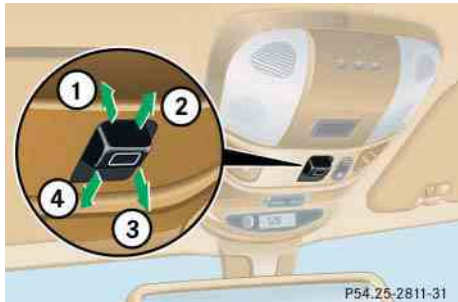

- ① Push up to raise roof at rear
- ② Push back to slide roof open
- ③ Push down to lower roof at rear
- ④ Push forward to slide roof closed

With the roof closed or tilted open, a screen can be slid into the roof opening to guard against sun rays. When sliding the roof open, the screen will also retract.

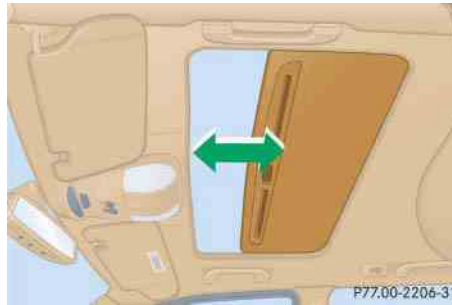

#### Warning!



When closing the sliding / pop-up roof, make sure that there is no danger of anyone being harmed by the closing procedure.

The closing procedure can be immediately reversed by moving the switch in direction ① or ②.

When leaving the vehicle, always remove the key from steering lock and lock your vehicle. Do not leave children unattended in the vehicle, or with access to an unlocked vehicle. Unsupervised use of vehicle equipment may cause an accident and / or serious personal injury.



To avoid damaging the seals, do not transport any objects with sharp edges which can stick out of the sliding / pop-up roof.

Do not open the sliding / pop-up roof if there is snow or ice on the roof, as this could result in malfunctions.

The sliding / pop-up roof can be opened or closed manually should an electrical malfunction occur (▷ page 265).

- ▶ Turn the key in the steering lock to position **1** or **2** (▷ page 33).

### Opening and closing the sliding / pop-up roof

- ▶ To open, close, raise or lower the sliding / pop-up roof, move the switch in the required direction ① to ④.

Release the switch when the roof has reached the desired position.

### Raising the roof

- ▶ Press and hold the switch in direction ①.

The roof is raised at rear.

### Lowering the roof

- ▶ Pull and hold the switch in direction ③.  
The sliding / pop-up roof is lowered and closed.

### Opening the sliding / pop-up roof automatically

- ▶ Briefly press switch in direction ②.  
The sliding / pop up roof will not open completely.
- ▶ Press switch again to open the sliding / pop-up roof completely.

### Stopping the roof

- ▶ Briefly press the switch in any direction.  
The movement of the roof will stop.

### Synchronizing the sliding / pop-up roof

The power sliding / pop-up roof must be re-synchronized each time after:

- the battery has been disconnected

- the sliding / pop-up roof has been closed manually
- the sliding / pop-up roof does not open smoothly
- a malfunction

### Synchronizing

- ▶ Remove the fuse from the fuse box (▷ page 287).
- ▶ Replace the fuse in the fuse box.
- ▶ Switch on ignition.
- ▶ Press and hold the switch in direction ① until the sliding / pop-up roof is fully raised at the rear.

Hold the switch for approximately one second.

The sliding / pop-up roof is synchronized.

## Controls in detail

### Sliding / pop-up roof\*

## Controls in detail

### Driving systems

#### ▼ Driving systems

The driving systems of your vehicle are described on the following pages:

- Cruise control, with which the vehicle can maintain a preset speed.
- Parktronic\*, with which you can assist your parking maneuvers.

The driving systems BAS, ABS, ESP, EBB and 4-ETS, are described in the “Safety and Security” section (▷ page 76).

#### Cruise control

Cruise control automatically maintains the speed you set for your vehicle.

Use of cruise control is recommended for driving at a constant speed for extended periods of time. You can set or resume cruise control at any speed over 20 mph (30 km / h).

The cruise control function is operated by means of the cruise control lever.

The cruise control lever is the uppermost lever found on the left-hand side of the steering column (▷ page 23).

#### Warning!



Cruise control is a convenience system designed to assist the driver during vehicle operation. The driver is and must remain responsible for the vehicle speed and for safe brake operation.

Only use cruise control if the road, traffic and weather conditions make it advisable to travel at a steady speed.

- The use of cruise control can be dangerous on winding roads or in heavy traffic because conditions do not allow safe driving at a steady speed.
- The use of cruise control can be dangerous on slippery roads. Rapid changes in tire traction can result in wheel spin and loss of control.
- Deactivate cruise control when driving in fog.

The “Resume” function should only be operated if the driver is fully aware of the previously set speed and wishes to resume this particular preset speed.

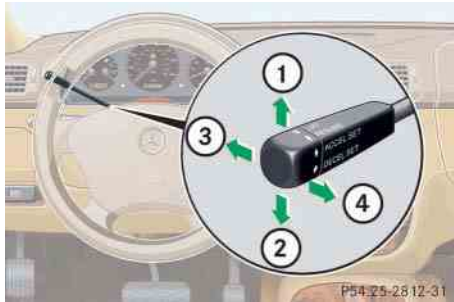

- ① Set current or higher speed
- ② Set current or lower speed
- ③ Cancel cruise control
- ④ Resume at last set speed

#### Setting current speed

- ▶ Accelerate or decelerate to the desired speed.
- ▶ Briefly lift ① or depress ② the cruise control lever.

The current speed is set.

- ▶ Remove your foot from the accelerator pedal.

Cruise control is activated.



On uphill or downhill grades, cruise control may not be able to maintain the set speed. Once the grade eases, the set speed will be resumed.

#### Canceling cruise control

There are several ways to cancel cruise control:

- ▶ Step on the brake pedal.
- or
- ▶ Briefly push the cruise control lever to position ③.

Cruise control will be canceled. The last speed set will be stored for later use.



Moving gear selector lever to position **N** while driving also cancels cruise control. However, the gear selector lever should not be moved to position **N** while driving except to coast when the vehicle is in danger of skidding (e.g. on icy roads).



The last stored speed is canceled when you turn off the engine.

## Controls in detail

### Driving systems

#### Setting a higher speed

- ▶ Lift the cruise control lever to position ① and hold it up until the desired speed is reached.
- ▶ Release the cruise control lever.  
The new speed is set.



Depressing the accelerator pedal does not deactivate the cruise control. After brief acceleration (e.g. for passing), cruise control will resume the last speed set.

#### Setting a lower speed

- ▶ Depress the cruise control lever to position ② and hold it down until the desired speed is reached.
- ▶ Release the cruise control lever.  
The new speed is set.



When you use the cruise control lever to decelerate, the transmission will automatically downshift if the engine's braking power does not brake the vehicle sufficiently.

#### Fine adjustment in 1 mph (Canada: 1 km/h) increments

##### *Faster*

- ▶ Briefly tip the cruise control lever in the direction of arrow ①.

##### *Slower*

- ▶ Briefly tip the cruise control lever in the direction of arrow ②.

#### Setting to last stored speed ("Resume" function)

##### **Warning!**



The speed stored in memory should only be set again if prevailing road conditions permit. Possible acceleration or deceleration differences arising from returning to preset speed could cause an accident and/or serious injury to you and others.

- ▶ Briefly push the cruise control lever to position ④.  
Cruise control will resume the last set speed.
- ▶ Remove your foot from the accelerator pedal.

#### Transmission in LOW RANGE mode



The cruise control should not be used during off-road driving.



## Parktronic system\* (Parking assist)

### Warning!



Parktronic is a supplemental system. It is not intended to nor does it replace the need for extreme care. The responsibility during parking and other critical maneuvers rests always with the driver.

Make sure that no persons or animals are located in the area in which you are maneuvering. They could otherwise be injured.

Special attention must be paid to objects with smooth surfaces or low silhouettes (e.g. trailer couplings, painted posts, or street curbs). Such objects may not be detected by the system and can damage the vehicle.

The operational function of the Parktronic system can be affected by dirty sensors, especially at times of snow and ice. For notes on cleaning the Parktronic system sensors (> page 237).

Interference caused by other ultrasonic signals (e.g. working jackhammers or the air brakes of trucks) can cause the system to send erratic indications, and should be taken into consideration.

The Parktronic system assists the driver during parking maneuvers. It visually and audibly indicates the distance between the vehicle and an obstacle.

With the ignition on, the Parktronic system engages automatically at speeds up to approximately 10 mph (15 km/h) and deactivates during higher speeds.

## Controls in detail

### Driving systems

Parktronic system monitors your vehicle's environment by means of six sensors in the front bumper and four sensors in the rear bumper.

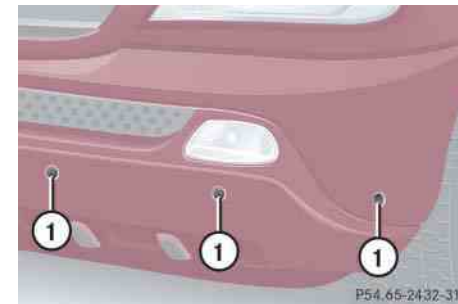

① Sensors located in front bumper

## Controls in detail

### Driving systems

#### Monitoring reach of sensors

The sensors must be free of dirt, ice and snow or they will be unable to function properly. Clean the sensors regularly without scratching or damaging them.

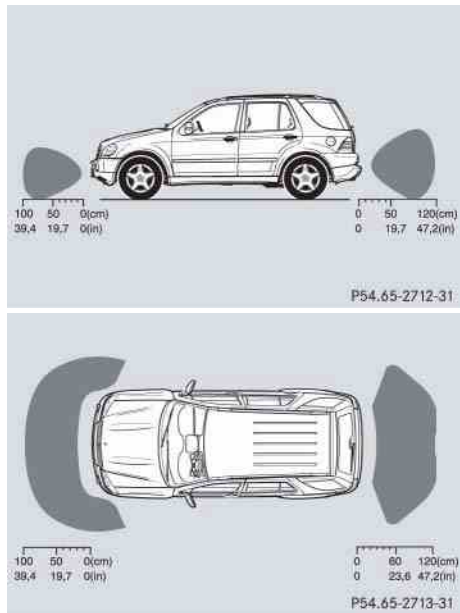

#### Front sensors

Center	<b>approx. 39 in (100 cm)</b>
Corners	<b>approx. 24 in (60 cm)</b>

#### Rear sensors

Center	<b>approx. 47 in (120 cm)</b>
Corners	<b>approx. 32 in (80 cm)</b>



During parking maneuvers, pay special attention to objects located above or below the height of the sensors (e.g. planters or trailer hitches). The Parktronic system will not detect such objects at close range and damage to your vehicle or the object may result.

Ultrasonic signals from outside sources (e.g. truck air brakes or jackhammers) may impair the operation of the Parktronic system.

#### Minimum distance

Center	<b>approx. 8 in (20 cm)</b>
Corners	<b>approx. 6 in (15 cm)</b>

When an obstacle is located in this area, all warning displays will light up and a warning tone will sound. If the vehicle moves closer than the minimum distance to an object, the distance may no longer be displayed.

#### Warning indicators

The warning indicators show the distance between the sensor and the obstacle. The warning indicators for the front area are located above the center air vents in the dashboard. The warning indicator for the rear area is located in the rear passenger compartment lamp.

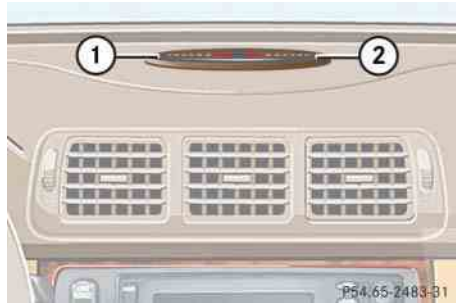

- ① Segments, left side of vehicle
- ② Segments, right side of vehicle

Each warning indicator has six yellow and two red segments.

The gear selector lever position determines which warning indicator is activated.

Selector lever position	Warning indicator
D, R, N, P	Front area activated
R	Rear area activated

As soon as the sensors detect an obstacle, one or more segments light up, depending on the distance. An intermittent acoustic warning will also sound as the seventh segment comes on and a constant acoustic warning lasting a maximum of three seconds will sound for the eighth segment.



If all red segments light up in the warning indicators, a dirty sensor or a ultrasonic signal could be the reason.

- Clean the sensors (> page 237).  
After cleaning the sensors, switch the ignition on.

## Controls in detail

### Driving systems

#### Switching Parktronic system on / off

You can switch Parktronic system off manually.

The switch is located on the lower part of the center console.



- ① Parktronic off
- ② Indicator lamp
- ③ Parktronic on



If the Parktronic system is malfunctioning, all red segments of the warning indicators light up and an additional warning sounds.

Contact your Mercedes-Benz Light Truck Center as soon as possible.

#### Switching Parktronic off

- ▶ Press switch on the upper part ①.  
Indicator lamp ② comes on.

#### Switching Parktronic on

- ▶ Press switch on the upper part ③.  
The indicator lamp ② goes out.



If you switch the ignition on, the Parktronic system will be automatically switched on.

The rear Parktronic sensors will not automatically disengage when towing a trailer. Therefore switch the Parktronic system off.

## ▼ Loading

### Loading instructions

#### Warning!



Always fasten items being carried as securely as possible using cargo tie-down rings and fastening materials appropriate for the weight and size of the load.

In an accident, during hard braking or sudden maneuvers, loose items will be thrown around inside the vehicle, and can cause injury to vehicle occupants unless the items are securely fastened in the vehicle.

To help avoid personal injury during a collision or sudden maneuver, always use partition net when transporting cargo.

Never drive vehicle with the liftgate open. Deadly carbon monoxide (CO) gases may enter vehicle interior resulting in unconsciousness and death.

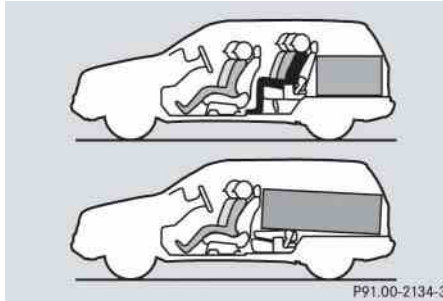

The gross vehicle weight which is the weight of the vehicle including fuel, tools, spare wheel, installed accessories, passengers and luggage / cargo must never exceed the Gross Vehicle Weight Rating (GVWR) for your vehicle. In addition, the load must be distributed in such a way so that the weight on each axle never exceeds the Gross Axle Weight Rating (GAWR) for the front and rear axle. The GVWR and GAWR for your vehicle are indicated on the certification label which can be found on the left door pillar.

## Controls in detail

### Loading

The handling characteristics of a fully loaded vehicle depend greatly on the load distribution. It is therefore recommended to load the vehicle according to the illustrations shown, with the heaviest items being placed towards the front of the vehicle.

Please pay attention to and comply with the following instructions when loading the vehicle and transporting cargo:

- Always place items being carried against front or rear seat backrests, and fasten them as securely as possible.
- The heaviest portion of the cargo should always be kept as low as possible against front or rear seat backrests.

## Controls in detail

### Loading

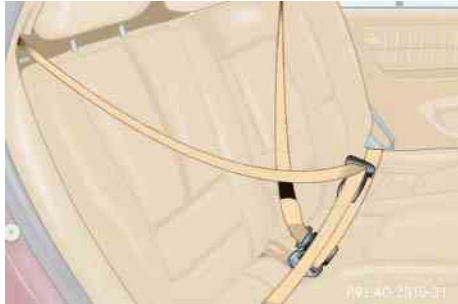

For additional safety when transporting cargo while the rear seats are unoccupied, fasten the outer seat belts crosswise into the opposite side buckles.



The cargo area is the preferred place to carry objects. The enlarged cargo area should only be used for items which do not fit in the cargo area alone.

#### Cargo tie-down rings

The cargo area is provided with four tie-down rings. Additional two rings are located at the rear of front seats.



#### Cargo tie-down ring

Carefully secure cargo by applying even load on all rings with rope of sufficient strength to hold down the cargo.



While the partition net\* (> page 159) will help protect you from smaller objects, it cannot prevent the movement of large, heavier objects into the passenger area in an accident. Such items must be properly secured using the cargo tie-down rings in the cargo area floor.

**Hooks**

Four hooks located on the rear compartment trim panels, two on each side.



P68.00-2793-31

**Hooks**

Use the hooks to secure light weight items. The maximum permissible weight per hook is 9 lbs (4 kg).

**Partition net\***

**Warning!**



Always lock backrest in its upright position when rear seat bench is occupied by passengers, or cargo is being carried behind the seat bench.

To help avoid personal injury from smaller objects flying in the occupant area during a collision or sudden maneuver, always use partition net when transporting cargo.

The partition net cannot prevent the movement of large, heavier objects into the passenger area in an accident. Such items must be properly secured using the cargo tie-down rings in the cargo area floor (▷ page 158).

Passenger use of seats behind installed partition net is restricted because of the footwell being taken up by the net.

Use of the partition net is a particularly important safety factor when the vehicle is loaded higher than the top of the seat backrests with smaller objects.

The partition net can be installed behind the backrests of the front or rear seats.

**Engaging partition net**

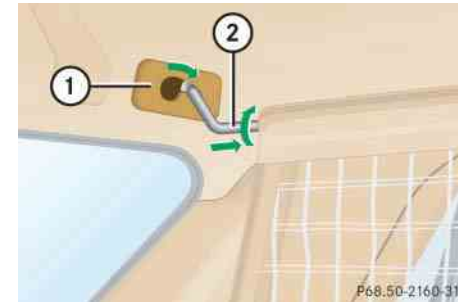

P68.50-2160-31

- ① Holder
- ② Mounting hook

## Controls in detail

### Loading

- ▶ One after the other, press the two mounting hooks ② inward against the spring pressure and turn them.  
The mounting hooks are locked in this position and you can move the net into position more easily.
- ▶ Turn one of the mounting hooks ② in the opposite direction.  
The spring pressure will push it out.
- ▶ Engage mounting hook ② in holder ①.
- ▶ Turn the other mounting hook and engage it in the opposite holder.
- ▶ Push both mounting hooks ② forward into holder ①.

### Tightening partition net



Before tightening the partition net, remove the cargo floor plates (▷ page 162).

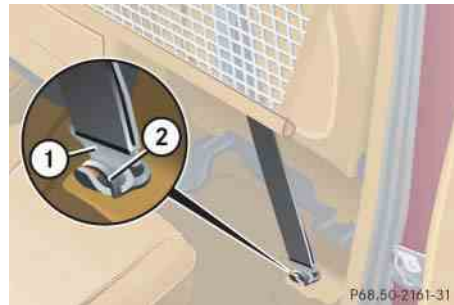

### Installation behind the front seats

- ① Tie-down hook
- ② Ring

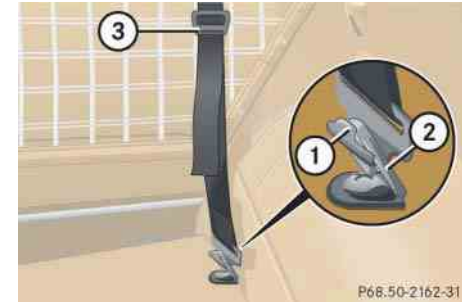

### Installation behind the rear seats

- ① Tie-down hook
  - ② Ring
  - ③ Tensioner
- ▶ Insert tie-down hook ① in rings ②.
  - ▶ Pull on loose ends of tie-down straps until net is tight.
  - ▶ After driving a short distance, check the tension on the net and retighten if necessary.



### Removing partition net

- ▶ Lift tensioner ③ upward to a horizontal position to release tensioning of the strap.
- ▶ Disengage tie-down hooks ① from rings ②.
- ▶ Remove mounting hooks ② (▷ page 159) from holder ① (▷ page 159).
- ▶ Roll up and close the partition net.
- ▶ Store partition net behind rear seat bench.

### Cargo area cover blind\*

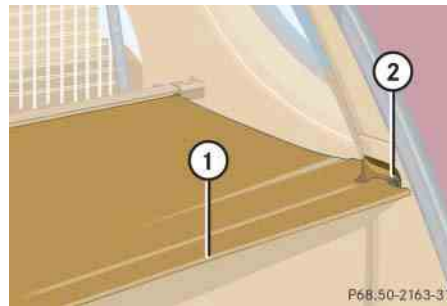

- ① Handle
- ② Holder

#### Warning!



Passenger use of third row seats with cargo area cover blind installed is restricted.

### Closing blind

- ▶ Pull blind on handle ① across the cargo area.
- ▶ Guide blind into holders ②.

## Controls in detail

### Loading

### Opening blind

- ▶ Disengage blind and guide retraction by its handle.

### Removing blind

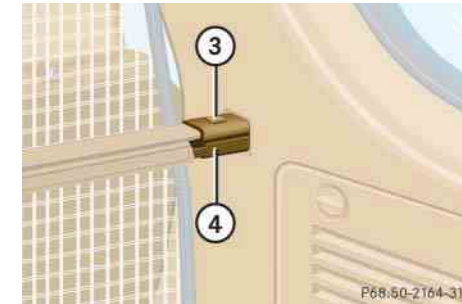

- ③ Button
- ④ Mounting sleeve

- ▶ Roll the blind up.
- ▶ Push mounting sleeve ④ inward against spring pressure until it engages.
- ▶ Remove blind from mounts.

## Controls in detail

### Loading

#### Installing blind

- ▶ Place left side of blind in left mount.
- ▶ Position right side of blind over right mount.
- ▶ Push button ③, releasing mounting sleeve to slide into mount.

#### Cargo floor plates

##### Removing cargo floor plates



Before you can remove the cargo floor plates, it is possible that the third row seats\* (▷ page 102) must be removed.



- ▶ Lift cargo floor plate at rear edge (arrow).  
Cargo floor plate unhinges automatically.
- ▶ Remove cargo floor plate by pulling it rearwards.

##### Storing cargo floor plates

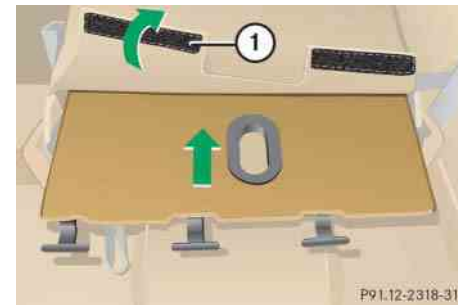

##### ① Hook and loop strip

- ▶ Fold the left cargo floor plate together.
- ▶ Open the hook and loop strip at the bottom of backrest of the third row seats\* and insert cargo floor plate.
- ▶ Close the hook and loop strip.

## Controls in detail

### Loading

#### Installing cargo floor plates

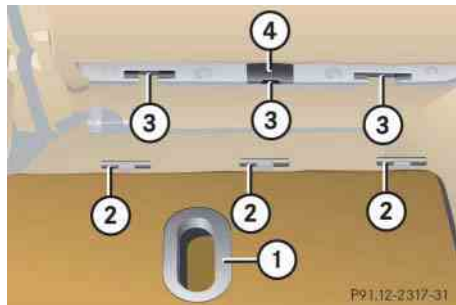

- ① Opening
- ② Pins
- ③ Attachment opening
- ④ Latch

- ▶ Grip into opening ① and guide pins ② into attachment opening ③.

The center pin must snap into place in latch ④.

#### Roof rack\*

##### Warning!



Take into consideration that when the roof rack is loaded, the handling characteristics are different from those when operating the vehicles without the roof rack loaded.

The maximum roof load when using roof rack systems is 220 lbs (100 kg).



#### Roof rails



Attach roof racks to the roof rails only.

Use only those roof racks approved by Mercedes-Benz for your vehicle model. Follow manufacturer's installation instructions.

The vehicle could otherwise be damaged.

For further information, inquire at your Mercedes-Benz Light Truck Center.

## Controls in detail

### Useful features

#### ▼ Useful features

##### Interior storage spaces

#### Warning!



To help avoid personal injury during a collision or sudden maneuver, exercise care when stowing objects in the vehicle. Put luggage or cargo in the cargo compartment if possible. Do not pile luggage or cargo higher than the seat backs.

Always use partition net when transporting cargo. Partition net cannot secure hard or heavy objects.

Parcel nets cannot secure hard or heavy objects.

Keep compartment lids closed. This will help to prevent stored objects from being thrown about and injuring vehicle occupants during an accident.

##### Glove box

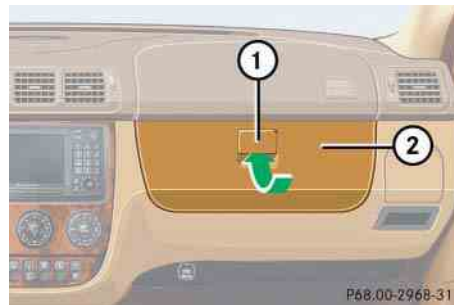

- ① Glove box lid release
- ② Glove box lid



The opened glove box is illuminated with the key in steering lock position 1 (► page 33).

##### **Opening the glove box**

- Grab in recess and pull lid release ①.  
The glove box lid ② opens downward.

##### **Closing the glove box**

- Push glove box lid up to close.

##### Storage compartment under front passenger seat\*

The storage compartment is lockable with its separate key.

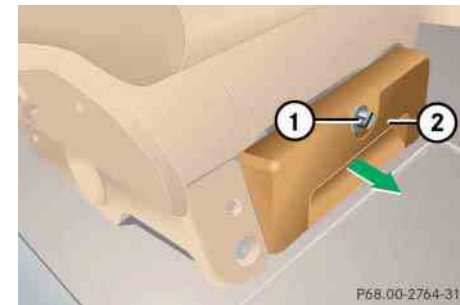

- ① Lock cylinder
- ② Handle

##### **Locking and unlocking the storage compartment**

- Turn the key clockwise.  
The storage compartment is locked.
- Turn the key counterclockwise.  
The storage compartment is unlocked.

### ***Opening the storage compartment***

- ▶ Press the lock cylinder in and pull storage compartment out using handle ②.

### ***Closing the storage compartment***

- ▶ Push the storage compartment in until the lock engages.

### **Armrest storage spaces**

A flat storage tray with a deeper storage compartment underneath is located below the armrest. Both can be opened separately.

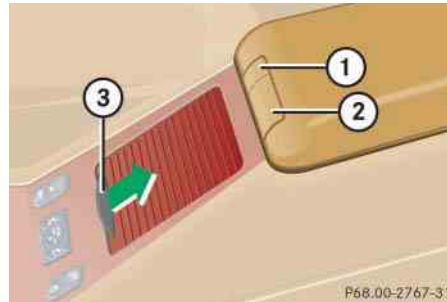

- ① Button to open storage tray
- ② Button to open storage compartment
- ③ Open cover

## **Controls in detail**

### **Useful features**

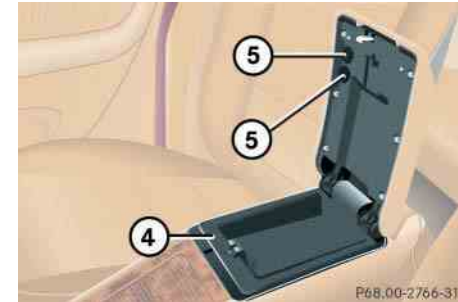

- ④ Storage tray
- ⑤ Coin holder

### ***Opening the storage tray***

- ▶ Press button ① and lift up armrest.  
The armrest contains two coin holders.

### ***Opening the storage compartment***

- ▶ Press button ② and lift up armrest.

## Controls in detail

### Useful features

#### *Opening the storage compartment in front of armrest*

- ▶ Slide the cover ③ rearward.

The storage compartment below contains a cup holder (▷ page 167).

#### Cup holders

##### **Warning!**



When not in use, keep the cup holder closed. Place only containers that fit into the cup holder to prevent spills. Use lids on open containers and do not fill containers to a height where the contents, especially hot liquids, could spill during vehicle maneuvers.

#### Cup holder in instrument panel

A cup holder is located on both the right and left side of the instrument panel.



#### *Opening the cup holder*

- ▶ Briefly touch top of cover.  
The cup holder opens automatically.

#### *Closing the cup holder*

- ▶ Fold the cup holder upwards and press on it until it engages.

Cup holder in front of armrest

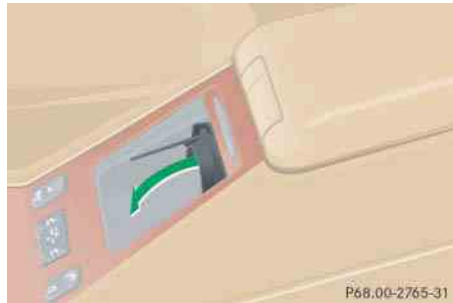

**Opening the cup holder**

- ▶ Slide cover rearward (▷ page 166).
- ▶ Fold the cup holder forward.

**Closing the cup holder**

- ▶ Fold the cup holder backward.
- ▶ Slide cover forward.

Cup holder in rear center console



**Opening the cup holder**

- ▶ Briefly touch the cover.  
The cup holder opens automatically.

**Closing the cup holder**

- ▶ Press the cup holder forward and press on it until it engages.



Close the cup holder before folding the rear seat bench.

Armrest in rear seat bench



- ▶ Pull the armrest down by its top.

## Controls in detail

### Useful features

#### Ashtrays and cigarette lighter

##### Warning!



Never touch the heating element or sides of the cigarette lighter; they are extremely hot. Hold the knob only.

When leaving the vehicle always remove the key from the steering lock. Do not leave children unattended in the vehicle, or with access to an unlocked vehicle. Unsupervised use of vehicle equipment may cause an accident and/or serious personal injury.



The cigarette lighter socket can be used to accommodate electrical accessories up to a maximum of 50 W.

If the engine is off, the battery may become discharged when used for long periods of time.

#### Ashtray and cigarette lighter in the front center console

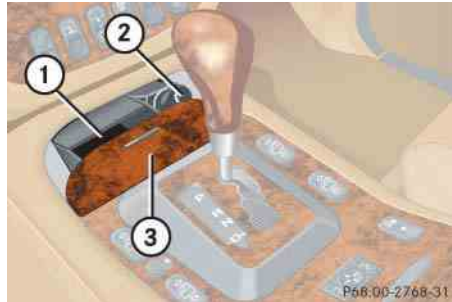

- ① Ashtray
- ② Cigarette lighter
- ③ Cover plate

#### Opening the ashtray

- ▶ Briefly touch cover plate ③.  
The ashtray opens automatically.

#### Removing ashtray insert

##### Warning!



Remove ashtray only with vehicle standing still. Set the parking brake to secure vehicle from movement. Move gear selector lever to position **N**. With gear selector lever in position **N**, turn off the engine.

- ▶ Secure vehicle from movement by setting the parking brake. Move the gear selector lever to position **N**.  
Now you have more room to take out the insert.
- ▶ Grip the insert on the sides and pull it out upwards.

#### Reinstalling ashtray insert

- ▶ Install ashtray insert.
- ▶ Close the ashtray.



**Cigarette lighter**

- ▶ Switch on the ignition.
- ▶ Push in cigarette lighter ② (▷ page 168).

The cigarette lighter will pop out automatically when hot.

**Ashtray and cigarette lighter in the rear center console**

Close the ashtray in the rear center console before folding the rear seat bench.



- ① Ashtray
- ② Cigarette lighter
- ③ Cover plate

**Opening the ashtray**

- ▶ Briefly touch cover plate ③.  
The ashtray opens automatically.

**Removing ashtray insert**

- ▶ Grip the insert on the sides and pull it out upwards.

**Reinstalling ashtray insert**

- ▶ Install ashtray insert.
- ▶ Close the ashtray.

**Cigarette lighter**

- ▶ Switch on the ignition.
- ▶ Push in cigarette lighter ②.

The cigarette lighter will pop out automatically when hot.

## Controls in detail

### Useful features

#### Electrical outlet



#### Electrical outlet

One outlet is located in the front passenger footwell and another on the right-hand side of the luggage compartment.

- ▶ Flip up cover and insert electrical plug (cigarette lighter type).



The outlets function even if the key is not in the ignition.

The electrical outlet can be used to accommodate electrical consumers (e.g. air pump, auxiliary lamps) up to a maximum of 180 W.

If the engine is off, the battery may become discharged if used for long periods of time.

#### Telephone\*

##### Warning!



Never operate radio transmitters equipped with a built-in or attached antenna (i.e. without being connected to an external antenna) from inside the vehicle while the engine is running. Doing so could lead to a malfunction of the vehicle's electronic system, possibly resulting in an accident and / or serious personal injury.

Radio transmitters, such as a portable telephone or a citizens band unit, should only be used inside the vehicle if they are connected to an antenna that is installed on the outside of the vehicle.

The external antenna must be approved by Mercedes-Benz. Please contact an authorized Mercedes-Benz Light Truck Center for information on the installation of an approved external antenna. Refer to the radio transmitter operation instructions regarding use of an external antenna.

## Controls in detail

### Useful features

#### Warning!



Please do not forget that your primary responsibility is to drive the vehicle. A driver's attention to the road must always be his / her primary focus when driving. For your safety and the safety of others, we recommend that you pull over to a safe location and stop before placing or taking a telephone call.

If you choose to use the telephone<sup>1</sup> while driving, please use the hands-free device and only use the telephone when road, weather and traffic conditions permit. Some jurisdictions prohibit the driver from using a cellular telephone while driving a vehicle.

Only operate the MCS (**M**odular **C**ontrol **S**ystem)<sup>1</sup> if road, weather and traffic conditions permit.

Bear in mind that at a speed of just 30 mph (approximately 50 km / h), your vehicle is covering a distance of approx. 44 feet (approximately 13.5 m) every second.

<sup>1</sup> Observe all legal requirements

You can take and place telephone calls using the **MCS** unit.

See separate instruction manual for information on how to operate the telephone.

#### Warning!



Some jurisdictions prohibit the driver from using a cellular telephone while driving a vehicle. Whether or not prohibited by law, for safety reasons, the driver should not use the cellular telephone while the vehicle is in motion.

Stop the vehicle in a safe location before answering or placing a call.

#### Tele Aid\*



The initial activation of the Tele Aid system may only be performed by completing the subscriber agreement and placing an acquaintance call using the SOS button. Failure to complete either of these steps will result in a system that is not activated. If the system is not activated, the indicator lamp in the SOS button stays on after turning key in steering lock to position **2** (▷ page 33) and the message **TELE AID - NOT ACTIVATED** will be shown in the MCS display for approximately 10 seconds.

If you have any questions regarding activation, please call the Response Center at 1-800-756-9018 (in the USA) or 1-888-923-8367 (in Canada).

## Controls in detail

### Useful features

#### The Tele Aid system



(Telematic Alarm Identification on Demand)

The Tele Aid system consists of three types of response:

- automatic and manual emergency
- roadside assistance and
- information.

The Tele Aid system is operational providing that the vehicle's battery is charged, properly connected, not damaged and cellular and GPS coverage is available.

The speaker volume of a Tele Aid call can be adjusted using the volume control on the MCS unit.

- ▶ To activate, press the SOS button, the Roadside Assistance button  or the Information button , depending on the type of response required.





The SOS button, the Roadside Assistance button  and the Information button  are located in the overhead control panel.

Shortly after the completion of your acquaintance call, you will receive a user ID and password via first call mail. By visiting [www.mbusa.com](http://www.mbusa.com) and selecting "Tele Aid" (USA only), you will have access to account information, remote door unlock, profile and more.



The Tele Aid system utilizes the cellular network for communication and the GPS (Global Positioning System) satellites for vehicle location. If either of these signals are unavailable, the Tele Aid system may not function and if this occurs, assistance must be summoned by other means.

#### System self-check

Initially, after turning the key in the steering lock to position **2**, malfunctions are detected and indicated (the indicator lamps in the SOS button, the Roadside Assistance button  and the Information button  stay on longer than 10 seconds or do not come on). The message TELE AID - VISIT WORKSHOP appears for approx. 10 seconds in the MCS display.

#### Warning!



The Tele Aid control unit is located under the front passenger seat. If there is accumulation of water or other liquid in this area, the Tele Aid control unit could suffer an electrical short circuit making the system inoperative. In this case the indicator lamp in the SOS button will not illuminate during or will remain illuminated after the system self-check. Have the system checked at the nearest Mercedes-Benz Light Truck Center as soon as possible.

If the indicator lamps in the SOS button, in the Roadside Assistance button and/or in the Information button do not come on during the system self-check or if any of these indicators remain illuminated constantly in red and/or the message TELE AID - VISIT WORKSHOP is displayed in the MCS display after the system self-check, a malfunction in the system has been detected.

If a malfunction is indicated as outlined above, the system may not operate as expected. Have the system checked at the nearest Mercedes-Benz Light Truck Center as soon as possible.

#### Emergency calls

An emergency call is initiated automatically:

- following an accident in which the emergency tensioning detractors (ETDs) or airbags deploy,
- if the anti-theft alarm or the tow-away alarm stays on for more than 20 seconds. See anti-theft alarm system (▷ page 83) and tow-away alarm (▷ page 84).

An emergency call can also be initiated manually by opening the cover next to the inside rear view mirror labeled SOS, then briefly pressing the button located under the cover. See below for instructions on initiating an emergency call manually.

## Controls in detail

### Useful features

Once the emergency call is in progress, the indicator lamp in the SOS button will begin to flash. The message `EMERGENCY CALL - CONNECTING CALL` appears in the MCS display. When the connection is established, the message `EMERGENCY CALL - CALL CONNECTED` appears in the MCS display. All information relevant to the emergency, such as the location of the vehicle (determined by the GPS satellite location system), vehicle model, identification number and color are generated.

A voice connection between the Response Center and the occupants of the vehicle will be established automatically soon after the emergency call has been initiated. When a voice connection is established the audio system mutes and the message `TELE AID - EMERGENCY CALL ACTIVE` appears in the MCS display. The Response Center will attempt to determine more precisely the nature of the accident provided they can speak to an occupant of the vehicle.

The Tele Aid system is available if:

- it has been activated and is operational. Activation requires a subscription for monitoring services, connection and cellular air time
- the relevant cellular phone network and GPS signals are available and pass the information on to the response center.



Location of the vehicle on a map is only possible if the vehicle is able to receive signals from the GPS satellite network and pass the information on to the response center.

### Warning!



If the indicator lamp in the SOS button is illuminated continuously and there was no voice connection to the Response Center established, then the Tele Aid system could not initiate an emergency call (e.g. the relevant cellular phone network is not available). The message `EMERGENCY CALL - CALL FAILED` appears in the MCS display for approx. ten seconds.

Should this occur, assistance must be summoned by other means.

### Initiating an emergency call manually



- ① Cover
- ② SOS button

- ▶ Briefly press on cover ①.  
The cover will open.
- ▶ Press SOS button ② briefly.  
The indicator lamp in SOS button ② will flash until the emergency call is concluded.
- ▶ Wait for a voice connection to the Response Center.
- ▶ Close cover ① after the emergency call is concluded.

### Warning!





If you feel at any way in jeopardy when in the vehicle (e.g. smoke or fire in the vehicle, vehicle in a dangerous road location), please do not wait for voice contact after you have pressed the emergency button. Carefully leave the vehicle and move to a safe location. The Response Center will automatically contact local emergency officials with the vehicle's approximate location if they receive an automatic SOS signal and cannot make voice contact with the vehicle occupants.

## Controls in detail

### Useful features

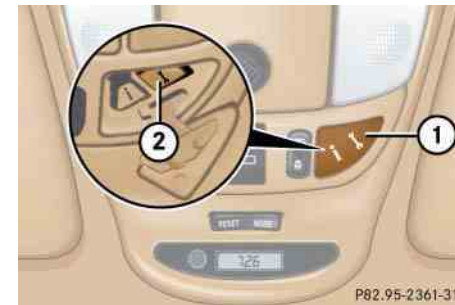
### Roadside Assistance button



- ① Cover
- ② Roadside Assistance button 

- ▶ Briefly press on cover ①.  
The cover will open.
- ▶ Press and hold the button ② (for longer than two seconds).  
A call to a Mercedes-Benz Roadside Assistance dispatcher will be initiated. The button will flash while the call is in progress. The message **ROADSIDE ASSISTANCE - CONNECTING CALL** will appear in the MCS display.

## Controls in detail

### Useful features

When the connection is established, the message **ROADSIDE ASSISTANCE - CALL CONNECTED** appears in the MCS display. The Tele Aid system will transmit data generating the vehicle identification number, model, color and location (subject to availability of cellular and GPS signals).



While the call is connected you can change to navigation menu by pressing NAVI button on the MCS unit.

A voice connection between the Roadside Assistance dispatcher and the occupants of the vehicle will be established. When a voice connection is established the audio system mutes and the message **TELE AID - ROADSIDE ASSISTANCE CALL ACTIVE** appears in the MCS display.



- ▶ Describe the nature of the need for assistance.

The Mercedes-Benz Roadside assistance dispatcher will either dispatch a qualified Mercedes-Benz technician or arrange to tow your vehicle to the nearest Mercedes-Benz Light Truck Center. For services such as labor and / or towing, charges may apply. Refer to the Roadside Assistance manual for more information.

These programs are only available in the USA:

- Sign and Drive services: Services such as jump start, a few gallons of fuel or the replacement of a flat tire with the vehicle spare tire are obtainable,
- Remote Vehicle Diagnostics: This function permits the Mercedes-Benz Roadside Assistance dispatcher to download malfunction codes and actual vehicle data.



The indicator lamp in the Roadside Assistance button  remains illuminated in red for approx. ten seconds during the system self-check after turning the key in the steering lock to position **2** (together with the SOS button and the Information button .

See system self-check (▷ page 172) when the indicator lamp does not light up in red or stays on longer than approximately ten seconds.



If the indicator lamp in the Roadside Assistance button  is illuminated continuously and there was no voice connection to the Response Center established, then the Tele Aid system could not initiate a Roadside Assistance call (e.g. the relevant cellular phone network was not available). The message **ROADSIDE ASSISTANCE - CALL FAILED** appears in the MCS display.

Roadside Assistance calls can be terminated using the END Button on the MCS unit.

#### Information button

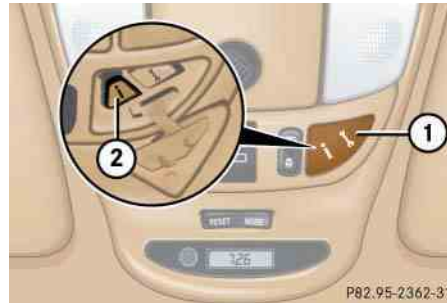

- ① Cover
- ② Information button 

► Briefly press on cover ①.  
The cover will open.

► Press and hold the button (for longer than two seconds).

A call to the Customer Assistance Center will be initiated. The button will flash while the call is in progress. The message **INFO - CONNECTING CALL** will appear in the MCS display.

## Controls in detail

### Useful features

When the connection is established, the message **INFO - CALL CONNECTED** appears in the MCS display. The Tele Aid system will transmit data generating the vehicle identification number, model, color and location (subject to availability of cellular and GPS signals).



While the call is connected, you can change to navigation menu by pressing NAVI button on the MCS unit.



A voice connection between the Customer Assistance Center representative and the occupants of the vehicle will be established. When a voice connection is established the audio system mutes and the message **TELE AID - INFO CALL ACTIVE** appears in the MCS display. Information regarding the operation of your vehicle, the nearest Mercedes-Benz Light Truck Center or Mercedes-Benz USA products and services is available to you.

## Controls in detail

### Useful features

For more details concerning the Tele Aid system, please visit [www.mbusa.com](http://www.mbusa.com) and use your ID and password (sent to you separately) to learn more (USA only).



The indicator lamp in the Information button  remains illuminated in red for approx. 10 seconds during the system self-check after turning key in the steering lock to position **2** (together with the SOS button and the Roadside Assistance button .

See system self-check (▷ page 172) when the indicator lamp does not light up in red or stays on longer than approximately ten seconds.

If the indicator lamp in the Information button  is illuminated continuously and there was no voice connection to the Response Center established, then the Tele Aid system could not initiate an Information call (e.g. the relevant cellular phone network is not available).

The message **INFO CALL FAILED** appears in the MCS display.

Information calls can be terminated using the **END** button on the MCS.



If the indicator lamps do not start flashing after pressing one of the buttons or remains illuminated (in red) at any time, the Tele Aid system has detected a fault or the service is not currently active, and may not initiate a call. Visit your Mercedes-Benz Light Truck Center and have the system checked or contact the Response Center at 1-800-756-9018 (in the USA) or 1-888-923-8367 (in Canada) as soon as possible.

### Upgrade signals

The Tele Aid system processes calls using the following priority.

- Automatic emergency – First priority
- Manual emergency – Second priority
- Roadside assistance – Third priority
- Information – Fourth priority

Should a higher priority call be initiated while you are connected, an upgrade (alternating) tone will be heard and the appropriate indicator lamp will flash. If certain information such as vehicle identification number or customer information is not available, the operator may need to retransmit.

During this time you will hear a beep and voice contact will be interrupted. Voice contact will resume once the retransmission is completed. Once a call is concluded, a beep will be heard and the respective indicator lamp will stop flashing. The MCS system operation will resume.

## Controls in detail

### Useful features



If the indicator lamp continues to flash or the system does not reset, contact the Response Center at 1-800-756-9018 (in the USA) or 1-888-923-8367 (in Canada), or Mercedes-Benz Customer Assistance at 1-800-FOR-MERCEdes (1-800-367-6372) in the USA or Customer Service at 1-800-387-0100 in Canada.



The indicator lamp on the corresponding button flashes until the call is concluded. Calls can only be terminated by a Response Center or Customer Assistance Center representative, except Roadside Assistance and Information calls, which can also be terminated by using the END button on the MCS unit.



When a Tele Aid call has been initiated, the MCS system audio is muted and the selected mode (radio, tape or CD) pauses. The optional cellular phone (if installed) switches off. If you must use this phone, the vehicle must be parked. Disconnect the coiled cord and place the call. The navigation system (if engaged) will continue to run. A pop-up window will appear in the MCS display to indicate that a Tele Aid call is in progress.

#### Remote door unlock

In case you have locked your vehicle unintentionally (e.g. key inside vehicle), and no other key is available:

- ▶ Contact the Mercedes-Benz Response Center at 1-800-756-9018 (in the USA) or 1-888-923-8367 (in Canada).

You will be asked to provide your password which you provided when you completed the subscriber agreement.

- ▶ Then return to your vehicle and pull outside handle of the liftgate for minimum of 20 seconds until the SOS button is flashing.

The message EMERGENCY CALL - CALL CONNECTED appears in the MCS display.

As an alternative, you may unlock the vehicle via Internet using the ID and password sent to you shortly after the completion of your acquaintance call.

## Controls in detail

### Useful features

The Response Center will then unlock your vehicle with the remote door unlocking feature.



The remote door unlock feature is available if the relevant cellular phone network is available.

The SOS button will flash and the message **EMERGENCY CALL - CALL CONNECTED** will appear in the MCS display to indicate receipt of the door unlock command.

Once the vehicle is unlocked, a Response Center specialist will attempt to establish voice contact with the vehicle occupants.

If the outside liftgate handle was pulled for more than 20 seconds before door unlock authorization was received by the Response Center, you must wait 15 minutes before pressing the outside liftgate handle again.

### Stolen vehicle tracking services

In the event your vehicle was stolen:

- ▶ Report the incident to the police  
The police will issue a numbered incident report.
- ▶ Pass this number on to the Mercedes-Benz Response Center along with your password issued to you when you subscribed to the service.

The Response Center will then attempt to covertly contact the vehicle's Tele Aid system. Once the vehicle is located, the Response Center will contact the local law enforcement and you. The vehicle's location will only be provided to law enforcement.

### Garage door opener

The built-in remote control is capable of operating up to three separately controlled devices, for example garage door openers, gate openers, or other devices compatible with HomeLink® or some other systems.

You can program the signal transmitter buttons.



**Remote control integrated into the overhead control panel**

- ① Hand-held remote control transmitter (not part of the vehicle equipment)
- ② Hand-held transmitter button
- ③,④,⑤ Signal transmitter button
- ⑥ Indicator lamp

**Warning!**



Before programming the integrated remote control to a garage door opener or gate operator, make sure that people and objects are out of the way of the device to prevent potential harm or damage.

When programming a garage door opener, the door moves up or down. When programming a gate operator, the gate opens or closes.

Do not use the integrated remote control with any garage door opener that lacks safety stop and reverse features as required by U.S. federal safety standards (this includes any garage door opener model manufactured before April 1, 1982). A garage door that cannot detect an object - signaling the door to stop and reverse - does not meet current U.S. federal safety standards.

**Controls in detail**

**Useful features**



Certain types of garage door openers are incompatible with the integrated opener. If you should experience difficulties with programming the transmitter, contact your authorized Mercedes-Benz Light Truck Center, or call Mercedes-Benz Customer Assistance Center (in the USA only) at 1-800-FOR-MERCEdes, or Customer Service (in Canada) at 1-800-387-0100.

## Controls in detail

### Useful features



For operation in the USA only:  
This device complies with Part 15 of the FCC Rules. Operation is subject to the following two conditions:

- (1) This device may not cause harmful interference, and
- (2) this device must accept any interference received, including interference that may cause undesired operation.

Any unauthorized modification to this device could void the user's authority to operate the equipment.

### Programming or reprogramming the integrated remote control

Step 1:

- ▶ Switch on ignition.

Step 2:

- ▶ If you have previously programmed an integrated signal transmitter button and wish to retain its programming, proceed to step 3. Otherwise, press and hold the two outer signal transmitter buttons ③ and ⑤ and release them only when the indicator light begins to flash after approximately 20 seconds (do not hold the button for longer than 30 seconds). This procedure erases any previous settings for all three channels and initializes the memory. If you later wish to program a second and/or third hand-held transmitter to the remaining two signal transmitter buttons, do not repeat this step and begin directly with step 3.

Step 3:

- ▶ Hold the end of the hand-held remote control transmitter ① of the device you wish to train approximately 2 to 5 in (5 to 12 cm) away from the surface of the integrated remote control located on the interior rear view mirror, keeping the indicator lamp ⑥ in view.

Step 4:

- ▶ Using both hands, simultaneously press the hand-held transmitter button ② and the desired integrated signal transmitter button (③, ④ or ⑤). Do not release the buttons until completing step 5.

The indicator lamp ⑥ on the integrated remote control will flash, first slowly and then rapidly.



The indicator lamp ⑥ flashes the first time the signal transmitter button is programmed. If this button has already been programmed, the indicator lamp will only start flashing after 20 seconds.

Step 5:

- ▶ When the indicator lamp ⑥ flashes rapidly, release both buttons.

Step 6:

- ▶ Press and hold the just-trained integrated signal transmitter button and observe the indicator lamp ⑥.

If the indicator lamp ⑥ stays on constantly, programming is complete and your device should activate when the integrated signal transmitter button is pressed and released.



If the indicator lamp ⑥ flashes rapidly for about two seconds and then turns to a constant light, continue with programming steps 8 through 12 as your garage door opener may be equipped with the “rolling code” feature.

Step 7:

- ▶ To program the remaining two buttons, repeat the steps above starting with step 3.

### ***Rolling code programming***

To train a garage door opener (or other rolling code devices) with the rolling code feature, follow these instructions after completing the “Programming” portion (steps 1 through 6) of this text. (A second person may make the following training procedures quicker and easier.)

Step 8:

- ▶ Locate “training” button on the garage door opener motor head unit.

Exact location and color of the button may vary by garage door opener brand. Depending on manufacturer, the “training” button may also be referred to as “learn” or “smart” button. If there is difficulty locating the transmitting button, refer to the garage door opener operator’s manual. ▷▷

## Controls in detail

### Useful features

▷▷ Step 9:

- ▶ Press “training” button on the garage door opener motor head unit.

The “training light” is activated.

You have 30 seconds to initiate the following step.

Step 10:

- ▶ Firmly press, hold for two seconds and release the programmed integrated signal transmitter button (③, ④ or ⑤).

Step 11:

- ▶ Press, hold for two seconds and release same button a second time to complete the training process.

Some garage door openers (or other rolling code equipped devices) may require you to perform this procedure a third time to complete the training.

Step 12:

- ▶ Confirm the garage door operation by pressing the programmed integrated signal transmitter button (③, ④ or ⑤).

Step 13:

- ▶ To program the remaining two buttons, repeat the steps above starting with step 3.

### ***Gate operator / Canadian programming***

Canadian radio-frequency laws require transmitter signals to “time-out” (or quit) after several seconds of transmission which may not be long enough for the integrated signal transmitter to pick up the signal during programming. Similar to this Canadian law, some U.S. gate operators are designed to “time-out” in the same manner.

If you live in Canada or if you are having difficulties programming a gate operator (regardless of where you live) by using the programming procedures, replace step 4 with the following:



Step 4:

- ▶ Continue to press and hold the integrated signal transmitter button (③, ④ or ⑤) while you press and re-press (“cycle”) your hand-held remote control transmitter ① every two seconds until the frequency signal has been learned. Upon successful training, the indicator lamp ⑥ will flash slowly and then rapidly after several seconds.
- ▶ Proceed with programming step 5 and step 6 to complete.

#### Operation of remote control

- ▶ Switch on ignition.
- ▶ Select and press the appropriate integrated signal transmitter button (③, ④ or ⑤) to activate the remote controlled device.

The integrated remote control transmitter continues to send the signal as long as the button is pressed – up to 20 seconds.

#### Erasing the remote control memory

- ▶ Switch on ignition.
- ▶ Simultaneously hold down the signal transmitter buttons ③ and ⑤, for approximately 20 seconds, or until the indicator lamp ⑥ flashes rapidly. Do not hold for longer than 30 seconds.

The codes of all three channels are erased.



If you sell your vehicle, erase the codes of all three channels.

#### Reprogramming a single integrated signal transmitter button

To program a device using a signal transmitter button previously trained, follow these steps:

- ▶ Press and hold the desired signal transmitter button (③, ④ or ⑤). Do not release the button.
- ▶ The indicator lamp will begin to flash after 20 seconds. Without releasing the integrated signal transmitter button, proceed with programming starting with step 3.

## Controls in detail

### Useful features

#### Trip computer\*

The trip computer is located in the overhead console.



- ① RESET
- ② MODE
- ③ Display

#### Switching on the trip computer

- ▶ Switch on ignition.  
Display ③ shows one of the available functions.
- ▶ If a function display does not appear, press MODE ②.



With engine not running, the display switches off automatically 30 seconds after the last entry.

#### Selecting functions

- ▶ Press MODE ② repeatedly until the desired display appears.

The functions are displayed in the following order:

- Date
- Compass
- Stop watch
- Present fuel consumption
- Average fuel consumption
- Distance remaining
- Country
- Switching off trip computer

#### Setting the date

- ▶ Press MODE ② repeatedly until the date appears.
- ▶ Press RESET ①.  
The month shown flashes.
- ▶ Press MODE ② to advance to selected month.
- ▶ Press RESET ①.  
The day shown flashes.
- ▶ Press MODE ② to advance to selected day.
- ▶ Press RESET ①.  
The year shown flashes.
- ▶ Press MODE ② to advance to selected year.
- ▶ Press RESET ①.  
The display stops flashing and the date is set.

### Compass

The compass displays the direction the vehicle is traveling. The display ③ will show you N, NE, E, SE, S, SW, W or NW.



The presence of buildings, bridges, power lines and large antenna masts can influence the displayed values. Metallic or magnetic objects in or on the vehicle can influence the accuracy of the compass.

To ensure the display is correct, the compass must be set to the proper geographic zone (▷ page 188). It may also be necessary to calibrate the compass (▷ page 188).

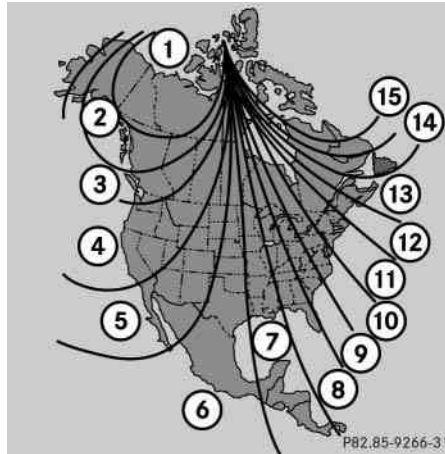

Zone map North America

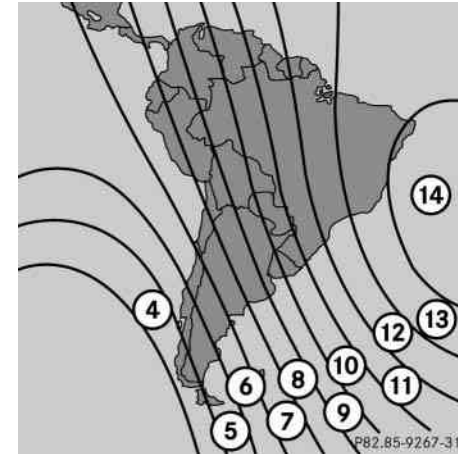

Zone map South America

## Controls in detail

### Useful features

#### Setting the compass zone

- ▶ Determine the geographical point of the vehicle with the aid of the zone maps.
- ▶ Switch on the ignition.
- ▶ Press MODE ② (▷ page 186) repeatedly until the compass display appears in the trip computer display ③.
- ▶ Press RESET ① (▷ page 186) to select the compass zone mode.

The zone selected last is shown in the display.

- ▶ Press RESET ① repeatedly until the correct compass zone, as determined from the zone map, is shown in the display.
- ▶ Press MODE ② twice.

The new compass zone is activated and the compass display will be shown.

#### Calibrating the compass

If the vehicle was exposed to a significant magnetic zone, such as high voltage power lines, the compass may have to be calibrated.

To calibrate the compass correctly, observe the following:

- Calibrate the compass in an area free of steel superstructures and power lines.
- Switch off all electrical consumers (e.g. exterior lamps, climate control, rear window defroster etc.).
- Do not open or close the sliding/pop-up roof.
- Close doors and liftgate.



An open liftgate triggers the display - - -.

- ▶ Start and run the engine.
- ▶ Press MODE ② (▷ page 186) repeatedly until the compass display appears in the trip computer display ③.

- ▶ Press RESET ① and afterwards press MODE ②.

In the display appears CAL-.

- ▶ Press and hold RESET ① for approximately two seconds.

The calibration mode is activated and the display shows CAL.

- ▶ Drive without interruption two full circles at a speed between 3 mph (5 km/h) and 7 mph (10 km/h).

The message CAL goes out after a short time. The calibration is now complete.



If CAL remains in the display, calibration was not successfully completed. You have to recalibrate:

- Remove the key from the steering lock.
- Start the vehicle and start the calibration procedure described previously.

We recommend that you have the compass calibrated at a Mercedes-Benz Light Truck Center.

#### Stop watch

- ▶ Press MODE ② (▷ page 186) repeatedly until the stop watch display appears in the trip computer display ③.

#### Counting

- ▶ Press RESET ① (▷ page 186) to start counting.

#### Stopping

- ▶ Press RESET ① again to stop counting.

#### Resetting

- ▶ Press and hold RESET ① until the display shows "0:00".

#### Average fuel consumption

- ▶ Press MODE ② (▷ page 186) repeatedly until the average fuel consumption display appears in the trip computer display ③.

#### Distance remaining with fuel presently in tank

- ▶ Press MODE ② (▷ page 186) repeatedly until the distance remaining display appears in the trip computer display ③.



When the fuel supply drops to reserve level the display flashes distance remaining.

- USA only:  
The display alternates between FUEL and distance remaining until supply is consistently below the reserve level. When the fuel supply is very low [approximately 1.5 gal (5.5 l)] FUEL is displayed continuously.

## Controls in detail

### Useful features

#### Country

- ▶ Press MODE ② (▷ page 186) repeatedly until the country display appears in the trip computer display ③.
- ▶ Press and hold RESET ① a minimum of five seconds to change the country unit system.

#### Canada units system selection

You can choose between CAN-English or CAN-French.

#### Setting CAN-English

- ▶ Press RESET ① repeatedly until CAN is displayed.
- ▶ Press MODE ② to select -ENG.
- ▶ Press MODE ② again to set CAN-English.

#### Setting CAN-French

- ▶ Press RESET ① repeatedly until CAN is displayed.
- ▶ Press MODE ②.  
-ENG is displayed.
- ▶ Press RESET ① to select -Fr.
- ▶ Press MODE ② to set CAN-French.

The language selected determines how the various displays are presented, see table.

Display	Language	Date	Cardinal points	Fuel consumption	Distance remaining
GEr	German	DD.MM	Süd, Nord, Ost, West	l / 100 km	Kilometer
GB	English	MM.DD	South, North, East, West	mi / gal (Imperial)	Miles
ESP	Spain	DD.MM	Sur, Norte, Este, Oeste	l / 100 km	Kilometer
Fr	French	DD.MM	Sud, Nord, Est, Ouest	l / 100 km	Kilometer
USA	American	MM.DD	South, North, East, West	mi / gal (US)	Miles
CAN-ENG	American	MM.DD	South, North, East, West	l / 100 km	Kilometer
CAN-Fr	French	DD.MM	Sud, Nord, Est, Ouest	l / 100 km	Kilometer
GEr	German	DD.MM	Süd, Nord, Ost, West	l / 100 km	Kilometer

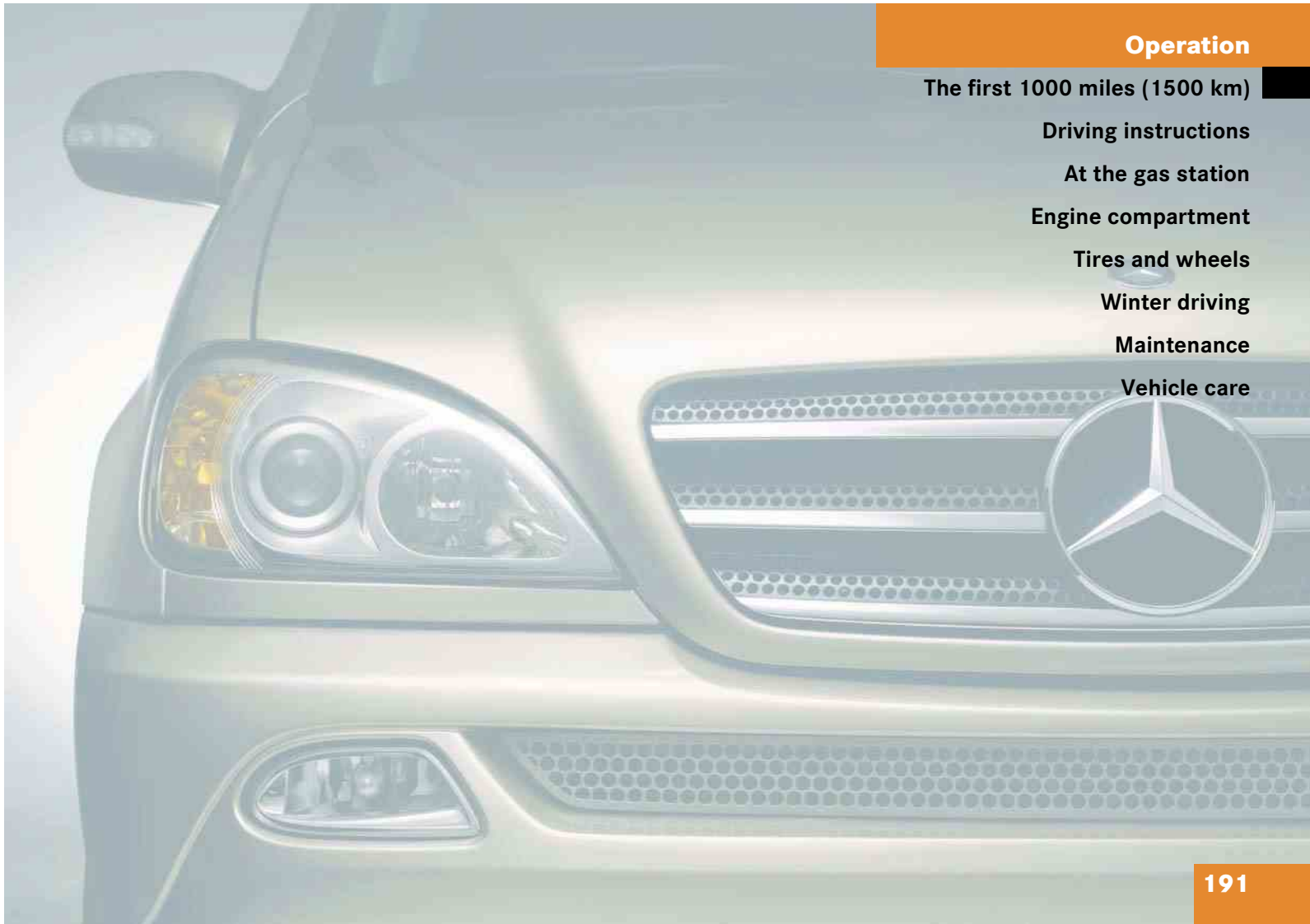

## **Operation**

**The first 1000 miles (1500 km)**

**Driving instructions**

**At the gas station**

**Engine compartment**

**Tires and wheels**

**Winter driving**

**Maintenance**

**Vehicle care**

## Operation

### The first 1000 miles (1500 km)

In the “Operation” section you will find detailed information on operating, maintaining and caring for your vehicle.

#### ▼ The first 1000 miles (1500 km)

The more cautiously you treat your vehicle during the break-in period, the more satisfied you will be with its performance later on.

- Drive your vehicle during the first 1000 miles (1500 km) at varying but moderate vehicle and engine speeds.
- During this period, avoid heavy loads (full throttle driving) and excessive engine speeds (no more than  $\frac{2}{3}$  of maximum rpm in each gear).
- Avoid accelerating by kick-down.
- Do not attempt to slow the vehicle down by shifting to a lower gear using the gear selector lever.
- Select positions **3**, **2** or **1** only when driving at moderate speeds (for hill driving).

After 1000 miles (1500 km) you may gradually increase vehicle and engine speeds to the permissible maximum.

All of the above instructions, as may apply to your vehicle type, also apply when the first 1000 miles (1500 km) after the engine, the transfer case, the front differential or the rear differential has been replaced.



Always obey applicable speed limits.



▼ **Driving instructions**

**Drive sensibly – save fuel**

Fuel consumption, to a great extent, depends on driving habits and operating conditions.

To save fuel you should:

- Keep tires at the recommended inflation pressures
- Remove unnecessary loads
- Allow engine to warm up under low load use
- Avoid frequent acceleration and deceleration
- Have all maintenance work performed at the intervals specified in the Service Booklet and as required by the FSS. Contact your authorized Mercedes-Benz Light Truck Center

Fuel consumption is also increased by driving in cold weather, in stop-and-go traffic, on short trips and in hilly country.

**Drinking and driving**

**Warning!**



Drinking and driving and / or taking drugs and driving are a very dangerous combination. Even a small amount of alcohol or drugs can affect your reflexes, perceptions and judgement.

The possibility of a serious or even fatal accident are greatly increased when you drink or take drugs and drive.

Do not drink or take drugs and drive or allow anyone to drive who has been drinking or taking drugs.

**Pedals**

**Warning!**



Keep driver's foot area clear at all times. Objects stored in this area may impair pedal movement.

**Power assistance**

**Warning!**



With the engine is not running, there is no power assistance for the brake and steering systems. In this case, it is important to keep in mind that a considerably higher degree of effort is necessary to brake and steer the vehicle.

## Operation

### Driving instructions

#### Brakes

##### Warning!



After driving in heavy rain for some time without applying the brakes or through water deep enough to wet brake components, the first braking action may be somewhat reduced and increased pedal pressure may be necessary to obtain expected braking effect. Maintain a safe distance from vehicles in front.

Resting your foot on the brake pedal will cause excessive and premature wear of the brake pads.

It can also result in the brakes overheating, thereby significantly reducing their effectiveness. It may not be possible to stop the vehicle in sufficient time to avoid an accident.

To help prevent brake disk corrosion after driving on wet road surfaces (particularly salted roads), it is advisable to brake the vehicle with considerable force prior to parking. The heat generated serves to dry the brakes.

If your brake system is normally only subjected to moderate loads, you should occasionally test the effectiveness of the brakes by applying above-normal braking pressure at higher speeds. This will also enhance the grip of the brake pads.



Be very careful not to endanger other road users when you apply the brakes.

Refer to the description of the Brake Assist System (BAS) (▷ page 78).

If the parking brake is released and the brake warning lamp in the instrument cluster stays on and there is no audible warning (EBP), the brake fluid level in the reservoir is too low.

Brake pad wear or a leak in the system may be the reason for low brake fluid in the reservoir.

Have the brake system inspected immediately. Contact your authorized Mercedes-Benz Light Truck Center.

All checks and service work on the brake system should be carried out by qualified technicians only. Contact your authorized Mercedes-Benz Light Truck Center.

Install only brake pads and brake fluid recommended by Mercedes-Benz.

**Warning!**



If other than recommended brake pads are installed, or other than recommended brake fluid is used, the braking properties of the vehicle can be degraded to an extent that safe braking is substantially impaired. This could result in an accident.



When driving down long and steep grades, relieve the load on the brakes by shifting into a lower gear to use the engine's braking power. This helps prevent overheating of the brakes and reduces brake pad wear.

After hard braking, it is advisable to drive on for some time, rather than immediately parking, so the air stream will cool down the brakes faster.

## Operation

### Driving instructions

#### Driving off

Apply the brakes to test them briefly after driving off. Perform this procedure only when the road is clear of other traffic.

Warm up the engine smoothly. Do not place full load on the engine until the operating temperature has been reached.

When starting off on a slippery surface, do not allow a drive wheel to spin for an extended period with the ESP switched off. Doing so may cause serious damage to the drivetrain which is not covered by the Mercedes-Benz Limited Warranty.

## Operation

### Driving instructions

#### Parking



Set the parking brake whenever parking or leaving the vehicle. In addition, move gear selector lever to position **P**. When parking on hills, always turn front wheels towards the curb.

#### Warning!



To reduce the risk of personal injury, or damage to the vehicle powertrain, as a result of vehicle / trailer movement, always:

- Keep right foot on brake pedal.
- Shift gear selector lever to position **N**.
- Have a second person place wheel chocks on downhill side of left and right trailer wheels.
- Slowly release brake pedal and let vehicle and trailer roll into chocks until stopped.
- Firmly depress parking brake pedal.
- Move gear selector lever to position **P**.
- When parked on an incline, turn front wheel towards the road curb.

#### Tires

#### Warning!



If you feel a sudden significant vibration or ride disturbance, or you suspect that possible damage to your vehicle has occurred, you should turn on the hazard warning flashers, carefully slow down, and drive with caution to an area which is a safe distance from the road.

Inspect the tires and the vehicle underbody for possible damage. If the vehicle or tires appear unsafe, have it towed to the nearest Mercedes-Benz Light Truck Center or tire dealer for repairs.

Tread wear indicators (TWI) are required by law. These indicators are located in six places on the tread circumference and become visible at a tread depth of approximately  $\frac{1}{16}$  in (1.6 mm), at which point the tire is considered worn and should be replaced.

The tread wear indicator appears as a solid band across the tread.

**Warning!**



Although the applicable federal motor vehicle safety laws consider a tire to be worn when the tread wear indicators (TWI) become visible at approximately  $\frac{1}{16}$  in (1.6 mm), we recommend that you do not allow your tires to wear down to that level. As tread depth approaches  $\frac{1}{8}$  in (3 mm), the adhesion properties on a wet road are sharply reduced.

Depending upon the weather and/or road surface (conditions), the tire traction varies widely.

Specified tire pressures must be maintained. This applies particularly if the tires are subjected to high loads (e.g. high speeds, heavy loads, high ambient temperatures).

**Warning!**



Do not drive with a flat tire. A flat tire affects the ability to steer or brake the vehicle. You may lose control of the vehicle. Continued driving with a flat tire or driving at high speed with a flat tire will cause excessive heat build-up and possibly a fire.

**Hydroplaning**

Depending on the depth of the water on the road, hydroplaning may occur even at low speeds and with new tires. Reduce vehicle speed, avoid track grooves in the road and apply brakes cautiously in the rain.

**Tire traction**

The safe speed on a wet, snow covered or icy road is always lower than on a dry road.

**Operation**

**Driving instructions**

You should pay particular attention to the condition of the road whenever the outside temperatures are close to the freezing point.

**Warning!**



If ice has formed on the road, tire traction will be substantially reduced. Under such weather conditions, drive, steer and brake with extreme caution.

Mercedes-Benz recommends M+S rated radial-ply tires with a minimum tread depth of approximately  $\frac{1}{6}$  in (4 mm) on all four wheels for the winter season to ensure normal balanced handling characteristics. On packed snow, they can reduce your stopping distance as compared with summer tires.

Stopping distance, however, is still considerably greater than when the road is not covered with snow or ice. Exercise appropriate caution.

## Operation

### Driving instructions



Avoid spinning of one drive wheel. This may cause serious damage to the drivetrain which is not covered by the Mercedes-Benz Limited Warranty.

#### Tire speed rating

Regardless of the tire speed rating, local speed limits should be obeyed. Use prudent driving speeds appropriate to prevailing conditions.

#### Warning!



Even when permitted by law, never operate a vehicle at speeds greater than the maximum speed rating of the tires.

Exceeding the maximum speed for which tires are rated can lead to sudden tire failure, causing loss of vehicle control and possibly resulting in an accident and/or serious injury and possible death, for you and for others.

#### ML 350

Your vehicle is factory equipped with “H”-rated tires, which have a speed rating of 130 mph (210 km/h).

An electronic speed limiter prevents your vehicle from exceeding a speed of 130 mph (210 km/h).

#### ML 500

Your vehicle is factory equipped with “V”-rated tires, which have a speed rating of 149 mph (240 km/h).

An electronic speed limiter prevents your vehicle from exceeding a speed of 130 mph (210 km/h).



For information on speed ratings for winter tires, see “Winter tires” (▷ page 230).

#### Winter driving instructions

The most important rule for slippery or icy roads is to drive sensibly and to avoid abrupt acceleration, braking and steering maneuvers. Do not use the cruise control system under such conditions.

When the vehicle is in danger of skidding, move gear selector lever to position **N**. Try to keep the vehicle under control by corrective steering action.



For information on driving with snow chains, see “Snow chains” (▷ page 231).

#### Warning!



On slippery road surfaces, never downshift in order to obtain braking action. This could result in drive wheel slip and reduced vehicle control. Your vehicle's ABS will not prevent this type of control loss.

Do not engage the transfer case in position **LOW** when driving on ice or packed snow. At speeds below 18 mph (30 km / h) vehicle steering is adversely affected by the LOW RANGE - ABS (▷ page 77).

Road salts and chemicals can adversely affect braking efficiency. Increased pedal force may become necessary to produce the normal brake effect.

Depressing the brake pedal periodically when traveling at length on salt-strewn roads can bring road-salt-impaired braking efficiency back to normal.

If the vehicle is parked after being driven on salt-treated roads, the braking efficiency should be tested as soon as possible after driving is resumed.

#### Warning!



Make sure not to endanger any other road users when carrying out these braking maneuvers.

#### Warning!



If the vehicle becomes stuck in snow, make sure that snow is kept clear of the exhaust pipe and from around the vehicle with the engine running. Otherwise, deadly carbon monoxide (CO) gases may enter vehicle interior resulting in unconsciousness and death.

To assure sufficient fresh air ventilation, open a window slightly on the side of the vehicle not facing the wind.

#### Warning!



The outside temperature indicator is not designed to serve as an ice-warning device and is therefore unsuitable for that purpose. Indicated temperatures just above the freezing point do not guarantee that the road surface is free of ice.

For more information, see "Winter driving" (▷ page 230).

## Operation

### Driving instructions

#### Standing water



Do not drive through flooded areas or water of unknown depth. Before driving through water, determine its depth. Never accelerate before driving into water. The bow wave could force water into the engine and auxiliary equipment, thus damaging them.

If you must drive through standing water, drive slowly to prevent water from entering the passenger compartment or the engine compartment. Water in these areas could cause damage to electrical components or wiring of the engine or transmission, or could result in water being ingested by the engine through the air intake, causing severe internal engine damage. Any such damage is not covered by the Mercedes-Benz Limited Warranty.

#### Off-road driving

##### Warning!



Drive slowly in unknown terrain. This will make it easier to recognize unexpected obstacles and avoid damage to the vehicle.

To help avoid the vehicle rolling over, never turn it around on steep inclines. If the vehicle cannot complete the attempted climb, back it down in reverse gear.

Do not drive along the side of a slope (danger of vehicle rollover). The vehicle might otherwise rollover. If in doing so the vehicle begins to show a tendency to roll, immediately steer into a line of gravity (straight up or downhill).

Never let the vehicle roll backwards in idle. You may lose control of the vehicle if you use only the service brake.

##### Warning!



Sand, dirt, mud and other material having friction property can cause exceptional wear and tear as well as brake failure.

Have the brakes checked for dirt build-up and cleaned. There is otherwise a risk that full braking power may not be available in an emergency.

Read this chapter carefully before you begin off-road travel.

Familiarize yourself with the vehicle characteristics and gear changing before you attempt any difficult terrain off-road driving. We recommend that you start out with easy off-road travel.



### Special driving features for off-road driving

The following driving features are available for specific kind of operation:

- LOW RANGE mode (▷ page 125)
- LOW RANGE – ABS (▷ page 77)
- LOW RANGE – 4-ETS (▷ page 80)
- LOW RANGE – ESP (▷ page 81)

### Off-road driving rules

Engage the LOW RANGE mode before driving under off-road conditions (▷ page 125).

Fasten items being carried as securely as possible (▷ page 157).



We recommend keeping doors, liftgate, windows, and sliding / pop-up roof\* closed whenever driving in off-road mode.



Observe the following during off-road driving:

- Adjust vehicle speed to condition of terrain. The more uneven, rutty and steeper the terrain, the lower the speed should be
- Watch out for obstacles, such as rocks, holes, tree stumps and ruts.
- Be especially careful when driving in unknown territory. It may be necessary to get out of the vehicle and scout the path you intend to take.
- Before driving through water, determine its depth.
- Do not stop vehicle while immersed in water, and do not shut off the engine.

## Operation

### Driving instructions

- In sandy soil, please drive at a steady speed as allowed by conditions. This helps overcome the vehicle rolling resistance and reduces the likelihood of the vehicle sinking into the ground.
- Do not initiate jumps with the vehicle. It interrupts the forward momentum of the vehicle.
- Always drive onto slopes with the engine running and the vehicle in gear.

### Checklist before off-road driving

#### Tires

- Check the tread depth and maintain specified tire pressure (see tire pressure label inside the fuel filler flap).
- Check tires for possible damage and remove foreign objects.
- Replace missing valve caps.

## Operation

### Driving instructions

#### Rims

- Dented or bent rims can cause tire pressure loss and damage the tire beads. For this reason, check and, if necessary, change rims before driving off-road.

#### Vehicle tool kit

- Check if the vehicle jack is functional.
- In all cases take the vehicle tool kit, a strong tow rope, a shovel and a small plank (to put under the vehicle jack on sandy soil) with you.

#### Driving in steep terrain

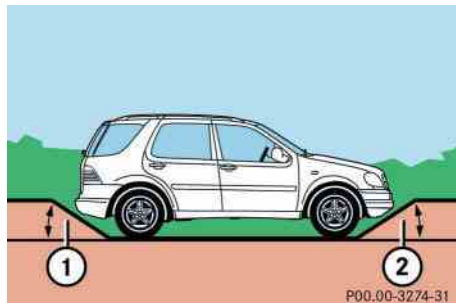

#### Slope angle

- ① 25°
- ② 26°

- Switch to LOW RANGE mode before starting to drive up or down steep inclines (> page 125).
- Driving on embankments, slopes and other steep inclines should only be done straight up or downhill, i.e. in the line of gravity. Maximum vehicle climbing ability is a 60% grade.
- Do not drive along the side of a slope (danger of vehicle rollover). If in doing so, the vehicle begins to show a tendency to roll, immediately steer into a line of gravity (straight up or downhill).
- To help avoid the vehicle rolling over, never turn it around on steep inclines. If the vehicle cannot complete the attempted climb, back it down in reverse gear.

- Utilize the engine's braking power when descending a slope, observe the engine speed (do not overview the engine). Apply the service brake as needed.
- Check the brakes after a lengthy down-grade drive.



Avoid excessive engine speeds – drive with moderate engine speeds (max. 3000 RPM).

Select gear range **2** or **1** on the automatic transmission (> page 121).

#### Traction in steep terrain

- Be easy on the accelerator and watch for continuous wheel traction when driving in steep terrain.

The 4-ETS helps greatly when starting out on a steep incline when the front wheels have then the tendency to slip due to the weight shifting away the front axle.

The 4-ETS recognizes the situation and limits the torque for the front wheels by braking them. Simultaneously the torque for the rear wheels is increased.

#### ***Driving across a hilltop***

- Decelerate just ahead of a hilltop (do not select gear range **N**), to prevent the vehicle from speeding up too much after climbing a hill.

Use the momentum of the vehicle to drive across the hilltop.

Driving in this manner prevents the vehicle from jumping across the hilltop and thus losing its forward momentum.

#### ***Driving downhill***

- Select gear range **1** on the automatic transmission (▷ page 121).
- Drive downhill observing the same rules as driving uphill (▷ page 202).
- The special LOW RANGE – ABS setting allows for precise and brief (cyclical) blocking of the front wheels, permitting them to dig into loose ground.

Remember that the front wheels when stopped, slide across a surface, thus lose their ability to steer the vehicle.

## Operation

### Driving instructions

#### **Driving through water**

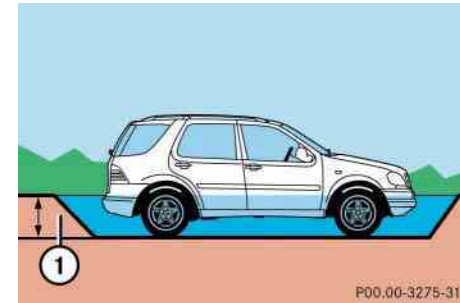

① 20 in (50 cm)

- Before driving through water, determine its depth.

It should not be deeper than approximately 20 inches (50 cm).

Make sure you check the water bed. The ground surface may not be firm which may result in deeper waters than expected when driving the vehicle through it.

- Switch to LOW RANGE mode before driving through water (▷ page 125).

## Operation

### Driving instructions

- Switch off the exterior lamps as well as the climate control.
- Select gear range **1** on the automatic transmission (▷ page 121).
- Enter the water only at a shallow spot, driving at walking speed.



Never accelerate before driving into the water. The bow wave could force water into the engine and auxiliary equipment, thus damaging them.

- Do not stop vehicle while immersed in water, and do not shut off the engine.  
There is a very high level of driving resistance in water. The surface is slippery and may not be firm, making pulling away in water difficult and dangerous.
- Clean mud off the tire tread after driving through water.

- To dry the brakes, apply pressure to the brake pedal several times after leaving the water.

### Crossing obstacles



Obstacles can damage the vehicle undercarriage or suspension components. If possible use the assistance of a second person outside the vehicle to scout the path you intend to take and check for adequate ground clearance when you cross obstacles with your vehicle. The person assisting you outside the vehicle should always be a safe distance away from the vehicle and positioned so that he or she cannot get hurt in case of any unexpected vehicle movement.

After off-road driving or crossing obstacles, inspect vehicle for any damage, especially vehicle undercarriage and suspension components. Failure to do so can adversely affect the vehicle's future performance, including increased chance of an accident.

- Check the vehicle clearance before crossing obstacles.
- Select gear range **1** on the automatic transmission (▷ page 121).
- Cross obstacles (e.g. tree stumps or big rocks) very slowly by aiming one of the front wheels at the center of the obstacle, and repeat same with the rear wheel.



Special attention is needed when you cross obstacles on a steep incline.

The vehicle could slide sideways as a result of its possible slanted position which in turn may result in the vehicle tipping or rolling over.

### **Ruts**

A number of off-road tracks or other by-ways have deep ruts which can cause the undercarriage to come in contact with the ground.

- Select gear range **1** on the automatic transmission (▷ page 121).
- Drive next to the ruts rather than through them if at all possible.

## Operation

### Driving instructions

#### Returning from off-road driving

##### **Warning!**



If you feel a sudden significant vibration or ride disturbance, or you suspect that possible damage to your vehicle has occurred, you should turn on the hazard warning flashers, carefully slow down, and drive with caution to an area which is a safe distance from the roadway.

Inspect the tires and under the vehicle for possible damage. If the vehicle or tires appear unsafe, have it towed to the nearest Mercedes-Benz Light Truck Center or tire dealer for repairs.

## Operation

### Driving instructions

Off-road driving increases strain on the vehicle.

We recommend that you inspect the vehicle for possible damage after each off-road trip. Recognizing any damage and a subsequent timely repair reduces the chance of a possible breakdown or accident later on.

Proceed as follows:

- Switch off the LOW RANGE mode (▷ page 125).
- Remove excessive dirt from tires, wheels, wheel housings, and underbody.

For instance, after driving in mud, clean the radiator, chassis, engine, brakes, and wheels from extreme dirt using a strong jet of water.

- Inspect frame, oil pan, brake hoses, etc., as well as vehicle underbody for possible damage.
- Check tires for possible damage, clean all exterior lamps, and conduct a brake test.
- Check for brush or branches caught in the undercarriage.  
They could increase the possibility of a fire, as well as cut fuel and / or brake lines, puncture rubber bellows of the axles or drive shafts.
- After continued operation in mud, sand, water or other dirty conditions clean the brake discs, wheels, brake pads and check and clean axle joints.

### Trailer towing

#### Warning!



Failure to use proper equipment and driving technique can result in a loss of vehicle control when towing a trailer.

Improper towing or failure to follow the instructions contained in this guide can result in serious injury. Follow the guidelines below carefully to assure safe trailer operation.

Ask your authorized Mercedes-Benz Light Truck Center should you require an explanation of information contained in this guide.

**Trailer hitches**

- Only install a trailer hitch receiver approved for your vehicle.  
For information on availability and installation, see your authorized Mercedes-Benz Light Truck Center.
- The bumpers on your vehicle are not designed for use with clamp-type hitches.  
Do not attach rental hitches or other bumper-type hitches to them.
- To reduce the possibility of damage, remove the hitch ball adaptor from the receiver when not in use.

**Electrical connections**

The vehicle is prewired to accept the seven-wire harness included in the Mercedes-Benz approved trailer hitch receiver kit.  
An additional four-pole conversion plug is included in the Mercedes-Benz supplied trailer hitch receiver kit.  
For further information, see your authorized Mercedes-Benz Light Truck Center.

**Vehicle and trailer weights and ratings**

**Gross Vehicle Weight Rating (GVWR)** is the maximum permissible vehicle weight:  
6614 lbs (3000 kg).

**Gross Vehicle Weight (GVW):**  
Comprises weight of vehicle including fuel, tools, spare wheel, installed accessories, passengers, cargo and trailer tongue. It must never exceed the GVWR.

**Gross Axle Weight Rating (GAWR)** is the maximum permissible axle weight:

front	2976 lbs	(1350 kg)
rear	3858 lbs	(1750 kg)

**Gross Trailer Weight (GTW)** is the maximum permissible trailer weight to be towed:  
5000 lbs (2260 kg).

**Trailer Tongue Weight Rating (TWR)** is the maximum permissible weight on the trailer tongue:  
500 lbs (225 kg) limit for Mercedes-Benz approved hitch receiver.

## Operation

### Driving instructions

#### *Loading a trailer*

- When loading a trailer, you should observe that neither the permissible GTW, nor the GVWR are exceeded.

Maximum permissible values are listed on the safety compliance certification labels for the vehicle and for the trailer to be towed.

The lowest value listed must be selected when determining how the vehicle and trailer are loaded.

- The tongue weight at the hitch ball must be added to the GVW to prevent exceeding your Mercedes-Benz tow vehicle's rear GAWR.



We recommend loading the trailer in such a manner that it has a tongue weight (TW) between 10% and 15% of the GTW.

#### *Checking weights of vehicle and trailer*

- To assure that the tow vehicle and trailer are in compliance with the maximum permissible weight limits have the loaded rig (tow vehicle including driver, passengers and cargo, trailer fully loaded) weighed on a commercial scale.
- Check the vehicle's front and rear Gross Axle Weight (GAW), the GTW and TW.

The values as measured must not be exceeded, according to the weight listed under "Vehicle and trailer weight and ratings".

#### *Attaching a trailer*

Observe maximum permitted trailer dimensions (width and length).

Most states and all Canadian provinces require

- safety chains between your tow vehicle and the trailer.

The chains should be crisscrossed under the trailer tongue. They must be attached to the hitch receiver, and not to the vehicle's bumper or axle.

Be sure to leave enough slack in the chains to permit turning corners.

- a separate brake system at various trailer weights.
- a break-away switch on trailers with a separate brake system.

The switch activates the trailer brakes in the possible event that the trailer might separate from the tow vehicle.





Do not connect a trailer brake system (if trailer is so equipped) directly to the vehicle's hydraulic brake system, as your vehicle is equipped with antilock brakes. If you do, neither the vehicle's brakes nor the trailer's brakes will function properly.



The provided vehicle electrical wiring harness for trailer towing has a brake signal wire (color orange) for hook-up to a brake controller.

You should consider using a trailer sway control system. For further information see your authorized Mercedes-Benz Light Truck Center.

### Towing a trailer

There are many different laws, including speed limit restrictions, having to do with trailer towing. Make sure your rig will be legal, not only for where you reside, but also for where you will be driving. A good source for this information can be the police or local authorities.

Note the following points, when driving with the trailer:

- In order to gain skill and an understanding of the vehicle's behavior, you should practice turning, stopping and backing up in an area which is free from traffic.
- Before you start driving check the
  - trailer hitch
  - break-away switch
  - safety chains
  - electrical connections
  - lighting and tires

Adjust the mirrors to permit unobstructed view beyond rear of trailer.

- If the trailer has electric brakes, start your vehicle and trailer moving slowly, and then apply only the trailer brake controller by hand to be sure the brakes are working properly.
- Always secure items in the trailer to prevent load shifts while driving.
- When towing a trailer, check occasionally to be sure that the load is secure, and that lighting and trailer brakes (if so equipped) are functioning properly.
- Take into consideration that when towing a trailer, the handling characteristics are different and less stable from those when operating the vehicle without a trailer.

It is important to avoid sudden maneuvers.

## Operation

### Driving instructions

- The vehicle and trailer combination is heavier, and therefore is limited in acceleration and climbing ability, and requires longer stopping distances.  
It is more prone to reacting to side wind gusts, and requires more sensitive steering input.
- If possible, do not brake abruptly, but rather engage the brake slightly at first to permit the trailer to activate its brake. Then increase the braking force.



If the trailer should begin to sway, reduce the vehicle's speed and use the brake controller by hand to straighten out the vehicle and trailer.

In no case should you attempt to straighten out the tow vehicle and trailer by increasing the speed or oversteering and stepping on the brakes.

- If the transmission hunts between gears on inclines, manually shift to a lower gear (select **4, 3, 2** or **1**).  
A lower gear and reduction of speed reduces the chance of engine overloading and / or overheating.
- On very steep inclines, not manageable with gear selector lever in position **1**, switch transfer case to LOW RANGE mode (▷ page 125).
- When going down a long hill, shift into a lower gear and use the engine's braking effect.

Avoid riding the brakes, thus overheating the vehicle and trailer brakes.

- If the engine coolant rises to an extremely high temperature (coolant temperature needle approaching the red zone) when the air conditioning is on, turn off the air conditioning system.  
Engine coolant heat can be additionally vented by opening the windows, switching the climate control fan speed to high and setting the temperature control to the maximum hot position.
- Extreme care must be exercised since your vehicle with a trailer will require additional passing distance ahead than when driving without a trailer.

Because your vehicle and trailer is longer than your vehicle alone, you will also need to go much farther ahead of the passed vehicle before you can return to your lane.

#### Passenger compartment

##### Warning!



Always fasten items being carried as securely as possible.

In an accident, during hard braking or sudden maneuvers, loose items will be thrown around inside the vehicle, and cause injury to vehicle occupants unless the items are securely fastened in the vehicle.

The rear cargo compartment is the preferred place to carry objects. Always use the partition net when transporting cargo. Partition net cannot secure hard or heavy objects. Always fasten items being carried as securely as possible using the cargo tie-down rings in the cargo floor area and fastening materials.

#### Driving abroad

Abroad, there is an extensive Mercedes-Benz service network at your disposal. If you plan to drive into areas which are not listed in the index of your Mercedes-Benz Light Truck Center directory, you should request pertinent information from your authorized Mercedes-Benz Light Truck Center.

#### Control and operation of radio transmitters

##### MCS, radio and telephone\*

##### Warning!



Do not forget that your primary responsibility is to drive the vehicle. Only operate the MCS, radio or telephone<sup>1</sup> if road, weather and traffic conditions permit.

Bear in mind that at a speed of just 30 mph (approximately 50 km / h), your vehicle is covering a distance of approximately 44 feet (approximately 13.5 m) every second.

<sup>1</sup> Observe all legal requirements.

## Operation

### Driving instructions

#### Telephones and two-way radios

##### Warning!



Never operate radio transmitters equipped with a built-in or attached antenna (i.e. without being connected to an external antenna) from inside the vehicle while the engine is running. Doing so could lead to a malfunction of the vehicle's electronic system, possibly resulting in an accident and / or personal injury.

Radio transmitters, such as a portable telephone or a citizens band unit should only be used inside the vehicle if they are connected to an antenna that is installed on the outside of the vehicle.

Refer to the radio transmitter operation instructions regarding use of an external antenna.

#### Catalytic converter

Your Mercedes-Benz is equipped with monolithic-type catalytic converters, an important element in conjunction with the oxygen sensors to achieve substantial control of the pollutants in the exhaust emissions. Keep your vehicle in proper operating condition by following our recommended maintenance instructions as outlined in your Service Booklet.



To prevent damage to the catalytic converters, use only premium unleaded gasoline in this vehicle.

Any noticeable irregularities in engine operation should be repaired promptly. Otherwise, excessive unburned fuel may reach the catalytic converter, causing it to overheat and start a fire.

##### Warning!



As with any vehicle, do not idle, park or operate this vehicle in areas where combustible materials such as grass, hay or leaves can come into contact with the hot exhaust system, as these materials could be ignited and cause a vehicle fire.

#### Emission control

Certain engine systems serve to keep the toxic components of the exhaust gases within permissible legal limits.

These systems, of course, will function properly only when maintained strictly according to factory specifications. Any adjustments on the engine should, therefore, be carried out only by qualified Mercedes-Benz Light Truck Center authorized technicians. Engine adjustments should not be altered in any way. Moreover, the specified service jobs must be

carried out regularly according to Mercedes-Benz servicing requirements. For details refer to the Service Booklet.

**Warning!**



Inhalation of exhaust gas is hazardous to your health. All exhaust gas contains carbon monoxide, and inhaling it can cause unconsciousness and lead to death.

Do not run the engine in confined areas (such as a garage) which are not properly ventilated. If you think that exhaust gas fumes are entering the vehicle while driving, have the cause determined and corrected immediately. If you must drive under these conditions, drive only with at least one window fully open at all times.

**Coolant temperature**

During severe operating conditions and stop-and-go city traffic, the coolant temperature may rise to approx. 248°F (120°C).

The engine should not be operated with the coolant temperature in the red zone. Doing so may cause serious engine damage which is not covered by the Mercedes-Benz Limited Warranty.

**Operation**

**Driving instructions**

**Warning!**



- Driving when your engine is badly overheated can cause some fluids which may have leaked into the engine compartment to catch fire. You could be seriously burned.
- Steam from an overheated engine can cause serious burns and can occur just by opening the engine hood. Stay away from the engine if you see or hear steam coming from it.

Turn off the engine, get out of the vehicle and do not stand near the vehicle until the engine has cooled down.

## Operation

### At the gas station

#### ▼ At the gas station

#### Refueling

##### Warning!



Gasoline is highly flammable and poisonous. It burns violently and can cause serious injury. Whenever you are around gasoline, avoid inhaling fumes and skin contact, extinguish all smoking materials. Never allow sparks, flame or smoking materials near gasoline!

The fuel filler flap is located on the left-hand side of the vehicle towards the rear. Locking/unlocking the vehicle with the remote control automatically locks/unlocks the fuel filler flap.

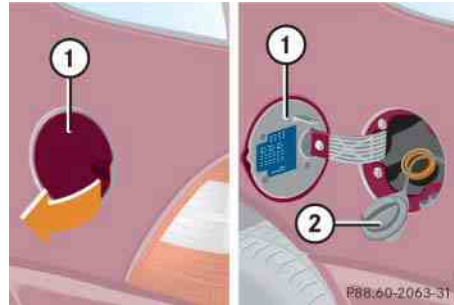

① Fuel filler flap

② Fuel cap

- ▶ Remove the key from the steering lock.
- ▶ Open the fuel filler flap ① by pulling in direction of the arrow.
- ▶ Turn the fuel cap ② to the left and hold on to it until possible pressure is released.
- ▶ Take off the cap.



The fuel filler cap is tethered to the fuel filler neck. Do not drop the cap. It could damage the vehicle paint finish.

- ▶ Only fill your tank until the filler nozzle unit cuts out – do not top up or overfill.



To prevent damaging the lens of the plastic tail lamp, make certain that no gasoline comes into contact with it.

##### Warning!



Overfilling of the fuel tank may create pressure in the system which could cause a gas discharge. This could cause the gas to spray back out when removing the fuel pump nozzle, which could cause personal injury.

- ▶ Replace the fuel cap by turning it to the right.  
You will hear when the fuel cap is tightened.
- ▶ Close the fuel filler flap.



Use only premium unleaded gasoline with a minimum Posted Octane Rating of 91 (average of 96 RON / 86 MON). Information on gasoline quality can normally be found on the fuel pump.

More information on gasoline can be found in the Factory Approved Service Products pamphlet.



Leaving the engine running and the fuel cap open can cause the yellow fuel tank reserve warning lamp to flash and the **CHECK ENGINE** lamp to illuminate.

See also “Practical hints” section (▷ page 248).

## Operation

### At the gas station

#### Check regularly and before a long trip

- ▶ Open the hood (▷ page 217)

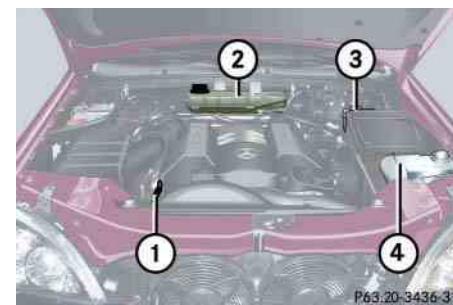

- ① Engine oil level
- ② Coolant level  
For normal replenishing, use water (potable water quality). More information on the coolant level can be found in the “Operation” section (▷ page 222).
- ③ Brake fluid
- ④ Windshield washer system and headlamp cleaning system\*  
More information on filling the reservoir can be found in the “Operation” section (▷ page 224).

## Operation

### At the gas station



If you find that the brake fluid in the brake fluid reservoir has fallen to the minimum mark or below, have the brake system checked for brake pad thickness and leaks immediately. Notify an authorized Mercedes-Benz Light Truck Center immediately. Do not add brake fluid as this will not solve the problem. For more information, see “Practical Hints” (▷ page 245).

#### Engine oil level

More information on engine oil see “Engine oil” (▷ page 218).

#### Vehicle lighting

Check function and cleanliness. More information on replacing light bulbs can be found in the “Practical hints” section (▷ page 266).

#### Tire inflation pressure

More information on tire inflation pressure can be found in the “Operation” section (▷ page 227).



## ▼ Engine compartment

### Hood

#### Warning!



Do not pull the release lever while the vehicle is in motion. Otherwise the hood could be forced open by passing air flow.

### Opening

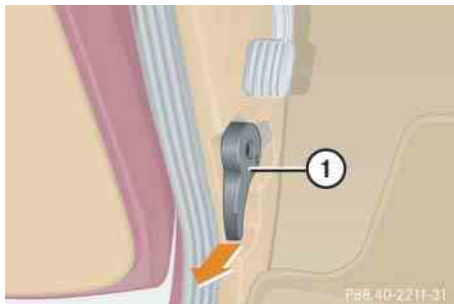

① Release lever

- ▶ Pull release lever ① downwards.

The hood is unlocked. Handle ② protrudes slightly from the radiator-grille. If not, lift the hood slightly.



To avoid damage to the windshield wipers or hood, never open the hood if the wiper arms are folded forward away from the windshield.

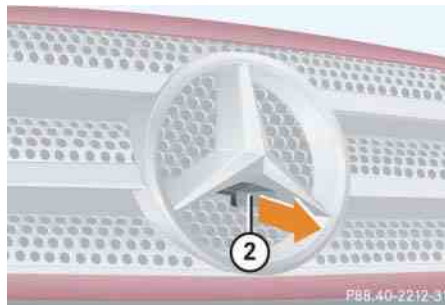

② Handle for opening the hood

- ▶ Pull handle ② to its stop out of the radiator-grille.

## Operation

### Engine compartment

- ▶ Pull up on the hood and then release it.

The hood will be automatically held open at shoulder height by gas-filled struts.

#### Warning!



To help prevent personal injury, stay clear of moving parts when the hood is open and the engine is running. Make sure the hood is properly closed before driving. When closing the hood, use extreme caution not to catch hands or fingers.

The radiator fan may continue to run for approximately 30 seconds or even restart after the engine has been turned off. Stay clear of fan blades.



## Operation

### Engine compartment



#### Warning!



If you see flames or smoke coming from the engine compartment, or if the coolant temperature gauge indicates that the engine is overheated, do not open the hood. Move away from vehicle and do not open the hood until the engine has cooled. If necessary, call the fire department.

#### Warning!



The engine is equipped with a transistorized ignition system. Because of the high voltage it is dangerous to touch any components (ignition coils, spark plug sockets, diagnostic socket) of the ignition system

- with the engine running
- while starting the engine
- if ignition is “on” and the engine is turned manually

### Closing

#### Warning!



Be careful that you do not close the hood on anyone.

- ▶ Let the hood drop from a height of approximately 1 ft (30 cm).

The hood will lock audibly.

- ▶ Check to make sure the hood is fully closed.

If you can raise the hood at a point above the headlamps, then it is not properly closed. Open it again and let it drop with somewhat greater force.



Do not push the hood closed manually, as this could damage it.

### Engine oil

The amount of oil your engine needs will depend on a number of factors, including driving style. Higher oil consumption can occur when

- the vehicle is new
- the vehicle is driven frequently at higher engine speeds

Engine oil consumption checks should only be made after the vehicle break-in period.



Do not use any special lubricant additives, as these may damage the drive assemblies. Using special additives not approved by Mercedes-Benz will restrict your warranty entitlement.

More information on this subject is available at any Mercedes-Benz Light Truck Center.

### Checking engine oil level via display

When checking the oil level the vehicle must

- be parked on level ground
- be at normal operating temperature
- have been stationary for at least five minutes with the engine turned off

To check the engine oil level via the display in the speedometer, do the following:

- ▶ Turn the key in the steering lock to position **2**.



① Button

② Display in speedometer

- ▶ Wait until the display ----- appears in the speedometer display ②.

- ▶ Within one second press button ① twice.

One of the following messages will subsequently appear in the display:

- OIL i.0

The oil level is correct. Engine oil does not to be added.

- - 1.0 L
  - ▶ Add 1.0 liter of engine oil.
- - 1.5 L
  - ▶ Add 1.5 liters of engine oil.
- - 2.0 L
  - ▶ Add 2.0 liters of engine oil.

For adding engine oil see (▷ page 302).

More information on engine oil can be found in the “Technical data” section (▷ page 300) and (▷ page 301).

### Other display messages

If there is excess engine oil with the engine at normal operating temperature, the following message will appear in the display:

OIL HI

The oil level is too high.

- ▶ Have excess oil siphoned.



Excess oil must be siphoned or drained off. It could cause damage to the engine and catalytic converter not covered by the Mercedes-Benz Limited Warranty.

## Operation

### Engine compartment

The display ----- flashes in the speedometer display, if a proper oil level check cannot be performed.

- ▶ If engine is at normal operating temperature, wait five minutes before repeating check procedure.
- ▶ If engine is not yet at normal operating temperature, wait 30 minutes before repeating check procedure.



Perform the engine oil level check with the dipstick if it cannot be completed via the speedometer display (▷ page 220).

In this case we recommend that you have the system checked at a Mercedes-Benz Light Truck Center.

See the “Practical hints” section (▷ page 253) if the low engine oil level warning lamp in the instrument cluster flashes.

### Checking engine oil level with the oil dipstick

When checking the oil level the vehicle must

- be parked on level ground
- be at normal operating temperature
- have been stationary for at least five minutes with the engine turned off



The engine oil level can be checked by either the oil dipstick or via the speedometer display in the instrument cluster (▷ page 219). The amount of engine oil needed is shown more precisely in the speedometer display.

To check the engine oil level with the oil dipstick, do the following:

- ▶ Open the hood (▷ page 217).
- ▶ Pull out oil dipstick ① (▷ page 221).

- ▶ Wipe oil dipstick ① clean.
- ▶ Fully insert oil dipstick ① into the dipstick guide tube.
- ▶ Pull out oil dipstick ① again after approximately three seconds to obtain accurate reading.

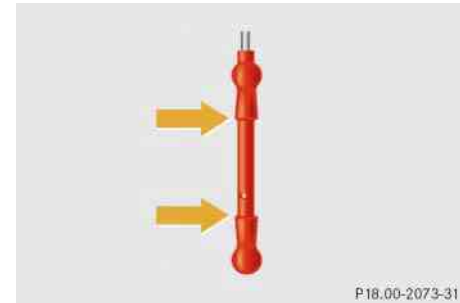

### Oil dipstick

The oil level is correct when it is between the lower (min) and upper (max) mark of the oil dipstick.



The filling quantity between the upper and lower marks on the oil dipstick is approximately 2.1 US qt. (2.0 l).

- ▶ If necessary, add engine oil.

For adding engine oil see (▷ page 221).

More information on engine oil can be found in the “Technical data” section (▷ page 300) and (▷ page 301).

See the “Practical hints” section (▷ page 253) if the low engine oil level warning lamp in the instrument cluster flashes.

### Adding engine oil



Only use approved engine oils. For a listing of approved engine oils, refer to the Factory Approved Service Products pamphlet in your vehicle literature portfolio.

In addition, check the oil filler cap for important information pertaining to the engine oil needing to meet a specific Mercedes-Benz specification (e.g. MB 229.5). If such information is printed on the oil filler cap, only use an engine oil from the list of approved engine oils in the Factory Approved Service Products pamphlet that meets the specification indicated on the oil filler cap. Using engine oils of other specification may cause the FSS to incorrectly determine the next service interval and will result in engine damage not covered by the Mercedes-Benz Limited Warranty.

## Operation

### Engine compartment

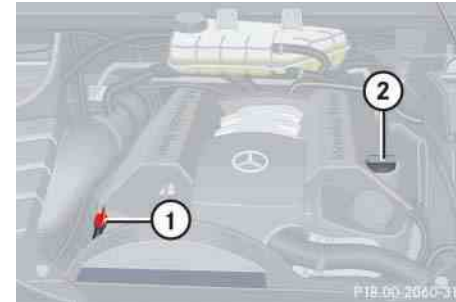

① Oil dipstick

② Filler cap

- ▶ Unscrew filler cap ② from filler neck.
- ▶ Add engine oil as required. Be careful not to overfill with oil.

Be careful not to spill any oil when adding. Avoid environmental damage caused by oil entering the ground or water. ▷▷

## Operation

### Engine compartment



Excess oil must be siphoned or drained off. It could cause damage to the engine and catalytic converter not covered by the Mercedes-Benz Limited Warranty.

- ▶ Screw filler cap ② back on filler neck.

More information on engine oil can be found in the “Technical data” section (▷ page 300) and (▷ page 301).

### Transmission fluid level

The transmission fluid level does not need to be checked. If you notice transmission fluid loss or gear shifting malfunctions, have an authorized Mercedes-Benz Light Truck Center check the automatic transmission.

### Coolant

The engine coolant is a mixture of water and anticorrosion / antifreeze. To check the coolant level, the vehicle must be parked on level ground and the engine must be cool.

### Warning!



In order to avoid any possibly serious burns:

- Use extreme caution when opening the hood if there are any signs of steam or coolant leaking from the cooling system, or if the coolant temperature gauge indicates that the coolant is overheated.
- Do not remove pressure cap on coolant reservoir if engine temperature is above 194°F (90°C). Allow engine to cool down before removing cap. The coolant reservoir contains hot fluid and is under pressure.
- Using a rag, slowly open the cap approximately ½ turn to relieve excess pressure. If opened immediately, scalding hot fluid and steam will be blown out under pressure.
- Do not spill antifreeze on hot engine parts. Antifreeze contains ethylene glycol which may burn if it comes into contact with hot engine parts.

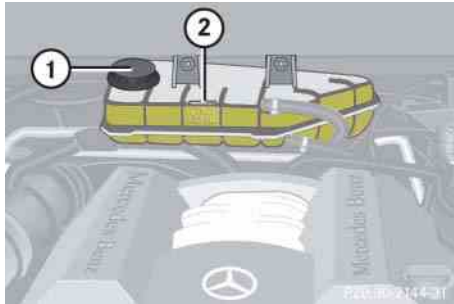

- ① Cap
- ② COLD LEVEL mark

The coolant level should reach the COLD LEVEL mark ② in the reservoir.



If the engine is already at its regular operating temperature, the coolant may be approximately 0.6 in (1.5 cm) above the COLD LEVEL mark.

- ▶ Using a rag, turn the cap slowly approximately one half turn to the left to release any excess pressure.
- ▶ Continue turning the cap to the left and remove it.
- ▶ Add coolant as required.
- ▶ Replace and tighten cap.

More information on coolant can be found in the “Technical data” section (▷ page 304).

### Battery

The battery is located in the engine compartment.

The battery should always be sufficiently charged in order to achieve its rated service life. Refer to Service Booklet for battery maintenance intervals.

If you use your vehicle mostly for short-distance trips, you will need to have the battery charge checked more frequently.

## Operation

### Engine compartment

When replacing batteries, always use batteries approved by Mercedes-Benz.

If you do not intend to operate your vehicle for an extended period of time, consult an authorized Mercedes-Benz Light Truck Center about steps you need to observe.

	Observe all safety instructions and precautions when handling automotive batteries.
	Risk of explosion
	Keep flames or sparks away from battery. Do not smoke.
	Battery acid is caustic. Do not allow it to come into contact with skin, eyes or clothing.  In case it does, immediately flush affected area with clear water and seek medical help if necessary.

## Operation

### Engine compartment



Wear eye protection.



Keep children away.



Follow the instructions in this Operator's Manual.

Batteries contain materials that can harm the environment if disposed of improperly. Recycling of batteries is the preferred method of disposal. Many states require sellers of batteries to accept old batteries for recycling.

### Windshield washer system and headlamp cleaning system\*

The windshield washer reservoir is located in the engine compartment.

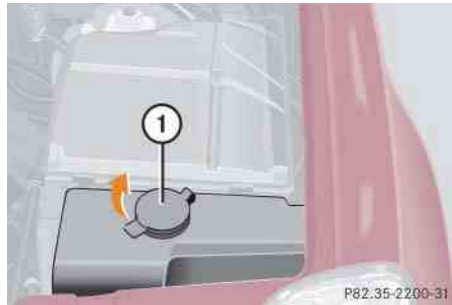

#### ① Cap

Fluid for the windshield washer system and the headlamp cleaning system\* is supplied from the windshield washer reservoir. It has a capacity of 8.0 US qt (7.6 l).

During all seasons, add MB Windshield Washer Concentrate “S” to water. Premix the windshield washer fluid in a suitable container.

- ▶ Use the tab to pull cap ① upwards (arrow).
- ▶ Refill the reservoir with MB Windshield Washer Concentrate “S” and water (or commercially available premixed windshield washer solvent / antifreeze, depending on ambient temperatures).

Always use washer solvent / antifreeze where temperatures may fall below freezing point. Failure to do so could result in damage to the washer system / reservoir.



Only use washer fluid which is suitable for plastic lenses. Improper washer fluid can damage the plastic lenses of the headlamps.



**Warning!**



Washer solvent / antifreeze is highly flammable. Do not spill washer solvent / antifreeze on hot engine parts, because it may ignite and burn. You could be seriously burned.

More information can be found in the “Technical data” section (▷ page 307).

## Operation

### Tires and wheels

#### ▼ Tires and wheels

See your authorized Mercedes-Benz Light Truck Center for information on tested and recommended rims and tires for summer and winter operation. They can also offer advice concerning tire service and purchase.

#### Warning!



Replace rims or tires with the same designation, manufacturer and type as shown on the original part. See your authorized Mercedes-Benz Light Truck Center for further information. If incorrectly sized rims and tires are mounted:

- The wheel brakes or suspension components can be damaged.
- The correct operating clearance of the wheels and the tires are no longer guaranteed.

#### Warning!



Worn, old tires can cause accidents. If the tire tread is badly worn, or if the tires have sustained damage, replace them.

When replacing rims, use only genuine Mercedes-Benz wheel bolts specified for the particular rim type. Failure to do so can result in the bolts loosening and possibly an accident.

Retreaded tires are not tested or recommended by Mercedes-Benz, since previous damage cannot always be recognized on retreads. Mercedes-Benz can therefore not assure the operating safety of the vehicle when such tires are used.

See your authorized Mercedes-Benz Light Truck Center for information on tested and recommended rims and tires for summer and winter operation.

#### Important guidelines

- Use only sets of tires and rims of the same type and make.
- Tires must be of the correct size for the rim.
- Break in new tires for approximately 60 miles (100 km) at moderate speeds.
- Regularly check the tires and rims for damage. Dented or bent rims can cause tire pressure loss or damage to the tire beads.
- If vehicle is heavily loaded, check tire pressure and correct as required.
- Do not allow your tires to wear down too far. Adhesion properties on wet roads are sharply reduced at tread depths under  $\frac{1}{8}$  in (3 mm).
- When replacing individual tires, you should mount new tires on the front wheels first.



When the wheels are heavily soiled, e.g. after driving through mud, clean the inside of the wheels with a jet of water.

#### Life of tire

The service life of a tire is dependent upon varying factors including but not limited to:

- Driving style
- Tire pressure
- Distance driven

#### Warning!



Tires and spare tire should be replaced after six years, regardless of the remaining tread.



Keep unmounted tires in a cool, dry place with as little exposure to light as possible. Protect tires from contact with oil, grease and gasoline.

#### Direction of rotation

Unidirectional tires offer added advantages, such as better hydroplaning performance. To benefit, however, you must ensure that the tires rotate in the direction specified.

An arrow on the sidewall indicates the intended direction of rotation of the tire.

#### Checking tire inflation pressure

#### Warning!



If the tire pressure drops repeatedly:

- Check the tires for punctures from foreign objects.
- Check to see whether air is leaking from the valves or from around the rim.

Correct the tire pressure only when tires are cold.

Regularly check your tire pressure at intervals of no more than 14 days.

If the tires are warm, you should only correct the tire pressure if it is too low for current operating conditions.

A table on the fuel filler flap lists the specified tire inflation pressures for warm and cold tires as well as for various operating conditions.

## Operation

### Tires and wheels



The pressures listed for light loads are minimum values offering high driving comfort.

Increased inflation pressures listed for heavier loads may also be used for light loads. These higher pressures produce favorable handling characteristics. The ride of the vehicle, however, will be somewhat harder. Never exceed the max. values or inflate tires below the min. values listed in the fuel filler flap.

Tire pressure changes by approximately 1.5 psi (0.1 bar) per 18°F (10°C) of air temperature change. Keep this in mind when checking tire pressure where the temperature is different from the outside temperature.

Tire temperature and tire pressure are also increased while driving, depending on the driving speed and the tire load.

#### Warning!



Follow recommended inflation pressures.

Do not overinflate tires. Overinflated tires can result in sudden deflation (blowout) because they are more likely to become punctured or damaged by road debris, potholes, etc.

Do not underinflate tires. Underinflated tires wear unevenly, adversely affect handling and fuel economy, and are more likely to fail from being overheated.

Do not overload the tires by exceeding the Gross Vehicle Weight Rating (GVWR) and the Gross Axle Weight Rating (GAWR) as indicated on the certification label on the driver's door pillar. Overloading the tires can overheat them, possibly causing a blowout.

Check the spare tire periodically for condition and inflation. Spare tire will age and become worn over time even if never used, and thus should be inspected and replaced when necessary.

#### Rotating wheels

#### Warning!



Rotate front and rear wheels only if they are of the same size,

The wheels can be rotated every 3000 to 6000 miles (5000 to 10000 km) or sooner if necessary, according to the degree of tire wear. The same direction of tire rotation must be retained.

Rotate the wheels before the characteristic tire wear pattern becomes visible (shoulder wear on front wheels and tread center wear on rear wheels).

Thoroughly clean the inner side of the wheels after each rotation. Check and ensure proper tire inflation pressure.

**Warning!**



Have the tightening torque checked after changing a wheel. Wheels could become loose if not tightened with a torque of 110 lb-ft (150 Nm).

Use only genuine Mercedes-Benz wheel bolts specified for your vehicle's rims.

## Operation

### Winter driving

#### ▼ Winter driving

Before the onset of winter, have your vehicle winterized at an authorized Mercedes-Benz Light Truck Center. This service includes:

- Check of anticorrosion and antifreeze concentration.
- Addition of cleaning concentrate to the water of the windshield and headlamp cleaning system. Add MB Concentrate “S” to a premixed windshield washer solvent / antifreeze which is formulated for temperatures below freezing point (▷ page 307).
- Battery test. Battery capacity drops with decreasing ambient temperature. A well charged battery helps to ensure that the engine can be started even at low ambient temperatures.
- Tire change. Mercedes-Benz recommends M+S rated radial-ply tires with a minimum tread depth of approximately  $\frac{1}{6}$  in (4 mm) on all four wheels for the winter season.

#### Winter tires

Always use winter tires at temperatures below 45°F (7°C) and whenever wintry road conditions prevail. Use of winter tires is the only way to achieve the maximum effectiveness of the ABS, ESP, 4-ETS, and EBP in winter operation.

For safe handling, ensure that all winter tires mounted are of the same make and have the same tread design.

#### Warning!



Winter tires with a tread depth under  $\frac{1}{6}$  in (4 mm) must be replaced. They are no longer suitable for winter operation.

Always observe the speed rating of the winter tires installed on your vehicle. If the maximum speed for which your tires are rated is below the speed rating of your vehicle, you must place a notice to this effect where it will be seen by the driver. Such notices are available at your tire dealer or any authorized Mercedes-Benz Light Truck Center.

#### Warning!



If you use your spare tire when winter tires are fitted on the other wheels, be aware that the difference in tire characteristics may very well impair turning stability and that overall driving stability may be reduced. Adapt your driving style accordingly.

Have the spare tire replaced with a winter tire at the nearest authorized Mercedes-Benz Light Truck Center.

### Block heater (Canada only)

The engine is equipped with a block heater.

The electrical cable may be installed at your authorized Mercedes-Benz Light Truck Center.

### Snow chains

Snow chains should only be driven on snow-covered roads at speeds not to exceed 30 mph (50 km/h). Remove chains as soon as possible when driving on roads without snow.



When driving with snow chains, you may wish to deactivate the ESP (▷ page 81) before setting the vehicle in motion. This will improve the vehicle's traction.

Observe the following guidelines when using snow chains:

- Use of snow chains is not permissible with all wheel / tire combinations.
- Snow chains should only be used on all four wheels. With only two chains available, they should be mounted on the rear wheels. Follow the manufacturer's mounting instructions.
- Only use snow chains that are approved by Mercedes-Benz. Your authorized Mercedes-Benz Light Truck Center will be glad to advise you on this subject.
- Use of snow chains may be prohibited depending on location. Always check local and state laws before installing snow chains.

## Operation

### Maintenance

#### ▼ Maintenance

We strongly recommend that you have your vehicle serviced by your authorized Mercedes-Benz Light Truck Center, in accordance with the Service Booklet at the times called for by the FSS (Flexible Service System).



Failure to have the vehicle maintained in accordance with the Service Booklet at the designated times / mileage called for by the FSS may result in vehicle damage not covered by the Mercedes-Benz Limited Warranty.

FSS will notify you when your next service is due.



- ① Knob
- ② Display in the speedometer

Approximately one month before your next service is due, the type of service is indicated in the speedometer display ②:

-  Minor service (A)
-  Major service (B)

The following information, depending on operating conditions throughout the year, is also shown:

- calculated distance remaining
- calculated remaining time in days

#### i

The interval between services depends on your driving habits. A gentle driving style, moderate engine speeds and the avoidance of short-distance trips will lengthen the interval between services.

#### Clearing the service indicator



The service indicator is automatically cleared after ten seconds when you switch on the ignition or when reaching the service threshold while driving. You can also clear it yourself.

- ▶ Press knob ①.



### Service term exceeded

If you have exceeded the suggested service term:

- the  or  symbol appears in the display ② for 30 seconds and a signal sounds after switching on the ignition.
- it is preceded by a “-” (minus symbol).

The Mercedes-Benz Light Truck Center will reset the service indicator following a completed service.

### Calling up the service indicator

- ▶ Within one second press knob ① twice.  
The FSS display will appear for ten seconds.

### Resetting the service indicator

In the event that the service on your vehicle is not carried out by an authorized Mercedes-Benz Light Truck Center, you can reset the service indicator yourself.

- ▶ Switch ignition on and immediately press knob ① twice within one second.  
The present status for days or distance is displayed.
- ▶ Within ten seconds turn the key in steering lock to position **0** (▷ page 33).
- ▶ Press and hold knob ① while switching the ignition on.

The present status for days or distance is displayed once more.

- ▶ Continue to hold knob ①.

After approximately ten seconds a signal sounds, and the display shows 10 000 miles (Canada: 15 000 km) for approximately ten seconds.

- ▶ Release knob ①.



If the service indicator was inadvertently reset, have a Mercedes-Benz Light Truck Center correct it.

Only reset if the proper service has been performed. Resetting the system without performing the proper service as called for by the FSS will cause the FSS to incorrectly determine the next service interval which will result in engine damage not covered by the Mercedes-Benz Limited Warranty.

If the battery is disconnected, the days of disconnection will not be included in the count shown by the service indicator. To arrive at the true service deadline, you will need to subtract these days from the days shown in the service indicator.

Do not confuse the service indicator with the engine oil level indicator .

## Operation

### Vehicle care

#### ▼ Vehicle care

##### Cleaning and care of the vehicle

###### Warning!



Many cleaning products can be hazardous. Some are poisonous, others are flammable. Always follow the instructions on the particular container. Always open your vehicle's doors or windows when cleaning the inside. Never use fluids or solvents that are not designed for cleaning your vehicle.

While in operation, even while parked, your vehicle is subjected to varying external influences which, if gone unchecked, can attack the paintwork as well as the underbody and cause lasting damage.

Such damage is caused not only by extreme and varying climatic conditions, but also by:

- Air pollution
- Road salt
- Tar
- Gravel and stone chipping

To avoid paint damage, you should immediately remove:

- Grease and oil
- Fuel
- Coolant
- Brake fluid
- Bird droppings
- Insects
- Tree resins, etc.

Frequent washing reduces and /or eliminates the aggressiveness and potency of the above adverse influences.

More frequent washings are necessary to deal with unfavorable conditions:

- near the ocean
- in industrial areas (smoke, exhaust emissions)
- during winter operation

You should check your vehicle from time to time for stone chipping or other damage. Any damage should be repaired as soon as possible to prevent corrosion.

In doing so, do not neglect the underbody of the vehicle. A prerequisite for a thorough check is a washing of the underbody followed by a thorough inspection. Damaged areas need to be re-undercoated.

Your vehicle has been treated at the factory with a wax-base rustproofing in the body cavities which will last for the lifetime of the vehicle. Post-production treatment is neither necessary nor recommended by Mercedes-Benz because of the possibility of incompatibility between materials used in the production process and others applied later.

We have selected car-care products and compiled recommendations which are specially matched to our vehicles and which always reflect the latest technology. You can obtain Mercedes-Benz approved car-care products at your authorized Mercedes-Benz Light Truck Center.

Scratches, corrosive deposits, corrosion or damage due to negligent or incorrect care cannot always be removed or repaired with the car-care products recommended here. In such cases it is best to seek aid at your authorized Mercedes-Benz Light Truck Center.

The following topics deal with the cleaning and care of your vehicle and give important “how-to” information as well as references to Mercedes-Benz approved car-care products.

Additional information can be found in the booklet entitled “Vehicle Care Guide”.

### Power washer

When using a power washer for cleaning the vehicle, always observe manufacturer’s operating instructions.



Never use a round nozzle to power-wash tires. The intense jet of water can result in damage to the tire.

Always replace a damaged tire.

Always keep the jet of water moving across the surface. Do not aim directly at electrical parts, electrical connectors, seals, or other rubber parts.

### Tar stains

Quickly remove tar stains before they dry and become more difficult to remove. A tar remover is recommended.

### Paintwork, painted body components

Mercedes-Benz approved Paint Care should be applied when water drops on the paint surface do not “bead up”, normally every three to five months, depending on climate and washing detergent used.

Mercedes-Benz approved Paint Cleaner should be applied if the paint surface shows signs of dirt embedding (i.e. loss of gloss).

Do not apply any of these products or wax if your vehicle is parked in the sun or if the hood is still hot.

Use the appropriate MB-Touch-Up Stick for quick and provisional repairs of minor paint damage (i.e. chips from stones, vehicle doors, etc.).

## Operation

### Vehicle care

#### Engine cleaning

Prior to cleaning the engine compartment make sure to protect electrical components and connectors from the intrusion of water and cleaning agents.

Corrosion protection, such as MB Anticorrosion Wax, should be applied to the engine compartment after every engine cleaning. Before applying, all control linkage bushings and joints should be lubricated. The poly-V-belt and all pulleys should be protected from any wax.

#### Vehicle washing

Do not use hot water or wash your vehicle in direct sunlight. Use only a mild car wash detergent, such as Mercedes-Benz approved Car Shampoo.

Thoroughly spray the vehicle with a diffused jet of water. Direct only a very weak spray towards the ventilation intake. Use plenty of water and rinse the sponge and chamois frequently.

Rinse with clear water and thoroughly dry with a chamois. Do not allow cleaning agents to dry on the finish.

Due to the width of the vehicle, fold in outside mirrors prior to running the vehicle through an automatic car wash to prevent damage to the mirrors.

In the winter, thoroughly remove all traces of road salt as soon as possible.

When washing the underbody, do not forget to clean the inner sides of the wheels.

#### Ornamental moldings

For regular cleaning and care of very dirty chrome-plated parts, use a chrome cleaner.

#### Headlamps, tail lamps, side markers, turn signal lenses

Use a mild car wash detergent, such as Mercedes-Benz approved Car Shampoo, with plenty of water.

To prevent scratches, never apply strong force and use only a soft, non-scratchy cloth when cleaning the lenses. Do not attempt to wipe dirty lenses with a dry cloth or sponge.

#### Cleaning the Parktronic\* system sensors

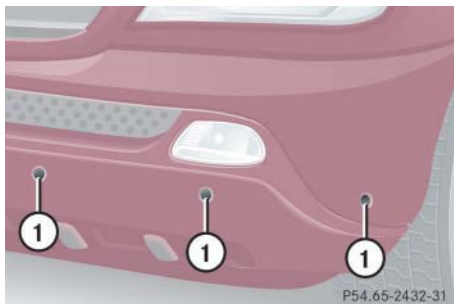

#### ① Parktronic system sensors

- ▶ Use a mild car wash detergent, such as Mercedes-Benz approved Car Shampoo, with plenty of water to clean the sensors ①.

When using a steam cleaner or power washer, aim nozzle only briefly from a minimum distance of 4 in (10 cm) at sensors ①.

To prevent scratches, never apply strong force and use only a soft, non-scratchy cloth when cleaning the sensor. Do not attempt to wipe dirty sensors with a dry cloth or sponge.

#### Wiper blades

- ▶ Fold wiper arm forward.

#### Warning!



For safety reasons, switch off wipers and remove key from steering lock before cleaning the wiper blades, otherwise the wiper motor might suddenly turn on and cause injury.

- ▶ Clean the wiper blade inserts with a clean cloth and detergent solution.



Fold the windshield wiper arms back onto the windshield before turning the key in the steering lock.

Hold on to the wiper when folding the wiper arm back. If released, the force of the impact from the tensioning spring could crack the windshield.

#### Window cleaning

- ▶ Fold wiper arms forward.

#### Warning!



For safety reasons, switch off wipers and remove key from steering lock before cleaning the wiper blades, otherwise the wiper motor might suddenly turn on and cause injury.

- ▶ Use a window cleaning solution on all glass surfaces. An automotive glass cleaner is recommended.

An automotive glass cleaner is recommended.

## Operation

### Vehicle care



Fold the windshield wiper arms back onto the windshield before turning the key in the steering lock.

Hold on to the wiper when folding the wiper arm back. If released, the force of the impact from the tensioning spring could crack the windshield.

#### Light alloy wheels

Mercedes-Benz approved Wheel Care should be used for regular cleaning of the light alloy wheels.

If possible, clean wheels once a week with Mercedes-Benz approved Wheel Care, using a soft bristle brush and a strong spray of water.

Follow instructions on container.



Only use acid-free cleaning materials. Acid may cause corrosion or damage the clear coat.

#### Instrument cluster

Use a gentle dishwashing detergent or mild detergent for delicate fabrics as a washing solution. Wipe with a cloth moistened in lukewarm solution. Do not use scouring agents.

#### Steering wheel and gear selector lever

Wipe with a damp cloth and dry thoroughly or clean with Mercedes-Benz approved Leather Care.

#### Cup holder

Use a gentle dishwashing detergent or mild detergent for delicate fabrics as a washing solution. Wipe with a cloth moistened in lukewarm solution. Do not use scouring agents.

#### Hard plastic trim items

Pour Mercedes-Benz approved Interior Care onto soft lint-free cloth and apply with light pressure.

#### Headliner and rear window shelf

Clean with soft bristle brush, or use a dry-shampoo cleaner in case of excessive dirt.

#### Seat belts

The webbing must not be treated with chemical cleaning agents. Use only clear, lukewarm water and soap. Do not dry the webbing at temperatures above 176°F (80°C) or in direct sunlight.

#### Warning!



Do not bleach or dye seat belts as this may severely weaken them. In a crash they may not be able to provide adequate protection.

**Upholstery**

Using aftermarket seat covers or wearing clothing that has the tendency to give off coloring (e.g. when wet, etc.) may cause the upholstery to become permanently discolored. By lining the seats with a proper intermediate cover, contact-discoloration will be prevented.

***Leather upholstery\****

Wipe leather upholstery with a damp cloth and dry thoroughly or clean with Mercedes-Benz approved Leather Care. Exercise particular care when cleaning perforated leather as its underside should not become wet.

***MB Tex upholstery***

Pour Mercedes-Benz approved Interior Care onto soft lint-free cloth and apply with light pressure.

**Plastic and rubber parts**

Do not use oil or wax on these parts.

**Wood trims**

Dampen cloth using water and use damp cloth to clean wood trims in your vehicle. Do not use solvents like tar remover or wheel cleaner nor polishes or waxes as these may be abrasive.





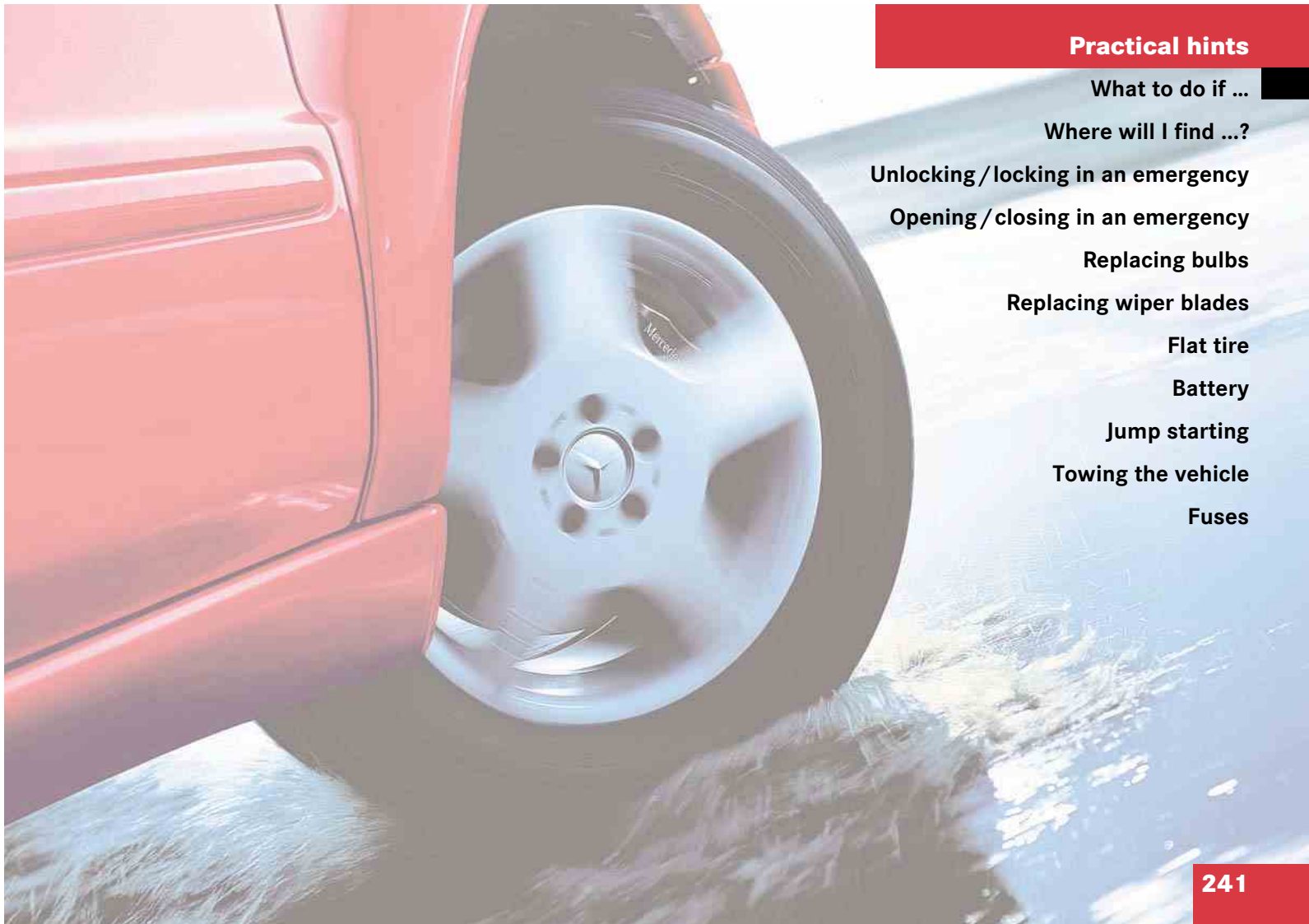

## Practical hints

What to do if ...

Where will I find ...?

Unlocking/locking in an emergency

Opening/closing in an emergency

Replacing bulbs

Replacing wiper blades

Flat tire

Battery

Jump starting

Towing the vehicle

Fuses

## Practical hints

### What to do if ...

#### ▼ What to do if ...

#### Lamps in instrument cluster

General information:



If a bulb in the instrument cluster fails to light up during the bulb self-check when

turning the key in steering lock to position **2**, have it checked and replaced if necessary.

Problem	Possible cause	Suggested solution
 The yellow ABS warning lamp comes on while driving.	<p>ABS has detected a malfunction and has switched off. The BAS, ESP, 4-ETS and EBP are also switched off.</p> <p>The brake system is still functioning normally but without ABS available.</p>	<ul style="list-style-type: none"><li>▶ Continue driving with added caution. Wheels may lock during hard braking reducing steering capability.</li><li>▶ Have the system checked at an authorized Mercedes-Benz Light Truck Center as soon as possible.</li></ul> <p>Failure to follow these instructions increases the risk of an accident.</p>
	<p>The charging voltage has fallen below 10 volts. The ABS has switched off.</p>	<p>When the voltage is above this value again, the ABS is operational again.</p> <ul style="list-style-type: none"><li>▶ If necessary, have the generator (alternator) and the battery checked.</li></ul>

## Practical hints



### What to do if ...

Problem	Possible cause	Suggested solution
 The indicator lamp comes on.	A BabySmart <sup>TM1</sup> child seat is installed on the front passenger seat. The front passenger airbag is therefore switched off. The system is malfunctioning when there is no BabySmart <sup>TM</sup> child seat installed on the front passenger seat.	<ul style="list-style-type: none"><li>▶ Have the system checked as soon as possible by an authorized Mercedes-Benz Light Truck Center.</li></ul>
 The indicator lamp does not light up with a BabySmart <sup>TM</sup> child seat properly installed on the front passenger seat.	The system is malfunctioning.	<ul style="list-style-type: none"><li>▶ Make sure there is nothing between seat cushion and child seat and check installation of the child seat (▷ page 67).</li><li>▶ If the light remains out, have the system checked as soon as possible by an authorized Mercedes-Benz Light Truck Center.</li></ul> <p>Do not use the BabySmart<sup>TM</sup> restraint to transport children on the front passenger seat until the system has been repaired.</p>

<sup>1</sup> Baby Smart<sup>TM</sup> is trademark of Siemens Automotive Corp.

## Practical hints

### What to do if ...

Problem	Possible cause	Suggested solution
 The red brake warning lamp comes on while driving.	There is insufficient brake fluid in the reservoir.	► Risk of accident! Carefully stop the vehicle and notify an authorized Mercedes-Benz Light Truck Center. Do not add brake fluid! This will not solve the problem.
 The red brake warning lamp comes on while driving and you hear a warning sound.	You are driving with the parking brake set.	► Release the parking brake (▷ page 47).

### Warning!





Driving with the brake warning lamp illuminated can result in an accident. Have your brake system checked immediately if the brake warning lamp stays on. Don't add brake fluid before checking the brake system. Overfilling the brake fluid reservoir can result in spilling brake fluid on hot engine parts and the brake fluid catching fire. You can be seriously burned.



If you find that the brake fluid in the brake fluid reservoir has fallen to the minimum mark or below, have the brake system checked for brake pad thickness and leaks.

## Practical hints

### What to do if ...

Problem	Possible cause	Suggested solution
 BRAKE  ABS The red brake warning lamp comes on in addition to the yellow ABS malfunction lamp and you hear a warning sound.	There is a malfunction in the Electronic Brake Proportioning (EBP) system. The enhanced braking effect is not available.	► Have the system checked immediately at an authorized Mercedes-Benz Light Truck Center. Failure to follow these instructions increases the risk of accidents.
 BAS ESP The yellow BAS / ESP malfunction indicator lamp comes on while driving.	The self-diagnosis has not been completed.	The BAS / ESP malfunction indicator lamp will go out after driving a short distance at more than approx. 12 mph (20 km/h).

## Practical hints

### What to do if ...



Problem	Possible cause	Suggested solution
 The yellow BAS / ESP malfunction indicator lamp comes on while driving.	The ESP is no longer synchronized following a voltage supply interruption (e.g. battery disconnected or discharged).	<p>Synchronize the ESP:</p> <ul style="list-style-type: none"><li>▶ With vehicle stationary and the engine running, turn the steering wheel completely to the left and then to the right.</li></ul> <p>If the BAS / ESP malfunction indicator lamp does not go out:</p> <ul style="list-style-type: none"><li>▶ Continue driving with added caution.</li><li>▶ Visit an authorized Mercedes-Benz Light Truck Center as soon as possible.</li></ul> <p>Failure to follow these instructions increases the risk of an accident.</p>



When synchronizing the ESP, make sure you can turn the steering wheel in both directions as far as it will go without the wheels hitting any objects, e.g. a road curb.

## Practical hints

### What to do if ...

Problem	Possible cause	Suggested solution
 The yellow BAS / ESP malfunction indicator lamp comes on while driving.	The charging voltage has fallen below 10 volts. The BAS and the ESP have switched off.	When the voltage is above this value again, the BAS and ESP are operational again. <ul style="list-style-type: none"><li>▶ If necessary, have the generator and the battery checked.</li></ul>
 The yellow BAS / ESP malfunction indicator lamp comes on while driving.	The BAS or the ESP is malfunctioning.	<ul style="list-style-type: none"><li>▶ Continue driving with added caution.</li><li>▶ Have the BAS / ESP checked at an authorized Mercedes-Benz Light Truck Center as soon as possible.</li></ul> Failure to follow these instructions increases the risk of an accident.

## Practical hints

### What to do if ...

Problem	Possible cause	Suggested solution
 The yellow “CHECK ENGINE” malfunction indicator lamp comes on while driving.	There is a malfunction of: <ul style="list-style-type: none"> <li>• The fuel management system</li> <li>• The ignition system</li> <li>• The emission control system</li> <li>• Systems which affect emissions</li> </ul> Such malfunctions may result in excessive emissions values and may switch the engine to its limp-home (emergency operation) mode.	► Have the vehicle checked as soon as possible by an authorized Mercedes-Benz Light Truck Center. An on-board diagnostic connector is used by the service station to link the vehicle to the shop diagnostics system. It allows the accurate identification of system malfunctions through the readout of diagnostic trouble codes. It is located in the front left area of the footwell next to the parking brake pedal.
	The fuel cap is not closed tightly.	Check the fuel cap (▷ page 214).
	Your fuel tank is empty.	► After refuelling start the engine three or four times in succession.  The limp-home mode is canceled. You do not need to have your vehicle checked.



## Practical hints

### What to do if ...

Problem	Possible cause	Suggested solution
 The yellow coolant warning lamp comes on when the engine is running.	<p>The coolant is too hot.</p> <p>The coolant level is too low.</p>	<ul style="list-style-type: none"> <li>▶ Stop as soon as possible and allow the engine and coolant to cool down.</li> <li>▶ Check the coolant level and add coolant if necessary (▷ page 222).</li> </ul>
	<p>If the warning lamp comes on frequently, there is a leak in the cooling system.</p>	<ul style="list-style-type: none"> <li>▶ Have the cooling system checked by an authorized Mercedes-Benz Light Truck Center.</li> </ul>
<p>The coolant temperature gauge is above 248 °F (120 °C).</p>	<p>The coolant level is too low.</p>	<ul style="list-style-type: none"> <li>▶ Stop as soon as possible and allow the engine and coolant to cool down.</li> <li>▶ Add coolant to prevent engine from overheating (▷ page 222).</li> </ul>
	<p>If the coolant level is correct, the electrical radiator fan may be broken.</p>	<ul style="list-style-type: none"> <li>▶ If the coolant temperature is below the red zone, drive on to the nearest authorized Mercedes-Benz Light Truck Center.</li> </ul> <p>Avoid high engine loads (e.g. driving uphill) and stop-and-go driving.</p>

## Practical hints

### What to do if ...

#### Warning!



Driving when your engine is badly overheated can cause some fluids which may have leaked into the engine compartment to catch fire. You could be seriously burned.

Steam from an overheated engine can cause serious burns and can occur just by opening the engine hood. Stay away from the engine if you see or hear steam coming from it.

Turn off the engine, get out of the vehicle and do not stand near the vehicle until the engine has cooled down.

#### Warning!



Do not spill antifreeze on hot engine parts. Antifreeze contains ethylene glycol which may burn if it comes into contact with hot engine parts. You can be seriously burned.





Do not ignore the coolant warning lamps. Extended driving with the symbol displayed may cause serious engine damage not covered by the Mercedes-Benz Limited Warranty.

Do not drive without sufficient amount of coolant. The engine will overheat, causing major engine damage.

## Practical hints

### What to do if ...

Problem	Possible cause	Suggested solution
 The yellow 4-ETS / ESP warning lamp comes on steady while driving.	The ESP is deactivated. Risk of accident! Adapt your speed and driving to the prevailing road and weather conditions.	▶ Switch the ESP back on (▷ page 82). If the ESP cannot be switched back on, have the system checked at an authorized Mercedes-Benz Light Truck Center as soon as possible.
 The yellow 4-ETS / ESP warning lamp flashes while driving.	The ESP or 4-ETS has come into operation because of detected traction loss in at least one tire.	▶ During take-off, apply as little throttle as possible. ▶ While driving, ease up on the accelerator. ▶ Adapt your speed and driving to the prevailing road and weather conditions. ▶ Do not deactivate the ESP. Exceptions: (▷ page 81). Failure to follow these instructions increases the risk of accidents.





## Practical hints

### What to do if ...

Problem	Possible cause	Suggested solution
<b>ETS</b> The yellow ETS malfunction indicator lamp comes on while driving.	4-ETS has switched off to prevent overheating of the brakes. Also see 4-ETS / ESP warning lamp (▷ page 251).	As soon as the brakes have cooled off, 4-ETS switches on again. The indicator lamp goes out.
	4-ETS is malfunctioning and has switched off.	▶ Have the 4-ETS checked at an authorized Mercedes-Benz Light Truck Center as soon as possible.
<b>LOW RANGE</b> The yellow LOW RANGE indicator lamp flashes after one or more switching conditions.	The gear selection conditions have not been adhered to.	▶ Repeat the gear selection process (▷ page 125).
<b>LOW RANGE</b> The yellow LOW RANGE indicator lamp flashes after switching the ignition on.	LOW RANGE mode is malfunctioning.	Have the LOW RANGE mode checked at an authorized Mercedes-Benz Light Truck Center.
The yellow fuel tank reserve warning lamp comes on while driving.	The fuel level has gone below the reserve mark.	▶ Refuel at the next gas station (▷ page 214).
The yellow fuel tank reserve warning lamp flashes when leaving the engine running.	The fuel cap is not closed tightly.	▶ Check the fuel cap (▷ page 214).



## Practical hints

### What to do if ...

Problem	Possible cause	Suggested solution
 The yellow warning lamp flashes after starting the engine or while driving.	The engine oil level has sunk to the minimum level. If the engine oil level continues to sink, the warning lamp will light up.	<ul style="list-style-type: none"> <li>▶ Add approved oil at the next gas station (▷ page 302).</li> <li>▶ If oil loss is visible on the engine, have the malfunction corrected as soon as possible at a Mercedes-Benz Light Truck Center.</li> </ul>
 The red indicator lamp does not go out after starting the engine.	The adjustable telescoping steering column is not properly locked.	▶ Lock the adjustable steering column (▷ page 39).
 The green front fog lamp indicator lamp lights up when ignition is turned on.	The front fog lamps are switched on.	▶ Fog lamps (▷ page 111).
 The red seat belt warning lamp illuminates for a brief period after starting the engine.	The warning lamp reminds you to fasten seat belts.	▶ Fasten your seat belt (▷ page 64).
 The yellow low washer system fluid level lamp comes on after starting the engine or while driving.	There is approximately 1.3 US qt. (1.25 l) of washer fluid remaining in the reservoir.	▶ Add washer fluid (▷ page 224).
	The washer fluid may have frozen.	<ul style="list-style-type: none"> <li>▶ Move the vehicle to a warmer environment so that the washer fluid will thaw.</li> <li>▶ Correct the concentration level after the washer fluid in the reservoir thaws.</li> </ul>

## Practical hints

### What to do if ...

Problem	Possible cause	Suggested solution
 The red charge indicator lamp comes on when the engine is running.	The battery is no longer charging. Possible causes: <ul style="list-style-type: none"><li>• alternator malfunctioning</li><li>• broken poly-V-belt</li></ul>	▶ Stop immediately and check the poly-V-belt. If it is broken ▶ Do not continue to drive, before the poly-V-belt is replaced. Notify an authorized Mercedes-Benz Light Truck Center.
 The yellow brake indicator lamp comes on during braking or after starting the engine.	The brake pads are worn down.	▶ Have the system checked at an authorized Mercedes-Benz Light Truck Center.



Brake pad thickness must be visually checked by a qualified technician at the intervals specified in the Service booklet.

## Practical hints

### What to do if ...

Problem	Possible cause	Suggested solution
<b>SRS</b> The red SRS indicator lamp lights up while driving.	There is a malfunction in the restraint systems. The airbags or emergency tensioning device (ETDs) could deploy unexpectedly or fail to activate in an accident.	► Drive with added caution to the nearest authorized Mercedes-Benz Light Truck Center.

### Warning!







In the event a malfunction of the SRS is indicated as outlined above, the SRS may not be operational. For your safety, we strongly recommend that you visit an authorized Mercedes-Benz Light Truck Center immediately to have the system checked, otherwise the SRS may not be activated when needed in an accident, which could result in serious or fatal injury, or it might deploy unexpectedly and unnecessarily which could result in an accident / or injury to you or to others.

## Practical hints

### What to do if ...

#### Additional indicators in the speedometer display

Display	Possible cause	Suggested solution
	Perform minor service (A) (▷ page 232).	▶ Visit an authorized Mercedes-Benz Light Truck Center to perform service.
	Perform major service (B) (▷ page 232).	▶ Visit an authorized Mercedes-Benz Light Truck Center to perform service.
  The StArt message comes on in addition to the Error message.	The immobilizer is not operational.	▶ Contact an authorized Mercedes-Benz Light Truck Center or call 1-800-FOR-MERCEdes (in the USA), or 1-800-387-0100 (in Canada).



## ▼ Where will I find ...?

### First aid kit



Check expiration dates and contents for completeness at least once a year and replace missing / expired items.

The first aid kit is stored in the liftgate.

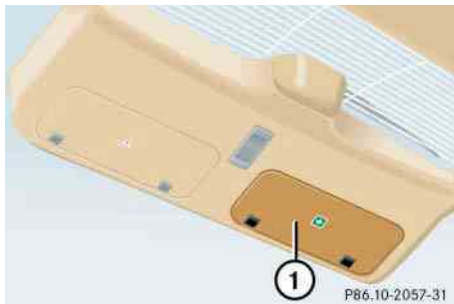

- ▶ Open and fold down panel ①.  
The first aid kit can be removed.

### Vehicle tool kit

The vehicle tool kit is stored in the cargo area behind the right trim panel.

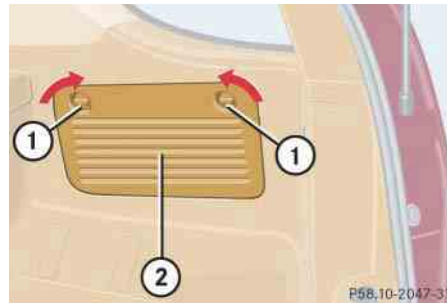

- ① Handles
- ② Panel
- ▶ Turn handles ① 90° in direction of arrows.
- ▶ Fold down the panel ②.

## Practical hints

### Where will I find ...?

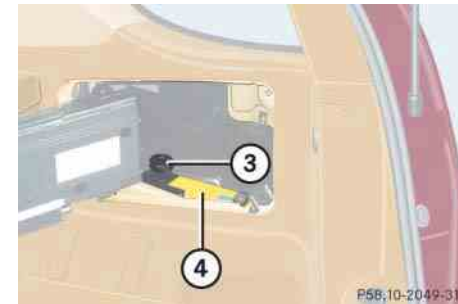

- ③ Screw
- ④ Vehicle jack with tool kit

- ▶ Turn screw ③ counterclockwise.
- ▶ Remove vehicle jack.

Vehicles with CD-changer\*  
(▷ page 258).

The jack is exclusively designed for lifting the vehicle during a wheel change. Always lower the vehicle on sufficient capacity jackstands before working under the vehicle.

## Practical hints

### Where will I find ...?

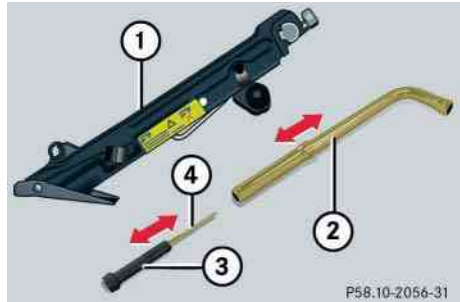

- ① Vehicle jack
- ② Wheel bolt wrench
- ③ Screwdriver
- ④ Interchangeable slot

Screwdriver ③ is placed inside the wheel-bolt wrench handle.

### Vehicle jack

Please also observe the safety guidelines in the “Flat tire” section (▷ page 274) when using the jack.

#### Warning!



The jack is designed exclusively for jacking up the vehicle at the jack take-up brackets built into both sides of the vehicle. To help avoid personal injury, use the jack only to lift the vehicle during a wheel change. Never get beneath the vehicle while it is supported by the jack. Keep hands and feet away from the area under the lifted vehicle. Always firmly set parking brake and block wheels before raising vehicle with jack.

Do not disengage parking brake while the vehicle is raised. Be certain that the jack is always vertical (plumb line) when in use, especially on hills. Always try to use the jack on level surface.

Make sure that the jack arm is fully seated in the jack take-up bracket. Always lower the vehicle onto sufficient capacity jack-stands before working under the vehicle.

### Vehicle with CD-changer\*

To access the vehicle tool kit, swing the CD-changer out of the panel.

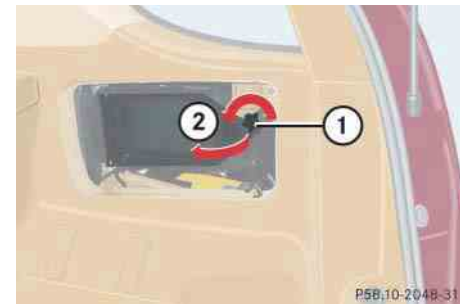

- ① Screw
- ② CD-changer

- ▶ Turn screw ① counterclockwise.
- ▶ Swing the CD-changer ② out of the panel.

### Spare wheel (space-saver tire)

Use the spare wheel only temporarily, while observing the following restrictions:

- Do not exceed vehicle speed of 50 mph (80 km/h).
- Drive to the nearest repair facility to have the flat tire repaired or replaced as appropriate.
- Do not operate vehicle with more than one spare wheel mounted.

#### Warning!



The dimensions of the spare wheel are different from those of the road wheels. As a result, the vehicle handling characteristics change when driving with a mounted spare wheel.



Please comply with the instructions for “Mounting the spare wheel” (▷ page 274).

### Removing spare wheel

#### Warning!



Exercise care when removing or installing spare wheel to prevent personal injury.

The spare wheel is located behind the rear bumper.

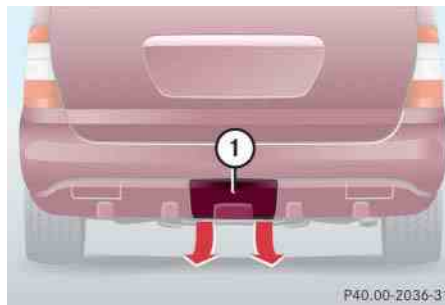

① Cover

- ▶ Hold left and right side of cover ① and pull away from bumper.

### Practical hints

#### Where will I find ...?

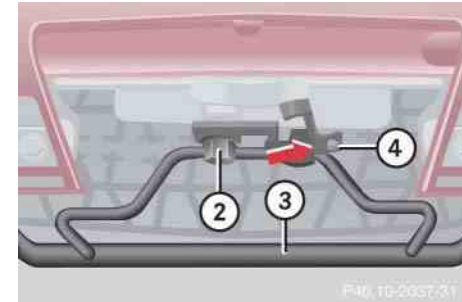

② Screw

③ Spare wheel carrier

④ Lever

- ▶ Turn screw ② counterclockwise using the wrench (▷ page 258).

Screw ② remains in spare wheel carrier ③.

- ▶ Lift spare wheel carrier slightly and push lever ④ to the right using screwdriver (▷ page 257).

- ▶ Swing spare wheel carrier ③ down and pull it out from under the bumper. ▷▷

## Practical hints

### Where will I find ...?

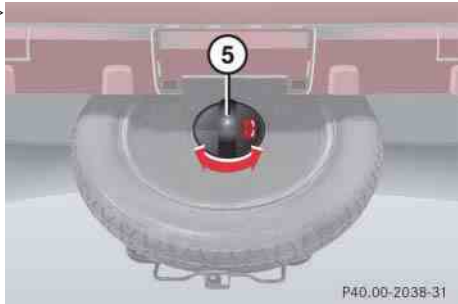

#### ⑤ Bayonet lock

- ▶ Turn the bayonet lock ⑤ 90° to the left.
- ▶ Pull off bayonet lock ⑤.
- ▶ Remove the spare wheel cover and the spare wheel.
- ▶ Store bayonet lock ⑤ and spare wheel cover in cargo area.
- ▶ Replace the spare wheel carrier and secure it in place.
- ▶ Install cover ① to the bumper.



When storing the space-saver spare wheel in its holder, secure it using the bayonet lock.

▼ **Unlocking/locking in an emergency**

**Unlocking the vehicle**

**Unlocking the driver's door**

If you are unable to unlock the driver's door using the remote control, open the door using the key.

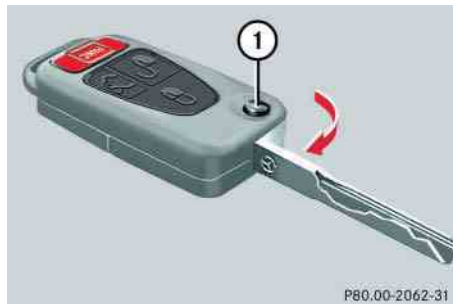

① Release button

- ▶ Press release button ① on the remote control.

The key folds out.

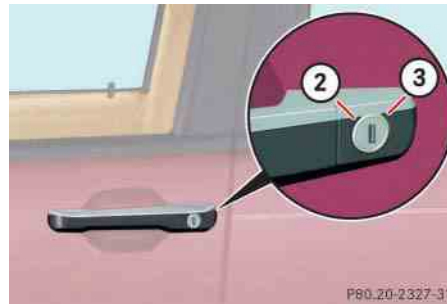

② Unlocking

③ Locking

- ▶ Remove the protective cap from the door lock.
- ▶ Unlock the door with the mechanical key. To do so, push the mechanical key in the lock until it stops and turn it to the left.

**i**

Unlocking and opening the driver's door with the mechanical key will trigger the anti-theft alarm system. To cancel the alarm, do one of the following:

- Press button or on the remote control.
- Insert the key in the steering lock.

## Practical hints

### Unlocking/locking in an emergency

#### Locking the vehicle

If you are unable to lock the vehicle with the remote control, lock it with the mechanical key as follows:

- ▶ Close the passenger doors and the liftgate.
- ▶ Press the upper part of the central locking button in the cockpit (▷ page 93).
- ▶ Check to see whether the locking knobs on the passenger doors are still visible. If necessary push them down manually.
- ▶ Lock the liftgate if necessary from inside (▷ page 91).
- ▶ Lock the driver's door with the mechanical key.

#### Changing batteries in the remote control

If the batteries in the remote control are discharged, the vehicle can no longer be locked or unlocked. It is recommended to have the batteries replaced at an authorized Mercedes-Benz Light Truck Center.

#### Warning!



Keep the batteries out of reach of children.  
If a battery is swallowed, seek medical help immediately.

Batteries contain materials that can harm the environment if disposed of improperly. Recycling of batteries is the preferred method of disposal. Many states require sellers of batteries to accept old batteries for recycling.

#### i

When changing batteries, always replace both batteries.

The required replacement batteries are available at any Mercedes-Benz Light Truck Center.

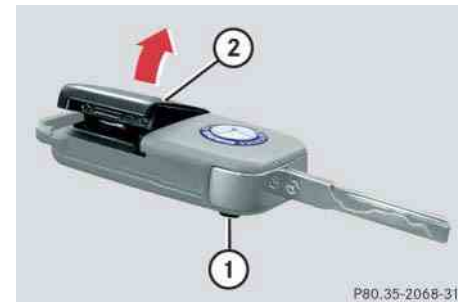

- ① Release button
- ② Battery cover

Replacement batteries: Lithium, type CR 2025 or equivalent.

- ▶ Unfold the key by pressing release button ①.

## Practical hints

### Unlocking/locking in an emergency





- ▶ Pull off battery cover ② in direction of arrow.
- ▶ Remove the batteries.



- ▶ Using a lint-free cloth, insert new batteries under the contact spring with the plus (+) side facing up.
- ▶ Press battery cover ② onto housing until locked in place.
- ▶ Push each button to assure proper operation of the remote control.

If remote control does not function correctly after replacing the batteries, the system may have to be resynchronized.

#### Synchronizing remote control

- ▶ Turn key in steering lock to position **2** (▷ page 33), then to position **0** and remove.
- ▶ Within ten seconds, push and hold button  while pushing button  five times.
- ▶ Release the button, and press ,  or  once.  
The remote control is resynchronized.
- ▶ Recheck all of the remote control functions.



If it is not possible to resynchronize the remote control, have the system checked at your authorized Mercedes-Benz Light Truck Center.

#### Fuel filler flap

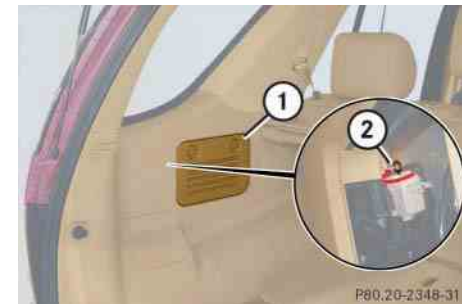

① Cover

② Lock rod

- ▶ Open the tailgate.
- ▶ Open cover ① in cargo area behind the left trim panel.
- ▶ Turn lock rod ② clockwise (arrow) to the end stop.

The fuel filler flap can now be opened.

## Practical hints

### Unlocking/locking in an emergency

#### Manually unlocking the transmission gear selector lever

In the case of power failure the transmission gear selector lever can be manually unlocked, e.g. to tow the vehicle.



① Pin

- ▶ Insert a pin ①, e.g. ball point pen, into the covered opening below the position **D** of the shift pattern.
- ▶ Perform the following two steps simultaneously:
  - ▶ Push the pin down.
  - ▶ Move gear selector lever from position **P**.
- ▶ Remove pin ①.

The cover returns to its closed position after moving the gear selector lever to position **D**.



The gear selector lever is locked again when moving it to position **P**.



▼ Opening / closing in an emergency

**Sliding / pop-up roof\***

You can open or close the sliding / pop-up roof manually should an electrical malfunction occur.

The sliding / pop-up roof drive is located behind the cover between the front interior lamps.

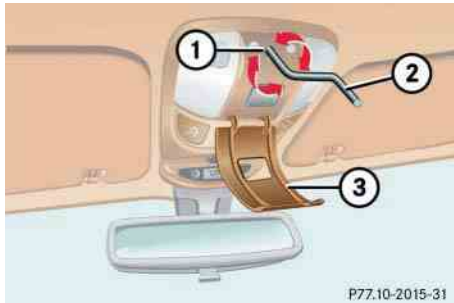

- ① Hexagon drive hole
- ② Crank
- ③ Cover

- ▶ Pry off cover ③ using a flat blade screwdriver.
- ▶ Obtain crank ②.
- ▶ Insert crank ② through hole.



Push crank ② upward while turning it, to disengage the electric motor.

- ▶ Turn crank ② clockwise to:
  - slide roof closed
  - raise roof at the rear
- ▶ Turn crank ② counterclockwise to:
  - slide roof open
  - lower roof at the rear

The sliding / pop-up roof must be synchronized if it has been operated manually (▷ page 149).

## Practical hints

### Replacing bulbs

#### ▼ Replacing bulbs

Safe vehicle operation depends on proper exterior lighting and signaling. It is therefore essential that all bulbs and lamp assemblies are in good working order at all times.

Correct headlamp adjustment is extremely important. Have headlamps checked and readjusted at regular intervals and when a bulb has been replaced. See your authorized Mercedes-Benz Light Truck Center for headlamp adjustment.



If the headlamps are fogged up on the inside as a result of high humidity, driving the vehicle a distance should clear out the fogging.

### Bulbs

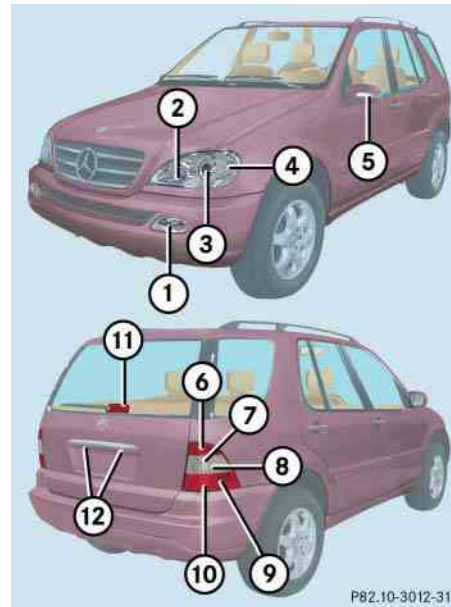

### Front lamps

Lamp	Type
① Fog lamp	H8 (35 W)
② High beam	H7 (55 W)
③ Low beam	H7 (55 W) Xenon* D2S-35 W
④ Turn signal, parking, standing and side marker lamp	1 157 NA (32 / 3 cp bulb)
⑤ Additional turn signal	LED

## Rear lamps

	Lamp	Type
⑥	Brake lamp	1073 (32 cp bulb)
⑦	Backup lamp	1073 (32 cp bulb)
⑧	Turn signal lamp	PY 21 W
⑨	Tail, parking and standing lamp Rear fog lamp, driver's side	P 21 / 4 W
⑩	Side marker lamp	W 5 W
⑪	High mounted brake lamp	1073 (32 cp bulb)
⑫	License plate lamps	C 5 W

## Notes on bulb replacement

### Warning!



Keep bulbs out of reach of children.

Bulbs and bulb sockets can be very hot. Allow the lamp to cool down before changing a bulb.

Halogen lamps contain pressurized gas. A bulb can explode if you:

- touch or move it when hot
- drop the bulb
- scratch the bulb

Wear eye and hand protection.

Because of high voltage in xenon lamps, it is dangerous to replace the bulb or repair the lamp and its components. We recommend that you have such work done by a qualified technician.

## Practical hints

### Replacing bulbs

- Use only 12-volt bulbs of the same type and with the specified watt rating.
- Switch lights off before changing a bulb to prevent short circuits.
- Always use a clean lint-free cloth when handling bulbs.
- Your hands should be dry and free of oil and grease.
- If the newly installed bulb does not light up, visit an authorized Mercedes-Benz Light Truck Center.
- Have the LEDs and bulbs for the following lamps replaced by an authorized Mercedes-Benz Light Truck Center:
  - Additional turn signals in the exterior rear view mirrors
  - Bi-Xenon lamps\*
  - Front fog lamps (vehicles with sport package)\*

## Practical hints

### Replacing bulbs

#### Replacing bulbs for front lamps

##### Replacing low beam bulbs

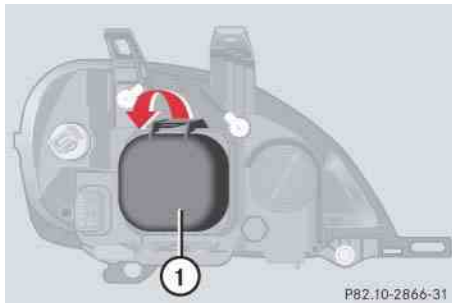

- ① Low beam halogen or Bi-Xenon\* headlamp cover with locking tab

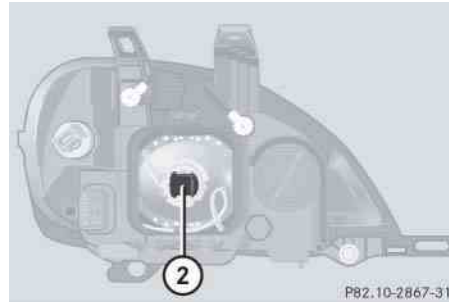

- ② Electrical connector

##### Bi-Xenon\* headlamp

#### Warning!



Do not remove the cover ① for the Bi-Xenon headlamp. Because of high voltage in xenon lamps, it is dangerous to replace the bulb or repair the lamp and its components. We recommend that you have such work done by a qualified technician.

##### Halogen headlamp

- ▶ Switch off the lights.
- ▶ Open the hood (▷ page 217).
- ▶ Push down tab at top end of cover ① and remove.
- ▶ Pull electrical connector ② off.
- ▶ Unclip the retainer springs and take out the bulb.
- ▶ Insert the new bulb so that the base locates in the recess on the holder.
- ▶ Clip the retainer springs.
- ▶ Plug the connector ② onto the bulb.
- ▶ Align headlamp cover and click into place.

## Practical hints

### Replacing bulbs

#### High beam bulbs

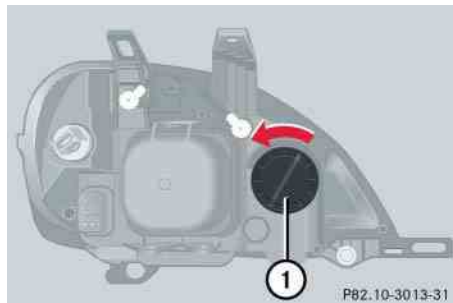

- ① High beam headlamp cover with locking tab
- ▶ Switch off the lights.
  - ▶ Open the hood (▷ page 217).
  - ▶ Twist cover ① counterclockwise and remove.

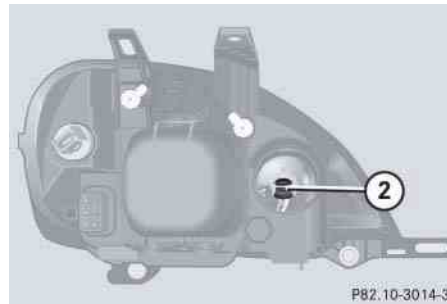

- ② Electrical connector
- ▶ Pull electrical connector ② off.
  - ▶ Unclip the retainer springs and take out the bulb.
  - ▶ Insert the new bulb so that the base locates in the recess on the holder.
  - ▶ Clip the retainer springs.
  - ▶ Plug the connector ② onto the bulb.
  - ▶ Align headlamp cover and click into place.

#### Turn signal, parking, standing and side marker lamp bulbs

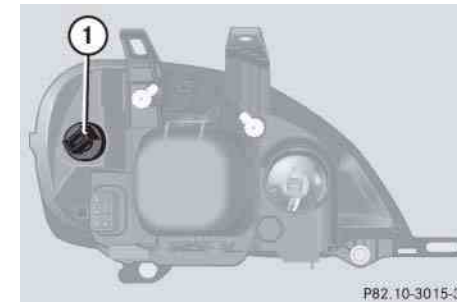

- ① Bulb socket
- ▶ Switch off the lights.
  - ▶ Open the hood (▷ page 217).
  - ▶ Twist bulb socket ① counterclockwise and pull out.
  - ▶ Push bulb into socket, turn counterclockwise and remove.
  - ▶ Insert new bulb in socket, push in and twist clockwise.
  - ▶ Reinstall the bulb socket. ▷▷

## Practical hints

### Replacing bulbs

- ▶▶ Align headlamp cover and click into place.

#### Fog lamp bulbs

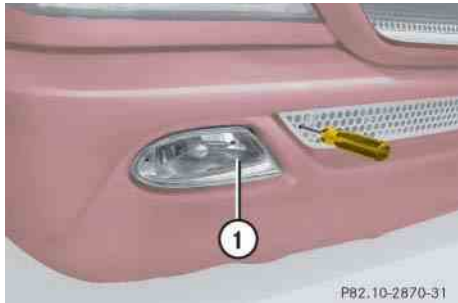

- ① Fog lamp
  - ▶ Switch off the lights.
  - ▶ Use a suitable object (e.g. screwdriver) to press on the release lever behind the front panel.Front fog lamp ① releases.
- ▶ Remove fog lamp out of bumper.

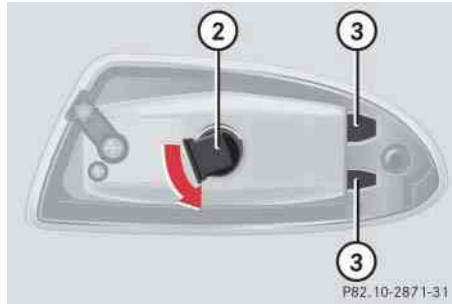

- ② Bulb socket
- ③ Tabs
  - ▶ Twist bulb socket ② counterclockwise to its end stop and pull out.
  - ▶ Pull bulb out of the bulb socket.
  - ▶ Insert new bulb in socket.
  - ▶ Reinstall bulb socket ②.
  - ▶ Twist bulb socket ② clockwise to its end stop.
  - ▶ Reinstall fog lamp into the bumper.Make sure tabs ③ firmly seat into the slots of holder.

### Replacing bulbs for rear lamps

#### Tail lamp assemblies

- ▶ Switch off the lights.
- ▶ Open liftgate.

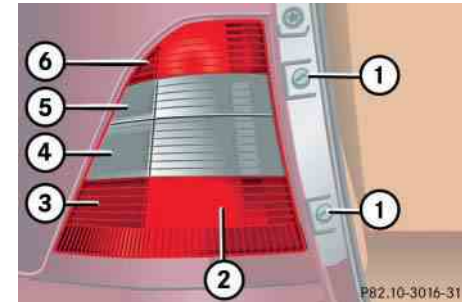

- ① Screws
- ② Tail, parking and standing lamp  
Fog lamp, driver's side
- ③ Side marker lamp
- ④ Turn signal lamp
- ⑤ Backup lamp
- ⑥ Brake lamp
  - ▶ Remove screws ①.
  - ▶ Remove tail lamp.

## Practical hints

### Replacing bulbs

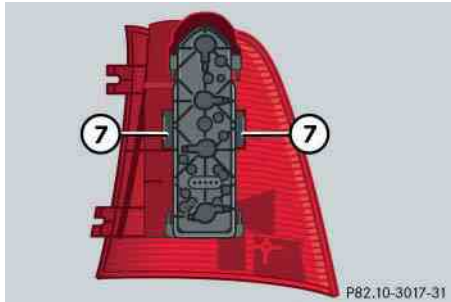

#### ⑦ Tabs

- ▶ Squeeze tabs ⑦ together and remove bulb holder.
- ▶ Gently push bulb into socket, turn counterclockwise and remove.
- ▶ Insert new bulb in socket, push in and turn clockwise.
- ▶ Reinstall bulb holder. You should hear it engage.
- ▶ Insert the tail lamp in the body, lower edge first. Make sure it engages.
- ▶ Retighten screws with washers on them.

#### License plate lamp

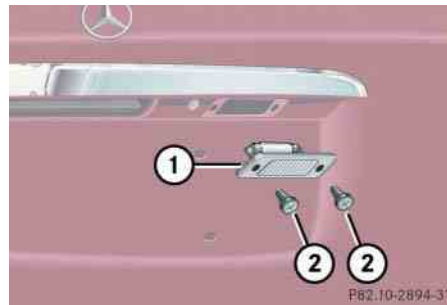

#### ① License plate lamp

#### ② Screws

- ▶ Switch off the lights.
- ▶ Loosen both screws ② and remove lamp.
- ▶ Replace the tubular lamp and reinstall lamp.
- ▶ Retighten the screws.

#### High mounted brake lamp

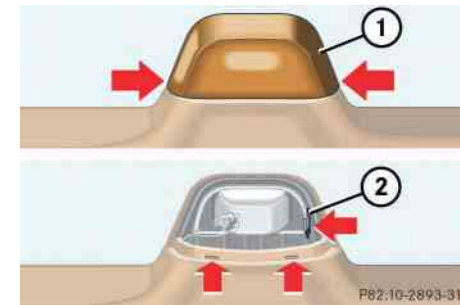

#### ① Cover

#### ② Tab

- ▶ Switch off the lights.
- ▶ Squeeze both sides of cover ①, fold it forward and remove.
- ▶ Press tab ② on reflector and remove reflector.
- ▶ Gently push bulb into socket, turn counterclockwise and remove.
- ▶ Insert new bulb in socket, push in and turn clockwise.



## Practical hints

### Replacing bulbs

- ▶▶ Insert reflector from the left so that it engages on the right.
- ▶ Position tabs of cover in slots and reinstall cover until properly seated.

### Adjusting headlamp aim

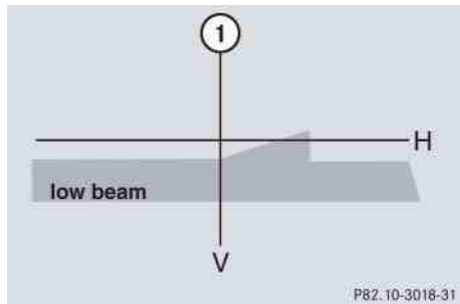

**V** Vertical centerline

**H** Headlamp mounting high, measured from the center



High beam adjustments simultaneously aim the low beam.

Vehicle should have a normal trunk load.

Correct headlamp adjustment is extremely important. To check and readjust a headlamp, follow the steps described:

- ▶ Park the vehicle on a level surface 25 feet (7.6 m) from a vertical test screen or wall.
- ▶ Switch the headlamps on (▶ page 110).

If the beam does not show a beam pattern as indicated in the figure left, then follow the steps below:

- ▶ Open hood (▶ page 217).

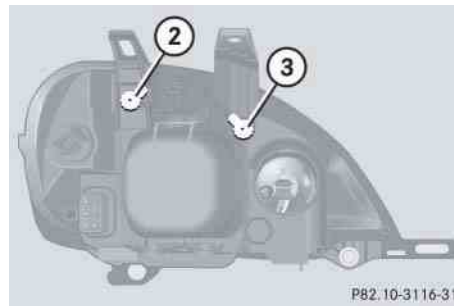

② Headlamp vertical adjustment screw

③ Headlamp vertical adjustment screw

- ▶ Always turn adjustment screws ② and ③ simultaneously for vertical adjustment until the headlamp is adjusted as shown ①. Turn clockwise for upward movement and counterclockwise for downward movement.

Graduations:

screw ②: 0.50° pitch

screw ③: 0.67° pitch

The left and right headlamps must be adjusted individually.



If it is not possible to obtain a proper headlamp adjustment, have the system checked at your authorized Mercedes-Benz Light Truck Center.



## ▼ Replacing wiper blades

### Warning!



For safety reasons, remove key from steering lock before replacing a wiper blade. Otherwise the motor could suddenly turn on and cause injury.

### Removing

- ▶ Fold the wiper arm forward.
- ▶ Turn wiper blade at a right angle to wiper arm.

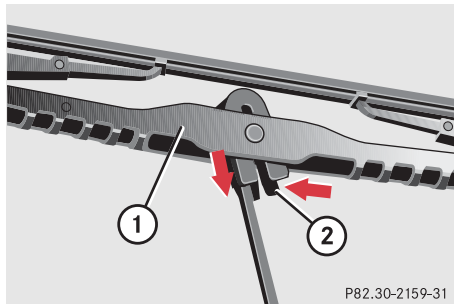

- ① Wiper blade
- ② Safety tab

- ▶ Press safety tab down ②.
- ▶ Push wiper blade downward ① and remove.

### Installing

- ▶ Slide the wiper blade into end of wiper arm until it locks in place.
- ▶ Fold the wiper arm back to rest on the windshield. Make sure you hold onto the wiper when folding the wiper arm back.

## Practical hints

### Replacing wiper blades



Never open the hood when the wiper arms are folded forward.

Hold on to the wiper when folding the wiper arm back. If released, the force of the impact from the tensioning spring could crack the windshield.

Do not allow the wiper arms to contact the windshield glass without a wiper blade inserted.

Make certain that the wiper blades are properly installed. Improperly installed wiper blades may cause windshield damage.

For your convenience, we recommend that you have this work carried out by an authorized Mercedes-Benz Center.

## Practical hints

### Flat tire

#### ▼ Flat tire

##### Mounting the spare wheel

###### Warning!



The dimensions of the spare wheel are different from those of the road wheels. As a result, the vehicle handling characteristics change when driving with a mounted spare wheel. Adapt your driving style accordingly.

The spare wheel is for temporary use only. When driving with spare wheel mounted, ensure proper tire pressure and do not exceed vehicle speed of 50 mph (80 km/h).

Drive to the nearest Mercedes-Benz Light Truck Center as soon as possible to have the spare wheel replaced with a regular road wheel.

Never operate the vehicle with more than one spare wheel mounted.

##### Preparing the vehicle

- ▶ Park the vehicle as far as possible from moving traffic on a hard surface.
- ▶ Turn on the hazard warning flashers.
- ▶ Engage the steering wheel lock in the straight ahead position and set the parking brake.
- ▶ Move the gear selector lever to **P**.
- ▶ Have any passenger exit the vehicle at a safe distance from the roadway.
- ▶ Take the spare wheel out of its carrier (▷ page 259).

##### Lifting the vehicle

- ▶ Prevent the vehicle from rolling away by blocking wheels with wheel chocks (not included) or other sizable objects.

When changing wheel on a level surface:

- ▶ Place one chock in front of and one behind the wheel that is diagonally opposite to the wheel being changed.

When changing wheel on a hill:

- ▶ Place chocks on the downhill side blocking both wheels of the other axle.
- ▶ Take the two-piece wheel wrench and the jack out of the rear compartment area (▷ page 257). Assemble wheel wrench.

### Warning!



The jack is designed exclusively for jacking up the vehicle at the jack take-up brackets built into both sides of the vehicle. To help avoid personal injury, use the jack only to lift the vehicle during a wheel change. Never get beneath the vehicle while it is supported by the jack. Keep hands and feet away from the area under the lifted vehicle. Always firmly set parking brake and block wheels before raising vehicle with jack.

Do not disengage parking brake while the vehicle is raised. Be certain that the jack is always vertical (plumb line) when in use, especially on hills. Always try to use the jack on level surface. Make sure that the jack arm is fully seated in the jack take-up bracket. Always lower the vehicle onto sufficient capacity jackstands before working under the vehicle.



- ▶ On wheel to be changed, loosen but do not yet remove the wheel bolts (approximately one full turn with wrench).

The jack take-up brackets are located directly behind the front wheel housings and in front of the rear wheel housings.



Do not position the jack on the body of the vehicle, as this may cause damage to the vehicle.

## Practical hints

### Flat tire

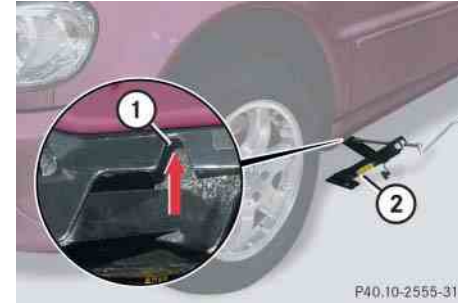

- ① Take-up bracket
- ② Jack

- ▶ Place jack ② on firm ground.
- ▶ Position jack ② under the take-up bracket ① so that it is always vertical (plumb-line) as seen from the side, even if the vehicle is parked on an incline.
- ▶ Jack up the vehicle until the wheel is a maximum of 1.2 in (3 cm) from the ground. Never start engine while vehicle is raised.

## Practical hints

### Flat tire

#### Removing the wheel

- ▶ Unscrew and remove all wheel bolts.
- ▶ Remove the remaining bolts.



Do not place wheel bolts in sand or dirt. This could result in damage to the bolt and wheel hub threads.

- ▶ Grip the wheel from the sides and remove it.

#### Mounting the new wheel

- ▶ Clean contact surfaces of wheel and wheel hub.
- ▶ Install spare wheel on wheel hub.
- ▶ Insert wheel bolts and tighten them slightly.



To avoid paint damage, place wheel flat against hub and hold it there while installing first wheel bolt.

#### Warning!



Always replace wheel bolts that are damaged or rusted.

Never apply oil or grease to wheel bolts.

Damaged wheel hub threads should be repaired immediately. Do not continue to drive under these circumstances! Contact an authorized Mercedes-Benz Light Truck Center or call Roadside Assistance.

Incorrect wheel bolts or improperly tightened wheel bolts can cause the wheel to come off. This could cause an accident. Make sure to use the correct wheel bolts.

#### Warning!



Use only genuine equipment Mercedes-Benz wheel bolts. Other wheel bolts may come loose.

Do not tighten the wheel bolts when the vehicle is raised. Otherwise the vehicle could tip over.

#### Lowering the vehicle

- ▶ Lower vehicle by turning crank counterclockwise until vehicle is resting fully on its own weight.
- ▶ Remove the jack.

## Practical hints

### Flat tire

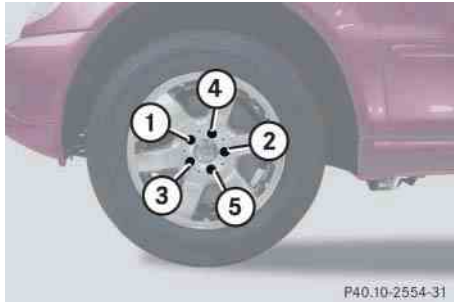

#### ①-⑤ Wheel bolts

- ▶ Tighten the five wheel bolts evenly, following the diagonal sequence illustrated (1 to 5), until all bolts are tight. Observe a tightening torque of 110 lb-ft (150 Nm).

#### Warning!



Have the tightening torque checked after changing a wheel. The wheels could come loose if they are not tightened to a torque of 110 lb-ft (150 Nm).

- ▶ Store jack and tool kit.



The removed road wheel cannot be stored in the spare wheel carrier, but should be transported in the rear cargo compartment wrapped in a protective cover supplied with the vehicle.

The protective cover is located in the rear cargo compartment behind the cover in the right side trim panel.

## Practical hints

### Battery

#### ▼ Battery

The battery is located on the passenger side of the engine compartment.

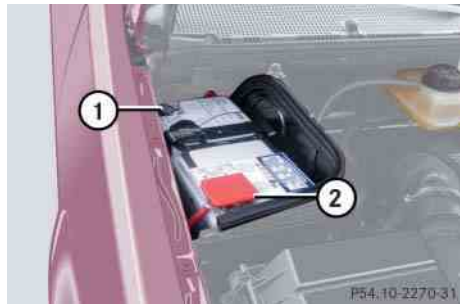

- ① Negative terminal
- ② Positive terminal

#### Warning!



Failure to follow these instructions can result in severe injury or death.

Observe all safety instructions and precautions when handling automotive batteries (▷ page 223).

Never lean over batteries while connecting, you might get injured.

Battery fluid contains sulfuric acid. Do not allow this fluid to come in contact with eyes, skin or clothing. In case it does, immediately flush affected area with water and seek medical help if necessary.

A battery will also produce hydrogen gas, which is flammable and explosive. Keep flames or sparks away from battery, avoid improper connection of jumper cables, smoking etc.



Never loosen or detach battery terminal clamps while the engine is running or the key is in the steering lock. Otherwise the alternator and other electronic components could be severely damaged.

Have the battery checked regularly by an authorized Mercedes-Benz Light Truck Center.

Refer to Service Booklet for maintenance intervals or contact your authorized Mercedes-Benz Light Truck Center for further information.

#### Warning!



Do not place metal objects on the battery as this could result in a short circuit.

Use leak-proof battery only to avoid the risk of acid burns in the event of an accident.

#### Disconnecting the battery

##### Warning!



With a disconnected battery

- you will no longer be able to turn the key in the steering lock
- the gear selector lever will remain locked in position **P**

- ▶ Depress parking brake firmly or move gear selector lever to position **P**.
- ▶ Turn off all electrical consumers.
- ▶ Remove key from the steering lock.
- ▶ Open the hood (▷ page 217).
- ▶ Disconnect the battery negative lead.
- ▶ Remove the cover from the positive terminal.
- ▶ Disconnect the battery positive lead.

#### Removing the batteries

- ▶ Remove the screw securing the battery.
- ▶ Remove the battery support and bracket. Take out the battery.

#### Charging and reinstalling batteries

##### Warning!



Never charge a battery while still installed in the vehicle. Gases may escape during charging and cause explosions that may result in paint damage, corrosion or personal injury.

- ▶ Charge battery in accordance with the instructions of the battery charger manufacturer.
- ▶ Reinstall the charged battery. Follow the previously described steps in reverse order.

#### Reconnecting the batteries

- ▶ Turn off all electrical consumers.
- ▶ Connect the positive lead and fasten its cover.
- ▶ Connect the negative lead.



Never invert the terminal connections!



The battery, its filler caps and the vent tube must always be securely installed when the vehicle is in operation.

## Practical hints

### Battery



The following procedures must be carried out following any interruption of battery power (e.g. due to reconnection):

- Set the clock (▷ page 118).
- Set the date in trip computer (▷ page 186).
- Calibrate the compass (▷ page 188).
- Resynchronize the ESP (▷ page 246).
- Resynchronize side power windows (▷ page 146).
- Resynchronize sliding / pop-up roof\* (▷ page 149).

Batteries contain materials that can harm the environment if disposed of improperly. Large 12-volt storage batteries contain lead. Recycling of batteries is the preferred method of disposal. Many states require sellers of batteries to accept old batteries for recycling.



## ▼ Jump starting

### Warning!



Failure to follow these directions will cause damage to the electronic components, and can lead to a battery explosion and severe injury or death.

Never lean over batteries while connecting or jump starting, you might get injured.

Battery fluid contains sulfuric acid. Do not allow this fluid to come in contact with eyes, skin or clothing. In case it does, immediately flush affected area with water, and seek medical help if necessary.

A battery will also produce hydrogen gas, which is flammable and very explosive. Keep flames or sparks away from battery, avoid improper connection of jumper cables, smoking, etc.

Attempting to jump start a frozen battery can result in it exploding, causing personal injury.

Read all instructions before proceeding.

If the battery is discharged, the engine can be started with jumper cables and the battery of another vehicle. Observe the following:

- Jump starting should only be performed when the engine and catalytic converter are cold.
- Do not start the engine if the battery is frozen. Let the battery thaw out first.
- Only jump start from batteries with the same voltage rating (12 V). Jump starting with a more powerful battery could damage the vehicle's electrical system, which will not be covered by the Mercedes-Benz Limited Warranty.
- Use only jumper cables with sufficient cross-section and insulated terminal clamps.
- Always make sure the jumper cables are not on or near pulleys, fans or other parts that move when the engine is started or running.

## Practical hints

### Jump starting



Avoid repeated and lengthy starting attempts.

Do not attempt to start the engine using a battery quick charge unit.

If engine does not run after several unsuccessful starting attempts, have it checked at the nearest authorized Mercedes-Benz Light Truck Center.

Excessive unburned fuel generated by repeated failed starting attempts may damage the catalytic converter and may present a fire risk.

Make sure the jumper cables do not have loose or missing insulation.

Make sure the cable clamps do not touch any other metal part while the other end is still attached to a battery.

## Practical hints

### Jump starting

#### Warning!



Keep flames or sparks away from battery.  
Do not smoke.

Observe all safety instructions and precautions when handling automotive batteries (> page 223).

The battery is located on the right side of the engine compartment.

- ▶ Make sure the two vehicles do not touch.
- ▶ Turn off all electrical consumers.
- ▶ Apply parking brake.
- ▶ Shift gear selector lever to position **P**.
- ▶ Open the hood.
- ▶ Connect positive terminals ① and ④ of the batteries with the jumper cable. Clamp cable to positive terminal ④ of charged battery first.



Never invert the terminal connections.

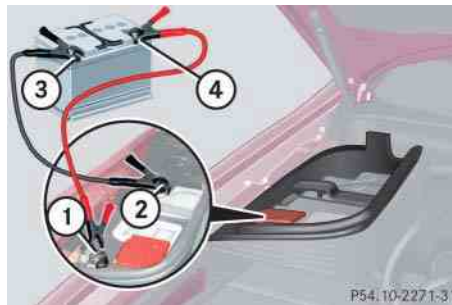

- ① Positive terminal of discharged battery
- ② Negative terminal of discharged battery
- ③ Negative terminal of charged battery
- ④ Positive terminal of charged battery

- ▶ Start engine of the vehicle with the charged battery and run at idle speed.
- ▶ Connect negative terminals ② and ③ of the batteries with the jumper cable. Clamp cable to negative terminal ③ of charged battery first.

- ▶ Start the engine of the disabled vehicle.

Now you can turn on the electrical consumers. Do not turn on the lights under any circumstances.

- ▶ Remove the jumper cables first from the negative terminals ② and ③ and then from positive terminals ① and ④.

You can now turn on the lights.

- ▶ Have the battery checked at the nearest authorized Mercedes-Benz Light Truck Center.



Do not tow-start the vehicle.

## ▼ Towing the vehicle

Mercedes-Benz recommends that the vehicle be transported with all wheels off the ground using flatbed or appropriate wheel lift / dolly equipment. This method is preferable to other types of towing.



Use flatbed or wheel lift / dolly equipment, with key in steering lock turned to position **0**.

Do not tow with sling-type equipment. Towing with sling-type equipment over bumpy roads will damage radiator and supports.

To prevent damage during transport, do not tie down vehicle by its chassis or suspension parts. Use the towing eyes.

Switch off the ESP (▷ page 81), tow-away alarm (▷ page 85) and the automatic central locking (▷ page 93).

When circumstances do not permit the recommended towing methods, the vehicle may be towed with all wheels on the ground only so far as necessary to have the vehicle moved to a safe location where the recommended towing methods can be employed.



When towing the vehicle with all wheels on the ground, the gear selector lever must be in position **N** and the key must be in steering lock position **2**.

When towing the vehicle with all wheels on the ground, the vehicle may be towed only for distances up to 30 miles (50 km) and at a speed not to exceed 30 mph (50 km / h).

If the vehicle is towed with the front axle raised (observe instructions regarding flexible drive shaft), the engine must be shut off (key in steering lock position **1**). Otherwise, the 4-ETS may become engaged which may cause loss of towing control.

## Practical hints

### Towing the vehicle



To be certain to avoid additional damage to the vehicle powertrain, however you should observe the following:

- With damage to the front axle
  - raise front axle
  - remove flexible drive shaft between rear axle and transfer case
- With damage to the rear axle
  - raise rear axle
  - tow vehicle with wheel lift or dolly placed under front wheels
- With damage to the transfer case
  - remove flexible drive shaft to the drive axles

Always install new self-locking nuts when reinstalling flexible drive shaft.

## Practical hints

### Towing the vehicle

#### Warning!



If circumstances require towing the vehicle with all wheels on the ground, always tow with a tow bar if:

- the engine will not run
- there is a malfunction in the power supply or in the vehicle's electrical system

Prior to towing the vehicle with all wheels on the ground, make certain that the key is in steering lock position **2**.

If the key is left in steering lock position **0** for an extended period of time, it can no longer be turned in the switch. In this case, the steering is locked. To unlock, remove key from steering lock and reinsert.

#### Warning!



With the engine not running, there is no power assistance for the brake and steering systems. In this case, it is important to keep in mind that a considerably higher degree of effort is necessary to brake and steer the vehicle. Adapt your driving accordingly.



To signal turns while being towed with hazard warning flasher in use, turn key in steering lock to position **2** and activate combination switch for left or right turn signal in usual manner – only the selected turn signal will operate.

Upon canceling the turn signal, the hazard warning flasher will operate again.



The vehicle cannot be started via tow-start.



When towing the vehicle with all wheels on the ground, note the following:

With the automatic central locking activated and the key in steering lock position **2**, the vehicle doors lock if the left front wheel is turning at vehicle speeds of approx. 9 mph (15 km/h) or more.

To prevent the vehicle doors from locking, deactivate the automatic central locking (▷ page 93).

Towing of the vehicle should only be done using the towing eye. Never attach tow cable, tow rope or tow rod to vehicle chassis, frame or suspension parts.



The gear selector lever will remain locked in position **P** and the key will not turn in the steering lock if the battery is disconnected or discharged. See notes on the battery (▷ page 278) or on jump starting (▷ page 281).

Manual unlocking transmission gear selector lever (▷ page 264).

### Front towing eye

The front towing eye is located on the passenger side below the bumper.

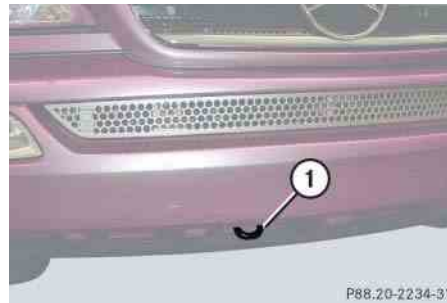

① Towing eye

### Rear towing eye

#### Warning!



In order to avoid possible serious burns or injury, use extreme caution when removing the cover, because the rear exhaust pipe is extremely hot.

## Practical hints

### Towing the vehicle

The rear towing eye is located behind the right side cover in the bumper panel.

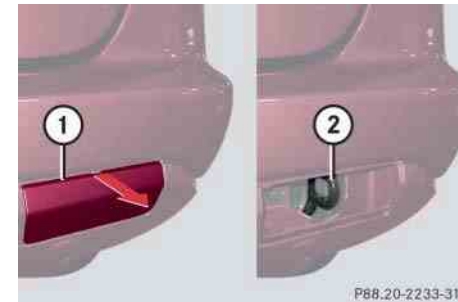

#### ML 350, ML 500

- ① Cover
- ② Towing eye

To remove cover:

- ▶ Pry out the cover ① using a flat blade screwdriver (▷ page 257).

To reinstall cover:

- ▶ Engage cover at bottom and press in top securely.

## Practical hints

### Towing the vehicle



#### Vehicles with sport package\*

- ① Cover
- ② Towing eye

To remove cover:

- ▶ Grip cover ① at bottom and securely pull out.

To reinstall cover:

- ▶ Engage cover and press in securely.

### Stranded vehicle

Freeing a stranded vehicle, on which the wheels are dug into sand or mud, should be done with the greatest of care, especially if the vehicle is heavily loaded.

Avoid pulling the vehicle jerkily or diagonally, since it could result in damage to the chassis alignment.

Never try to free a vehicle that is still coupled to a trailer.

If possible, a vehicle equipped with trailer hitch receiver should be pulled backward in its own previously made tracks.

## ▼ Fuses



Only install fuses that have been tested and approved by Mercedes-Benz and that have the specified amperage rating.

Never attempt to repair or bridge a blown fuse. Have the cause determined and remedied by an authorized Mercedes-Benz Light Truck Center.

The fuse chart is printed on the corresponding fuse box cover. The amperages of the fuses are also indicated there.

### Fuse box in engine compartment

The fuse box is located in the engine compartment on the left-hand side.

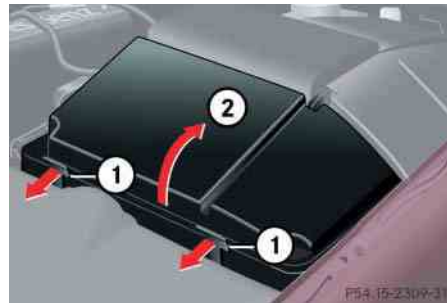

- ① Clamps
- ② Fuse box cover

### Removing / installing cover

- ▶ Release clamps ①.
- ▶ Lift fuse box cover ② up.
- ▶ Install cover ① in reverse order.

## Practical hints

### Fuses



- ③ Fuse chart
- ④ Fuse extractor
- ⑤ Spare fuses

## Practical hints

### Fuses

#### Auxiliary fuse box in front passenger footwell

The auxiliary fuse box is located in the front passenger compartment.

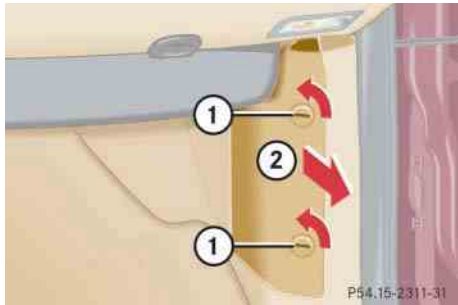

- ① Lock
- ② Cover

#### Removing / installing cover

- ▶ Turn both locks ① 90° counterclockwise.
- ▶ Remove cover ② in direction of arrow.
- ▶ Install cover ② in reverse order.



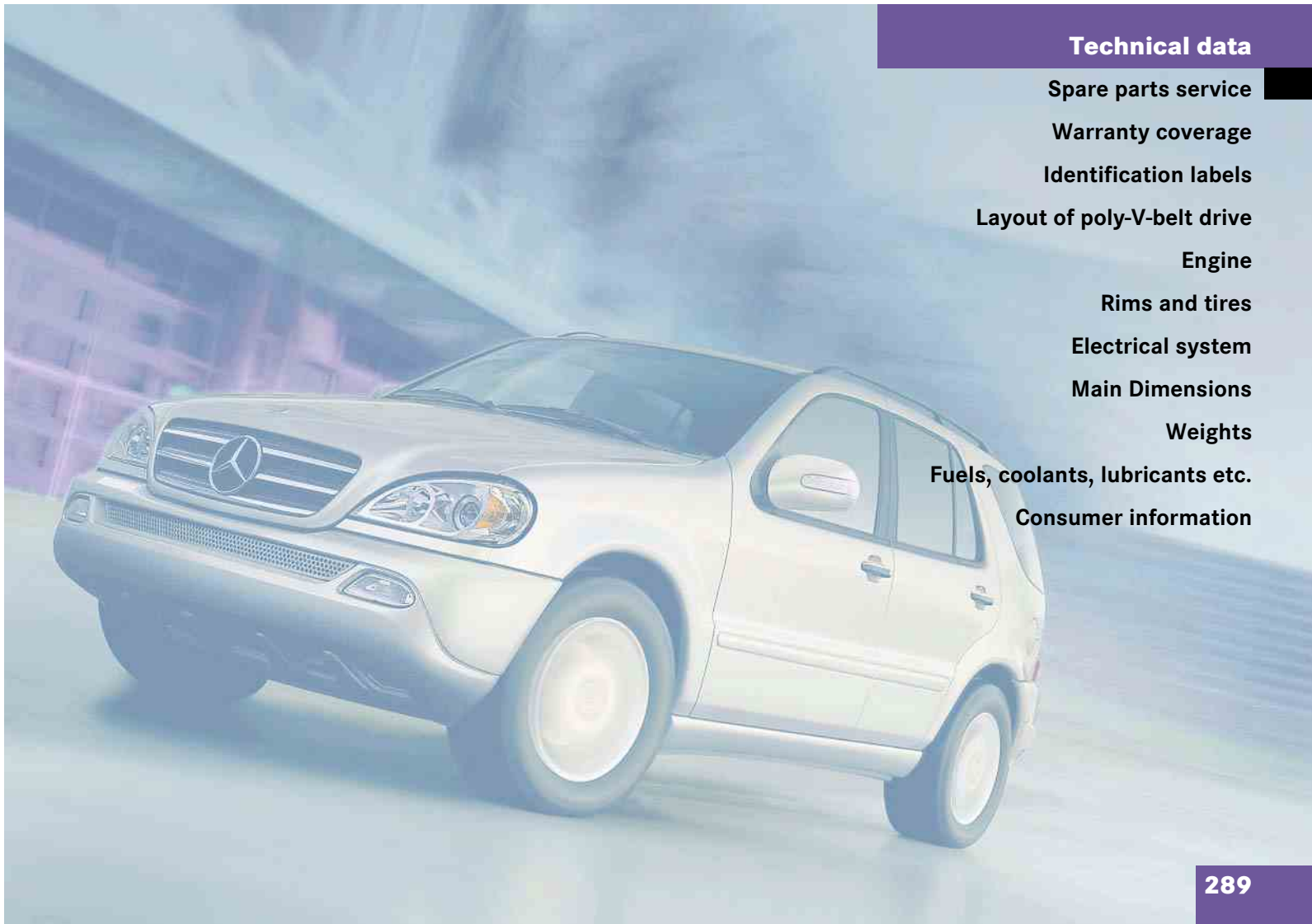

## **Technical data**

**Spare parts service**

**Warranty coverage**

**Identification labels**

**Layout of poly-V-belt drive**

**Engine**

**Rims and tires**

**Electrical system**

**Main Dimensions**

**Weights**

**Fuels, coolants, lubricants etc.**

**Consumer information**

## Technical data

### Spare parts service

The “Technical data” section provides the necessary technical data for your vehicle.

#### ▼ Spare parts service

All authorized Mercedes-Benz Centers maintain a stock of genuine Mercedes-Benz Parts parts required for maintenance and repair work. In addition, strategically located parts distribution centers provide quick and reliable parts service.

More than 300 000 different spare parts for Mercedes-Benz models are available.

Genuine Mercedes-Benz spare parts are subjected to stringent quality inspections. Each part has been specifically developed, manufactured or selected for and adapted to Mercedes-Benz vehicles.

Therefore, genuine Mercedes-Benz spare parts should be installed.



The use of non-genuine Mercedes-Benz parts and accessories not authorized by Mercedes-Benz could damage the vehicle, which is not covered by the Mercedes-Benz Limited Warranty, or could compromise the vehicle’s durability or safety.

▼ **Warranty coverage**

Your vehicle is covered under the terms of the “warranties” printed in the Service and Warranty Information booklet. Your authorized Mercedes-Benz Light Truck Center will exchange or repair any defective parts originally installed on the vehicle in accordance with the terms of the following warranties:

- New Vehicle Limited Warranty
- Emission System Warranty
- Emission Performance Warranty
- California, Maine, Massachusetts, and Vermont Emission Control Systems Warranty

Replacement parts and accessories are covered by the Mercedes-Benz Spare Parts and Accessories warranties, copies of which are available at any Mercedes-Benz Center.

**Loss of Service and Warranty Information Booklet**

---

Should you lose your Service and Warranty Information booklet, have your authorized Mercedes-Benz Center arrange for a replacement. It will be mailed to you.

## Technical data

### Identification labels

#### ▼ Identification labels



- ① Certification label and Paintwork number



- ② Engine number (engraved on engine)  
③ VIN, visible (lower edge of windshield)  
④ Emission control label  
Vacuum line routing for emission control system  
⑤ Information label, California version



When ordering spare parts, please specify vehicle identification and engine numbers.

▼ Layout of poly-V-belt drive

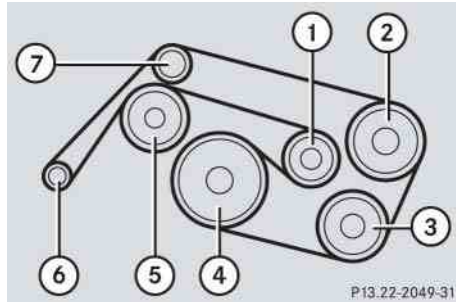

- ① Automatic belt tensioner
- ② Power steering pump
- ③ Air conditioning compressor
- ④ Crankshaft
- ⑤ Coolant pump
- ⑥ Generator (alternator)
- ⑦ Idler pulley

## Technical data

### Engine

#### ▼ Engine

Model	ML 350 (163.157 <sup>1</sup> )	ML 500 (163.175) <sup>1</sup>
Engine	112	113
Mode of operation	4-stroke engine, gasoline injection	4-stroke engine, gasoline injection
No. of cylinders	6	8
Bore	3.81 in (97.00 mm)	3.81 in (97.00 mm)
Stroke	3.31 in (84.00 mm)	3.31 in (84.00 mm)
Total piston displacement	227 cu in (3724 cm <sup>3</sup> )	303 cu in (4966 cm <sup>3</sup> )
Compression ratio	10:1	10:1
Output acc. to SAE J 1349	232 hp / 5750 rpm (173 kW / 5750 rpm)	288 hp / 5600 rpm (215 kW / 5600 rpm)
Maximum torque acc. to SAE J 1349	254 lb-ft / 3000-4500 rpm (345 Nm / 3000-4500 rpm)	325 lb-ft / 2700 rpm (440 Nm / 2700 rpm)
Maximum engine speed	6000 rpm	6000 rpm
Firing order	1-4-3-6-2-5	1-5-4-2-6-3-7-8
Poly-V-belt	2370 mm	2370 mm

<sup>1</sup> The quoted data apply only to the standard vehicle. See an authorized Mercedes-Benz Light Truck Center for the corresponding data of all special bodies and special equipment.

## Technical data

### Rims and tires

#### ▼ Rims and tires

Use only tires and rims which have been specifically developed for your vehicle and tested and approved by Mercedes-Benz. Other tires and rims can have detrimental effects, such as

- poor handling characteristics
- increased noise
- increased fuel consumption



Moreover, tires and rims not approved by Mercedes-Benz may, under load, exhibit dimensional variations and different tire deformation characteristics that could cause them to come into contact with the vehicle body or axle parts. This may result in damage to the tires or the vehicle.



Further information on tires and rims is available at any authorized Mercedes-Benz Light Truck Center. A tire inflation pressure table is located on the fuel filler cap of the vehicle. The tire pressure should be checked regularly and should only be adjusted on cold tires. Follow tire manufacturer's maintenance recommendation included with vehicle.

#### Rims and tires

Model	ML 350	ML 500
Rims (light alloy)	8 J x 17 H2	8 1/2 J x 17 H2
Wheel offset	2.0 in (52 mm)	2.0 in (52 mm)
All-season tires (radial-ply tires)	255 / 60 R17 106 H	275 / 55 R17 109 V
Rims* (light alloy)	8 1/2 J x 17 H2	8 1/2 J x 17 H2
Wheel offset*	1.85 in (47 mm)	1.85 in (47 mm)
All-season tires (radial-ply tires)*	275 / 55 R17 109 V	275 / 55 R17 109 V

## Technical data

### Rims and tires

#### Spare wheel

---

<b>Model</b>	<b>ML 350, ML 500</b>
<b>Rim</b>	4 Jx18 H2 ET0
<b>Wheel offset</b>	0 in (0 mm)
<b>Space-saver tire</b>	T155/90 D18 113M <sup>1</sup>

<sup>1</sup> Must not be used with snow chains.



▼ **Electrical system**

Model	ML 350	ML 500
Generator (alternator)	14 V / 120 A	14 V / 150 A
Starter motor	12 V / 1.7 kW	12 V / 1.7 kW
Battery	12 V / 100 Ah	12 V / 100 Ah
Spark plugs	Bosch F 8 DPP332 Bosch F 8 DPER	Bosch F 8 DPP332 Bosch F 8 DPER
Electrode gap	0.039 in (1.0 mm)	0.039 in (1.0 mm)
Tightening torque	15 – 22 lb-ft (20 – 30 Nm)	15 – 22 lb-ft (20 – 30 Nm)

## Technical data

### Main Dimensions

#### ▼ Main Dimensions

<b>Model</b>	<b>ML 350, ML 500</b>
<b>Overall vehicle length</b>	182.6 in (4638 mm)
<b>Overall vehicle width</b>	83.7 in (2126 mm)
<b>Overall vehicle height</b>	71.7 in (1820 mm)
<b>Wheelbase</b>	111.0 in (2820 mm)
<b>Track, front</b>	61.2 in (1555 mm)
<b>Track, rear</b>	61.2 in (1555 mm)
<b>Ground clearance</b>	8.03 in (204 mm)
<b>Turning radius</b>	468.5 in (11.9 m)

## Technical data

### Weights

#### ▼ Weights

Roof load max.	220 lbs (100 kg)
----------------	------------------

## Technical data

### Fuels, coolants, lubricants etc.

#### ▼ Fuels, coolants, lubricants etc.

##### Capacities

Vehicle components and their respective lubricants must match.

Therefore use only brands tested and approved by Mercedes-Benz.

Please refer to the Factory Approved Service Products pamphlet, or inquire at your Mercedes-Benz Light Truck Center.

	Model	Capacity	Fuels, coolants, lubricants etc.
<b>Engine with oil filter</b>	ML 350, ML 500	8.5 US qt (8.0 l)	Approved engine oils
<b>Automatic transmission</b>		9.0 US qt (8.5 l)	MB Automatic Transmission Oil
<b>Transfer case</b>		1.6 US qt (1.5 l)	(Dexron 3 or Dexron 2E)
<b>Rear axle</b>		1.3 US qt (1.25 l)	(Hypoid gear oil SAE 90, 85 W 90)
<b>Front axle</b>		1.2 US qt (1.1 l)	(Hypoid gear oil SAE 90)
<b>Power steering</b>		approx. 0.65 US qt (0.6 l)	MB Power Steering Fluid
<b>Front wheel hubs</b>		approx. 1.5 oz (43 g) each	High temperature roller bearing grease

## Technical data

### Fuels, coolants, lubricants etc.

	Model	Capacity	Fuels, coolants, lubricants etc.
<b>Cooling system</b>		approx. 12.7 US qt (12.0 l)	MB Anticorrosion / Antifreeze
<b>Fuel tank</b>	ML 350, ML 500	22.0 US gal (83.0 l)	Premium unleaded gasoline: Posted Octane 91 (Avg. of 96 RON / 86 MON)
<b>including a reserve of</b>		approx. 3.2 US gal (12.0 l)	
<b>Air conditioning system</b>			R-134a refrigerant and special PAG lubricant oil (never R-12)
<b>Windshield washer and headlamp cleaning system*</b>		8.0 US qt (7.6 l)	MB Windshield Washer Concentrate <sup>1</sup>

<sup>1</sup> Use MB Windshield Washer Concentrate "S" and water for temperatures above freezing or MB Windshield Washer Concentrate "S" and commercially available pre-mixed windshield washer solvent / antifreeze for temperatures below freezing. Follow suggested mixing ratios (▷ page 307).

## Technical data

### Fuels, coolants, lubricants etc.

#### Engine oils

Engine oils are specifically tested for their suitability in our engines. Therefore, use only engine oils approved by Mercedes-Benz. Information on approved engine oils is available in the Factory Approved Service Products pamphlet, or at your authorized Mercedes-Benz Light Truck Center.



Always check the oil filler cap (> page 221) for important information pertaining to the engine oil needing to meet a specific Mercedes-Benz specification (e.g. MB 229.5). If such information is printed on the oil filler cap, only use an engine oil from the list of approved engine oils in the Factory Approved Service Products pamphlet that meets the specification indicated on the oil filler cap.

Using engine oils of other specification may cause the FSS to incorrectly determine the next service interval and will result in engine damage not covered by the Mercedes-Benz Limited Warranty.

#### Engine oil additives

Do not blend oil additives with engine oil. They may damage the engine.

Damage or malfunctions resulting from blending oil additives are not covered by the Mercedes-Benz Limited Warranty.

#### Air conditioning refrigerant

R-134a (HFC) refrigerant and special PAG lubricating oil is used in the air conditioning system.

Never use R-12 (CFC) or mineral-based lubricating oil. Otherwise damage to the system will occur.

#### Brake fluid

During vehicle operation, the boiling point of the brake fluid is continuously reduced through the absorption of moisture from the atmosphere. Under extremely strenuous operating conditions, this moisture content can lead to the formation of bubbles in the system, thus reducing the system's efficiency.

Therefore, the brake fluid must be replaced every two years, preferably in the spring.

Only brake fluid approved by Mercedes-Benz is recommended. Your authorized Mercedes-Benz Light Truck Center will provide you with additional information.

#### Premium unleaded gasoline



To maintain the engine's durability and performance, premium unleaded gasoline must be used. If premium unleaded is not available and low octane fuel is used, follow these precautions:

- Have the fuel tank only partially filled with unleaded regular and fill up with premium unleaded as soon as possible.
- Avoid full throttle driving and abrupt acceleration.
- Do not exceed an engine speed of 3000 rpm if the vehicle is loaded with a light load such as two persons and no luggage.
- Do not exceed  $\frac{2}{3}$  of maximum accelerator pedal position if the vehicle is fully loaded or operating in mountainous terrain.

#### Fuel requirements

Use only premium unleaded meeting ASTM standard D 439:

- The octane number (posted at the pump) must be 91 min. It is an average of both the Research (R) octane number and the Motor (M) octane number:  $(R+M) / 2$ . This is also known as the ANTI-KNOCK INDEX.

Unleaded gasoline containing oxygenates such as ethanol, IPA, IBA and TBA can be used provided the ratio of any one of these oxygenates to gasoline does not exceed 10%; MTBE must not exceed 15%.

The ratio of methanol to gasoline must not exceed 3% plus additional cosolvents.

Using mixtures of ethanol and methanol is not allowed. Gasohol, which contains 10% ethanol and 90% unleaded gasoline, can be used.

These blends must also meet all other fuel requirements, such as resistance to spark knock, boiling range, vapor pressure, etc.

#### Gasoline additives

A major concern among engine manufacturers is carbon build-up caused by gasoline. Mercedes-Benz recommends only the use of quality gasoline containing additives that prevent the build-up of carbon deposits.

After an extended period of using fuels without such additives, carbon deposits can build up especially on the intake valves and in the combustion area, leading to engine performance problems such as:

- Warm-up hesitation
- Unstable idle
- Knocking / pinging
- Misfire
- Power loss

Do not blend other specific fuel additives with fuel. This only results in unnecessary costs and may be harmful to the engine operation.

## Technical data

### Fuels, coolants, lubricants etc.

Damage or malfunctions resulting from poor fuel quality or from blending specific fuel additives are not covered by the Mercedes-Benz Limited Warranty.

#### Coolants

The engine coolant is a mixture of water and anticorrosion / antifreeze, which provides:

- Corrosion protection
- Freeze protection
- Boiling protection (by increasing the boiling point)

The cooling system was filled at the factory with a coolant providing freeze protection to approximately  $-35^{\circ}\text{F}$  ( $-37^{\circ}\text{C}$ ) and corrosion protection.

If the antifreeze mixture is effective to  $-22^{\circ}\text{F}$  ( $-30^{\circ}\text{C}$ ), the boiling point of the coolant in the pressurized cooling system is reached at approximately  $266^{\circ}\text{F}$  ( $130^{\circ}\text{C}$ ).

The coolant solution must be used year round to provide the necessary corrosion protection and increase in boil-over protection. Refer to Service Booklet for replacement interval.

To provide important corrosion protection, the solution must be at least 45% anticorrosion / antifreeze (equivalent to freeze protection to approx.  $-22^{\circ}\text{F}$  [ $-30^{\circ}\text{C}$ ]). If you use a solution that is more than 55% anticorrosion / antifreeze (freeze protection to approx.  $-49^{\circ}\text{F}$  [ $-45^{\circ}\text{C}$ ]), the engine temperature will increase due to the lower heat transfer capability of the solution. Therefore, do not use more than this amount of anticorrosion / antifreeze.

If the coolant level is low, water and MB anticorrosion / antifreeze should be used to bring it up to the proper level (have cooling system checked for signs of leakage). Please make sure the mixture is in accordance with label instructions.

The water in the cooling system must meet minimum requirements, which are usually satisfied by normal drinking water. If you are not sure about the water quality, consult your authorized Mercedes-Benz Light Truck Center.



### Anticorrosion / antifreeze

---

Your vehicle contains a number of aluminum parts. The use of aluminum components in motor vehicle engines necessitates that anticorrosion / antifreeze coolant used in such engines be specifically formulated to protect the aluminum parts. (Failure to use such anticorrosion / antifreeze coolant will result in a significantly shortened service life.)

Therefore, the following product is strongly recommended for use in your vehicle:  
Mercedes-Benz Anticorrosion / Antifreeze agent.

Before the start of the winter season (or once a year in hot southern regions), you should have the anticorrosion / antifreeze concentration checked. The coolant is also regularly checked each time you bring your vehicle to your authorized Mercedes-Benz Light Truck Center for service.

## Technical data

### Fuels, coolants, lubricants etc.

#### Anticorrosion /antifreeze quantity

Model	Approx. freeze protection	
	- 35°F (- 37°C)	- 49°F (- 45°C)
ML 350, ML 500,	6.4 US qt (6.0 l)	7.0 US qt (6.6 l)

## Technical data

### Fuels, coolants, lubricants etc.

#### Windshield washer system and headlamp cleaning system\*

Both the windshield washer and headlamp cleaning system\* are supplied from the windshield washer fluid reservoir.

The windshield and headlamp washer fluid reservoir has a capacity of approx. 8.0 US qt (7.6 l).

- ▶ Refill the reservoir with MB Windshield Washer Concentrate "S" and water (or concentrate and commercially available premixed windshield washer solvent / antifreeze, depending on ambient temperatures).

#### Warning!



Washer solvent / antifreeze is highly flammable. Do not spill washer solvent / antifreeze on hot engine parts, because it may ignite and burn. You could be seriously burned.

#### Windshield and headlamp washer fluid mixing ratio

For temperatures above freezing, use MB Windshield Washer Concentrate "S" and water:

- 1 part "S" to 100 parts water  
[40 ml "S" to 1 gallon (4 liters) water].

For temperatures below freezing, use MB Windshield Washer Concentrate "S" and commercially available premixed windshield washer solvent / antifreeze:

- 1 part "S" to 100 parts solvent  
[40 ml "S" to 1 gallon (4 liters) solvent].

## Technical data

### Consumer information

#### ▼ Consumer information

This has been prepared as required of all manufacturers of passenger cars under Title 49, Code of U.S. Federal Regulations, Part 575 pursuant to the “National Traffic and Motor Vehicle Safety Act of 1966”.

#### Uniform tire quality grading

Quality grades can be found, where applicable, on the tire sidewall between tread shoulder and maximum section width. For example:

Tread wear	Traction	Temperature
200	AA	A

All passenger car tires must conform to federal safety requirements in addition to these grades.

#### Tread wear

The tread wear grade is a comparative rating based on the wear rate of the tire when tested under controlled conditions on a specified government test course. For example, a tire graded 150 would wear one and one-half (1½) times as well on the government course as a tire graded 100. The relative performance of tires depends upon the actual conditions of their use, however, and may depart significantly from the norm due to variations in driving habits, service practices and differences in road characteristics and climate.

#### Traction

The traction grades, from highest to lowest are AA, A, B, and C. Those grades represent the tire’s ability to stop on wet pavement as measured under controlled conditions on specified government test surfaces of asphalt and concrete. A tire marked C may have poor traction performance.

#### Warning!



The traction grade assigned to this tire is based on straightahead braking traction tests, and does not include acceleration, cornering, hydroplaning, or peak traction characteristics.

### Temperature

The temperature grades are A (the highest), B, and C, representing the tire's resistance to the generation of heat and its ability to dissipate heat when tested under controlled conditions on a specified indoor laboratory test wheel. Sustained high temperature can cause the material of the tire to degenerate and reduce tire life, and excessive temperature can lead to sudden tire failure. The grade C corresponds to a level of performance which all passenger car tires must meet under the Federal Motor Vehicle Safety Standard No. 109. Grades B and A represent higher levels of performance on the laboratory test wheel than the minimum required by law.

### Warning!



The temperature grade for this tire is established for a tire that is properly inflated and not overloaded. Excessive speed, underinflation, or excessive loading, either separately or in combination, can cause excessive heat build-up and possible tire failure.



**ABS**

(Antilock Brake System)

Prevents the wheels from locking up during braking so that the vehicle can continue to be steered.

**BabySmart™ airbag deactivation system**

This system detects if a special system compatible child restraint seat is installed on the front passenger seat. The system will automatically deactivate the passenger front airbag when such a seat is properly installed (indicator lamp  in the instrument cluster lights up). See your authorized Mercedes-Benz Light Truck Center for availability.

**BabySmart™ compatible child seats**

Special restraint system for children. The sensor system for the passenger seat prevents deployment of the passenger front airbag if a BabySmart™ compatible child seat is installed.

**BAS**

(Brake Assist System)

System for potentially reducing braking distances in emergency braking situations. The system is activated when it senses an emergency based on how fast the brake is applied.

**Bi-Xenon headlamps\***

Headlamps which use an electric arc as the light source and produce a more intense light than filament headlamps. Bi-Xenon headlamps produce low beam and high beam.

**CAC**

(Customer Assistance Center)

Mercedes-Benz customer service center, which can help you with any questions about your vehicle and provide assistance in the event of a breakdown.

**CAN system**

(Controller Area Network)

Data bus network serving to control vehicle functions such as door locking or windshield wiping.

**Cockpit**

All instruments, switches, buttons and indicator / warning lamps in the passenger compartment needed for vehicle operation and monitoring.

**Cruise control**

Driving convenience system for automatically maintaining the vehicle speed set by the driver.

**Engine number**

The number set by the manufacturer and placed on the cylinder block to uniquely identify each engine produced.

## Technical terms

### Engine oil viscosity

Measurement for the inner friction (viscosity) of the oil at different temperatures. The higher the temperature an oil can tolerate without becoming thin, or the lower the temperature it can tolerate without becoming viscous, the better the viscosity.

### ESP

(Electronic Stability Program)  
Improves vehicle handling and directional stability.

### ETD

(Emergency Tensioning Device)  
Device which deploys in certain frontal and rear collisions exceeding the system's threshold to tighten the seat belts.  
->SRS

### FSS

(Flexible Service System)  
Service indicator in the speedometer display that informs the driver when the next vehicle maintenance service is due.

### Gear range

Number of gears which are available to the automatic transmission for shifting. The automatic gear shifting process can be adapted to specific operating conditions using the gear selector lever.

### GPS

(Global Positioning System)  
Satellite-based system for relaying geographic location information to and from vehicles equipped with special receivers. Employs CD or DVD digital maps for navigation.

### GAWR

(Gross Axle Weight Rating)  
The GAWR is the maximum permissible axle weight. The gross vehicle weight on each axle must never exceed the GAWR for the front and rear axle indicated on the certification label located on the driver's door pillar.

### GVW

(Gross Vehicle Weight)  
The GVW comprises the weight of the vehicle including fuel, tools, spare wheel, installed accessories, passengers and cargo. The GVW must never exceed the GVWR, indicated on the certification label located on the driver's door pillar.



**GVWR**

(Gross Vehicle Weight Rating)

This is the maximum permissible vehicle weight. It is indicated on certification label located on the driver's door pillar.

**Instrument cluster**

The displays and indicator / warning lamps in the driver's field of vision, including the tachometer, speedometer, engine temperature and fuel gauge.

**Kickdown**

Depressing the accelerator past the point of resistance shifts the transmission down to the lowest possible gear. This very quickly accelerates the vehicle and should not be used for normal acceleration needs.

**Line of fall**

The direct line that an object moves downhill when influenced by the force of gravity alone.

**Lock button**

Button on the door which indicates whether the door is locked or unlocked. Pushing the lock button down on an individual door from inside will lock that door.

**MCS**

(Modular Control System)

Information and operating center for vehicle sound and communications systems, including the radio and the radio and navigation system, as well as for other optional equipment (CD changer, telephone, etc.).

**Memory function\***

Used to store three individual seat, steering wheel and mirror positions.

**MON**

(Motor Octane Number)

The Motor Octane Number for gasoline as determined by a standardized method. It is an indication of a gasoline's ability to resist undesired detonation (knocking). The average of both the MON (Motor Octane Number) and ->RON (Research Octane Number) is posted at the pump, also known as ANTI-KNOCK INDEX.

**Multifunction display**

A display field in the instrument cluster used to present information provided by the control system.

**Parktronic system\* (Parking assist)**

System which uses visual and acoustic signals to assist the driver during parking maneuvers.

## Technical terms

### **Poly-V-belt drive**

Drives engine-components (alternator, AC compressor, etc.) from the engine.

### **Power train**

Collective term designating all components used to generate and transmit motive power to the drive axles, including

- engine
- clutch / torque converter
- transmission
- transfer case
- drive shaft
- differential
- axle shafts / axles

### **Remote Vehicle Diagnostics**

Transmission of vehicle data and current location to the Mercedes-Benz Customer Assistance Center for subscribers to Tele Aid service.

### **REST**

(Residual engine heat utilization)  
Feature that uses the engine heat stored in the coolant to heat the vehicle interior for a short time after the engine has been turned off.

### **Restraint system**

Seat belts, belt tensioner, airbags and child seat restraint systems. As independent systems, their protective functions complement one another.

### **RON**

(Research Octane Number)  
The Research Octane Number for gasoline as determined by a standardized method. It is an indication of a gasoline's ability to resist undesired detonation (knocking). The average of both the →MON (Motor Octane Number) and RON (Research Octane Number) is posted at the pump, also known as ANTI-KNOCK INDEX.

### **Shift lock**

When the vehicle is parked, this lock prevents the transmission selector lever from being moved out of position **P** without key turned and brake pedal depressed.

### **SRS**

(Supplemental Restraint System)  
Seat belts, emergency tensioning device and airbags. Though independent systems, they are closely interfaced to provide effective occupant protection.

**Tele Aid System\***

(Telematic Alarm Identification on Demand)

The Tele Aid system consists of three types of response: automatic and manual emergency, roadside assistance and information. Tele Aid is initially activated by completing a subscriber agreement and placing an acquaintance call.

The Tele Aid system is operational provided that the vehicle's battery is charged, properly connected, not damaged and cellular and GPS coverage is available.

**Telematics\***

A combination of the terms "telecommunications" and "informatics".

**Tightening torque**

Force times lever arm (e.g. a lug wrench) with which threaded fasteners such as wheel bolts are tightened.

**Tire speed rating**

Part of tire designation; indicates the speed range for which a tire is approved.

**Traction**

Force exerted by the vehicle on the road via the tires.

**Transfer case**

Speed of rotation / torque converter that works together with the ->automatic transmission. In the LOW mode off-road position, the transfer case decreases the output rotational speed of the ->automatic transmission by approximately half. This results in a corresponding increase of torque on the drive axles.

The vehicle then has nearly double the driving force but drives only approximately half as fast.

**TWR**

(Tongue Weight Rating)

The TWR is the maximum permissible weight on the trailer tongue.

**VIN**

(Vehicle Identification Number)

The number set by the manufacturer and placed on the body to uniquely identify each vehicle produced.

**Voice control system\***

Voice control system for car phones, portable cell phones and audio systems (radio, CD, etc.).



**A**

- ABS 25, 76, 311
  - ABS control 76
  - LOW RANGE mode 77
  - Malfunction indicator lamp 242
  - Warning lamp 242
- Accelerator position, automatic transmission 123
- Accident
  - In case of 52
- Activating
  - Air circulation mode 139
  - Air recirculation mode 139
  - Anti-theft alarm system 83
  - Automatic climate control 135
  - ESP 82
  - Exterior headlamps 48
  - Hazard warning flasher 112
  - Headlamps 48
  - High beams 110
  - Ignition 33
- Immobilizer 54, 83
- Rear passenger compartment ventilation and climate control 141
- Rear window defroster 133
- Rear window wiper 51
- Residual heat 140
- Seat heater\* 98
- Tow-away alarm 85
- Warning indicators (Parktronic\*) 155
- Windshield wipers 50
- Activating automatic central locking 93
- Adding
  - Coolant 223
  - Engine oil 221
- Additional turn signals 266
- Adjustable steering column
  - Indicator lamp 253
- Adjusting 34
  - Backrest tilt 36, 38
  - Exterior rear view mirror 40
  - Head restraint height 36, 38
- Head restraint tilt 37, 39
- Headlamp aim 272
- Instrument cluster illumination 116
- Manual seat 35
- Mirrors 40
- Power seats\* 37
- Seat cushion tilt 38
- Seat fore and aft 35
- Seat fore and aft adjustment 37
- Seat height 36, 38
- Seats 34
- Steering wheel 39
- Adjusting air distribution
  - Automatic climate control 137
- Adjusting air volume
  - Automatic climate control 137
- Air conditioner (cooling)
  - Turning on 139
- Air conditioning
  - Cooling 139

## Index

- Air conditioning refrigerant 302
- Air outlets
  - Automatic climate control 142
- Air pressure see Tire inflation pressure 227
- Air recirculation mode 138
  - Activating 139
  - Deactivating 139
- AIRBAG OFF
  - Warning lamp 243
- Airbags 59
  - BabySmart™ airbag deactivation system 311
  - BabySmart™ deactivation system 70
  - Children 60
  - Front 63
  - Passenger 63
  - Safety guidelines 62
  - Side impact 64
  - Window curtain 64
- Alarm
  - Audible 75, 84, 86
  - Canceling 84, 86
  - Visual 83
- Alarm system
  - Anti-theft 83
- Anticorrosion/antifreeze 305
- Antiglare
  - Automatic 126
- Antilock brake system (ABS) 311
- Anti-theft alarm system
  - Arming 83
  - Canceling alarm 84, 86
  - Disarming 84
- Anti-theft systems
  - Anti-theft alarm system 83
  - Immobilizer 83
  - Tow-away alarm, glass breakage sensor 84
- Aquaplaning see Hydroplaning 197
- Armrest
  - Storage compartment in front of 165
  - Storage spaces 165
- Armrest in rear seat bench 167
- Ashtray
  - Front center console 168
  - Rear center console 169
- ATF (automatic transmission fluid) 222
- Attaching a trailer 208
- Automatic antiglare for rear view mirror 126
- Automatic central locking
  - Activating 93
  - Deactivating 93
- Automatic climate control 134
  - Adjusting air distribution 137
  - Adjusting air volume 137
- Air conditioning 139
- Air outlets 142
- Air recirculation mode 138
- Basic setting 137
- Changing basic setting 137
- Defrosting 138
- Economy mode 135

- Rear passenger compartment 141
  - Rear window defroster 133
  - Residual heat utilization 140
  - Residual ventilation 140
  - Switching off 137
  - Switching on 137
  - Automatic headlamp mode 108
  - Automatic interior lighting control
    - Activating 113
    - Deactivating 113
  - Automatic locking when driving 93
  - Automatic transmission 119
    - Accelerator position 123
    - Emergency operation (Limp Home Mode) 124
    - Gear ranges 121
    - Gear selector lever position 122
    - Gear shifting malfunctions 124
    - Kickdown 123
    - Manual shifting 120
    - One-touch gearshifting 120
  - Selector lever position 119
  - Towing a trailer 124
  - Transmission fluid 222
- B**
- BabySmart™
    - Airbag deactivation system 70
    - Compatible child seats 70, 311
    - Self-test 70
  - BabySmart™ airbag deactivation system 311
  - Backrest tilt 35
  - Backup lamps 267, 270
    - Bulbs 267
  - BAS 78, 311
    - Malfunction indicator lamp 245, 246, 247
    - Warning lamp 245, 246, 247
  - Batteries, remote control
    - Changing 262
  - Batteries, vehicle 223
  - Battery discharged
    - Jump starting 281
  - Battery indicator lamp
    - Indicator lamp 254
  - Battery, vehicle 223, 278
    - Charging 279
    - Disconnecting 279
    - Reconnecting 279
    - Reinstalling 279
    - Removing 279
  - Bi-Xenon headlamps\* 311
  - Blocking
    - Rear door window operation 73
  - Brake assist system (BAS) 311
  - Brake fluid 302
  - Brake lamp bulbs 267
  - Brake lamp, high mounted 267
  - Brake pad wear
    - Indicator lamp 254
  - Brakes 194
    - Warning lamp 244
  - Break-in period 192

## Index

Bulbs, replacing 266  
  Additional turn signals 266  
  Backup lamps 267  
  Brake lamps 267  
  Fog lamps 266  
  Front fog lamp 270  
  Front lamps 266  
  High beam 266  
  High mounted brake lamp 267, 271  
  License plate lamps 267, 271  
  Low beam 266  
  Parking lamps 266, 267, 269  
  Rear fog lamp 267  
  Rear fog lamps 270  
  Rear side marker lamp bulbs 270  
  Side marker lamps 266, 267, 269  
  Standing lamps 266, 267  
  Tail lamp assemblies 267, 270  
  Turn signal lamps 266, 267, 269

**C**  
CAC (Customer Assistance Center) 311  
Calibrating compass 188  
California  
  Important notice 11  
Calling up  
  Service indicator 233  
CAN system 311  
Capacities  
  Fuels, coolants, lubricants, etc. 300  
Cargo area cover blind\* 161  
  Closing 161  
  Installing 162  
  Opening 161  
  Removing 161  
Cargo area see Cargo compartment 89  
Cargo compartment  
  Liftgate 89  
  Lighting 114  
  Tie-down rings 158

Cargo floor plates 162  
  Installing 163  
  Removing 162  
  Storing 162  
Cargo tie-down rings 158  
Catalytic converter 212  
CD-changer\* 258  
Center console 27  
  Lower part 28  
  Upper part 27  
Central locking  
  Automatic 93  
  From inside 93  
  Switch 94  
  Unlocking from inside 93, 94  
Central locking switch 94  
Certification label 292  
Charge indicator lamp 254  
Charging  
  Vehicle battery 279



- Chart
  - Fuses 287
- CHECK ENGINE malfunction indicator lamp 248
- Checking
  - Coolant level 215, 222
  - Oil level 218
  - Tire inflate pressure 216
  - Vehicle lighting 216
- Checking weights
  - Trailer and vehicle 208
- Checklist
  - Off-road driving 201
  - Returning from off-road driving 206
- Child safety 67
  - Airbags 60
  - Infant and child restraint systems 64, 68
  - LATCH child seat mounts 72
- Child safety switch see Blocking of rear door window operation 73
- Cigarette lighter
  - Front center console 168
- Cleaning
  - Cup holder 238
  - Gear selector lever 238
  - Hard plastic trim items 238
  - Headlamps 131
  - Headliner 238
  - Instrument cluster 238
  - Leather upholstery 239
  - Light alloy wheels 238
  - MB Tex upholstery 239
  - Plastic and rubber parts 239
  - Seat belts 238
  - Steering wheel 238
  - Windows 237
  - Windshield 50
  - Wiper blades 237
- Clock 26, 118
- Closing
  - Glove box 164
  - Hood 218
  - Liftgate 92
  - Rear quarter windows\* 147
  - Side windows 145
  - Sliding/pop-up roof\* 148, 265
- Closing sliding/pop-up roof\*
  - In an emergency 265
- Cockpit 22, 311
- Combination switch
  - High beam flasher 49, 110
  - Turn signals 49
  - Windshield wipers 49
- Compass 187
  - Calibrating 188
  - Setting compass zone 188
- Compass zone 188
- Consumer information 308
- Control and operation of radio transmitters 211

## Index

- Coolant 222, 304
  - Adding 223
  - Anticorrosion/antifreeze quantity 304
  - Checking level 222
  - Indicator lamp 249
  - Temperature 213
  - Temperature gauge 117
- Coolant level
  - Checking 215, 222
- Crossing obstacles 204
- Cruise control 150, 311
  - Canceling 151
  - Driving downhill 151
  - Driving uphill 151
  - Fine adjustment 152
  - LOW RANGE mode 152
  - Saving current speed 151
  - Setting speeds 152
- Cruise control lever 150
- Cup holder 166
  - Cleaning 238
  - In front seat armrest 167
  - In instrument panel 166
  - In rear centerconsole 167
- Customer Assistance Center (CAC) 311
- D**
- Daytime running lamp mode 109
- Deactivating
  - Air conditioning (cooling) 139
  - Air recirculation mode 139
  - Alarm 84
  - Anti-theft alarm system 84
  - Automatic climate control 135, 137
  - Cruise control 151
  - Defrost 138
  - Engine 54
  - ESP 81
  - Front fog lamps, rear fog lamp 111
  - Hazard warning flasher 112
  - Headlamps 54
  - Immobilizer 83
  - Rear passenger compartment ventilation and climate control 141
  - Rear window defroster 133
  - Residual heat 140
  - Seat heater\* 98
  - Tow-away alarm 85
  - Tow-away alarm (vehicles with trip computer\*) 85
  - Tow-away alarm (vehicles without trip computer\*) 86
- Deactivating automatic central locking 93
- Deep water see Standing water 200
- Defogging
  - Windshield 138
- Defrosting 138
- Difficulties
  - While driving see Problems while driving 51
  - With starting 47
- Direction of rotation (tires) 227
- Discharged battery
  - Jump starting 281
- Disconnecting
  - Vehicle battery 279
- Display in the speedometer 117

Display messages  
     Error 256  
     Service indicator (FSS) 256  
     StArt 256  
 Displays  
     Messages 219  
     Service indicator 232  
 Distance remaining 189  
 Door entry lamps 113  
 Door unlock  
     With Tele Aid\* 179  
 Doors  
     Opening from inside vehicle 90  
     Opening from outside 89  
 Downhill driving  
     Cruise control 151  
 Downshifting 120  
 Drink holder see Cup holder 167  
 Drinking and driving 193

Driving 42, 47  
     Abroad 211  
     In winter 198  
     Problems 51  
     Safety systems 76  
     Through standing water 200  
 Driving abroad 211  
 Driving instructions  
     Towing a trailer 209  
 Driving off 195  
 Driving safety systems  
     4-ETS 79  
     ABS 76  
     BAS 78  
     ESP 80  
 Driving systems 150  
     Cruise control 150  
     Driving safety systems 76  
     EBP 80  
     Parktronic\* 153  
 Driving through water 203

**E**

Easy entry/exit feature\* 101  
 EBP 80  
     Indicator lamp 245  
 Economy mode  
     Automatic climate control 135  
 Electrical connections  
     Trailer 207  
 Electrical fuses 287  
 Electrical outlet 170  
 Electrical system  
     Technical data 297  
 Electrically folding exterior rear view  
     mirrors 128  
 Electronic Brake Proportioning see EBP  
 Electronic Stability Program see ESP 25,  
     80  
 Electronic stability program see ESP 312  
 Electronic Traction System see 4-ETS 25  
 Emergency call system  
     Requirements 172  
 Emergency call system\* 172

## Index

- Emergency calls
  - Initiating an emergency call 175
  - With Tele Aid\* 173
- Emergency operation (Limp Home Mode) 124
- Emergency operations
  - Closing sliding/pop-up roof\* 265
  - Locking the vehicle 262
  - Opening sliding/pop-up roof\* 265
  - Remote door unlock 179
  - Unlocking the vehicle 261
- Emergency tensioning device see ETD 67, 312
- Emission control 212
- Emission control label 292
- Engine
  - Starting 46
  - Technical data 294
  - Turning off 54
- Engine cleaning 236
- Engine compartment
  - Fuse box in 287
  - Hood 217
- Engine malfunction indicator lamp 25, 248
- Engine number 311
- Engine oil 218, 302
  - Adding 221
  - Additives 302
  - Checking level 218
  - Consumption 218
  - Messages in display 219
  - Oil dipstick 221
  - Viscosity 312
- Enlarged cargo area 99
- Error
  - Display messages 256
- ESP 25, 80, 312
  - LOW RANGE mode 81
  - Malfunction indicator lamp 245, 246, 247
  - Switching off 81
  - Switching on 82
  - Synchronizing 246
  - Warning lamp 245, 246, 247, 251
- ETD 312
  - Safety guidelines 62
- ETD (Emergency tensioning device) 67
- Exterior mirrors
  - Folding 128
- Exterior rear view mirrors 40
  - Adjusting 40
  - Folding electrically 128

**F**

- Fastening the seat belts 42
- Fine adjustment
  - Cruise control 152
- First aid kit 257
- Flat tire 274
  - Lowering the vehicle 276
  - Mounting the spare wheel 274
  - Preparing the vehicle 274
  - Spare wheel 259
- Flexible Service System (FSS) 232, 312
- Fluid level
  - Automatic transmission 222
- Fog lamp, rear 267
- Fog lamps 111
  - Replacing bulbs 266
- Fog lamps, front
  - Replacing bulbs 267
  - Switching on 111
- Folding
  - Exterior mirrors 128
- Folding electrically
  - Exterior rear view mirrors 128
- 4-ETS 25, 79
  - Indicator lamp 252
  - LOW RANGE mode 80
  - Malfunction indicator lamp 252
  - Warning lamp 251
- Front airbags 63
- Front fog lamps
  - Indicator lamp 253
- Front lamps
  - Replacing bulbs 266, 268
- Front towing eyes 285
- FSS (Flexible Service System) 232, 312
- Fuel 215
  - Additives 303
  - Fuel reserve warning lamp 252
  - Gasoline additives 303
  - Premium unleaded gasoline 215, 303
  - Requirements 303
  - Reserve warning 25
- Fuel additives 303
- Fuel filler flap 214
  - Locking 214
  - Opening 263
  - Unlocking 214
- Fuel requirements 303

## Fuel tank

- Filler flap 214
- Fuels, coolants, lubricants etc. 300
- Functions
  - Trip computer\* 186
- Fuse box 287, 288
- Fuse chart 287
- Fuses 287
  - Fuse box in engine compartment 287
  - Fuse box in passenger footwell 288
  - Fuse chart 287
  - Fuse extractor 287
  - Spare fuses 287

**G**

- Garage door opener 29, 180
  - Erasing in remote control 185
- Gasoline see Fuel 215
  - Gasoline additives 303
- Gauge for
  - Coolant temperature 25
  - Fuel 25
  - Outside temperature 25

## Index

Gear range 312  
    Automatic transmission 121  
    Limiting 121  
    Shifting into optimal 120  
Gear range limit  
    Canceling 120  
Gear selector lever  
    Cleaning 238  
    Position 122  
Glass breakage sensor 84  
Global Positioning System (GPS) 312  
Glossary 311  
Glove box 23, 164  
    Closing 164  
    Opening 164  
Good visibility 126  
GPS 312

**H**  
Hard plastic trim items  
    Cleaning 238  
Hazard warning flasher 112  
    Switching off 112  
    Switching on 112  
Head restraints  
    Manual seats 36  
    Power seats\* 38  
Headlamp aim  
    Adjusting 272  
Headlamp cleaning system\* 224  
Headlamps  
    Automatic control 108  
    Bi-Xenon\* 311  
    Cleaning 236  
    Cleaning system\* 131, 224  
    Refilling washer fluid 224  
    Switching off 54  
    Switching on 48  
    Washer fluid 307  
    Washer system 307

Headliner  
    Cleaning 238  
Heated seats\* 98  
Height adjustment  
    Head restraints 36, 38  
    Seat belts 45  
    Steering wheel 39  
High beam flasher 49, 110  
High beam headlamps  
    Replacing bulbs 266, 269  
    Switching on 110  
High mounted brake lamp 267  
    Replacing bulbs 271  
Hood 217  
    Closing 218  
    Opening 217  
Hooks  
    Loading 159  
Hydroplaning 197

**I**

Identification labels 292  
     Certification label 292  
     Vehicle identification number (VIN) 292  
 Ignition 33  
 Immobilizer 83  
     Activating 54, 83  
     Deactivating 83  
 Indicator lamp  
     Adjustable steering column 253  
     Brake pad wear 254  
     Coolant 249  
     Front fog lamps 253  
     Low engine oil level 253  
 Indicators, additional  
     Speedometer display 256  
 Infant and child restraint systems 68  
     Installing 71  
     LATCH child seat mounts 72

## Information

    About service and warranty 10  
     Button for Tele Aid\* 177  
 Inside rear view mirror  
     Antiglare 126  
 Installing  
     Infant and child restraint systems 71  
     Wiper blades 273  
 Instrument cluster 24, 116, 313  
     Cleaning 238  
     Coolant temperature gauge 117  
     Display in the speedometer 117  
     Illumination 116  
     Lamps in 252  
     Outside temperature indicator 118  
 Instruments and controls see Cockpit 22  
 Integrated remote control  
     Erasing memory 185  
     Operating 185  
 Interior lighting 112

    Activating automatic control 113  
     Deactivating automatic control 113  
     Manual operation 113  
     Reading lamps 114  
 Interior storage spaces 164  
     Armrest 165  
     Cup holder 167  
     Glove box 164  
     Storage compartment in front of armrest 165  
     Storage compartment under front passenger seat\* 164  
 Intermittent wiping 130  
**J**  
 Jack 258  
 Jump starting 281

## Index

### K

#### Key

- Global locking 89
- Global unlocking 89
- Loss of 90
- Positions in steering lock 33
- Remote control with folding key 88
- Unlocking liftgate 89
- Unlocking the driver's door, fuel filler flap 89

Key positions in steering lock 33

Key, Mechanical 261

Key, Remote control

- Unlocking with 32

Kickdown 123, 313

### L

Labels, identification 292

Lamp bulbs, exterior 266

Lamps, exterior

- Front 266
- Rear 267

Lamps, indicator and warning

- 4-ETS 251, 252
- ABS 242
- Adjustable steering column 253
- AIRBAG OFF 63, 243
- BAS 78, 245, 246, 247
- Battery indicator lamp 254
- Brake pad wear 254
- Brakes 244
- CHECK ENGINE 248
- Coolant 249
- EBP 245
- Engine diagnostics 248
- ESP 245, 246, 247, 251
- Front fog lamps 253
- Fuel reserve 252
- Low engine oil level 253
- LOW RANGE 252
- Low washer system fluid level 253
- Seat belts 253
- Service indicator 232
- SRS 255
- Turn signals 25

LATCH child seat anchors 72

LATCH child seat mounts 72

Layout of poly-V-belt drive 293

Leather upholstery

- Cleaning 239

Lever

- For cruise control 150

License plate lamps

- Replacing bulbs 267, 271

Liftgate

- Closing 92
- Opening 89, 91
- Opening from inside 91
- Opening from outside 91

Light alloy wheels

- Cleaning 238

Lighter

- Rear center console 169

Lighter see cigarette lighter 168



- Lighting 107
  - Automatic headlamp mode 108
  - Cargo compartment 114
  - Combination switch 110
  - Daytime running lamp mode 109
  - Door entry lamps 113
  - Front fog lamps 111
  - High beam flasher 110
  - High beams 110
  - Instrument cluster illumination 116
  - Interior 112
  - Locator lighting 110
  - Night security illumination 109
- Limiting the gear range 121
- Limp Home Mode 124
- Line of fall 313
- Loading 157
  - Cargo area cover blind\* 161
  - Cargo floor plates 162
  - Cargo tie-down rings 158
  - Hooks 159
  - Instructions 157, 158
  - Partition net\* 159
  - Roof rack 163
  - Split rear bench seat 99
  - Trailer 208
- Locator lighting 110
- Lock button 313
- Locking 88
  - Automatic while driving 93
  - Centrally from inside 94
  - Fuel filler flap 214
  - Global 89
  - Vehicle in an emergency 262
- Locking knobs 32
- Loss of keys 90
- Loss of Service and Warranty Information
  - Booklet 291
- Low beam headlamps
  - Replacing bulbs 266, 268
  - Switching on 48
- Low engine oil level
  - Indicator lamp 253
- LOW RANGE - 4-ETS 80
- LOW RANGE - ABS 77
- LOW RANGE - ESP 81
- LOW RANGE mode 125
- Low washer system fluid level
  - Indicator lamp 253
- Lowering
  - Vehicle 276
- M**
- Main dimensions 298
- Maintenance 12
  - Display messages 256
- Manual operations
  - Fuel filler flap 263
  - Interior lighting control 113
  - Locking the vehicle 262
  - Sliding/pop-up roof\* 265
  - Unlocking the driver's door 261
  - Unlocking transmission selector lever 264

## Index

### Manual seat

- Adjusting 35
- Adjusting backrest tilt 36
- Adjusting head restraint height 36
- Adjusting head restraint tilt 37, 39
- Seat fore and aft adjustment 35
- Seat height 36

### MB Tex upholstery

- Cleaning 239

### MCS

- Modular Control System 313

### Mechanical key 261

### Memory function 105, 313

### Memory function\* 106

- Recalling positions from memory 106

### Mirror

- Inside rear view mirror 40

### Mirrors

- Activating exterior mirror parking position 127
- Adjusting 40
- Automatic antiglare for rear view mirror 126
- Exterior rear view mirror 40
- Storing exterior rear view mirror parking position 106

### MON 215

### MON (Motor Octane Number) 313

### Monitoring reach

- Parktronic\* 154

### Multifunction display 313

## N

### Night security illumination 109

- Deactivation temporarily 109
- Setting time 109

## O

### Occupant safety 58

- Children and airbags 60
- Children in the vehicle 67
- Fastening the seat belt 42
- Infant and child restraint systems 68
- LATCH child seat mounts 72
- Seat belts 42, 62

### Odometer display 117

### Odometer, main 25

### Off-road driving

- Checklist 201, 206
- Crossing obstacles 204
- Driving instructions off-road driving 200
- Driving through water 203
- Returning 205
- Rules 201
- Special driving features 201
- Steep terrain 202

- Oil
    - Adding 221
    - Consumption 218
    - Dipstick 218
    - Oil dipstick 221
    - Viscosity 312
  - One-touch gearshifting 120
    - Canceling gear range limit 120
    - Downshifting 120
    - Upshifting 120
  - Opening
    - Doors from the inside 90
    - Fuel filler flap 214
    - Fuel filler flap manually 263
    - Glove box 164
    - Hood 217
    - Liftgate 89, 91
    - Liftgate from inside 91
    - Liftgate from outside 91
    - Rear quarter windows 146
    - Side windows 145
  - Sliding/pop-up roof\* 148, 265
  - Sliding/pop-up roof\* in an emergency 265
  - Storage compartment in front of armrest 166
  - Storage compartment under passenger seat 165
  - Windows 145
  - Opening and closing
    - Side windows 144
  - Operating
    - Garage door opener 185
    - Integrated remote control 185
    - Radio transmitters 211
    - Vehicle outside the USA and Canada 13
  - Operating safety 17
  - Operator's Manual 10
  - Ornamental moldings 236
  - Outside temperature indicator 118
  - Overdue service 233
  - Overhead control panel 29
- P**
- Paintwork 235
  - Panic alarm 75
    - Panic button on remote control 75
  - Parking and locking 53
  - Parking brake 47, 53
    - Engaging 53
    - Releasing 47
  - Parking lamps
    - Replacing bulbs 266, 267, 269
    - Replacing the bulbs 269
    - Switching on 107
  - Parktronic\* 153, 313
    - Cleaning system sensor 237
    - Monitoring reach 154
    - Sensor cover 237
    - Switching off 156
    - Switching on 156
    - Warning indicators 155

## Index

- Partition net\* 159
    - Engaging 159
    - Removing 161
    - Tightening 160
  - Parts see Spare parts service
  - Passenger compartment 211
    - Interior lighting 112
  - Passenger footwell
    - Fuse box in 288
  - Passenger safety see Occupant safety 58
  - Pedals 193
  - Plastic and rubber parts
    - Cleaning 239
  - Poly-V-belt drive 314
    - Layout 293
  - Positions (Memory function\*)
    - Recalling from memory 106
    - Storing into memory 106
  - Power assistance 193
  - Power seat\*
    - Adjusting backrest tilt 38
    - Adjusting head restraint height 38
    - Adjusting seat cushion tilt 38
    - Adjusting seat height 38
    - Seat fore and aft adjustment 37
  - Power seats\* 37
  - Power train 314
  - Power washer 235
  - Power windows
    - Blocking of rear door window operation 73
    - Side windows 144
    - Synchronizing 146
  - Practical hints
    - First aid kit 257
    - Fuses 287
    - Lamps in instrument cluster 242
    - Spare wheel 259
    - Towing the vehicle 283
    - Vehicle jack 258
    - Vehicle tool kit 257
  - Premium unleaded gasoline 303
  - Problems
    - While driving 51
    - With vehicle 18
  - Product information 9
  - Programming or reprogramming the integrated remote control 182
- R**
- Radio transmitters, control and operation 211
  - Rain sensor\* 130, 131
  - Rapid seat heating
    - Switching off 99
  - Rapid seat heating\*
    - Switching on 98
  - Reading lamp 29

- Reading lamps 114
- Rear automatic climate control 141
  - Adjusting air volume and air distribution manually 141
  - Automatic mode 141
- Rear bench seat
  - Foldable 99
- Rear door window
  - Blocking operation 73
- Rear fog lamp 267
  - Bulb 267
  - Switching on 111
- Rear lamp bulbs
  - Replacing 270
- Rear parking lamp
  - Replacing bulbs 270
- Rear passenger compartment ventilation and climate control
  - Activating 141
  - Deactivating 141
- Rear passenger compartment ventilation and rear automatic climate control 141
- Rear quarter windows\* 146
  - Opening 146
  - Closing 147
- Rear seats 99
  - Easy entry/exit feature\* 101
  - Enlarging cargo area 99
  - Folding down backrest 100
  - Folding up 101
  - Folding up backrest 100
  - Fore and aft 99
  - Lowering 100
  - Third row\* 102
- Rear standing lamp
  - Replacing bulbs 270
- Rear towing eyes 285
- Rear view mirror automatic antiglare 126
- Rear view mirrors see Mirrors
- Rear window defroster 133
  - Activating 133
  - Deactivating 133
- Rear window wiper 131
  - Rain sensor\* 131
- Rear window wiper/washer 51
- Reconnecting
  - Vehicle battery 279
- Refrigerant
  - Air conditioning 302
- Refueling 214
- Regular checks 215
- Reinstalling vehicle battery 279
- Remote control
  - Changing battery 262
  - Global locking 89
  - Global unlocking 89
  - Synchronizing 263
  - Unlocking liftgate 89
  - Unlocking the driver's door, fuel filler flap 89
  - Unlocking with 32
- Remote control with folding key 88

## Index

- Remote door unlock
    - With Tele Aid\* 179
  - Remote Vehicle Diagnostics 314
  - Removing
    - Vehicle battery 279
    - Wheel 276
    - Wiper blades 273
  - Removing spare wheel 259
  - Replacing
    - Backup lamp bulbs 270
    - Brake lamp bulbs 270
    - Bulbs 266
    - Front lamp bulbs 268
    - Front turn signal bulbs 268
    - Fuses 287
    - High beam bulbs 269
    - High mounted brake lamp 271
    - License plate lamp bulbs 271
    - Low beam bulbs 268
    - Rear fog lamp bulbs 270
    - Rear lamp bulbs 267, 270
    - Rear parking lamp bulbs 270
    - Rear side marker lamp bulbs 270
    - Rear standing lamp bulbs 270
    - Rear turn signal bulbs 270
    - Wiper blades 273
  - Replacing front fog lamp bulb 270
  - Reporting
    - Safety defects 19
  - Resetting
    - Service indicator (FSS) 233
    - Trip odometer 118
  - Residual heat utilization 140, 314
  - Residual ventilation 140
  - REST (Residual engine heat utilization) 314
  - Restraint system 314
  - Restraint system see Infant and child restraint systems 68, 71
  - Returning from off-road driving 205
  - Rims 295
  - Roadside assistance 12
    - Tele Aid\* 175
  - RON 215
  - RON (Research Octane Number) 314
  - Roof rack 163
  - Rotating wheels 228
  - Rubber parts
    - Cleaning 239
- S**
- Safety
    - Occupant 58
  - Safety belts see Seat belts 42
  - Safety defects
    - Reporting 19
  - Safety systems
    - Driving 76
  - Saving current speed 151
  - Seat belt force limiter 67
  - Seat belt height adjustment 45

- Seat belts 64
  - Cleaning 238
  - Fastening 42
  - Height adjustment 45
  - Proper use of 44, 66
  - Safety guidelines 62
  - Warning lamp 253
- Seat heater\*
  - Switching off 98
  - Switching on 98
- Seats 95
  - Adjusting 34
  - Heater\* 98
  - Manual 35
  - Power 37
  - Rapid seat heating\* 98
  - Rear 99
  - Split rear bench seat 99
- Securing cargo
  - Cargo tie-down rings 158
- Selector lever 26
  - Lock 46
  - Position 26, 119
- Self-test
  - BabySmart™ airbag deactivation system 70
  - Tele Aid\* 172
- Service
  - Calling up the service indicator 233
  - Major service (Service B) 232
  - Minor service (Service A) 232
  - Overdue 233
  - Spare parts
  - Types 233
  - When due 232
- Service and Warranty Booklet
  - Loss of 291
- Service and warranty information 10
- Service indicator 232
  - Calling up 233
  - Clearing 232, 233
- Service indicator (FSS)
  - Display messages 256
- Service life (tires) 227
- Service System see FSS
- Setting
  - Cruise control 151
  - Higher speed in cruise control 152
  - Hours (clock) 118
  - Lower speed in cruise control 152
  - Minutes (clock) 118
  - Slower speed in cruise control 152
  - Speed in cruise control 152
- Setting date
  - Trip computer\* 186
- Setting language
  - Trip computer\* 190
- Shift lock 314
- Shifting
  - Gear selector lever positions 122
  - Into optimal gear range (automatic transmission) 120
- Side impact airbags 64
- Side marker lamps
  - Replacing bulbs 266, 267, 269

## Index

- Side windows 144
  - Automatic closing 145
  - Automatic opening 145
  - Cleaning 237
  - Closing 145
  - Closing fully (Express-close) 145
  - Opening 145
  - Opening and closing 144
  - Opening fully (Express-open) 145
  - Rear quarter window 146
  - Stopping 145
  - Synchronizing power windows 146
- Simultaneous wiping and washing
  - Rear window wiper/washer 51
  - Windshield wipers 50
- Single wipe 50
- Sliding/pop-up roof\* 148
  - Closing 148, 265
  - Opening 148, 265
  - Synchronizing 149
- Snow chains 231
- Spare fuses 287
- Spare parts service 290
- Spare wheel 259
  - Mounting 274
  - Removing 259
- Speed
  - Saving current 151
- Speed settings
  - Cruise control 152
- Speedometer 25
- Speedometer display
  - Additional indicators 256
- Split rear bench seat 99
- SRS 66, 314
  - Indicator lamp 255
- Standing lamps 107
  - Replacing bulbs 266, 267
- Standing water
  - Driving instructions 200
- StArt
  - Display messages 256
- Starting difficulties 47
- Starting position 33
- Starting the engine 46
- Steep terrain
  - Driving 202
- Steering column
  - Height adjustment 39
  - Length adjustment 39
- Steering lock 23, 33
  - Positions 33
- Steering wheel
  - Adjusting 39
  - Adjustment 39
  - Cleaning 238
- Stolen vehicle
  - Tracking services 180
- Stop watch 189
- Stopping
  - Windows 145
- Storage compartments
  - Glove box 164
  - Under front passenger seat\* 164
- Storing (Memory function\*)
  - Positions into memory 106
- Stranded vehicle 286



Sun visor 132  
 Supplemental Restraint System (SRS) 314  
 Switching off  
     Automatic climate control 137  
     ESP 81  
     Hazard warning flasher 112  
     Headlamps 54  
     Rapid seat heating 99  
     Transmission control – LOW RANGE mode 125  
 Switching on  
     Automatic climate control 137  
     ESP 82  
     Front fog lamps 111  
     Front fog lamps, rear fog lamp 111  
     Hazard warning flasher 112  
     Headlamps 48  
     High beams 110  
     Rapid seat heating\* 98  
     Seat heating\* 98  
     Transmission control – LOW RANGE mode 125  
     Trip computer\* 186  
     Windshield wipers 49

Synchronizing  
     ESP 246  
     Power windows 146  
     Remote control 263  
     Sliding/pop-up roof\* 149  
**T**  
 Tachometer 26, 118  
     Displaying gear range 121  
 Tail lamps 270  
     Cleaning 236  
     Replacing bulbs 267

Tar stains 235  
 Technical data 302  
     Brake fluid 302  
     Coolants 304  
     Electrical system 297  
     Engine 294  
     Engine oil 302  
     Engine oil additives 302  
     Fuel requirements 303  
     Gasoline additives 303  
     Main dimensions 298  
     Premium unleaded gasoline 303  
     Rims and tires 295  
     Weights 299  
     Windshield and headlamp washer system 307  
 Tele Aid System\* 315

## Index

- Tele Aid\* 171
  - Emergency calls 173
  - Information 177
  - Initiating an emergency call manually 175
  - Remote door unlock 179
  - Roadside assistance 175
  - Stolen vehicle tracking services 180
  - System self-check 172
  - Upgrade signals 178
- Telematics\* 315
- Telephone\* 170
- Temperature
  - Grades of tires 309
  - Tires 228
- Third row seats\* 102
  - Folding down single seat 102
  - Installing single seat 104
  - Removing single seat 104
  - Storing single seat 103
- Tie-down rings (Cargo compartment) 158
- Tightening torque 315
- Tightening torque (Wheel bolts) 277
- Tilt
  - Head restraint 37, 39
- Time
  - Setting hours 118
  - Setting minutes 118
- Tire inflation pressure
  - Checking 216, 227
- Tire speed rating 198, 315
- Tire traction 197
- Tires 295, 308
  - Direction of rotation 227
  - Driving instructions 196
  - Retreads 226
  - Rims and tires 295
  - Rotating 228
  - Service life 227
  - Temperature 228
  - Temperature grades 309
  - Tread depth 230
  - Wear pattern 228
  - Winter 230
- Tools 257
  - Vehicle jack 258
  - Vehicles with CD-changer\* 258
  - Wheel bolt wrench 258
- Tow-away alarm 29, 84
  - Arming 84
  - Disarming 84
  - Disarming for transport 84
- Towing
  - Trailer 206
- Towing a trailer 209
  - Automatic transmission 124
- Towing eyes
  - Front 285
  - Rear 285
- Towing the vehicle 283
  - Stranded vehicle 286
- Tracking services
  - For stolen vehicle 180

- Traction 308, 315
- Trailer
  - Attaching 208
  - Loading 208
  - Towing 209
- Trailer hitches 207
- Trailer towing 206
  - Attaching a trailer 208
  - Checking weights 208
  - Electrical connections 207
  - Hitches 207
  - Loading 208
  - Weights and ratings 207
- Trailer weights and ratings 207
- Transfer case 315
- Transmission control – LOW RANGE mode 125
  - Switching off 125
  - Switching on 125
- Transmission selector lever 264
  - Unlocking manually 264
- Tread depth (tires) 230
- Treadwear 308
- Trip computer\* 29, 186
  - Average fuel consumption 189
  - Compass 187
  - Country 190
  - Distance remaining 189
  - Language 190
  - Selecting functions 186
  - Setting date 186
  - Stop watch 189
  - Switching on 186
- Trip odometer
  - Resetting 118
- Trip odometer display 117
- Trunk see Cargo compartment 89
- Turn signal lamps
  - Replacing bulbs 266, 267, 269
- Turn signals 49
  - Additional in mirrors 266
  - Cleaning lenses 236
  - Front bulbs 266
  - Indicator lamps 25
  - Rear bulbs 267, 270
- Turning off
  - Engine 54
- U**
- Unlocking 32, 88
  - Centrally from inside 94
  - Driver's door in an emergency 261
  - Driver's door, fuel filler flap 89
  - Fuel filler flap 214
  - In an emergency 261
  - Transmission selector lever manually 264
  - Vehicle in an emergency 179
  - With the remote control 32
- Upgrade signals
  - Tele Aid\* 178
- Uphill driving
  - Cruise control 151
- Upholstery
  - Cleaning 239
- Upshifting 120

## Index

- Useful features 164
  - Ashtrays and cigarette lighter 168
  - Cup holder 166
  - Electrical outlet 170
  - Garage door opener 180
  - Interior storage spaces 164
  - Programming or reprogramming the integrated remote control 182
  - Tele Aid\* 171
  - Telephone\* 170
  - Trip computer\* 186
- V**
- Vehicle
  - Locking 28
  - Locking in an emergency 262
  - Lowering 276
  - Proper use of 17
  - Service battery 278
  - Towing 283
  - Unlocking 28
  - Unlocking in an emergency 261
- Vehicle and trailer weights and ratings 207
- Vehicle battery 278
- Vehicle care
  - Cup holder 238
  - Engine cleaning 236
  - Gear selector lever 238
  - Hard plastic trim items 238
  - Headlamps 236
  - Instrument cluster 238
  - Leather upholstery 239
  - Light alloy wheels 238
  - MB Tex upholstery 239
  - Ornamental moldings 236
  - Paintwork 235
  - Parktronic\* system sensor 237
  - Plastic and rubber parts 239
  - Power washer 235
  - Seat belts 238
  - Steering wheel 238
  - Tail lamps 236
  - Tar stains 235
  - Turn signals 236
  - Upholstery 239
  - Vehicle washing 236
  - Window cleaning 237
  - Wiper blades 237
- Vehicle identification number (VIN) 292
- Vehicle jack 258
- Vehicle lighting
  - Checking 216
- Vehicle tool kit 257
  - Vehicle with CD-changer\* 258
- Vehicle washing 236
- VIN (Vehicle Identification Number) 292, 315
- Voice control system\* 315
- W**
- Warning indicators
  - Parktronic\* 155
- Warning sounds
  - Drivers seat belts 64
  - Parking brake 48
- Warranty coverage 291
- Washer fluid see Windshield washer fluid
- Washing the vehicle 234

- Wear pattern (tires) 228
- Weights 299
- Wheel bolt wrench 258
- Wheel change
  - Tightening torque 277
- Wheels
  - Rotating 228
- Window curtain airbags 64
- Windows see Side windows
- Windshield
  - Defogging 138
  - Refilling washer fluid 224
  - Replacing wiper blades 273
  - Washer fluid 224, 307
  - Washer system 307
- Windshield washer fluid 307
  - Filler neck 224
  - Mixing ratio 307
  - Refilling 224
  - Wiping with 50
- Windshield washer system 307
- Windshield wipers 49, 129
  - Intermittent 49
  - Interval wiping 130
  - Normal wiper speed 49
  - Rain sensor\* 130
  - Rear window wiper/washer 51
  - Replacing wiper blades 273
  - Simultaneous wiping and washing 51
  - Single wipe 50
  - Switching on 49
  - Wiping with windshield washer fluid 50
- Winter driving
  - Snow chains 231
  - Tires 230
- Winter driving instructions 198
- Winter tires 230
- Wiper blades
  - Cleaning 237
  - Installing 273
  - Removing 273
  - Replacing 273
- Wiper switch 49
- Wiper/washer
  - Rear window 51
- Wiping
  - And washing simultaneously 50
  - Intermittent 49, 130
  - With windshield washer fluid 50
- Wiping and washing simultaneously 51
- X**
- Xenon headlamps\*
  - Bi-Xenon\* 311



### Service and Literature

Your authorized Mercedes-Benz Center has trained technicians and original Mercedes-Benz parts to service your vehicle properly. For expert advice and quality service, see your authorized Mercedes-Benz Light Truck Center.

If you are interested in obtaining service literature for your vehicle, please contact your authorized Mercedes-Benz Light Truck Center. We consider this the best way for you to obtain accurate information for your vehicle.

For further information you can find us on the Mercedes-Benz web-site *www.mbusa.com* or *www.mercedes-benz.ca*.

#### Warning!



To help avoid personal injury, be extremely careful when performing any service work or repairs. Improper or incomplete service or the use of incorrect or inappropriate parts or materials may damage the vehicle or its equipment, which may in turn result in personal injury.

If you have questions about carrying out any type of service, turn to the advice of an authorized Mercedes-Benz Light Truck Center.

We reserve the right to modify the technical details of the vehicle as given in the data and illustrations of this Operator's Manual. Reprinting, translation and copying, even of excerpts, is not permitted without our prior authorization in writing.

Title illustration no. P00.01-2273-31

Press time 08 / 20 / 03

GSP / TIP

Printed in Germany

