

G 500

G 55 AMG

Our company and staff congratulate you on the purchase of your new Mercedes-Benz.

Your selection of our product is a demonstration of your trust in our company name. Furthermore, it exemplifies your desire to own an automobile that will be as easy as possible to operate and provide years of service.

Your Mercedes-Benz represents the efforts of many skilled engineers and craftsmen. To help assure your driving pleasure, and also the safety of you and your passengers, we ask you to make a small investment of time:

- Please read this manual carefully, then return it to your vehicle where it will be handy for your reference.
- Please follow the recommendations contained in this manual. They are designed to acquaint you with the operation of your Mercedes-Benz.
- Please pay attention to the warnings and cautions contained in this manual. They are designed to help improve the safety of the vehicle operator and occupants.

We extend our best wishes for many miles of safe, pleasurable driving.

Mercedes-Benz USA, LLC
A DaimlerChrysler Company

Contents

Introduction	9	At a glance	21	Driving.....	40
Product information.....	9	Cockpit.....	22	Fastening the seat belt	40
Operator's Manual.....	10	Instrument cluster	24	Starting the engine	43
Service and warranty information ..	10	Multifunction steering wheel	26	Switching on headlamps.....	46
Important notice for California		Center console	27	Turn signals and high beam	46
retail buyers and lessees of		Upper part	27	Windshield wipers.....	47
Mercedes-Benz automobiles	11	Lower part	28	Rear window wiper/washer.....	49
Maintenance	12	Overhead control panel	29	Problems while driving.....	50
Roadside Assistance	12	Door control panel.....	30	Parking and locking.....	51
Change of address or ownership....	13			Parking brake	51
Operating your vehicle outside the				Switching off headlamps.....	52
USA or Canada.....	13	Getting started	31	Turning off engine.....	52
Where to find it.....	15	Unlocking	32		
Symbols.....	16	Unlocking with the SmartKey.....	32	Safety and Security	55
Operating safety	17	Adjusting	34	Occupant safety	56
Proper use of the vehicle	17	Seats.....	34	Airbags	57
Problems with your vehicle.....	18	Steering wheel.....	37	Seat belts	62
Reporting safety defects.....	19	Mirrors.....	38	Children in the vehicle	65
Reporting safety defects	19			Blocking rear door window	
				operation	71
				Panic alarm	73

Contents

Driving and safety systems	74	Seats	94	Instrument cluster	112
ABS	74	Easy-entry/exit feature	94	Instrument cluster illumination	112
BAS	76	Removing and installing front seat		Coolant temperature display.....	112
4-ETS.....	77	head restraints.....	95	Trip odometer	113
EBB.....	78	Synchronizing head restraints and		Tachometer.....	113
ESP.....	78	seat adjustment fore and aft for		Outside temperature indicator	114
Anti-theft systems.....	82	front seats.....	95	Control system	115
Immobilizer.....	82	Rear seat head restraints	96	Multifunction display.....	115
Anti-theft alarm	82	Multicontour seat*	97	Multifunction steering wheel.....	116
Tow-away alarm	83	Heated seats	98	Menus	118
		Memory function	101	Standard display menu	120
		Storing positions into memory	102	AUDIO menu	120
		Recalling positions from memory .	102	NAVI menu.....	122
		Storing exterior rear view mirror		Malfunction memory menu	122
		parking position	103	Settings menu.....	123
		Lighting.....	104	Trip computer menu.....	136
		Exterior lamp switch.....	104	TEL menu	137
		Combination switch	107	Automatic transmission.....	140
		Hazard warning flasher	108	One-touch gearshifting	141
		Interior lighting.....	109	Gear ranges	142
		Rear interior lamps.....	110	Gear selector lever position	142
		Cargo compartment lamps.....	110	Accelerator position.....	144
				Emergency operation	
				(Limp Home Mode)	144
Controls in detail	85				
Locking and unlocking	86				
SmartKey	86				
Opening the doors from the inside .	89				
Opening the tailgate	89				
Closing the tailgate	90				
Separately locking the tailgate	90				
Separately unlocking the tailgate ...	91				
Automatic central locking	91				
Locking and unlocking from					
the inside	92				

Contents

Transfer case	145	Power windows	164	Operation	205
Gear range	145	Opening and closing the windows.	164	The first 1000 miles (1500 km).....	206
Switching transfer case.....	145	Sliding/pop-up roof.....	166	Driving instructions	207
Differential locks	148	Opening and closing the		Drive sensibly – save fuel	207
A few words about differentials		sliding/pop-up roof.....	166	Drinking and driving.....	207
and differential locks.....	149	Driving systems	169	Pedals.....	207
Switching differential locks		Cruise control	169	Power assistance.....	208
on and off.....	150	Rear Parking Assist*	172	Brakes	208
Good visibility	152	Loading.....	175	Driving off	209
Rear view mirror.....	152	Roof rack	175	Parking	209
Headlamp cleaning system	153	Cargo compartment cover	175	Tires.....	210
Sun visors	154	Enlarged cargo compartment.....	176	Hydroplaning	210
Rear window defroster	155	Split rear seat bench.....	176	Tire traction	211
Climate control.....	156	Partition net* (MB Accessory)	178	Tire speed rating.....	211
Setting the temperature.....	158	Loading instructions	180	Winter driving instructions.....	212
Adjusting air distribution and		Cargo tie-down rings.....	182	Standing water	213
volume	159	Useful features	183	Passenger compartment.....	213
Defrosting	160	Interior storage spaces	183	Off-road driving.....	213
Air recirculation.....	160	Ashtrays.....	186	Control and operation of radio	
Residual engine heat utilization....	161	Cigarette lighter.....	188	transmitters	221
Deactivating the climate control		Electrical outlet.....	188	Driving abroad	222
system	162	Telephone*	189	Catalytic converter	222
Air conditioning.....	162	Tele Aid.....	190	Emission control	222
Rear passenger compartment		Garage door opener.....	198	Coolant temperature	223
adjustable air vents.....	163	Heated steering wheel.....	203		

Contents

At the gas station.....	224	Maintenance.....	242	Unlocking/locking in an emergency..	287
Refueling.....	224	Clearing the service indicator	242	Unlocking the vehicle.....	287
Check regularly and before		Service term exceeded	242	Locking the vehicle	288
a long trip.....	225	Calling up the service indicator....	243	Changing batteries in	
Engine compartment.....	227	Resetting the service indicator....	243	the SmartKey	288
Hood	227	Vehicle care.....	244	Fuel filler flap	290
Engine oil.....	228	Cleaning and care of the vehicle ..	244	Manually unlocking the	
Transmission fluid level	232			transmission gear selector lever ..	290
Coolant level	232			Opening/closing in an emergency	292
Windshield/rear window washer		Practical hints	251	Sliding/pop-up roof	292
system and headlamp cleaning		What to do if	252	Brush guard*	293
system.....	234	Lamps in instrument cluster	252	Lowering and raising brush guard	294
Battery	235	Lamp in center console.....	259	Replacing bulbs	295
Tires and wheels	236	Messages in the multifunction		Bulbs	295
Important guidelines	236	display.....	260	Replacing bulbs for front lamps ...	297
Life of tire.....	237	Where will I find ...?	283	Replacing bulbs for rear lamps	301
Direction of rotation	237	First aid kit	283	Replacing wiper blades.....	304
Checking tire inflation pressure ...	237	Vehicle tool kit	283	Removing wiper blades	304
Rotating wheels.....	238	Vehicle jack.....	284	Installing wiper blades	305
Winter driving.....	240	CD changer	284	Flat tire	306
Winter tires.....	240	Spare wheel	285	Preparing the vehicle	306
Block heater (Canada only)	240			Mounting the spare wheel	307
Snow chains	241				



▼ **Product information**

Please observe the following in your own best interest:

We recommend using genuine Mercedes-Benz parts as well as conversion parts and accessories explicitly approved by us for your vehicle model.

We have tested these parts to determine their reliability, safety and special suitability for Mercedes-Benz vehicles.

We are unable to make an assessment for other products and therefore cannot be held responsible for them, even if in individual cases an official approval or authorization by governmental or other agencies should exist. Use of such parts and accessories could adversely affect the safety, performance or reliability of your vehicle. Please do not use them.

Genuine Mercedes-Benz original parts as well as conversion parts and accessories approved by us are available at your authorized Mercedes-Benz Light Truck Center where you will receive comprehensive information, also on permissible technical modifications, and where proper installation will be performed.

Introduction

Operator's Manual

▼ Operator's Manual

This Operator's Manual contains a great deal of useful information. We urge you to read it carefully and familiarize yourself with the vehicle before driving.

For your own safety and longer service life of the vehicle, we urge you to follow the instructions and warnings contained in this manual. Ignoring them could result in damage to the vehicle or personal injury to you or others. Vehicle damage caused by failure to follow instructions is not covered by the Mercedes-Benz Limited Warranty.

Your vehicle may have some or all of the equipment described in this manual. Therefore, you may find explanations for optional equipment not installed in your vehicle. If you have any questions about the operation of any equipment, your authorized Mercedes-Benz Light Truck Center will be glad to demonstrate the proper procedures.

We continuously strive to improve our product, and ask for your understanding that we reserve the right to make changes in design and equipment. Therefore, information, illustrations and descriptions in this Operator's Manual might differ from your vehicle.

Optional equipment is also described in this manual, including operating instructions wherever necessary. Since they are special-order items, the descriptions and illustrations herein may vary slightly from the actual equipment of your vehicle.

If there are any equipment details that are not shown or described in this Operator's Manual, your authorized Mercedes-Benz Light Truck Center will be glad to inform you of correct care and operating procedures.

The Operator's Manual and Service Booklet are important documents and should be kept with the vehicle.

Service and warranty information

The Service and Warranty Information Booklet contains detailed information about the warranties covering your Mercedes-Benz, including:

- New Light Truck Limited Warranty,
- Emission System Warranty,
- Emission Performance Warranty,
- California, Maine, Massachusetts, and Vermont Emission Control System Warranty (California, Maine, Massachusetts, and Vermont only),
- State Warranty Enforcement Laws (Lemon Laws).

Important notice for California retail buyers and lessees of Mercedes-Benz automobiles

Under California law you may be entitled to a replacement of your vehicle or a refund of the purchase price or lease price, if Mercedes-Benz USA, LLC and /or its authorized repair or service facilities fail to fix one or more substantial defects or malfunctions in the vehicle that are covered by its express warranty after a reasonable number of repair attempts. During the period of 18 months from original delivery of the vehicle or the accumulation of 18 000 miles (approx. 29 000 km) on the odometer of the vehicle, whichever occurs first, a reasonable number of repair attempts is presumed for a retail buyer or lessee if one or more of the following occurs:

- (1) the same substantial defect or malfunction results in a condition that is likely to cause death or serious bodily injury if the vehicle is driven, that defect or malfunction has been subject to repair two or more times, and you have directly notified Mercedes-Benz USA, LLC in writing of the need for its repair,
- (2) the same substantial defect or malfunction of a less serious nature than category (1) has been subject to repair four or more times and you have directly notified us in writing of the need for its repair, or
- (3) the vehicle is out of service by reason of repair of the same or different substantial defects or malfunctions for a cumulative total of more than 30 calendar days. Written notification should be sent to us, not a dealer, at Mercedes-Benz USA, LLC, Customer Assistance Center, One Mercedes Drive, Montvale, NJ 07645-0350.

Introduction

Operator's Manual

Maintenance

The Service Booklet describes all the necessary maintenance work which should be performed at regular intervals.

Always have the Service Booklet with you when you take the vehicle to your authorized Mercedes-Benz Light Truck Center for service. The service advisor will record each service in the booklet for you.

Roadside Assistance

The Mercedes-Benz Roadside Assistance Program provides factory-trained technical help in the event of a breakdown. Calls to the toll-free Roadside Assistance number

1-800-FOR-MERCEdes (in the USA)
1-800-387-0100 (in Canada)

will be answered by Mercedes-Benz Customer Assistance Representatives 24 hours a day, 365 days a year.

Roadside Assistance will be provided in accordance with standard program guidelines which include providing service to the vehicle up to a reasonable distance from a paved roadway. We will make every effort to assist in a breakdown situation, however, the accessibility of your vehicle will be determined by our authorized Mercedes-Benz Light Truck Center technician or the tow service provider on a case by case basis and may be a factor in our ability to respond.

Additional charges may be applicable for a breakdown location determined not to be a reasonably accessible roadside location as determined by our authorized technician and tow service provider.

For additional information refer to the Mercedes-Benz Roadside Assistance Program Brochure in your glove box.

Change of address or ownership

If you change your address, be sure to send in the “Change of Address Notice” found in the Service and Warranty Information Booklet, or simply call the Mercedes-Benz Customer Assistance Center (in the USA) at 1-800-FOR-MER-Cedes, or Customer Service (in Canada) at 1-800-387-0100. It is in your own interest that we can contact you should the need arise.

If you sell your Mercedes, please leave all literature with the vehicle to make it available to the next operator.

If you bought this vehicle used, be sure to send in the “Notice of Purchase of Used Truck” found in the Service and Warranty Information Booklet, or call the Mercedes-Benz Customer Assistance Center (in the USA) at 1-800-FOR-MER-Cedes, or Customer Service (in Canada) at 1-800-387-0100.

Operating your vehicle outside the USA or Canada

If you plan to operate your vehicle in foreign countries, please be aware that:

- service facilities or replacement parts may not be readily available,
- unleaded gasoline for vehicles with catalytic converters may not be available; the use of leaded fuels will damage the catalyts,
- gasoline may have a considerably lower octane rating, and improper fuel can cause engine damage.

Certain Mercedes-Benz models are available for delivery in Europe under our European Delivery Program. For details, consult your authorized Mercedes-Benz Center or write to:

In the USA:

Mercedes-Benz USA, LLC
European Delivery Department
One Mercedes Drive
Montvale, NJ 07645-0350

In Canada:

Mercedes-Benz Canada, Inc.
European Delivery Department
849 Eglinton Avenue East
Toronto, Ontario M4G 2L5

Introduction

Operator's Manual

Warning!



This Sport Utility Vehicle is designed for both on-road and off-road use. It can go places and perform tasks for which conventional 2-wheel drive passenger cars are not intended. This vehicle will handle and maneuver differently from conventional passenger cars in driving conditions which may occur on streets, highways and off-road use.

This vehicle has a higher ground clearance and a higher center of gravity than many passenger cars. As with other vehicles of this type, if you make sharp turns at excessive speeds or abrupt maneuvers, the vehicle may roll over or may go out of control and crash. Utility vehicles have a significantly higher rollover rate than other types of vehicles. Failure to operate this vehicle safely may result in an accident, rollover of the vehicle, and severe or fatal injury.

Before you start to drive this vehicle, read the Operator's Manual. Take time to become familiar with the driving characteristics of this vehicle. Be sure you are familiar with all vehicle controls. Learn how your vehicle handles on different road surfaces. Do not attempt sharp turns at excessive speeds or abrupt maneuvers or other unsafe driving actions that can cause loss of vehicle control. When driving off-road or working the vehicle hard, do not overload it. And, always wear your seat belts at all times. In a rollover crash, an unbelted person is significantly more likely to die than a person wearing a seat belt.

▼ Where to find it

This Operator's Manual is designed to provide comprehensive support information for you, the vehicle operator. Each section has its own reference color so you can find information quickly.

At a glance

Here you will find an overview of all the controls that can be operated from the driver's seat.

Getting started

Here you will find all the information you need for your first drive. You should read this section first if this is your first Mercedes-Benz vehicle or if you are renting or borrowing this vehicle.

Safety and Security

Here you will find descriptions of the safety features of your vehicle.

Controls in detail

Here you will find detailed information about the equipment installed on your vehicle. This section expands on the "Getting started" section and also describes technical innovations. If you are already familiar with the basic functions of your vehicle, this section will be of particular interest to you.

Operation

Here you will find all the information you need for the proper operation of your vehicle.

Practical hints

This section provides fast assistance for dealing with problems you may encounter.

Technical data

All important technical data for your vehicle can be found in this section.

Indexes

The glossary provides explanations of the most important technical terms.

The table of contents and the index are designed to help you find information quickly and easily.

The following publications are part of your vehicle documentation:

- this Operator's Manual
- the Service Booklet

Separate operating instructions will be provided as required depending on the equipment options installed in your vehicle.

Introduction

Symbols

▼ Symbols

The following symbols are found in this Operator's Manual:

- * Optional equipment is identified with an asterisk. Since standard equipment varies between models, the descriptions and illustrations in this manual may differ slightly from the actual equipment of your vehicle.

Warning!



Warning notices draw your attention to hazards that may endanger your health or life, or the health or life of others.



Highlights hazards that may result in damage to your vehicle.



Helpful hints or further information you may find useful.

- ▶ This symbol points to instructions for you to follow.
- ▶ A number of these symbols appearing in succession indicates a multiple-step procedure.
- ▷ Page This symbol tells you where to look for further information on a topic.
- ▷▷ This continuation symbol marks an interrupted procedure which will be continued on the next page.
- > In the glossary of technical terms, this symbol is used to indicate cross-references to term definitions.
- Display Words appearing in the multi-function display are printed in the type shown here.

▼ Operating safety

Warning!



Work improperly carried out on electronic components and associated software could cause them to cease functioning. Because the vehicle's electronic components are interconnected, any modifications made may produce an undesired effect on other systems. Electronic malfunctions could seriously impair the operating safety of your vehicle.

See your authorized Mercedes-Benz Light Truck Center for repairs or modifications to electronic components.

Other improper work or modifications on the vehicle could also have a negative impact on the operating safety of the vehicle.

Some safety systems only function while the engine is running. You should therefore never turn off the engine while driving.

Warning!



Heavy blows against the vehicle underbody or tires / wheels, for example when running over an obstacle, road debris or a pothole, may cause serious damage and impair the operating safety of your vehicle. If you feel a sudden significant vibration or ride disturbance, or you suspect that damage to your vehicle has occurred, you should turn on your hazard warning flashers, carefully slow down, and drive with caution to an area which is a safe distance from the road.

Inspect the vehicle underbody and tires / wheels for possible damage. If the vehicle appears unsafe, have it towed to the nearest authorized Mercedes-Benz Light Truck Center or other qualified maintenance or repair facility for further inspection or repairs.

Proper use of the vehicle

Proper use of the vehicle requires that you are familiar with the following information and rules:

- the safety precautions in this manual
- the “Technical data” section in this manual
- traffic rules and regulations
- motor vehicle laws and safety standards

Warning!



Various warning labels are attached to your vehicle. These warning labels are intended to make you and others aware of various risks. You should not remove any of these warning labels unless explicitly instructed to do so by information on the label itself. Removal of any of these labels may cause you and others to be unaware of certain risks which may result in an accident and/or personal injury.

Introduction

Problems with your vehicle

▼ Problems with your vehicle

If you should experience a problem with your vehicle, particularly one that you believe may affect its safe operation, we urge you to immediately contact your authorized Mercedes-Benz Light Truck Center to have the problem diagnosed and corrected if required. If the matter is not handled to your satisfaction, please discuss the problem with the Mercedes-Benz Light Truck Center management, or if necessary contact us at one of the following addresses:

In the USA:

Customer Assistance Center
Mercedes-Benz USA, LLC
One Mercedes Drive
Montvale, NJ 07645-0350

In Canada:

Customer Relations Department
Mercedes-Benz Canada, Inc.
849 Eglinton Avenue East
Toronto, Ontario, M4G 2L5

▼ **Reporting safety defects**

For the USA only:

The following text is published as required of manufacturers under Title 49, Code of U.S. Federal Regulations, Part 575 pursuant to the “National Traffic and Motor Vehicle Safety Act of 1966”.

Reporting safety defects

If you believe that your vehicle has a defect which could cause a crash or could cause injury or death, you should immediately inform the National Highway Traffic Safety Administration (NHTSA) in addition to notifying Mercedes-Benz USA, LLC.

If NHTSA receives similar complaints, it may open an investigation, and if it finds that a safety defect exists in a group of vehicles, it may order a recall and remedy campaign. However, NHTSA cannot become involved in individual problems between you, your dealer, or Mercedes-Benz USA, LLC.

To contact NHTSA, you may either call the Auto Safety Hotline toll-free at 1-888-327-4236 (or 366-0123 in Washington, D.C. area) or write to: NHTSA, U.S. Department of Transportation, Washington, D.C. 20590. You can also obtain other information about motor vehicle safety from the Hotline.





At a glance

Cockpit

Instrument cluster

Multifunction steering wheel

Center console

Overhead control panel

Door control panel

At a glance

Cockpit

▼ Cockpit



	Item	Page
①	Combination switch	
	• Turn signals	46
	• Windshield wipers	47
	• High beam	46
②	Headlamp cleaning system	153
③	Cruise control lever	169
④	Instrument cluster	24
⑤	Lever for voice control system*, see separate operating instructions	

	Item	Page
⑥	Starter switch	33
⑦	Glove box	183
⑧	Multifunction steering wheel	26, 116, 203
⑨	Horn	
⑩	Steering wheel adjustment stalk	37, 203
⑪	Exterior lamp switch	46, 104
⑫	Exterior rear view mirror adjustment	38

At a glance

Instrument cluster





▼ Instrument cluster





P54.32-2313-31

At a glance

Instrument cluster

	Item	Page
①	Reset button for:	
	• Resetting trip odometer	113
	• Resetting individual or all settings	123, 125, 137, 243
	• Instrument cluster illumination	112
②	 Left turn signal indicator lamp	24
③	 Engine malfunction indicator lamp	256
	 Electronic Stability Program (ESP) warning lamp	78, 257
	 High beam headlamp indicator	47, 108

	Item	Page
④	 Right turn signal indicator lamp	24
⑤	Fuel gauge with:	
	Fuel reserve warning lamp	24
	 Supplemental Restraint System (SRS) indicator lamp	60, 258
	 Seat belt non-usage warning lamp	62, 258
⑥	Multifunction display with:	115
	Trip odometer	24
	Main odometer	24
	Transfer case program mode	145
	Gear selector lever position	140
	Outside temperature indicator	114
	Clock (see COMAND operating instructions)	115





	Item	Page
⑦	Speedometer	
⑧	Tachometer with:	
	 Brake warning lamp (USA only)	44, 254
	 Brake warning lamp (Canada only)	44, 254
	 ABS indicator lamp	74, 252





At a glance

Multifunction steering wheel

▼ Multifunction steering wheel



Item	Page
① Multifunction display in speedometer	115
Operating control system:	116
② Selecting the submenu or setting the volume	
<ul style="list-style-type: none">  down / to decrease  up / to increase 	
③ Telephone*: Press button	
<ul style="list-style-type: none">  to take a call  to end a call 	

Item	Page
④ Menu systems: Press button	
<ul style="list-style-type: none">  for next system  for previous system 	
⑤ Moving within a menu: Press button	
<ul style="list-style-type: none">  for next display  for previous display 	

At a glance

Center console

▼ Center console

Upper part

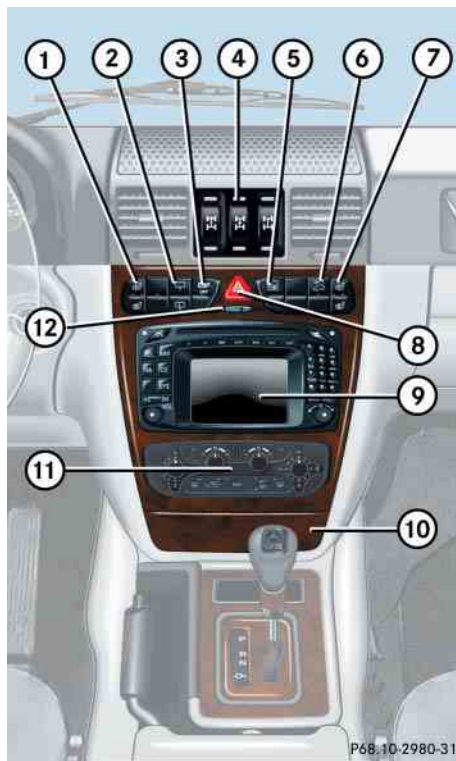

Item	Page
① Left front seat heater switch	98
② Switch for rear window wiper/washer	49
③ ESP control switch	79
④ Differential lock switches	150
⑤ Central locking switch	92
⑥ Anti-theft alarm system indicator lamp	82
Tow-away alarm switch	83
⑦ Right front seat heater switch	98

Item	Page
⑧ Hazard warning flasher switch	108
⑨ COMAND system, see separate operating instructions	
⑩ Ashtray with lighter	186, 188
⑪ Climate control	156
⑫ AIRBAG OFF indicator lamp	68, 259

At a glance

Center console

Lower part



Item	Page
① Storage tray	
② Gear selector lever for automatic transmission	43, 140
③ Transfer case switch	145
④ Parking brake	44, 51

At a glance

Overhead control panel

▼ Overhead control panel

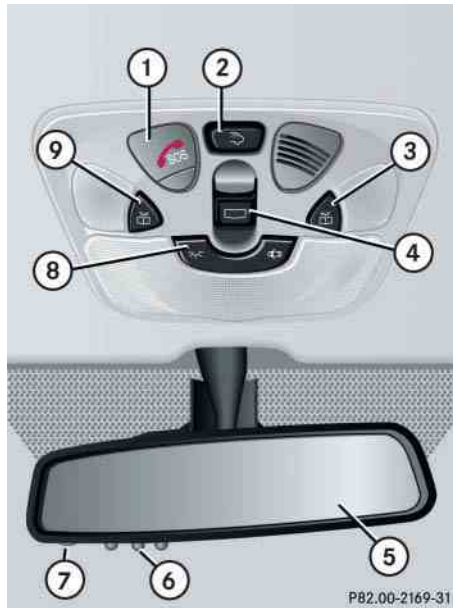

Item	Page
① Tele Aid (emergency call system)	190
② Cargo compartment lamps	110
③ Right front reading lamp	109
④ Sliding/pop-up roof	166
⑤ Interior rear view mirror	38

Item	Page
⑥ Signal transmitter keys for garage door opener	198
⑦ Indicator lamp for garage door opener	198
⑧ Interior lighting control	109
⑨ Left front reading lamp	109

At a glance

Door control panel

▼ Door control panel



Item	Page
① Switches for opening/closing power window	164
Switch for rear door window override	71
② Seat adjustment	34, 94
③ Door handle	89
④ Memory function (for storing seat, exterior mirrors and steering wheel settings)	101



Getting started

Unlocking

Adjusting

Driving

Parking and locking

Getting started

Unlocking

The “Getting started” section provides an overview of the vehicle’s most basic functions. First-time Mercedes-Benz owners should pay special attention to the information given here.



If you are already familiar with the basic functions described here, the “Controls in detail” section will help you with further information. The corresponding page references are at the end of each segment.

▼ Unlocking

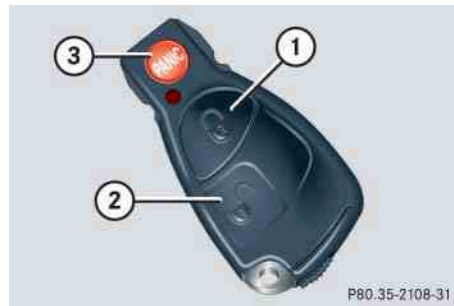
Unlocking with the SmartKey



SmartKey with remote control

- ①  Lock button
- ②  Unlock button
- ③  Panic button (▷ page 73)

- ▶ Press unlock button  on the SmartKey.

All turn signal lamps blink once. The locking knobs in the doors move up.

- ▶ Get in the vehicle and insert the SmartKey in the starter switch.

For more information, see “Locking and unlocking” (▷ page 86).

Starter switch positions

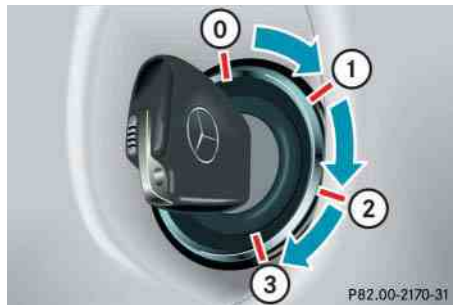

Starter switch

- 0** For removing SmartKey
The steering is locked when the SmartKey is removed from the starter switch. If necessary, move steering wheel slightly to allow the locking mechanism to engage.
- 1** Power supply to some electrical consumers, such as seat adjustment
- 2** Ignition (power supply for all electrical consumers) and driving position
- 3** Starting position

Warning!



When leaving the vehicle, always remove the SmartKey from the starter switch and lock the vehicle. Do not leave children unattended in the vehicle, or with access to an unlocked vehicle. Unsupervised use of vehicle equipment may cause an accident and/or serious personal injury.



The SmartKey can only be removed from the starter switch with the gear selector lever in position **P**.



If the SmartKey cannot be turned, the battery may not be sufficiently charged.

- Check the battery and charge it if necessary (▷ page 311).
- Get a jump start (▷ page 313).

To prevent accelerated battery discharge and a possible dead battery, always remove the SmartKey from the starter switch when the engine is not in operation.

Getting started

Adjusting

▼ Adjusting

Warning!



All seat, head restraint, steering wheel, and rear view mirror adjustments, as well as fastening of seat belts, must be done before the vehicle is put into motion.

Seats

Warning!



Do not adjust the driver's seat while driving. Adjusting the seat while driving could cause the driver to lose control of the vehicle.

Never ride in a moving vehicle with the seat back reclined. Sitting in an excessively reclined position can be dangerous. You could slide under the seat belt in a collision. If you slide under it, the belt would apply force at the abdomen or neck. That could cause serious or fatal injuries.

The seat back and seat belts provide the best restraint when the wearer is in an upright position and belts are properly positioned on the body. Your seat must be adjusted so that you can correctly fasten your seat belt (▷ page 40).

Never place hands under the seat or near any moving parts while a seat is being adjusted.

Warning!



When leaving the vehicle, always remove the SmartKey from the starter switch, and lock your vehicle.

The power seats can also be operated with the driver's or front passenger door open. Do not leave children unattended in the vehicle, or with access to an unlocked vehicle. Unsupervised use of vehicle equipment may cause an accident and/or serious personal injury.

Warning!



Children 12 years old and under must never ride in the front seat, except in a Mercedes-Benz authorized BabySmart™ compatible child seat, which operates with the BabySmart™ system installed in the vehicle to deactivate the passenger front airbag when it is properly installed. Otherwise they will be struck by the airbag when it inflates in a crash. If this happens, serious or fatal injury will result.

According to accident statistics, children are safer when properly restrained in the rear seating positions than in the front seating positions. Infants and small children must ride in the back seats and be seated in an appropriate infant or child restraint system, which is properly secured with the vehicle's seat belt and top tether strap, or secured via lower anchors and top tether strap, fully in accordance with the child seat manufacturer's instructions.

A child's risk of serious or fatal injuries is significantly increased if the child restraints are not properly secured in the vehicle and the child is not properly secured in the child restraint.

Seat adjustment

The seat adjustment switches are located in each front door.



- ① Head restraint height
- ② Seat backrest tilt
- ③ Seat fore and aft adjustment
- ④ Seat cushion tilt
- ⑤ Seat height

- ▶ Turn the SmartKey in the starter switch to position **1** or **2** (▷ page 33).

or

- ▶ Open the driver's or front passenger door.

Seat fore and aft adjustment

- ▶ Press the switch forward or back in the direction of arrow ③.

Adjust to a comfortable seating position that still allows you to reach the accelerator/brake pedal safely. The position should be as far to the rear as possible, consistent with ability to properly operate controls.

Getting started

Adjusting



When moving the seat, be sure that

- there are no items in the footwell or behind the seats
- the cup holder next to the armrest is removed (▷ page 185)
- the cup holder in the front passenger footwell is folded closed (▷ page 185)

Otherwise you could damage the seats and/or cup holders.

The memory function (▷ page 101) lets you store the setting for the seat position together with the setting for the steering wheel and the exterior rear view mirrors.

Getting started

Adjusting

Seat cushion tilt

- ▶ Press the switch up or down in the direction of arrow ④ until your upper legs are lightly supported.

Seat backrest tilt

- ▶ Press the switch forward or backward in the direction of arrow ② until your arms are slightly angled when holding the steering wheel.

Seat height

- ▶ Press the switch up or down in the direction of arrow ⑤.
Make sure you have sufficient headroom.

Head restraint height

- ▶ Press the switch up or down in the direction of arrow ①.

Warning!



For your protection, drive only with properly positioned head restraints.

Adjust head restraint so that the head restraint supports the back of the head at eye level. This will reduce the potential for injury to the head and neck in the event of an accident or similar situation.

Do not drive the vehicle without the seat head restraints. Head restraints are intended to help reduce injuries during an accident.

Adjust head restraint to support the back of the head approximately at eye level.

Head restraint tilt



Manually adjust the angle of the head restraint.

- ▶ Push or pull on the upper edge of the head restraint cushion.

For more information, see “Seats” (▷ page 94).

Steering wheel

Warning!



Do not adjust the steering wheel while driving. Adjusting the steering wheel while driving, or driving without the adjustment locked could cause the driver to lose control of the vehicle.

When leaving the vehicle, always remove the SmartKey from the starter switch, and lock your vehicle.

The steering wheel adjustment feature can also be operated with the driver's door open. Do not leave children unattended in the vehicle, or with access to an unlocked vehicle. Unsupervised use of vehicle equipment may cause an accident and/or serious personal injury.

The stalk is located on the steering column (lower left).



- ① Adjusting steering column, in or out
- ② Adjusting steering column, up or down

- ▶ Turn the SmartKey in the starter switch to position **1** or **2** (▷ page 33).
or
- ▶ Open the driver's door.

Getting started

Adjusting

Adjusting steering column in or out

- ▶ Move stalk forward or back in the direction of arrow ① until a comfortable steering wheel position is reached with your arms slightly bent at the elbow.

Adjusting steering column up or down

- ▶ Move stalk up or down in the direction of arrow ②.

Make sure your legs can move freely and that all the displays (incl. malfunction and indicator lamps) on the instrument cluster are clearly visible.



The memory function (▷ page 101) lets you store the setting for the steering wheel together with the setting for the seat position and the exterior rear view mirrors.

For more information, see “Heated steering wheel” (▷ page 203).

Getting started

Adjusting

Mirrors

Adjust the interior and exterior rear view mirrors before driving so that you have a good view of the road and traffic conditions.

Warning!



In the case of an accident, liquid electrolyte may escape the mirror housing if the mirror glass breaks.

Electrolyte has an irritating effect. Do not allow the liquid to come into contact with eyes, skin, clothing, or the respiratory system. In case it does, immediately flush affected area with water, and seek medical help if necessary.



Electrolyte drops coming into contact with the vehicle paint finish can only be completely removed while in their liquid state and by applying plenty of water.

Interior rear view mirror

- ▶ Manually adjust the interior rear view mirror.

Exterior rear view mirror

Warning!



Exercise care when using the passenger-side exterior rear view mirror. The mirror surface is convex (outwardly curved surface for a wider field of view). Objects in mirror are closer than they appear. Check your interior rear view mirror or glance over your shoulder before changing lanes.

The buttons are located above the exterior lamp switch.

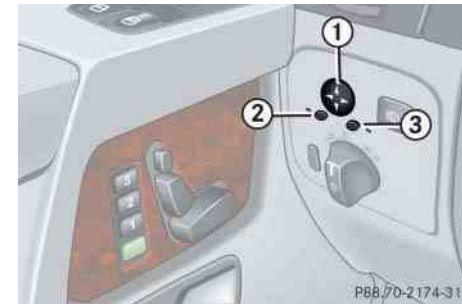

- ① Adjustment button
- ② Driver's side mirror
- ③ Passenger-side mirror

- ▶ Make sure the ignition is switched on. All the lights in the instrument cluster come on.
- ▶ Press button ② for driver's side exterior rear view mirror or button ③ for passenger-side exterior rear view mirror.
- ▶ Push adjustment button ① up, down, left or right according to the setting desired.



The memory function (▷ page 101) lets you store the setting for the exterior rear view mirrors together with the setting for the steering wheel and the seat position.



If an exterior rear view mirror housing is forcibly pushed forward or rearward, reposition it by applying firm pressure until it snaps into place. The exterior rear view mirror housing is now properly positioned and you can adjust the mirror normally.

For more information, see “Storing exterior rear view mirror parking position” (▷ page 103).

Getting started

Driving

▼ Driving

Warning!



Do not lay any objects in the driver's footwell. Be careful that floor mats or carpets in the driver's footwell have sufficient clearance for the pedals.

During sudden driving or braking maneuvers, the objects could get caught between the pedals. You could then no longer brake or accelerate.

Fastening the seat belt

Warning!



Always fasten your seat belt before driving off. Always make sure your passengers are properly restrained, even those sitting in the rear and pregnant women.

Failure to wear and properly fasten and position your seat belt greatly increases your risk of injuries and their likely severity in an accident. You and your passengers should always wear seat belts.

If you are ever in an accident, your injuries can be considerably more severe without your seat belt properly buckled. Without your seat belt buckled, you are much more likely to hit the interior of the vehicle or be ejected from it. You can be seriously injured or killed.

In the same crash, the possibility of injury or death is lessened if you are wearing your seat belt. The airbags can only protect as expected if the occupants are using their seat belts (> page 56).

Warning!



Children 12 years old and under must never ride in the front seat, except in a Mercedes-Benz authorized BabySmartTM¹ compatible child seat, which operates with the BabySmartTM system installed in the vehicle to deactivate the passenger front airbag when it is properly installed. Otherwise they will be struck by the airbag when it inflates in a crash. If this happens, serious or fatal injury will result.

According to accident statistics, children are safer when properly restrained in the rear seating positions than in the front seating positions. Infants and small children must ride in back seats and be seated in an appropriate infant or child restraint system, which is properly secured with the vehicle's seat belt and top tether strap, or secured via lower anchors and top tether strap, fully in accordance with the child seat manufacturer's instructions.

¹ BabySmartTM is a trademark of Siemens Automotive Corp.

A child's risk of serious or fatal injuries is significantly increased if the child restraints are not properly secured in the vehicle and the child is not properly secured in the child restraint.

Warning!



Never ride in a moving vehicle with the seat backrest reclined. Sitting in an excessively reclined position can be dangerous. You could slide under the seat belt in a collision. If you slide under it, the belt would apply force at the abdomen or neck. That could cause serious or even fatal injuries. The seat backrest and seat belt provide the best restraint when the wearer is in an upright position and the belt is properly positioned on the body.

Warning!



Never let more people ride in the vehicle than there are seat belts available. Be sure everyone riding in the vehicle is correctly restrained with a separate seat belt.

Warning!



Read and observe the additional warning notices printed in the "Safety and Security" section (▷ page 60) and (▷ page 62).

Getting started

Driving



- ① Latch plate
- ② Buckle
- ③ Release button

- ▶ With a smooth motion, pull the belt from the belt outlet.
- ▶ Place the belt over your shoulder.
- ▶ Push latch plate ① into buckle ② until it clicks. ▷▷

Getting started

Driving

- ▷▷▶ If necessary, tighten the lap portion to a snug fit by pulling shoulder portion up.

Proper use of seat belts

- Do not twist the belt when fastening.
- Adjust seat belt so that the shoulder portion is located as close as possible to the middle of the shoulder (it should not touch the neck or pass under the arm). For this purpose, you can adjust the height of the belt outlet, see below.
- Position the lap belt as low as possible on your hips (over hip joint) and not across the abdomen.
- Place the seat backrest in a nearly upright position.
- Never use a seat belt for more than one person at a time.
- Do not fasten a seat belt around a person and another object at the same time.

- Check your seat belt during travel to ensure it is properly positioned.
- Make sure the seat belt is always fitted snugly. You should avoid wearing bulky clothing, such as winter coats, when traveling in the vehicle.

Warning!



Do not pass belts over sharp edges. They could tear.

Do not allow the belt to get caught in the door or in the seat adjustment mechanism. This could damage the belt.

Never attempt to make modifications to seat belts. This could impair the effectiveness of the belts.

Damaged seat belts or belts that were highly stressed in an accident must be replaced. Contact an authorized Mercedes-Benz Light Truck Center.

Seat belt height adjustment

Adjust the height so that the upper part of the belt runs over the middle of the shoulder.



- ① Button for belt outlet height adjustment

Adjusting belt outlet higher

- ▶ Slide belt outlet upward.

The belt outlet engages in five various positions.

Adjusting belt outlet lower

- ▶ Press and hold release button ①.
- ▶ Slide belt outlet in desired position.
- ▶ Let go of release button ①.

Please comply with the instructions for “Proper use of seat belts” (▷ page 42).

Starting the engine**Warning!**

Inhalation of exhaust gas is hazardous to your health. All exhaust gas contains carbon monoxide, and inhaling it can cause unconsciousness and lead to death.

Do not run the engine in confined areas (such as garage) which are not properly ventilated. If you think that exhaust gas fumes are entering the vehicle while driving, have the cause determined and corrected immediately. If you must drive under these conditions, drive only with at least one window fully open.

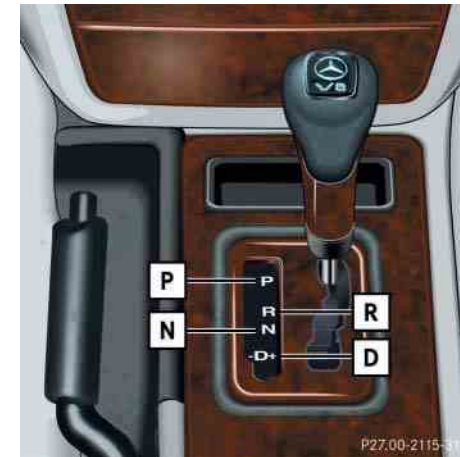
Automatic transmission**Gearshift pattern for automatic transmission**

- P** Park position with gear selector lever lock
- R** Reverse gear
- N** Neutral
- D** Drive position

For more information, see “Automatic transmission” (▷ page 140).

Getting started

Driving

Starting

- ▶ Make sure the gear selector lever is set to **P**.
- ▶ Do not depress accelerator.
- ▶ Turn SmartKey in the starter switch to position **3** and hold until the engine starts (▷ page 33).



You can also use the “touch-start” function. Turn the SmartKey to position **3** and release it again immediately. The engine then starts automatically.

- ▶ Depress the brake pedal.

The gear selector lever lock is released.

For information on turning off the engine, see “Turning off engine” (▷ page 52).

Starting difficulties

If the engine does not start as described, carry out the following steps:

- ▶ Turn SmartKey in starter switch to position **0** and repeat starting procedure.
- ▶ Remember that extended starting attempts can drain the battery.
- ▶ Get a jump start (▷ page 313).

If the engine does not start after several starting attempts, there could be a malfunction in the engine electronics or in the fuel supply system.

- ▶ Notify an authorized Mercedes-Benz Light Truck Center.

Parking brake

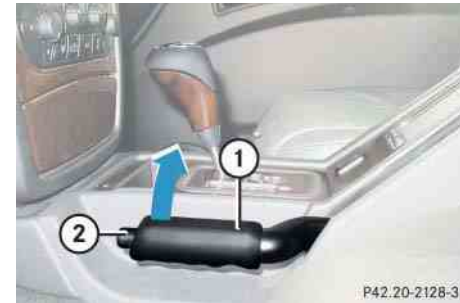

- ① Lever
- ② Button

Warning!



When leaving the vehicle, always remove the SmartKey from the starter switch, and lock the vehicle.

Do not leave children unattended in the vehicle, or with access to an unlocked vehicle. Children could release the parking brake, which could result in an accident and/or serious personal injury.

- ▶ Release the parking brake by lifting lever ① up slightly, pressing button ② on the lever and moving lever ① down to the stop.

The warning lamp **BRAKE** (USA only) or **(P)** (Canada only) in the instrument cluster goes out.

Driving

- ▶ Depress the brake pedal.
- ▶ Move gear selector lever to position **D** or **R**.

Warning!



It is dangerous to shift the gear selector lever out of **P** or **N** if the engine speed is higher than idle speed. If your foot is not firmly on the brake pedal, the vehicle could accelerate quickly forward or in reverse. You could lose control of the vehicle and hit someone or something. Only shift into gear when the engine is idling normally and when your right foot is firmly on the brake pedal.



In order to avoid damaging the transmission,

- wait for the gear selection process to complete before setting the vehicle in motion.
- place the gear selector lever in position **R** only when the vehicle is stopped.

- ▶ Release the brake pedal.
- ▶ Carefully depress the accelerator.

Once the vehicle is in motion, the automatic central locking system engages and the locking knobs drop down.



If you hear a warning signal when driving off, you have forgotten to release the parking brake.

Release the parking brake.

After a cold start, the automatic transmission shifts at a higher revolution. This allows the catalytic converter to reach its operating temperature earlier.



Do not run cold engine at high engine speeds. Running a cold engine at high engine speeds may shorten the service life of the engine.



You can open the doors from inside at any time. Open doors only when the conditions are safe to do so.

You can deactivate the automatic locking using the control system (> page 133).



Simultaneously depressing the accelerator pedal and applying the brake reduces engine performance and causes premature brake and drivetrain wear.

Getting started

Driving

Warning!



On slippery road surfaces, never downshift in order to obtain braking action. This could result in drive wheel slip and reduced vehicle control. Your vehicle's ABS will not prevent this type of loss of control.

For more information, see “Driving instructions” (▷ page 207).

For information on off-road driving, see “Off-road driving” (▷ page 213).

Switching on headlamps

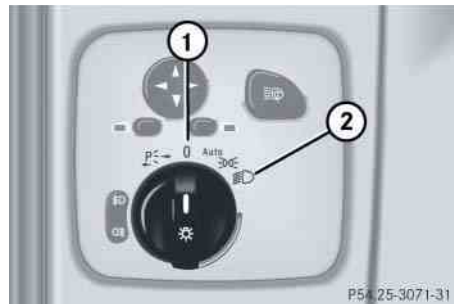

Exterior lamp switch

- ① Off
 - ② Low beam headlamps on
- Turn the switch to .

For more information, see “Exterior lamp switch” (▷ page 104).

Turn signals and high beam

The combination switch is located on the left of the steering column.



Combination switch

- ① Turn signals, right
 - ② Turn signals, left
- Press combination switch up ① or down ②.

The switch is automatically canceled when the steering wheel is turned a sufficient degree.



To signal minor directional changes, move combination switch to point of resistance only and release. The turn signal blinks three times.

High beam

- ▶ Push the combination switch forward.

The high beam headlamp indicator  in the instrument cluster comes on.

For more information, see “High beam flasher” (▷ page 108).

Windshield wipers

The combination switch is located on the left of the steering column.



Combination switch

- ① Single wipe
- ② Switching on windshield wipers

- ▶ Make sure the ignition is switched on.

Getting started

Driving

Switching on windshield wipers

- ▶ Turn the combination switch to the desired position depending on the intensity of the rain.

- 0 Windshield wipers off
- I Intermittent wiping
- II Normal wiper speed
- III Fast wiper speed



The intermittent wiping interval depends on the wetness of the windshield. Wiping will not occur with a front door open.

Getting started

Driving



Do not leave windshield wipers in intermittent setting when vehicle is taken to an automatic car wash or during windshield cleaning. Wipers will operate in the presence of water sprayed on the windshield, and wipers may be damaged as a result.

The switch should not be left in intermittent setting as the wipers will wipe the windshield once every time the engine is started. Dust that accumulates on the windshield might scratch the glass and / or damage the wiper blades when wiping occurs on a dry windshield.

Single wipe

- ▶ Press switch briefly in the direction of arrow ①.

The windshield wipers wipe one time without washer fluid.

Wiping with windshield washer fluid

- ▶ Push switch in the direction of arrow ① past the resistance point.

The windshield wipers operate with washer fluid until the switch is released.

For information on filling up the washer reservoir, see “Windshield/rear window washer system and headlamp cleaning system” (▷ page 234).



If anything blocks the windshield wipers (leaves, snow, etc.), switch them off immediately.

- For safety reasons, withdraw SmartKey from starter switch before attempting to remove any blockage.
- Remove blockage.
- Turn the windshield wipers on again.

If windshield wipers fail to function at all in switch position I,

- set the combination switch to the next highest wiper speed
- have the windshield wipers checked at the nearest authorized Mercedes-Benz Light Truck Center

Rear window wiper/washer

The rear window wiper / washer switch is located on the upper part of the center console.

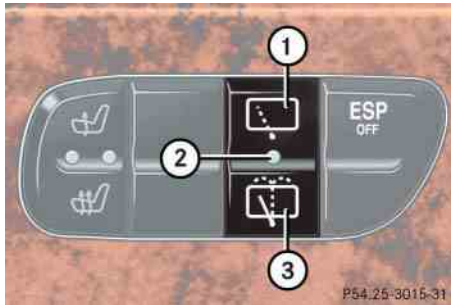

- ① Interval wiping on/off
- ② Indicator lamp
- ③ Simultaneous operation of wiper and washer



The rear window wiper will also automatically engage if

- the windshield wipers are engaged
- the gear selector lever is placed in **R** “Reverse”

- ▶ Make sure the ignition is switched on.

Interval wiping

Switching on

- ▶ Press upper half ① of the switch.
The indicator lamp ② comes on.

Switching off

- ▶ Press upper half ① of the switch again.
The indicator lamp ② goes out.

Wiping with windshield washer fluid

- ▶ Press and hold lower half ③ of the switch.

The wiper operates with washer fluid. The rear window will be wiped for approximately another five seconds after the switch is released.

For information on filling up the washer reservoir, see “Windshield/rear window washer system and headlamp cleaning system” (▷ page 234).

Getting started

Driving

Problems while driving

The engine runs erratically and misfires

- An ignition cable may be damaged.
- The engine electronics may not be operating properly.
- Unburned gasoline may have entered the catalytic converter and damaged it.
- ▶ Give very little gas.
- ▶ Have the problem repaired by an authorized Mercedes-Benz Light Truck Center as soon as possible.

The coolant temperature is over 248°F (120°C)

The coolant is too hot and is no longer cooling the engine.

- ▶ Stop the vehicle as soon as possible and turn off the engine. Allow engine and coolant to cool down.
- ▶ Check the coolant level and add coolant if necessary (▷ page 232).



Excessive coolant temperatures trigger a warning message in the multifunction display (▷ page 269).

In case of accident

If the vehicle is leaking gasoline:

- ▶ Do not start the engine under any circumstances.
- ▶ Notify local fire and/or police authorities.

If the extent of the damage cannot be determined:

- ▶ Notify an authorized Mercedes-Benz Light Truck Center.

If no damage can be determined on the

- major assemblies
- fuel system
- engine mount
- ▶ Start the engine in the usual manner.

▼ Parking and locking

You have now completed your first drive. You have properly stopped and parked your vehicle. End your drive as follows.

Warning!



Wait until the vehicle is stationary before removing the SmartKey from the starter switch. The vehicle cannot be steered when the SmartKey is removed.

Warning!



With the engine not running, there is no power assistance for the brake and steering systems. In this case, it is important to keep in mind that a considerably higher degree of effort is necessary to brake and steer the vehicle.

Warning!



Do not park this vehicle in areas where combustible materials such as grass, hay or leaves can come into contact with the hot exhaust system, as these materials could be ignited and cause a vehicle fire.

To reduce the risk of personal injury as a result of vehicle movement, before turning off the engine and leaving the vehicle always:

- Keep right foot on brake pedal.
- Pull the parking brake lever up as many notches as possible.
- Move the gear selector lever to position **P**.
- Slowly release brake pedal.
- When parked on an incline, turn front wheels towards the road curb.
- Turn the SmartKey to starter switch position **0** and remove.
- Take the SmartKey and lock vehicle when leaving.

Getting started

Parking and locking

Parking brake



① Lever

② Button

- ▶ Pull lever ① up as many notches as possible.

When the engine is running, the warning lamp **BRAKE** (USA only) or  (Canada only) in the instrument cluster will be illuminated.

Getting started

Parking and locking

Warning!



When leaving the vehicle, always remove the SmartKey from the starter switch, and lock the vehicle. Do not leave children unattended in the vehicle, or with access to an unlocked vehicle. Children could release the parking brake and/or move the gear selector lever from position **P**, either of which could result in an accident and/or serious personal injury.

Warning!



Getting out of your vehicle with the gear selector lever not fully engaged in position **P** is dangerous. Also, when parked on an incline, position **P** alone may not prevent your vehicle from moving, possibly hitting people or objects.

Always set the parking brake in addition to shifting to position **P**.

When parked on an incline, turn front wheels towards the road curb.

Switching off headlamps

- ▶ Turn the exterior lamp switch to **0** (▷ page 46).

For more information, see “Exterior lamp switch” (▷ page 104).

Turning off engine

- ▶ Place the gear selector lever in position **P**.



Always set the parking brake in addition to shifting to position **P**.

On slopes, turn the front wheels towards the road curb.

- ▶ Turn SmartKey in the starter switch to position **0** and remove it. The immobilizer is activated.



The SmartKey can only be pulled out when:

- it has been turned to position **0** in the starter switch
- the gear selector lever for the automatic transmission is in position **P**
- you are not depressing the brake pedal

- ▶ Press the seat belt release button ③ (▷ page 41).

Allow the retractor to completely re-wind the seat belt by guiding the latch plate.



With the SmartKey removed and the driver's door open, a warning sounds if the vehicle's exterior lamps are not switched off.

Warning!



To prevent possible personal injury, always keep hands and fingers away from the door openings when closing the doors. Be especially careful when small children are around.

Before closing doors, ensure there is no possibility of someone getting caught in a door during closing.

- ▶ After exiting the vehicle, press the lock button  on the SmartKey (▷ page 32).

The locking knobs on the doors move down.

Getting started

Parking and locking

Warning!



When leaving the vehicle, always remove the SmartKey from the starter switch, and lock your vehicle. Do not leave children unattended in the vehicle, or with access to an unlocked vehicle. Unsupervised use of vehicle equipment may cause an accident and/or serious personal injury.

For more information, see “Locking and unlocking” (▷ page 86).



Safety and Security

Occupant safety

Panic alarm

Driving and safety systems

Anti-theft systems

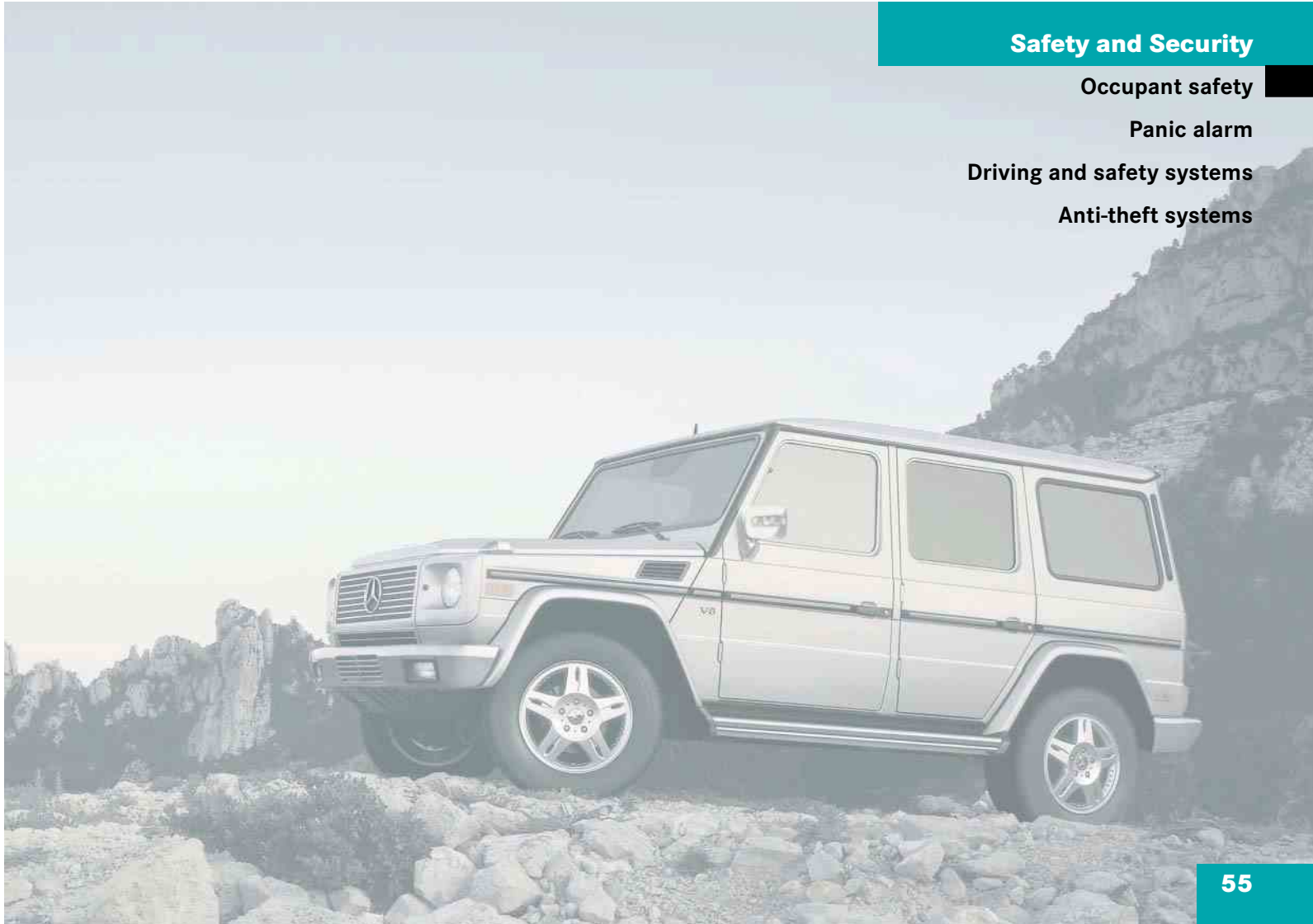

Safety and Security

Occupant safety

In this section you will learn the most important facts about the restraint systems of the vehicle.

▼ Occupant safety

The restraint systems are

- Seat belts
- Emergency tensioning device
- Airbags
- Child seats
- Child seat recognition
- Lower anchors and tethers for children (LATCH)

As independent systems, their protective effects work in conjunction with each other.



For information on infants and children traveling with you in the vehicle and restraint systems for infants and children, see “Children in the vehicle” (▷ page 65).

The **SRS** indicator lamp in the instrument cluster (▷ page 25) comes on:

- for about four seconds when you turn the SmartKey in the starter switch to position **1**.
- for about four seconds when you start the engine by turning the SmartKey.



The **SRS** indicator lamp remains lit if the SmartKey is turned to position **2** and left there. The indicator lamp will go out when you start the engine.

The **SRS** indicator lamp goes out shortly after you start the engine. This shows that the restraint systems are operational.

A malfunction in the system has been detected if the **SRS** indicator lamp:

- fails to extinguish after approximately four seconds.
- does not come on at all.
- comes on after the engine was started or while driving.

For safety reasons, we strongly recommend that you visit an authorized Mercedes-Benz Light Truck Center immediately to have the system checked.

For more information, see “Practical hints” (▷ page 258).

Warning!



In the event that the **SRS** indicator lamp comes on during driving or does not come on at all, the SRS may not be operational. For your safety, we strongly recommend that you visit an authorized Mercedes-Benz Light Truck Center immediately to have the system checked; otherwise the SRS may not be activated when needed in an accident, which could result in serious or fatal injury, or it might deploy unexpectedly and unnecessarily which could also result in injury.

Improper work on the restraint systems, including incorrect installation and removal, can lead to possible injury through an unintended activation of the SRS.

In addition, through improper work there is a risk of rendering the SRS inoperative or causing unintended airbag deployment. Work on the SRS must therefore only be performed by qualified technicians. Contact an authorized Mercedes-Benz Light Truck Center.

Airbags

Warning!



Airbags are designed to reduce the potential of injury in certain frontal (front airbags) impacts, which may cause significant injuries. However, no system available today can totally eliminate injuries and fatalities.

The activation of the SRS temporarily releases a small amount of dust from the airbags. This dust, however, is neither injurious to your health, nor does it indicate a fire in the vehicle. The dust might cause some temporary breathing difficulty for people with asthma or other breathing trouble. To avoid this, you may wish to get out of the vehicle as soon as it is safe to do so. If you have any breathing difficulty but cannot get out of the vehicle after the airbag inflates, then get fresh air by opening a window or door.

Safety and Security

Occupant safety

Warning!



The service life of the passenger front airbag extends to the date indicated on the label located on the driver side B pillar. To provide continued reliability after that date, they should be inspected by an authorized Mercedes-Benz Light Truck Center at that time and replaced when necessary.

Warning!



To reduce the risk of injury when the front airbags inflate, it is very important for the driver and front passenger to always be in a properly seated position and to wear your seat belt.

For maximum protection in the event of a collision always be in normal seated position with your back against the backrest. Fasten your seat belt and ensure it is properly positioned on your body (▷ page 62).

Since the airbag inflates with considerable speed and force, a proper seating and hands on steering wheel position will help to keep you at a safe distance from the airbag. Occupants who are unbelted, out of position or too close to the airbag can be seriously injured by an airbag as it inflates with great force in the blink of an eye:

- Sit properly belted in an upright position with your back against the backrest.

- Adjust the driver seat as far as possible rearward, still permitting proper operation of vehicle controls. The distance from the center of the driver's breastbone to the center of the airbag cover on the steering wheel must be at least ten inches (25 cm) or more. You should be able to accomplish this by a combination of adjustments to the seat and steering wheel. If you have any problems, please see your authorized Mercedes-Benz Light Truck Center.
- Do not lean with your head or chest close to the steering wheel or dashboard.
- Keep hands on the outside of steering wheel rim. Placing hands and arms inside the rim can increase the risk and potential severity of hand/arm injury when driver front airbag inflates.
- Adjust the front passenger seat as far as possible rearward from the dashboard when the seat is occupied.

- Always sit upright, properly use the seat belts and appropriate size infant or child restraint system.
- Children 12 years old and under must never ride in the front seat, except in a Mercedes-Benz authorized BabySmart™¹ compatible child seat, which operates with the BabySmart™ system installed in the vehicle to deactivate the passenger front airbag when it is properly installed. Otherwise they will be struck by the airbag when it inflates in a crash. If this happens, serious or fatal injury will result.

Failure to follow these instructions can result in severe injuries to you or other occupants.

If you sell your vehicle you are responsible to make the buyer aware of these points. Make sure to give the buyer this Operator's Manual.

¹ BabySmart™ is a trademark of Siemens Automotive Corp.

Warning!



Accident research shows that the safest place for children in an automobile is in the rear seat. Should you choose to place a child 12 years old or under in the front passenger seat of your vehicle, you must properly use a BabySmart™ child restraint which will turn off the passenger front airbag (▷ page 68).

Safety and Security

Occupant safety



Airbags are designed to activate only in certain frontal (front airbags) impacts which exceed preset thresholds.

Only during these types of impacts, if of sufficient severity to meet the deployment thresholds, will they provide their supplemental protection.

The driver and passenger should always wear their seat belts. Otherwise it is not possible for the airbags to provide their supplemental protection.

In cases of other frontal impacts, angled impacts, roll-overs, other side impacts, rear collisions, or other accidents, the airbags will not be activated. The driver and passengers will then be protected by the fastened seat belts.

We caution you not to rely on the presence of the airbags in order to avoid wearing your seat belt.

Safety and Security

Occupant safety

Your vehicle was originally equipped with airbags that are designed to activate in certain impacts exceeding a preset threshold to reduce the potential and severity of injury. It is important to your safety and that of your passenger that you replace deployed airbags and repair any malfunctioning airbags to make sure the vehicle will continue to provide supplemental crash protection for occupants.

Safety guidelines for the seat belt, emergency tensioning device and airbag

Warning!



- Damaged seat belts or belts that were highly stressed in an accident must be replaced and their anchoring points must also be checked. Use only belts installed or supplied by an authorized Mercedes-Benz Light Truck Center.
 - No modifications of any kind may be made to any components or wiring of the SRS. This includes changing or removing any component or part of the SRS, the installation of additional trim material, badges, etc. over the steering wheel hub, passenger front airbag cover, or door trim panels, and installation of additional electrical/electronic equipment on or near SRS components and wiring. Keep area between airbags and occupants free from objects (e.g. packages, purses, umbrellas, etc.).
- Airbags and emergency tensioning devices (ETDs) are designed to function on a one-time-only basis. An airbag or ETD that was activated must be replaced.
 - Do not pass belts over sharp edges. They could tear.
 - Do not make any modification that could change the effectiveness of the belts.
 - An airbag system component within the steering wheel gets hot after the airbag has inflated. Do not touch.
 - Improper work on the system, including incorrect installation and removal, can lead to possible injury through an unintended activation of the SRS.

Safety and Security

Occupant safety

- In addition, through improper work there is a risk of rendering the SRS inoperative or causing unintended airbag deployment. Work on the SRS must therefore only be performed by qualified technicians. Contact an authorized Mercedes-Benz Light Truck Center.
- For your protection and the protection of others, when scrapping the airbag unit or emergency tensioning device, our safety instructions must be followed. These instructions are available from your authorized Mercedes-Benz Light Truck Center.
- Given the considerable deployment speed and the textile structure of the airbags, there is the possibility of abrasions or other injuries resulting from airbag deployment.

When you sell your vehicle we strongly urge you to give notice to the subsequent owner that it is equipped with an SRS by alerting them to the applicable section in the Operator's Manual.

Warning!



In the event that the **SRS** indicator lamp comes on while driving, the SRS may not be operational. For your safety, we strongly recommend that you visit an authorized Mercedes-Benz Light Truck Center immediately to have the system checked; otherwise the SRS may not be activated when needed in an accident, which could result in serious or fatal injury, or it might deploy unexpectedly and unnecessarily which could also result in injury.

Front airbags



- ① Driver airbag
- ② Passenger front airbag

Driver and passenger airbags are deployed:

- in the event of a frontal impact
- if impact exceeds a preset deployment threshold

Safety and Security

Occupant safety

The airbags will not deploy in impacts which do not exceed the system's deployment thresholds. You will then be protected by the fastened seat belts.



The passenger front airbag will only be deployed if:

- the passenger seat is occupied
- the  indicator lamp in the center console is not lit (▷ page 68)
- the impact exceeds a preset deployment threshold



Do not place objects heavier than 20 lbs (9 kg) on the front passenger seat. This could cause the passenger front airbag to deploy in a crash which exceeds the system's deployment threshold.

Seat belts

When the engine is started, the seat-belt non-usage warning lamp  illuminates to remind you and your passengers to fasten your seat belts. If the driver's seat belt is not fastened before the engine is started, the seat belt non-usage warning lamp  illuminates and a warning chime sounds for approximately six seconds when the engine is started.

The use of seat belts and infant and child restraint systems is required by law in all 50 states, the District of Columbia and all Canadian provinces. Even where this is not the case, all vehicle occupants should have their seat belts fastened whenever the vehicle is in motion.

For more information, see “Fastening the seat belt” (▷ page 40).



For information on infants and children traveling with you in the vehicle and restraint systems for infants and children, see “Children in the vehicle” (▷ page 65).

Safety and Security

Occupant safety

Warning!



Always fasten your seat belt before driving off. Always make sure your passengers are properly restrained, even those sitting in the rear and pregnant women.

Failure to wear and properly fasten and position your seat belt greatly increases your risk of injuries and their likely severity in an accident. You and your passengers should always wear seat belts.

If you are ever in an accident, your injuries can be considerably more severe without your seat belt properly buckled. Without your seat belt buckled, you are much more likely to hit the interior of the vehicle or be ejected from it. You can be seriously injured or killed.

In the same crash, the possibility of injury or death is lessened if you are properly wearing your seat belt. Airbags can only protect as they are designed if the occupants are properly wearing their seat belts.

Warning!



Never ride in a moving vehicle with the backrest reclined. Sitting in an excessively reclined position can be dangerous. You could slide under the seat belt in a collision. If you slide under it, the belt would apply force at the abdomen or neck. That could cause serious or even fatal injuries. The backrest and seat belt provide the best restraint when the wearer is in an upright position and the belt is properly positioned on the body.

Warning!



Never let more people ride in the vehicle than there are seat belts available. Be sure everyone riding in the vehicle is correctly restrained with a separate seat belt.

Warning!



Damaged seat belts or belts that were highly stressed in an accident must be replaced and their anchoring points must also be checked.

Only use seat belts which have been approved by Mercedes-Benz.

Do not make any modifications to the seat belts. This can lead to unintended activation or to failure.

Have all work carried out only by qualified technicians. Contact an authorized Mercedes-Benz Light Truck Center.

Safety and Security

Occupant safety

Warning!



USE SEAT BELTS PROPERLY

- Seat belts can only work when used properly. Never wear seat belts in any other way than as described in this section, as that could result in serious injuries in case of an accident.
- Each occupant should wear their seat belt at all times, because seat belts help reduce the likelihood of and potential severity of injuries in accidents, including rollovers. The integrated restraint system includes SRS (driver airbag and passenger front airbag), ETB (seat belt emergency tensioning device for driver's seat, front passenger seat and the outboard passenger seats). The system is designed to enhance the protection offered to properly belted occupants in certain frontal (front airbags) impacts which exceed preset deployment thresholds.

- Never wear the shoulder belt under your arm, against your neck or off your shoulder. In a crash, your body would move too far forward. That would increase the chance of head and neck injuries. The belt would also apply too much force to the ribs or abdomen, which could severely injure internal organs such as your liver or spleen.
 - Never wear belts over rigid or breakable objects in or on your clothing, such as eyeglasses, pens, keys, etc., as these might cause injuries.
 - Position the lap belt as low as possible on your hips and not across the abdomen. If the belt is positioned across your abdomen, it could cause serious injuries in a crash.
 - Never use a seat belt for more than one person at a time. Do not fasten a seat belt around a person and another person or other objects.
- Belts should not be worn twisted. In a crash, you wouldn't have the full width of the belt to manage impact forces. The twisted belt against your body could cause injuries.
 - Pregnant women should also use a lap-shoulder belt. The lap belt portion should be positioned as low as possible on the hips to avoid any possible pressure on the abdomen.
 - Never place your feet on the instrument panel or on the seat. Always keep both feet on the floor in front of the seat.

Emergency tensioning device (ETD), seat belt force limiter

The seat belts for the front and rear outer seats are equipped with emergency tensioning devices and belt force limiters.

The ETD is designed to activate only when the seat belt is fastened and in the following cases:

- in frontal or rear-end impacts exceeding a preset severity level
- if the restraint systems are operational and functioning correctly, see **SRS** indicator lamp (▷ page 56)

In an impact, emergency tensioning devices remove slack from the belts in such a way that the seat belts fit more snugly against the body.

Warning!



An emergency tensioning device (ETD) that was activated must be replaced.

When disposing of the emergency tensioning device, our safety instructions must be followed. These are available at your authorized Mercedes-Benz Light Truck Center.



Do not place objects heavier than 20 lbs (9 kg) on the front passenger seat. This could cause the passenger front airbag to deploy in a crash which exceeds the system's deployment threshold.

Children in the vehicle

If an infant or child is traveling with you in the vehicle:

- Secure the child using an infant or child restraint appropriate to the age and size of the child and recommended for use by Mercedes-Benz.
- Make sure the infant or child is properly secured by a belt at all times while the vehicle is in motion.

Infant and child restraint seats and information on choosing an appropriate restraint system can be obtained from any Mercedes-Benz Light Truck Center.

Safety and Security

Occupant safety

Infant and child restraint systems

Use only a BabySmart™¹ compatible child restraint for the front passenger seat in this vehicle.

We recommend that all infants and children be properly restrained at all times while the vehicle is in motion. All lap-shoulder belts except the driver's seat belt have special seat belt retractors for secure fastening of child restraints.

To fasten a child restraint, follow manufacturer's instructions for mounting child restraints. Then pull shoulder belt out completely and let it retract. During the seat belt retraction a ratcheting sound can be heard to indicate that the special seat belt retractor is activated. The belt is now locked. Push down on child restraint to take up any slack.

To deactivate, release seat belt buckle and let seat belt retract completely. The seat belt can again be used in the usual manner.

¹ BabySmart™ is a trademark of Siemens Automotive Corp.



For more information on child seats with mounting fittings for tether anchorages, see “Installation of infant and child restraint system” (▷ page 69).

For information on LATCH-type child seat anchors, see (▷ page 70).

Warning!



Never release the seat belt buckle while the vehicle is in motion, since the special seat belt retractor will be deactivated.



The use of infant or child restraints is required by law in all 50 states, the District of Columbia, the U.S. territories and all Canadian provinces.

Infants and small children should be seated in an appropriate infant or child restraint system properly secured by a lap-shoulder belt or, if so equipped, a child restraint lower anchorage system that complies with U.S. Federal Motor Vehicle Safety Standards 213 and 225 and Canadian Motor Vehicle Safety Standards 213 and 210.2.

A statement by the child restraint manufacturer of compliance with this standard can be found on the instruction label on the restraint and in the instruction manual provided with the restraint.

When using any infant or child restraint system, be sure to carefully read and follow all manufacturer's instructions for installation and use.

Please read and observe warning labels affixed to inside of vehicle and to infant or child restraints.

Warning!



Children 12 years old and under must never ride in the front seat, except in a Mercedes-Benz authorized BabySmart™ compatible child seat, which operates with the BabySmart™ System installed in the vehicle to deactivate the passenger front airbag when it is properly installed. Otherwise they will be struck by the airbag when it inflates in a crash. If this happens, serious or fatal injury can result.

According to accident statistics, children are safer when properly restrained in the rear seating positions than in the front seating positions. Infants and small children must ride in back seats and be seated in an appropriate infant or child restraint system, which is properly secured with the vehicle's seat belt and top tether strap, or secured via lower anchors and top tether strap, fully in accordance with the child seat manufacturer's instructions.

Safety and Security

Occupant safety

Infants and small children should never share a seat belt with another occupant. During an accident, they could be crushed between the occupant and seat belt.

A child's risk of serious or fatal injuries is significantly increased if the child restraints are not properly secured in the vehicle and the child is not properly secured in the child restraint.

Safety and Security

Occupant safety

Warning!



Children too big for child restraint systems must ride in back seats using regular seat belts. Position shoulder belt across chest and shoulder, not face or neck. A booster seat may be necessary to achieve proper belt positioning for children from 41 lbs until they reach a height where a lap / shoulder belt fits properly without a booster.

When the child restraint is not in use, remove it from the vehicle or secure it with the seat belt to prevent the child restraint from becoming a projectile in the event of an accident.

Do not leave children unattended in the vehicle, even if the children are secured in a child restraint system. Unsupervised children in a child restraint system may use vehicle equipment and may cause serious personal injury.

BabySmart™ airbag deactivation system



indicator lamp

Special BabySmart™¹ compatible child seats, designed for use with the Mercedes-Benz system and available at any authorized Mercedes-Benz Light Truck Center are required for use with the BabySmart™ airbag deactivation system. With the special child seat properly installed, the passenger front airbag will not deploy.

¹ BabySmart™ is a trademark of Siemens Automotive Corp.

The  indicator lamp located in the center console will be illuminated, except with the SmartKey removed or in the starter switch position **0**.



The system does not deactivate the emergency tensioning device.

Self-test BabySmart™ without special child seat installed

After turning the SmartKey in the starter switch to position **1** or **2**, the

 indicator lamp located in the center console comes on for approximately six seconds and then goes out.

If the indicator lamp should not come on or is continuously lit, the system is not functioning. You must see an authorized Mercedes-Benz Light Truck Center before seating any child on the front passenger seat.

For more information, see “Practical hints” section (> page 259).

Safety and Security

Occupant safety

Warning!



The BabySmart™ airbag deactivation system will ONLY work with a special child seat designed to operate with it. It will not work with child seats which are not BabySmart™ compatible.

Never place anything between seat cushion and child seat (e.g. pillow), since it reduces the effectiveness of the deactivation system. The bottom of the child seat must make full contact with the passenger seat cushion. An incorrectly mounted child seat could cause injuries to the child in case of an accident, instead of protecting the child.

Follow the manufacturer's instructions for installation of special child seats.

When using a BabySmart™ compatible child seat on the front passenger seat, the passenger front airbag will not deploy only if the  indicator lamp remains illuminated.

Warning!



Make sure to check the indicator every time you use the special system child seat. Should the light go out while the restraint is installed, please check installation. If the light remains out, do not use the BabySmart™ restraint to transport children on the front passenger seat until the system has been repaired.

Warning!



Do not place powered-on laptops, cell phones and like electronic devices on the front passenger seat. Signals from such devices may interfere with the BabySmart™ system. Such signal interference may cause the  indicator lamp not to come on during self-test or be continuously lit, indicating that the system is not functioning.

Installation of infant and child restraint system

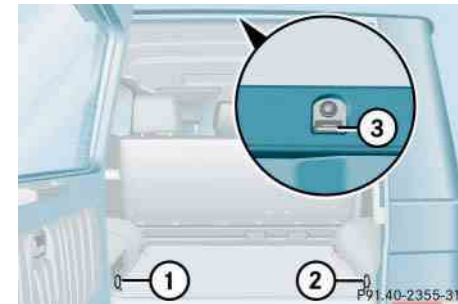

- ① Anchorage ring for rear left side seat
- ② Anchorage ring for rear right side seat
- ③ Anchorage ring for rear center seat

Safety and Security

Occupant safety

- ▶ Guide top tether strap between head restraint and top of seat back. Head restraint must be installed and positioned such that the top tether strap can pass freely between the head restraint and top of seat back.

When mounting a tether strap on the rear outer seats, reinstall the cargo compartment cover blind (▷ page 176) and optional partition net (▷ page 178).

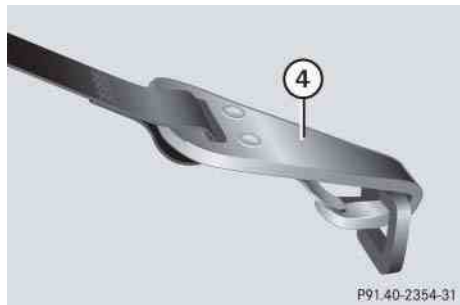

④ Hook

- ▶ Securely fasten hook ④ to anchorage ring.



For safety, make sure the hook is attached to the ring beyond the safety catch, as illustrated.

Warning!



Use only the described anchorage rings for the respective child seat. Other lashing eyelets could tear in the case of an accident.

Make sure

- the fastening straps are not crossed or twisted.
- the hook is properly attached and is closed.

Child seat anchors – LATCH type

This vehicle is provided with two LATCH (LOWER Anchors and Tethers for CHildren) type anchors (at each of the outer rear seats) for installation of a LATCH child seat with matching mounting fittings.

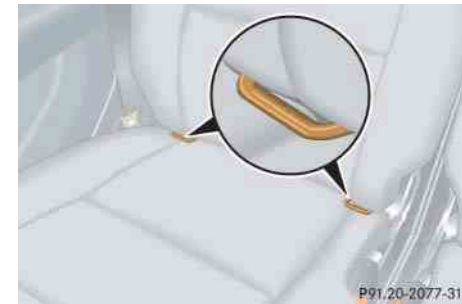

Anchors

Install a LATCH type child seat according to the manufacturer's instructions.

- ▶ Install child seat according to manufacturer's instructions.



With a child seat installed in the left rear seat, the seat belt for the center seat occupied by a passenger must operate freely.

Non-LATCH type child seats may also be used and can be installed using the vehicle's seat belt system. Install child seat according to the manufacturer's instructions.

Warning!



Install child seat according to manufacturer's instructions.

The child seat must be firmly attached in the right and left side anchors.

Warning!



An incorrectly mounted child seat may come loose during an accident.

Damaged or impact-damaged child seats or child seat mounting fittings must be replaced.

Do not leave children unattended in the vehicle, even if the children are secured in a child restraint system.

Children too big for child restraint systems must ride in back seats using regular seat belts. Position shoulder belt across chest and shoulder, not face or neck. A booster seat may be necessary to achieve proper belt positioning for children from 41 lbs until they reach a height where a lap / shoulder belt fits properly without a booster.

Safety and Security

Occupant safety

Blocking rear door window operation

The override switch is located in the driver's door.



① Override switch

Activating override switch

- ▶ Slide override switch ① to the right.

A dot becomes visible. The functions in the rear are disabled.



Operation of the rear windows with the switches located in the driver's door is still possible.

Safety and Security

Occupant safety

Warning!



Activate the override switch when children are riding in the back seats of the vehicle. The children may otherwise injure themselves, e.g. by becoming trapped in the window opening.

When leaving the vehicle, always remove the SmartKey from the starter switch, and lock the vehicle. Do not leave children unattended in the vehicle, or with access to an unlocked vehicle. Unsupervised use of vehicle equipment can cause an accident and/or serious personal injury.

Deactivating override switch

- ▶ Slide override switch ① to the left.
The functions in the rear are enabled again.

For more information on power windows, see “Power windows” (▷ page 164).

▼ Panic alarm



① **PANIC** button

An audible alarm and blinking turn signal lamps will operate for approximately 2½ minutes.

- ▶ To activate: Press and hold button ① for at least one second.
- ▶ To deactivate: Press button ① again or insert SmartKey in starter switch.

i

For operation in the USA only: This device complies with Part 15 of the FCC Rules. Operation is subject to the following two conditions:

- This device may not cause harmful interference, and
- this device must accept any interference received, including interference that may cause undesired operation.

Any unauthorized modification to this device could void the user's authority to operate the equipment.

Safety and Security

Driving and safety systems

▼ Driving and safety systems

In this section you will find information on the following driving safety systems:

- ABS (Antilock Brake System)
- BAS (Brake Assist System)
- 4-ETS (Electronic Traction System)
- EBB (Electronic Brake Booster)
- ESP (Electronic Stability Program)



In winter operation, the maximum effectiveness of the ABS, ESP, EBB and 4-ETS is only achieved with winter tires (M+S tires), or snow chains as required.

Warning!



The following factors increase the risk of accidents:

- Excessive speed, especially in turns
- Wet and slippery road surfaces
- Following another vehicle too closely

The ABS, BAS, ESP and 4-ETS cannot reduce this risk.

Always adjust your driving style to the prevailing road and weather conditions.

ABS

Warning!



Do not pump the brake pedal. Use firm, steady brake pedal pressure instead. Pumping the brake pedal defeats the purpose of ABS and significantly reduces braking effectiveness.

The ABS regulates the brake pressure so that the wheels do not lock during braking. This allows you to maintain the ability to steer your vehicle.

The ABS is functional above a speed of approximately 5 mph (8 km/h) independent of road surface conditions (as long as the differential locks are not engaged).

At the instant one of the wheels is about to lock up, a slight pulsation can be felt in the brake pedal, indicating that the ABS is in the regulating mode. Keep firm and steady pressure on the brake pedal while experiencing the pulsation.

Continuous steady brake pedal pressure yields the advantages provided by the ABS, namely braking power and the ability to steer the vehicle.

On slippery road surfaces, the ABS will respond even with light brake pressure. The pulsating brake pedal can be an indication of hazardous road conditions and functions as a reminder to take extra care while driving.

The  indicator lamp in the instrument cluster (▷ page 24) comes on when you turn the SmartKey to position **2**. It goes out when the engine is running.

Braking

At the instant one of the wheels is about to lock up, a slight pulsation can be felt in the brake pedal, indicating that the ABS is in the regulating mode.

- ▶ Keep firm and steady pressure on the brake pedal while experiencing the pulsation.

Emergency brake maneuver

- ▶ Keep continuous full pressure on the brake pedal.



If the ABS is malfunctioning, the BAS, EBB, ESP and 4-ETS are also switched off.

Normal driving and braking functions are still available.

LOW RANGE– ABS

During off-road driving a special low range system for the antilock brake system (ABS) is operational with transfer case in position LOW (▷ page 145).

An improved braking action (dig-in effect) is obtained for vehicle speeds up to 37 mph (60 km/h) through a change in the ABS control function.

For more information, see “Practical hints” (▷ page 252).

Safety and Security

Driving and safety systems

Warning!



The ABS cannot prevent the natural laws of physics from acting on the vehicle, nor can it increase braking or steering efficiency beyond that afforded by the condition of the vehicle brakes and tires or the traction afforded. The ABS cannot prevent accidents, including those resulting from excessive speed in turns, following another vehicle too closely, or aquaplaning. Only a safe, attentive, and skillful driver can prevent accidents. The capabilities of an ABS equipped vehicle must never be exploited in a reckless or dangerous manner which could jeopardize the user's safety or the safety of others.

BAS

The Brake Assist System (BAS) operates in emergency situations. If you apply the brakes very quickly, the BAS automatically provides full brake boost, thereby potentially reducing braking distance. Apply continuous full braking pressure until the emergency braking situation is over. The ABS will prevent the wheels from locking.

When you release the brake pedal the brakes function again as normal. The BAS is then deactivated.

With the BAS malfunctioning, the ABS, ESP and 4-ETS are also switched off.

Warning!



The BAS cannot prevent the natural laws of physics from acting on the vehicle, nor can it increase braking efficiency beyond that afforded by the condition of the vehicle brakes and tires or the traction afforded. The BAS cannot prevent accidents, including those resulting from excessive speed in turns, following another vehicle too closely, or aquaplaning. Only a safe, attentive, and skillful driver can prevent accidents. The capabilities of a BAS equipped vehicle must never be exploited in a reckless or dangerous manner which could jeopardize the user's safety or the safety of others.

For more information, see "Practical hints" (▷ page 261).

4-ETS

The 4-ETS improves vehicle's ability to utilize available traction, especially under slippery road conditions. The brakes are applied to the spinning wheel and power is allowed to flow to the wheel(s) with traction.

The 4-ETS function is available between vehicle speeds of 0 mph (km/h) and 37 mph (60 km/h).

The ESP warning lamp  in the instrument cluster (> page 24) comes on when you turn the SmartKey to position **2**. It goes out when the engine is running.

The ESP warning lamp  starts to flash at any vehicle speed, as soon as the tires lose traction and the wheels begin to spin.

Warning!



When you see the ESP warning lamp  flashing in the instrument cluster, then proceed as follows:

- While driving off, apply as little throttle as possible.
- While driving ease up on the accelerator.
- Adapt your speed and driving style to the prevailing road conditions.

Failure to observe these guidelines could cause the vehicle to skid.

The 4-ETS cannot prevent accidents resulting from excessive speed.

Safety and Security

Driving and safety systems



The engine must be shut off when

- the parking brake is being tested on a brake test dynamometer.
- the vehicle is being towed with one axle raised.

Otherwise, the 4-ETS will engage the brakes and seriously damage the brake system.

For more information, see "Practical hints" (> page 257).

Safety and Security

Driving and safety systems

EBB

The EBB enhances braking effectiveness by allowing the rear brakes to supply a greater proportion of the braking effort in straight line braking circumstances without a loss of vehicle stability.

ESP

The Electronic Stability Program (ESP) monitors the vehicle's traction (force of adhesive friction between the tires and the road surface) and handling.

The ESP recognizes when a wheel is spinning or if the vehicle starts to skid. By applying brakes to the appropriate wheel and by limiting engine output, the ESP works to stabilize the vehicle.

The ESP warning lamp  in the instrument cluster (> page 24) flashes when the ESP is engaged.

The ESP warning lamp  comes on when you turn the SmartKey to position **2**. It goes out when the engine is running.

Warning!



Never switch off the ESP when you see the ESP warning lamp  flashing in the instrument cluster. In this case proceed as follows:

- While driving off, apply as little throttle as possible.
- While driving ease up on the accelerator.
- Adapt your speed and driving style to the prevailing road conditions.

Failure to observe these guidelines could cause the vehicle to skid.

The ESP cannot prevent accidents resulting from excessive speed.

Warning!



The ESP cannot prevent the natural laws of physics from acting on the vehicle, nor can it increase the traction afforded. The ESP cannot prevent accidents, including those resulting from excessive speed in turns, following another vehicle too closely, or aquaplaning. Only a safe, attentive, and skillful driver can prevent accidents. The capabilities of a ESP equipped vehicle must never be exploited in a reckless or dangerous manner which could jeopardize the user's safety or the safety of others.



Driving the vehicle with varied size tires will cause the wheels to rotate at different speeds, possibly causing the ESP to activate. For this reason, all wheels, including the spare wheel, must have the same tire outside diameter.



The engine must be shut off when

- the parking brake is being tested on a brake test dynamometer.
- the vehicle is being towed with one axle raised.

Otherwise, the ESP will engage the brakes and seriously damage the brake system.



The ABS, BAS and ESP are automatically switched off when the differential locks are switched on (▷ page 150).

Switching off the ESP

Warning!



The ESP should not be switched off during normal driving other than in the circumstances described below. Disabling of the system will reduce vehicle stability in standard driving maneuvers.

To improve the vehicle's traction, turn off the ESP in driving situations where it would be advantageous to have the drive wheels spin and thus cut into surfaces for better grip such as:

- starting out on slippery surfaces and in deep snow in conjunction with snow chains.
- sand or gravel.
- when driving off-road.

When the ESP is turned off

- engine torque is not limited.
- the drive wheels can spin.

Safety and Security

Driving and safety systems



Avoid spinning of a drive wheel for an extended period of time with the ESP switched off. This may cause serious damage to the drivetrain which is not covered by the Mercedes-Benz Limited Warranty.



Turn ESP on immediately if the aforementioned circumstances do not apply anymore.

The ESP control switch is located in the upper center console.

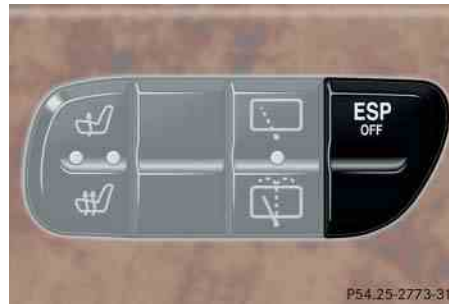

ESP on/off

- ▶ Press upper half of switch.

ESP is deactivated and the ESP warning lamp  in the instrument cluster comes on.

Even if the ESP has been turned off, it is still active in the following situations:

- when braking
- at vehicle speeds up to approximately 37 mph (60 km/h), if one wheel reaches the grip limit, e.g. when the street is icy on one side

The brake is applied until the wheel regains sufficient traction.

If one or more drive wheels are spinning, the ESP warning lamp  in the instrument cluster flashes, regardless of the speed.



If the ESP is switched off, it will be automatically activated when exceeding a vehicle speed of 37 mph (60 km/h) or exceeding a severity threshold of side acceleration.

Warning!



When the ESP warning lamp  is illuminated continuously, the ESP is switched off.

Adapt your speed and driving to the prevailing road conditions and to the non-operating status of the ESP.

Switching on the ESP

- ▶ Press lower half of switch.

The ESP warning lamp  in the instrument cluster goes out. You are now again in normal driving mode.

For more information, see “Practical hints” (> page 257).

Safety and Security

Anti-theft systems

▼ Anti-theft systems

Immobilizer

The immobilizer prevents unauthorized persons from starting your vehicle.

Activating

Removing the SmartKey from the starter switch activates the immobilizer.

Deactivating

Inserting the SmartKey in the starter switch deactivates the immobilizer.



In case the engine cannot be started (yet the vehicle's battery is charged), the system is not operational. Contact an authorized Mercedes-Benz Light Truck Center or call 1-800-FOR-MERCEdes (in the USA), or 1-800-387-0100 (in Canada).

Anti-theft alarm

Once the alarm system has been armed, a visual and audible alarm is triggered when someone:

- opens a door
- opens the tailgate
- opens the hood

The alarm will stay on even if the activating element (a door, for example) is immediately closed.

The alarm system will also be triggered when

- someone attempts to raise the vehicle
- the vehicle is opened with the mechanical key



If the alarm stays on for more than 20 seconds, an emergency call is initiated automatically by the Tele Aid system (▷ page 190) provided Tele Aid service was subscribed to and properly activated, and that necessary cellular service and GPS coverage are available.

Arming the alarm system

The alarm system is armed after locking the vehicle with the SmartKey. The turn signal lamps blink three times to indicate that the alarm system is activated. A red lamp in the tow-away alarm switch begins to blink after arming the alarm system (▷ page 27).

Safety and Security

Anti-theft systems



If the turn signal lamps do not blink three times, one of the following elements may not be properly closed:

- a door
- the tailgate
- the hood



Close the respective element and lock the vehicle again.

Disarming the alarm system

The alarm system is disarmed when you unlock your vehicle with the SmartKey. The turn signal lamps blink once to indicate that the alarm system is deactivated.

Canceling the alarm

To cancel the alarm:

- ▶ Press the  or  button on the SmartKey.

or

- ▶ Insert the SmartKey in the starter switch.

Tow-away alarm

Once the tow-away alarm is armed, a visual and audible alarm will be triggered when someone attempts to raise the vehicle.



The tow-away protection alarm is triggered, for example, if the vehicle is lifted on one side.

If the alarm stays on for more than 20 seconds, an emergency call is initiated automatically by the Tele Aid system provided Tele Aid service was subscribed to and properly activated, and that necessary cellular service and GPS coverage are available.

Safety and Security

Anti-theft systems

Arming tow-away alarm

When you lock your vehicle, the tow-away alarm is automatically armed.

When you unlock your vehicle, the tow-away protection disarms automatically.

Disarming tow-away alarm

To prevent triggering the tow-away alarm feature, switch off the tow-away alarm before towing the vehicle, or when parking on a surface subject to movement, such as a ferry or auto train.

The switch is located on the center console.

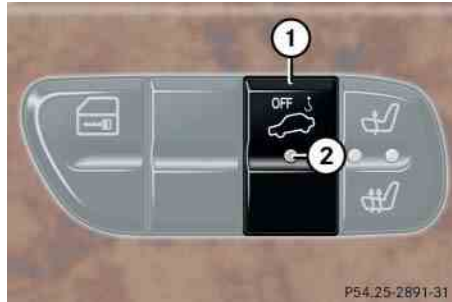

- ① Tow-away alarm off switch
- ② Indicator lamp

- ▶ Turn off the ignition and remove the SmartKey.





You cannot disarm the tow-away alarm while the ignition is turned on.

- ▶ Press upper half ① of the switch. Indicator lamp ② in the switch comes on briefly.
- ▶ Lock your vehicle with the SmartKey.

The tow-away alarm remains disarmed until you lock your vehicle again.

Canceling the tow-away alarm

To cancel the alarm:

- ▶ Press the  or  button on the SmartKey.
- or
- ▶ Insert the SmartKey in the starter switch.



Controls in detail

Locking and unlocking

Seats

Memory function

Lighting

Instrument cluster

Control system

Automatic transmission

Transfer case

Differential locks

Good visibility

Climate control

Power windows

Sliding/pop-up roof

Driving systems

Loading

Useful features

Controls in detail

Locking and unlocking

In the “Controls in detail” section you will find detailed information on how to operate the equipment installed in your vehicle. If you are already familiar with the basic functions of your vehicle, this section will be of particular interest to you.

To quickly familiarize yourself with the basic functions of the vehicle, refer to the “Getting started” section of this manual. The corresponding page numbers are given at the beginning of each segment.

▼ Locking and unlocking

SmartKey

Your vehicle comes supplied with two SmartKeys, each with remote control and a removable mechanical key. The locking tabs for the mechanical key portion of the two SmartKeys are a different color to help distinguish each key unit.

The SmartKey provides an extended operating range. To prevent theft, however, it is advisable to only unlock the vehicle when you are in close proximity to it.

The SmartKey centrally locks and unlocks:

- the doors
- the tailgate
- the fuel filler flap

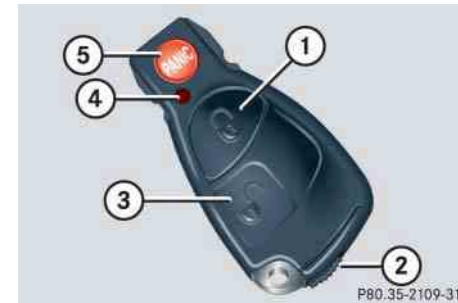

SmartKey with remote controls

- ① Lock button
- ② Locking tab for mechanical key
- ③ Unlock button
- ④ Battery check lamp
- ⑤ **PANIC** Panic button (▷ page 73)



You can also open and close the power windows (▷ page 165) and sliding/pop-up roof (▷ page 167) using the SmartKey.



To prevent possible malfunction, avoid exposing the SmartKey to high levels of electromagnetic radiation.

Factory setting

Global unlocking

- ▶ Press button

All turn signal lamps blink once. The locking knobs in the doors move up.

The vehicle will lock again automatically within approximately 40 seconds of unlocking if neither door nor tailgate is opened, the SmartKey is not inserted in the starter switch, or the central locking switch is not activated.

Global locking

- ▶ Press button

All turn signal lamps blink three times. The locking knobs in the doors move down.

Selective setting

If you frequently travel alone, you may wish to reprogram the SmartKey so that pressing only unlocks the driver's door and the fuel filler flap.

- ▶ Press and hold buttons and simultaneously for about five seconds until battery check lamp blinks twice.

The SmartKey will then function as follows:

Unlocking driver's door and fuel filler flap

- ▶ Press button once.

Global unlocking

- ▶ Press button twice.

Global locking

- ▶ Press button .

Controls in detail

Locking and unlocking

Restoring to factory setting

- ▶ Press and hold buttons and simultaneously for about six seconds until the battery check lamp blinks twice.

Warning!



When leaving the vehicle, always remove the SmartKey from the starter switch, and lock the vehicle. Do not leave children unattended in the vehicle, or with access to an unlocked vehicle. It is possible for children to open a locked door from the inside, which could result in an accident and/or serious personal injury.

Controls in detail

Locking and unlocking



If you can no longer lock or unlock the vehicle with the SmartKey, then the batteries in the SmartKey are discharged, the SmartKey is malfunctioning or the vehicle battery is drained.

- Check the batteries in the SmartKey (▷ page 88) and replace them if necessary (▷ page 288).
- Use the mechanical key to unlock the doors (▷ page 287).
- Have the vehicle battery and the battery connections checked by an authorized Mercedes-Benz Light Truck Center (▷ page 311).
- Use the mechanical key to lock the doors and the tailgate (▷ page 288).

If the SmartKey is malfunctioning, contact an authorized Mercedes-Benz Light Truck Center.

Checking the batteries

- ▶ Press button or .

Battery check lamp ④ comes on briefly to indicate that the SmartKey batteries are in order.



If battery check lamp ④ does not come on briefly during check, then the SmartKey batteries are discharged.

Replace the batteries (▷ page 288).

You can obtain the required batteries at any authorized Mercedes-Benz Light Truck Center.



If the batteries are checked within signal range of the vehicle, pressing the button or will lock or unlock the vehicle accordingly.

Loss of SmartKey or mechanical key

If you lose a SmartKey or mechanical key, you should do the following:

- ▶ Have the SmartKey deactivated by an authorized Mercedes-Benz Light Truck Center.
- ▶ Report the loss of the SmartKey or the mechanical key immediately to your car insurance company.
- ▶ If necessary have the mechanical lock replaced.

Your authorized Mercedes-Benz Light Truck Center will be glad to supply you with a replacement.

Opening the doors from the inside

You can open a locked door from the inside. Open door only when conditions are safe to do so.

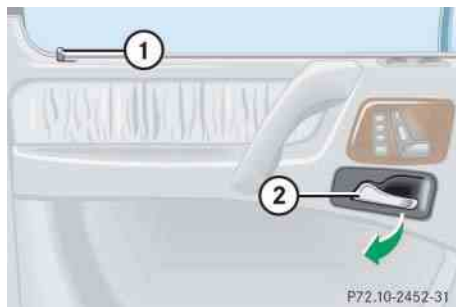

- ① Locking knob
- ② Inside door handle



- ▶ Pull on door handle ②.

If the door was locked, locking knob ① moves up.



If the vehicle has previously been locked from the outside with the SmartKey, opening a door from the inside will trigger the alarm.

To cancel the alarm do one the following:

- Press the  or  button on the SmartKey.
- Insert the SmartKey in the starter switch.

Opening the tailgate

Warning!



The tailgate swings open to one side. Always make sure there is sufficient clearance for the tailgate.

Only drive with the tailgate closed as otherwise exhaust fumes may enter the vehicle interior.

Controls in detail

Locking and unlocking

Opening the tailgate from the outside

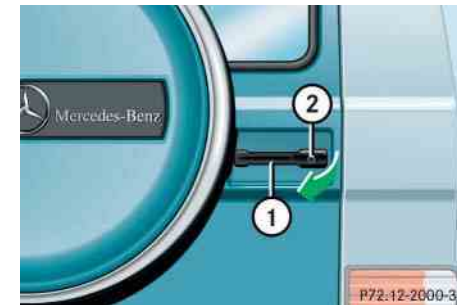

- ① Handle
- ② Lock cylinder

- ▶ Press lock cylinder ② and pull on tailgate handle ①.
- ▶ Open the tailgate to the side.



The vehicle must be unlocked.

Controls in detail

Locking and unlocking

Opening the tailgate from inside

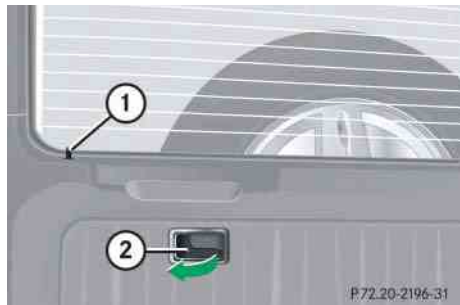

- ① Locking knob
- ② Inside door handle

- ▶ Pull on door handle ②.
If door was locked, the locking knob ① moves up.

Warning!



Do not leave children unattended in the vehicle. Unsupervised use of vehicle equipment may cause an accident and/or serious personal injury.

Closing the tailgate

Warning!



To prevent possible personal injury, always keep hands and fingers away from the tailgate opening when closing the tailgate. Be especially careful when small children are around.

Warning!



Only drive with the tailgate closed as otherwise exhaust fumes may enter the vehicle interior.



To prevent an inadvertent lockout, do not place the SmartKey in the cargo compartment.

Separately locking the tailgate



To deny any unauthorized person access to the tailgate, lock it separately with the mechanical key. Leave only the SmartKey less its mechanical key with the vehicle.

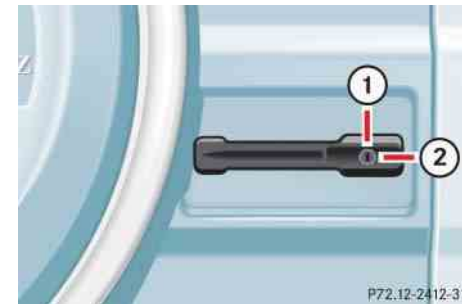

- ① Neutral position
- ② Locked

- ▶ Close the tailgate (▷ page 90).
- ▶ Pull the mechanical key out of the SmartKey (▷ page 287).
- ▶ Insert the mechanical key in the lock cylinder.
- ▶ Turn the mechanical key clockwise to position ②.

The tailgate remains locked even when the vehicle is centrally unlocked.



You can only cancel the separate tailgate locking mode by means of the mechanical key.

Separately unlocking the tailgate

- ▶ Pull the mechanical key out of the SmartKey (▷ page 287).
- ▶ Insert the mechanical key in the lock cylinder.
- ▶ Turn the mechanical key to neutral position ① (▷ page 90).

You can now open the tailgate (▷ page 89).

Warning!



Only drive with the tailgate closed as otherwise exhaust fumes may enter the vehicle interior.

Controls in detail

Locking and unlocking

Automatic central locking

The doors and the tailgate automatically lock when the ignition is switched on and the wheels are turning at vehicle speeds of approximately 9 mph (15 km/h) or more.

You can open a locked door from the inside. Open door only when conditions are safe to do so.

Controls in detail

Locking and unlocking



The doors and the tailgate unlock automatically after an accident if the force of the impact exceeds a preset threshold.

The vehicle automatically locks when the ignition is switched on and the wheels are turning at vehicle speeds of approximately 9 mph (15 km/h) or more. You could therefore lock yourself out when the vehicle

- is pushed
- is on a test stand

You can deactivate the automatic locking using the control system (> page 133).

For information on towing the vehicle, see “Towing the vehicle” (> page 315).

Locking and unlocking from the inside

You can lock or unlock the vehicle from inside using the central locking switches. This can be useful, for example, if you want to unlock the passenger door from the inside or want to lock the vehicle before starting to drive.

The fuel filler flap cannot be locked or unlocked with the central locking switch.

Warning!



When leaving the vehicle, always remove the SmartKey from the starter switch, and lock the vehicle. Do not leave children unattended in the vehicle, or with access to an unlocked vehicle. Unsupervised use of vehicle equipment may cause an accident and/or serious personal injury.

The central locking switch is located in the center console.

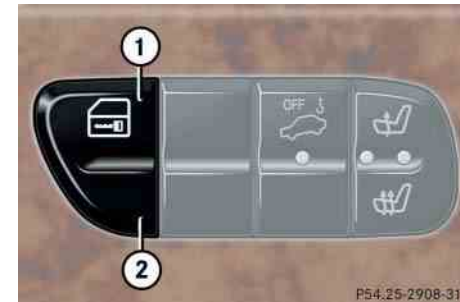

Central locking switch

- ① Locking
- ② Unlocking

Locking

- ▶ Press central locking switch ①.
If all the doors and the tailgate are closed, the vehicle locks.

Unlocking

- ▶ Press central locking switch ②.
The vehicle unlocks.



You can open a locked door from the inside. Open door only when conditions are safe to do so.

If the vehicle was previously centrally locked using the SmartKey, it will not unlock using the central locking switch.

If the vehicle was previously locked with the central locking switch

- while in the selective remote control mode, only the door opened from the inside is unlocked.
- while in the global remote control mode, the complete vehicle is unlocked when a door is opened from the inside.

Controls in detail

Seats

▼ Seats

For more information on seat adjustment, see the “Getting started” section (▷ page 34).

Easy-entry/exit feature

With the easy-entry/exit feature activated the steering wheel tilts upwards.

This allows easier entry into and exit from the vehicle when the driver’s door is opened. However, the engine must be turned off.

When the SmartKey is inserted in the starter switch and the driver’s door is closed, the steering wheel returns to the last set position.

Warning!



You must ensure no one can become trapped or injured by the moving steering wheel when the easy-entry/exit feature is activated, the driver’s door is being opened and the engine is turned off.

Do not leave children unattended in the vehicle, or with access to an unlocked vehicle. Children could open the driver’s door and unintentionally activate the easy-entry/exit feature, which could result in an accident and/or serious personal injury.

The easy-entry/exit feature can be switched on or off in the individual setting menu **CONVENIENCE - EASY-ENTRY FEATURE ACTIVATE** (▷ page 133).



To cancel steering wheel movement, do one the following:

- Move the steering column stalk (▷ page 22)
- Press the memory button (▷ page 102)

Removing and installing front seat head restraints

For more information on head restraint adjustment, see the “Getting started” section (▷ page 36).

Warning!



For your protection, drive only with properly positioned head restraints.

Adjust head restraint so that the head restraint supports the back of the head at eye level. This will reduce the potential for injury to the head and neck in the event of an accident or similar situation.

Do not drive the vehicle without the seat head restraints. Head restraints are intended to help reduce injuries during an accident.

Do not interchange head restraints from front and rear seat.



Tilt the seat backrest rearward for easier removal and installation of the head restraints.

Front seat head restraints



① Switch

Removing front seat head restraint

- ▶ Press switch ① upwards and hold until the head restraint is fully extended.
- ▶ Pull head restraint out.

Installing front seat head restraint

- ▶ Press switch ① upwards and hold for about five seconds.
- ▶ Press the head restraint down until it engages.
- ▶ Adjust head restraint to the desired position.

Synchronizing head restraints and seat adjustment fore and aft for front seats

If the power supply was interrupted (battery disconnected or discharged), the head restraints and the seat adjustment fore and aft are no longer adjusted automatically.

The head restraints and the seat adjustment fore and aft must be resynchronized:

- ▶ Turn SmartKey in starter switch to position **2**.
- ▶ Move the seat completely forward (▷ page 35) and the head restraint fully down (▷ page 36) and hold the switches for approximately one second.

Controls in detail

Seats

Rear seat head restraints

Warning!



For your protection, drive only with properly positioned head restraints.

Adjust head restraint so that the head restraint supports the back of the head at eye level. This will reduce the potential for injury to the head and neck in the event of an accident or similar situation.

Do not drive the vehicle without the seat head restraints. Head restraints are intended to help reduce injuries during an accident.

Head restraint height

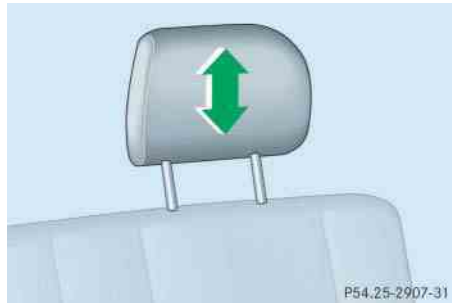

Manually adjust the height of the head restraint.

- Push or pull on the head restraint.

Removing and installing rear seat head restraints

Warning!



For your protection, drive only with properly positioned head restraints.

Adjust head restraint so that the head restraint supports the back of the head at eye level. This will reduce the potential for injury to the head and neck in the event of an accident or similar situation.

Do not drive the vehicle without the seat head restraints. Head restraints are intended to help reduce injuries during an accident.

Do not interchange head restraints from front and rear seat.

Removing rear seat head restraints

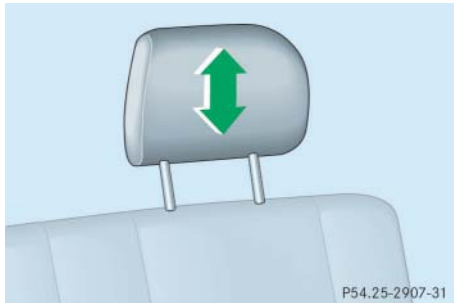

- ▶ Pull out head restraint with both hands.



The head restraint(s) should be stored in a secure place.

Installing rear seat head restraints

- ▶ Insert the head restraint and push it down to the stop.

Ensure proper head restraint positioning (▷ page 36).

Multicontour seat*

The multicontour seat has a movable seat cushion and inflatable air cushions built into the seat backrest to provide additional lumbar and side support.

The seat cushion movement and amount of seat backrest cushion height and curvature can be continuously varied with regulators on the right side of the seat after turning the SmartKey in the starter switch to position **2**.

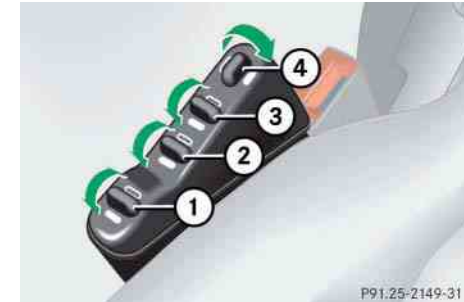

- ① Seat cushion length
- ② Backrest bottom
- ③ Backrest center
- ④ Backrest side bolsters

- ▶ Make sure the ignition is switched on. All the lamps in the instrument cluster come on.

Seat cushion length

- ▶ Adjust the seat cushion to the length of your upper leg using switch ①.

Controls in detail

Seats

Controls in detail

Seats

Backrest contour

- ▶ Adjust the contour of the backrest to the desired position using switches ② and ③.

Backrest side bolsters

- ▶ Adjust the backrest side bolsters so that they provide good lateral support using switch ④.

Heated seats

Driver's and front passenger seats

The switch is located in the center console.

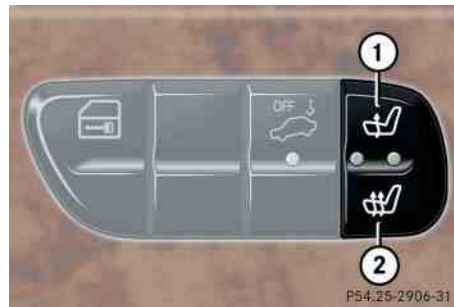

- ① Normal heating
- ② Rapid heating

- ▶ Make sure the ignition is switched on.
All the lamps in the instrument cluster come on.

Switching on seat heating

- ▶ Press upper switch position ①.
A red indicator lamp on the switch comes on.

Switching off seat heating

- ▶ Press upper switch position ① again.



The seat heater will be automatically switched off after approximately 30 minutes.

Switching on rapid seat heating

- ▶ Press lower switch position ②.
Both red indicator lamps on the switch come on.



The system switches over to normal heating mode after approximately five minutes. Only one indicator lamp remains lit.

Switching off rapid seat heating

- ▶ Press lower switch position ② again.



If one or both of the lamps on the seat heater switch are blinking, there is insufficient voltage available as too many electrical consumers are turned on. The seat heater switches off automatically.

The seat heater will switch back on again automatically as soon as sufficient voltage is available.

Rear seats

The switch is located on the B (center) pillar.



- ① Normal heating
- ② Rapid heating

- ▶ Make sure the ignition is switched on.

All the lamps in the instrument cluster come on.

Switching on seat heating

- ▶ Press upper switch position ①.

A red indicator lamp on the switch comes on.

Switching off seat heating

- ▶ Press upper switch position ① again.



The seat heater will be automatically switched off after approximately 30 minutes.

Switching on rapid seat heating

- ▶ Press lower switch position ②.

Both red indicator lamps on the switch come on.



The system switches over to normal heating mode after approximately five minutes. Only one indicator lamp remains lit.

Controls in detail

Seats

Switching off rapid seat heating

- ▶ Press lower switch position ② again.



If one or both of the lamps on the seat heater switch are blinking, there is insufficient voltage available as too many electrical consumers are turned on.

The seat heater switches off automatically.

The seat heater will switch back on again automatically as soon as sufficient voltage is available.

▼ Memory function



Prior to operating the vehicle, the driver should check and adjust the seat height, seat position fore and aft, and seat backrest angle if necessary, to ensure adequate control, reach and comfort. The head restraint should also be adjusted for proper height. See also the section on airbags (▷ page 57) for proper seat positioning.

In addition, adjust the steering wheel to ensure adequate control, reach, operation and comfort. Both the interior and exterior rear view mirrors should be adjusted for adequate rear vision.

Fasten seat belts. Infants and small children should be seated in a properly secured restraint system that complies with U.S. Federal Motor Vehicle Safety Standards 213 and 225 and Canadian Motor Vehicle Safety Standards 213 and 210.2.

The memory button and stored position switch are located on the door.

You can store up to three different settings per SmartKey.

The following settings are saved for each stored position:

- Driver's seat and seat backrest position
- Steering wheel position
- Driver's side exterior rear view mirror position
- Passenger-side exterior rear view mirror position
- Front passenger seat position

These key-dependent memory settings can be deactivated if desired (▷ page 135).

Controls in detail

Memory function

Warning!



Do not activate the memory function while driving. Activating the memory function while driving could cause the driver to lose control of the vehicle.

Controls in detail

Memory function

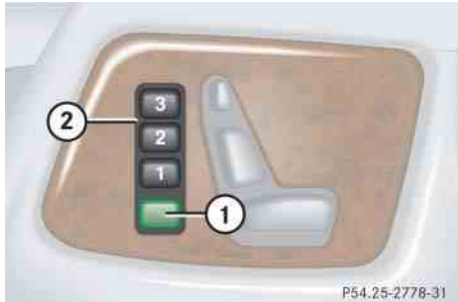

① Memory button

② Stored position buttons

- ▶ Make sure the ignition is switched on or the relevant door is open and the SmartKey is inserted in the starter switch.

Storing positions into memory

- ▶ Adjust the seats, steering wheel and exterior rear view mirrors to the desired position (▷ page 34).
- ▶ Press memory button ①.
- ▶ Release memory button and push position button ② within three seconds.

All the settings are stored at the selected position.

Recalling positions from memory

- ▶ Press and hold position button ② until the seat, steering wheel and rear view mirrors have fully moved to the stored positions.



Releasing the button immediately stops movement to the stored positions.

Warning!



Do not operate the power seats using the memory button if the seat backrest is in an excessively reclined position. Doing so could cause damage to front or rear seats.

First move seat backrest to an upright position.

Storing exterior rear view mirror parking position

For easier parking, you can adjust the passenger-side exterior rear view mirror so that you can see the right rear wheel as soon as you engage reverse gear **R**.

For information on activating the parking position, see “Activating exterior rear view mirror parking position” (▷ page 153).



You can store a parking position for the passenger-side exterior rear view mirror for each SmartKey using the memory switch.

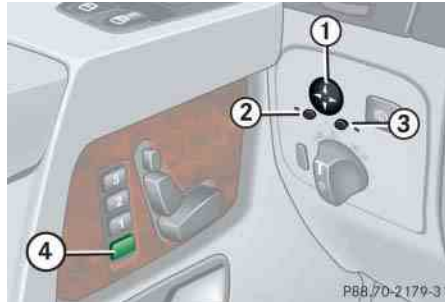

- ① Adjustment button
- ② Driver's side mirror
- ③ Passenger-side mirror
- ④ Memory button

- ▶ Stop the vehicle.
- ▶ Switch ignition on (if not already on).
- ▶ Press button ③.

The passenger-side exterior rear view mirror is selected.

Controls in detail

Memory function

- ▶ Adjust the exterior rear view mirror with button ① so that you see the rear wheel and the curb.
- ▶ Press memory button ④ on the door.
- ▶ Within three seconds, press bottom of adjustment button ① above the exterior lamp switch.

The parking position is stored if the mirror does not move.



If the mirror does move, repeat the above steps. After the setting is stored you can move the mirror again.

Controls in detail

Lighting

▼ Lighting

For notes on how to switch on the headlamps and use the turn signals, see the “Getting started” section (▷ page 46).



If you drive in countries where vehicles drive on the other side of the road than the country where the vehicle is registered, you must have the headlamps modified for symmetrical low beams. Relevant information can be obtained at your authorized Mercedes-Benz Light Truck Center.

Exterior lamp switch

The exterior lamp switch is located on the dashboard to the left of the steering wheel.



- 0** Off
- AUTO** Automatic headlamp mode
- P<=>** Parking lamps (also side marker lamps, tail lamps, license plate lamps, instrument panel lamps)
Canada only: When engine is running, the low beam is additionally switched on.
- P<** Parking lamps plus low beam or high beam headlamps (combination switch pushed forward).
- P<=>** Standing lamps, right (turn left one stop)
- P<** Standing lamps, left (turn left two stops)



If you remove the SmartKey and open the driver's door while the parking lamps or low beam headlamps are switched on:

- a warning sounds
-  appears in the multifunction display
- the message **TURN OFF LIGHTS!** appears in the multifunction display



With the daytime running lamp mode activated and the engine running, the low beam headlamps cannot be switched off manually.

Manual headlamp mode

The low beam headlamps and parking lamps can be switched on and off with the exterior lamp switch, see (▷ page 104).

Automatic headlamp mode

The parking lamps, low beam headlamps and license plate lamps switch on and off automatically depending on the brightness of the ambient light.

- ▶ Turn the exterior lamp switch to **AUTO**.

Warning!





If the exterior lamp switch is set to **AUTO**,

- the headlamps may switch off unexpectedly when the system senses bright ambient light, for example light from oncoming traffic.
- the headlamps will not be automatically switched on under foggy conditions.

Controls in detail

Lighting

To minimize risk to you and to others, activate headlamps by turning exterior lamp switch to  when driving or when traffic and /or ambient lighting conditions require you to do so.

In low ambient lighting conditions, only switch from position **AUTO** to  with the vehicle at a standstill. Switching from **AUTO** to  will briefly switch off the headlamps. Doing so while driving in low ambient lighting conditions may result in an accident.

The automatic headlamp feature is only an aid to the driver. The driver is responsible for the operation of the vehicle's lights at all times.

Controls in detail

Lighting



With the daytime running lamp mode activated, the low beam headlamps will not be switched off automatically.



Front fog lamps and rear fog lamp can not be switched on manually with exterior lamp switch in position **AUTO**. To activate the fog lamps, turn exterior lamp switch to position .

Daytime running lamp mode

- ▶ Turn exterior lamp switch to position **0** or **AUTO**.

When the engine is running, the low beam headlamps are automatically switched on. In low ambient light conditions the parking lamps will also switch on.

Canada only

When you shift from a driving position to position **N** or **P**, the low beam switches off (three minutes delay).

For nighttime driving, you should turn the exterior lamp switch to position  to permit activation of the high beam headlamps.

USA only

The high beam headlamps can also be activated when driving with the daytime running lamp mode activated and exterior lamp switch in position **0**.

To activate the daytime running lamp mode, see “Setting daytime running lamp mode” (▷ page 129).



See notes on the exterior lamp switch (▷ page 104).

Locator lighting and night security illumination

Locator lighting and night security illumination are described in the control system section under “Setting locator lighting” (▷ page 130) and “Setting night security illumination” (▷ page 131).

Exterior rear view mirror lamps

If the vehicle is centrally unlocked in the darkness, the lamps in the exterior rear view mirrors come on.



If a door is opened, the lamp on this side goes out. If no doors are opened, the lamps go out:

- when the ignition is switched on
- after a maximum of 40 seconds

Switching on front fog lamps

Warning!



In low ambient lighting or foggy conditions, only switch from position **AUTO** to  with the vehicle at a standstill. Switching from **AUTO** to  will briefly switch off the headlamps. Doing so while driving in low ambient lighting conditions may result in an accident.

- ▶ Make sure the low beam headlamps are switched on.
- ▶ Pull out exterior lamp switch to first stop.

The green indicator lamp  in the lamp switch comes on.



Fog lamps will operate with the parking lamps and/or the low beam headlamps on. Fog lamps should only be used in conjunction with low beam headlamps. Consult your State or Province Motor Vehicle Regulations regarding allowable lamp operation.

Switching on rear fog lamp

- ▶ Check that the low beam headlamps are switched on.
- ▶ Pull out exterior lamp switch to second stop.

The yellow indicator lamp  in the lamp switch comes on.

Controls in detail

Lighting

Combination switch

The combination switch is located on the left side of the steering column.





- ① High beam
- ② High beam flasher

Controls in detail

Lighting

Switching on high beams

- ▶ Turn exterior lamp switch to position  or to **AUTO** (▷ page 104).
- ▶ Push the combination switch in direction ①.

The high beam headlamp indicator  in the instrument cluster comes on.

High beam flasher

- ▶ Pull the combination switch briefly in direction ②.

Hazard warning flasher

The hazard warning flasher can be activated with the ignition switched on or off. It is activated automatically when an airbag is deployed.

The switch is located on the center console.



① Hazard warning flasher switch

Switching on the hazard warning flasher

- ▶ Press the hazard warning flasher switch.

All the turn signals will blink.



With the hazard warning flasher activated and the combination switch set for either left or right turn, only the respective left or right turn signals will operate when the SmartKey in the starter switch is in position 1 or 2.

Switching off the hazard warning flasher

- ▶ Press hazard warning flasher switch again.

Interior lighting



- ① Cargo compartment lamps
- ② Right reading lamp
- ③ Rocker switch for automatic control system
- ④ Left reading lamp



If the door remains open, the interior lamps switch off automatically after approximately five minutes.

Activating automatic control

- Move rocker switch ③ to center position.

Interior lamps are switched on in darkness, when you

- unlock the vehicle
- open a door
- remove the SmartKey from the starter switch

In addition, the entry lamps in the door trays will come on when you open a door.

The interior lamps are switched off following an adjustable time delay (► page 132).

Deactivating automatic control

- Press the  symbol on rocker switch ③.

The interior lighting and the entry lamps remain switched off in darkness, even when you

- unlock the vehicle
- open a door
- remove the SmartKey from the starter switch

Manual control

Switching lamps on

- Press the  symbol on rocker switch ③.

The interior lighting remains on even when the doors are closed.

Controls in detail

Lighting

Switching lamps off

- Move rocker switch ③ to center position to activate the automatic control.



To prevent the vehicle battery from being discharged, all interior lamps switch off automatically after approximately 30 minutes with the tailgate open.

If an interior lamp is switched on manually, it does not go out automatically. Before leaving the vehicle, make sure the interior lamps are switched off.

The rear interior lamps can be switched on with the SmartKey in starter switch position **0** or SmartKey removed from the starter switch for up to 30 minutes.

Rear interior lamps

The rear interior lamps are located above the rear seat bench on the left and right side.



- ① The lamps are switched on continuously
- ② The lamps are switched off
- ③ Automatic function

Cargo compartment lamps

Switching on and off



- ① Switch for cargo compartment lamps
- Press button  to switch the cargo compartment lamps ② on/off.

Controls in detail

Lighting

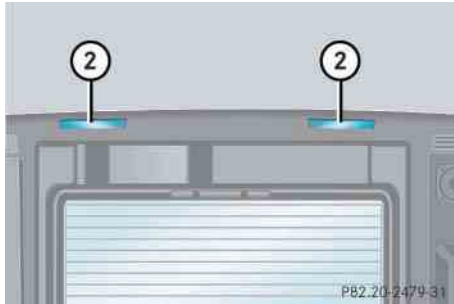

② Cargo compartment lamps

Switching on and off with the tailgate open

If the tailgate should remain open for a longer period of time, the cargo compartment lamps may be switched off separately.



① Door lock
② Lock cylinder

Switching off

- ▶ Open the tailgate.
- ▶ Press door lock ① down until it engages (arrow).



Do not close the tailgate if the lock is engaged in down position. The lock could otherwise be damaged.

When locking the tailgate, it is important that the door lock be in the same position as shown in the illustration.

Switching on

- ▶ Press lock cylinder ② to activate the cargo compartment lamps again.

The cargo compartment lamps will switch on.

Warning!



To prevent possible personal injury, always keep hands and fingers away from the tailgate opening when closing the tailgate. Be especially careful when small children are around.

Only drive with the tailgate closed as otherwise exhaust fumes may enter the vehicle interior.

Controls in detail

Instrument cluster

▼ Instrument cluster

A full view illustration of the instrument cluster can be found in the “At a glance” section of this manual (▷ page 24).



① Reset button

The instrument cluster is activated when you:

- open a door
- turn on the ignition
- press reset button ①
- switch on the exterior lamps

You can change the instrument cluster settings in the Instrument cluster submenu of the control system (▷ page 127).

Instrument cluster illumination

Use the reset button to adjust the illumination brightness for the instrument cluster.



The instrument cluster illumination is dimmed or brightened automatically to suit ambient light conditions.

The instrument cluster illumination will also be adjusted automatically when you switch on the vehicle's exterior lamps.

To brighten illumination

- ▶ Turn reset button ① in the instrument cluster clockwise.

The instrument cluster illumination will brighten.

To dim illumination

- ▶ Turn reset button ① in the instrument cluster counterclockwise.

The instrument cluster illumination will dim.

Coolant temperature display





Warning!

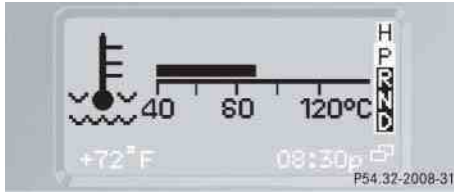

- Driving when your engine is badly overheated can cause some fluids which may have leaked into the engine compartment to catch fire. You could be seriously burned.
- Steam from an overheated engine can cause serious burns and can occur just by opening the hood. Stay away from the engine if you see or hear steam coming from it.

Turn off the engine, get out of the vehicle and do not stand near the vehicle until the engine has cooled down.



- ▶ Turn the SmartKey in the starter switch to position **1** or **2**.
- ▶ Call up the trip odometer and main odometer by pressing button  or  on the multifunction steering wheel (▷ page 116).
- ▶ Press button  or  until the coolant temperature display appears.





Excessive coolant temperature triggers a warning in the multifunction display (▷ page 269).

During severe operating conditions, e.g. stop-and-go traffic, the coolant temperature may rise close to 248°F (120°C).

The engine should not be operated with the coolant temperature above 248°F (120°C). Doing so may cause serious engine damage which is not covered by the Mercedes-Benz Limited Warranty.

Trip odometer

- ▶ Make sure you are viewing the trip odometer display (▷ page 115).
- ▶ If it is not displayed, press button  or  on the multifunction steering wheel (▷ page 116) until the trip odometer appears.
- ▶ Press and hold the reset button on the instrument cluster (▷ page 112) until the trip odometer is reset.

Controls in detail

Instrument cluster

Tachometer

The red marking on the tachometer denotes excessive engine speed.



Avoid driving at excessive engine speeds, as it may result in serious engine damage that is not covered by the Mercedes-Benz Limited Warranty.

To help protect the engine, the fuel supply is interrupted if the engine is operated within the red marking.

Controls in detail

Instrument cluster

Outside temperature indicator

Warning!



The outside temperature indicator is not designed to serve as an ice-warning device and is therefore unsuitable for that purpose.

Indicated temperatures just above the freezing point do not guarantee that the road surface is free of ice. The road may still be icy, especially in wooded areas or on bridges.

The outside temperature is displayed in the multifunction display (▷ page 115). For information on how to select the unit of the displayed temperature, i.e. degrees Celsius (°C) or degrees Fahrenheit (°F), see “Selecting temperature display mode” (▷ page 127).

The temperature sensor is located in the front bumper area. Due to its location, the sensor can be affected by road or engine heat during idling or slow driving. This means that the accuracy of the displayed temperature can only be verified by comparison to a thermometer placed next to the sensor, not by comparison to external displays (e.g. bank signs, etc.).

When moving the vehicle into colder ambient temperatures (e.g. when leaving your garage), you will notice a delay before the lower temperature is displayed.

A delay also occurs when ambient temperatures rise. This prevents inaccurate temperature indications caused by heat radiated from the engine during idling or slow driving.

▼ Control system

The control system is activated as soon as the SmartKey in the starter switch is turned to position **1**. The control system enables you to

- call up information about your vehicle
- change vehicle settings

For example, you can use the control system to find out when your vehicle is next due for service, to set the language for messages in the instrument cluster display and much more.

Warning!



A driver's attention to the road and traffic conditions must always be his/her primary focus when driving.

For your safety and the safety of others, selecting features through the multifunction steering wheel should only be done by the driver when traffic and road conditions permit it to be done safely.

Bear in mind that at a speed of just 30 mph (approximately 50 km/h), your vehicle is covering a distance of 44 feet (approximately 13.5 m) every second.

The control system relays information to the multifunction display.

Controls in detail

Control system

Multifunction display

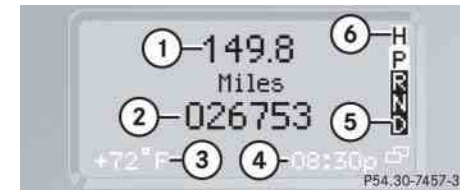

- ① Trip odometer
- ② Main odometer
- ③ Outside temperature
- ④ Clock¹
- ⑤ Current gear selector lever position
- ⑥ Transfer case program mode

¹ See separate operating instructions for the COMAND system for clock setting.

Controls in detail

Control system

Multifunction steering wheel

The displays in the multifunction display and the settings in the control system are controlled by the buttons on the multifunction steering wheel.



- ① Multifunction display in the speedometer

Operating the control system

- ② Selecting the submenu or setting the volume

— down / to decrease

+ up / to increase

- ③ Telephone*

 to take a call

 to end a call

- ④ Menu systems

 for next menu

 for previous menu

- ⑤ Moving within a menu

 for next display





 for previous display

Pressing any of the buttons on the multifunction steering wheel will alter what is shown in the multifunction display.

The information available in the multifunction display is arranged in menus, each containing a number of functions or sub-menus.

The individual functions are then found within the relevant menu (radio or CD operations under AUDIO, for example). These functions serve to call up relevant information or to customize the settings for your vehicle.

It is helpful to think of the menus, and the functions within each menu, as being arranged in a circular pattern.

- If you press button  or  repeatedly, you will pass through each menu one after the other.
- If you press button  or  repeatedly, you will pass through each function display, one after the other, in the current menu.

In the **SETTINGS** menu, instead of functions you will find a number of submenus for calling up and changing settings. For instructions on using these submenus, see the “Settings menu” section (▷ page 123).

The number of menus available in the system depends on which optional equipment is installed in your vehicle.

The menus are described on the following pages.

Controls in detail

Control system

Menus

This is what you will see when you scroll through the menus.

The table on the next page provides an overview of the individual menus.

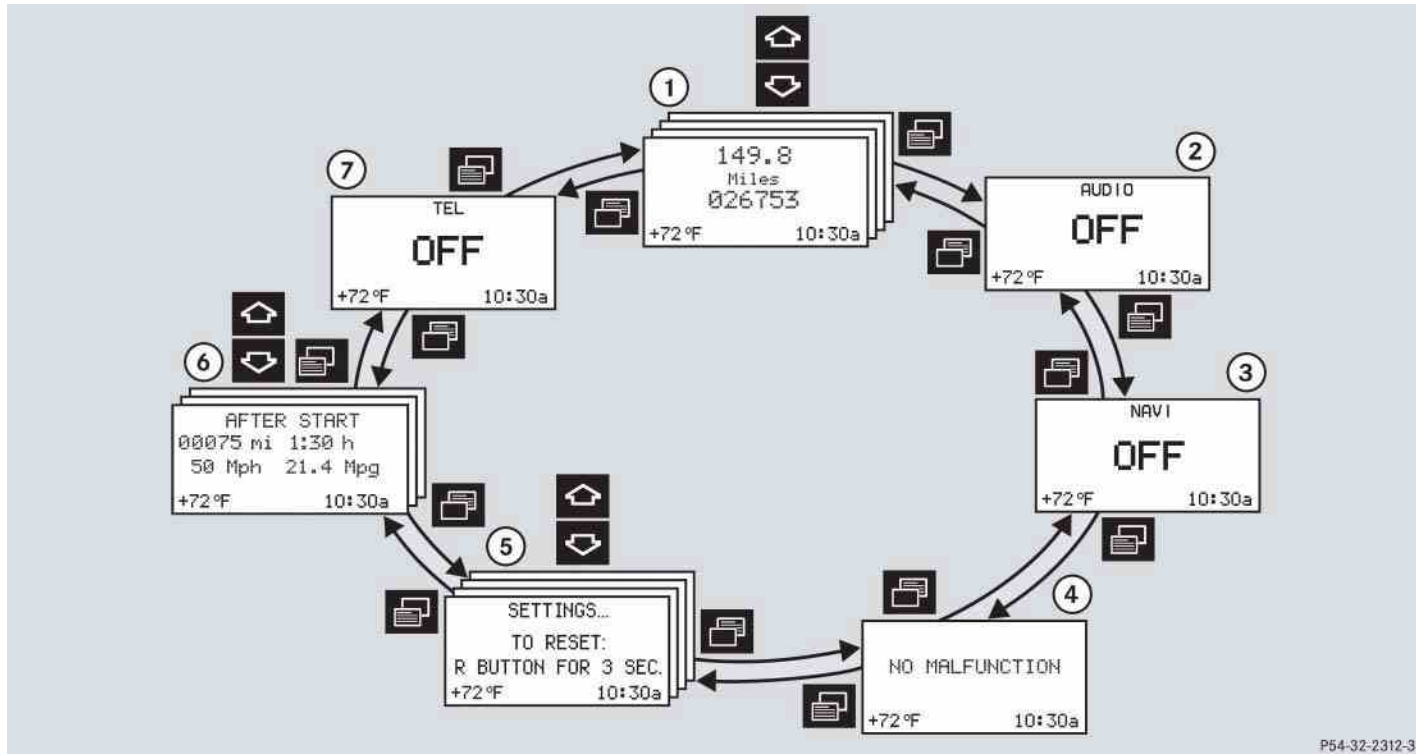

Menus, submenus and functions

	Menu ①	Menu ②	Menu ③	Menu ④	Menu ⑤	Menu ⑥	Menu ⑦
	Standard display	AUDIO	NAVI	Malfunction memory	Settings	Trip computer	Telephone
Commands/submenu	Coolant temperature display	Select radio station	Activate route guidance	Call up malfunction messages	Reset to factory settings	Fuel consumption statistics after start	Load phone book
	Digital speedometer	Operate CD player			Instrument cluster submenu	Fuel consumption statistics since the last reset	Search for name in phone book
	Call up FSS				Lighting submenu	Call up range	
	Check engine oil level				Vehicle submenu Convenience submenu		

Controls in detail

Control system



The headings used in the menus table are designed to facilitate navigation within the system and are not necessarily identical to those shown in the control system displays.

The first function displayed in each menu will automatically show you which part of the system you are in.

Standard display menu

You can select the functions in the standard display menu with button or .

The following functions are available:

Function	Page
Call up coolant temperature display	112
Call up digital speedometer	120
Call up FSS	242
Check engine oil level	229

Display digital speedometer

- ▶ Press button twice.

The current vehicle speed is shown in the multifunction display.

AUDIO menu



The functions in the AUDIO menu operate the audio equipment which you currently have turned on.

If no audio equipment is currently turned on, the message AUDIO OFF is shown in the display.

The following functions are available:



Function	Page
Select radio station	121
Operate CD player	121

Select radio station

- ▶ Turn on the radio. Refer to separate operating instructions.
- ▶ Press button  or  repeatedly until you see the currently tuned station in the display.



- ① Station
- ② Waveband setting
- ③ Setting for station selection using memory

- ▶ Press button  or  repeatedly until the desired station is found.
The type of search depends on the setting for the station tuning:
 - The next stored station is selected (SP)
 - Station search





You can only store new stations by using the corresponding feature on the radio. Refer to separate operating instructions.

You can also operate the radio in the usual manner.



Controls in detail

Control system

Operate the CD player

- ▶ Turn on the radio and select the CD player. Refer to separate operating instructions.
- ▶ Press button  or  repeatedly until the settings for the CD currently being played are shown in the display.



- ① Current track
 - ② Current CD (for CD changer)
- ▶ Press button  or  repeatedly until the desired track is selected.





To select a CD from the magazine, press a number on the COMAND system key pad located in the center dashboard.

Controls in detail

Control system

NAVI menu

The NAVI menu contains the functions needed to operate your navigation system.

- ▶ Press button  or  repeatedly until you see the message NAVI in the display.
- If the navigation system is off, the message NAVI OFF is shown in the display.
- If the navigation system is on, the message NAVI ACTIVE is shown in the display.

Please refer to the COMAND manual for instructions on how to activate the route guidance system*.



Malfunction memory menu

Use the malfunction memory menu to scan malfunction and warning messages that may be stored in the system. The information shown in the display depends on whether malfunctions have actually occurred.

Warning!



Malfunction and warning messages are only indicated for certain systems and are intentionally not very detailed. The malfunction and warning messages are simply a reminder with respect to the operation of certain systems and do not replace the owner's and/or driver's responsibility to maintain the vehicle's operating safety by having all required maintenance and safety checks performed on the vehicle and by bringing the vehicle to an authorized Mercedes-Benz Light Truck Center to address the malfunction and warning messages (> page 260).

- ▶ Press button  or  repeatedly until you see the malfunction message memory in the display.

No malfunction messages

If no malfunctions have occurred, the message in the display is:

NO MALFUNCTION

Malfunctions have occurred

If malfunctions have occurred, you will see the number of malfunctions in the display:

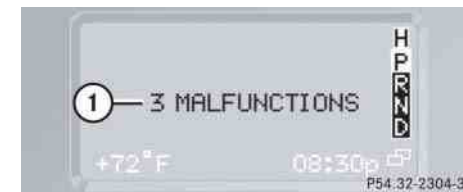

① Number of malfunctions

- ▶ Press button  or .

The stored messages will now be displayed in order. See the “Practical hints” section for malfunction and warning messages (> page 260).



Should any malfunctions occur while driving, the number of malfunctions will reappear in the display when the SmartKey in the starter switch is turned to position **0** or removed from the starter switch.



The message memory will be cleared when you turn the SmartKey in the starter switch to position **1** or **2**. You will then only see Priority 1 malfunctions (▷ page 260).

Settings menu

In the SETTINGS... menu there are two functions:

- The function RESET: R BUTTON FOR 3 SEC., with which you can reset all the settings to those set at the factory.
 - A collection of submenus with which you can make individual settings for your vehicle.
- ▶ Press button  or  repeatedly until the SETTINGS... menu is seen in the display.



Resetting all settings

You can reset all the functions of all submenus to the factory settings.

- ▶ Press the reset button in the instrument cluster (▷ page 112) for approximately three seconds.

In the display you will see the request to press the reset button again to confirm.

- ▶ Press the reset button again.

The functions of all the submenus will reset to factory settings.

Controls in detail

Control system



The settings you have changed will not be reset unless you confirm the action by pressing the reset button a second time. Approximately five seconds after pressing the reset button for the second time, the SETTINGS... menu reappears in the display.

For safety reasons, the following functions are not reset while driving:

- the LIGHT CIRCUIT HEADLIGHT MODE function in the LIGHTING submenu
- the SETTINGS KEY-DEPENDENT function in the CONVENIENCE submenu

Submenus in the Settings menu

- ▶ Press button or .

In the display you see the collection of the submenus.



- ▶ Press button .

The selection marker moves to the next submenu.

The submenus are arranged by hierarchy. Scroll down with the button, scroll up with the button.

Move within the submenus with the or button to the individual functions.

The settings themselves are made with button or .

Resetting the functions of a submenu

For each submenu you can reset all the functions to the factory settings.

- ▶ Move to a function in the submenu.
- ▶ Press the reset button in the instrument cluster (▷ page 112) for approximately three seconds.

In the display you will see the request to press the reset button again to confirm.

- ▶ Press the reset button again.

All functions of the submenu will reset to factory settings



The settings you have changed will not be reset unless you confirm the action by pressing the reset button a second time. Approximately five seconds after pressing the reset button for the second time, the `SETTINGS...` menu reappears in the display.

Controls in detail

Control system

The table below shows what settings can be changed within the various menus. Detailed instructions on making individual settings can be found on the following pages.

INSTRUMENT CLUSTER	LIGHTING	VEHICLE	CONVENIENCE
Select time display mode	Set daytime running lamp mode (USA only)	Set station selection mode (radio)	Activate easy-entry/exit feature
Select temperature display mode	Set locator lighting	Set automatic locking	Set key-dependency
Select speedometer display mode	Exterior lamps delayed switch-off		Set parking position for exterior rear view mirror
Select language	Interior lighting delayed switch-off		
Select display (speed display or outside temperature)			

Controls in detail

Control system

Instrument cluster submenu

Access the INSTRUMENT CLUSTER menu via the SETTINGS menu. Use the INSTRUMENT CLUSTER submenu to change the instrument cluster display settings. The following functions are available:

Function	Page
Select time display mode	127
Select temperature display mode	127
Select speedometer display mode	128
Select language	128
Select display (speed display or outside temperature)	129

Selecting time display mode

- ▶ Move the selection marker with the **+** or **-** button to the INSTRUMENT CLUSTER submenu.
- ▶ Press button **▲** or **▼** repeatedly until you see this message in the display: 12/24 HOUR.

The selection marker is on the current setting.

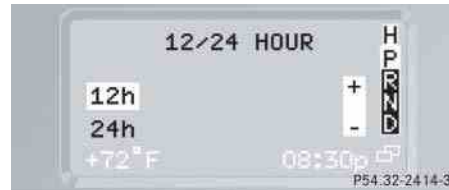

- ▶ Press **+** or **-** to set the 12h or 24h time display mode.

Selecting temperature display mode

- ▶ Move the selection marker with the **+** or **-** button to the INSTRUMENT CLUSTER submenu.
- ▶ Press button **▲** or **▼** repeatedly until you see this message in the display: TEMP. INDICATOR.

The selection marker is on the current setting.



- ▶ Press **+** or **-** to set temperature unit to degrees Celsius (°C) or degrees Fahrenheit (°F).

Controls in detail

Control system

Selecting speedometer display mode

- ▶ Move the selection marker with the **+** or **-** button to the INSTRUMENT CLUSTER submenu.
- ▶ Press button **▲** or **▼** repeatedly until you see this message in the display: DISPLAY VALUES IN.

The selection marker is on the current setting.

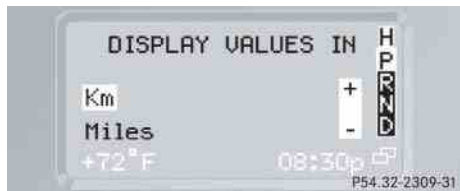

- ▶ Press **+** or **-** to set speedometer unit to KM or Miles.

Selecting language

- ▶ Move the selection marker with the **+** or **-** button to the INSTRUMENT CLUSTER submenu.
- ▶ Press button **▲** or **▼** repeatedly until you see this message in the display: TEXT.

The selection marker is on the current setting.



- ▶ Press **+** or **-** to select the language to be used for the multifunction display messages.

Available languages:

- German
- English
- French
- Italian
- Spanish

Selecting display (speed display or outside temperature)

- ▶ Move the selection marker with the **+** or **-** button to the INSTRUMENT CLUSTER submenu.
- ▶ Press button **▲** or **▼** repeatedly until you see this message in the display: SELECT DISPLAY.

The selection marker is on the current setting.

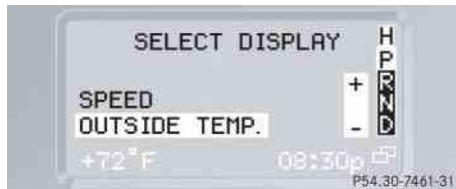

- ▶ Press **+** or **-** to select the display permanently shown in the multi-function display.

Lighting submenu

Access the LIGHTING submenu via the SETTINGS menu. Use the LIGHTING submenu to change the lamp and lighting settings on your vehicle. The following functions are available:

Function	Page
Set daytime running lamp mode (USA only)	129
Set locator lighting	130
Exterior lamps delayed switch-off	131
Interior lighting delayed switch-off	132

Setting daytime running lamp mode (USA only)

- ▶ Move the selection marker with the **+** or **-** button to the LIGHTING submenu.

Controls in detail

Control system

- ▶ Press button **▲** or **▼** repeatedly until you see this message in the display: LIGHT CIRCUIT HEADLIGHT MODE.

The selection marker is on the current setting.



- ▶ Press **+** or **-** to select manual or daytime running lamp (constant) mode. This function is not available in countries where daytime running lamps are mandatory.

With daytime running lamp mode selected and the exterior lamp switch at position **0**, the following lamps will come on automatically when the engine is turned on:

- Parking lamps and low beam headlamps
- License plate lamps

▷▷

Controls in detail

Control system



If you turn the exterior lamp switch to another position, the corresponding lamp(s) will switch on.

For safety reasons, resetting the LIGHTING submenu to factory settings (> page 123) will not reset the daytime running lamp mode.

In the display you will then see the message: LIGHTING - CANNOT BE TOTALLY RESET TO FACTORY SETTINGS WHILE DRIVING.



Setting locator lighting

During darkness, the following lamps will come on when the exterior lamp switch is in position **AUTO**, the locator lighting feature is activated, and the vehicle is unlocked by SmartKey:

- parking lamps
- tail lamps
- license plate lamps
- front fog lamps

The locator lighting switches off when the driver's door is opened. It switches off automatically after a period of approximately 40 seconds.

- ▶ Move the selection marker with the **+** or **-** button to the LIGHTING submenu.

- ▶ Press button  or  repeatedly until you see this message in the display: LOCATOR LIGHTING.

The selection marker is on the current setting.

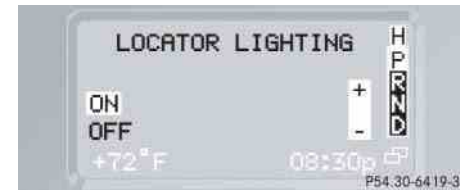

- ▶ Press **+** or **-** to select the desired setting.

The locator lighting will be switched on or off.

Setting night security illumination

(Exterior lamps delayed switch-off)

Use the HEADLIGHTS DELAYED SHUT-OFF function to set whether and for how long you would like the exterior lamps to illuminate during darkness after all doors are closed. When the delayed shut-off feature is activated and the exterior lamp switch is in position **AUTO**, the following lamps will remain lit after you remove the SmartKey from the starter switch:

- parking lamps
- tail lamps
- license plate lamps
- front fog lamps



You can reactivate this function within ten minutes by opening a door.

If you do not open a door after removing the SmartKey, the lamps will automatically switch off after 60 seconds.

- ▶ Move the selection marker with the **+** or **-** button to the LIGHTING submenu.
- ▶ Press button **▲** or **▼** repeatedly until you see this message in the display: HEADLIGHTS DELAYED SHUT-OFF.

The selection marker is on the current setting.



Controls in detail

Control system

- ▶ Press **+** or **-** to select the desired lamp-on period.

You can select:

- 0 s, the delayed switch-off feature is deactivated
- 15 s, 30 s, 45 s or 60 s, the delayed switch-off feature is activated

You can temporarily deactivate the delayed switch-off feature:

- ▶ Before leaving the vehicle, turn the SmartKey in the starter switch to position **0**.
- ▶ Then turn it to position **2** and back to **0**.

The delayed switch-off feature is deactivated. It will reactivate as soon as you reinsert the SmartKey in the starter switch.

Controls in detail

Control system

Interior lighting delayed switch-off

Use this function to set whether and for how long you would like the interior lighting to remain lit during darkness after the SmartKey is removed from the starter switch.

- ▶ Move the selection marker with the **+** or **-** button to the LIGHTING submenu.
- ▶ Press button **▲** or **▼** repeatedly until you see this message in the display: INT. LIGHTING DELAYED SHUT-OFF.

The selection marker is on the current setting.



- ▶ Press **+** or **-** to select the desired lamp-on time period. You can select:
 - 0 s, the delayed switch-off feature is deactivated
 - 5 s, 10 s, 15 s or 20 s, the delayed switch-off feature is activated

Vehicle submenu

Access the VEHICLE submenu via the SETTINGS menu. Use the VEHICLE submenu to make general vehicle settings. The following functions are available:

Function	Page
Set station selection mode (radio)	132
Set automatic locking	133

Setting station selection mode

Use the PRESS BUTTON IN AUDIO MODE function to select the manual or memory station selection mode for the radio.

- ▶ Move the selection marker with the **+** or **-** button to the VEHICLE submenu.



Controls in detail

Control system

- ▶ Press button  or  repeatedly until you see this message in the display: PRESS BUTTON IN AUDIO MODE.





The selection marker is on the current setting.



- ▶ Press  or  to select the desired station selection mode. You can select:
 - STATION SEARCH
 - MEMORY selects next stored station

Setting automatic locking

Use this function to activate or deactivate the automatic central locking. With the automatic central locking system activated, the vehicle is centrally locked at vehicle speeds of approximately 9 mph (15 km/h).

- ▶ Move the selection marker with the  or  button to the Vehicle submenu.
- ▶ Press button  or  repeatedly until you see this message in the display: AUTOMATIC DOOR LOCK.

The selection marker is on the current setting.



- ▶ Press  or  to switch function ON or OFF.

Convenience submenu

Access the CONVENIENCE submenu via the SETTINGS menu. Use the CONVENIENCE submenu to change the settings for a number of convenience features. The following functions are available:

Function	Page
Activate easy-entry/exit feature	133
Set key-dependency	135
Set parking position for exterior rear view mirror	135

Activating easy-entry/exit feature

Use this function to activate and deactivate the easy-entry/exit feature. When the feature is activated, the steering wheel will move back to facilitate exiting when you

- remove the SmartKey from the starter switch
- open the driver's door

However, the engine must be turned off.

Controls in detail

Control system

Warning!



Make sure no one can become trapped or injured by the moving steering wheel when the easy-entry/exit feature is in operation and the driver's door is being opened or the SmartKey is removed from the starter switch.

Do not leave children unattended in the vehicle, or with access to an unlocked vehicle. Children could open the driver's door and unintentionally activate the easy-entry/exit feature, which could result in an accident and/or serious personal injury.

After entering the vehicle, the steering wheel will move into the position stored in memory when

- the driver's door is closed
- you put the SmartKey in the starter switch and
- press the appropriate stored position button on the memory switch (▷ page 103)



To cancel steering wheel movement, do one of the following:

- Move the steering column stalk (▷ page 22)
 - Press the memory switch (▷ page 102)
- ▶ Move the selection marker with the **+** or **-** button to the CONVENIENCE submenu.

- ▶ Press button  or  repeatedly until you see this message in the display: EASY-ENTRY FEATURE ACTIVATE.

The selection marker is on the current setting.



- ▶ Press **+** or **-** to change the easy-entry/exit setting.

The following settings are available for the easy-entry/exit feature

OFF	The easy-entry/exit feature is deactivated
STEERING COLUMN	The easy-entry/exit feature is activated

Setting key-dependency

Use this function to set whether the memory settings for the seats, the steering wheel and the exterior mirrors should be stored separately for each SmartKey (▷ page 101).

- ▶ Move the selection marker with the **+** or **-** button to the CONVENIENCE submenu.
- ▶ Press button **↶** or **↷** repeatedly until you see this message in the display: SETTINGS KEY-DEPENDENT.

The selection marker is on the current setting.



- ▶ Press **+** or **-** to set key dependency to ON or OFF.



For safety reasons, resetting the SETTINGS KEY-DEPENDENT submenu to factory settings will not reset while driving.

In the display you will then see the message: CONVENIENCE - CANNOT BE TOTALLY RESET TO FACTORY SETTINGS WHILE DRIVING.

Setting parking position for exterior rear view mirror

Use the MIRROR SETTING WHEN PARKING function to select whether the passenger-side exterior rear view mirror should be turned downward during parking maneuvers when reverse gear is engaged. For more information, see “Activating exterior rear view mirror parking position” (▷ page 153).

Controls in detail

Control system

- ▶ Move the selection marker with the **+** or **-** button to the CONVENIENCE submenu.
- ▶ Press button **↶** or **↷** repeatedly until you see this message in the display: MIRROR SETTING WHEN PARKING.

The selection marker is on the current setting.



- ▶ Press **+** or **-** to switch function ON or OFF.

Controls in detail





Control system

Trip computer menu

Use the trip computer menu to call up statistical data on your vehicle. The following information is available:

Function	Page
Fuel consumption statistics after start	136
Fuel consumption statistics since last reset	136
Call up range (distance to empty)	137





Fuel consumption statistics after start

- ▶ Press button  or  repeatedly until you see the first function of the Trip computer menu.
- ▶ Press button  or  repeatedly until you see this message in the multi-function display: AFTER START.



- ① Time elapsed since start
- ② Average fuel consumption since start
- ③ Average speed since start
- ④ Distance driven since start

Fuel consumption since last reset

- ▶ Press button  or  repeatedly until you see the first function of the Trip computer menu.
- ▶ Press button  or  repeatedly until you see this message in the display: AFTER RESET.



- ① Time elapsed since last reset
- ② Average fuel consumption since last reset
- ③ Average speed since last reset
- ④ Distance driven since last reset



All statistics stored since the last engine start will be reset approximately four hours after the SmartKey in the starter switch is turned to position **0** or removed from the starter switch.

Resetting will not occur if you turn the SmartKey back to position **1** or **2** within this time period.

Resetting fuel consumption statistics

- ▶ Press button or repeatedly until you see the first function of the Trip computer menu.
- ▶ Press button or repeatedly until you see the reading that you want to reset in the display.
- ▶ Press and hold the reset button in the instrument cluster (▷ page 112) until the value is reset to 0.

Call up range (distance to empty)

- ▶ Press button or repeatedly until you see the first function of the Trip computer menu.
- ▶ Press button or repeatedly until you see this message in the display: RANGE.

In the display you will see the calculated range based on the current fuel tank level.



TEL menu

Warning!



A driver's attention to the road and traffic conditions must always be his/her primary focus when driving. For your safety and the safety of others, we recommend that you pull over to a safe location and stop before placing or taking a telephone call. If you choose to use the telephone while driving, please use the hands-free device and only use the telephone when weather, road and traffic conditions permit.

Some jurisdictions prohibit the driver from using a cellular telephone while driving a vehicle.

Bear in mind that at a speed of just 30 mph (approximately 50 km/h), your vehicle is covering a distance of approximately 44 feet (approximately 13.5 m) every second.





Controls in detail

Control system

- ▷▷ Never operate radio transmitters equipped with a built-in or attached antenna (i.e. without being connected to an external antenna) from inside the vehicle while the engine is running. Doing so could lead to a malfunction of the vehicle's electronic system, possibly resulting in an accident and/or personal injury.

You can use the functions in the TEL menu to operate your telephone, provided it is connected to a hands-free system and switched on.

- ▶ Switch on the telephone and COMAND.
- ▶ Press button  or  on the steering wheel repeatedly until you see the TEL menu in the display.

Which messages will appear in the display field depends on whether your telephone is switched on or off:

- If the telephone is off, the message in the multifunction display is: TEL OFF.

- If the telephone is on:

The telephone will then search for a network. During this time the display is empty.

As soon as the telephone has found a network, READY is indicated in the display.



① Signal strength

This standby message indicates that your telephone is ready for use and you can operate it using the control system.

Answering a call

When your telephone is ready to receive calls, you can answer a call at any time. In the display you will then see the message:



- ▶ Press button .

You have answered the call. In the display you see the length of the call.

Ending a call

- ▶ Press button .





You have ended the call. In the display you will again see the standby message.

Controls in detail

Control system



Dialing a number from the phone book

If your telephone is ready to receive calls, you may select and dial a number from the phone book at any time.

- ▶ Press button  or  repeatedly until you see the TEL menu in the display.
- ▶ Press button  or .



The control system reads the phone book which is stored in the telephone. This may take up to 30 seconds. In the display you will see the message PLEASE WAIT!.

When the message PLEASE WAIT! disappears, the phone book has been loaded.

- ▶ Press button  or  repeatedly until the desired name appears in the display.

The stored names are displayed in ascending or descending alphabetical order.



If you press and hold  or  for longer than one second, the system scrolls rapidly through the list of names until you release the button again.

Cancel the quick search mode by pressing .

- ▶ Press button .

The system dials the selected phone number.



- If connection is successful, the name of the party you called and the duration of the call will appear in the display.





- If no connection is made, the control system stores the dialed number in the redial memory.

Redialing

The control system stores the most recently dialed phone numbers. This eliminates the need to search through your entire phone book.

- ▶ Press button  or  repeatedly until you see the TEL menu in the display.
- ▶ Press button .

In the display, you see the first number in the redial memory.

- ▶ Press button  or  repeatedly until the desired name appears in the display.
- ▶ Press button .

The control system dials the selected phone number.

Controls in detail

Automatic transmission

▼ Automatic transmission

For more information on driving with an automatic transmission, see the “Getting started” section (▷ page 43).

Your vehicle’s transmission adapts its gear shifting process to your individual driving style by continually adjusting the shift points up or down. These shift point adjustments are performed based on current operating and driving conditions.

If the operating conditions change, the automatic transmission reacts by adjusting its gear shift program.



During the brief warm-up, transmission upshifting is delayed. This allows the catalytic converter to heat up more quickly to operating temperature.

The automatic transmission selects individual gears automatically, dependent upon

- the gear selector lever position **D** with gear ranges **4, 3, 2, 1** (▷ page 142)
- transfer case position (**HIGH** or **LOW**)
- the position of the accelerator pedal (▷ page 144)
- the vehicle speed

The current gear selector lever position and the transfer case position (**HIGH** or **LOW**) appear in the multifunction display.



- ① Transfer case display
- ② Gear selector lever position/gear range

Warning!



It is dangerous to shift the gear selector lever out of **P** or **N** if the engine speed is higher than idle speed. If your foot is not firmly on the brake pedal, the vehicle could accelerate quickly forward or reverse. You could lose control of the vehicle and hit someone or something. Only shift into gear when the engine is idling normally and when your right foot is firmly on the brake pedal.

When the gear selector lever is in position **D**, you can influence transmission shifting by

- limiting the gear range
- changing gears manually

One-touch gearshifting

Even with an automatic transmission, you can change the gears manually when the gear selector lever is in position **D**.

Downshifting

- ▶ Briefly press the gear selector lever to the left in the **D-** direction.

The transmission will shift from the current gear to the next lower gear. This action simultaneously limits the gear range of the transmission (> page 142).

Warning!



On slippery road surfaces, never downshift in order to obtain braking action. This could result in drive wheel slip and reduced vehicle control. Your vehicle's ABS will not prevent this type of loss of control.



To avoid overrevving the engine when the gear selector lever is moved to the **D-** direction, the transmission will not shift to a lower gear if the engine's max. speed would be exceeded.

Upshifting

- ▶ Briefly press the gear selector lever to the right in the **D+** direction.

The transmission will shift from the current gear to the next higher gear as permitted by the shift program. This action simultaneously extends the gear range of the transmission.

Controls in detail

Automatic transmission

Canceling gear range limit

- ▶ Press and hold the gear selector lever in the **D+** direction until **D** reappears in the multifunction display.

The transmission will shift from the current gear range directly to gear range **D**.

Shifting into optimal gear range

- ▶ Press and hold the gear selector lever in the **D-** direction.

The transmission will automatically select the gear range suited for optimal acceleration and deceleration. This will involve shifting down one or more gears.

Controls in detail

Automatic transmission

Gear ranges

With the gear selector lever in position **D**, you can limit the transmission's gear range by pressing the gear selector lever to the left (**D-**), and reverse the gear range limit by pressing the gear selector lever to the right (**D+**).

The selected gear range will appear in the multifunction display. If you press on the accelerator when the engine has reached its rpm limit, the transmission will upshift beyond any gear range limit selected.



If the transfer case is in off-road driving position **LOW**, the automatic transmission will not shift up automatically, even when the engine has reached the speed limit for that gear. There is a risk of damaging the engine.

It is very important to make sure the permissible engine speed is not exceeded.

	Effect
4	The transmission shifts through fourth gear only.
3	The transmission shifts through third gear only. With this selection you can use the braking effect of the engine.
2	The transmission shifts through second gear only. Allows the use of engine's braking power when driving <ul style="list-style-type: none">• on steep downgrades• in mountainous regions• under extreme operating conditions
1	The transmission operates in first gear only. For maximum use of engine's braking effect on very steep or lengthy downgrades.

Gear selector lever position

	Effect
P	Park position Gear selector lever position when the vehicle is parked. Place gear selector lever in position P only when vehicle is stopped. The park position is not intended to serve as a brake when the vehicle is parked. Rather, the driver should always set the parking brake in addition to placing the gear selector lever in position P to secure the vehicle.

	Effect
	<p>The SmartKey can only be removed from the starter switch with the gear selector lever in position P. With the SmartKey removed, the gear selector lever is locked in position P.</p> <p>If the vehicle's electrical system is malfunctioning, the gear selector lever could remain locked in position P (▷ page 290).</p>
R	<p>Reverse gear</p> <p>Place gear selector lever in position R only when vehicle is stopped.</p>

	Effect
N	<p>Neutral</p> <p>No power is transmitted from the engine to the drive axle. When the brakes are released, the vehicle can be moved freely (pushed or towed).</p> <p>Do not engage N while driving except:</p> <ul style="list-style-type: none"> • to coast when vehicle is in danger of skidding (e.g. on icy roads) when the ESP is deactivated or malfunctioning • when you have to shift the transfer case
D	<p>Drive</p> <p>The transmission shifts automatically. All five forward gears are available.</p>

Controls in detail

Automatic transmission



Coasting the vehicle, or driving for any other reason with gear selector lever in **N** can result in transmission damage that is not covered by the Mercedes-Benz Limited Warranty.

Warning!



Getting out of your vehicle with the gear selector lever not fully engaged in position **P** is dangerous. Also, position **P** alone is not intended to or capable of preventing your vehicle from moving, possibly hitting people or objects.

Always set the parking brake in addition to shifting to position **P** (▷ page 51).

When parked on an incline, turn the front wheels towards the road curb.

Do not park this vehicle in areas where combustible materials such as grass, hay or leaves can come into contact with the hot exhaust system, as these materials could be ignited and cause a vehicle fire.

Controls in detail

Automatic transmission

Warning!



When leaving the vehicle, always remove the SmartKey from the starter switch, and lock the vehicle. Do not leave children unattended in the vehicle, or with access to an unlocked vehicle. Children could move the gear selector lever from position **P**, which could result in an accident and/or serious personal injury.

Accelerator position

Your driving style influences the transmission's shifting behavior:

Less throttle Earlier upshifting
More throttle Later upshifting

Kickdown

Use kickdown when you want maximum acceleration.

- ▶ Press the accelerator past the point of resistance.
The transmission shifts into a lower gear.
- ▶ Ease on the accelerator when you have reached the desired speed.
The transmission shifts up again.

Emergency operation (Limp Home Mode)

If vehicle acceleration worsens or the transmission no longer shifts, the transmission is most likely operating in limp home (emergency operation) mode. In this mode, only 2nd gear and reverse gear can be activated.

- ▶ Stop the vehicle.
- ▶ Move gear selector lever to **P**.
- ▶ Turn off the engine.
- ▶ Wait at least ten seconds before re-starting.
- ▶ Restart the engine.
- ▶ Move gear selector lever to position **D** (for second gear) or **R**.
- ▶ Have the transmission checked at an authorized Mercedes-Benz Light Truck Center as soon as possible.

▼ Transfer case

For more information on off-road driving, see “Off-road driving” (▷ page 213).

Gear range

H	HIGH Road position
L	LOW Off-road position This position is intended for driving off-road and step gradients. The transmission will not up-shift automatically to the next higher gear range when driving at the rpm limit. The transfer case supports the engine’s driving force (approx. $\frac{1}{2}$ speed). Output is therefore increased.

N	Neutral No power is transmitted from the engine to the drive axle.
----------	--

Switching transfer case

The switch is located in the center console.



Controls in detail

Transfer case



- ① Transfer case indicator
- ② Gear range indicator

Transfer case indicator ① in the multi-function display shows the gear position of the transfer case.

Controls in detail

Transfer case

Switching from HIGH to LOW



The shift procedure can only be performed when:

- The engine is running.
- The gear selector lever for the automatic transmission is in position **N**.
- The vehicle is not at standstill.
- The vehicle speed does not exceed 25 mph (40 km/h).

- ▶ Press upper half (“LOW”) of the transfer case switch.

Once the shift is complete, gear position **L** is displayed in the transfer case indicator.



If the shift procedure does not take place press upper half (“LOW”) of the transfer case switch again.

- ▶ Put gear selector in **D**.

Switching from LOW to HIGH



The shift procedure can only be performed when:

- The engine is running.
- The gear selector lever for the automatic transmission is in position **N**.
- The vehicle is not at standstill.
- The vehicle speed does not exceed 40 mph (70 km/h).

- ▶ Press lower half (“HIGH”) of the transfer case switch.

Once the shift is complete, gear position **H** is displayed in the transfer case indicator.



If the shift procedure does not take place press lower half (“HIGH”) of the transfer case switch again.

- ▶ Put gear selector in **D**.

Messages in the multifunction display

If a shift was not completed and the multifunction display shows one of the following messages:

- TC SHIFT CONDITIONS NOT FULFILLED

The shift did not take place. At least one shift condition was not met.

- ▶ Repeat the shift procedure.

- TC IN NEUTRAL

The shift did not take place. The transfer case is in neutral. The gear position **N** is displayed in the transfer case indicator ①.

- ▶ Repeat the shift procedure.

Warning!



If TC is in neutral, transmission position **P** will not hold vehicle. The parking brake must be applied to hold vehicle in place.

- TC SHIFT - CANCELLED
The shift did not take place.
- ▶ Repeat the shift procedure.
- TRANSFER CASE - VISIT WORKSHOP!
There may be a malfunction in the system.
- ▶ Repeat the shift procedure.
- ▶ If the shift procedure still does not take place, have the vehicle checked at your authorized Mercedes-Benz Light Truck Center as soon as possible.



If the SmartKey is in starter switch position **0** or **1**, an alarm will sound if the transfer case is in position **N** and the driver's door is opened.

Engage transfer case to gear position **HIGH** or **LOW**.

For more information, see "Practical hints" section (▷ page 281).

Controls in detail

Differential locks

▼ Differential locks

For more information on off-road driving, see “Off-road driving” (▷ page 213).

Differential locks improve the vehicle’s tractive power off-road. Switch on differential locks:

- for off-road driving
- to turn the ABS off during off-road driving
- for driving through water
- when driving on deep snow and icy or fouled surfaces



Do not engage the front axle differential lock when driving around tight corners. This restricts steering ability.



When driving off-road, apply only moderate pressure to the accelerator pedal if the differential locks are switched on.

When running on a (single-axle) dynamometer – no matter how briefly – you must:

- raise the non-driven axle
- or
- disconnect its drive shaft
- and
- engage the transfer differential lock

Otherwise the transfer case can be damaged, which is not covered by the Mercedes-Benz Limited Warranty.

Warning!



Never drive on pavement with differential locks engaged.

Steering control will be strongly affected with the differential locks activated.

The ABS, BAS and ESP are switched off automatically when the transfer case differential lock is activated.

A few words about differentials and differential locks

When a vehicle negotiates a turn, wheels on the outside of the curve must travel farther and rotate faster than the inside wheels. The differential, the operation of a set of gears that allows the powered wheels in a vehicle to turn at different speeds, makes this essential function possible.

The drawback is that the differential also sends most of the engine's power to the wheel with the least load or strain on it. For example, if one of a vehicle's powered wheels sits on a patch of snow and spins because there is no traction, all of the engine's power will go to that wheel because the power will take the path of least resistance. Meanwhile, the opposite wheel, sitting on dry pavement where it could get enough grip to start the vehicle moving, sits idle because it receives no power.

The Electronic Traction System (ETS) addresses this problem and provides for good control and steering ability by automatically slowing the slipping wheel and thus increasing the power to the other non-slipping drive wheels to get the vehicle moving. The ESP and ETS in this vehicle feature such intelligent limited-slip differential technology, ideally suited for on-road and light off-road driving. Transfer case position LOW (▷ page 145) also enhances off-road driving capabilities (▷ page 213).

More extreme off-road conditions may call for another solution, engaging a differential lock or preventing the differential from operating altogether. As part of its standard equipment, this vehicle comes with three differential locks: front, transfer case (center) and rear. Each can be engaged simply by pushing dashboard-mounted buttons in sequential order (center, rear, front) (▷ page 150). When the transfer case (center) differential is locked, half of the engine's power is automatically distributed to the front wheels and half to the

rear wheels. When the rear differential is locked, power going to the rear wheels is equally distributed, so that both rear wheels turn at the same speed and torque. When the front differential is locked, all four wheels now turn with equal power and torque. Please be aware that engaging the differential locks will significantly reduce the steering ability of the vehicle.

For your safety and the safety of others and to prevent damage to the vehicle, the differential locks must not be engaged when driving on paved roads. It is important to understand that during on-road/paved driving, differentials are absolutely necessary for providing the essential control and steering ability of the vehicle. The differential locks, therefore, must not be engaged when driving on paved roads and should only be used to the extent necessary to negotiate off-road conditions which cannot be handled by the systems (automatic 4-ETS, the ESP, manual switch position "LOW" of transfer case) this vehicle comes equipped with.

Controls in detail

Differential locks

Controls in detail

Differential locks

Switching differential locks on and off

The switch is located in the center console.



- ① Transfer case (center) differential lock
- ② Rear axle differential lock
- ③ Front differential lock
- ④ Engagement indicator lamps (yellow)
- ⑤ Function indicator lamps (red)



The differential locks can only be switched on in the sequence ①, ②, ③.

Switching differential locks on



To avoid damage to the transfer case and differential locks:

- Engage differential locks only at low speed (walking speed, not more than 5 mph).
- Do not engage differential locks if the driving wheels are spinning due to lack of traction.
- Do not engage on paved roads.

Transfer case differential lock



- ▶ Press switch ①.

The yellow engagement indicator lamp ④ for the transfer case differential lock comes on.

The ESP warning lamp  comes on.

When the differential lock engagement operation has been completed, the red function indicator lamp ⑤ comes on.

The message ABS NOT AVAILABLE - DIFFERENTIAL LOCKED appears in the multifunction display.

The ESP warning lamp  and the ABS  warning lamp in the instrument cluster come on.

Once the transfer case differential lock is switched on, you can now, if needed,

- switch on rear axle differential lock ②
- or
- switch on rear axle differential lock and front differential lock ② and ③.

Controls in detail

Differential locks

Rear axle differential lock

- ▶ Press switch ②.

The yellow engagement indicator lamp ④ comes on first, followed by the red function indicator lamp ⑤.

The rear axle differential lock is switched on.

Front differential lock

- ▶ Press switch ③.

The yellow engagement indicator lamp ④ comes on first, followed by the red function indicator lamp ⑤.

The front differential lock is switched on.



Switching differential locks off

There are two different methods to disengage differential locks:

- You can switch the differential locks off in reverse order (③, ②, ①).
- To switch off all differential locks at the same time:
 - ▶ Press switch ①.

The yellow engagement indicator lamps ④ go out first. The red function indicator lamps ⑤ go out when the switching process has been carried out in the differential.

To activate the ESP, BAS and ABS systems, drive again for three seconds using a constant driving style.

All messages in the multifunction display disappear. The ESP warning lamp  and the ABS  warning lamp in the instrument cluster go out.



If the function lamps do not go out when the differential locks are disengaged, bring vehicle to a stop and then continue driving. Changing the vehicle load can help to disengage locks.

Warning!



Always remember to disengage the differential locks when returning to drive on paved roads, see “A few words about differentials and differential locks” (> page 149).

Controls in detail

Good visibility

▼ Good visibility

For information on windshield wipers, see “Windshield wipers” (▷ page 47) and for setting the exterior rear view mirrors, see “Exterior rear view mirror” (▷ page 38).

Rear view mirror

Automatic antiglare rear view mirrors

The reflection brightness of the exterior rear view mirrors and the interior rear view mirror will respond automatically to glare when

- the ignition is switched on, and
- incoming light from headlamps falls on the sensor in the interior rear view mirror

The interior rear view mirror will not react if

- reverse gear is engaged
- the interior lighting is turned on

Warning!



The automatic antiglare function does not react if incoming light is not aimed directly at sensors in the interior rear view mirror.

The interior rear view mirror and the exterior rear view mirrors do not react, for example, if the cargo compartment is fully loaded.

Glare can endanger you and others.

Warning!



Exercise care when using the passenger-side exterior rear view mirror. The mirror surface is convex (outwardly curved surface for a wider field of view). Objects in mirror are closer than they appear. Check your inside rear view mirror or glance over your shoulder before changing lanes.

Warning!



In the case of an accident, liquid electrolyte may escape from the mirror housing if the mirror glass breaks.

Electrolyte has an irritating effect. Do not allow the liquid to come into contact with eyes, skin, clothing, or the respiratory system. In case it does, immediately flush affected area with water, and seek medical help if necessary.

Activating exterior rear view mirror parking position

Follow these steps to activate the mirror parking position so that the passenger-side exterior rear view mirror will be turned downward to the stored position.

- ▶ Make sure you stored a parking position for the passenger-side exterior rear view mirror (▷ page 103).
- ▶ Make sure the MIRROR SETTING WHEN PARKING function, found under the CONVENIENCE submenu in the control system, is switched to ON (▷ page 135).
- ▶ Switch on ignition.
- ▶ Press button ② for the passenger-side exterior rear view mirror.
- ▶ Place the gear selector lever in reverse gear **R**.

The passenger-side exterior rear view mirror will be turned downward to the stored position.

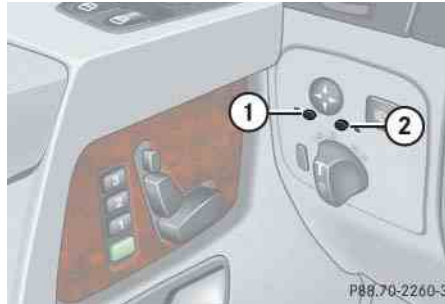

- ① Driver's side exterior rear view mirror button
- ② Passenger-side exterior rear view mirror button

The exterior rear view mirror returns to its previously stored driving position:

- 10 seconds after you put the gear selector lever out of position **R**
- immediately once you exceed a vehicle speed of approx. 6 mph (10 km/h)
- immediately when you press button ① for driver's side exterior rear view mirror

Headlamp cleaning system

The switch is located to the left of the steering column.



- ① Headlamp washer switch

- ▶ Switch on ignition.
- ▶ Press switch ①.

The headlamps will be cleaned with a high-pressure water jet.

Controls in detail

Good visibility

Sun visors

The sun visors protect you from sun glare while driving.

Warning!



Do not use the vanity mirror while driving. Keep the mirrors in the sun visors closed while vehicle is in motion. Reflected glare can endanger you and others.

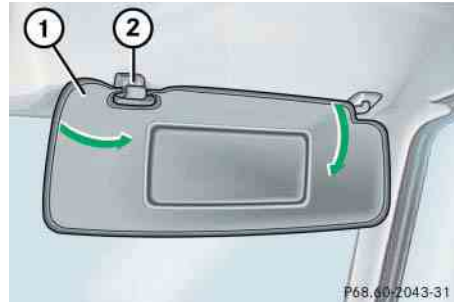

- ① Sun visor
- ② Mounting

- ▶ Swing sun visors ① down to protect against sun glare.
- ▶ If sunlight enters through a side window, disengage visor ① from inner mounting ② and pivot it to the side.

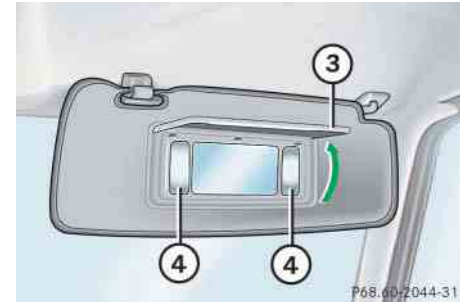

- ③ Mirror cover
- ④ Mirror lamp

- ▶ Make sure the ignition is switched on and that the sun visor is engaged in mounting ②.
- ▶ Open mirror cover ③. Mirror lamps ④ switch on.

Rear window defroster

Turn the SmartKey in starter switch to position **2**.

Activating

- ▶ Press button  in the control panel of the climate control.

The indicator lamp in the button comes on.

Deactivating

- ▶ Press button  in the control panel of the climate control.

The indicator lamp in the button goes out.



Heavy accumulation of snow and ice should be removed before activating the defroster.

The defroster is automatically turned off after approximately 6-17 minutes of operation depending on the outside temperature and vehicle speed.

If several power consumers are turned on simultaneously, or the battery is only partially charged, it is possible that the defroster will automatically turn itself off.

When this happens, the indicator lamp inside the switch starts blinking.

As soon as the battery has sufficient voltage, the defroster turns itself back on.

Controls in detail

Good visibility



The rear window defroster uses a large amount of power. To keep the battery drain to a minimum, turn off the defroster as soon as the rear window is clear.

Controls in detail

Climate control

▼ Climate control



Controls in detail

Climate control

- ① Windshield defroster air vents
- ② Center air vent, adjustable
- ③ Thumbwheel for center air vent
- ④ Side air vent, adjustable
- ⑤ Side defroster air vent, fixed
- ⑥ Thumbwheel for side air vent
- ⑦ Footwell air vents
- ⑧ Climate control panel

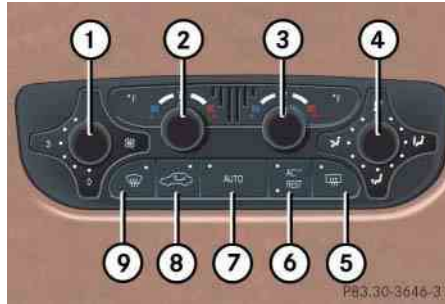

Climate control panel



For draft-free ventilation, move the sliders for the center air vents to the middle position.

- ① Air volume
- ② Temperature control, left
- ③ Temperature control, right
- ④ Air distribution control
- ⑤ Rear window defroster (▷ page 155)
- ⑥ AC cooling on / off (**AC^{OFF}**)
Residual engine heat utilization (REST)
- ⑦ Air distribution and air volume (automatic mode)
- ⑧ Air recirculation
- ⑨ Defrosting

Controls in detail

Climate control

The climate control is operational whenever the engine is running. You can operate the climate control system in either the automatic or manual mode. The system cools or heats the interior depending on the selected interior temperature and the current outside temperature.

Warning!



When operating the automatic climate control, the air that enters the passenger compartment through the air vents in the footwell can be very hot or very cold (depending on the set temperature). This may cause burns or frostbite on unprotected skin in the immediate area of the air vents. Always keep sufficient distance between unprotected parts of the body and the footwell air vents. If necessary, change the air flow using the air distribution controls to direct the air away from the footwell air vents (▷ page 159).

Nearly all dust particles, pollutants and odors are filtered out before outside air enters the passenger compartment through the air distribution system.

The air conditioning will not engage (no cooling) if the **AC^{OFF}** mode is selected (▷ page 162).

Warning!



Follow the recommended settings for heating and cooling given on the following pages. Otherwise the windows could fog up, impairing visibility and endangering you and others.



If the vehicle interior is hot, ventilate the interior before driving off.

Keep the air intake grille in front of the windshield free of snow and debris.

Setting the temperature

Use temperature controls ② and ③ to separately adjust the air temperature on each side of the passenger compartment. You should raise or lower the temperature setting in small increments, preferably starting at 72°F (22°C).



When operating the climate control system in automatic mode, you will only rarely need to adjust the temperature, air volume and air distribution.

Controls in detail

Climate control

Increasing

- ▶ Turn the temperature control a few degrees to the right.

The climate control system will correspondingly adjust the interior air temperature.





Decreasing

- ▶ Turn the temperature control a few degrees to the left.

The climate control system will correspondingly adjust the interior air temperature.

Adjusting air distribution and volume

Use air distribution control ④ (▷ page 157) to adjust the air distribution. The following symbols are found on the controls:

Symbol	Function
	Directs air through the center, side and rear passenger compartment air vents
	Directs air to the windows
	Directs air into the entire vehicle interior
	Directs air to the footwells

Adjusting manually

- ▶ Press the **AUTO** button.
The indicator lamp on the button goes out.
- ▶ Select any of the six air volume speeds and the air distribution.



Controls in detail

Climate control

Adjusting automatically

- ▶ Press the **AUTO** button.
The indicator lamp on the button comes on. Air distribution and volume are adjusted automatically.

Windshield fogged on the outside

- ▶ Switch the windshield wipers on.
- ▶ Switch to manual mode.
- ▶ Turn the air distribution control to  or .

Defrosting

Activating

- ▶ Press button .
The indicator lamp in the button illuminates.
The climate control automatically switches to the following functions:
 - maximum blower and heat output
 - air distribution to the windshield and the side windows
 - rear ventilation is turned off

Deactivating

- ▶ Press the  button.
The indicator lamp in the button goes out. Defrosting is turned off.

Air recirculation

Switch to air recirculation mode to prevent unpleasant odors from entering the vehicle from the outside. This setting cuts off the intake of outside air and recirculates the air in the passenger compartment.

Warning!



When the outside temperature is below 41°F (5°C), only switch to air recirculation mode for short periods to prevent window fogging.

Activating

- ▶ Press button  briefly.
The indicator lamp in the button illuminates.



The air recirculation mode is activated automatically at high outside temperatures.

If you have turned off the air conditioner or the outside temperature is below 41°F (5°C), the air recirculation mode will not switch on automatically.

Deactivating

- ▶ Press button  briefly.

The indicator lamp in the button goes out.

The air recirculation mode is deactivated automatically:

- after 30 minutes if the outside temperature is above about 41°F (5°C)
- after 5 minutes if the outside temperature is below about 41°F (5°C)
- after 5 minutes if economy mode **AC^{OFF}** is selected

Residual engine heat utilization

With the engine switched off, it is possible to continue to heat or ventilate the interior for a short while, depending on the temperature setting of the climate control. Air volume and distribution are controlled automatically.

Activating

- ▶ Turn the SmartKey in starter switch to position **1** or **0** or remove it from the starter switch.
- ▶ Press button .

The indicator lamp in the button comes on.

Set the left and right temperature to your personal requirements.

Controls in detail

Climate control

Deactivating

- ▶ Press button  again to switch off.

The indicator lamp in the button goes out.

The residual heat is automatically turned off:

- when the SmartKey in starter switch is turned to position **2**
- after about 30 minutes
- if the battery voltage drops

Controls in detail

Climate control

Deactivating the climate control system

Deactivating

- ▶ Set the air volume control switch to position **0**.

Reactivating

- ▶ Set the air volume control switch to any speed.

Air conditioning

The air conditioning is operational while the engine is running and cools the interior air to the temperature set by the operator.



Condensation may drip out from underneath the vehicle. This is normal and not an indication of a malfunction.

Deactivating

It is possible to deactivate the air conditioning (cooling) function of the climate control system. The air in the vehicle will then no longer be cooled or dehumidified.

- ▶ Press button .

The indicator lamp on the button  comes on.

Activating

Moist air can fog up the windows. You can dehumidify the air with the air conditioner.

- ▶ Press button  again.

The indicator lamp on the button  goes out.

The air conditioner uses the refrigerant R134a. This refrigerant is free of CFCs which are harmful to the ozone layer.



If the  button on the climate control panel starts to blink, this indicates that the air conditioner is losing refrigerant. The compressor has turned itself off. The air conditioner cannot be turned on again.

- Have the air conditioner checked at the nearest authorized Mercedes-Benz Light Truck Center.

**Rear passenger compartment
adjustable air vents**

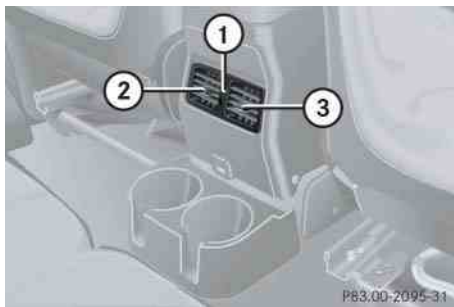

- ① Air volume control for center air vents
- ② Left center air vent, adjustable
- ③ Right center air vent, adjustable

Controls in detail

Power windows

▼ Power windows

Opening and closing the windows

The side windows can be opened and closed electrically. The switches for all the side windows are on the driver's door. The switches for the respective windows are on the front passenger and the rear doors.

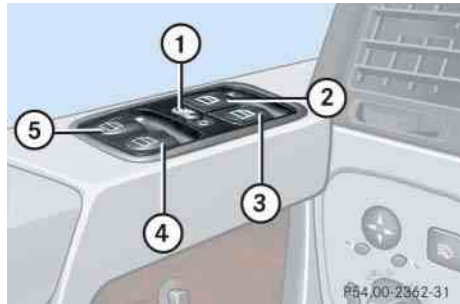

- ① Switch for rear door window override (▷ page 71)
- ② Left front window
- ③ Right front window
- ④ Right rear window
- ⑤ Left rear window

Warning!



When closing the windows, make sure there is no danger of anyone being harmed by the closing procedure.

The closing procedure can be immediately halted by releasing the switch or by releasing button  on the SmartKey.

When leaving the vehicle, always remove the SmartKey from starter switch, and lock your vehicle. Do not leave children unattended in the vehicle, or with access to an unlocked vehicle. Unsupervised use of vehicle equipment can cause an accident and/or serious personal injury.

- ▶ Turn SmartKey in the starter switch to position **1** or **2**.

Opening the windows

- ▶ Press switch ② to ⑤ to the resistance point.

The corresponding window will move downwards until you release the switch.

Closing the windows

- ▶ Pull on switch ② to ⑤.

The corresponding window will move upwards until you release the switch.

Fully opening windows (Express-open)

- ▶ Press switch ② to ⑤ past the resistance point and release.

The corresponding window opens completely.

Stopping windows

- ▶ Press or pull respective switch again.



Opening and closing windows with the SmartKey

The sliding/pop-up roof (▷ page 166) will also be opened or closed when the power windows are operated with the SmartKey.

Warning!



Never operate the windows or sliding/pop-up roof if there is the possibility of anyone being harmed by the opening or closing procedure.

In case the procedure causes potential danger, the procedure can be immediately halted by releasing the button on the SmartKey. To reverse direction of movement, press  for opening or  for closing.

- ▶ Aim transmitter eye at the driver's door handle.

Opening (Summer opening feature)

- ▶ Press and hold button  after unlocking the vehicle.

The windows and sliding/pop-up roof begin to open after approximately one second.

- ▶ Release transmit button to interrupt procedure.

Closing (Convenience feature)

- ▶ Press and hold button  after locking the vehicle.

The windows and sliding/pop-up roof begin to close after approximately one second.

- ▶ Release transmit button to interrupt procedure.

Make sure all side windows and the sliding/pop-up roof are properly closed before leaving the vehicle.

Controls in detail

Power windows

Controls in detail

Sliding/pop-up roof

▼ Sliding/pop-up roof

Opening and closing the sliding/pop-up roof



- ① Push up to raise roof at rear
- ② Pull down to lower roof at rear
- ③ Push forward to slide roof closed
- ④ Push back to slide roof open

With the roof closed or tilted open, a screen can be slid into the roof opening to guard against sun rays. When sliding the roof open, the screen will also retract.

Warning!



When closing the sliding/pop-up roof, make sure there is no danger of anyone being harmed by the closing procedure.

The closing procedure of the sliding/pop-up roof can be immediately halted by releasing the switch.

When leaving the vehicle, always remove the SmartKey from starter switch, and lock your vehicle. Do not leave children unattended in the vehicle, or with access to an unlocked vehicle. Unsupervised use of vehicle equipment can cause an accident and/or serious personal injury.



To avoid damaging the seals, do not transport any objects with sharp edges which can stick out of the sliding/pop-up roof.

Do not open the sliding/pop-up roof if there is snow or ice on the roof, as this could result in malfunctions.

The sliding/pop-up roof can be opened or closed manually should an electrical malfunction occur (▷ page 292).



You can also open or close the sliding/pop-up roof using the SmartKey (summer opening/convenience feature) (▷ page 167).

- ▶ Turn the SmartKey in the starter switch to position **1** or **2**.

Opening and closing the sliding/pop-up roof

- ▶ To open, close, raise or lower the sliding/pop-up roof, move the switch to the resistance point in the required direction ① to ④.

Release the switch when the roof has reached the required position.

Fully opening (Express-open)

- ▶ To open the sliding/pop-up roof, move the switch past the resistance point in direction ④ and release.

The sliding/pop up roof opens completely.

Stopping the sliding /pop-up roof

- ▶ Move the switch in any direction.



If the movement of the sliding/pop-up roof is blocked during the closing procedure, the roof will stop and reopen slightly.

Controls in detail

Sliding/pop-up roof



Opening and closing the sliding/pop-up roof with the SmartKey

The power windows (▷ page 164) will also be opened or closed when you operate the sliding/pop-up roof with the SmartKey.

Warning!



Never operate the windows or sliding/pop-up roof if there is the possibility of anyone being harmed by the opening or closing procedure.

In case the procedure causes potential danger, the procedure can be immediately halted by releasing the button on the SmartKey. To reverse direction of movement, press  for opening or  for closing.

- ▶ Aim transmitter eye at the driver's door handle.

Controls in detail

Sliding/pop-up roof

Opening (Summer opening feature)

- ▶ Press and hold button  after unlocking the vehicle.
The windows and sliding/pop-up roof begin to open after approximately one second.
- ▶ Release transmit button to interrupt procedure.

Closing (Convenience feature)

- ▶ Press and hold button  after locking the vehicle.
The windows and sliding/pop-up roof begin to close after approximately one second.
- ▶ Release transmit button to interrupt procedure.

Make sure all side windows and the sliding/pop-up roof are properly closed before leaving the vehicle.

▼ Driving systems

The driving systems of your vehicle are described on the following pages:

- Cruise control, with which the vehicle can maintain a preset speed.
- Rear Parking Assist*, with which you can assist your parking maneuvers.

The BAS, ABS, ESP, 4-ETS and EBB driving systems are described in the “Safety and Security” section (▷ page 74).

Cruise control

Cruise control automatically maintains the speed you set for your vehicle.

Use of cruise control is recommended for driving at a constant speed for extended periods of time. You can set or resume cruise control at any speed over 20 mph (30 km/h).

The cruise control function is operated by means of the cruise control lever.

The cruise control lever is the uppermost lever found on the left-hand side of the steering column (▷ page 23).



The cruise control should not be activated during off-road driving.

Controls in detail

Driving systems

Warning!



Cruise control is a convenience system designed to assist the driver during vehicle operation. The driver is and must always remain responsible for the vehicle speed and for safe brake operation.

Only use cruise control if the road, traffic and weather conditions make it advisable to travel at a steady speed.

- The use of cruise control can be dangerous on winding roads or in heavy traffic because conditions do not allow safe driving at a steady speed.
- The use of cruise control can be dangerous on slippery roads. Rapid changes in tire traction can result in wheel spin and loss of control.
- Deactivate cruise control when driving in fog.

The “Resume” function should only be operated if the driver is fully aware of the previously set speed and wishes to resume this particular preset speed.

Controls in detail

Driving systems

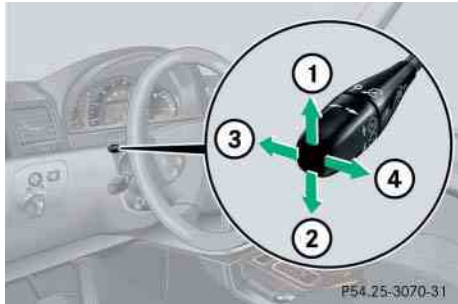

- ① Set current or higher speed
- ② Set current or lower speed
- ③ Cancel cruise control
- ④ Resume at last set speed

Setting current speed

- ▶ Accelerate or decelerate to the desired speed.
- ▶ Briefly lift ① or depress ② the cruise control lever.

The current speed is set.

- ▶ Remove your foot from the accelerator pedal.

Cruise control is activated.



On uphill or downhill grades, cruise control may not be able to maintain the set speed. Once the grade eases, the set speed will be resumed.

Canceling cruise control

There are several ways to cancel cruise control:

- ▶ Step on the brake pedal.
- or
- ▶ Briefly push the cruise control lever to position ③.

Cruise control will be canceled. The last speed set will be stored for later use.



Moving gear selector lever to position **N** while driving also cancels cruise control. However, the gear selector lever should not be moved to position **N** while driving except to coast when the vehicle is in danger of skidding (e.g. on icy roads).



The last stored speed is canceled when you turn off the engine.

Setting a higher speed

- ▶ Lift the cruise control lever to position ① and hold it up until the desired speed is reached.
- ▶ Release the cruise control lever.
The new speed is set.



Depressing the accelerator pedal does not deactivate the cruise control. After brief acceleration (e.g. for passing), the cruise control will resume the last speed set.

Setting a lower speed

- ▶ Depress the cruise control lever to position ② and hold it down until the desired speed is reached.
- ▶ Release the cruise control lever.
The new speed is set.



When you use the cruise control lever to decelerate, the transmission will automatically downshift if the engine's braking power does not brake the vehicle sufficiently.

Fine adjustment in 1 mph (Canada: 1 km/h) increments

Faster

- ▶ Briefly tip the cruise control lever in the direction of arrow ①.

Slower

- ▶ Briefly tip the cruise control lever in the direction of arrow ②.

Setting to last stored speed ("Resume" function)

Warning!



The speed stored in memory should only be set again if prevailing road conditions permit. Possible acceleration or deceleration differences arising from returning to preset speed could endanger yourself and others.

- ▶ Briefly push the cruise control lever to position ④.
Cruise control will resume the last set speed.
- ▶ Remove your foot from the accelerator pedal.

Controls in detail

Driving systems

Rear Parking Assist*

Warning!



Rear Parking Assist (rear Parktronic) is a supplemental system. It is not intended to, nor does it replace, the need for extreme care. The responsibility during parking and other critical maneuvers always rests with the driver.

Special attention must be paid to objects with smooth surfaces or low silhouettes (e.g. trailer couplings, painted posts, or street curbs). Such objects may not be detected by the system and can damage the vehicle.

The operational function of the Rear Parking Assist can be affected by dirty sensors, especially at times of snow and ice. See “Cleaning the Rear Parking Assist sensors” (▷ page 247).

Interference caused by other ultrasonic signals (e.g. working jackhammers or the air brakes of trucks) can cause the system to send erratic indications, and should be taken into consideration.

Warning!



Make sure no persons or animals are in the area in which you are maneuvering. You could otherwise injure them.

The Rear Parking Assist system is an electronic aid designed to assist the driver during parking maneuvers. It visually and audibly indicates the relative distance between the rear of the vehicle and an obstacle.

The Rear Parking Assist system is automatically activated when you switch on the ignition and shift the gear selector lever to position **R**.

The Rear Parking Assist system monitors the rear area of your vehicle by means of four sensors in the rear bumper.

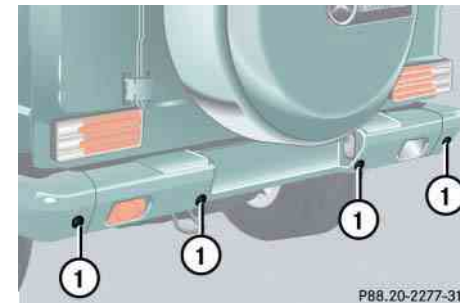

① Sensors

Range of the sensors

To function properly, the sensors must be free of dirt, ice, snow and slush. Clean the sensors regularly, being careful not to scratch or damage them.

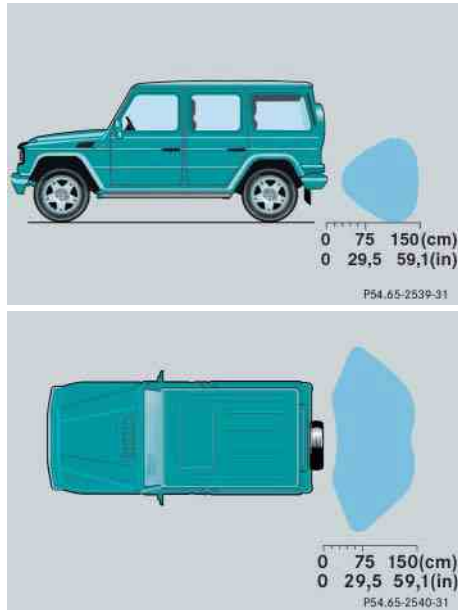

Center	approx. 59.1 in (150 cm)
Corners	approx. 40 in (100 cm)



During parking maneuvers, pay special attention to objects located above or below the height of the sensors (e.g. planters or trailer hitches). The Rear Parking Assist system will not detect such objects at close range and damage to your vehicle or the object may result.

Ultrasonic signals from outside sources (e.g. truck air brakes or jackhammers) may impair the operation of the Rear Parking Assist system.

Minimum distance

The minimum distance between the sensors and an obstacle is approximately 20 in (50 cm). If you encounter an obstacle in this range, all the warning lamps come on and you hear a warning signal. If the obstacle is closer than the minimum distance, the actual distance may no longer be indicated by the system.

Controls in detail

Driving systems

Warning indicator

Visual signals indicate to the driver the relative distance between the sensors and an obstacle. The warning indicator is located next to the tailgate.



Warning indicator

As your vehicle approaches an object, one or more segments will come on, depending on the distance. When the sixth segment lights, you have reached the minimum distance.

An intermittent acoustic warning will sound when the first yellow segment comes on. This signal quickens with each additional segment lit. When all segments illuminate, the acoustic warning becomes a constant signal. The signal is canceled when the gear selector lever is placed in position **D** or **P**.

Rear Parking Assist malfunction

There is a malfunction in the Rear Parking Assist system if:

- a low warning tone sounds while the vehicle is reversing

The Rear Parking Assist sensors are dirty or malfunctioning.

- ▶ Clean the Rear Parking Assist system sensors (▷ page 247).
- ▶ Switch on the ignition again.

- no segments come on and no warning sounds

The Rear Parking Assist is malfunctioning.

- ▶ Have the Rear Parking Assist system checked by an authorized Mercedes-Benz Light Truck Center as soon as possible.

Malfunction may also be caused by interference from other radio or ultrasonic signals.

- ▶ Check the Rear Parking Assist operation at another location to rule out interference from outside radio or ultrasonic signals.

▼ Loading

Roof rack

This vehicle is not intended to carry items on its roof. Thus roof rails and any roof-mounted devices must not be used.

Warning!



Do not load items on the roof. It may cause instability during some maneuvers which could result in an accident.

Cargo compartment cover

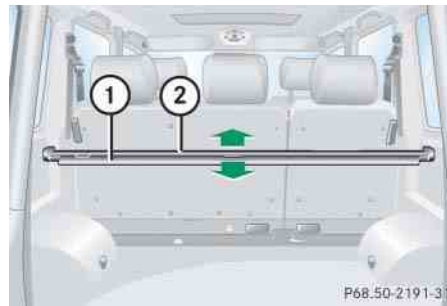

- ① Rear seat bench cover
- ② Tailgate cover

- ▶ Pull cover ① out. Hook it into the mountings on the rear seat bench.
- ▶ Pull cover ② out. Hook it into the mountings to the left and right of the tailgate.

Rolling up the cover

- ▶ Grip the cover strap and remove it from the mountings on both sides.
- ▶ Guide it slowly back into place.

Controls in detail

Loading

Removing and installing the cover

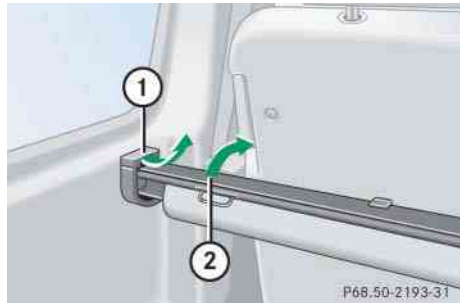

Removing the cover

- ▶ Open latch ① on right and left side in direction of arrow.
- ▶ Pull cover ② out upwards.

Installing the cover

- ▶ Place cover into recesses.
- ▶ Press right and left sides of cover down until it locks into place.

Enlarged cargo compartment

The rear seat bench can be folded and lowered to increase the cargo compartment. The left, right or both seat backrest sections may be folded down according to need.

Warning!



Always lock seat backrest in its upright position when rear seat bench is occupied by passengers, or cargo is being carried behind the seat bench.

To help avoid personal injury from smaller objects flying in the occupant area during a collision or sudden maneuver, always use partition net when transporting cargo (▷ page 178).

For more information, see “Split rear seat bench” (▷ page 176).

Split rear seat bench

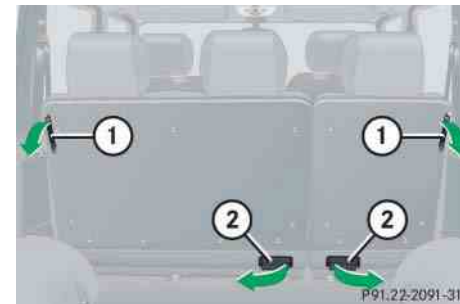

- ① Lever for seat backrest sections
- ② Lever for seat bench sections

The rear seat bench can be folded and lowered to enlarge the cargo compartment. The left, right or both seat backrest sections may be folded down as required.

Warning!



Failure to assure that seats and seat backrest are locked into place could result in an increased chance of injury in an accident.

Never place hands under seat or near any moving parts while a seat is being adjusted.

For safety reasons, the rear seat bench must only be adjusted when the vehicle is stationary.

Never ride vehicle with the tailgate open. Deadly carbon monoxide (CO) gases may enter vehicle interior resulting in unconsciousness and death.



Before folding the seat backrest forward and the rear seat bench down, be sure that all containers in the rear cup holder are removed.

Folding seat backrest forward

- ▶ Remove the head restraints (▷ page 96).
- ▶ Pull release lever ① in direction of arrow and fold seat backrest forward until it locks in place.

Folding seat bench forward

- ▶ Fold seat backrest forward.
- ▶ Pull release lever ② in direction of arrow and fold seat bench forward together with the seat backrest.

Controls in detail

Loading

Returning seat bench and seat backrest to sitting position

- ▶ Fold up seat bench until it locks in place.
- ▶ Pull release lever ① and raise seat backrest until it locks in place.
- ▶ Check to ensure the seat is locked by pushing and pulling on the seat backrest.

Warning!



Failure to assure that seats and seat backrests are locked into place could result in an increased chance of injury in an accident.

Controls in detail

Loading

Partition net* (MB Accessory)

Use of the partition net is a particularly important safety factor when the vehicle is loaded higher than the top of the seat backrests with smaller objects.

While the partition net will help protect you from smaller objects, it cannot prevent the movement of large, heavier objects into the passenger area in an accident. Such items must be properly secured using the cargo tie-down rings in the cargo compartment floor.

The partition net can be installed behind the seat backrests of the rear seat bench, or behind the front seats if the rear seat bench is folded down.



Installation can be performed by opening the rear doors.

Installation behind rear seat bench



- ① Partition net
- ② Mounting

- ▶ Fold the rear seat bench forward (▷ page 176).



This cannot be done by folding the rear seat backrest forward.

- ▶ Hook partition net ① in mountings ② on both sides.

Controls in detail

Loading

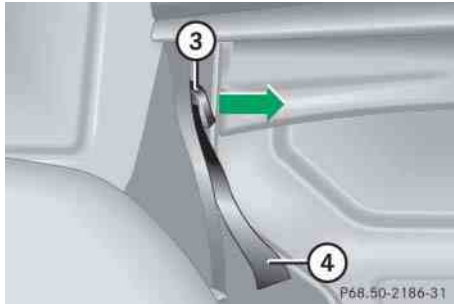

- ③ Lift tensioner
- ④ Tie down

Lift tensioner ③ on tie downs ④ must point in the direction of the arrow.

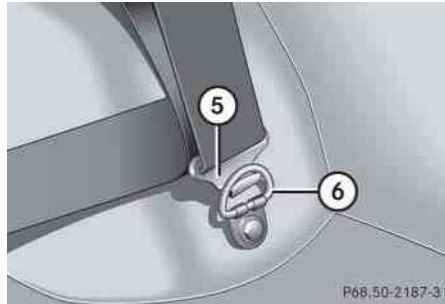

- ⑤ Hook
- ⑥ Ring

- ▶ Set the length of the tie downs ④ and lift tensioner ③ to the rings ⑥.
- ▶ Insert tie down hooks ⑤ in rings ⑥.
Pull on loose ends of tie downs until net is slightly tensioned.
- ▶ Fold up seat bench until it locks in place.

The partition net will be tightened by the rear seat bench cushion.

After driving a short period, check the tension of the partition net, retighten if necessary.

Installation behind front seats

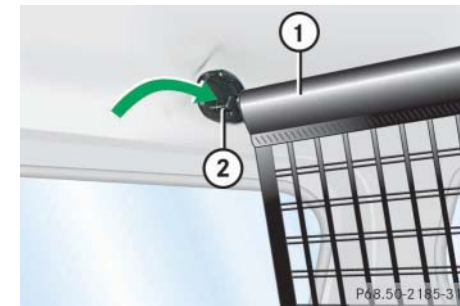

- ① Partition net
- ② Mounting

- ▶ Fold rear seat bench fully forward (▷ page 176).
- ▶ Engage partition net ① in holders ②. ▷▷

Controls in detail

Loading

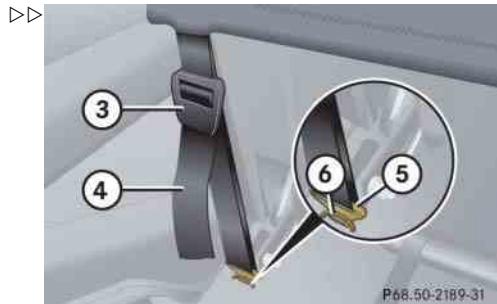

- ③ Lift tensioner
- ④ Tie down
- ⑤ Hook
- ⑥ Ring

Lift tensioner ③ must point in the direction of the cargo compartment.

- ▶ Set the length of tie downs ④ and lift tensioner ③ to the rings ⑥.
- ▶ Insert tie down hooks ⑤ in rings ⑥.
- ▶ Pull loose ends of tie downs ④ until net is tight.

After driving a short-distance, check the tension of the partition net, retighten if necessary.

Removing partition net

- ▶ Lift tensioner upward to a horizontal position to release tensioning of strap.
- ▶ Disengage tie down hooks from rings.
- ▶ Remove partition net from holders.

Storing partition net

- ▶ Roll up partition net and secure it.
- ▶ Store partition net behind rear seat bench.

Loading instructions

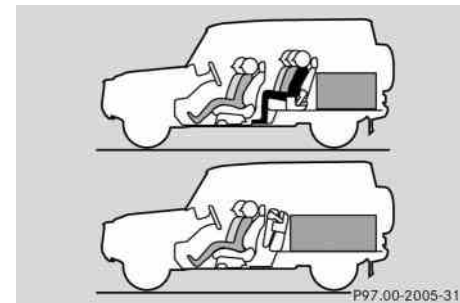

The gross vehicle weight which is the weight of the vehicle including fuel, tools, spare wheel, installed accessories, passengers and luggage / cargo must never exceed the Gross Vehicle Weight Rating (GVWR) for your vehicle. In addition, the load must be distributed in such a way so that the weight on each axle never exceeds the Gross Axle Weight Rating (GAWR) for the front and rear axle. The GVWR and GAWR for your vehicle are indicated on the certification label which can be found on the left door pillar (▷ page 326).

The handling characteristics of a fully loaded vehicle depend greatly on the load distribution. It is therefore recommended to load the vehicle according to the illustrations shown, with the heaviest items being placed towards the front of the vehicle.

Warning!



Always fasten items being carried as securely as possible using cargo tie-down rings and fastening materials appropriate for the weight and size of the load.

In an accident, during hard braking or sudden maneuvers, loose items will be thrown around inside the vehicle, and can cause injury to vehicle occupants unless the items are securely fastened in the vehicle.

To help avoid personal injury during a collision or sudden maneuver, always use partition net when transporting cargo.

Never ride vehicle with the tailgate open. Deadly carbon monoxide (CO) gases may enter vehicle interior resulting in unconsciousness and death.



- Always place items being carried against front or rear seat backrests, and fasten them as securely as possible.
- The heaviest portion of the cargo should always be kept as low as possible against front or rear seat backrest since it influences the handling characteristics of the vehicle.

Controls in detail

Loading

- For additional safety when transporting cargo while the rear seats are unoccupied, fasten the outer seat belts crosswise into the opposite side buckles.
- Always pad off sharp edges.



The rear cargo compartment is the preferred place to carry objects. The enlarged cargo compartment (rear seats folded) should only be used for items which do not fit in the rear cargo compartment alone.

Controls in detail

Loading

Cargo tie-down rings



The cargo compartment is provided with four tie-down anchors.

Carefully secure cargo by applying even load on all rings with rope of sufficient strength to hold down the cargo.

Warning!



While the partition net will help protect you from smaller objects, it cannot prevent the movement of large, heavier objects into the passenger area in an accident.

Such items must be properly secured using the cargo tie-down rings in the cargo compartment floor.

▼ Useful features

Interior storage spaces

Warning!



To help avoid personal injury during a collision or sudden maneuver, exercise care when stowing objects in the vehicle. Put luggage or cargo in the cargo compartment if possible. Do not pile luggage or cargo higher than the seat backs.

Luggage nets cannot secure hard or heavy objects.

Warning!



Do not load items on the roof. It may cause instability during some maneuvers which could result in an accident.

Warning!



Keep compartment lids closed. This will help to prevent stored objects from being thrown about and injuring vehicle occupants during an accident and sudden maneuvers.

Glove box

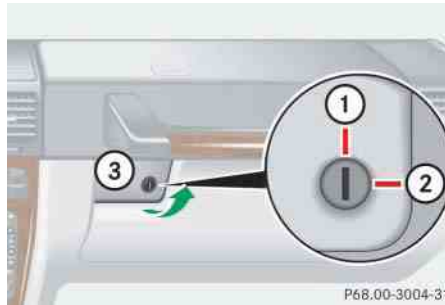

- ① Unlocked position
- ② Locked position
- ③ Handle

Controls in detail

Useful features

Opening the glove box

- ▶ Pull handle to open.

The glove box is illuminated with SmartKey in starter switch position **1** or **2** when opening the lid.



The glove box can be locked and unlocked with the mechanical key.

Closing the glove box

- ▶ Push lid up to close.

Controls in detail

Useful features

Storage compartments below the armrest

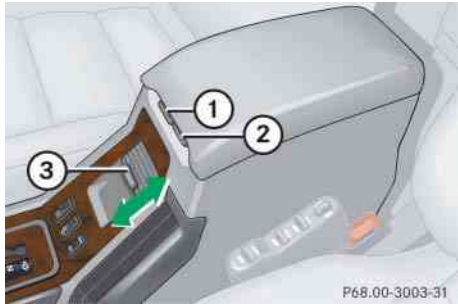

Opening small compartment

- ▶ Press button ① and lift armrest.

Closing small compartment

- ▶ Lower armrest until it engages in lock.



Located in the cover of the storage compartment is a storage area for small items such as checks.

Opening large compartment

- ▶ Press button ② and lift armrest.

Closing large compartment

- ▶ Lower armrest until it engages in lock.



In the large storage compartment there is a storage area for up to three CDs.

Storage compartment in front of armrest

Opening

- ▶ Slide cover ③ backward.

Closing

- ▶ Slide cover ③ forward.

Cup holders

Warning!



When not in use, keep the cup holder closed. Place only containers that fit into the cup holder to prevent spills. Use lids on open containers and do not fill containers to a height where the contents, especially hot liquids, could spill during vehicle maneuvers.

Cup holder next to the armrest



- ▶ Place cup holder bracket ① into recess.

If the cup holder is no longer in use, it can for example, be stored in the storage compartment below the armrest or in storage pouch on the door panel.

Cup holder in front passenger footwell

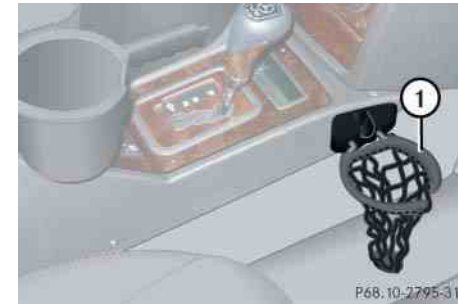

- ▶ Swing bracket ① upwards until it clicks into place.



Fold the cup holder closed before moving the front passenger seat fully forward.

Controls in detail

Useful features

Cup holder in rear passenger footwell



Before folding the seat backrest forward and the rear seat bench down, be sure that all containers in the rear cup holder are removed.

Parcel net in front passenger footwell

A small convenience parcel net is located in the front passenger footwell. It is for small and light items, such as road maps, mail, etc.

Warning!



Do not place heavy or fragile objects, or objects having sharp edges in the parcel net.

In an accident, during hard braking or sudden maneuvers, they could be thrown around inside the vehicle and cause injury to vehicle occupants.



When large objects are stored in the parcel net, do not slide the seat fully forward, it could damage them.

Ashtrays

Center console ashtray

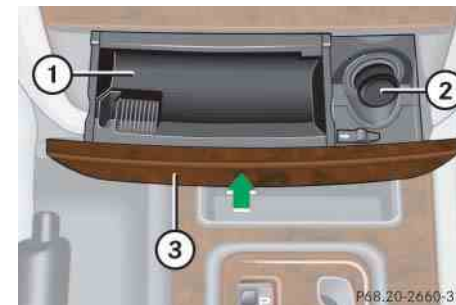

- ① Ashtray
- ② Cigarette lighter
- ③ Cover plate

Opening ashtray

- ▶ Briefly push the cover plate ③.
The ashtray opens automatically.

Removing the ashtray insert

Warning!



Remove ashtray only with vehicle standing still. Turn off the engine and set the parking brake. Otherwise the vehicle might move as a result of unintended contact with the gear selector lever.

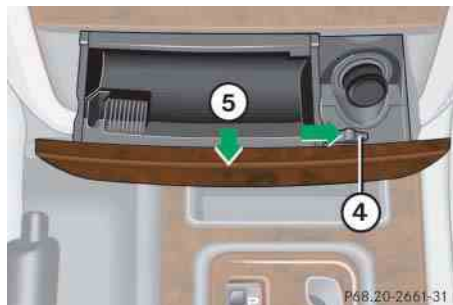

- ④ Sliding knob
- ⑤ Ashtray insert

- ▶ Press sliding knob ④ to the right.
The insert will protrude a short-distance.
- ▶ Remove insert ⑤ in direction of arrow.

Reinstalling the ashtray insert

- ▶ Press the insert into the frame until it snaps into place.

Rear passenger compartment



- ① Cover
- ② Catch
- ③ Ashtray insert

Opening ashtray

- ▶ Pull at top of cover ①.

Removing the ashtray insert

- ▶ Push down on catch ②.
- ▶ Pull out the ashtray insert ③.

Reinstalling the ashtray insert

- ▶ Position the insert and close the cover.

Controls in detail

Useful features

Cigarette lighter

The lighter socket can be used to accommodate electrical accessories up to a maximum of 180 W.



① Cigarette lighter

- ▶ Briefly touch the cover plate.
The ashtray opens automatically.
- ▶ Turn the SmartKey in the starter switch to position **1** or **2**.
- ▶ Push in cigarette lighter ①.
The lighter will pop out automatically when hot.

Warning!



Never touch the heating element or sides of the lighter; they are extremely hot. Hold the knob only.

When leaving the vehicle, always remove the SmartKey from the starter switch. Do not leave children unattended in the vehicle, or with access to an unlocked vehicle. Unsupervised use of vehicle equipment may cause an accident and/or serious personal injury.

Electrical outlet



Electrical outlet

An electrical outlet is located in the rear passenger footwell.

- ▶ Turn the SmartKey in the starter switch to position **1** or **2**.
- ▶ Flip up cover and insert electrical plug (cigarette lighter type).



The electrical outlet can be used to accommodate electrical consumers (e.g. air pump, auxiliary lamps) up to a maximum of 180 W.

Telephone*

Warning!



Never operate radio transmitters equipped with a built-in or attached antenna (i.e. without being connected to an external antenna) from inside the vehicle while the engine is running. Doing so could lead to a malfunction of the vehicle's electronic system, possibly resulting in an accident and/or personal injury.

Radio transmitters, such as a portable telephone or a citizens band unit, should only be used inside the vehicle if they are connected to an antenna that is installed on the outside of the vehicle.

The external antenna must be approved by Mercedes-Benz. Please contact an authorized Mercedes-Benz Light Truck Center for information on the installation of an approved external antenna. Refer to the radio transmitter operation instructions regarding use of an external antenna.

Warning!



Please do not forget that your primary responsibility is to drive the vehicle. A driver's attention to the road must always be his/her primary focus when driving. For your safety and the safety of others, we recommend that you pull over to a safe location and stop before placing or taking a telephone call.

If you choose to use the telephone¹ while driving, please use the hands-free device and only use the telephone when road, traffic and weather conditions permit. Some jurisdictions prohibit the driver from using a cellular telephone while driving a vehicle.



Only operate the COMAND (Cockpit Management and Data System)¹ if road, traffic and weather conditions permit.

Bear in mind that at a speed of just 30 mph (approximately 50 km/h), your vehicle is covering a distance of approx. 44 feet (approximately 13.5 m) every second.

¹ Observe all legal requirements

Controls in detail

Useful features

You can take and place telephone calls using the  and  buttons on the steering wheel. Use the control system for performing other telephone functions (▷ page 137).

See separate instruction manual for information on how to operate the telephone.

Warning!



Some jurisdictions prohibit the driver from using a cellular telephone while driving a vehicle. Whether or not prohibited by law, for safety reasons, the driver should not use the cellular telephone while the vehicle is in motion.

Stop the vehicle in a safe location before answering or placing a call.

Controls in detail

Useful features

Tele Aid



The initial activation of the Tele Aid system may only be performed by completing the subscriber agreement and placing an acquaintance call using the SOS button. Failure to complete either of these steps will result in a system that is not activated. If the system is not activated, the indicator lamp in the SOS button stays on after turning SmartKey in starter switch to position **2** and the message TELE AID EMERG. CALL - NOT ACTIVATED will be shown in the multifunction display for approx. 10 seconds.

If you have any questions regarding activation, please call the Response Center at 1-800-756-9018 (in the USA) or 1-888-923-8367 (in Canada).

The Tele Aid system

(Telematic Alarm Identification on Demand)

The Tele Aid system consists of three types of response:

- Automatic and manual emergency
- Roadside Assistance and
- Information

The Tele Aid system is operational providing that the vehicle's battery is charged, properly connected, not damaged and cellular and GPS coverage is available.

The speaker volume of a Tele Aid call can be adjusted when using the volume control on the multifunction steering wheel. To raise, press button and to lower, press button .

- ▶ To activate, press the SOS button, the Roadside Assistance button or the Information button , depending on the type of response required.



The SOS button is located above the interior rear view mirror.



The Roadside Assistance button and the Information button are located below the center armrest cover.

Shortly after the completion of your acquaintance call, you will receive a user ID and password via first call mail. By visiting www.mbusa.com and selecting "Tele Aid" (USA only), you will have access to account information, remote door unlock, profile and more.



The Tele Aid system utilizes the cellular network for communication and the GPS (Global Positioning System) satellites for vehicle location. If either of these signals are unavailable, the Tele Aid system may not function and if this occurs, assistance must be summoned by other means.

System self-check

Initially, after turning the SmartKey in starter switch to position **2**, malfunctions are detected and indicated (the indicator lamps in the SOS button, the Roadside Assistance button  and the Information button  stay on longer than 10 seconds or do not come on). The message TELE AID - DRIVE TO WORKSHOP! appears for approx. 10 seconds in the multifunction display.

Warning!



If the indicator lamps in the SOS button, in the Roadside Assistance button and/or in the Information button do not come on during the system self-check or if any of these indicators remain illuminated constantly in red and/or the message TELE AID - DRIVE TO WORKSHOP is displayed in the multifunction display after the system self-check, a malfunction in the system has been detected.

If a malfunction is indicated as outlined above, the system may not operate as expected. Have the system checked at the nearest Mercedes-Benz Light Truck Center as soon as possible.

Emergency calls

An emergency call is initiated automatically:

- following an accident in which the emergency tensioning devices (ETDs) or airbags deploy
- if the anti-theft alarm or the tow-away alarm stays on for more than 20 seconds. See anti-theft alarm system (▷ page 82) and tow-away alarm (▷ page 83)

An emergency call can also be initiated manually by opening the cover next to the interior rear view mirror labeled SOS, then briefly pressing the button located under the cover. See below for instructions on initiating an emergency call manually.

Once the emergency call is in progress, the indicator lamp in the SOS button will begin to flash. The message EMERGENCY CALL - CONNECTING CALL appears in the multifunction display. When the connection is established, the message EMERGENCY CALL - CALL CONNECTED appears in the

Controls in detail

Useful features

multifunction display. All information relevant to the emergency, such as the location of the vehicle (determined by the GPS satellite location system), vehicle model, identification number and color are generated.

A voice connection between the Response Center and the occupants of the vehicle will be established automatically soon after the emergency call has been initiated. When a voice connection is established the audio system mutes and the message TELE AID - EMERGENCY CALL ACTIVE appears in the multifunction display. The Response Center will attempt to determine more precisely the nature of the accident provided they can speak to an occupant of the vehicle.

The Tele Aid system is available if:

- it has been activated and is operational. Activation requires a subscription for monitoring services, connection and cellular air time
- the relevant cellular phone network and GPS signals are available and pass the information on to the response center



Location of the vehicle on a map is only possible if the vehicle is able to receive signals from the GPS satellite network and pass the information on to the response center.

Warning!



If the indicator lamp in the SOS button is illuminated continuously and there was no voice connection to the Response Center established, then the Tele Aid system could not initiate an emergency call (e.g. the relevant cellular phone network is not available). The message EMERGENCY CALL - CALL FAILED appears in the multifunction display for approx. 10 seconds.

Should this occur, assistance must be summoned by other means.

Initiating an emergency call manually



- ① Cover
- ② SOS button

- ▶ Briefly press on cover ①.
The cover opens.
- ▶ Press SOS button ② briefly.
The indicator lamp in SOS button ② flashes until the emergency call is concluded.

- ▶ Wait for a voice connection to the Response Center.
- ▶ Close the cover ① after the emergency call is concluded.

Warning!



If you feel at any way in jeopardy when in the vehicle (e.g. smoke or fire in the vehicle, vehicle in a dangerous road location), please do not wait for voice contact after you have pressed the emergency button. Carefully leave the vehicle and move to a safe location. The Response Center will automatically contact local emergency officials with the vehicle's approximate location if they receive an automatic SOS signal and cannot make voice contact with the vehicle occupants.

Controls in detail

Useful features

Roadside Assistance button

Located below the center armrest cover is the Roadside Assistance button .

- ▶ Press and hold the button (for longer than two seconds).

A call to a Mercedes-Benz Roadside Assistance dispatcher will be initiated. The button will flash while the call is in progress. The message **TELE-DIAGNOSIS - CONNECTING CALL** will appear in the multifunction display.

When the connection is established, the message **TELE-DIAGNOSIS - CALL CONNECTED** appears in the multifunction display. The Tele Aid system will transmit data generating the vehicle identification number, model, color and location (subject to availability of cellular and GPS signals).

A voice connection between the Roadside Assistance dispatcher and the occupants of the vehicle will be established. When a voice connection is established the audio

Controls in detail

Useful features

▷▷system mutes and the message TELE AID - ROADSIDE ASSISTANCE CALL ACTIVE appears in the multifunction display.



- ▶ Describe the nature of the need for assistance.

The Mercedes-Benz Roadside Assistance dispatcher will either dispatch a qualified Mercedes-Benz technician or arrange to tow your vehicle to the nearest Mercedes-Benz Light Truck Center. For services such as labor and/or towing, charges may apply. Refer to the Roadside Assistance manual for more information.

These programs are only available in the USA:

- Sign and Drive services: Services such as jump start, a few gallons of fuel or the replacement of a flat tire with the vehicle spare tire are obtainable
- Remote Vehicle Diagnostics: This function permits the Mercedes-Benz Roadside Assistance dispatcher to download malfunction codes and actual vehicle data.



The indicator lamp in the Roadside Assistance button  remains illuminated in red for approx. 10 seconds during the system self-check after turning the SmartKey in the starter switch to position **2** (together with the SOS button and the Information button .

See system self-check (▷ page 191) when the indicator lamp does not come on in red or stays on longer than approximately ten seconds.

If the indicator lamp in the Roadside Assistance button  is illuminated continuously and there was no voice connection to the Response Center established, then the Tele Aid system could not initiate a Roadside Assistance call (e.g. the relevant cellular phone network was not available). The message TELE-DIAGNOSIS - CALL FAILED appears in the multifunction display.

Roadside Assistance calls can be terminated using the  button on the multifunction steering wheel.

Information button

Located below the center armrest cover is the Information button .

- ▶ Press and hold the button (for longer than 2 seconds).

A call to the Customer Assistance Center will be initiated. The button will flash while the call is in progress. The message INFO - CONNECTING CALL will appear in the multifunction display.

When the connection is established, the message INFO - CALL CONNECTED appears in the multifunction display. The Tele Aid system will transmit data generating the vehicle identification number, model, color and location (subject to availability of cellular and GPS signals).



Controls in detail

Useful features

A voice connection between the Customer Assistance Center representative and the occupants of the vehicle will be established. When a voice connection is established the audio system mutes and the message **TELE AID - INFO CALL ACTIVE** appears in the multifunction display. Information regarding the operation of your vehicle, the nearest Mercedes-Benz Light Truck Center or Mercedes-Benz USA products and services is available to you.

For more details concerning the Tele Aid system, please visit www.mbusa.com and use your ID and password (sent to you separately) to learn more (USA only).



The indicator lamp in the Information button  remains illuminated in red for approx. ten seconds during the system self-check after turning SmartKey in the starter switch to position **2** (together with the SOS button and the Roadside Assistance button .

See system self-check (▷ page 191) when the indicator lamp does not come on in red or stays on longer than approximately ten seconds.

If the indicator lamp in the Information button  is illuminated continuously and there was no voice connection to the Response Center established, then the Tele Aid system could not initiate an Information call (e.g. the relevant cellular phone network is not available). The message **INFO - CALL FAILED** appears in the multifunction display.

Information calls can be terminated using the  button on the multifunction steering wheel.



If the indicator lamps do not start flashing after pressing one of the buttons or remains illuminated (in red) at any time, the Tele Aid system has detected a fault or the service is not currently active, and may not initiate a call. Visit your Mercedes-Benz Light Truck Center and have the system checked or contact the Response Center at 1-800-756-9018 (in the USA) or 1-888-923-8367 (in Canada) as soon as possible.

Controls in detail

Useful features

Upgrade Signals

The Tele Aid system processes calls using the following priority.

- Automatic emergency – First priority
- Manual emergency – Second priority
- Roadside assistance – Third priority
- Information – Fourth priority

Should a higher priority call be initiated while you are connected, an upgrade (alternating) tone will be heard and the appropriate indicator lamp will flash. If certain information such as vehicle identification number or customer information is not available, the operator may need to retransmit.

During this time you will hear a beep and voice contact will be interrupted. Voice contact will resume once the retransmission is completed. Once a call is concluded, a beep will be heard and the appropriate indicator lamp will stop flashing. The COMAND system operation will resume.



If the indicator lamp continues to flash or the system does not reset, contact the Response Center at 1-800-756-9018 (in the USA) or 1-888-923-8367 (in Canada), or Mercedes-Benz Customer Assistance at 1-800-FOR-MERCEdes (1-800-367-6372) in the USA or Customer Service at 1-800-387-0100 in Canada.



The indicator lamp in the respective button flashes until the call is concluded. Calls can only be terminated by a Response Center or Customer Assistance Center representative, except Roadside Assistance and Information calls, which can also be terminated by pressing button  on the multifunction steering wheel.



When a Tele Aid call has been initiated, the COMAND system audio is muted and the selected mode (radio or CD) pauses. The optional cellular phone (if installed) switches off. If you must use this phone, the vehicle must be parked. Disconnect the coiled cord and place the call. The navigation system (if engaged) will continue to run. The display in the instrument cluster is available for use and spoken commands are only available by pressing the RPT button on the COMAND unit. A pop-up window will appear in the COMAND display to indicate that a Tele Aid call is in progress.

Remote door unlock

In case you have locked your vehicle unintentionally (e.g. SmartKey inside vehicle), and the reserve key is not handy:

- ▶ Contact the Mercedes-Benz Response Center at 1-800-756-9018 (in the USA) or 1-888-923-8367 (in Canada).

You will be asked to provide your password which you provided when you completed the subscriber agreement.

- ▶ Then return to your vehicle and press the tailgate lock for minimum of 20 seconds until the SOS button is flashing.

The message **EMERGENCY CALL - CALL CONNECTED** appears in the multifunction display.

As an alternative, you may unlock the vehicle via Internet using the ID and password sent to you shortly after the completion of your acquaintance call.

The Response Center will then unlock your vehicle with the remote door unlocking feature.



The remote door unlock feature is available if the relevant cellular phone network is available.

The SOS button will flash and the message **EMERGENCY CALL - CALL CONNECTED** will appear in the multifunction display to indicate receipt of the door unlock command.

Once the vehicle is unlocked, a Response Center specialist will attempt to establish voice contact with the vehicle occupants.

If the tailgate lock was pressed for more than 20 seconds before door unlock authorization was received by the Response Center, you must wait 15 minutes before pressing the tailgate lock again.

Stolen vehicle tracking services

In the event your vehicle was stolen:

- ▶ Report the incident to the police.
The police will issue a numbered incident report.
- ▶ Pass this number on to the Mercedes-Benz Response Center along with your password issued to you when you subscribed to the service.

The Response Center will then attempt to covertly contact the vehicle's Tele Aid system. Once the vehicle is located, the Response Center will contact the local law enforcement and you. The vehicle's location will only be provided to law enforcement.

Controls in detail

Useful features

Garage door opener

The built-in remote control is capable of operating up to three separately controlled devices, for example garage door openers, gate openers, or other devices compatible with HomeLink® or some other systems.

You can program the signal transmitter buttons.

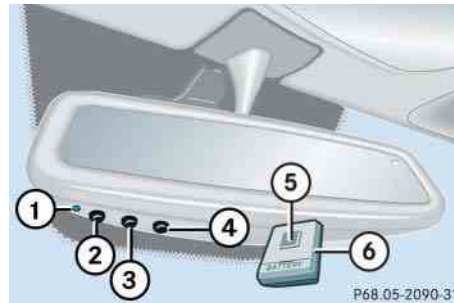

Remote control integrated into the interior rear view mirror

- ① Indicator lamp
- ② ③ ④ Signal transmitter button
- ⑤ Hand-held transmitter button
- ⑥ Hand-held remote control transmitter (not part of the vehicle equipment)

Warning!



Before programming the integrated remote control to a garage door opener or gate operator, make sure people and objects are out of the way of the device to prevent potential harm or damage.

When programming a garage door opener, the door moves up or down. When programming a gate operator, the gate opens or closes.

Do not use the integrated remote control with any garage door opener that lacks safety stop and reverse features as required by U.S. federal safety standards (this includes any garage door opener model manufactured before April 1, 1982). A garage door that cannot detect an object - signaling the door to stop and reverse - does not meet current U.S. federal safety standards.



Certain types of garage door openers are incompatible with the integrated opener. If you should experience difficulties with programming the transmitter, contact your authorized Mercedes-Benz Light Truck Center, or call Mercedes-Benz Customer Assistance Center (in the USA only) at 1-800-FOR-MERCEdes, or Customer Service (in Canada) at 1-800-387-0100.



For operation in the USA only: This device complies with Part 15 of the FCC Rules. Operation is subject to the following two conditions:

- (1) This device may not cause harmful interference, and
- (2) this device must accept any interference received, including interference that may cause undesired operation.

Any unauthorized modification to this device could void the user's authority to operate the equipment.

Controls in detail

Useful features

Programming or reprogramming the integrated remote control

Step 1:

- ▶ Switch on ignition.

Step 2:

- ▶ If you have previously programmed an integrated signal transmitter button and wish to retain its programming, proceed to step 3. Otherwise, press and hold the two outer signal transmitter buttons ② and ④ and release them only when the indicator light begins to flash after approximately 20 seconds (do not hold the button for longer than 30 seconds). This procedure erases any previous settings for all three channels and initializes the memory. If you later wish to program a second and/or third hand-held transmitter to the remaining two signal transmitter buttons, do not repeat this step and begin directly with step 3. >>

Controls in detail

Useful features

▷▷Step 3:

- ▶ Hold the end of the hand-held remote control transmitter ⑥ of the device you wish to train approximately 2 to 5 in (5 to 12 cm) away from the surface of the integrated remote control located on the interior rear view mirror, keeping the indicator lamp ① in view.

Step 4:

- ▶ Using both hands, simultaneously press the hand-held transmitter button ⑤ and the desired integrated signal transmitter button (②, ③ or ④). Do not release the buttons until completing step 5.

The indicator lamp ① on the integrated remote control will flash, first slowly and then rapidly.



The indicator lamp ① flashes the first time the signal transmitter button is programmed. If this button has already been programmed, the indicator lamp will only start flashing after 20 seconds.

Step 5:

- ▶ When the indicator lamp ① flashes rapidly, release both buttons.

Step 6:

- ▶ Press and hold the just-trained integrated signal transmitter button and observe the indicator lamp ①.

If the indicator lamp ① stays on constantly, programming is complete and your device should activate when the integrated signal transmitter button is pressed and released.



If the indicator lamp ① blinks rapidly for about two seconds and then turns to a constant light, continue with programming steps 8 through 12 as your garage door opener may be equipped with the “rolling code” feature.

Step 7:

- ▶ To program the remaining two buttons, repeat the steps above starting with step 3.

Rolling code programming

To train a garage door opener (or other rolling code devices) with the rolling code feature, follow these instructions after completing the “Programming” portion (steps 1 through 6) of this text. (A second person may make the following training procedures quicker and easier.)

Step 8:

- ▶ Locate “training” button on the garage door opener motor head unit.

Controls in detail

Useful features

Exact location and color of the button may vary by garage door opener brand. Depending on manufacturer, the “training” button may also be referred to as “learn” or “smart” button. If there is difficulty locating the transmitting button, refer to the garage door opener operator’s manual.

Step 9:

- ▶ Press “training” button on the garage door opener motor head unit.

The “training light” is activated.

You have 30 seconds to initiate the following step.

Step 10:

- ▶ Firmly press, hold for two seconds and release the programmed integrated signal transmitter button (②, ③ or ④).

Step 11:

- ▶ Press, hold for two seconds and release same button a second time to complete the training process.

Some garage door openers (or other rolling code equipped devices) may require you to perform this procedure a third time to complete the training.

Step 12:

- ▶ Confirm the garage door operation by pressing the programmed integrated signal transmitter button (②, ③ or ④).

Step 13:

- ▶ To program the remaining two buttons, repeat the steps above starting with step 3.

Gate operator/Canadian programming

Canadian radio-frequency laws require transmitter signals to “time-out” (or quit) after several seconds of transmission which may not be long enough for the integrated signal transmitter to pick up the signal during programming. Similar to this Canadian law, some U.S. gate operators are designed to “time-out” in the same manner.

If you live in Canada or if you are having difficulties programming a gate operator (regardless of where you live) by using the programming procedures, replace step 4 with the following:

Step 4:

- ▶ Continue to press and hold the integrated signal transmitter button (②, ③ or ④) while you press and re-press (“cycle”) your hand-held remote control transmitter ⑥ every two seconds until the frequency signal has been learned. Upon successful training, the indicator lamp ① will flash slowly and then rapidly after several seconds.
- ▶ Proceed with programming step 5 and step 6 to complete.

Controls in detail

Useful features

Operation of integrated remote control

- ▶ Switch on ignition.
- ▶ Select and press the appropriate integrated signal transmitter button (②, ③ or ④) to activate the remote controlled device.

The integrated remote control transmitter continues to send the signal as long as the button is pressed – up to 20 seconds.

Erasing the integrated remote control memory

- ▶ Switch on ignition.
- ▶ Simultaneously hold down the signal transmitter buttons ② and ④, for approximately 20 seconds, until the indicator lamp ① blinks rapidly. Do not hold for longer than 30 seconds.

The codes of all three channels are erased.



If you sell your vehicle, erase the codes of all three channels.

Reprogramming a single integrated signal transmitter button

To program a device using a signal transmitter button previously trained, follow these steps:

- ▶ Press and hold the desired signal transmitter button (②, ③ or ④). Do not release the button.
- ▶ The indicator lamp will begin to flash after 20 seconds. Without releasing the integrated signal transmitter button, proceed with programming starting with step 3.

Heated steering wheel

The steering wheel heater warms up the leather area of the steering wheel.

The stalk with the heated steering wheel switch is on the lower left-hand side of the steering wheel.

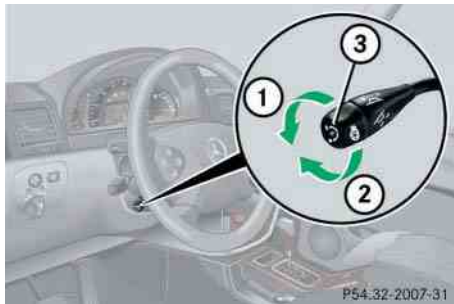

- ① Switching on
- ② Switching off
- ③ Indicator lamp

Switching on

- ▶ Switch on the ignition.
All lamps in the instrument cluster come on.
- ▶ Turn switch at the tip of stalk in direction of arrow ①.
The steering wheel is heated. Indicator lamp ③ comes on.

Switching off

- ▶ Turn switch at the tip of stalk in direction of arrow ②.
The steering wheel heater is turned off. Indicator lamp ③ goes out.



The steering wheel heater does not turn off automatically.



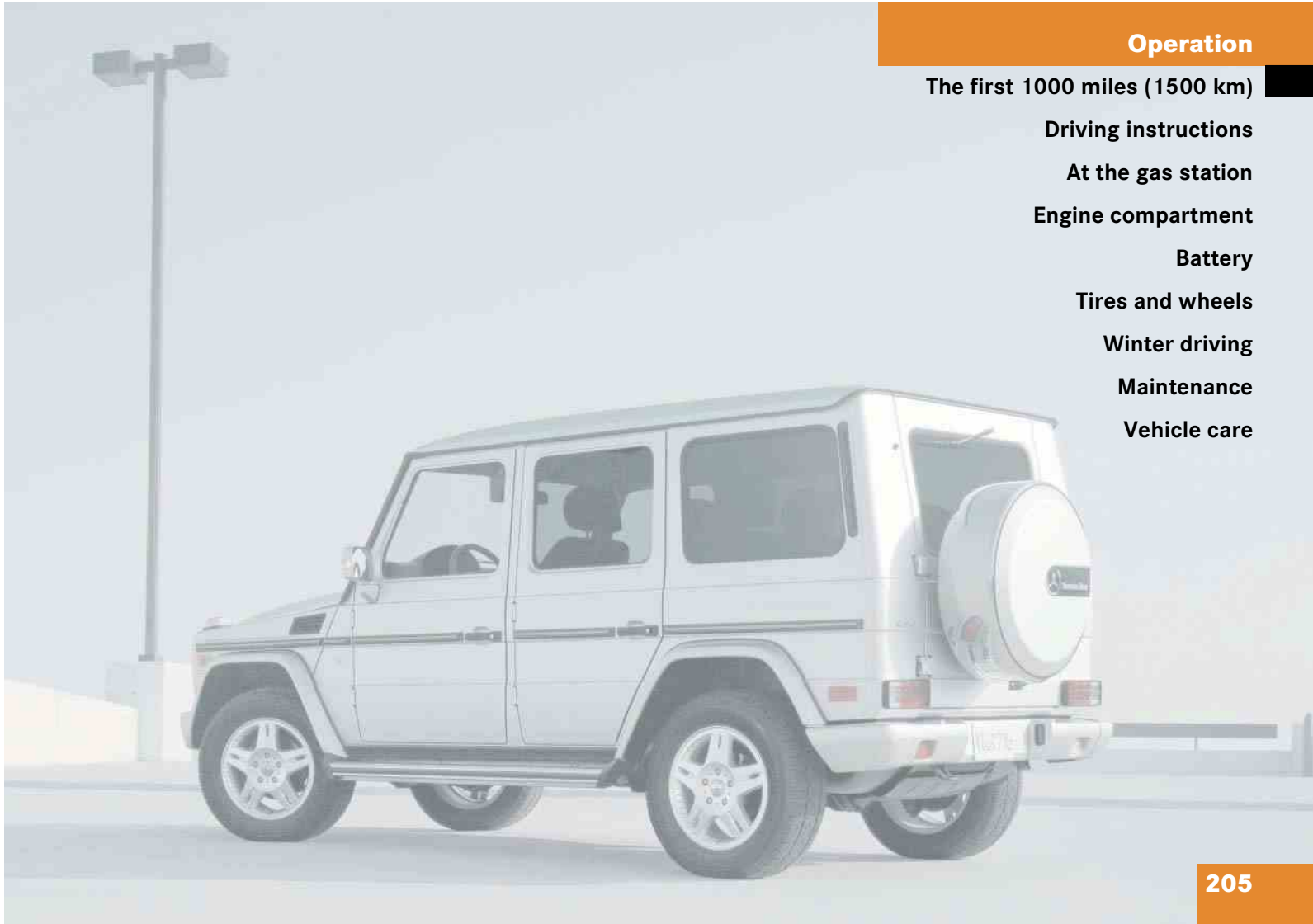

Operation

The first 1000 miles (1500 km)

Driving instructions

At the gas station

Engine compartment

Battery

Tires and wheels

Winter driving

Maintenance

Vehicle care

Operation

The first 1000 miles (1500 km)

In the “Operation” section you will find detailed information on operating, maintaining and caring for your vehicle.

▼ The first 1000 miles (1500 km)

The more cautiously you treat your vehicle during the break-in period, the more satisfied you will be with its performance later on.

- Drive your vehicle during the first 1000 miles (1500 km) at varying but moderate vehicle and engine speeds.
- During this period, avoid heavy loads (full throttle driving) and excessive engine speeds (no more than $\frac{2}{3}$ of maximum rpm in each gear).
- Avoid accelerating by kick-down.
- Do not attempt to slow the vehicle down by shifting to a lower gear using the gear selector lever.
- Select positions **3**, **2** or **1** only when driving at moderate speeds (for hill driving).

After 1000 miles (1500 km) you may gradually increase vehicle and engine speeds to the permissible maximum.



Additional instructions for AMG vehicles:

- During the first 1000 miles (1500 km), do not exceed a speed of 85 mph (140 km/h).
- During this period, avoid engine speeds above 4500 rpm in each gear.

All of the above instructions, as may apply to your vehicle type, also apply when driving the first 1000 miles (1500 km) after the engine, the transfer case, the front differential or the rear differential has been replaced.



Always obey applicable speed limits.

▼ **Driving instructions**

Drive sensibly – save fuel

Fuel consumption, to a great extent, depends on driving habits and operating conditions.

To save fuel you should:

- Keep tires at the recommended inflation pressures.
- Remove unnecessary loads.
- Allow engine to warm up under low load use.
- Avoid frequent acceleration and deceleration.
- Have all maintenance work performed at the intervals specified in the Service Booklet and as required by the FSS. Contact an authorized Mercedes-Benz Light Truck Center.

Fuel consumption is also increased by driving in cold weather, in stop-and-go traffic, on short trips and in hilly country.

Drinking and driving

Warning!



Drinking and driving and/or taking drugs and driving are very dangerous combinations. Even a small amount of alcohol or drugs can affect your reflexes, perceptions and judgement.

The possibility of a serious or even fatal accident are greatly increased when you drink or take drugs and drive.

Do not drink or take drugs and drive or allow anyone to drive who has been drinking or taking drugs.

Pedals

Warning!



Keep driver's foot area clear at all times. Objects stored in this area may impair pedal movement.

Operation

Driving instructions

Power assistance

Warning!



With the engine not running, there is no power assistance for the brake and steering systems. In this case, it is important to keep in mind that a considerably higher degree of effort is necessary to brake and steer the vehicle.

Brakes

Warning!



After driving in heavy rain for some time without applying the brakes or through water deep enough to wet brake components or salty road conditions, the first braking action may be somewhat reduced and increased pedal pressure may be necessary to obtain expected braking effect. Maintain a safe distance from vehicles in front.

Resting your foot on the brake pedal will cause excessive and premature wear of the brake pads.

It can also result in the brakes overheating, thereby significantly reducing their effectiveness. It may not be possible to stop the vehicle in sufficient time to avoid an accident.

To help prevent brake disk corrosion after driving on wet road surfaces (particularly salted roads), it is advisable to brake the vehicle with considerable force prior to parking. The heat generated serves to dry the brakes.

If your brake system is normally only subjected to moderate loads, you should occasionally test the effectiveness of the brakes by applying above-normal braking pressure at higher speeds. This will also enhance the grip of the brake pads.



Be very careful not to endanger other road users when you apply the brakes.

Refer to the description of the Brake Assist System (BAS) (▷ page 76).

If the parking brake is released and the brake warning lamp in the instrument cluster stays on and there is no audible warning (EBB), the brake fluid level in the reservoir is too low.

Brake pad wear or a leak in the system may be the reason for low brake fluid in the reservoir.

Have the brake system inspected immediately. Contact an authorized Mercedes-Benz Light Truck Center.

All checks and service work on the brake system should be carried out by qualified technicians only. Contact an authorized Mercedes-Benz Light Truck Center.

Install only brake pads and brake fluid recommended by Mercedes-Benz.

Warning!



If other than recommended brake pads are installed, or other than recommended brake fluid is used, the braking properties of the vehicle can be degraded to an extent that safe braking is substantially impaired. This could result in an accident.



When driving down long and steep grades, relieve the load on the brakes by selecting gear range **3**, **2** or **1** on the automatic transmission to use the engine's braking power (▷ page 142). This helps prevent overheating of the brakes and reduces brake pad wear.

After hard braking, it is advisable to drive on for some time, rather than immediately parking, so the air stream will cool down the brakes faster.

Driving off

Apply the brakes to test them briefly after driving off. Perform this procedure only when the road is clear of other traffic.

Warm up the engine smoothly. Do not place full load on the engine until the operating temperature has been reached.

When starting off on a slippery surface, do not allow a drive wheel to spin for an extended period with the ESP switched off. Doing so may cause serious damage to the drivetrain which is not covered by the Mercedes-Benz Limited Warranty.

To ensure sufficient traction during off-road driving, activate differential locks as needed (▷ page 150).

Operation

Driving instructions

Parking

Warning!



Do not park this vehicle in areas where combustible materials such as grass, hay or leaves can come into contact with the hot exhaust system, as these materials could be ignited and cause a vehicle fire.

To reduce the risk of personal injury as a result of vehicle movement, before turning off the engine and leaving the vehicle always:

- Keep right foot on brake pedal.
- Pull the parking brake lever up as many notches as possible.
- Move the selector lever to position **P**.
- Slowly release brake pedal.
- When parked on an incline, turn front wheel towards the road curb.
- Turn the SmartKey to starter switch position **0** and remove.
- Take the SmartKey and lock vehicle when leaving.

Operation

Driving instructions



Set the parking brake whenever parking or leaving the vehicle. In addition, move gear selector lever to position **P**. In addition, when parking on hills, always set the parking brake and turn front wheel towards the road curb.

Tires

Warning!



If you feel a sudden significant vibration or ride disturbance, or you suspect that possible damage to your vehicle has occurred, you should turn on the hazard warning flashers, carefully slow down, and drive with caution to an area which is a safe distance from the road.

Inspect the tires and the vehicle underbody for possible damage. If the vehicle or tires appear unsafe, have it towed to the nearest Mercedes-Benz Light Truck Center or tire dealer for repairs.

Tread wear indicators (TWI) are required by law. These indicators are located in six places on the tread circumference and become visible at a tread depth of approximately $\frac{1}{16}$ in (1.6 mm), at which point the tire is considered worn and should be replaced.

The tread wear indicator appears as a solid band across the tread.

Warning!



Although the applicable federal motor vehicle safety laws consider a tire to be worn when the tread wear indicators (TWI) become visible at approximately $\frac{1}{16}$ in (1.6 mm), we recommend that you do not allow your tires to wear down to that level. As tread depth approaches $\frac{1}{8}$ in (3.0 mm), the adhesion properties on a wet road are sharply reduced.

Depending upon the weather and/or road surface (conditions), the tire traction varies widely.

Specified tire pressures must be maintained. This applies particularly if the tires are subject to high loads (e.g. high speeds, heavy loads, high ambient temperatures).

Warning!



Do not drive with a flat tire. A flat tire affects the ability to steer or brake the vehicle. You may lose control of the vehicle. Continued driving with a flat tire or driving at high speed with a flat tire will cause excessive heat build-up and possibly a fire.

Hydroplaning

Depending on the depth of the water layer on the road, hydroplaning may occur even at low speeds and with new tires. Reduce vehicle speed, avoid track grooves in the road and apply brakes cautiously in the rain.

Tire traction

The safe speed on a wet, snow covered or icy road is always lower than on a dry road.

You should pay particular attention to the condition of the road whenever the outside temperatures are close to the freezing point.

Warning!



If ice has formed on the road, tire traction will be substantially reduced. Under such weather conditions, drive, steer and brake with extreme caution.

Mercedes-Benz recommends M+S rated radial-ply tires with a minimum tread depth of approximately $\frac{1}{8}$ in (4 mm) for the winter season for all four wheels to ensure normal balanced handling characteristics. On packed snow, they can reduce your stopping distance as compared with summer tires.

Stopping distance, however, is still considerably greater than when the road is not covered with snow or ice. Exercise appropriate caution.



Avoid spinning of one drive wheel. This may cause serious damage to the drivetrain which is not covered by the Mercedes-Benz Limited Warranty.

Tire speed rating

Despite of the tire speed rating, local speed limits should be obeyed. Use prudent driving speeds appropriate to prevailing conditions.

Operation

Driving instructions

Warning!



Even when permitted by law, never operate a vehicle at speeds greater than the maximum speed rating of the tires.

Exceeding the maximum speed for which tires are rated can lead to sudden tire failure, causing loss of vehicle control and possibly resulting in an accident and/or serious injury and possible death, for you and for others.

Your vehicle is factory equipped with “V”-rated tires, which have a speed rating of 149 mph (240 km/h).

An electronic speed limiter prevents your vehicle from exceeding a speed of 130 mph (210 km/h).



For information on tire speed rating for winter tires, see “Winter tires” (> page 240).

Operation

Driving instructions

Winter driving instructions

The most important rule for slippery or icy roads is to drive sensibly and to avoid abrupt acceleration, braking and steering maneuvers. Do not use the cruise control system under such conditions.

When the vehicle is in danger of skidding, move gear selector lever to position **N**. Try to keep the vehicle under control by corrective steering action.



For information on driving with snow chains, see “Snow chains” (▷ page 241).

Warning!



On slippery road surfaces, never downshift in order to obtain braking action. This could result in drive wheel slip and reduced vehicle control. Your vehicle’s ABS will not prevent this type of control loss.

Do not engage the transfer case in position **LOW** when driving on ice or packed snow. At speeds below 18 mph (30 km/h) vehicle steering is adversely affected by the **LOW RANGE - ABS** (▷ page 75).

Road salts and chemicals can adversely affect braking efficiency. Increased pedal force may become necessary to produce the normal brake effect.

Depressing the brake pedal periodically when traveling at length on salt-strewn roads can bring road-salt-impaired braking efficiency back to normal.

If the vehicle is parked after being driven on salt-treated roads, the braking efficiency should be tested as soon as possible after driving is resumed.

Warning!



Make sure not to endanger any other road users when carrying out these braking maneuvers.

Warning!



If the vehicle becomes stuck in snow, make sure snow is kept clear of the exhaust pipe and from around the vehicle with the engine running. Otherwise, deadly carbon monoxide (CO) gases may enter vehicle interior resulting in unconsciousness and death.

To assure sufficient fresh air ventilation, open a window slightly on the side of the vehicle not facing the wind.

Warning!



The outside temperature indicator is not designed to serve as an ice-warning device and is therefore unsuitable for that purpose. Indicated temperatures just above the freezing point do not guarantee that the road surface is free of ice.

For more information, see “Winter driving” (▷ page 240).

Standing water



Do not drive through flooded areas or water of unknown depth. Before driving through water, determine its depth. Never accelerate before driving into water. The bow wave could force water into the engine and auxiliary equipment, thus damaging them.

If you must drive through standing water, drive slowly to prevent water from entering the passenger compartment or the engine compartment. Water in these areas could cause damage to electrical components or wiring of the engine or transmission, or could result in water being ingested by the engine through the air intake, causing severe internal engine damage. Any such damage is not covered by the Mercedes-Benz Limited Warranty.

Passenger compartment

Warning!



Always fasten items being carried as securely as possible.

In an accident, during hard braking or sudden maneuvers, loose items will be thrown around inside the vehicle, and cause injury to vehicle occupants unless the items are securely fastened in the vehicle.

The rear cargo compartment is the preferred place to carry objects. Always use partition net when transporting cargo. Partition net cannot secure hard or heavy objects. Always fasten items being carried as securely as possible using the cargo tie-down rings in the cargo compartment floor and fastening material.

Do not load items on the roof. It may cause instability during some maneuvers which could result in an accident. This vehicle is not intended to carry items on its roof. Thus roof rails and roof mounted ski or bike holders must not be used.

Off-road driving

Warning!



Do not load items on the roof. It may cause instability during some maneuvers which could result in an accident.

Operation

Driving instructions

Warning!



Drive slowly in unknown terrain. This will make it easier to recognize unexpected obstacles and avoid damage to the vehicle.

To help avoid the vehicle rolling over, never turn it around on steep inclines. If the vehicle cannot complete the attempted climb, back it down in reverse gear.

Do not drive along the side of a slope (danger of vehicle rollover). If in doing so the vehicle begins to show a tendency to roll, immediately steer into a line of gravity (straight up or downhill).

Never let the vehicle roll backwards in idle. You may lose control of the vehicle if you use only the service brake.

Sand, dirt, mud and other material having friction property can cause exceptional wear and tear as well as brake failure.

Have the brakes checked for dirt build-up and cleaned. There is otherwise a risk that full braking power may not be available in an emergency.

Read this chapter carefully before you begin off-road travel.

Familiarize yourself with the vehicle characteristics and gear changing before you attempt any difficult terrain off-road driving. We recommend that you start out with easy off-road travel.

Special driving features for off-road driving

The following driving features are available for specific kind of operation:

- ABS (▷ page 74)
- ESP (▷ page 78)
- 4-ETS (▷ page 77)
- Differential lock (▷ page 148)
- Transfer case (▷ page 145)

Off-road driving rules

- ▶ Engage the transfer case in position **LOW** before driving under off-road conditions (▷ page 145).
- ▶ If necessary activate differential locks (▷ page 150).

The ABS, BAS and ESP are switched off automatically when the differential locks are activated.

- ▶ Fasten items being carried as securely as possible (▷ page 180).



Whenever driving in off-road mode, we recommend:

- Keeping doors, tailgate, windows and sliding/pop-up roof closed.
- Switching cruise control off.



Observe the following during off-road driving:

- Adjust vehicle speed to condition of terrain. The more uneven, rutty and steeper the terrain, the lower the speed should be. Drive through water slowly at an even speed, avoiding a bow wave.
- Be especially careful when driving in unknown territory. It may be necessary to get out of the vehicle and scout the path you intend to take.
- Watch out for obstacles, such as rocks, holes, tree stumps and ruts.

- Avoid excessive engine speeds – drive at moderate engine speeds (max. 3000 rpm).
- Before driving through water, determine its depth.
- Do not stop vehicle while immersed in water, and do not shut off the engine.
- In sandy soil, drive at a steady speed as allowed by conditions. This helps overcome the vehicle rolling resistance and reduces the likelihood of the vehicle sinking into the ground.
- Do not initiate jumps with the vehicle. It interrupts the forward momentum of the vehicle.
- Always drive on slopes with the engine running and the vehicle in gear.
- Inspect the vehicle for possible damage after each off-road trip.

Checklist before off-road driving

Engine oil level

- Check the engine oil level (▷ page 229). The display ENGINE OIL LEVEL - OK must appear in the multi-function display.

Only then can the vehicle obtain a trouble-free oil supply, even on steep gradients.

Tires

- Check the tread depth and maintain specified tire pressure (see tire pressure label inside the fuel filler flap).
- Check tires for possible damage and remove foreign objects.
- Replace missing valve caps.

Operation

Driving instructions

Rims

- Dented or bent rims can cause tire pressure loss and damage the tire beads. For this reason, check and, if necessary, change rims before driving off-road.

Vehicle tool kit

- Check if the vehicle jack is functional.
- In all cases take the vehicle tool kit, a strong tow rope, a shovel and a small plank (to put under the vehicle jack on sandy soil) with you.

Driving in steep terrain

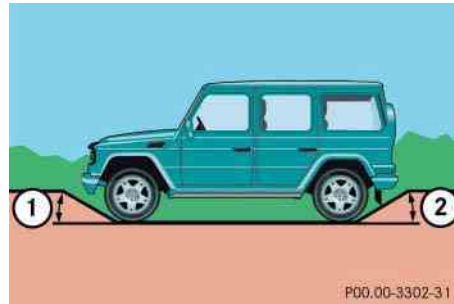

Slope angle

- ① 27°
- ② 36°

- Comply with the warnings (▷ page 214) and rules for off-road driving (▷ page 214).
- Driving on embankments, slopes and other steep inclines should only be done straight up or downhill, i.e. in the line of gravity. Maximum vehicle climbing ability is a 80% grade.
- Select gear range **2** or **1** on the automatic transmission (▷ page 142).

- Drive slowly.
- Utilize the engine's braking power when descending a slope, observe the engine speed (do not overrev the engine). Apply the service brake as needed.
- Check the brakes after a lengthy down-grade drive.

Traction in steep terrain

Be easy on the accelerator and watch for continuous wheel traction when driving in steep terrain.



The 4-ETS helps greatly when starting out on a steep incline when the front wheels have then the tendency to slip due to the weight shifting away the front axle. The 4-ETS recognizes the situation and limits the torque for the front wheels by braking them. Simultaneously the torque for the rear wheels is provided.

Driving across a hilltop

Decelerate just ahead of a hilltop (do not select gear range **N**), to prevent the vehicle from speeding up too much after climbing a hill.

Use the momentum of the vehicle to drive across the hilltop.

After climbing a hill, driving in this manner prevents the vehicle from:

- jumping across the hilltop
- losing its forward momentum
- speeding up too much after climbing the hill

Driving downhill

- Select gear range **1** on the automatic transmission (▷ page 142).
- Drive downhill observing the same rules as driving uphill (▷ page 216).



Only apply the service brake if the vehicle is traveling straight downhill, i.e. in the line of gravity.



The special LOW RANGE – ABS setting allows for precise and brief (cyclical) blocking of the front wheels, permitting them to dig into loose ground.

Remember that, when stopped, the front wheels slide across a surface and thus lose their ability to steer the vehicle.

Driving through water

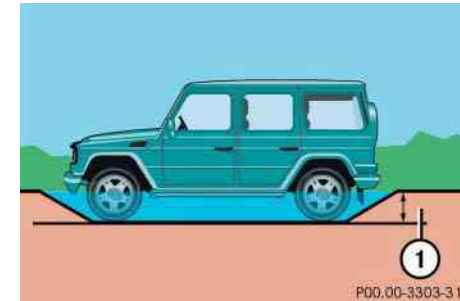

① 19 in (48 cm)

- Before driving through water, determine its depth.

It should not be deeper than approximately 19 in (48 cm).

Make sure you check the water bed. The ground surface may not be firm which may result in deeper waters than expected when driving the vehicle through it.

Operation

Driving instructions

- Comply with the warnings (▷ page 214) and rules for off-road driving (▷ page 214).
- Switch off the exterior lamps as well as the climate control.
- Select gear range **2** or **1** on the automatic transmission (▷ page 142).
- Enter the water only at a shallow spot, driving at walking speed.



Never accelerate before driving into the water. The bow wave could force water into the engine and auxiliary equipment, thus damaging them.

- Do not stop vehicle while immersed in water, and do not shut off the engine.

There is a very high level of driving resistance in water. The surface is slippery and may not be firm, making pulling away in water difficult and dangerous.

- Clean mud off the tire tread after driving through water.
- To dry the brakes, apply pressure to the brake pedal several times after leaving the water.

Crossing obstacles



If possible, use the assistance of a second person outside the vehicle to scout the path you intend to take and check for adequate ground clearance when you cross obstacles with your vehicle. The person assisting you outside the vehicle should always be a safe distance away from the vehicle and positioned so that he or she cannot get hurt in case of any unexpected vehicle movement.

After off-road driving or crossing obstacles, inspect vehicle for any damage, especially vehicle undercarriage and suspension components. Failure to do so can adversely affect the vehicle's future performance, including increased chance of an accident.

- Check the vehicle clearance before crossing obstacles.
- Comply with the warnings (▷ page 214) and rules for off-road driving (▷ page 214).
- Select gear range **1** on the automatic transmission (▷ page 142).
- Cross obstacles (e.g. tree stumps or big rocks) very slowly by aiming one of the front wheels at the center of the obstacle, and repeat same with the rear wheel.



Special attention is needed when you cross obstacles on a steep incline.

The vehicle could slide sideways as a result of its possible slanted position which in turn may result in the vehicle tipping or rolling over.

Ruts



A number of off-road tracks or other by-roads have deep ruts. If the vehicle does not have enough ground clearance:

- it could be damaged
- the underside of the vehicle may come down on a surface and remain stuck

After off-road driving or crossing obstacles, inspect vehicle for any damage, especially vehicle undercarriage and suspension components. Failure to do so can adversely affect the vehicle's future performance, including increased chance of an accident.

Operation

Driving instructions

- Check the vehicle clearance before driving in ruts.
- Comply with the warnings (▷ page 214) and rules for off-road driving (▷ page 214).
- Select gear range **1** on the automatic transmission (▷ page 142).
- Drive slowly next to the ruts rather than through them if at all possible.

Operation

Driving instructions

Returning from off-road driving

Warning!



Never drive on pavement with activated differential locks. Engaged front axle differential locks limits ability to move around curves.

If you feel a sudden significant vibration or ride disturbance, or you suspect that possible damage to your vehicle has occurred, you should turn on the hazard warning flashers, carefully slow down, and drive with caution to an area which is a safe distance from the roadway.

Inspect the tires and under the vehicle for possible damage. If the vehicle or tires appear unsafe, have it towed to the nearest Mercedes-Benz Light Truck Center or tire dealer for repairs.

Damage to the vehicle negatively influences driving comfort and poses the risk of accident to you and other drivers.

Off-road driving increases strain on the vehicle.

We recommend that you inspect the vehicle for possible damage after each off-road trip. Recognizing any damage and a subsequent timely repair reduces the chance of a possible breakdown or accident later on.

Proceed as follows:

- Switch the transfer case in position **HIGH** (> page 145).
- Disengage differential locks (> page 151).

- Remove excessive dirt from tires, wheels, wheel housings, and underbody.

For instance, after driving in mud, clean the radiator, chassis, engine, brakes, and wheels from extreme dirt using a strong jet of water.

- Inspect frame, oil pan, brake hoses, etc., as well as vehicle underbody for possible damage.
- Check tires for possible damage and remove foreign objects. Clean all exterior lamps and conduct a brake test.

- Clean all exterior lamps and check them for possible damage.
- Check for brush or branches caught in the undercarriage.

They could increase the possibility of a fire, as well as cut fuel and/or brake lines, puncture rubber bellows of the axles or drive shafts.

- After continued operation in mud, sand, water or other dirty conditions, clean the brake discs, wheels, brake pads and check and clean axle joints.
- Conduct a brake test.

Control and operation of radio transmitters

COMAND, radio and telephone*

Warning!



Do not forget that your primary responsibility is to drive the vehicle safely. Only operate the COMAND, radio or telephone¹ if road, traffic and weather conditions permit.

Bear in mind that at a speed of just 30 mph (approximately 50 km/h), your vehicle is covering a distance of approximately 50 feet (approximately 14 m) every second.

¹ Observe all legal requirements.

Operation

Driving instructions

Telephones and two-way radios

Warning!



Never operate radio transmitters equipped with a built-in or attached antenna (i.e. without being connected to an external antenna) from inside the vehicle while the engine is running. Doing so could lead to a malfunction of the vehicle's electronic system, possibly resulting in an accident and/or personal injury.

Radio transmitters, such as a portable telephone or citizens band unit should only be used inside the vehicle if they are connected to an antenna that is installed on the outside of the vehicle.

Refer to the radio transmitter operation instructions regarding use of an external antenna.

Operation

Driving instructions

Driving abroad

Abroad, there is a widely-spread Mercedes-Benz service network at your disposal. If you plan to drive into areas which are not listed in the index of your Mercedes-Benz Light Truck Center directory, you should request pertinent information from your authorized Mercedes-Benz Light Truck Center.

Catalytic converter

Your Mercedes-Benz is equipped with monolithic-type catalytic converters, an important element in conjunction with the oxygen sensors to achieve substantial control of the pollutants in the exhaust emissions. Keep your vehicle in proper operating condition by following our recommended maintenance instructions as outlined in your Service Booklet.



To prevent damage to the catalytic converters, use only premium unleaded gasoline in this vehicle.

Any noticeable irregularities in engine operation should be repaired promptly. Otherwise, excessive unburned fuel may reach the catalytic converter, causing it to overheat and start a fire.

Warning!



As with any vehicle, do not idle, park or operate this vehicle in areas where combustible materials such as grass, hay or leaves can come into contact with the hot exhaust system, as these materials could be ignited and cause a vehicle fire.

Emission control

Certain engine systems serve to keep the toxic components of the exhaust gases within permissible legal limits.

These systems, of course, will function properly only when maintained strictly according to factory specifications. Any adjustments on the engine should, therefore, be carried out only by qualified Mercedes-Benz Light Truck Center authorized technicians. Engine adjustments should not be altered in any way. Moreover, the specified service jobs must be

carried out regularly according to Mercedes-Benz servicing requirements. For details refer to the Service Booklet.

Warning!



Inhalation of exhaust gas is hazardous to your health. All exhaust gas contains carbon monoxide, and inhaling it can cause unconsciousness and lead to death.

Do not run the engine in confined areas (such as a garage) which are not properly ventilated. If you think that exhaust gas fumes are entering the vehicle while driving, have the cause determined and corrected immediately. If you must drive under these conditions, drive only with at least one window fully open at all times.

Coolant temperature

During severe operating conditions and stop-and-go city traffic, the coolant temperature may rise to approx. 248°F (120°C).

The engine should not be operated with the coolant temperature above 248°F (120°C). Doing so may cause serious engine damage which is not covered by the Mercedes-Benz Limited Warranty.



Excessive coolant temperatures trigger a warning message in the multifunction display (> page 269).

Operation

Driving instructions

Warning!



- Driving when your engine is badly overheated can cause some fluids which may have leaked into the engine compartment to catch fire. You could be seriously burned.
- Steam from an overheated engine can cause serious burns and can occur just by opening the hood. Stay away from the engine if you see or hear steam coming from it.

Turn off the engine, get out of the vehicle and do not stand near the vehicle until the engine has cooled down.

Operation

At the gas station

▼ At the gas station

Refueling

Warning!



Gasoline is highly flammable and poisonous. It burns violently and can cause serious injury. Whenever you are around gasoline, avoid inhaling fumes and skin contact, extinguish all smoking materials. Never allow sparks, flame or smoking materials near gasoline!

Failure to remove the fuel cap slowly could result in personal injury.

The fuel filler flap is located on the right-hand side of the vehicle towards the rear. Locking/unlocking the vehicle with the remote control automatically locks/unlocks the fuel filler flap.

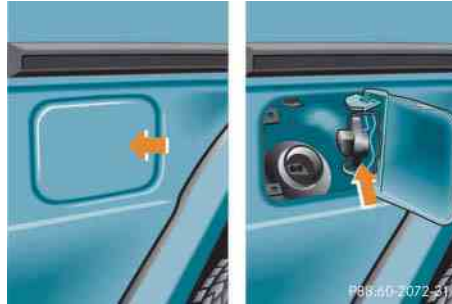

- ▶ Turn off the engine.
- ▶ Remove the SmartKey from the starter switch.
- ▶ Open the fuel filler flap by pushing at the point indicated by the arrow.
- ▶ Turn the fuel cap to the left and hold on to it until possible pressure is released.
- ▶ Take off the cap and set it in the recess on the fuel filler flap.
- ▶ To prevent fuel vapors from escaping into open air, fully insert filler nozzle unit.
- ▶ Only fill your tank until the filler nozzle unit cuts out – do not top up or overfill.

Warning!



Overfilling of the fuel tank may create pressure in the system which could cause a gas discharge. This could cause the gas to spray back out when removing the fuel pump nozzle, which could cause personal injury.

- ▶ Replace the fuel cap by turning it to the right.
You should hear the fuel filler cap engage.
- ▶ Close the fuel filler flap.



The fuel filler cap is tethered to the fuel filler neck. Do not drop the cap. It could damage the vehicle paint finish.

When refueling the vehicle, make certain that no gasoline comes into contact with plastic tail lamp to prevent damaging the lens.



Use only premium unleaded gasoline with a minimum Posted Octane Rating of 91 (average of 96 RON / 86 MON). Information on gasoline quality can normally be found on the fuel pump.

More information on gasoline can be found in the Factory Approved Service Products pamphlet.



Leaving the engine running and the fuel cap open can cause the **CHECK ENGINE** malfunction indicator lamp to illuminate.

See also “Practical hints” section (▷ page 256).

Check regularly and before a long trip

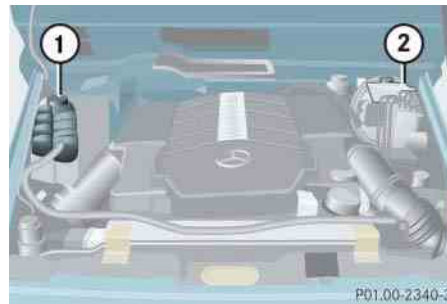

- ① Coolant
- ② Brake fluid



Opening the hood, see (▷ page 227).

Coolant

For normal replenishing, use water (potable water quality). For more information, see “Coolant level” (▷ page 232) and see “Fuels, coolants, lubricants, etc.” (▷ page 333).

Operation

At the gas station

Brake fluid



If you find that the brake fluid in the brake fluid reservoir has fallen to the minimum mark or below, have the brake system checked for brake pad thickness and leaks immediately. Notify an authorized Mercedes-Benz Light Truck Center immediately. Do not add brake fluid as this will not solve the problem. For more information, see “Practical hints” (▷ page 254).

Windshield/rear window washer system and headlamp cleaning system

For more information on refilling the reservoir, see “Windshield/rear window washer system and headlamp cleaning system” (▷ page 234).

Operation

At the gas station

Engine oil level

For more information on engine oil, see (▷ page 228).

Vehicle lighting

Check function and cleanliness. For information on replacing light bulbs, see “Replacing bulbs” (▷ page 295).

For more information, see “Exterior lamp switch” (▷ page 104).

Tire inflation pressure

For more information, see “Checking tire inflation pressure” (▷ page 237).

▼ Engine compartment

Hood

Warning!



Do not pull the release lever while the vehicle is in motion. Otherwise the hood could be forced open by passing air flow.

Opening

The pull release lever is under the driver's side of the instrument panel.



① Release lever

- ▶ Pull release lever ① upward.
The hood is unlocked.



To avoid damage to the windshield wipers or hood, open the hood only with wipers in parked position.



- ② Safety hook
- ▶ Lift hood up slightly.
- ▶ Pull safety hook ② in direction of arrow and open hood.

Operation

Engine compartment

Warning!



To help prevent personal injury, stay clear of moving parts when the hood is open and the engine is running. Make sure the hood is properly closed before driving. When closing the hood, use extreme caution not to catch hands or fingers.

The radiator fan may continue to run for approximately 30 seconds or even restart after the engine has been turned off. Stay clear of fan blades.

Warning!



If you see flames or smoke coming from the engine compartment, or if the coolant temperature display indicates that the engine is overheated, do not open the hood. Move away from vehicle and do not open the hood until the engine has cooled down. If necessary, call the fire department.

Operation

Engine compartment

Warning!



The engine is equipped with a transistorized ignition system. Because of the high voltage, it is dangerous to touch any components (ignition coils, spark plug sockets, diagnostic socket) of the ignition system

- with the engine running
- while starting the engine
- if ignition is “on” and the engine is turned manually

Closing

Warning!



Be careful that you do not close the hood on anyone.

- ▶ Lower hood and let it drop into lock from a height of approximately 0.7 ft (20 cm).

The hood will lock audibly.

- ▶ Check to make sure the hood is fully closed.

If you can raise the hood at a point above the headlamps, then it is not properly closed. Open it again and let it drop with somewhat greater force.



Do not push the hood closed manually, as this could damage it.

Engine oil

The amount of oil your engine needs will depend on a number of factors, including driving style. Higher oil consumption can occur when

- the vehicle is new
- the vehicle is driven frequently at higher engine speeds

Engine oil consumption checks should only be made after the vehicle break-in period.



Do not use any special lubricant additives, as these may damage the drive assemblies. Using special additives not approved by Mercedes-Benz will restrict your warranty entitlement.

More information on this subject is available at any Mercedes-Benz Light Truck Center.

Checking engine oil level with the control system



When checking the oil level the vehicle must

- be parked on level ground
- be at normal operating temperature
- have been stationary for at least five minutes with the engine turned off

To check the engine oil level via the multifunction display, do the following:

- ▶ Turn the SmartKey in the starter switch to position **2**.

The standard display (▷ page 115) should appear in the multifunction display.

- ▶ Press button  or  on the steering wheel until the following message is seen in the multifunction display:

MEASURE. CORRECT
ONLY IF VEH. LEVEL

After about three seconds this message is displayed:

ENGINE OIL LEVEL
MEASURING NOW

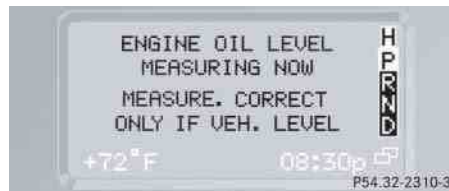



One of the following messages will subsequently appear in the indicator:

- ENGINE OIL LEVEL
OK
- ADD 1.0 Qt. TO
REACH MAX. OIL LEVEL!
(Canada: 1.0 LITER)
- ADD 1.5 Qts. TO
REACH MAX. OIL LEVEL!
(Canada: 1.5 LITERS)
- ADD 2.0 Qts. TO
REACH MAX. OIL LEVEL!
(Canada: 2.0 LITERS)

Operation

Engine compartment



If you want to interrupt the checking procedure, press the  or  button on the multifunction steering wheel.

- ▶ If necessary, add engine oil.

For adding engine oil see (▷ page 231).

For more information on engine oil, see the “Technical data” section (▷ page 333) and (▷ page 334).

Other display messages

If the SmartKey is not turned to position **2** in the starter switch, the following message will appear:

FOR ENGINE OIL LEVEL
SWITCH ON IGNITION!

- ▶ Switch on the ignition.

If you see the message:

OBSERVE WAITING PERIOD

Operation

Engine compartment

- ▶ If engine is at normal operating temperature, wait five minutes before repeating check procedure.
- ▶ If engine is not yet at normal operating temperature, wait 30 minutes before repeating check procedure.

If you see the message:

ENGINE OIL LEVEL
NOT WHEN ENGINE ON!

- ▶ Turn off the engine.
- ▶ If the engine is at normal operating temperature, wait five minutes before checking oil.
- ▶ If the engine is not yet at normal operating temperature, you must wait 30 minutes before checking oil.

If there is excess engine oil with the engine at normal operating temperature, the following message will appear:

ENGINE OIL LEVEL
REDUCE OIL LEVEL

- ▶ Have excess oil siphoned or drained off. Contact your authorized Mercedes-Benz Light Truck Center.



Excess oil must be siphoned or drained off. It could cause damage to the engine and catalytic converter not covered by the Mercedes-Benz Limited Warranty.



Perform the engine oil level check with the dipstick if it cannot be completed with the control system (▷ page 230).

In this case we recommend that you have the system checked at a Mercedes-Benz Light Truck Center.

For more information on messages in the display concerning engine oil, see the “Practical hints” section (▷ page 271).

Checking engine oil level with the oil dipstick

When checking the oil level the vehicle must

- be parked on level ground
- be at normal operating temperature
- have been stationary for at least five minutes with the engine turned off



The engine oil level can be checked by either the oil dipstick or via the multi-function display in the instrument cluster (▷ page 229). The amount of engine oil needed is shown more precisely in the multifunction display.

To check the engine oil level with the oil dipstick, do the following:

- ▶ Open the hood (▷ page 227).
- ▶ Pull out oil dipstick ① (▷ page 232)
- ▶ Wipe oil dipstick ① clean.
- ▶ Fully insert oil dipstick ① into the dipstick guide tube.
- ▶ Pull out oil dipstick ① again after approximately three seconds to obtain accurate reading.

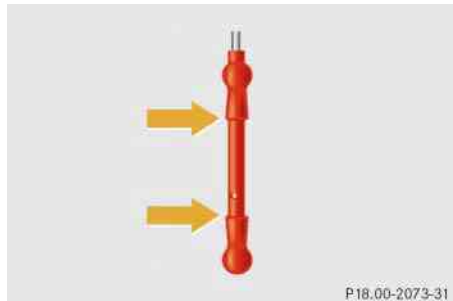

Oil dipstick

The oil level is correct when it is between the lower (min) and upper (max) mark of the oil dipstick.



The filling quantity between the upper and lower marks on the oil dipstick is approximately 2.1 US qt. (2.0 l).

- ▶ If necessary, add engine oil.

For adding engine oil see (▷ page 231).

For more information on engine oil, see the “Technical data” section (▷ page 333) and (▷ page 334).

For more information on messages in the display concerning engine oil, see the “Practical hints” section (▷ page 271).

Adding engine oil



Only use approved engine oils. For a listing of approved engine oils, refer to the Factory Approved Service Products pamphlet in your vehicle literature portfolio.

In addition, check the oil filler cap for important information pertaining to the engine oil needing to meet a specific Mercedes-Benz specification (e.g. MB 229.5). If such information is printed on the oil filler cap, only use an engine oil from the list of approved engine oils in the Factory Approved Service Products pamphlet that meets the specification indicated on the oil filler cap. Using engine oils of other specification may cause the FSS to incorrectly determine the next service interval and will result in engine damage not covered by the Mercedes-Benz Limited Warranty.

Operation

Engine compartment

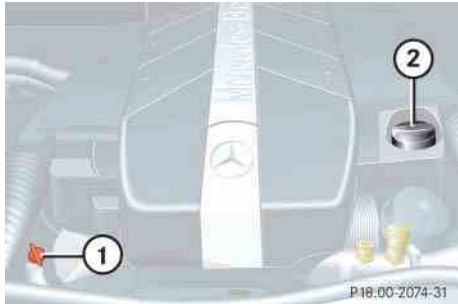

- ① Oil dipstick
- ② Oil filler cap

- ▶ Unscrew oil filler cap ② from filler neck.
- ▶ Add engine oil as required. Be careful not to overfill with oil.

Be careful not to spill any oil when adding. Avoid environmental damage caused by oil entering the ground or water.



Excess oil must be siphoned or drained off. It could cause damage to the engine and catalytic converter not covered by the Mercedes-Benz Limited Warranty.

- ▶ Screw oil filler cap ② back on filler neck.

For more information on engine oil, see the “Technical data” section (▷ page 333) and (▷ page 334).

Transmission fluid level

The transmission fluid level does not need to be checked. The transmission has a permanent supply of automatic transmission fluid.

If you notice transmission fluid loss or gear shifting malfunctions, have an authorized Mercedes-Benz Light Truck Center check the automatic transmission.

Coolant level

The engine coolant is a mixture of water and anticorrosion/antifreeze.

When checking the coolant level,

- the vehicle must be parked on level ground.
- the engine must be cool. The coolant level should reach the **COLD LEVEL** mark in the reservoir.

Warning!



In order to avoid any possibly serious burns:

- Use extreme caution when opening the hood if there are any signs of steam or coolant leaking from the cooling system, or if the coolant temperature display indicates that the coolant is overheated.
- Do not remove pressure cap on coolant reservoir if engine temperature is above 194°F (90°C). Allow engine to cool down before removing cap. The coolant reservoir contains hot fluid and is under pressure.
- Using a rag, slowly open the cap approximately $\frac{1}{2}$ turn to relieve excess pressure. If opened immediately, scalding hot fluid and steam will be blown out under pressure.
- Do not spill antifreeze on hot engine parts. Antifreeze contains ethylene glycol which may burn if it comes into contact with hot engine parts.

The coolant expansion tank is located on the passenger side of the engine compartment.



① Cap

Operation

Engine compartment

- ▶ Using a rag, turn the cap slowly approximately one half turn to the left to release any excess pressure.
- ▶ Continue turning the cap to the left and remove it.
- ▶ Check coolant level.

The coolant level is correct if the level

- for cold coolant: is level with the mark on the reservoir
- for warm coolant: is approx. 0.6 in (1.5 cm) higher

- ▶ Add coolant as required.
- ▶ Replace and tighten cap until you hear it click a few times.

For more information on coolant, see “Coolants” (▷ page 336).

Operation

Engine compartment

Windshield/rear window washer system and headlamp cleaning system

The windshield washer reservoir is located in the engine compartment on the passenger side. It holds approximately 5.3 US qt (5.0 l). The headlamp cleaning system is also supplied from the windshield washer reservoir.

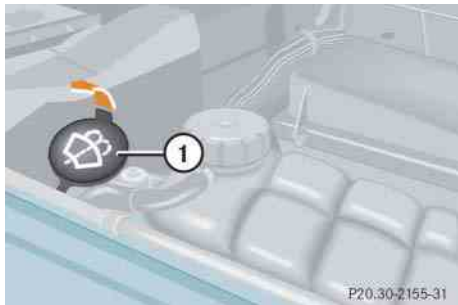

① Cap

- ▶ Use the tab to pull cap ① upwards.
- ▶ Check washer solvent level and add washer solvent as required.
- ▶ Press cap ① on the filler neck until it has completely engaged.

Add MB Windshield Washer Concentrate “S” to the water during all seasons.

- At temperatures above freezing point, use MB Windshield Washer Concentrate “S” to prevent smearing.
- If there is a danger of frost, use MB Windshield Washer Concentrate “S” and commercially available premixed windshield washer solvent/antifreeze to prevent water from freezing on the windshield and the reservoir from being damaged.

Premix the windshield washer fluid in a suitable container, adapting the mixing ratio to the outside temperature (▷ page 339).

Warning!



Washer solvent / antifreeze is highly flammable. Do not spill washer solvent / antifreeze on hot engine parts, because it may ignite and burn. You could be seriously burned.



Only use washer fluid which is suitable for plastic lenses. Improper washer fluid can damage the plastic lenses of the headlamps.

▼ Battery

The battery is located in front of the rear seat bench and below the cup holder. Jump starting terminals are located in the left side of the engine compartment (▷ page 314). Refer to Service Booklet for battery maintenance intervals.

The battery should always be sufficiently charged in order to achieve its rated service life.

If you use your vehicle less than approximately 200 miles (300 km) per month, mostly for short-distance trips, or if it is not used for long periods of time, you will need to have the battery charge checked more frequently and corrected if necessary.

When replacing batteries, always use batteries approved by Mercedes-Benz.

If you do not intend to operate your vehicle for an extended period of time, consult an authorized Mercedes-Benz Light Truck Center about steps you need to observe.

	Observe all safety instructions and precautions when handling automotive batteries.
	Risk of explosion
	Keep flames or sparks away from battery. Do not smoke.
	Battery acid is caustic. Do not allow it to come into contact with skin, eyes or clothing. In case it does, immediately flush affected area with clear water and seek medical help if necessary.
	Wear eye protection.
	Keep children away.
	Follow the instructions in this Operator's Manual.

Operation

Battery

Batteries contain materials that can harm the environment if disposed of improperly. Recycling of batteries is the preferred method of disposal. Many states require sellers of batteries to accept old batteries for recycling.



If the battery is discharged

- you will no longer be able to turn the SmartKey in the starter switch
- the gear selector lever will remain locked in position **P**

For more information, see “Battery” (▷ page 311).

Operation

Tires and wheels

▼ Tires and wheels

See your authorized Mercedes-Benz Light Truck Center for information on tested and recommended rims and tires for summer and winter operation. They can also offer advice concerning tire service and purchase.

Warning!



Replace rims or tires with the same designation, manufacturer and type as shown on the original part. See your authorized Mercedes-Benz Light Truck Center for further information. If incorrectly sized rims and tires are mounted:

- The wheel brakes or suspension components can be damaged.
- The correct operating clearance of the wheels and the tires are no longer guaranteed.

Warning!



Do not mix different tire construction types (i.e. radial, bias, bias-belted) on your vehicle because handling may be adversely affected and may result in loss of control.

Warning!



Worn, old tires can cause accidents. If the tire tread is badly worn, or if the tires have sustained damage, replace them.

When replacing rims, use only genuine Mercedes-Benz wheel bolts specified for the particular rim type. Failure to do so can result in the bolts loosening and possibly an accident.

Retreaded tires are not tested or recommended by Mercedes-Benz, since previous damage cannot always be recognized on retreads. Mercedes-Benz can therefore not assure the operating safety of the vehicle when such tires are used.

Important guidelines

- Use only sets of tires and rims of the same type and make.
- Tires must be of the correct size for the rim.
- Break in new tires for approximately 60 miles (100 km) at moderate speeds.
- Regularly check the tires and rims for damage. Dented or bent rims can cause tire pressure loss and damage to the tire beads.
- If vehicle is heavily loaded, check tire pressure and correct as required.
- Do not allow your tires to wear down too far. Adhesion properties on wet roads are sharply reduced at tread depths under $\frac{1}{8}$ in (3 mm).
- When replacing individual tires, you should mount new tires on the front wheels first (on vehicles with same-sized wheels all around).

Life of tire

The service life of a tire is dependent upon varying factors including but not limited to:

- Driving style
- Tire pressure
- Distance driven

Warning!



Tires and spare wheel should be replaced after six years, regardless of the remaining tread.



Keep unmounted tires in a cool, dry place with as little exposure to light as possible. Protect tires from contact with oil, grease and gasoline.

Direction of rotation

Unidirectional tires offer added advantages, such as better hydroplaning performance. To benefit, however, you must ensure the tires rotate in the direction specified.

An arrow on the sidewall indicates the intended direction of rotation of the tire.

Checking tire inflation pressure

Warning!



If the tire pressure drops repeatedly:

- Check the tires for punctures from foreign objects.
- Check to see whether air is leaking from the valves or from around the rim.

Correct the tire pressure only when tires are cold.

Regularly check your tire pressure at intervals of no more than 14 days.

If the tires are warm, you should only correct the tire pressure if it is too low for current operating conditions.

A table on the fuel filler flap lists the specified tire inflation pressures for warm and cold tires as well as for various operating conditions.

Operation

Tires and wheels



The pressures listed for light loads are minimum values offering high driving comfort.

Increased inflation pressures listed for heavier loads may also be used for light loads. These higher pressures produce favorable handling characteristics. The ride of the vehicle, however, will be somewhat harder. Never exceed the max. values or inflate tires below the min. values listed in the fuel filler flap.

Tire pressure changes by approximately 1.5 psi (0.1 bar) per 18°F (10°C) of air temperature change. Keep this in mind when checking tire pressure where the temperature is different from the outside temperature.

Tire temperature and tire pressure are also increased while driving, depending on the driving speed and the tire load.

Warning!



Follow recommended inflation pressures.

Do not overinflate tires. Overinflated tires can result in sudden deflation (blowout) because they are more likely to become punctured or damaged by road debris, potholes, etc.

Do not underinflate tires. Underinflated tires wear unevenly, adversely affect handling and fuel economy, and are more likely to fail from being overheated.

Do not overload the tires by exceeding the Gross Vehicle Weight Rating (GVWR) and the Gross Axle Weight Rating (GAWR) as indicated on the certification label on the driver's door pillar. Overloading the tires can overheat them, possibly causing a blowout.

Check the spare tire periodically for condition and inflation. Spare tire will age and become worn over time even if never used, and thus should be inspected and replaced when necessary.

Rotating wheels

Warning!



Rotate front and rear wheels only if there are of the same size.

The wheels can be rotated every 3000 to 6000 miles (5000 to 10000 km) or sooner if necessary, according to the degree of tire wear. The same direction of tire rotation must be retained.

Rotate the wheels before the characteristic tire wear pattern becomes visible (shoulder wear on front wheels and tread center wear on rear wheels).

Thoroughly clean the inner side of the wheels after each rotation. Check and ensure proper tire inflation pressure.

Warning!



Have the tightening torque checked after changing a wheel. Wheels could become loose if not tightened with a torque of 97 lb-ft (130 Nm).

Use only genuine Mercedes-Benz wheel bolts specified for your vehicle's rims.

Operation

Winter driving

▼ Winter driving

Before the onset of winter, have your vehicle winterized at an authorized Mercedes-Benz Light Truck Center. This service includes:

- Check of anticorrosion and antifreeze concentration.
- Addition of cleaning concentrate to the water of the windshield and headlamp cleaning system. Add MB Concentrate “S” to a premixed windshield washer solvent/antifreeze which is formulated for below freezing point temperatures (▷ page 339).
- Battery test. Battery capacity drops with decreasing ambient temperature. A well charged battery helps to ensure the engine can be started even at low ambient temperatures.
- Tire change. Mercedes-Benz recommend M+S rated radial-ply tires with a minimum tread depth of approximately $\frac{1}{8}$ in (4 mm) on all four wheels for the winter season.

Winter tires

Always use winter tires at temperatures below 45°F (7°C) and whenever wintry road conditions prevail. Use of winter tires is the only way to achieve the maximum effectiveness of the ABS, ESP, EBB and 4-ETS in winter operation.

For safe handling, make sure all winter tires mounted are of the same make and have the same tread design.

Warning!



Winter tires with a tread depth under $\frac{1}{8}$ in (4 mm) must be replaced. They are no longer suitable for winter operation.

Always observe the speed rating of the winter tires installed on your vehicle. If the maximum speed for which your tires are rated is below the speed rating of your vehicle, you must place a notice to this effect where it will be seen by the driver. Such no-

tices are available at your tire dealer or any authorized Mercedes-Benz Light Truck Center.

Warning!



If you use your spare tire when winter tires are fitted on the other wheels, be aware that the difference in tire characteristics may very well impair turning stability and that overall driving stability may be reduced. Adapt your driving style accordingly.

Have the spare tire replaced with a winter tire at the nearest authorized Mercedes-Benz Light Truck Center.

Block heater (Canada only)

The engine is equipped with a block heater.

The electrical cable may be installed at your authorized Mercedes-Benz Center.

Snow chains

Snow chains should only be driven on snow-covered roads at speeds not to exceed 30 mph (50 km/h). Remove chains as soon as possible when driving on roads without snow.



When driving with snow chains, you may wish to deactivate the ESP (▷ page 79) before setting the vehicle in motion. This will improve the vehicle's traction.

Observe the following guidelines when using snow chains:

- Use of snow chains is not permissible on all wheel/tire combinations.
- Snow chains should only be used on all four wheels. With only two chains available, they should be mounted on the rear wheels. Follow the manufacturer's mounting instructions.
- Only use snow chains that are approved by Mercedes-Benz. Your authorized Mercedes-Benz Light Truck Center will be glad to advise you on this subject.
- Use of snow chains may be prohibited depending on location. Always check local and state laws before installing snow chains.

Operation

Maintenance

▼ Maintenance

We strongly recommend that you have your vehicle serviced by your authorized Mercedes-Benz Light Truck Center, in accordance with the Service Booklet at the times called for by the FSS (Flexible Service System).

Failure to have the vehicle maintained in accordance with the Service Booklet at the designated times /mileage called for by the FSS may result in vehicle damage not covered by the Mercedes-Benz Limited Warranty.



FSS will notify you when your next service is due.

Approximately one month before your next service is due, one of the following messages will appear in the multifunction display while you are driving or when you switch on the ignition (example service A):

SERVICE A IN XX DAYS
SERVICE A IN XX MILES (KM)
SERVICE A DUE NOW!



The type of service due is indicated in the speedometer display field:

-  Minor service (A)
-  Major service (B)



The interval between services depends on your driving habits. A gentle driving style, moderate engine speeds and the avoidance of short-distance trips will lengthen the interval between services.

Clearing the service indicator

The service indicator is automatically cleared

- after 10 seconds when you switch on the ignition or when reaching the service threshold while driving
- after 30 seconds, once the suggested service term has passed

You can also clear it yourself.

- ▶ Press the reset button on the instrument cluster (▷ page 25).

Service term exceeded



If you have exceeded the suggested service term, you will see the following message in the multifunction display:

SERVICE A EXCEEDED BY XX DAYS
SERVICE A EXCEEDED BY XX MILES (KM)

An acoustic signal will sound.

The Mercedes-Benz Light Truck Center will reset the service indicator following a completed service.

Calling up the service indicator

- ▶ Switch ignition on.
The standard display of the control system appears (▷ page 115).
- ▶ Press button  or  on the multifunction steering wheel until the FSS indicator appears in the multifunction display.





If the vehicle battery is disconnected, the days of disconnection will not be included in the count shown by the service indicator. To arrive at the true service deadline, you will need to subtract these days from the days shown in the service indicator.

Do not confuse the service indicator with the engine oil level indicator .

Resetting the service indicator

In the event that the service on your vehicle is not carried out by an authorized Mercedes-Benz Light Truck Center, you can reset the service indicator yourself.

- ▶ Switch ignition on.
The standard display of the control system appears (▷ page 115).
- ▶ Press button  or  on the multifunction steering wheel until the FSS indicator appears in the multifunction display.
- ▶ Press the reset button (▷ page 25) for about three seconds.

This message appears in the tachometer:

SERVICE INTERVAL?
RESET WITH R BUTTON FOR 3 SEC.

- ▶ To confirm, press reset button until you hear a signal.

The service indicator now displays the reset interval.



If the service indicator was inadvertently reset, have a Mercedes-Benz Light Truck Center correct it.

Only reset if the proper service has been performed. Resetting the system without performing proper service as called for by the FSS will cause the FSS to incorrectly determine the next service interval which will result in engine damage not covered by the Mercedes-Benz Limited Warranty.

Operation

Vehicle care

▼ Vehicle care

Cleaning and care of the vehicle

Warning!



Many cleaning products can be hazardous. Some are poisonous, others are flammable. Always follow the instructions on the particular container. Always open your vehicle's doors or windows when cleaning the inside. Never use fluids or solvents that are not designed for cleaning your vehicle.

While in operation, even while parked, your vehicle is subjected to varying external influences which, if gone unchecked, can attack the paintwork as well as the underbody and cause lasting damage.

Such damage is caused not only by extreme and varying climatic conditions, but also by:

- Air pollution
- Road salt
- Tar
- Gravel and stone chipping

To avoid paint damage, you should immediately remove:

- Grease and oil
- Fuel
- Coolant
- Brake fluid
- Bird droppings
- Insects
- Tree resins, etc.

Frequent washing reduces and/or eliminates the aggressiveness and potency of the above adverse influences.

More frequent washings are necessary to deal with unfavorable conditions:

- Near the ocean
- In industrial areas (smoke, exhaust emissions)
- During winter operation

You should check your vehicle from time to time for stone chipping or other damage. Any damage should be repaired as soon as possible to prevent corrosion.

In doing so, do not neglect the underbody of the vehicle. A prerequisite for a thorough check is a washing of the underbody followed by a thorough inspection. Damaged areas need to be re-undercoated.

Your vehicle has been treated at the factory with a wax-base rustproofing in the body cavities which will last for the lifetime of the vehicle. Post-production treatment is neither necessary nor recommended by Mercedes-Benz because of the possibility of incompatibility between materials used in the production process and others applied later.

We have selected car-care products and compiled recommendations which are specially matched to our vehicles and which always reflect the latest technology. You can obtain Mercedes-Benz approved car-care products at your authorized Mercedes-Benz Light Truck Center.

Scratches, corrosive deposits, corrosion or damage due to negligent or incorrect care cannot always be removed or repaired with the car-care products recommended here. In such cases it is best to seek aid at your authorized Mercedes-Benz Light Truck Center.

The following topics deal with the cleaning and care of your vehicle and give important “how-to” information as well as references to Mercedes-Benz approved car-care products.

Additional information can be found in the booklet “Vehicle Care Guide”.

Power-washer

When using a power-washer for cleaning the vehicle, always observe manufacturer’s operating instructions.



Never use a round nozzle to power-wash tires. The intense jet of water can result in damage to the tire.

Always replace a damaged tire.

Always keep the jet of water moving across the surface. Do not aim directly at electrical parts, electrical connectors, sensors, seals, or other rubber parts.

Tar stains

Quickly remove tar stains before they dry and become more difficult to remove. A tar remover is recommended.

Paintwork, painted body components

Mercedes-Benz approved Paint Care should be applied when water drops on the paint surface do not “bead up”, normally every three to five months, depending on climate and washing detergent used.

Mercedes-Benz approved Paint Cleaner should be applied if the paint surface shows signs of dirt embedding (i.e. loss of gloss).

Do not apply any of these products or wax if your vehicle is parked in the sun or if the hood is still hot.

- ▶ Use the appropriate MB-Touch-Up Stick for quick and provisional repairs of minor paint damage (i.e. chips from stones, vehicle doors, etc.).

Operation

Vehicle care

Engine cleaning

Prior to cleaning the engine compartment, make sure to protect electrical components and connectors from the intrusion of water and cleaning agents.

Corrosion protection, such as MB Anticorrosion Wax should be applied to the engine compartment after every engine cleaning. Before applying, all control linkage bushings and joints should be lubricated. The poly-V-belt and all pulleys should be protected from any wax.

Vehicle washing

Do not use hot water or wash your vehicle in direct sunlight. Use only a mild car wash detergent, such as Mercedes-Benz approved Car Shampoo.

Thoroughly spray the vehicle with a diffused jet of water. Direct only a very weak spray towards the ventilation intake. Use plenty of water and rinse the sponge and chamois frequently.

Rinse with clear water and thoroughly dry with a chamois. Do not allow cleaning agents to dry on the finish.

Due to the width of the vehicle, fold in exterior rear view mirrors prior to running the vehicle through an automatic car wash to prevent damage to the mirrors.

In the winter, thoroughly remove all traces of road salt as soon as possible.

When washing the underbody, do not forget to clean the inner sides of the wheels.

Ornamental moldings

For regular cleaning and care of very dirty chrome-plated parts, use a chrome cleaner.

Headlamps, tail lamps, side marker, turn signal lenses

- ▶ Use a mild car wash detergent, such as Mercedes-Benz approved Car Shampoo, with plenty of water.

To prevent scratches, never apply strong force and use only a soft, non-scratchy cloth when cleaning the lenses. Do not attempt to wipe dirty lenses with a dry cloth or sponge.

Cleaning the Rear Parking Assist sensors*

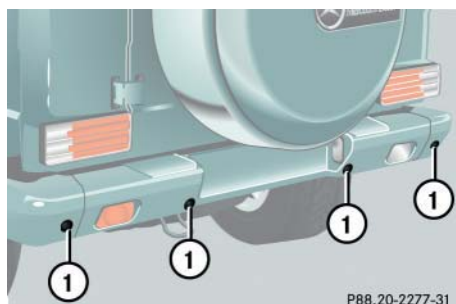

① Sensor

- ▶ Use a mild car wash detergent, such as Mercedes-Benz approved Car Shampoo, with plenty of water to clean sensor ①.

To prevent scratches, never apply strong force and use only a soft, non-scratchy cloth when cleaning the sensor. Do not attempt to wipe dirty sensors with a dry cloth or sponge.

Wiper blades

- ▶ Fold wiper arms forward.

Warning!



For safety reasons, switch off wipers and remove SmartKey from starter switch before cleaning the wiper blades, otherwise the wiper motor can suddenly turn on and cause injury.

- ▶ Clean the wiper blade inserts with a clean cloth and detergent solution.



Fold the windshield wiper arms back onto the windshield before turning the SmartKey in the starter switch.

Hold on to the wiper when folding the wiper arm back. If released, the force of the impact from the tensioning spring could crack the windshield.

Window cleaning

- ▶ Fold wiper arms forward.

Warning!



For safety reasons, switch off wipers and remove SmartKey from starter switch before cleaning the windshield, otherwise the wiper motor can suddenly turn on and cause injury.

- ▶ Use a window cleaning solution on all glass surfaces.

An automotive glass cleaner is recommended.



Fold the windshield wiper arms back onto the windshield before turning the SmartKey in the starter switch.

Hold on to the wiper when folding the wiper arm back. If released, the force of the impact from the tensioning spring could crack the windshield.

Operation

Vehicle care

Light alloy wheels

Mercedes-Benz approved Wheel Care should be used for regular cleaning of the light alloy wheels.

If possible, clean wheels once a week with Mercedes-Benz approved Wheel Care, using a soft bristle brush and a strong spray of water.

Follow instructions on container.



Only use acid-free cleaning materials. The acid could lead to corrosion or may damage the clear coat.

Instrument cluster

Use a gentle dishwashing detergent or mild detergent for delicate fabrics as a washing solution. Wipe with a cloth moistened in lukewarm solution. Do not use scouring agents.

Steering wheel and gear selector lever

Wipe with a damp cloth and dry thoroughly or clean with Mercedes-Benz approved Leather Care.

Cup holder

Use a gentle dishwashing detergent or mild detergent for delicate fabrics as a washing solution. Wipe with a cloth moistened in lukewarm solution. Do not use scouring agents.

Hard plastic trim items

Pour Mercedes-Benz approved Interior Care onto soft lint-free cloth and apply with light pressure.

Headliner

Clean with soft bristle brush, or use a dry-shampoo cleaner in case of excessive dirt.

Seat belts

The webbing must not be treated with chemical cleaning agents. Use only clear, lukewarm water and soap. Do not dry the webbing at temperatures above 176°F (80°C) or in direct sunlight.

Warning!



Do not bleach or dye seat belts as this may severely weaken them. In a crash they may not be able to provide adequate protection.

Upholstery

Using aftermarket seat covers or wearing clothing that have the tendency to give off coloring (e.g. when wet, etc.) may cause the upholstery to become permanently discolored. By lining the seats with a proper intermediate cover, contact-discoloration will be prevented.

Leather upholstery

Wipe leather upholstery with a damp cloth and dry thoroughly or clean with Mercedes-Benz approved Leather Care. Exercise particular care when cleaning perforated leather as its underside should not become wet.

Cloth upholstery

Clean with soft bristle brush, or use a dry-shampoo cleaner in case of excessive dirt.

MB Tex upholstery

Pour Mercedes-Benz approved Interior Care onto soft lint-free cloth and apply with light pressure.

Plastic and rubber parts

Do not use oil or wax on these parts.

Illuminated door sill panels

Use a gentle dishwashing detergent or mild detergent for delicate fabrics as a washing solution. Wipe with a cloth moistened in lukewarm solution. Do not use scouring agents.

Wood trims

Dampen cloth using water and use damp cloth to clean wood trims in your vehicle. Do not use solvents like tar remover or wheel cleaner nor polishes or waxes as these may be abrasive.





Practical hints

What to do if ...

Where will I find ...?

Unlocking/locking in an emergency

Opening/closing in an emergency

Brush guard*

Replacing bulbs

Replacing wiper blades

Flat tire

Battery

Jump starting

Towing the vehicle

Fuses

Practical hints

What to do if ...

▼ What to do if ...

Lamps in instrument cluster

General information:

If a bulb in the instrument cluster fails to come on during the bulb self-check when

turning the SmartKey in starter switch to position **2**, have it checked and replaced if necessary.

Problem	Possible cause	Suggested solution
 The yellow ABS indicator lamp comes on while driving.	<p>You engaged the differential locks. The ABS, ESP, BAS, EBB and 4-ETS are switched off.</p> <p>The ABS has detected a malfunction and has switched off. The ESP, BAS, EBB and 4-ETS are also switched off (see messages in display).</p> <p>If the ABS control unit is malfunctioning, other systems such as the navigation system or Rear Parking Assist* may also malfunction.</p> <p>The brake system is still functioning normally but without the ABS available.</p>	<ul style="list-style-type: none"> ▶ The driving systems will switch on again after the differential locks have been disengaged. ▶ Continue driving with added caution. Wheels will lock during hard braking reducing steering capability. ▶ Have the system checked at an authorized Mercedes-Benz Light Truck Center as soon as possible. <p>Failure to follow these instructions increases the risk of an accident.</p>

Practical hints

What to do if ...

Problem	Possible cause	Suggested solution
 The yellow ABS indicator lamp comes on while driving.	The ABS has switched off because charging voltage has fallen below 10 volts. The battery may not be charged.	<ul style="list-style-type: none">▶ Turn off unnecessary electric consumers. When the battery voltage is above this value again, the ABS is operational again.▶ Note the messages in the multifunction display (▷ page 260).

Practical hints

What to do if ...

Problem	Possible cause	Suggested solution
BRAKE (USA only)  (Canada only) The red brake warning lamp comes on while driving and you hear a warning sound. The red brake warning lamp comes on while driving.	You are driving with the parking brake set. There is insufficient brake fluid in the reservoir.	<ul style="list-style-type: none"> ▶ Release the parking brake (▷ page 44). ▶ Also note the messages in the multi-function display (▷ page 260). ▶ Risk of accident! Carefully stop the vehicle and notify an authorized Mercedes-Benz Light Truck Center. Do not add brake fluid! This will not solve the problem. ▶ Also note the messages in the multi-function display (▷ page 260).

Warning!



Driving with the brake warning lamp illuminated can result in an accident. Have your brake system checked immediately if the brake warning lamp stays on.



Do not add brake fluid before checking the brake system. Overfilling the brake fluid reservoir can result in spilling brake fluid on hot engine parts and the brake fluid catching fire. You could be seriously burned.



If you find that the brake fluid in the brake fluid reservoir has fallen to the minimum mark or below, have the brake system checked for brake pad thickness and leaks.

Practical hints

What to do if ...

Problem	Possible cause	Suggested solution
 (USA only)  (Canada only)  The red brake warning lamp and the yellow ABS indicator lamp come on when the engine is running and you hear a warning sound for approximately five seconds.	The EBB has detected a malfunction and has switched off. You should be prepared for your vehicle to perform differently than normal when braking.	<ul style="list-style-type: none">▶ Continue driving with added caution.▶ Have the system checked at an authorized Mercedes-Benz Light Truck Center as soon as possible.▶ Also note the messages in the multi-function display (▷ page 260). Failure to follow these instructions increases the risk of accidents.

Practical hints

What to do if ...

Problem	Possible cause	Suggested solution
CHECK ENGINE The yellow "CHECK ENGINE" malfunction indicator lamp comes on while driving.	There is a malfunction of: <ul style="list-style-type: none"> • The fuel management system • The ignition system • The emission control system • Systems which impact emissions Such malfunctions may result in excessive emissions values and may switch the engine to its limp-home (emergency operation) mode. Serious damage can occur to the emission system.	► Have the vehicle checked as soon as possible by an authorized Mercedes-Benz Light Truck Center. An on-board diagnostic connector is used by the service station to link the vehicle to the shop diagnostics system. It allows the accurate identification of system malfunctions through the readout of diagnostic trouble codes. It is located near the hood lock release on the upper left of footwell.
	The fuel cap is not closed tightly.	► Check the fuel cap.
	Your gas tank is empty.	► After refuelling, start the engine three or four times in succession. The limp-home mode is canceled.



Practical hints

What to do if ...

Problem	Possible cause	Suggested solution
 The yellow ESP warning lamp comes on and remains on while driving.	You engaged the differential locks. The ABS, ESP, BAS, EBB and 4-ETS are switched off.	<ul style="list-style-type: none"> ▶ The driving systems will switch on again after the differential locks have been disengaged. ▶ Also note the messages in the multi-function display (▷ page 260).
	The ESP is deactivated. Risk of accident! Adapt your speed and driving to the prevailing road conditions.	<ul style="list-style-type: none"> ▶ Turn the ESP back on (▷ page 81). If the ESP cannot be turned back on, have the system checked at an authorized Mercedes-Benz Light Truck Center as soon as possible.
	The ESP is deactivated because of interrupted power supply. The ABS may still be operational. The ESP has to be synchronized.	<ul style="list-style-type: none"> ▶ Note the messages in the multifunction display (▷ page 260).
	The ESP, ABS, BAS, EBB or 4-ETS has detected a malfunction. All driving systems are switched off. Risk of accident! Adapt your speed and driving to the prevailing road conditions.	<ul style="list-style-type: none"> ▶ Note the messages in the multifunction display (▷ page 260).

Practical hints

What to do if ...

Problem	Possible cause	Suggested solution
 The red seat belt non-usage warning lamp illuminates briefly after starting the engine.	The warning lamp reminds you to fasten seat belts.	▶ Fasten your seat belt.
The yellow fuel tank reserve warning lamp illuminates while driving.	The fuel level has gone below the reserve mark.	▶ Refuel at the next gas station. ▶ Also note the messages in the multi-function display (▷ page 260).
The yellow fuel tank reserve warning lamp is blinking.	The fuel cap is not closed tight.	▶ Check the fuel cap.
 The red SRS indicator lamp comes on while driving.	There is a malfunction in the restraint systems. The airbags or emergency tensioning device (ETD) could deploy unexpectedly or fail to activate in an accident.	▶ Drive with added caution to the nearest authorized Mercedes-Benz Light Truck Center.

Warning!





In the event a malfunction of the SRS is indicated as outlined above, the SRS may not be operational.

For your safety, we strongly recommend that you visit an authorized Mercedes-Benz Light Truck Center immediately to have the system checked; otherwise the SRS may not be activated when needed in an accident.

This could result in serious or fatal injury, or it might deploy unexpectedly and unnecessarily which could also result in an accident and/or injury to you or to others.

Lamp in center console

Problem	Possible cause	Suggested solution
<p> The indicator lamp comes on.</p>	<p>A BabySmart™ child seat is installed on the front passenger seat. Therefore the passenger front airbag is switched off.</p> <p>The system is malfunctioning when there is no BabySmart™ child seat installed on the front passenger seat.</p>	<p>► Have the system checked as soon as possible by an authorized Mercedes-Benz Light Truck Center.</p>
<p> The indicator lamp does not come on with a BabySmart™¹ child seat properly installed on the front passenger seat.</p>	<p>The system is malfunctioning.</p>	<p>► Make sure there is nothing between seat cushion and child seat and check installation of the child seat.</p> <p>► If the light remains out, have the system checked as soon as possible by an authorized Mercedes-Benz Light Truck Center.</p> <p>Do not use the BabySmart™ restraint to transport children on the front passenger seat until the system has been repaired.</p>

¹ BabySmart™ is a trademark of Siemens Automotive Corp.

Practical hints

What to do if ...

Messages in the multifunction display

The control system shows warning and malfunction messages in the multifunction display.

Certain warning and malfunction messages are accompanied by an audible signal.

Address these messages accordingly and follow the additional instructions given in this Operator's Manual.

Selecting the malfunction memory menu in the control system (▷ page 122) displays both cleared and uncleared messages.

High-priority messages appear in the multifunction display in red colour.

Certain messages of high priority cannot be cleared from the multifunction display using the reset button (▷ page 112).

Other high-priority messages and messages of less immediate priority (regular display colours) can be cleared from the multifunction display using the reset button and are then stored in the malfunction message memory (▷ page 122).

Warning!



All categories of messages contain important information which should be taken note of and, where a malfunction is indicated, addressed as soon as possible at an authorized Mercedes-Benz Light Truck Center.

Failure to repair condition noted may cause damage not covered by the Mercedes-Benz Limited Warranty, or result in property damage or personal injury.

Warning!



No messages will be displayed if either the instrument cluster or the multifunction display is inoperative. Systems that have a significant influence on handling performance may not be functioning.

Contact your nearest authorized Mercedes-Benz Light Truck Center.



Turning the SmartKey in starter switch to position **2** causes all lamps as well as the multifunction display to come on. Make sure they are all in working order before starting your journey.

On the pages that follow, you will find a compilation of the most important warning and malfunction messages that may appear in the multifunction display. High-priority messages appear on a red background.

Text messages

Display symbol	Display message	Possible cause	Possible solution
ABS	ABS SYSTEM VISIT WORKSHOP!	The ABS has detected a malfunction and has switched off. The ESP, BAS, EBB and 4-ETS are also deactivated. The brake system is still functioning normally but without the ABS available. Wheels will lock during hard braking, reducing steering capability.	<ul style="list-style-type: none"> ▶ Continue driving with added caution. ▶ Have the system checked at an authorized Mercedes-Benz Light Truck Center as soon as possible. <p>Failure to follow these instructions increases the risk of accident.</p>
	VISIT WORKSHOP! DISPLAY MALFUNCTION:	The ABS or the ABS display is malfunctioning. Wheels will lock in hard braking reducing steering capability.	<ul style="list-style-type: none"> ▶ Continue driving with added caution. ▶ Have the system checked at an authorized Mercedes-Benz Light Truck Center as soon as possible. <p>Failure to follow these instructions increases the risk of accident.</p>
BAS	BRAKE ASSIST VISIT WORKSHOP!	The BAS has detected a malfunction and switched off. The brake system is still functioning normally but without the BAS available. Wheels will lock in hard braking reducing steering capability.	<ul style="list-style-type: none"> ▶ Continue driving with added caution. ▶ Have the system checked at an authorized Mercedes-Benz Light Truck Center as soon as possible. <p>Failure to follow these instructions increases the risk of accident.</p>

Practical hints

What to do if ...

Display	Display message	Possible cause	Possible solution
BAS	VISIT WORKSHOP! DISPLAY MALFUNCTION:	The BAS or the BAS display is malfunctioning.	<ul style="list-style-type: none"> ▶ Continue driving with added caution. ▶ Have the system checked at an authorized Mercedes-Benz Light Truck Center as soon as possible. <p>Failure to follow these instructions increases the risk of accident.</p>
DIFFERENTIAL LOCK	ABS NOT AVAILABLE DIFFERENTIAL LOCKED	You have engaged the differential locks.	<ul style="list-style-type: none"> ▶ The ABS switches on again after the differential locks have been disengaged.
ESP	VISIT WORKSHOP! DISPLAY MALFUNCTION:	The ESP or the ESP display is malfunctioning.	<ul style="list-style-type: none"> ▶ Continue driving with added caution. ▶ Have the system checked at an authorized Mercedes-Benz Light Truck Center as soon as possible. <p>Failure to follow these instructions increases the risk of accident.</p>
	ESP NOT AVAILABLE	The ESP is temporarily unavailable. The self-diagnosis has not been completed.	The display will clear itself after driving a short-distance at more than approximately 12 mph (20 km/h).

Practical hints

What to do if ...

Display	Display message	Possible cause	Possible solution
ESP	ESP NOT AVAILABLE	The charging voltage has fallen below 10 volts and the ESP has switched off.	<ul style="list-style-type: none"> ▶ When the voltage is above this value again, the ESP is operational again. ▶ If necessary, have the generator (alternator) and battery checked.
		<p>The ESP is deactivated because of a malfunction or interrupted power supply. The ABS and BAS might not be operational. The system must be resynchronized.</p>	<ul style="list-style-type: none"> ▶ Synchronize the ESP. With vehicle stationary and the engine running, turn the steering wheel completely to the left and then to the right to synchronize the ESP. <p>If the ESP message does not go out:</p> <ul style="list-style-type: none"> ▶ Continue driving with added caution. ▶ Visit an authorized Mercedes-Benz Light Truck Center as soon as possible. <p>Failure to follow these instructions increases the risk of accident.</p>



When synchronizing the ESP, make sure you can turn the steering wheel in

both directions as far as it will go without the wheels hitting any objects, e.g. a road curb.

Practical hints

What to do if ...



Display	Display message	Possible cause	Possible solution
ESP	ESP VISIT WORKSHOP!	<p>The ESP is switched off due to a malfunction or an interruption in the power supply.</p> <p>The brake system is still functioning normally but without ESP, ABS and BAS available.</p> <p>If in addition the ABS is malfunctioning, only partial engine output will be available.</p>	<ul style="list-style-type: none">▶ Continue driving with added caution.▶ Have the system checked at an authorized Mercedes-Benz Light Truck Center as soon as possible. <p>Failure to follow these instructions increases the risk of accident.</p>

Symbol messages

Display symbol	Display message	Possible cause	Possible solution
	BATTERY/ALTERNATOR VISIT WORKSHOP!	The battery was charged with a battery charger or jump started.	▶ Have the battery checked at a service station.
		The battery is no longer charging. Possible causes: <ul style="list-style-type: none"> • alternator malfunctioning • broken poly-V-belt 	▶ Stop immediately and check the poly-V-belt. If it is broken: <ul style="list-style-type: none"> ▶ Do not continue to drive. Otherwise the engine will overheat due to an inoperative water pump which may result in serious engine damage not covered by the Mercedes-Benz Limited Warranty. Notify an authorized Mercedes-Benz Light Truck Center. If it is intact: <ul style="list-style-type: none"> ▶ Turn off unnecessary electric consumers. ▶ Drive immediately to the nearest authorized Mercedes-Benz Light Truck Center.
	UNDERVOLTAGE ENGINE ON!	The battery has insufficient voltage.	▶ Start the engine.

Practical hints

What to do if ...

Display symbol	Display message	Possible cause	Possible solution
	UNDERVOLTAGE SWITCH CONSUMERS OFF!	The battery has insufficient voltage.	▶ Have the battery checked at a service station.
	BRAKE WEAR VISIT WORKSHOP!	The brake pads have reached their wear limit.	▶ Have the brake pads replaced as soon as possible.
	BRAKE FLUID VISIT WORKSHOP!	There is insufficient brake fluid in the reservoir.	▶ Risk of accident! Stop the vehicle and notify an authorized Mercedes-Benz Light Truck Center. Do not add brake fluid! This will not solve the problem.

Warning!



Driving with the last message displayed can result in an accident. Have your brake system checked immediately.

Do not add brake fluid before checking the brake system. Overfilling the brake fluid reservoir can result in spilling brake fluid on hot engine parts and the brake fluid catching fire. You can be seriously burned.





If you find that the brake fluid in the brake fluid reservoir has fallen to the minimum mark or below, have the brake system checked for brake pad thickness and leaks.



Brake pad thickness must be visually checked by a qualified technician at the intervals specified in the Service booklet.

Practical hints

What to do if ...

Display symbol	Display message	Possible cause	Possible solution
	ELEC. BRAKE BOOST. VISIT WORKSHOP!	<p>The EBB has detected a malfunction and has switched off.</p> <p>The brake system is still functioning normally but without the EBB available.</p>	<ul style="list-style-type: none"> ▶ Continue driving with added caution. ▶ Have the system checked at an authorized Mercedes-Benz Light Truck Center as soon as possible. <p>Failure to follow these instructions increases the risk of accident.</p>
<p> (USA only)</p> <p> (Canada only)</p>	PARK. BRAKE RELEASE BRAKE!	You are driving with the parking brake set.	▶ Release the parking brake (▷ page 44).

Practical hints

What to do if ...

Display symbol	Display message	Possible cause	Possible solution
	COOLANT CHECK LEVEL!	The coolant level is too low.	<ul style="list-style-type: none">▶ Add coolant (▷ page 232).▶ If you have to add coolant frequently, have the cooling system checked by an authorized Mercedes-Benz Light Truck Center.

Warning!



Do not spill antifreeze on hot engine parts. Antifreeze contains ethylene glycol which may burn if it comes into contact with hot engine parts. You could be seriously burned.



Do not ignore the low engine coolant level warning. Extended driving with the message and symbol displayed may cause serious engine damage not covered by the Mercedes-Benz Limited Warranty.

Do not drive without sufficient amount of coolant in the cooling system. The engine will overheat causing serious engine damage.

Observe the coolant temperature display (▷ page 112).

Practical hints

What to do if ...

Display symbol	Display message	Possible cause	Possible solution
	COOLANT STOP, ENGINE OFF!	The coolant is too hot.	<ul style="list-style-type: none">▶ Stop the vehicle and turn off the engine.▶ Only start the engine again after the message disappears. You could otherwise damage the engine.

Warning!



Driving when your engine is badly overheated can cause some fluids which may have leaked into the engine compartment to catch fire. You could be seriously burned.

Steam from an overheated engine can cause serious burns and can occur just by opening the hood. Stay away from the engine if you see or hear steam coming from it.

Turn off the engine, get out of the vehicle and do not stand near the vehicle until the engine has cooled down.

During severe operating conditions and stop-and-go city traffic, the coolant temperature may rise close to 248°F (120°C).



The engine should not be operated with the coolant temperature above 248°F (120°C). Doing so may cause serious engine damage which is not covered by the Mercedes-Benz Limited Warranty.





Practical hints

What to do if ...

Display symbol	Display message	Possible cause	Possible solution
	COOLANT STOP, ENGINE OFF!	The poly-V-belt could be broken.	<ul style="list-style-type: none"> ▶ Stop immediately and check the poly-V-belt. <p>If it is broken:</p> <ul style="list-style-type: none"> ▶ Do not continue to drive. Otherwise the engine will overheat due to an in-operative water pump which may result in damage to the engine. Notify an authorized Mercedes-Benz Light Truck Center. <p>If it is in order:</p> <ul style="list-style-type: none"> ▶ Do not continue to drive the vehicle with this message displayed. Doing so could result in serious engine damage that is not covered by the Mercedes-Benz Limited Warranty.
	COOLANT VISIT WORKSHOP!	The cooling fan for the coolant is malfunctioning.	<ul style="list-style-type: none"> ▶ Observe the coolant temperature display (> page 112). ▶ Have the fan replaced as soon as possible.

Practical hints

What to do if ...

Display symbol	Display message	Possible cause	Possible solution
	CRUISE CONTROL DRIVE TO WORKSHOP!	Cruise control is malfunctioning.	▶ Visit an authorized Mercedes-Benz Light Truck Center.
	DOOR OPEN!	You are attempting to drive with one or more doors open.	▶ Close the doors.
	ENGINE AIR FILTER VISIT WORKSHOP!	The engine filter is clogged and must be replaced.	▶ Visit an authorized Mercedes-Benz Light Truck Center as soon as possible.
	USA only: ADD 1.0 Qt. ENGINE OIL WHEN NEXT REFUELING! Canada only: ADD 1.0 LITER ENG. OIL WHEN NEXT REFUELING!	The engine oil level is too low.	▶ Add engine oil (▷ page 231) and check the engine oil level (▷ page 229).

When the ADD 1.0 QT. ENG. OIL - WHEN NEXT REFUELLING! (Canada: 1.0 LITER) message appears while the engine is running and at operating temperature, the engine oil level has dropped to approximately the minimum level.

When this occurs, the warning will first come on intermittently and then stay on if the oil level drops further.

Visually check for oil leaks. If no obvious oil leaks are noted, drive to the nearest service station where the engine oil should be topped to the required level with an approved oil.



The engine oil level warnings should not be ignored. Extended driving with the symbol displayed could result in serious engine damage that is not covered by the Mercedes-Benz Limited Warranty.



Practical hints

What to do if ...

Display symbol	Display message	Possible cause	Possible solution
	ENGINE OIL LEVEL REDUCE OIL LEVEL!	You have added too much engine oil. There is a risk of damaging the engine or the catalytic converter.	▶ Have oil siphoned or drained off. Ob- serve all legal requirements with re- spect to its disposal.
	ENGINE OIL LEVEL STOP, ENGINE OFF!	There is no oil in the engine. There is a danger of engine damage.	▶ Carefully bring the vehicle to a halt as soon as possible. ▶ Turn off the engine. ▶ Add engine oil (▷ page 231) and check the engine oil level (▷ page 229).
	ENGINE OIL VISIT WORKSHOP!	It may be that there is water in the engine oil.	▶ Have the oil checked.
	ENGINE OIL LEVEL VISIT WORKSHOP!	The engine oil has dropped to a critical level.	▶ Check the engine oil level (▷ page 229) and add oil as required (▷ page 231). ▶ If you must add engine oil frequently, have the engine checked for possible leaks.
		The measuring system is malfunctioning.	▶ Have the measuring system checked by an authorized Mercedes-Benz Light Truck Center.

Practical hints

What to do if ...

Display symbol	Display message	Possible cause	Possible solution
	RESERVE FUEL GO TO GAS STATION	The fuel level has dropped below the reserve mark.	▶ Refuel at the next gas station (▷ page 224).
	CHECK GAS CAP SEE OPERATOR'S MANUAL	The fuel cap is not closed tightly.	▶ Check the fuel cap (▷ page 224).
	HOOD OPEN!	You are driving with the hood open.	▶ Close the hood (▷ page 228).
	REMOVE KEY!	You have forgotten to remove the SmartKey.	▶ Remove the SmartKey from the starter switch.
	REPLACE KEY DRIVE TO WORKSHOP!	No additional code available for SmartKey.	▶ Visit an authorized Mercedes-Benz Light Truck Center.

Practical hints

What to do if ...

Display symbol	Display message	Possible cause	Possible solution
	3RD BRAKE LIGHT CHECK LIGHT!	The high mounted brake lamp is malfunctioning. This message will only appear if all light emitting diodes have stopped working.	► Visit an authorized Mercedes-Benz Center as soon as possible.
	ADD. TURN SIG., L CHECK LIGHT!	The left turn signal in the exterior rear view mirror is malfunctioning. This message will only appear if all light emitting diodes have stopped working.	► Have the LEDs replaced as soon as possible.
	ADD. TURN SIG., R CHECK LIGHT!	The right turn signal in the exterior rear view mirror is malfunctioning. This message will only appear if all light emitting diodes have stopped working.	► Have the LEDs replaced as soon as possible.
	AUTOM. LIGHT ON REMOVE KEY!	You have left the SmartKey in the starter switch.	► Remove the SmartKey from the starter switch.
	BRAKE LIGHT DRIVE TO WORKSHOP!	Brake lamp illumination is delayed or lamp is permanently on.	► Visit an authorized Mercedes-Benz Light Truck Center as soon as possible.
	BRAKE LIGHT, L CHECK LIGHT!	The left brake lamp is malfunctioning.	► Visit an authorized Mercedes-Benz Center as soon as possible.

Practical hints

What to do if ...

Display symbol	Display message	Possible cause	Possible solution
	BRAKE LIGHT, R CHECK LIGHT!	The right brake lamp is malfunctioning.	► Visit an authorized Mercedes-Benz Center as soon as possible.
	FRONT FOGLIGHT, L CHECK LIGHT!	The left front fog lamp is malfunctioning.	► Replace the bulb as soon as possible.
	FRONT FOGLIGHT, R CHECK LIGHT!	The right front fog lamp is malfunctioning.	► Replace the bulb as soon as possible.
	FR. L. PARK. LAMP CHECK LIGHT! BACK-UP LIGHT ON!	The left parking lamps are malfunctioning. A backup bulb is being used.	► Replace the bulb as soon as possible.
	FR. R. PARK LAMP CHECK LIGHT! BACK-UP LIGHT ON!	The right parking lamps are malfunctioning. A backup bulb is being used.	► Replace the bulb as soon as possible.
	HIGH BEAM, L CHECK LIGHT!	The left high beam lamp is malfunctioning.	► Replace the bulb as soon as possible.
	HIGH BEAM, R CHECK LIGHT!	The right high beam lamp is malfunctioning.	► Replace the bulb as soon as possible.

Practical hints

What to do if ...

Display symbol	Display message	Possible cause	Possible solution
	LIGHT SENSOR DRIVE TO WORKSHOP!	The lamp sensor is malfunctioning. The headlamps switch on automatically.	<ul style="list-style-type: none"> ▶ In the control system, set lamp operation to manual (▷ page 129). ▶ Switch on headlamps using the exterior lamp switch (▷ page 104). ▶ Visit an authorized Mercedes-Benz Light Truck Center as soon as possible.
	LICENSE PLATE LIGHT, L CHECK LIGHT!	The left license plate lamp is malfunctioning.	▶ Replace the bulb as soon as possible.
	LICENSE PLATE LIGHT R CHECK LIGHT!	The right license plate lamp is malfunctioning.	▶ Replace the bulb as soon as possible.
	LIGHTS TURN OFF LIGHTS!	The display appears if the driver's door is opened with the engine shut off and no SmartKey in the starter switch.	<ul style="list-style-type: none"> ▶ Insert SmartKey in the starter switch. ▶ Switch off the lights (▷ page 104).
	LOW BEAM, L CHECK LIGHT!	The left low beam lamp is malfunctioning.	▶ Visit an authorized Mercedes-Benz Light Truck Center as soon as possible.
	LOW BEAM, R CHECK LIGHT!	The right low beam lamp is malfunctioning.	▶ Visit an authorized Mercedes-Benz Light Truck Center as soon as possible.

Practical hints

What to do if ...

Display symbol	Display message	Possible cause	Possible solution
	MARKER LIGHT, FL CHECK LIGHT!	The left front side marker lamp is malfunctioning.	► Replace the bulb as soon as possible.
	MARKER LIGHT, FR CHECK LIGHT!	The right front side marker lamp is malfunctioning.	► Replace the bulb as soon as possible.
	REAR FOGLIGHT CHECK LIGHT!	The rear fog lamp is malfunctioning.	► Replace the bulb as soon as possible.
	REAR FOGLIGHT TURN OFF BACK-UP LIGHT ON!	A lamp is malfunctioning. A backup bulb is being used.	► Turn the rear fog lamp off.
	REVERSE LIGHT, R CHECK LIGHT!	The right backup lamp is malfunctioning.	► Replace the bulb as soon as possible.
	TAIL LIGHT, L CHECK LIGHT! BACK-UP LIGHT ON!	The left tail lamp is malfunctioning. A backup bulb is being used.	► Replace the bulb as soon as possible.
	TAIL LIGHT, R CHECK LIGHT! BACK-UP LIGHT ON!	The right tail lamp is malfunctioning. A backup bulb is being used.	► Replace the bulb as soon as possible.
	TURN SIG., LF CHECK LIGHT! BACK-UP LIGHT ON!	The left front turn signal lamp is malfunctioning. A backup bulb is being used.	► Replace the bulb as soon as possible.

Practical hints

What to do if ...

Display symbol	Display message	Possible cause	Possible solution
	TURN SIG., RF CHECK LIGHT! BACK-UP LIGHT ON!	The right front turn signal lamp is malfunctioning. A backup bulb is being used.	► Replace the bulb as soon as possible.
	TURN SIG., LR CHECK LIGHT! BACK-UP LIGHT ON!	The left rear turn signal lamp is malfunctioning. A backup bulb is being used.	► Replace the bulb as soon as possible.
	TURN SIG., RR CHECK LIGHT! BACK-UP LIGHT ON!	The right rear turn signal lamp is malfunctioning. A backup bulb is being used.	► Replace the bulb as soon as possible.
	VISIT WORKSHOP! DISPLAY MALFUNCTION	The display for the lamps or the system is malfunctioning.	► Visit an authorized Mercedes-Benz Light Truck Center as soon as possible.
	TURN SIG. MIRROR, L CHECK LIGHT!	The left turn signal in the side mirror is malfunctioning. This message will only appear if all light emitting diodes have stopped working.	► Visit an authorized Mercedes-Benz Light Truck Center as soon as possible.
	TURN SIG. MIRROR, R CHECK LIGHT!	The right turn signal in the side mirror is malfunctioning. This message will only appear if all light emitting diodes have stopped working.	► Visit an authorized Mercedes-Benz Light Truck Center as soon as possible.

Practical hints

What to do if ...

Display symbol	Display message	Possible cause	Possible solution
SRS	RESTRAINT SYSTEM SERVICE	The system is malfunctioning. The airbags or emergency tensioning device (ETD) could deploy unexpectedly or fail to activate in an accident.	► Drive with added caution to the nearest authorized Mercedes-Benz Light Truck Center.
	RESTRAINT SYSTEM DRIVE TO WORKSHOP!	The system is malfunctioning. The airbags or emergency tensioning device (ETD) could deploy unexpectedly or fail to activate in an accident.	► Drive with added caution to the nearest authorized Mercedes-Benz Light Truck Center.

Warning!





In the event a malfunction of the SRS is indicated as outlined above, the SRS may not be operational.

For your safety, we strongly recommend that you visit an authorized Mercedes-Benz Light Truck Center immediately to have the system checked.

Otherwise the SRS may not be activated when needed in an accident, which could result in serious or fatal injury, or it might deploy unexpectedly and unnecessarily which could also result in injury.

Practical hints

What to do if ...

Display symbol	Display message	Possible cause	Possible solution
	SEAT BELT SYSTEM DRIVE TO WORKSHOP!	The seat belt system is malfunctioning.	▶ Visit an authorized Mercedes-Benz Light Truck Center as soon as possible.
	DRIVER'S SEAT BELT FASTEN SEAT BELT!	The display reminds you and your passengers to fasten seat belts.	▶ Fasten the seat belts.
	FR. PASS. SEAT BELT FASTEN SEAT BELT!	The display reminds you and your passengers to fasten seat belts.	▶ Fasten the seat belts.
	TC IN NEUTRAL	No gear has been selected in the transfer case, it is in NEUTRAL .	▶ Engage transfer case to gear position HIGH or LOW (> page 145).







Warning!



If the transfer case is in **NEUTRAL**, the **P** position of transmission will not hold vehicle. The parking brake must be applied to hold vehicle in place.





Practical hints

What to do if ...

Display symbol	Display message	Possible cause	Possible solution
	TC SHIFT CANCELLED	The shift process in the transfer case was canceled because of a malfunction.	▶ Repeat the shift process (▷ page 145).
	TC SHIFT CONDITIONS NOT FULFILLED	You have not met the shift conditions for a selection process in the transfer case.	▶ Repeat the shift process (▷ page 145).
	TRANSFER CASE VISIT WORKSHOP!	The transfer case is malfunctioning.	▶ Do not switch the transfer case on. ▶ Visit an authorized Mercedes-Benz Light Truck Center as soon as possible.
	CLOSE SUNROOF!	You have opened the driver's door with the SmartKey removed from the starter switch and the sliding/pop-up roof open.	▶ Close the sliding/pop-up roof (▷ page 166).
	CLOSE SUNROOF!	You have opened the driver's door with the SmartKey removed from the starter switch and the sliding/pop-up roof open.	▶ Close the sliding/pop-up roof (▷ page 166).
	TELE AID DRIVE TO WORKSHOP!	One or more main functions of the Tele Aid system are malfunctioning.	▶ Have the Tele Aid system checked by an authorized Mercedes-Benz Light Truck Center.
	FUNCTION NOT AVAILABLE!	This display appears if button  or  on the multifunction steering wheel is pressed and the vehicle is not equipped with a telephone.	

Practical hints

What to do if ...

Display		Possible cause	Possible solution
	TRUNK OPEN!	This message will appear whenever the tailgate is open.	▶ Close the tailgate.
	VISIT WORKSHOP! DISPLAY MALFUNCTION:	The instrument cluster display is malfunctioning. Some systems themselves may also have failed.	▶ Continue driving with added caution. ▶ Visit an authorized Mercedes-Benz Light Truck Center as soon as possible.
	VISIT WORKSHOP! DISPLAY MALFUNCTION:	Certain electronic systems are unable to relay information to the control system. The following systems may have failed: <ul style="list-style-type: none"> • Coolant temperature display • Tachometer • Cruise control display 	▶ Have the electronic systems checked by an authorized Mercedes-Benz Light Truck Center.
	WASHER FLUID CHECK LEVEL!	The fluid level has dropped to about $\frac{1}{3}$ of total reservoir capacity.	▶ Add washer fluid (▷ page 339).

Practical hints

Where will I find ...?

▼ Where will I find ...?

First aid kit

The first aid kit is stored in the storage pocket in the front passenger door.



① First aid kit



Check expiration dates and contents for completeness at least once a year and replace missing/expired items.

Vehicle tool kit

The vehicle tool kit is stored under a cover in the rear footwell.

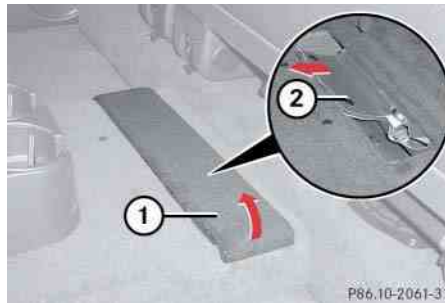

① Cover

② Tab

- ▶ Fold cover ① to the side.
- ▶ Pull vehicle tool kit out using tab ②.

The following is included:

- Vehicle tool kit
- Wheel wrench
- Vehicle jack

Practical hints

Where will I find ...?

Vehicle jack

The vehicle jack is under the rear bench seat.



- ① Cover
- ② Tab
- ③ Vehicle jack

- ▶ Fold the rear bench seat forward (▷ page 177).
- ▶ Open cover ①.
- ▶ Open tab ② and remove vehicle jack ③.

Warning!



The jack is designed exclusively for jacking up the vehicle under the axle housing. To help avoid personal injury, use the jack only to lift the vehicle during a wheel change. Never get beneath the vehicle while it is supported by the jack. Keep hands and feet away from the area under the lifted vehicle. Always firmly set parking brake and block wheels before raising vehicle with jack.

Do not disengage parking brake while the vehicle is raised. Be certain that the jack is always vertical (plumb line) when in use, especially on hills. Always try to use the jack on level surface. Make sure the jack is positioned correctly under the axle housing. Always lower the vehicle onto sufficient capacity jackstands before working under the vehicle.

Please also observe the safety guidelines in the “Flat tire” section (▷ page 306) when using the jack.

CD changer

The CD changer is located on the left side of the cargo compartment.



CD changer



For CD changer instructions, see separate COMAND operator's manual.

Spare wheel

The spare wheel is located under a cover on the outside of the vehicle's tailgate. For information on rim and tire specifications, see (▷ page 329) and (▷ page 330).

Removing cover

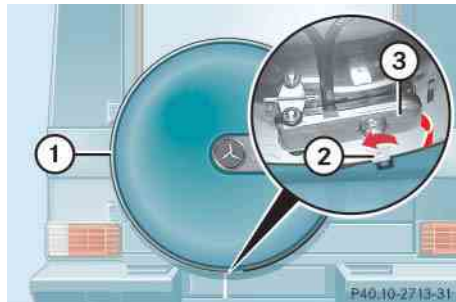

- ① Cover ring
- ② Key
- ③ Tab

- ▶ Open lock for cover ring ① with key ② for the spare wheel cover.
- ▶ Fold tab ③ downwards.

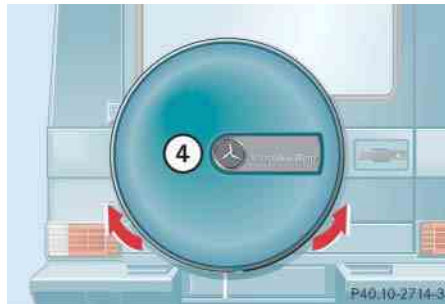

- ④ Cover plate
- ▶ Pull cover ring ① slightly outwards in direction of arrows and remove.
- ▶ Pull cover plate ④ upward towards you.

Practical hints

Where will I find ...?

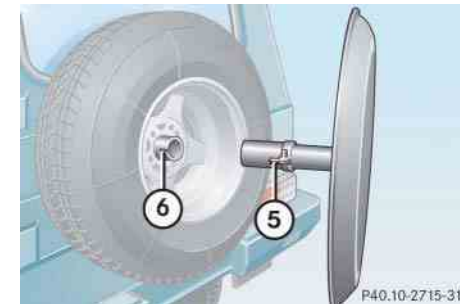

- ⑤ Catch
- ⑥ Recess

1

When replacing cover plate ④, make sure catch ⑤ engages in recess ⑥.

Make sure the lock faces downwards when mounting cover ring ①.

For safety reasons, check regularly that the spare wheel is securely fastened.

Practical hints

Where will I find ...?

Removing the spare wheel



① Mounting screws

- ▶ Unscrew mounting screws ①.
- ▶ Remove the spare wheel.

Warning!



Make sure no one is injured when removing the spare wheel.

Grip wheel from the sides.
Keep hands from beneath the wheel.

i

After changing the wheel, secure the replaced wheel on the spare wheel carrier. Make sure the wheel cannot come loose.

Cover the wheel with the cover plate.

Repair or replace damaged tire as soon as possible and return spare tire as original spare.

For more information on changing the wheel, see “Flat tire” (> page 306).

Unlocking/locking in an emergency

▼ **Unlocking/locking in an emergency**

Unlocking the vehicle

If you are unable to unlock the vehicle with the SmartKey, open the driver's door and the tailgate using the mechanical key.

The passenger door cannot be unlocked manually.



Unlocking your vehicle with the mechanical key will trigger the anti-theft alarm system. To cancel the alarm, do one of the following:

- Press button or on the SmartKey.
- Insert the SmartKey in the starter switch.



- ① Mechanical key locking tab
- ② Mechanical key

- ▶ Move locking tab ① in direction of arrow and slide the mechanical key ② out of the housing.

Unlocking the driver's door

- ▶ Unlock the door with the mechanical key. To do so, push the mechanical key in the lock until it stops and turn it to the left.

Unlocking the tailgate

If you are unable to unlock the tailgate with the SmartKey, open the tailgate with the mechanical key as follows:

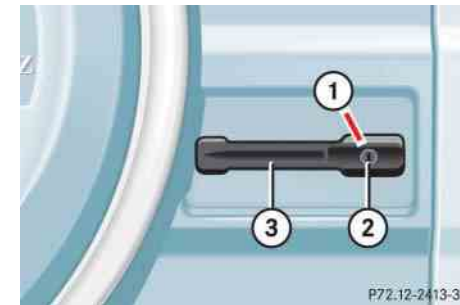

- ① Unlocking in an emergency
- ② Lock cylinder
- ③ Handle

- ▶ Insert the mechanical key into the tailgate lock.
- ▶ Turn the mechanical key counterclockwise to position ① and hold it in this position. ▷▷

Practical hints

Unlocking/locking in an emergency

- ▶▶ Press lock cylinder ② and pull on tailgate handle ③.
- ▶ Open the tailgate to the side.



Warning!



The tailgate swings open to one side. Always make sure there is sufficient clearance for tailgate.



Unlocking your vehicle with the mechanical key will trigger the anti-theft alarm system. To cancel the alarm, do one of the following:

- Press button  or  on the SmartKey.
- Insert the SmartKey in the starter switch.

Locking the vehicle

If you are unable to lock the vehicle with the SmartKey, lock it with the mechanical key as follows:

- ▶ Close the passenger doors and the tailgate.
- ▶ Press the central locking switch in the cockpit (> page 92).
- ▶ Check to see whether the locking knobs on the passenger doors are still visible. If necessary, push them down manually.
- ▶ Slide the mechanical key ② out of the SmartKey.
- ▶ Lock the driver's door with the mechanical key.
- ▶ Check if the tailgate is locked. If necessary lock the tailgate with the mechanical key.

Changing batteries in the SmartKey

If the batteries in the SmartKey are discharged, the vehicle can no longer be locked or unlocked. It is recommended to have the batteries replaced at an authorized Mercedes-Benz Light Truck Center.

Warning!



Keep the batteries out of reach of children.
If a battery is swallowed, seek medical help immediately.

Batteries contain materials that can harm the environment if disposed of improperly. Recycling of batteries is the preferred method of disposal. Many states require sellers of batteries to accept old batteries for recycling.

Practical hints

Unlocking/locking in an emergency



- ① Mechanical key
- ② Battery compartment

Replacement batteries:
Lithium, type CR 2025 or equivalent.



When changing batteries, always replace both batteries.

The required replacement batteries are available at any Mercedes-Benz Light Truck Center.

- ▶ Remove mechanical key (▷ page 287).
- ▶ Insert the mechanical key ① in side opening and push briefly gray slide. Battery compartment ② is unlatched.
- ▶ Pull battery compartment ② out of the SmartKey housing in direction of arrow.
- ▶ Remove the batteries.

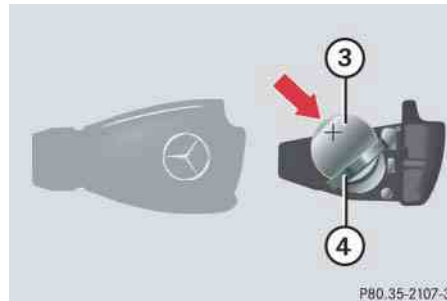

- ③ Battery
- ④ Contact spring



When inserting the batteries, make sure they are clean and free of lint.

Practical hints

Unlocking/locking in an emergency

Fuel filler flap

The emergency release is in the cargo compartment behind the rear panel trim.



- ① Edge protection
- ② Rear panel trim

- ▶ Open the tailgate.
- ▶ Remove edge protection ① from the door pillar.
- ▶ Remove rear panel trim ②.



- ③ Release strap

- ▶ Pull strap ③ upwards.

The fuel filler flap is unlocked and can be opened.

Manually unlocking the transmission gear selector lever

In the case of power failure the transmission gear selector lever can be manually unlocked, e.g. to tow the vehicle.



- ① Pin

- ▶ Insert a pin ①, e.g. ball point pen, into the covered opening.
- ▶ Perform the following two steps simultaneously:
 - ▶ Push pin ① down.
 - ▶ Move gear selector lever from position **P**.
- ▶ Remove pin ①.

The cover returns to its closed position after moving the gear selector lever to positions **D+** and **D-**.



The gear selector lever is locked again when moving it to position **P**.

Practical hints

Opening/closing in an emergency

▼ Opening/closing in an emergency

Sliding/pop-up roof

You can open or close the sliding/pop-up roof manually in the case of power failure.

The sliding/pop-up roof drive is located on the left side of the cargo compartment behind the rear panel trim.

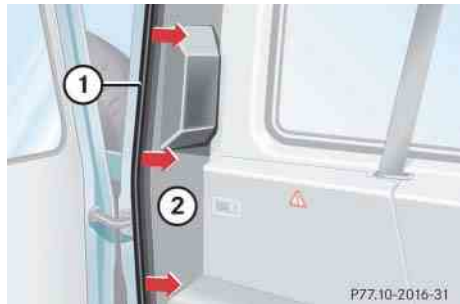

① Edge protection

② Rear panel trim

- ▶ Open the tailgate.
- ▶ Remove edge protection ① from door pillar.
- ▶ Remove rear panel trim ②.



③ Key (vehicle tool kit)

④ Screwdriver (vehicle tool kit)



Do not disconnect electrical connectors.

- ▶ Fit key ③ into hexagon nut of drive.
- ▶ Insert screwdriver ④ into the key as a lever.

- ▶ Turn screwdriver ④ clockwise to:
 - close slide roof
 - raise roof at the rear
- ▶ Turn screwdriver ④ counterclockwise to:
 - open slide roof
 - lower roof at the rear

▼ Brush guard*



Warning!



The brush guard is designed solely to enhance the appearance of the vehicle and help protect grille and head lights from minor mishaps, either on- or off-road. Since the safety characteristics are limited in the event of an accident, brush guards are not intended to prevent injury or damage in the event of an accident. Also check state and local regulations on installation and use.

Raise and lower brush guard in an open space with plenty of room.

To help prevent personal injury when opening or closing the brush guard, use extreme caution not to trap hands or feet.

The brush guard must be in raised and locked position while driving.

Practical hints

Brush guard*



Only lower brush guard to clean head lamps or to replace bulbs.

Practical hints

Brush guard*

Lowering and raising brush guard

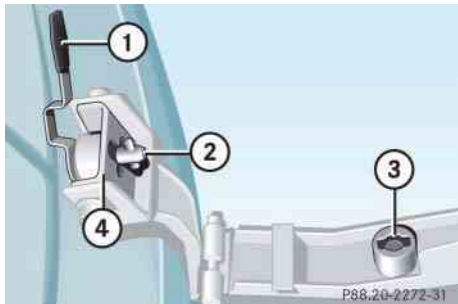

- ① Lock and unlocking handle
- ② Quick lock
- ③ Lock
- ④ End stop joint

Lowering

- ▶ While holding brush guard firmly, open quick lock ② using lock and unlocking handle ①.
- ▶ Gently lower brush guard until it reaches its fully lowered position.

Raising and securing

- ▶ Flip up brush guard until it contacts end stop joint ④.
Quick lock stop pin ② must engage the cross slot recess in lock ③.
- ▶ Now turn quick lock ② so that quick lock makes contact with end stop joint ④.
- ▶ Lock quick lock ② on both sides of brush guard using lock and unlocking handle ①.



Make sure both quick stop pins ② are seated fully in lock ③.

Practical hints

Replacing bulbs

▼ Replacing bulbs

Safe vehicle operation depends on proper exterior lighting and signaling. It is therefore essential that all bulbs and lamp assemblies are in good working order at all times.

Correct headlamp adjustment is extremely important. Have headlamps checked and readjusted at regular intervals and when a bulb has been replaced. See your authorized Mercedes-Benz Light Truck Center for headlamp adjustment.



Backup bulbs will be brought into use when the following lamps malfunction:

- Parking lamps
- Turn signal lamps
- Tail lamps

Bulbs

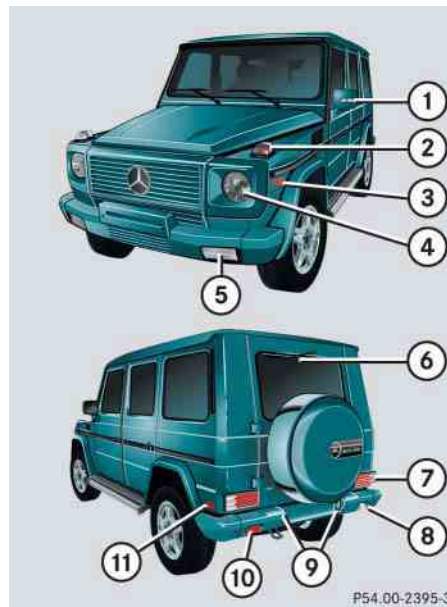

Front lamps

Lamp	Type
① Additional turn signal lamp	LED
② Turn signal lamp	1 156 NA
③ Side marker lamp	T 4 W
④ High and low beam	H4 60 (55 W)
Parking and standing lamp	T 4 W
⑤ Fog lamp	H3 (55 W)

Practical hints

Replacing bulbs

Rear lamps

	Lamp	Type
⑥	High mounted brake lamp	LED
⑦	Turn signal lamp	PY 21 W
	Brake lamp	P 21 W
	Tail, parking and standing lamp	R 5 W
⑧	Backup lamp	P 21 W
⑨	License plate lamps	C 5 W
⑩	Rear fog lamp	P 21 W
⑪	Side marker lamp	T 4 W

Notes on bulb replacement

Warning!



Keep bulbs out of reach of children.

Bulbs and bulb sockets can be very hot. Allow the lamp to cool down before changing a bulb.

Halogen lamps contain pressurized gas. A bulb can explode if you:

- touch or move it when hot
- drop the bulb
- scratch the bulb

Wear eye and hand protection.

- Use only 12 volt bulbs of the same type and with the specified watt rating.
- Switch lights off before changing a bulb to prevent short circuits.
- Always use a clean lint-free cloth when handling bulbs.

- Your hands should be dry and free of oil and grease.
- If the newly installed bulb does not come on, visit an authorized Mercedes-Benz Light Truck Center.
- Have the LEDs for the following lamps replaced by an authorized Mercedes-Benz Light Truck Center.
 - The additional turn signals in the exterior rear view mirrors
 - The high mounted brake lamp



Have the headlamp settings checked regularly by a Mercedes-Benz Light Truck Center.

Do not turn the headlamp adjusting screws. If the adjusting screws are turned, the headlamp setting must be checked by a Mercedes-Benz Light Truck Center.

Replacing bulbs for front lamps

Headlamp assembly (halogen)



For vehicles with brush guard*:
Fold the brush guard* down before replacing bulbs (▷ page 293).

G 55 AMG:

Remove the protective grille before replacing the bulbs.

Removing

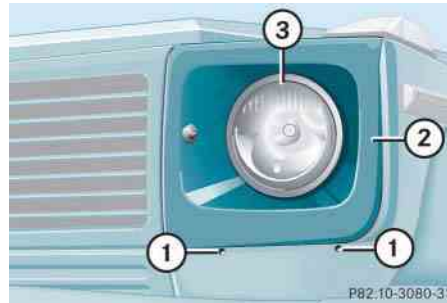

Left headlamp, right headlamp laterally reversed

- ① Securing screw (trim panel)
 - ② Head lamp trim panel
 - ③ Headlamp
- ▶ Switch off the lights.
 - ▶ Unscrew securing screws ①.
 - ▶ Remove head lamp trim panel ② and seal.

Practical hints

Replacing bulbs

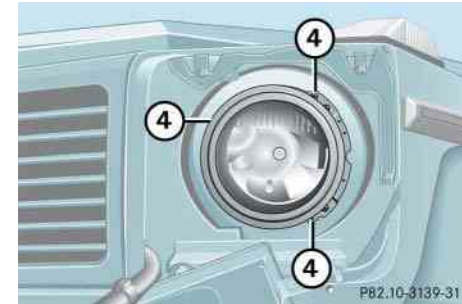

④ Securing screw (headlamp)

- ▶ Unscrew headlamp-securing screws ④.
- ▶ Remove headlamp ③.

Installing

- ▶ Insert headlamp ③ and screw in headlamp-securing screws ④.
- ▶ Install head lamp trim panel ② and seal and screw in securing screws ①.

Practical hints

Replacing bulbs

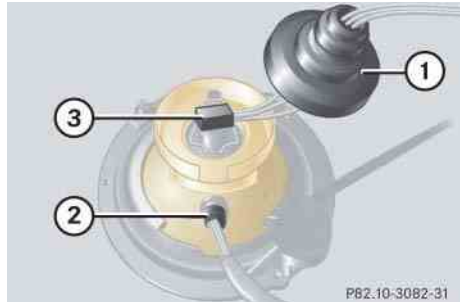

- ① Protection cover
- ② Electrical connector (parking and standing lamps)
- ③ Electrical connector (high and low beam)

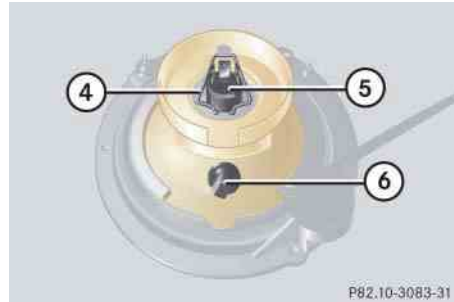

- ④ Retainer spring
- ⑤ Bulb for high and low beam
- ⑥ Bulb socket for parking and standing lamps

High and low beam bulb

- ▶ Remove protection cover ①.
- ▶ Pull off electrical connector ③.
- ▶ Unclip retainer spring ④.
- ▶ Remove bulb ⑤.
- ▶ Insert new bulb so that the base locates in the recess on the holder.

- ▶ Clip in retainer spring ④.
- ▶ Plug electrical connector ③ onto bulb ⑤.
- ▶ Press on protection cover ①.

Parking and standing lamp bulb

- ▶ Pull off electrical connector ② from bulb socket ⑥.
- ▶ Push bulb into bulb socket ⑥, turn counterclockwise and remove.
- ▶ Insert new bulb in bulb socket ⑥, push in and turn clockwise until it clicks in.
- ▶ Plug electrical connector ② onto bulb socket ⑥.

Front fog lamp

Removing

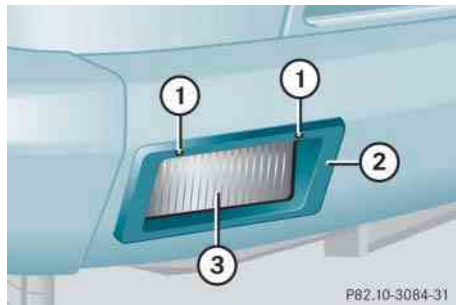

Right front fog lamp, left front fog lamp laterally reversed

- ① Securing screw (trim panel)
- ② Fog lamp trim panel
- ③ Fog lamp
- ▶ Switch off the lights.
- ▶ Unscrew securing screws ①.
- ▶ Remove fog lamp trim panel ② and seal.



- ④ Securing screw (fog lamp)
- ⑤ Adjusting screw (fog lamp)

- ▶ Unscrew fog lamp-securing screws ④.
- ▶ Remove fog lamp ③.

Installing

- ▶ Insert fog lamp ③ and screw in fog lamp-securing screws ④.
- ▶ Reinstall fog lamp trim panel ② and screw in securing screws ①.

Practical hints

Replacing bulbs

Fog lamp bulb

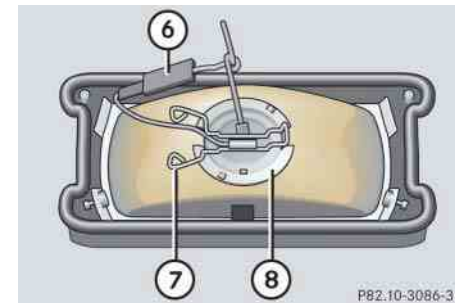

- ⑥ Electrical connector
- ⑦ Retainer spring
- ⑧ Bulb socket
- ▶ Pull off electrical connector ⑥.
- ▶ Unclip retainer spring ⑦.
- ▶ Pull out bulb socket ⑧.
- ▶ Insert the new bulb so that the base locates in the recess on the holder.
- ▶ Clip in retainer spring ⑦.
- ▶ Plug electrical connector ⑥ together.

Practical hints

Replacing bulbs

Front turn signal lamp



G 55 AMG:
Remove the protective grille before replacing bulbs.



- ① Securing screw
- ② Turn signal lens

- ▶ Switch off the lights.
- ▶ Unscrew securing screws ①.
- ▶ Remove turn signal lens ②.

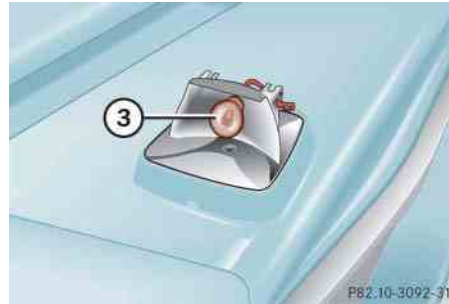

- ③ Bulb

- ▶ Push bulb ③ into socket, turn counter-clockwise and remove.
- ▶ Insert new bulb in socket, push in and turn clockwise until it clicks in.
- ▶ Reinstall turn signal lens ② and screw in securing screws ①.



Do not overtighten securing screws ①. Otherwise turn signal lens ② could be damaged.

Side marker lamp

The following description applies to both the front and the rear side marker lamps.

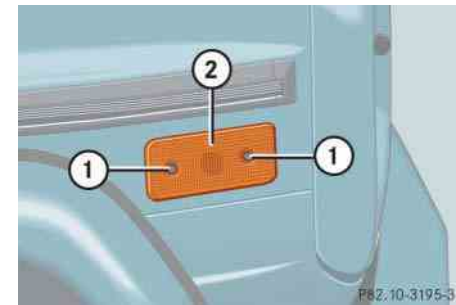

Front side marker shown

- ① Securing screw
- ② Side marker lamp housing

- ▶ Switch off the lights.
- ▶ Unscrew securing screws ①.
- ▶ Remove side marker lamp housing ②.

Practical hints

Replacing bulbs

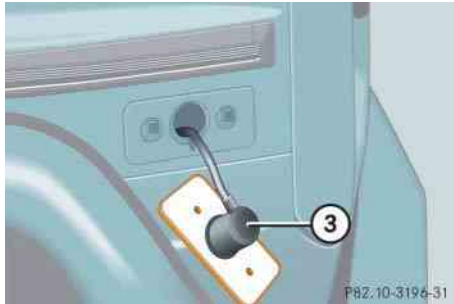

③ Dust cover

- ▶ Remove dust cover ③.
- ▶ Press catch aside and pull out bulb socket from side marker lamp housing ②.



④ Bulb

- ▶ Push bulb ④ into socket, turn counter-clockwise and remove.
- ▶ Insert new bulb in socket, push in and turn clockwise until it clicks in.
- ▶ Insert bulb socket in lamp housing ② and reinstall the dust cover.
- ▶ Reinstall side marker lamp housing ② and screw in securing screws ①.



Do not overtighten the securing screw ①. Otherwise side marker lamp housing ② could be damaged.

Replacing bulbs for rear lamps

Tail lamp assemblies



G 55 AMG:
Remove the protective grille before replacing bulbs.

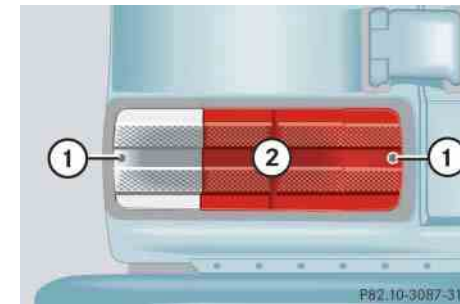

① Securing screw

② Lens

- ▶ Switch off the lights.
- ▶ Unscrew securing screws ①.
- ▶ Remove lens ②.

Practical hints

Replacing bulbs

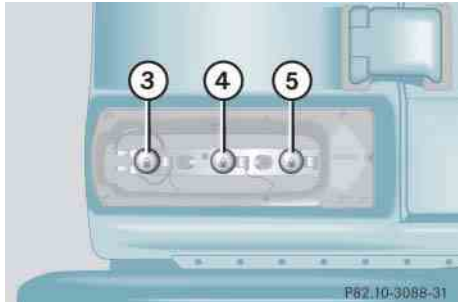

- ③ Bulb for turn signal lamp
- ④ Bulb for tail lamp
- ⑤ Bulb for brake lamp

- ▶ Push defective bulb ③, ④ or ⑤ into socket, turn counterclockwise and remove.
- ▶ Insert new bulb in socket, push in and turn clockwise until it clicks in.
- ▶ Reinstall lens ② and screw in securing screws ①.



Do not overtighten securing screws ①. Otherwise lens ② could be damaged.

Rear fog lamp/Backup lamp

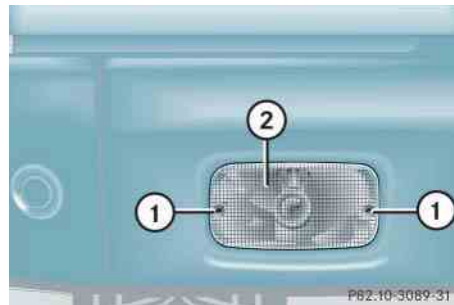

- ① Securing screw
 - ② Lens
- ▶ Switch off the lights.
 - ▶ Unscrew securing screws ①.
 - ▶ Remove lens ②.



- ③ Bulb
- ▶ Push bulb ③ into socket, turn counterclockwise and remove.
 - ▶ Insert new bulb in socket, push in and turn clockwise until it clicks in.
 - ▶ Reinstall lens ② and screw in securing screws ①.



Do not overtighten securing screws ①. Otherwise lens ② could be damaged.

Practical hints

Replacing bulbs

License plate lamp



- ① Securing screw
- ② Holder with light lens
- ▶ Switch off the lights.
- ▶ Unscrew securing screws ①.
- ▶ Remove holder ②.



- ③ Tubular lamp
- ▶ Replace tubular lamp ③.
- ▶ Reinstall holder ② and screw in securing screws ①.



Do not overtighten securing screws ①. Otherwise holder with light lens ② could be damaged.

Practical hints

Replacing wiper blades

▼ Replacing wiper blades

Warning!



For safety reasons, remove SmartKey from starter switch before replacing a wiper blade. Otherwise the motor could suddenly turn on and cause injury.



Never open the hood when the wiper arm is folded forward.

Hold on to the wiper when folding the wiper arm back. If released, the force of the impact from the tensioning spring could crack the windshield.

Do not allow the wiper arms to contact the windshield glass without a wiper blade inserted.

Make certain that the wiper blades are properly installed. Improperly installed wiper blades may cause windshield damage.

The wiper with air spoiler should be mounted on the driver's side

For your convenience, we recommend that you have this work carried out by an authorized Mercedes-Benz Light Truck Center.

Removing wiper blades

- ▶ Fold the wiper arm forward.

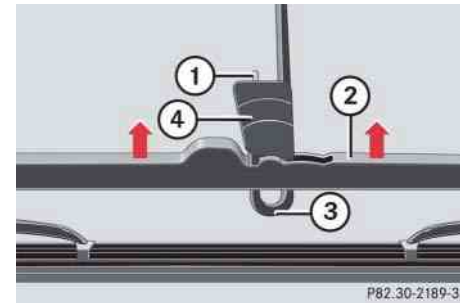

- ① Safety tab
- ② Wiper blade
- ③ Wiper arm
- ④ Attachment link

- ▶ Turn wiper blade ② at a right angle to wiper arm ③.
- ▶ Press safety tab ① of attachment link ④ down and slide wiper blade ② from the end of wiper arm ③.
- ▶ Remove wiper blade ②.

Practical hints

Replacing wiper blades

Installing wiper blades

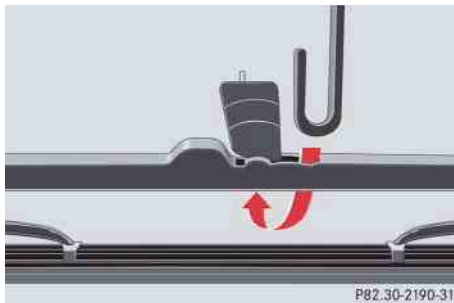

- ▶ Guide wiper blade ② so that opening goes through wiper arm ③.
- ▶ Press wiper blade ② into arch of wiper arm ③ until locking spring ① engages in attachment link ④.
- ▶ Fold the wiper arm back to rest on the windshield.

Practical hints

Flat tire

▼ Flat tire

Preparing the vehicle

- ▶ Park the vehicle as far as possible from moving traffic on a hard surface.
- ▶ Turn on the hazard warning flashers.
- ▶ Engage the steering wheel lock in the straight ahead position and set the parking brake.
- ▶ Move the gear selector lever to **P**.
- ▶ Have any passenger exit the vehicle at a safe distance from the roadway.
- ▶ Remove the vehicle tool kit (▷ page 283) and the jack (▷ page 284).
- ▶ Remove the spare wheel from the spare wheel mounting bracket (▷ page 285).

Warning!



For your safety, remove spare wheel from the spare wheel mounting bracket before undertaking any further steps.

Information on spare wheel

When you replace the vehicle's tires, you can use the spare wheel as a regular wheel if:

- it is not more than six years old
- rim and tire are the same model as the regular wheels

Warning!



If the spare tire is more than six years old or is not the same model as the regular tires, have the spare tire replaced with a new tire at the nearest Mercedes-Benz Light Truck Center.

Never operate the vehicle with more than one spare tire.

Warning!



G 55 AMG only

Vehicles with different tire dimensions on the front and rear axle: rim and tire size of spare wheel and normal wheel differ. Handling will be adversely affected when the spare wheel is used.

Do not exceed the maximum speed of 50 mph (80 km/h).

Mounting the spare wheel

- ▶ Prepare the vehicle (▷ page 306).

Lifting the vehicle

- ▶ Prevent the vehicle from rolling away by blocking wheels with wheel chocks (not included) or other sizable objects.

When changing wheel on a level surface:

- ▶ Place one chock in front of and one behind the wheel that is diagonally opposite to the wheel being changed.

When changing wheel on a hill:

- ▶ Place chocks on the downhill side blocking both wheels of the other axle.

Warning!



The jack is designed exclusively for jacking up the vehicle under the axle housing. To help avoid personal injury, use the jack only to lift the vehicle during a wheel change. Never get beneath the vehicle while it is supported by the jack. Keep hands and feet away from the area under the lifted vehicle. Always firmly set parking brake and block wheels before raising vehicle with jack.

Do not disengage parking brake while the vehicle is raised. Be certain that the jack is always vertical (plumb line) when in use, especially on hills. Always try to use the jack on level surface. Make sure the jack is positioned correctly under the axle housing. Always lower the vehicle onto sufficient capacity jackstands before working under the vehicle.

If the vehicle is not raised as described, it could slip off the jack as a result of vibrations (e.g. opening or closing a door or the tailgate).

Practical hints

Flat tire



P40.10-2178-31

Wheel wrench

- ▶ On wheel to be changed, loosen but do not yet remove the wheel bolts (approximately one full turn with wrench).

Practical hints

Flat tire

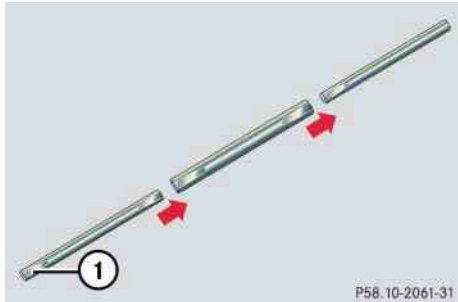

Pump handle (three pieces)

- ① Indent for activation of release bolt ②
- ▶ Assemble the pump handle for the jack. The pump handle is located in the vehicle tool kit.

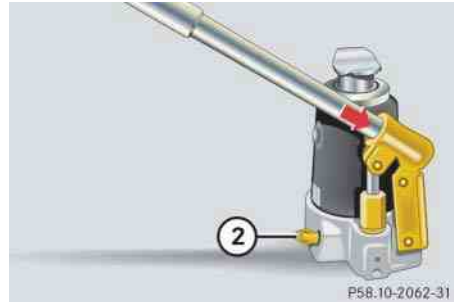

Jack

- ② Release bolt
- ▶ Close release bolt ②.
To do so, turn indent ① to the right in the pump lever until its stop.



Never turn release bolt ② more than one or two revolutions. Hydraulic fluid can otherwise escape.

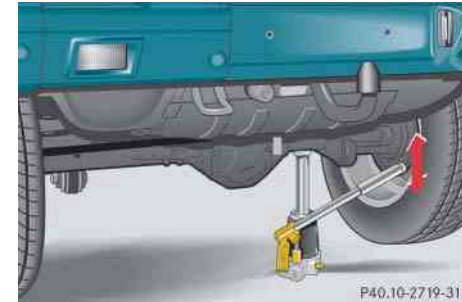

- ▶ Place jack on firm ground.
- ▶ Position jack under the axle housing, so that it is always vertical (plumb-line) as seen from the side, even if the vehicle is parked on an incline.

Be certain the jack arm is positioned correctly under the axle housing (axle must fall into jack contour).

- ▶ Jack up the vehicle by pumping (arrow) until the wheel is clear of the ground.

Never start engine while vehicle is raised.

Removing the wheel

- ▶ Remove the wheel bolts.



Do not place wheel bolts in sand or dirt. This could result in damage to the bolt and wheel hub threads.

- ▶ Remove the wheel.

Warning!



Make sure no one is injured when removing the wheel.

Grip wheel from the sides.

Keep hands from beneath the wheel.

Mounting the new wheel

- ▶ Clean contact surfaces of wheel and wheel hub.
- ▶ Push the wheel onto the wheel hub and press firmly.
- ▶ Insert wheel bolts and tighten them slightly.

Warning!



Always replace wheel bolts that are damaged or rusted.

Never apply oil or grease to wheel bolts.

Damaged wheel hub threads should be repaired immediately. Do not continue to drive under these circumstances! Contact an authorized Mercedes-Benz Light Truck Center or call Roadside Assistance.

Incorrect wheel bolts or improperly tightened wheel bolts can cause the wheel to come off. This could cause an accident. Make sure to use the correct wheel bolts.

Practical hints

Flat tire

Warning!



Use only genuine equipment Mercedes-Benz wheel bolts. Other wheel bolts may come loose.

Do not tighten the wheel bolts when the vehicle is raised. Otherwise the vehicle could tip over.

Practical hints

Flat tire

Lowering the vehicle

- ▶ Using the pump lever, open the lowering screw on the jack approximately one turn (▷ page 308).

The vehicle is resting fully on its own weight.

- ▶ Remove the jack.

After use, disassemble pump handle (▷ page 308) and store jack in the designated storage compartment (▷ page 284).

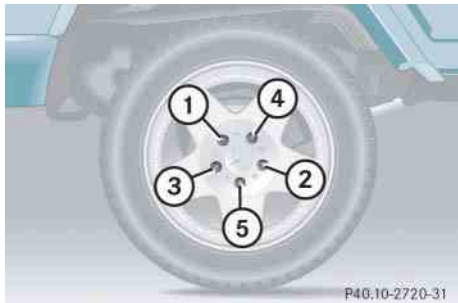

① - ⑤ Wheel bolts

- ▶ Tighten the five wheel bolts evenly, following the diagonal sequence illustrated (① to ⑤), until all bolts are tight. Observe a tightening torque of 97 lb-ft (130 Nm).

Warning!



Have the tightening torque checked after changing a wheel as soon as possible. The wheels could come loose if they are not tightened to a torque of 97 lb-ft (130 Nm).

- ▶ Press the jack piston in again and close the lowering screw. Store the jack (▷ page 284) and the other vehicle tools (▷ page 283).
- ▶ After changing the wheel, secure the damaged wheel on the spare wheel mounting bracket (▷ page 286). Make sure the wheel cannot come loose.
- ▶ Check the tire inflation pressure and correct it if necessary.

A table with the tire pressure values for your vehicle is located on the fuel filler flap.

▼ Battery

The battery is located in front of the rear seat bench and below the cup holder

Warning!



Failure to follow these instructions can result in severe injury or death.

Observe all safety instructions and precautions when handling automotive batteries (> page 235).

Never lean over batteries while connecting, you might get injured.

Battery fluid contains sulfuric acid. Do not allow this fluid to come in contact with eyes, skin or clothing. In case it does, immediately flush affected area with water and seek medical help if necessary.

A battery will also produce hydrogen gas, which is flammable and explosive. Keep flames or sparks away from battery, avoid improper connection of jumper cables, smoking, etc.

Warning!



Do not place metal objects on the battery as this could result in a short circuit.

Use leak-proof battery only to avoid the risk of acid burns in the event of an accident.

Batteries contain materials that can harm the environment if disposed of improperly. Large 12 volt storage batteries contain lead.

Recycling of batteries is the preferred method of disposal. Many states require sellers of batteries to accept old batteries for recycling.

Practical hints

Battery

Charging the battery

Warning!



Never charge a battery while still installed in the vehicle. Gases may escape during charging and cause explosions that may result in paint damage, corrosion or personal injury.

Have the battery removed at a Mercedes-Benz Light Truck Center.



Have the battery checked regularly by an authorized Mercedes-Benz Light Truck Center.

Refer to Service Booklet for maintenance intervals or contact your authorized Mercedes-Benz Light Truck Center for further information.

If you charge the battery yourself, make sure to comply with the operating instructions for your battery charger.

Practical hints

Battery

Disconnecting the battery



Never loosen or detach battery terminal clamps while the engine is running or the SmartKey is in the starter switch. Otherwise the alternator and other electronic components could be severely damaged.

- ▶ Turn off all electrical consumers.
- ▶ Disconnect the battery negative lead.
- ▶ Remove the cover from the positive terminal.
- ▶ Disconnect the battery positive lead.
- ▶ Remove the breather hose from the battery.



With a disconnected battery

- you will no longer be able to turn the SmartKey in the starter switch
- the gear selector lever will remain locked in position **P**

Reconnecting the battery

- ▶ Turn off all electrical consumers.
- ▶ Connect the positive lead and fasten its cover.
- ▶ Connect the negative lead.



Never invert the terminal connections.

- ▶ Install the breather hose.



The battery, its filler caps and the vent tube must always be securely installed when the vehicle is in operation.



The following procedures must be carried out following any interruption of battery power (e.g. due to reconnection):

- Set the clock (see COMAND operator's manual).
- Resynchronize the front seat head restraints and seat adjustment fore, aft (▷ page 95).
- Synchronize the ESP (▷ page 263).

▼ Jump starting

Warning!



Failure to follow these directions will cause damage to the electronic components, and can lead to a battery explosion and severe injury or death.

Never lean over batteries while connecting or jump starting, you might get injured.

Battery fluid contains sulfuric acid. Do not allow this fluid to come in contact with eyes, skin or clothing. In case it does, immediately flush affected area with water, and seek medical help if necessary.

A battery will also produce hydrogen gas, which is flammable and very explosive. Keep flames or sparks away from battery, avoid improper connection of jumper cables, smoking, etc.

Attempting to jump start a frozen battery can result in it exploding, causing personal injury.

Read all instructions before proceeding.

If the battery is discharged, the engine can be started with jumper cables and the battery of another vehicle. Observe the following:

- Jump starting should only be performed when the engine and catalytic converter are cold.
- Do not start the engine if the battery is frozen. Let the battery thaw out first.
- Only use 12 volt battery to jump start your vehicle. Jump starting with a more powerful battery could damage the vehicle's electrical system, which will not be covered by the Mercedes-Benz Limited Warranty.
- Use only jumper cables with sufficient cross-section and insulated terminal clamps.
- Always make sure the jumper cables are not on or near pulleys, fans, or other parts that move when an engine is started or running.

Practical hints

Jump starting



Avoid repeated and lengthy starting attempts.

Do not attempt to start the engine using a battery quick charge unit.

If engine does not run after several unsuccessful starting attempts, have it checked at the nearest authorized Mercedes-Benz Light Truck Center.

Excessive unburned fuel generated by repeated failed starting attempts may damage the catalytic converter and may present a fire risk.

Make sure the jumper cables do not have loose or missing insulation.

Make sure the cable clamps do not touch any other metal part while the other end is still attached to a battery.



Do not tow-start the vehicle.

Practical hints

Jump starting

Warning!



Keep flames or sparks away from battery.
Do not smoke.

Observe all safety instructions and precautions when handling automotive batteries (> page 311).

The jump-start contacts are located in the engine compartment.

- ▶ Make sure the two vehicles do not touch.
- ▶ Turn off all electrical consumers.
- ▶ Apply parking brake.
- ▶ Shift gear selector lever to position **P**.
- ▶ Start engine of the vehicle with the charged battery and run at idle speed.

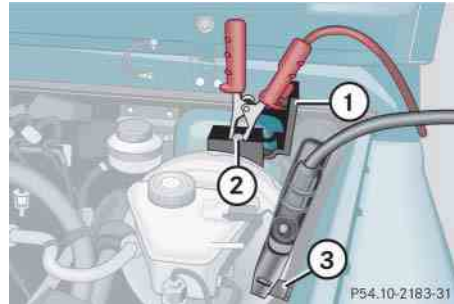

- ① Cover
- ② Positive (+) terminal
- ③ Negative (-) terminal

- ▶ Open cover ① of the positive terminal of both vehicles.
- ▶ Connect the positive terminals ② of the batteries with the jumper cable. Clamp cable to discharged battery first.
- ▶ Connect negative terminals ③ of the batteries with the jumper cable. Clamp cable to charged battery first.
- ▶ Start the engine of the disabled vehicle.

Now you can again turn on the electrical consumers. Do not turn on the lights under any circumstances.

- ▶ Remove the jumper cables first from negative terminals ③ of the batteries and then from positive terminals ②.

You can now turn on the lights.

- ▶ Have the battery checked at the nearest authorized Mercedes-Benz Light Truck Center.

▼ Towing the vehicle

Mercedes-Benz recommends that the vehicle be transported with all wheels off the ground using flatbed or appropriate wheel lift/dolly equipment. This method is preferable to other types of towing.



Use flatbed or wheel lift/dolly equipment, with SmartKey in starter switch turned to position **0**.

Do not tow with sling-type equipment. Towing with sling-type equipment over bumpy roads will damage radiator and supports.

To prevent damage during transport, do not tie down vehicle by its chassis or suspension parts. Use the towing eyes.

Switch off the ESP (▷ page 79), tow-away alarm (▷ page 83) and the automatic central locking (▷ page 133).

When circumstances do not permit the recommended towing methods, the vehicle may be towed with all wheels on the

ground only so far as necessary to have the vehicle moved to a safe location where the recommended towing methods can be employed.



When towing the vehicle with all wheels on the ground, the gear selector lever must be in position **N** and the SmartKey must be in starter switch position **2**.

When towing the vehicle with all wheels on the ground, the vehicle may be towed only for distances up to 30 miles (50 km) and at a speed not to exceed 30 mph (50 km/h).

If the vehicle is towed with one axle raised (observe instructions regarding flexible drive shaft and propeller shafts), the engine must be shut off (SmartKey in starter switch position **1**). Otherwise, the 4-ETS may become engaged which may cause loss of towing control.

Practical hints

Towing the vehicle



Do not tow-start the vehicle.

Warning!



Prior to towing the vehicle with all wheels on the ground, make certain that the SmartKey is in starter switch position **2**.

If the SmartKey is left in the starter switch position **0** for an extended period of time, it can no longer be turned in the switch. In this case, the steering is locked. To unlock, remove SmartKey from starter switch and reinsert.

Always tow with a tow bar if:

- the engine will not run
- there is a malfunction in the power supply or in the vehicle's electrical system

as that will be necessary to adequately control the towed vehicle.

Practical hints

Towing the vehicle

Warning!



With the engine not running, there is no power assistance for the brake and steering systems. In this case, it is important to keep in mind that a considerably higher degree of effort is necessary to brake and steer the vehicle. Adapt your driving accordingly.



The gear selector lever will remain locked in position **P** and the SmartKey will not turn in the starter switch if the battery is disconnected or discharged. See notes on the battery (▷ page 311) or on jump starting (▷ page 313).

Manually unlocking transmission gear selector lever (▷ page 290).



To signal turns while being towed with hazard warning flasher in use, turn SmartKey in starter switch to position **2** and activate combination switch for left or right turn signal in usual manner – only the selected turn signal will operate.

Upon canceling the turn signal, the hazard warning flasher will operate again.



When towing the vehicle with all wheels on the ground, note the following:

With the automatic central locking activated and the SmartKey in starter switch position **2**, the vehicle doors lock if the wheels are turning at vehicle speeds of approx. 9 mph (15 km/h) or more.

To prevent the vehicle doors from locking, deactivate the automatic central locking (▷ page 133).

Towing of the vehicle should only be done using the towing eye. Never attach tow cable, tow rope or tow rod to vehicle chassis, frame or suspension parts.

Practical hints

Towing the vehicle

Transporting the vehicle

When transporting the vehicle, you can use the towing eyes for pulling the vehicle onto a trailer or transporter.

- ▶ Move the gear selector lever to position **N**.
- ▶ Shift the transfer case to neutral position **N**.
- ▶ To avoid damaging the vehicle, it should only be tied down on the wheels / wheel rims, not on chassis components such as the transverse link or trailing arm.

Towing the vehicle - various problem scenarios



When removing drive shaft, place M10 nuts on bolts as distance sleeves and tighten using M8 nuts. Always install new self-locking nuts when reinstalling the drive shaft.

- ▶ Comply with all towing information (▷ page 315).

In case of engine damage, transmission damage or malfunctions in electrical equipment

- ▶ Move the gear selector lever to position **N**.
- ▶ Shift the transfer case to neutral position **N**.

In case of transfer case damage or for towing vehicle distances exceeding 30 miles (50 km)

The propeller shafts to the drive axles must be removed.

In case of front axle damage

Raise the front axle when towing. The propeller shaft between the rear axle and the transfer case must be removed.

In case of rear axle damage

When the rear axle is raised, the vehicle can only be towed with a wheel lift or a dolly placed under its front wheels.

Practical hints

Towing the vehicle

Front towing eye

In the front, the towing eye is located on the driver's side under the bumper.

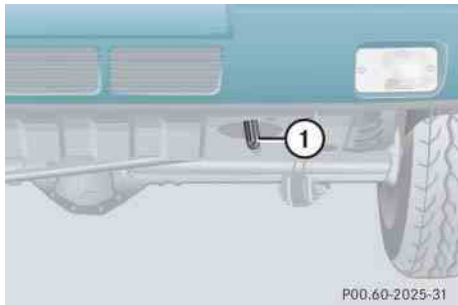

① Towing eye

Rear towing eye

In the rear, the towing eye is located on the driver's side under the bumper.

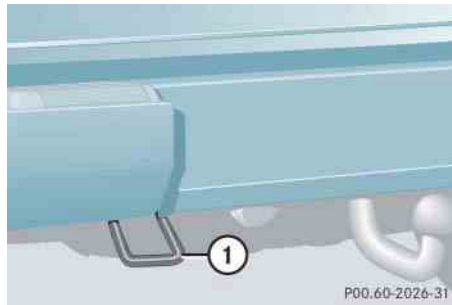

① Towing eye

Freeing a stranded vehicle

Freeing a stranded vehicle, on which the wheels are dug into sand or mud, should be done with the greatest of care, especially if the vehicle is heavily loaded.

Avoid pulling the vehicle jerkily or diagonally, since it could result in damage to the chassis alignment.

Never try to free a vehicle that is still coupled to a trailer.

If possible, a vehicle equipped with trailer hitch receiver should be pulled backward in its own previously made tracks.

▼ Fuses



Only install fuses that have been tested and approved by Mercedes-Benz and that have the specified amperage rating.

Never attempt to repair or bridge a blown fuse. Have the cause determined and remedied by an authorized Mercedes-Benz Light Truck Center.

The fuse box is located on the left side of the cockpit in the passenger compartment. It contains:

- a fuse chart
- spare fuses
- a special spare extractor

Additional fuses are located in:

- battery box
- front passenger footwell under the cockpit
- middle tunnel

Fuse box in passenger compartment

Opening

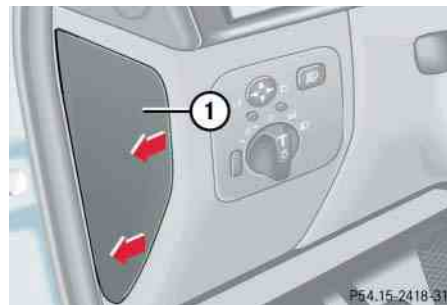

- ① Cover
- ▶ Open the driver's door.
- ▶ Remove cover ① in direction of arrows.

Fuse box in battery box

The battery box is located under the cover in the rear footwell.

Replacement of fuses can only be performed by a Mercedes-Benz Light Truck Center.

Practical hints

Fuses

Fuse box in front passenger footwell



We recommend having the fuses changed at a Mercedes-Benz Light Truck Center.

Opening

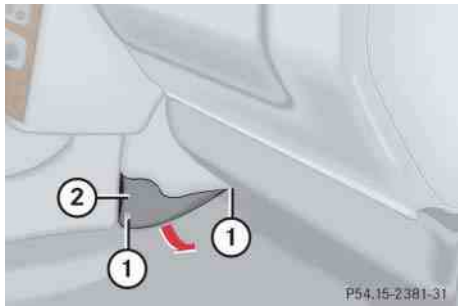

① Mounting screw

② Cover

- ▶ Unscrew mounting screws ①.
- ▶ Remove cover ② in direction of arrows.

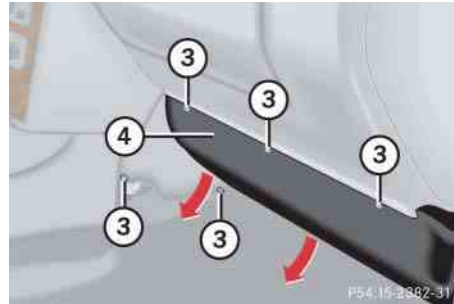

③ Mounting screw

④ Cover

- ▶ Unscrew mounting screws ③.
- ▶ Remove cover ④ in direction of arrows.

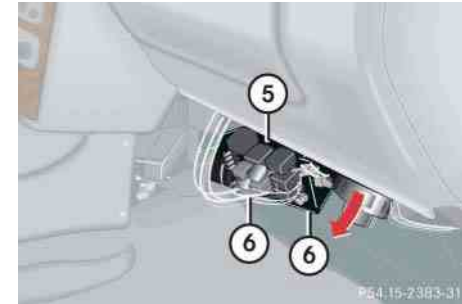

⑤ Fuse box

⑥ Mounting screw

To make changing the fuses easier, fuse box ⑤ can be folded down slightly:

- ▶ Unscrew mounting screws ⑥.
- ▶ Fold fuse box ⑤ downward.

Fuse box in middle tunnel



We recommend having the fuses changed at a Mercedes-Benz Light Truck Center.

Removing front end stops

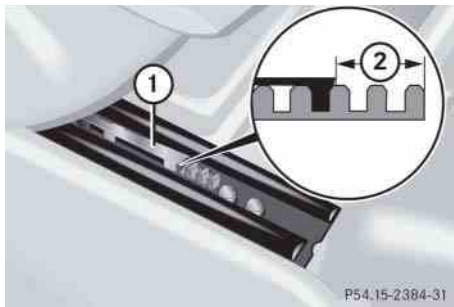

Front end stop on the right seat rail, left seat rail laterally reversed

- ① Front end stop
- ② Spacing

- ▶ Remove both front end stops ① of the front passenger seat tracks with a screwdriver.
- ▶ Move front passenger seat fully forward.



When reinstalling front passenger seat track stops, place end stops in correct position. For your safety, maintain proper spacing ②.

Warning!



Do not drive the vehicle when the front end stops are not correctly installed. Failure to reinstall stops as indicated may result in serious injury in certain frontal crashes.

Adjust the front passenger seat as far as possible rearward from the dashboard when the seat is occupied. Comply with information on occupant safety (▷ page 56).

Practical hints

Fuses

Opening fuse box

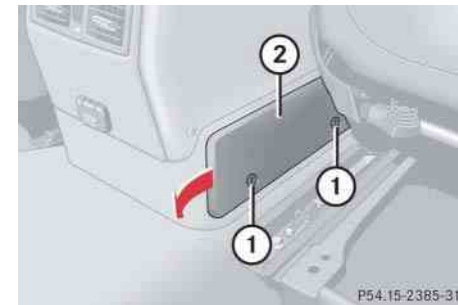

- ① Mounting screw
- ② Cover

- ▶ Unscrew mounting screws ①.
- ▶ Remove cover ② in direction of arrows.





Technical data

Spare parts service

Warranty coverage

Identification labels

Layout of poly-V-belt drive

Engine

Rims and tires

Electrical system

Main dimensions, vehicle weights and ratings

Fuels, coolants, lubricants, etc.

Consumer information

Technical data

Spare parts service

The “Technical data” section provides the necessary technical data for your vehicle.

▼ Spare parts service

All authorized Mercedes-Benz Light Truck Centers maintain a stock of genuine Mercedes-Benz parts required for maintenance and repair work. In addition, strategically located parts distribution centers provide quick and reliable parts service.

More than 300 000 different spare parts for Mercedes-Benz models are available.

Genuine Mercedes-Benz parts are subjected to stringent quality inspections. Each part has been specifically developed, manufactured or selected for and adapted to Mercedes-Benz vehicles.

Therefore, genuine Mercedes-Benz parts should be installed.



The use of non-genuine Mercedes-Benz parts and accessories not authorized by Mercedes-Benz could damage the vehicle, which is not covered by the Mercedes-Benz Limited Warranty, or could compromise the vehicle’s durability or safety.

▼ **Warranty coverage**

Your vehicle is covered under the terms of the “warranties” printed in the Service and Warranty Information booklet. Your authorized Mercedes-Benz Light Truck Center will exchange or repair any defective parts originally installed in the vehicle in accordance with the terms of the following warranties:

- New vehicle limited warranty
- Emission system warranty
- Emission performance warranty
- California, Maine, Massachusetts, and Vermont emission control systems warranty

Replacement parts and accessories are covered by the Mercedes-Benz Spare Parts and Accessories warranties, copies of which are available at any Mercedes-Benz Light Truck Center.

Loss of Service and Warranty Information Booklet

Should you lose your Service and Warranty Information booklet, have your authorized Mercedes-Benz Light Truck Center arrange for a replacement. It will be mailed to you.

Technical data

Identification labels

▼ Identification labels

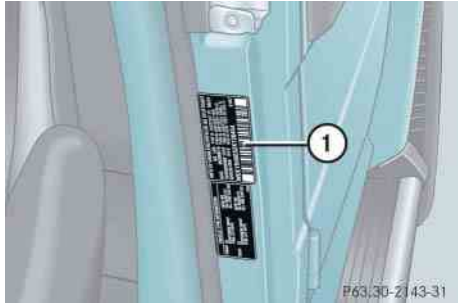

- ① Certification label and Paintwork Number located on the driver's B-pillar

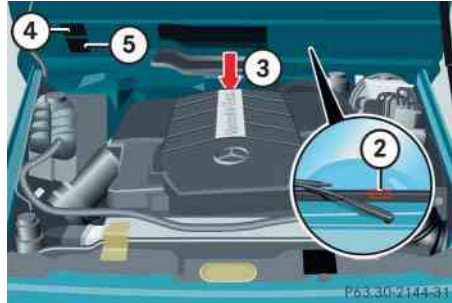

- ② Vehicle Identification Number (VIN)
(lower edge of windshield)
- ③ Engine number (engraved on engine)
- ④ Information label, California version
- ⑤ Emission control label
Vacuum line routing for emission control system

When ordering spare parts, please specify vehicle identification and engine numbers.

▼ Layout of poly-V-belt drive

For dimensions of the poly-V-belt, see technical data (▷ page 328).

G 500/G 55 AMG

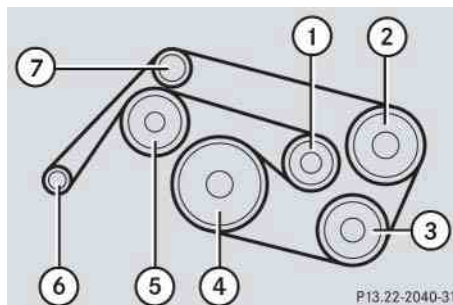

- ① Automatic belt tensioner
- ② Power steering pump
- ③ Air conditioning compressor
- ④ Crankshaft
- ⑤ Coolant pump
- ⑥ Generator (alternator)
- ⑦ Idler pulley

Technical data

Layout of poly-V-belt drive

Technical data

Engine

▼ Engine

	G 500 (463.249¹)	G 55 AMG (463.246)¹
Engine	113	113
Mode of operation	4-stroke engine, gasoline injection	4-stroke engine, gasoline injection
No. of cylinders	8	8
Bore	3.82 in (97.00 mm)	3.82 in (97.00 mm)
Stroke	3.31 in (84.00 mm)	3.60 in (92.00 mm)
Total piston displacement	303.0 cu in (4966 cm ³)	331.8 cu in (5439 cm ³)
Compression ratio	10:1	10.5:1
Output acc. to SAE J 1349	292 hp / 5500 rpm (218 kW / 5500 rpm)	349 hp / 5500 rpm (260 kW / 5500 rpm)
Maximum torque acc. to SAE J 1349	336 lb-ft / 2800 - 4000 rpm (456 Nm / 2800 - 4000 rpm)	391 lb-ft / 3250 rpm (530 Nm / 3250 rpm)
Maximum engine speed	6000 rpm	6000 rpm
Firing order	1-5-4-2-6-3-7-8	1-5-4-2-6-3-7-8
Poly-V-belt	2380 mm	2380 mm

¹ The quoted data apply only to the standard vehicle. See an authorized Mercedes-Benz Light Truck Center for the corresponding data of all special bodies and special equipment.

Technical data

Rims and tires

▼ Rims and tires

Use only tires and rims which have been specifically developed for your vehicle and tested and approved by Mercedes-Benz. Other tires and rims can have detrimental effects, such as

- poor handling characteristics
- increased noise
- increased fuel consumption



Moreover, tires and rims not approved by Mercedes-Benz may, under load, exhibit dimensional variations and different tire deformation characteristics that could cause them to come into contact with the vehicle body or axle parts. This may result in damage to the tires or the vehicle.



Further information on tires and rims is available at any authorized Mercedes-Benz Light Truck Center. A tire inflation pressure table is located on the fuel filler flap of the vehicle. The tire pressure should be checked regularly and should only be adjusted on cold tires. Follow tire manufacturer's maintenance recommendation included with vehicle.

Rims and Tires

	G 500	G 55 AMG
Rims (light alloy)	7 ¹ / ₂ J x 18 H2	9 ¹ / ₂ J x 18 EH2
Wheel offset	1.69 in (43 mm)	1.97 in (50 mm)
All season tires (radial-ply tires)	265/60 R18 110V	285/55 R18 113V

Technical data

Rims and tires

Spare wheels

	G 500	G 55 AMG
Rims (light alloy)	7 ¹ / ₂ J x18 H2	8 ¹ / ₂ J x18 H2
Wheel offset	1.69 in (43 mm)	1.89 in (48 mm)
All season tires (radial-ply tires)	265/60 R18 110V	265/60 R18 110V M+S

▼ **Electrical system**

	G 500	G 55 AMG
Generator (alternator)	14 V/150 A	14 V/150 A
Starter motor	12 V/1.7 kW	12 V/1.7 kW
Battery	12 V/90 Ah	12 V/90 Ah
Spark plugs	Bosch F 8 DPER Beru 14 FGH 8 DPUR X 2	NGK PFR5R-11
Electrode gap	0.039 in (1.0 mm)	0.039 in (1.0 mm)
Tightening torque	15 – 22 lb-ft (20 – 30 Nm)	15 – 22 lb-ft (20 – 30 Nm)

Technical data

Main dimensions, vehicle weights and ratings

▼ Main dimensions, vehicle weights and ratings

Main dimensions

	G 500	G 55 AMG
Overall vehicle length (inc. spare wheel)	185.6 in (4715 mm)	185.6 in (4715 mm)
Overall vehicle width	71.3 in (1811 mm)	73.4 in (1864 mm)
Overall vehicle height	77.8 in (1977 mm)	77.8 in (1977 mm)
Wheel base	112.2 in (2850 mm)	112.2 in (2850 mm)
Ground clearance	8.3 in (211 mm)	8.3 in (211 mm)
Turning radius	523.6 in (13.3 m)	523.6 in (13.3 m)
Track, front and rear	59.6 in (1515 mm)	59.1 in (1501 mm)

Vehicle weights and ratings

	G 500	G 55 AMG
Gross Vehicle Weight Rating ¹	6615 lbs (3000 kg)	6615 lbs (3000 kg)
Gross Axle Weight Rating, front ²	3110 lbs (1410 kg)	3110 lbs (1410 kg)
Gross Axle Weight Rating, rear ²	3965 lbs (1800 kg)	3965 lbs (1800 kg)

¹ GVWR is the maximum permissible vehicle weight. Gross Vehicle Weight (GVW) comprises weight of vehicle including fuel, tools, spare wheel, installed accessories, passengers, cargo and trailer tongue. It must never exceed the GVWR.

² GAWR is the maximum permissible axle weight.

Technical data

Fuels, coolants, lubricants, etc.

▼ Fuels, coolants, lubricants, etc.

Capacities

Vehicle components and their respective lubricants must match.

Therefore use only brands tested and approved by Mercedes-Benz.

Please refer to the Factory Approved Service Products pamphlet, or inquire at your Mercedes-Benz Light Truck Center.

	Model	Capacity	Fuels, coolants, lubricants, etc.
Engine with oil filter	G 500	8.5 US qt (8.0 l)	Approved engine oils
	G 55 AMG	8.0 US qt (7.5 l)	
Automatic transmission		9.0 US qt (8.5 l)	MB Automatic Transmission Oil
Transfer case		2.96 US qt (2.8 l)	MB part no. A 001 989 28 03 10
Differential lock mechanism		0.47 - 0.63 US qt (0.45 - 0.6 l)	Brake fluid DOT 3+4, SAE J1703
Front axle		1.5 US qt (1.4 l)	Hypoid gear oil SAE 90, 85 W 90
Rear axle		1.9 US qt (1.8 l)	Hypoid gear oil SAE 90, 85 W 90
Power steering		approx. 1.06 US qt (1.0 l)	MB Power Steering Fluid, or approved Dexron III ATF
Front wheel hubs		approx. 1.5 oz (43 g) each	High temperature roller bearing grease
Fuel tank including a reserve of		25.4 US gal (96.0 l) 5.3 US gal (20.0 l)	Premium unleaded gasoline: Posted Octane 91 (average of 96 RON/86 MON)

Technical data

Fuels, coolants, lubricants, etc.

	Model	Capacity	Fuels, coolants, lubricants, etc.
Cooling system		approx. 12.7 US qt (12.0 l)	MB Anticorrosion/Antifreeze
Air conditioning system			R-134a refrigerant and special PAG lubricant oil (never R-12)
Windshield/rear window washer system and headlamp cleaning system		approx. 7.9 US qt (7.5 l)	MB Windshield Washer Concentrate and water ¹

¹ Use MB Windshield Washer Concentrate "S" and water for temperatures above freezing point or MB Windshield Washer Concentrate "S" and commercially available premixed windshield washer solvent /antifreeze for temperatures below freezing point. Follow suggested mixing ratios (▷ page 339).

Engine oils

Engine oils are specifically tested for their suitability in our engines. Therefore, use only engine oils recommended by Mercedes-Benz. Information on approved engine oils is available in the Factory Approved Service Products pamphlet, or at your authorized Mercedes-Benz Light Truck Center.



Always check the oil filler cap (▷ page 232) for important information pertaining to the engine oil needing to meet a specific Mercedes-Benz specification (e.g. MB 229.5). If such information is printed on the oil filler cap, only use an engine oil from the list of approved engine oils in the Factory Approved Service Products pamphlet that meets the specification indicated on the oil filler cap.

Using engine oils of other specification may cause the FSS to incorrectly determine the next service interval and will result in engine damage not covered by the Mercedes-Benz Limited Warranty.

Please follow the FSS and Service Booklet recommendations for scheduled oil changes. Failure to do so could result in engine damage not covered by the Mercedes-Benz Limited Warranty.

Engine oil additives

Do not blend oil additives with engine oil. They may damage the engine.

Damage or malfunctions resulting from blending oil additives are not covered by the Mercedes-Benz Limited Warranty.

Air conditioning refrigerant

R-134a (HFC) refrigerant and special PAG lubricating oil is used in the air conditioning system.

Never use R-12 (CFC) or mineral-based lubricating oil. Otherwise damage to the system will occur.

Brake fluid

During vehicle operation, the boiling point of the brake fluid is continuously reduced through the absorption of moisture from the atmosphere. Under extremely strenuous operating conditions, this moisture content can lead to the formation of bubbles in the system, thus reducing the system's efficiency.

Therefore, the brake fluid must be replaced every two years, preferably in the spring.

Only brake fluid approved by Mercedes-Benz is recommended. Your authorized Mercedes-Benz Light Truck Center will provide you with additional information.

Premium unleaded gasoline



To maintain the engine's durability and performance, premium unleaded gasoline must be used. If premium unleaded is not available and low octane fuel is used, follow these precautions:

- Have the fuel tank only partially filled with unleaded regular and fill up with premium unleaded as soon as possible.
- Avoid full throttle driving and abrupt acceleration.
- Do not exceed an engine speed of 3000 rpm if the vehicle is loaded with a light load such as two persons and no luggage.
- Do not exceed $\frac{2}{3}$ of maximum accelerator pedal position if the vehicle is fully loaded or operating in mountainous terrain.

Technical data

Fuels, coolants, lubricants, etc.

Fuel requirements

Use only premium unleaded meeting ASTM standard D 439:

- The octane number (posted at the pump) must be 91 min. It is an average of both the Research (R) octane number and the Motor (M) octane number: $(R+M) / 2$. This is also known as the ANTI-KNOCK INDEX.

Unleaded gasoline containing oxygenates such as ethanol, IPA, IBA and TBA can be used provided the ratio of any one of these oxygenates to gasoline does not exceed 10%; MTBE must not exceed 15%.

The ratio of methanol to gasoline must not exceed 3% plus additional cosolvents.

Using mixtures of ethanol and methanol is not allowed. Gasohol, which contains 10% ethanol and 90% unleaded gasoline, can be used.

These blends must also meet all other fuel requirements, such as resistance to spark knock, boiling range, vapor pressure, etc.

Gasoline additives

A major concern among engine manufacturers is carbon build-up caused by gasoline. Mercedes-Benz recommends only the use of quality gasoline containing additives that prevent the build up of carbon deposits.

After an extended period of using fuels without such additives, carbon deposits can build up especially on the intake valves and in the combustion area, leading to engine performance problems such as:

- Warm-up hesitation
- Unstable idle
- Knocking/pinging
- Misfire
- Power loss

Do not blend other specific fuel additives with fuel. This only results in unnecessary cost and may be harmful to the engine operation.

Damage or malfunctions resulting from poor fuel quality or from blending specific fuel additives are not covered by the Mercedes-Benz Limited Warranty.

Coolants

The engine coolant is a mixture of water and anticorrosion / antifreeze, which provides:

- Corrosion protection
- Freeze protection
- Boiling protection (by increasing the boiling point)

The cooling system was filled at the factory with a coolant providing freeze protection to approximately -35°F (-37°C) and corrosion protection.

If the antifreeze mixture is effective to -22°F (-30°C), the boiling point of the coolant in the pressurized cooling system is reached at approximately 266°F (130°C).

Technical data

Fuels, coolants, lubricants, etc.

The coolant solution must be used year round to provide the necessary corrosion protection and increase in the boil-over protection. Refer to Service Booklet for replacement interval.

To provide important corrosion protection, the solution must be at least 45% anticorrosion/antifreeze (equivalent to freeze protection to approx. - 22°F [-30°C]). If you use a solution that is more than 55% anticorrosion/antifreeze (freeze protection to approx. - 49°F [-45°C]), the engine temperature will increase due to the lower heat transfer capability of the solution. Therefore, do not use more than this amount of anticorrosion/antifreeze.

If the coolant level is low, water and MB anticorrosion /antifreeze should be used to bring it up to the proper level (have cooling system checked for signs of leakage). Please make sure the mixture is in accordance with label instructions.

The water in the cooling system must meet minimum requirements, which are usually satisfied by normal drinking water. If you are not sure about the water quality, consult your authorized Mercedes-Benz Light Truck Center.

Anticorrosion/antifreeze

Your vehicle contains a number of aluminum parts. The use of aluminum components in motor vehicle engines necessitates that anticorrosion/antifreeze coolant used in such engines be specifically formulated to protect the aluminum parts. (Failure to use such anticorrosion/antifreeze coolant will result in a significantly shortened service life.)

Therefore, the following product is strongly recommended for use in your vehicle: Mercedes-Benz anticorrosion/antifreeze agent.

Technical data

Fuels, coolants, lubricants, etc.

Before the start of the winter season (or once a year in hot southern regions), you should have the anticorrosion/antifreeze concentration checked. The coolant is also

regularly checked each time you bring your vehicle to your authorized Mercedes-Benz Light Truck Center for service.

Anticorrosion/antifreeze quantity

Model	Approx. freeze protection	
	- 35°F (- 37°C)	- 49°F (- 45°C)
G 500/ G 55 AMG	6.35 US qt (6.0 l)	7.0 US qt (6.6 l)

Windshield/rear window washer system and headlamp cleaning system

The windshield washer reservoir is located in the engine compartment on the front passenger side. It holds approximately 5.3 US qt (5.0 l). The headlamp cleaning system is also supplied from the windshield washer reservoir.

- ▶ Refill the reservoir with MB Windshield Washer Concentrate “S” to and water (or concentrate and commercially available premixed windshield washer solvent / antifreeze, depending on ambient temperatures) (▷ page 339).

Warning!



Washer solvent / antifreeze is highly flammable. Do not spill washer solvent / antifreeze on hot engine parts, because it may ignite and burn. You could be seriously burned.

Technical data

Fuels, coolants, lubricants, etc.

Washer fluid mixing ratio

For temperatures above freezing point use MB Windshield Washer Concentrate “S” and water:

- 1 part “S” to 100 parts water
[40 ml “S” to 1 gallon (4 liters) water]

For temperatures below freezing point use MB Windshield Washer Concentrate “S” and commercially available premixed windshield washer solvent / antifreeze:

- 1 part “S” to 100 parts solvent
[40 ml “S” to 1 gallon (4 liters) solvent]

Technical data

Consumer information

▼ Consumer information

This has been prepared as required of all manufacturers of passenger cars under Title 49, Code of U.S. Federal Regulations, Part 575 pursuant to the “National Traffic and Motor Vehicle Safety Act of 1966”.

Uniform tire quality grading

Quality grades can be found, where applicable, on the tire sidewall between tread shoulder and maximum section width. For example:

Tread wear	Traction	Temperature
200	AA	A

All passenger car tires must conform to federal safety requirements in addition to these grades.

Tread wear

The tread wear grade is a comparative rating based on the wear rate of the tire when tested under controlled conditions on a specified government test course. For example, a tire graded 150 would wear one and one-half ($1\frac{1}{2}$) times as well on the government course as a tire graded 100. The relative performance of tires depends upon the actual conditions of their use, however, and may depart significantly from the norm due to variations in driving habits, service practices and differences in road characteristics and climate.

Traction

The traction grades, from highest to lowest are AA, A, B, and C. Those grades represent the tire’s ability to stop on wet pavement as measured under controlled conditions on specified government test surfaces of asphalt and concrete. A tire marked C may have poor traction performance.

Warning!



The traction grade assigned to this tire is based on straight ahead braking traction tests, and does not include acceleration, cornering, hydroplaning, or peak traction characteristics.

Temperature

The temperature grades are A (the highest), B, and C, representing the tire's resistance to the generation of heat and its ability to dissipate heat when tested under controlled conditions on a specified indoor laboratory test wheel. Sustained high temperature can cause the material of the tire to degenerate and reduce tire life, and excessive temperature can lead to sudden tire failure. Grade C corresponds to a level of performance which all passenger car tires must meet under the Federal Motor Vehicle Safety Standard No. 109. Grades B and A represent higher levels of performance on the laboratory test wheel than the minimum required by law.

Warning!



The temperature grade for this tire is established for a tire that is properly inflated and not overloaded. Excessive speed, underinflation, or excessive loading, either separately or in combination, can cause excessive heat build-up and possible tire failure.



ABS

(Antilock Brake System)

Prevents the wheels from locking up during braking so that the vehicle can continue to be steered.

BabySmart™ airbag deactivation system

This system detects if a special system compatible child restraint seat is installed on the front passenger seat. The system will automatically deactivate the passenger front airbag when such a seat is properly installed (indicator lamp  in the center console comes on). See your authorized Mercedes-Benz Light Truck Center for availability.

BabySmart™ compatible child seats

Special restraint system for children. The sensor system for the passenger seat prevents deployment of the passenger front airbag if a BabySmart™ compatible child seat is installed.

BAS

(Brake Assist System)

System for potentially reducing braking distances in emergency braking situations. The system is activated when it senses an emergency based on how fast the brake is applied.

CAC

(Customer Assistance Center)

Mercedes-Benz customer service center, which can help you with any questions about your vehicle and provide assistance in the event of a breakdown.

CAN system

(Controller Area Network)

Data bus network serving to control vehicle functions such as door locking or windshield wiping.

Cockpit

All instruments, switches, buttons and indicator/warning lamps in the passenger compartment needed for vehicle operation and monitoring.

COMAND

(Cockpit Management and Data System)

Information and operating center for vehicle sound and communications systems, including the radio and the navigation system, as well as other optional equipment (CD changer, telephone, etc.).

Control system

The control system is used to call up vehicle information and to change component settings. Information and messages appear in the multifunction display. The driver uses the buttons on the multifunction steering wheel to navigate through the system and to adjust settings.

Technical terms

Differential locks

On slippery surfaces, differential locks prevent one wheel of an axle from spinning while the other wheel stands still, resulting in driving force no longer being transferred.

Cruise control

Driving convenience system for automatically maintaining the vehicle speed set by the driver.

Engine number

The number set by the manufacturer and placed on the cylinder block to uniquely identify each engine produced.

Engine oil viscosity

Measurement for the inner friction (viscosity) of the oil at different temperatures. The higher the temperature an oil can tolerate without becoming thin, or the lower the temperature it can tolerate without becoming viscous, the better the viscosity.

ESP

(Electronic Stability Program)
Improves vehicle handling and directional stability.

ETD

(Emergency Tensioning Device)
Device which deploys in certain frontal and rear collisions exceeding the system's threshold to tighten the seat belts.
->SRS

FSS

(Flexible Service System)
Service indicator in the speedometer display that informs the driver when the next vehicle maintenance service is due.

GAWR

(Gross Axle Weight Rating)
The GAWR is the maximum permissible axle weight. The gross vehicle weight on each axle must never exceed the GAWR for the front and rear axle indicated on the certification label located on the driver's door pillar.

GVW

(Gross Vehicle Weight)
The GVW comprises the weight of the vehicle including fuel, tools, spare wheel, installed accessories, passengers and cargo. The GVW must never exceed the GVWR indicated on the certification label located on the driver's door pillar.

GVWR

(Gross Vehicle Weight Rating)
This is the maximum permissible vehicle weight. It is indicated on certification label located on the driver's door pillar.

Gear range

Number of gears which are available to the automatic transmission for shifting. The automatic gear shifting process can be adapted to specific operating conditions using the gear selector lever.

GPS

(Global Positioning System)
Satellite-based system for relaying geographic location information to and from vehicles equipped with special receivers. Employs CD digital maps for navigation.

Instrument cluster

The displays and indicator/warning lamps in the driver's field of vision, including the tachometer, speedometer, engine temperature and fuel gauge.

Kickdown

Depressing the accelerator past the point of resistance shifts the transmission down to the lowest possible gear. This very quickly accelerates the vehicle and should not be used for normal acceleration needs.

Line of fall

The direct line that an object moves downhill when influenced by the force of gravity alone.

Lock button

Button on the door which indicates whether the door is locked or unlocked. Pushing the lock button down on an individual door from inside will lock that door.

Memory function*

Used to store three individual seat, steering wheel and mirror positions for each key.

Menu

The control system displays are arranged in menus. Each menu contains a number of commands for particular systems. In the Audio menu, for example, you will find the commands *Select radio station* or *Operate CD player*. Using commands, you can directly change the settings for your vehicle.

MON

(Motor Octane Number)
The Motor Octane Number for gasoline as determined by a standardized method. It is an indication of a gasoline's ability to resist undesired detonation (knocking). The average of both the MON (Motor Octane Number) and ->RON (Research Octane Number) is posted at the pump, also known as ANTI-KNOCK INDEX.

Multifunction display

A display field in the instrument cluster used to present information provided by the control system.

Overspeed range

Engine speeds within the red marking of the tachometer dial. Avoid this engine speed range, as it may result in serious engine damage that is not covered by the Mercedes-Benz Limited Warranty.

Technical terms

Poly-V-belt drive

Drives engine-components (alternator, AC compressor, etc.) from the engine.

Power train

Collective term designating all components used to generate and transmit motive power to the drive axles, including

- engine
- clutch/torque converter
- transmission
- transfer case
- drive shaft
- differential
- axle shafts/axles

Rear Parking Assist*

System which uses visual and acoustic signals to assist the driver during parking maneuvers.

Remote Vehicle Diagnostics

Transmission of vehicle data and current location to the Mercedes-Benz Customer Assistance Center for subscribers to Tele Aid service.

REST

(Residual engine heat utilization)
Feature that uses the engine heat stored in the coolant to heat the vehicle interior for a short time after the engine has been turned off.

Restraint system

Seat belts, belt tensioner, airbags and child seat restraint systems. As independent systems, their protective functions complement one another.

RON

(Research Octane Number)
The Research Octane Number for gasoline as determined by a standardized method. It is an indication of a gasoline's ability to resist undesired detonation (knocking). The average of both the →MON (Motor Octane Number) and RON (Research Octane Number) is posted at the pump, also known as ANTI-KNOCK INDEX.

Shift lock

When the vehicle is parked, this lock prevents the transmission gear selector lever from being moved out of position **P** without key turned and brake pedal depressed.

SRS

(Supplemental Restraint System)
Seat belts, emergency tensioning device and airbags. Though independent systems, they are closely interfaced to provide effective occupant protection.

Tele Aid System

(Telematic Alarm Identification on Demand)

The Tele Aid system consists of three types of response: automatic and manual emergency, roadside assistance and information. Tele Aid is initially activated by completing a subscriber agreement and placing an acquaintance call.

The Tele Aid system is operational provided that the vehicle's battery is charged, properly connected, not damaged and cellular and GPS coverage is available.

Telematics*

A combination of the terms "telecommunications" and "informatics".

Tightening torque

Force times lever arm (e.g. a lug wrench) with which threaded fasteners such as wheel bolts are tightened.

Tire speed rating

Part of tire designation; indicates the speed range for which a tire is approved.

Traction

Force exerted by the vehicle on the road via the tires.

Transfer case

Speed of rotation/torque converter that works together with the ->automatic transmission. In the LOW mode off-road position, the transfer case decreases the output rotational speed of the ->automatic transmission by approximately half. This results in a corresponding increase of torque on the drive axles.

The vehicle then has nearly double the driving force but drives only approximately half as fast.

VIN

(Vehicle Identification Number)

The number set by the manufacturer and placed on the body to uniquely identify each vehicle produced.

Voice control system*

Voice control system for car phones, portable cell phones and audio systems (radio, CD, etc.).



A

- ABS 25, 74, 343
 - LOW RANGE mode 75
 - Malfunction indicator lamp 252, 253
 - Messages in display 261
 - Warning lamp 252, 253
- Accelerator position, automatic transmission 144
- Accident
 - In case of 50
- Activating
 - Air conditioning (cooling) 162
 - Air recirculation mode 160
 - Anti-theft alarm system 82
 - Central locking (control system) 133
 - Defrost 160
 - Easy-entry/exit feature 133
 - ESP 81
 - Exterior headlamps 46
 - Exterior lamps 105
 - Exterior rear view mirror parking position 153
 - Hazard warning flasher 108
 - Headlamps 46
 - High beams 108
 - Ignition 33
 - Rear fog lamp 106
 - Rear window defroster 155
 - Windshield wipers 47
- Adding
 - Coolant 233
 - Engine oil 231
- Additional turn signals 295
- Adjusting 34
 - Air distribution 159
 - Air volume 159
 - Backrest tilt 36
 - Exterior rear view mirror 38
 - Head restraint height 36
 - Head restraint height, rear seats 96
 - Head restraint tilt 36
 - Instrument cluster illumination 112
 - Interior rear view mirror 38
 - Mirrors 38
 - Multicontour seat* 97
 - Seat cushion length 97
 - Seat cushion tilt 36
 - Seat fore and aft adjustment 35
 - Seat height 36
 - Seats 34
 - Steering column in/out 37
 - Steering column up/down 37
 - Steering wheel 37
- Air conditioning (cooling)
 - Turning off 162
 - Turning on 162
- Air conditioning refrigerant 335
- Air distribution
 - Adjusting 159
- Air pressure see Tire inflation pressure
- Air recirculation mode 160
 - Activating 160
 - Deactivating 161

Index

- Air volume
 - Adjusting 159
 - AIRBAG OFF indicator lamp 259
 - Airbags 57
 - BabySmart™ airbag deactivation system 68, 343
 - Front 61
 - Safety guidelines 60
 - Alarm
 - Audible 73, 82
 - Canceling 83, 84
 - Visual 82
 - Alarm system
 - Anti-theft 82
 - Anticorrosion/antifreeze 337
 - Antiglare
 - Automatic 152
 - Antilock brake system (ABS) 343
 - Anti-theft alarm system
 - Arming 82
 - Canceling alarm 83
 - Disarming 83
 - Anti-theft systems 82
 - Anti-theft alarm system 82
 - Tow-away alarm 83
 - Aquaplaning see Hydroplaning
 - Armrest
 - Storage compartment below 184
 - Storage compartment in front of 184
 - Ashtrays 186
 - At the gas station 224
 - ATF (automatic transmission fluid) 232
 - AUDIO menu 120
 - Selecting radio station 121
 - Automatic antiglare for rear view mirror 152
 - Automatic central locking
 - Activating/deactivating (control system) 133
 - Automatic climate control
 - Deactivating 162
 - Automatic headlamp mode 105
 - Automatic lighting control
 - Activating 109
 - Deactivating 109
 - Automatic locking when driving 91
 - Automatic transmission 140
 - Accelerator position 144
 - Emergency operation (Limp Home Mode) 144
 - Fluid level 232
 - Gear ranges 142
 - Gear selector lever position 140, 142
 - Gear shifting malfunctions 144
 - Kickdown 144
 - Manual shifting 141
 - One-touch gearshifting 141
 - Transmission fluid 232
- B**
- BabySmart™
 - Airbag deactivation system 68, 343
 - Compatible child seats 68, 343
 - Self-test 68

- Backup lamps 296
 - Bulbs 296
 - Replacing bulbs 302
 - BAS 74, 76, 343
 - Messages in display 261
 - Batteries, SmartKey
 - Changing 288
 - Check lamp 87
 - Checking 88
 - Battery box
 - Fuse box in 319
 - Battery discharged
 - Jump starting 313
 - Battery, vehicle 235, 311
 - Charging 311
 - Disconnecting 312
 - Messages in display 265, 266
 - Reconnecting 312
 - Block heater 240
 - Blocking rear door window operation 71
 - B-pillar 326
 - Brake assist system (BAS) 343
 - Brake fluid 225, 335
 - Brake lamp bulbs, left and right 296
 - Brake lamp, high mounted 296
 - Brake pads
 - Message in display 266
 - Brakes 208
 - Warning lamp 254, 255
 - Break-in period 206
 - Brush guard* 293
 - Lowering 294
 - Raising and securing 294
 - Bulbs, replacing
 - Additional turn signals 295
 - Backup lamps 296, 302
 - Brake lamps 296, 302
 - Front fog lamps 295, 299
 - Front lamps 295
 - Front turn signal lamps 295, 300
 - High and low beam 297
 - High beam lamps 295
 - High mounted brake lamp 296
 - License plate lamps 296, 303
 - Low beam lamps 295
 - Parking lamps 295, 296, 297
 - Rear fog lamp 296, 302
 - Rear turn signal lamps 296
 - Side marker lamps 295, 300
 - Standing lamps 295, 296, 297
 - Tail lamp assemblies 296, 301
- C**
- CAC (Customer Assistance Center) 343
 - Calling up
 - Range (distance to empty) 137
 - Service indicator 243
 - CAN system 343
 - Capacities
 - Fuels, coolants, lubricants, etc. 333
 - Cargo area see Cargo compartment

Index

- Cargo compartment
 - Tailgate 89, 90
 - Tie-down rings 182
- Cargo compartment cover 175
 - Installing 176
 - Removing 176
- Cargo tie-down rings 182
- Catalytic converter 222
- CD changer 284
- CD player
 - Operating 121
- Center console 27
 - AIRBAG OFF indicator lamp 259
 - Lower part 28
 - Upper part 27
- Centigrade
 - Setting temperature units 127
- Central locking
 - From inside 92
 - Switch 92
- Switching on/off (control system) 133
- Unlocking from inside 92
- Certification label 326
- Changing
 - Batteries (SmartKey) 288
 - Key setting 133
- Charging
 - Vehicle battery 311
- CHECK ENGINE malfunction indicator lamp 256
- Checking
 - Coolant level 225, 232
 - Oil level 226, 228
- Checklist
 - Off-road driving 215
- Child safety 65
 - Infant and child restraint systems 56, 62, 66
 - LATCH child seat anchors 70
- Child safety switch see Blocking of rear door window operation
- Cigarette lighter 188
- Cleaning
 - Cup holders 248
 - Gear selector lever 248
 - Hard plastic trim items 248
 - Headlamps 153
 - Headliner 248
 - Illuminated door sill panels 249
 - Instrument cluster 248
 - Leather upholstery 249
 - Light alloy wheels 248
 - MB Tex upholstery 249
 - Plastic and rubber parts 249
 - Rear Parking Assist sensors* 247
 - Seat belts 248
 - Steering wheel 248
 - Windows 247
 - Windshield 48
 - Wiper blades 247
 - Wood trims 249

- Climate control 156
 - Adjusting 159, 160
 - Defogging windshield 160
 - Defrosting 160
 - Rear window defroster 155
 - Setting the temperature 158
- Clock 25
- Closing
 - Glove box 183
 - Hood 228
 - Side windows 164
 - Sliding/pop-up roof 166, 292
 - Sliding/pop-up roof with SmartKey 167
 - Tailgate 90
 - Windows 164
 - Windows with SmartKey 165
- Closing sliding/pop-up roof
 - In an emergency 292
- Cockpit 22, 343
- Cockpit management and data system (COMAND) 343
- COMAND 343
- COMAND see separate operating instructions
- Combination switch 23, 107, 108
 - High beam flasher 47, 108
 - Turn signals 46
 - Windshield wipers 47
- Control and operation of radio transmitters 221
- Control system 115, 343
 - AUDIO menu 120
 - Convenience submenu 133
 - Display digital speedometer 120
 - Functions 116, 119
 - Instrument cluster submenu 127
 - Lighting submenu 129
 - Malfunction memory menu 122
 - Menus 118, 119, 345
 - Multifunction display 115
 - Multifunction steering wheel 116
 - NAVI menu 122
 - Selecting radio system 121
 - Settings menu 123
 - Standard display menu 120
- Submenus 117, 119
 - TEL menu 137
 - Trip computer menu 136
 - Vehicle submenu 132
- Convenience feature 165
- Convenience submenu 133
 - Activating easy-entry/exit feature 133
 - Setting key-dependency 135
 - Setting parking position for exterior rear view mirror 135
- Coolant 232, 336
 - Adding 233
 - Anticorrosion/antifreeze quantity 337
 - Capacities 333
 - Checking level 232
 - Messages in display 268, 269
 - Temperature 223
 - Temperature display 112
 - Warning lamp 268
- Coolant level
 - Checking 225, 232

Index

Crossing obstacles 218
Cruise control 169, 344
 Canceling 170
 Driving downhill 170
 Driving uphill 170
 Fine adjustment 171
 Setting current speed 170
 Setting speed 171
Cruise control lever 169
Cup holder
 In rear passenger footwell 186
Cup holders 185
 Cleaning 248
 In front passenger footwell 185
 Next to the armrest 185
Customer Assistance Center (CAC) 343

D
Daytime running lamp mode 106
 Setting 129
Deactivating
 Air conditioning (cooling) 162
 Air recirculation mode 161
 Alarm 83
 Anti-theft alarm system 83
 Central locking (control system) 133
 Cruise control 170
 Defrost 160
 ESP 79
 Exterior lamps 105
 Exterior lamps delayed
 switch-off 131
 Hazard warning flasher 108
 Headlamps 52
 Immobilizer 82
 Interior lighting delayed
 switch-off 132
 Rear window defroster 155
 Tow-away alarm 84
Deep water see Standing water

Defogging
 Windshield 160
Defrosting 160
Delayed switch-off
 Exterior lamps 131
 Interior lighting 132
Dialing
 A number (telephone) 139
Differential locks 148, 344
 Switching off 151
 Switching on 150
Difficulties
 While driving see Problems while driving
 With starting 44
Digital speedometer 120
Direction of rotation (tires) 237
Discharged battery
 Jump starting 313
Disconnecting
 Vehicle battery 312
Display
 Selecting 129

- Displays
 - Digital speedometer 120
 - Messages 229, 260
 - Selecting 129
 - Service indicator 242
 - Showing malfunctions 122
- Distance to empty (range)
 - Calling up 136
- Door control panel 30
- Door handle 30
- Door sill panels
 - Cleaning 249
- Door unlock
 - With Tele Aid 197
- Doors
 - Message in display 271
 - Opening from the inside 89
 - Opening from the outside 87
- Downhill driving
 - Cruise control 170
- Downshifting 141
- Drink holders see Cup holders
- Drinking and driving 207
- Driving
 - General instructions 40, 207
 - In winter 212
 - Problems 50
 - Safety systems 74
 - Through standing water 213
- Driving abroad 222
- Driving and safety systems
 - 4-ETS 77
 - ABS 74
 - BAS 76
 - EBB 78
 - ESP 78
- Driving instruction
 - Passenger compartment 213
- Driving instructions 207
- Driving off 209
- Driving systems 169
 - Cruise control 169
 - Driving safety systems 74
- Driving through water 217
- E**
- Easy-entry/exit feature 94
 - Activating 133
 - Interrupting movement 134
- EBB 74, 78
- Electrical fuses 319
- Electrical outlet 188
- Electrical system
 - Technical data 331
- Electronic Brake Booster (EBB) 78
- Electronic Stability Program see ESP
- Electronic Stability program see ESP
- Electronic Traction System (ETS) 77
- Emergency call system 190
- Emergency calls
 - Initiating an emergency call 193
 - With Tele Aid 191

Index

- Emergency operation (Limp Home Mode) 144
- Emergency operations
 - Closing sliding/pop-up roof 292
 - Locking the vehicle 288
 - Opening sliding/pop-up roof 292
 - Remote door unlock 197
 - Unlocking the tailgate 287
 - Unlocking the vehicle 287
- Emergency tensioning device see ETD
- Emission control 222
- Emission control label 326
- Ending
 - A call (telephone) 138
- Engine
 - Compartment 227
 - Message in display 256
 - Starting with the key 44
 - Technical data 328
 - Turning off with the key 52
- Engine cleaning 246
- Engine compartment 227
 - Hood 227
- Engine malfunction indicator lamp 25, 256
- Engine number 344
- Engine oil 228, 334
 - Adding 231
 - Additives 335, 340
 - Checking level 228
 - Consumption 228
 - Display messages 272
 - Messages in display 229, 271
 - Oil dipstick 232
 - Viscosity 344
- Engine oil level see Oil level
- Enlarged cargo compartment 176
- ESP 25, 74, 78, 344
 - Messages in display 263
 - Switching off 79
 - Switching on 81
 - Synchronizing 263
 - Warning lamp 257
- ETD 56, 65, 344
 - Safety guidelines 60
- Exterior lamp switch 104
- Exterior lamps
 - Delayed switch-off 131
- Exterior rear view mirrors
 - Adjusting 38
 - Parking position for 135
- F**
- Fahrenheit
 - Setting temperature units 127
- Fastening the seat belts 40
- Fine adjustment
 - Cruise control 171
- First aid kit 283
- Flat tire 306
 - Lowering the vehicle 310
 - Mounting the spare wheel 307
 - Spare wheel 285

- Flexible Service System (FSS) 242, 344
- Fog lamp, rear 107, 296
- Fog lamps, front 107
 - Messages in display 275
 - Switching on 107
- 4-ETS 74, 77
- Front airbags 61
- Front axle differential lock
 - Switching on 151
- Front fog lamps
 - Replacing bulbs 295, 299
- Front lamps
 - Messages in display 274, 276
 - Replacing bulbs 295, 297
 - Switching on 104
- Front seat head restraints
 - Installing 95
 - Removing 95
- Front towing eye 318
- Front turn signal lamp
 - Replacing bulbs 300
- FSS (Flexible Service System) 242, 344
- Fuel 225
 - Additives 336
 - Fuel reserve warning lamp 258
 - Gasoline additives 336
 - Premium unleaded gasoline 225, 333, 335
 - Refueling 224
 - Requirements 336
 - Reserve warning 25
 - Technical data 333
- Fuel additives 336
- Fuel consumption statistics
 - After start 136
 - Since last reset 136
- Fuel filler flap 224
 - Locking 224
 - Opening 290
 - Unlocking 224
- Fuel requirements 336
- Fuel reserve tank
 - Message in display 273
- Fuel tank
 - Capacity 333
 - Filler flap 224
- Fuels, coolants, lubricants, etc.
 - Capacities 333
- Functions (control system) 116, 119
 - Resetting 125
- Fuse box 319, 320, 321
- Fuses 319
 - Fuse box in battery box 319
 - Fuse box in front passenger footwell 320
 - Fuse box in middle tunnel 321
 - Fuse box in passenger compartment 319
- G**
- Garage door opener 29, 198
- Gasoline see Fuel
 - Gasoline additives 336
- GAWR 344

Index

Gear range 344
 Automatic transmission 142
 Limiting 142
 Shifting into optimal 141
 Transfer case 145
Gear range limit
 Canceling 141
Gear selector lever
 Cleaning 248
 Position 142
 Position (automatic transmission) 140
Global
 Locking 87
 Unlocking 87
Global Positioning System (GPS) 345
Glove box 23, 183
 Closing 183
 Opening 183
Good visibility 152
GPS 345
GVW 344
GVWR 344

H
Hard plastic trim items
 Cleaning 248
Hazard warning flasher 108
 Switching off 108
 Switching on 108
Head restraints 95
 Power seats 36
 Synchronizing 95
Headlamp cleaning system 234
Headlamps
 Automatic control 105
 Cleaning 246
 Cleaning system 153, 234
 Switching off 52
 Switching on 46
 Washer fluid 339
 Washer system 339

Headlight switch-off delay see Delayed switch-off, exterior lamps
Headliner
 Cleaning 248
Heated seats 98
Heated steering wheel 203
Height adjustment
 Head restraints 36
 Seat belts 42
 Steering wheel 37
High beam flasher 47, 108
High beam headlamps
 Messages in display 275
 Replacing bulbs 295, 297
 Switching on 108
High mounted brake lamp 296
Hood 227
 Closing 228
 Messages in display 273
 Opening 227
Hydroplaning 210

- I**
- Identification labels 326
 - Certification label 326
 - Vehicle identification number (VIN) 326
 - Ignition 33
 - Switching on 44
 - Immobilizer 82
 - Activating 82
 - Deactivating 82
 - Infant and child restraint systems 66
 - Installing 69
 - LATCH child seat anchors 70
 - Information
 - Button for Tele Aid 194
 - Inside rear view mirror
 - Antiglare 152
 - Installing
 - Cargo compartment cover 176
 - Infant and child restraint systems 69
 - Wiper blades 305
 - Instructions
 - Loading 180
 - Instrument cluster 24, 112, 345
 - Cleaning 248
 - Coolant temperature display 112
 - Illumination 112
 - Lamps in 258
 - Multifunction display 115
 - Outside temperature indicator 114
 - Selecting language 128
 - Instrument lighting 112
 - Instruments and controls see Cockpit
 - Interior lighting 109
 - Activating automatic control 109
 - Deactivating automatic control 109
 - Delayed switch-off 132
 - Manual operation 109
 - Interior rear view mirror
 - Adjusting 38
 - Interior storage spaces 183
 - Cup holders 185, 186
 - Glove box 183
 - Parcel net in front passenger footwell 186
 - Storage compartment below armrest 184
 - Storage compartment in front of armrest 184
 - Interval wiping 49
 - Switching off 49
 - Switching on 49

J

 - Jack 283, 284
 - Jump starting 313

K

 - Key positions in starter switch 33
 - Key, mechanical 287
 - Key, SmartKey
 - Battery check lamp 87
 - Changing the batteries 288
 - Checking the batteries 88
 - Factory setting 87
 - Global locking 87
 - Global unlocking 87
 - Loss of 88
 - Positions in starter switch 33
 - Remote controls 86
 - Restoring to factory setting 87
 - Selective setting 87
 - Starting the engine 44
 - Unlocking with 32
 - Key-dependency memory
 - Settings 135

Index

Keys 86
Kickdown 144, 345
Kilometers/miles in speedometer 128
Km/h or mph in speedometer 128

L

Labels, identification 326
Lamp bulbs, exterior 295
Lamps, exterior
 Front 295
 Light sensor 276
 Messages in display 274, 276
 Rear 296
 Replacing bulbs for rear 301
Lamps, indicator and warning
 ABS 252, 253
 Battery (SmartKey) 87
 Brakes 254, 255
 CHECK ENGINE 256
 Engine diagnostics 256
 ESP 257
 Fuel reserve 258
 Instrument cluster 258
 Seat belts 258
 Service indicator 242
 SRS 57
 Turn signals 25

Language
 Multifunction display 128
 Setting 128
LATCH child seat anchors 70
Layout of poly-V-belt drive 327
Leather upholstery
 Cleaning 249
License plate lamps
 Messages in display 276
 Replacing bulbs 296, 303
Light alloy wheels
 Cleaning 248
 Technical data 329, 330
Light sensor 276
Lighter see Cigarette lighter
Lighting 104
 Automatic headlamp mode 105
 Combination switch 108
 Daytime running lamp mode 106
 Exterior lamp switch 104
 Front fog lamps 107
 High beam flasher 108
 High beams 108
 Instrument cluster illumination 112

Interior 109
Locator lighting 106
Low beams 104
Manual headlamp mode 105
Night security illumination 106
Parking lamps 104
Rear fog lamp 107
 Settings (control system) 129
Limiting the gear range 142
Limp Home Mode 144
Line of fall 345
Loading 175
 Cargo compartment cover 175
 Cargo tie-down rings 182
 Instructions 180
 Partition net* 178
 Roof rack 175
 Split rear bench seat 176
Locator lighting 106
 Setting 130

- Lock button 345
- Locking 51, 86
 - Fuel filler flap 224
 - Global, SmartKey 87
 - Separately the tailgate 90
 - Vehicle in an emergency 288
- Loss of keys 88
- Loss of Service and Warranty Information
 - Booklet 325
- Low beam headlamps
 - Messages in display 276
 - Replacing bulbs 295, 297
- LOW RANGE - ABS 75
- Lowering
 - Vehicle 310
- Lubricants
 - Technical data 333
- M**
- Main dimensions 332
- Maintenance 242
- Malfunction
 - Displaying 122
 - Rear Parking Assist* 174
- Malfunction memory 122
 - Calling up 122
 - Clearing 123
- Manual headlamp mode 105
- Manual operations
 - Fuel filler flap 290
 - Interior lighting control 109
 - Locking the tailgate 90
 - Locking the vehicle 288
 - Sliding/pop-up roof 292
 - Unlocking the driver's door 287
 - Unlocking the tailgate 91, 287
 - Unlocking transmission gear selector lever 290
- MB Tex upholstery
 - Cleaning 249
- Mechanical key 287
- Memory function 101, 345
 - Recalling positions from memory 102
- Storing exterior rear view mirror parking positions 103
- Storing key dependent settings 102
- Menus 116
 - AUDIO 120
 - Control system 345
 - In control system 118, 119
 - Malfunction memory 122
 - NAVI 122
 - Settings menu 123
 - Standard display 120
 - Submenus 117
 - TEL 137
 - Trip computer 136
- Messages in the multifunction display
 - Symbol messages 265
 - Text messages 261
- Middle tunnel
 - Fuse box in 321
- Miles/kilometers in speedometer
 - Setting 128

Index

Mirrors

- Activating exterior rear view mirror parking position 153
 - Adjusting 38
 - Automatic antiglare for rear view mirror 152
 - Exterior rear view mirror 38
 - Exterior rear view mirror parking positions 135
 - Interior rear view mirror 38
 - Storing exterior rear view mirror parking position 103
- MON 225
- MON (Motor Octane Number) 345
- Monitoring reach
- Rear Parking Assist* 173
- Mph or km/h in speedometer setting 128
- Multicontour seat* 97
- Multifunction display 115, 345
- Selecting language 128
 - Standard display 119

Multifunction display messages

- ABS 261
 - BAS 261
 - Battery 265, 266
 - Brake fluid 266
 - Brake pads 266
 - Check engine 256
 - Coolant 268, 269
 - Display 282
 - Doors 271
 - Engine 256
 - Engine oil level 271
 - ESP 263
 - Fuel reserve tank 273
 - Hood 273
 - Key 273
 - Lamps 274, 276
 - Parking brake 267
 - Sunroof 281
 - Tailgate 282
 - Tele Aid 281
 - Telephone* 281
 - Washer fluid 282
- Multifunction steering wheel 26, 116
- Buttons 116

N

- Navigation system
- Operating 122
 - See separate COMAND operating instructions
- Night security illumination 106
- Setting 131

O

- Occupant safety 56
- Airbags 57
 - Children in the vehicle 65
 - Fastening the seat belt 40
 - Infant and child restraint systems 66
 - LATCH child seat anchors 70
 - Seat belts 40, 60
- Odometer, main 25
- Off-road driving 213
- Checklist 215
 - Crossing obstacles 218
 - Driving through water 217
 - Returning 220
 - Rules 214
 - Special driving features 214
 - Steep terrain 216

- Oil
 - Adding 231
 - Consumption 228
 - Dipstick 228
 - Oil dipstick 232
 - Viscosity 344
 - Oil level
 - Checking 226
 - One-touch gearshifting 141
 - Canceling gear range limit 141
 - Downshifting 141
 - Upshifting 141
 - Opening
 - Ashtray 186
 - Doors from the inside 89
 - Fuel filler flap 224
 - Fuel filler flap manually 290
 - Glove box 183
 - Hood 227
 - Side windows 164
 - Sliding/pop-up roof 166, 292
 - Sliding/pop-up roof in an emergency 292
 - Sliding/pop-up roof with SmartKey 167
 - Tailgate 89, 90
 - Windows 164
 - Windows with SmartKey 165
 - Operating
 - CD player 121
 - COMAND see separate operating instructions
 - Navigation system 122
 - Radio 121
 - Radio transmitters 221
 - Telephone 137
 - Operator's Manual 10
 - Ornamental moldings 246
 - Outside temperature indicator 114
 - Overdue service 242
 - Overhead control panel 29
 - Overspeed range 345
- P**
- Paintwork 245
 - Panic alarm 73
 - Panic button on SmartKey 73
 - Parcel net
 - In front passenger footwell 186
 - Parking 51, 209
 - Parking brake 44, 51
 - Engaging 51
 - Message in display 267
 - Releasing 44
 - Parking lamp, front
 - Replacing bulbs 297
 - Parking lamps
 - Replacing bulbs 295, 296
 - Switching on 104
 - Parking position
 - Exterior rear view mirrors 103, 135, 153
 - Parktronic see Rear Parking Assist*
 - Partition net* 178
 - Installing behind front seats 179
 - Installing behind rear seat bench 178
 - Removing 180
 - Parts see Spare parts service

Index

- Passenger compartment 213
 - Fuse box in 319
 - Interior lighting 109
 - Interior rear view mirror 38
 - Parcel net in front passenger footwell 186
 - Passenger footwell
 - Fuse box in 320
 - Passenger safety see Occupant safety
 - Pedals 207
 - Phone book
 - Loading 139
 - Quick search 139
 - Phone number
 - Dialing 139
 - Redialing 139
 - Plastic and rubber parts
 - Cleaning 249
 - Poly-V-belt drive 346
 - Layout 327
 - Positions (Memory function)
 - Recalling from memory 102
 - Storing into memory 102
 - Power assistance 208
 - Power seat
 - Adjusting backrest tilt 36
 - Adjusting head restraint height 36
 - Adjusting head restraint tilt 36
 - Adjusting seat cushion tilt 36
 - Adjusting seat height 36
 - Seat fore and aft adjustment 35
 - Power train 346
 - Power windows 164
 - Blocking of rear door window operation 71
 - Convenience feature 165
 - Side windows 164
 - Summer opening feature 165
 - Power-washer 245
 - Practical hints
 - First aid kit 283
 - Fuses 319
 - Lamp in center console 259
 - Lamps in instrument cluster 252
 - Messages in the display 260
 - Spare wheel 285
 - Towing the vehicle 315
 - Vehicle jack 284
 - Vehicle tool kit 283
 - Premium unleaded gasoline 335
 - Problems
 - While driving 50
 - Product information 9
- Q**
- Quick search
 - Phone book 139
- R**
- Radio
 - Selecting stations 121
 - Station search 121
 - Station selection setting 132
 - Radio transmitters, control and operation 221
 - Range (distance to empty)
 - Calling up 137
 - Range of sensor
 - Rear Parking Assist* 173
 - Reading lamp 29
 - Rear axle differential lock
 - Switching on 151
 - Rear bench seat
 - Foldable 176
 - Rear door window
 - Blocking operation 71

- Rear fog lamp
 - Replacing bulbs 302
 - Switching on 107
- Rear lamps see Tail lamps
- Rear Parking Assist* 172, 346
 - Cleaning sensors 247
 - Malfunction 174
 - Monitoring reach 173
 - Warning indicators 174
- Rear seat head restraints 96
 - Installing 96
 - Removing 96
- Rear towing eye 318
- Rear view mirror automatic antiglare 152
- Rear view mirrors see Mirrors
- Rear window defroster 155
 - Activating 155
 - Deactivating 155
- Rear window wiper/washer 49
- Reconnecting
 - Vehicle battery 312
- Refrigerant
 - Air conditioning 335
- Refueling 224
- Regular checks 225
- Remote controls
 - SmartKey 86
- Remote door unlock
 - With Tele Aid 197
- Remote Vehicle Diagnostics 346
- Removing
 - Cargo compartment cover 176
 - Wheel 309
 - Wiper blades 304
- Replacing
 - Brake lamp bulbs 296
 - Bulbs 295
 - Front lamp bulbs 297
 - Rear lamp bulbs 296, 301
 - Wiper blades 304
- Resetting
 - All functions (control system) 123
 - All functions of a submenu 125
 - Fuel consumption 136
 - Service indicator (FSS) 243
 - Trip odometer 113
- Residual heat utilization 346
- REST (Residual engine heat utilization) 346
- Restraint systems 56, 346
 - Airbags 56
 - Child seat recognition 56
 - Child seats 56
 - Emergency Tensioning Device (ETD) 56
 - Lower anchors and tethers for children (LATCH) 56
 - Seat belts 56
- Restraint systems see Infant and child restraint systems
- Returning from off-road driving 220
- Rims 329
- Roadside Assistance
 - Tele Aid 193

Index

- RON 225
- RON (Research Octane Number) 346
- Roof rack 175
- Rotating wheels 238
- Rubber parts
 - Cleaning 249
- S**
- Safety
 - Occupant 56
 - Safety belts see Seat belts
 - Safety systems
 - Driving 74
- Searching
 - Radio station 121
- Seat adjustment
 - Synchronizing 95
- Seat backrest
 - Folding forward 177
 - Returning to sitting position 177
- Seat belt force limiter 65
- Seat belt height adjustment 42
- Seat belts 56, 62
 - Cleaning 248
 - Fastening 40
 - Height adjustment 42
 - Proper use of 42, 64
 - Safety guidelines 60
 - Warning lamp 258
- Seat bench
 - Folding forward 177
 - Returning to sitting position 177
- Seat cushion length
 - Adjusting 97
- Seats 94
 - Adjusting 34
 - Easy entry/exit feature 94
 - Heater 98
 - Multicontour seat* 97
 - Split rear bench seat 176
- Selecting
 - Display 129
- Selector lever 25
 - Lock 43
 - Position (automatic transmission) 25
- Self-test
 - BabySmart™ airbag deactivation system 68
 - Tele Aid 191
- Service
 - Calling up the service indicator 243
 - Major service (Service B) 242
 - Minor service (Service A) 242
 - Overdue 242
 - Spare parts 324
 - Types 242
 - When due 242
- Service and Warranty Booklet
 - Loss of 325
- Service indicator 242
 - Calling up 243
 - Clearing 242, 243

- Service life (tires) 237
- Service System see FSS
- Setting
 - Clock 25
 - Convenience functions 133
 - Cruise control 170
 - Daytime running lamp mode 129
 - Higher speed in cruise control 171
 - Individual vehicle settings 123
 - Instrument lighting 112
 - Interior lighting delayed switch-off 132
 - Key-dependent memory 135
 - Lamps and lighting (control system) 129
 - Language, multifunction display 128
 - Locator lighting 130
 - Lower speed in cruise control 171
 - Miles/kilometers in speedometer 128
 - Night security illumination 131
 - Parking position for exterior rear view mirrors 135
 - Slower speed in cruise control 171
 - Speed in cruise control 171
 - Speedometer display mode 128
 - Station selection mode 132
 - Temperature (interior) 158
 - Temperature indicator 127
 - Time display mode 127
 - Units
 - Speedometer 128
 - Temperature 127
 - Time 127
- Setting current speed 170
- Settings
 - Convenience functions 133
 - Factory, SmartKey 87
 - Individual (SmartKey) 135
 - Lighting (control system) 129
 - Menus and submenus 117
 - Resetting all (control system) 123
 - Resetting in the submenu 125
 - Selective 87
- Settings menu
 - Functions in 123
 - Individual vehicle settings 123
 - Submenus 124
- Shift lock 346
- Shifting
 - Gear selector lever positions 142
- Shifting into optimal
 - Gear range 141
- Side marker lamps 296
 - Replacing bulbs 295, 300
- Side markers
 - Cleaning 246
- Side windows
 - Automatic opening 164
 - Cleaning 247
 - Closing 164, 165
 - Closing with SmartKey 165
 - Opening 164, 165
 - Opening fully 164
 - Opening with SmartKey 165
 - Stopping 164

Index

- Signal strength (telephone) 138
- Simultaneous wiping and washing
 - Windshield wipers 48
- Single wipe 48
- Sliding/pop-up roof 166
 - Closing 166, 292
 - Closing with SmartKey 167
 - Opening 166, 292
 - Opening with SmartKey 167
 - Stopping 167
- SmartKey 86
 - Locking and unlocking 86
 - Opening and closing the sliding/pop-up roof with 167
 - Opening and closing windows with 165
 - Unlocking with 32
- Snow chains 241
- Spare parts service 324
- Spare wheel 285
- Mounting 307
- Speed
 - Setting current 170
- Speed settings
 - Cruise control 171
- Speedometer 25
 - Setting units 128
- Speedometer display mode
 - Selecting 128
- Split rear bench seat 176
- SRS 64, 346
 - Indicator lamp 258
- Standing lamp, front
 - Replacing bulbs 297
- Standing lamps
 - Replacing bulbs 295, 296
- Standing water
 - Driving instructions 213
- Starter switch 23, 33
 - Positions 33
- Starting difficulties 44
- Starting position 33
- Starting the engine 43
- Station (radio)
 - Search 121
- Station selection
 - Setting 132
- Steep terrain 216
- Steering column
 - Adjusting in /out 37
 - Adjusting up/down 37
- Steering wheel
 - Adjusting 37
 - Adjusting in/out 37
 - Adjusting up/down 37
 - Buttons 26
 - Cleaning 248
 - Heated 203
- Stolen vehicle
 - Tracking services 197

- Stopping
 - Sliding/pop-up roof 167
 - Windows 164
- Storage compartments
 - Armrest 184
 - Glove box 183
- Storage spaces
 - Cup holders 184
- Storing (Memory function)
 - Positions into memory 102
- Submenus
 - Convenience 133
 - For settings 117
 - In control system 119
 - Instrument cluster 127
 - Lighting 129
 - Resetting functions in Control system 125
 - Selecting 124
 - Settings menu 124
 - Vehicle 132
- Summer opening feature 165
- Sun visors 154
- Sunroof
 - Messages in display 281
- Supplemental Restraint System (SRS) 346
- Switching
 - Transfer case 145
- Switching off
 - Automatic central locking (control system) 133
 - Delayed (exterior lamps) 131
 - Differential locks 151
 - Engine 52
 - ESP 79
 - Hazard warning flasher 108
 - Headlamps 52
 - Heated steering wheel 203
- Switching on
 - Automatic central locking (control system) 133
 - Differential locks 150
 - ESP 81
- Front axle differential lock 151
- Front fog lamps 107
- Hazard warning flasher 108
- Headlamps 46
- Heated steering wheel 203
- High beams 108
- Rear axle differential lock 151
- Rear fog lamp 107
- Transfer case differential lock 150
- Windshield wipers 47
- Symbol messages
 - Multifunction display 265
- Synchronizing
 - ESP 263
 - Head restraints 95
 - Seat adjustment 95
- T**
 - Tachometer 25, 113
 - Displaying gear range 142
 - Overspeed range 113

Index

- Tail lamps 301
 - Cleaning 246
 - Replacing bulbs 296
- Tailgate
 - Closing 90
 - Message in display 282
 - Opening 89, 90
 - Separately locking 90
 - Separately unlocking 91
 - Tailgate lock 284
 - Unlocking in an emergency 287
- Tar stains 245
- Technical data
 - Air conditioning refrigerant 335
 - Brake fluid 335
 - Coolant 333
 - Coolants 336
 - Electrical system 331
 - Engine 328
 - Engine oil 334
 - Engine oil additives 335, 340
 - Fuel requirements 336
 - Fuels 333
 - Gasoline additives 336
 - Lubricants 333
 - Main dimensions 332
 - Premium unleaded gasoline 335
 - Rims and tires 329
 - Weights and ratings 332
 - Windshield and headlamp washer system 334, 339
- Tele Aid 190
 - Emergency calls 191
 - Information 194
 - Initiating an emergency call manually 193
 - Messages in display 281
 - Remote door unlock 197
 - Roadside Assistance 193
 - Stolen vehicle tracking services 197
 - System self-check 191
 - Tele Aid System 190
 - Upgrade signals 196
- Tele Aid System 347
- Telematics* 347
- Telephone
 - Answering a call 138
 - Dialing a number from the phone book 139
 - Ending a call 138
 - Loading phone book 139
 - Operating 137
 - Redialing 139
- Telephone* 26, 189
 - Messages in display 281
- Temperature
 - Display mode 127
 - Grades of tires 341
 - Setting interior temperature 158
 - Setting units in display 127
 - Tires 238
- Text messages
 - Multifunction display 261
- Tie-down rings (Cargo compartment) 182
- Tightening torque 347

- Tightening torque (Wheel bolts) 310
- Time
 - Setting display mode 127
- Time display mode
 - Setting 127
- Tire inflation pressure
 - Checking 237
- Tire speed rating 211, 347
- Tire traction 211
- Tires 236, 329
 - Direction of rotation 237
 - Driving instructions 210
 - Retreads 236
 - Rims and tires 329
 - Service life 237
 - Temperature 238
 - Temperature grades 341
 - Tread depth 240
 - Wear pattern 238
 - Winter 240
- Tools 283
- Tow-away alarm 27, 83
 - Arming 83
 - Disarming 83
 - Disarming for transport 83
- Tow-away alarm system
 - Canceling alarm 84
- Towing eye, front 318
- Towing eye, rear 318
- Towing the vehicle 315
 - Stranded vehicle 318
- Towing the vehicle - various problem scenarios 317
- Tracking services
 - For stolen vehicle 197
- Traction 340, 347
- Transfer case 145, 347
 - Gear range 145
 - Messages in the multifunction display 146
 - Switching 145
- Transfer case differential lock
 - Switching on 150
- Transmission gear selector lever 290
 - Unlocking manually 290
- Transmission see Automatic transmission
- Tread depth (tires) 240
- Treadwear 340
- Trip computer 136
- Trip odometer
 - Resetting 113
- Trunk see Cargo compartment
- Turn signal lamps
 - Replacing bulbs 295, 296
- Turn signals 23, 46
 - Additional in mirrors 295
 - Cleaning lenses 246
 - Front bulbs 295
 - Indicator lamps 25
 - Rear bulbs 296
- Turning off
 - Engine 52

Index

U

Units

- Setting speedometer units 128
- Setting temperature units 127
- Setting time units 127

Unlocking 32, 86

- Driver's door in an emergency 287
- Fuel filler flap 224
- Global 87
- In an emergency 287
- Selective settings 87
- Separately the tailgate 91
- Tailgate in an emergency 287
- Transmission gear selector lever manually 290
- Vehicle in an emergency 197
- With the SmartKey 32

Upgrade signals

- Tele Aid 196

Uphill driving

- Cruise control 170

Upshifting 141

Useful features 183

- Ashtrays 186
- Cigarette lighter 188
- Electrical outlet 188
- Interior storage spaces 183
- Tele Aid 190
- Telephone* 189

V

Vehicle

- Individual settings 123, 126
- Locking 27
- Locking in an emergency 288
- Lowering 310
- Service battery 311
- Towing 315
- Unlocking 27
- Unlocking in an emergency 287

Vehicle battery 311

Vehicle care 244

- Cup holders 248
- Engine cleaning 246
- Gear selector lever 248
- Hard plastic trim items 248
- Headlamps 246
- Instrument cluster 248
- Leather upholstery 249
- Light alloy wheels 248
- MB Tex upholstery 249
- Ornamental moldings 246
- Paintwork 245
- Plastic and rubber parts 249
- Power-washer 245
- Seat belts 248
- Side markers 246
- Steering wheel 248
- Tail lamps 246
- Tar stains 245

- Turn signals 246
- Vehicle washing 246
- Window cleaning 247
- Wiper blades 247
- Wood trims 249
- Vehicle identification number (VIN) 326
- Vehicle jack 284
- Vehicle tool kit 283
- Vehicle washing 246
- VIN (Vehicle Identification Number) 326, 347
- Voice control system* 347
- W**
- Warning indicators
 - Rear Parking Assist* 174
- Warning sounds
 - Drivers seat belts 62
 - Exterior lighting 105
 - Parking brake 45
- Warranty coverage 325
- Washer fluid see Windshield washer fluid
- Washing the vehicle 245
- Wear pattern (tires) 238
- Weights and ratings 332
- Wheel change
 - Tightening torque 310
- Wheels
 - Rotating 238
 - Tires and wheels 236
- Windows see Side windows
- Windshield
 - Defogging 160
 - Replacing wiper blades 304
 - Washer fluid 234, 339
 - Washer system 339
- Windshield washer fluid 339
 - Message in display 282
 - Mixing ratio 339
 - Refilling 234
 - Wiping with 48
- Windshield washer system 339
- Windshield wipers 23, 47
 - Fast wiper speed 47
 - Interval wiping 49
 - Rear window wiper/washer 49
 - Replacing wiper blades 304
 - Single wipe 48
 - Switching on 47
 - Wiping with windshield washer fluid 48
- Winter driving 240
 - Block heater 240
 - Snow chains 241
 - Tires 240
- Winter driving instructions 212
- Winter tires 240
- Wiper blades
 - Cleaning 247
 - Installing 305
 - Removing 304
 - Replacing 304
- Wiper/washer
 - Rear window 49

Index

- Wiping
 - And washing simultaneously 48
 - Interval 47, 49
 - With windshield washer fluid 48
- Wood trims
 - Cleaning 249

Service and Literature

Your authorized Mercedes-Benz Light Truck Center has trained technicians and original Mercedes-Benz parts to service your vehicle properly. For expert advice and quality service, see your authorized Mercedes-Benz Light Truck Center.

If you are interested in obtaining service literature for your vehicle, please contact your authorized Mercedes-Benz Light Truck Center. We consider this the best way for you to obtain accurate information for your vehicle.

For further information you can find us on the Mercedes-Benz web-site www.mbusa.com or www.mercedes-benz.ca.

Warning!



To help avoid personal injury, be extremely careful when performing any service work or repairs. Improper or incomplete service or the use of incorrect or inappropriate parts or materials may damage the vehicle or its equipment, which may in turn result in personal injury.

If you have questions about carrying out any type of service, turn to the advice of an authorized Mercedes-Benz Light Truck Center.

We reserve the right to modify the technical details of the vehicle as given in the data and illustrations of this Operator's Manual. Reprinting, translation and copying, even of excerpts, is not permitted without our prior authorization in writing.

Title illustration no. P00.01-2285-31

Press time 08/20/03

GSP/TIP

Printed in Germany

