

C 230 Kompressor

C 320

Our company and staff congratulate you on the purchase of your new Mercedes-Benz.

Your selection of our product is a demonstration of your trust in our company name. Furthermore, it exemplifies your desire to own an automobile that will be as easy as possible to operate and provide years of service.

Your Mercedes-Benz represents the efforts of many skilled engineers and craftsmen. To help assure your driving pleasure, and also the safety of you and your passengers, we ask you to make a small investment of time:

- Please read this manual carefully, then return it to your vehicle where it will be handy for your reference.
- Please follow the recommendations contained in this manual. They are designed to acquaint you with the operation of your Mercedes-Benz.
- Please pay attention to the warnings and cautions contained in this manual. They are designed to help improve the safety of the vehicle operator and occupants.

We extend our best wishes for many miles of safe, pleasurable driving.

Mercedes-Benz USA, LLC  
A DaimlerChrysler Company

## Contents

<b>Introduction</b> .....	9	Center console .....	25	<b>Safety and Security</b> .....	55
Product information.....	9	Upper part .....	25	Occupant safety .....	56
Operator's Manual.....	10	Lower part .....	26	Airbags .....	57
Service and warranty information ..	10	Overhead control panel .....	27	Seat belts .....	62
Important notice for California		Door control panel.....	28	Children in the vehicle .....	65
retail buyers and lessees of				Panic alarm* .....	72
Mercedes-Benz automobiles .....	11	<b>Getting started</b> .....	29	Activating.....	72
Maintenance .....	12	Unlocking .....	30	Deactivating.....	72
Roadside Assistance .....	12	Unlocking with the SmartKey.....	30	Driving safety systems .....	73
Change of address or ownership....	12	Adjusting .....	32	ABS.....	73
Operating your vehicle		Seats.....	32	BAS.....	74
outside the USA or Canada .....	13	Steering wheel .....	37	ESP .....	75
Where to find it.....	14	Mirrors.....	39	Anti-theft systems .....	78
Symbols.....	15	Driving.....	41	Immobilizer .....	78
Operating safety .....	16	Fastening the seat belt .....	41	Anti-theft alarm system* .....	78
Proper use of the vehicle .....	16	Starting the engine .....	44	Tow-away alarm* .....	79
Problems with your vehicle.....	17	Switching on headlamps .....	48		
Reporting safety defects.....	18	Turn signals .....	48	<b>Controls in detail</b> .....	81
Reporting Safety Defects .....	18	High beam .....	48	Locking and unlocking .....	82
		Windshield wipers.....	49	Keys.....	82
		Problems while driving.....	50	Opening the doors from the inside .	85
<b>At a glance</b> .....	19	Parking and locking .....	52	Opening the trunk lid .....	85
Cockpit.....	20	Parking brake.....	52	Closing the trunk lid .....	86
Instrument cluster .....	22	Switching off headlamps.....	53	Trunk lid emergency release.....	86
Multifunction steering wheel .....	24	Turning off the engine .....	53		

## Contents

Automatic central locking .....	87	Multifunction display .....	109	Setting the temperature.....	153
Locking and unlocking		Multifunction steering wheel.....	110	Adjusting	
from the inside .....	88	Menus .....	112	air distribution and volume .....	153
Seats.....	89	Standard display menu .....	114	Defrosting .....	154
Easy-entry/exit feature* .....	89	AUDIO menu .....	114	Air recirculation mode.....	154
Removing and installing		NAVI* menu .....	117	Deactivating the	
front seat head restraints.....	90	Malfunction memory menu .....	117	climate control system.....	155
Rear seat head restraints .....	91	Settings menu.....	118	Air conditioning.....	156
Heated seats* .....	93	Trip computer menu.....	132	Ventilated storage compartment .	157
Memory function* .....	95	TEL menu* .....	134	Rear passenger compartment	
Storing positions into memory .....	96	Manual transmission .....	137	adjustable air vents.....	158
Recalling positions from memory ...	96	Shifting into reverse .....	138	Audio system.....	159
Storing exterior rear view mirror		Automatic transmission* .....	139	Audio and telephone, operation...	159
parking position .....	97	One-touch gearshifting.....	140	Operating safety .....	159
Lighting.....	98	Gear ranges.....	141	Operating and display elements...	160
Exterior lamp switch.....	98	Gear selector lever position .....	142	Button and soft key operation.....	162
Combination switch.....	102	Program mode selector switch.....	144	Operation.....	162
Hazard warning flasher.....	102	Accelerator position .....	145	Radio operation .....	165
Interior lighting .....	103	Emergency operation		Satellite radio (SAT)* (USA only)..	168
Instrument cluster .....	105	(Limp Home Mode) .....	145	Cassette operation .....	172
Instrument cluster illumination.....	105	Good visibility .....	146	CD changer* operation.....	175
Coolant temperature display .....	106	Rear view mirrors .....	146	Telephone* operation .....	179
Trip odometer.....	107	Headlamp cleaning system* .....	148	Power windows .....	186
Tachometer .....	107	Sun visors .....	148	Opening and closing the windows	186
Outside temperature indicator .....	107	Rear window defroster .....	149	Synchronizing power windows .....	188
Control system .....	109	Climate control .....	150	Panorama sliding/pop-up roof* .....	189

## Contents

Opening and closing the roller sunblinds for the panorama sliding/pop-up roof .....	189	Driving instructions .....	223	Hood .....	236
Opening and closing the panorama sliding/pop-up roof .....	190	Drive sensibly – save fuel.....	223	Engine oil .....	237
Synchronizing the panorama sliding /pop-up roof and the roller sunblinds .....	193	Drinking and driving.....	223	Transmission fluid level .....	241
Driving systems .....	194	Pedals .....	223	Coolant level.....	241
Cruise control .....	194	Power assistance.....	223	Battery .....	242
Loading.....	197	Brakes.....	224	Windshield washer system and headlamp cleaning system .....	243
Roof rack*.....	197	Driving off .....	225	Tires and wheels .....	244
Luggage cover.....	197	Parking.....	225	Important guidelines.....	244
Split rear bench seat.....	197	Tires.....	226	Life of tire .....	245
Loading instructions.....	199	Hydroplaning.....	227	Direction of rotation .....	245
Useful features .....	200	Tire traction .....	227	Checking tire inflation pressure....	245
Interior storage spaces .....	200	Tire speed rating.....	228	Rotating wheels .....	246
Ashtrays.....	203	Winter driving instructions.....	228	Winter driving.....	247
Cigarette lighter .....	204	Standing water.....	229	Winter tires .....	247
Telephone* .....	205	Passenger compartment.....	230	Block heater (Canada only).....	248
Tele Aid* .....	206	Driving abroad .....	230	Snow chains .....	248
Garage door opener .....	214	Control and operation of radio transmitter.....	230	Maintenance .....	249
<b>Operation</b> .....	221	Catalytic converter.....	231	Clearing the service indicator .....	249
The first 1000 miles (1500km) .....	222	Emission control .....	231	Service term exceeded .....	249
		Coolant temperature.....	232	Calling up the service indicator ....	250
		At the gas station .....	233	Resetting the service indicator .....	250
		Refueling.....	233	Vehicle care .....	251
		Check regularly and before a long trip .....	234	Cleaning and care of the vehicle...	251
		Engine compartment .....	236		

## Contents

<b>Practical hints</b> .....	257	Removing .....	300	Identification labels .....	322
What to do if ... ..	258	Installing .....	300	Layout of poly-V-belt drive .....	323
Lamps in instrument cluster.....	258	Flat tire .....	301	C 230 Kompressor.....	323
Lamp in center console .....	263	Preparing the vehicle .....	301	C 320 .....	323
Messages in the display .....	264	Mounting the spare wheel.....	301	Engine .....	324
Where will I find ...?.....	284	Battery .....	307	Rims and Tires.....	325
First aid kit .....	284	Disconnecting the battery.....	308	Same size tires.....	326
Spare wheel .....	285	Removing the batteries .....	308	Spare wheel .....	326
Vehicle tool kit .....	285	Charging and reinstalling		Electrical system .....	327
Unlocking/locking in an emergency ..	288	batteries.....	308	Main Dimensions.....	328
Unlocking the vehicle .....	288	Reconnecting the batteries .....	308	Weights .....	329
Locking the vehicle .....	289	Jump starting.....	310	Fuels, coolants, lubricants, etc. ....	330
Changing batteries in		Towing the vehicle .....	313	Capacities .....	330
the SmartKey .....	290	Installing towing eye bolt .....	316	Engine oils .....	332
Fuel filler flap .....	291	Fuses .....	317	Engine oil additives .....	332
Manually unlocking the		Fuse box in		Air conditioning refrigerant .....	332
gear selector lever.....	291	passenger compartment .....	317	Brake fluid.....	332
Opening/closing in an emergency.....	292	Fuse box in engine compartment.	317	Premium unleaded gasoline .....	333
Panorama sliding/pop-up roof .....	292	Auxiliary fuse box in trunk.....	318	Fuel requirements.....	333
Replacing bulbs .....	293			Gasoline additives.....	334
Bulbs .....	293			Flexible Fuel Vehicles.....	334
Replacing bulbs for front lamps....	295	<b>Technical data</b> .....	319	Coolants .....	336
Side marker lamp bulb .....	298	Spare parts service.....	320	Windshield washer system and	
Replacing bulbs for rear lamps.....	298	Warranty coverage.....	321	headlamp cleaning system.....	338
Replacing wiper blades .....	300	Loss of Service and Warranty		Consumer information.....	339
		Information Booklet .....	321	Uniform tire quality grading .....	339

## Contents

---

**Technical terms** ..... 341

---

**Index** ..... 347





▼ **Product information**

Please observe the following in your own best interest:

We recommend using genuine Mercedes-Benz parts as well as conversion parts and accessories explicitly approved by us for your vehicle model.

We have tested these parts to determine their reliability, safety and special suitability for Mercedes-Benz vehicles.

We are unable to make an assessment for other products and therefore cannot be held responsible for them, even if in individual cases an official approval or authorization by governmental or other agencies should exist. Use of such parts and accessories could adversely affect the safety, performance or reliability of your vehicle. Please do not use them.

Genuine Mercedes-Benz parts as well as conversion parts and accessories approved by us are available at your authorized Mercedes-Benz Center where you will receive comprehensive information, also on permissible technical modifications, and where proper installation will be performed.

## Introduction

### Operator's Manual

#### ▼ Operator's Manual

This Operator's Manual contains a great deal of useful information. We urge you to read it carefully and familiarize yourself with the vehicle before driving.

For your own safety and longer service life of the vehicle, we urge you to follow the instructions and warnings contained in this manual. Ignoring them could result in damage to the vehicle or personal injury to you or others. Vehicle damage caused by failure to follow instructions is not covered by the Mercedes-Benz Limited Warranty.

Your vehicle may have some or all of the equipment described in this manual. Therefore, you may find explanations for optional equipment not installed in your vehicle. If you have any questions about the operation of any equipment, your authorized Mercedes-Benz Center will be glad to demonstrate the proper procedures.

We continuously strive to improve our product, and ask for your understanding that we reserve the right to make changes in design and equipment. Therefore, information, illustrations and descriptions in this Operator's Manual might differ from your vehicle.

Optional equipment is also described in this manual, including operating instructions wherever necessary. Since they are special-order items, the descriptions and illustrations herein may vary slightly from the actual equipment of your vehicle.

If there are any equipment details that are not shown or described in this Operator's Manual, your authorized Mercedes-Benz Center will be glad to inform you of correct care and operating procedures.

The Operator's Manual and Service Booklet are important documents and should be kept with the vehicle.

#### Service and warranty information

The Service and Warranty Information Booklet contains detailed information about the warranties covering your Mercedes-Benz, including:

- New Car Limited Warranty,
- Emission System Warranty,
- Emission Performance Warranty,
- California, Maine, Massachusetts, and Vermont Emission Control System Warranty (California, Maine, Massachusetts, and Vermont only),
- State Warranty Enforcement Laws (Lemon Laws).

**Important notice for California retail buyers and lessees of Mercedes-Benz automobiles**

Under California law you may be entitled to a replacement of your vehicle or a refund of the purchase price or lease price, if Mercedes-Benz USA, LLC and /or its authorized repair or service facilities fail to fix one or more substantial defects or malfunctions in the vehicle that are covered by its express warranty after a reasonable number of repair attempts. During the period of 18 months from original delivery of the vehicle or the accumulation of 18 000 miles (approx. 29 000 km) on the odometer of the vehicle, whichever occurs first, a reasonable number of repair attempts is presumed for a retail buyer or lessee if one or more of the following occurs:

- (1) the same substantial defect or malfunction results in a condition that is likely to cause death or serious bodily injury if the vehicle is driven, that defect or malfunction has been subject to repair two or more times, and you have directly notified Mercedes-Benz USA, LLC in writing of the need for its repair,
- (2) the same substantial defect or malfunction of a less serious nature than category (1) has been subject to repair four or more times and you have directly notified us in writing of the need for its repair, or
- (3) the vehicle is out of service by reason of repair of the same or different substantial defects or malfunctions for a cumulative total of more than 30 calendar days. Written notification should be sent to us, not a dealer, at Mercedes-Benz USA, LLC, Customer Assistance Center, One Mercedes Drive, Montvale, NJ 07645-0350.

## Introduction

### Operator's Manual

#### Maintenance

---

The Service Booklet describes all the necessary maintenance work which should be performed at regular intervals.

Always have the Service Booklet with you when you take the vehicle to your authorized Mercedes-Benz Center for service. The service advisor will record each service in the booklet for you.

#### Roadside Assistance

---

The Mercedes-Benz Roadside Assistance Program provides factory-trained technical help in the event of a breakdown. Calls to the toll-free Roadside Assistance number

**1-800-FOR-MER-Cedes (in the USA)**  
**1-800-387-0100 (in Canada)**

will be answered by Mercedes-Benz Customer Assistance Representatives 24 hours a day, 365 days a year.

For additional information refer to the Mercedes-Benz Roadside Assistance Program Brochure in your glove box.

#### Change of address or ownership

---

If you change your address, be sure to send in the "Change of Address Notice" found in the Service and Warranty Information Booklet, or simply call the Mercedes-Benz Customer Assistance Center (in the USA) at 1-800-FOR-MER-Cedes, or Customer Service (in Canada) at 1-800-387-0100. It is in your own interest that we can contact you should the need arise.

If you sell your Mercedes, please leave all literature with the vehicle to make it available to the next operator.

If you bought this vehicle used, be sure to send in the "Notice of Purchase of Used Car" found in the Service and Warranty Information Booklet, or call the Mercedes-Benz Customer Assistance Center (in the USA) at 1-800-FOR-MER-Cedes, or Customer Service (in Canada) at 1-800-387-0100.

**Operating your vehicle outside the USA or Canada**

---

If you plan to operate your vehicle in foreign countries, please be aware that:

- service facilities or replacement parts may not be readily available,
- unleaded gasoline for vehicles with catalytic converters may not be available; the use of leaded fuels will damage the catalyts,
- gasoline may have a considerably lower octane rating, and improper fuel can cause engine damage.

Certain Mercedes-Benz models are available for delivery in Europe under our European Delivery Program. For details, consult your authorized Mercedes-Benz Center or write to:

In the USA:

Mercedes-Benz USA, LLC  
European Delivery Department  
One Mercedes Drive  
Montvale, NJ 07645-0350

In Canada:

Mercedes-Benz Canada, Inc.  
European Delivery Department  
849 Eglinton Avenue East  
Toronto, Ontario M4G 2L5

## Introduction

### Where to find it

#### ▼ Where to find it

This Operator's Manual is designed to provide comprehensive support information for you, the vehicle operator. Each section has its own reference color so you can find information quickly.

#### At a glance

Here you will find an overview of all the controls that can be operated from the driver's seat.

#### Getting started

Here you will find all the information you need for your first drive. You should read this section first if this is your first Mercedes-Benz vehicle or if you are renting or borrowing this vehicle.

#### Safety and Security

Here you will find descriptions of the safety features of your vehicle.

#### Controls in detail

Here you will find detailed information about the equipment installed in your vehicle. This section expands on the "Getting started" section and also describes technical innovations. If you are already familiar with the basic functions of your vehicle, this section will be of particular interest to you.

#### Operation

Here you will find all the information you need for the proper operation of your vehicle.

#### Practical hints

This section provides fast assistance for dealing with problems you may encounter.

#### Technical data

All important technical data for your vehicle can be found in this section.

#### Indexes

The glossary provides explanations of the most important technical terms.

The table of contents and the index are designed to help you find information quickly and easily.

The following publications are part of your vehicle documentation:

- this Operator's Manual
- the Service Booklet

Separate operating instructions will be provided as required depending on the equipment options installed in your vehicle.

## ▼ Symbols

The following symbols are found in this Operator's Manual:

- \* Optional equipment is identified with an asterisk. Since standard equipment varies between models, the descriptions and illustrations in this manual may differ slightly from the actual equipment of your vehicle.

### Warning!



Warning notices draw your attention to hazards that may endanger your health or life, or the health or life of others.



Highlights hazards that may result in damage to your vehicle.



Helpful hints or further information you may find useful.

- ▶ This symbol points to instructions for you to follow.
- ▶ A number of these symbols appearing in succession indicates a multiple-step procedure.
- ▷ Page This symbol tells you where to look for further information on a topic.
- ▷▷ This continuation symbol marks an interrupted procedure which will be continued on the next page.
- > In the glossary of technical terms, this symbol is used to indicate cross-references to term definitions.
- Display Words appearing in the multi-function display are printed in the type shown here.

## Introduction

### Operating safety

#### ▼ Operating safety

##### Warning!



Work improperly carried out on electronic components and associated software could cause them to cease functioning. Because the vehicle's electronic components are interconnected, any modification made may produce an undesired effect on other systems. Electronic malfunctions could seriously impair the operating safety of your vehicle.

See your authorized Mercedes-Benz Center for repairs or modifications to electronic components.

Other improper work or modifications on the vehicle could also have a negative impact on the operating safety of the vehicle.

Some safety systems only function while the engine is running. You should therefore never turn off the engine while driving.

##### Warning!



Heavy blows against the vehicle underbody or tires/wheels, for example when running over an obstacle, road debris or a pothole, may cause serious damage and impair the operating safety of your vehicle. If you feel a sudden significant vibration or ride disturbance, or you suspect that damage to your vehicle has occurred, you should turn on your hazard warning flashers, carefully slow down, and drive with caution to an area which is a safe distance from the road.

Inspect the vehicle underbody and tires/wheels for possible damage. If the vehicle appears unsafe, have it towed to the nearest authorized Mercedes-Benz Center or other qualified maintenance or repair facility for further inspection or repairs.

#### Proper use of the vehicle

Proper use of the vehicle requires that you are familiar with the following information and rules:

- the safety precautions in this manual
- the “Technical data” section in this manual
- traffic rules and regulations
- motor vehicle laws and safety standards

##### Warning!



Various warning labels are attached to your vehicle. These warning labels are intended to make you and others aware of various risks. You should not remove any of these warning labels unless explicitly instructed to do so by information on the label itself. Removal of any of these labels may cause you and others to be unaware of certain risks which may result in an accident and/or personal injury.



**Problems with your vehicle**

If you should experience a problem with your vehicle, particularly one that you believe may affect its safe operation, we urge you to immediately contact your authorized Mercedes-Benz Center to have the problem diagnosed and corrected if required. If the matter is not handled to your satisfaction, please discuss the problem with the Mercedes-Benz Center management, or if necessary contact us at one of the following addresses:

In the USA:

Customer Assistance Center  
Mercedes-Benz USA, LLC  
One Mercedes Drive  
Montvale, NJ 07645-0350

In Canada:

Customer Relations Department  
Mercedes-Benz Canada, Inc.  
849 Eglinton Avenue East  
Toronto, Ontario, M4G 2L5

## Introduction

### Reporting safety defects

#### Reporting safety defects

For the USA only:

The following text is published as required of manufacturers under Title 49, Code of U.S. Federal Regulations, Part 575 pursuant to the “National Traffic and Motor Vehicle Safety Act of 1966”.

#### Reporting Safety Defects

---

If you believe that your vehicle has a defect which could cause a crash or could cause injury or death, you should immediately inform the National Highway Traffic Safety Administration (NHTSA) in addition to notifying Mercedes-Benz USA, LLC.

If NHTSA receives similar complaints, it may open an investigation, and if it finds that a safety defect exists in a group of vehicles, it may order a recall and remedy campaign. However, NHTSA cannot become involved in individual problems between you, your dealer, or Mercedes-Benz USA, LLC.

To contact NHTSA, you may either call the Auto Safety Hotline toll-free at 1-888-327-4236 (or 366-0123 in Washington, D.C. area) or write to: NHTSA, U.S. Department of Transportation, Washington, D.C. 20590. You can also obtain other information about motor vehicle safety from the Hotline.

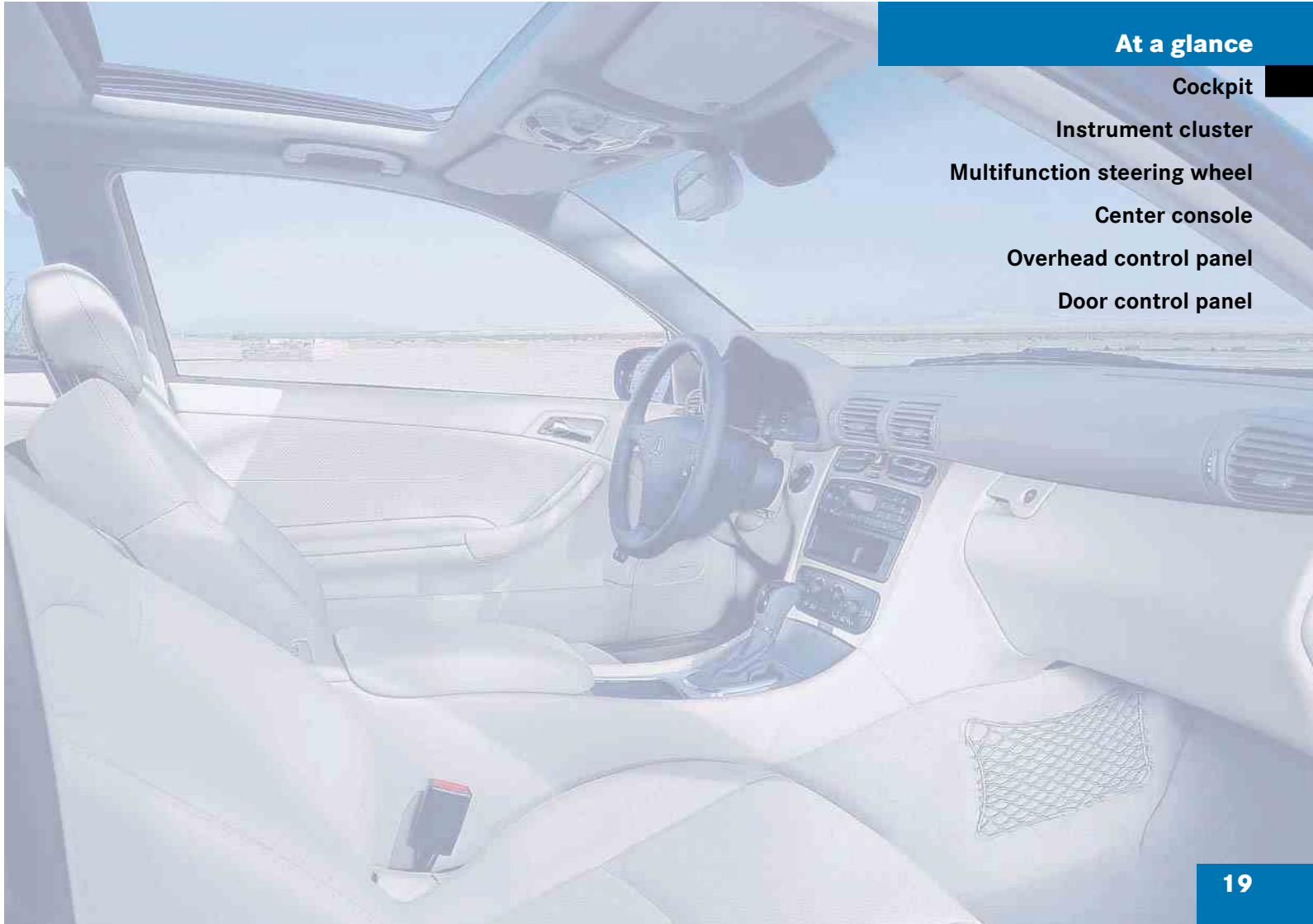

**At a glance**

**Cockpit**

**Instrument cluster**

**Multifunction steering wheel**

**Center console**

**Overhead control panel**

**Door control panel**

## At a glance

### Cockpit

#### ▼ Cockpit

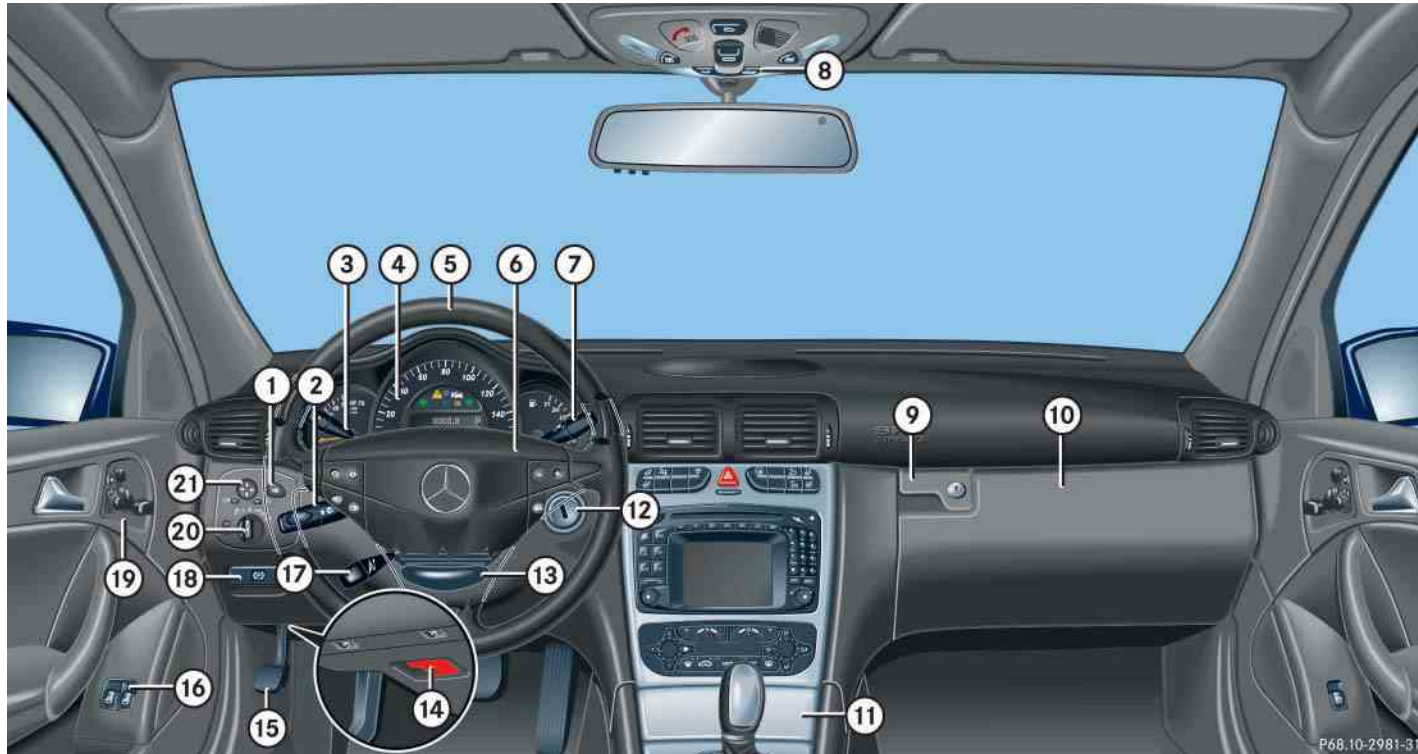

	Item	Page
①	Headlamp washer switch*	148
②	Combination switch	48
	• Turn signals	48
	• Windshield wipers	49
	• High beam	102
③	Cruise control lever	194
④	Instrument cluster	22, 105
⑤	Multifunction steering wheel	24, 110
⑥	Horn	
⑦	Lever for voice control system*, see separate operating instructions	
⑧	Overhead control panel	27
⑨	Glove box lid release	200

	Item	Page
⑩	Glove box lid	200
⑪	Center console	25
⑫	Starter switch	31
⑬	Steering wheel adjustment handle, manual	38
⑭	Hood lock release	236
⑮	Parking brake pedal	46
⑯	Power window switches	186
⑰	Steering wheel adjustment stalk, electrical*	38
⑱	Parking brake release	46
⑲	Door control panel	28
⑳	Exterior lamp switch	48, 98
㉑	Exterior mirror adjustment	40

## At a glance

### Instrument cluster





#### ▼ Instrument cluster









P54.30-7568-31

## At a glance

### Instrument cluster

	Item	Page
①	<b>Reset button for:</b>	
	• Resetting trip odometer	107
	• Instrument cluster illumination	105
②	<b>Tachometer with:</b>	
	 Engine malfunction indicator lamp	260
	 Antilock Brake System (ABS) malfunction warning lamp	258
	 Brake warning lamp, except Canada	259
	 Brake warning lamp, Canada only	259

	Item	Page
③	<b>Speedometer with:</b>	
	 Left turn signal indicator lamp	
	 Right turn signal indicator lamp	
	 Electronic Stability Program (ESP) warning lamp	261
	 High beam headlamp indicator	102
	 Indicator lamp without function <sup>1</sup>	
	<b>DTR</b> Indicator lamp without function <sup>1</sup>	

	Item	Page
④	<b>Multifunction display with:</b>	
	Trip odometer	107
	Main odometer	
	Outside temperature display	107
	Digital clock	122
	Display for program mode and gear selector lever position	144
⑤	<b>Fuel gauge with:</b>	
	Fuel reserve warning lamp	262
	 Seat belt non-usage warning lamp	262
	 Supplemental restraint system indicator lamp	262

<sup>1</sup> The indicator lamp illuminates briefly when you turn the SmartKey in the starter switch to position 2

## At a glance

### Multifunction steering wheel

#### ▼ Multifunction steering wheel



Item	Page
① Multifunction display in speedometer	109
<b>Operating control system</b>	110
② Selecting the submenu or setting the volume	
— down/to decrease	
+ up/to increase	
③ Telephone*: Press button	
☎ to take a call	
☎ to end a call	

Item	Page
④ Menu systems: Press button	
▶ for next system	
◀ for previous system	
⑤ Moving within a menu: Press button	
▲ for next display	
▼ for previous display	



▼ Center console

Upper part



Item	Page
① Seat heater*, driver's side	93
② ESP control switch	75
③ Hazard warning flasher switch – switching on/off	102
④ Central locking switch	88
⑤ Anti-theft alarm system indicator lamp	78
⑥ Seat heater*, passenger side	93
⑦ PASS. AIRBAG OFF indicator lamp	67
⑧ Audio system, or COMAND* (see separate operating instructions)	159
⑨ Climate control	150

## At a glance

### Center console

#### Lower part



Item	Page
① Ashtray	203
② Gearshift lever for manual transmission	44
Selector lever for automatic transmission	45
③ Storage compartment	201
④ Armrest	202
⑤ Program mode selector for automatic transmission	144

▼ Overhead control panel



Item	Page
① Rear interior lighting on/off	104
② Panorama sliding/pop-up roof*	189
③ Right reading lamp on/off	104
④ Interior lighting control	103
⑤ Hands-free microphone for Tele Aid* (emergency call system), telephone* and voice control system* (see separate operating instructions)	205
⑥ Interior rear view mirror	39, 146
⑦ Garage door opener*	214
⑧ Left reading lamp on/off	104
⑨ Tele Aid* (emergency call system) button	209

## At a glance

### Door control panel

#### ▼ Door control panel

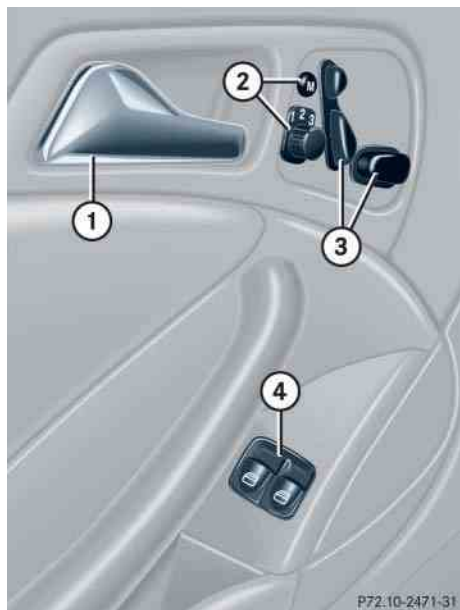

Item	Page
① Door handle	85
② Memory function (for storing seat, exterior rear view mirror and steering wheel settings)	95
③ Seat adjustment	35
④ Switches for opening/closing front door windows	186



**Getting started**

**Unlocking**

**Adjusting**

**Driving**

**Parking and locking**

## Getting started

### Unlocking

The “Getting started” section provides an overview of the vehicle’s most basic functions. First-time Mercedes-Benz owners should pay special attention to the information given here.



If you are already familiar with the basic functions described here, the “Controls in detail” section will provide you with further information. The corresponding page references are located at the end of each segment.

### ▼ Unlocking

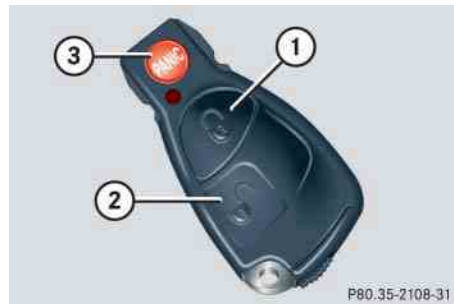
#### Unlocking with the SmartKey



#### SmartKey with remote control

- ①  Lock button
- ②  Unlock button
- ③  Panic button\* (▷ page 72)

#### **i**

Canada only:  
Only vehicles equipped with an anti-theft alarm system\* have SmartKeys with integrated panic button\* ③.

- ▶ Press unlock button  on the SmartKey.

All turn signal lamps flash once. The locking knobs in the doors move up.

- ▶ Get in the vehicle and insert the SmartKey in the starter switch.

For more information, see “Locking and unlocking” (▷ page 82).

### Starter switch positions

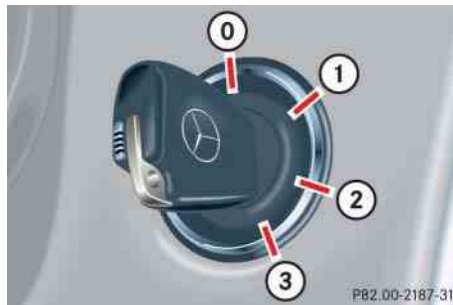

### Starter switch

- 0** For removing SmartKey  
The steering is locked when the SmartKey is removed from the starter switch. If necessary, move steering wheel slightly to allow the locking mechanism to engage.
- 1** Power supply to some electrical consumers, such as seat adjustment
- 2** Ignition (power supply for all electrical consumers) and driving position
- 3** Starting position

### Warning!



When leaving the vehicle, always remove the SmartKey from the starter switch and lock the vehicle. Do not leave children unattended in the vehicle, or with access to an unlocked vehicle. Unsupervised use of vehicle equipment may cause an accident and/or serious personal injury.



Vehicles with automatic transmission:  
The SmartKey can only be removed from the starter switch with the gear selector lever in position **P**.



If the SmartKey cannot be turned in the starter switch, the battery may not be sufficiently charged.

- Check the battery and charge it if necessary (▷ page 307).
- Get a jump start (▷ page 310).

To prevent accelerated battery discharge and a possible dead battery, always remove the SmartKey from the starter switch when the engine is not in operation.

## Getting started

### Adjusting

#### ▼ Adjusting

##### Warning!



All seat, head restraint, steering wheel, and rear view mirror adjustments, as well as fastening of seat belts, must be done before the vehicle is put into motion.

#### Seats

The seats can be adjusted either manually or electrically, depending on the vehicle's equipment.

##### Warning!



Do not adjust the driver's seat while driving. Adjusting the seat while driving could cause the driver to lose control of the vehicle.

Never ride in a moving vehicle with the seat back reclined. Sitting in an excessively reclined position can be dangerous. You could slide under the seat belt in a collision. If you slide under it, the belt would apply force at the abdomen or neck.

That could cause serious or fatal injuries. The seat back and seat belts provide the best restraint when the wearer is in an upright position and belts are properly positioned on the body. Your seat must be adjusted so that you can correctly fasten your seat belt (▷ page 41).

Never place hands under the seat or near any moving parts while a seat is being adjusted.

##### Warning!



When leaving the vehicle, always remove the SmartKey from the starter switch and lock your vehicle.

The power seats\* can also be operated with the driver's or passenger door open. Do not leave children unattended in the vehicle, or with access to an unlocked vehicle. Unsupervised use of vehicle equipment may cause an accident and/or serious personal injury.

##### Warning!



Children 12 years old and under must never ride in the front seat, except in a Mercedes-Benz authorized BabySmart™ compatible child seat, which operates with the BabySmart™ system installed in the vehicle to deactivate the passenger front airbag when it is properly installed. Otherwise they will be struck by the airbag when it inflates in a crash. If this happens, serious or fatal injury will result.

According to accident statistics, children are safer when properly restrained in the rear seating positions than in the front seating positions. Infants and small children must ride in back seats and be seated in an appropriate infant or child restraint system, which is properly secured with the vehicle's seat belt and top tether strap, or secured via lower anchors and top tether strap, fully in accordance with the child seat manufacturer's instructions.



A child's risk of serious or fatal injuries is significantly increased if the child restraints are not properly secured in the vehicle and the child is not properly secured in the child restraint.

### Manual seat adjustment



- ① Backrest tilt
- ② Seat height
- ③ Seat cushion tilt
- ④ Seat fore and aft adjustment

### Seat fore and aft adjustment

- ▶ Lift handle ④.
- ▶ Slide seat to the desired position.
- ▶ Allow handle ④ to reengage.
- ▶ Check for proper engagement before driving.

Adjust seat to a comfortable seating position that still allows you to reach the accelerator/brake pedal safely. The position should be as far rearward as possible, consistent with ability to properly operate controls.



When moving the seats, be sure that there are no items in the footwell or behind the seats. Otherwise you could damage the seats.

### Seat cushion tilt

- ▶ Turn handwheel ③ forward or backward until your upper legs are lightly supported.

### Seat backrest tilt

- ▶ Turn handwheel ① forward or backward until your arms are slightly angled when holding the steering wheel.

### Seat height

- ▶ Pull handle ② up to raise seat cushion.
- ▶ Push handle ② down to lower seat cushion.

## Getting started

### Adjusting

#### Head restraint height

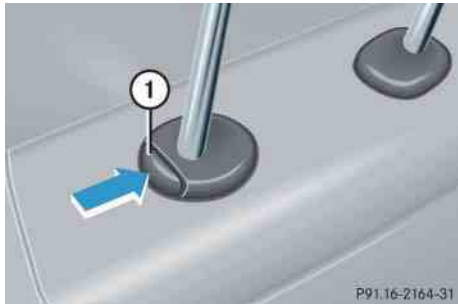

① Release button

Raising:

- ▶ Manually adjust the height of the head restraint by pulling it upward.

Lowering:

- ▶ To lower the head restraint, push release button ① and press down on the head restraint.

#### Warning!



For your protection, drive only with properly positioned head restraints.

Adjust head restraint so that the head restraint supports the back of the head at eye level. This will reduce the potential for injury to the head and neck in the event of an accident or similar situation.

Do not drive the vehicle without the seat head restraints. Head restraints are intended to help reduce injuries during an accident.

#### Head restraint tilt



Manually adjust the angle of the head restraint.

- ▶ Push or pull on the lower edge of the head restraint cushion.

For more information, see “Seats” (▷ page 89)

**Power seat\* adjustment**

The seat adjustment switches are located in each door.

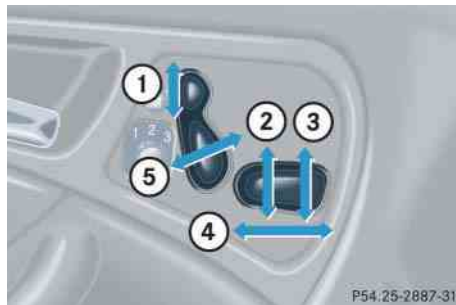

- ① Head restraint height
- ② Seat height
- ③ Seat cushion tilt
- ④ Seat fore and aft adjustment
- ⑤ Backrest tilt

► Turn the SmartKey in the starter switch to position **1** or **2** (▷ page 31).

or

► Open the driver's or passenger door.

**Seat fore and aft adjustment**

► Press the switch forward or backward in the direction of arrow ④.

Adjust seat to a comfortable seating position that still allows you to reach the accelerator / brake pedal safely.

The position should be as far to the rear as possible, consistent with ability to properly operate controls.



When moving the seat, be sure that there are no items in the footwell or behind the seat. Otherwise you could damage the seat.

The memory function\* (▷ page 95) lets you store the settings for the seat position together with the setting for the steering wheel and the exterior rear view mirrors.

**Seat cushion tilt**

► Press the switch up or down in the direction of arrow ③ until your upper legs are lightly supported.

**Seat backrest tilt**

► Press the switch forward or backward in the direction of arrow ⑤ until your arms are slightly angled when holding the steering wheel.

**Seat height**

► Press the switch up or down in the direction of arrow ②.

## Getting started

### Adjusting

#### Head restraint height

- ▶ Press the switch up or down in the direction of arrow ①.

#### Warning!



For your protection, drive only with properly positioned head restraints.

Adjust head restraint so that the head restraint supports the back of the head at eye level. This will reduce the potential for injury to the head and neck in the event of an accident or similar situation.

Do not drive the vehicle without the seat head restraints. Head restraints are intended to help reduce injuries during an accident.

#### Head restraint tilt



Manually adjust the angle of the head restraint.

- ▶ Push or pull on the lower edge of the head restraint cushion.

For more information, see “Seats” (▷ page 89)

#### Folding front seat backrest forward

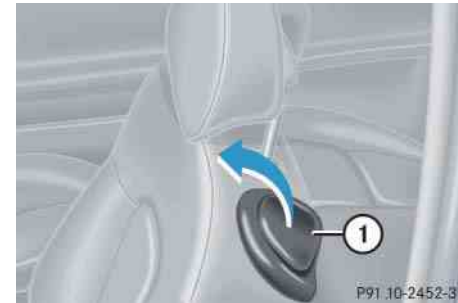

- ① Release lever



In addition to the front seat backrests, the front seat cushions can also be shifted forward to permit easy access to the rear whenever the seat is located in the rear half of its adjustment range. Swivel backrest forward by pulling the release lever until the seat moves in a combined forward and upward movement.

#### **Folding backrest forward**

- ▶ Pull release lever ① forward and fold the seat backrest forward.



Vehicles with power seat\*: The head restraints will automatically move down.

Vehicles with manual seat adjustment:

- ▶ If necessary, press the head restraint downward while tilting the backrest forward.

#### **Folding backrest back**

- ▶ Fold and press the backrest rearward until it engages in driving position.



Vehicles with power seat\*: The head restraint returns to its previous positions.

Vehicles with manual seat adjustment:

- ▶ If necessary, pull the head restraint out while tilting the seat back.

For more information, see “Seats” (▷ page 89).

#### **Steering wheel**

##### **Warning!**



Do not adjust the steering wheel while driving. Adjusting the steering wheel while driving, or driving without the adjustment locked could cause the driver to lose control of the vehicle.

When leaving the vehicle, always remove the SmartKey from the starter switch and lock your vehicle.

The electrical steering wheel adjustment feature\* can also be operated with the driver's door open. Do not leave children unattended in the vehicle, or with access to an unlocked vehicle. Unsupervised use of vehicle equipment may cause an accident and/or serious personal injury.

## Getting started

### Adjusting

#### Steering wheel adjustment, manual



##### ① Handle

- ▶ To unlock the steering column, pull handle ① out until its stop limit.
- ▶ Move steering wheel to the desired position.
- ▶ To lock the steering column, push handle ① all the way in until it engages.

The steering wheel is once again locked into position.



Do not drive the vehicle until you have properly locked the steering column.

If the warning message STEERING WHEEL ADJ. - LOCK! (▷ page 282) is displayed while the engine is running, the steering column is not locked.

#### Steering wheel adjustment, electrical\*

The stalk for steering wheel adjustment is located on the steering column (lower left).

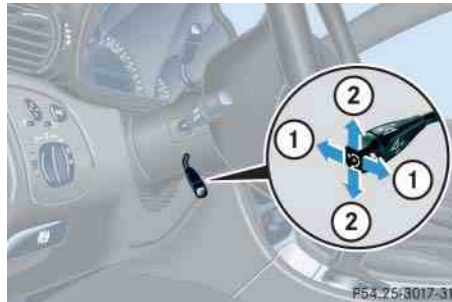

- ① Adjusting steering column, in or out
- ② Adjusting steering column, up or down

- ▶ Turn the SmartKey in the starter switch to position **1** or **2** (▷ page 31).

or

- ▶ Open the driver's door.

#### Adjusting steering column in or out

- ▶ Move stalk forward or back in the direction of arrow ① until a comfortable steering wheel position is reached with your arms slightly bent at the elbow.

#### Adjusting steering column, up or down

- ▶ Move stalk up or down in the direction of arrow ②.

Make sure your legs can move freely and that all the displays (incl. malfunction and indicator lamps) on the instrument cluster are clearly visible.



The memory function\* (▷ page 95) lets you store the setting for the steering wheel together with the setting for the seat position and exterior rear view mirrors.

### Mirrors

Adjust the interior and exterior rear view mirrors before driving so that you have a good view of the road and traffic conditions.

#### Warning!



In the case of an accident, liquid electrolyte may escape the mirror housing if the mirror glass breaks.

Electrolyte has an irritating effect. Do not allow the liquid to come into contact with eyes, skin, clothing, or respiratory system. In case it does, immediately flush affected area with water, and seek medical help if necessary.

### Interior rear view mirror

- ▶ Manually adjust the interior rear view mirror.

For more information, see “Rear view mirrors” (▷ page 146).

## Getting started

### Adjusting

#### Exterior rear view mirrors

##### Warning!



Exercise care when using the passenger side exterior rear view mirror. The mirror surface is convex (outwardly curved surface for a wider field of view). Objects in mirror are closer than they appear. Check your inside rear view mirror or glance over your shoulder before changing lanes.



Electrolyte drops coming into contact with the vehicle paint finish can only be completely removed while in their liquid state by applying plenty of water.

The buttons are located above the exterior lamp switch.



- ① Adjustment button
- ② Passenger side mirror
- ③ Driver's side mirror

- ▶ Make sure the ignition is switched on. All the lights in the instrument cluster come on.
- ▶ Press button ③ for the left mirror or button ② for the right mirror.
- ▶ Push adjustment button ① up, down, left or right according to the setting desired.



The memory function\* (▷ page 95) lets you store the setting for the exterior rear view mirrors together with the settings for the steering wheel and seat positions.



If an exterior rear view mirror was forcibly pushed forward (hit from the rear) or forcibly pushed backward (hit from the front), reposition it by applying firm pressure until it snaps into place. The mirror housing is now properly positioned and you can adjust the mirror normally.



At low ambient temperatures, the mirrors will be heated automatically.

For more information, see “Rear view mirrors” (▷ page 146).



## ▼ Driving

**Warning!**

Do not lay any objects in the driver's footwell. Be careful that floor mats or carpets in the driver's footwell have sufficient clearance for the pedals.

During sudden driving or braking maneuvers the objects could get caught between the pedals. You could then no longer brake or accelerate.

**Fastening the seat belt****Warning!**

Always fasten your seat belt before driving off. Always make sure your passengers are properly restrained, even those sitting in the rear and pregnant women.

Failure to wear and properly fasten and position your seat belt greatly increases your risk of injuries and their likely severity in an accident. You and your passengers should always wear seat belts.

If you are ever in an accident, your injuries can be considerably more severe without your seat belt properly buckled. Without your seat belt buckled, you are much more likely to hit the interior of the vehicle or be ejected from it. You can be seriously injured or killed.

In the same crash, the possibility of injury or death is lessened if you are wearing your seat belt. The airbags can only protect as expected if the occupants are using their seat belts (▷ page 56).

**Warning!**

Children 12 years old and under must never ride in the front seat, except in a Mercedes-Benz authorized BabySmart™ compatible child seat, which operates with the BabySmart™ system installed in the vehicle to deactivate the passenger front airbag when it is properly installed. Otherwise they will be struck by the airbag when it inflates in a crash. If this happens, serious or fatal injury will result.

According to accident statistics, children are safer when properly restrained in the rear seating positions than in the front seating positions. Infants and small children must ride in back seats and be seated in an appropriate infant or child restraint system, which is properly secured with the vehicle's seat belt and top tether strap, or secured via lower anchors and top tether strap, fully in accordance with the child seat manufacturer's instructions.



## Getting started

### Driving

- ▷▷ A child's risk of serious or fatal injuries is significantly increased if the child restraints are not properly secured in the vehicle and the child is not properly secured in the child restraint.

#### Warning!



Never ride in a moving vehicle with the seat backrest reclined. Sitting in an excessively reclined position can be dangerous. You could slide under the seat belt in a collision. If you slide under it, the belt would apply force at the abdomen or neck. That could cause serious or even fatal injuries. The seat backrest and seat belt provide the best restraint when the wearer is in an upright position and the belt is properly positioned on the body.

#### Warning!



Never let more people ride in the vehicle than there are seat belts available. Be sure everyone riding in the vehicle is correctly restrained with a separate seat belt.

#### Warning!



Read and observe the additional warning notices printed in the "Safety and Security" section (▷ page 60).

The seat belt presenter for driver and passenger makes it easier to put on the seat belt.

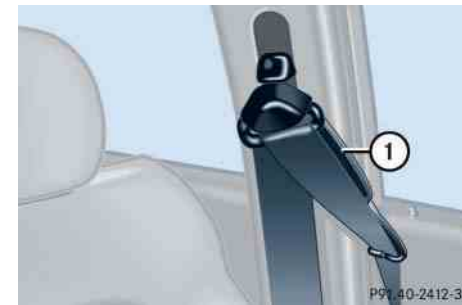

#### ① Seat belt presenter

- ▶ Manually adjust the seat belt presenter to the desired position

#### ①

The seat belt presenter must be put back to its original position before leaning the seat backrest toward the rear or letting someone enter the rear passenger compartment.

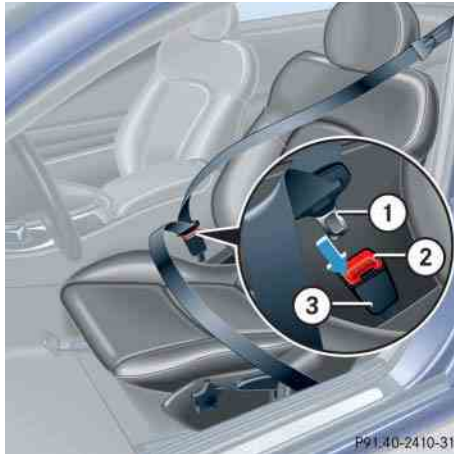

- ① Latch plate
- ② Release button
- ③ Buckle

- ▶ With a smooth motion, pull the belt from the belt outlet.
- ▶ Place the belt over your shoulder.
- ▶ Push latch plate ① into buckle ③ until it clicks.

- ▶ If necessary, tighten the lap portion to a snug fit by pulling shoulder portion up.

#### Belt outlet height adjustment

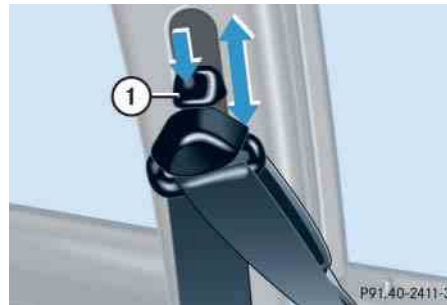

- ① Button for belt outlet height adjustment
- ▶ To raise, slide belt outlet upward.
- ▶ To lower, press button ① and slide belt outlet downward.

#### Proper use of seat belts

- Do not twist the belt when fastening.
- Adjust seat belt so that the shoulder portion is located as close as possible to the middle of the shoulder (it should not touch the neck or pass under the arm). For this purpose, you can adjust the height of the belt outlet.
- Position the lap belt as low as possible on your hips (over hip joint) and not across the abdomen.
- Place the seat backrest in a nearly upright position.
- Never use a seat belt for more than one person at a time.
- Do not fasten a seat belt around a person and another object at the same time.
- Check your seat belt during travel to ensure that it is properly positioned.

## Getting started

### Driving

- Ensure that the seat belt is always fitted snugly. You should avoid wearing bulky clothing, such as winter coats, when traveling in the vehicle.

#### Warning!



Do not pass belts over sharp edges. They could tear.

Do not allow the belt to get caught in the door or in the seat adjustment mechanism. This could damage the belt.

Never attempt to make modifications to seat belts. This could impair the effectiveness of the belts.

Damaged seat belts or belts that were highly stressed in an accident must be replaced. Contact an authorized Mercedes-Benz Center.

### Starting the engine

#### Warning!



Inhalation of exhaust gas is hazardous to your health. All exhaust gas contains carbon monoxide, and inhaling it can cause unconsciousness and lead to death.

Do not run the engine in confined areas (such as garage) which are not properly ventilated. If you think that exhaust gas fumes are entering the vehicle while driving, have the cause determined and corrected immediately. If you must drive under these conditions, drive only with at least one window fully open.

### Manual transmission

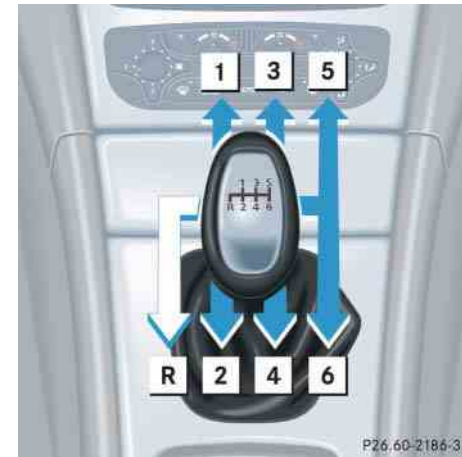

#### Gearshift pattern for manual transmission

For more information, see “Manual transmission” (▷ page 137).

**Starting**

- ▶ Depress brake pedal.
- ▶ Make sure the gearshift lever is in neutral position (no gear selected).
- ▶ Fully depress clutch pedal.  
Otherwise the engine cannot be started due to the integrated safety interlock.
- ▶ Do not depress accelerator.
- ▶ Turn the SmartKey in the starter switch to position **3** and hold until the engine starts (▷ page 31).

For information on turning off the engine with the SmartKey, see “Turning off the engine” (▷ page 53).

**Automatic transmission\*****Gearshift pattern for automatic transmission**

- P** Park position with selector lever lock
- R** Reverse gear
- N** Neutral
- D** Drive position

For more information, see “Automatic transmission\*” (▷ page 139).

**Starting**

- ▶ Make sure the gear selector lever is set to **P**.
- ▶ Do not depress accelerator.
- ▶ Turn the SmartKey in the starter switch to position **3** and hold until the engine starts (▷ page 31).



You can also use the “touch-start” function. Turn the SmartKey to position **3** and release it again immediately. The engine then starts automatically.

- ▶ Depress brake pedal.

The selector lever lock is released.

For information on turning off the engine with the SmartKey, see “Turning off the engine” (▷ page 53).

## Getting started

### Driving

#### Starting difficulties

If the engine does not start as described, carry out the following steps:

- ▶ Turn SmartKey in starter to position **0** and repeat starting procedure.

Remember that extended starting attempts can drain the battery.

- ▶ Get a jump start (▷ page 310).

If the engine does not start after several starting attempts, there could be a malfunction in the engine electronics or in the fuel supply system.

- ▶ Notify an authorized Mercedes-Benz Center.

#### Parking brake

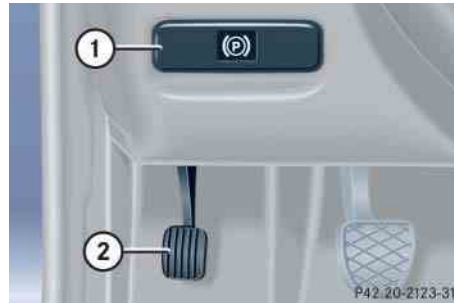

- ① Release handle
- ② Parking brake

#### Warning!



When leaving the vehicle, always remove the SmartKey from the starter switch and lock the vehicle. Do not leave children unattended in the vehicle, or with access to an unlocked vehicle. Children could release the parking brake, which could result in an accident and/or serious injury.

- ▶ Release the parking brake by pulling on handle ①.

The indicator lamp **BRAKE** (USA only) or **(P)** (Canada only) in the instrument cluster goes out.

#### Driving

- ▶ Depress brake pedal.
- ▶ Move gear selector lever to position **D** or **R** (manual transmission: first or reverse gear).
- ▶ Release the brake pedal.
- ▶ Carefully depress the accelerator pedal.

Once the vehicle is in motion, the automatic central locking system engages and the locking knobs drop down.



You can open a locked door from the inside. Open doors only when conditions are safe to do so.

You can deactivate the automatic locking using the control system (▷ page 129).



If you hear a warning signal when driving off, you have forgotten to release the parking brake.

Release the parking brake.



Simultaneously depressing the accelerator pedal and applying the brake reduces engine performance and causes premature brake and drivetrain wear.

After a cold start, the automatic transmission shifts at a higher engine revolution. This allows the catalytic converter to reach its operating temperature earlier.



Vehicles with automatic transmission: Wait for the gear selection process to complete before setting the vehicle in motion.

### Warning!



Vehicles with automatic transmission: It is dangerous to shift the gear selector lever out of **P** or **N** if the engine speed is higher than idle speed. If your foot is not firmly on the brake pedal, the vehicle could accelerate quickly forward or in reverse. You could lose control of the vehicle and hit someone or something. Only shift into gear when the engine is idling normally and when your right foot is firmly on the brake pedal.

## Getting started

### Driving

### Warning!



On slippery road surfaces, never downshift in order to obtain braking action. This could result in drive wheel slip and reduced vehicle control. Your vehicle's ABS will not prevent this type of loss of control.



Place the gear selector lever in position **R** only when the vehicle is stopped in order to avoid damaging the transmission.



Do not run cold engine at high engine speeds. Running a cold engine at high speeds may shorten the service life of the engine.

For more information on driving, see "Driving instructions" (▷ page 223).

## Getting started

### Driving

#### Switching on headlamps



#### Exterior lamp switch

- ① Off
- ② Low beam headlamps on
- ▶ Turn the switch to .

For more information on headlamps, see “Lighting” (> page 98).



#### Turn signals

The combination switch is located on the left of the steering column.



#### Combination switch

- ① Turn signal, right
- ② Turn signal, left
- ▶ Press the combination switch up ① or down ②.

The corresponding turn signal indicator lamp  or  in the instrument cluster flashes.

#### **i**

To signal minor directional changes, move combination switch to point of resistance only and release. The turn signal flashes three times.

#### High beam

- ▶ Push the combination switch forward.
- The high beam symbol  in the instrument cluster comes on.

For more information on high beam, see “Combination switch” (> page 102).

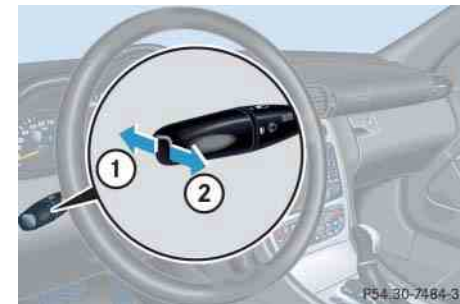

- ① High beam
- ② High beam flasher



## Windshield wipers

The combination switch is located on the left of the steering column.



### Combination switch

- ① Single wipe
- ② Switching on windshield wipers

- ▶ Make sure the ignition is switched on.

## Switching on windshield wipers

- ▶ Turn the combination switch to the desired position depending on the intensity of the rain.

- Windshield wipers off
- I Intermittent wiping
- II Normal wiper speed
- III Fast wiper speed



Vehicles without rain sensor\*: Fast wiper speed III goes to setting II when the vehicle is standing still.

Vehicles with rain sensor\*: Intermittent wiping interval dependent on wetness of windshield. Wiping will not occur with a door open.



Vehicles with rain sensor\*: Do not leave in intermittent setting when vehicle is taken to an automatic car wash or during windshield cleaning. Wipers will operate in presence of water sprayed on the windshield, and wipers may be damaged as a result.

The switch should not be left in intermittent setting as the wipers will wipe the windshield once every time the engine is started. Dust that accumulates on the windshield might scratch the glass and/or damage the wiper blades when wiping occurs on a dry windshield.

## Getting started

### Driving

#### Single wipe

- ▶ Press switch briefly in the direction of arrow ①.

The windshield wipers wipe one time without washer fluid.

#### Wiping with windshield washer fluid

- ▶ Push switch in the direction of arrow ① past the resistance point.

The windshield wiper operates with washer fluid.

For information on filling up the washer reservoir, see “Windshield washer system and headlamp cleaning system” (▷ page 243).



If anything blocks the windshield wipers (leaves, snow, etc.), switch them off immediately.

- For safety reasons, withdraw SmartKey from starter switch before attempting to remove any blockage.
- Remove blockage.
- Turn the windshield wipers on again.

If windshield wipers fail to function at all in switch position I,

- set the combination switch to the next highest wiper speed
- have the windshield wipers checked at the nearest authorized Mercedes-Benz Center

#### Problems while driving

##### The engine runs erratically and misfires

- An ignition cable may be damaged.
  - The engine electronics may not be operating properly.
  - Unburned gasoline may have entered the catalytic converter and damaged it.
- ▶ Give very little gas.
  - ▶ Have the problem repaired by an authorized Mercedes-Benz Center as soon as possible.

**The coolant temperature is over 248°F (120°C)**

The coolant is too hot and is no longer cooling the engine.

- ▶ Stop the vehicle as soon as possible and turn off the engine. Allow engine and coolant to cool.
- ▶ Check the coolant level and add coolant if necessary (▷ page 241).

**In case of accident**

If the vehicle is leaking gasoline:

- ▶ Do not start the engine under any circumstances.
- ▶ Notify local fire and/or police authorities.

If the extent of the damage cannot be determined:

- ▶ Notify an authorized Mercedes-Benz Center.

If no damage can be determined on the

- major assemblies
  - fuel system
  - engine mount
- ▶ Start the engine in the usual manner.

## Getting started

### Parking and locking

#### ▼ Parking and locking

You have now completed your first drive. You have properly stopped and parked your vehicle. End your drive as follows.

#### Warning!



Wait until the vehicle is stationary before removing the SmartKey from the starter switch. The vehicle cannot be steered when the SmartKey is removed.

#### Warning!



With the engine not running, there is no power assistance for the brake and steering system. In this case, it is important to keep in mind that a considerably higher degree of effort is necessary to brake and steer the vehicle.

#### Warning!



Do not park this vehicle in areas where combustible materials such as grass, hay or leaves can come into contact with the hot exhaust system, as these materials could be ignited and cause a vehicle fire.

To reduce the risk of personal injury as a result of vehicle movement, before turning off the engine and leaving the vehicle always:

- Keep right foot on brake pedal.
- Firmly depress parking brake pedal.
- Move the gear selector lever to position **P** (manual transmission: first or reverse gear).
- Slowly release brake pedal.
- When parked on an incline, turn front wheels towards road curb.
- Turn the SmartKey to starter switch position **0** and remove.
- Take the SmartKey and lock vehicle when leaving.

### Parking brake

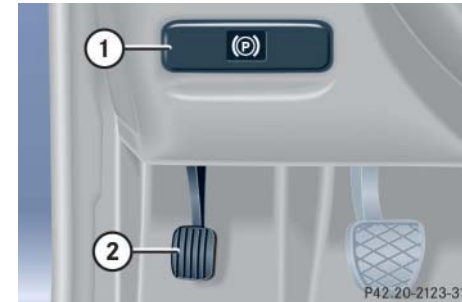

- ① Release handle
- ② Parking brake

- Step firmly on parking brake ②.

When the engine is running, the indicator lamp **BRAKE** (USA only) or  (Canada only) in the instrument cluster will be illuminated.

### Warning!



When leaving the vehicle, always remove the SmartKey from the starter switch and lock the vehicle. Do not leave children unattended in the vehicle, or with access to an unlocked vehicle. Children could release the parking brake and/or move the gear selector lever from position **P**, either of which could result in an accident and/or serious injury.

### Warning!



Getting out of your vehicle with the gear selector lever not fully engaged in position **P** is dangerous. Also, when parked on an incline, position **P** alone may not prevent your vehicle from moving, possibly hitting people or objects.

Always set the parking brake in addition to shifting to position **P** (manual transmission: first or reverse gear).

When parked on an incline, turn front wheels towards the road curb.

### Switching off headlamps

- ▶ Turn the exterior lamp switch to **0** (▷ page 48).

For more information on headlamps, see “Lighting” (▷ page 98).

## Getting started

### Parking and locking

#### Turning off the engine

- ▶ Place the gear selector lever in position **P** (manual transmission: first or reverse gear).



Always set the parking brake in addition to shifting to position **P** (manual transmission: first or reverse gear).

On steep slopes, turn the front wheels towards the road curb.

- ▶ Turn the SmartKey in the starter switch to position **0** and remove it. The immobilizer is activated.



Vehicles with automatic transmission: The SmartKey can only be removed from the starter switch with the gear selector lever in position **P**.

- ▶ Press the seat belt release button (▷ page 41).



## Getting started

### Parking and locking

- ▷▷ Allow the retractor to completely re-wind the seat belt by guiding the latch plate.



With the SmartKey removed and the driver's door open, a warning sounds if the vehicle's exterior lamps are not switched off.

#### Warning!



To prevent possible personal injury, always keep hands and fingers away from the door openings when closing the doors. Be especially careful when small children are around.

Before closing doors, make sure there is no possibility of someone getting caught in a door during closing.

- ▶ After exiting the vehicle, press the lock button  on the SmartKey (▷ page 30).

All turn signal lamps flash three times. The locking knobs in the doors move down.

#### Warning!



When leaving the vehicle, always remove the SmartKey from the starter switch, and lock your vehicle. Do not leave children unattended in the vehicle, or with access to an unlocked vehicle. Unsupervised use of vehicle equipment may cause an accident and/or serious personal injury.

For more information, see “Locking and unlocking” (▷ page 82).



**Safety and Security**

**Occupant safety**

**Panic alarm\***

**Driving safety systems**

**Anti-theft systems**

## Safety and Security

### Occupant safety

#### ▼ Occupant safety

In this section you will learn the most important facts about the restraint systems of the vehicle.

The restraint systems are

- Seat belts
- Emergency tensioning device
- Airbags
- Child seats
- Child seat recognition
- Lower anchors and tethers for children (LATCH)

As independent systems, their protective effects work in conjunction with each other.



For information on infants and children traveling with you in the vehicle and restraint systems for infants and children, see “Children in the vehicle” (▷ page 65).

The **SRS** indicator lamp in the instrument cluster (▷ page 22) comes on:

- for about four seconds when you turn the SmartKey in the starter switch to position **1**.
- for about four seconds when you start the engine by turning the SmartKey.



The **SRS** indicator lamp remains lit if the SmartKey is turned to position **2** and left there. The indicator lamp will go out when you start the engine.

The **SRS** indicator lamp goes out shortly after you start the engine. This shows that the restraint systems are operational.

A malfunction in the system has been detected if the **SRS** indicator lamp:

- fails to extinguish after approximately four seconds.
- does not come on at all.
- comes on after the engine was started or while driving.

For safety reasons, we strongly recommend that you visit an authorized Mercedes-Benz Center immediately to have the system checked.

For more information see “Practical hints” section (▷ page 262).



#### Warning!



In the event that the SRS malfunction indicator lamp comes on during driving or does not come on at all, the SRS may not be operational. For your safety, we strongly recommend that you visit an authorized Mercedes-Benz Center immediately to have the system checked; otherwise the SRS may not be activated when needed in an accident, which could result in serious or fatal injury, or it might deploy unexpectedly and unnecessarily which could also result in injury.

Improper work on the restraint systems, including incorrect installation and removal, can lead to possible injury through an unintended activation of the SRS.

In addition, through improper work there is a risk of rendering the SRS inoperative or causing unintended airbag deployment. Work on the SRS must therefore only be performed by qualified technicians. Contact your authorized Mercedes-Benz Center.

#### Airbags

#### Warning!



Airbags are designed to reduce the potential of injury and fatality in certain frontal impacts (front airbags), or side impacts (side impact airbags and head protection window curtain airbags). However, no system available today can totally eliminate injuries and fatalities.

The activation of the SRS temporarily releases a small amount of dust from the airbags. This dust, however, is neither injurious to your health, nor does it indicate a fire in the vehicle. The dust might cause some temporary breathing difficulty for people with asthma or other breathing trouble. To avoid this, you may wish to get out of the vehicle as soon as it is safe to do so. If you have any breathing difficulty but cannot get out of the vehicle after the airbag inflates, then get fresh air by opening a window or door.

#### Warning!



To reduce the risk of injury when the front airbags inflate, it is very important for the driver and front passenger to always be in a properly seated position and to wear your seat belts.

For maximum protection in the event of a collision always be in normal seated position with your back against the backrest. Fasten your seat belt and ensure that it is properly positioned on your body.

Since the airbag inflates with considerable speed and force, a proper seating and hands on steering wheel position will help to keep you at a safe distance from the airbag. Occupants who are unbelted, out of position or too close to the airbag can be seriously injured by an airbag as it inflates with great force in the blink of an eye:

- Sit properly belted in an upright position with your back against the seat backrest.



## Safety and Security

### Occupant safety



- Adjust the driver seat as far as possible rearward, still permitting proper operation of vehicle controls. The distance from the center of the driver's breastbone to the center of the airbag cover on the steering wheel must be at least ten inches (25 cm) or more. You should be able to accomplish this by a combination of adjustments to the seat and steering wheel. If you have any problems, please see your authorized Mercedes-Benz Center.
- Do not lean with your head or chest close to the steering wheel or dashboard.
- Keep hands on the outside of steering wheel rim. Placing hands and arms inside the rim can increase the risk and potential severity of hand/arm injury when driver front airbag inflates.
- Adjust the front passenger seat as far as possible rearward from the dashboard when the seat is occupied.

- Occupants, especially children, should never lean their heads in the area of the door where the side airbag inflates. This could result in serious injuries or death should the airbag be triggered. Always sit upright, properly use the seat belts and appropriate size infant or child restraint system.
- Children 12 years old and under must never ride in the front seat, except in a Mercedes-Benz authorized BabySmart™ compatible child seat, which operates with the BabySmart™ system installed in the vehicle to deactivate the passenger front airbag when it is properly installed. Otherwise they will be struck by the airbag when it inflates in a crash. If this happens, serious or fatal injury will result.

Failure to follow these instructions can result in severe injuries to you or other occupants.

If you sell your vehicle you are responsible to make the buyer aware of these points. Be sure to give the buyer this Operator's Manual.

### Warning!



Accident research shows that the safest place for children in an automobile is in the rear seat. Should you choose to place a child 12 years old or under in the front passenger seat of your vehicle, you must properly use a BabySmart™ child restraint which will turn off the passenger front airbag. BabySmart™ will not, however, turn off any side impact airbag.

It should be noted that with respect to both front and rear side impact airbags there is a possibility for a side airbag related injury if occupants, especially children, are not properly seated or restrained when next to a side airbag which needs to deploy rapidly in a side impact in order to do its job.

To help avoid the possibility of injury, please follow these guidelines:

- (1) Occupants, especially children, should never place their bodies or lean their heads in the area of the door or rear

## Safety and Security

### Occupant safety

quarter trim panels where the side airbag inflates. This could result in serious injuries or death should the side airbag be activated.

- (2) Always sit upright, properly use the seat belts and use an appropriately sized infant or child restraint system for all children 12 years old or under.
- (3) Always wear seat belts properly.

If you believe that, even with the use of these guidelines, it would be safer for your rear seat occupants to have both rear side airbags deactivated, then deactivation can be accomplished upon your written request to do so at your authorized Mercedes-Benz Center at an additional cost.

Please contact your local authorized Mercedes-Benz Center or call our Customer Assistance Center at 1-800-FOR-MERCEDES (1-800-367-6372) for details.



Airbags are designed to activate only in certain frontal impacts (front airbags) and in side impacts (side impact and head protection window curtain airbags) which exceed preset thresholds.

Only during these types of impacts, if of sufficient severity to meet the deployment thresholds, will they provide their supplemental protection.

The driver and passengers should always wear their seat belts. Otherwise it is not possible for airbags to provide their supplemental protection.

In cases of other frontal impacts, angled impacts, roll-overs, other side impacts, rear collisions, or other accidents, the airbags will not be activated. The driver and passengers will then be protected by the fastened seat belts.

We caution you not to rely on the presence of the airbags in order to avoid wearing your seat belt.

Your vehicle was originally equipped with airbags that are designed to activate in certain impacts exceeding a preset threshold to reduce the potential and severity of injury. It is important to your safety and that of your passenger that you replace deployed airbags and repair any malfunctioning airbags to ensure that the vehicle will continue to provide supplemental crash protection for occupants.

## Safety and Security

### Occupant safety

#### Safety guidelines for the seat belt, emergency tensioning device and airbag

##### Warning!



- Damaged seat belts or belts that were highly stressed in an accident must be replaced and their anchoring points must also be checked. Use only belts installed or supplied by an authorized Mercedes-Benz Center.
- Airbags and emergency tensioning device (ETDs) are designed to function on a one-time only basis. An airbag or ETD that was activated must be replaced

- No modifications of any kind may be made to any components or wiring of the SRS. This includes changing or removing any component or part of the SRS, the installation of additional trim material, badges, etc. over the steering wheel hub, front passenger airbag cover, door trim panels, or door frame trims, and installation of additional electrical/electronic equipment on or near SRS components and wiring. Keep area between airbags and occupants free from objects (e.g. packages, purses, umbrellas, etc.).
- Do not pass belts over sharp edges. They could tear.
- Do not make any modification that could change the effectiveness of the belts.
- Do not hang items such as coat hangers from the coat hooks or handles over the door. These items may turn into projectiles and cause head and other injuries when curtain airbag is deployed.
- An airbag system component within the steering wheel gets hot after the airbag has inflated. Do not touch.
- Improper work on the system, including incorrect installation and removal, can lead to possible injury through an unintended activation of the SRS.
- In addition, through improper work there is a risk of rendering the SRS inoperative or causing unintended airbag deployment. Work on the SRS must therefore only be performed by qualified technicians. Contact your authorized Mercedes-Benz Center.
- For your protection and the protection of others, when scrapping the airbag unit or emergency tensioning device, our safety instructions must be followed. These instructions are available from your authorized Mercedes-Benz Center.
- Given the considerable deployment speed and the textile structure of the airbags, there is the possibility of abrasions or other injuries resulting from airbag deployment.

## Safety and Security

### Occupant safety

When you sell your vehicle we strongly urge you to give notice to the subsequent owner that it is equipped with an SRS by alerting them to the applicable section in the Operator's Manual.

#### Front airbags

Driver and passenger airbags are deployed:

- in the event of a frontal impact
- if impact exceeds a preset deployment threshold
- independently of the side impact airbags

The airbags will not deploy in impacts which do not exceed the system's deployment thresholds. You will then be protected by the fastened seat belts.

The front passenger airbag will only be deployed if:

- the front passenger seat is occupied
- the PASS. AIRBAG OFF indicator lamp in the center console is not lit (▷ page 67)
- the impact exceeds a preset deployment threshold.



- ① Driver airbag
- ② Passenger airbag



Do not place objects heavier than 20 lbs (9kg) on the front passenger seat. This could cause the front or side impact airbag on the front passenger side to deploy in a crash which exceeds the system's deployment threshold.

#### Side impact airbags, window curtain airbags

The side impact airbags and window curtain airbags are deployed:

- on the impacted side of the vehicle
- in impacts exceeding a preset deployment threshold
- independently of the front airbags

The side impact airbags and window curtain airbags are not deployed in impacts which do not exceed the system's deployment threshold.

## Safety and Security

### Occupant safety

The front passenger side impact airbag will only deploy if the system senses that the front passenger seat is occupied.

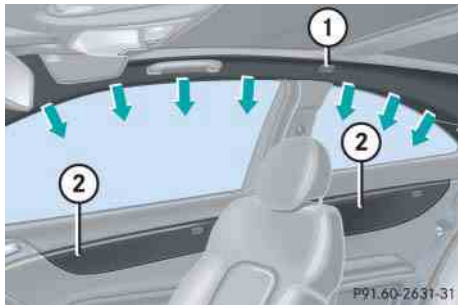

- ① Window curtain airbag
- ② Side impact airbags

#### Seat belts

When the engine is started, the seat belt non-usage warning lamp  illuminates to remind you and your passengers to fasten your seat belts. If the driver's seat belt is not fastened before the engine is started, the seat belt non-usage warning

lamp  illuminates and a warning chime sounds for approximately six seconds when the engine is started.

The use of seat belts and infant and child restraint systems is required by law in most states and all Canadian provinces. Even where this is not the case, all vehicle occupants should have their seat belts fastened whenever the vehicle is in motion.

For more information on seat belts see “Fastening the seat belt” (▷ page 41).



For information on infants and children traveling with you in the vehicle and restraint systems for infants and children, see “Children in the vehicle” (▷ page 65).

#### Warning!



Always fasten your seat belt before driving off. Always make sure your passengers are properly restrained, even those sitting in the rear and pregnant women.

Failure to wear and properly fasten and position your seat belt greatly increases your risk of injuries and their likely severity in an accident. You and your passengers should always wear seat belts.

If you are ever in an accident, your injuries can be considerably more severe without your seat belt properly buckled. Without your seat belt buckled, you are much more likely to hit the interior of the vehicle or be ejected from it. You can be seriously injured or killed.

In the same crash, the possibility of injury or death is lessened if you are properly wearing your seat belt. Airbags can only protect as they are designed if the occupants are properly wearing their seat belts.

## Safety and Security

### Occupant safety

#### Warning!



Never ride in a moving vehicle with the seat backrest reclined. Sitting in an excessively reclined position can be dangerous. You could slide under the seat belt in a collision. If you slide under it, the belt would apply force at the abdomen or neck. That could cause serious or even fatal injuries. The seat backrest and seat belt provide the best restraint when the wearer is in an upright position and the belt is properly positioned on the body.

#### Warning!



Never let more people ride in the vehicle than there are seat belts available. Be sure everyone riding in the vehicle is correctly restrained with a separate seat belt.

#### Warning!



Damaged seat belts or belts that were highly stressed in an accident must be replaced and their anchoring points must also be checked.

Only use seat belts which have been approved by Mercedes-Benz.

Do not make any modifications to the seat belts. This can lead to unintended activation or to failure.

Have all work carried out only by qualified technicians. Contact an authorized Mercedes-Benz Center.

#### Warning!



#### USE SEAT BELTS PROPERLY

- Seat belts can only work when used properly. Never wear seat belts in any other way than as described in this section, as that could result in serious injuries in case of an accident.
- Each occupant should wear their seat belt at all times, because seat belts help reduce the likelihood of and potential severity of injuries in accidents, including rollovers. The integrated restraint system includes SRS (driver airbag, passenger front airbag, side impact airbags, head protection window curtain airbags for side windows), ETD (seat belt emergency tensioning device), and front seat knee bolsters. The system is designed to enhance the protection offered to properly belted occupants in certain frontal (front airbags) and side (side impact and window curtain airbags) impacts which exceed preset deployment thresholds.



## Safety and Security

### Occupant safety



- Never wear the shoulder belt under your arm, against your neck or off your shoulder. In a crash, your body would move too far forward. That would increase the chance of head and neck injuries. The belt would also apply too much force to the ribs or abdomen, which could severely injure internal organs such as your liver or spleen.
- Never wear belts over rigid or breakable objects in or on your clothing, such as eyeglasses, pens, keys, etc., as these might cause injuries.
- Position the lap belt as low as possible on your hips and not across the abdomen. If the belt is positioned across your abdomen, it could cause serious injuries in a crash.

- Never use a seat belt for more than one person at a time. Do not fasten a seat belt around a person and another person or other objects.
- Belts should not be worn twisted. In a crash, you wouldn't have the full width of the belt to manage impact forces. The twisted belt against your body could cause injuries.
- Pregnant women should also use a lap-shoulder belt. The lap belt portion should be positioned as low as possible on the hips to avoid any possible pressure on the abdomen.
- Never place your feet on the instrument panel or on the seat. Always keep both feet on the floor in front of the seat.

### Emergency tensioning device (ETD)

The seat belts are equipped with emergency tensioning devices and belt force limiters.

The ETD is designed to activate in the following cases when the seat belts are fastened:

- in frontal or rear-end impacts exceeding a preset severity level
- if the restraint systems are operational and functioning correctly, see **SRS** indicator lamp (▷ page 56).

In an impact, emergency tensioning devices remove slack from the belts in such a way that the seat belts fit more snugly against the body. Belt force limiters reduce the force exerted by the seat belts on occupants during a crash.



#### Warning!



An emergency tensioning device (ETD) that was activated must be replaced.

When disposing of the emergency tensioning device, our safety instructions must be followed. These are available at your authorized Mercedes-Benz Center.



Do not place objects heavier than 20 lbs (9kg) on the front passenger seat. This could cause the front or side impact airbag on the front passenger side to deploy in a crash which exceeds the system's deployment threshold.

#### Children in the vehicle

If an infant or child is traveling with you in the vehicle:

- Secure the child using an infant or child restraint appropriate to the age and size of the child and recommended for use by Mercedes-Benz.
- Ensure that the infant or child is properly secured by a belt at all times while the vehicle is in motion.

Infant and child restraint seats and information on choosing an appropriate restraint system can be obtained from any Mercedes-Benz Center.

#### Infant and child restraint systems

Use only a BabySmart™<sup>1</sup> compatible child restraint for the front passenger seat in this vehicle.

We recommend all infants and children be properly restrained at all times while the vehicle is in motion.

All lap-shoulder belts except the driver's seat belt have special seat belt retractors for secure fastening of child restraints.

To fasten a child restraint, follow child restraint instructions for mounting. Then pull the shoulder belt out completely and let it retract. During the seat belt retraction, a ratcheting sound can be heard to indicate that the special seat belt retractor is activated. The belt is now locked. Push down on child restraint to take up any slack.

To deactivate, release seat belt buckle and let seat belt retract completely. The seat belt can again be used in the usual manner.

<sup>1</sup> BabySmart™ is a trademark of Siemens Automotive Corp.

## Safety and Security

### Occupant safety



For information on child seats with mounting fittings for tether anchorages, see “Installation of infant and child restraint systems” (▷ page 69).

For information on LATCH-type child seat anchors, see “Child seat anchors – LATCH-type” (▷ page 70).

#### Warning!



Never release the seat belt buckle while the vehicle is in motion, since the special seat belt retractor will be deactivated.



The use of infant or child restraints is required by law in all 50 states, the District of Columbia, the U.S. territories and all Canadian provinces.

Infants and small children should be seated in an appropriate infant or child restraint system properly secured by a lap-shoulder belt or, if so equipped, a child restraint lower anchorage system that complies with U.S. Federal Motor Vehicle Safety Standards 213 and 225 and Canadian Motor Vehicle Safety Standards 213 and 210.2.

A statement by the child restraint manufacturer of compliance with this standard can be found on the instruction label on the restraint and in the instruction manual provided with the restraint.

When using any infant or child restraint system, be sure to carefully read and follow all manufacturer’s instructions for installation and use.

Please read and observe warning labels affixed to inside of vehicle and to infant or child restraints.

#### Warning!



Children 12 years old and under must never ride in the front seat, except in a Mercedes-Benz authorized BabySmart™<sup>1</sup> compatible child seat, which operates with the BabySmart™ system installed in the vehicle to deactivate the passenger front airbag when it is properly installed. Otherwise they will be struck by the airbag when it inflates in a crash. If this happens, serious or fatal injury will result.

According to accident statistics, children are safer when properly restrained in the rear seating positions than in the front seating positions. Infants and small children must ride in back seats and be seated in an appropriate infant or child restraint system, which is properly secured with the vehicle’s seat belt and top tether strap, or secured via lower anchors and top tether strap, fully in accordance with the child seat manufacturer’s instructions.

<sup>1</sup> BabySmart™ is a trademark of Siemens Automotive Corp.

## Safety and Security

### Occupant safety

Infants and small children should never share a seat belt with another occupant. During an accident, they could be crushed between the occupant and seat belt.

A child's risk of serious or fatal injuries is significantly increased if the child restraints are not properly secured in the vehicle and the child is not properly secured in the child restraint.

Children too big for child restraint systems must ride in back seats using regular seat belts. Position shoulder belt across chest and shoulder, not face or neck. A booster seat may be necessary to achieve proper belt positioning for children from 41 lbs until they reach a height where a lap/shoulder belt fits properly without a booster.

When the child restraint is not in use, remove it from the vehicle or secure it with the seat belt to prevent the child restraint from becoming a projectile in the event of an accident.

Do not leave children unattended in the vehicle; even if the children are secured in a child restraint system. Unsupervised children in a child restraint system may use vehicle equipment and may cause an accident and/or serious personal injury.

#### BabySmart™ airbag deactivation system



Special BabySmart™ compatible child seats, designed for use with the Mercedes-Benz system and available at any authorized Mercedes-Benz Center are required for use with the BabySmart™ airbag deactivation system. With the special child seat properly installed, the passenger front airbag will not deploy.

The PASS. AIRBAG OFF indicator lamp located in the center console will be illuminated, except with the SmartKey removed or in starter switch position **0**.



The system does not deactivate the side impact airbag and the emergency tensioning device.

## Safety and Security

### Occupant safety

#### Self-test BabySmart™<sup>1</sup> without special child seat installed

After turning the SmartKey in the starter switch to position **1** or **2**, the PASS. AIRBAG OFF indicator lamp located in the center console comes on for approx. six seconds and then goes out.

If the indicator lamp should not come on or is continuously lit, the system is not functioning. You must see an authorized Mercedes-Benz Center before seating any child on the passenger seat.

For more information see “Practical hints” section (▷ page 262).

#### Warning!



The BabySmart™ airbag deactivation system will ONLY work with a special child seat designed to operate with it. It will not work with child seats which are not BabySmart™ compatible.

Never place anything between seat cushion and child seat (e.g. pillow), since it reduces the effectiveness of the deactivation system. The bottom of the child seat must make full contact with the passenger seat cushion. An incorrectly mounted child seat could cause injuries to the child in case of an accident, instead of protecting the child.

Follow the manufacturer's instructions for installation of special child seats.

#### Warning!



When using a BabySmart™ compatible child seat on the front passenger seat, the passenger front airbag will not deploy only if the PASS. AIRBAG OFF indicator lamp remains illuminated.

Please be sure to check the indicator every time you use the special system child seat. Should the light go out while the restraint is installed, please check installation. If the light remains out, do not use the BabySmart™ restraint to transport children on the front passenger seat until the system has been repaired.

<sup>1</sup> BabySmart™ is a trademark of Siemens Automotive Corp.

## Safety and Security

### Occupant safety

#### Warning!



Do not place powered-on laptops, cell phones and like electronic devices on the front passenger seat. Signals from such devices may interfere with the BabySmart™ system. Such signal interference may cause the PASS. AIRBAG OFF indicator lamp not to come on during self-test or be continuously lit, indicating that the system is not functioning.

#### Installation of infant and child restraint systems

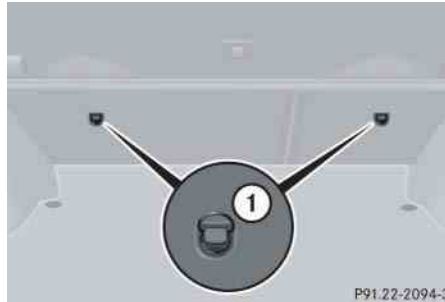

Anchorage rings ① are located on the back side of the rear backrests and on the floor behind rear seat.

Prior to installing a tether strap, note the following steps:

- ▶ Fold backrest forward.

- ▶ Guide tether strap between head restraints and rear shelf.

Head restraint must be installed (if removable) and positioned such that the top tether strap can pass freely between the head restraint and top of seat back.

Make sure the tether strap is not twisted.

- ▶ Fold backrest back until it locks in place.

#### Warning!



Always lock backrest in its upright position when rear seat bench is occupied by passengers, or the extended cargo area is not in use. Check for secure locking by pushing and pulling on the backrest.



## Safety and Security

### Occupant safety

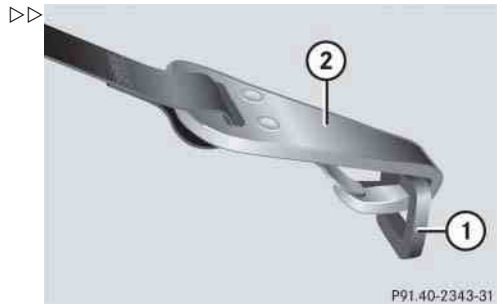

- ▶ Fold up anchorage ring ①.
- ▶ Securely fasten hook ②, which is part of the tether strap, to anchorage ring ①.



For safety, make sure the hook has attached to the ring beyond the safety catch, as illustrated.

### Child seat anchors – LATCH-type

This vehicle is equipped with two LATCH (Lower Anchors and Tethers for Children) type anchors (at each of the rear seats) for the installation of a LATCH child seat with the matching anchor fittings.

If a child seat is not installed, the LATCH anchors can be folded back between the seat cushion and the backrest.

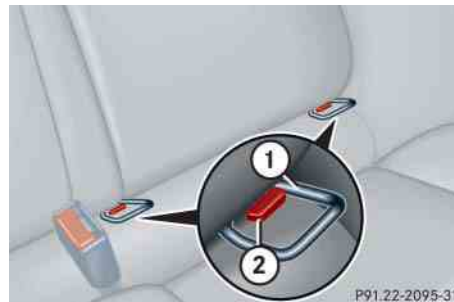

- ① Anchors
- ② Button

- ▶ Grip inner side of anchors ① and fold forward until they audibly lock in place.

- ▶ Install child seat according to the manufacturer's instructions.



The child seat must be firmly attached in the right and left side anchors.

### To fold anchors back

- ▶ Press down button ② on each anchor and return anchor to its catch.



Non-LATCH-type child seats may also be used and can be installed using the vehicle's seat belt system. Install child seat according to the manufacturer's instructions.

## Safety and Security

### Occupant safety

#### Warning!



Children too big for child restraint systems must ride in back seats using regular seat belts. Position shoulder belt across chest and shoulder, not face or neck.

A booster seat may be necessary to achieve proper belt positioning for children from 41 lbs until they reach a height where a lap/shoulder belt fits properly without a booster.

Before installing the child seat, make sure anchors ① are folded out and locked in place.

Install child seat according to manufacturer's instructions.

The child seat must be firmly attached in the right and left side anchors ①.

An incorrectly mounted child seat may come loose during an accident which could result in serious injury or death to your child.

Damaged or impact-damaged child seats or child seat anchors must be replaced.

Do not leave children unattended in the vehicle, even if the children are secured in a child restraint system.

## Safety and Security

### Panic alarm\*

#### ▼ Panic alarm\*

An audible alarm and flashing exterior lamps will operate for approximately 2½ minutes.



① PANIC button



Canada only:  
Only vehicles equipped with an anti-theft alarm system\* have SmartKeys with integrated panic button ①.

#### Activating

- ▶ Press and hold button ① for at least one second.

#### Deactivating

- ▶ Press button ① again.
- ▶ Insert SmartKey in starter switch.



For operation in the USA only: This device complies with Part 15 of the FCC Rules. Operation is subject to the following two conditions:

- (1) This device may not cause harmful interference, and
- (2) this device must accept any interference received, including interference that may cause undesired operation.

Any unauthorized modification to this device could void the user's authority to operate the equipment.



#### ▼ Driving safety systems

In this section you will find information on the following driving safety systems:

- ABS (Antilock Brake System)
- BAS (Brake Assist System)
- ESP (Electronic Stability Program)



In winter operation, the maximum effectiveness of the ABS, ESP is only achieved with winter tires (M+S tires), or snow chains as required.

#### Warning!



The following factors increase the risk of accidents:

- Excessive speed, especially in turns
- Wet and slippery road surfaces
- Following another vehicle too closely

The ABS, BAS, ESP cannot reduce this risk.

Always adjust your driving style to the prevailing road and weather conditions.

#### ABS

#### Warning!



Do not pump the brake pedal. Use firm, steady brake pedal pressure instead. Pumping the brake pedal defeats the purpose of the ABS and significantly reduces braking effectiveness.

The Antilock Brake System (ABS) regulates the brake pressure so that the wheels do not lock during braking. This allows you to maintain the ability to steer your vehicle.

The ABS is functional above a speed of approximately 5 mph (8 km/h) independent of road surface conditions.

On slippery road surfaces, the ABS will respond even with light brake pressure.

The  indicator lamp in the instrument cluster (▷ page 22) comes on when you turn the SmartKey in the starter switch to position **2**. It goes out when the engine is running.

#### Braking

At the instant one of the wheels is about to lock up, a slight pulsation can be felt in the brake pedal, indicating that the ABS is in the regulating mode.

- ▶ Keep firm and steady pressure on the brake pedal while experiencing the pulsation.

Continuous, steady brake pedal pressure yields the advantages provided by the ABS, namely braking power and the ability to steer the vehicle.

The pulsating brake pedal can be an indication of hazardous road conditions and functions as a reminder to take extra care while driving.

## Safety and Security

### Driving safety systems

#### Emergency brake maneuver

- ▶ Keep continuous full pressure on the brake pedal.

#### Warning!



The ABS cannot prevent the natural laws of physics from acting on the vehicle, nor can it increase braking or steering efficiency beyond that afforded by the condition of the vehicle brakes and tires or the traction. The ABS cannot prevent accidents, including those resulting from excessive speed in turns, following another vehicle too closely, or hydroplaning. Only a safe, attentive, and skillful driver can prevent accidents. The capabilities of an ABS equipped vehicle must never be exploited in a reckless or dangerous manner which could jeopardize the user's safety or the safety of others.

For more information, see "Practical hints" (▷ page 258).

#### BAS

The Brake Assist System (BAS) operates in emergency situations. If you apply the brakes very quickly, the BAS automatically provides full brake boost, thereby potentially reducing the braking distance. Apply continuous full braking pressure until the emergency braking situation is over. The ABS will prevent the wheels from locking.

When you release the brake pedal, the brakes function again as normal. The BAS is then deactivated.

For more information, see "BAS" (▷ page 265).

#### Warning!





The BAS cannot prevent the natural laws of physics from acting on the vehicle, nor can it increase braking efficiency beyond that afforded by the condition of the vehicle brakes and tires or the traction. The BAS cannot prevent accidents, including those resulting from excessive speed in turns, following another vehicle too closely, or hydroplaning. Only a safe, attentive, and skillful driver can prevent accidents. The capabilities of a BAS equipped vehicle must never be exploited in a reckless or dangerous manner which could jeopardize the user's safety or the safety of others.

#### ESP

The Electronic Stability Program (ESP) monitors the vehicle's traction (force of adhesive friction between the tires and the road surface) and handling.

The ESP recognizes when a wheel is spinning or if the vehicle starts to skid. By applying brakes to the appropriate wheel and by limiting engine output, the ESP works to stabilize the vehicle. The ESP is especially useful while driving off and on wet or slippery road surfaces.

The ESP warning lamp  in the speedometer flashes when the ESP is engaged.

The ESP warning lamp  in the speedometer comes on when you turn the SmartKey in the starter switch to position **2**. It goes out when the engine is running.

#### Warning!



Never switch off the ESP when you see the ESP warning lamp  flashing in the speedometer dial. In this case proceed as follows:

- While driving off, apply as little throttle as possible.
- While driving, ease up on the accelerator.
- Adapt your speed and driving style to the prevailing road conditions.

Failure to observe these guidelines could cause the vehicle to skid.

The ESP cannot prevent accidents resulting from excessive speed.

#### Warning!



The ESP cannot prevent the natural laws of physics from acting on the vehicle, nor can it increase the traction afforded. The ESP cannot prevent accidents, including those resulting from excessive speed in turns, or hydroplaning. Only a safe, attentive, and skillful driver can prevent accidents. The capabilities of an ESP equipped vehicle must never be exploited in a reckless or dangerous manner which could jeopardize the user's safety or the safety of others.

## Safety and Security

### Driving safety systems



Because of the ESP's automatic operation, the engine must be shut off (SmartKey in starter switch position **0** or **1**) when

- the parking brake is being tested on a brake test dynamometer
- the vehicle is being towed with the front axle raised

Active braking action through the ESP may otherwise seriously damage the rear axle brake system.

The ESP will only function properly if you use wheels of the recommended tire size.

For more information, see "Practical hints" (▷ page 261).

### Switching off the ESP

#### Warning!



The ESP should not be switched off during normal driving other than in the circumstances described below. Disabling of the system will reduce vehicle stability in standard driving maneuvers.

To improve the vehicle's traction, turn off the ESP in driving situations where it would be advantageous to have drive wheels spin and thus cut into surfaces for better grip such as:

- starting out on slippery surfaces and in deep snow in conjunction with snow chains
- sand or gravel

The switch is located on the center console.



- ① ESP off
- ② ESP on

- ▶ Press upper half ① of the ESP switch until the ESP warning lamp  in the speedometer comes on.

The ESP is deactivated.

If one or more drive wheels are spinning, the ESP warning lamp  in the speedometer dial flashes, regardless of the speed.

Traction control brakes a spinning wheel even when the ESP is deactivated.

The ESP always operates when you are braking, even when it has been deactivated.



Avoid spinning of a drive wheel for an extended period with the ESP switched off. This may cause serious damage to the drivetrain which is not covered by the Mercedes-Benz Limited Warranty.

### Warning!



When the ESP warning lamp  is illuminated continuously, the ESP is switched off.

Adapt your speed and driving to the prevailing road conditions and to the non-operating status of the ESP.

### Switching on the ESP

- ▶ Press lower half ② of the ESP switch until the ESP warning lamp  in the speedometer goes out

You are now again in normal driving mode.

## Safety and Security

### Driving safety systems



Turn on the ESP immediately if the aforementioned circumstances do not apply anymore.

## Safety and Security

### Anti-theft systems

#### ▼ Anti-theft systems

##### Immobilizer

The immobilizer prevents unauthorized persons from starting your vehicle.

##### Activating

- Removing the SmartKey from the starter switch activates the immobilizer.

##### Deactivating

- Inserting the SmartKey in the starter switch deactivates the immobilizer.



In case the engine cannot be started (yet the vehicle's battery is charged), the system is not operational. Contact an authorized Mercedes-Benz Center or call 1-800-FOR-MER-Cedes (in the USA), or 1-800-387-0100 (in Canada).

##### Anti-theft alarm system\*

Once the alarm system has been armed, a visual and audible alarm is triggered when someone opens

- a door
- the trunk lid
- the hood.

The alarm will stay on even if the activating element (a door, for example) is immediately closed.

The alarm system will also be triggered when

- someone attempts to raise the vehicle
- the vehicle is opened with the mechanical key.



If the alarm stays on for more than 20 seconds, an emergency call is initiated automatically by the Tele Aid system\* provided Tele Aid service was subscribed to and properly activated,

and that necessary cellular service and GPS coverage are available.

##### Arming the alarm system

The alarm system is armed after locking the vehicle with the SmartKey. The turn signal lamps flash three times to indicate that the alarm system is activated. The indicator lamp in the switch for the tow-away alarm will flash after approximately ten seconds when the alarm system is completely armed (> page 80).



If the turn signal lamps do not flash three times one of the following elements may not be properly closed:

- a door
- the trunk lid
- the hood

Close the respective element and lock the vehicle again.

#### Disarming the alarm system

The alarm system is disarmed when you unlock your vehicle with the SmartKey. The turn signal lamps flash once to indicate that the alarm system is deactivated.





The alarm system will rearm automatically after approximately 40 seconds if a door or the trunk lid is not opened.

#### Canceling the alarm

To cancel the alarm:

- ▶ Insert the SmartKey in the starter switch.

or

- ▶ Press the  or  button on the SmartKey.

#### Tow-away alarm\*

Once the tow-away alarm is armed, a visual and audible alarm will be triggered when someone attempts to raise the vehicle.



The tow-away protection alarm is triggered, for example, if the vehicle is lifted on one side.

If the alarm stays on for more than 20 seconds, an emergency call is initiated automatically by the Tele Aid system provided Tele Aid service was subscribed to and properly activated, and that necessary cellular service and GPS coverage are available.

#### Arming tow-away alarm

When you lock your vehicle, the tow-away alarm is automatically armed after about 30 seconds.

When you unlock your vehicle, the tow-away protection disarms automatically.

## Safety and Security

### Anti-theft systems

#### Disarming tow-away alarm

To prevent triggering the tow-away alarm feature, switch off the tow-away alarm before towing the vehicle, or when parking on a surface subject to movement, such as a ferry or auto train.



- ① Tow-away alarm off switch
- ② Indicator lamp

The switch is located on the center console.

- ▶ Turn off the ignition and remove the SmartKey.



You cannot disarm the tow-away alarm while the ignition is turned on.

- ▶ Press upper half ① of the switch.  
Indicator lamp ② in the switch comes on briefly.
- ▶ Lock your vehicle with the SmartKey.

The tow-away alarm remains disarmed until you lock your vehicle again.





**Controls in detail**

**Locking and unlocking**

**Seats**

**Memory function\***

**Lighting**

**Instrument cluster**

**Control system**

**Manual transmission**

**Automatic transmission\***

**Good visibility**

**Climate control**

**Audio system**

**Power windows**

**Panorama sliding/pop-up roof\***

**Driving systems**

**Loading**

**Useful features**

## Controls in detail

### Locking and unlocking

In the “Controls in detail” section you will find detailed information on how to operate the equipment installed on your vehicle. If you are already familiar with the basic functions of your vehicle, this section will be of particular interest to you.

To quickly familiarize yourself with the basic functions of the vehicle, refer to the “Getting started” section of this manual. The corresponding page numbers are given at the beginning of each segment.

### ▼ Locking and unlocking

#### Keys

Your vehicle comes supplied with two SmartKeys, each with remote control and a removable mechanical key. The locking tabs for the mechanical key portion of the two keys are a different color to help distinguish each key unit.

The SmartKey provides an extended operating range. To prevent theft, however, it is advisable to only unlock the vehicle when you are in close proximity to it.

The SmartKey centrally locks and unlocks:

- the doors
- the trunk lid
- the fuel filler flap



You can also open and close the power windows (▷ page 186) and panorama sliding/pop-up roof\* (▷ page 192) using the SmartKey.

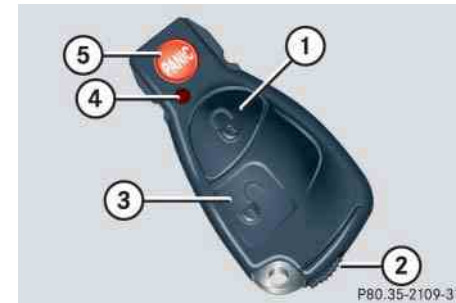

#### SmartKey with remote controls

- ① Lock button
- ② Mechanical key locking tab
- ③ Unlock button
- ④ Battery check lamp
- ⑤ **PANIC** Panic button\* (▷ page 72)



Canada only:

Only vehicles equipped with an anti-theft alarm system\* have SmartKeys with integrated panic button\* ⑤.



To prevent possible malfunction, avoid exposing the SmartKey to high levels of electromagnetic radiation.

### Factory setting

#### Global unlocking

- ▶ Press button .

All turn signal lamps flash once. The locking knobs in the doors move up.

The vehicle will lock again automatically within approximately 40 seconds of unlocking if neither door nor trunk lid is opened, the SmartKey is not inserted in the starter switch, or the central locking switch is not activated.



#### Global locking

- ▶ Press button .

All turn signal lamps flash three times. The locking knobs in the doors move down.

### Individual setting

If you frequently travel alone, you may wish to reprogram the SmartKey so that pressing  only unlocks the driver's door and the fuel filler flap.

- ▶ Press and hold buttons  and  simultaneously for about five seconds until battery check lamp  flashes twice.

The SmartKey will then function as follows:

Unlocking driver's door and fuel filler flap.

- ▶ Press button  once.

Global unlocking

- ▶ Press button  twice.



Global locking

- ▶ Press button .

## Controls in detail

### Locking and unlocking

#### Restoring to factory setting

- ▶ Press and hold buttons  and  simultaneously for about six seconds until battery check lamp  flashes twice.

#### Warning!



When leaving the vehicle, always remove the SmartKey from the starter switch, take it with you and lock the vehicle. Do not leave children unattended in the vehicle, or with access to an unlocked vehicle. It is possible for children to open a locked door from the inside, which could result in an accident and/or serious injury.

## Controls in detail

### Locking and unlocking



If you can no longer lock or unlock the vehicle with the SmartKey, then the batteries in the SmartKey are discharged, the SmartKey is malfunctioning or the vehicle battery is drained.

- Check the batteries in the SmartKey and replace them if necessary (▷ page 290).
- Use the mechanical key to unlock the doors (▷ page 288). Lock the vehicle using the mechanical key (▷ page 289).
- Have the vehicle battery and the battery connections checked by an authorized Mercedes-Center.

If the SmartKey is malfunctioning, contact an authorized Mercedes-Benz Center.

#### Checking the batteries

- ▶ Press button or .

Battery check lamp ④ comes on briefly to indicate that the SmartKey batteries are in order.



If battery check lamp ④ does not come on briefly during check, then the SmartKey batteries are discharged.

Replace the batteries (▷ page 290).

You can obtain the required batteries at any authorized Mercedes-Benz Center.



If the batteries are checked within signal range of the vehicle, pressing the or button will lock or unlock the vehicle accordingly.

#### Loss of SmartKey or mechanical key

If you lose a SmartKey or mechanical key, you should do the following:

- ▶ Have the SmartKey deactivated by an authorized Mercedes-Benz Center.
- ▶ Report the loss of the SmartKey or the mechanical key immediately to your car insurance company.
- ▶ If necessary, have the mechanical lock replaced.

Your authorized Mercedes-Benz Center will be glad to supply you with a replacement.

## Controls in detail

### Locking and unlocking

#### Opening the doors from the inside

You can open a locked door from the inside. Open door only when conditions are safe to do so.

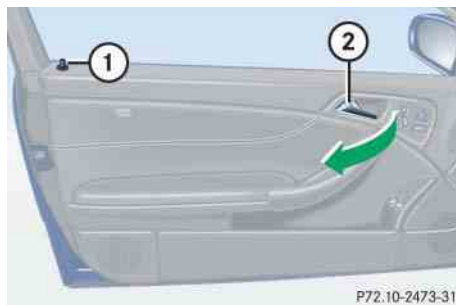

- ① Locking knob
- ② Inside door handle



- ▶ Pull on door handle ②.

If door was locked, locking knob ① will move up.



If the vehicle has previously been locked from the outside with the SmartKey, opening a door from the inside will trigger the alarm.

To cancel the alarm, do one of the following:

- Press button  or  on the SmartKey.
- Insert the SmartKey in the starter switch.

#### Opening the trunk lid

A minimum height clearance of 7.1 ft. (2.16 m) is required to open the trunk lid.

The handle is located above the rear license plate recess.

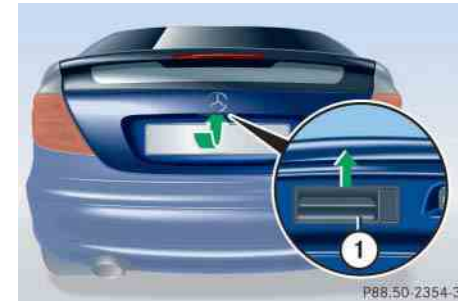

- ① Handle

- ▶ Pull on handle ① and lift the trunk lid.



The trunk lid swings open upwards automatically. Always make sure there is sufficient overhead clearance.

## Controls in detail

### Locking and unlocking



The vehicle must be unlocked.

The trunk can also be opened from its inside in an emergency, see “Trunk lid emergency release” (▷ page 86).

### Closing the trunk lid



① Handle

- ▶ Lower trunk lid by pulling firmly on grip ①.
- ▶ Close trunk lid with hands placed flat on it.

### Warning!



To prevent possible personal injury, always keep hands and fingers away from the trunk opening when closing the trunk. Be especially careful when small children are around.

### Warning!



Only drive with the trunk closed. Among other dangers, such as your view being blocked, exhaust fumes may enter the vehicle interior.



To prevent an inadvertent lockout, do not place the SmartKey in the trunk.

### Trunk lid emergency release

The emergency release button is located on the inside of the trunk lid.

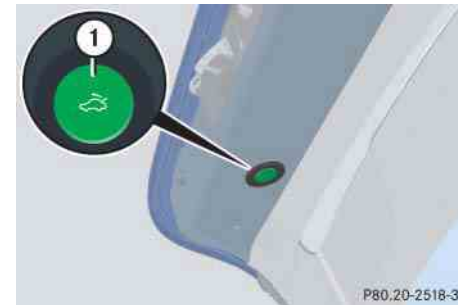

① Emergency release button

- ▶ Briefly press emergency release button ①.

The trunk unlocks and the trunk lid opens.



The trunk lid swings open upwards automatically. Always make sure there is sufficient overhead clearance.



The emergency release button unlocks and opens the trunk while the vehicle is standing or driving.



The emergency release button does not open the trunk lid, if the vehicle battery is discharged or disconnected.

Illumination of the emergency release button:

- The button will flash for 30 minutes after opening the trunk.
- The button will flash for 60 minutes after closing the trunk.



If the emergency release button is pressed and the vehicle was centrally locked, the exterior lamps will flash and the alarm will sound as the trunk lid opens. To cancel the alarm, do one of the following:

- Press button  or  on the SmartKey.
- Insert the SmartKey in the starter switch.

#### Automatic central locking

The doors and the trunk lid automatically lock when the ignition is switched on and the wheels are turning at vehicle speeds of approximately 9 mph (15 km/h) or more.

You can open a locked door from the inside. Open door only when conditions are safe to do so.



The doors unlock automatically after an accident if the force of the impact exceeds a preset threshold.

The vehicle automatically locks when the ignition is switched on and the wheels are turning at vehicle speeds of approximately 9 mph (15 km/h) or more. You could therefore lock yourself out when the vehicle

- is pushed or towed
- is on a test stand

For more information on towing the vehicle, see “Towing the vehicle” (> page 313).

You can deactivate the automatic locking mode using the control system (> page 129).

## Controls in detail

### Locking and unlocking

## Controls in detail

### Locking and unlocking

#### Locking and unlocking from the inside

You can lock or unlock the doors and the trunk lid from inside using the central locking switch. This can be useful, for example, if you want to lock the vehicle before starting to drive.

The fuel filler flap will not be locked or unlocked with the central locking switch.

#### Warning!



When leaving the vehicle, always remove the SmartKey from the starter switch, take it with you and lock the vehicle. Do not leave children unattended in the vehicle, or with access to an unlocked vehicle. Unsupervised use of vehicle equipment may cause an accident and/or serious personal injury.

The switch is located in the center console.



#### Central locking switch

- ① Locking
- ② Unlocking

#### Locking

- ▶ Press upper half ① of the central locking switch.

If all the doors are closed, the vehicle locks.

#### Unlocking

- ▶ Press lower half ② of the central locking switch.

The vehicle unlocks.



You can open a locked door from inside. Open door only when conditions are safe to do so.

If the vehicle was previously centrally locked with the SmartKey, it will not unlock using the central locking switch.

If the vehicle was previously locked with the central locking switch

- while in the individual remote control mode, only the door opened from the inside is unlocked.
- while in the global remote control mode, the complete vehicle is unlocked when a door is opened from the inside.



## ▼ Seats

For information on seat adjustment, see “Adjusting” (▷ page 32).

### Easy-entry/exit feature\*

With the easy-entry/exit feature activated, the steering wheel tilts upwards and the driver’s seat moves to the rear.

This allows easier entry into and exit from the vehicle when the driver’s door is opened. However, the engine must be turned off.

When the SmartKey is inserted in the starter switch and the driver’s door is closed, the steering wheel and the driver’s seat return to their last set position.

### Warning!



You must make sure that no one can become trapped or injured by the moving steering wheel and driver’s seat when the easy-entry/exit feature\* is activated, the driver’s door is being opened and the engine is turned off or the SmartKey is removed from the starter switch.

Do not leave children unattended in the vehicle, or with access to an unlocked vehicle. Children could open the driver’s door and unintentionally activate the easy-entry/exit feature\*, which could result in an accident and/or serious personal injury.

## Controls in detail

### Seats

You can activate the following functions:

- Steering column:  
Only the steering column is adjusted.
- Steering column and seat:  
The steering column and the seat are adjusted.

The easy-entry/exit feature can be switched on or off in the convenience sub-menu of the control system (▷ page 130).



To cancel seat/steering wheel movement, do one of the following:

- Press the seat adjustment switch\* (▷ page 35).
- Move the steering column stalk\* (▷ page 38).
- Press the memory button\* (▷ page 96).

## Controls in detail

### Seats

#### Removing and installing front seat head restraints

For more information on head restraint adjustment, see “Adjusting” (▷ page 32).

#### Warning!



For your protection, drive only with properly positioned head restraints.

Adjust head restraint so that the head restraint supports the back of the head at eye level. This will reduce the potential for injury to the head and neck in the event of an accident or similar situation.

Do not drive the vehicle without the seat head restraints. Head restraints are intended to help reduce injuries during an accident.

Do not interchange head restraints from front and rear seat.



Tilt the backrest to the rear for easier removal and installation of the head restraints.

#### Front seat head restraints, manual seat

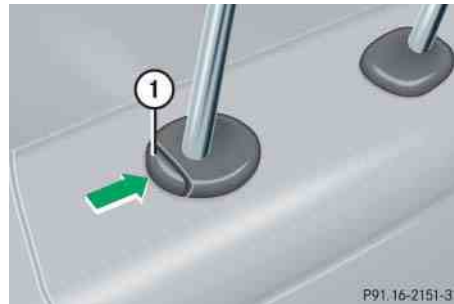

① Release button

#### Removing front seat head restraints

- ▶ Pull head restraint to its highest position.
- ▶ Press release button ① and pull out head restraint.

#### Installing front seat head restraints

- ▶ Insert head restraint and push it down to the stop.
- ▶ Press release button ① and adjust head restraint to desired position.

#### Front seat head restraints, power seat\*

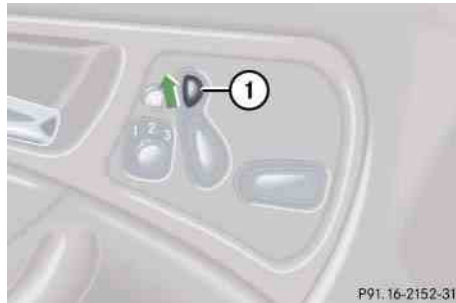

#### **Removing front seat head restraints**

- ▶ Press switch ① upwards and hold until the head restraint is fully extended.
- ▶ Pull out head restraint.

#### **Installing front seat head restraints**

- ▶ Press switch ① upwards and hold for about five seconds.
- ▶ Push the head restraint down until it engages.
- ▶ Adjust head restraint to desired position.

#### Rear seat head restraints

#### Head restraint height

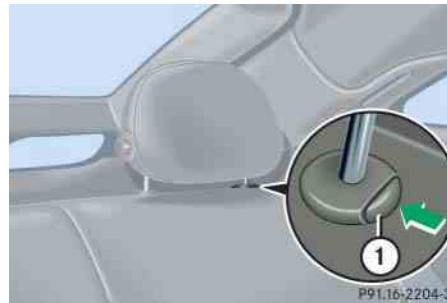

- ① Release button

#### Raising:

- ▶ Manually adjust the height of the head restraint by pulling it upward.

If the head restraint is fully retracted, press release button ① and pull the head restraint out.

#### Lowering:

- ▶ To lower the head restraint, press release button ① and press down on the head restraint.

#### **Warning!**



For your protection, drive only with properly positioned head restraints.

Adjust head restraint so that the head restraint supports the back of the head at eye level. This will reduce the potential for injury to the head and neck in the event of an accident or similar situation.

Do not drive the vehicle without the seat head restraints. Head restraints are intended to help reduce injuries during an accident.

## Controls in detail

### Seats

#### Folding head restraints back

The rear seat head restraints can be folded backward for increased visibility.

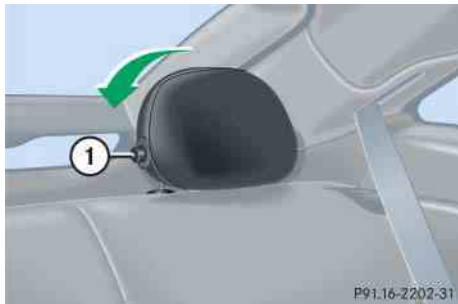

① Release button

- ▶ Press release button ①.

The head restraints will fold backward.

#### Warning!



For safety reasons, always drive with the rear head restraints in the upright position when the rear seats are occupied.

Keep the area around head restraints clear of articles (e.g. clothing) to not obstruct the folding operation of the head restraints.

#### Placing head restraints upright



- ▶ Pull the head restraint forward until it locks into position.



Make sure the head restraints engage when placing them upright. Otherwise their protective function cannot be assured.

#### Head restraint tilt

Two different head restraint angle positions are available.

- ▶ Press the release button and tilt the head restraint to the desired position.

## Removing and installing rear seat head restraints

### Warning!



For your protection, drive only with properly positioned head restraints.

Adjust head restraint so that the head restraint supports the back of the head at eye level. This will reduce the potential for injury to the head and neck in the event of an accident or similar situation.

Do not drive the vehicle without the seat head restraints. Head restraints are intended to help reduce injuries during an accident.

Do not interchange head restraints from front and rear seat.

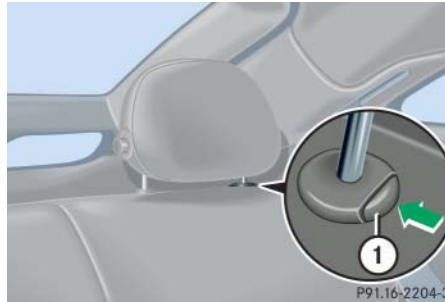

① Release button

### Removing rear seat head restraints

- ▶ Fold back head restraint (▷ page 92).
- ▶ Pull head restraint to its highest position.
- ▶ Press release button ① and pull out head restraint.

### Installing rear seat head restraints

- ▶ Insert head restraint and push it down until it engages.
- ▶ Press release button ① and adjust head restraint to desired position.

## Controls in detail

### Seats

### Heated seats\*

Both switches for the front seats are located in the center console.



- ① Normal heating
- ② Rapid heating

- ▶ Make sure the ignition is switched on.

All the lights in the instrument cluster come on.

## Controls in detail

### Seats

#### Switching on seat heating

- ▶ Press upper switch position ①.  
A red indicator lamp on the switch comes on.

#### Switching off seat heating

- ▶ Press upper switch position ① again.



The seat heater will be automatically switched off after approximately 30 minutes.

#### Switching on rapid seat heating

- ▶ Press lower switch position ②.

Both red indicator lamps on the switch come on.



The system switches over to normal heating mode after approximately five minutes. Only one indicator lamp remains lit.

#### Switching off rapid seat heating

- ▶ Press lower switch position ② again.



If one or both of the indicator lamps on the seat heater switch are flashing, there is insufficient voltage available since too many electrical consumers are turned on. The seat heater switches off automatically.

The seat heater will switch back on again automatically as soon as sufficient voltage is available.

## ▼ Memory function\*



Prior to operating the vehicle, the driver should check and adjust the seat height, seat position fore and aft, and seat backrest angle if necessary, to ensure adequate control, reach and comfort. The head restraint should also be adjusted for proper height. See also the section on airbags (▷ page 57) for proper seat positioning.

In addition, adjust the steering wheel to ensure adequate control, reach, operation and comfort. Both the interior and exterior rear view mirrors should be adjusted for adequate rear vision.

Fasten seat belts. Infants and small children should be seated in a properly secured restraint system that complies with U.S. Federal Motor Vehicle Safety Standards 213 and 225 and Canadian Motor Vehicle Safety Standards 213 and 210.2.

The memory button and stored position switch are located on the door.

You can store up to three different settings per SmartKey.

The following settings are saved for each stored position:

- Driver's seat and backrest position
- Steering wheel position
- Driver's side exterior rear view mirror position
- Passenger side exterior rear view mirror position
- Front passenger seat position

These key-dependent memory settings can be deactivated if desired (▷ page 131).

## Controls in detail

### Memory function\*

#### Warning!



Do not activate the memory function while driving. Activating the memory function while driving could cause the driver to lose control of the vehicle.

## Controls in detail

### Memory function\*

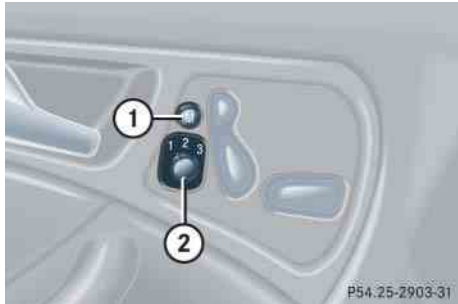

- ① Memory button
- ② Stored position button

- ▶ Make sure the ignition is switched on or the relevant door is open and the SmartKey is inserted in the starter switch.

#### Storing positions into memory

- ▶ Adjust the seats, steering wheel and rear view mirrors to the desired position (▷ page 32).
- ▶ Turn button ② to selected memory position.
- ▶ Press memory button ①.
- ▶ Release memory button and press button ② within three seconds.

All the settings are stored at the selected position.

#### Recalling positions from memory

- ▶ Turn button ② to selected memory position.
- ▶ Press and hold button ② until the seat, steering wheel and exterior rear view mirrors have fully moved to the stored positions.



Releasing the button immediately stops movement to the stored positions.

#### Warning!



Do not operate the power seats using the memory button if the seat backrest is in an excessively reclined position. Doing so could cause damage to front or rear seats. First move backrest to an upright position.



### Storing exterior rear view mirror parking position

For easier parking, you can adjust the passenger-side exterior rear view mirror so that you can see the right rear wheel as soon as you engage reverse gear **R**.

For information on activating the parking position, see see “Activating exterior rear view mirror parking position” (> page 147).



You can store a parking position for the passenger side exterior rear view mirror for each SmartKey using the memory switch.

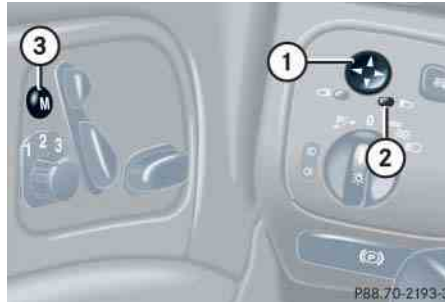

- ① Adjustment button
  - ② Passenger side exterior rear view mirror
  - ③ Memory button
- ▶ Stop the vehicle.
  - ▶ Switch ignition on (if not already on).
  - ▶ Press button ②.

The passenger side exterior rear view mirror is selected.

## Controls in detail

### Memory function\*

- ▶ Adjust the exterior rear view mirror with button ① so that you see the rear wheel and the curb.
- ▶ Press memory button “M” ③ on the door.
- ▶ Within three seconds press bottom of adjustment button ① above the exterior lamp switch.

The parking position is stored if the mirror does not move.



If the mirror does move, repeat the above steps. After the setting is stored you can move the mirror again.

## Controls in detail

### Lighting

#### ▼ Lighting

For information on how to switch on the headlamps and use the turn signals, see the “Getting started” section (▷ page 48).



If you drive in countries where vehicles drive on the other side of the road than the country where the vehicle is registered, you must have the headlamps modified for symmetrical low beams. Relevant information can be obtained at your authorized Mercedes-Benz Center.

#### Exterior lamp switch

The exterior lamp switch is located on the dashboard to the left of the steering wheel



- 0** Off
- AUTO** Automatic headlamp mode
- ▷◁** Parking lamps (also side marker lamps, tail lamps, license plate lamps, instrument panel lamps)  
Canada only: When engine is running, the low beam is also switched on.
- ☰** Low beam plus parking lamps or high beam headlamps (combination switch pushed forward).
- P ←** Standing lamps, right (turn left one stop)
- P** Standing lamps, left (turn left two stops)



If you remove the SmartKey and open the driver's door while the parking lamps or low beam headlamps are switched on,

- a warning sounds
-  appears in the multifunction display
- the message **TURN OFF LIGHTS!** appears in the multifunction display



With the daytime running lamp mode activated and the engine running, the low beam headlamps cannot be switched off manually.

### Manual headlamp mode

The low beam headlamps and parking lamps can be switched on and off with the exterior lamp switch.

### Automatic headlamp mode

The parking lamps, low beam headlamps and license plate lamps switch on and off automatically depending on the brightness of the ambient light.

- ▶ Turn the exterior lamp switch to **AUTO**.

### Warning!





If the exterior lamp switch is set to **AUTO**,

- the headlamps may switch off unexpectedly when the system senses bright ambient light, for example light from oncoming traffic.
- the headlamps will not be automatically switched on under foggy conditions.

## Controls in detail

### Lighting

To minimize risk to you and to others, activate headlamps by turning exterior lamp switch to  when driving or when traffic and /or ambient lighting conditions require you to do so.

In low ambient lighting conditions, only switch from position **AUTO** to  with the vehicle at a standstill. Switching from **AUTO** to  will briefly switch off the headlamps. Doing so while driving in low ambient lighting conditions may result in an accident.

The automatic headlamp feature is only an aid to the driver. The driver is responsible for the operation of the vehicle's lights at all times.

## Controls in detail

### Lighting



With the daytime running lamp mode activated, the low beam headlamps will not be switched off automatically.



The front fog lamps and rear fog lamp cannot be switched on manually with exterior lamp switch in position **AUTO**. To activate the fog lamps, turn exterior lamp switch to position  and pull the exterior lamp switch to first or second stop.

#### Daytime running lamp mode

- ▶ Turn exterior lamp switch to position **0** or **AUTO**.

When the engine is running, the low beam headlamps are automatically switched on. In low ambient light conditions, the parking lamps will also switch on.

#### Canada only

When you shift from a driving position to position **N** or **P**, the low beam switches off (with a three-minute delay).

For nighttime driving you should turn the exterior lamp switch to position  to permit activation of the high beam headlamps.

#### USA only

The high beam headlamps can also be activated when driving with the daytime running lamp mode activated and exterior lamp switch in position **0**.

To activate the daytime running lamp mode, see “Setting daytime running lamp mode (USA only)” (▷ page 125).



For exterior lamp switch, see (▷ page 98).

#### Locator lighting and night security illumination

Locator lighting and night security illumination are described in the control system section under “Setting locator lighting” (▷ page 126) and “Exterior lamps delayed shut off” (▷ page 127).

### Switching on fog lamps





Fog lamps will operate with the parking lamps and/or the low beam headlamps on. Fog lamps should only be used in conjunction with low beam headlamps. Consult your State or Province Motor Vehicle Regulations regarding allowable lamp operation.

### Switching on front fog lamps

#### Warning!



In low ambient lighting or foggy conditions, only switch from position **AUTO** to  with the vehicle at a standstill. Switching from **AUTO** to  will briefly switch off the headlamps. Doing so while driving in low ambient lighting conditions may result in an accident.

- ▶ Make sure the low beam headlamps are switched on.
- ▶ Pull out exterior lamp switch to first stop.  
The green indicator lamp  in the lamp switch comes on.

## Controls in detail

### Lighting

#### Switching on rear fog lamps

- ▶ Make sure the low beam headlamps are switched on.
- ▶ Pull out exterior lamp switch to second stop.

The yellow indicator lamp  in the lamp switch comes on.

## Controls in detail

### Lighting

#### Combination switch

The combination switch is located on the left side of the steering column.

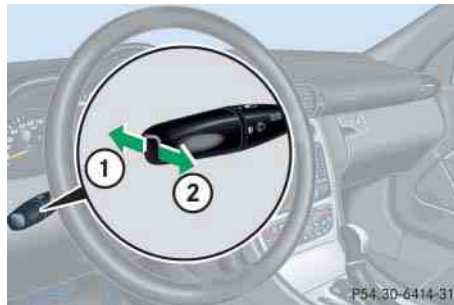

- ① High beam
- ② High beam flasher

#### Switching on high beams

- ▶ Turn exterior lamp switch to position  or to **AUTO** (▷ page 98).
- ▶ Push the combination switch in direction ①.

The high beam indicator  on the instrument cluster is illuminated (▷ page 22).

#### High beam flasher

- ▶ Pull the combination switch briefly in direction ②.

#### Hazard warning flasher

The hazard warning flasher can be activated with the ignition switched on or off. It is activated automatically when an airbag is deployed.

The switch is located on the center console.



- ① Hazard warning flasher switch

#### Switching on the hazard warning flasher

- ▶ Press the hazard warning flasher switch.

All turn signals will flash.



With the hazard warning flasher activated and the combination switch set for either left or right turn, only the respective left or right turn signals will operate when the SmartKey in the starter switch is in position 1 or 2.

#### Switching off the hazard warning flasher

- ▶ Press hazard warning flasher switch again.



If the hazard warning flasher was activated automatically press switch ① twice.

#### Interior lighting

The controls are located in the overhead control panel.



- ① Rear interior lights
- ② Right front reading lamp
- ③ Rocker switch for automatic control system
- ④ Left front reading lamp

#### Activating automatic control

- ▶ Press the rocker switch ③ to center position.

Interior lamps are switched on in darkness, when you

- unlock the vehicle
- open a door
- remove the SmartKey from starter switch

The interior lamps are switched off following a preset time (▷ page 128).



If the door remains open, the interior lamps switch off automatically after approximately five minutes, when the SmartKey is removed or in the starter switch position 0.

An interior lamp switched on manually does not go out automatically.

#### Deactivating automatic control

- ▶ Press the  symbol on rocker switch ③.

The interior lighting remains switched off, even when you

- unlock the vehicle
- open a door
- remove the SmartKey from the starter switch

#### Manual control

##### **Switching all front interior lights on and off**

- ▶ Press the  symbol on rocker switch ③.



The front interior lights come on.

- ▶ Press rocker switch ③ to center position to activate the automatic control.



## Controls in detail

### Lighting



#### **Switching rear interior lights on and off**

- ▶ Press button .  
The lights in the rear passenger compartment come on.
- ▶ Press button  again.  
The lights in the rear passenger compartment go out.

#### **Switching right front reading lamp on and off**

- ▶ Press right button .  
The right reading lamp comes on.  
Press right button  again.
- ▶ The right reading lamp goes out.

#### **Switching left front reading lamp on and off**

- ▶ Press left button .  
The left reading lamp comes on.  
Press left button  again.
- ▶ The left reading lamp goes out.



The setting selected for the interior lighting is used for the trunk lighting as well.

If you leave the trunk lid open for an extended period of time, the trunk lighting will switch off automatically after approximately ten minutes.



## ▼ Instrument cluster

For a full view illustration of the instrument cluster, see “At a glance” (▷ page 22).

The instrument cluster is activated when you:

- open a door
- turn on the ignition
- press the reset button (▷ page 22)
- switch on the exterior lamps

You can change the instrument cluster settings in the Instrument cluster submenu of the control system (▷ page 122).

### Instrument cluster illumination

Use the reset button (▷ page 22) to adjust the illumination brightness for the instrument cluster.



The instrument cluster illumination is dimmed or brightened automatically to suit ambient light conditions.

The instrument cluster illumination will also be adjusted automatically when you switch on the vehicle’s exterior lamps.

## Controls in detail

### Instrument cluster

#### To brighten illumination

- ▶ Turn the reset button in the instrument cluster (▷ page 22) clockwise.

The instrument cluster illumination will brighten.

#### To dim illumination

- ▶ Turn the reset button in the instrument cluster (▷ page 22) counterclockwise.

The instrument cluster illumination will dim.

## Controls in detail

### Instrument cluster

#### Coolant temperature display

##### Warning!





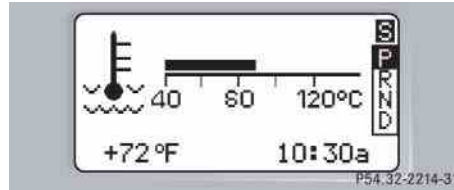

- Driving when your engine is badly overheated can cause some fluids which may have leaked into the engine compartment to catch fire. You could be seriously burned.
- Steam from an overheated engine can cause serious burns and can occur just by opening the engine hood. Stay away from the engine if you see or hear steam coming from it.

Turn off the engine, get out of the vehicle and do not stand near the vehicle until it has cooled down.



Turn the SmartKey in the starter switch to position **1** or **2**.

- ▶ Call up the trip odometer and main odometer by pressing button  or  on the multifunction steering wheel (▷ page 110).
- ▶ Press button  or  until the coolant temperature display appears.





Excessive coolant temperature trigger a warning in the multifunction display.

During severe operating conditions e.g. stop-and-go city traffic, the coolant temperature may rise close to 248°F (120°C).

The engine should not be operated with the coolant temperature above 248°F (120°C). Doing so may cause serious engine damage which is not covered by the Mercedes-Benz Limited Warranty.

#### Trip odometer

- ▶ Make sure you are viewing the trip odometer and main odometer (▷ page 109) in the multifunction display.
- ▶ If it is not displayed, press button  or  on the multifunction steering wheel (▷ page 110) repeatedly until the trip odometer appears.
- ▶ Press and hold the reset button on the instrument cluster (▷ page 22) until the trip odometer is reset.

#### Tachometer

The red marking on the tachometer denotes excessive engine speed.



Avoid driving at excessive engine speeds, as it may result in serious engine damage that is not covered by the Mercedes-Benz Limited Warranty.

To help protect the engine, the fuel supply is interrupted if the engine is operated within the red marking.

#### Outside temperature indicator

##### Warning!



The outside temperature indicator is not designed to serve as an ice-warning device and is therefore unsuitable for that purpose.

Indicated temperatures just above the freezing point do not guarantee that the road surface is free of ice. The road may still be icy, especially in wooded areas or on bridges.

The outside temperature is displayed in the instrument cluster (▷ page 22). For information how to select the unit of the displayed temperature, i.e. degrees Celsius (°C) or degrees Fahrenheit (°F) see “Selecting temperature display mode” (▷ page 123).

## Controls in detail

### Instrument cluster

The temperature sensor is located in the front bumper area. Due to its location, the sensor can be affected by road or engine heat during idling or slow driving. This means that the accuracy of the displayed temperature can only be verified by comparison to a thermometer placed next to the sensor, not by comparison to external displays (e.g. bank signs, etc.).

When moving the vehicle into colder ambient temperatures (e.g. when leaving your garage), you will notice a delay before the lower temperature is displayed.

A delay also occurs when ambient temperatures rise. This prevents inaccurate temperature indications caused by heat radiated from the engine during idling or slow driving.

## ▼ Control system

The control system is activated as soon as the SmartKey in the starter switch is turned to position **1**. The control system enables you to

- call up information about your vehicle
- change vehicle settings

For example, you can use the control system to find out when your vehicle is next due for service, to set the language for messages in the instrument cluster display, and much more.



The displays for the audio systems (radio, CD player, cassette player) will appear in English, regardless of the language selected.

### Warning!



A driver's attention to the road and traffic conditions must always be his/her primary focus when driving.

For your safety and the safety of others, selecting features through the multifunction steering wheel should only be done by the driver when traffic and road conditions permit it to be done safely.

Bear in mind that at a speed of just 30 mph (approximately 50 km/h), your vehicle is covering a distance of 44 feet (approximately 13.5 m) every second.

The control system relays information to the multifunction display.

## Controls in detail

### Control system

#### Multifunction display



- ① Outside temperature
- ② Main odometer
- ③ Trip odometer
- ④ Automatic transmission program mode
- ⑤ Current gear selector lever position
- ⑥ Digital clock

## Controls in detail

### Control system

#### Multifunction steering wheel

The displays in the multifunction display and the settings in the control system are controlled by the buttons on the multifunction steering wheel.



- ① Multifunction display in the speedometer

#### Operating the control system

- ② Selecting the submenu or setting the volume

— down / to decrease

+ up / to increase

- ③ Telephone\*

☎ to take a call

☎ to end a call

- ④ Menu systems

☰ for next menu

☰ for previous menu

- ⑤ Moving within a menu

⬆ for next display





⬇ for previous display

Pressing any of the buttons on the multifunction steering wheel will alter what is shown in the multifunction display.

The information available in the multifunction display is arranged in menus, each containing a number of functions or sub-menus.

The individual functions are then found within the relevant menu (radio or CD operations under AUDIO, for example). These functions serve to call up relevant information or to customize the settings for your vehicle.

It is helpful to think of the menus, and the functions within each menu, as being arranged in a circular pattern.

- If you press button  or  repeatedly, you will pass through each menu one after the other.
- If you press button  or  repeatedly, you will pass through each function display, one after the other, in the current menu.

In the **SETTINGS** menu, instead of functions you will find a number of submenus for calling up and changing settings. For instructions on using these submenus, see “Submenus in the Settings menu” (▷ page 119).

The number of menus available in the system depends on which optional equipment is installed in your vehicle.

The menus are described on the following pages.

## Controls in detail

### Control system

#### Menus

This is what you will see when you scroll through the menus.

The table on the next page provides an overview of the individual menus.

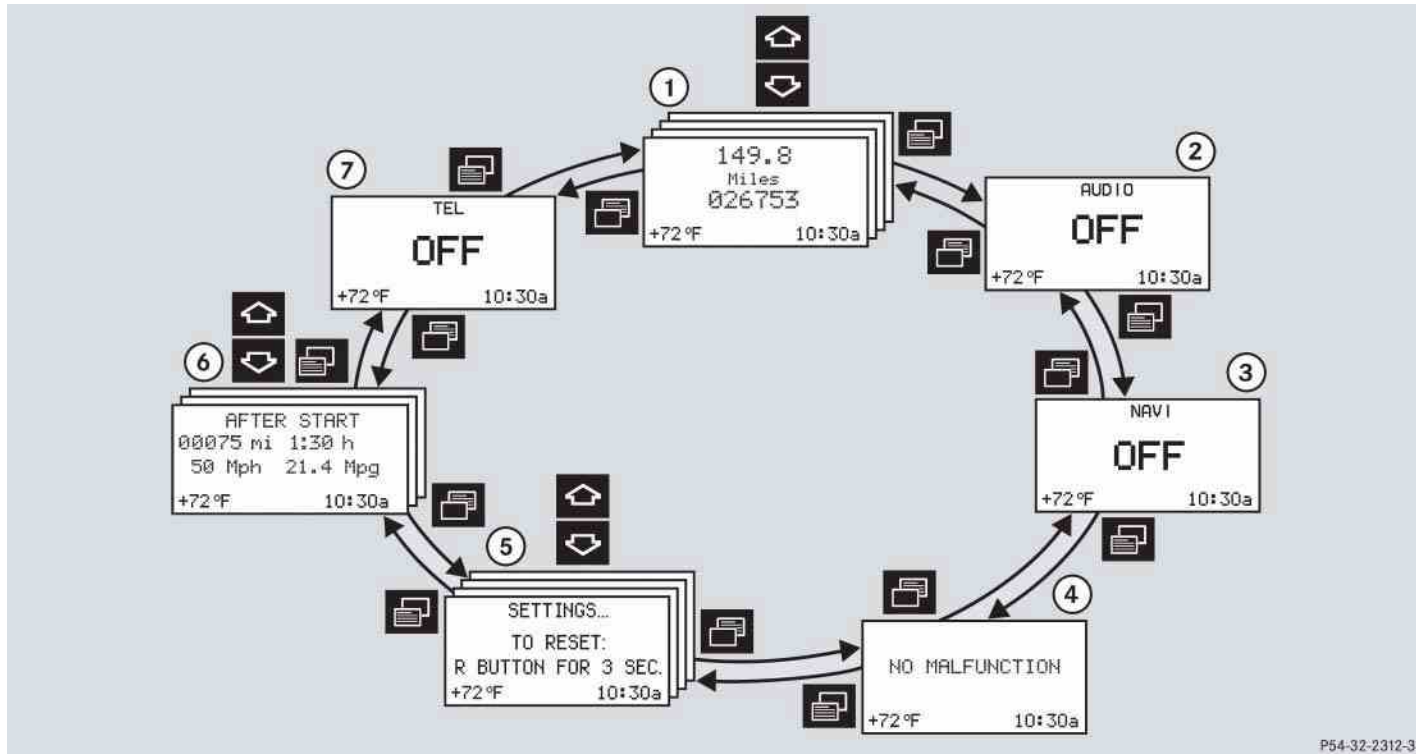



**Menus, submenus and functions**

	<b>Menu ①</b>	<b>Menu ②</b>	<b>Menu ③</b>	<b>Menu ④</b>	<b>Menu ⑤</b>	<b>Menu ⑥</b>	<b>Menu ⑦</b>
	<b>Standard display</b>	<b>AUDIO</b>	<b>NAVI*</b>	<b>Malfunction memory</b>	<b>Settings</b>	<b>Trip computer</b>	<b>Telephone</b>
<b>Commands / submenus</b>	Coolant temperature display	Select radio station	Activate route guidance	Call up malfunction messages	Reset to factory settings	Fuel consumption statistics after start	Load phone book
	Digital speedometer	Operate CD player*			Instrument cluster submenu	Fuel consumption statistics since the last reset	Search for name in phone book
	Call up FSS	Operate cassette player			Lighting submenu	Call up range	
	Check engine oil level				Vehicle submenu Convenience submenu		

## Controls in detail

### Control system



The headings used in the menus table are designed to facilitate navigation within the system and are not necessarily identical to those shown in the control system displays.

The first function displayed in each menu will automatically show you which part of the system you are in.

#### Standard display menu

You can select the functions in the standard display menu with button or .

The following functions are available:

Function	Page
Call up coolant temperature display	106
Call up digital speedometer	114
Call up FSS	249
Check engine oil level	238

#### Display digital speedometer

- ▶ Press button twice.

The current vehicle speed is shown in the multifunction display.

#### AUDIO menu



The functions in the AUDIO menu operate the audio equipment which you currently have turned on.

If no audio equipment is currently turned on, the message AUDIO OFF is shown in the display.

The following functions are available:

Function	Page
Select radio station	115
Select satellite radio station*	115
Operate CD player*	116
Operate cassette player	116

### Select radio station

- ▶ Turn on the radio (▷ page 160). Vehicles with COMAND\*: Refer to separate operating instructions.
- ▶ Press button  or  repeatedly until you see the currently tuned station in the display.



- ① Station frequency
- ② Waveband setting
- ③ Setting for station selection using memory

- ▶ Press button  or  repeatedly until the desired station is found.

The type of search depends on the setting for the station tuning (▷ page 128):

- The next stored station is selected (SP)
- Station search



You can only store new stations using the corresponding feature on the radio (▷ page 165).

Vehicles with COMAND\*: Refer to separate operating instructions.

You can also operate the radio in the usual manner.

## Controls in detail

### Control system



#### Select satellite radio station \*

The Sirius-Satellite-Radio is treated as a radio application.

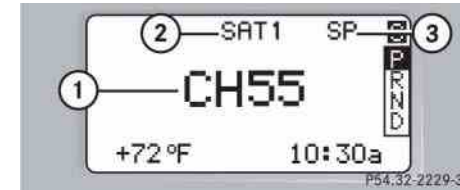
- ▶ Select SAT radio with the corresponding softkey in the radio menu.



- ① Channel name or number
- ② SAT mode and preset number
- ③ Setting for station selection using memory

- ▶ Press button  or  repeatedly until the desired channel is found.

## Controls in detail

### Control system



Feature description is based on preliminary information available at time of printing.

For more information on satellite radio operation, see “Satellite radio (SAT)\* (USA only)” (▷ page 168)

Vehicles with COMAND\*: Refer to separate operating instructions.

#### Operate the CD player\*

- ▶ Turn on the radio and select the CD player (▷ page 175). Vehicles with COMAND\*: Refer to separate operating instructions.
- ▶ Press button or repeatedly until the settings for the CD currently being played are shown in the display.

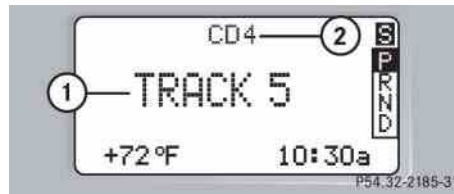

- ① Current track
- ② Current CD (for CD changer\*)

- ▶ Press button or repeatedly until the desired track is selected.



To select a CD from the magazine, press a number on the audio system or the COMAND\* system key pad located in the center dashboard.

#### Operate the cassette player\*

- ▶ Turn on the radio and select the cassette player (▷ page 116). Vehicles with COMAND\*: Refer to separate operating instructions.
- ▶ Press button or repeatedly until the settings for the cassette currently being played are shown in the display.



- ① Current side
- ▶ Press button to fast forward to the next track.
- ▶ Press button to rewind the cassette to the beginning of the current track.



To select the reverse side of the tape, press button below track number on the audio system display, or enter request on the COMAND\* system located in the center dashboard.

### NAVI\* menu

The NAVI menu contains the functions needed to operate your navigation system.

- ▶ Press button or repeatedly until you see the message NAVI in the display.
- If the navigation system is switched off, the message NAVI OFF is shown in the display.
- If the navigation system is on, the message NAVI ACTIVE is shown in the display.

Please refer to the COMAND\* manual for instructions on how to activate the route guidance system\*.

### Malfunction memory menu

Use the malfunction memory menu to scan malfunction and warning messages that may be stored in the system. What information is shown in the display depends on whether malfunctions have actually occurred.

#### Warning!



Malfunction and warning messages are only indicated for certain systems and are intentionally not very detailed. The malfunction and warning messages are simply a reminder with respect to the operation of certain systems and do not replace the owner's and/or driver's responsibility to maintain the vehicle's operating safety by having all required maintenance and safety checks performed on the vehicle and by bringing the vehicle to an authorized Mercedes-Benz Center to address the malfunction and warning messages (▷ page 264).

## Controls in detail

### Control system

- ▶ Press button or repeatedly until you see the malfunction message memory in the display.

#### No malfunction messages

If no malfunctions have occurred, the message in the display is:

NO MALFUNCTION

## Controls in detail



### Control system

#### Malfunctions have occurred

If malfunctions have occurred, you will see the number of malfunctions in the display:



① Number of malfunctions

▶ Press button  or .

The stored messages will now be displayed in order. For malfunction and warning messages, see “Messages in the display” (▷ page 264).



Should any malfunctions occur while driving, the number of malfunctions will reappear in the display when the SmartKey in the starter switch is turned to position **0** or removed from the starter switch.



The message memory will be cleared when you turn the SmartKey in the starter switch to position **1** or **2**. You will then only see high-priority messages in the multifunction display (▷ page 264).

#### Settings menu

In the **SETTINGS** menu there are two functions:

- The function **RESET TO FACTORY SETTINGS**, with which you can reset all the settings to the original factory settings.
  - A collection of submenus with which you can make individual settings for your vehicle.
- ▶ Press button  or  repeatedly until the **SETTINGS** menu is seen in the display.



### Resetting all settings

You can reset all the functions of all submenus to the factory settings.

- ▶ Press the reset button in the instrument cluster (▷ page 22) for approximately three seconds.

In the display you will see the request to press the reset button again to confirm.

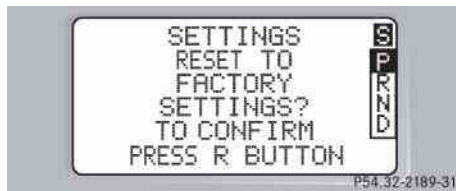

- ▶ Press the reset button again.

The functions of all the submenus will reset to factory settings.



The settings you have changed will not be reset unless you confirm the action by pressing the reset button a second time. Approximately five seconds after pressing the reset button for the second time, the SETTINGS menu reappears in the display.



For safety reasons, the following functions are not reset while driving:

- the LIGHT CIRCUIT HEADLIGHT MODE function in the LIGHTING submenu
- the SETTINGS KEY-DEPENDENT function in the CONVENIENCE submenu

## Controls in detail

### Control system

#### Submenus in the Settings menu

- ▶ Press button  or .

In the display you see the collection of the submenus.







- ▶ Press button .



The selection marker moves to the next submenu.

## Controls in detail

### Control system

The submenus are arranged by hierarchy. Scroll down with the  button, scroll up with the  button.

Move within the submenus with the  or  button to the individual functions.

The settings themselves are made with button  or .

#### Resetting the functions of a submenu

For each submenu you can reset all the functions to the factory settings.

- ▶ Move to a function in the submenu.
- ▶ Press the reset button in the instrument cluster for approximately three seconds.

In the display you will see the request to press the reset button again to confirm.

- ▶ Press the reset button again.

All functions of the submenu will reset to factory settings.



The settings you have changed will not be reset unless you confirm the action by pressing the reset button a second time. Approximately five seconds after pressing the reset button for the second time, the SETTINGS menu reappears in the display.



The table below shows what settings can be changed within the various menus. Detailed instructions on making individual settings can be found on the following pages.

<b>INSTRUMENT CLUSTER</b>	<b>LIGHTING</b>	<b>VEHICLE</b>	<b>CONVENIENCE</b>
Set time (hours)	Set daytime running lamp mode (USA only)	Set station selection mode (radio)	Activate easy-entry/exit feature
Set time (minutes)	Set locator lighting	Set automatic locking	Set key-dependency
Select time display mode	Exterior lamps delayed shut-off		Set parking position for exterior rear view mirror
Select temperature display mode	Interior lighting delayed shut-off		
Select speedometer display mode			
Select language			
Select display (speed display or outside temperature)			

## Controls in detail

### Control system

#### Instrument cluster submenu

Access the INSTRUMENT CLUSTER submenu via the SETTINGS menu. Use the INSTRUMENT CLUSTER submenu to change the instrument cluster display settings. The following functions are available:

Function	Page
Set time (hours)	122
Set time (minutes)	122
Select time display mode	123
Select temperature display mode	123
Select speedometer display mode	124
Select language	124
Select display (speed display or outside temperature)	125

#### Set time (hours)

This function can only be seen with audio system.



Vehicles with COMAND\*: For information on setting the time, refer to the separate COMAND operating instructions.

- ▶ Move the selection marker with the **+** or **-** button to the INSTRUMENT CLUSTER submenu.
- ▶ Press button or repeatedly until you see this message in the display: TIME SETTINGS - HOURS.

The selection marker is on the hour setting.



- ▶ Press **+** or **-** to set the hour.

#### Set time (minutes)

This function can only be seen with audio system.





Vehicles with COMAND\*: For information on setting the time, refer to the separate COMAND operating instructions.

- ▶ Move the selection marker with the **+** or **-** button to the INSTRUMENT CLUSTER submenu.

## Controls in detail

### Control system



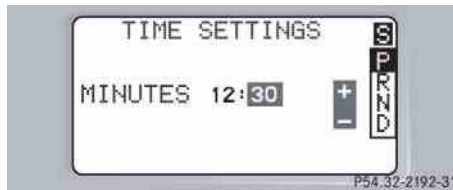

- ▶ Press button  or  repeatedly until you see this message in the display: TIME SETTINGS - MINUTES.

The selection marker is on the minute setting.





- ▶ Press  or  to set the minutes.

#### Selecting time display mode



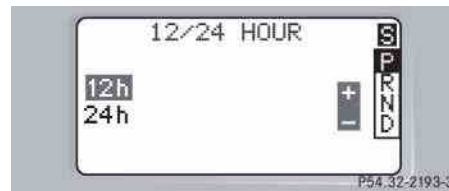

- ▶ Move the selection marker with the  or  button to the INSTRUMENT CLUSTER submenu.
- ▶ Press button  or  repeatedly until you see this message in the display: 12/24 Hour.

The selection marker is on the current setting.





- ▶ Press  or  to set the 12h or 24h time display mode.

#### Selecting temperature display mode

- ▶ Move the selection marker with the  or  button to the INSTRUMENT CLUSTER submenu.
- ▶ Press button  or  repeatedly until you see this message in the display: TEMP. INDICATOR.

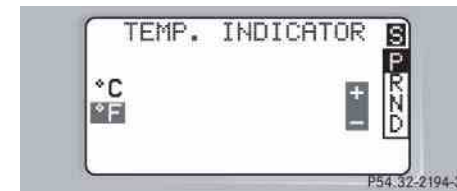
The selection marker is on the current setting.



- ▶ Press  or  to set temperature unit to degrees Celsius (°C) or degrees Fahrenheit (°F).

## Controls in detail

### Control system

#### Selecting speedometer display mode

- ▶ Move the selection marker with the **+** or **-** button to the INSTRUMENT CLUSTER submenu.
- ▶ Press button **▲** or **▼** repeatedly until you see this message in the display: DISPLAY VALUES IN.

The selection marker is on the current setting.



- ▶ Press **+** or **-** to set speedometer unit to Km or Miles.

#### Selecting language

- ▶ Move the selection marker with the **+** or **-** button to the INSTRUMENT CLUSTER submenu.
- ▶ Press button **▲** or **▼** repeatedly until you see this message in the display: TEXT.

The selection marker is on the current setting.



- ▶ Press **+** or **-** to select the language to be used for the multifunction display messages.

Available languages:

- German
- English
- French
- Italian
- Spanish

## Controls in detail

### Control system

#### Selecting display (speed display or outside temperature)

- ▶ Move the selection marker with the **+** or **-** button to the INSTRUMENT CLUSTER submenu.
- ▶ Press button **▲** or **▼** repeatedly until you see this message in the display: SELECT DISPLAY.

The selection marker is on the current setting.



P54\_32-2197-31

- ▶ Press **+** or **-** to select the display permanently shown in the multi-function display.

#### Lighting submenu

Access the LIGHTING submenu via the SETTINGS menu. Use the LIGHTING submenu to change the lamp and lighting settings on your vehicle. The following functions are available:

Function	Page
Set daytime running lamp mode (USA only)	125
Set locator lighting	126
Exterior lamps delayed shut-off	127
Interior lighting delayed shut-off	128

#### Setting daytime running lamp mode (USA only)

- ▶ Move the selection marker with the **+** or **-** button to the LIGHTING submenu.
- ▶ Press button **▲** or **▼** repeatedly until you see this message in the display: LIGHT CIRCUIT HEADLIGHT MODE. The selection marker is on the current setting.



P54\_32-2198-31

- ▶ Press **+** or **-** to select manual or daytime running lamp (constant) mode. This function is not available in countries where daytime running lamps are mandatory.

▷▷

## Controls in detail

### Control system

- ▷▷ With daytime running lamp mode selected and the exterior lamp switch at position **0**, the following lamps will come on automatically when the engine is turned on:
- Parking lamps and low beam headlamps
  - License plate lamps in low ambient light conditions



If you turn the exterior lamp switch to another position, the corresponding lamp(s) will switch on.

For safety reasons, resetting the LIGHTING submenu to factory settings (▷ page 120) while driving will not reset the daytime running lamp mode.

In the display you will then see the message: LIGHTING - CANNOT BE TOTALLY RESET TO FACTORY SETTINGS WHILE DRIVING.

### Setting locator lighting

During darkness, the following lamps will come on when the exterior lamp switch is in position **AUTO**, the locator lighting feature is activated, and the vehicle is unlocked by SmartKey:

- Parking lamps
- Tail lamps
- License plate lamps
- Front fog lamps

To activate locator lighting:

- ▶ Make sure the function LOCATOR LIGHTING is set.
- ▶ Turn the exterior lamp switch to position **AUTO**.

The locator lighting switches off when the driver's door is opened. It switches off automatically after a period of approximately 40 seconds.

- ▶ Move the selection marker with the **+** or **-** button to the LIGHTING submenu.
- ▶ Press button or repeatedly until you see this message in the display: LOCATOR LIGHTING.

The selection marker is on the current setting.

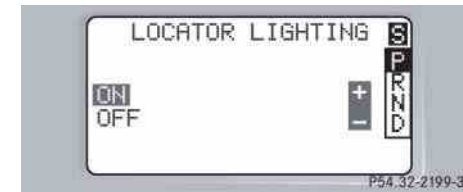

- ▶ Press **+** or **-** to select the desired setting.

The locator lighting will be switched on or off.

## Controls in detail

### Control system

#### Setting night security illumination

(Exterior lamps delayed shut-off)

Use the HEADLIGHTS DELAYED SHUT-OFF function to set whether and for how long you would like the exterior lamps to illuminate during darkness after all doors are closed.

When the delayed shut-off feature is activated and the exterior lamp switch is in position **AUTO**, the following lamps will remain lit after you remove the SmartKey from the starter switch:

- Parking lamps
- Tail lamps
- License plate lamps
- Front fog lamps



You can reactivate this function within ten minutes by opening a door.

If you do not open a door after removing the SmartKey, the lamps will automatically switch off after 60 seconds.

To activate night security illumination:

- ▶ Select delayed shut-off period (see below).
- ▶ Turn the exterior lamp switch to position **AUTO**.

To select delayed shut-off period:

- ▶ Move the selection marker with the **+** or **-** button to the LIGHTING submenu.
- ▶ Press button or repeatedly until you see this message in the display: HEADLIGHTS DELAYED SHUT-OFF.

The selection marker is on the current setting.



- ▶ Press **+** or **-** to select the desired lamp-on period.

You can select:

- 0 s, the delayed shut-off feature is deactivated
- 15 s, 30 s, 45 s or 60 s, the delayed shut-off feature is activated

You can temporarily deactivate the delayed shut-off feature:

- ▶ Before leaving the vehicle turn the SmartKey in the starter switch to position **0**.
- ▶ Then turn it to position **2** and back to **0**.

The delayed shut-off feature is deactivated. It will reactivate as soon as you reinsert the SmartKey in the starter switch.

## Controls in detail

### Control system

#### *Interior lighting delayed shut-off*

Use this function to set whether and for how long you would like the interior lighting to remain lit during darkness after the SmartKey is removed from the starter switch.

- ▶ Move the selection marker with the **+** or **-** button to the LIGHTING submenu.
- ▶ Press button **▲** or **▼** repeatedly until you see this message in the display: INT. LIGHTING DELAYED SHUT-OFF.

The selection marker is on the current setting.



- ▶ Press **+** or **-** to select the desired lamp-on time period. You can select:
  - 0 s, the delayed shut-off feature is deactivated
  - 5 s, 10 s, 15 s or 20 s, the delayed shut-off feature is activated

#### **Vehicle submenu**

Access the VEHICLE submenu via the SETTINGS menu. Use the VEHICLE submenu to make general vehicle settings. The following functions are available:



Function	Page
Set station selection mode (radio)	128
Set automatic locking	129

#### ***Setting station selection mode***

Use the PRESS BUTTON IN AUDIO MODE function to select the manual or memory station selection mode for the radio (▷ page 115).



- ▶ Move the selection marker with the **+** or **-** button to the VEHICLE submenu.



- ▶ Press button  or  repeatedly until you see this message in the display: PRESS BUTTON IN AUDIO MODE.

The selection marker is on the current setting.







- ▶ Press  or  to select the desired station selection mode. You can select:

- STATION SEARCH
- MEMORY selects next stored station

#### Setting automatic locking

Use this function to activate or deactivate the automatic central locking. With the automatic central locking system activated, the vehicle is centrally locked at vehicle speeds of approximately 9 mph (15 km/h).

- ▶ Move the selection marker with the  or  button to the Vehicle submenu.
- ▶ Press button  or  repeatedly until you see this message in the display: AUTOMATIC DOOR LOCK.

The selection marker is on the current setting.



- ▶ Press  or  to switch AUTOMATIC DOOR LOCK ON or OFF.

#### Convenience submenu

Access the CONVENIENCE submenu via the SETTINGS menu. Use the CONVENIENCE submenu to change the settings for a number of convenience features. The following functions are available:

Function	Page
Activate easy-entry/exit feature	130
Set key-dependency	131
Set parking position for exterior rear view mirror	132

## Controls in detail

### Control system

#### **Activating easy-entry/exit feature\***

Use this function to activate and deactivate the easy-entry/exit feature. When the feature is activated, the steering wheel and driver's seat will move back to facilitate exiting when you

- remove the SmartKey from the starter switch
- open the driver's door

However, the engine must be turned off.

#### **Warning!**



You must make sure that no one can become trapped or injured by the moving steering wheel and the driver's seat when the easy-entry/exit feature is activated and the driver's door is being opened or the SmartKey is removed from the starter switch.

Do not leave children unattended in the vehicle, or with access to an unlocked vehicle. Children could open the driver's door and unintentionally activate the easy-entry/exit feature\*, which could result in an accident and/or serious personal injury.

After entering the vehicle, the steering wheel and seat will move into the position stored in memory when

- the driver's door is closed
- you put the SmartKey in the starter switch and
- press the appropriate stored position button on the memory switch (▷ page 96)



To cancel seat/steering wheel movement, do one of the following:

- Press the seat adjustment switch\* (▷ page 35).
- Move the steering column stalk\* (▷ page 38).
- Press the memory switch\* (▷ page 96).

## Controls in detail

### Control system

- ▶ Move the selection marker with the **+** or **-** button to the CONVENIENCE submenu.
- ▶ Press button **▲** or **▼** repeatedly until you see this message in the display: EASY-ENTRY FEATURE ACTIVATE.

The selection marker is on the current setting.

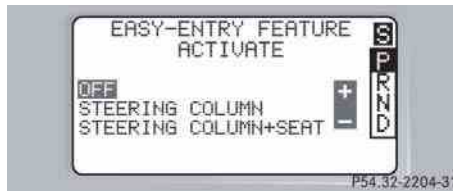

- ▶ Press **+** or **-** to change the easy-entry/exit setting.

The following settings are available for the easy-entry/exit feature:

OFF	The easy-entry/exit feature is deactivated.
STEERING COLUMN	Only the steering column is moved.
STEERING COLUMN + SEAT	Both the steering column and the seat are moved.

### Setting key-dependency

Use this function to set whether the memory settings for the seats, the steering wheel and the mirrors should be stored separately for each SmartKey (▶ page 95).

- ▶ Move the selection marker with the **+** or **-** button to the CONVENIENCE submenu.
- ▶ Press button **▲** or **▼** repeatedly until you see this message in the display: SETTINGS KEY-DEPENDENT.

The selection marker is on the current setting.



- ▶ Press **+** or **-** to set key-dependency to ON or OFF.

## Controls in detail

### Control system

#### **Setting parking position for exterior rear view mirror**

Use the MIRROR SETTING WHEN PARKING function to select whether the passenger-side exterior rear view mirror should be turned downward during parking maneuvers when reverse gear is engaged. For additional information, see “Activating exterior rear view mirror parking position” (▷ page 147).

You can store a parking position for the passenger exterior rear view mirror using the memory switch (▷ page 97).

- ▶ Move the selection marker with the **+** or **-** button to the CONVENIENCE submenu.

- ▶ Press button **↶** or **↷** repeatedly until you see this message in the display: MIRROR SETTING WHEN PARKING.

The selection marker is on the current setting.



- ▶ Press **+** or **-** to switch function ON or OFF.

#### **Trip computer menu**





Use the trip computer menu to call up statistical data on your vehicle. The following information is available:

Function	Page
Fuel consumption statistics after start	133
Fuel consumption statistics since last reset	133
Call up range (distance to empty)	134

## Controls in detail

### Control system





#### Fuel consumption statistics after start

- ▶ Press button  or  repeatedly until you see the first function of the Trip computer menu.
- ▶ Press button  or  repeatedly until you see this message in the display: AFTER START.



- ① Distance driven since start
- ② Time elapsed since start
- ③ Average speed since start
- ④ Average fuel consumption since start

#### Fuel consumption since last reset

- ▶ Press button  or  repeatedly until you see the first function of the Trip computer menu.
- ▶ Press button  or  repeatedly until you see this message in the display: After RESET.







- ① Distance driven since last reset
- ② Time elapsed since last reset
- ③ Average speed since last reset
- ④ Average fuel consumption since last reset

#### i

All statistics stored since the last engine start will be reset approximately four hours after the SmartKey in the starter switch is turned to position 0 or removed from the starter switch.

Resetting will not occur if you turn the SmartKey back to position 1 or 2 within this time period.





#### Resetting fuel consumption statistics

- ▶ Press button  or  repeatedly until you see the first function of the Trip computer menu.
- ▶ Press button  or  repeatedly until you see the reading that you want to reset in the display.
- ▶ Press and hold the reset button in the instrument cluster (▶ page 22) until the value is reset to 0.

## Controls in detail

### Control system

#### Call up range (distance to empty)

- ▶ Press button  or  repeatedly until you see the first function of the Trip computer menu.
- ▶ Press button  or  repeatedly until you see this message in the display: RANGE.

In the display you will see the calculated range based on the current fuel tank level.



#### TEL menu\*

##### Warning!





A driver's attention to the road must always be his/her primary focus when driving. For your safety and the safety of others, we recommend that you pull over to a safe location and stop before placing or taking a telephone call. If you choose to use the telephone while driving, please use the hands-free device and only use the telephone when weather, road and traffic conditions permit.

Some jurisdictions prohibit the driver from using a cellular telephone while driving a vehicle.

Bear in mind that at a speed of just 30 mph (approximately 50 km/h), your vehicle is covering a distance of approximately 44 feet (approximately 13.5 m) every second.

Never operate radio transmitters equipped with a built-in or attached antenna (i.e. without being connected to an external antenna) from inside the vehicle while the engine is running. Doing so could lead to a malfunction of the vehicle's electronic system, possibly resulting in an accident and/or personal injury.

You can use the functions in the TEL menu to operate your telephone, provided it is connected to a hands-free system and switched on.

- ▶ Switch on the telephone and COMAND\*.
- ▶ Press button  or  on the steering wheel repeatedly until you see the TEL menu in the display.

## Controls in detail

### Control system

Which messages will appear in the display field depends on whether your telephone is switched on or off:

- If the telephone is off, the message in the multifunction display is: TEL OFF.
- If the telephone is on:  
The telephone will then search for a network. During this time the display is empty.

As soon as the telephone has found a network, READY is indicated in the display.



① Signal strength

This standby message indicates that your telephone is ready for use and you can operate it using the control system.



Vehicles with Audio system: the signal strength is indicated in the top right corner, for example "S9". The higher the number, the stronger the signal from the cellular network.

Vehicles with COMAND\*: the signal strength is indicated by bars in the top left corner. The higher the number of bars, the stronger the signal from cellular network.

### Answering a call

When your telephone is ready to receive calls, you can answer a call at any time. In the display you will then see the message:



- ▶ Press button .

You have answered the call. In the display you see the length of the call.

### Ending a call

- ▶ Press button .





You have ended the call. In the display you will again see the standby message.

## Controls in detail

### Control system



#### Dialing a number from the phone book

If your telephone is ready to receive calls, you may select and dial a number from the phone book at any time.

- ▶ Press button  or  repeatedly until you see the TEL menu in the display.
- ▶ Press button  or .



The control system reads the phone book which is stored in the telephone. This may take up to 30 seconds. In the display you will see the message PLEASE WAIT.

When the message PLEASE WAIT disappears, the phone book has been loaded.

- ▶ Press button  or  repeatedly until the desired name appears in the display.

The stored names are displayed in ascending or descending alphabetical order.



If you press and hold  or  for longer than one second, the system scrolls rapidly through the list of names until you release the button again.

Cancel the quick search mode by pressing .

- ▶ Press button .

The system dials the selected phone number.



- If the connection is successful, the name of the party you called and the duration of the call will appear in the display.





- If no connection is made, the control system stores the dialed number in the redial memory.

#### Redialing

The control system stores the most recently dialed phone numbers. This eliminates the need to search through your entire phone book.

- ▶ Press button  or  repeatedly until you see the TEL menu in the display.
- ▶ Press button .

In the display you see the first number in the redial memory.

- ▶ Press button  or  repeatedly until the desired name appears in the display.
- ▶ Press button .

The control system dials the selected phone number.



### ▼ Manual transmission

For information on driving with a manual transmission, see “Manual transmission” (▷ page 137).

Do not exceed the maximum speed in the individual gears. Refer to tachometer (▷ page 22) for engine speeds.

#### Warning!



On slippery road surfaces, never downshift in order to obtain braking action. This could result in drive wheel slip and reduced vehicle control. Your vehicle's ABS will not prevent this type of loss of control.

#### Warning!



When leaving the vehicle, always remove the SmartKey from the starter switch and lock the vehicle. Do not leave children unattended in the vehicle, or with access to an unlocked vehicle. Children could move the gearshift lever, which could result in an accident and/or serious injury.

## Controls in detail

### Manual transmission

#### Warning!



For vehicles equipped with a manual transmission, getting out of your vehicle with the gearshift lever not engaged in 1st or reverse gear and parking brake engaged is dangerous. Also, when parked on an incline, an engaged 1st or reverse gear alone may not prevent your vehicle from moving, possibly hitting people or objects

Always set the parking brake in addition to engaging 1st or reverse gear (▷ page 52).

When parked on an incline, turn the front wheel towards the road curb.

Do not park this vehicle in areas where combustible materials such as grass, hay, or leaves can come into contact with the hot exhaust system, as these materials could be ignited and cause a vehicle fire.

## Controls in detail

### Manual transmission



Downshifting gears leading to overrevving the engine can result in engine damage that is not covered by the Mercedes-Benz Limited Warranty.

Do not exceed the engine speed limits (▷ page 324).

Never hold the vehicle stopped on a hill by using the clutch pedal. The clutch may be damaged which is not covered by the Mercedes-Benz Limited Warranty.

#### Shifting into reverse

---

- ▶ Stop the vehicle completely.
- ▶ Pull gearshift lever up and shift in **R** reverse.

### ▼ Automatic transmission\*

For more information on driving with an automatic transmission, see “Automatic transmission\*” (▷ page 45).

Your vehicle’s transmission adapts its gear shifting process to your individual driving style by continually adjusting the shift points up or down. These shift point adjustments are performed based on current operating and driving conditions.

If the operating conditions change, the automatic transmission reacts by adjusting its gear shift program.



During the brief warm-up, transmission upshifting is delayed. This allows the catalytic converter to heat up more quickly to operating temperature.

The automatic transmission selects individual gears automatically, depending on:

- the gear selector lever position **D** with gear ranges **4, 3, 2, 1** (▷ page 141)
- the selected shift program (**C/S**) (▷ page 144)
- the position of the accelerator pedal (▷ page 145)
- the vehicle speed

The current gear selector lever position and shift program (C/S) appear in the multifunction display (▷ page 109).

An additional indication of the current gear selector lever position can be found on the cover of the shifting-gate. The indicators come on when you activate a switch (e.g. unlocking the vehicle or opening a door) and go out after approximately 15 minutes.

## Controls in detail

### Automatic transmission\*

#### Warning!



It is dangerous to shift the gear selector lever out of **P** or **N** if the engine speed is higher than idle speed. If your foot is not firmly on the brake pedal, the vehicle could accelerate quickly forward or reverse. You could lose control of the vehicle and hit someone or something. Only shift into gear when the engine is idling normally and when your right foot is firmly on the brake pedal.

When the gear selector lever is in position **D**, you can influence transmission shifting by:

- limiting the gear range
- changing gears manually

## Controls in detail

### Automatic transmission\*

#### One-touch gearshifting

Even with an automatic transmission you can change the gears manually when the gear selector lever is in position **D**.

#### Downshifting

- ▶ Briefly press the gear selector lever to the left in the **D-** direction.

The transmission will shift from the current gear to the next lower gear. This action simultaneously limits the gear range of the transmission (▷ page 141).

#### Warning!



On slippery road surfaces, never downshift in order to obtain braking action. This could result in drive wheel slip and reduced vehicle control. Your vehicle's ABS will not prevent this type of loss of control.



To avoid overrevving the engine when the gear selector lever is moved to the **D-** direction, the transmission will not shift to a lower gear if the engine's max. speed would be exceeded.

#### Upshifting

- ▶ Briefly press the gear selector lever to the right in the **D+** direction.

The transmission will shift from the current gear to the next higher gear as permitted by the shift program. This action simultaneously extends the gear range of the transmission.

#### Canceling gear range limit

- ▶ Press and hold the gear selector lever in the **D+** direction until **D** reappears in the multifunction display.

The transmission will shift from the current gear range directly to gear range **D**.

#### Shifting into optimal gear range

- ▶ Press and hold the gear selector lever in the **D-** direction.

The transmission will automatically select the gear range suited for optimal acceleration and deceleration. This will involve shifting down one or more gears.

## Gear ranges

With the gear selector lever in position **D**, you can limit the transmission's gear range by pressing the gear selector lever to the left (**D-**), and reverse the gear range limit by pressing the gear selector lever to the right (**D+**).

The selected gear range appears in the multifunction display. If you press on the accelerator when the engine has reached its rpm limit, the transmission will upshift beyond any gear range limit selected.

	Effect
<b>4</b>	The transmission shifts through fourth gear only.
<b>3</b>	The transmission shifts through third gear only.  With this selection you can use the braking effect of the engine.

## Controls in detail

### Automatic transmission\*

	Effect
<b>2</b>	The transmission shifts through second gear only.  Allows the use of engine's braking power when driving: <ul style="list-style-type: none"><li>• on steep downgrades</li><li>• in mountainous regions</li><li>• under extreme operating conditions</li></ul>
<b>1</b>	The transmission operates in first gear only.  For maximum use of engine's braking effect on very steep or lengthy downgrades.

## Controls in detail

### Automatic transmission\*

#### Gear selector lever position

	Effect
<b>P</b>	<b>Park position</b> Gear selector lever position when the vehicle is parked. Place gear selector lever in position <b>P</b> only when vehicle is stopped. The park position is not intended to serve as a brake when the vehicle is parked. Rather, the driver should always set the parking brake in addition to placing the gear selector lever in position <b>P</b> to secure the vehicle.

	Effect
	The SmartKey can only be removed from the starter switch with the gear selector lever in position <b>P</b> . With the SmartKey removed, the gear selector lever is locked in position <b>P</b> .  If the vehicle's electrical system is malfunctioning, the gear selector lever could remain locked in position <b>P</b> (▷ page 291).
<b>R</b>	<b>Reverse gear</b> Place gear selector lever in position <b>R</b> only when vehicle is stopped.

	Effect
<b>N</b>	<b>Neutral</b> No power is transmitted from the engine to the drive axle. When the brakes are released, the vehicle can be moved freely (pushed or towed).  To avoid damage to the transmission, never engage <b>N</b> while driving.  If the ESP is deactivated or malfunctioning: Move gear selector lever to <b>N</b> only if the vehicle is in danger of skidding, e.g. on icy roads.
<b>D</b>	<b>Drive</b> The transmission shifts automatically. All five forward gears are available.



Coasting the vehicle, or driving for any other reason with gear selector lever in **N** can result in transmission damage that is not covered by the Mercedes-Benz Limited Warranty.

### Warning!



Getting out of your vehicle with the gear selector lever not fully engaged in position **P** is dangerous. Also, position **P** alone is not intended to or capable of preventing your vehicle from moving, possibly hitting people or objects.

Always set the parking brake in addition to shifting to position **P** (> page 46).

When parked on an incline, turn the front wheels towards the road curb.

Do not park this vehicle in areas where combustible materials such as grass, hay, or leaves can come into contact with the hot exhaust system, as these materials could be ignited and cause a vehicle fire.

## Controls in detail

### Automatic transmission\*

### Warning!



When leaving the vehicle, always remove the SmartKey from the starter switch, take it with you and lock the vehicle. Do not leave children unattended in the vehicle, or with access to an unlocked vehicle. Children could move the gear selector lever from position **P**, which could result in an accident and/or serious personal injury.

## Controls in detail

### Automatic transmission\*

#### Program mode selector switch

The program mode selector switch is located on the lower part of the center console.



① Program mode selector switch

**S** Sport            For standard driving

**C** Comfort        For comfort driving



Never change the program mode when the gear selector lever is out of position **P**. This could result in a change of driving characteristics for which you may not be prepared.

- ▶ Press program mode selector switch ① repeatedly until the letter of the desired shift program appears in the multifunction display (▷ page 109).

Select **C** for comfort driving:

- The vehicle starts out in second gear (both forward and reverse) for gentler starts. This does not apply if full throttle is applied or gear range **1** is selected.
- Traction and driving stability are improved on icy roads.
- Upshifts occur earlier even when you give more gas. The engine then operates at lower rpms and the wheels are less likely to spin.
- The power transmission ratio for gear selector lever position **R** changes depending on the program mode selected (**S** or **C**).



#### Accelerator position

---

Your driving style influences the transmission's shifting behavior:

Less throttle	Earlier upshifting
More throttle	Later upshifting

#### Kickdown

Use kickdown when you want maximum acceleration.

- ▶ Press the accelerator past the point of resistance.

The transmission shifts into a lower gear.

- ▶ Ease on the accelerator when you have reached the desired speed.

The transmission shifts up again.

#### Emergency operation (Limp Home Mode)

---

If vehicle acceleration worsens or the transmission no longer shifts, the transmission is most likely operating in limp home (emergency operation) mode. In this mode only second gear and reverse gear can be activated.

- ▶ Stop the vehicle.
- ▶ Move gear selector lever to **P**.
- ▶ Turn off the engine.
- ▶ Wait at least ten seconds before restarting.
- ▶ Restart the engine.
- ▶ Move gear selector lever to position **D** (for second gear) or **R**.
- ▶ Have the transmission checked at an authorized Mercedes-Benz Center as soon as possible.

## Controls in detail

### Good visibility

#### ▼ Good visibility

Information on the windshield wipers (▷ page 49) and for setting the rear view mirrors (▷ page 39) is found in the “Getting started” section.

#### Rear view mirrors

##### Interior rear view mirror, antiglare position



① Lever

Tilt the mirror to the antiglare night position using lever ①.

##### Automatic antiglare rear view mirrors\*

The reflection brightness of the exterior rear view mirror on the driver's side and the interior rear view mirror will respond automatically to glare when

- the ignition is switched on and
- incoming light from headlamps falls on the sensor in the interior rear view mirror.

The rear view mirror will not react if

- reverse gear is engaged
- the interior lighting is turned on.

#### Warning!



The automatic antiglare function does not react if incoming light is not aimed directly at sensors in the interior rear view mirror.

The interior rear view mirror and the exterior rear view mirror on the driver's side do not react, for example, when transporting cargo which covers the rear window.

Glare can endanger you and others.

#### Warning!



In the case of an accident liquid electrolyte may escape from the mirror housing if the mirror glass breaks.

Electrolyte has an irritating effect. Do not allow the liquid to come into contact with eyes, skin, clothing, or respiratory system. In case it does, immediately flush affected area with water, and seek medical help if necessary.

### Warning!



Exercise care when using the passenger side exterior rear view mirror. The mirror surface is convex (outwardly curved surface for a wider field of view). Objects in mirror are closer than they appear. Check your inside rear view mirror or glance over your shoulder before changing lanes.



Electrolyte drops coming into contact with the vehicle paint finish can be completely removed only while in the liquid state by applying plenty of water.

### Activating exterior rear view mirror parking position

Follow these steps to activate the mirror parking position so that the passenger-side exterior rear view mirror will be turned downward to the stored positions.

- ▶ Make sure you stored a parking position for the passenger-side exterior rear view mirror (▷ page 97)
- ▶ Make sure the MIRROR SETTING WHEN PARKING function, found under the CONVENIENCE submenu in the control system, is switched to ON (▷ page 132).
- ▶ Switch on ignition.
- ▶ Press button ② for the passenger-side exterior rear view mirror.
- ▶ Place the gear selector lever in reverse gear **R**.

The passenger-side exterior rear view mirror will be turned downward to the stored position.

## Controls in detail

### Good visibility



- ① Driver's side exterior rear view mirror button
- ② Passenger-side exterior rear view mirror button

The exterior rear view mirror returns to its previously stored driving position:

- ten seconds after you put the gear selector lever out of position **R**
- immediately once you exceed a vehicle speed of approx. 6 mph (10 km/h)
- immediately when you press button ① for driver's side mirror

## Controls in detail

### Good visibility

#### Headlamp cleaning system\*

The switch is located on the left side of the dashboard.



#### ① Headlamp washer switch

- ▶ Switch on ignition.
- ▶ Press switch ①.

The headlamps are cleaned with a high-pressure water jet.

For information on filling up the washer reservoir, see “Windshield washer system and headlamp cleaning system” (▷ page 243).

#### Sun visors

The sun visors protect you from sun glare while driving.

#### Warning!



Do not use the vanity mirror while driving.

Keep the mirrors in the sun visors closed while vehicle is in motion. Reflected glare can endanger you and others.

- ▶ Swing sun visors down when you experience glare.

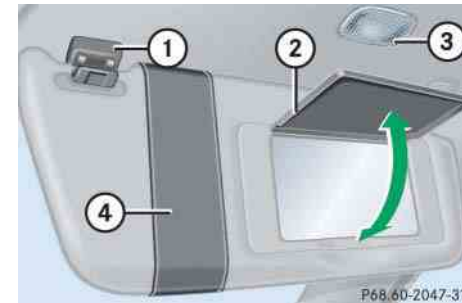

- ① Mounting
- ② Mirror cover
- ③ Mirror lamp\*
- ④ Sun visor

- ▶ To use mirror, lift up cover ②.

#### i

If sunlight enters through a side window, disengage sun visor from mounting ① and pivot to the side.

The mirror lamp\* ③ will switch off.

## Rear window defroster

The rear window defroster uses a large amount of power. To keep the battery drain to a minimum, switch off the defroster as soon as the rear window is clear. The defroster is automatically deactivated after approximately 6 to 17 minutes of operation depending on the outside temperature.

### Activating

- ▶ Press button  (▷ page 151).  
The indicator lamp on the button comes on.

### Deactivating

- ▶ Press button  (▷ page 151) again.  
The indicator lamp on the button goes out.

### Warning!



Any accumulation of snow and ice should be removed from the rear window before driving. Visibility could otherwise be impaired, endangering you and others.

## Controls in detail

### Good visibility



If the rear window defroster switches off too soon and the indicator lamp starts flashing, this means that too many electrical consumers are operating simultaneously and there is insufficient voltage in the battery. The system responds automatically by deactivating the rear window defroster.

As soon as the battery has sufficient voltage, the rear window defroster automatically turns itself back on.

## Controls in detail

### Climate control

#### ▼ Climate control



## Controls in detail

### Climate control

Item
① Climate control panel
② Left center air vent, adjustable
③ Right center air vent, adjustable
④ Thumbwheel for air volume control for left center air vent
⑤ Thumbwheel for air volume control for right center air vent
⑥ Air volume control for side air vent
⑦ Side air vent, adjustable
⑧ Side defroster vent, fixed



Climate control panel



For draft-free ventilation, move the sliders for the center air vents ②, ③ and ⑦ to the middle position.

Item
① Air volume control
② Left-side temperature control
③ Right-side temperature control
④ Air distribution control switch
⑤ Rear window defroster
⑥ AC cooling on/off ( <b>AC<sup>OFF</sup></b> )
⑦ Air distribution and air volume (automatic)
⑧ Air recirculation
⑨ Defrosting

The storage compartment between the front seats can be ventilated (▷ page 157).

For information on rear passenger compartment adjustable air vents see “Rear passenger compartment adjustable air vents” (▷ page 158).

## Controls in detail

### Climate control

The climate control is operational whenever the engine is running. You can operate the climate control system in either the automatic or manual mode. The system cools or heats the interior depending on the selected interior temperature and the current outside temperature.

#### Warning!



When operating the climate control, the air that enters the passenger compartment through the air vents in the footwell can be very hot or very cold (depending on the set temperature). This may cause burns or frostbite on unprotected skin in the immediate area of the air vents. Always keep sufficient distance between unprotected parts of the body and the footwell air vents. If necessary, change the air flow using the air distribution controls to direct the air away from the footwell air vents (▷ page 153).

Nearly all dust particles, pollutants and odors are filtered out before outside air enters the passenger compartment through the air distribution system.

The air conditioning will not engage (no cooling) if the **AC<sup>OFF</sup>** mode is selected (▷ page 156).

#### Warning!



Follow the recommended settings for heating and cooling given on the following pages. Otherwise the windows could fog up, impairing visibility and endangering you and others.

#### i

Severe conditions (e.g. strong air pollution) may require replacement of the filter before its scheduled interval. A clogged filter will reduce the air volume to the interior.

If the vehicle interior is hot, ventilate the interior before driving off.

Keep the air intake grille in front of the windshield free of snow and debris.



## Controls in detail

### Climate control

#### Setting the temperature

Use temperature controls ② and ③ to separately adjust the air temperature on each side of the passenger compartment. You should raise or lower the temperature setting in small increments, preferably starting at 72°F (22°C).



When operating the climate control system in automatic mode, you will only rarely need to adjust the temperature, air volume and air distribution.

#### Increasing

- ▶ Turn the temperature control ② or ③ slightly to the right.

The climate control system will correspondingly adjust the interior air temperature.

#### Decreasing

- ▶ Turn the temperature control ② or ③ slightly to the left.

The climate control system will correspondingly adjust the interior air temperature.

#### Adjusting air distribution and volume

Use the air distribution control ④ (▷ page 151) to adjust the air distribution. The following symbols are found on the controls:

Symbol	Function
	Directs air through the center, side and rear passenger compartment air vents
	Directs air to the windows
	Directs air into the entire vehicle interior
	Directs air to the footwells

Use the air volume control ① to adjust the air volume. You can select between six air volume speeds.

#### Adjusting manually

- ▶ Press the **AUTO** button.

The indicator lamp on the button goes out.

- ▶ Select any of the six air volume speeds using the air volume control ① (▷ page 151) and the air distribution.

#### Adjusting automatically

- ▶ Press the **AUTO** button.

The indicator lamp on the button comes on. The air distribution and volume is adjusted automatically.

#### Windshield fogged on the outside

- ▶ Switch the windshield wipers on.
- ▶ Switch to manual mode.
- ▶ Turn the air distribution control to or .

## Controls in detail



### Climate control

#### Defrosting



These settings should only be selected for a short time.

#### Activating

- ▶ Press button  (▷ page 151).  
The indicator lamp on the button comes on
- or
- ▶ Switch off air recirculation, if selected.
- ▶ Press button  (▷ page 151).  
The indicator lamp on the button goes out.
- ▶ Close center air vents.
- ▶ Open left and right side air vents (▷ page 151) and adjust side air vents upwards.

#### Deactivating

- ▶ Press button  (▷ page 151).  
The indicator lamp on the button goes out. Defrosting is turned off.

#### Air recirculation mode

Switch to air recirculation mode to prevent unpleasant odors from entering the vehicle from the outside. This setting cuts off the intake of outside air and recirculates the air in the passenger compartment.

#### Warning!



When the outside temperature is below 41°F (5°C), only switch to air recirculation mode for short periods to prevent window fogging.

#### Activating

- ▶ Press button  (▷ page 151).  
The indicator lamp on the button comes on.



If you keep button  pressed the side windows and panorama sliding/pop-up roof\* will close.

The air recirculation mode is activated automatically at high outside temperatures.

If you have turned off the air conditioning (▷ page 156) or the outside temperature is below 41°F (5°C), the air recirculation mode will not switch on automatically.

#### Warning!



Never operate the windows or panorama sliding/pop-up roof\* if there is the possibility of anyone being harmed by the closing procedure.



## Controls in detail

### Climate control

Vehicles without panorama sliding /pop-up roof:

In the event that the procedure causes potential danger, the opening and closing of the side windows can be immediately halted by pressing or pulling the respective window switch.

Vehicles with panorama sliding /pop-up roof:

In the event that the procedure causes potential danger, the opening and closing of the side windows can be immediately halted by releasing the  button or by pressing or pulling the respective window switch. The opening and closing of the panorama sliding /pop-up roof\* can be immediately halted by releasing the  button or by moving the panorama sliding /pop-up roof switch in the overhead control panel in any direction.

#### Deactivating

- ▶ Press button  (▷ page 151).

The indicator lamp on the button goes out.



If you keep button  pressed the side windows and panorama sliding /pop-up roof\* will return to their previous position.

The air recirculation mode is deactivated automatically:

- after five minutes if the outside temperature is below approximately 41°F (5 °C)
- after five minutes if the air conditioning is turned off
- after 30 minutes if the outside temperature is above approximately 41°F (5 °C)

At outside temperatures above 79°F (26 °C) the system will not automatically switch back to outside air. A quantity of outside air is added after approximately 30 minutes.

#### Deactivating the climate control system

##### Deactivating

- ▶ Set the air volume control  (▷ page 151) to position **0**.

The indicator lamp on the button comes on.

##### Reactivating

- ▶ Set the air volume control  (▷ page 151) to any speed.

## Controls in detail

### Climate control

#### Air conditioning

The air conditioning is operational while the engine is running and cools the interior air to the temperature set by the operator.



Condensation may drip out from underneath the vehicle. This is normal and not an indication of a malfunction.

#### Activating

Moist air can fog up the windows. You can dehumidify the air with the air conditioning.

- ▶ Press **AC<sup>OFF</sup>** again (▷ page 151).

The indicator lamp on the button **AC<sup>OFF</sup>** goes out.

The air conditioning system uses the refrigerant R134a. This refrigerant is free of CFCs which are harmful to the ozone layer.

#### Deactivating

It is possible to deactivate the air conditioning (cooling) function of the climate control system. The air in the vehicle will then no longer be cooled or dehumidified.

- ▶ Press button **AC<sup>OFF</sup>** (▷ page 151).

The indicator lamp on the button **AC<sup>OFF</sup>** comes on.



If the air conditioning cannot be turned on again, this indicates that the air conditioning system is losing refrigerant. The compressor has turned itself off.

Have the air conditioning system checked at the nearest authorized Mercedes-Benz Center.

## Controls in detail

### Climate control

#### Ventilated storage compartment

The front center console storage compartment has its own air vent that allows for cooling ventilation when the climate control system is activated.



You should keep this air vent closed when outside temperatures are low.

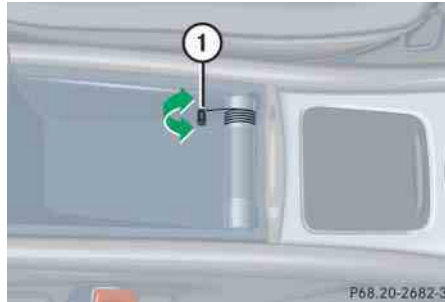

① Lever

#### Opening the air vent

- ▶ Raise lever ①.

#### Closing the air vent

- ▶ Lower lever ①.



The compartment can get very warm due to its confined space. When storing heat sensitive objects in the compartment, close the air vent while heating the passenger compartment.



Do not obstruct the air vent in the storage compartment.

## Controls in detail

### Climate control

#### Rear passenger compartment adjustable air vents

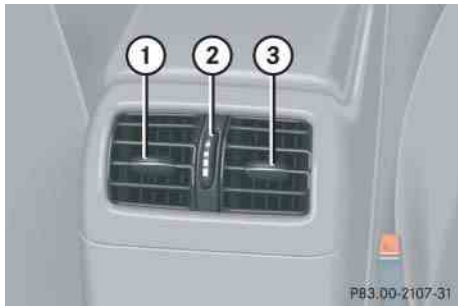

- ① Left center air vent
- ② Thumbwheel for air volume control for center air vents
- ③ Right center air vent

To open center air vents:

- ▶ Turn thumbwheel ② upward.



The temperature at the air vents for rear passenger compartment ① and ③ is the same as at the dashboard center air vents.

#### ▼ Audio system

##### Audio and telephone, operation

These instructions are intended to help you become familiar with your Mercedes-Benz audio system. They contain useful tips and a detailed description of the user functions.

##### Warning!



In order to avoid distraction which could lead to an accident, the driver should enter system settings with the vehicle at a standstill and operate the system only when road and traffic conditions permit. Always pay full attention to traffic conditions first before operating system controls while driving.

Bear in mind that at a speed of just 30 mph (approximately 50 km/h), your car is covering a distance of 50 feet (approximately 14 m) every second.

##### Operating safety

##### Warning!



Any alterations made to electronic components can cause malfunctions.

The radio, amplifier, CD changer\*, satellite radio\*, telephone\* and voice control system\* are interconnected. When one of the components is not operational or has not been removed/replaced properly, the function of other components may be impaired.

This condition might seriously impair the operating safety of your vehicle.

We recommend that you have any service work on electronic components carried out by an authorized Mercedes-Benz Center.

## Controls in detail

### Audio system

#### Operating and display elements

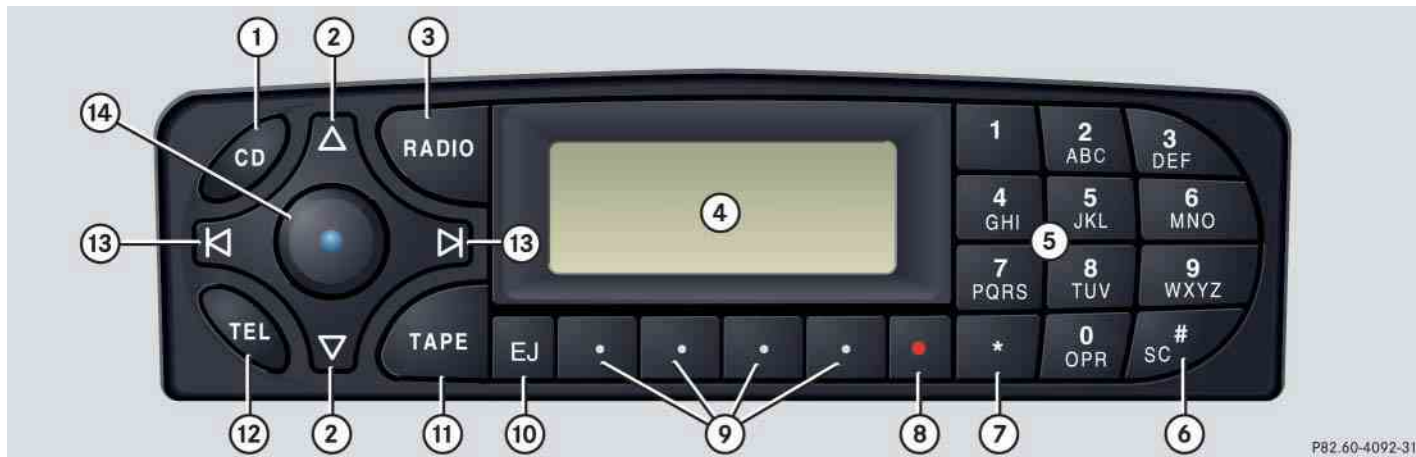



## Controls in detail

### Audio system

Item	Page
① CD mode selector	175
② Manual tuning (radio)	165
Fast forward/reverse (cassette, CD)	174, 178
Speed dialing memory (telephone*)	183
③ Radio mode selector	165
④ Display panel	
Cassette compartment behind display panel	

Item	Page
⑤ Alpha-numeric keypad	
Band selection, station buttons (radio)	165
CD selection (CD)	177
Telephone number entry, retrieving speed dialing memory (telephone)	180
⑥ Scanning (radio, cassette, CD)	167, 174, 178
⑦ Function button	166
⑧ Light-emitting diode	

Item	Page
⑨ Function keys	
⑩ Cassette eject	173
⑪ Cassette mode selector	172
⑫ Telephone* mode selector	179
⑬ Seek tuning (radio)	166
Track search (cassette, CD)	173, 178
Speed dialing memory (telephone)	183
⑭ On/off	162
Volume	162

## Controls in detail

### Audio system

#### Button and soft key operation

In these instructions, the alpha-numeric keypad (right side of radio panel) and the function buttons (left side of radio panel) are referred to as “buttons”. The four keys below the display panel are referred to as “soft keys”.



Do not press directly on the display face. Otherwise, the display will be damaged.

#### Operation

##### Switching on/off

Switching on:

- ▶ Turn SmartKey in starter switch to position **1** or **2**.

or

- ▶ Turn control knob



If the radio is switched on without the SmartKey in the starter switch, it will automatically switch off again after approx. 30 minutes.

Switching off:

- ▶ Remove SmartKey from starter switch.

or

- ▶ Turn control knob

#### Adjusting the volume

- ▶ Turn control knob .

The volume will increase or decrease depending on the direction turned.



The volume setting can be selected separately for the telephone\*, audio system and voice control system\*.

#### Adjusting audio functions

Press the AUD key to call up the bass, treble, balance and fader functions in the various operating modes. Settings for bass and treble are stored separately for the AM and FM frequency bands, satellite radio (SAT) mode, cassette mode and CD mode.

## Controls in detail

### Audio system

#### Bass

- ▶ Regardless of operating mode, press the **AUD** key repeatedly until **BASS** appears on the display.

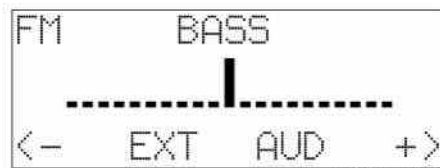

- ▶ Press **+** or **-** key to increase or decrease level.
- or
- ▶ Press both **+** and **-** keys simultaneously to reset the Bass to its center (flat) level.

#### Treble

- ▶ Regardless of operating mode, press the **AUD** key repeatedly until **TREBLE** appears on the display.

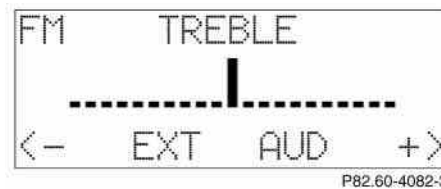

- ▶ Press **+** or **-** key to increase or decrease level.
- or
- ▶ Press both **+** and **-** keys simultaneously to reset the Treble to its center (flat) level.

#### Fader



Your vehicle may or may not have the fader function, depending on the vehicle equipment and model.

- ▶ Regardless of operating mode, press the **AUD** key repeatedly until **FADER** appears on the display.

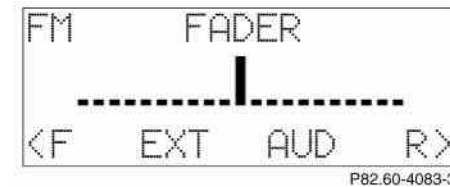

- ▶ Press **F** or **R** key to shift sound accordingly to the front or rear speakers.

or

- ▶ Press both **F** and **R** keys simultaneously to reset the Fader to its center level.

## Controls in detail

### Audio system

#### Balance

- ▶ Regardless of operating mode, press the **AUD** key repeatedly until **BALANCE** appears on the display.

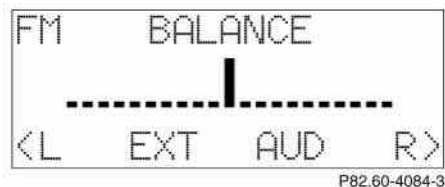

P82.60-4084-31

- ▶ Press **L** or **R** key to shift sound accordingly to the left or right speakers.

or

- ▶ Press both **L** and **R** keys simultaneously to reset the Balance to its center level.

#### Returning audio functions to factory settings



P82.60-4085-31

- ▶ Regardless of operating mode, press and hold **AUD** key longer than two seconds. **RESET** will appear on the display.

All settings for bass, treble and balance are returned to the center level and the volume is set to a predefined level.

#### Audio system sound selection (EXT)\*

- ▶ Regardless of operating mode, press the **AUD** key.

The sound settings menu appears on the display.

- ▶ Press the **EXT** key.



P82.60-4065-31

- ▶ Press one of the function keys.

You can select from among the following settings:

- **DRV:** The tone level is set to the Driver position; sound is directed toward the passengers.
- **SP:** The tone level is set for Speech, optimizing the sound for the spoken word.
- **AMB:** The tone level is set for Ambience, producing a three-dimensional sound.
- **OFF:** The audio system sound selection is turned off.

#### Telephone\* muting

If a telephone has been installed in the vehicle, the radio will switch to telephone mode when a call is incoming. The current audio source is muted.

#### Radio operation

##### Selecting radio mode

- ▶ Press **RADIO** button.
- ▶ You can now receive radio stations over the analog FM, AM or WB station frequencies or you can receive channels digitally via satellite radio (SAT)\*.

##### Analog station frequencies

##### Selecting the band

You can select from among FM, AM or WB frequency bands.

Weather band (▷ page 168).



FM frequency band:  
FM 87.7.....107.9 MHz  
AM frequency band:  
MW (medium wave) 530.....1710 KHz

- ▶ Press FM, AM or WB key repeatedly until desired band has been selected.

The FM, AM and WB frequency bands are called up one after the other.

The frequency band currently selected appears in the upper left-hand corner of the display.

##### Selecting a station

The following options are available for selecting a station:

- Direct frequency band input (▷ page 166)
- Manual tuning (▷ page 166)
- Automatic seek tuning (▷ page 166)
- Scan tuning (▷ page 167)
- Preset buttons (▷ page 167)
- Automatic station memory (Autostore) (▷ page 167)

## Controls in detail

### Audio system

#### Direct frequency input

Select the desired frequency band.



- ▶ Press **\*** button.
- ▶ Enter desired frequency using buttons **1** to **0**.



You can only enter frequencies within the respective waveband.

If a button is not pressed within four seconds, the radio will return to the station last tuned to.

#### Manual tuning

▶ Select the desired frequency band.



- ▶ Press and hold either the **▲** or **▼** button until the desired frequency is reached.

Step-by-step station tuning takes place in ascending or descending order of frequency. The first three tuning steps will take place without muting. Afterwards, the radio will be muted and highspeed tuning will take place until the button is released.

#### Automatic seek tuning

▶ Select the desired frequency band.



- ▶ Press either the **▶** or **◀** button. The radio will tune to the next higher or next lower receivable frequency.

## Controls in detail

### Audio system

#### Scan tuning

- Starting scan tuning
  - ▶ Select desired frequency band.



- ▶ Press **SC#** button.  
SC will appear on the display. The radio briefly tunes in all receivable stations on the band selected. The first scan cycle will tune in only the stations with a strong signal. The second scan cycle will tune in every receivable station.
- Ending scan tuning
  - ▶ Press **SC#** button or **▲**, **▼**, **▶** or **◀** button.  
SC disappears from the display.

#### Manual station memory (Presets)

You can store ten AM and ten FM stations.

- Storing stations
  - ▶ Tune in the desired station.
  - ▶ Press and hold desired station button **1** to **0** until a brief signal tone is heard.



The frequency is stored on the selected station button.

The frequency band and station button number are shown in the upper left-hand corner of the display.

- Retrieving a station from memory
  - ▶ Press desired station button **1** to **0**.

#### Automatic station memory (Autostore)

The Autostore memory function provides an additional memory level. The station memory for manually stored stations is not overwritten.

- Calling up Autostore memory level
  - ▶ Briefly press the AS key.

AS is highlighted in the display.

The radio finds the ten stations with the strongest signals. These stations are stored on the station buttons **1** to **0** in order of signal strength.

- Retrieving a station from memory
  - ▶ Press desired station button **1** to **0**.
- Leaving the Autostore memory level
  - ▶ Press the AS key.

The highlighted AS in the display disappears.

## Controls in detail

### Audio system

#### Weather band



- ▶ Press the WB key.  
The weather band station last selected is tuned in.
- ▶ Select the desired weather band station with buttons **1** to **7** PQRS.  
If a station cannot be tuned in, a scan is automatically started.
- ▶ Press **▶** or **◀** button. The next receivable weather band station is tuned in.

#### Satellite radio (SAT)\* (USA only)



Additional optional satellite radio equipment and a subscription to satellite radio service provider is required for the satellite radio operation described here. Feature description is based on preliminary information available at time of printing.

At time of printing, no date for availability of optional equipment required for satellite radio operation had been set. Contact your authorized Mercedes-Benz Center for details and availability for your vehicle.

Satellite radio service may be unavailable or interrupted from time to time for a variety of reasons, such as environmental or topographic conditions and other things we can't control. Service might also not be available in certain places (e.g., in tunnels, parking garages, or within or next to buildings) or near other technologies.

Sirius Satellite Radio provides 100 channels of digital-quality radio, among others music, sports, news, and entertainment, free of commercials. Sirius Satellite Radio uses a fleet of high-power satellites to broadcast 24 hours per day coast-to-coast.

This diverse, satellite-delivered programming is available for a monthly subscription fee.

For more information, call the Sirius service or contact [www.siriusradio.com](http://www.siriusradio.com).

#### Program categories

The channels are categorized. The categories allow you to tune to stations broadcasting a certain type of program (PTY mode) (▷ page 171).



## Controls in detail

### Audio system

#### Starting satellite radio (SAT)

- ▶ Start radio mode.

If the radio was in SAT radio mode before being turned off or changed to another operating mode, the last SAT channel selected is called up.

or

- ▶ Press the SAT key.

When you call up the SAT radio mode for the first time, ACQUIRING will appear on the display during the initialization process.

or

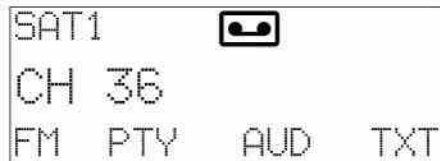

The last channel selected is called up.

#### Entering the Electronic Serial Number (ESN)

The first time SAT radio is called up, you must give your SAT radio provider the Electronic Serial Number (ESN) of your SAT receiver over the telephone.

- ▶ Press the SAT key.

The radio switches to SAT mode. CALL SIRI appears on the display.



- ▶ Press the ESN key.

The provider's phone number will appear first. After pressing the ESN key again, the ESN number will appear. Make note of the phone number and ESN number.

- ▶ Press the ESN key repeatedly until all required information has appeared on the display.

- ▶ Call the telephone number and give provider your ESN number.



Credit card information is also required for your application.

The activation process takes approximately five to ten minutes after calling the SIRIUS Service Center.

## Controls in detail

### Audio system

#### Channel selection

The following options are available for selecting a channel:

- Direct channel input (▷ page 170)
- Manual tuning (▷ page 170)
- Preset channels (▷ page 170)

#### Direct channel input



- ▶ Press **\*** key.
- ▶ Enter desired channel number using buttons **1** to **0**.



Only inputs for available channels are possible.

If a button is not pressed within four seconds, the radio will return to the last station tuned.

#### Manual tuning

- ▶ Press and hold **▶**, **▲**, **▼** or **◀** button until the desired channel has been reached.

#### Preset channels

You can store up to ten channels.

- Retrieving a channel from memory
  - ▶ Press the desired channel button **1** to **0**.

- Storing channels

- ▶ Tune in the desired channel.
- ▶ Press and hold desired channel button **1** to **0** until a brief signal tone sounds.



The channel is stored on the selected channel button.

**Program type (PTY) mode**

In PTY mode, you can tune in and select channels of a specific program type.

**Calling up PTY mode**

- ▶ Start SAT radio mode.
- ▶ Press the **PTY** key.  
The name of the channel currently being received is shown.

**Leaving PTY mode**

- ▶ Press the **CH** key.  
The number of the channel currently being received is shown.

**Selecting channel category**

- ▶ Press **▲** or **▼** button.  
The individual program types are selected.

**Tuning in a PTY channel**

Once you have selected a program type, you can tune in channels broadcasting a program that corresponds to the selected program type.

- ▶ Press **▶** or **◀** button.  
The radio will tune to the next highest or lowest channel broadcasting this type of program.

**Program Descriptive Text (PDT)**

In PDT mode, you can call up additional information on the channel, the current track and the performing artists(s).

- ▶ Press the **TXT** key.  
The station category appears on the display.
- ▶ Press the **TXT** key again within four seconds.  
The title of the current track appears.
- ▶ Press the **TXT** key again within four seconds.  
The name of the musician(s) of the current track appear on the display.

## Controls in detail

### Audio system

#### Cassette operation

##### Playing cassettes

- ▶ Press **[EJ]** button.

The display panel folds down and the cassette compartment becomes accessible.

- ▶ Insert cassette into the cassette compartment until it engages and tap it gently.

The cassette will be pulled in automatically. The system switches to cassette mode. Side 1 will be played and **SIDE 1** appears in the display. Side 1 is the side of the cassette which is facing upward. The cassette deck will automatically detect the type of tape.

- ▶ Fold display panel back up and press gently on the display panel frame to lock it in place.



Do not press directly on the display face. Otherwise the display will be damaged.

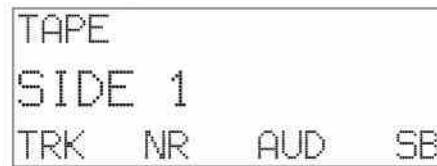

P82.60-4071-31

or

- ▶ If a cassette is already in the mechanism, press **[TAPE]** button.



A warning signal will sound after 20 seconds if the display panel is left in the down position. Fold display panel back up. If the display panel is not closed, a warning signal will sound and the radio will be muted.

#### Track selection



P82.60-4072-31

- ▶ Press the **TRK** key.  
The current track will be displayed as **SIDE 1** or **SIDE 2**.
- ▶ You can switch sides at any time.  
The side will be changed automatically at the end of the tape.

### **Cassette eject**

- ▶ Press eject button **[EJ]**.  
The display folds down and the cassette is ejected. The system will switch back to radio mode automatically.
- ▶ Fold display panel back up and press gently on the display panel frame to lock it.



Do not press directly on the display face. Otherwise the display will be damaged.



The cassette will not be ejected when the system is switched off or switched to another operating mode.

### **Track search**

#### **Track search forward**



- ▶ Press **[▶]** button.  
SEEK FWD will appear in the display. Track search will run the tape forward to the start of the next track and switch to Play.



The beginning of a track can only be found if there is pause of at least four seconds between tracks.

## **Controls in detail**

### **Audio system**

#### **Track search backward**

- ▶ Press **[◀]** button.  
SEEK RWD will appear on the display. Track search will run the tape backward to the start of the track currently playing and switch to Play.

#### **Stopping track search**

- ▶ Press **[▲]**, **[▼]**, **[▶]** or **[◀]** button.  
The cassette will switch over to Play.

## Controls in detail

### Audio system

#### Scanning

- Starting scan



- ▶ Press **SC#** button.

SC will appear on the display.

Each track on the cassette will be played briefly in ascending order.

- Stopping scan

- ▶ Press **SC#**, **▲**, **▼**, **▶** or **◀** button.

The system will switch to Play.

#### Fast forward/reverse

- Starting cassette fast forward mode



- ▶ Press **▲** button.

FORWARD will appear on the display.

- Starting cassette fast reverse mode

- ▶ Press **▼** button.

REWIND will appear on the display.

The cassette will automatically switch over to the play mode at the end or beginning of the tape.

- Stopping the cassette fast forward/reverse mode

- ▶ Press **▲**, **▼**, **▶** or **◀** button.

The cassette will switch over to the play mode.

#### Skipping blank sections (skip blank)

##### Switching on the skip blank function

- ▶ Press the SB key.

SB is highlighted in the display.

If the system does not detect a sound signal, the cassette will automatically fast forward to the next sound signal.

##### Switching off the skip blank function

- ▶ Press the SB key.

The highlighted SB in the display disappears.

#### Dolby NR<sup>1</sup> (noise reduction system)

To enable optimum sound reproduction of cassettes recorded using Dolby B NR, the Dolby NR system should be switched on.



The Dolby NR function should be switched off when playing cassettes not recorded with Dolby B NR.

#### Switching on

- ▶ Press the NR key.  
NR is highlighted in the display.

#### Switching off

- ▶ Press the NR key.  
The highlighted NR in the display disappears.

#### CD changer\* operation

##### General notes

Should excessively high temperatures occur while in CD mode, CD TEMP HIGH will appear on the display and the CD will be muted. The unit will then switch back to the last operating mode used until the temperature has decreased to a safe operating level.



P82.60-4066-31

Should excessively low temperatures occur while in CD mode, CD TEMP LOW will appear on the display, but the CD will continue to play.

Handle CDs carefully to prevent interference during playback. Avoid fingerprints and dust on CDs. Do not write on CDs or apply any labels or other material to them.

<sup>1</sup> DOLBY and the double-D symbol  are trademarks of Dolby Laboratories Licensing Corporation. The Dolby noise reduction system is manufactured under license from Dolby Laboratories Licensing Corporation.

## Controls in detail

### Audio system

Use only original CDs. Using copied CDs may create problems during playback.

Clean CDs from time to time with a commercially available cleaning cloth. Do not use solvents, anti-static sprays, etc. for cleaning. Replace the CD in its case after use. Protect CDs from heat and direct sunlight.



Only use CDs, which bear the label shown and that conform to the compact disc digital audio standard (IEC 60908). You can therefore only use CDs with a maximum thickness of 1.3 mm.



Use of CDs which do not meet this standard may cause damage to the CD changer. Do not play single-CDs (80 mm) with an adapter.

Your CD drive has been designed to play CDs which correspond to the EN 60908 standard.

If you insert thicker data carriers, e.g. ones that have data on both sides (one side with DVD data, the other side with audio data), they cannot be ejected and will damage the drive.

### Operational readiness of CD changer

If a CD changer has been installed in the system, it can be operated from the front control panel of the radio. A loaded magazine must be installed to play CDs.

### Loading/unloading the CD magazine

- ▶ Slide changer door to the right and press eject button .
- ▶ The magazine will be ejected.

### Warning!



The CD changer\* is a Class 1 laser product. There is a danger of invisible laser radiation if the cover is opened or damaged.

Do not remove the cover. The CD changer\* does not contain any parts which can be serviced by the user. For safety reasons, have any service work which may be necessary performed only by qualified personnel.



## Controls in detail

### Audio system

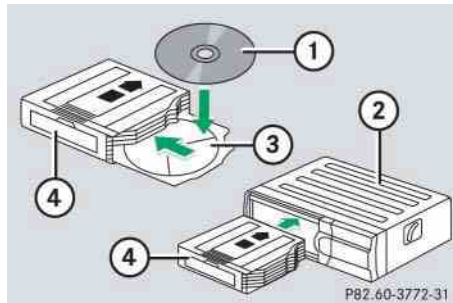

- ① CD
- ② CD changer
- ③ CD tray
- ④ CD magazine

- ▶ Remove magazine and pull CD tray fully out.
- ▶ Place CD in recess of tray, label side up.
- ▶ Push tray into magazine in direction of arrow.



CDs which have been inserted improperly or are unreadable will not be played.

- ▶ Push magazine into CD changer in direction of arrow and close sliding door.

#### Playing CDs

- ▶ Press **CD** button.

CD will appear on the display.

The last CD listened to will then start playing at the point where it was switched off. After the last track on a CD has finished, the next CD is automatically played.

#### Selecting CDs

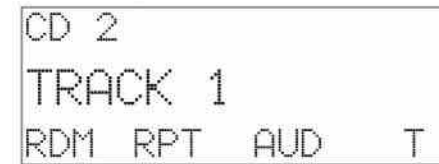

P82.60-4067-31

- ▶ You can select from among the CDs in the CD magazine using buttons **1** to **6**.

CD and the magazine slot number of the selected CD appear on the display. The number of the current track is displayed after TRACK.

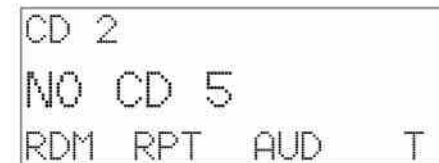



P82.60-4068-31



If there is no CD in the selected magazine slot, NO CD appears on the display with the corresponding slot number.

## Controls in detail

### Audio system

#### Skipping tracks forward/backward

- Skipping tracks forward
  - ▶ Press  button.  
The next track will be played.
- Skipping tracks backward
  - ▶ Press  button.  
If the track has been playing for more than ten seconds, it will revert to the start of that track. If it has been playing for less than ten seconds, it will revert to the preceding track.

Pressing the  or  button repeatedly will result in multiple tracks being skipped.

#### Fast forward/reverse

- Fast forward
  - ▶ Press and hold  button until desired point has been reached.

- Fast reverse
  - ▶ Press and hold  button until desired point has been reached.



The relative time of the track is shown on the display during the search.

#### Scanning





- Starting scan
  - ▶ Press **SC#** button.



P82.60-4069-31

SC appears in the display.

Each track on the current CD will be played for approx. eight seconds in ascending order.

- Ending scan
  - ▶ Press **SC#**, , ,  or  button.

#### Random play

The random play function (RDM) plays the tracks on the current CD in random order.

- Switching on random play

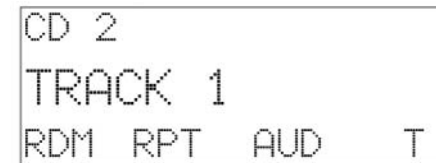

P82.60-4067-31

- ▶ Press the RDM key.  
RDM is highlighted in the display.
- Switching off random play
  - ▶ Press the RDM key.  
The highlighted RDM in the display disappears.

#### Repeat

The repeat function (RPT) repeats the current track.

Switching on repeat:



P82.60-4067-31

- ▶ Press the RPT key.  
RPT is highlighted in the display.

Switching off repeat:

- ▶ Press the RPT key.  
The highlighted RPT in the display disappears.



The Random play and Repeat function cannot be used simultaneously.

#### Track and time display



P82.60-4070-31

- ▶ Press the T key.  
The number of the track being played and the elapsed playing time appear in the display.
- ▶ Press the T key.  
The total number of tracks and the total playing time of the CD appear in the display.  
The CD main menu appears again after eight seconds.

#### Telephone\* operation

Various car telephone\* functions and operating steps for the car telephone can be performed and displayed via the audio system.

Further operating instructions not covered here can be found in the operating instructions for the multifunction steering wheel, voice control\* and the telephone\*.

## Controls in detail

### Audio system

#### Switching on the telephone

- ▶ Press **TEL** button.  
If you have programmed an unlock code for the telephone, you must enter the code now.
- ▶ Enter the desired telephone number using buttons **1** to **0**.
- ▶ If necessary, correct number entered with the CLR key. Press key briefly to delete the last digit entered; press key and hold to delete the complete number.
- ▶ Press the OK key after entering correct code.  
The telephone is unlocked. If you have entered the wrong code, you must repeat the entering procedure with the correct code.

#### Switching off the telephone

- ▶ Press **TEL** button repeatedly until PHONE OFF appears in the display.  
The receiving symbol in the display disappears.

#### Adjusting the volume

- ▶ Turn control knob  during telephone operation.

The volume increases or decreases depending on the direction in which the knob is turned.



The volume can be adjusted separately for the telephone\*, voice control system\* and radio.

#### Placing a call

##### *Entering a telephone number and starting the dialing process*



- ▶ Enter the desired telephone number using buttons **1** to **0**.  
The number can have up to 32 digits, but only 13 of these are visible on the display.  
If necessary, correct number entered with the CLR key.
- ▶ Press key briefly to delete the last digit entered.
- ▶ Press key and hold to delete the complete number.
- ▶ After correct telephone number has been entered, press the SND key.

## Phone book

The numbers stored in the phone book can be called up either by name or number.

### Calling up the phone book

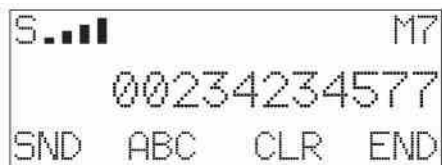

- ▶ Press , ,  or  button.

### Switching between name search and number search

- ▶ Press the ABC key.  
The name search is called up.

or

- ▶ Press the NUM key.  
The number search is called up.

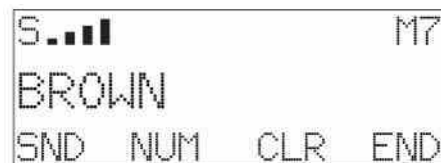

### Searching and calling up phone book entries by name





- ▶ Press the ABC key.  
The current name is highlighted on the display.

## Controls in detail



### Audio system

- ▶ Press either the  or  button.  
The stored entries are selected according to the alphabetical order of the initial letter.

or

- ▶ Press either the  or  button.  
The stored entries are selected in increments of four.

or

- ▶ Press the desired numerical key  to .  
The stored entries are selected according to the alphabetical order of the initial letters (e.g. for B-Brown, press button  twice).

#### i

Several characters and symbols cannot be shown on the display for technical reasons. They have been replaced with spaces.

## Controls in detail

### Audio system

#### Searching and selecting phone book entries by number



P82.60-4077-31

- ▶ Press the NUM key.  
The current number is marked in the display.
  - ▶ Press either the or button.  
The stored entries are selected according to numerical order.
- or
- ▶ Press either the or button.  
The stored entries are selected in increments of 5 (e.g. Entry M5, Entry M10, etc.)

#### Starting dialing process

- ▶ Once you have selected a number, press the SND key.

#### Repeat dialing

If the number dialed is busy, you can again place calls to the last ten telephone numbers dialed using the repeat dialing function.

#### Manual repeat dialing (redial)

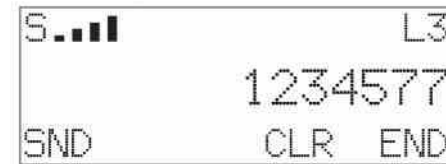

P82.60-4079-31

- ▶ Press the SND key.  
The last number dialed is shown in the display.
- ▶ Select the desired telephone number using , , or button.  
The abbreviation L and the number of the entry are shown in the top line of the display.
- ▶ When you have selected a number, press the SND key.  
The call will be made.

#### ***Automatic repeat dialing (redial)***

If a call cannot be connected, press the SND key.

REDIAL will appear on the display and repeated attempts to place the call will be made for the next four minutes.

#### **Selecting numbers directly from the directory**

- ▶ Enter previously selected 3-digit (1-999) number of the entry using number keys **1** to **0**.
- ▶ Press the RCL key.  
The telephone number stored under that entry will be dialed.
- ▶ Press the SND key.  
The call will be made.

#### **Speed dialing**

- ▶ Input desired entry number using number keys **1** to **0**.

A maximum of two digits can be entered.

If necessary, correct the last number entered with the CLR key.

- ▶ Press the SND key.

The telephone number stored under that entry will be dialed. The number, L and the full entry number will be shown in the display.

#### **Quick-dialing**

- ▶ Press one of the desired number buttons **1** to **0** longer than one second.

The telephone number saved under that number will be dialed.



Please be aware that button **1** might already be reserved for an emergency call number.

## Controls in detail

### Audio system

#### Emergency call

- ▶ Press button **1** longer than one second.
- ▶ A call will be placed to the saved number (e.g. 911).



Please be aware that the 911 emergency call system is a public service. Using it without due cause is a criminal offense.

You can make an emergency call to an emergency rescue station with a mobile communications network.

The emergency call will be placed as long as the corresponding mobile communications network is available. To do this, switch the telephone on if this has not already been done.

The call will also be placed even if the unlock code is not entered.

Emergency calls may not be possible with all telephone networks or if certain network services and/or telephone functions are active. Check with your local network operation company. It may take some time to set up an emergency call.

To use this function you must ensure that the number stored in memory location 1 is the number to be dialed in case of emergency.

If an emergency call cannot be connected, the message `SYSTM BUSY` appears.

#### Accepting an incoming call

##### *Accepting an incoming call in telephone mode*

With an incoming call, a ringing tone can be heard and the caller's telephone number, or the name under which this telephone number has been saved in the telephone book, appears on the display. If the caller's number is not transmitted, `CALL` will appear in the display.

- ▶ Press the `SND` key to accept call.



#### ***Accepting an incoming call in cassette, CD or radio mode***

If the telephone is activated in the background (receiving symbol S visible on display), the audio source is muted when a call is received. The ringing tone is heard and the caller's telephone number or the name under which this telephone number has been saved in the telephone book appears on the display. If the caller's number is not transmitted, CALL appears in the display.

- ▶ Press the SND key to accept the call.

#### **Muting a call**

It is possible to mute a call; the caller is then no longer able to hear you.

##### ***Mute on***

- ▶ Press the MUT key.

##### ***Mute off***

- ▶ Press the MUT key.

#### **Terminating a call**

- ▶ Press the END key.

The current call is terminated.

#### **Call waiting**

If you receive another call during an already active call, you can accept the second call and switch between the two.

##### ***Accepting a second call***

- ▶ Press the SND key.

You are connected with the second caller, the first call is muted.

##### ***Switching between the calls***

- ▶ Press the SND key.

##### ***Terminating the second call***

- ▶ Press the END key.

The current call will be terminated. You are connected with the muted call again.

## Controls in detail

### Power windows

#### ▼ Power windows

##### Opening and closing the windows

The side windows can be opened and closed electrically. The switches for all the side windows are on the driver's door. The switch for the passenger door is on the passenger door.



- ① Left front window
- ② Right front window

#### Warning!



When closing the windows, make sure there is no danger of anyone being harmed by the closing procedure.

The closing of the door windows can be immediately halted by releasing the switch or, if switch was pulled past the resistance point and released, by either pressing or pulling the respective switch.

If the window encounters an obstruction that blocks its path in a circumstance where you pulled the switch past the resistance point and released it to close the window, the automatic reversal function will stop the window and open it slightly.

If the window encounters an obstruction that blocks its path in a circumstance where you are closing the window by pulling and holding the switch, or by pressing and holding button  on the SmartKey, the automatic reversal function will not operate

When leaving the vehicle, always remove the SmartKey from starter switch, and lock your vehicle. Do not leave children unattended in the vehicle, or with access to an unlocked vehicle. Unsupervised use of vehicle equipment can cause an accident and/or serious personal injury.

#### i

You can also open or close the windows using the:

- SmartKey (summer opening/convenience feature) (▷ page 188).
- button  in the control panel of the climate control (▷ page 151).

- ▶ Turn SmartKey in the starter switch to position **1** or **2**.

### Opening the windows

- ▶ Press switch ① or ② to the resistance point.

The corresponding window will move downwards until you release the switch.

### Closing the windows

- ▶ Pull switch ① or ② to the resistance point.

The corresponding window will move upwards until you release the switch.

#### Warning



If you pull and hold the switch up when closing the window, and upward movement of the window is blocked by some obstruction including but not limited to arms, hands, fingers, etc., the automatic reversal will not operate.

### Fully opening the windows (Express-open)

- ▶ Press switch ① or ② past the resistance point and release.

The corresponding window opens completely.

### Fully closing the windows (Express-close)

- ▶ Pull switch ① or ② past the resistance point and release.

The corresponding window closes completely.



If the upward movement of the window is blocked during the closing procedure, the window will stop and open slightly.

Remove the obstruction, pull the switch again past the resistance point and release.

## Controls in detail

### Power windows

If the window still does not close when there is no obstruction, then pull and hold the switch again. The side window will then close without the obstruction sensor function.

#### Warning!



Driver's door only:

If within five seconds you again pull the switch past the resistance point and release, the automatic reversal will not function.

### Stopping windows

- ▶ Press or pull respective switch again.

## Controls in detail

### Power windows



#### Opening and closing the windows with the SmartKey

The panorama sliding/pop-up roof\* (▷ page 189) will also be opened or closed when the power windows are operated with the SmartKey.

#### Warning!



Never operate the windows or panorama sliding/pop-up roof\* if there is the possibility of anyone being harmed by the opening or closing procedure.

In the event that the procedure causes potential danger, the procedure can be immediately halted by releasing the button on the SmartKey. To reverse direction of movement, press  for opening or  for closing.

- ▶ Aim transmitter eye at the front door handle.

#### Opening (Summer opening feature)

- ▶ Press and hold button  after unlocking the vehicle.

The windows and panorama sliding/pop-up roof\* (▷ page 189) begin to open after approximately one second.

- ▶ Release the  button to stop procedure.

#### Closing (Convenience feature)

- ▶ Press and hold button  after locking the vehicle.

The windows and panorama sliding/pop-up roof\* begin to close after approximately one second.

- ▶ Release the  button to stop procedure.

Make sure all side windows and the panorama sliding/pop-up roof\* are properly closed before leaving the vehicle.

#### Synchronizing power windows

The power window must be resynchronized each time

- after the battery has been disconnected.
- if the power windows cannot be fully opened (Express-open) or closed (Express-close).

#### Synchronizing the power windows

- ▶ Switch on ignition.
- ▶ Pull the power window switches until the side windows are closed.  
Hold the switches for approximately one second.  
The power window are adjusted.

## ▼ Panorama sliding/pop-up roof\*

### Warning!



When opening or closing the panorama sliding / pop-up roof, make sure there is no danger of anyone being harmed by the opening or closing procedure.

If the panorama sliding / pop-up roof is closed with the convenience closing feature and becomes blocked, it will not open automatically. Should this occur, press the  button on the SmartKey and hold it down; the panorama sliding / pop-up roof opens again.

The panorama roof is made out of glass. In the event of an accident, the glass may shatter. This may result in an opening in the roof.

In a vehicle rollover, occupants not wearing their seat belts or not wearing them properly may be thrown out of the opening. Such an opening also presents a potential for injury for occupants wearing their seat belts properly as entire body parts or portions of them may protrude from the passenger compartment.

### Opening and closing the roller sunblinds for the panorama sliding/pop-up roof

The sliding / pop-up roof and the roller sunblinds can be opened and closed electrically. The switch for the sliding / pop-up roof and the roller sunblinds is on the overhead control panel.

The roller sunblinds only operate with panorama sliding / pop-up roof closed.

## Controls in detail

### Panorama sliding/pop-up roof\*



- ①, ④ Open  
②, ③ Close

- Turn SmartKey in the starter switch to position 1 or 2.

### Opening and closing the roller sunblinds

- To open or close the roller sunblinds, move the switch to the resistance point in the required direction ① to ④.

Release the switch when the roller sunblinds have reached the desired position.

## Controls in detail

### Panorama sliding/pop-up roof\*

#### Warning!



When closing the roller sunblinds, make sure that no one is in danger of being injured by the closing procedure. The closing of the roller sunblinds can be immediately halted by releasing the switch.

#### Fully opening the roller sunblinds (Express-open)

- ▶ Move the panorama sliding/pop-up roof switch or the rear roller sunblind switch past the resistance point in direction ④ and release.  
The roller sunblinds opens completely.

#### Stopping the roller sunblinds

- ▶ Move the switch in any direction.

#### Opening and closing the panorama sliding/pop-up roof

The panorama sliding/pop-up roof only operates with the roller sunblinds opened.

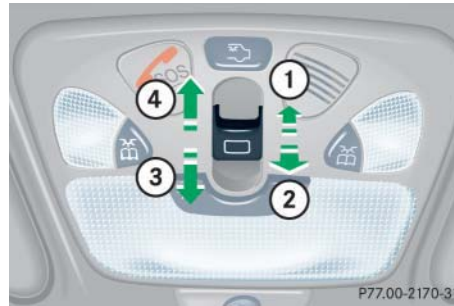

- ① Push up to raise roof at rear
- ② Pull down to lower roof at rear
- ③ Push forward to slide roof closed
- ④ Push back to slide roof open

#### Warning!



When opening or closing the panorama sliding/pop-up roof, make sure there is no danger of anyone being harmed by the opening or closing procedure.

The opening procedure of the panorama sliding/pop-up roof can be immediately halted by releasing the switch or, if the switch was moved past the resistance point and released, by moving the switch in any direction.

The closing procedure of the panorama sliding/pop-up roof can be immediately halted by releasing the switch.

When leaving the vehicle, always remove the SmartKey from starter switch and lock your vehicle. Do not leave children unattended in the vehicle, or with access to an unlocked vehicle. Unsupervised use of vehicle equipment may cause an accident and/or serious personal injury.



Do not transport any objects that protrude out of the panorama sliding / pop-up roof as the seals could be damaged.

Do not open the panorama sliding / pop-up roof if there is snow or ice on the roof, as this could result in malfunctions.

The panorama sliding / pop-up roof can be opened or closed manually should an electrical malfunction occur (▷ page 292).



You can also open or close the panorama sliding / pop-up roof using the:

- SmartKey (summer opening / convenience feature) (▷ page 192)
- button  in the control panel of the climate control (▷ page 150)

- ▶ Turn SmartKey in the starter switch to position **1** or **2**.

#### **Opening and closing the panorama sliding / pop-up roof**

- ▶ To open, close, raise or lower the panorama sliding / pop-up roof, move the switch to the resistance point in the required direction ① to ④.

Release the switch when the roof has reached the desired position.

## **Controls in detail**

### **Panorama sliding / pop-up roof\***

#### **Opening the panorama sliding / pop-up roof automatically**

- ▶ Move the switch past the resistance point in direction ④ and release.

The panorama sliding / pop-up roof will not open completely.

- ▶ Press the switch again to open it completely.



The panorama sliding / pop-up roof cannot be closed automatically.

#### **Stopping the panorama sliding / pop-up roof**

- ▶ Move the switch in any direction.

## Controls in detail

### Panorama sliding/pop-up roof\*



#### Opening the panorama sliding/pop-up roof with the SmartKey

The power windows (▷ page 186) will also be opened or closed when you operate the panorama sliding/pop-up roof with the SmartKey.

#### Warning!



Never operate the windows or panorama sliding/pop-up roof if there is the possibility of anyone being harmed by the opening or closing procedure.

In the event that the procedure causes potential danger, the procedure can be immediately halted by releasing the button on the SmartKey. To reverse direction of movement, press  for opening or  for closing.

- ▶ Aim transmitter eye at the driver's door handle.

#### Opening (Summer opening feature)

If the roller sunblind is closed:

- ▶ Press and hold button  after unlocking the vehicle.

The windows and the roller sunblind begin to open after approximately one second.

- ▶ Press and hold button  again.

The panorama sliding/pop-up roof tilts.

- ▶ Press and hold button  again.

The panorama sliding/pop-up roof begins to open after approximately one second.

If roller sunblind is already open:

- ▶ Press and hold button  after unlocking the vehicle.

The windows move down and the panorama sliding/pop-up roof tilts after approximately one second.

- ▶ With the windows fully open, press and hold button  again.

The panorama sliding/pop-up roof begins to slide open after approximately one second.

- ▶ Release transmit button to stop procedure.

#### Closing (Convenience feature)

- ▶ Press and hold button  after locking the vehicle.

The windows and the panorama sliding/pop-up roof begin to close after approximately one second.

- ▶ Release the  button to stop procedure.

Make sure all side windows and the panorama sliding/pop-up roof are properly closed before leaving the vehicle.



### Synchronizing the panorama sliding/pop-up roof and the roller sunblinds

It is necessary to resynchronize the panorama sliding/pop-up roof after

- voltage supply interruption due to a disconnected or discharged battery
- the panorama sliding/pop-up roof has been closed manually
- the panorama sliding/pop-up roof has been opened with an abrupt movement
- a malfunction.

- ▶ Switch on ignition.
- ▶ Move the switch in direction ③ and wait until the roller sunblind are fully closed.  
Hold the switch for approximately one second.
- ▶ Move the switch in the direction ④ and wait until the roller sunblind is approximately 4 in (10 cm) opened.  
Release the switch.
- ▶ Move the switch in the direction ③ and wait until the roller sunblind is fully closed.  
Hold the switch for approximately one second.  
The roller sunblind is synchronized.

- ▶ Move the switch in direction ④ and wait until the roller sunblind are fully opened.  
Hold the switch for approximately one second.
  - ▶ Move the switch in the direction ④ and wait until the panorama sliding/pop-up roof is approximately 4 in (10 cm) opened.  
Release the switch.
  - ▶ Move the switch in the direction ③ and wait until the panorama sliding/pop-up roof is fully closed.  
Hold the switch for approximately one second.
- The panorama sliding/pop-up roof is synchronized when the panorama sliding/pop-up roof opens automatically.
- Repeat synchronization if necessary.

## Controls in detail

### Panorama sliding/pop-up roof\*

## Controls in detail

### Driving systems

#### ▼ Driving systems

The driving system of your vehicle is described on the following pages:

- Cruise control, with which the vehicle can maintain a preset speed

For information on the BAS, ABS and ESP driving systems, see “Driving safety systems” (▷ page 73).

#### Cruise control

Cruise control automatically maintains the speed you set for your vehicle.

Use of cruise control is recommended for driving at a constant speed for extended periods of time. You can set or resume cruise control at any speed over 20 mph (30 km/h).

The cruise control function is operated by means of the cruise control lever.

The cruise control lever is the uppermost lever found on the left-hand side of the steering column.

#### Warning!



Cruise control is a convenience system designed to assist the driver during vehicle operation. The driver is and must remain at all times responsible for the vehicle speed and for safe brake operation.

Only use cruise control if the road, the traffic and weather conditions make it advisable to travel at a steady speed.

- The use of cruise control can be dangerous on winding roads or in heavy traffic because conditions do not allow safe driving at a steady speed.
- The use of cruise control can be dangerous on slippery roads. Rapid changes in tire traction can result in wheel spin and loss of control.
- Deactivate cruise control when driving in fog.

The “Resume” function should only be operated if the driver is fully aware of the previously set speed and wishes to resume this particular preset speed.

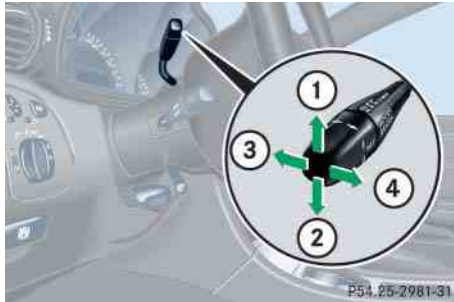

- ① Set current or higher speed
- ② Set current or lower speed
- ③ Cancel cruise control
- ④ Resume at last set speed

#### Setting current speed

- ▶ Accelerate or decelerate to the desired speed.
- ▶ Briefly lift ① or depress ② the cruise control lever.

The current speed is set.

- ▶ Remove your foot from the accelerator pedal.

Cruise control is activated.



On uphill or downhill grades, cruise control may not be able to maintain the set speed. Once the grade eases, the set speed will be resumed.

#### Canceling cruise control

There are several ways to cancel cruise control:

- ▶ Step on the brake pedal.
- or
- ▶ Briefly push the cruise control lever to position ③.

Cruise control will be canceled. The last speed set will be stored for later use.



Moving gear selector lever to position **N** while driving also cancels cruise control. However, the gear selector lever should not be moved to position **N** while driving except to coast when the vehicle is in danger of skidding (e.g. on icy roads).



Vehicles with manual transmission:  
The set cruise controlled speed is switched off when declutching exceeds four seconds during downshifting a gear.



The last stored speed is canceled when you turn off the engine.

## Controls in detail

### Driving systems

#### Setting a higher speed

- ▶ Lift the cruise control lever to position ① and hold it up until the desired speed is reached.
- ▶ Release the cruise control lever.  
The new speed is set.



Depressing the accelerator pedal does not deactivate cruise control. After brief acceleration (e.g. for passing), cruise control will resume the last speed set.

#### Setting a lower speed

- ▶ Depress the cruise control lever to position ② and hold it down until the desired speed is reached.
- ▶ Release the cruise control lever.  
The new speed is set.



Vehicles with automatic transmission: When you use the cruise control lever to decelerate, the transmission will automatically downshift if the engine's braking power does not brake the vehicle sufficiently.

#### Fine adjustment in 1 mph (Canada: 1 km/h) increments

##### *Faster*

- ▶ Briefly tip the cruise control lever in the direction of arrow ①.

##### *Slower*

- ▶ Briefly tip the cruise control lever in the direction of arrow ②.

#### Setting to last stored speed ("Resume" function)

##### **Warning!**



The speed stored in memory should only be set again if prevailing road conditions permit. Possible acceleration or deceleration differences arising from returning to preset speed could cause an accident and/or serious injury to you and others.

- ▶ Briefly push the cruise control lever to position ④.  
The cruise control will resume the last set speed.
- ▶ Remove your foot from the accelerator pedal.

▼ Loading

Roof rack\*

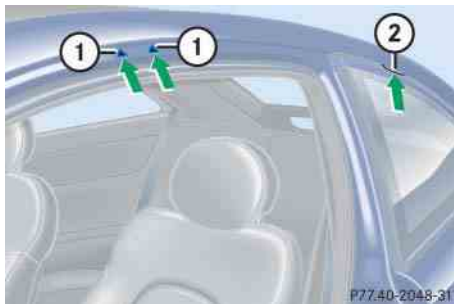

Mount the roof rack only between the fastening points ① and in the recess of the rubber strip ②.

**Warning!**



Use only roof racks approved by Mercedes-Benz for your vehicle model to avoid damage to the vehicle. Follow manufacturer's installation instructions.

Luggage cover

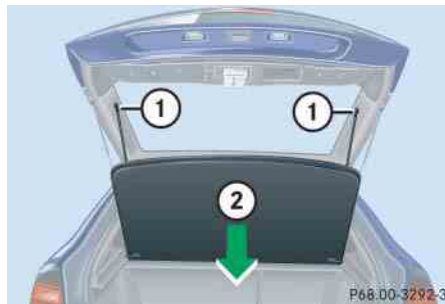

**Removal**

- ▶ Take off securing straps ①.
- ▶ Pull cover towards rear ②.

**Installation**

- ▶ Place cover into holder.
- ▶ Attach securing straps to trunk lid.



Do not place anything on the luggage cover below the rear window.

Split rear bench seat

To expand the cargo area, you can fold down the left and right rear seat backrests. The two sections can be folded down separately.

**Warning!**



When expanding the luggage compartment, always fold the seat cushions fully forward.

Unless you are transporting cargo, the backrests must remain properly locked in the upright position.

In an accident, during hard braking or sudden maneuvers, loose items will be thrown around inside the vehicle, and cause injury to vehicle occupants unless the items are securely fastened in the vehicle.

## Controls in detail

### Loading

#### Folding the backrest forward



- ▶ Pull release handle ①.
- ▶ Fold seat cushion ② forward.
- ▶ Fully retract and fold rearward head restraints (> page 92).

- ▶ Pull release lever ③.
- ▶ Fold backrest ④ forward.

#### Setting up rear seat bench

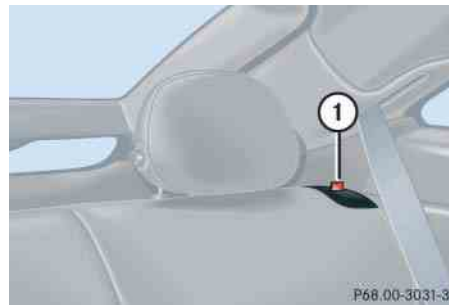

- ▶ Fold backrest rearward until it engages.
- ▶ Fold seat cushion rearward until it locks into position.

If the backrest is not locked into position, a red indicator ① will be visible.

- ▶ Check for secure locking by pushing and pulling on the backrest.

#### Warning!



If a red indicator is visible with the backrest up, then the backrest is not properly locked into position.

Always lock backrest in its upright position when rear seat bench is occupied, or the extended cargo compartment is not in use. Check for secure locking by pushing and pulling on the backrest.

In an accident, during hard braking or sudden maneuvers, loose items will be thrown around inside the vehicle, and cause injury to vehicle occupants unless the items are securely fastened in the vehicle.

To help avoid personal injury during a collision or sudden maneuver, exercise care when transporting cargo.

#### Loading instructions

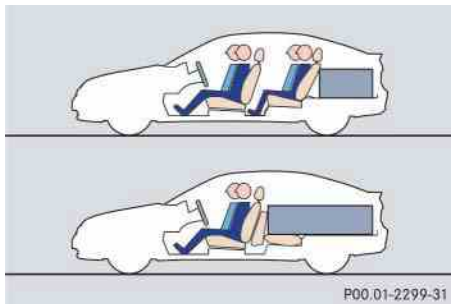

The total load weight including vehicle occupants and luggage/cargo should not exceed the vehicle capacity weight indicated on the certification tag which can be found on the left door pillar.

The handling characteristics of a fully loaded vehicle depend greatly on the load distribution. It is therefore recommended to load the vehicle according to the illustrations shown, with the heaviest items being placed towards the front of the vehicle.

Always place items being carried against front or rear seat backrests, and fasten them as securely as possible.

The heaviest portion of the cargo should always be kept as low as possible since it influences the handling characteristics of the vehicle.

#### Warning!



Always fasten items being carried as securely as possible.

In an accident, during hard braking or sudden maneuvers, loose items will be thrown around inside the vehicle and can cause injury to vehicle occupants unless the items are securely fastened in the vehicle.

To help avoid personal injury during a collision or sudden maneuver, exercise care when transporting cargo. Put luggage or cargo in the trunk if possible. Do not pile luggage or cargo higher than the seat backs. Do not place anything on the rear-window shelf.

Never drive vehicle with trunk lid open. Deadly carbon monoxide (CO) gases may enter vehicle interior resulting in unconsciousness and death.

## Controls in detail

### Useful features

#### ▼ Useful features

##### Interior storage spaces

#### Warning!



To help avoid personal injury during a collision or sudden maneuver, exercise care when stowing objects in the vehicle. Put luggage or cargo in the trunk if possible. Do not pile luggage or cargo higher than the seat backs. Do not place anything on the luggage cover below the rear window.

Luggage nets cannot secure hard or heavy objects.

Keep compartment lids closed. This will help to prevent stored objects from being thrown about and injuring vehicle occupants during an accident.

#### Glove box

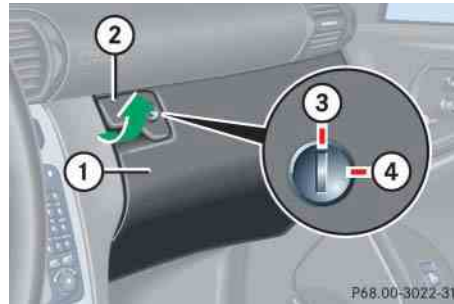

- ① Glove box
- ② Glove box lid release

#### **Opening the glove box**

- ▶ Pull lid release ②.  
The glove box lid opens downward.

#### **Closing the glove box**

- ▶ Push lid up to close.

#### **i**

Prior to closing the glove box, close the compartment for glasses first.

#### **Locking the glove box**

- ▶ Insert mechanical key into the glove box lock and turn it to position ④.

#### **Unlocking the glove box**

- ▶ Turn mechanical key in the glove box lock to position ③.



#### Storage compartment in front of arm-rest

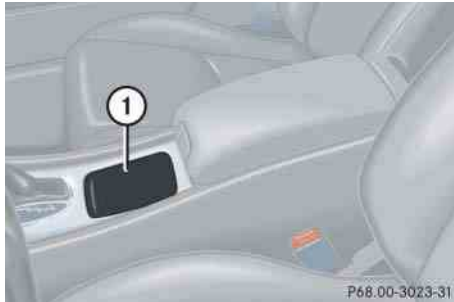

#### Opening

- ▶ Slide cover ① rearward.

The compartment contains a cigarette lighter (▷ page 204), a coin holder, and a cup holder.

#### Closing

- ▶ Slide cover ① forward.

#### Cup holder

#### Warning!



When not in use, keep the cup holder closed. Place only containers that fit into the cup holder to prevent spills. Use lids on open containers and do not fill containers to a height where the contents, especially hot liquids, could spill during vehicle maneuvers.

#### Opening cup holder

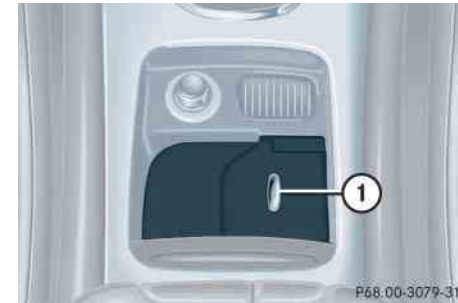

- ▶ Slide cover rearward.
- ▶ Push button ①.  
The cup holder opens automatically.

## Controls in detail

### Useful features

#### Closing cup holder



- ▶ Push in direction of arrow until cup holder engages.

#### Armrest storage spaces

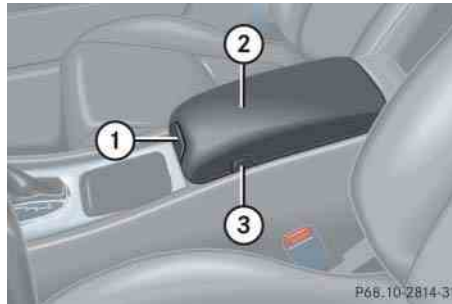

- ① To open storage compartment
- ② Armrest
- ③ To open telephone compartment from the left side

#### Opening storage compartment

- ▶ Pull handle ① and lift armrest.

#### Closing storage compartment

- ▶ Press armrest down until it engages into place.

#### Opening telephone compartment

- ▶ Press button on left ③ or right side and lift up armrest.

#### Closing telephone compartment

- ▶ Press armrest down until it engages into place.

#### Changing inclination of armrest

- ▶ Pull up on armrest.

#### Lowering armrest

- ▶ Pull handle ① to lower armrest.



Vehicles with climate control:

The storage compartment can be heated or cooled.

The compartment can get very warm due to its confined space. When storing heat sensitive objects in the compartment, close the air vent (▷ page 157) while heating the passenger compartment.



Vehicles with climate control:

Do not obstruct the air vent in the storage compartment.

### Parcel net in front passenger footwell

A small convenience parcel net is located in the front passenger footwell. It is for small and light items, such as road maps, mail, etc.

#### Warning!



Do not place heavy or fragile objects, or objects having sharp edges, in the parcel net.

In an accident, during hard braking or sudden maneuvers, they could be thrown around inside the vehicle, and cause injury to vehicle occupants.

## Controls in detail

### Useful features

### Ashtrays

#### Center console ashtray

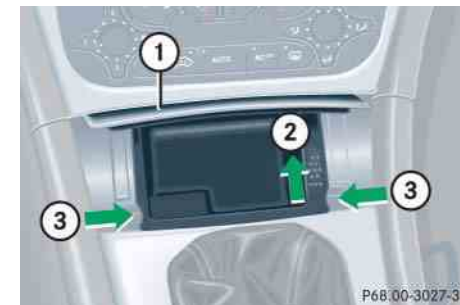

#### Opening ashtray

- ▶ Briefly touch cover plate ①.  
The ashtray opens automatically.

## Controls in detail

### Useful features

#### Removing ashtray insert

##### Warning!



Remove front ashtray only with vehicle standing still. Set the parking brake to secure vehicle from movement. Move gear selector lever to position **N**. With gear selector lever in position **N**, turn off the engine.

- ▶ Secure vehicle from movement by setting the parking brake. Move the gear selector lever to position **N**.  
Now you have more room to take out the insert.
- ▶ Slide ashtray insert in direction of arrow ② until it disengages.
- ▶ Grip ashtray at indents (arrows ③) and remove insert from ashtray frame.

#### Reinstalling the ashtray insert

- ▶ Install insert by pushing back into frame until it engages again.

#### Rear seat ashtray

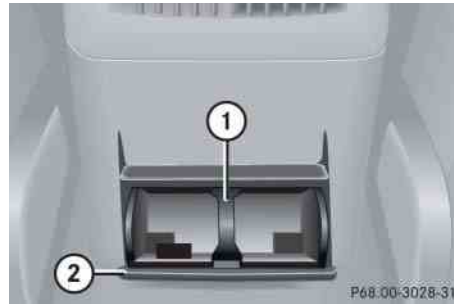

#### Opening ashtray

- ▶ Pull at top of cover ② to open ashtray.

#### Removing ashtray insert

- ▶ Press latch ① to disengage ashtray insert and remove it.

#### Reinstalling the ashtray insert

- ▶ Install ashtray insert.
- ▶ Close the ashtray.

#### Cigarette lighter



- ① Cigarette lighter
- ② Cover

- ▶ Turn SmartKey in the starter switch to position **1** or **2**.
- ▶ Slide cover ② rearward.
- ▶ Push in cigarette lighter ①.

The cigarette lighter will pop out automatically when hot.

#### Warning!



Never touch the heating element or sides of the cigarette lighter; they are extremely hot. Hold the knob only.

When leaving the vehicle, always remove the SmartKey from the starter switch and lock your vehicle. Do not leave children unattended in the vehicle, or with access to an unlocked vehicle. Unsupervised use of vehicle equipment may cause an accident and/or serious personal injury.



The cigarette lighter socket can be used to accommodate electrical accessories up to a maximum 85 W.

#### Telephone\*

#### Warning!



Never operate radio transmitters equipped with a built-in or attached antenna (i.e. without being connected to an external antenna) from inside the vehicle while the engine is running. Doing so could lead to a malfunction of the vehicle's electronic system, possibly resulting in an accident and/or serious personal injury.

Radio transmitters, such as a portable telephone or a citizens band unit, should only be used inside the vehicle if they are connected to an antenna that is installed on the outside of the vehicle.

The external antenna must be approved by Mercedes-Benz. Please contact an authorized Mercedes-Benz Center for information on the installation of an approved external antenna. Refer to the radio transmitter operation instructions regarding use of an external antenna.

#### Warning!



Please do not forget that your primary responsibility is to drive the vehicle. A driver's attention to the road must always be his/her primary focus when driving. For your safety and the safety of others, we recommend that you pull over to a safe location and stop before placing or taking a telephone call.

If you choose to use the telephone<sup>1</sup> while driving, please use the hands-free device and only use the telephone when road, weather and traffic conditions permit. Some jurisdictions prohibit the driver from using a cellular telephone while driving a vehicle.

Only operate the COMAND\* (Cockpit Management and Data System)<sup>1</sup> if road, weather and traffic conditions permit.





<sup>1</sup> Observe all legal requirements.

## Controls in detail

### Useful features

- ▷▷ Bear in mind that at a speed of just 30 mph (approximately 50 km/h), your vehicle is covering a distance of approx. 44 feet (approximately 13.5 m) every second.

You can take and place telephone calls using the  and  buttons on the steering wheel. To carry out other telephone functions, use the control system (▷ page 134).

See separate operating manual for instructions on how to use the telephone.

#### Warning!



Some jurisdictions prohibit the driver from using a cellular telephone while driving a vehicle. Whether or not prohibited by law, for safety reasons, the driver should not use the cellular telephone while the vehicle is in motion.

Stop the vehicle in a safe location before answering or placing a call.

### Tele Aid\*



The initial activation of the Tele Aid system may only be performed by completing the subscriber agreement and placing an acquaintance call using the SOS button. Failure to complete either of these steps will result in a system that is not activated. If the system is not activated, the indicator lamp in the SOS button stays on after turning SmartKey in starter switch to position **2** and the message TELE AID EMREG. CALL - NOT ACTIVATED will be shown in the multifunction display for approx. ten seconds.

If you have any questions regarding activation, please call the Response Center at 1-800-756-9018 (in the USA) or 1-888-923-8367 (in Canada).



### The Tele Aid system



(Telematic Alarm Identification on Demand)

The Tele Aid system consists of three types of response:

- automatic and manual emergency
- roadside assistance and
- information



The Tele Aid system is operational providing that the vehicle's battery is charged, properly connected, not damaged and cellular and GPS coverage is available.

The speaker volume of a Tele Aid call can be adjusted when using the volume control on the multifunction steering wheel. To raise, press button  and to lower, press button .

- ▶ To activate, press the SOS button, the Roadside Assistance button  or the Information button , depending on the type of response required.



The SOS button is located above the inside rear view mirror.



The Roadside Assistance button  and the Information button  are located below the center armrest cover.

Shortly after the completion of your Acquaintance Call, you will receive a user ID and password via first call mail. By visiting [www.mbusa.com](http://www.mbusa.com) and selecting “Tele Aid” (USA only), you will have access to account information, remote door unlock and more.



The Tele Aid system utilizes the cellular network for communication and the GPS (Global Positioning System) satellites for vehicle location. If either of these signals are unavailable, the Tele Aid system may not function and if this occurs, assistance must be summoned by other means.

### System self-check

Initially, after turning the SmartKey in starter switch to position 2, malfunctions are detected and indicated (the indicator lamps in the SOS button, the Roadside Assistance button  and the Information button  stay on longer than ten seconds or do not come on). The message TELE AID MALFUNCTION - DRIVE TO WORKSHOP! appears for approx. ten seconds in the multifunction display.

## Controls in detail

### Useful features

#### Warning!



If the indicator lamps in the SOS button, in the Roadside Assistance button and/or in the Information button do not come on during the system self-check or if any of these indicators remain illuminated constantly in red and/or the message TELE AID MALFUNCTION - DRIVE TO WORKSHOP! is displayed in the multifunction display after the system self-check, a malfunction in the system has been detected.

If a malfunction is indicated as outlined above, the system may not operate as expected. Have the system checked at the nearest Mercedes-Benz Center as soon as possible.

## Controls in detail

### Useful features

#### Emergency calls

An emergency call is initiated automatically:

- following an accident in which the emergency tensioning devices (ETDs) or airbags deploy
- if the anti-theft alarm or the tow-away alarm stays on for more than 20 seconds. See anti-theft alarm system (▷ page 78) and tow-away alarm (▷ page 79).

An emergency call can also be initiated manually by opening the cover next to the inside rear view mirror labeled “SOS”, then briefly pressing the button located under the cover. See below for instructions on initiating an emergency call manually.

Once the emergency call is in progress, the indicator lamp in the “SOS” button will begin to flash. The message `EMERGENCY CALL - CONNECTING CALL` appears in the multifunction display. When the connection is established, the message `EMERGENCY CALL - CALL CONNECTED` appears in the multi-

function display. All information relevant to the emergency, such as the location of the vehicle (determined by the GPS satellite location system), vehicle model, identification number and color are generated.

A voice connection between the Response Center and the occupants of the vehicle will be established automatically soon after the emergency call has been initiated. When a voice connection is established the audio system mutes and the message `TELE AID - EMERGENCY CALL ACTIVE` appears in the multifunction display. The Response Center will attempt to determine more precisely the nature of the accident provided they can speak to an occupant of the vehicle.

The Tele Aid system is available if:

- it has been activated and is operational. Activation requires a subscription for monitoring services, connection and cellular air time
- the relevant cellular phone network and GPS signals are available and pass the information on to the response center



Location of the vehicle on a map is only possible if the vehicle is able to receive signals from the GPS satellite network and pass the information on to the response center.



## Controls in detail

### Useful features

#### Warning!



If the indicator lamp in the SOS button is illuminated continuously and there was no voice connection to the Response Center established, then the Tele Aid system could not initiate an emergency call (e.g. the relevant cellular phone network is not available). The message **EMERGENCY CALL - CALL FAILED** appears in the multifunction display for approx. ten seconds.

Should this occur, assistance must be summoned by other means.

#### Initiating an emergency call manually



- ① Cover
- ② SOS button

- ▶ Briefly press on cover ①.  
The cover will open.
- ▶ Press SOS button ② briefly.  
The indicator lamp in the SOS button ② will flash until the emergency call is concluded.
- ▶ Wait for a voice connection to the Response Center.
- ▶ Close cover ① after the emergency call is concluded.

#### Warning!



If you feel at any way in jeopardy when in the vehicle (e.g. smoke or fire in the vehicle, vehicle in a dangerous road location), please do not wait for voice contact after you have pressed the emergency button. Carefully leave the vehicle and move to a safe location. The Response Center will automatically contact local emergency officials with the vehicle's approximate location if they receive an automatic SOS signal and cannot make voice contact with the vehicle occupants.

## Controls in detail

### Useful features

#### Roadside Assistance button

The Roadside Assistance button  is located below the center armrest cover.

- ▶ Press and hold the button (for longer than two seconds).

A call to a Mercedes-Benz Roadside Assistance dispatcher will be initiated. The button will flash while the call is in progress. The message `TELE DIAGNOSIS - CONNECTING CALL` will appear in the multifunction display.

When the connection is established, the message `TELE DIAGNOSIS - CALL CONNECTED` appears in the multifunction display. The Tele Aid system will transmit data generating the vehicle identification number, model, color and location (subject to availability of cellular and GPS signals).

A voice connection between the Roadside Assistance dispatcher and the occupants of the vehicle will be established. When a voice connection is established the audio

system mutes and the message `TELE AID - ROADSIDE ASSISTANCE CALL ACTIVE` appears in the multifunction display.



- ▶ Describe the nature of the need for assistance.

The Mercedes-Benz Roadside assistance dispatcher will either dispatch a qualified Mercedes-Benz technician or arrange to tow your vehicle to the nearest Mercedes-Benz Center. For services such as labor and/or towing, charges may apply. Refer to the Roadside Assistance manual for more information.

These programs are only available in the USA:

- Sign and Drive services: Services such as jump start, a few gallons of fuel or the replacement of a flat tire with the vehicle spare tire are obtainable.
- Remote Vehicle Diagnostics: This function permits the Mercedes-Benz Roadside Assistance dispatcher to download malfunction codes and actual vehicle data.

#### i

The indicator lamp in the Roadside Assistance button  remains illuminated in red for approx. ten seconds during the system self-check after turning the SmartKey in the starter switch to position **2** (together with the “SOS” button and the Information button ).

See system self-check (▷ page 207) when the indicator lamp does not come on in red or stays on longer than approximately ten seconds.

If the indicator lamp in the Roadside Assistance button  is illuminated continuously and there was no voice connection to the Response Center established, then the Tele Aid system could not initiate a Roadside Assistance call (e.g. the relevant cellular phone network is not available). The message `TELE DIAGNOSIS - CALL FAILED` appears in the multifunction display.

Roadside Assistance calls can be terminated using the  button on the multifunction steering wheel.

### Information button

The Information button  is located below the center armrest cover.

- ▶ Press and hold the button (for longer than two seconds).

A call to the Customer Assistance Center will be initiated. The button will flash while the call is in progress. The message `INFO - CONNECTING CALL` will appear in the multifunction display.



When the connection is established, the message `INFO - CALL CONNECTED` appears in the multifunction display. The Tele Aid system will transmit data generating the vehicle identification number, model, color and location (subject to availability of cellular and GPS signals).

A voice connection between the Customer Assistance Center representative and the occupants of the vehicle will be estab-

lished. When a voice connection is established the audio system mutes and the message `TELE AID - INFO CALL ACTIVE` appears in the multifunction display. Information regarding the operation of your vehicle, the nearest Mercedes-Benz Center or Mercedes-Benz USA products and services is available to you.

For more details concerning the Tele Aid system, please visit [www.mbusa.com](http://www.mbusa.com) and use your ID and password (sent to you separately) to learn more (USA only).





The indicator lamp in the Information button  remains illuminated in red for approx. ten seconds during the system self-check after turning SmartKey in the starter switch to position **2** (together with the “SOS” button and the Roadside Assistance button ).

## Controls in detail

### Useful features

See System self-check (▷ page 207) when the indicator lamp does not come on in red or stays on longer than approximately ten seconds.

If the indicator lamp in the Information button  is illuminated continuously and there was no voice connection to the Response Center established, then the Tele Aid system could not initiate an Information call (e.g. the relevant cellular phone network is not available). The message `INFO - CALL FAILED` appears in the multifunction display.

Information calls can be terminated using the  button on the multifunction steering wheel.

## Controls in detail

### Useful features



If the indicator lamps do not start flashing after pressing one of the buttons or remain illuminated (in red) at any time, the Tele Aid system has detected a fault or the service is not currently active, and may not initiate a call. Visit your Mercedes-Benz Center and have the system checked or contact the Response Center at 1-800-756-9018 (in the USA) or 1-888-923-8367 (in Canada) as soon as possible.

#### Upgrade signals

The Tele Aid system processes calls using the following priority:

- Automatic emergency – First priority
- Manual emergency – Second priority
- Roadside assistance – Third priority
- Information – Fourth priority

Should a higher priority call be initiated while you are connected, an upgrade (alternating) tone will be heard, and the appropriate indicator lamp will flash. If certain information such as vehicle identification number or customer information is not available, the operator may need to retransmit.

During this time you will hear a beep and voice contact will be interrupted. Voice contact will resume once the retransmission is completed. Once a call is concluded, a beep will be heard and the respective indicator lamp will stop flashing. The CO-MAND\* system operation will resume.



If the indicator lamp continues to flash or the system does not reset, contact the Response Center at 1-800-756-9018 (in the USA) or 1-888-923-8367 (in Canada), or Mercedes-Benz Customer Assistance at 1-800-FOR-MERCEdes (1-800-367-6372) in the USA or Customer Service at 1-800-387-0100 in Canada.



The indicator lamp in the respective button flashes until the call is concluded. Calls can only be terminated by a Response Center or Customer Assistance Center representative except Roadside Assistance and Information calls, which can also be terminated by pressing button  on the multifunction steering wheel.



When a Tele Aid call has been initiated, the audio system or the COMAND\* system audio is muted and the selected mode (radio, tape or CD) pauses. The optional cellular phone (if installed) switches off. If you must use this phone, the vehicle must be parked. Disconnect the coiled cord and place the call. The COMAND\* navigation system (if engaged) will continue to run. The display in the instrument cluster is available for use and spoken commands are only available by pressing the RPT button on the COMAND\* unit. A pop-up window will appear in the COMAND\* display to indicate that a Tele Aid call is in progress.

### Remote door unlock

In case you have locked your vehicle unintentionally (e.g. SmartKey inside vehicle), and the reserve key is not handy:

- ▶ Contact the Mercedes-Benz Response Center at 1-800-756-9018 (in the USA) or 1-888-923-8367 (in Canada).

You will be asked to provide your password which you provided when you completed the subscriber agreement.

- ▶ Then return to your vehicle and pull the trunk lid recessed handle for minimum of 20 seconds until the “SOS” button is flashing.

The message EMERGENCY CALL - CALL CONNECTED appears in the multifunction display.

As an alternative, you may unlock the vehicle via Internet using the ID and password sent to you shortly after the completion of your acquaintance call.

## Controls in detail

### Useful features

The Response Center will then unlock your vehicle with the remote door unlocking feature.



The remote door unlock feature is available if the relevant cellular phone network is available.

The “SOS” button will flash and the message EMERGENCY CALL - CALL CONNECTED will appear in the multifunction display to indicate receipt of the door unlock command.

Once the vehicle is unlocked, a Response Center specialist will attempt to establish voice contact with the vehicle occupants.

If the trunk lid recessed handle was pulled for more than 20 seconds before door unlock authorization was received by the Response Center, you must wait 15 minutes before pulling the trunk lid recessed handle again.

## Controls in detail

### Useful features

#### Stolen vehicle tracking services

In the event your vehicle was stolen:

- ▶ Report the incident to the police.  
The police will issue a numbered incident report.
- ▶ Pass this number on to the Mercedes-Benz Response Center along with your password issued to you when you subscribed to the service.

The Response Center will then attempt to covertly contact the vehicle's Tele Aid system. Once the vehicle is located, the Response Center will contact the local law enforcement and you. The vehicle's location will only be provided to law enforcement.

#### Garage door opener

The built-in remote control is capable of operating up to three separately controlled devices, for example garage door openers, gate openers, or other devices compatible with HomeLink® or some other systems.

You can program the signal transmitter buttons.

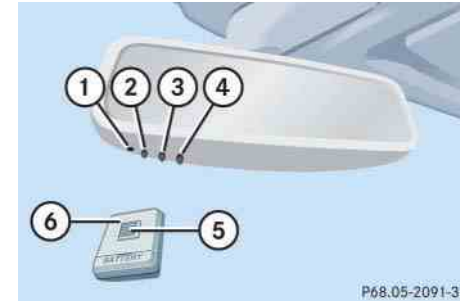

#### Remote control integrated into the interior rear view mirror

- ① Indicator lamp
- ② ③ ④ Signal transmitter button
- ⑤ Hand-held transmitter button
- ⑥ Hand-held remote control transmitter (not part of the vehicle equipment)

### Warning!



Before programming the integrated remote control to a garage door opener or gate operator, make sure that people and objects are out of the way of the device to prevent potential harm or damage.

When programming a garage door opener, the door moves up or down. When programming a gate operator, the gate opens or closes.

Do not use the integrated remote control with any garage door opener that lacks safety stop and reverse features as required by U.S. federal safety standards (this includes any garage door opener model manufactured before April 1, 1982). A garage door that cannot detect an object - signaling the door to stop and reverse - does not meet current U.S. federal safety standards.



Certain types of garage door openers are incompatible with the integrated opener. If you should experience difficulties with programming the transmitter, contact your authorized Mercedes-Benz Center, or call Mercedes-Benz Customer Assistance Center (in the USA only) at 1-800-FOR-MERCEdes, or Customer Service (in Canada) at 1-800-387-0100.

## Controls in detail

### Useful features



For operation in the USA only:  
This device complies with Part 15 of the FCC Rules. Operation is subject to the following two conditions:

- (1) This device may not cause harmful interference, and
- (2) this device must accept any interference received, including interference that may cause undesired operation.

Any unauthorized modification to this device could void the user's authority to operate the equipment.

## Controls in detail

### Useful features

#### Programming or reprogramming the integrated remote control

Step 1:

- ▶ Switch on ignition.

Step 2:

- ▶ If you have previously programmed an integrated signal transmitter button and wish to retain its programming, proceed to step 3. Otherwise, press and hold the two outer signal transmitter buttons ② and ④ and release them only when the indicator light begins to flash after approximately 20 seconds (do not hold the button for longer than 30 seconds). This procedure erases any previous settings for all three channels and initializes the memory. If you later wish to program a second and/or third hand-held transmitter to the remaining two signal transmitter buttons, do not repeat this step and begin directly with step 3.

Step 3:

- ▶ Hold the end of the hand-held remote control transmitter ⑥ of the device you wish to train approximately 2 to 5 in (5 to 12 cm) away from the surface of the integrated remote control located on the interior rear view mirror, keeping the indicator lamp ① in view.

Step 4:

- ▶ Using both hands, simultaneously press the hand-held transmitter button ⑤ and the desired integrated signal transmitter button (②, ③ or ④). Do not release the buttons until completing step 5.

The indicator lamp ① on the integrated remote control will flash, first slowly and then rapidly.

#### 1

The indicator lamp ① flashes the first time the signal transmitter button is programmed. If this button has already been programmed, the indicator lamp will only start flashing after 20 seconds.

Step 5:

- ▶ When the indicator lamp ① flashes rapidly, release both buttons.

Step 6:

- ▶ Press and hold the just-trained integrated signal transmitter button and observe the indicator lamp ①.

If the indicator lamp ① stays on constantly, programming is complete and your device should activate when the integrated signal transmitter button is pressed and released.





If the indicator lamp ① blinks rapidly for about two seconds and then turns to a constant light, continue with programming steps 8 through 12 as your garage door opener may be equipped with the “rolling code” feature.

Step 7:

- ▶ To program the remaining two buttons, repeat the steps above starting with step 3.

#### ***Rolling code programming***

To train a garage door opener (or other rolling code devices) with the rolling code feature, follow these instructions after completing the “Programming” portion (steps 1 through 6) of this text. (A second person may make the following training procedures quicker and easier.)

Step 8:

- ▶ Locate “training” button on the garage door opener motor head unit.

Exact location and color of the button may vary by garage door opener brand. Depending on manufacturer, the “training” button may also be referred to as “learn” or “smart” button. If there is difficulty locating the transmitting button, refer to the garage door opener operator’s manual.

Step 9:

- ▶ Press “training” button on the garage door opener motor head unit.

The “training light” is activated.

You have 30 seconds to initiate the following step.

Step 10:

- ▶ Firmly press, hold for two seconds and release the programmed integrated signal transmitter button (②, ③ or ④).

Step 11:

- ▶ Press, hold for two seconds and release same button a second time to complete the training process.

Some garage door openers (or other rolling code equipped devices) may require you to perform this procedure a third time to complete the training. >>

## Controls in detail

### Useful features

▷▷ Step 12:

- ▶ Confirm the garage door operation by pressing the programmed integrated signal transmitter button (②, ③ or ④).

Step 13:

- ▶ To program the remaining two buttons, repeat the steps above starting with step 3.

#### ***Gate operator/Canadian programming***

Canadian radio-frequency laws require transmitter signals to “time-out” (or quit) after several seconds of transmission which may not be long enough for the integrated signal transmitter to pick up the signal during programming. Similar to this Canadian law, some U.S. gate operators are designed to “time-out” in the same manner.

If you live in Canada or if you are having difficulties programming a gate operator (regardless of where you live) by using the programming procedures, replace step 4 with the following:

Step 4:

- ▶ Continue to press and hold the integrated signal transmitter button (②, ③ or ④) while you press and re-press (“cycle”) your hand-held remote control transmitter (⑥) every two seconds until the frequency signal has been learned. Upon successful training, the indicator lamp (①) will flash slowly and then rapidly after several seconds.
- ▶ Proceed with programming step 5 and step 6 to complete.

#### **Operation of integrated remote control**

- ▶ Switch on ignition.
- ▶ Select and press the appropriate integrated signal transmitter button (②, ③ or ④) to activate the remote controlled device.

The integrated remote control transmitter continues to send the signal as long as the button is pressed – up to 20 seconds.

#### Erasing the integrated remote control memory

- ▶ Switch on ignition.
- ▶ Simultaneously hold down the signal transmitter buttons ② and ④, for approximately 20 seconds, until the indicator lamp ① blinks rapidly. Do not hold for longer than 30 seconds.

The codes of all three channels are erased.



If you sell your vehicle, erase the codes of all three channels.

#### Reprogramming a single integrated signal transmitter button

To program a device using a signal transmitter button previously trained, follow these steps:

- ▶ Press and hold the desired signal transmitter button (②, ③ or ④). Do not release the button.
- ▶ The indicator lamp will begin to flash after 20 seconds. Without releasing the integrated signal transmitter button, proceed with programming starting with step 3.



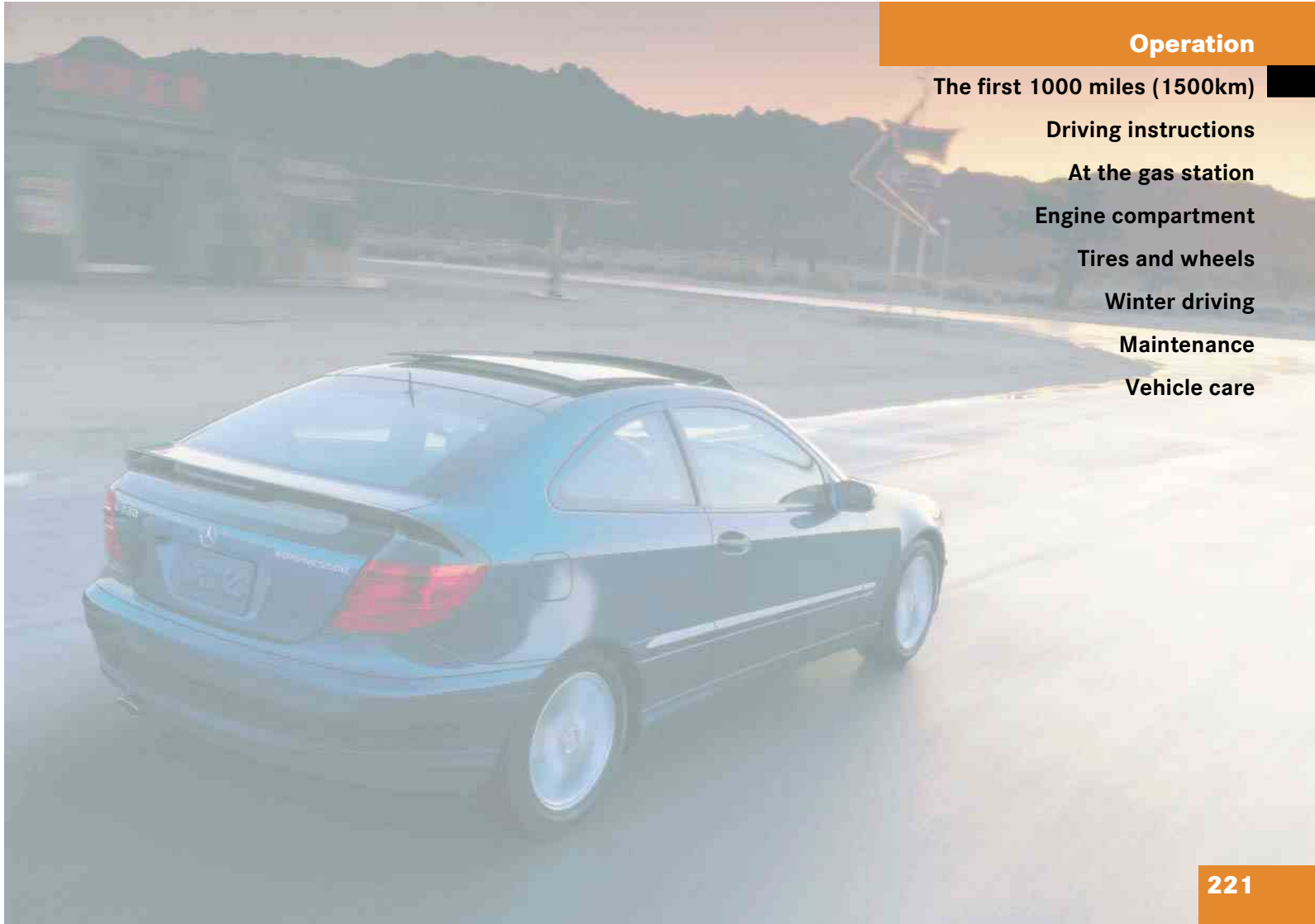

## **Operation**

**The first 1000 miles (1500km)**

**Driving instructions**

**At the gas station**

**Engine compartment**

**Tires and wheels**

**Winter driving**

**Maintenance**

**Vehicle care**

## Operation

### The first 1000 miles (1500km)

In the “Operation” section you will find detailed information on operating, maintaining and caring for your vehicle.

#### ▼ The first 1000 miles (1500km)

The more cautiously you treat your vehicle during the break-in period, the more satisfied you will be with its performance later on.

- Drive your vehicle during the first 1000 miles (1500 km) at varying but moderate vehicle and engine speeds.
- During this period, avoid heavy loads (full throttle driving) and excessive engine speeds (no more than 2/3 of maximum rpm in each gear).
- Shift gears in a timely manner.

- Avoid accelerating by kick-down.
- Do not attempt to slow the vehicle down by shifting to a lower gear using the gear selector lever.
- Select positions 3, 2 or 1 only when driving at moderate speeds (for hill driving).

After 1000 miles (1500 km) you may gradually increase vehicle and engine speeds to the permissible maximum.

All of the above instructions also apply when driving the first 1000 miles (1500 km) after the engine or the rear differential has been replaced.



Always obey applicable speed limits.

▼ **Driving instructions**

**Drive sensibly – save fuel**

Fuel consumption, to a great extent, depends on driving habits and operating conditions.

To save fuel you should:

- Keep tires at the recommended inflation pressures
- Remove unnecessary loads
- Remove roof rack when not in use
- Allow engine to warm up under low load use
- Avoid frequent acceleration and deceleration
- Have all maintenance work performed by qualified technicians at the intervals specified in the Service Booklet and as required by the FSS. Contact your authorized Mercedes-Benz Center

Fuel consumption is also increased by driving in cold weather, in stop-and-go traffic, on short trips and in hilly country.

**Drinking and driving**

**Warning!**



Drinking and driving and/or taking drugs and driving are very dangerous combinations. Even a small amount of alcohol or drugs can affect your reflexes, perceptions and judgement.

The possibility of a serious or even fatal accident are greatly increased when you drink or take drugs and drive.

Do not drink or take drugs and drive or allow anyone to drive who has been drinking or taking drugs.

**Pedals**

**Warning!**



Keep driver's foot area clear at all times. Objects stored in this area may impair pedal movement.

**Power assistance**

**Warning!**



With the engine not running, there is no power assistance for the brake and steering systems. In this case, it is important to keep in mind that a considerably higher degree of effort is necessary to brake and steer the vehicle.

## Operation

### Driving instructions

#### Brakes

##### Warning!



After driving in heavy rain for some time without applying the brakes or through water deep enough to wet brake components, the first braking action may be somewhat reduced and increased pedal pressure may be necessary to obtain expected braking effect. Maintain a safe distance from vehicles in front.

Resting your foot on the brake pedal will cause excessive and premature wear of the brake pads.

It can also result in the brakes overheating, thereby significantly reducing their effectiveness. It may not be possible to stop the vehicle in sufficient time to avoid an accident.

To help prevent brake disk corrosion after driving on wet road surfaces (particularly salted roads), it is advisable to brake the vehicle with considerable force prior to parking. The heat generated serves to dry the brakes.

If your brake system is normally only subjected to moderate loads, you should occasionally test the effectiveness of the brakes by applying above-normal braking pressure at higher speeds. This will also enhance the grip of the brake pads.



Be very careful not to endanger other road users when you apply the brakes.

Refer to the description of the Brake Assist System (BAS), (▷ page 74).

If the parking brake is released and the brake warning lamp in the instrument cluster stays on, the brake fluid level in the reservoir is too low.

Brake pad wear or a leak in the system may be the reason for low brake fluid in the reservoir.

Have the brake system inspected by qualified technicians immediately. Contact your authorized Mercedes-Benz Center.

All checks and service work on the brake system should be carried out by qualified technicians only. Contact your authorized Mercedes-Benz Center.

Install only brake pads and brake fluid recommended by Mercedes-Benz.



#### Warning!



If other than recommended brake pads are installed, or other than recommended brake fluid is used, the braking properties of the vehicle can be degraded to an extent that safe braking is substantially impaired. This could result in an accident.



When driving down long and steep grades, relieve the load on the brakes by shifting into a lower gear to use the engine's braking power. This helps prevent overheating of the brakes and reduces brake pad wear.

After hard braking, it is advisable to drive on for some time, rather than immediately parking, so that the air stream will cool down the brakes faster.

#### Driving off

Apply the brakes to test them briefly after driving off. Perform this procedure only when the road is clear of other traffic.

Warm up the engine smoothly. Do not place full load on the engine until the operating temperature has been reached.

When starting off on a slippery surface, do not allow a wheel to spin for an extended period with the ESP switched off. Doing so may cause serious damage to the drivetrain which is not covered by the Mercedes-Benz Limited Warranty.



Simultaneously depressing the accelerator pedal and applying the brake reduces engine performance and causes premature brake and drivetrain wear.

#### Parking



Set the parking brake whenever parking or leaving the vehicle. In addition, move gear selector lever to position **P** (manual transmission: first or reverse gear).

When parking on hills, always turn front wheel towards the curb.

#### Warning!



Do not park this vehicle in areas where combustible materials such as grass, hay or leaves can come into contact with the hot exhaust system, as these materials could be ignited and cause a vehicle fire. ▷▷

## Operation

### Driving instructions



To reduce the risk of personal injury as a result of vehicle movement, before turning off the engine and leaving the vehicle always:

- Keep right foot on brake pedal.
- Firmly depress parking brake pedal.
- Move the gear selector lever to position **P** (manual transmission: first or reverse gear).
- Slowly release brake pedal.
- When parked on an incline, turn front wheel against curb.
- Turn the SmartKey to starter switch position **0**.
- Take the SmartKey and lock vehicle when leaving.

### Tires

#### Warning!



If you feel a sudden significant vibration or ride disturbance, or you suspect that possible damage to your vehicle has occurred, you should turn on the hazard warning flashers, carefully slow down, and drive with caution to an area which is a safe distance from the road.

Inspect the tires and the vehicle underbody for possible damage. If the vehicle or tires appear unsafe, have it towed to the nearest Mercedes-Benz Center or tire dealer for repairs.

Tread wear indicators (TWI) are required by law. These indicators are located in six places on the tread circumference and become visible at a tread depth of approximately  $1/16$  in (1.6 mm), at which point the tire is considered worn and should be replaced.

The tread wear indicator appears as a solid band across the tread.

#### Warning!



Although the applicable federal motor vehicle safety laws consider a tire to be worn when the tread wear indicators (TWI) become visible at approximately  $1/16$  in (1.6 mm), we recommend that you do not allow your tires to wear down to that level. As tread depth approaches  $1/8$  in (3 mm), the adhesion properties on a wet road are sharply reduced.

Depending upon the weather and/or road surface (conditions), the tire traction varies widely.

Specified tire pressures must be maintained. This applies particularly if the tires are subjected to high loads (e.g. high speeds, heavy loads, high ambient temperatures).

#### Warning!



Do not drive with a flat tire. A flat tire affects the ability to steer or brake the vehicle. You may lose control of the vehicle. Continued driving with a flat tire or driving at high speed with a flat tire will cause excessive heat build-up and possibly a fire.

#### Hydroplaning

Depending on the depth of the water layer on the road, hydroplaning may occur, even at low speeds and with new tires. Reduce vehicle speed, avoid track grooves in the road and apply brakes cautiously in the rain.

#### Tire traction

The safe speed on a wet, snow covered or icy road is always lower than on a dry road.

You should pay particular attention to the condition of the road whenever the outside temperatures are close to the freezing point.

#### Warning!



If ice has formed on the road, tire traction will be substantially reduced. Under such weather conditions, drive, steer and brake with extreme caution.

Mercedes-Benz recommends M+S rated radial-ply tires with a minimum tread depth of approximately  $\frac{1}{6}$  in (4 mm) on all four wheels for the winter season to ensure normal balanced handling characteristics. On packed snow, they can reduce your stopping distance as compared to summer tires. Stopping distance, however, is still considerably greater than when the road is not covered with snow or ice. Exercise appropriate caution.



Avoid spinning of a drive wheel. This may cause serious damage to the drivetrain which is not covered by the Mercedes-Benz Limited Warranty.

## Operation

### Driving instructions

#### Tire speed rating

Regardless of the tire speed rating, local speed limits should be obeyed. Use prudent driving speeds appropriate to prevailing conditions.

#### Warning!



Even when permitted by law, never operate a vehicle at greater than the maximum speed rating of the tires.

Exceeding the maximum speed for which tires are rated can lead to sudden tire failure, causing loss of vehicle control and possibly resulting in an accident and/or personal injury and possible death, for you and for others.

#### C 230 Kompressor (standard in U.S.A.; optional in Canada), C 320

Your vehicle is factory equipped with “W”-rated tires, which have a speed rating of 168 mph (270 km/h).

An electronic speed limiter prevents your vehicle from exceeding a speed of 130 mph (210 km/h).

#### C 230 Kompressor (standard in Canada; Canada only)

Your vehicle is factory equipped with “H”-rated tires, which have a speed rating of 130 mph (210 km/h).

An electronic speed limiter prevents your vehicle from exceeding a speed of 130 mph (210 km/h).



For information on tire speed rating for winter tires, see “Winter driving” (> page 247).

#### Winter driving instructions

The most important rule for slippery or icy roads is to drive sensibly and to avoid abrupt acceleration, braking and steering maneuvers. Do not use the cruise control system under such conditions.

When the vehicle is in danger of skidding, move gear selector lever to position **N** or, in case of manual transmission declutch. Try to keep the vehicle under control by corrective steering action.



For information on driving with snow chains, see “Snow chains” (> page 248).

#### Warning!



On slippery road surfaces, never downshift in order to obtain braking action. This could result in drive wheel slip and reduced vehicle control. Your vehicle’s ABS will not prevent this type of loss of control.

Road salts and chemicals can adversely affect braking efficiency. Increased pedal force may become necessary to produce the normal braking effect.

Depressing the brake pedal periodically when traveling at length on salt-strewn roads can bring road-salt-impaired braking efficiency back to normal.

If the vehicle is parked after being driven on salt-treated roads, the braking efficiency should be tested as soon as possible after driving is resumed.

**Warning!**



Make sure not to endanger any other road users when carrying out these braking maneuvers.

**Warning!**



If the vehicle becomes stuck in snow, make sure snow is kept clear of the exhaust pipe and from around the vehicle with the engine running. Otherwise, deadly carbon monoxide (CO) gases may enter vehicle interior resulting in unconsciousness and death.

To assure sufficient fresh air ventilation, open a window slightly on the side of the vehicle not facing the wind

**Warning!**



The outside temperature indicator is not designed to serve as an ice-warning device and is therefore unsuitable for that purpose. Indicated temperatures just above the freezing point do not guarantee that the road surface is free of ice.

For more information on winter driving, see “Winter driving” (▷ page 247).

## Operation

### Driving instructions

#### Standing water



Do not drive through flooded areas or water of unknown depth. Before driving through water, determine its depth. Never accelerate before driving into water. The bow wave could force water into the engine and auxiliary equipment, thus damaging them.

If you must drive through standing water, drive slowly to prevent water from entering the passenger compartment or the engine compartment. Water in these areas could cause damage to electrical components or wiring of the engine or transmission, or could result in water being ingested by the engine through the air intake causing severe internal engine damage. Any such damage is not covered by the Mercedes-Benz Limited Warranty.

## Operation

### Driving instructions

#### Passenger compartment

##### Warning!



Always fasten items being carried as securely as possible.

In an accident, during hard braking or sudden maneuvers, loose items will be thrown around inside the vehicle, and cause injury to vehicle occupants unless the items are securely fastened in the vehicle.

The trunk is the preferred place to carry objects.

#### Driving abroad

Abroad, there is an extensive Mercedes-Benz service network at your disposal. If you plan to drive into areas which are not listed in the index of your Mercedes-Benz Center directory, you should request pertinent information from your authorized Mercedes-Benz Center.

#### Control and operation of radio transmitter

##### COMAND\*, radio and telephone\*

##### Warning!



Please do not forget that your primary responsibility is to drive the vehicle safely. Only operate the COMAND (Cockpit Management and Data System), radio or telephone<sup>1</sup> if road, weather and traffic conditions permit.

Bear in mind that at a speed of just 30 mph (approximately 50 km/h), your vehicle is covering a distance of approximately 44 feet (approximately 13.5 m) every second.

<sup>1</sup> Observe all legal requirements

#### Telephones and two-way radios

##### Warning!



Never operate radio transmitters equipped with a built-in or attached antenna (i.e. without being connected to an external antenna) from inside the vehicle while the engine is running. Doing so could lead to a malfunction of the vehicle's electronic system, possibly resulting in an accident and/or personal injury.

Radio transmitters, such as a portable telephone or a citizens band unit should only be used inside the vehicle if they are connected to an antenna that is installed on the outside of the vehicle.

Refer to the radio transmitter operation instructions regarding use of an external antenna.

### Catalytic converter

Your Mercedes-Benz is equipped with monolithic-type catalytic converters, an important element in conjunction with the oxygen sensors to achieve substantial control of the pollutants in the exhaust emissions. Keep your vehicle in proper operating condition by following our recommended maintenance instructions as outlined in your Service Booklet.



To prevent damage to the catalytic converters, use only premium unleaded gasoline in this vehicle.

Any noticeable irregularities in engine operation should be repaired promptly. Otherwise, excessive unburned fuel may reach the catalytic converter, causing it to overheat and start a fire.

### Warning!



As with any vehicle, do not idle, park or operate this vehicle in areas where combustible materials such as grass, hay or leaves can come into contact with the hot exhaust system, as these materials could be ignited and cause a vehicle fire.

### Emission control

Certain systems of the engine serve to keep the toxic components of the exhaust gases within permissible limits required by law.

These systems, of course, will function properly only when maintained strictly according to factory specifications. Any adjustments on the engine should, therefore, be carried out only by qualified Mercedes-Benz Center authorized technicians. Engine adjustments should not be altered in any way. Moreover, the specified service jobs must be carried out regularly

according to Mercedes-Benz servicing requirements. For details refer to the Service Booklet.

### Warning!



Inhalation of exhaust gas is hazardous to your health. All exhaust gas contains carbon monoxide (CO), and inhaling it can cause unconsciousness and lead to death.

Do not run the engine in confined areas (such as a garage) which are not properly ventilated. If you think that exhaust gas fumes are entering the vehicle while driving, have the cause determined and corrected immediately. If you must drive under these conditions, drive with at least one window fully open at all times.

## Operation

### Driving instructions

#### Coolant temperature

During severe operating conditions and stop-and-go city traffic, the coolant temperature may rise close to approx. 248°F (120°C).

The engine should not be operated with the coolant temperature over 248°F (120°C). Doing so may cause serious engine damage which is not covered by the Mercedes-Benz Limited Warranty.

#### Warning!



- Driving when your engine is badly overheated can cause some fluids, which may have leaked into the engine compartment, to catch fire. You could be seriously burned.
- Steam from an overheated engine can cause serious burns and can occur just by opening the engine hood. Stay away from the engine if you see or hear steam coming from it. Turn off the engine, get out of the vehicle and do not stand near the vehicle until it has cooled down.

Turn off the engine, get out of the vehicle and do not stand near the vehicle until it has cooled down.



## ▼ At the gas station

### Refueling

#### Warning!



Gasoline is highly flammable and poisonous. It burns violently and can cause serious injury. Whenever you are around gasoline, avoid inhaling fumes and skin contact, extinguish all smoking materials. Never allow sparks, flame or smoking materials near gasoline!

#### Warning!



Flexible Fuel Vehicles (identified by a label reading **Premium gasoline or E85 only!** on fuel filler flap):  
Ethanol fuel (E85) and its vapors are highly flammable, poisonous and burn easily. Ethanol fuel can cause serious injuries if ignited or if you come into contact with it or inhale fumes of it. Avoid inhalation of Ethanol fumes and skin contact with Ethanol. Extinguish all open flames before refueling. Never smoke or create sparks close to Ethanol.

The fuel filler flap is located on the right-hand side of the vehicle towards the rear. Locking/unlocking the vehicle with the remote control automatically locks/unlocks the fuel filler flap.

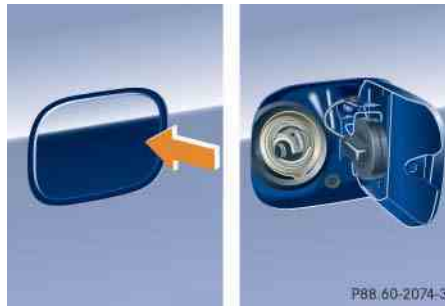

- ▶ Turn off the engine
- ▶ Remove the SmartKey from the starter switch.
- ▶ Open the fuel filler flap by pushing at the point indicated by the arrow.  
The fuel filler flap springs open.
- ▶ Turn the fuel cap to the left and hold on to it until possible pressure is released.

## Operation

### At the gas station

- ▶ Take off the cap and set it in the recess on the fuel filler flap.

To prevent fuel vapors from escaping into open air, fully insert filler nozzle unit.

- ▶ Only fill your tank until the filler nozzle unit cuts out – do not top up or overfill.

#### Warning!



Overfilling of the fuel tank may create pressure in the system which could cause a gas discharge. This could cause the gas to spray back out when removing the fuel pump nozzle, which could cause personal injury.

- ▶ Replace the fuel cap by turning it to the right.

You should hear the fuel cap engage.

- ▶ Close the fuel filler flap. >>

## Operation

### At the gas station



Use only premium unleaded gasoline with a minimum Posted Octane Rating of 91 (average of 96 RON / 86 MON). Information on gasoline quality can normally be found on the fuel pump.

More information on gasoline can be found in the Factory Approved Service Products pamphlet.

Flexible Fuel Vehicles are identified by a label reading **Premium gasoline or E85 only!** on the fuel filler flap.

For more information, see “Flexible Fuel Vehicles” (▷ page 334).



Leaving the engine running and the fuel cap open can cause the  lamp to illuminate.

For more information, see “Practical hints” section (▷ page 260).

### Check regularly and before a long trip

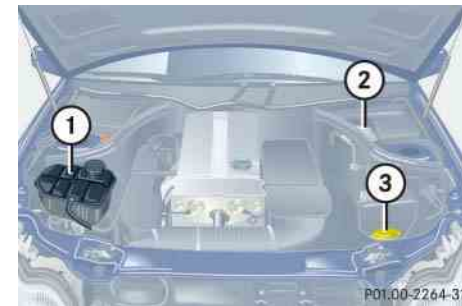

- ① Coolant level  
For more information, see “Coolant level” (▷ page 241).
- ② Brake fluid (fuse box cover removed)  
Removing fuse box cover, see “Fuses” (▷ page 317).
- ③ Windshield washer and headlamp cleaning system\*  
For more information on filling up the washer reservoir, see “Windshield washer system and headlamp cleaning system” (▷ page 243).



If you find that the brake fluid in the brake fluid reservoir has fallen to the minimum mark or below, have the brake system checked for brake pad thickness and leaks immediately. Notify an authorized Mercedes-Benz Center immediately. Do not add brake fluid as this will not solve the problem. For more information, see “Practical Hints” (▷ page 259).

#### **Engine oil level**

For more information on engine oil, see “Engine oil” (▷ page 237).

Opening hood, see (▷ page 236).

#### **Coolant**

For normal replenishing, use water (potable water quality). For more information on coolant, see “Coolant level” (▷ page 241)

## **Operation**

### **At the gas station**

#### **Vehicle lighting**

Check function and cleanliness. For information on replacing light bulbs, see “Replacing bulbs” (▷ page 293).

Exterior lamp switch (▷ page 98).

#### **Tire inflation pressure**

For information on tire inflation pressure, see “Checking tire inflation pressure” (▷ page 245).

## Operation

### Engine compartment

#### ▼ Engine compartment

##### Hood

#### Warning!



Do not pull the release lever while the vehicle is in motion. Otherwise the hood could be forced open by passing air flow.

##### Opening



#### ① Hood release

- ▶ Pull lever ① downwards.

The hood is unlocked and handle ② will extend out of the radiator grille.



To avoid damage to the windshield wipers or hood, never open the hood if the wiper arms are folded forward away from the windshield.

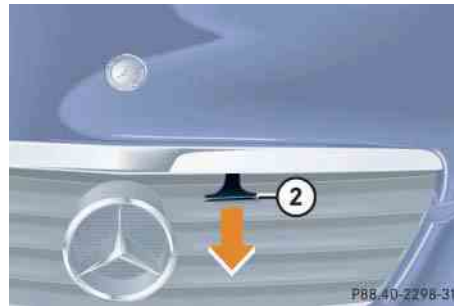

#### ② Handle for opening the hood

- ▶ Pull handle ② to its stop out of radiator grille.

- ▶ Pull up on the hood (do not pull up on the handle) and then release it.

The hood will be automatically held open at shoulder height by gas-filled struts.

#### Warning!



To help prevent personal injury, stay clear of moving parts when the hood is open and the engine is running. Make sure the hood is properly closed before driving. When closing the hood, use extreme caution not to catch hands or fingers.

The radiator fan may continue to run for approximately 30 seconds or even restart after the engine has been turned off. Stay clear of fan blades.

#### Warning!



If you see flames or smoke coming from the engine compartment, or if the coolant temperature display indicates that the engine is overheated, do not open the hood. Move away from vehicle and do not open the hood until the engine has cooled. If necessary, call the fire department.

#### Warning!



The engine is equipped with a transistorized ignition system. Because of the high voltage it is dangerous to touch any components (ignition coils, spark plug sockets, diagnostic socket) of the ignition system

- with the engine running
- while starting the engine
- if ignition is “on” and the engine is turned manually

#### Closing

#### Warning!



Be careful that you do not close the hood on anyone.

- ▶ Let the hood drop from a height of approximately 1 ft (30 cm).  
The hood will lock audibly.
- ▶ Check to make sure the hood is fully closed.

If you can raise the hood at a point above the headlamps, then it is not properly closed. Open it again and let it drop with somewhat greater force.

#### Engine oil

The amount of oil your engine needs will depend on a number of factors, including driving style. Higher oil consumption can occur when

- the vehicle is new
- the vehicle is driven frequently at higher engine speeds

Engine oil consumption checks should only be made after the vehicle break-in period.



Do not use any special lubricant additives, as these may damage the drive assemblies. Using special additives not approved by Mercedes-Benz will restrict your warranty entitlement.

More information on this subject is available at any Mercedes-Benz Center.

## Operation

### Engine compartment

#### Checking engine oil level with the control system



When checking the oil level the vehicle must

- be parked on level ground
- be at normal operating temperature
- have been stationary for at least five minutes with the engine turned off

To check the engine oil level via the multifunction display, do the following:

- ▶ Turn the SmartKey in the starter switch to position **2**.

The standard display (▷ page 109) should appear in the multifunction display.

- ▶ Press button  or  on the steering wheel until the following message is seen in the multifunction display:



```
ENGINE OIL LEVEL  
MEASURING NOW  
MEASURE. CORRECT  
ONLY IF VEH. LEVEL
```



One of the following messages will subsequently appear in the indicator:

- ENGINE OIL LEVEL OK
- ADD 1.0 Qt. TO REACH MAX. OIL LEVEL!  
(Canada: 1.0 LITER)
- ADD 1.5 Qts. TO REACH MAX. OIL LEVEL!  
(Canada: 1.5 LITERS)
- ADD 2.0 Qts. TO REACH MAX. OIL LEVEL!  
(Canada: 2.0 LITERS)



If you want to interrupt the checking procedure, press the  or  button on the multifunction steering wheel.

- ▶ If necessary, add engine oil.

For adding engine oil, see (▷ page 239).

For more information on engine oil, see “Technical data” section (▷ page 330).

#### **Other display messages**

If the SmartKey is not turned to position **2** in the starter switch, the following message will appear:

```
FOR ENGINE OIL LEVEL  
SWITCH ON IGNITION!
```

- ▶ Switch on the ignition.

If you see the message:

OBSERVE WAITING PERIOD

- ▶ If engine is at normal operating temperature, wait five minutes before repeating check procedure.
- ▶ If engine is not yet at normal operating temperature, wait 30 minutes before repeating check procedure.

If you see the message:

ENGINE OIL LEVEL  
NOT WHEN ENGINE ON!

- ▶ Turn off the engine.
- ▶ If the engine is at normal operating temperature, wait five minutes before checking oil.
- ▶ If the engine is not yet at normal operating temperature, you must wait 30 minutes before checking oil.

If there is excess engine oil with the engine at normal operating temperature, the following message will appear:

ENGINE OIL LEVEL  
REDUCE OIL LEVEL

- ▶ Have excess oil siphoned or drained off. Contact your authorized Mercedes-Benz Center.



Excess oil must be siphoned or drained off. It could cause damage to the engine and catalytic converter not covered by the Mercedes-Benz Limited Warranty.

For more information on messages in the display concerning engine oil, see “Practical hints” (▷ page 275).

### Adding engine oil



Only use approved engine oils. For a listing of approved engine oils, refer to the Factory Approved Service Products pamphlet in your vehicle literature portfolio.

In addition, check the oil filler cap for important information pertaining to the engine oil needing to meet a specific Mercedes-Benz specification (e.g. MB 229.5). If such information is printed on the oil filler cap, only use an engine oil from the list of approved engine oils in the Factory Approved Service Products pamphlet that meets the specification indicated on the oil filler cap. Using engine oils of other specification may cause the FSS to incorrectly determine the next service interval and will result in engine damage not covered by the Mercedes-Benz Limited Warranty.

## Operation

### Engine compartment

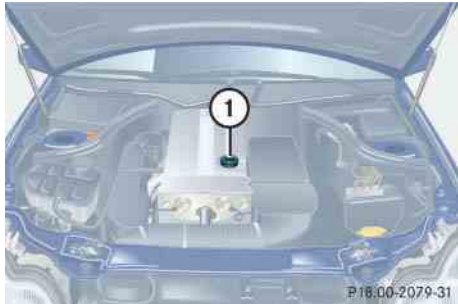

#### C 230 Kompressor

① Oil filler cap

- ▶ Unscrew oil filler cap ① from filler neck.
- ▶ Add engine oil as required. Be careful not to overfill with oil.

Be careful not to spill any oil when adding. Avoid environmental damage caused by oil entering the ground or water.



Excess oil must be siphoned or drained off. It could cause damage to the engine and catalytic converter not covered by the Mercedes-Benz Limited Warranty.

- ▶ Screw oil filler cap ① back on filler neck.



#### C 320

① Oil filler cap

- ▶ Unscrew oil filler cap ① from filler neck.

- ▶ Add engine oil as required. Be careful not to overfill with oil.

Be careful not to spill any oil when adding. Avoid environmental damage caused by oil entering the ground or water.



Excess oil must be siphoned or drained off. It could cause damage to the engine and catalytic converter not covered by the Mercedes-Benz Limited Warranty.

- ▶ Screw oil filler cap ① back on filler neck.

For more information on engine oil, see “Technical data” section (▷ page 330).



### Transmission fluid level

The transmission fluid level does not need to be checked. If you notice transmission fluid loss or gear shifting malfunctions, have an authorized Mercedes-Benz Center check the transmission.

### Coolant level

The engine coolant is a mixture of water and anticorrosion/antifreeze. To check the coolant level, the vehicle must be parked on level ground and the engine must be cool.

The coolant expansion tank is located on the passenger side of the engine compartment.

For more information on coolant, see "Coolants" (> page 336).

### Warning!



In order to avoid any possibly serious burns:

- Use extreme caution when opening the hood if there are any signs of steam or coolant leaking from the cooling system, or if the coolant temperature display indicates that the coolant is overheated.
- Do not remove pressure cap on coolant reservoir if engine temperature is above 194°F (90°C). Allow engine to cool down before removing cap. The coolant reservoir contains hot fluid and is under pressure.
- Using a rag, slowly open the cap approximately ½ turn to relieve excess pressure. If opened immediately, scalding hot fluid and steam will be blown out under pressure.
- Do not spill antifreeze on hot engine parts. Antifreeze contains ethylene glycol which may ignite and burn if it comes into contact with hot engine parts.

## Operation

### Engine compartment



#### ① Coolant expansion tank

- ▶ Using a rag, turn the cap slowly approximately one half turn to the left to release any excess pressure.
- ▶ Continue turning the cap to the left and remove it.

The coolant level is correct if the level

- for cold coolant: reaches the black top part of the reservoir
  - for warm coolant: is approx. 0.6 in (1.5 cm) higher
- ▶ Add coolant as required.
  - ▶ Replace and tighten cap.

## Operation

### Engine compartment

#### Battery

Your vehicle's battery is located in the engine compartment on the right hand side.

The battery should always be sufficiently charged in order to achieve its rated service life. Refer to Service Booklet for battery maintenance intervals.

If you use your vehicle mostly for short-distance trips, you will need to have the battery charge checked more frequently.

When replacing the battery, always use batteries approved by Mercedes-Benz.

If you do not intend to operate your vehicle for an extended period of time, consult an authorized Mercedes-Benz Center about steps you need to observe.



Observe all safety instructions and precautions when handling automotive batteries.



Risk of explosion.



Keep flames or sparks away from battery. Do not smoke.



Battery acid is caustic. Do not allow it to come into contact with skin, eyes or clothing.

In case it does, immediately flush affected area with clear water and seek medical help if necessary.



Wear eye protection.



Keep children away.



Follow the instructions in this Operator's Manual.

Batteries contain materials that can harm the environment if disposed of improperly. Recycling of batteries is the preferred method of disposal. Many states require sellers of batteries to accept old batteries for recycling.

### Windshield washer system and headlamp cleaning system

Fluid for the windshield washer system and the headlamp cleaning system is supplied from the windshield washer reservoir. It has a capacity of

- Vehicles without headlamp cleaning system: approx. 3.2 US qt. (3 l).
- Vehicles with headlamp cleaning system: approx. 6.4 US qt. (6 l).

During all seasons, add MB Windshield Washer Concentrate "S" to water. Premix the windshield washer fluid in a suitable container.

- ▶ Refill the reservoir with MB Windshield Washer Concentrate and water (or commercially available premixed windshield washer solvent / antifreeze, depending on ambient temperatures).

Always use washer solvent / antifreeze where temperatures may fall below freezing point. Failure to do so could result in damage to the washer system / reservoir.

#### Warning!



Washer solvent / antifreeze is highly flammable. Do not spill washer solvent / antifreeze on hot engine parts, because it may ignite and burn. You could be seriously burned.

For more information see "Windshield washer system and headlamp cleaning system" (▷ page 338).

## Operation

### Engine compartment

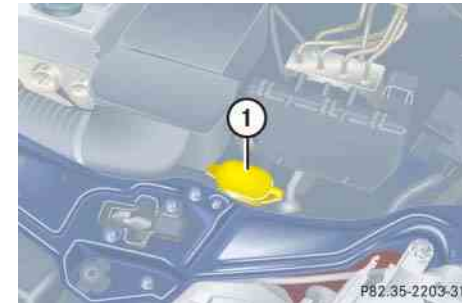

① Washer fluid reservoir



Only use washer fluid which is suitable for plastic lenses. Improper washer fluid can damage the plastic lenses of the headlamps.

## Operation

### Tires and wheels

#### ▼ Tires and wheels

See your authorized Mercedes-Benz Center for information on tested and recommended rims and tires for summer and winter operation. They can also offer advice concerning tire service and purchase

#### Warning!



Replace rims or tires with the same designation, manufacturer and type as shown on the original part. See your authorized Mercedes-Benz Center for further information. If incorrectly sized rims and tires are mounted:

- The wheel brakes or suspension components can be damaged.
- The correct operating clearance of the wheels and the tires are no longer guaranteed.

#### Warning!



Worn, old tires can cause accidents. If the tire tread is badly worn, or if the tires have sustained damage, replace them.

When replacing rims, use only genuine Mercedes-Benz wheel bolts specified for the particular rim type. Failure to do so can result in the bolts loosening and possibly an accident.

Retreaded tires are not tested or recommended by Mercedes-Benz, since previous damage cannot always be recognized on retreads. Mercedes-Benz can therefore not assure the operating safety of the vehicle when such tires are used.

See your authorized Mercedes-Benz Center for information on tested and recommended rims and tires for summer and winter operation.

#### Important guidelines

- Use only sets of tires and rims of the same type and make.
- Tires must be of the correct size for the rim.
- Break in new tires for approximately 60 miles (100 km) at moderate speeds.
- Regularly check the tires and rims for damage. Dented or bent rims can cause tire pressure loss and damage to the tire beads
- If vehicle is heavily loaded, check tire pressure and correct as required.
- Do not allow your tires to wear down too far. Adhesion properties on wet roads are sharply reduced at tread depths under  $\frac{1}{8}$  in (3 mm).
- When replacing individual tires, you should mount new tires on the front wheels first (on vehicles with same-sized wheels all around).

### Life of tire

The service life of a tire is dependent upon varying factors including but not limited to:

- Driving style
- Tire pressure
- Distance driven

#### Warning!



Tires and spare tire should be replaced after six years, regardless of the remaining tread.



Keep unmounted tires in a cool, dry place with as little exposure to light as possible. Protect tires from contact with oil, grease and gasoline.

### Direction of rotation

Unidirectional tires offer added advantages, such as better aquaplaning performance. To benefit, however, you must ensure that the tires rotate in the direction specified.

An arrow on the sidewall indicates the intended direction of tire rotation.

### Checking tire inflation pressure

#### Warning!



If the tire pressure drops repeatedly:

- Check the tires for punctures from foreign objects.
- Check to see whether air is leaking from the valves or from around the rim.

Correct the tire pressure only when tires are cold.

Regularly check your tire pressure at intervals of no more than 14 days.

If the tires are warm you should only correct the tire pressure if it is too low for current operating conditions.

A table on the fuel filler flap lists the specified tire inflation pressures for warm and cold tires as well as for various operating conditions.



The pressures listed for light loads are minimum values offering high driving comfort.

Increased inflation pressures listed for heavier loads may also be used for light loads. These higher pressures produce favorable handling characteristics. The ride of the vehicle, however, will be somewhat harder. Never exceed the max. values or inflate tires below the min. values listed in the fuel filler flap.

## Operation

### Tires and wheels

Tire pressure changes by approximately 1.5 psi (0.1 bar) per 18°F (10°C) of air temperature change. Keep this in mind when checking tire pressure where the temperature is different from the outside temperature.

Tire temperature and tire pressure are also increased while driving, depending on the driving speed and the tire load.

#### Warning!



Follow recommended inflation pressures.

Do not overinflate tires. Overinflating tires can result in sudden deflation (blowout) because they are more likely to become punctured or damaged by road debris, potholes, etc.

Do not underinflate tires. Underinflated tires wear unevenly, adversely affect handling and fuel economy, and are more likely to fail from being overheated.

Do not overload the tires by exceeding the specified vehicle capacity weight (as indicated by the label on the pillar in the driver's door opening). Overloading the tires can overheat them, possibly causing a blowout.

Check the spare tire periodically for condition and inflation. Spare tires will age and become worn over time even if never used, and thus should be inspected and replaced when necessary.

#### Rotating wheels

#### Warning!



Rotate front and rear wheels only if they are of the same size.

On vehicles with the same wheel size all around, wheels can be rotated every 3000 to 6000 miles (5000 to 10000 km), or

sooner if necessary, according to the degree of tire wear. The same direction of tire rotation must be retained.

Rotate the wheels before the characteristic tire wear pattern becomes visible (shoulder wear on front wheels and tread center wear on rear wheels).

Thoroughly clean the inner side of the wheels after each rotation. Check and ensure proper tire inflation pressure.

#### Warning!



Have the tightening torque checked after changing a wheel. Wheels could become loose if not tightened with a torque of 80 lb-ft (110 Nm).

Use only genuine Mercedes-Benz wheel bolts specified for your vehicle's rims.

## ▼ Winter driving

Before the onset of winter, have your vehicle winterized at an authorized Mercedes-Benz Center. This service includes:

- Check of anticorrosion and antifreeze concentration.
- Addition of cleaning concentrate to the water of the windshield and headlamp cleaning system. Add MB Concentrate "S" to a premixed windshield washer solvent / antifreeze which is formulated for temperatures below freezing point (▷ page 338).
- Battery test. Battery capacity drops with decreasing ambient temperature. A well charged battery helps to ensure that the engine can be started, even at low ambient temperatures.
- Tire change. Mercedes-Benz recommends M+S rated radial-ply tires with a minimum tread depth of approximately  $\frac{1}{6}$  in (4 mm) on all four wheels for the winter season.

### Winter tires

Always use winter tires at temperatures below 45°F (7°C) and whenever wintry road conditions prevail. Use of winter tires is the only way to achieve the maximum effectiveness of the ABS and ESP in winter operation.

For safe handling, ensure that all mounted winter tires are of the same make and have the same tread design.

## Operation

### Winter driving

#### Warning!



Winter tires with a tread depth under  $\frac{1}{6}$  in (4 mm) must be replaced. They are no longer suitable for winter operation.

Always observe the speed rating of the winter tires installed on your vehicle. If the maximum speed for which your tires are rated is below the speed rating of your vehicle, you must place a notice to this effect where it will be seen by the driver. Such notices are available at your tire dealer or any authorized Mercedes-Benz Center.

## Operation

### Winter driving

#### Warning!



If you use your spare tire when winter tires are fitted on the other wheels, be aware that the difference in tire characteristics may very well impair turning stability and that overall driving stability may be reduced. Adapt your driving style accordingly.

Have the spare tire replaced with a winter tire at the nearest authorized Mercedes-Benz Center.

#### Block heater (Canada only)

The engine is equipped with a block heater.

The electrical cable may be installed at your authorized Mercedes-Benz Center.

#### Snow chains

Snow chains should only be driven on snow-covered roads at speeds not to exceed 30 mph (50 km/h). Remove chains as soon as possible when driving on roads without snow.



When driving with snow chains, you may wish to deactivate the ESP (▷ page 75) before setting the vehicle in motion. This will improve the vehicle's traction.

Please observe the following guidelines when using snow chains:

- Use of snow chains is not permissible with all wheel/tire combinations.
- Snow chains should only be used on the rear wheels. Follow the manufacturer's mounting instructions.
- Only use snow chains that are approved by Mercedes-Benz. Your authorized Mercedes-Benz Center will be glad to advise you on this subject.
- Use of snow chains may be prohibited depending on location. Always check local and state laws before installing snow chains.



Use of snow chains is not permissible with tire sizes:

- 225/45 R17



### ▼ Maintenance

We strongly recommend that you have your vehicle serviced by your authorized Mercedes-Benz Center, in accordance with the Service Booklet at the times called for by the FSS (Flexible Service System).



Failure to have the vehicle maintained in accordance with the Service Booklet at the designated times/mileage called for by the FSS may result in vehicle damage not covered by the Mercedes-Benz Limited Warranty.

FSS will notify you when your next service is due.

Approximately one month before your next service is due, one of the following messages will appear in the multifunction display while you are driving or when you switch on the ignition (example service A):

SERVICE A - IN xx DAYS  
 SERVICE A - IN xx MILES (KM)  
 SERVICE A - DUE NOW

The type of service due is indicated in the multifunction display field:

-  Minor service (A)
-  Major service (B)



The interval between services depends on your driving habits. A gentle driving style, moderate engine speeds and the avoidance of short-distance trips will lengthen the interval between services.

### Clearing the service indicator

The service indicator is automatically cleared

- after ten seconds when you switch on the ignition or when reaching the service threshold while driving.
- after 30 seconds, once the suggested service term had passed.

You can also clear it yourself:

- ▶ Press the reset button on the instrument cluster (▷ page 22).

### Service term exceeded

If you have exceeded the suggested service term, you will see the following message in the multifunction display:

SERVICE A EXCEEDED BY XX DAYS  
 SERVICE A EXCEEDED BY XX MI (KM)

An acoustic signal will also sound.

## Operation



### Maintenance

The Mercedes-Benz Center will reset the service indicator following a completed service.

#### Calling up the service indicator

- ▶ Switch ignition on.

The standard display of the control system appears (▷ page 109).

- ▶ Press button  or  on the multifunction steering wheel until the FSS indicator appears in the multifunction display.



If the battery is disconnected, the days of disconnection will not be included in the count shown by the service indicator. To arrive at the true service deadline, you will need to subtract these days from the days shown in the service indicator.



Do not confuse the service indicator with the engine oil level indicator .

#### Resetting the service indicator

In the event that the service on your vehicle is not carried out by an authorized Mercedes-Benz Center, you can reset the service indicator yourself.

- ▶ Switch on ignition.

The standard display of the control system appears (▷ page 109).

- ▶ Press button  or  on the multifunction steering wheel until the FSS indicator appears in the multifunction display.

- ▶ Press the reset button for about four seconds.

This message appears in the multifunction display:

SERVICE INTERVAL? RESET WITH R  
BUTTON FOR 3 SEC.

- ▶ To confirm, hold down the reset button for about four seconds.

The service indicator now displays the reset interval.



If the service indicator was inadvertently reset, have a Mercedes-Benz Center correct it.

Only reset if the proper service has been performed. Resetting the system without performing the proper service as called for by the FSS will cause the FSS to incorrectly determine the next service interval which will result in engine damage not covered by the Mercedes-Benz Limited Warranty.

## ▼ Vehicle care

### Cleaning and care of the vehicle

#### Warning!



Many cleaning products can be hazardous. Some are poisonous, others are flammable. Always follow the instructions on the particular container. Always open your vehicle's doors or windows when cleaning the inside. Never use fluids or solvents that are not designed for cleaning your vehicle.

While in operation, even while parked, your vehicle is subjected to varying external influences which, if gone unchecked, can attack the paintwork as well as the underbody and cause lasting damage.

Such damage is caused not only by extreme and varying climatic conditions, but also by:

- Air pollution
- Road salt
- Tar
- Gravel and stone chipping

To avoid paint damage, you should immediately remove:

- Grease and oil
- Fuel
- Coolant
- Brake fluid
- Bird droppings
- Insects
- Tree resins, etc.

Frequent washing reduces and/or eliminates the aggressiveness and potency of the above adverse influences.

More frequent washings are necessary to deal with unfavorable conditions:

- near the ocean
- in industrial areas (smoke, exhaust emissions)
- during winter operation

You should check your vehicle from time to time for stone chipping or other damage. Any damage should be repaired as soon as possible to prevent corrosion.

In doing so, do not neglect the underbody of the vehicle. A prerequisite for a thorough check is a washing of the underbody followed by a thorough inspection. Damaged areas need to be re-undercoated.

Your vehicle has been treated at the factory with a wax-base rustproofing in the body cavities which will last for the lifetime of the vehicle. Post-production treatment is neither necessary nor recommended by Mercedes-Benz because of the possibility of incompatibility between materials used in the production process and others applied later.

## Operation

### Vehicle care

We have selected car-care products and compiled recommendations which are specially matched to our vehicles and which always reflect the latest technology. You can obtain Mercedes-Benz approved car-care products at your authorized Mercedes-Benz Center.

Scratches, corrosive deposits, corrosion or damage due to negligent or incorrect care cannot always be removed or repaired with the car-care products recommended here. In such cases it is best to seek aid at your authorized Mercedes-Benz Center.

The following topics deal with the cleaning and care of your vehicle and give important “how-to” information as well as references to Mercedes-Benz approved car-care products.

Additional information can be found in the booklet “Vehicle Care Guide”.

#### Power washer

When using a power washer for cleaning the vehicle, always observe the manufacturer’s operating instructions.



Never use a round nozzle to power-wash tires. The intense jet of water can result in damage to the tire.

Always replace a damaged tire.

Always keep the jet of water moving across the surface. Do not aim directly at electrical parts, electrical connectors, seals, or other rubber parts.

#### Tar stains

Quickly remove tar stains before they dry and become more difficult to remove. A tar remover is recommended.

#### Paintwork, painted body components

Mercedes-Benz approved Paint Care should be applied when water drops on the paint surface do not “bead up”, normally every three to five months, depending on climate and washing detergent used.

Mercedes-Benz approved Paint Cleaner should be applied if the paint surface shows signs of embedded dirt (i.e. loss of gloss).

Do not apply any of these products or wax if your vehicle is parked in the sun or if the hood is still hot.

Use the appropriate MB-Touch-Up Stick for quick and provisional repairs of minor paint damage (i.e. chips from stones, vehicle doors, etc.).

**Engine cleaning**

Prior to cleaning the engine compartment make sure to protect electrical components and connectors from the intrusion of water and cleaning agents.

Corrosion protection, such as MB Anticorrosion Wax, should be applied to the engine compartment after every engine cleaning. Before applying, all control linkage bushings and joints should be lubricated. The poly-V-belt and all pulleys should be protected from any wax.

**Vehicle washing**

Do not use hot water or wash your vehicle in direct sunlight. Use only a mild car wash detergent, such as Mercedes-Benz approved Car Shampoo.

Thoroughly spray the vehicle with a diffused jet of water. Direct only a very weak spray towards the ventilation intake. Use plenty of water and rinse the sponge and chamois frequently.

Rinse with clear water and thoroughly dry with a chamois. Do not allow cleaning agents to dry on the finish.

Due to the width of the vehicle, fold in exterior rear view mirrors prior to running the vehicle through an automatic car wash to prevent damage to the mirrors.

In the winter, thoroughly remove all traces of road salt as soon as possible.

When washing the underbody, do not forget to clean the inner sides of the wheels.

**Ornamental moldings**

For regular cleaning and care of very dirty chrome-plated parts, use a chrome cleaner.

**Headlamps, tail lamps, side markers, turn signal lenses**

Use a mild car wash detergent, such as Mercedes-Benz approved Car Shampoo, with plenty of water.

To prevent scratches, never apply strong force and use only a soft, non-scratchy cloth when cleaning the lenses. Do not attempt to wipe dirty lenses with a dry cloth or sponge.

## Operation

### Vehicle care

#### Wiper blades

- ▶ Fold wiper arms forward.

#### Warning!



For safety reasons, switch off wipers and remove SmartKey from starter switch before cleaning the wiper blades, otherwise the wiper motor might suddenly turn on and cause injury.

- ▶ Clean the wiper blade inserts with a clean cloth and detergent solution.



Fold the windshield wiper arms back onto the windshield before turning the SmartKey in the starter switch.

Hold on to the wiper when folding the wiper arm back. If released, the force of the impact from the tensioning spring could crack the windshield.

#### Window cleaning

- ▶ Fold wiper arms forward.

#### Warning!



For safety reasons, switch off wipers and remove SmartKey from starter switch before cleaning the wiper blades, otherwise the wiper motor might suddenly turn on and cause injury.

- ▶ Use a window cleaning solution on all glass surfaces.



Fold the windshield wiper arms back onto the windshield before turning the SmartKey in the starter switch.

Hold onto the wiper when folding the wiper arm back. If released, the force of the impact from the tensioning spring could crack the windshield.

#### Light alloy wheels

Mercedes-Benz approved Wheel Care should be used for regular cleaning of the light alloy wheels.

If possible, clean wheels once a week with Mercedes-Benz approved Wheel Care, using a soft bristle brush and a strong spray of water.

Follow the instructions on container.



Only use acid-free cleaning materials. Acid may cause corrosion or damage the clear coat.

**Instrument cluster**

Use a gentle dishwashing detergent or mild detergent for delicate fabrics as a washing solution. Wipe with a cloth moistened in lukewarm solution. Do not use scouring agents.

**Steering wheel and gear selector lever**

Wipe with a damp cloth and dry thoroughly or clean with Mercedes-Benz approved Leather Care.

**Cup holder**

Use a gentle dishwashing detergent or mild detergent for delicate fabrics as a washing solution. Wipe with a cloth moistened in lukewarm solution. Do not use scouring agents.

**Hard plastic trim items**

Pour Mercedes-Benz approved Interior Care onto soft lint-free cloth and apply with light pressure.

**Headliner and rear window shelf**

Clean with soft bristle brush, or use a dry-shampoo cleaner in case of excessive dirt.

**Seat belts**

The webbing must not be treated with chemical cleaning agents. Use only clear, lukewarm water and soap. Do not dry the webbing at temperatures above 176°F (80°C) or in direct sunlight.

**Warning!**

Do not bleach or dye seat belts as this may severely weaken them. In a crash they may not be able to provide adequate protection.

## Operation

### Vehicle care

#### Upholstery

Using aftermarket seat covers or wearing clothing that have the tendency to give off coloring (e.g. when wet, etc.) may cause the upholstery to become permanently discolored. By lining the seats with a proper intermediate cover, contact-discoloration will be prevented.

#### *Leather upholstery*

Wipe leather upholstery with a damp cloth and dry thoroughly or clean with Mercedes-Benz approved Leather Care. Exercise particular care when cleaning perforated leather as its underside should not become wet.

#### *MB Tex upholstery*

Pour Mercedes-Benz approved Interior Care onto soft lint-free cloth and apply with light pressure.

#### Plastic and rubber parts

Do not use oil or wax on these parts.

#### Wood trims

Dampen cloth using water and use damp cloth to clean wood trims in your vehicle. Do not use solvents like tar remover or wheel cleaner nor polishes or waxes as these may be abrasive.



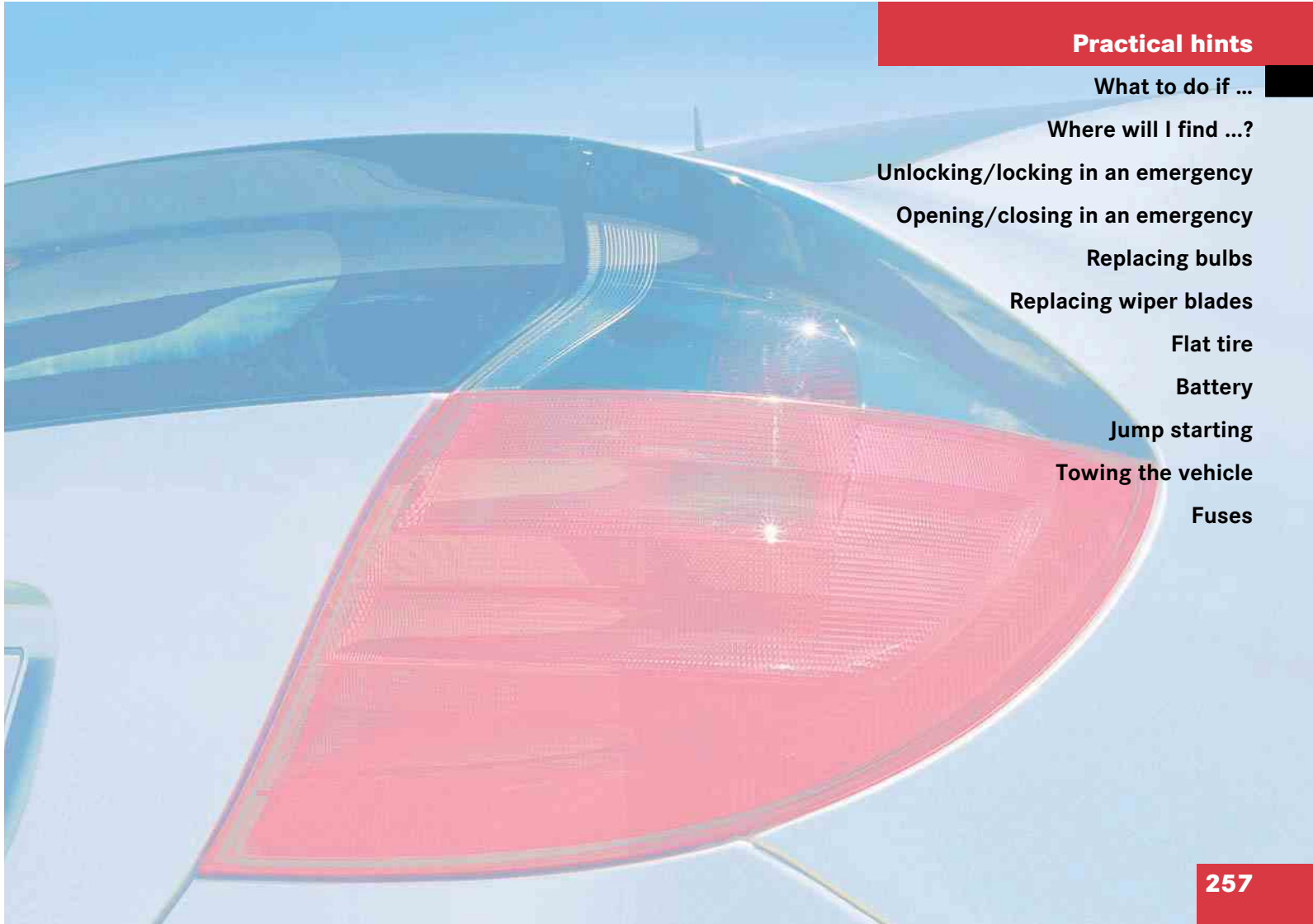

## **Practical hints**

**What to do if ...**

**Where will I find ...?**

**Unlocking/locking in an emergency**

**Opening/closing in an emergency**

**Replacing bulbs**

**Replacing wiper blades**

**Flat tire**

**Battery**

**Jump starting**

**Towing the vehicle**

**Fuses**

## Practical hints

### What to do if ...

#### ▼ What to do if ...

#### Lamps in instrument cluster

General information:



If a bulb in the instrument cluster fails to come on during the bulb self-check when

turning the SmartKey in the starter switch to position **2**, have it checked and replaced if necessary.

Problem	Possible cause	Suggested solution
 The yellow ABS malfunction indicator lamp comes on while driving.	<p>The ABS has detected a malfunction and has switched off. The BAS and the ESP are also switched off (see messages in display).</p> <p>The brake system is still functioning normally but without the ABS available.</p>	<ul style="list-style-type: none"><li>▶ Continue driving with added caution. Wheels may lock during hard braking, reducing steering capability.</li><li>▶ Have the system checked at an authorized Mercedes-Benz Center as soon as possible.</li></ul> <p>Failure to follow these instructions increases the risk of an accident.</p> <ul style="list-style-type: none"><li>▶ Read and observe messages in the display (▷ page 264).</li></ul>
	<p>The charging voltage has fallen below ten volts. The ABS has switched off.</p>	<ul style="list-style-type: none"><li>▶ When the voltage is above this value again, the ABS is operational again.</li><li>▶ If necessary, have the generator (alternator) and battery checked.</li></ul>

## Practical hints

### What to do if ...

Problem		Possible cause	Suggested solution
 (Canada only)	The red brake warning lamp comes on while driving and you hear a warning sound.	You are driving with the parking brake set.	► Release the parking brake (▷ page 46).
 (USA only)	The red brake warning lamp comes on while driving.	There is insufficient brake fluid in the reservoir.	► Risk of accident! Carefully stop the vehicle and notify an authorized Mercedes-Benz Center. Do not add brake fluid! This will not solve the problem.

### Warning!



Driving with the brake warning lamp illuminated can result in an accident. Have your brake system checked immediately if the brake warning lamp stays on. Don't add brake fluid before checking the brake system. Overfilling the brake fluid reservoir can result in spilling brake fluid on hot engine parts and the brake fluid catching fire. You can be seriously burned.



If you find that the brake fluid in the brake fluid reservoir has fallen to the minimum mark or below, have the brake system checked for brake pad thickness and leaks.

## Practical hints

### What to do if ...

Problem	Possible cause	Suggested solution
<b>CHECK ENGINE</b> The yellow "CHECK ENGINE" malfunction indicator lamp comes on while driving.	There is a malfunction in: <ul style="list-style-type: none"> <li>• The fuel management system</li> <li>• The ignition system</li> <li>• The emission control system</li> <li>• Systems which affect emissions</li> </ul> Such malfunctions may result in excessive emissions values and may switch the engine to its limp-home (emergency operation) mode.	► Have the vehicle checked as soon as possible by an authorized Mercedes-Benz Center. An on-board diagnostic connector is used by the service station to link the vehicle to the shop diagnostics system. It allows the accurate identification of system malfunctions through the readout of diagnostic trouble codes. It is located in the front left area of the footwell next to the parking brake pedal.
	The fuel cap is not closed tight.	► Check the fuel cap.
	Your gas tank is empty.	► After refuelling start the engine three or four times in succession.  The limp-home mode is canceled. You do not need to have your vehicle checked.

## Practical hints

### What to do if ...

Problem	Possible cause	Suggested solution
 The yellow ESP warning lamp comes on while driving.	The ESP is deactivated. Risk of accident! Adapt your speed and driving to the prevailing road and weather conditions.	▶ Switch the ESP back on (▷ page 77). If the ESP cannot be switched back on, have the system checked at an authorized Mercedes-Benz Center as soon as possible.
The yellow ESP warning lamp flashes while driving.	The ESP or traction control has come into operation because of detected traction loss in at least one tire.	▶ When driving off, apply as little throttle as possible. ▶ While driving, ease up on the accelerator. ▶ Adapt your speed and driving to the prevailing road and weather conditions. ▶ Do not deactivate the ESP. Exceptions: (▷ page 75). Failure to follow these instructions increases the risk of an accident.

## Practical hints

### What to do if ...

Problem	Possible cause	Suggested solution
The yellow fuel tank reserve warning lamp comes on while driving.	The fuel level has gone below the reserve mark.	▶ Refuel at the next gas station (▷ page 233).
 The red seat belt non-usage warning lamp illuminates for a brief period after starting the engine.	The warning lamp reminds you to fasten seat belts.	▶ Fasten your seat belt.
<b>SRS</b> The red SRS indicator lamp comes on while driving.	There is a malfunction in the restraint systems. The airbags or emergency tensioning device (ETDs) could deploy unexpectedly or fail to activate in an accident.	▶ Drive with added caution to the nearest authorized Mercedes-Benz Center.

### Warning!



In the event a malfunction of the SRS is indicated as outlined above, the SRS may not be operational. For your safety, we strongly recommend that you visit an authorized Mercedes-Benz Center immediately to have the system checked; otherwise the SRS may

not be activated when needed in an accident, which could result in serious or fatal injury, or it might deploy unexpectedly and unnecessarily which could result in an accident and/or injury to you or to others.

**Lamp in center console**

<b>Problem</b>	<b>Possible cause</b>	<b>Suggested solution</b>
<p>PASS.AIRBAG OFF The indicator lamp comes on.</p>	<p>A BabySmart™ child seat is installed on the front passenger seat. Therefore the passenger front airbag is switched off.</p>	
	<p>The system is malfunctioning when there is no BabySmart™ child seat installed on the front passenger seat.</p>	<ul style="list-style-type: none"> <li>▶ Have the system checked as soon as possible by an authorized Mercedes-Benz Center.</li> </ul>
<p>The indicator lamp does not come on with a BabySmart™<sup>1</sup> child seat properly installed on the front passenger seat.</p>	<p>The system is malfunctioning.</p>	<ul style="list-style-type: none"> <li>▶ make sure there is nothing between seat cushion and child seat and check installation of the child seat.</li> <li>▶ If the light remains out, have the system checked as soon as possible by an authorized Mercedes-Benz Center.</li> </ul> <p>Do not use the BabySmart™ restraint to transport children on the front passenger seat until the system has been repaired.</p>

<sup>1</sup> BabySmart™ is a trademark of Siemens Automotive Corp.

## Practical hints

### What to do if ...

#### Messages in the display

The control system shows warning and malfunction messages in the multifunction display.

Certain warning and malfunction messages are accompanied by an audible signal.

Address these messages accordingly and follow the additional instructions given in this Operator's Manual.

Selecting the malfunction memory menu in the control system (▷ page 117) displays both cleared and uncleared messages.

High-priority messages appear in the multifunction display in red color.

Certain messages of high priority cannot be cleared from the multifunction display using the reset button.

Other messages of high priority and messages of less immediate priority can be cleared from the multifunction display using the reset button (▷ page 22) and are then stored in the malfunction message memory (▷ page 117).

#### Warning!



All categories of messages contain important information which should be taken note of and, where a malfunction is indicated, addressed as soon as possible at an authorized Mercedes-Benz Center.

Failure to repair condition noted may cause damage not covered by the Mercedes-Benz Limited Warranty, or result in property damage or personal injury.

#### Warning!



No messages will be displayed if either the instrument cluster or the multifunction display is inoperative.

Contact your nearest authorized Mercedes-Benz Center.



Turning the SmartKey in starter switch to position **2**, causes all lamps as well as the multifunction display to come on. Ensure that they are all in working order before starting your journey.

On the pages that follow, you will find a compilation of the most important warning and malfunction messages that may appear in the display. High priority messages appear on a red background.



**Text messages**

Display message		Possible cause	Possible solution
BAS	BRAKE ASSIST NOT AVAILABLE!	The charging voltage has fallen below ten volts. The BAS has switched off.	<ul style="list-style-type: none"> <li>▶ When the voltage is above this value again, the BAS is operational again.</li> <li>▶ If necessary, have the generator and battery checked.</li> </ul>
	BRAKE ASSIST VISIT WORKSHOP!	The BAS has detected a malfunction and switched off. The brake system is still functioning normally but without the BAS available.	<ul style="list-style-type: none"> <li>▶ Continue driving with added caution.</li> <li>▶ Have the system checked at an authorized Mercedes-Benz Center as soon as possible.</li> </ul> <p>Failure to follow these instructions increases the risk of an accident.</p>
	DISPLAY MALFUNCTION VISIT WORKSHOP!	The BAS or the BAS display is malfunctioning.	<ul style="list-style-type: none"> <li>▶ Continue driving with added caution.</li> <li>▶ Have the system checked at an authorized Mercedes-Benz Center as soon as possible.</li> </ul> <p>Failure to follow these instructions increases the risk of an accident.</p>

## Practical hints

### What to do if ...

Display message	Possible cause	Possible solution
ESP ESP NOT AVAILABLE!	The ESP was deactivated because of a malfunction or interrupted power supply. The ABS might not be operational.	<ul style="list-style-type: none"><li>▶ Synchronize the ESP. With vehicle stationary and the engine running, turn the steering wheel completely to the left and then to the right.</li></ul> If the ESP message does not go out: <ul style="list-style-type: none"><li>▶ Continue driving with added caution.</li><li>▶ Visit an authorized Mercedes-Benz Center as soon as possible.</li></ul> Failure to follow these instructions increases the risk of an accident.
	The self-diagnosis has not been completed.	The display will clear after driving a short distance at more than 12 mph (20 km/h).



When synchronizing the ESP, make sure you can turn the steering wheel in both directions as far as it will go without the wheels hitting any objects, e.g. a road curb.

## Practical hints

### What to do if ...

Display message	Possible cause	Possible solution
ESP ESP NOT AVAILABLE!	The charging voltage has fallen below ten volts. The ESP has switched off.	<ul style="list-style-type: none"><li>▶ When the voltage is above this value again, the ESP is operational again.</li><li>▶ If necessary, have the generator and battery checked.</li></ul>
ESP VISIT WORKSHOP!	The ESP is deactivated because of a malfunction.	<ul style="list-style-type: none"><li>▶ Continue driving with added caution.</li><li>▶ Visit an authorized Mercedes-Benz Center as soon as possible.</li></ul> <p>Failure to follow these instructions increases the risk of an accident.</p>
DISPLAY MALFUNCTION VISIT WORKSHOP!	The ESP or the ESP display is malfunctioning.	<ul style="list-style-type: none"><li>▶ Continue driving with added caution.</li><li>▶ Visit an authorized Mercedes-Benz Center as soon as possible.</li></ul> <p>Failure to follow these instructions increases the risk of an accident.</p>

## Practical hints



### What to do if ...

#### Symbol messages

Display symbol	Display message	Possible cause	Possible solution
	ABS SYSTEM VISIT WORKSHOP!	<p>The ABS has detected a malfunction and has switched off. The ESP and the BAS are also deactivated.</p> <p>The brake system is still functioning normally but without the ABS available.</p>	<ul style="list-style-type: none"><li>▶ Continue driving with added caution. Wheels may lock during hard braking, reducing steering capability.</li><li>▶ Have the system checked at an authorized Mercedes-Benz Center as soon as possible.</li></ul> <p>Failure to follow these instructions increases the risk of an accident.</p>
	DISPLAY MALFUNCTION VISIT WORKSHOP!	The ABS or the ABS display is malfunctioning.	<ul style="list-style-type: none"><li>▶ Continue driving with added caution. Wheels may lock during hard braking, reducing steering capability.</li><li>▶ Have the system checked at an authorized Mercedes-Benz Center as soon as possible.</li></ul> <p>Failure to follow these instructions increases the risk of an accident.</p>



## Practical hints

### What to do if ...

Display symbol	Display message	Possible cause	Possible solution
	BATTERY/ALTERNATOR VISIT WORKSHOP!	The battery was charged with a battery charger or jump started.	▶ Have the battery checked at a service station.
		The battery is no longer charging. Possible causes: <ul style="list-style-type: none"> <li>• alternator malfunctioning</li> <li>• broken poly-V-belt</li> </ul>	▶ Stop immediately and check the poly-V-belt.  If it is broken: <ul style="list-style-type: none"> <li>▶ Do not continue to drive. Otherwise the engine will overheat due to an inoperative water pump which may result in damage to the engine. Notify an authorized Mercedes-Benz Center.</li> </ul> If it is intact: <ul style="list-style-type: none"> <li>▶ Drive immediately to the nearest authorized Mercedes-Benz Center.</li> </ul>
	UNDERVOLTAGE ENGINE ON!	The battery has insufficient voltage and can no longer supply the convenience functions such as seat heater*.	▶ Start the engine (▷ page 44).
	UNDERVOLTAGE SWITCH CONSUMERS OFF!	The battery is malfunctioning.	▶ Have the battery checked at a service station.
 (Canada only)  (USA only)	PARK. BRAKE RELEASE BRAKE!	You are driving with the parking brake set.	▶ Release the parking brake (▷ page 46).

## Practical hints

### What to do if ...

Display symbol	Display message	Possible cause	Possible solution
	BRAKE WEAR VISIT WORKSHOP!	The brake pads have reached their wear limit.	▶ Have the brake pads replaced as soon as possible.
	BRAKE FLUID VISIT WORKSHOP!	There is insufficient brake fluid in the reservoir.	▶ Risk of accident! Stop the vehicle and notify an authorized Mercedes-Benz Center. Do not add brake fluid! This will not solve the problem.

#### Warning!



Driving with this message displayed can result in an accident. Have your brake system checked immediately. Do not add brake fluid before checking the brake system. Overfilling the brake fluid reservoir can result in spilling brake fluid on hot engine parts and the brake fluid catching fire. You can be seriously burned.



If you find that the brake fluid in the brake fluid reservoir has fallen to the minimum mark or below, have the brake system checked for brake pad thickness and leaks.



Brake pad thickness must be visually checked by a qualified technician at the intervals specified in the Service booklet.

## Practical hints

### What to do if ...

Display symbol	Display message	Possible cause	Possible solution
	COOLANT CHECK LEVEL!	The coolant level is too low.	<ul style="list-style-type: none"><li>▶ Add coolant (▷ page 241).</li><li>▶ If you have to add coolant frequently, have the cooling system checked by an authorized Mercedes-Benz Center.</li></ul>

### Warning!



Do not spill antifreeze on hot engine parts. Antifreeze contains ethylene glycol which may ignite and burn if it comes into contact with hot engine parts. You can be seriously burned.



Do not ignore the low engine coolant level warning. Extended driving with the message and symbol displayed may cause serious engine damage not covered by the Mercedes-Benz Limited Warranty.

Do not drive without sufficient amount of coolant in the cooling system. The engine will overheat causing major engine damage.

## Practical hints

### What to do if ...

Display symbol	Display message	Possible cause	Possible solution
	COOLANT STOP, ENGINE OFF!	The coolant is too hot.	<ul style="list-style-type: none"><li>▶ Stop the vehicle and turn off the engine.</li><li>▶ Only start the engine again after the message disappears. You could otherwise damage the engine.</li></ul>

#### Warning!



Driving when your engine is badly overheated can cause some fluids which may have leaked into the engine compartment to catch fire. You could be seriously burned.

Steam from an overheated engine can cause serious burns and can occur just by opening the engine hood. Stay away from the engine if you see or hear steam coming from it.

Turn off the engine, get out of the vehicle and do not stand near the vehicle until it cools down.

During severe operating conditions and stop-and-go city traffic, the coolant temperature may rise close to 248°F (120°C).



The engine should not be operated with the coolant temperature above 248°F (120°C). Doing so may cause serious engine damage which is not covered by the Mercedes-Benz Limited Warranty.







## Practical hints

### What to do if ...

Display symbol	Display message	Possible cause	Possible solution
	COOLANT STOP, ENGINE OFF!	The poly-V-belt could be broken.	<ul style="list-style-type: none"><li>▶ Stop immediately and check the poly-V-belt.</li></ul> If it is broken: <ul style="list-style-type: none"><li>▶ Do not continue to drive. Otherwise the engine will overheat due to an inoperative water pump which may result in damage to the engine. Notify an authorized Mercedes-Benz Center.</li></ul> If it is intact: <ul style="list-style-type: none"><li>▶ Do not continue to drive the vehicle with this message displayed. Doing so could result in serious engine damage that is not covered by the Mercedes-Benz Limited Warranty.</li></ul>
	COOLANT VISIT WORKSHOP!	The cooling fan for the coolant is malfunctioning.	<ul style="list-style-type: none"><li>▶ Observe the coolant temperature display.</li><li>▶ Have the fan replaced as soon as possible.</li></ul>

## Practical hints

### What to do if ...

Display symbol	Display message	Possible cause	Possible solution
	CRUISE CONTROL DRIVE TO WORKSHOP!	Cruise control is malfunctioning.	▶ Visit an authorized Mercedes-Benz Center.
	VISIT WORKSHOP! DISPLAY MALFUNCTION	The instrument cluster display is malfunctioning.  The displays for several systems have malfunctioned. Some systems themselves may also have malfunctioned.	▶ Continue driving with added caution. ▶ Visit an authorized Mercedes-Benz Center as soon as possible. ▶ Have the electronic systems checked by an authorized Mercedes-Benz Center.
	VISIT WORKSHOP! DISPLAY MALFUNCTION	Certain electronic systems are unable to relay information to the control system. The following systems may have failed: <ul style="list-style-type: none"> <li>• Coolant temperature display</li> <li>• Tachometer</li> <li>• Cruise control display</li> </ul>	▶ Have the electronic systems checked by an authorized Mercedes-Benz Center (▷ page 260).
	DOOR OPEN!	You are attempting to drive with one or more doors open.	▶ Close the doors.

## Practical hints

### What to do if ...

Display symbol	Display message	Possible cause	Possible solution
	USA only: ADD 1.0 Qt. ENGINE OIL WHEN NEXT REFUELING!  Canada only: ADD 1.0 LITER ENG. OIL WHEN NEXT REFUELING!	The engine oil level is too low.	▶ Add engine oil (▷ page 239) and check the engine oil level (▷ page 238).
	ENGINE OIL LEVEL STOP, ENGINE OFF!	There is no oil in the engine. There is a danger of engine damage.	▶ Carefully bring the vehicle to a halt as soon as possible. ▶ Turn off the engine. ▶ Add engine oil.
	ENGINE OIL LEVEL REDUCE OIL LEVEL!	You have added too much engine oil. There is a risk of damaging the engine or the catalytic converter.	▶ Have excess oil siphoned or drained off. Observe all legal requirements with respect to its disposal.

## Practical hints

### What to do if ...

Display symbol	Display message	Possible cause	Possible solution
	ENGINE OIL VISIT WORKSHOP!	It may be that there is water in the engine oil.	▶ Have the engine oil checked.
	ENGINE OIL LEVEL VISIT WORKSHOP!	The engine oil has dropped to a critical level.	▶ Check the engine oil level (▷ page 238) and add oil as required. ▶ If you must add engine oil frequently, have the engine checked for possible leaks.
	ENGINE OIL SENSOR VISIT WORKSHOP!	The measuring system is malfunctioning.	▶ Have the measuring system checked by an authorized Mercedes-Benz Center.

When the message ADD 1.0 Qt. ENGINE OIL WHEN NEXT REFUELING! (Canada: 1.0 Liter) appears while the engine is running and at operating temperature, the engine oil level has dropped to approximately the minimum mark on the dipstick.

When this occurs, the warning will first come on intermittently and then stay on if the oil level drops further.





Visually check for oil leaks. If no obvious oil leaks are noted, drive to the nearest service station where the engine oil should be topped to the “full” mark on the dipstick with an approved oil.



The engine oil level warnings should not be ignored. Extended driving with the symbol displayed could result in serious engine damage that is not covered by the Mercedes-Benz Limited Warranty.

## Practical hints

### What to do if ...

Display symbol	Display message	Possible cause	Possible solution
	RESERVE FUEL GO TO GAS STATION!	The fuel level has dropped below the reserve mark.	▶ Refuel at the next gas station (▷ page 233).
	CHECK GAS CAP! SEE OPERATOR'S MANUAL	The fuel cap is not closed tightly.	▶ Check the fuel cap.
	<b>HOOD OPEN!</b>	You are driving with the hood open.	▶ Close the hood (▷ page 236).
	REMOVE KEY!	You have forgotten to remove the SmartKey.	▶ Remove the SmartKey from the starter switch.
	REPLACE KEY! DRIVE TO WORKSHOP!	No additional code available for SmartKey.	▶ Change the SmartKey.
	3RD BRAKE LIGHT CHECK LIGHT!	The high mounted brake lamp is malfunctioning.	▶ Visit an authorized Mercedes-Benz Center as soon as possible.
	AUTOM. LIGHT ON REMOVE KEY!	SmartKey in starter switch position <b>1</b> or <b>2</b> .	▶ Remove SmartKey from the starter switch.
	BRAKE LIGHT DRIVE TO WORKSHOP!	Brake lamp illumination is delayed or lamp is permanently on.	▶ Visit an authorized Mercedes-Benz Center as soon as possible.
	BRAKE LIGHT, L CHECK LIGHT!	The left brake lamp is malfunctioning.	▶ Visit an authorized Mercedes-Benz Center as soon as possible.
	BRAKE LIGHT, R CHECK LIGHT!	The right brake lamp is malfunctioning.	▶ Visit an authorized Mercedes-Benz Center as soon as possible.
	DISPLAY MALFUNCTION VISIT WORKSHOP!	The display for the lamps or the system is malfunctioning.	▶ Visit an authorized Mercedes-Benz Center as soon as possible.

## Practical hints

### What to do if ...

Display symbol	Display message	Possible cause	Possible solution
	FRONT FOGLIGHT, L CHECK LIGHT!	The left front fog lamp is malfunctioning.	▶ Replace the bulb as soon as possible.
	FRONT FOGLIGHT, R CHECK LIGHT!	The right front fog lamp is malfunctioning.	▶ Replace the bulb as soon as possible.
	REAR FOGLIGHT CHECK LIGHT!	The rear fog lamp is malfunctioning.	▶ Replace the bulb as soon as possible.
	HIGH BEAM, L CHECK LIGHT!	The left high beam lamp is malfunctioning.	▶ Replace the bulb as soon as possible.
	HIGH BEAM, R CHECK LIGHT!	The right high beam lamp is malfunctioning.	▶ Replace the bulb as soon as possible.
	LIGHT SENSOR VISIT WORKSHOP!	The lamp sensor is malfunctioning. The headlamps switch on automatically.	<ul style="list-style-type: none"> <li>▶ In the control system, set lamp operation to manual (▷ page 125).</li> <li>▶ Switch on headlamps using the exterior lamp switch.</li> <li>▶ Visit an authorized Mercedes-Benz Center as soon as possible.</li> </ul>
	LICENSE PLATE LIGHT, L CHECK LIGHT!	The left license plate lamp is malfunctioning.	▶ Replace the bulb as soon as possible.
	LICENSE PLATE LIGHT, R CHECK LIGHT!	The right license plate lamp is malfunctioning.	▶ Replace the bulb as soon as possible.

## Practical hints

### What to do if ...

Display symbol	Display message	Possible cause	Possible solution
	LIGHTS TURN OFF LIGHTS!	This display appears if the driver's door is opened with the engine shut off and no SmartKey in the starter switch.	<ul style="list-style-type: none"> <li>▶ Insert SmartKey in the starter switch.</li> <li>▶ Switch off the headlights.</li> </ul>
	LOW BEAM, L CHECK LIGHT!	The left low beam lamp is malfunctioning.	▶ Visit an authorized Mercedes-Benz Center as soon as possible.
	LOW BEAM, R CHECK LIGHT!	The right low beam lamp is malfunctioning.	▶ Visit an authorized Mercedes-Benz Center as soon as possible.
	REVERSE LIGHT, L CHECK LIGHT!	The left backup lamp is malfunctioning.	▶ Replace the bulb as soon as possible.
	REVERSE LIGHT, R CHECK LIGHT!	The right backup lamp is malfunctioning.	▶ Replace the bulb as soon as possible.
	MARKER LIGHT, FL CHECK LIGHTS! BACK-UP LIGHT ON!	The left side marker/parking lamps are malfunctioning. A backup bulb is being used.	▶ Visit an authorized Mercedes-Benz Center as soon as possible.
	MARKER LIGHT, FR CHECK LIGHTS! BACK-UP LIGHT ON!	The right side marker/parking lamps are malfunctioning. A backup bulb is being used.	▶ Visit an authorized Mercedes-Benz Center as soon as possible.
	TAIL LIGHT, L CHECK LIGHTS! BACK-UP LIGHT ON!	The left tail lamp is malfunctioning. A backup bulb is being used.	▶ Visit an authorized Mercedes-Benz Center as soon as possible.

## Practical hints



### What to do if ...

Display symbol	Display message	Possible cause	Possible solution
	TAIL LIGHT, R CHECK LIGHTS! BACK-UP LIGHT ON!	The right tail lamp is malfunctioning. A backup bulb is being used.	▶ Visit an authorized Mercedes-Benz Center as soon as possible.
	TURN SIG., LF CHECK LIGHT!	The left front turn signal lamp is malfunctioning.	▶ Replace the bulb as soon as possible.
	TURN SIG., RF CHECK LIGHT!	The right front turn signal lamp is malfunctioning.	▶ Replace the bulb as soon as possible.
	TURN SIG., LR CHECK LIGHT!	The left rear turn signal lamp is malfunctioning.	▶ Replace the bulb as soon as possible.
	TURN SIG., RR CHECK LIGHT!	The right rear turn signal lamp is malfunctioning.	▶ Replace the bulb as soon as possible.
	TURN SIG. MIRROR, L CHECK LIGHT!	The left turn signal in the exterior rear view mirror is malfunctioning. This message will only appear if all light emitting diodes have stopped working.	▶ Have the LEDs replaced as soon as possible.
	TURN SIG. MIRROR, R CHECK LIGHT!	The right turn signal in the exterior rear view mirror is malfunctioning. This message will only appear if all light emitting diodes have stopped working.	▶ Have the LEDs replaced as soon as possible.





## Practical hints

### What to do if ...

Display symbol	Display message	Possible cause	Possible solution
	DRIVER'S SEAT BELT FASTEN SEAT BELT!	The display reminds you to fasten the seat belt.	► Fasten the seat belts.
	FR. PASS. SEAT BELT FASTEN SEAT BELT!	The display reminds you and your passengers to fasten seat belts.	► Fasten the seat belts.
	SEAT BELT SYSTEM DRIVE TO WORKSHOP!	The seat belt system is malfunctioning.	► Visit an authorized Mercedes-Benz Center as soon as possible.
	CLOSE SUNROOF!	You have opened the driver's door with the SmartKey removed from the starter switch and the sliding/pop-up roof open.	Close the sliding/pop up roof (▷ page 190).
	CLOSE SUNROOF!	You have opened the driver's door with the SmartKey removed from the starter switch and the sliding/pop-up roof open.	Close the sliding/pop up roof (▷ page 190).

## Practical hints

### What to do if ...

Display symbol	Display message	Possible cause	Possible solution
	RESTRAINT SYSTEM DRIVE TO WORKSHOP!	The system is malfunctioning.	► Drive with added caution to the nearest authorized Mercedes-Benz Center.
	STEERING WHEEL ADJ. LOCK!	The steering column is not properly locked.	► Lock steering column (▷ page 38).
	STEERING OIL VISIT WORKSHOP!	The steering gear oil level is too low. There is a danger of steering gear damage.	► Have the system checked by an authorized Mercedes-Benz Center.

#### Warning!



In the event a malfunction of the SRS is indicated as outlined above, the SRS may not be operational. For your safety, we strongly recommend that you visit an authorized Mercedes-Benz Center immediately to have the system checked; otherwise the SRS may

not be activated when needed in an accident, which could result in serious or fatal injury, or it might deploy unexpectedly and unnecessarily which could also result in injury.

#### Warning!









If the level of steering gear oil in reservoir is too low, the steering power assistance could fail. Much greater effort will then be needed to turn the steering wheel.

Do not add steering oil without checking the steering system.

Do not drive the vehicle. Have the system checked at your authorized Mercedes-Benz Center as soon as possible.

## Practical hints

### What to do if ...

Display symbol	Display message	Possible cause	Possible solution
	TELE AID DRIVE TO WORKSHOP!	One or more main functions of the Tele Aid system* are malfunctioning.	► Have the Tele Aid system* checked by an authorized Mercedes-Benz Center.
	FUNCTION NOT AVAILABLE!	This display appears if button  or  on the multifunction steering wheel is pressed and the vehicle is not equipped with a telephone*.	
	TRUNK OPEN!	This message will appear whenever the trunk lid is open.	► Close the trunk lid.
	WASHER FLUID CHECK LEVEL!	The fluid level has dropped to about $\frac{1}{3}$ of total reservoir capacity.	► Add washer fluid (▷ page 243).

## Practical hints

### Where will I find ...?

#### ▼ Where will I find ...?

##### First aid kit

The first aid kit is stored in the trunk behind the left trim panel.

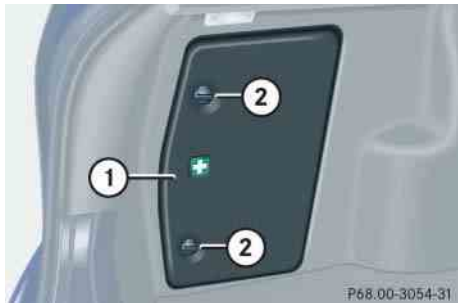

- ▶ Turn handles ②.
- ▶ Remove the trim panel ①.

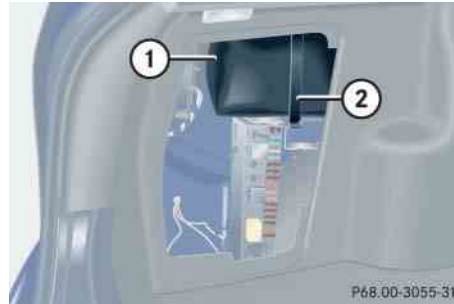

- ▶ Loosen the securing strap ②.
- ▶ Remove first aid kit ①.

### i

Check expiration dates and contents for completeness at least once a year and replace missing/expired items.

## Spare wheel

The spare wheel is located under the trunk floor.

### Removing the spare wheel

- ▶ Lift trunk floor and engage handle in the upper edge of the trunk.

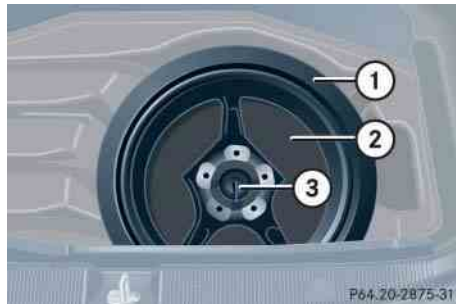

- ① Spare wheel
  - ② Storage tray with vehicle tool kit
  - ③ Mounting screw for spare wheel/cover for vehicle tools
- ▶ Turn the mounting screw ③ counter-clockwise.
  - ▶ Remove the spare wheel ①.

### Storing the spare wheel

- ▶ Place spare wheel ① in wheel well.
- ▶ Turn mounting screw ③ clockwise to its stop to secure the spare wheel.
- ▶ Lower the trunk floor before closing the trunk lid.

## Practical hints

### Where will I find ...?

### Vehicle tool kit

The vehicle tool kit and air pump are stored in the wheel well below the trunk floor.

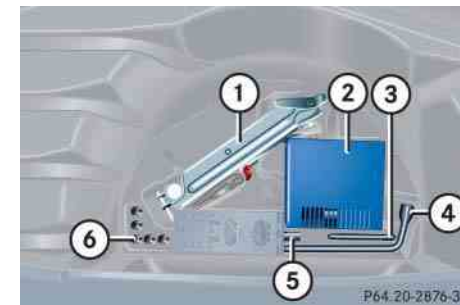

- ① Vehicle jack
- ② Air pump
- ③ Alignment bolt
- ④ Wheel wrench
- ⑤ Towing eye bolt
- ⑥ Spare wheel bolts

## Practical hints

### Where will I find ...?

#### Vehicle jack

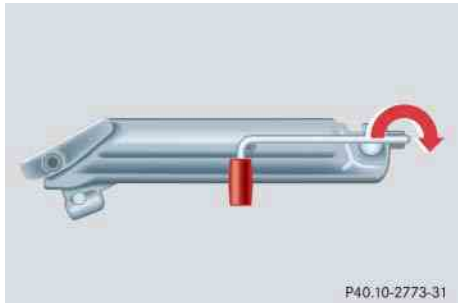

- ▶ Remove the vehicle jack from the spare wheel well under the trunk floor.
- ▶ Push the crank handle up.

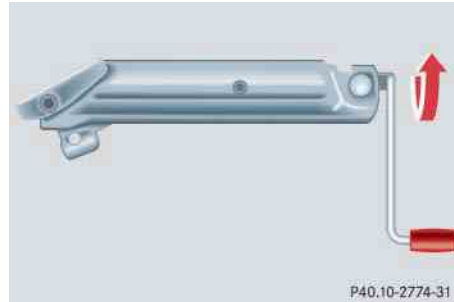

- ▶ Turn the crank handle clockwise until it engages (operational position).

Before storing the vehicle jack in its compartment:

- It should be fully collapsed.
- The handle must be folded in (storage position).

#### Warning!



The jack is designed exclusively for jacking up the vehicle at the jack take-up brackets built into both sides of the vehicle. To help avoid personal injury, use the jack only to lift the vehicle during a wheel change. Never get beneath the vehicle while it is supported by the jack. Keep hands and feet away from the area under the lifted vehicle. Always firmly set parking brake and block wheels before raising vehicle with jack.

Do not disengage parking brake while the vehicle is raised. Be certain that the jack is always vertical (plumb line) when in use, especially on hills. Always try to use the jack on level surface. make sure the jack arm is fully seated in the jack take-up bracket. Always lower the vehicle onto sufficient capacity jack stands before working under the vehicle.

### Spare wheel bolts

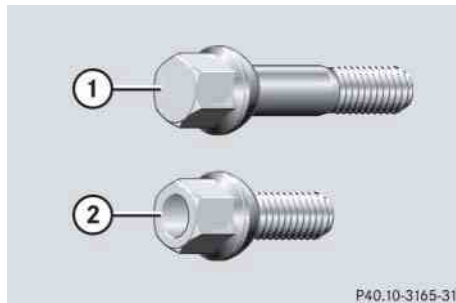

- ① Wheel bolt for light alloy rims
- ② Wheel bolt for light alloy spare wheel rim size 4 1/2B x 15 H2



Wheel bolts ② must be used when mounting spare wheel rim size 4 1/2B x 15 H2 (▷ page 326).

The use of any wheel bolts other than wheel bolts ② for spare wheel rim size 4 1/2B x 15 H2 can cause physical damage to the vehicle.

### Practical hints

#### Where will I find ...?

#### Warning!



Make sure to use the original length wheel bolts when remounting the original wheel after it has been repaired.

For more information on model and spare wheel rim size, see “Technical data” section (▷ page 326).

## Practical hints

### Unlocking/locking in an emergency

#### ▼ Unlocking/locking in an emergency



##### Unlocking the vehicle

If you are unable to unlock the vehicle with the SmartKey, open the driver's door using the mechanical key.

The passenger door cannot be unlocked manually.



Unlocking your vehicle with the mechanical key will trigger the anti-theft alarm system. To cancel the alarm, do one of the following:

- Press button  or  on the SmartKey.
- Insert the SmartKey in the starter switch.



① Mechanical key locking tab

② Mechanical key

- ▶ Move locking tab ① in direction of arrow and slide the mechanical key ② out of the housing.

##### Unlocking the driver's door

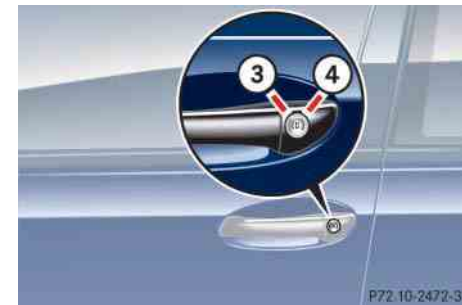

③ Unlocking

④ Locking

- ▶ Unlock the door with the mechanical key. To do so, push the mechanical key in the lock until it stops and turn it to the left.



### Unlocking/locking in an emergency

#### Unlocking the trunk lid

If you are unable to unlock the trunk lid with the SmartKey, you can use the emergency release on the inside of the trunk lid to unlock it.

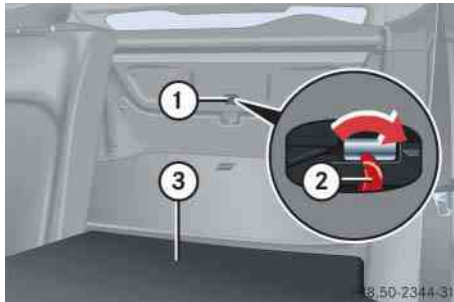

- ① Cover
- ② Release lever
- ③ Rear bench seat backrest

- ▶ Fold backrest ③ forward.
- ▶ Remove cover ① from the trim on the trunk lid.
- ▶ Push release lever ② all the way to the right.
- ▶ Open the trunk lid.



The trunk lid swings open upwards automatically. Always make sure there is sufficient overhead clearance. A minimum height clearance of 6.92 ft (2.11 m) is required to open the trunk lid.

#### Locking the vehicle

If you are unable to lock the vehicle with the SmartKey, lock it with the mechanical key as follows:

- ▶ Close the passenger door and the trunk lid.
- ▶ Press the central locking switch in the cockpit (▷ page 88).
- ▶ Check to see whether the locking knob on the passenger door is down. If necessary push it down manually.
- ▶ Lock the driver's door with the mechanical key.

## Practical hints

### Unlocking/locking in an emergency

#### Changing batteries in the SmartKey

If the batteries in the SmartKey are discharged, the vehicle can no longer be locked or unlocked. It is recommended to have the batteries replaced at an authorized Mercedes-Benz Center.

#### Warning!



Keep the batteries out of reach of children.

If a battery is swallowed, seek medical help immediately.

Batteries contain materials that can harm the environment if disposed of improperly. Recycling of batteries is the preferred method of disposal. Many states require sellers of batteries to accept old batteries for recycling.



- ① Mechanical key
- ② Battery compartment

Replacement batteries: Lithium, type CR 2025 or equivalent.



When changing batteries, always replace both batteries.

The required replacement batteries are available at any Mercedes-Benz Center.

- ▶ Remove mechanical key ① (▷ page 288).
- ▶ Insert mechanical key ① in side opening and push grey slide.  
The battery compartment is unlatched.
- ▶ Pull the battery compartment out of the key housing in direction of arrow.

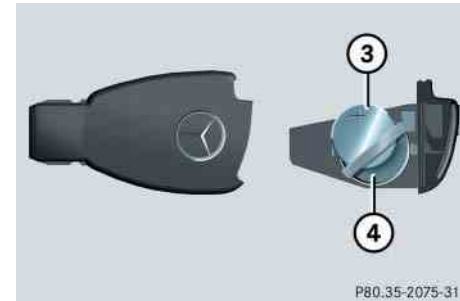

- ③ Battery
- ④ Contact spring

- ▶ Remove the batteries.
- ▶ Using a lint-free cloth, insert new batteries under the contact spring with the plus (+) side facing up.

- ▶ Return battery compartment into housing until it locks in place.
- ▶ Slide mechanical key ① back into the SmartKey.



When inserting the batteries, make sure they are clean and free of lint.

### Fuel filler flap

In case the central locking system does not release the fuel filler flap, you can open it manually.

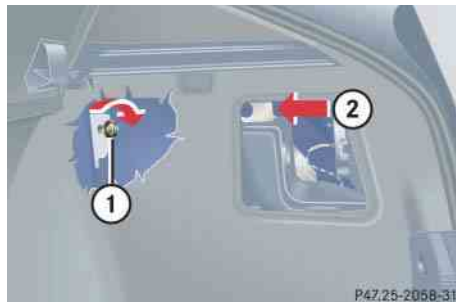

- ▶ Open the trunk lid.

- ▶ Fold right-side tail lamp trim aside.
- ▶ Reach inside through opening ②.
- ▶ Turn release knob ① clockwise (arrow).

The fuel filler flap can now be opened.

### Manually unlocking the gear selector lever

In the case of power failure the gear selector lever can be manually unlocked, e.g. to tow the vehicle.

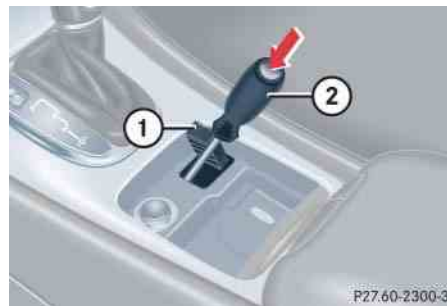

- ① Coin holder
- ② Tool

## Practical hints

### Unlocking/locking in an emergency

- ▶ Open the storage compartment in front of the center armrest.
- ▶ Release coin holder ① (e.g. using a small coin).
- ▶ Swing coin holder ① aside.
- ▶ Insert a tool ② (e.g. flat blade screwdriver) into the opening.
- ▶ Perform the following two steps simultaneously:
  - ▶ Push the tool down.
  - ▶ Move gear selector lever from position **P**.
- ▶ Reinstall the coin holder after removing the tool from the opening.



The gear selector lever is locked again when moving it to position **P**.

## Practical hints

### Opening/closing in an emergency

#### ▼ Opening/closing in an emergency

##### Panorama sliding/pop-up roof

You can open or close the panorama sliding/pop-up roof manually should an electrical malfunction occur.

The panorama sliding/pop-up roof drive is located behind the lens of the interior overhead light.



- ▶ Pry off lens ① using a flat blade screwdriver.



- ▶ Slide both locking tabs ② in direction of arrow.
- ▶ Lower rear of cover and remove.
- ▶ Remove cover.



Do not disconnect electrical connectors.

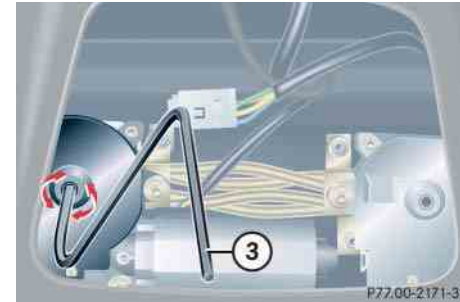

- ▶ Obtain crank ③.
- ▶ Insert crank ③ through hole.
- ▶ Turn crank ③ clockwise to:
  - slide roof closed
  - raise roof at the rear
- ▶ Turn crank ③ counterclockwise to:
  - slide roof open
  - lower roof at the rear

The panorama sliding/pop-up roof must be resynchronized after being operated manually (▷ page 193).

## Practical hints

### Replacing bulbs

#### ▼ Replacing bulbs

Safe vehicle operation depends on proper exterior lighting and signaling. It is therefore essential that all bulbs and lamp assemblies are in good working order at all times.

Correct headlamp adjustment is extremely important. Have headlamps checked and readjusted at regular intervals and when a bulb has been replaced. See your authorized Mercedes-Benz Center for headlamp adjustment.



Backup bulbs will be brought into use when the following lamps malfunction:

- Rear fog lamp
- Tail lamps
- Standing lamps

#### Bulbs



#### Front lamps

Lamp	Type
① Additional turn signal lamps	LED
② Turn signal lamp Halogen headlamp	1156A
Turn signal lamp Bi-Xenon* headlamp	2357A
③ Halogen headlamps: Low beam	H7 (55W)
Bi-Xenon* headlamps: Low and high beam	D2S-35W
④ Halogen headlamps: High beam	H7 (55 W)
Bi-Xenon* headlamps: High beam flasher	H7 (55 W)
Parking and standing lamp	W 5 W
⑤ Fog lamp	HB4/9006 (55 W)

## Practical hints

### Replacing bulbs

#### Rear lamps

	Lamp	Type
⑥	Side marker lamp	5W5
⑦	High mounted brake lamp	LED
⑧	License plate lamps	C5W
⑨	Brake lamp	P 21 W
	Turn signal lamp	PY21W
	Tail, parking standing and side marker lamp	P21/5W
	Rear fog lamp, driver's side	P21/4W

#### Notes on bulb replacement

##### Warning!



Keep bulbs out of reach of children.

Bulbs and bulb sockets can be very hot. Allow the lamp to cool down before changing a bulb.

Halogen lamps contain pressurized gas. A bulb can explode if you

- touch or move it when hot
- drop the bulb
- scratch the bulb

Wear eye and hand protection.

Because of high voltage in xenon lamps, it is dangerous to replace the bulb or repair the lamp and its components. We recommend that you have such work done by a qualified technician.

- Use only 12-volt bulbs of the same type and with the specified watt rating.
- Switch lights off before changing a bulb to prevent short circuits.
- Always use a clean lint-free cloth when handling bulbs.
- Your hands should be dry and free of oil and grease.
- If the newly installed bulb does not come on, visit an authorized Mercedes-Benz Center.
- Have the LEDs and bulbs for the following lamps replaced by an authorized Mercedes-Benz Center.
  - Additional turn signals in the exterior rear view mirrors
  - High mounted brake lamp
  - Xenon lamps
  - Front fog lamps

## Replacing bulbs for front lamps

### Halogen headlamps

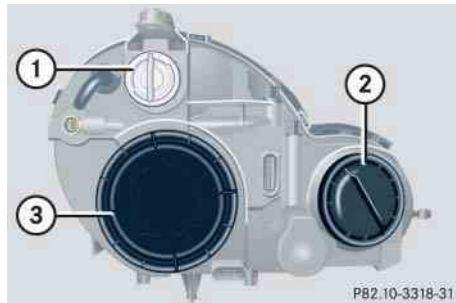

- ① Bulb socket for turn signal lamp
- ② Headlamp cover for high beam headlamp and for parking and standing lamp
- ③ Headlamp cover for low beam headlamp

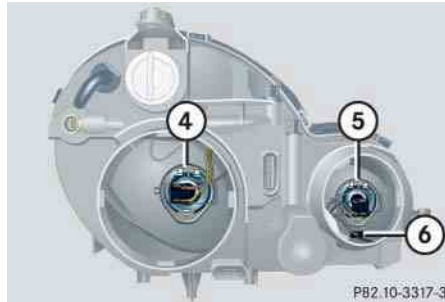

- ④ Low beam bulb
- ⑤ High beam bulb
- ⑥ Parking and standing lamp

### Low and high beam bulb

- ▶ Switch off the lights.
- ▶ Open the hood (> page 236).
- ▶ Turn headlamp cover ② or ③ to the left and remove.
- ▶ Turn bulb holder with bulb to the left and pull out.
- ▶ Pull out the bulb from the base (do not pull on glass tube).

## Practical hints

### Replacing bulbs

- ▶ Insert new bulb so that the base fits in the bulb holder recess and is level.
- ▶ Place the bulb holder with bulb on the headlamp mounting and turn the bulb holder to the right until it engages.
- ▶ Replace headlamp cover ② or ③ and turn to the right until it engages.

### Front turn signal lamp bulb

- ▶ Switch off the lights.
- ▶ Open the hood (> page 236).
- ▶ Turn bulb socket ① to the left and pull out.
- ▶ Push bulb into socket, turn to the left and remove.
- ▶ Insert new bulb in socket, push in and turn to the right.
- ▶ Reinsert bulb socket in lamp and turn to the right.

## Practical hints

### Replacing bulbs

#### *Parking and standing lamp bulb*

- ▶ Switch off the lights.
- ▶ Open the hood (▷ page 236).
- ▶ Turn headlamp cover ② to the left and remove.
- ▶ Pull out the bulb socket with the bulb.
- ▶ Pull the bulb out of the bulb socket.
- ▶ Insert a new bulb in the socket.
- ▶ Reinstall the bulb socket.
- ▶ Replace headlamp cover ② and turn to the right until it engages.



If the inside of the headlamps is fogged up, switch the lights on for a sufficient amount of time.

#### **Bi-Xenon\* headlamps**

##### **Warning!**



Do not remove the cover ③ for the Bi-Xenon headlamp. Because of high voltage in Bi-Xenon lamps, it is dangerous to replace the bulb or repair the lamp and its components. We recommend that you have such work done by a qualified technician.

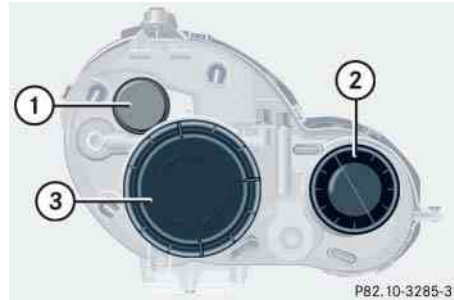

- ① Bulb socket for turn signal lamp
- ② Cover for high beam flasher, parking and standing lamp

- ③ Headlamp cover for Bi-Xenon headlamp

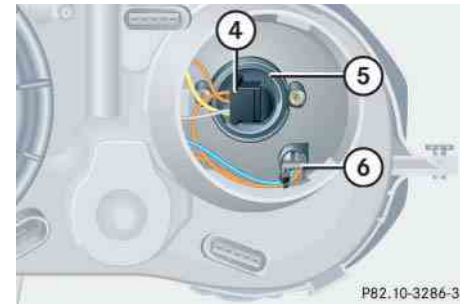

- ④ High beam bulb for high beam flasher
- ⑤ Bulb holder
- ⑥ Parking and standing lamp

#### **High beam bulb for high beam flasher**

- ▶ Switch off the lights.
- ▶ Open the hood (▷ page 236).
- ▶ Turn headlamp cover ② to the left and remove.



- ▶ Turn bulb holder ⑤ with bulb to the left and pull out.
- ▶ Pull out bulb from the base (do not pull on glass tube).
- ▶ Insert new bulb so that the base fits in the bulb holder recess and is level.
- ▶ Place the bulb holder with bulb on the lamp mounting and turn bulb holder to the right until it engages.
- ▶ Install cover ② and turn to the right until it engages.

#### ***Front turn signal lamp bulb***

- ▶ Switch off the lights.
- ▶ Open the hood (▷ page 236).
- ▶ Turn bulb socket ① to the left and pull out.
- ▶ Push bulb into socket, turn to the left and remove.
- ▶ Insert new bulb in socket, push in and turn to the right.
- ▶ Reinsert bulb socket in lamp and turn to the right.

#### ***Parking and standing lamp bulb***

- ▶ Switch off the lights.
- ▶ Open the hood (▷ page 236).
- ▶ Turn headlamp cover ② to the left and remove.
- ▶ Pull out the bulb socket ⑥ with the bulb.
- ▶ Pull the bulb out of the bulb socket.
- ▶ Insert a new bulb in the socket.
- ▶ Reinstall the bulb socket.
- ▶ Install cover ② and turn to the right until it engages.

## **Practical hints**

### **Replacing bulbs**

## Practical hints

### Replacing bulbs

#### Side marker lamp bulb

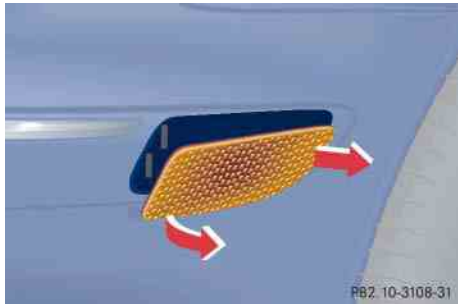

- ▶ Switch off the lights.
- ▶ Carefully slide lamp towards rear.
- ▶ Remove front end first.
- ▶ Twist bulb socket counterclockwise and pull out.
- ▶ Pull bulb out of the bulb socket.
- ▶ Insert new bulb in socket.
- ▶ Reinstall bulb socket, push in and twist clockwise.
- ▶ To reinstall lamp, set rear end in bumper and let front end snap into place.

#### Replacing bulbs for rear lamps

##### Tail lamp assemblies

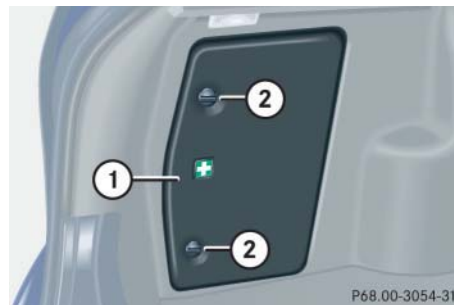

- ▶ Switch off the lights.
- ▶ Open the trunk lid (▷ page 85).
- ▶ Turn handles (2).
- ▶ Remove the trim panel (1).



- ▶ Press together the latches (1).
- ▶ Remove bulb holder.
- ▶ Gently push bulb into socket, turn counterclockwise and remove.
- ▶ Insert new bulb and reinstall bulb socket.
- ▶ Reinstall trim panel.

## Practical hints

### Replacing bulbs

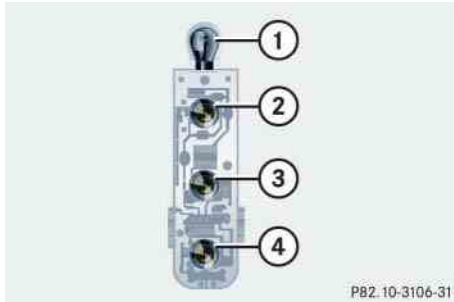

- ① Stop lamp
- ② Back up lamp
- ③ Turn signal lamp
- ④ Tail, parking, standing and rear fog lamp (driver's side)

### License plate lamp



- ① Screws
- ▶ Switch off the lights.
  - ▶ Loosen both screws ① and remove lamp.
  - ▶ Replace the tubular lamp and reinstall lamp.
  - ▶ Retighten the screws.

## Practical hints

### Replacing wiper blades

#### ▼ Replacing wiper blades

#### Warning!



For safety reasons, remove SmartKey from starter switch before replacing a wiper blade, otherwise the motor could suddenly turn on and cause injury.

#### Removing

- ▶ Fold the wiper arm forward.

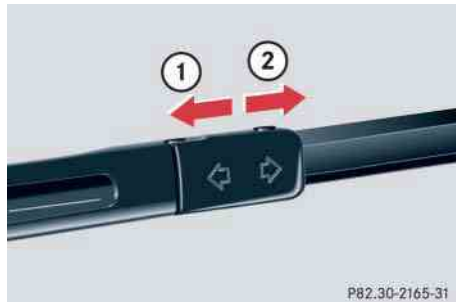

P82.30-2165-31

- ① Lock
- ② Unlock

- ▶ Pull the tab in the direction of arrow ② and remove windshield wiper.

#### Installing

- ▶ Slide the wiper blade into the cutout on the wiper arm.
- ▶ Slide the tab back in the direction of arrow ① until it audibly engages.
- ▶ Fold the wiper arm back to rest on the windshield.



Never open the hood when the wiper arm is folded forward.

Hold onto the wiper when folding the wiper arm back. If released, the force of the impact from the tensioning spring could crack the windshield.

Do not allow the wiper arms to contact the windshield glass without a wiper blade inserted.

Make certain that the wiper blades are properly installed. Improperly installed wiper blades may cause windshield damage.

For your convenience, we recommend that you have this work carried out by an authorized Mercedes-Benz Center.

**▼ Flat tire****Preparing the vehicle**

- ▶ Park the vehicle as far as possible from moving traffic on a hard surface.
- ▶ Turn on the hazard warning flashers.
- ▶ Engage the steering wheel lock in the straight ahead position and set the parking brake.
- ▶ Move the gear selector lever to **P** (manual transmission to 1st or reverse gear).
- ▶ Have any passenger exit the vehicle at a safe distance from the roadway.

**Mounting the spare wheel****Warning!**

The dimensions of the spare wheel are different from those of the road wheels. As a result, the vehicle handling characteristics change when driving with a spare wheel mounted. Adapt your driving style accordingly.

The spare wheel is for temporary use only. When driving with spare wheel mounted, ensure proper tire pressure and do not exceed vehicle speed of 50 mph (80 km/h).

Drive to the nearest Mercedes-Benz Center as soon as possible to have the spare wheel replaced with a regular road wheel.

Never operate the vehicle with more than one spare wheel mounted.

**Preparing the vehicle**

Prepare the vehicle as described under “Preparing the vehicle” on this page.

- ▶ Take the wheel wrench and the jack out of wheel well below the trunk floor (▷ page 285).
- ▶ Take the spare wheel out of the trunk (▷ page 285).

**Lifting the vehicle**

- ▶ Prevent the vehicle from rolling away by blocking wheels with wheel chocks (not included) or other sizable objects.

When changing wheel on a level surface:

- ▶ Place one chock in front of and one behind the wheel that is diagonally opposite to the wheel being changed.

## Practical hints

### Flat tire

When changing wheel on a hill:

- ▶ Place chocks on the downhill side blocking both wheels of the other axle.
- ▶ Take the two-piece wheel wrench and the jack out of the vehicle tool kit (▷ page 285). Assemble wheel wrench.

#### Warning!



The jack is designed exclusively for jacking up the vehicle at the jack take-up brackets built into both sides of the vehicle. To help avoid personal injury, use the jack only to lift the vehicle during a wheel change. Never get beneath the vehicle while it is supported by the jack. Keep hands and feet away from the area under the lifted vehicle. Always firmly set parking brake and block wheels before raising vehicle with jack.

Do not disengage parking brake while the vehicle is raised. Be certain that the jack is

always vertical (plumb line) when in use, especially on hills. Always try to use the jack on level surface. make sure the jack arm is fully seated in the jack take-up bracket. Always lower the vehicle onto sufficient capacity jackstands before working under the vehicle.



- ▶ On wheel to be changed, loosen but do not yet remove the wheel bolts (approximately one full turn with wrench).

The jack take-up brackets are located directly behind the front wheel housings and in front of the rear wheel housings.

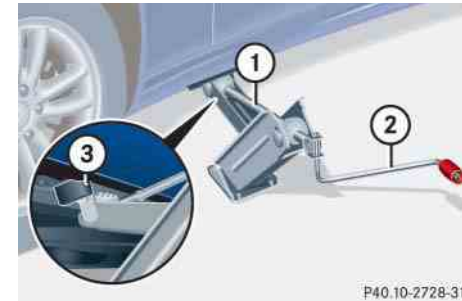

- ① Jack
- ② Crank
- ③ Take-up bracket

- ▶ Place jack on firm ground.
- ▶ Position jack ① under the take-up bracket ③ so that it is always vertical (plumb-line) as seen from the side, even if the vehicle is parked on an incline.
- ▶ Jack up the vehicle until the wheel is a maximum of 1.2 in (3 cm) from the ground. Never start engine while vehicle is raised.

## Removing the wheel

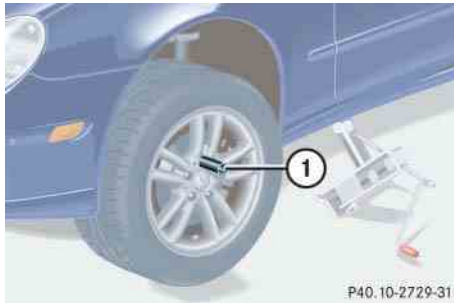

### ① Alignment bolt

- ▶ Unscrew upper-most wheel bolt and remove.
- ▶ Replace this wheel bolt with the alignment bolt ① supplied in the tool kit.
- ▶ Remove the remaining bolts.



Do not place wheel bolts in sand or dirt. This could result in damage to the bolt and wheel hub threads.

- ▶ Remove the wheel.

## Mounting the new wheel

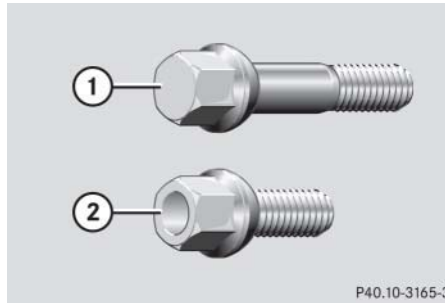

### ① Wheel bolt for light alloy rims

### ② Wheel bolt for light alloy spare wheel rim size 4 1/2B x 15 H2



Wheel bolts ② must be used when mounting spare wheel rim size 4 1/2B x 15 H2 (▷ page 326).

The use of any wheel bolts other than wheel bolts ② for spare wheel rim size 4 1/2B x 15 H2 can cause physical damage to the vehicle.

## Practical hints

### Flat tire

#### Warning!



Make sure to use original length wheel bolts when remounting the original wheel after it has been repaired.

- ▶ Clean contact surfaces of wheel and wheel hub.
- ▶ Guide the spare wheel onto the alignment bolt and push it on.
- ▶ Insert wheel bolts and tighten them slightly.
- ▶ Inflate the spare tire using the electric pump (▷ page 304).

#### Warning!



Inflate spare wheel with collapsible tire only after the wheel is properly mounted.

Inflate the spare wheel tire using the electric air pump before lowering the vehicle.

## Practical hints

### Flat tire



To avoid paint damage, place wheel flat against hub and hold it there while installing first wheel bolt.

#### Warning!



Always replace wheel bolts that are damaged or rusted.

Never apply oil or grease to wheel bolts.

Damaged wheel hub threads should be repaired immediately. Do not continue to drive under these circumstances! Contact an authorized Mercedes-Benz Center or call Roadside Assistance.

Incorrect wheel bolts or improperly tightened wheel bolts can cause the wheel to come off. This could cause an accident. Make sure to use the correct mounting bolts.

#### Warning!



Use only genuine equipment Mercedes-Benz wheel bolts. Other wheel bolts may come loose.

Do not tighten the wheel bolts when the vehicle is raised. Otherwise the vehicle could tip over.

- Unscrew the alignment bolt, install last wheel bolt and tighten slightly.

### Inflating the spare tire

- Take the electric air pump out of the trunk.

#### Warning!



Observe instructions on air pump label.

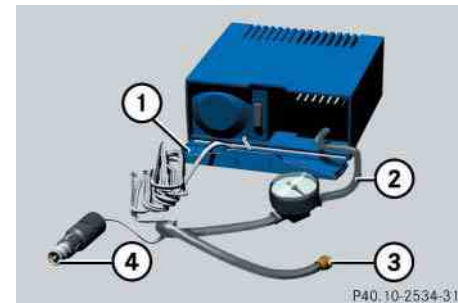

- ① Flap
- ② Air hose with pressure gauge and vent screw
- ③ Union nut
- ④ Electrical plug

Please exercise appropriate caution



- ▶ Open flap ① on air pump.
- ▶ Pull out electrical plug ④ and air hose with the pressure gauge ②.  
Observe instructions on air pump label.
- ▶ Remove the valve cap from valve.
- ▶ Screw the air hose ② on to the tire valve.
- ▶ Insert electrical plug ④ into vehicle cigarette lighter socket.
- ▶ To switch on the air pump turn the SmartKey in the starter switch to position **1** (▷ page 31).
- ▶ Operate air pump until the pressure gauge displays 36 psi (2.5 bar)  
This takes about five minutes for the spare tire. The air hose ② and the union nut ③ can become hot during inflation.



Do not operate the electric air pump longer than eight minutes without interruption. Otherwise it may overheat.

You may operate the air pump again after it has cooled off.

- ▶ To switch off the air pump turn the SmartKey in the starter switch to position **0** (▷ page 31).
- ▶ If the tire pressure is above 36 psi (2.5 bar), release excess tire pressure using the vent screw.

## Practical hints

### Flat tire

#### Warning!



Follow recommended inflation pressures.

Do not overinflate tires. Overinflated tires can result in sudden deflation (blowout) because they are more likely to become punctured or damaged by road debris, potholes, etc.

Do not underinflate tires. Underinflated tires wear unevenly, adversely affect handling and fuel economy, and are more likely to fail from being overheated.

Do not overload the tires by exceeding the specified vehicle capacity weight (as indicated by the label on the driver's door latch post). Overloading the tires can overheat them, possibly causing a blowout.

- ▶ Detach the electric air pump.
- ▶ Store the electrical plug and the air hose behind the flap and place the air pump back in the trunk.

## Practical hints

### Flat tire

#### Lowering the vehicle

- ▶ Lower vehicle by turning crank counterclockwise until vehicle is resting fully on its own weight.
- ▶ Remove the jack.

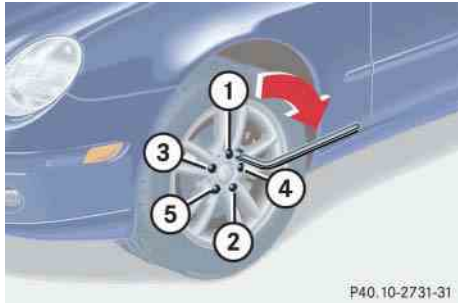

① - ⑤ Wheel bolts

- ▶ Tighten the five wheel bolts evenly, following the diagonal sequence illustrated (① to ⑤), until all bolts are tight. Observe a tightening torque of 80 lb-ft (110 Nm).

#### Warning!



Have the tightening torque checked after changing a wheel. The wheels could come loose if they are not tightened to a torque of 80 lb-ft (110 Nm).

- ▶ Before storing the jack in the trunk, it should be fully collapsed, with handle folded in.

## ▼ Battery

The battery is located in the engine compartment on the right hand side.

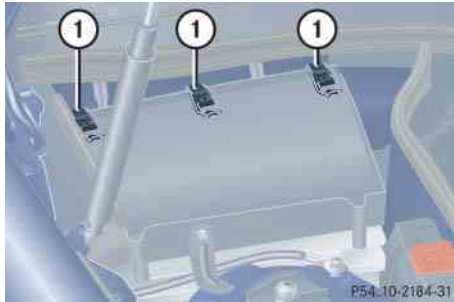

Removal of filter box:

- ▶ Release the three clamps ①.
- ▶ Remove filter box.

Installation of filter box:

- ▶ Insert filter box properly.
- ▶ Secure it with the three clamps ①.

### Warning!



Failure to follow these instructions can result in severe injury or death.

Never lean over batteries while connecting, you might get injured.

Battery fluid contains sulfuric acid. Do not allow this fluid to come in contact with eyes, skin or clothing. In case it does, immediately flush affected area with water and seek medical help if necessary.

A battery will also produce hydrogen gas, which is flammable and explosive. Keep flames or sparks away from battery, avoid improper connection of jumper cables, smoking, etc.

## Practical hints

### Battery



Never loosen or detach battery terminal clamps while the engine is running or the SmartKey is in the starter switch. Otherwise the alternator and other electronic components could be severely damaged.

Have the battery checked regularly by an authorized Mercedes-Benz Center.

Refer to Service Booklet for maintenance intervals or contact your authorized Mercedes-Benz Center for further information.

### Warning!



Do not place metal objects on the battery as this could result in a short circuit.

Use leak-proof battery only to avoid the risk of acid burns in the event of an accident.

## Practical hints

### Battery

#### Warning!



With a disconnected battery

- you will no longer be able to turn the SmartKey in the starter switch
- the gear selector lever will remain locked in position **P**

#### Disconnecting the battery

- ▶ Turn off all electrical consumers.
- ▶ Open the hood (▷ page 236).
- ▶ Remove the filter box (▷ page 307).
- ▶ Disconnect the battery negative lead.
- ▶ Remove the cover from the positive terminal.
- ▶ Disconnect the battery positive lead.

#### Removing the batteries

- ▶ Remove the screw-nuts securing the battery.
- ▶ Remove the battery bracket.
- ▶ Take out the battery.

#### Charging and reinstalling batteries

- ▶ Charge battery in accordance with the instructions of the battery charger manufacturer.
- ▶ Reinstall the charged battery. Follow the previously described steps in reverse order.

#### Warning!



Never charge a battery while still installed in the vehicle. Gases may escape during charging and cause explosions that may result in paint damage, corrosion or personal injury.

#### Reconnecting the batteries

- ▶ Turn off all electrical consumers.
- ▶ Connect the positive lead and fasten its cover.
- ▶ Connect the negative lead.



NEVER invert the terminal connections!

- ▶ Reinstall the filter box (▷ page 307).



The battery, its filler caps and the vent tube must always be securely installed when the vehicle is in operation.



The following procedures must be carried out following any interruption of battery power (e.g. due to reconnection):

- Set the clock (▷ page 122) (vehicles with COMAND\*: see COMAND operator's manual).
- Resynchronize the ESP (▷ page 266).
- Resynchronize side windows (▷ page 188).
- Resynchronize panorama sliding/pop-up roof (▷ page 188).

Batteries contain materials that can harm the environment if disposed of improperly. Large 12-volt storage batteries contain lead. Recycling of batteries is the preferred method of disposal. Many states require sellers of batteries to accept old batteries for recycling.

## Practical hints

### Jump starting

#### ▼ Jump starting

#### Warning!



Failure to follow these directions will cause damage to the electronic components, and can lead to a battery explosion and severe injury or death.

Never lean over batteries while connecting or jump starting, you might get injured.

Battery fluid contains sulfuric acid. Do not allow this fluid to come in contact with eyes, skin or clothing. In case it does, immediately flush affected area with water, and seek medical help if necessary.

A battery will also produce hydrogen gas, which is flammable and very explosive. Keep flames or sparks away from battery, avoid improper connection of jumper cables, smoking, etc.

Attempting to jump start a frozen battery can result in it exploding, causing personal injury.

Read all instructions before proceeding.

If the battery is discharged, the engine can be started with jumper cables and the battery of another vehicle. Observe the following:

- Jump starting should only be performed when the engine and catalytic converter are cold.
- Do not start the engine if the battery is frozen. Let the battery thaw out first.
- Only jump start from batteries with the same voltage rating (12 V). Jump starting with a more powerful battery could damage the vehicle's electrical system, which will not be covered by the Mercedes-Benz Limited Warranty.
- Use only jumper cables with sufficient cross-section and insulated terminal clamps.
- Always make sure the jumper cables are not on or near pulleys, fans or other parts that move when an engine is started or running.



Jump starting may only be performed on the battery installed in the engine compartment.

Avoid repeated and lengthy starting attempts.

Do not attempt to start the engine using a battery quick charge unit.

If engine does not run after several unsuccessful starting attempts, have it checked at the nearest authorized Mercedes-Benz Center.

Excessive unburned fuel generated by repeated failed starting attempts may damage the catalytic converter and may present a fire risk.

Make sure the jumper cables do not have loose or missing insulation.

Make sure the cable clamps do not touch any other metal part while the other end is still attached to a battery.

### Warning!



Keep flames or sparks away from battery.  
Do not smoke.

Observe all safety instructions and precautions when handling automotive batteries (▷ page 242).

The battery is located in the engine compartment on the right hand side. The terminals for jump starting are located in front of the battery.

- ▶ Make sure the two vehicles do not touch.
- ▶ Turn off the engine.

On both vehicles:

- ▶ Turn off all electrical consumers.
- ▶ Apply parking brake.
- ▶ Shift gear selector lever to position **P** (manual transmission to Neutral).

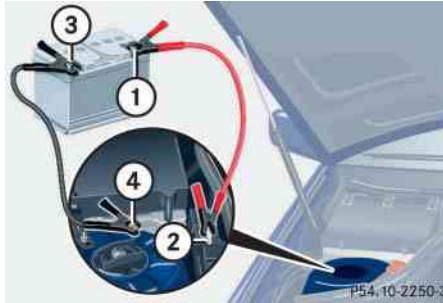

- ① Positive terminal of charged battery
- ② Positive under hood terminal in front of discharged battery
- ③ Negative terminal of charged battery
- ④ Negative under hood terminal in front of discharged battery

- ▶ Connect positive terminal ① of the charged battery with positive under hood terminal ② in front of the discharged battery with the jumper cables. Clamp cable to charged battery ① first.

## Practical hints

### Jump starting

- ▶ Start engine of the vehicle with the charged battery and run at idle speed.
- ▶ Connect negative terminal ③ of the charged battery with negative under hood terminal ④ in front of the discharged battery with the jumper cables. Clamp cable to charged battery ③ first.
- ▶ Start the engine of the disabled vehicle.

Now you can turn on the electrical consumers. Do not turn on the lights under any circumstances.

## Practical hints

### Jump starting

- ▶ Remove the jumper cables first from negative terminals ③ and ④ and then from positive terminals ① and ②.

You can now turn on the lights.

- ▶ Have the battery checked at the nearest authorized Mercedes-Benz Center.



Vehicles with automatic transmission:  
Do not tow-start the vehicle.



## ▼ Towing the vehicle

Mercedes-Benz recommends that the vehicle be transported with all wheels off the ground using flatbed or appropriate wheel lift/dolly equipment. This method is preferable to other types of towing.



Use flatbed or wheel lift/dolly equipment with SmartKey in starter switch turned to position **0**.

Do not tow with sling-type equipment. Towing with sling-type equipment over bumpy roads will damage radiator and supports.

To prevent damage during transport, do not tie down vehicle by its chassis or suspension parts.

Switch off the tow-away alarm (▷ page 79) and deactivate the automatic central locking (▷ page 129).

When circumstances do not permit the recommended towing methods, the vehicle may be towed with all wheels on the ground or front wheels raised only so far as necessary to have the vehicle moved to a safe location where the recommended towing methods can be employed.



Vehicles with automatic transmission: Do not tow-start the vehicle.

## Practical hints

### Towing the vehicle



If the vehicle is towed with the front axle raised, the engine must be shut off (SmartKey in starter switch position **0** or **1**). Otherwise, the ESP will immediately be engaged and will apply the rear wheel brakes.

When towing the vehicle with all wheels on the ground, the gear selector lever must be in position **N** (manual transmission: gears disengaged) and the SmartKey must be in starter switch position **2**.

When towing the vehicle with all wheels on the ground or the front axle raised, the vehicle may be towed only for distances up to 30 miles (50 km) and at a speed not to exceed 30 mph (50 km/h).

## Practical hints

### Towing the vehicle



To be certain to avoid a possibility of damage to the transmission, however, we recommend the drive shaft be disconnected at the rear axle drive flange for any towing beyond a short tow to a nearby garage.

#### Warning!



If circumstances require towing the vehicle with all wheels on the ground, always tow with a tow bar if:

- the engine will not run
- there is a malfunction in the power supply or in the vehicle's electrical system

as that will be necessary to adequately control the towed vehicle.

Prior to towing the vehicle with all wheels on the ground, make certain that the SmartKey is in starter switch position **2**.

If the SmartKey is left in starter switch position **0** for an extended period of time, it can no longer be turned in the switch. In this case, the steering is locked. To unlock, remove SmartKey from starter switch and reinsert.



To signal turns while being towed with the hazard warning flasher in use, turn SmartKey in starter switch to position **2** and activate the combination switch for the left or right turn signal in the usual manner – only the selected turn signal will operate.

Upon canceling the turn signal, the hazard warning flasher will operate again.

### Warning!



With the engine not running, there is no power assistance for the brake and steering systems. In this case, it is important to keep in mind that a considerably higher degree of effort is necessary to brake and steer the vehicle. Adapt your driving accordingly.



When towing the vehicle with all wheels on the ground, please note the following:

With the automatic central locking activated and the SmartKey in starter switch position **2**, the vehicle doors lock if the left front wheel as well as the right rear wheel are turning at vehicle speeds of approx. 9 mph (15 km/h) or more.

Switch off the tow-away alarm (▷ page 79).

To prevent the vehicle doors from locking, deactivate the automatic central locking (▷ page 129).

Towing of the vehicle should only be done using the properly installed towing eye bolt. Never attach tow cable, tow rope or tow rod to vehicle chassis, frame or suspension parts.

## Practical hints

### Towing the vehicle



If the battery is disconnected or discharged

- the SmartKey will not turn in the starter switch. See notes on the battery (▷ page 307) or on jump starting (▷ page 310).
- the gear selector lever will remain locked in position **P**. See notes on manual unlocking of gear selector lever (▷ page 291).

## Practical hints

### Towing the vehicle

#### Installing towing eye bolt

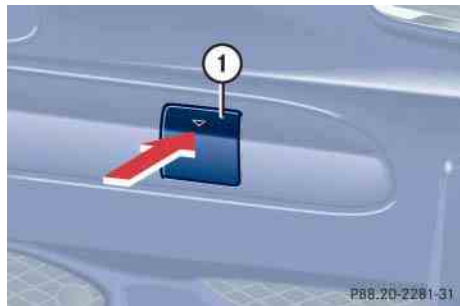

① Cover on right side of front bumper.

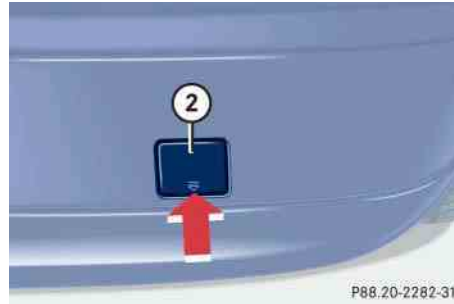

② Cover on right side of rear bumper.

To remove cover:

- ▶ Press mark on cover in direction of arrow.
- ▶ Lift cover off to reveal threaded hole for towing eye bolt.

The towing eye bolt is supplied with the tool kit (located in the wheel well below the trunk floor).

- ▶ Screw towing eye bolt in to its stop and tighten with lug wrench.

To reinstall cover:

- ▶ Fit cover and snap into place.

▼ Fuses



Only install fuses that have been tested and approved by Mercedes-Benz and that have the specified amperage rating.

Never attempt to repair or bridge a blown fuse. Have the cause determined and remedied by an authorized Mercedes-Benz Center.

Fuse box in passenger compartment



Opening

- ▶ Pry cover ① open with a screw driver or similar tool.
- ▶ Remove cover rearward.

Closing

- ▶ Attach the cover in the front.
- ▶ Fold the cover in until it engages.

Fuse chart

The fuse chart is found in the fuse box in the passenger compartment. The amperages of the fuses are also given there.

Fuse box in engine compartment

The fuse box is located in the engine compartment on the left-hand side.

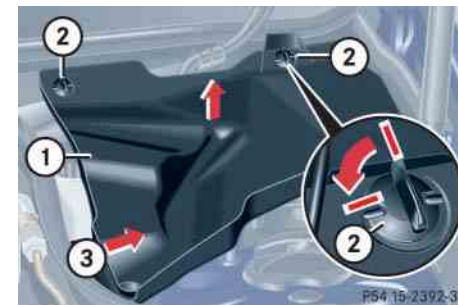

- ① Cover
- ② Screw
- ③ Retainer

## Practical hints

### Fuses

#### Removing/installing cover

- ▶ Twist screws ② 90° counterclockwise.
- ▶ Pull up cover ①.
- ▶ Slide out retainer ③ and remove cover by pulling towards front.
- ▶ Install cover ① in reverse order.

#### Opening fuse box

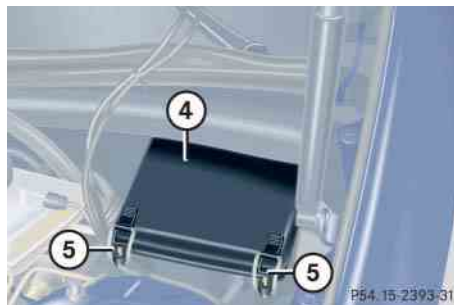

④ Fuse box cover

⑤ Clamps

- ▶ Release clamps ⑤.
- ▶ Remove cover ④.

#### Closing fuse box

- ▶ Ensure that the sealing rubber is properly positioned.
- ▶ Press the cover down and secure with clamps ⑤.

#### Auxiliary fuse box in trunk

The auxiliary fuse box is located in the trunk behind the left hand trim panel.

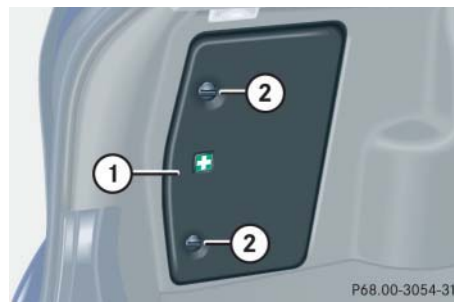

① Trim panel

② Handles

#### Opening trim panel

- ▶ Turn handles ②.
- ▶ Remove trim panel ①.

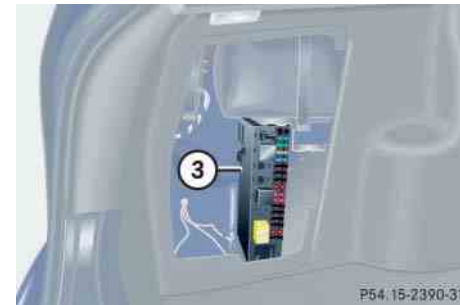

③ Auxiliary fuse box

#### Fuse extractor

The fuse extractor is found in the cover of the auxiliary fuse box.

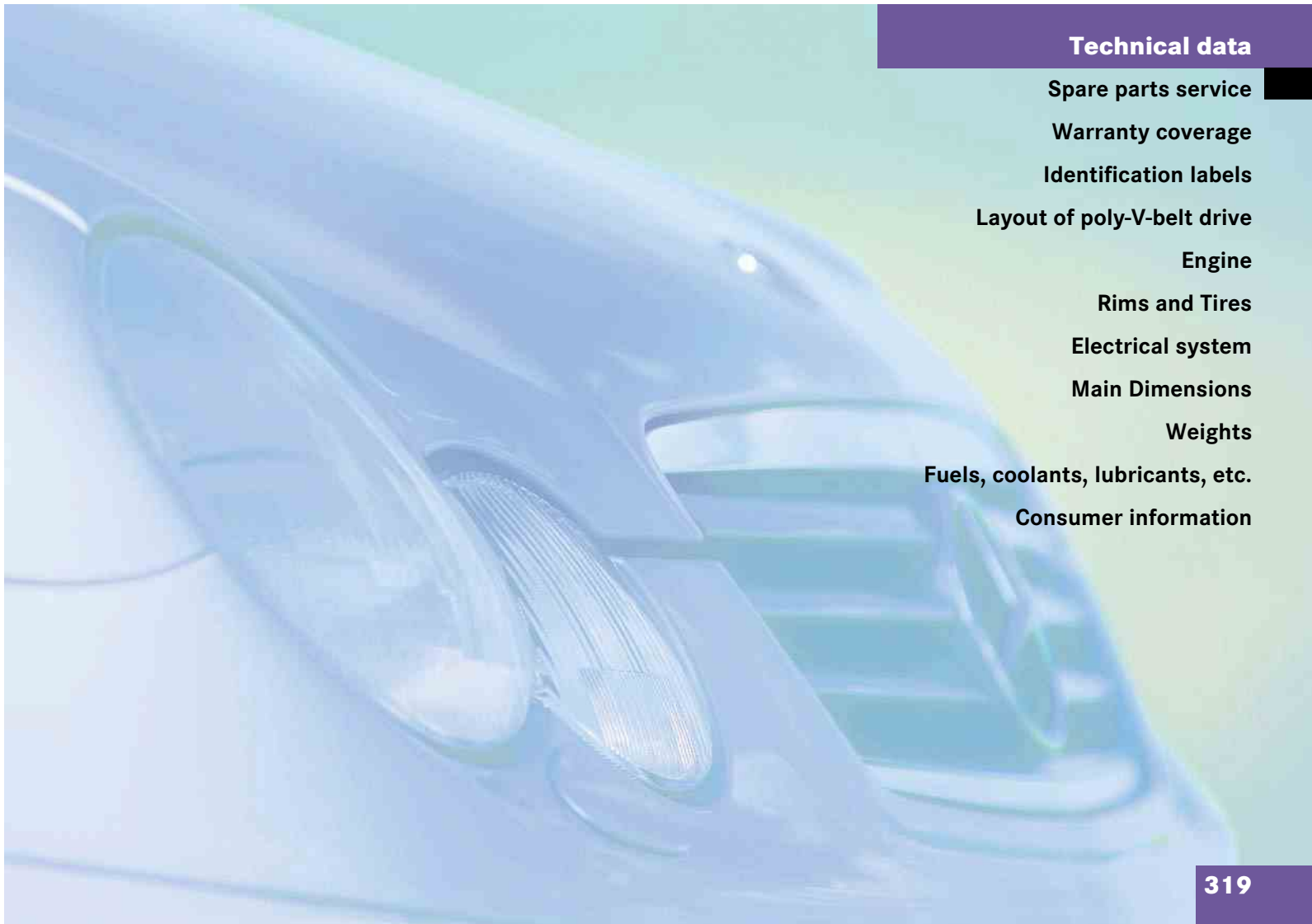

## **Technical data**

**Spare parts service**

**Warranty coverage**

**Identification labels**

**Layout of poly-V-belt drive**

**Engine**

**Rims and Tires**

**Electrical system**

**Main Dimensions**

**Weights**

**Fuels, coolants, lubricants, etc.**

**Consumer information**

## Technical data

### Spare parts service

The “Technical data” section provides the necessary technical data for your vehicle.

#### ▼ Spare parts service

All authorized Mercedes-Benz Centers maintain a stock of genuine Mercedes-Benz parts required for maintenance and repair work. In addition, strategically located parts distribution centers provide quick and reliable parts service.

More than 300 000 different spare parts for Mercedes-Benz models are available.

Genuine Mercedes-Benz parts are subject to stringent quality inspections. Each part has been specifically developed, manufactured or selected for and adapted to Mercedes-Benz vehicles.

Therefore, genuine Mercedes-Benz parts should be installed.



The use of non-genuine Mercedes-Benz parts and accessories not authorized by Mercedes-Benz could damage the vehicle, which is not covered by the Mercedes-Benz Limited Warranty, or could compromise the vehicle’s durability or safety.



▼ **Warranty coverage**

Your vehicle is covered under the terms of the “warranties” printed in the Service and Warranty Information booklet. Your authorized Mercedes-Benz Center will exchange or repair any defective parts originally installed in the vehicle in accordance with the terms of the following warranties:

- New Vehicle Limited Warranty
- Emission System Warranty
- Emission Performance Warranty
- California, Maine, Massachusetts, and Vermont Emission Control Systems Warranty

Replacement parts and accessories are covered by the Mercedes-Benz Spare Parts and Accessories warranties, copies of which are available at any Mercedes-Benz Center.

**Loss of Service and Warranty Information Booklet**

---

Should you lose your Service and Warranty Information booklet, have your authorized Mercedes-Benz Center arrange for a replacement. It will be mailed to you.

## Technical data

### Identification labels

#### ▼ Identification labels



① Certification label



② Vehicle Identification Number (VIN)

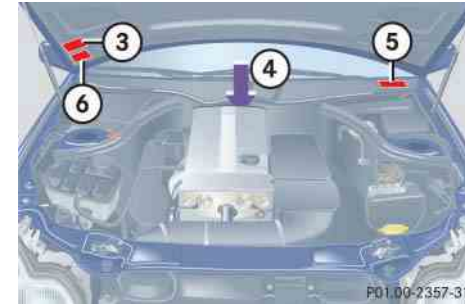

- ③ Information label, California version Vacuum line routing for emission control system
- ④ Engine number (engraved on engine)
- ⑤ VIN, visible (lower edge of windshield)
- ⑥ Emission control label

When ordering spare parts, please specify vehicle identification and engine numbers.

▼ Layout of poly-V-belt drive

C 230 Kompressor

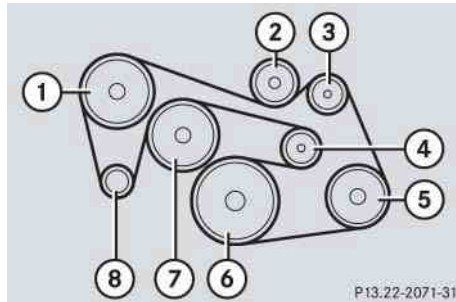

- ① Power steering pump
- ② Idler pulley
- ③ Supercharger
- ④ Automatic belt tensioner
- ⑤ Air conditioning compressor
- ⑥ Crankshaft
- ⑦ Coolant pump
- ⑧ Generator (alternator)

C 320

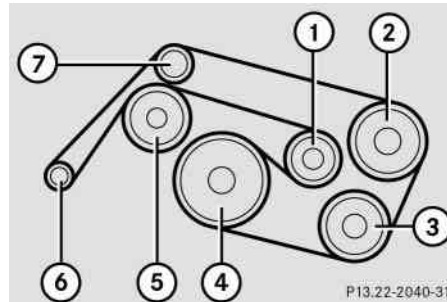

- ① Automatic belt tensioner
- ② Power steering pump
- ③ Air conditioning compressor
- ④ Crankshaft
- ⑤ Coolant pump
- ⑥ Generator (alternator)
- ⑦ Idler pulley

## Technical data

### Engine

#### ▼ Engine

Model	C 230 Kompressor (203.740) <sup>1</sup>	C 320 (203.764) <sup>1</sup>
Engine	271	112
Mode of operation	4-stroke engine, gasoline injection	4-stroke engine, gasoline injection
No. of cylinders	4	6
Bore	3.23 in (82.00 mm)	3.54 in (89.90 mm)
Stroke	3.35 in (85.00 mm)	3.3 in (84.00 mm)
Total piston displacement	109.6 cu in (1796 cm <sup>3</sup> )	195.2 cu in (3199 cm <sup>3</sup> )
Compression ratio	8.5:1	10:1
Output acc. to SAE J 1349	189 hp / 5800 rpm (141 kW / 5800 rpm)	215 hp / 5700 rpm (160 kW / 5700 rpm)
Maximum torque acc. to SAE J 1349	192 lb-ft / 3500 rpm (260 Nm / 3500 rpm)	229 lb-ft / 3000 rpm (310 Nm / 3000 rpm)
Maximum engine speed	6000 rpm	6000 rpm
Firing order	1-3-4-2	1-4-3-6-2-5
Poly-V-belt	2420 mm	2380 mm

<sup>1</sup> The quoted data apply only to the standard vehicle. See an authorized Mercedes-Benz Center for the corresponding data of all special bodies and special equipment.

### ▼ Rims and Tires

Use only tires and rims which have been specifically developed for your vehicle and tested and approved by Mercedes-Benz. Other tires and rims can have detrimental effects, such as

- poor handling characteristics
- increased noise
- increased fuel consumption



Moreover, tires and rims not approved by Mercedes-Benz may, under load, exhibit dimensional variations and different tire deformation characteristics that could cause them to come into contact with the vehicle body or axle parts. This may result in damage to the tires or the vehicle.



Further information on tires and rims is available at any authorized Mercedes-Benz Center. A tire inflation pressure table is located on the fuel filler flap of the vehicle. The tire pressure should be checked regularly and should only be adjusted on cold tires. Follow tire manufacturer's maintenance recommendation included with vehicle.

## Technical data

### Rims and Tires

## Technical data

### Rims and Tires

#### Same size tires

Model	<b>C 230 Kompressor</b> (standard in U.S.A.; optional in Canada) <b>Evolution Package</b> <b>C 320</b> <b>Evolution Package</b>	<b>C 230 Kompressor</b> (standard in Canada; Canada only)
<b>Rims (light alloy)</b>	7 1/2J x17	7J x 16 H2
<b>Wheel offset</b>	1.46 in (37 mm)	1.46 in (37 mm)
<b>Summer tires (radial-ply tires)</b> <b>All season tires (radial-ply tires)</b>	225/45 R17 91 W <sup>1</sup>	205/55 R16 91 H
<b>Winter tires (radial-ply tires)</b>	225/45 R17 91 H M+S <sup>1</sup>	205/55R16 91 H M+S

<sup>1</sup> Must not be used with snow chains

#### Spare wheel

	<b>C 230 Kompressor</b>	<b>C 320</b>
<b>Rim (light alloy)</b>	4.5 B x 15 H2	4.5 B x 16 H2
<b>Wheel offset</b>	0.47 in (12 mm)	0.47 in (12 mm)
<b>Collapsible Tire</b>	165 - 15 89P <sup>1</sup>	165/70 - 16 92P <sup>1</sup>

<sup>1</sup> Must not be used with snow chains.

**Technical data****Electrical system****▼ Electrical system**

<b>Model</b>	<b>C 230 Kompressor</b>	<b>C 320</b>
<b>Generator (alternator)</b>	14 V/120 A	14 V/120 A
<b>Starter motor</b>	12 V/1.1 kW	12 V/1.7 kW
<b>Battery</b>	12V/100 Ah	12V/100 Ah
<b>Spark plugs</b>	Bosch F 6 MPP 332	Bosch F 8 DPP332 NGK PFR 5 R-11
<b>Electrode gap</b>	0.031 in (0.8 mm)	0.039 in (1.0 mm)
<b>Tightening torque</b>	18 – 22 lb-ft (25 - 30 Nm)	15 – 22 lb-ft (20 – 30 Nm)

## Technical data

### Main Dimensions

#### ▼ Main Dimensions

<b>Model</b>	<b>C 230 Kompressor C 320</b>
<b>Overall vehicle length</b>	171.0 in (4345 mm)
<b>Overall vehicle width</b>	68.0 in (1728 mm)
<b>Overall vehicle height</b>	55.4 in (1406 mm)
<b>Wheelbase</b>	106.9 in (2715 mm)
<b>Track, front</b>	58.8 in (1493 mm)
<b>Track, rear</b>	57.6 in (1464 mm)



▼ Weights

Roof load max.	220 lb (100 kg)
Trunk load max.	220 lb (100 kg)

## Technical data

### Fuels, coolants, lubricants, etc.

#### ▼ Fuels, coolants, lubricants, etc.

##### Capacities

Vehicle components and their respective lubricants must match. Therefore use only brands tested and approved by

Mercedes-Benz. Please refer to the Factory Approved Service Products pamphlet, or inquire at your Mercedes-Benz Center.

	Model	Capacity	Fuels, coolants, lubricants, etc.
<b>Engine with oil filter</b>	C 230 Kompressor	5.8 US qt (5.5 l)	approved engine oils
	C 320	7.9 US qt (7.5 l)	
<b>Automatic transmission</b>		8.5 US qt (8.0 l)	MB Automatic Transmission Oil
<b>Manual transmission</b>		1.3 US qt (1.2 l)	MB Manual Transmission Oil
<b>Rear axle</b>		1.2 US qt (1.1 l)	Hypoid gear oil SAE 85 W 90
<b>Power steering</b>		approx. 1.1 US qt (1.0 l)	MB Power Steering Fluid (Pentosin CHF 11S)
<b>Front wheel hubs</b>		approx. 2.1 oz (60 g) each	High temperature roller bearing grease
<b>Cooling system</b>	C 230 Kompressor	approx. 5.9 US qt (5.6 l)	MB 325.0 Anticorrosion/Antifreeze Agent
	C 320	approx. 6.8 US qt (6.4 l)	

## Technical data

### Fuels, coolants, lubricants, etc.

	Model	Capacity	Fuels, coolants, lubricants, etc.
<b>Fuel tank including a reserve of</b>		16.4 US gal (62.0 l) 2.1 US gal (8.0 l)	Premium unleaded gasoline: Posted Octane 91 (Avg. of 96 RON / 86 MON)  Flexible Fuel Vehicles (identified by a label reading <b>Premium gasoline or E85 only!</b> on fuel filler flap): Alternative fuel: Ethanol fuel (E85)
<b>Air conditioning system</b>			R-134a refrigerant and special PAG lubricant oil (never R-12)
<b>Windshield washer and headlamp cleaning system:</b>			MB Windshield Washer Concentrate <sup>1</sup>
<b>Without headlamp cleaning system</b>		3.2 US qt (3 l)	
<b>With headlamp cleaning system</b>		6.4 US qt (6 l)	

<sup>1</sup> Use MB Windshield Washer Concentrate "S" and water for temperatures above freezing point or MB Windshield Washer Concentrate "S" and commercially available premixed windshield washer solvent/antifreeze for temperatures below freezing point. Follow suggested mixing ratios (▷ page 338).

## Technical data

### Fuels, coolants, lubricants, etc.

#### Engine oils

Engine oils are specifically tested for their suitability in our engines. Therefore, use only engine oils approved by Mercedes-Benz. Information on approved products is available in the Factory Approved Service Products pamphlet, or at your authorized Mercedes-Benz Center.



Always check the oil filler cap (> page 240) for important information pertaining to the engine oil needing to meet a specific Mercedes-Benz specification (e.g. MB 229.5). If such information is printed on the oil filler cap, only use an engine oil from the list of approved engine oils in the Factory Approved Service Products pamphlet that meets the specification indicated on the oil filler cap.



Using engine oils of other specification may cause the FSS to incorrectly determine the next service interval and will result in engine damage not covered by the Mercedes-Benz Limited Warranty.

Please follow FSS recommendations for scheduled oil changes. Failure to do so could result in engine damage not covered by the Mercedes-Benz Limited Warranty.

#### Engine oil additives

Do not blend oil additives with engine oil. They may damage the engine.

Damage or malfunctions resulting from blending oil additives are not covered by the Mercedes-Benz Limited Warranty.

#### Air conditioning refrigerant

R-134a (HFC) refrigerant and special PAG lubricating oil is used in the air conditioning system.

Never use R-12 (CFC) or mineral-based lubricating oil. Otherwise damage to the system will occur.

#### Brake fluid

During vehicle operation, the boiling point of the brake fluid is continuously reduced through the absorption of moisture from the atmosphere. Under extremely strenuous operating conditions, this moisture content can lead to the formation of bubbles in the system, thus reducing the system's efficiency.

Therefore, the brake fluid must be replaced every two years, preferably in the spring.

Only brake fluid approved by Mercedes-Benz is recommended. Your authorized Mercedes-Benz Center will provide you with additional information.

#### Premium unleaded gasoline



To maintain the engine's durability and performance, premium unleaded gasoline must be used. If premium unleaded is not available and low octane fuel is used, follow these precautions:

- Have the fuel tank only partially filled with unleaded regular and fill up with premium unleaded as soon as possible.
- Avoid full throttle driving and abrupt acceleration.
- Do not exceed an engine speed of 3000 rpm if the vehicle is loaded with a light load such as two persons and no luggage.
- Do not exceed  $\frac{2}{3}$  of maximum accelerator pedal position if the vehicle is fully loaded or operating in mountainous terrain.

#### Fuel requirements



Flexible Fuel Vehicles (identified by a label reading **Premium gasoline or E85 only!** on fuel filler flap) are designed to operate on premium unleaded gasoline or Ethanol fuel (E85), or any mixture of these two.

See notes on Flexible Fuel Vehicles (> page 334).

Use only premium unleaded meeting ASTM standard D 439:

- The octane number (posted at the pump) must be 91 min. It is an average of both the Research (R) octane number and the Motor (M) octane number:  $(R+M) / 2$ . This is also known as the ANTI-KNOCK INDEX.

Unleaded gasoline containing oxygenates such as ethanol, IPA, IBA and TBA can be used provided the ratio of any one of these oxygenates to gasoline does not exceed 10%; MTBE must not exceed 15%.

The ratio of methanol to gasoline must not exceed 3% plus additional cosolvents.

Using mixtures of ethanol and methanol is not allowed. Gasohol, which contains 10% ethanol and 90% unleaded gasoline, can be used.

These blends must also meet all other fuel requirements, such as resistance to spark knock, boiling range, vapor pressure, etc.

## Technical data

### Fuels, coolants, lubricants, etc.

#### Gasoline additives

A major concern among engine manufacturers is carbon build-up caused by gasoline. Mercedes-Benz recommends only the use of quality gasoline containing additives that prevent the build-up of carbon deposits.

After an extended period of using fuels without such additives, carbon deposits can build up especially on the intake valves and in the combustion area, leading to engine performance problems such as:

- Warm-up hesitation
- Unstable idle
- Knocking/pinging
- Misfire
- Power loss

Do not blend any specific fuel additives with fuel. This only results in unnecessary cost and may be harmful to engine operation.

Damage or malfunctions resulting from poor fuel quality or from blending specific fuel additives are not covered by the Mercedes-Benz Limited Warranty.

#### Flexible Fuel Vehicles

Flexible Fuel Vehicles are identified by a label reading **Premium gasoline or E85 only!** on fuel filler flap).

These vehicles are designed to operate on premium unleaded gasoline or Ethanol fuel (E85), or on any mixture of these two.

Ethanol fuel (E85) is a mixture of approximately 85% Ethanol and 15% unleaded gasoline.

#### Warning!



Ethanol fuel (E85) and its fumes are highly flammable, poisonous and burn easily. Ethanol fuel can cause serious injuries if ignited or if you come into contact with it or inhale fumes of it. Avoid inhalation of Ethanol fumes and skin contact with Ethanol. Extinguish all open flames before fueling. Never smoke or create sparks close to Ethanol.

#### Switching fuels

For best performance and driveability it is recommended to use either one or the other fuel. A refueling pattern that alternates between the two different fuels should be avoided if possible.

## Technical data

### Fuels, coolants, lubricants, etc.

When switching fuels, make sure:

- Fuel level is below half full.
- Fuel level is above reserve (reserve warning lamp is not lit).
- Amount of added fuel is more than 5 gallons (20 liters).
- Ignition is off during refill.
- Immediately after refueling engine is started and operated for at least five minutes.

These precautions and recommendations are supposed to prevent any difficulties when starting and operating the engine which otherwise may be experienced before the engine has fully adapted to the different fuel.

If in spite of these recommendations the engine does not perform properly, adding more gasoline (at least 3 gallons [12 liters]) to the fuel may improve the engine behavior.

#### Cold weather performance

It is possible that starting times will significantly increase at temperatures below 32°F (0°C). At low temperatures the use of a block heater is recommended (see your authorized Mercedes-Benz Center for further information). Rough idling may also be experienced at such temperatures before the engine is fully warmed up.



E85 fuel is unsuitable for use when ambient temperatures fall below 14°F (-10°C).

#### Hot weather performance

At ambient temperatures above 95°F (35°C) start times may increase and be accompanied by a rough idle following the start.

#### Cruising range

E85 fuel contains less energy per gallon than gasoline. To ensure that engine performance with Ethanol fuel is similar to that when using gasoline, the engine must burn more Ethanol fuel. As a result, it is to be expected that the fuel consumption will increase when using E85 compared to gasoline operation.



Use of E85 may reduce your driving range.

#### Maintenance

Please inform your Mercedes-Benz Center if you use or have used E85 fuel when your vehicle is delivered for maintenance or repairs.

## Technical data

### Fuels, coolants, lubricants, etc.

#### Coolants

The engine coolant is a mixture of water and anticorrosion/antifreeze, which provides:

- Corrosion protection
- Freeze protection
- Boiling protection (by increasing the boiling point)

The cooling system was filled at the factory with a coolant providing freeze protection to approximately  $-22^{\circ}\text{F}$  ( $-30^{\circ}\text{C}$ ) and corrosion protection.

If the antifreeze mixture is effective to  $-22^{\circ}\text{F}$  ( $-30^{\circ}\text{C}$ ), the boiling point of the coolant in the pressurized cooling system is reached at approximately  $266^{\circ}\text{F}$  ( $130^{\circ}\text{C}$ ).

The coolant solution must be used year-round to provide the necessary corrosion protection and increase boil-over protection. Refer to Service Booklet for replacement interval.

Coolant system design and coolant used stipulate the replacement interval. The replacement interval published in the Service Booklet is only applicable if MB 325.0 anticorrosion/antifreeze solution or other Mercedes-Benz approved products of equal specification (see Factory Approved Service Products pamphlet) are used to renew the coolant concentration or bring it back up to the proper level.

To provide important corrosion protection, the solution must be at least 45% anticorrosion/antifreeze (equivalent to freeze protection to approx.  $-22^{\circ}\text{F}$  [ $-30^{\circ}\text{C}$ ]).

If you use a solution that is more than 55% anticorrosion/antifreeze (freeze protection to approx.  $-49^{\circ}\text{F}$  [ $-45^{\circ}\text{C}$ ]), the engine temperature will increase due to the lower heat transfer capability of the solution. Therefore, do not use more than this amount of anticorrosion/antifreeze.

If the coolant level is low, water and MB 325.0 anticorrosion/antifreeze should be used to bring it up to the proper level (have cooling system checked for signs of leakage). Please make sure the mixture is in accordance with label instructions.

The water in the cooling system must meet minimum requirements, which are usually satisfied by normal drinking water. If you are not sure about the water quality, consult your authorized Mercedes-Benz Center.



## Technical data

### Fuels, coolants, lubricants, etc.

#### Anticorrosion/antifreeze

Your vehicle contains a number of aluminum parts. The use of aluminum components in motor vehicle engines necessitates that anticorrosion/antifreeze coolant used in such engines be specifically formulated to protect the aluminum

parts. (Failure to use such anticorrosion/antifreeze coolant will result in a significantly shortened service life.)

Therefore, the following product is strongly recommended for use in your vehicle: Mercedes-Benz 325.0 Anticorrosion/Antifreeze agent.

Before the start of the winter season (or once a year in hot southern regions), you should have the anticorrosion/antifreeze concentration checked. The coolant is also regularly checked each time you bring your vehicle to your authorized Mercedes-Benz Center for service.

#### Anticorrosion/antifreeze quantity

Model	Approx. freeze protection	
	-35°F (-37°C)	-49°F (-45°C)
C 230 Kompressor	3.0 US qt (2.8 l)	3.3 US qt (3.1 l)
C 320	3.4 US qt (3.2 l)	3.8 US qt (3.6 l)

## Technical data

### Fuels, coolants, lubricants, etc.

#### Windshield washer system and headlamp cleaning system

Both the windshield and headlamp washer systems are supplied from the windshield washer fluid reservoir.

The washer fluid reservoir has a capacity of approx.

- 6.4 US qt (6.0 l) in vehicles with headlamp cleaning system\*
- 3.2 US qt (3.0 l) in vehicles without headlamp cleaning system

- ▶ Refill the reservoir with MB Windshield Washer Concentrate and water (or concentrate and commercially available premixed windshield washer solvent/antifreeze, depending on ambient temperatures).

#### Warning!



Washer solvent/antifreeze is highly flammable. Do not spill washer solvent/antifreeze on hot engine parts, because it may ignite and burn. You can be seriously burned.

#### Windshield and headlamp washer fluid mixing ratio

For temperatures above freezing point use MB Windshield Washer Concentrate “S” and water:

- 1 part “S” to 100 parts water  
[40 ml “S” to 1 gallon (4 liters) water]

For temperatures below freezing point use MB Windshield Washer Concentrate “S” and commercially available premixed windshield washer solvent/antifreeze:

- 1 part “S” to 100 parts solvent  
[40 ml “S” to 1 gallon (4 liters) solvent].

### ▼ Consumer information

The following text is published as required of all manufacturers of passenger cars under Title 49, Code of U.S. Federal Regulations, Part 575 pursuant to the “National Traffic and Motor Vehicle Safety Act of 1966”.

#### Uniform tire quality grading

Quality grades can be found, where applicable, on the tire sidewall between tread shoulder and maximum section width. For example:

Tread wear	Traction	Temperature
200	AA	A

All passenger car tires must conform to federal safety requirements in addition to these grades.

#### Tread wear

The tread wear grade is a comparative rating based on the wear rate of the tire when tested under controlled conditions on a specified government test course. For example, a tire graded 150 would wear one and one-half (1½) times as well on the government course as a tire graded 100. The relative performance of tires depends upon the actual conditions of their use, however, and may depart significantly from the norm due to variations in driving habits, service practices and differences in road characteristics and climate.

## Technical data

### Consumer information

#### Traction

The traction grades, from highest to lowest are AA, A, B, and C. Those grades represent the tire’s ability to stop on wet pavement as measured under controlled conditions on specified government test surfaces of asphalt and concrete. A tire marked C may have poor traction performance.

#### Warning!



The traction grade assigned to this tire is based on straightahead braking traction tests, and does not include acceleration, cornering, hydroplaning, or peak traction characteristics.

## Technical data

### Consumer information

#### Temperature

The temperature grades are A (the highest), B, and C, representing the tire's resistance to the generation of heat and its ability to dissipate heat when tested under controlled conditions on a specified indoor laboratory test wheel. Sustained high temperature can cause the material of the tire to degenerate and reduce tire life, and excessive temperature can lead to sudden tire failure. Grade C corresponds to a level of performance which all passenger car tires must meet under the Federal Motor Vehicle Safety Standard No. 109. Grades B and A represent higher levels of performance on the laboratory test wheel than the minimum required by law.

#### Warning!



The temperature grade for this tire is established for a tire that is properly inflated and not overloaded. Excessive speed, underinflation, or excessive loading, either separately or in combination, can cause excessive heat build-up and possible tire failure.

**ABS**

(Antilock Brake System)

Prevents the wheels from locking up during braking so that the vehicle can continue to be steered.

**Alignment bolt**

Metal pin with thread. The centering pin is an aid used when changing a tire to align the wheel with the wheel hub.

**BabySmart™ airbag deactivation system**

This system detects if a special system compatible child restraint seat is installed on the front passenger seat. The system will automatically deactivate the passenger front airbag when such a seat is properly installed (indicator lamp PASS. AIRBAG OFF in the center console comes on). See your authorized Mercedes-Benz Center for availability.

**BabySmart™ compatible child seats**

Special restraint system for children. The sensor system for the passenger seat prevents deployment of the passenger front airbag if a BabySmart™ compatible child seat is installed.

**BAS**

(Brake Assist System)

System for potentially reducing braking distances in emergency braking situations. The system is activated when it senses an emergency based on how fast the brake is applied.

**Bi-Xenon headlamps\***

Headlamps which use an electric arc as the light source and produce a more intense light than filament headlamps. Bi-Xenon headlamps produce low beam and high beam.

**CAC**

(Customer Assistance Center)

Mercedes-Benz customer service center, which can help you with any questions about your vehicle and provide assistance in the event of a breakdown.

**CAN system**

(Controller Area Network)

Data bus network serving to control vehicle functions such as door locking or windshield wiping.

**Cockpit**

All instruments, switches, buttons and indicator/warning lamps in the passenger compartment needed for vehicle operation and monitoring.

## Technical terms

### **Collapsible tire**

An especially compact spare tire that must be inflated with a provided air pump before using. It should only be used to bring the vehicle to the nearest service station.

### **COMAND\***

(Cockpit Management and Data System)

Information and operating center for vehicle sound and communications systems, including the radio and navigation system, as well as other optional equipment (CD changer, telephone, etc.).

### **Control system**

The control system is used to call up vehicle information and to change component settings. Information and messages appear in the multifunction display. The driver uses the buttons on the multifunction steering wheel to navigate through the system and to adjust settings.

### **Cruise control**

Driving convenience system for automatically maintaining the vehicle speed set by the driver.

### **Engine number**

The number set by the manufacturer and placed on the cylinder block to uniquely identify each engine produced.

### **Engine oil viscosity**

Measurement for the inner friction (viscosity) of the oil at different temperatures. The higher the temperature an oil can tolerate without becoming thin, or the lower the temperature it can tolerate without becoming viscous, the better the viscosity.

### **ESP**

(Electronic Stability Program)  
Improves vehicle handling and directional stability.

### **ETD**

(Emergency Tensioning Device)  
Device which deploys in certain frontal and rear collisions exceeding the system's threshold to tighten the seat belts.  
->SRS

### **FSS**

(Flexible Service System)  
Service indicator in the multifunction display that informs the driver when the next vehicle maintenance service is due.

### **Gear range**

Number of gears which are available to the automatic transmission for shifting. The automatic gear shifting process can be adapted to specific operating conditions using the gear selector lever.

**GPS\***

(Global Positioning System)  
Satellite-based system for relaying geographic location information to and from vehicles equipped with special receivers. Employs CD digital maps for navigation.

**Instrument cluster**

The displays and indicator/warning lamps in the driver's field of vision, including the tachometer, speedometer and fuel gauge.

**Kickdown**

Depressing the accelerator past the point of resistance shifts the transmission down to the lowest possible gear. This very quickly accelerates the vehicle and should not be used for normal acceleration needs.

**Lock button**

Button on the door which indicates whether the door is locked or unlocked. Pushing the lock button down on an individual door from inside will lock that door.

**Memory function\***

Used to store three individual seat, steering wheel and mirror positions for each SmartKey.

**Menu**

The control system displays are arranged in menus. Each menu contains a number of commands for particular systems. In the Audio menu, for example, you will find the commands *Select radio station* or *Operate CD player*. Using commands, you can directly change the settings for your vehicle.

**MON**

(Motor Octane Number)  
The Motor Octane Number for gasoline as determined by a standardized method. It is an indication of a gasoline's ability to resist undesired detonation (knocking). The average of both the MON (Motor Octane Number) and ->RON (Research Octane Number) is posted at the pump, also known as ANTI-KNOCK INDEX.

**Multifunction display**

Display field in the instrument cluster used to present information provided by the control system.

**Multifunction steering wheel**

Steering wheel with buttons for operating the control system.

**Overspeed range**

Engine speeds within the red marking of the tachometer dial. Avoid this engine speed range, as it may result in serious engine damage that is not covered by the Mercedes-Benz Limited Warranty.

## Technical terms

### Power train

Collective term designating all components used to generate and transmit motive power to the drive axles, including

- engine
- clutch/torque converter
- transmission
- transfer case
- drive shaft
- differential
- axle shafts/axles

### Poly-V-belt drive

Drives engine-components (alternator, AC compressor, etc.) from the engine.

### Program mode selector switch

Used to switch the automatic transmission between standard operation S and winter operation C.

### Remote Vehicle Diagnostics

Transmission of vehicle data and current location to the Mercedes-Benz Customer Assistance Center for subscribers to Tele Aid service.

### Restraint systems

Seat belts, belt tensioners, airbags and child restraint systems. As independent systems, their protective functions complement one another.

### RON

(Research Octane Number)

The Research Octane Number for gasoline as determined by a standardized method. It is an indication of a gasoline's ability to resist undesired detonation (knocking). The average of both the →MON (Motor Octane Number) and RON (Research Octane Number) is posted at the pump, also known as ANTI-KNOCK INDEX.

### Shift lock

When the vehicle is parked, this lock prevents the gear selector lever from being moved out of position **P** without SmartKey turned and brake pedal depressed.



**SRS**

(Supplemental Restraint System)  
Seat belts, emergency tensioning device and airbags. Though independent systems, they are closely interfaced to provide effective occupant protection.

**Tele Aid\* System**

(Telematic Alarm Identification on Demand)  
The Tele Aid system consists of three types of response: automatic and manual emergency, roadside assistance and information. Tele Aid is initially activated by completing a subscriber agreement and placing an acquaintance call.  
The Tele Aid system is operational provided that the vehicle's battery is charged, properly connected, not damaged and cellular and GPS coverage is available.

**Tightening torque**

Force times lever arm (e.g. a lug wrench) with which threaded fasteners such as wheel bolts are tightened.

**Tire speed rating**

Part of tire designation; indicates the speed range for which a tire is approved.

**Traction**

Force exerted by the vehicle on the road via the tires.

**VIN**

(Vehicle Identification Number)  
The number set by the manufacturer and placed on the body to uniquely identify each vehicle produced.

**Voice control system\***

Voice control system for car phones, portable cell phones and audio systems (radio, CD, etc.).



**A**

- ABS 23, 73, 341
  - Malfunction indicator lamp 258
  - Messages in display 268
  - Warning lamp 258
- Accelerator position, automatic transmission 145
- Accident
  - In case of 51
- Activating
  - Air conditioning (cooling) 156
  - Air recirculation mode 154
  - Anti-theft alarm system 78
  - Central locking (control system) 129
  - Climate control 151
  - Defrost 154
  - Easy-entry/exit feature 130
  - ESP 77
  - Exterior headlamps 48
  - Exterior lamps 99
  - Hazard warning flasher 102
  - Headlamps 48
  - High beams 102
  - Ignition 31
  - Immobilizer 78
  - Rear fog lamp 100
  - Rear window defroster 149
  - Seat heater\* 94
  - Tow-away alarm 79
  - Windshield wipers 49
- Adding
  - Coolant 241
  - Engine oil 239
- Additional turn signals 293
- Adjustable air outlets
  - Rear passenger compartment 158
- Adjusting 32
  - Air distribution 153
  - Air volume 153
  - Backrest tilt 33, 35
  - Exterior rear view mirror 40
  - Head restraint height 34, 36, 91
  - Head restraint tilt 34, 36
  - Head restraints 92
  - Instrument cluster illumination 105
  - Interior rear view mirror 39
  - Manual seat 33
  - Mirrors 39
  - Rear seat head restraints 91
  - Seat cushion tilt 33, 35
  - Seat fore and aft adjustment 33, 35
  - Seat height 33, 35
  - Seats 32
  - Steering column height 38
  - Steering column length 38
  - Steering wheel 37
- Air conditioner (cooling)
  - Turning off 156
  - Turning on 156
- Air conditioner refrigerant 332

## Index

- Air distribution
  - Adjusting 153
- Air outlets
  - Rear passenger compartment 158
- Air pressure see Tire inflation
  - pressure 245
- Air recirculation mode 154
  - Activating 154
  - Deactivating 155
- Air volume
  - Adjusting 153
- Airbags 57
  - BabySmart™
    - airbag deactivation system 67, 341
  - Children 58
  - Front 61
  - PASS.AIRBAG OFF
    - indicator lamp 67, 263
  - Passenger 61
  - Safety guidelines 60
  - Side impact 61
  - Window curtain 61
- Alarm
  - Audible 72, 79
  - Canceling 79
  - Visual 78
- Alarm system
  - Anti-theft 78
- Alignment bolt 303
- Alignment bolt (vehicle tool kit) 341
- Anticorrosion/antifreeze 337
- Antiglare
  - Automatic 146
- Antilock brake system (ABS) 341
- Anti-theft alarm system
  - Arming 78
  - Canceling alarm 79
  - Disarming 79
- Anti-theft systems 78
  - Anti-theft alarm system 78
  - Immobilizer 78
  - Tow-away alarm 79
- Aquaplaning 227
- Armrest
  - Storage compartment in front of 201
  - Storage spaces 202
- Ashtray 203
- ATF (automatic transmission fluid) 241
- AUDIO menu 114
  - Selecting radio station 115
- Audio system 159
  - Audio and telephone, operation 159
  - Button and soft key operation 162
  - Cassette operation 172
  - CD operation 175
  - Operating and display elements 160
  - Operating safety 159
  - Operation 162
  - Radio operation 165
  - Switching off 162
  - Switching on 162
  - Telephone operation 179
- Automatic antiglare for rear view mirror 146
- Automatic central locking
  - Activating/deactivating (control system) 129

- Automatic climate control
  - Deactivating 156
- Automatic headlamp mode 99
- Automatic lighting control
  - Activating 103
  - Deactivating 103
- Automatic locking when driving 87
- Automatic transmission 139
  - Accelerator position 145
  - Emergency operation (Limp Home Mode) 145
  - Fluid level 241
  - Gear ranges 141
  - Gear selector lever position 142
  - Gear shifting malfunctions 145
  - Kickdown 145
  - Manual shifting 140
  - One-touch gearshifting 140
  - Program mode selector switch 144
  - Selector lever position 139
- Starting with 45
- Transmission fluid 241
- Winter program mode 144
- Auxiliary fuse box 318
- B**
- BabySmart™
  - Airbag deactivation system 67, 341
  - Compatible child seats 67, 341
  - Self-test 68
- Backrest
  - Folding forward 198
  - Folding rearward 198
- BAS 74, 341
  - Messages in display 265
- Batteries, SmartKey
  - Changing 290
  - Check lamp 83
  - Checking 84
- Battery discharged
  - Jump starting 310
- Battery, vehicle 242, 307
  - Charging 308
  - Disconnecting 308
  - Messages in display 269
  - Reconnecting 308
  - Reinstalling 308
  - Removing 308
- Bi-Xenon headlamps\* 341
- Bi-Xenon type
  - Front lamp bulbs 296
- Block heater 248
- Bolts
  - For spare wheel 287
- Brake assist system (BAS) 341
- Brake fluid 234, 332
- Brake lamp bulbs 294
- Brake lamp, high mounted 294
- Brake pads
  - Message in display 270
- Brakes 224

## Index

- Warning lamp 259
- Break-in period 222
- Bulbs, replacing 293
  - Additional turn signals 293
  - Brake lamps 294
  - Fog lamps 293
  - Front lamps 293
  - High beam 293
  - High mounted brake lamp 294
  - License plate lamps 294, 299
  - Low beam 293
  - Parking lamps 293, 294, 296, 297
  - Rear fog lamp 294
  - Rear fog lamps 298
  - Side marker lamps 294, 298
  - Standing lamps 293, 294, 296, 297
  - Tail lamp assemblies 294, 298
  - Turn signal lamps 293, 294
- Button
  - Audio system 162
- C**
- CAC (Customer Assistance Center) 341
- Calling up
  - Range (distance to empty) 134
  - Service indicator 250
- CAN system 341
- Capacities
  - Fuels, coolants, lubricants, etc. 330
- Cargo compartment
  - Lighting 104
- Cassette operation
  - Playing cassettes 172
- Cassette player
  - Operating 116
- Catalytic converter 231
- CD changer\* 175
- CD operation 175
- CD player
  - Operating 116
- Center console 25
- Lower part 26
- PASS.AIRBAG OFF indicator lamp 263
- Upper part 25
- Centigrade
  - Setting temperature units 123
- Central locking
  - From inside 88
  - Switch 88
  - Switching on/off (control system) 129
  - Unlocking from inside 88
- Central locking switch 88
- Changing
  - Batteries (SmartKey) 290
  - Key setting 129
- Changing CDs 175
- Charging
  - Vehicle battery 308
- CHECK ENGINE
  - malfunction indicator lamp 260
- Check gas cap
  - Message in display 277

- Checking
  - Coolant level 235, 241
  - Oil level 235, 237
  - Tire inflate pressure 235
  - Vehicle lighting 235
- Child safety 65
  - Airbags 58
  - Infant and child restraint systems 62, 65
  - LATCH child seat mounts 70
- Child seat mounts see LATCH child seat mounts 70
- Cigarette lighter 204
- Cleaning
  - Cup holder 255
  - Gear selector lever 255
  - Hard plastic trim items 255
  - Headlamps 148
  - Headliner and shelf below rear window 255
  - Instrument cluster 255
  - Leather upholstery 256
  - Light alloy wheels 254
  - MB Tex upholstery 256
  - Plastic and rubber parts 256
  - Seat belts 255
  - Steering wheel 255
  - Upholstery 256
  - Windows 254
  - Windshield 50
  - Wiper blades 254
  - Wood trims 256
- Climate control 150
  - Adjusting 153
  - Defogging windshield 153
  - Defrosting 154
  - Rear window defroster 149
  - Setting the temperature 153
- Clock 23, 122
- Closing
  - Glove box 200
  - Hood 237
  - power window with SmartKey 188
  - Roller sunblind for the sliding/pop-up roof 189
- Side windows 187
- Sliding/pop-up roof 190, 292
- Trunk lid 86
- Windows 186
- Windows with SmartKey 188
- Closing sliding/pop-up roof
  - In an emergency 292
- Cockpit 20, 341
- Cockpit management and data system (COMAND\*) 342
- Collapsible tire 342
- COMAND\* 342
- COMAND\* see separate operating instructions
- Combination switch 102
  - High beam flasher 102
  - Turn signals 48
  - Windshield wipers 49
- Consumer information 339
- Control and operation of radio transmitters 230
- Control system 109, 342

## Index

- AUDIO menu 114
  - Convenience submenu 129
  - Display digital speedometer 114
  - Functions 110, 113
  - Instrument cluster submenu 122
  - Lighting submenu 125
  - Malfunction memory menu 117
  - Menus 112, 113, 343
  - Multifunction display 109
  - Multifunction steering wheel 110
  - NAV menu 117
  - Selecting radio system 115
  - Settings menu 118
  - Standard display menu 114
  - Submenus 111, 113
  - TEL\* menu 134
  - Trip computer menu 132
  - Vehicle submenu 128
  - Convenience submenu 129
    - Activating easy-entry/exit feature 130
    - Setting key dependency 131
    - Setting parking position for exterior rear view mirror 132
  - Coolant 241, 336
    - Adding 241
    - Anticorrosion/antifreeze quantity 336
    - Capacities 330
    - Checking level 241
    - Messages in display 271, 272
    - Temperature 232
    - Temperature indicator 106
    - Warning lamp 272
  - Coolant level
    - Checking 235, 241
  - Cruise control 194, 342
    - Canceling 195
    - Driving downhill 195
    - Driving uphill 195
    - Fine adjustment 196
    - Message in display 274
    - Saving current speed 195
    - Setting speeds 196
  - Cruise control lever 194
  - Cruising range, fuel 335
  - Cup holder
    - Cleaning 255
    - In front seat armrest 201
  - Customer Assistance Center (CAC) 341
- D**
- Daytime running lamp mode 100
    - Setting 125, 126
  - Deactivating
    - Air conditioning (cooling) 156
    - Air recirculation mode 155
    - Alarm 79
    - Anti-theft alarm system 79
    - Central locking (control system) 129
    - Climate control 151
    - Cruise control 195
    - Defrost 154
    - ESP 76



- Exterior lamps 99
- Exterior lamps delayed shut-off 127
- Front fog lamps 127
- Hazard warning flasher 102
- Headlamps 53
- Immobilizer 78
- Interior lighting delayed shut-off 128
- Rear window defroster 149
- Seat heater 94
- Tow-away alarm 80
- Deep water see Standing water 229
- Defogging
  - Windshield 153
- Defrosting 154
- Delayed shut-off
  - Exterior lamps 127
  - Interior lighting 128
- Dialing
  - A number (telephone) 136
- Difficulties
  - While driving
    - see Problems while driving 50
  - With starting 46
- Digital speedometer 114
- Direction of rotation (tires) 245
- Discharged battery
  - Jump starting 310
- Disconnecting
  - Vehicle battery 308
- Display
  - Selecting 125
- Display elements
  - Audio system 160
- Displays
  - Digital speedometer 114
  - Messages 238, 264
  - Selecting 125
  - Service indicator 249
  - Showing malfunctions 118
  - Symbol messages 268
  - Text messages 265
- Distance to empty (range)
  - Calling up 132
- Door control panel 28
- Door handle 28
- Door unlock
  - With Tele Aid\* 213
- Doors
  - Message in display 274
  - Opening from inside vehicle 85
  - Opening from outside 83
- Downhill driving
  - Cruise control 195
- Downshifting 138, 140
- Drink holder see Cup holder 201
- Drinking and driving 223
- Driving
  - Aquaplaning 227
  - General instructions 41, 223
  - In winter 228
  - Problems 50

## Index

- Safety systems 73
  - Through standing water 229
- Driving abroad 230
- Driving instructions 223
- Driving off 225
- Driving safety systems
  - ABS 73
  - BAS 74
  - ESP 75
- Driving systems 194
  - Cruise control 194
  - Driving safety systems 73

### E

- Easy-entry/exit feature 89
  - Activating 130
  - Interrupting movement 89, 130
- Electrical fuses 317
- Electrical system
  - Technical data 327
- Electronic Stability Program
  - see ESP 23, 75, 342

- Emergency call system\* 206
- Emergency calls
  - Initiating an emergency call 209
  - Telephone\* 184
  - With Tele Aid\* 208
- Emergency operation
  - (Limp Home Mode) 145
- Emergency operations
  - Closing sliding/pop-up roof 292
  - Locking the vehicle 289
  - Opening sliding/pop-up roof 292
  - Remote door unlock 213
  - Unlocking the vehicle 288
- Emergency release
  - Trunk lid 86
- Emergency tensioning device
  - see ETD 64, 342
- Emission control 231
- Emission control label 322
- Ending
  - A call (telephone) 135

- Engine
  - Compartment 236
  - Message in display 260
  - Starting with
    - automatic transmission 45
    - Starting with manual transmission 44
    - Starting with the key 45
  - Technical data 324
  - Turning off with the key 53
- Engine cleaning 253
- Engine compartment 236
  - Fuse box in 317
  - Hood 236
- Engine malfunction
  - indicator lamp 23, 260
- Engine number 342
- Engine oil 237, 332
  - Adding 239
  - Additives 332
  - Checking level 237
  - Consumption 237
  - Display messages 275
  - Filler neck 240

- Messages in display 238, 276
  - Viscosity 342
- Engine oil level see Oil level 235
- ESP 23, 75, 342
  - Messages in display 266
  - Switching off 76
  - Switching on 77
  - Synchronizing 266
  - Warning lamp 261
- ETD 342
  - Safety guidelines 60
- ETD (Emergency tensioning device) 64
- Ethanol fuel
  - At the gas station 233
  - Switching fuels 334
- Exterior lamp switch 98
- Exterior lamps
  - Delayed shut-off 127
- Exterior rear view mirror
  - Activating parking position 147
- Exterior rear view mirrors
  - Adjusting 40
  - Parking position for 132
- F**
- Fahrenheit
  - Setting temperature units 123
- Fastening the seat belts 41
- Fine adjustment
  - Cruise control 196
- First aid kit 284
- Flat tire 301
  - Inflating the spare tire 304
  - Lowering the vehicle 306
  - Mounting the spare wheel 301
  - Preparing the vehicle 301
  - Spare wheel 285
- Flexible fuel vehicles 334
  - At the gas station 233
  - Switching fuels 334
- Flexible Service System (FSS) 249, 342
- Fog lamp, front 101
- Fog lamp, rear 101, 294
- Fog lamps
  - Replacing bulbs 293
- Fog lamps, front
  - Messages in display 278
  - Replacing bulbs 294
- Front airbags 61
- Front fog lamp
  - Switching on 101
- Front lamps
  - Bi-Xenon type 296
  - Halogen-type 295
  - Messages in display 277, 279
  - Replacing bulbs 293, 295
  - Switching on 98
- Front seat backrest
  - Folding backrest back 37
  - Folding backrest forward 36

## Index

- Front seat head restraints
    - Installing 90
    - Manual seat 90
    - Power seat\* 91
    - Removing 90
  - Front seats
    - Heater 93
  - FSS (Flexible Service System) 249, 342
  - Fuel 234
    - Additives 334
    - Cruising range 335
    - E85 (Ethanol fuel) 335
    - Fuel reserve warning lamp 262
    - Gasoline additives 334
      - Premium
        - unleaded gasoline 234, 331, 333
    - Requirements 333
    - Reserve warning 23
    - Switching (Flexible fuel vehicle) 334
    - Technical data 330
  - Fuel additives 334
  - Fuel consumption statistics
    - After start 133
    - Since last reset 133
  - Fuel filler flap 233
    - Locking 233
    - Opening 291
    - Unlocking 233
  - Fuel requirements 333
  - Fuel reserve tank
    - Message in display 277
  - Fuel tank
    - Capacity 331
    - Filler flap 233
  - Fuels, coolants, lubricants etc.
    - Capacities 330
  - Functions (control system) 110, 113
    - Resetting 120
  - Fuse box 317
  - Fuse chart 317
  - Fuse extractor 318
  - Fuses 317
  - Auxiliary fuse box in trunk 318
  - Fuse box in engine compartment 317
  - Fuse box in passenger compartment 317
  - Fuse chart 317
  - Fuse extractor 318
- ### G
- Garage door opener 27, 214
  - Gasoline see Fuel 234
    - Gasoline additives 334
  - Gear range 342
    - Automatic transmission 141
    - Limiting 141
    - Shifting into optimal 140
  - Gear range limit
    - Canceling 140
  - Gear selector lever 291
    - Cleaning 255
    - Position 142
    - Unlocking manually 291
  - Global
    - Locking 83
    - Unlocking 83

- Global Positioning System (GPS) 343
- Glove box 21, 200
  - Closing 200
  - Opening 200
- Good visibility 146
- GPS 343
- H**
- Halogen-type
  - Front lamp bulbs 295
- Hands-free microphone 27
- Hard plastic trim items
  - Cleaning 255
- Hazard warning flasher 102
  - Switching off 102
  - Switching on 102
- Head restraints 90
  - Manual seats 34
  - Power seats\* 36
- Rear seats 91
- Headlamp cleaning system 243
- Headlamps
  - Automatic control 99
  - Bi-Xenon 341
  - Bi-Xenon type\*
    - Replacing bulbs 296
  - Cleaning 253
  - Cleaning system 148, 243
  - Halogen-type
    - Replacing bulbs 295
  - Refilling washer fluid 243
  - Switching off 53
  - Switching on 48
  - Washer fluid 338
  - Washer system 338
- Headliner and shelf below rear window
  - Cleaning 255
- Heated seats 93
- Height adjustment
  - Head restraints 34, 36, 91
  - Seat belts 43
  - Steering wheel 37
- High beam flasher 102
- High beam headlamps
  - Messages in display 278
  - Replacing bulbs 293, 295
  - Switching on 102
- High beam headlamps xenon type
  - Replacing bulbs 296
- High mounted brake lamp 294
- Hood 236
  - Closing 237
  - Message in display 277
  - Opening 236
- Hydroplaning see Aquaplaning 227
- I**
- Identification labels 322
- Ignition 31
  - Switching on 45

## Index

- Immobilizer 78
    - Activating 78
    - Deactivating 78
  - Infant and child restraint systems 65
    - Installing 69
    - LATCH child seat mounts 70
  - Inflating
    - Spare tire 304
  - Information
    - Button for Tele Aid\* 211
  - Installing
    - Infant and child restraint systems 69
    - Towing eye bolt 316
    - Wiper blades 300
  - Instrument cluster 22, 105, 343
    - Cleaning 255
    - Coolant temperature indicator 106
    - Illumination 105
    - Lamps in 261–262
    - Multifunction display 109
    - Outside temperature indicator 107
    - Selecting language 124
  - Instruments and controls see Cockpit 20
  - Interior lighting 103
    - Activating automatic control 103
    - Deactivating automatic control 103
    - Delayed shut-off 128
    - Manual operation 103
  - Interior rear view mirror
    - Adjusting 39
    - Antiglare 146
  - Interior storage spaces 200
    - Armrest 202
    - Cup holder 201
    - Glove box 200
    - Parcel net in
      - front passenger footwell 203
    - Storage compartment in
      - front of armrest 201
- ## J
- Jack 285, 286
  - Jump starting 310
- ## K
- Key dependency memory
    - Settings 131
  - Key positions in starter switch 31
  - Key, mechanical 288, 289
  - Key, SmartKey
    - Battery check lamp 83
    - Changing the batteries 290
    - Checking the batteries 84
    - Factory setting 83
    - Global locking 83
    - Global unlocking 83
    - Individual setting 83
    - Loss of 84
    - Positions in starter switch 31
    - Remote controls 82
    - Restoring to factory setting 83

- Starting the engine 45
- Unlocking with 30
- Kickdown 145, 343
- Kilometers/miles in speedometer 124
- Km/h or mph in speedometer 124
- L**
- Labels, identification 322
- Lamp bulbs, exterior 293
- Lamps
  - Fog lamps 101
- Lamps, exterior
  - Front 293
  - Light sensor 278
  - Messages in display 277, 279-??
  - Rear 294
- Lamps, indicator and warning
  - ABS 258
  - Airbag Off 61
  - Battery (SmartKey) 83
  - Brakes 259
- CHECK ENGINE 260
- Coolant 271
- Engine diagnostics 260, 262
- ESP 261
- Fuel reserve 262
- Instrument cluster 261-262
- Seat belts 262
- Service indicator 249
- SRS 57
- Turn signals 23
- Language
  - Multifunction display 124
  - Setting 124
- LATCH child seat mounts 70
  - Folding back 70
- Layout of poly-V-belt drive 323
- Leather upholstery
  - Cleaning 256
- License plate lamps
  - Messages in display 278
- Replacing bulbs 294, 299
- Light alloy wheels
  - Cleaning 254
  - Technical data 326
- Light sensor 278
- Lighter see Cigarette lighter 204
- Lighting 98
  - Automatic headlamp mode 99
  - Combination switch 102
  - Daytime running lamp mode 100
  - Exterior lamp switch 98
  - Fog lamps 101
  - Front fog lamp 101
  - High beam flasher 102
  - High beams 102
  - Instrument cluster illumination 105
  - Interior 103
  - Locator lighting 100
  - Low beam 98
  - Manual headlamp mode 99

## Index

- Night security illumination 100
- Parking lamps 98
- Rear fog lamp 101
- Settings (control system) 125
- Trunk 104
- Limiting the gear range 141
- Limp Home Mode 145
- Loading 197
  - Instructions 199
  - Roof rack 197
  - Split rear bench seat 197
- Locator lighting 100
  - Setting 126
- Lock button 343
- Lock buttons 343
- Locking 52, 82
  - Fuel filler flap 233
  - Global, SmartKey 83
  - Vehicle in an emergency 289
- Loss of keys 84
- Loss of Service and Warranty Information Booklet 321
- Low beam headlamps
  - Messages in display 279
  - Replacing bulbs 293, 295
- Lowering
  - Vehicle 306
- Lubricants
  - Technical data 330
- Luggage cover 197
- M**
- Main dimensions 328
- Maintenance 249
  - Vehicles with E85 fuel 335
- Malfunction
  - Displaying 118
- Malfunction memory 117
  - Calling up 117
- Manual headlamp mode 99
- Manual operations
  - Fuel filler flap 291
- Interior lighting control 103
- Locking the vehicle 289
- Sliding/pop-up roof 292
- Unlocking gear selector lever 291
- Unlocking the driver's door 288
- Unlocking the trunk lid 289
- Manual seat
  - Adjusting 33
  - Adjusting backrest tilt 33
  - Adjusting head restraint height 34
  - Adjusting head restraint tilt 34, 36
  - Adjusting seat cushion tilt 33
  - Adjusting seat height 33
  - Front seat head restraints 90
  - Seat fore and aft adjustment 33
- Manual transmission 137
  - Shifting into reverse 138
  - Starting with 44
- MB Tex upholstery
  - Cleaning 256



- Mechanical key 288, 289
- Memory function 95, 343
  - Recalling positions from memory 96
  - Storing exterior rear view mirror parking positions 97
  - Storing key dependent settings 96
- Menus 110
  - AUDIO 114
  - Control system 343
  - In control system 112, 113
  - Malfunction memory 117
  - NAV 117
  - Settings menu 118
  - Standard display 114
  - Submenus 111
  - TEL\* 134
  - Trip computer 132
- Microphone
  - Hands-free microphone 27
- Miles/kilometers in speedometer
  - Setting 124
- Mirrors
  - Adjusting 39
  - Automatic antiglare for rear view mirror 146
  - Exterior rear view mirror 40
  - Exterior rear view mirror parking positions 132
  - Interior rear view mirror 39
  - Storing exterior rear view mirror parking position 97
- MON 234
- MON (Motor Octane Number) 343
- Mph or km/h in speedometer 124
- Multifunction display 109, 343
  - Displaying gear range 141
  - Selecting language 124
  - Standard display 113
- Multifunction display messages
  - ABS 268
  - BAS 265
  - Battery 269
  - Brake fluid 270
  - Brake pads 270
- Check engine 260
- Check gas cap 277
- Coolant 272
- Coolant level 271
- Cruise control 274
- Display 274
- Doors 274
- Engine 260
- Engine oil 276
- ESP 266
- Fuel reserve tank 277
- Hood 277
- Key 277
- Lamps 277, 279-??
- Parking brake 269
- Steering column
  - not properly locked 282
- Steering gear oil level 282
- Tele Aid\* 283
- Telephone\* 283
- Trunk lid 283

## Index

Washer fluid 283  
Multifunction steering wheel 24, 110, 343  
Buttons 110

### N

Navigation system  
Operating 117  
See separate COMAND\* operating instructions  
Night security illumination 100  
Setting 127

### O

Occupant safety 56  
Airbags 57  
Children and airbags 58  
Children in the vehicle 65  
Fastening the seat belt 41  
Infant and child restraint systems 65  
LATCH child seat mounts 70  
Seat belts 41, 60  
Odometer, main 23

### Oil

Adding 239  
Consumption 237  
Dipstick 237  
Filler neck 240  
Viscosity 342  
Oil level  
Checking 235  
One-touch gearshifting 140  
Canceling gear range limit 140  
Downshifting 140  
Upshifting 140

### Opening

Ashtray 203  
Doors from the inside 85  
Fuel filler flap 233  
Fuel filler flap manually 291  
Glove box 200  
Hood 236  
power window with SmartKey 188  
Roller sunblind for the  
sliding/pop-up roof 189

Side windows 187  
Sliding/pop-up roof 190, 292  
Sliding/pop-up roof in an  
emergency 292  
Sliding/pop-up roof with  
SmartKey 192  
Trunk 85  
Windows 186, 187  
Windows with SmartKey 188

### Operating

Audio system 159  
Cassette player 116  
CD player 116  
COMAND\* see separate operating instructions  
Navigation system 117  
Radio 115  
Radio transmitters 230  
Telephone\* 134, 159, 179  
Operating safety  
Audio system 159  
Operator's Manual 10  
Ornamental moldings 253

- Outside temperature indicator 107
- Overdue service 249
- Overhead control panel 27
- Overspeed range 343
- P**
- Paintwork 252
- Panic alarm 72
  - Panic button on SmartKey 72
- Panorama sliding/pop-up roof\* 189
- Parcel net
  - In front passenger footwell 203
- Parking 52, 225
- Parking brake 46, 52
  - Engaging 52
  - Message in display 269
  - Releasing 46
- Parking lamps
  - Replacing bulbs 293, 294, 296, 297
  - Switching on 98
- Parking position
  - Exterior rear view mirrors 97, 132
- Parts see Spare parts service 320
- PASS.AIRBAG OFF
  - indicator lamp 67, 263
- Passenger compartment 230
  - Fuse box in 317
  - Interior lighting 103
  - Interior rear view mirror 39
  - Parcel net
    - in front passenger footwell 203
- Passenger safety see Occupant safety 56
- Pedals 223
- Performance
  - In cold weather 335
  - In hot weather 335
- Phone book\*
  - Loading 136
  - Quick search 136
- Phone number\*
  - Dialing 136
  - Redialing 136
- Plastic and rubber parts
  - Cleaning 256
- Playing
  - CDs 177
- Poly-V-belt drive 344
  - Layout 323
- Positions (Memory function\*)
  - Recalling from memory 96
  - Storing into memory 96
- Power assistance 223
- Power seat\*
  - Adjusting backrest tilt 35
  - Adjusting head restraint height 36
  - Adjusting seat cushion tilt 35
  - Adjusting seat height 35
  - Front seat head restraints 91
  - Seat fore and aft adjustment 35
- Power train 344
- Power washer 252
- Power window
  - Opening and closing with SmartKey 188

## Index

- Power windows 186
  - Side windows 186
  - Synchronizing 188
- Practical hints
  - First aid kit 284
  - Fuses 317
  - Lamp in center console 263
  - Lamps in instrument cluster 258
  - Messages in the display 264
  - Spare wheel 285
  - Spare wheel bolts 287
  - Symbol messages 268
  - Text messages 265
  - Towing the vehicle 313
  - Vehicle jack 286
  - Vehicle tool kit 285
- Premium unleaded gasoline 333
- Problems
  - While driving 50
- Program mode selector switch 344
- Automatic transmission 144
- Programme type ID
  - see PTY ID
- PTY ID 168
- Q**
- Quick search
  - Phone book\* 136
- R**
- Radio
  - Selecting stations 115
  - Station search 115
  - Station selection setting 128
- Radio operation 165
- Radio see Radio operation
- Radio transmitters
  - Control and operation 230
- Range (distance to empty)
  - Calling up 134
- Rapid seat heating
  - Switching on 94
- RDS
  - Programme type ID 168
  - PTY ID 168
- Reading lamp 27
- Rear bench seat
  - Foldable 197
- Rear fog lamp 294
  - Bulb 294
  - Switching on 101
- Rear head restraint tilt 92
- Rear lamp bulbs
  - Replacing 298
- Rear lamps see Tail lamps
- Rear passenger compartment
  - Adjustable air outlets 158
- Rear seat head restraints 91, 93
  - Adjusting 91
  - Folding back 92
  - Installing 93
  - Placing upright 92

- Removing 93
- Rear seats
  - Adjusting head restraint height 91
- Rear view mirror automatic antiglare 146
- Rear view mirrors see Mirrors
- Rear window defroster 149
  - Activating 149
  - Deactivating 149
- Reconnecting
  - Vehicle battery 308
- Refrigerant
  - Air conditioner 332
- Refuelling 233
- Regular checks 234
- Reinstalling vehicle battery 308
- Remote controls
  - SmartKey 82
- Remote door unlock
  - With Tele Aid\* 213
- Remote Vehicle Diagnostics 344
- Removing
  - Vehicle battery 308
  - Wheel 303
  - Wiper blades 300
- Replacing
  - Backup lamp bulbs 298
  - Brake lamp bulbs 298
  - Bulbs 293
  - Front lamp bulbs 295
  - Front turn signal bulbs 295, 296
  - High beam bulbs 295
  - High beam bulbs
    - (xenon-type headlamps) 296
  - License plate lamp bulbs 299
  - Low beam bulbs 295
  - Parking lamp bulbs 296, 297
  - Rear fog lamp bulbs 298
  - Rear lamp bulbs 294, 298
  - Rear turn signal bulbs 298
  - Side marker lamp bulbs 298
  - Standing lamp bulbs 296, 297
- Wiper blades 300
- Reset button in
  - the instrument cluster 119
- Reset knob in
  - the instrument cluster 119, 120
- Resetting
  - All functions (control system) 119
  - All functions of a submenu 120
  - Fuel consumption 133
  - Service indicator (FSS) 250
  - Trip odometer 107
- Residual heat utilization 344
- REST
  - (Residual engine heat utilization) 344
- Restraint system see
  - Infant and child restraint systems 65, 69
- Reverse (manual transmission)
  - Shifting into 138
- Rims 325
- Roadside assistance
  - Tele Aid\* 210
- Roller sunblind for the sliding/pop-up roof
  - Closing 189
  - Opening 189

## Index

RON 234  
RON (Research Octane Number) 344  
Roof rack 197  
Rotating wheels 246  
Rubber parts  
    Cleaning 256

### S

Safety  
    Occupant 56  
Safety belts see Seat belts 41  
Safety systems  
    Driving 73  
Saving current speed 195  
Searching  
    Radio station 115  
Seat belt force limiter 64  
Seat belt outlet height adjustment 43  
Seat belts 62  
    Cleaning 255  
    Fastening 41

    Height adjustment 43  
    Proper use of 43, 63  
    Safety guidelines 60  
    Warning lamp 262  
Seat heater\*  
    Switching off 94  
    Switching on 94  
Seats 89  
    Adjusting 32  
    Easy entry/exit feature 89  
    Heater 93  
    Manual 33  
    Rapid seat heating 94  
    Split rear bench seat 197  
Selecting  
    Display 125  
Selector lever 23  
    Lock 45  
    Position  
        (automatic transmission) 23, 139

Self-test  
    BabySmart™  
        airbag deactivation system 68  
    Tele Aid\* 207  
Service  
    Calling up the service indicator 250  
    Major service (Service B) 249  
    Minor service (Service A) 249  
    Overdue 249  
    Spare parts 320  
    Types 249  
    When due 249  
Service and Warranty Booklet  
    Loss of 321  
Service indicator 249  
    Calling up 250  
    Clearing 249, 250  
Service life (tires) 245  
Service System see FSS 249  
Setting  
    Convenience functions 121, 129  
    Cruise control 195

- Daytime running lamp mode 125, 126
- Exterior rear view mirror
  - parking position 97
- Higher speed in cruise control 196
- Hours (clock) 122
- Individual vehicle settings 118
- Interior lighting delayed shut-off 128
- Key dependent memory 131
- Lamps and lighting
  - (control system) 125
- Language, multifunction display 124
- Locator lighting 126
- Lower speed in cruise control 196
- Miles/kilometers in
  - speedometer 124
- Minutes (clock) 122
- Night security illumination 127
- Parking position for
  - exterior rear view mirrors 132
- Slower speed in cruise control 196
- Speed in cruise control 196
- Speedometer display mode 124
- Station selection mode 128
- Temperature (interior) 153
- Temperature indicator 123
- Time display mode (Clock) 123
- Units
  - Speedometer 124
  - Temperature 123
- Settings
  - Convenience functions 129
  - Factory, SmartKey 83
  - Individual (SmartKey) 131
  - Lighting (control system) 125
  - Menus and submenus 111
  - Resetting all (control system) 119
  - Resetting in the submenu 120
  - Selective 83
- Settings menu
  - Functions in 118
  - Individual vehicle settings 118
  - Submenus 119, 120
- Shift lock 344
- Shifting
  - Gear selector lever positions 142
  - Into optimal gear range (automatic transmission) 140
  - Into reverse (manual transmission) 138
- Side impact airbags 61
- Side marker lamps
  - Replacing bulbs 294, 298
- side markers
  - Cleaning 253
- Side windows
  - Automatic closing 187
  - Automatic opening 187
  - Cleaning 254
  - Closing 186, 187
  - Closing fully (Express-close) 187
  - Closing with SmartKey 188
  - Opening 186, 187
  - Opening fully (Express-open) 187
  - Opening with SmartKey 188
  - Stopping 187
  - Synchronizing power windows 188

## Index

- Signal strength (telephone\*) 135
- Simultaneous wiping and washing
  - Windshield wipers 50
- Single wipe 50
- Sliding/pop-up roof
  - Closing 190, 292
  - Opening 190, 292
  - Opening with SmartKey 192
  - Stopping 191
- SmartKey 82
  - Locking and unlocking 82
  - Opening and closing
    - power window with 188
  - Opening and closing windows 188
  - Opening the
    - sliding/pop-up roof with 192
  - Unlocking with 30
- Snow chains 248
- Soft keys
  - Audio system 162
- Spare parts service 320
- Spare tire
  - Inflating 304
- Spare wheel\* 285
  - Bolts 287
  - Mounting 301
- Speed
  - Saving current 195
- Speed settings
  - Cruise control 196
- Speedometer 23
  - Settings units 124
- Speedometer display mode
  - Selecting 124
- Split rear bench seat 197
- SRS 63, 345
  - Indicator lamp 262
- Standing lamps 98
  - Replacing bulbs 293, 294, 296, 297
- Standing water
  - Driving instructions 229
- Starter switch 21, 31
  - Positions 31
- Starting difficulties 46
- Starting position 31
- Starting the engine 44
- Station (radio)
  - Search 115
- Station selection
  - Setting 128
- Steering column
  - Height adjustment 38
  - Length adjustment 38
  - Messages in display 282
- Steering gear oil
  - Message in display 282
- Steering wheel
  - Adjusting 37
  - Buttons 24
  - Cleaning 255
  - Electrical adjustment 38
  - Height adjustment 38



- Manual adjustment 38
  - Stolen vehicle
    - Tracking services 214
  - Stopping
    - Sliding/pop-up roof 191
    - Windows 187
  - Storage compartments
    - Armrest 201
    - Glove box 200
    - Ventilated compartments 157
  - Storage spaces
    - Cup holder 201
  - Storing (Memory function\*)
    - Positions into memory 96
  - Submenus
    - Convenience 129
    - For settings 111
    - In control system 113
    - Instrument cluster 122
    - Lighting 125
  - Resetting functions in
    - Control system 120
    - Selecting 120
    - Settings menu 119, 120
    - Vehicle 128
  - Sun visors 148
  - Supplemental Restraint System (SRS) 345
  - Switching
    - Fuel (Flexible fuel vehicle) 334
  - Switching off
    - Audio system 162
    - Automatic central locking (control system) 129
    - Delayed (exterior lamps) 127
    - Engine 53
    - ESP 76
    - Hazard warning flasher 102
    - Headlamps 53
    - Seat heating 94
  - Switching on
    - Audio system 162
    - Automatic central locking (control system) 129
  - ESP 77
  - Fog lamps 101
  - Front fog lamp 101
  - Hazard warning flasher 102
  - Headlamps 48
  - High beams 102
  - Rapid seat heating 94
  - Rear fog lamp 101
  - Seat heating\* 94
  - Windshield wipers 49
  - Synchronizing
    - ESP 266
    - Panorama sliding/pop-up roof\* and roller sunblinds\* 193
    - Power windows 188
- T**
- Tachometer 23, 107
    - Overspeed range 107
  - Tail lamps
    - Cleaning 253
    - Replacing bulbs 294, 298

## Index

- Tar stains 252
- Technical data 332
  - Brake fluid 332
  - Coolant 330
  - Coolants 336
  - Electrical system 327
  - Engine 324
  - Engine oil 332
  - Engine oil additives 332
  - Flexible fuel vehicles 334
  - Fuel requirements 333
  - Fuels 330
  - Gasoline additives 334
  - Lubricants 330
  - Main dimensions 328
  - Premium unleaded gasoline 333
  - Rims and tires 325
  - Weights 329
  - Windshield and headlamp washer system 331, 338
- Tele Aid
  - Information 211
  - Initiating an emergency call manually 209
  - Roadside assistance 210
  - Tele Aid System 206
- Tele Aid System 345
- Tele Aid\* 206
  - Emergency calls 208
  - Messages in display 283
  - Remote door unlock 213
  - Stolen vehicle tracking services 214
  - System self-check 207
  - Upgrade signals 212
- Telephone\* 24, 205
  - Answering a call 135
  - Dialing a number from the phone book 136
  - Emergency call 184
  - Ending a call 135
  - Hands-free microphone 27
  - Loading phone book\* 136
  - Messages in display 283
  - Operating 134
  - Operation 179
  - Redialing 136
- Temperature
  - coolant temperature indicator 106
  - Display mode 123
  - Grades of tires 340
  - Setting interior temperature 153
  - Setting units in display 123
  - Tires 246
- Tightening torque 345
- Tightening torque (Wheel bolts) 306
- Tilt
  - Backrest 33
  - Head restraint 34, 36
  - Seat cushion 33
- Time
  - Setting hours 122
  - Setting minutes 122
- Time display
  - Setting 123

- Tire inflation pressure
  - Checking 235, 245
- Tire speed rating 228, 345
- Tire traction 227
- Tires 244, 325
  - Collapsible 342
  - Consumer information 339
  - Direction of rotation 245
  - Driving instructions 226
  - Retreads 244
  - Rims and tires 325
  - Service life 245
  - Temperature 246
  - Temperature grades 340
  - Tread depth 247
  - Wear pattern 246
  - Winter 247
- Tools 285
- Tow-away alarm 25, 79
- Arming 79
- Disarming 79
  - Disarming for transport 79
- Towing eye bolt (vehicle tool kit)
  - Installing 316
- Towing the vehicle 313
- Tracking services
  - For stolen vehicle 214
- Traction 144, 339, 345
- Transmission see
  - Automatic transmission 241
- Tread depth (tires) 247
- Treadwear 339
- Trim panel
  - Opening 318
- Trip computer 132
- Trip odometer
  - Resetting 107
- Trunk
  - Auxiliary fuse box 318
  - Lighting 104
  - Opening 85
- Trunk lid
  - Closing 86
  - Emergency release 86
  - Message in display 283
- Turn signal lamps
  - Replacing bulbs 293, 294
- Turn signals 48
  - Additional in mirrors 293
  - Cleaning lenses 253
  - Front bulbs 293, 295, 297
  - Indicator lamps 23
  - Rear bulbs 294, 299
- Turning off
  - Engine 53
- U**
- Units
  - Setting speedometer units 124
  - Setting temperature units 123
- Unlocking 30, 82

## Index

Driver's door in an emergency 288  
Fuel filler flap 233  
Gear selector lever manually 291  
Global 83  
In an emergency 288  
Individual settings 83  
Trunk lid in an emergency 289  
Vehicle in an emergency 213  
With the SmartKey 30  
Upgrade signals  
  Tele Aid\* 212  
Uphill driving  
  Cruise control 195  
Upholstery  
  Cleaning 256  
Upshifting 140  
Useful features 200  
  Ashtrays 203  
  Cigarette lighter 204  
  Interior storage spaces 200

Tele Aid\* 206  
Telephone\* 205

## V

Vehicle  
  Individual settings 118, 121  
  Locking 25  
  Locking in an emergency 289  
  Lowering 306  
  Performance in cold weather 335  
  Performance in hot weather 335  
  Service battery 307  
  Towing 313  
  Unlocking 25  
  Unlocking in an emergency 288  
  With flexible fuel 334  
Vehicle battery 307  
Vehicle care 251  
  Cup holder 255  
  Engine cleaning 253  
  Gear selector lever 255

Hard plastic trim items 255  
Headlamps 253  
Instrument cluster 255  
Leather upholstery 256  
Light alloy wheels 254  
MB Tex upholstery 256  
Ornamental moldings 253  
Paintwork 252  
Plastic and rubber parts 256  
Power washer 252  
Seat belts 255  
side markers 253  
Steering wheel 255  
Tail lamps 253  
Tar stains 252  
Turn signals 253  
Upholstery 256  
Vehicle washing 253  
Window cleaning 254  
Wiper blades 254

- Wood trims 256
- Vehicle jack 286
- Vehicle lighting
  - Checking 235
- Vehicle tool kit 285
  - Alignment bolt 285
  - Spare fuses 285
  - Special fuse puller 285
  - Towing eye bolt 285
  - Vehicle jack 285
  - Wheel bolts 285
  - Wheel wrench 285
- Vehicle washing 253
- Ventilated storage compartment 157
- Ventilation
  - Storage compartment 157
- VIN (Vehicle Identification Number) 345
- Voice control system\* 345
- Voice recognition system\*
  - Hands-free microphone 27

**W**

- Warning sounds
  - Drivers seat belts 62
  - Parking brake 47
- Warranty coverage 321
- Washer fluid see Windshield washer fluid
- Washing the vehicle 251
- Wear pattern (tires) 246
- Weights 329
- Wheel change
  - Tightening torque 306
- Wheels
  - Rotating 246
  - Tires and wheels 244
- Window curtain airbags 61
- Windows see Side windows
- Windshield
  - Defogging 153
  - Refilling washer fluid 243
  - Replacing wiper blades 300

- Washer fluid 243, 338
- Washer system 338
- Windshield washer fluid 338
  - Message in display 283
  - Mixing ratio 338
  - Refilling 243
  - Wiping with 50
- Windshield washer system 338
- Windshield wipers 49
  - Fast wiper speed 49
  - Replacing wiper blades 300
  - Single wipe 50
  - Switching on 49
  - Wiping with
    - windshield washer fluid 50
- Winter driving 247
  - Block heater 248
  - Snow chains 248
  - Tires 247
  - Transmission program mode 144
- Winter driving instructions 228

## Index

Winter tires 247

Wiper blades

    Cleaning 254

    Installing 300

    Removing 300

    Replacing 300

Wiping

    And washing simultaneously 50

    Interval 49

    With windshield washer fluid 50

Wood trims

    Cleaning 256

## X

Xenon headlamps

    Bi-Xenon 341

### Service and Literature

Your authorized Mercedes-Benz Center has trained technicians and original Mercedes-Benz parts to service your vehicle properly. For expert advice and quality service, see your authorized Mercedes-Benz Center.

If you are interested in obtaining service literature for your vehicle, please contact your authorized Mercedes-Benz Center. We consider this the best way for you to obtain accurate information for your vehicle.

For further information you can find us on the Mercedes-Benz web-site [www.mbusa.com](http://www.mbusa.com) or [www.mercedes-benz.ca](http://www.mercedes-benz.ca).

#### Warning!



To help avoid personal injury, be extremely careful when performing any service work or repairs. Improper or incomplete service or the use of incorrect or inappropriate parts or materials may damage the vehicle or its equipment, which may in turn result in personal injury.

If you have questions about carrying out any type of service, turn to the advice of an authorized Mercedes-Benz Center.

We reserve the right to modify the technical details of the vehicle as given in the data and illustrations of this Operator's Manual. Re-printing, translation and copying, even of excerpts, is not permitted without our prior authorization in writing.

Title illustration no. P00.01-2284-31

Press time 08 / 20 / 03

GSP / TIP

Printed in Germany

