



Mercedes-Benz



# G-Class Operator's Manual

G 500

Our company and staff congratulate you on the purchase of your new Mercedes-Benz.

Your selection of our product is a demonstration of your trust in our company name. Further, it exemplifies your desire to own an automobile that will be as easy as possible to operate and provide years of service.

Your Mercedes-Benz represents the efforts of many skilled engineers and craftsmen. To ensure your pleasure of ownership, and for your safety and that of your passengers, we ask you to make a small investment of your time:

- Please read this manual carefully before putting it aside. Then return it to your vehicle where it will be handy for your reference.
- Please abide by the recommendations contained in this manual. They are designed to acquaint you with the operation of your Mercedes-Benz.
- Please abide by the warnings and cautions contained in this manual. They are designed to help improve the safety of the vehicle operator and occupants.

We extend our best wishes for many miles of safe, pleasurable driving.

DaimlerChrysler AG

## Introduction

Product information .....	7
Roadside assistance .....	10
Where to find it .....	14
Reporting Safety Defects .....	16

## Instruments and controls

Instruments and controls .....	18
Center console .....	20
Door control panel .....	22
Overhead control panel .....	23

## Operation

Vehicle keys .....	26
Start lock-out .....	28
General notes on the central locking system .....	28
Central locking system .....	29
Radio frequency and infrared remote control .....	29
Locking and unlocking .....	31

Choosing global or selective mode on remote control .....	31
Opening and closing windows and sliding / pop-up roof from outside .....	32
Panic button .....	33
Mechanical keys .....	33
Doors .....	34
Locking and unlocking driver's door manually .....	36
Tailgate .....	37
Locking and unlocking the tailgate manually .....	38
Locking the tailgate separately .	39
Central locking switch .....	40
Automatic central locking .....	41
Emergency unlocking in case of accident .....	41
Antitheft alarm system .....	42
Tow-away alarm .....	43
Easy-entry/exit feature .....	44
Front seat adjustment .....	45

Synchronizing head restraints and seat adjustment fore, aft .....	47
Removal and installation of front seat head restraints .....	51
Seat heater, front .....	52
Seat heater, rear .....	54
Seat belts and integrated restraint system .....	56
Seat belts .....	56
Seat belt nonusage warning system .....	57
BabySmart™ airbag deactivation system .....	63
Self-test BabySmart™ without special child seat installed .....	63
Supplemental restraint system (SRS) .....	64
Emergency tensioning retractor (ETR) .....	65
Airbags .....	66
Safety guidelines for the seat belt, emergency tensioning retractor and airbag .....	71

Infant and child restraint systems .....	73	Flexible service system (FSS) .....	124	Storage compartments, armrest and cup holder .....	162
Steering wheel adjustment (electrical) .....	78	Engine oil level indicator .....	127	Glove box .....	163
Inside rear view mirror .....	79	Exterior lamp switch .....	129	Ashtrays .....	168
Antiglare night position .....	79	Headlamp mode .....	130	Lighter .....	170
Exterior rear view mirrors .....	80	Night security illumination .....	132	Floor mat .....	170
Instrument cluster .....	84	Locator lighting .....	133	Split rear seat bench .....	171
Multifunction steering wheel, multifunction display .....	90	Headlamp cleaning system .....	133	Rear seat head restraints .....	173
Trip and main odometer and sub menu .....	94	Combination switch .....	134	Enlarged cargo area .....	174
Audio systems .....	96	Rear window wiper/washer .....	138	Cargo tie-down rings .....	174
Radio .....	96	Hazard warning flasher switch .....	139	Partition net .....	175
CD player .....	97	Climate control .....	140	Loading instructions .....	178
Telephone .....	98	Rear passenger compartment adjustable air outlets .....	150	Parcel net in front passenger footwell .....	180
Navigation system .....	103	Power windows .....	151	Cargo area cover blind .....	180
Trip computer .....	104	Sliding/pop-up roof .....	154	Roof racks .....	181
Malfunction/warning message memory .....	106	Interior lighting .....	156	Brush guard .....	182
Individual settings .....	108	Door entry lamps .....	157	Telephone, general .....	184
Setting the audio volume .....	122	Rear interior lamps .....	158	Cellular telephone .....	184
Coolant temperature gauge .....	123	Cargo compartment lamps .....	159	Garage door opener .....	185
		Sun visors .....	161		
		Illuminated vanity mirrors .....	161		
		Interior .....	162		

## Driving

Control and operation of radio transmitters .....	190
The first 1 000 miles (1 500 km) .....	191
Maintenance .....	191
Tele Aid .....	192
Catalytic converter .....	202
Emission control .....	203
Starter switch .....	204
Starting and turning off the engine .....	206
Automatic transmission .....	207
Parking brake .....	215

Driving instructions .....	216
Drive sensibly – save fuel .....	216
Drinking and driving .....	216
Pedals .....	216
Power assistance .....	217
Brakes .....	217
Driving off .....	218
Parking .....	219
Tires .....	219
Snow chains .....	222
Winter driving instructions .....	222
Deep water .....	224
Passenger compartment .....	225
Traveling abroad .....	225
Off-Road driving .....	226
Cruise control .....	234
Brake assist system (BAS) .....	237

Antilock brake system (ABS) .....	239
Four-wheel electronic traction system (4-ETS) .....	241
Electronic Brake Booster (EBB) .....	242
Electronic stability program (ESP) .....	243
Transfer case .....	247
Switching transfer case .....	248
A few words about differentials and differential locks .....	251
Differential locks .....	253
What you should know at the gas station .....	258
Check regularly and before a long trip .....	261

**Instrument cluster display**

Malfunction and indicator lamps in the instrument cluster .....	264
On-board diagnostic system .....	265
Check engine malfunction indicator lamp .....	265
Brake warning lamp .....	266
Supplemental restraint system (SRS) indicator lamp .....	267
Fuel reserve warning .....	268
ABS malfunction indicator lamp .....	269
Electronic stability program (ESP) – warning lamp .....	270
Seat belt nonusage warning lamp .....	270
Malfunction and indicator lamp in the center console .....	271
AIRBAG OFF indicator lamp .....	271

Malfunction and warning messages in the multifunction display .....	272
DISPLAY DEFECTIVE (engine control unit) .....	273
DISPLAY DEFECTIVE (several systems) .....	273
BATTERY / ALTERNATOR .....	274
ANTILOCK BRAKE SYSTEM .....	275
BRAKE ASSIST .....	276
BRAKE PAD WEAR .....	277
BRAKE FLUID .....	277
PARKING BRAKE .....	278
SEAT BELT SYSTEM .....	278
ELEC. STABIL. PROG. (Electronic stability program) .....	279
COOLANT (coolant level) .....	280
COOLANT (coolant temperature) .....	281
ENGINE OIL LEVEL .....	282

LIGHTING SYSTEM .....	283
LIGHT SENSOR .....	285
DOOR .....	285
TRUNK OPEN .....	286
HOOD .....	286
TELEPHONE – FUNCTION .....	287
TELE AID .....	287
WASHER FLUID .....	288
RESTRAINT SYSTEM .....	289
KEY .....	289
FUEL RESERVE .....	290
UNDERVOLTAGE .....	290
ELECTRONIC BRAKE BOOSTER (EBB) .....	291
ENGINE AIR FILTER .....	291
TC SHIFT .....	292
TC SHIFT CONDITIONS .....	292
TC IN NEUTRAL .....	293
TRANSFER CASE .....	293

## Practical hints

First aid kit, vehicle tools and jack .....	296	Vehicle jack .....	308	Turn signal lamp, side .....	335
CD-changer .....	296	Wheels .....	310	Front and rear side marker lamps .....	337
Fuses .....	297	Tire replacement .....	310	Taillamp assemblies .....	339
Electrical outlet .....	301	Rotating wheels .....	311	License plate lamp .....	340
Stowing items in the vehicle .....	301	Spare wheel cover .....	312	Rear fog lamp / Backup lamp ...	341
Hood .....	302	Spare wheel .....	313	Changing batteries in the electronic key .....	343
Checking engine oil level .....	304	Changing wheels .....	314	Synchronizing remote control .....	345
Automatic transmission fluid level .....	305	Tire inflation pressure .....	318	Emergency operation of sliding/pop-up roof .....	346
Engine oil consumption .....	305	Battery .....	319	Manual release for fuel filler flap .....	347
Coolant level .....	306	Jump starting .....	321	Replacing wiper blades .....	348
Adding coolant .....	306	Towing the vehicle .....	324		
Windshield washer/headlamp cleaning system .....	307	Transmission selector lever, manually unlocking .....	327		
Windshield and headlamp washer fluid mixing ratio .....	307	Stranded vehicle .....	327		
		Exterior lamps .....	328		
		Headlamp assembly .....	329		
		Fog lamp, front .....	332		
		Turn signal lamp, front .....	334		



**Vehicle care**

Cleaning and care of the vehicle .....	350
Power washer .....	351
Tar stains .....	351
Paintwork, painted body components .....	351
Engine cleaning .....	352
Vehicle washing .....	352
Ornamental moldings .....	352
Headlamps, taillamps, turn signal lenses .....	352
Window cleaning .....	353
Wiper blades .....	353
Light alloy wheels .....	353
Instrument cluster .....	353
Steering wheel and gear selector lever .....	353
Cup holder .....	354
Seat belts .....	354

Headliner .....	354
Upholstery .....	354
Hard plastic trim items .....	354
Plastic and rubber parts .....	354

**Technical data**

Spare parts service .....	356
Warranty coverage .....	356
Identification labels .....	357
Layout of poly-V-belt drive .....	358
Technical data .....	359
Fuels, coolants, lubricants etc. – capacities .....	361
Engine oils .....	363
Engine oil additives .....	363
Air conditioner refrigerant .....	363
Brake fluid .....	363
Premium unleaded gasoline .....	364
Fuel requirements .....	364
Gasoline additives .....	365
Coolants .....	365
Consumer information .....	367

**Index**

Index .....	369
-------------	-----

## **Product information**

Kindly observe the following in your own best interest:

We recommend using Mercedes-Benz original parts as well as conversion parts and accessories explicitly approved by us for your vehicle model.

We have tested these parts to determine their reliability, safety and their special suitability for Mercedes-Benz vehicles.

We are unable to make an assessment for other products and therefore cannot be held responsible for them, even if in individual cases an official approval or authorization by governmental or other agencies should exist. Use of such parts and accessories could adversely affect the safety, performance or reliability of your vehicle. Please do not use them.

Mercedes-Benz original parts as well as conversion parts and accessories approved by us are available at your authorized Mercedes-Benz Light Truck Center where you will receive comprehensive information, also on permissible technical modifications, and where proper installation will be performed.

**Operator's manual**

This Operator's Manual contains a great deal of useful information. We urge you to read it carefully and familiarize yourself with the vehicle before driving.

For your own safety and longer service life of the vehicle, we urge you to follow the instructions and warnings contained in this manual. Ignoring them could result in damage to the vehicle or personal injury to you or others. Vehicle damage caused by failure to follow instructions is not covered by the Mercedes-Benz Limited Warranty.

Your vehicle may have some or all of the equipment described in this manual. Therefore, you may find explanations for optional equipment not installed in your vehicle. If you have any questions about the operation of any equipment, your authorized Mercedes-Benz Light Truck Center will be glad to demonstrate the proper procedures.

**Service and warranty information**

The Service and Warranty Information Booklet contains detailed information about the warranties covering your Mercedes-Benz, including:

- New Light Truck Limited Warranty,
- Emission System Warranty,
- Emission Performance Warranty,
- California, Maine, Massachusetts, and Vermont Emission Control System Warranty (California, Maine, Massachusetts, and Vermont only),
- State Warranty Enforcement Laws (Lemon Laws).

### **Important notice for California retail buyers of Mercedes-Benz automobiles**

Under California law you may be entitled to a replacement of your vehicle or a refund of the purchase price or lease price, if Mercedes-Benz USA, LLC and/or its authorized repair or service facilities fail to fix one or more substantial defects or malfunctions in the vehicle that are covered by its express warranty after a reasonable number of repair attempts. During the period of 18 months from original delivery of the vehicle or the accumulation of 18 000 miles on the odometer of the vehicle, whichever occurs first, a reasonable number of repair attempts is presumed for a retail buyer or lessee if one or more of the following occurs: (1) the same substantial defect or malfunction results in a condition that is likely to cause death or serious bodily injury if the vehicle is driven, that defect or malfunction has been subject to repair two or more times, and you have directly notified Mercedes-Benz USA, LLC in writing of the need for its repair and have given us a direct opportunity to perform a repair ourselves, (2) the same substantial defect or malfunction of a less serious nature than category (1) has been subject to repair four or more times and you have directly notified us of the need for its repair and given us the opportunity to repair ourselves, or (3) the vehicle is out of service by reason of repair of the same or different substantial defects or malfunctions for a cumulative total of more than 30 calendar days. Written notification should be sent to us, not a dealer, at Mercedes-Benz USA, LLC, Customer Assistance Center, One Mercedes Drive, Montvale, NJ 07645-0350.

### **Maintenance**

The Service Booklet describes all the necessary maintenance work which should be performed at regular intervals.

Always have the Service Booklet with you when you take the vehicle to your authorized Mercedes-Benz Light Truck Center for service. The service advisor will record each service in the booklet for you.

### **Roadside assistance**

The Mercedes-Benz Roadside Assistance Program provides factory trained technical help in the event of a breakdown. Calls to the toll-free Roadside Assistance number:

**1-800-FOR-MERCEdes (in the USA)**

**1-800-387-0100 (in Canada)**

will be answered by Mercedes-Benz Customer Assistance Representatives 24 hours a day, 365 days a year.

Roadside assistance will be provided in accordance with standard program guidelines which include providing service to the vehicle up to a reasonable distance from a paved roadway. We will make every effort to assist in a breakdown situation, however, the accessibility of your vehicle will be determined by our authorized Mercedes-Benz Light Truck Center technician or the tow service provider on a case by case basis and may be a factor in our ability to respond.

Additional charges may be applicable for a breakdown location determined not to be a reasonably accessible roadside location as determined by our authorized technician and tow service provider.

For additional information refer to the Mercedes-Benz Roadside Assistance Program brochure in your glove box.

### **Change of address or ownership**

If you change your address, be sure to send in the “Change of Address Notice” found in the Service and Warranty Information Booklet, or simply call the Mercedes-Benz Customer Assistance Center (in the USA) at 1-800-FOR-MERCEdes, or Customer Service (in Canada) at 1-800-387-0100. It is in your own interest that we can contact you should the need arise.

If you sell your Mercedes, please leave all literature with the vehicle to make it available to the next operator.

If you bought this vehicle used, be sure to send in the “Notice of Purchase of Used Car” found in the Service and Warranty Information Booklet, or call the Mercedes-Benz Customer Assistance Center (in the USA) at 1-800-FOR-MERCEdes, or Customer Service (in Canada) at 1-800-387-0100.

### **Operating your vehicle outside the USA or Canada**

If you plan to operate your vehicle in foreign countries, please be aware that:

- Service facilities or replacement parts may not be readily available,
- unleaded gasoline for vehicles with catalytic converters may not be available; the use of leaded fuels will damage the catalyts,
- gasoline may have a considerably lower octane rating, and improper fuel can cause engine damage.

We continuously strive to improve our product, and ask for your understanding that we reserve the right to make changes in design and equipment. Therefore, information, illustrations and descriptions in this Operator's Manual might differ from your vehicle.

Optional equipment is also described in this manual, including operating instructions wherever necessary. Since they are special-order items, the descriptions and illustrations herein may vary slightly from the actual equipment of your vehicle.

If there are any equipment details that are not shown or described in this Operator's Manual, your authorized Mercedes-Benz Light Truck Center will be glad to inform you of correct care and operating procedures.

The Operator's Manual and Service Booklet are important documents and should be kept with the vehicle.

## **Warning!**

**This Sport Utility Vehicle is designed for both on-road and off-road use. It can go places and perform tasks for which conventional 2-wheel drive passenger cars were not intended. This vehicle will handle and maneuver differently from conventional passenger cars in driving conditions which may occur on streets, highways and off-road use.**

**This vehicle has a higher ground clearance and a higher center of gravity than many passenger cars. As with other vehicles of this type, if you make sharp turns at excessive speeds or abrupt maneuvers, the vehicle may roll over or may go out of control and crash. Utility vehicles have a significantly higher rollover rate than other types of vehicles. Failure to operate this vehicle safely may result in an accident, rollover of the vehicle, and severe or fatal injury.**

**Before you start to drive this vehicle, read the Operator's Manual. Take time to become familiar with the driving characteristics of this vehicle. Be sure you are familiar with all vehicle controls. Learn how your vehicle handles on different road surfaces. Do not attempt sharp turns at excessive speeds or abrupt maneuvers or other unsafe driving actions that can cause loss of vehicle control. When driving off-road or working the vehicle, do not overload it. And, always wear your seat belts at all times. In a rollover crash, an unbelted person is significantly more likely to die than a person wearing a seat belt.**



### Where to find it

The Operator's Manual is divided into eight sections:

- **Instruments and controls:** An overview of all the controls that can be operated from the driver's seat.
- **Operation:** Information on the vehicle's equipment and its operation.
- **Driving:** Important information on driving.
- **Instrument cluster display:** Indicator lamps on the instrument cluster with brief instructions.
- **Practical hints:** Assistance and instructions in the event of an emergency.
- **Car care:** Instructions on caring for your vehicle.
- **Technical data:** All the important technical data for your vehicle as well as consumer information such as fuels, coolants, lubricants etc. is contained here.
- **Index:** Key terms to help you find a topic quickly.

Other documents may also be supplied, depending on your vehicle's equipment.

Explanation of color used:

Warning notices for the protection of yourself and others appear on red background.

## Problems with your vehicle

If you should experience a problem with your vehicle, particularly one that you believe may affect its safe operation, we urge you to immediately contact your authorized Mercedes-Benz Light Truck Center to have the problem diagnosed and corrected if required. If the matter is not handled to your satisfaction, please discuss the problem with the Mercedes-Benz Light Truck Center management, or if necessary contact us at the following addresses:

In the USA: Customer Assistance Center  
Mercedes-Benz USA, LLC  
One Mercedes Drive  
Montvale, NJ 07645-0350

In Canada: Customer Relations Department  
Mercedes-Benz Canada, Inc.  
849 Eglinton Avenue East  
Toronto, Ontario, M4G 2L5

For the USA only:

The following text is published as required of manufacturers under Title 49, Code of U.S. Federal Regulations, Part 575 pursuant to the “National Traffic and Motor Vehicle Safety Act of 1966”.

### **Reporting Safety Defects**

If you believe that your vehicle has a defect which could cause a crash or could cause injury or death, you should immediately inform the National Highway Traffic Safety Administration (NHTSA) in addition to notifying Mercedes-Benz USA, LLC.

If NHTSA receives similar complaints, it may open an investigation, and if it finds that a safety defect exists in a group of vehicles, it may order a recall and remedy campaign. However, NHTSA cannot become involved in individual problems between you, your retailer, or Mercedes-Benz USA, LLC.

To contact NHTSA, you may either call the Auto Safety Hotline toll-free at 1-888-327-4236 or write to: NHTSA, U.S. Department of Transportation, Washington, D.C. 20590. You can also obtain other information about motor vehicle safety from the Hotline.

## **Instruments and controls**

Instruments and controls .....	18
Center console .....	20
Door control panel .....	22
Overhead control panel .....	23

Instruments and controls



For adjustment of air outlets, refer to climate control, see page 140.

- 1 Exterior lamp switch, see page 129
- 2 Headlamp cleaning system, see page 133
- 3 Exterior rear view mirror adjustment switch, see page 80
- 4 Combination switch, see page 134
- 5 Control lever for Linguatronic voice control system (optional), see separate Operating Instructions
- 6 Instrument cluster, see page 84
- 7 Multifunction steering wheel, see page 90
- 8 Horn (with key in steering lock position 1 or 2), Driver airbag, see page 68
- 9 Starter switch, see page 204
- 10 Glove box, see page 163

Instruments and controls

Center console

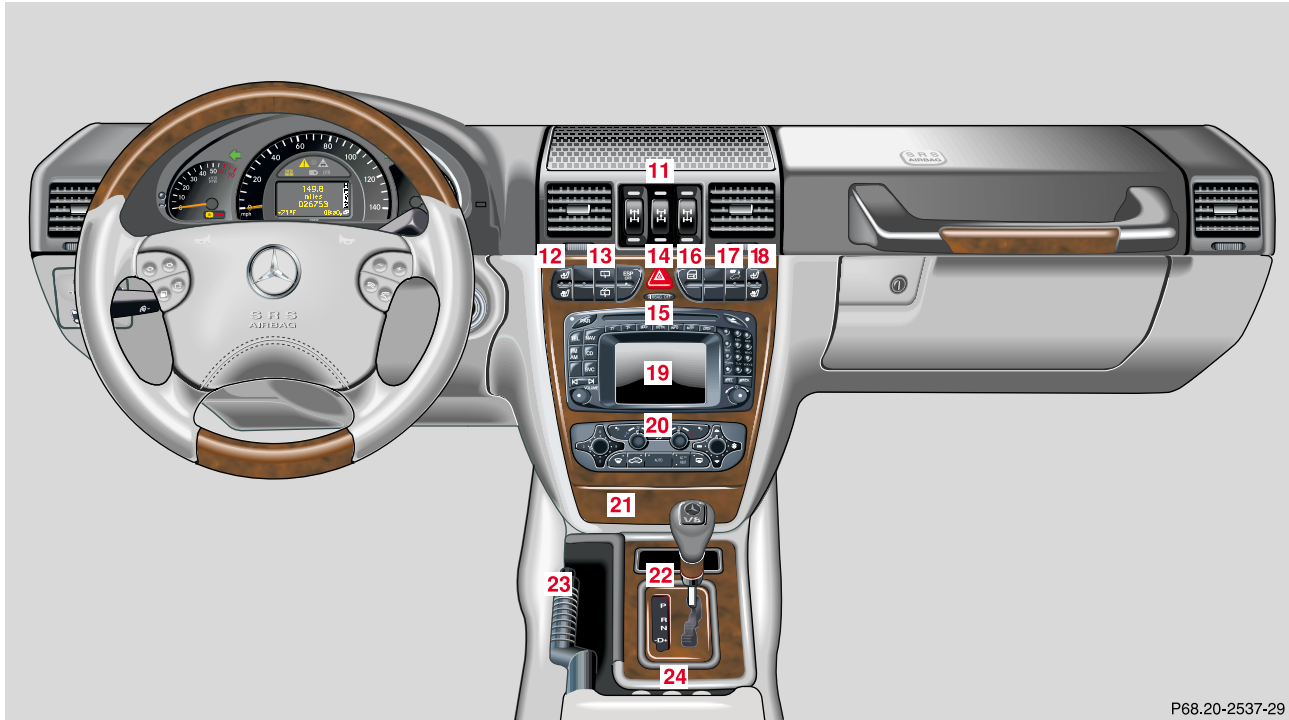

- 11** Differential-lock switch, see page 253
- 12** Left front seat heater switch, see page 52
- 13** Switch for rear window washer/wiper, see page 138
- 14** Hazard warning flasher switch, see page 139
- 15** AIRBAG OFF indicator lamp, see page 271
- 16** Central locking switch, see page 40
- 17** Antitheft alarm system, see page 42
  - Switch for Tow-away alarm, see page 43
- 18** Right front seat heater switch, see page 52
- 19** COMAND system (Cockpit Management and Data System), see separate operating instructions
- 20** Automatic climate control, see page 140
- 21** Ashtray with lighter, see page 168
- 22** Automatic transmission, see page 207
- 23** Parking brake, see page 215
- 24** Transfer case, see page 247



## Instruments and controls

22

## Door control panel

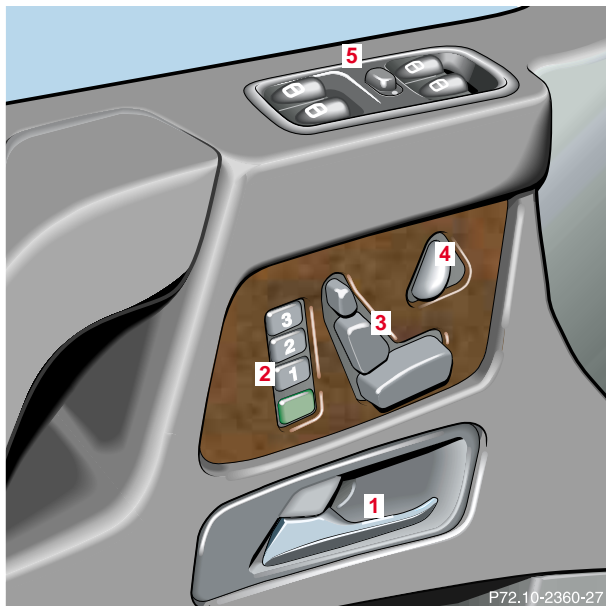

- 1 Door handle, pull to open, see page 34
- 2 Memory function, for storing seat, steering wheel and exterior rear view mirrors, see page 48
- 3 Front seat adjustment switch, see page 45
- 4 Steering wheel adjustment switch, see page 78
- 5 Power window switches, see page 151

P72.10-2360-27

## Overhead control panel

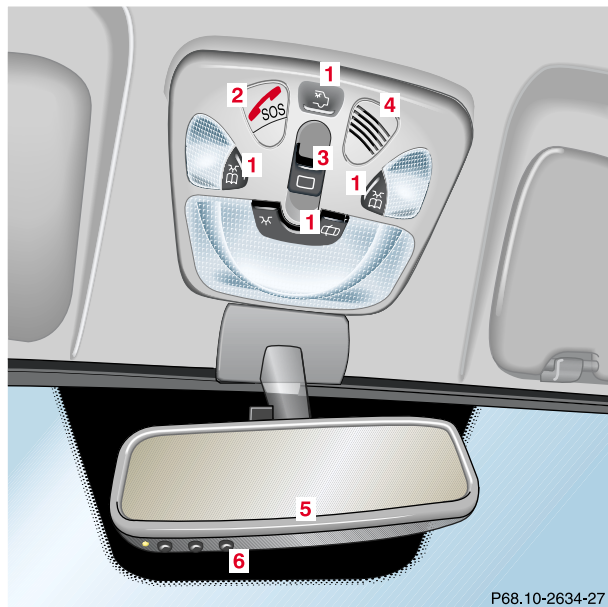

- 1 Interior lighting, see page 156
- 2 Tele Aid (emergency call system), see page 192
- 3 Sliding/pop-up roof, see page 154
- 4 Hands-free microphone for Tele Aid, telephone and voice recognition system
- 5 Rear view mirror, see page 79
- 6 Garage door opener, see page 185

## Contents - Operation

## 24

**Operation**

Vehicle keys .....	26	Locking the tailgate separately .....	39	Self-test BabySmart™ without special child seat installed .....	63
Start lock-out .....	28	Central locking switch .....	40	Supplemental restraint system (SRS) .....	64
General notes on the central locking system .....	28	Automatic central locking .....	41	Emergency tensioning retractor (ETR) .....	65
Central locking system .....	29	Emergency unlocking in case of accident .....	41	Airbags .....	66
Radio frequency and infrared remote control .....	29	Antitheft alarm system .....	42	Safety guidelines for the seat belt, emergency tensioning retractor and airbag .....	71
Locking and unlocking .....	31	Tow-away alarm .....	43	Infant and child restraint systems .....	73
Choosing global or selective mode on remote control .....	31	Easy-entry/exit feature .....	44	Steering wheel adjustment (electrical) .....	78
Opening and closing windows and sliding / pop-up roof from outside .....	32	Front seat adjustment .....	45	Inside rear view mirror .....	79
Panic button .....	33	Synchronizing head restraints and seat adjustment fore, aft .....	47	Antiglare night position .....	79
Mechanical keys .....	33	Removal and installation of front seat head restraints .....	51	Exterior rear view mirrors .....	80
Doors .....	34	Seat heater, front .....	52	Instrument cluster .....	84
Locking and unlocking driver's door manually .....	36	Seat heater, rear .....	54	Multifunction steering wheel, multifunction display .....	90
Tailgate .....	37	Seat belts and integrated restraint system .....	56	Trip and main odometer and sub menu .....	94
Locking and unlocking the tailgate manually .....	38	Seat belts .....	56		
		Seat belt nonusage warning system .....	57		
		BabySmart™ airbag deactivation system .....	63		

Audio systems .....	96	Headlamp cleaning system .....	133	Ashtrays .....	168
Radio .....	96	Combination switch .....	134	Lighter .....	170
CD player .....	97	Rear window wiper/washer .....	138	Floor mat .....	170
Telephone .....	98	Hazard warning flasher switch ....	139	Split rear seat bench .....	171
Navigation system .....	103	Climate control .....	140	Rear seat head restraints .....	173
Trip computer .....	104	Rear passenger compartment		Enlarged cargo area .....	174
Malfunction/warning		adjustable air outlets .....	150	Cargo tie-down rings .....	174
message memory .....	106	Power windows .....	151	Partition net .....	175
Individual settings .....	108	Sliding/pop-up roof .....	154	Loading instructions .....	178
Setting the audio volume .....	122	Interior lighting .....	156	Parcel net in	
Coolant temperature gauge .....	123	Door entry lamps .....	157	front passenger footwell .....	180
Flexible service system		Rear interior lamps .....	158	Cargo area cover blind .....	180
(FSS) .....	124	Cargo compartment lamps .....	159	Roof racks .....	181
Engine oil level indicator .....	127	Sun visors .....	161	Brush guard .....	182
Exterior lamp switch .....	129	Illuminated vanity mirrors .....	161	Telephone, general .....	184
Headlamp mode .....	130	Interior .....	162	Cellular telephone .....	184
Night security illumination .....	132	Storage compartments,		Garage door opener .....	185
Locator lighting .....	133	armrest and cup holder .....	162		
		Glove box .....	163		

## Central locking system

26

**Vehicle keys**

Included with your vehicle are 2 electronic keys with integrated radio frequency and infrared remote controls plus removable mechanical key.

The locking tabs for the mechanical key portion of the two electronic keys are a different color (black and grey) to help distinguish each individual key.

**Warning!**

**When leaving the vehicle always remove the key from the starter switch, and lock your vehicle. Do not leave children unattended in the vehicle, or with access to an unlocked vehicle. Unsupervised use of vehicle equipment may cause serious personal injury.**

## Electronic key



The electronic key has an integrated radio frequency and infrared remote control, plus removable mechanical key.

The remote control (1) operates all locks on the vehicle.

The mechanical key (2) works only in the driver's door, tailgate, and glove box lock.

When using the mechanical key (2) for lock operations, it can be removed by sliding it out of the remote control. To do so, move locking tab (3) to the right and slide the mechanical key (2) in direction of arrow (4).

The remote control transmitter is located in the electronic key.

The infrared receiver is located in the driver's door below the door handle.

Note:

Remove the mechanical key from the electronic key when using valet parking service. To prevent access to rear cargo area or storage compartments lock them separately and retain the mechanical key.

See page 39 for separate locking of tailgate and page 163 for locking of glove box.

### Obtaining replacement keys

Your vehicle is equipped with a theft deterrent locking system requiring a special key manufacturing process. For security reasons, replacement keys can only be obtained from your authorized Mercedes-Benz Light Truck Center.

## Central locking system

28

**Start lock-out****Important!**

Removing the electronic key from the starter switch activates the start lock-out. The engine cannot be started.

Inserting the electronic key in the starter switch deactivates the start lock-out.

**Note:**

In case the engine cannot be started (vehicle's battery is in order), the system is not operational. Contact an authorized Mercedes-Benz Light Truck Center or call 1-800-FOR-MERCEdes (in the USA), or 1-800-387-0100 (in Canada).

**General notes on the central locking system**



If the electronic key is inserted in the starter switch, the vehicle cannot be locked or unlocked with the remote control.

If the vehicle cannot be locked or unlocked:

- Check the batteries of the electronic key, see page 343, or synchronize the electronic key, see page 345.
- Use the mechanical key to unlock the vehicle. To start engine, insert the electronic key in the starter switch. There could be a slight delay until the electronic key can be turned in the starter switch.

**Important!**

When unlocking the driver's door with the mechanical key, the exterior lamps will flash and the alarm will sound.

To cancel the alarm, insert the electronic key in the starter switch or press button  or  on the electronic key.



## Central locking system

### Radio frequency and infrared remote control

The electronic key has an integrated radio frequency and infrared remote control.

Due to the extended operational range of the remote control, it could be possible to unintentionally lock or unlock the vehicle by pressing the transmit button. If one of the transmit buttons is pressed, the battery check lamp lights up briefly – indicating that the batteries are in order. See page 343 for checking batteries.

The vehicle doors, tailgate and fuel filler flap can be centrally locked and unlocked via remote control.

Opening and closing the windows can only be done with the infrared portion of the remote control. Aim transmitter eye at the receiver of the driver's door (6), press and hold transmit button  or , see page 32.

If the electronic key is inserted in the starter switch, the vehicle cannot be locked or unlocked with the remote control.



#### 1 Transmit button

 Locking

 Unlocking

#### 2 Lamp for battery check (see page 343 for changing batteries if it does not light up briefly)

#### 3 PANIC button

#### 4 Transmitter eye

#### 5 Locking tab for mechanical key



## Central locking system

30

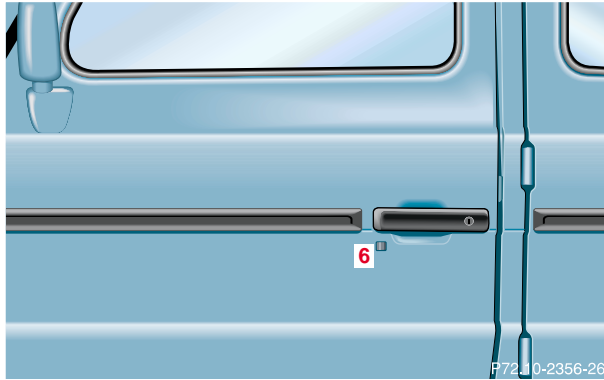

6 Infrared receiver at the driver's door

## Locking and unlocking with remote control

Unlocking:

Press transmit button . All turn signal lamps blink once to indicate that the vehicle is unlocked.

The remote control can be programmed for two kinds of unlocking modes (see below):

Selective unlocking mode –

Press transmit button  once to unlock driver's door and fuel filler flap.

Press transmit button  twice to unlock all doors, fuel filler flap, and tailgate.

Global unlocking mode –

Press transmit button  once to unlock all doors, fuel filler flap, and tailgate.

Notes:

If the tailgate was previously locked separately, it will remain locked, see page 39.

The presently active unlocking mode (selective or global) can only be determined by unlocking the vehicle with the remote control (see below for changing mode).

If within 40 seconds of unlocking with the remote control, neither door or tailgate is opened, the electronic key is not inserted in the starter switch, or the central locking switch is not activated, the vehicle will automatically lock.



Locking:

Press transmit button  once. All turn signal lamps blink three times to indicate that the vehicle is locked. If they do not blink three times, a door or the tailgate is not properly closed.

Note:

If the vehicle cannot be locked or unlocked by pressing the transmit button, then it may be necessary to change the batteries in the electronic key (if ok, battery check lamp in electronic key will light briefly when pressing transmit button) or to synchronize the remote control, see pages 343 and 345.

### Choosing global or selective mode on remote control

Press and hold transmit buttons  and  simultaneously for 6 seconds to reprogram the remote control. Battery check lamp will blink two times indicating the completed mode change.

## Central locking system

32

**Opening and closing windows and sliding/pop-up roof from outside (summer opening/convenience feature)**

Aim transmitter eye of remote control at the driver's door receiver.

**Summer opening:**

The sliding/pop-up roof and all side windows can be opened automatically.

Continue to press transmit button  after unlocking the vehicle.

The windows and sliding/pop-up roof begin to open after approximately 1 second.

To interrupt opening procedure, release transmit button.

**Convenience feature:**

The sliding/pop-up roof and the side windows can be closed.

Continue to press transmit button  after locking the vehicle.



The windows and sliding/pop-up roof begin to close after approximately 1 second.

To interrupt closing procedure, release transmit button.

Ensure that all side windows and the sliding/pop-up roof are properly closed before leaving the vehicle.

**Warning!**

**Never operate the windows or sliding/pop-up roof if there is the possibility of anyone being harmed by the opening or closing procedure.**

**In case the procedure causes potential danger, the procedure can be immediately halted by releasing the remote control button. To reverse direction of movement press  for opening or  for closing.**

Note:

If the windows and sliding/pop-up roof cannot be operated automatically by pressing the transmit button of the remote control then it may be necessary to change the batteries in the electronic key (if ok, battery check lamp in electronic key will light briefly when transmitting), or to synchronize the remote control, see page 343 and 345.

## Panic button



To activate press and hold button (1) for at least one second. An audible alarm and blinking exterior lamps will operate for approximately 3 minutes.

To deactivate press button (1) again, or insert electronic key in starter switch.

Note:

For operation in the USA only: This device complies with Part 15 of the FCC Rules. Operation is subject to the following two conditions:

- (1) This device may not cause harmful interference, and
- (2) this device must accept any interference received, including interference that may cause undesired operation.



Any unauthorized modification to this device could void to the user's authority to operate the equipment.

## Mechanical keys

The mechanical keys work only in the driver's door, tailgate, and storage compartment locks.

Notes:

The mechanical key does not operate the central locking system or arm or disarm the antitheft alarm system.

The alarm sounds when unlocking the driver's door or tailgate. Cancel alarm by turning electronic key in starter switch to position 1, or with the remote control by pressing button  or .

Unlocking and locking the driver's door manually, see page 36.

Unlocking the tailgate manually, see page 38.

Locking the tailgate separately, see page 39.

## Central locking system

34

## Doors

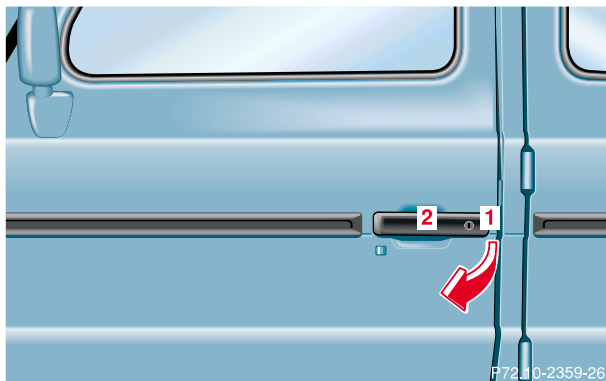

To open the door, press the lock cylinder (1) and pull on the door handle (2).

Note:

The passenger side door cannot be unlocked using the mechanical key.

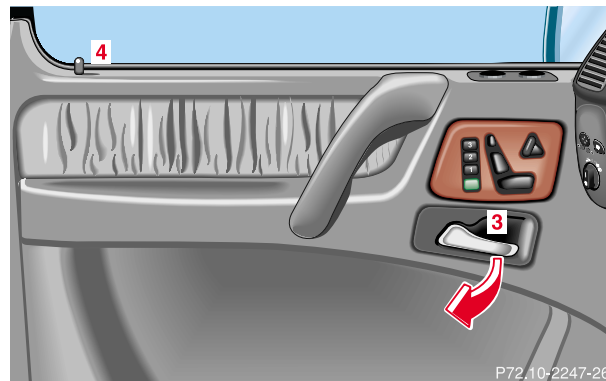

3 Front door from inside:  
Pull handle to unlock.

4 Individual door from inside:  
Push button down to lock.  
Pull lock button up to unlock.



**Important!**

The mechanical key does not operate the central locking system or arm or disarm the antitheft alarm system.

When you lock the driver's door with the mechanical key, the door lock button should move down.

Each individual door must be locked with the respective door lock button – the driver's door can only be locked when it is closed.

Notes:

The alarm sounds when unlocking the driver's door with the mechanical key. Cancel alarm by turning electronic key in starter switch to position 1, or with the remote control by pressing button  or .

If the vehicle has previously been locked from the outside, only the door being opened from the inside will unlock, and the alarm will come on. The doors, the tailgate and fuel filler flap remain locked.

In case of a malfunction in the central locking system the doors can be locked and unlocked individually.

To lock, push down lock buttons and turn mechanical key in driver's door lock to position 4. In addition lock the tailgate.

To unlock the driver's manually, see page 36.

Rear doors, previously centrally locked, can be opened from inside by first unlocking the vehicle with the central locking switch, see page 40, or by first pulling up the door lock button.

If the fuel filler flap cannot be opened, see page 347.

## Central locking system

36

## Locking and unlocking driver's door manually

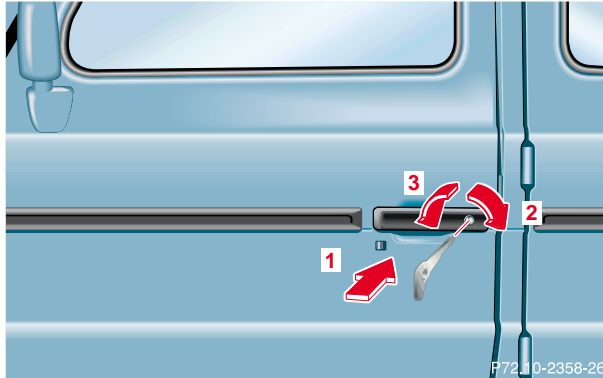

- 1 To open, press lock cylinder
- 2 Locking driver's door
- 3 Unlocking driver's door

If the vehicle cannot be locked or unlocked using the remote control, lock or unlock the driver's door using the mechanical key.

Notes:

The alarm sounds when unlocking the driver's door with the mechanical key. Cancel alarm by turning electronic key in starter switch to position 1.

The passenger door cannot be unlocked manually.

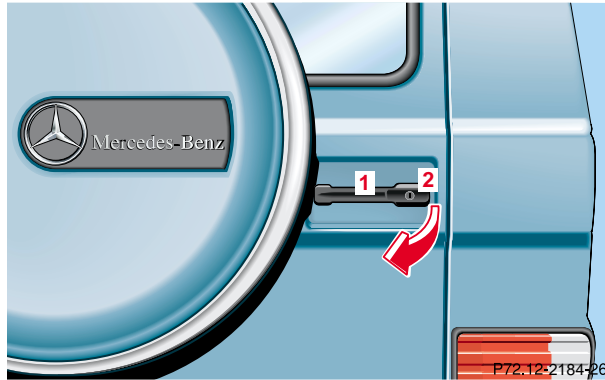

## Tailgate



To open the tailgate, press the lock cylinder (2) and pull on the tailgate handle (1).

Note:

When unlocking the tailgate with the mechanical key, the exterior lamps will flash and the alarm will sound.

To cancel the alarm, insert the electronic key in the starter switch to position 1 or press button  or  on the electronic key.

### Important!

Only drive with the tailgate closed as otherwise exhaust fumes may enter the vehicle interior.

### Warning!

The tailgate swings open to one side. Always make sure there is sufficient clearance for tailgate.



## Central locking system

## Locking and unlocking the tailgate manually

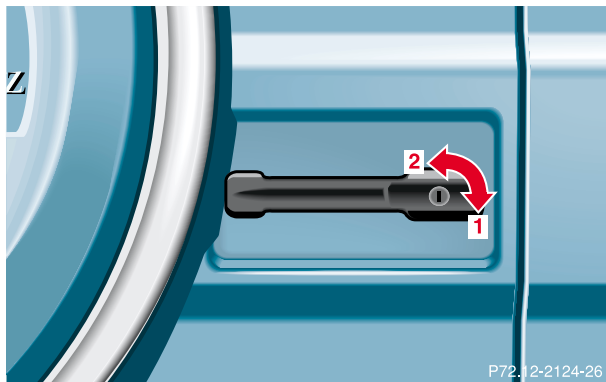

**1** Locking



**2** Unlocking

38

If the tailgate cannot be unlocked with remote control due to a malfunction, unlock the tailgate using the mechanical key.

Note:

When unlocking the tailgate with the mechanical key, the exterior lamps will flash and the alarm will sound.

To cancel the alarm, insert the electronic key in the starter switch to position 1 or press button  or  on the electronic key.

## Locking the tailgate separately

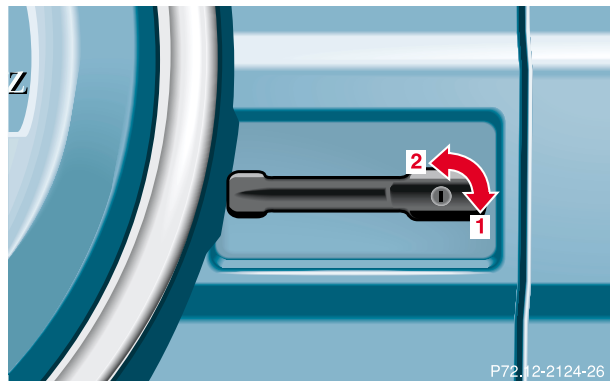

Locking tailgate separately:

Lock tailgate using the mechanical key (1).

The tailgate will remain locked, even if the vehicle is centrally unlocked.

Cancellation of separate tailgate locking:

Turn mechanical key in lock cylinder to position (2).

## Central locking system

40

## Central locking switch

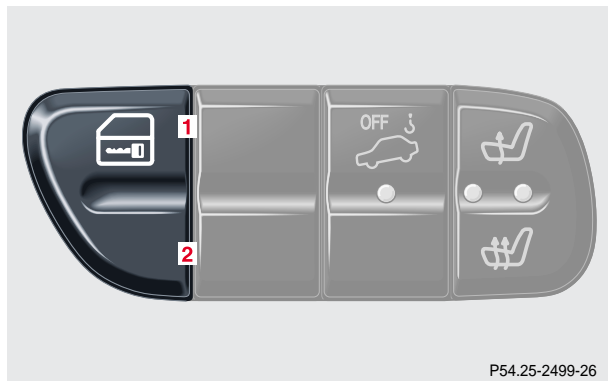

- 1 Locking
- 2 Unlocking

The central locking switch is located in the center console.

Doors and tailgate can only be locked with the central locking switch, if all doors and the tailgate are closed.



If the vehicle was previously locked with the central locking switch, while in the selective remote control mode, only the door opened from the inside is unlocked.

If the vehicle was previously locked with the central locking switch, while in the global remote control mode, the complete vehicle is unlocked when a door is opened from the inside.

Notes:

If the vehicle was previously locked with the remote control, the doors and tailgate cannot be unlocked with the central locking switch.

The fuel filler flap cannot be locked or unlocked with the central locking switch.

If the vehicle has previously been locked from the outside, opening a door from the inside will trigger the alarm. To cancel the alarm, insert the electronic key in the starter switch or press button  or  on the electronic key.

**Warning!**

**When leaving the vehicle always remove the electronic key from the starter switch, and lock your vehicle. Do not leave children unattended in the vehicle, or with access to an unlocked vehicle. Unsupervised use of vehicle equipment may cause serious personal injury.**

### Automatic central locking

With the automatic central locking system activated, the doors and tailgate are locked at vehicle speeds of approximately 9 mph (15 km/h) or more. The fuel filler flap remains unlocked.

The automatic central locking function can be switched on or off in the individual setting menu “VEHICLE” – “AUTOMATIC DOOR LOCK”, see page 118.

Notes:

If doors are unlocked with the central locking switch after activating the automatic central locking, and neither door is opened, then the doors remain unlocked even at vehicle speeds of approximately 9 mph (15 km/h) or more.

If a door is opened from the inside at speeds of approximately 9 mph (15 km/h) or less with the automatic central locking activated, the door will again be automatically locked at speeds of approximately 9 mph (15 km/h) or more.

### Important!

When towing the vehicle, or with the vehicle on a dynamometer test stand, please, note the following:

With the automatic central locking activated and the electronic key in starter switch position 2, the vehicle doors will lock if the left front wheel spin at vehicle speeds of approximately 9 mph (15 km/h) or more.

### Emergency unlocking in case of accident

The doors unlock automatically a short time after an accident in which an airbag or emergency tensioning retractor deploys (this is intended to aid rescue and exit).

## Antitheft alarm system

42

## Antitheft alarm system

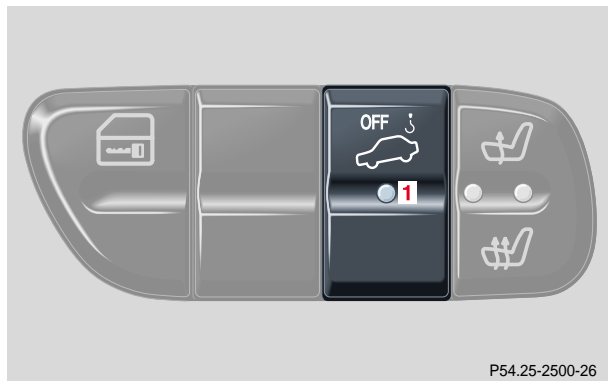

**1** Indicator lamp in switch located in center console

The antitheft alarm is automatically armed or disarmed with the remote control by locking or unlocking the vehicle.

The antitheft alarm is armed within approximately 15 seconds after locking the vehicle.

A blinking lamp (1) indicates that the alarm is armed.

Operation:



Once the alarm system has been armed, the exterior vehicle lamps will flash and an alarm will sound when someone:

- opens a door,
- opens the tailgate,
- opens the hood,
- attempts to raise the vehicle.

The alarm will last approximately 3 minutes in form of flashing exterior lamps. At the same time an alarm will sound for 30 seconds. The alarm will stay on even if the activating element (a door, for example) is immediately closed. If the alarm stays on for more than 20 seconds, an emergency call is initiated automatically. See Tele Aid on page 192.

Notes:

When unlocking the driver's door or the tailgate with the mechanical key, the exterior lamps will flash and the alarm will sound.

To cancel the alarm, insert the electronic key in the starter switch to position 1 or press button  or  on the electronic key.

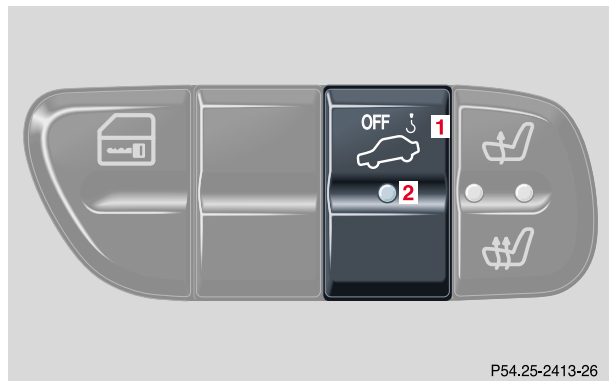

## Tow-away alarm



The switch is located in the center console.

- 1 Press to switch off tow-away alarm
- 2 Indicator lamp

Once the alarm system has been armed, the exterior vehicle lamps will flash and an alarm will sound when someone attempts to raise the vehicle.

The alarm will last approximately 3 minutes in form of flashing exterior lamps. At the same time an alarm will sound for 30 seconds. The alarm will stay on even if the vehicle is immediately lowered. To cancel the alarm, insert the electronic key in the starter switch or press button  or  on the electronic key.

If the alarm stays on for more than 20 seconds, an emergency call is initiated automatically. See Tele Aid on page 192.

To prevent triggering the tow-away alarm feature, switch off the tow-away alarm before towing the vehicle, or when parking on a surface subject to movement, such as a ferry or auto train.

To do so, turn electronic key in starter switch to position 1 or 0, or remove electronic key from starter switch. Press tow-away alarm switch (1). The indicator lamp (2) illuminates briefly.

Exit vehicle, and lock vehicle with the electronic key.

The tow-away alarm remains switched off until the vehicle is locked again with the electronic key, at which time it is automatically reactivated.

**Easy-entry/exit feature**

With the easy-entry/exit feature activated the steering wheel tilts upwards. This allows easier entry into and exit from the vehicle when the driver's door is opened. However, the engine must be turned off.

The easy-entry/exit feature can be switched on or off in the individual setting menu "CONVENIENCE" – "EASY-ENTRY FEATURE ACTIVATE", see page 120.

When the electronic key is inserted in the starter switch and the driver's door is closed the steering wheel returns to the last position set for it.

**Warning!**

**You must ensure that no one can become trapped or injured by the moving steering wheel when the easy-entry/exit feature is in operation and the driver's door is being opened or the electronic key is removed from the starter switch. Do not leave children unattended in the vehicle, or with access to an unlocked vehicle. Unsupervised use of vehicle equipment may cause serious personal injury.**

## Front seat adjustment

### Warning!

**Do not adjust the driver's seat while driving. Adjusting the seat while driving could cause the driver to lose control of the vehicle.**

**Never ride in a moving vehicle with the seat back reclined. Sitting in an excessively reclined position can be dangerous. You could slide under the seat belt in a collision. If you slide under it, the belt would apply force at the abdomen or neck. That could cause serious or fatal injuries. The seat back and seat belts provide the best restraint when the wearer is in an upright position and belts are properly positioned on the body.**

**Never place hands under seat or near any moving parts while a seat is being adjusted.**

**When leaving the vehicle always remove the electronic key from the starter switch, and lock your vehicle.**

**The power seats can also be operated with the driver's or front passenger door open. Do not leave children unattended in the vehicle, or with access to an unlocked vehicle. Unsupervised use of vehicle equipment may cause serious personal injury.**

To operate the front power seat adjustment switches, turn the electronic key in starter switch to position 1 or 2 (with respective front door open, the power seats can also be operated with the electronic key removed or in starter switch position 0).

Note:

If the passenger side seat backrest is set to a full upright position and the passenger seat is moved fully forward, the cup holder next to the armrest must be removed (page 166) and the cup holder in the passenger footwell (page 167) must be folded closed.



## Power seat

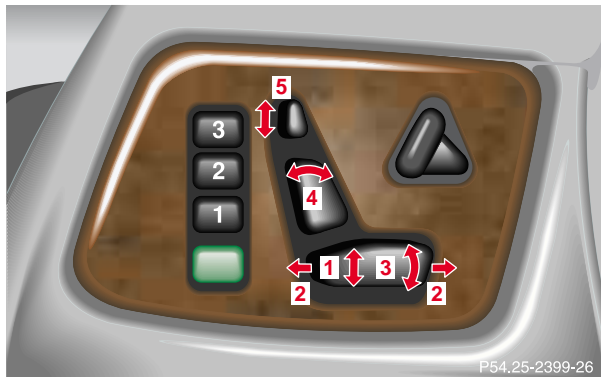

The switches are located in each front door.

We recommend to adjust the power seat in the following order:

### 1 Seat, up/down

Press the switch (up/down direction) until comfortable seating position with still sufficient headroom is reached.

### 2 Seat adjustment, fore/aft

Press the switch (fore/aft direction) until a comfortable seating position is reached that still allows you to reach the accelerator/brake pedal safely. The position should be as far rearward as possible, consistent with ability to properly operate controls.

### 3 Seat cushion tilt

Press the switch in the direction of the arrow until your legs are lightly supported.

### 4 Backrest tilt

Press the switch in the direction of the arrow until your arms are slightly angled when holding the steering wheel.

### 5 Head restraint

The height of the head restraint is adjusted automatically with the seat so that the back of the head is supported approximately at ear level. Adjust the head restraint using the switch to support the back of your head approximately at ear level.

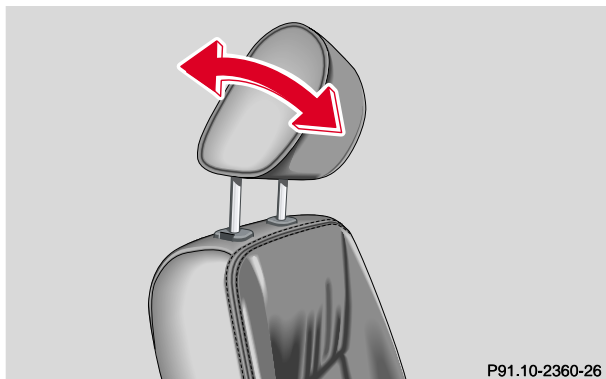

Adjust the head restraint angle by hand. Push or pull the head restraint in direction of arrow.

For notes on inside rear view mirrors adjustment, see page 79;  
For exterior rear view mirrors adjustment, see page 80 and for steering wheel adjustment, see page 78.

### Synchronizing head restraints and seat adjustment fore, aft

If the power supply was interrupted (battery disconnected or empty), the head restraints and the seat adjustment fore, aft are no longer adjusted automatically.

To resynchronize the adjustment feature, turn electronic key in starter switch to position 2, move the seat completely forward and the head restraint fully down.

To recall the desired seat position push and hold position button (2) until the adjustment has stopped, see page 48 for notes on the memory function.

### Caution!

Do not remove head restraints except when mounting seat covers. For removal refer to head restraints, front on page 51. Whenever restraints have been removed be sure to reinstall them before driving.

## Memory function



The buttons are located on the doors.

- 1 Memory button, used to store selected positions which can be retrieved by pressing
- 2 Position buttons

### Warning!

**Do not activate the memory function while driving. Activating the memory function while driving could cause the driver to lose control of the vehicle.**

Together with the driver's seat position you can store the positions for steering wheel and exterior rear view mirrors.

For the front passenger seat you can store the seat position.

Three stored positions for the driver's seat are available for each of the two electronic keys.

This is only possible if you select "ON" in the menu "SETTINGS KEY-DEPENDENT". Refer to individual setting menu "CONVENIENCE" – "SETTINGS KEY-DEPENDENT", see page 120.

### **Storing positions into memory:**

With the electronic key in starter switch position 1 or 2 or with the relevant door open and the electronic key inserted in the starter switch.

Adjust the seat to the desired position, see page 46.

#### **Driver's seat:**

You can also adjust the steering wheel and the exterior rear view mirrors electrically for the driver's seat. See page 80 for exterior rear view mirror adjustment and page 78 for steering wheel adjustment.

Push memory button (1), release and push the position button (2) within 3 seconds.

### **Recalling positions from memory:**

To recall a seat/steering wheel/exterior rear view mirror position, push and hold button (2) to selected memory position until the adjustment has stopped.

The seat/steering wheel/exterior rear view mirror movement stops when the button is released.

#### **Caution!**

Do not operate the power seats using the memory button if the backrest is in an excessively reclined position. Doing so could cause damage to front or rear seats.

First move backrest to an upright position.

**Important!**

Prior to operating the vehicle, the driver should check and adjust if necessary the seat height, seat position fore and aft, and backrest angle to insure adequate control, reach and comfort. The head restraint should also be adjusted for proper height. See also airbag section for proper seat positioning.

In addition, also adjust the steering wheel to ensure adequate control, reach, operation and comfort. Both the inside and outside rear view mirrors should be adjusted for adequate rearward vision.

Fasten seat belts. Infants and small children should be seated in a properly secured restraint system that complies with U.S. Federal Motor Vehicle Safety Standard 213 and Canadian Motor Vehicle Safety Standard 213.

All seat, head restraint, steering wheel, and rear view mirror adjustments as well as fastening of seat belts should be done before the vehicle is put into motion.

**Warning!**

**Children 12 years old and under must never ride in the front seat, except in a Mercedes-Benz authorized BabySmart™ compatible child seat, which operates with the BabySmart™ system installed in the vehicle to deactivate the passenger side front airbag when it is properly installed. Otherwise they will be struck by the airbag when it inflates in a crash. If this happens, serious or fatal injury can result.**

**According to accident statistics, children are safer when properly restrained in the rear seating positions than in the front seating positions. Infants and small children must ride in back seats and be seated in an appropriate infant or child restraint system, which is properly secured with the vehicle's seat belt, fully in accordance with the child seat manufacturer's instructions.**

**A child's risk of serious or fatal injuries is significantly increased if the child restraints are not properly secured in the vehicle and the child is not properly secured in the child restraint.**

## Removal and installation of front seat head restraints



### Caution!

Do not remove head restraints except when mounting seat covers. Whenever restraints have been removed be sure to reinstall them before driving.

Note:

Tilt the backrest rearward for easier removal and installation of the head restraints.

To remove:

Press switch (1) upwards and hold until the head restraint is fully extended. Pull head restraint out.

To install:

Press switch (1) upwards and hold for about 5 seconds.

Press the head restraint down until it engages.

Adjust head restraint to the desired position.

Adjusting head restraint, see page 46.

### Warning!

**For your protection, drive only with properly positioned head restraints.**

**Adjust head restraint to support the back of the head approximately at ear level.**

**Do not drive the vehicle without the seat head restraints. Head restraints are intended to help reduce injuries during an accident.**

### Seat heater, front

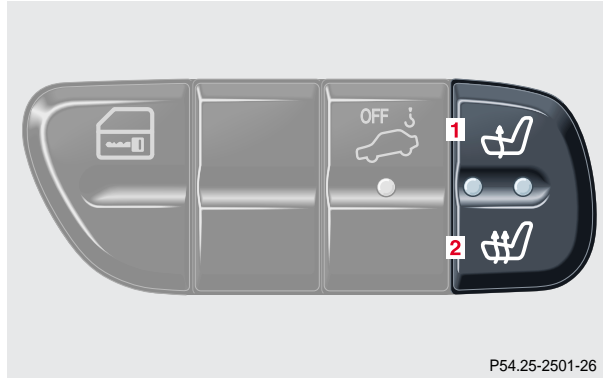

The switch is located in the center console.

The front seat heaters can be switched on with the electronic key in starter switch position 1 or 2.

Press switch to turn on seat heater:

- 1** Normal seat heating mode. One indicator lamp in the switch lights up.
- 2** Rapid seat heating mode. Both indicator lamps in the switch light up. After approximately 5 minutes in the rapid seat heating mode, the seat heater automatically switches to normal operation and only one indicator lamp will stay on.

Turning off seat heater:

If one indicator lamp is on, press upper half of switch.

If both indicator lamps are on, press lower half of switch.

If left on, the seat heater automatically turns off after approximately 30 minutes of operation.

## Notes:

When in operation, the seat heater consumes a large amount of electrical power. It is not advisable to use the seat heater longer than necessary.

The seat heaters may automatically switch off if too many power-consuming devices are switched on at the same time, or if the battery charge is low. When this occurs, the indicator lamp in the switch will blink (both indicator lamps blink during rapid seat heating mode). The seat heaters will switch on again automatically as soon as sufficient voltage is available.

If the blinking of the indicator lamps is distracting to you, the seat heaters can be switched off.



**Seat heater, rear**

The switch is located on the center pillar.

The rear seat heaters can be switched on with the electronic key in starter switch position 1 or 2.

Press switch to turn on seat heater:

- 1** Normal seat heating mode. One indicator lamp in the switch lights up.
- 2** Rapid seat heating mode. Both indicator lamps in the switch light up. After approximately 5 minutes in the rapid seat heating mode, the seat heater automatically switches to normal operation and only one indicator lamp will stay on.

Turning off seat heater:

If one indicator lamp is on, press upper half of switch.

If both indicator lamps are on, press lower half of switch.

If left on, the seat heater automatically turns off after approximately 30 minutes of operation.

Notes:

When in operation, the seat heater consumes a large amount of electrical power. It is not advisable to use the seat heater longer than necessary.

The seat heaters may automatically switch off if too many power-consuming devices are switched on at the same time, or if the battery charge is low. When this occurs, the indicator lamp in the switch will blink (both indicator lamps blink during rapid seat heating mode). The seat heaters will switch on again automatically as soon as sufficient voltage is available.

If the blinking of the indicator lamps is distracting to you, the seat heaters can be switched off.

The heater circuit will be switched off for safety reasons to prevent a build up of heat and overheating of the seat, (for example, seat is folded forward).

### Seat belts and integrated restraint system

Your vehicle is equipped with seat belts for all seats, emergency tensioning retractors for front and second row outboard seat belts, and single front airbags. Their protective functions are designed to complement one another.

### Seat belts

#### Important!

Laws in most states and all Canadian provinces require seat belt use.

All states and provinces require use of child restraints that comply with U.S. Federal Motor Vehicle Safety Standard 213 and Canadian Motor Vehicle Safety Standard 213.

All child restraint systems are designed to be secured in vehicle seats by lap belts or the lap belt portion of a lap-shoulder belt.

For your safety and that of your passengers we strongly recommend their use.

#### Warning!

**Children 12 years old and under must never ride in the front seat, except in a Mercedes-Benz authorized BabySmart™ compatible child seat, which operates with the BabySmart™ system installed in the vehicle to deactivate the passenger side front airbag when it is properly installed. Otherwise they will be struck by the airbag when it inflates in a crash. If this happens, serious or fatal injury will result.**

**According to accident statistics, children are safer when properly restrained in the rear seating positions than in the front seating positions. Infants and small children must ride in back seats and be seated in an appropriate infant or child restraint system, which is properly secured with the vehicle's seat belt, fully in accordance with the child seat manufacturer's instructions.**

**A child's risk of serious or fatal injuries is significantly increased if the child restraints are not properly secured in the vehicle and the child is not properly secured in the child restraint.**

### **Warning!**

Never ride in a moving vehicle with the backrest reclined. Sitting in an excessively reclined position can be dangerous. You could slide under the seat belt in a collision. If you slide under it, the belt would apply force at the abdomen or neck. That could cause serious or even fatal injuries. The backrest and seat belt provide the best restraint when the wearer is in an upright position and the belt is properly positioned on the body.

Note:

For cleaning and care of the seat belts, see page 354.

### **Seat belt nonusage warning system**

After starting the engine, a warning sounds a short time and the seat belt warning lamp  remains illuminated if the driver's seat belt is not fastened.

### **Warning!**

Failure to wear and properly fasten and position your seat belt greatly increases your risk of injuries and their likely severity in an accident. You and your passengers should always wear seat belts.

If you are ever in an accident, your injuries can be considerably more severe without your seat belt properly buckled. Without your seat belt buckled, you are much more likely to hit the interior of the vehicle or be ejected from it. You can be seriously injured or killed.

In the same crash, the possibility for injury or death is lessened if you are wearing your seat belt.

### **Warning!**

Never let more people ride in the vehicle than there are seat belts available. Be sure everyone riding in the vehicle is correctly restrained with a separate seat belt.

## Restraint systems

58

## Fastening of seat belts

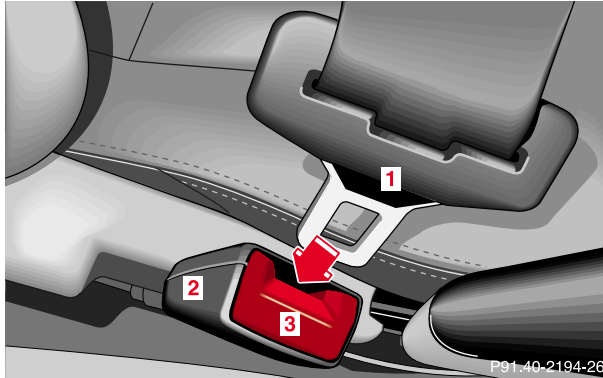

- 1 Latch plate
- 2 Buckle
- 3 Release button

Push latch plate (1) into buckle (2) until it clicks. Do not twist the belt. A twisted seat belt may cause injury.

To help avoid severe or fatal injuries, the lap belt must be positioned as low as possible on your hips and not across the abdomen.

**Warning!**

**Always fasten your seat belt before driving off. Always make sure your passengers are properly restrained – even those sitting in the rear.**

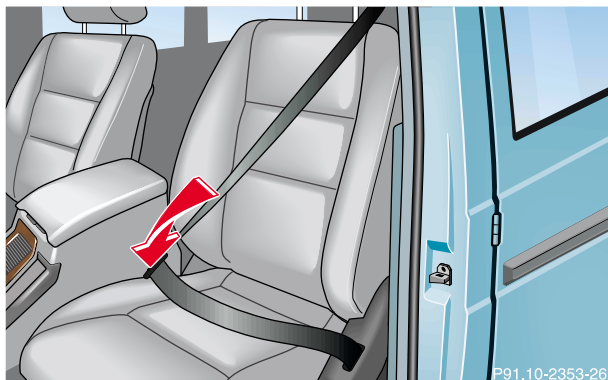

Tighten the lap portion to a snug fit by pulling shoulder portion up.

The shoulder portion of the seat belt must be pulled snug and checked for snugness immediately after engaging it.

Adjust seat belt so that shoulder portion is located as close as possible to the middle of your shoulder (it should not touch the neck). For this purpose, you can adjust the height of the belt outlet. Five positions are available.

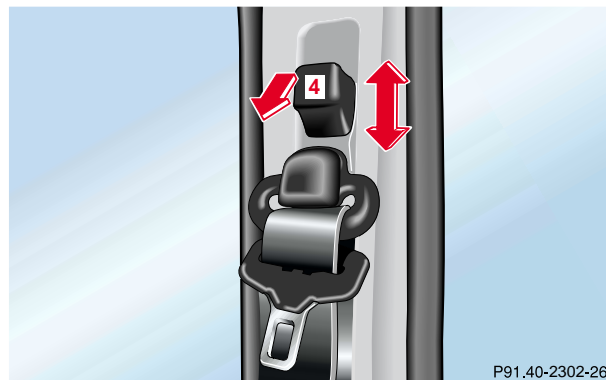

4 Button for belt outlet height adjustment

To raise, slide belt height adjustment upward.

To lower, press button (4) and slide belt outlet downward.

**Caution!**

For safety reasons, avoid adjusting the seat or backrest into positions which could affect the correct seat belt positioning.

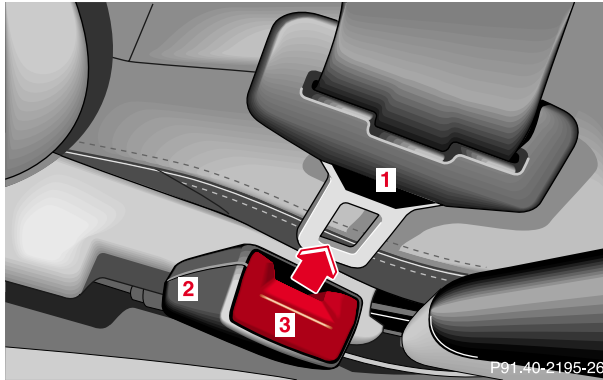

### Operation of seat belts

The inertia reel stops the belt from unwinding during sudden vehicle stops or when quickly pulling on the belt. The locking function of the reel may be checked by quickly pulling out the belt.

### Unfastening of seat belts

Push the release button (3) in the belt buckle (2).

Allow the retractor to completely rewind the seat belt by guiding the latch plate (1).

### Warning!

#### USE SEAT BELTS PROPERLY.

- Seat belts can only work when used properly. Never wear seat belts in any other way than as described in this section, as that could result in serious injuries in case of an accident.
- Each occupant should wear their seat belt at all times, because seat belts help reduce the likelihood of and potential severity of injuries in accidents, including rollovers. The integrated restraint system includes “SRS” (driver airbag and front passenger airbag) and “ETR” (seat belt emergency tensioning retractors for the driver’s seat, passenger’s seat and rear outboard passenger seats). The system is designed to enhance the protection offered to properly belted occupants in certain frontal (front airbags) impacts which exceed preset deployment thresholds.

- **Never wear the shoulder belt under your arm, against your neck or off your shoulder. In a crash, your body would move too far forward. That would increase the chance of head and neck injuries. The belt would also apply too much force to the ribs or abdomen, which could severely injure internal organs such as your liver or spleen.**
- **Never wear belts over rigid or breakable objects in or on your clothing, such as eyeglasses, pens, keys etc., as these might cause injuries.**
- **Position the lap belt as low as possible on your hips and not across the abdomen. If the belt is positioned across your abdomen, it could cause serious injuries in a crash.**

- **Each seat belt should never be used for more than one person at a time. Do not fasten a seat belt around a person and another person or other objects.**
- **Belts should not be worn twisted. In a crash, you wouldn't have the full width of the belt to manage impact forces. The twisted belt against your body could cause injuries.**
- **Pregnant women should also use a lap-shoulder belt. The lap belt portion should be positioned as low as possible on the hips to avoid any possible pressure on the abdomen.**
- **Never place your feet on the instrument panel or on the seat. Always keep both feet on the floor in front of the seat.**



**Warning!****USE CHILD RESTRAINTS PROPERLY.**

Children 12 years old and under must never ride in the front seat, except in a Mercedes-Benz authorized BabySmart™ compatible child seat, which operates with the BabySmart™ system installed in the vehicle to deactivate the passenger front airbag when it is properly installed. Otherwise they will be struck by the airbag when it inflates in a crash. If this happens, serious or fatal injury will result.

According to accident statistics, children are safer when properly restrained in the rear seating positions than in the front seating positions. Infants and small children must ride in back seats and be seated in an appropriate infant or child restraint system, which is properly secured with the vehicle's seat belt, fully in accordance with the child seat manufacturer's instructions.

A child's risk of serious or fatal injuries is significantly increased if the child restraints are not properly secured in the vehicle and the child is not properly secured in the child restraint.

Children too big for child restraint systems must ride in back seats using regular seat belts. Position shoulder belt across chest and shoulder, not face or neck. A booster seat may be necessary to achieve proper belt positioning.

## BabySmart™ airbag deactivation system

Special BabySmart™ compatible child seats, designed for use with the Mercedes-Benz system and available at any authorized Mercedes-Benz Light Truck Center are required for use with the BabySmart™ airbag deactivation system. With the special child seat properly installed, the passenger front airbag will not deploy.

The  indicator lamp located in the center console will be illuminated, except with electronic key removed or in starter switch position 0.

## Self-test BabySmart™ without special child seat installed

After turning electronic key in starter switch to position 1 or 2, the  indicator lamp located in the center console comes on for approximately 6 seconds and then extinguishes.

If the indicator lamp should not come on or is continuously lit, the system is not functioning. You must see an authorized Mercedes-Benz Light Truck Center before seating any child on the front passenger seat. See page 271 for notes on the  indicator lamp.

## Warning!

**The BabySmart™ airbag deactivation system will ONLY work with a special child seat designed to operate with it. It will not work with child seats which are not BabySmart™ compatible.**

**Never place anything between seat cushion and child seat (e.g. pillow), since it reduces the effectiveness of the deactivation system. The bottom of the child seat must make full contact with the passenger seat cushion. An incorrectly mounted child seat could cause injuries to the child in case of an accident instead of protecting the child.**

**Follow the manufacturer's instructions for installation of special child seats.**

**The passenger front airbag will not deploy only if the  indicator lamp remains illuminated.**

**Please be sure to check the indicator every time you use the special system child seat. Should the light go out while the restraint is installed, please check installation. If the light remains out, do not use the BabySmart™ restraint to transport children on the front passenger seat until the system has been repaired.**

BabySmart™ is a trademark of Siemens Automotive Corp.

## Restraint systems

64

**Supplemental restraint system (SRS)**

Airbags are intended as a supplement to seat belts. Airbags alone cannot protect as well as airbags plus seat belts in impacts for which the airbags were designed to operate, and do not afford any protection whatsoever in crashes for which the airbags are not designed to deploy.

The SRS uses two crash severity levels (thresholds) to activate either the Emergency Tensioning Retractor (ETR) or front airbag or both. Activation depends on the direction and severity of the impact exceeding the preset thresholds and whether the seat belt is fastened.

Seat belt fastened

- first threshold exceeded: ETR activates
- second threshold exceeded: airbag also activates

Seat belt not fastened

Front seats:

- first threshold exceeded:  
airbag activates, but not ETR

Rear outer seats:

- first threshold exceeded:  
ETR activates

Notes:

Driver, front passenger and rear outer seat systems operate independently of each other.

Heavy objects on the front passenger seat can appear to the “SRS” to indicate the presence of an occupant in that seat which causes the passenger front airbag to deploy in a crash exceeding the appropriate threshold.

### **Emergency tensioning retractor (ETR)**

The seat belts for the front seats and outboard passenger seats are equipped with emergency tensioning retractors. These tensioning retractors are located in each seat belt buckle and become operationally ready with the key in starter switch position 1 or 2.

The emergency tensioning retractors are designed to activate only when the seat belts are fastened during frontal impacts exceeding the first threshold of the SRS and in rear impacts exceeding a preset severity level. They remove slack from the belts in such a way that the seat belts fit more snugly against the body restricting its forward movement as much as possible.

In cases of other frontal impacts, angled impacts, roll-overs, certain side impacts, or other accidents without sufficient frontal or rear impact forces, the emergency tensioning retractors will not be activated. The driver and passengers will then be protected by the fastened seat belts and inertia reel in the usual manner.

For seat belt and emergency tensioning retractor see page 71.

Note:

The emergency tensioning retractors for the driver and front passenger seats will only deploy if the front seat belts are buckled.

The rear center automatic two point seat belt is not equipped with an emergency tensioning retractor.

## Restraint systems

66

## Airbags

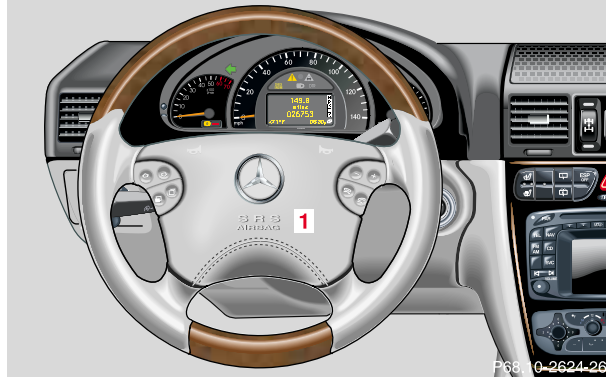

## 1 Driver airbag

The most effective occupant restraint system yet developed for use in production vehicles is the seat belt. In some cases, however, the protective effect of a seat belt can be further enhanced by an airbag.

The driver airbag is located in the steering wheel hub.

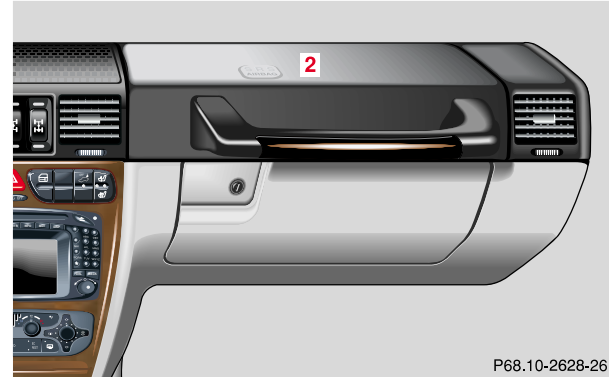

## 2 Front passenger airbag

The passenger front airbag is located in the dashboard ahead of the front passenger.

In conjunction with wearing the seat belts, the driver and front passenger airbags can provide increased protection for the driver and front passenger in certain frontal impacts exceeding preset thresholds.

## Important!

The operational readiness of the airbag system is verified by the indicator lamp “SRS” in the instrument cluster when turning the key in starter switch to position 1 or 2. If no fault is detected, the lamp will go out after approximately 5 seconds; after the lamp goes out, the system continues to monitor the components and circuitry of the airbag system and will indicate a malfunction by coming on again. If the lamp does not come on at all or if it fails to extinguish after approximately 5 seconds or if it comes on thereafter, a malfunction in the system has been detected.

The following system components are monitored or undergo a self-check: crash-sensor(s), airbag ignition circuits, front seat belt buckle, emergency tensioning retractors, seat sensor.

Initially, when the key is turned from starter switch position 0 to positions 1 or 2, malfunctions in the crash-sensor are detected and indicated (the “SRS” indicator lamp stays on longer than 5 seconds or does not come on).

Have the system checked at your authorized Mercedes-Benz Light Truck Center immediately.

In the operational mode, after the indicator lamp has gone out following the initial check, interruptions or short circuits in the airbag ignition circuit and in the driver and front passenger seat belt buckle harnesses, and low voltage in the entire system are detected and indicated.

## Warning!

**In the event a malfunction of the “SRS” is indicated as outlined above, the “SRS” may not be operational. For your safety, we strongly recommend that you visit an authorized Mercedes-Benz Light Truck Center immediately to have the system checked; otherwise the “SRS” may not be activated when needed in an accident, which could result in serious or fatal injury, or it might deploy unexpectedly and unnecessarily which could also result in injury.**

## Restraint systems

68

**Front airbags**

The driver and front passenger front airbags are designed to activate only in certain frontal impacts exceeding a preset threshold.

The front passenger airbag deploys only if the front passenger seat is occupied and the  indicator lamp in the instrument cluster is not illuminated, see page 271.

Note:

Heavy objects on the front passenger seat can appear to the “SRS” to indicate the presence of an occupant in that seat which causes the passenger front airbag to deploy in a crash exceeding the appropriate threshold.

**Important!**

**Airbags are designed to activate only in certain frontal (front airbags) impacts which exceed preset thresholds.**

**Only during these types of impacts, if of sufficient severity to meet the deployment thresholds, will they provide their supplemental protection.**

**The driver and passenger should always wear their seat belts, otherwise it is not possible for the airbags to provide their intended supplemental protection.**

**In cases of other frontal impacts, angled impacts, roll-overs, other side impacts, rear collisions, or other accidents in which the airbags are not designed to deploy, the airbags will not be activated. The driver and passenger will then be protected by the fastened seat belts.**

**We caution you not to rely on the presence of the airbags in order to avoid wearing your seat belt.**

### Warning!

Airbags are designed to reduce the potential of injury in certain frontal (front airbags) impacts, which may cause significant injuries, however, no system available today can totally eliminate injuries and fatalities.

The activation of the “SRS” temporarily releases a small amount of dust from the airbags. This dust, however, is neither injurious to your health, nor does it indicate a fire in the vehicle. The dust might cause some temporary breathing difficulty for people with asthma or other breathing trouble. To avoid this, you may wish to get out of the vehicle as soon as it is safe to do so. If you have any breathing difficulty but cannot get out of the vehicle after the airbag inflates, then get fresh air by opening a window or door.

The service life of the front passenger airbag extends to the date indicated on the label located on the driver side B pillar. To provide continued reliability after that date, they should be inspected by an authorized Mercedes-Benz Light Truck Center at that time and replaced when necessary.

Your vehicle was originally equipped with airbags which are designed to activate in certain impacts exceeding a preset threshold to reduce the potential and severity of injury. It is important to your safety and that of your passenger that you replace deployed airbags and repair any malfunctioning airbags to ensure the vehicle will continue to provide crash protection for occupants.

### Warning!

To reduce the risk of injury when the front airbags inflate, it is very important for the driver and front passenger to always be in a properly seated position and to wear their seat belts.

For maximum protection in the event of a collision always be in normal seated position with your back against the backrest. Fasten your seat belt and ensure that it is properly positioned on your body.

Since the airbag inflates with considerable speed and force, a proper seating and hands on steering wheel position will help to keep you at a safe distance from the airbag. Occupants who are unbelted, out of position or too close to the airbag can be seriously injured by an airbag as it inflates with great force in the blink of an eye.



## Restraint systems

70

- Sit properly belted in an upright position with your back against the backrest.
- Adjust the driver's seat as far as possible rearward, still permitting proper operation of vehicle controls. The distance from the center of the driver's breastbone to the center of the airbag cover on the steering wheel must be at least ten inches (25 cm) or more. You should be able to accomplish this by a combination of adjustments to the seat and steering wheel. If you have any problems, please see your authorized Mercedes-Benz Light Truck Center.
- Do not lean with your head or chest close to the steering wheel or dashboard.
- Keep hands on the outside of steering wheel rim. Placing hands and arms inside the rim can increase the risk and potential severity of hand/arm injury when the driver front airbag inflates.
- Adjust the front passenger seat as far as possible rearward from the dashboard when the seat is occupied.

- Always sit upright, properly use the seat belts and appropriate size infant or child restraint system.
- Children 12 years old and under must never ride in the front seat, except in a Mercedes-Benz authorized BabySmart™ compatible child seat, which operates with the BabySmart™ system installed in the vehicle to deactivate the passenger side front airbag when it is properly installed. Otherwise they will be struck by the airbag when it inflates in a crash. If this happens, serious or fatal injury can result.
- Accident research shows that the safest place for children in an automobile is in the rear seat. Should you choose to place a child 12 years old or under in the front passenger seat of your vehicle, you must properly use a BabySmart™ child restraint which will turn off the passenger side front airbag.

Failure to follow these instructions can result in severe or fatal injuries to you or other occupants.

## Safety guidelines for the seat belt, emergency tensioning retractor and airbag

### Warning!

- Damaged seat belts or belts that were highly stressed in an accident must be replaced and their anchoring points must also be checked. Use only belts installed or supplied by an authorized Mercedes-Benz Light Truck Center.
- Airbags and “ETR’s” are designed to function on a one-time-only basis. An airbag or emergency tensioning retractor (ETR) that was activated must be replaced.
- Do not pass belts over sharp edges.
- Do not make any modification that could change the effectiveness of the belts.
- Do not use handles above doors for placing such items as coat hangers etc.

- No modifications of any kind may be made to any components or wiring of the “SRS”. This includes changing or removing any component or part of the “SRS”, the installation of additional trim material, badges etc. over the steering wheel hub, front passenger airbag cover, door trim panels, or door frame trims, and installation of additional electrical/ electronic equipment on or near “SRS” components and wiring. Keep area between airbags and occupants free from objects (e.g. packages, purses, umbrellas, etc.).
- An airbag system component within the steering wheel gets hot after the airbag has inflated. Do not touch.
- Improper work on the system, including incorrect installation and removal, can lead to possible injury through an unintended activation of the “SRS”.
- In addition, through improper work there is a risk of rendering the “SRS” inoperative or causing unintended airbag deployment. Work on the “SRS” must therefore only be performed by an authorized Mercedes-Benz Light Truck Center.

## Restraint systems

72

- **For your protection and the protection of others, when scrapping the airbag unit or emergency tensioning retractor, our safety instructions must be followed. These instructions are available from your authorized Mercedes-Benz Light Truck Center.**
- **Given the considerable deployment speed and the textile structure of the airbags, there is the possibility of abrasions or other injuries resulting from airbag deployment.**

When you sell your vehicle we strongly urge you to give notice to the subsequent owner that it is equipped with an “SRS” by alerting them to the applicable section in the Operator’s Manual.

## Infant and child restraint systems

We recommend that all infants and children be properly restrained at all times while the vehicle is in motion. All lap-shoulder belts except the driver's seat belt have special seat belt retractors for secure fastening of child restraints.

To fasten a child restraint follow child restraint instructions for routing. Then pull shoulder belt out completely and let it retract. During the seat belt retraction a ratcheting sound can be heard to indicate that the special seat belt retractor is activated. The belt is now locked. Push down on child restraint to take up any slack.

To deactivate, release seat belt buckle and let seat belt retract completely. The seat belt can again be used in the usual manner.

Note:

For child seats with mounting fittings for tether anchorages refer to page 75 (installation of infant and child restraint systems).

### Warning!

**Never release the seat belt buckle while vehicle is in motion, since the special seat belt retractor will be deactivated.**

### Important!

The use of infant or child restraints is required by law in all 50 states and all Canadian provinces.

Infants and small children should be seated in an appropriate infant or child restraint system properly secured by a lap-shoulder belt, and that complies with U.S. Federal Motor Vehicle Safety Standard 213 and Canadian Motor Vehicle Safety Standard 213.

A statement by the child restraint manufacturer of compliance with this standard can be found on the instruction label on the restraint and in the instruction manual provided with the restraint.

When using any infant or child restraint system, be sure to carefully read and follow all manufacturer's instructions for installation and use.

Please read and observe warning labels affixed to inside of vehicle and to infant or child restraints.

**Warning!**

Children 12 years old and under must never ride in the front seat, except in a Mercedes-Benz authorized BabySmart™ compatible child seat, which operates with the BabySmart™ System installed in the vehicle to deactivate the passenger front airbag when it is properly installed. Otherwise they will be struck by the airbag when it inflates in a crash. If this happens, serious or fatal injury can result.

According to accident statistics, children are safer when properly restrained in the rear seating positions than in the front seating positions. Infants and small children must ride in back seats and be seated in an infant or child restraint system, which is properly secured with the vehicle's seat belt, fully in accordance with the child seat manufacturer's instructions.

Infants and small children should never share a seat belt with another occupant. During an accident, they could be crushed between the occupant and seat belt.

Children too big for child restraint systems must ride in back seats using regular seat belts. Position shoulder belt across chest and shoulder, not face or neck. A booster seat may be necessary to achieve proper belt positioning for children from 41 lbs. to the point where a lap/shoulder belt fits properly without one.

When the child restraint is not in use, remove it from the vehicle or secure it with the seat belt to prevent the child restraint from becoming a projectile in the event of an accident.

Do not leave children unattended in the vehicle; even if the children are secured in a child restraint system. Unsupervised children in a child restraint system may use vehicle equipment and may cause serious personal injury.

## Installation of infant and child restraint systems

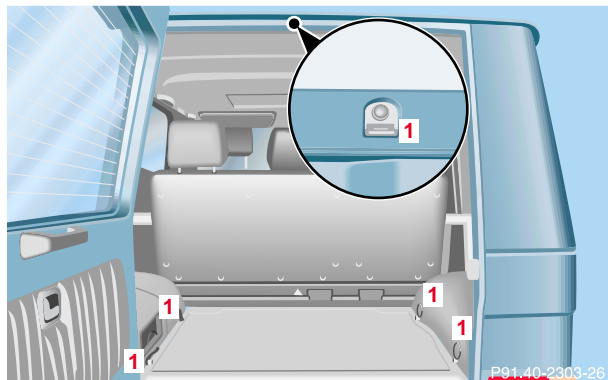

The anchorage rings (1) are located in the rear cargo compartment. Located on each side of the passenger compartment are two anchorage rings (for the rear outer seats) and one on the roof pillar above the tailgate (for the rear center seat).

Guide tether strap between head restraints. Be carefully that the tether strap is not twisted.

When mounting a tether strap on the rear outer seats, reinstall the cargo area cover blind (page 180) and the optional partition net (page 175).



To secure a tether strap to the anchorage, securely fasten the hook (3), which is part of the tether strap, to the anchorage ring (2). For safety, please make sure that the hook has attached to the ring beyond the safety catch, as illustrated.

## Restraint systems

76

## Child seat mounts – “LATCH” type

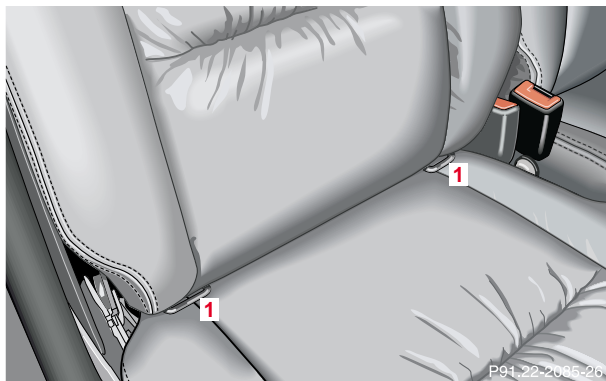

This vehicle is provided with two “LATCH” type mounts (at each of the outer rear seats) for the installation of a “LATCH” child seat having the matching mounting fittings.

Install child seat according to the manufacturer’s instructions.

The child seat must be firmly attached in the right and left side mounting fittings (1).

Non-“LATCH” type child seats may also be used and are capable of being installed using the vehicle’s seat belt system. Install child seat according to the manufacturer’s instructions.

Note:

With a child seat installed in the left rear seat, the seat belt for the center seat occupied by a passenger must operate freely.

**Warning!**

The “LATCH” mounting fittings are intended for children up to 50 lbs (22 kg) in weight.

Children too big for child restraint systems must ride in back seats using regular seat belts. Position shoulder belt across chest and shoulder, not face or neck. A booster seat may be necessary to achieve proper belt positioning for children from 41 lbs. to the point where a lap/shoulder belt fits properly without one.

Install child seat according to manufacturer’s instructions.

The child seat must be firmly attached in the right and left side mounting fittings (1).

An incorrectly mounted child seat may come loose during an accident.

Damaged or impact damaged child seats or child seat mounting fittings must be replaced.

Do not leave children unattended in the vehicle, even if the children are secured in a child restraint system.



## Steering wheel adjustment

78

**Steering wheel adjustment****Warning!**

Do not adjust the steering wheel while driving. Adjusting the steering wheel while driving could cause the driver to lose the control of the vehicle.

When leaving the vehicle always remove the electronic key from the starter switch and lock your vehicle.

The steering wheel adjustment feature can also be operated with the driver's door open. Do not leave children unattended in the vehicle, or with access to an unlocked vehicle. Unsupervised use of vehicle equipment may cause serious personal injury.

To operate the steering wheel adjustment switches, turn the electronic key in starter switch to position 1 or 2 (with a front door opened, the steering wheel adjustment can also be operated with the electronic key removed or in starter switch position 0 for approximately 30 minutes).

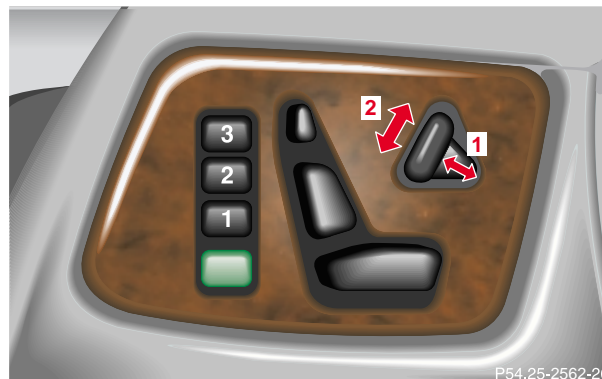

The switch is located on the driver's door.

**1 Steering column, lengthen or shorten column**

Move the switch to the front or rear.

**2 Steering column, height**

Move the switch up or down.

Note:

The steering wheel adjustment can be stored together with the seat and exterior rear view mirror adjustment. See page 48 for notes on the memory function.

## Inside rear view mirror

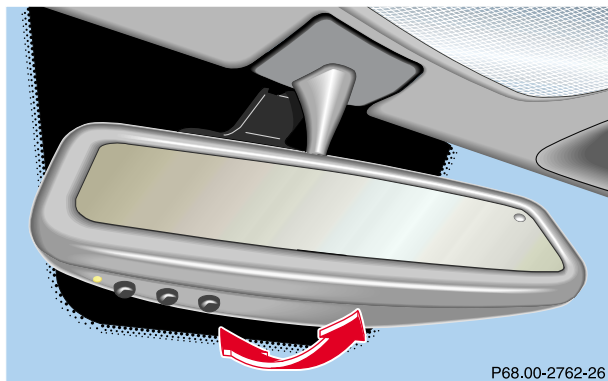

Manually adjust the mirror.

### Automatic antiglare night position

With the key in starter switch position 2 and the automatic antiglare function activated, the mirror reflection brightness responds to changes in light sensitivity.

Notes:

With gear selector lever in position “R”, or with the interior lamps (except cargo compartment lamp) switched on, the mirror brightness does not respond to changes in light sensitivity.

The automatic antiglare function does not react, if incoming light is not aimed directly at sensors in the mirror.

The antiglare function will not react for example, if the cargo area is fully loaded.

### Warning!

**In the case of an accident liquid electrolyte may escape the mirror housing when the mirror glass breaks.**

**Electrolyte has an irritating effect. Do not allow the liquid come into contact with eyes, skin, clothing, or respiratory system. In cases it does, immediately flush affected area with water, and seek medical help if necessary.**

## Rear view mirrors

80

## Exterior rear view mirrors

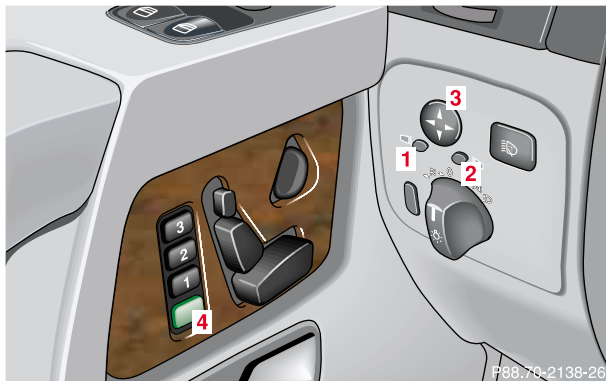

- 1 Exterior rear view mirror left
- 2 Exterior rear view mirror right
- 3 Position button
- 4 Memory button

The buttons are located above the exterior lamp switch.  
The memory button (4) is located on the driver's door.

**Warning!**

Exercise care when using the passenger side exterior mirror. The mirror surface is convex (outwardly curved surface for a wider field of view). Objects in mirror are closer than they appear. Check your inside rear view mirror or glance over your shoulder before changing lanes.

**Exterior mirror adjustment**

Turn the electronic key in starter switch to position 2.

Push button to select mirror to be adjusted:

Driver's side – Push button (1).

Passenger side – Push button (2).

Push the adjustment button (3) up, down, left or right according to the setting desired.

Notes:

The exterior rear view mirrors have electrically heated glass. The heater switches on automatically, depending on outside temperature.

If an exterior mirror housing is forcibly pivoted from its normal position, it must be repositioned by applying firm pressure until it snaps into place.

Before running the vehicle through an automatic car wash, fold the mirrors in, otherwise they might get damaged.

### **Storing mirror positions in memory**

The exterior rear view mirror positions are stored in memory with the seat/steering wheel adjustment and can be recalled when necessary. See page 48 for notes on the memory function.

## Rear view mirrors

82

**Parking position exterior mirror**

The passenger side exterior mirror can be adjusted and programmed to assist the driver during parking maneuvers (e.g. to observe the curb or other objects close to the vehicle).

With the electronic key in starter switch position 2, and the exterior rear view mirror switch in the passenger side position (button 2), the passenger side mirror will be turned downward when placing the gear selector lever in “R” reverse.

Note:

The button 2 must not be pressed, when the individual setting menu “CONVENIENCE” – “MIRROR SETTING WHEN PARKING” – “ON” is set, see page 120.

The passenger side mirror will return to its previous position:

- immediately at speeds above approx. 6 mph (10 km/h) – independent of the engaged gear,
- after 10 seconds when shifting gear selector lever from “R” Reverse,
- by pressing the driver’s side mirror button .

To store passenger mirror parking position:

1. The vehicle must be stationary.  
Turn the electronic key in starter switch to position 1 or 2.
2. Select passenger side mirror  (button 2) and adjust the mirror to view the curb.
3. Push the memory button “M” (4).
4. Within 3 seconds push bottom of adjustment button (3).  
The mirror should not move.  
Repeat the memory procedure if the mirror moves.

Note:

One stored parking position is available for each of the two electronic keys.

This is only possible if you select “ON” in the menu, “SETTINGS KEY-DEPENDENT”, see under individual setting menu “CONVENIENCE” – “SETTINGS KEY-DEPENDENT”, see page 120.

## Instrument cluster

84

## Instrument cluster

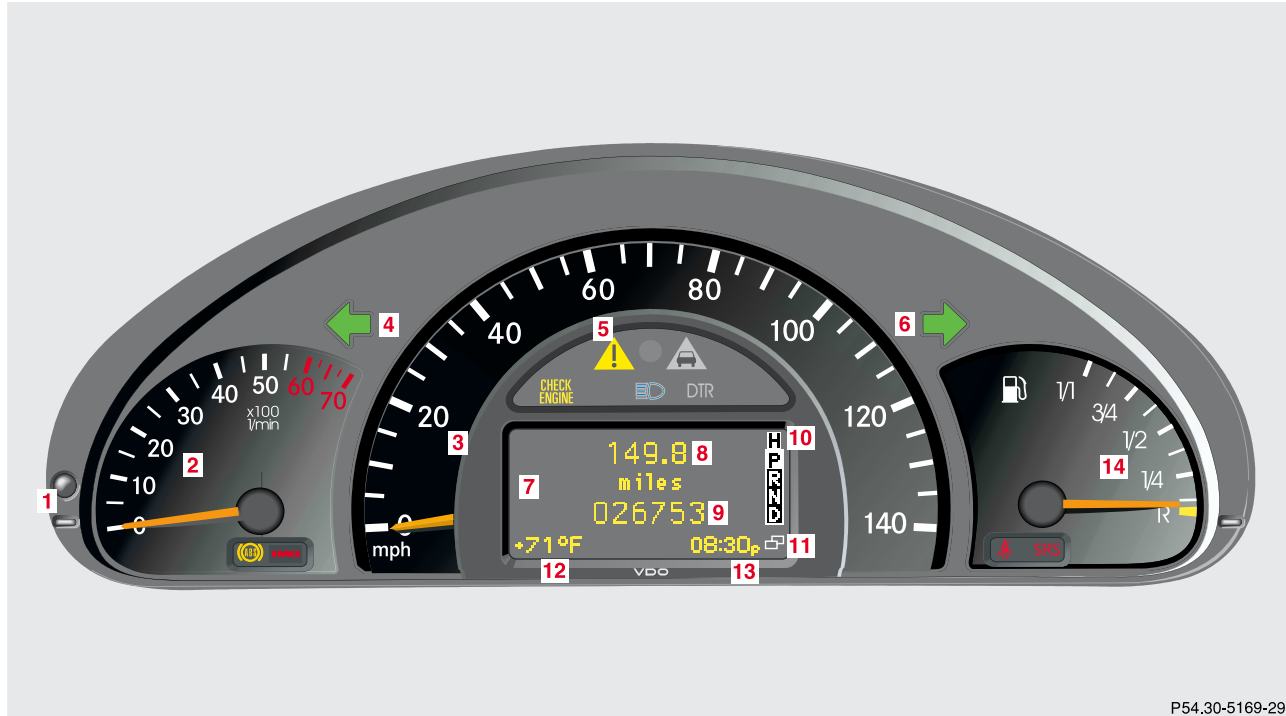

- 1 Knob for instrument cluster illumination, see page 84  
Reset knob for trip odometer, see page 88 and individual settings, see page 108
- 2 Tachometer
- 3 Speedometer
- 4 Left turn signal indicator lamp, see combination switch on page 134
- 5 Electronic stability program (ESP) warning lamp, see page 270
- 6 Right turn signal indicator lamp, see combination switch on page 134
- 7 Multifunction display, see page 90  
Malfunction and warning messages in the multifunction display, see page 272
- 8 Trip odometer, see page 88 and 94
- 9 Main odometer, see page 94
- 10 Display for transfer case program mode and gear range indicators, page 210
- 11 Malfunction/warning message memory, see page 106
- 12 Outside temperature indicator, see page 89
- 13 Digital clock  
To set the time, see individual settings on page 110
- 14 Fuel gauge with reserve warning lamp, see page 268



**Indicator lamps in the instrument cluster**

High beam, see page 134



ABS malfunction, see page 269



Brake warning lamp (except Canada), see page 266.  
Parking brake engaged, see page 266  
Brake fluid low, see page 266



ESP. Adjust driving to road condition, see page 270



Fasten seat belts, see page 270



SRS malfunction, see page 267



Engine malfunction indicator lamp. If the malfunction indicator lamp comes on when the engine is running, it indicates a malfunction of the fuel management system, emission control system, systems which impact emissions, or the fuel cap is not closed tight. In all cases, we recommend that you have the malfunction checked as soon as possible, see page 265.

## Activating instrument cluster display

The instrument cluster is activated by:

- Opening the door<sup>1</sup>.
- Pressing button (1) on the instrument cluster<sup>1</sup>.
- Turning the electronic key in starter switch to position 1 or 2.
- Switching on the exterior lamps.

<sup>1</sup> The instrument cluster is activated for approximately 30 seconds.

## Instrument cluster illumination

The instrument cluster illumination is dimmed or brightened automatically to suit daylight lighting conditions.

The instrument cluster illumination will also be adjusted when the vehicle's exterior lamps are switched on.

Display illumination, changing basic settings for driving at dusk or in darkness:

Rotate adjusting knob (1) clockwise – instrument lamp intensity increases.

Rotate adjusting knob (1) counterclockwise – instrument lamp intensity decreases.

Note:

It is not possible to select a basic brightness setting in daylight – the intensity is adjusted automatically.

## Instrument cluster

88

**Tachometer (2)**

The red marking on the tachometer denotes excessive engine speed.

Avoid this engine speed, as it may result in serious engine damage that is not covered by the Mercedes-Benz Limited Warranty.

To help protect the engine, the fuel supply is interrupted if the engine is operated within the red marking.

**Trip odometer (8)**

To reset to “0” miles/km:

Activate the instrument cluster if it is not already activated, see page 87.

Press button  or  on the multifunction steering wheel repeatedly until the trip odometer appears if it is not displayed. See page 94.

Press and hold button (1) on the instrument cluster, see page 84.

## Outside temperature indicator (12)

### Warning!

**The outside temperature indicator is not designed to serve as an Ice-Warning Device and is therefore unsuitable for that purpose. Indicated temperatures just above the freezing point do not guarantee that the road surface is free of ice.**

The temperature sensor is located in the front bumper area. Due to its location, the sensor can be affected by road or engine heat during idling or slow driving. This means that the accuracy of the displayed temperature can only be verified by comparison to a thermometer placed next to the sensor, not by comparison to external displays (e.g. bank signs etc.).

Adaption to ambient temperature takes place in steps and depends on the prevailing driving conditions (stop-and-go or moderate, constant driving) and amount of temperature change.

### Note:

The unit for the temperature indicator display can be set in the individual setting menu “INSTRUMENT CLUSTER” – “TEMP. INDICATOR” on page 110.





Depending on your vehicle's equipment, you may use the buttons on the multifunction steering wheel to call up, control and set the following systems in the multifunction display:

- 1 Trip odometer and main odometer, see page 88 and page 94
  - Flexible service system (FSS), see page 124
  - Vehicle speed, see page 94
  - Coolant temperature gauge, see page 123
  - Engine oil level indicator, see page 127
- 2 Audio systems, see page 96
  - Radio, see page 96
  - CD player, see page 97

- 3 Navigation system, see page 103
- 4 Malfunction message memory, see page 106
- 5 Individual settings, see page 108
- 6 Trip computer, see page 104
  - After start
  - After reset
  - Fuel tank content
- 7 Telephone, see page 98

Press the  or  button repeatedly until the required system is displayed.

The display advances by one system each time the button is pressed.

You may call up additional displays within some of these categories by pressing the  or  button.

## Multifunction steering wheel, multifunction display

92

**Warning!**

**A driver's attention to the road must always be his/her primary focus when driving.**

**For your safety and the safety of others, selecting features through the multifunction steering wheel should only be done by the driver when traffic and road conditions permit it to be done safely.**

**Bear in mind that at a speed of just 30 mph (approximately 50 km/h), your vehicle is covering a distance of approximately 50 feet (approximately 14 m) every second.**

**Note:**

The displays in the multifunction display can be set to German, English, French, Italian or Spanish language. See the "INSTRUMENT CLUSTER" individual settings on page 110 for instructions on changing the language setting.

The displays for the audio systems (radio, CD player) and for the telephone will appear in English, regardless of the language selected.

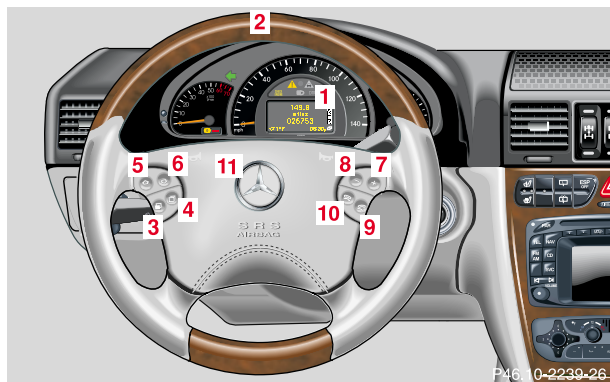









**1** Multifunction display

**2** Multifunction steering wheel

Turn the electronic key in starter switch to position 1 or 2.

Press button:



- 3**  for next system
- 4**  for previous system
- 5**  for next display in system
- 6**  for previous display in system
- 7**  to increase the volume, see page 122
- 8**  to decrease the volume, see page 122
- 9**  to dial a telephone number, see page 98
- 10**  to end a call

See page 98 for telephone and page 102 for instructions on answering an incoming call.

**11** Horn pad

Press the  or  button repeatedly until the required system is displayed.

The display advances by one system each time the button is pressed.

You may call up additional displays in some systems by pressing the  or  button.





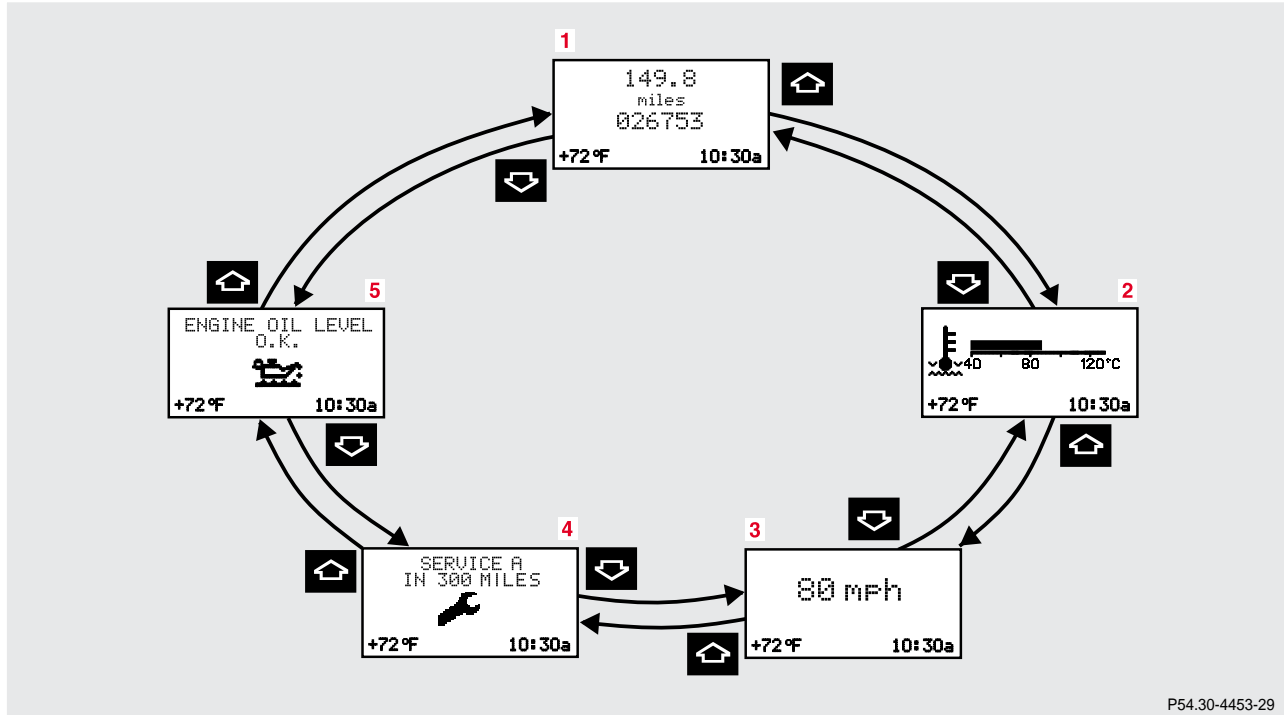

Multifunction steering wheel, multifunction display

Trip and main odometer and sub menu



- 1 Trip odometer and main odometer  
See page 88 for instructions on resetting the trip odometer.
- 2 Coolant temperature gauge, see page 123
- 3 Vehicle speed if “SPEED DISP.” is selected in the individual setting menu “INSTRUMENT CLUSTER” - “SELECT DISPLAY”, refer to page 110  
  
Outside temperature if “OUTSIDE TEMPERATURE” is selected in the individual setting menu “INSTRUMENT CLUSTER” - “SELECT DISPLAY”, see page 110
- 4 FSS (Flexible service system), see page 124
- 5 Engine oil level indicator, see page 127

Press  or  button repeatedly until the trip odometer and main odometer display (1) appears.

Press the  or  button repeatedly until the required display (2, 3, 4, 5, 1) appears.

Pressing the  or  button displays the next or previous system.

## Multifunction steering wheel, multifunction display

96

## Audio systems

## Radio

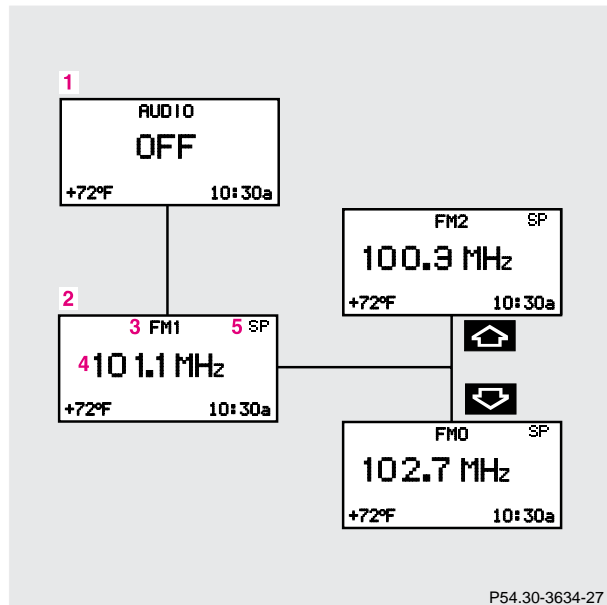

- 1 Audio system is switched off.
- 2 The radio is switched on.
- 3 Wave band setting and memory location number, where appropriate.
- 4 Station name setting or station frequency.
- 5 This only appears when “MEMORY” rather than “STATION SEARCH” has been selected in the setting menu “VEHICLE” – “PRESS BUTTON IN AUDIO MODE”, page 118.

The radio must be switched on.

Press the or button repeatedly until display (2) appears.

Press button or repeatedly until the required station or frequency is displayed.

Use the or button to select a stored station or station frequency. This depends on the selection made in the setting menu “PRESS BUTTON IN AUDIO MODE”. See individual settings, page 118.

Pressing the or button displays the next or previous system.

## CD player

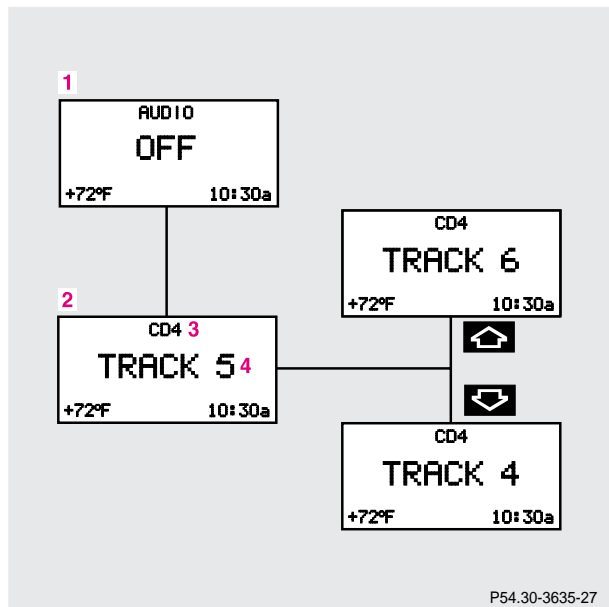

- 1 Radio system is switched off.
- 2 The CD player is switched on.
- 3 The number of the CD currently playing is displayed if you are using a CD changer.
- 4 Track number.



"TITLE" appears on vehicles with COMAND system.

"TRACK" appears on vehicles with audio system.

The radio must be switched on.

The CD player must be switched on.

Press the  or  button repeatedly until display (2) appears.

Press the  or  button repeatedly until the required track number (4) is displayed.

Pressing the  or  button displays the next or previous system.

Note:

To select a CD from the magazine, press a number on the audio system or the (optional) COMAND system key pad located in the center dashboard.

## Multifunction steering wheel, multifunction display

98



## Telephone

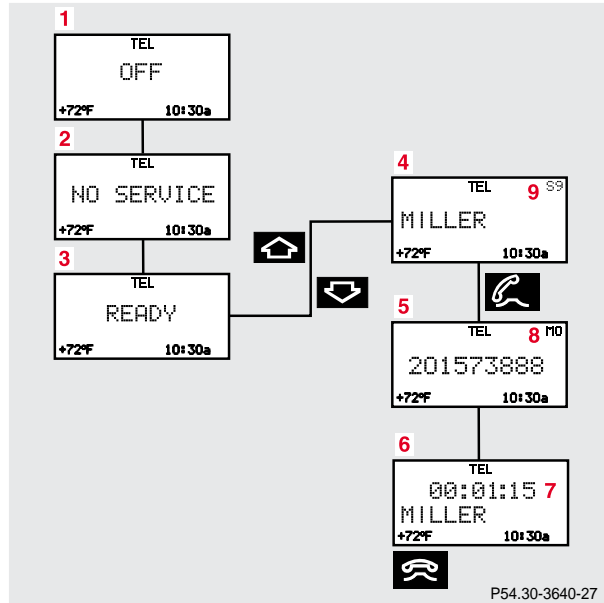



## Telephone book



- 1 The telephone is switched off.
- 2 The vehicle is currently outside the transmitter or receiver range.
- 3 The telephone is ready for use.
- 4 Name selected from the telephone book.
- 5 Number for the name selected. The dialing commences.
- 6 Dialing is completed. The name is displayed. The display remains for the duration of the call.
- 7 Duration of call
- 8 Memory location number
- 9 Signal strength (in top left corner):  
The higher the number of bars, the stronger the signal received from the net.

The telephone must be switched on.

Press the  or  button repeatedly until the display (3) appears. See the separate telephone instructions manual.

Pressing  or  “browses” alphabetically forward or backward through the telephone book, providing it was previously downloaded. See telephone operator’s manual for details concerning downloading. Pressing button  or  for longer than a second “browses” rapidly through the telephone book. The name selected appears in the display.

Note:

Press the  button if you do not wish to make a call. The procedure is cancelled and display (4) appears.

Press the  button when the name you require appears in the display (4). The telephone number (5) is dialed.

The name will be displayed when dialing is completed. Display (6) remains for the duration of the call.

Pressing the  button hangs up and display (3) appears.

Pressing the  or  button displays the next or previous system.

## Multifunction steering wheel, multifunction display

100

## Redialing

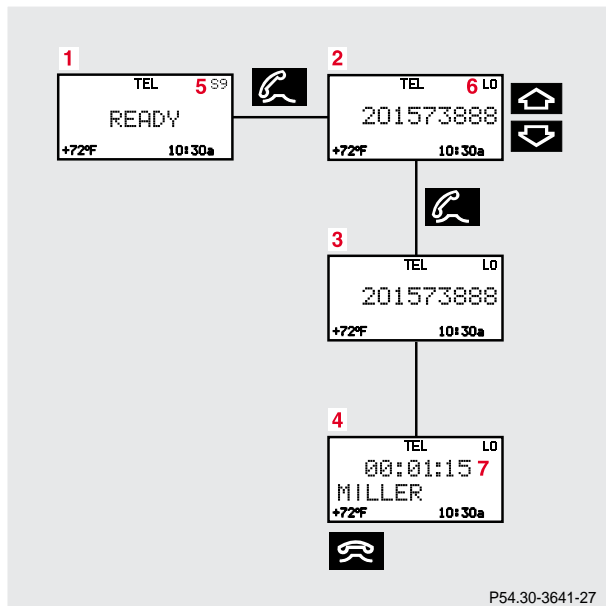

- 1** The telephone is ready for use.
- 2** Number or name stored in the redial memory.
- 3** Number in the redial memory – redialing has commenced.
- 4** Dialing is completed and the name stored in the telephone book is displayed or the number dialed will remain displayed if no name has been store. The display remains for the duration of the call.
- 5** Signal strength (in top left corner): the higher the number, the stronger the signal received from the net.
- 6** Memory location numbers – the 10 most recently dialed numbers are stored. L0, most recently dialed number, L1 to L9, previously dialed numbers.
- 7** Duration of call.

The telephone must be switched on.

Press the  or  button repeatedly until the display (1) appears.

Pressing the  button activates the redial memory and the most recently dialed number is displayed.

Pressing the  or  button “browses” forward or backward through the redial memory. The number selected appears in the display.

Note:

Press the  button if you do not wish to make a call.

The procedure is cancelled and display (1) appears.

Press the  button when the required number or name appears in the display (2).

The telephone number (3) is dialed.

Once dialing is complete the name (4) is displayed if the name is stored in the telephone book; failing that the number dialed will remain displayed. The display remains for the duration of the call.

Pressing the  button hangs up and display (1) appears.

Pressing the  or  button displays the next or previous system.



## Multifunction steering wheel, multifunction display

102

## Incoming call

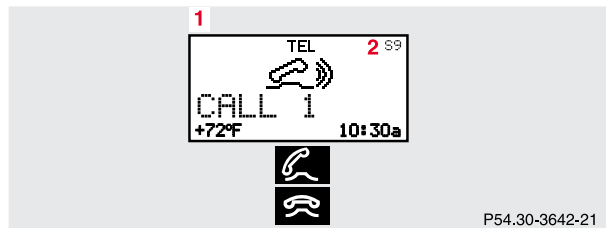

The telephone must be switched on.

- 1 “CALL” – you are being called.
- 2 Signal strength (in top right corner):  
the higher the number, the stronger the signal  
received from the net.

Press the  button to answer the call.

Press the  button to hang up or if you do not wish to answer the incoming call.

## Navigation system

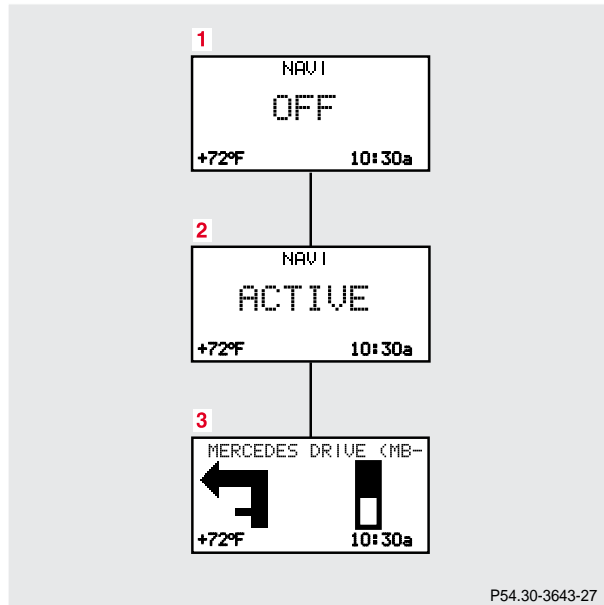

- 1 The navigation system is switched off.
- 2 The navigation system is switched on but no destination has been specified.
- 3 The navigation system is switched on and destination guidance is active.

Press the  or  button repeatedly until the required system is displayed.

See the separate COMAND (Cockpit Management and Data System) operator's manual for notes on the navigation system.

Pressing the  or  button displays the next or previous system.

## Multifunction steering wheel, multifunction display

104

## Trip computer

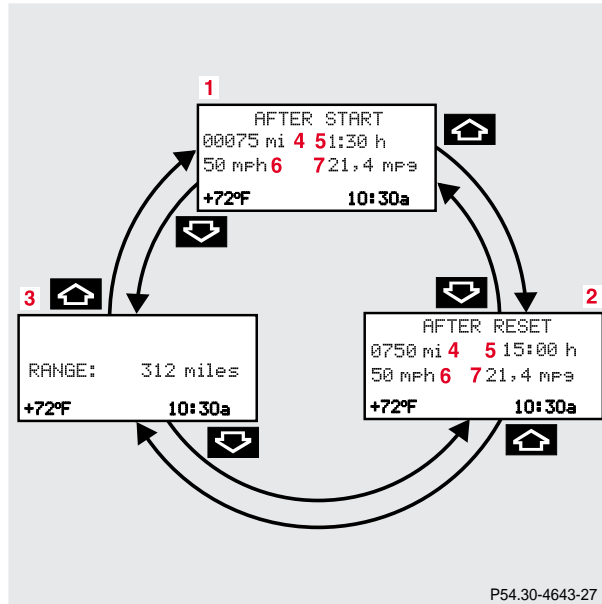

- 1 “AFTER START” – short distance memory
- 2 “AFTER RESET” – long distance memory
- 3 Estimated range remaining
- 4 Distance covered “AFTER START” or “AFTER RESET”
- 5 Elapsed time “AFTER START” or “AFTER RESET”
- 6 Average speed “AFTER START” or “AFTER RESET”
- 7 Average fuel consumption “AFTER START” or “AFTER RESET”

Press the button or repeatedly until the display (1, 2 or 3) appears.



Press the or button until the “AFTER START” short distance memory (1), the “AFTER RESET” long distance memory (2) and estimated range remaining indicator (3) appears.

Pressing the or button displays the next or previous system.

Note:

The display (1) always appears the next time the trip computer is called up.

**To reset the short “AFTER START” (1) or long “AFTER RESET” distance memory (2):**

Call up the relevant display (1 or 2) using the  or  button and press the reset knob on the instrument cluster, see page 84, until the values are reset to “0”.

Note:

The “AFTER START” trip odometer reading is automatically reset after four hours of electronic key not being in starter switch position 1 or 2.

## Multifunction steering wheel, multifunction display

106

## Malfunction/warning message memory

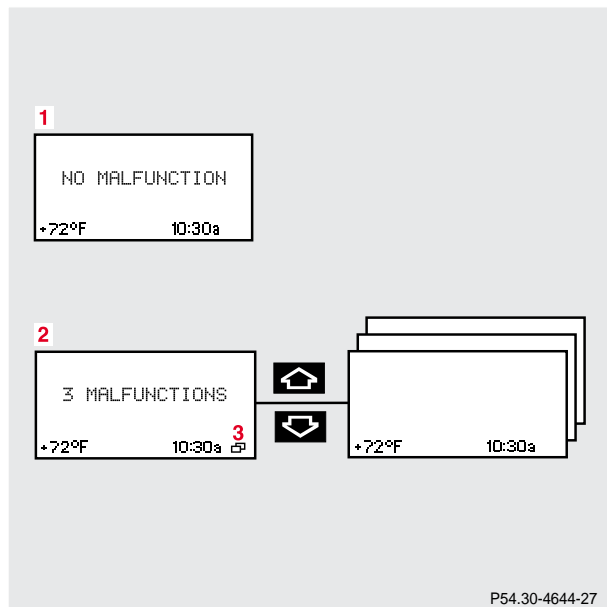

- 1 There are no messages stored in the system.
- 2 Number of messages stored in the system.
- 3 There are messages stored in the system.

Press the or button repeatedly until the message memory (1 or 2) is displayed.

Press the or button if display (2) appears. The stored messages will now be displayed in order.

See page 272 for malfunction and warning messages.

Display (2) will reappear after you have scanned all the malfunction and warning messages.

Should any malfunction or warning messages be stored while driving, they will reappear in the display (2) when the electronic key is in starter switch position 0 or removed from the starter switch.

The malfunction or warning messages will now be displayed for approximately 5 seconds each.

Pressing the reset knob on the instrument cluster (see page 84) displays the malfunction and warning messages once more.

The message memory will be cleared when the electronic key is turned in the starter switch to position 1 or 2. Should any subsequent faults occur, they will be displayed in the message memory.

Pressing the  or  button displays the next or previous system.

### **Important!**

Malfunction and warning messages are only indicated for certain systems and displayed to a low level of detail. The malfunction and warning messages are simply a reminder with respect to the operation of certain systems and do not replace the driver's responsibility to maintain the vehicle's operating safety by having all required maintenance and safety checks performed on the vehicle and by bringing the vehicle to an authorized Mercedes-Benz Light Truck Center to address the malfunction and warning messages. See page 272 for malfunction and warning messages.



## Multifunction steering wheel, multifunction display

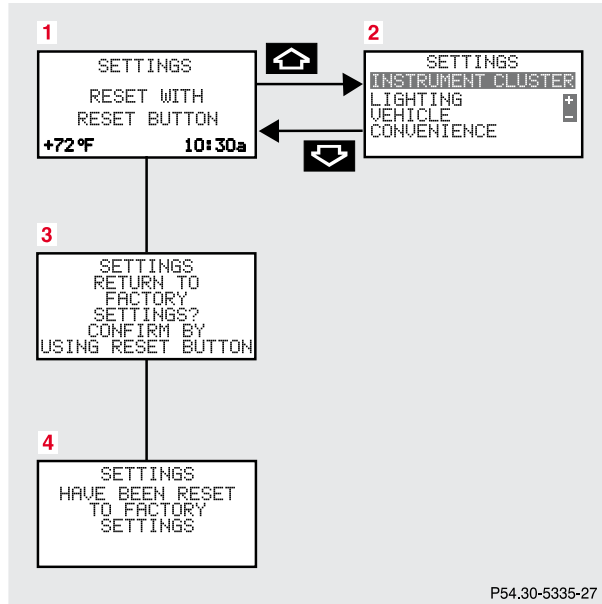

108



## Individual settings



- 1** Preliminary display of the individual settings.
- 2** “SETTINGS” – the requested menu can be called up in this options menu:  
“INSTRUMENT CLUSTER”, see page 110.  
“LIGHTING”, see page 114.  
“VEHICLE”, see page 118.  
“CONVENIENCE”, see page 120.  
The four menus contain additional submenus. Individual settings can be selected in these submenus.
- 3** See below for instructions on returning the setting menus to the factory settings.
- 4** Acknowledgment.

Press the  or  button repeatedly until the individual setting preliminary display (1) appears.

Press the  or  button until the setting menu “SETTINGS” (2) is displayed.

Pressing the  or  button controls the selection marker in the setting menu.

“INSTRUMENT CLUSTER”, see page 110.

“LIGHTING”, see page 114.

“VEHICLE”, see page 118.

“CONVENIENCE”, see page 120

Pressing the  or  button displays the next or previous system.

Note:

These settings may only be performed with the electronic key in starter switch position 1 or 2.

**To return menu “SETTINGS” (2) to its factory setting:**

- Call up the individual setting preliminary display (1) or display (2).
- Press the reset knob on the instrument cluster (see page 84) for approximately 3 seconds. Display (3) will appear.
- Press the reset knob on the instrument cluster once more. The menu “SETTINGS” is reset to factory settings, acknowledged by display (4).

The individual setting preliminary display (1) will appear if you do not press the reset knob on the instrument cluster within about 5 seconds. The setting menus will not be reset.

Note:

For safety reasons, the individual setting “LIGHT CIRCUIT HEADLAMP MODE” in menu “LIGHTING” cannot be reset while driving, see page 114. If an attempt is made, the message “LIGHTING” – “CANNOT BE COMPLETELY RESET TO FACTORY SETTINGS WHILE DRIVING” will be displayed.





Multifunction steering wheel, multifunction display

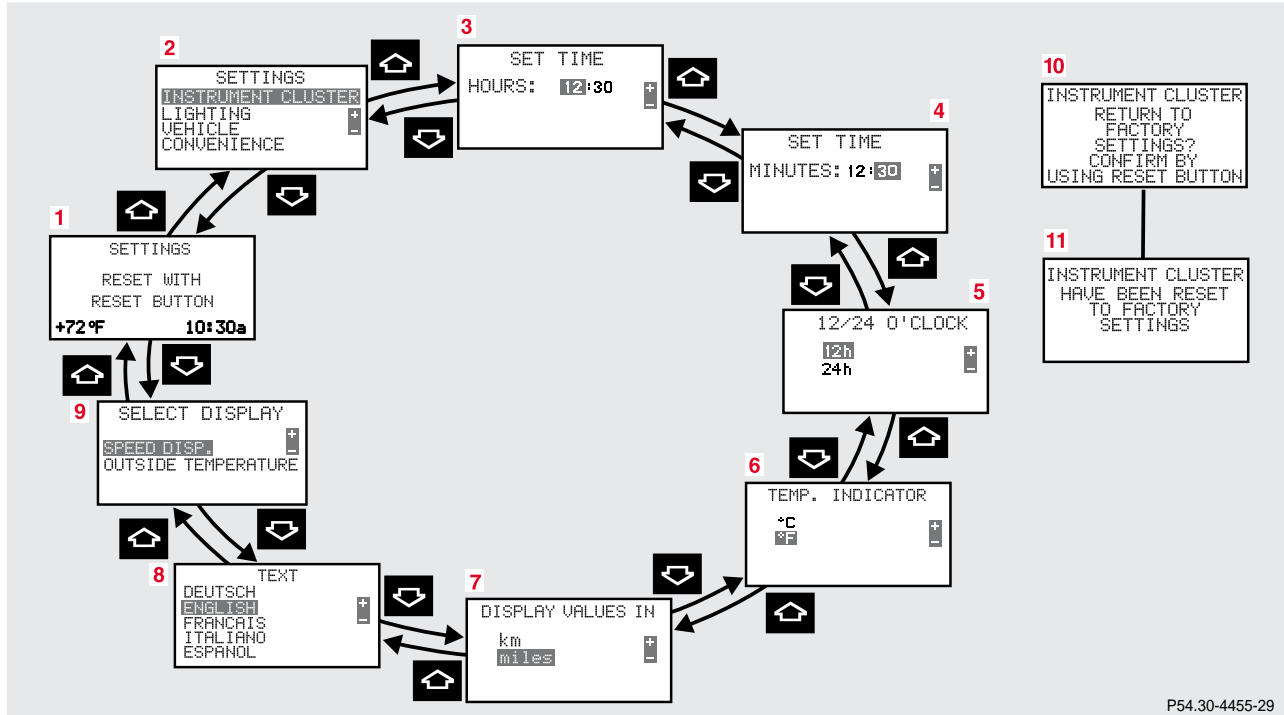

“INSTRUMENT CLUSTER”



- 1 Preliminary display of the individual settings
- 2 “SETTINGS” – the individual setting menu  
“INSTRUMENT CLUSTER” can be called up in this options menu.  
Pressing button **+** or **-** on the multifunction steering wheel controls the selection marker.
- 3 “SET TIME HOURS:”, see separate COMAND operator’s manual
- 4 “SET TIME MINUTES”, see separate COMAND operator’s manual
- 5 “12/24 O’CLOCK” – the unit set is displayed in the instrument cluster display
- 6 “TEMP. INDICATOR” – the unit set is displayed in the outside temperature display, in the instrument cluster and in the automatic air conditioner display.
- 7 “DISPLAY VALUES IN” – the unit set is displayed in the multifunction display (except speedometer).
- 8 “TEXT” – sets the language used in the multifunction display
- 9 “SELECT DISPLAY” – The selection “SPEED DISP.” respectively “OUTSIDE TEMPERATURE” is permanently displayed in the multifunction display. “SPEED DISP.” can be used to display, for instance, the present speed in km/h if the setting menu (7) “DISPLAY VALUES IN” is set to indicate km.
- 10 See page 113 for instructions on returning the individual setting menu “INSTRUMENT CLUSTER” to the factory setting.
- 11 Acknowledgment.

**Multifunction steering wheel, multifunction display**



Press the  or  button repeatedly until the individual setting preliminary display (1) appears.

Press the  or  button until the setting menu "SETTINGS" (2) is displayed.



Press button  or  until the individual setting menu "INSTRUMENT CLUSTER" is selected by the selection marker.

Press the  or  button until the required display (3 to 9) is displayed.

**112**

Pressing the  or  button sets the time in setting menus (3, 4) and controls the selection marker in the setting menus (5 to 9).

The settings made are stored and applied immediately.

The individual setting preliminary display (1) will appear again after you have run through all the setting menus. Pressing the  or  button displays the next or previous system.

**To return menu “INSTRUMENT CLUSTER” (5 to 9) to its factory setting:**

- Call up one of the setting menus(3 to 9).
- Press the reset knob on the instrument cluster, see page 84, for approximately 3 seconds. Display (10) will appear.
- Press the reset knob on the instrument cluster once more. The individual setting menu “INSTRUMENT CLUSTER” is reset to factory settings, acknowledged by display (11).  
The individual setting display “SETTINGS” (2) will appear if you do not press the reset knob on the instrument cluster within about 5 seconds. The setting menus will not be reset.



Multifunction steering wheel, multifunction display

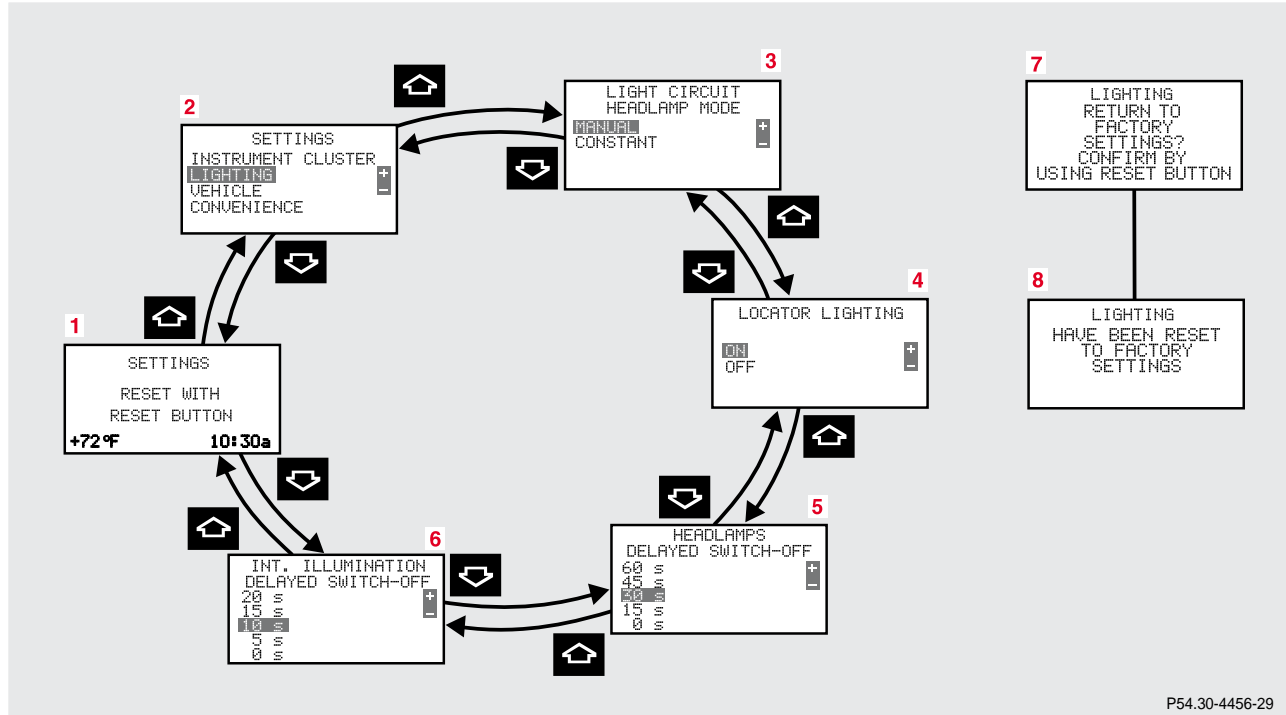

“LIGHTING”









- 1 Preliminary display of the individual settings
- 2 “SETTINGS” – in this options menu you can call up the individual setting menu “LIGHTING”. Pressing button **+** or **-** on the multifunction steering wheel controls the selection marker.
- 3 “LIGHT CIRCUIT HEADLAMP MODE”<sup>1,2</sup>, see page 130.
- 4 “LOCATOR LIGHTING”, see page 133.
- 5 “HEADLAMPS DELAYED SWITCH-OFF”, see “Night security illumination” on page 132.
- 6 “INT. ILLUMINATION DELAYED SWITCH-OFF”, see “Interior lighting” on page 156.
- 7 Returning the individual setting menu “LIGHTING” to the factory setting, see page 117.
- 8 Acknowledgment.
  - 1 Except Canada
  - 2 For safety reasons, setting only possible while vehicle is standing still.



**Multifunction steering wheel, multifunction display****116**

Press the  or  button repeatedly until the individual setting menu preliminary display (1) appears.

Press the  or  button until the individual setting menu “SETTINGS” (2) is displayed.

Press button  or  until the menu “LIGHTING” is selected by the selection marker.

Press the  or  button until the required display (3 to 6) is displayed. Pressing the  or  button controls the selection marker. The settings made are stored and applied immediately.

The individual setting preliminary display (1) will appear again after you have run through all the setting menus. Pressing the  or  button displays the next or previous system.

**To return menu “LIGHTING” (3 to 6) to its factory setting:**

- Call up menu (3 to 6).
- Press the reset knob on the instrument cluster (see page 84) in the instrument cluster for approximately 3 seconds. Display (7) will appear.
- Press the reset knob on the instrument cluster once more. The individual setting menu “LIGHTING” is reset to factory settings, acknowledged by display (8).  
The individual setting display “SETTINGS” (2) will appear if you do not press the reset knob on the instrument cluster within about 5 seconds. The setting menus will not be reset.

**Note:**

For safety reasons, the individual setting “LIGHT CIRCUIT HEADLAMP MODE” in menu “LIGHTING” cannot be reset while driving. If an attempt is made, the message “LIGHTING” – “CANNOT BE COMPLETELY RESET TO FACTORY SETTINGS WHILE DRIVING” will be displayed.









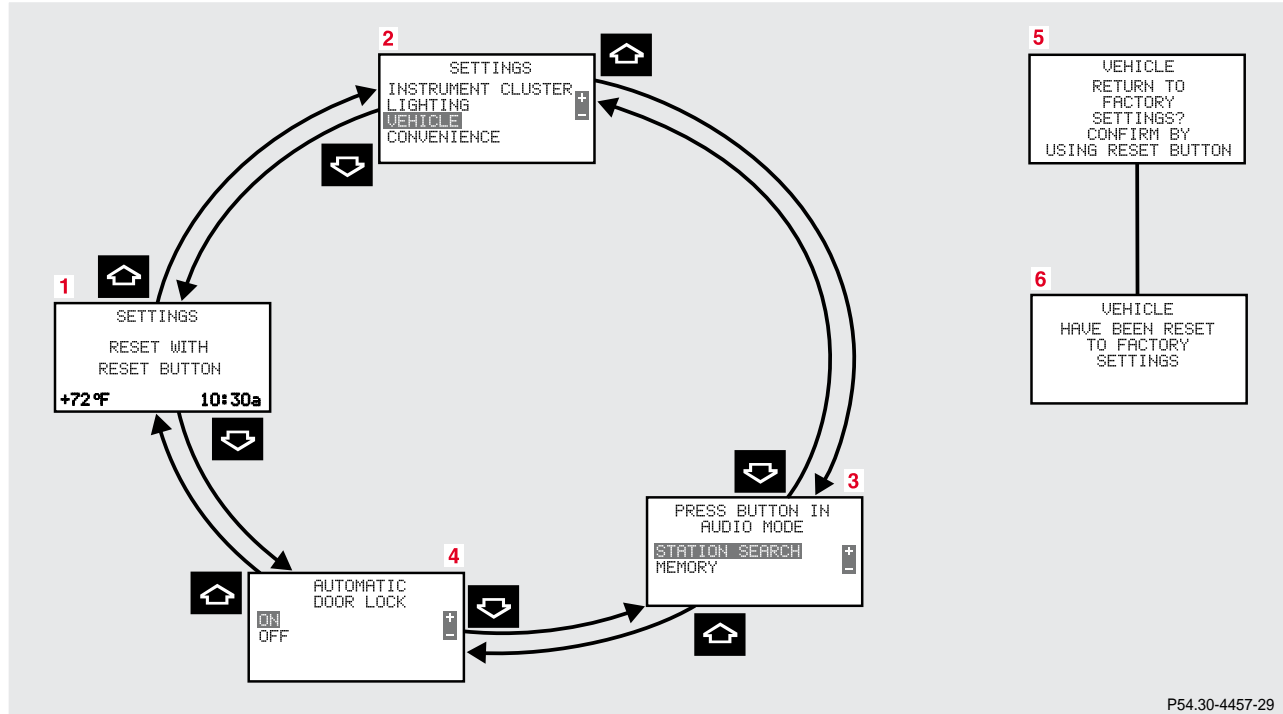

## Multifunction steering wheel, multifunction display



118



## “VEHICLE” (audio and central locking system)









- 1 Preliminary display of the individual settings
- 2 “SETTINGS” – in this options menu you can call up the individual setting menu “VEHICLE”. Pressing button  or  on the multifunction steering wheel controls the selection marker.
- 3 “PRESS BUTTON IN AUDIO MODE”
  - radio adjustment “STATION SEARCH”: use the  or  button to select a frequency.
  - radio adjustment “MEMORY”: use the  or  button to select a stored station (preset memory).
- 4 “AUTOMATIC DOOR LOCK”, see automatic central locking on page 41.
- 5 Returning the individual setting menu “VEHICLE” to the factory setting, see page 119.
- 6 Acknowledgment.

Press the  or  button repeatedly until the individual setting preliminary display (1) appears.

Press the  or  button until the setting menu “SETTINGS” (2) is displayed.

Press button  or  until the individual setting menu “VEHICLE” is selected by the selection marker.

Press the  or  button until the required display (3 to 4) is displayed. Pressing the  or  button controls the selection marker. The settings made are stored and applied immediately.

The individual setting preliminary display (1) will appear again after you have run through all the setting menus. Pressing the  or  button displays the next or previous system.

#### To return menu “VEHICLE” (3 and 4) to its factory setting:



- Call up menu (3 or 4).
- Press the reset knob on the instrument cluster (see page 84) in the instrument cluster for approximately 3 seconds. Display (5) will appear.
- Press the reset knob on the instrument cluster once more. The individual setting menu “VEHICLE” is reset to factory settings, acknowledged by display (6).  
The individual setting display “SETTINGS” (2) will appear if you do not press the knob for instrument cluster illumination within about 5 seconds. The setting menus will not be reset.



Multifunction steering wheel, multifunction display

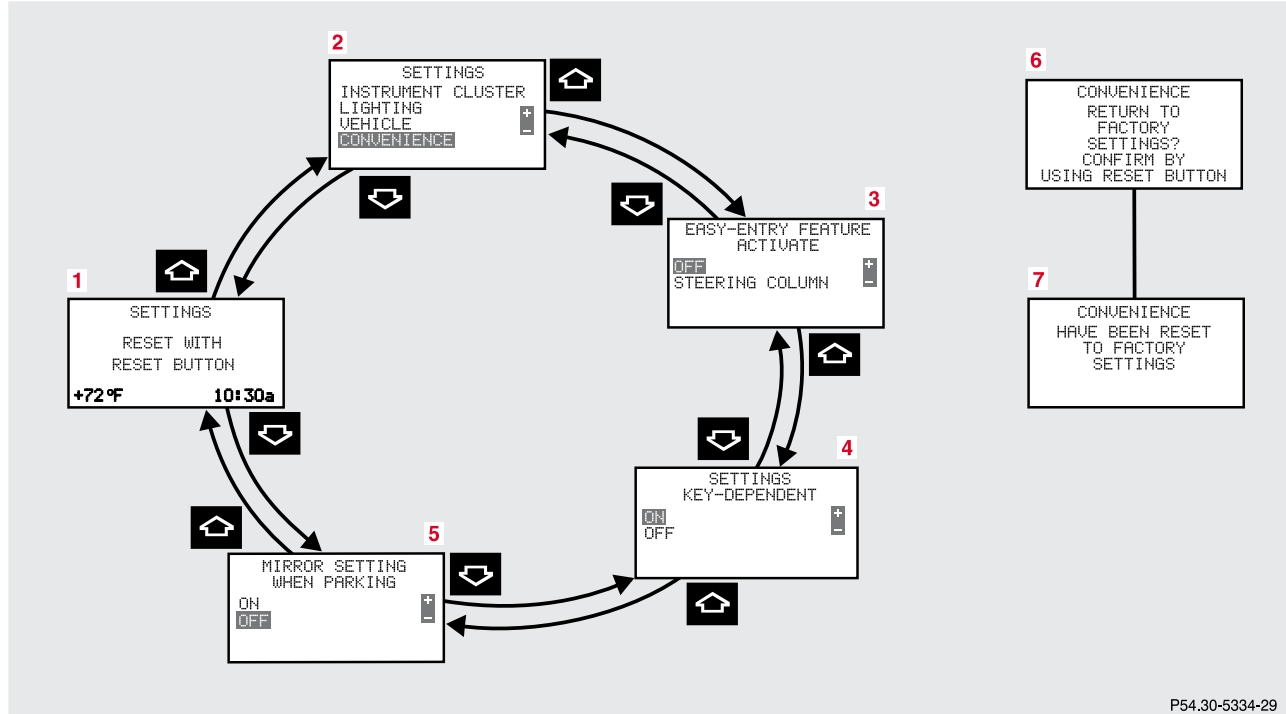

120



“CONVENIENCE”









- 1 Preliminary display of the individual settings
- 2 “SETTINGS” – in this options menu you can call up the individual setting menu “CONVENIENCE”. Pressing button  or  on the multifunction steering wheel controls the selection marker.
- 3 “EASY-ENTRY FEATURE ACTIVATE”, see page 44.
- 4 “SETTINGS KEY-DEPENDENT”  
if setting “ON” is selected, all settings selected in the individual setting can be stored key-dependent in memory. Memory function, see page 48.
- 5 “MIRROR SETTING WHEN PARKING” – the passenger side exterior mirror can be adjusted and programmed to assist the driver during parking maneuvers, see page 82.
- 6 Returning the individual setting menu “CONVENIENCE” to the factory setting, see page 122.
- 7 Acknowledgment.

Press the  or  button repeatedly until the individual setting preliminary display (1) appears.

Press the  or  button until the setting menu “SETTINGS” (2) is displayed.

Press button  or  until the individual setting menu “CONVENIENCE” is selected by the selection marker.

Press the  or  button until the required display (3 to 5) is displayed. Pressing the  or  button controls the selection marker. The settings made are stored and applied immediately.

The individual setting preliminary display (1) will appear again after you have run through all the setting menus. Pressing the  or  button displays the next or previous system.

## Multifunction steering wheel, multifunction display

122

**To return menu “CONVENIENCE” (3 to 5) to its factory setting:**

- Call up menu (3 to 5).
- Press the reset knob on the instrument cluster, see page 84, in the instrument cluster for approximately 3 seconds. Display (6) will appear.
- Press the reset knob on the instrument cluster once more. The individual setting menu “CONVENIENCE” is reset to factory settings, acknowledged by display (7). The individual setting display “SETTINGS” (2) will appear if you do not press the reset knob on the instrument cluster within about 5 seconds. The setting menus will not be reset.

**Setting the audio volume**

You can only adjust the volume of the system currently in use.

The volume setting for each system (audio, telephone, navigation and voice recognition system) is stored separately.

Setting button:



 increases the volume.



 reduces the volume.

## Coolant temperature gauge



Turn the electronic key in starter switch to position 1 or 2.

Call up the trip odometer and main odometer by pressing button  or  on the multifunction steering wheel. See page 94.

Press button  or  until the coolant temperature gauge appears.

During severe operating conditions and stop-and-go city traffic or uphill driving, the coolant temperature may rise close to 120°C.

The engine should not be operated with the coolant temperature above 120°C. Doing so may cause serious engine damage which is not covered by the Mercedes-Benz Limited Warranty.

### Warning!

- Driving when your engine is badly overheated can cause some fluids which may have leaked into the engine compartment to catch fire. You could be seriously burned.
- Steam from an overheated engine can cause serious burns and can occur just by opening the engine hood. Stay away from the engine if you see or hear steam coming from it.

**Turn off the engine, get out of the vehicle and do not stand near the vehicle until it cools down.**

Note:

Excessive coolant temperatures trigger a warning message in the multifunction display. See page 281.

## Flexible service system

124

**Flexible service system (FSS)  
(service indicator)**

The FSS permits a flexible service schedule that is directly related to the operating conditions of the vehicle.

The symbol  or  appears together with a message in the multifunction indicator prior to the next suggested service.

Depending on operating conditions throughout the year, the next service is calculated and displayed in days or distance remaining.

The message is displayed for approximately 10 seconds when turning the electronic key in starter switch to position 2, or while driving when reaching the service warning threshold.

The symbols and messages indicate the type of service to be performed:

 Service A

 Service B

One of the following messages will appear in the display (e.g. Service A):

“SERVICE A – IN xx DAYS”

“SERVICE A – IN xx MILES” (Canada: KM)

“SERVICE A – EXCEEDED BY xx DAYS”

“SERVICE A – EXCEEDED BY xx MILES” (Canada: KM)

“SERVICE A – DUE NOW”



The next service due date is displayed either in days or in miles, depending on your driving style.

Once the suggested service term has passed, the symbol and message appear for approximately 30 seconds and a signal sounds every time when turning the electronic key in starter switch to position 2.



The service indicator disappears automatically after 30 seconds or if the knob for instrument cluster illumination, see page 84, in the instrument cluster is pressed.

Calling up service indicator manually:

Turn the electronic key in starter switch to position 1 or 2.

Call up the trip odometer and main odometer by pressing button  or  on the multifunction steering wheel until the display appears. See page 94.

Press button  or  until the FSS indicator appears.

The next or previous system is displayed by pressing button  or .

### **Important!**

The FSS indicator is not an engine oil level indicator. See page 127 for engine oil level indicator.

Note:

When disconnecting vehicle battery for one or more days at a time, such days will not be counted. Any such days not counted by the FSS can be added by your Mercedes-Benz Light Truck Center.

The interval between services is determined by the type of driving for which the vehicle is used. For example, driving at extreme speeds, and cold starts combined with short distance driving in which the engine does not reach operating normal temperature, reduce the interval between services.





## Flexible service system

126

Following a completed A or B service the Mercedes-Benz Center sets the counter mileage to 10 000 miles (Canada: 15 000 km).

The counter can also be set by any individual. To do so:

Turn the electronic key in starter switch to position 1 or 2.

To call up the trip odometer and main odometer, press button  or  on the multifunction steering wheel until the display appears. See page 94.

Press button  or  until the FSS indicator appears.

Press the reset knob on the instrument cluster, see page 84, for approximately 4 seconds.

The multifunction display will show the question: “DO YOU WANT TO RESET SERVICE INTERVAL? – CONFIRM BY PRESSING R”

Press the reset knob on the instrument cluster again for approximately 4 seconds to reset the service indicator until a signal sounds.

The new service indicator is displayed with the reset distance of 10 000 miles (Canada 15 000 km).

If the FSS counter was inadvertently reset, have a Mercedes-Benz Center correct it.

However you choose to set your reference numbers, the scheduled services as posted in the Service Booklet must be followed to properly care for your vehicle.

## Engine oil level indicator



To check the engine oil level, park vehicle on level ground, with engine at normal operational temperature.



Check oil level approximately 5 minutes after turning off the engine, allowing for the oil to return to the oil pan.





The message “PERF. SERV. ON TIME” (perform service [engine oil level check] on time) will be displayed if the required waiting period has not been observed after turning off the engine:

- with engine at operational temperature approximately 5 minutes.
- with engine not at operational temperature up to approximately 30 minutes.

The engine oil level check can be repeated after a short time.

Turn the electronic key in starter switch to position 2.

To call up the trip odometer and main odometer, press button  or  on the multifunction steering wheel until the display appears. See page 94.

With the multifunction display showing the trip odometer and main odometer, press button  or  on the multifunction steering wheel repeatedly until the “CORRECT MEASUREMENT – ONLY IF VEH. LEVEL” engine oil level indicator appears. This indicator is only a reminder. Measurement can be cancelled by pressing button  or  if the vehicle is not parked on level ground. An incorrect reading will be recorded if you do not cancel the measurement. Move the vehicle to level ground and measure again.

The electronic key in starter switch is not in position 2 if the “ENGINE OIL LEVEL – IGNITION ON PLEASE!” message appears.

## Engine oil level indicator

128

The “ENGINE OIL LEVEL – MEASUREMENT IN PROCESS” message is displayed after approximately 3 seconds.

One of the following messages will subsequently appear on the indicator:

**“ENGINE OIL LEVEL – O.K.”**

No oil needs to be added.

**“ENGINE OIL LEVEL – ADD 1.0 QUART”**

(Canada: 1.0 L)

**“ENGINE OIL LEVEL – ADD 1.5 QUART”**

(Canada: 1.5 L)

**“ENGINE OIL LEVEL – ADD 2.0 QUART”**

(Canada: 2.0 L)

See “Checking engine oil level”, on page 304 for instructions on adding engine oil.

**“ENGINE OIL LEVEL – REDUCE OIL LEVEL”**

This message will only be displayed if the engine is at operational temperature.

Do not overfill the engine.

Excessive oil must be siphoned or drained off. It could cause damage to the engine and catalytic converter not covered by the Mercedes-Benz Limited Warranty.

The “PERF. SERV. ON TIME” message will be displayed if a proper oil level check cannot be performed. The engine oil level check can be repeated after a short while.

Perform the engine oil level check with the dipstick, if it cannot be completed via the multifunction display.

See “Checking engine oil level”, on page 304.

In this case we recommend that you have the system checked at a Mercedes-Benz Light Truck Center.

Notes:

See malfunction and warning messages on page 272 and page 282 if an engine oil level indicator appears on the multifunction display when the engine is running.

The engine oil level cannot be checked while the engine is running. The “ENGINE OIL LEVEL – NOT WHEN ENGINE ON” message will appear.

## Exterior lamp switch

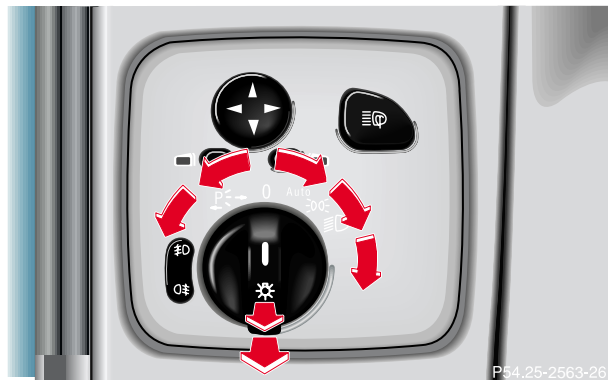

- 0** Off
- AUTO** Automatic headlamp mode, see below.
- ☞☞☞** Parking lamps (also side marker lamps, taillamps, licence plate lamps, instrument panel lamps)  
Canada only: When the engine is running, the low beam is additionally switched on.

- ☞** Parking lamps plus low beam or high beam headlamps (combination switch pushed forward).
- ☞☞** Standing lamps, right (turn left one stop)
- ☞☞☞** Standing lamps, left (turn left two stops)
- ☞☞☞** Front fog lamps (pull out one stop) with parking lamps and/or low beam headlamps on. Green indicator in lamp switch comes on.
- ☞☞☞☞** Rear fog lamp (pull out to second detent) in addition to the front fog lamps. Yellow indicator in lamp switch comes on.

### Note:

With the electronic key removed and the driver's door open, a warning sounds if the vehicle's exterior lamps (except standing lamps) are not switched off.

Fog lamps will operate with the parking lamps and/or the low beam headlamps on. Fog lamps should only be used in conjunction with low beam headlamps. Consult your State or Province Motor Vehicle Regulations regarding allowable lamp operation.

Fog lamps are automatically switched off when the exterior lamp switch is turned to position **0** or **AUTO**.

## Exterior lamp switch

130

**Headlamp mode****Manual headlamp mode**

The low beam headlamps and parking lamps can be switched on and off with the exterior lamp switch. For exterior lamp switch, see above.

Note:

With the daytime running lamp mode activated and the engine running, the low beam headlamps cannot be switched off manually.

**Warning!**

**The driver is responsible for the operation of the vehicle's lights at all times. The automatic headlamp feature is only an aid to the driver. Switch on the vehicle lights by hand when driving or traffic conditions require you to do so.**

**Automatic headlamp mode**

Turn exterior lamp switch to position **AUTO**.

- Electronic key in starter switch position 1:

The parking lamps switch on and off automatically depending on the brightness of the ambient light.

- Electronic key in starter switch position 2 and the engine running:

The low beam headlamps and parking lamps are switched on and off automatically depending on the brightness of the ambient light.

The low beam headlamps and parking lamps can still be switched on and off manually using the exterior lamp switch.

Note:

With the daytime running lamp mode activated, the low beam headlamps cannot be switched off manually.

The headlamps will not be automatically switched on under foggy conditions.

Front fog lamps and rear fog lamp cannot be switched on manually with exterior lamp switch in position **AUTO**. To activate the fog lamps turn exterior switch to position .

## Daytime running lamp mode

Turn exterior lamp switch to position **0** or **AUTO**.

When the engine is running, the low beam headlamps are automatically switched on. In low ambient light conditions the parking lamps will also switch on.

- Canada only:  
When shifting from a driving position to position “N” or “P”, the low beam switches off (3 minutes delay).

For nighttime driving the exterior lamp switch should be turned to position  to permit activation of the high beam headlamps.

- USA only:  
The high beam headlamps can also be activated when driving with the daytime running lamp mode activated and exterior lamp switch in position **0**.

To activate the daytime running lamp mode, see the individual setting menu “LIGHTING” – “LIGHT CIRCUIT HEADLAMP MODE” on page 114.

Note:

See page 129 for notes on the exterior lamp switch.

## Exterior lamp switch

132

**Night security illumination**

Turn exterior lamp switch to position **AUTO**.

At low ambient light conditions and with the engine having been switched off, the exterior lamps (fog lamps and parking lamps) switch on for added illumination, (except in daytime running mode). After the last door has been closed the lamp-on time period commences.

See the individual setting menu “LIGHTING” – “HEADLAMPS DELAYED SWITCH-OFF” on page 114, for instructions on how to activate the function.

The lamp-on time period for night security illumination can be set at several different timed levels from 0 (off) to 60 seconds, see the individual setting menu “LIGHTING” – “HEADLAMPS DELAYED SWITCH-OFF” on page 114.

Notes:

Within 10 minutes after closing the last door the night security illumination can be reactivated by opening a door.

If after switching the engine off, no doors are opened or if after opening the doors or tailgate they are not closed, the night security illumination will switch off automatically after 60 seconds.

Deactivating night security illumination temporarily:

Turn the electronic key in starter switch to position 0 then to position 2 and back to position 0 again before getting out of the vehicle. The night security illumination will not be activated when the door is opened.

## Locator lighting

Turn exterior lamp switch to position **AUTO**.

After unlocking the vehicle with the electronic key during darkness the fog lamps and parking lamps switch on for approximately 40 seconds.

The exterior lamps will be switched off when opening the driver's door.

See the individual setting menu "LIGHTING" – "LOCATOR LIGHTING" on page 114, for instructions on how to activate the function.

## Headlamp cleaning system



Turn the electronic key in starter switch to position 1.

The headlamps will be cleaned with a high-pressure water jet when you press the headlamp washer button (1).

See page 307 for instructions on filling up the windshield/headlamp washer reservoir.





## Combination switch

134

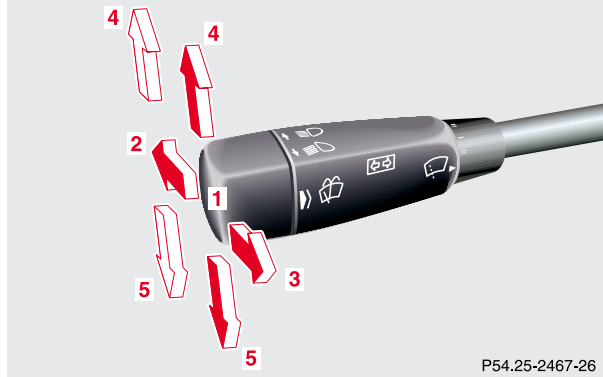
## Combination switch



- 1 Low beam  
(exterior lamp switch position )
- 2 High beam  
(exterior lamp switch position )

- 3 High beam flasher (high beam available independent of exterior lamp switch position)
- 4 Turn signals, right
- 5 Turn signals, left

To signal minor directional changes, such as changing lanes on a highway, move combination switch briefly to the point of resistance only and release. The turn signals blink three times.

To operate the turn signals continuously, move the combination switch past the point of resistance (up or down). The switch is automatically canceled when the steering wheel is turned to a large enough degree.

**Turn signal failure**

If one of the turn signals fails, the turn signal indicator system flashes and sounds at a faster than normal rate.



**6** Press switch briefly:

Single wipe without washer fluid  
(select only if windshield is wet).

Push switch past resistance point:  
Windshield washer system, windshield wipers.

See page 307 for instructions on filling the  
windshield washer reservoir and page 348 for notes  
on replacing the wiper blade inserts.

**7** Windshield wipers

0 Off

I Intermittent wiping

One initial wipe, pauses between wipes are  
automatically controlled by a rain sensor  
monitoring the wetness of the windshield. This  
will not occur with a front door open.

Notes:

With switch in this position, one wipe occurs  
when turning the electronic key in starter switch  
from position 0. However, this might cause  
scratches in a dry windshield. Turn combination  
switch to Off position before turning the  
electronic key in starter switch from position 0.

Do not leave in intermittent setting when vehicle  
is taken to an automatic car wash or during  
windshield cleaning. Wipers will operate in  
presence of water spray at windshield, and  
wipers may be damaged as a result.

II Normal wiper speed

III Fast wiper speed

## Combination switch

136

**Blocked windshield wipers**

If the windshield wipers become blocked (for example, due to snow), switch off the wipers.

For safety reasons before removing ice or snow, remove electronic key from starter switch. Remove blockage.

Activate combination switch again (electronic key in starter switch position 1).

**Emergency operation of windshield wipers**

In case of windshield wiper malfunction in switch positions I or III, turn combination switch to wiper setting II. Have the system checked at your authorized Mercedes-Benz Light Truck Center as soon as possible.

### Windshield wipers smear

If the windshield wipers smear the windshield, even during rain, activate the washer system as often as necessary. The fluid in the washer reservoir should be mixed in the correct ratio.

See page 307 for instructions on filling up the windshield washer reservoir and page 348 for notes on replacing the wiper blade inserts.

### Windshield and headlamp washer fluid mixing ratio

For temperatures above freezing:

MB Windshield Washer Concentrate “S” and water.

1 part “S” to 100 parts water  
(40 ml “S” to 1 gallon water).

For temperature below freezing:

MB Windshield Washer Concentrate “S” and commercially available premixed windshield washer solvent/antifreeze

1 part “S” to 100 parts solvent  
(40 ml “S” to 1 gallon solvent).

## Rear window wiper/washer

138

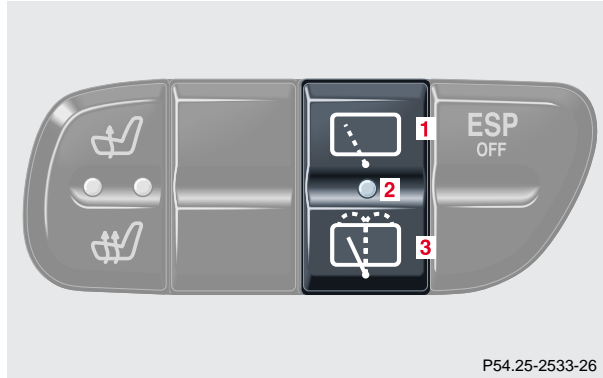
**Rear window wiper/washer**

The rear window wiper/washer switch is located in the center console.

With key in starter switch position 2:

**1** Press for interval wiping, indicator lamp in the switch comes on.

Press again to switch off, indicator lamp goes out.

**2** Indicator lamp

**3** Rear window washer,  
rear window wiper.

The rear window wiper will also automatically engage if the windshield wiper is engaged and the gear selector lever is placed in “R” Reverse.

## Hazard warning flasher switch

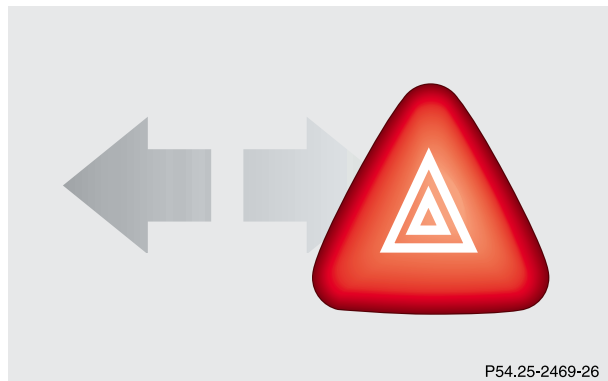

The hazard warning flasher can be activated either manually via the switch located in the center console, or it is activated automatically at the time an airbag is deployed.

To activate hazard warning flasher, press switch once. To deactivate, press switch again.

If hazard warning flasher was activated automatically, press switch once to deactivate.

Note:

With the hazard warning flasher activated, the combination switch in position for either left or right turn, and the electronic key in starter switch position 1 or 2, only the respective left or right side turn signals will operate.

Climate control

Climate control



- 1 Display and controls
- 2 Air volume control for left center air outlet  
To open: Turn thumbwheel to the right
- 3 Air volume control for right center air outlet  
To open: Turn thumbwheel to the right
- 4 Center air outlet, left, adjustable
- 5 Center air outlet, right, adjustable
- 6 Air volume control for side air outlet  
To open: Turn thumbwheel to the right
- 7 Side air outlet, adjustable



## Climate control

142

## Display and controls

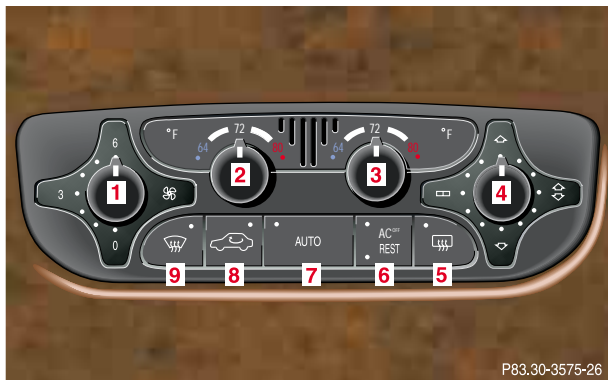

- 1 Air volume
- 2 Temperature control, left
- 3 Temperature control, right
- 4 Air distribution control switch

- 5 Rear window defroster, see page 149
- 6 Economy mode AC<sup>OFF</sup>, see page 147  
Residual engine heat utilization, see page 148
- 7 Air distribution and air volume (automatic)
- 8 Air recirculation, see page 146
- 9 Defrosting, see page 145

**Important!**

This vehicle is equipped with an air conditioning system that uses R-134a (HFC: hydrofluorocarbon) as a refrigerant. Repairs should always be performed by a qualified technician, and refrigerant should be collected in a recovery system for recycling.

## Climate control

The system is always at operational readiness, except when manually switched off, see page 147.

The climate control only operates with the engine running.

The air conditioning will not engage (no cooling) if the economy mode AC<sup>OFF</sup> is selected, see page 147.

The temperature selector should be left at the desired temperature setting. The temperature selected is reached as quickly as possible.

The system will not heat or cool any quicker by setting a higher or lower temperature.

The desired interior temperature can be selected separately for the left and right side of the passenger compartment. Adjust the temperature settings in small increments.

The climate control removes considerable moisture from the air during operation in the cooling mode. It is normal for water to drip on the ground through ducts in the underbody.

Notes:

Do not obstruct the air flow by placing objects on the air flow-through exhaust slots on the back left and right trim panel in the rear cargo compartment.

Also keep the air intake grill in front of the windshield free of snow and debris.

The air conditioner switches itself off for its own protection if refrigerant is lost. No cooling will then take place. Economy mode AC<sup>OFF</sup> cannot be switched off. Have the air conditioner checked by a Mercedes-Benz Light Truck Center should this happen.

If the vehicle interior has been heated by direct sunlight and is very hot, ventilate the interior (open door or windows for a short period) before driving off.

## Dust filter

Nearly all dust particles and pollen are filtered out before outside air enters the passenger compartment through the air distribution system.

### Basic setting – automatic mode

In the automatic mode the climate control cools or heats the interior depending on outside temperature and the selected interior temperature. With the automatic mode switched off, the air volume and distribution can still be set manually.

Press **AUTO** button. Air volume and distribution are controlled automatically.

We recommend to set the left and right temperature to 72°F (22°C). Please make changes from this setting to suit your personal requirements.

### Special settings (use only for short duration)

#### Air distribution and air volume, manual

Press **AUTO** button. The indicator lamp in the button will go out.

Select any of the six air volume speeds and the air distribution.

The air distribution for the right and left side operate together.

Air distribution, manual:



Air from the center, side and rear passenger compartment air outlets.



Air from the windshield and side defroster air outlets.



Air from the footwell and rear passenger footwell air outlets.





Air from the windshield, center, side defroster, footwell, rear passenger footwell and rear passenger compartment air outlets.

To return to automatic mode:

Press the **AUTO** button. The indicator lamp in the button illuminates.

## Defrosting

Press the  button. The indicator lamp in the button illuminates and the fan is set to a higher speed. The warm air is directed to the defroster and windshield air outlets.

Switch off air recirculation, if selected. Press button , the indicator lamp in the button will go out.

Close center air outlets.

Turn thumbwheels (6, page 140) to the right to open left and right side air outlets. Adjust side air outlets upward.

Pressing the  button again returns the system to the previous setting.

Notes:

Heavy accumulation of snow and ice should be removed before activating the defroster.

The defroster uses a large amount of power. To keep the battery drain to a minimum, turn off the defroster as soon as the windshield is clear.

## Windows fogged up on the inside

Switch off the economy mode, if selected. Press button AC<sup>OFF</sup>. The indicator lamp in the button will go out.

Switch off air recirculation, if selected. Press button . The indicator lamp in the button will go out.

Press the  button. The indicator lamp in the button illuminates.

Increase temperature setting.

Open the side air outlets and direct them onto the side windows.

## Climate control

146

**Windshield fogged up on the outside**

Switch on the windshield wiper.

Switch to manual mode.

Turn air distribution switch to position  or .

**Air recirculation**

Select air recirculation:

Press button  briefly. The indicator lamp in the button illuminates.

To switch off the air recirculation:

Press button  briefly. The indicator lamp in the button will go out.

The system automatically switches from air recirculation to fresh air:

- after 30 minutes if the outside temperature is above about 40°F (5°C),
- after 5 minutes if the outside temperature is below about 40°F (5°C),
- after 5 minutes if economy mode AC<sup>OFF</sup> is selected.

The system switches automatically to air recirculation at high outside temperatures. A quantity of outside air is added after about 30 minutes.

If the windows should fog up from the inside, switch from recirculated air back to fresh air.

### Climate control - OFF/ON

To switch the climate control off, set the air volume control switch to position 0.

The fresh air supply to the vehicle interior is shut off.

While driving, use this setting only temporarily, otherwise the windshield could fog up.

To switch the climate control on again, set air volume control switch to any speed.

### Economy mode

The function of this setting corresponds to the automatic mode. However, because the air conditioning compressor will not engage (fuel savings), it is not possible to air condition in this setting.

Press AC<sup>OFF</sup> button to activate. The indicator lamp in the button illuminates.

Press AC<sup>OFF</sup> button once again to return to the previous setting. The indicator lamp in the button goes out.

### Important!

In the AC<sup>OFF</sup> mode the windows could fog up on the inside. Switch off AC<sup>OFF</sup> mode.

### Residual engine heat utilization

With the engine switched off, it is possible to continue to heat or ventilate the interior for a short while, dependent of the temperature setting of the climate control. Air volume and distribution are controlled automatically.

To select:

Turn the electronic key in starter switch to position 1 or 0 or remove it altogether.

Press button **REST**. The indicator lamp in the button illuminates.

Set the left and right temperature to your personal requirements.

This function selection will not activate if the battery level is insufficient.

Press button **REST** again to switch off. The indicator lamp in the button will go out.

The function switches off automatically:

- if the electronic key in starter switch is turned to position 2,
- after approximately 30 minutes,
- if the battery voltage drops.

## Rear window defroster

Turn the electronic key in starter switch to position 2.

To select:

Press the  button in the control panel of the automatic air conditioner. The indicator lamp in the button illuminates.

To cancel:

Press the  button in the control panel of the automatic air conditioner. The indicator lamp in the button goes out.

Notes:

Heavy accumulation of snow and ice should be removed before activating the defroster.

The rear window defroster uses a large amount of power. To keep the battery drain to a minimum, turn off the defroster as soon as the rear window is clear.

The defroster is automatically turned off after approximately 6–17 minutes of operation depending on the outside temperature and vehicle speed.

If several power consumers are turned on simultaneously, or the battery is only partially charged, it is possible that the defroster will automatically turn itself off. When this happens, the indicator lamp inside the switch starts blinking.

As soon as the battery has sufficient voltage, the defroster automatically turns itself back on.



## Climate control

150

**Rear passenger compartment adjustable air outlets****1** Air volume control for center air outlets

To open: Turn the thumbwheel upward.

**2** Center air outlet, left, adjustable**3** Center air outlet, right, adjustable

Note:

The air temperature can be set on the control panel (see page 142) using the temperature wheels for the left and right compartments separately.

## Power windows

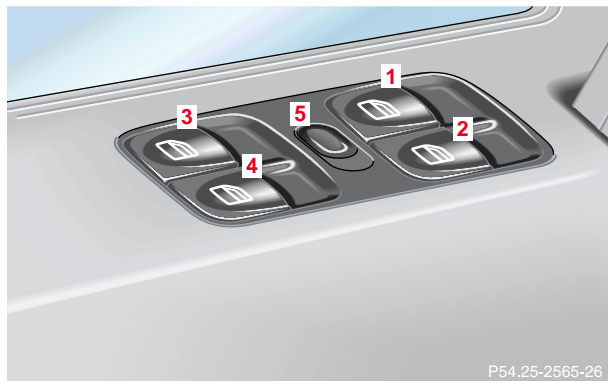

The control panel is located on the driver's door.

The switches for the respective windows are located on the passenger and the rear doors.

Switches for:

- 1** left, front
- 2** right, front
- 3** left, rear
- 4** right, rear
- 5** Switches for rear door window override, see page 153

Turn electronic key in starter switch to position 1 or 2.

Opening the windows:

Press the switch to resistance point.

Closing the windows:

Pull the switch to resistance point.

Release switch when window is in desired position.

## Interior equipment

152

**Express opening**

Press switch past resistance point and release – window opens completely.

To interrupt procedure, briefly press or pull switch.

Note:

The power windows can also be opened and closed using the summer opening/convenience feature, see page 32.

With a front door opened and the key in starter switch position 0 or 1, or removed from starter switch, the power windows can be operated for approx. 30 minutes.

**Warning!**

**When closing the windows, be sure that there is no danger of anyone being harmed by the closing procedure.**

**The closing procedure can be immediately reversed by either pressing or pulling the switch, or pressing button  on the electronic key and holding it.**

**When leaving the vehicle, always remove the electronic key from starter switch, and lock your vehicle. Do not leave children unattended in the vehicle, or with access to an unlocked vehicle. Unsupervised use of vehicle equipment can cause serious personal injury.**

### **Blocking of rear door window operation**

If no operation of the rear windows by switch (for instance by children) is desired, slide override switch (5) to the right; the  symbol becomes visible.

Operation of the rear door windows with the switches located in the driver's door is still possible.

## Interior equipment

154

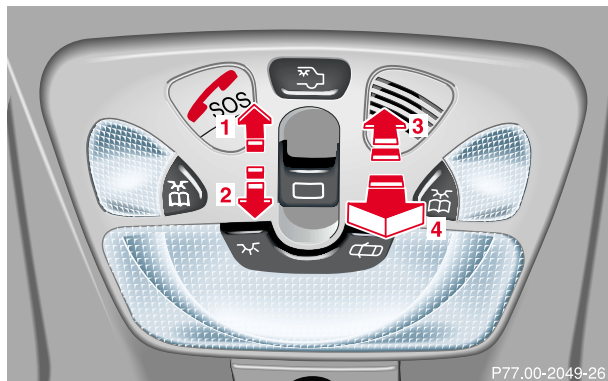
**Sliding/pop-up roof (optional)**

- 1** to slide roof open
- 2** to slide roof closed
- 3** to raise roof at rear
- 4** to lower roof at rear

The sliding/pop-up roof can be operated with key in starter switch position 1 or 2.

To open, close, raise or lower the sliding/pop-up roof: Move the switch to resistance point in the required direction.

Release the switch when the roof has reached the required position.

**Warning!**

When closing the sliding/pop-up roof, be sure that there is no danger of anyone being harmed by the closing procedure.

When leaving the vehicle, always remove the key from starter switch, and lock your vehicle. Do not leave children unattended in the vehicle, or with access to an unlocked vehicle. Unsupervised use of vehicle equipment can cause serious personal injury.

## Notes:

To avoid damaging the seals, do not transport any objects with sharp edges which can stick out of the sliding/pop-up roof.

The sliding/pop-up roof can be opened or closed manually should an electrical malfunction occur, see page 346.

### Express opening of sliding/pop-up roof

To open sliding/pop-up roof automatically, briefly move switch in direction (1) and release. The roof will open fully.

To interrupt procedure, briefly move switch in any direction.

Note:

The sliding/pop-up roof can also be opened and closed using the summer opening/convenience feature, see page 32.

### Warning!

When closing the sliding/pop-up roof, be sure that there is no danger of anyone being harmed by the closing procedure.

The closing procedure of the sliding/pop-up roof can be immediately reversed by either moving the switch in any direction, or pressing button  on the electronic key and holding it.

When leaving the vehicle, always remove the key from starter switch, and lock your vehicle. Do not leave children unattended in the vehicle, or with access to an unlocked vehicle. Unsupervised use of vehicle equipment can cause serious personal injury.

## Interior equipment

156

## Interior lighting

**1** Cargo compartment lamps

Press the button to switch the cargo compartment lamps on/off.

For notes on the cargo compartment lamps, see page 159.

**2** Right front reading lamp

Press the button to switch the reading lamp on or off. The right reading lamp will be switched on or off.

**3** To switch off automatic function:  
Press the rocker switch.

The interior lighting remains switched off, even when centrally unlocking the vehicle or opening a door or the electronic key is removed from the starter switch.

**4** To select automatic function:  
Press the rocker switch to the center position.

Interior lamps are switched on in darkness, when unlocking the vehicle, opening a door or removing the electronic key from starter switch.

Interior lamps are switched off (soft fade) delayed, when locking the vehicle, closing the doors or inserting the electronic key in starter switch. However, there will be no delay when the electronic key is in starter switch position 2.

**5** Interior lamps, front:  
Press rocker switch in to switch front interior lamps on. The interior lighting stays on while the rocker switch is pressed in.

Switching off the front interior lighting:  
Press rocker switch to position (3).

- 6** Left front reading lamp:  
Press the button to switch the reading lamp on or off. The left reading lamp will be switched on or off.

Notes:

The time delay for the interior light to switch off after the electronic key is removed from the starter switch can be adjusted in the individual setting menu “LIGHTING” – “INT. ILLUMINATION DELAYED SWITCH-OFF”. See page 114.

To prevent the vehicle battery from being discharged with doors open, all interior lamps switch off after approximately 5 minutes, when the electronic key removed or in starter switch position 0.

An interior lamp switched on manually does not go out automatically. Before leaving the vehicle, make sure that all interior lamps are switched off.

### Door entry lamps

The appropriate entry lamp switches on if a door is opened in darkness and if the interior lighting is switched to automatic function.

The entry lamp switches off automatically when the door is closed.



## Interior equipment

158

## Rear interior lamps

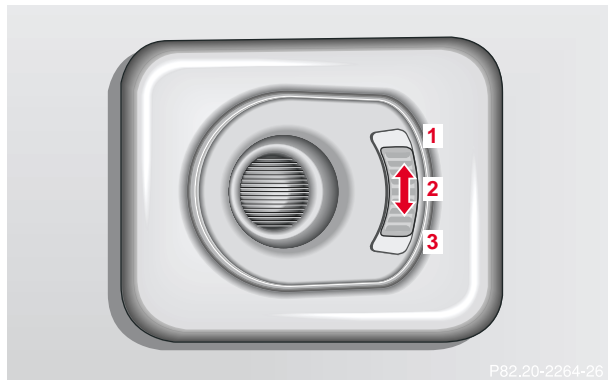

Right rear interior lamp shown.

The rear interior lamps are located above the rear seat bench on the left and right side.

- 1 The lamps are switched on continuously.
- 2 The lamps are switched off.
- 3 The lamps are switched on and off with the interior lamps (automatic function).

Notes:

To prevent the vehicle battery from being discharged, with the tailgate open, all interior lamps switch off automatically after approximately 30 minutes.

If a rear interior lamp is switched on manually, it does not go out automatically. Before leaving the vehicle, make sure that the rear interior lamps are switched off.

The rear interior lamps can be switched on with the electronic key in position 0 or key removed from the starter switch for up to 30 minutes.

## Cargo compartment lamps



- 1 Press button (1) to switch the cargo compartment lamps (2) on/off.

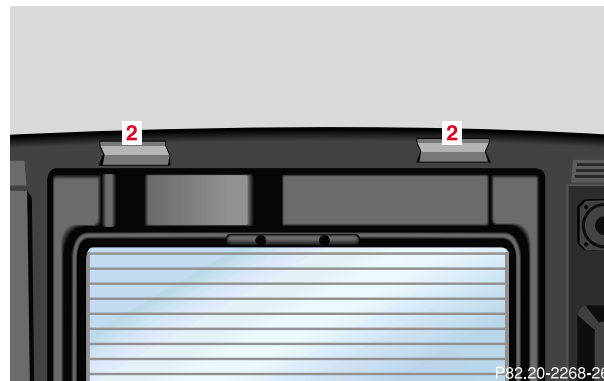

- 2 Cargo compartment lamps

## Interior equipment

160

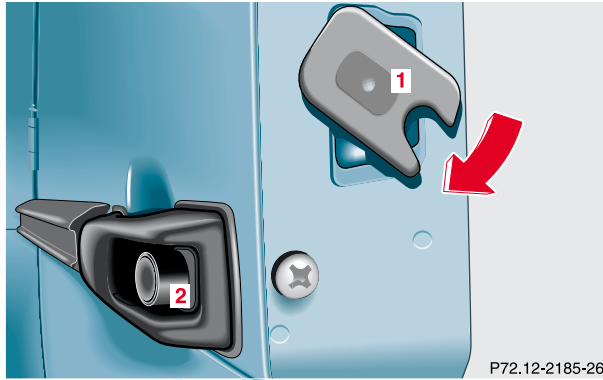

If the tailgate should remain open for a longer period of time, the cargo area lamps may be switched off separately from the rear compartment lamps. Press the door lock (1) down until it clicks into place (arrow).

To activate the cargo area lamps again, press the lock cylinder (2). The cargo area lamps will switch on.

**Important!**

When locking the tailgate, it is important that the door lock be in the same position as shown in the illustration.

Only drive with the tailgate closed as otherwise exhaust fumes may enter the vehicle interior.

## Sun visors

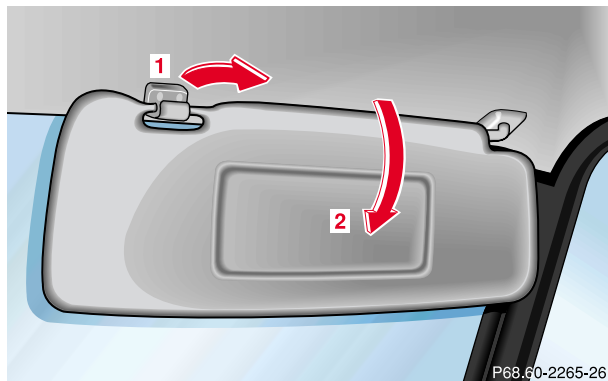

Swing sun visors (2) down to protect against sun glare.

If sunlight enters through a side window, disengage visor from inner mounting (1) and pivot it to the side.

## Illuminated vanity mirrors

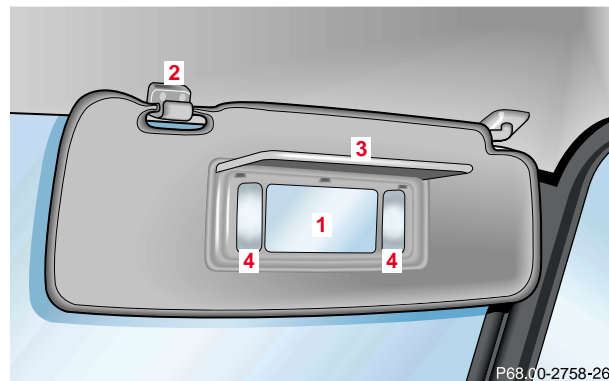

### 1 Illuminated vanity mirror

With the visor engaged in its inner mounting (2), the lamps (4) can be switched on by opening the cover (3).

Fold the cover (3) down to close the vanity mirror.

### Warning!

**Do not use the vanity mirror while driving.**

**Interior****Warning!**

To help avoid personal injury during a collision or sudden maneuver, exercise care when stowing things. Put luggage or cargo in the rear cargo area and secure. Do not pile luggage or cargo higher than the seat backs.

Luggage nets cannot secure hard or heavy objects.

**Warning!**

Do not load items on the roof. It may cause instability during some maneuvers which could result in an accident.

**Storage compartments, armrest and cup holder****Warning!**

Keep compartment lids closed. This will help to prevent stored objects from being thrown about and injuring vehicle occupants during an accident and sudden maneuvers.

## Glove box

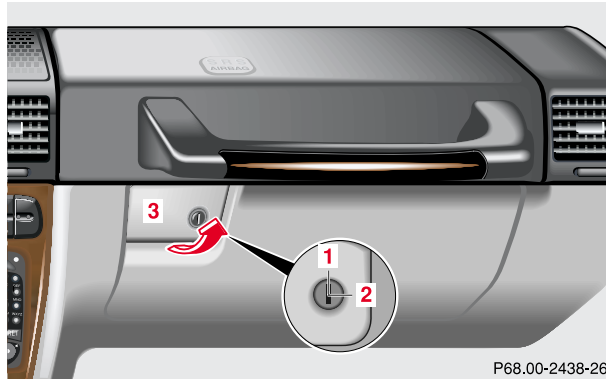

- 1 Unlocked position
- 2 Locked position
- 3 Handle  
Pull handle to open.

The glove box is illuminated with key in starter switch position 1 or 2 when opening the lid.

The glove box can be locked and unlocked with the mechanical key. See page 27 for instructions on how to remove the mechanical key from the electronic key (e.g. for valet parking service).

## Interior equipment

164

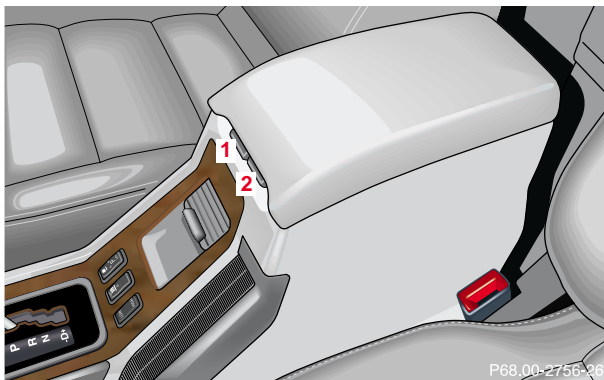
**Storage compartments below the armrest**

To open small compartment in armrest:  
Press button (1) and lift armrest.

To close:  
Lower armrest until it engages in lock.

Note:

Located in the cover of the storage compartment is a storage area for small items such as checks.

To open large compartment under armrest:  
Press button (2) and lift armrest.

To close:  
Lower armrest until it engages in lock.

Note:

In the large storage compartment there is a storage area for up to 3 CDs.

### Storage compartment in front of armrest

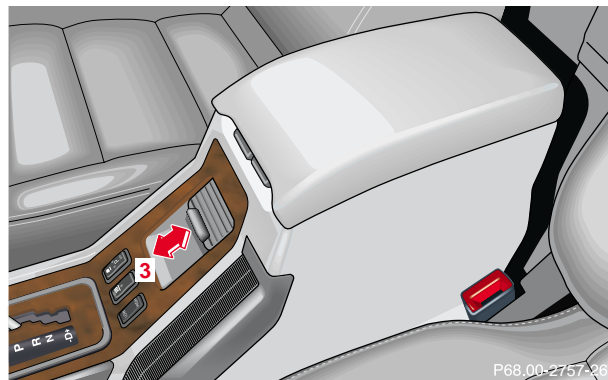

To open:  
Slide cover rearward.

To close:  
Slide cover forward

3 Storage compartment in front of armrest



## Interior equipment

166

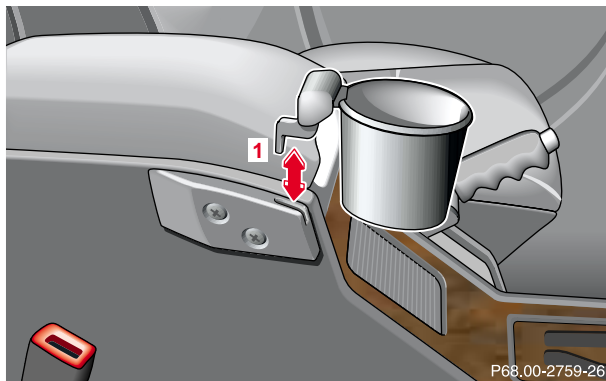
**Cup holder next to the armrest**

Place cup holder bracket (1) into recess.

If the cup holder is no longer in use, it can for example, be stored in the storage compartment below the armrest or in storage pouch on the door panel.

**Caution!**

Remove cup holder before traveling. Place only containers that fit into the cup holder to prevent spills.

Do not fill containers to a height where the contents could spill during vehicle maneuvers, especially hot liquids.

## Cup holder in passenger footwell

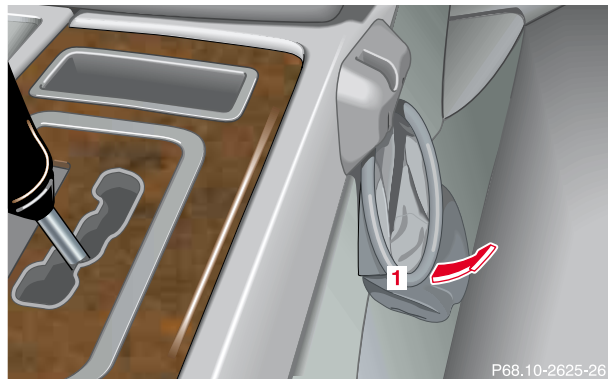

To open cup holder:  
Swing bracket (1) upwards until it clicks into place.

### Caution!

Keep cup holder closed while traveling. Place only containers that fit into the cup holder to prevent spills.

Do not fill containers to a height where the contents could spill during vehicle maneuvers, especially hot liquids.

## Cup holder in rear passenger footwell

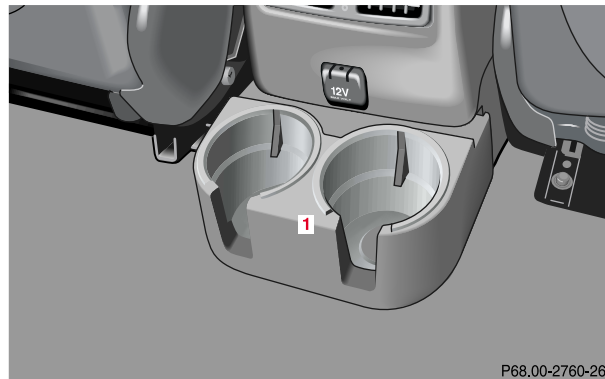

### Caution!

Place only containers that fit into the cup holder to prevent spills.

Do not fill containers to a height where the contents could spill during vehicle maneuvers, especially hot liquids.

## Interior equipment

168

## Ashtrays

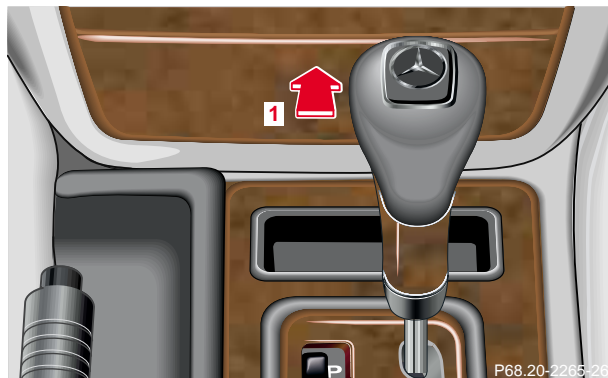

## Center console

By touching the top of the cover (1) lightly, the ashtray opens automatically.

**Warning!**

**Remove front ashtray only with vehicle standing still. Turn off the engine and set the parking brake. Otherwise the vehicle might move as a result of unintended contact with the gear selector lever.**

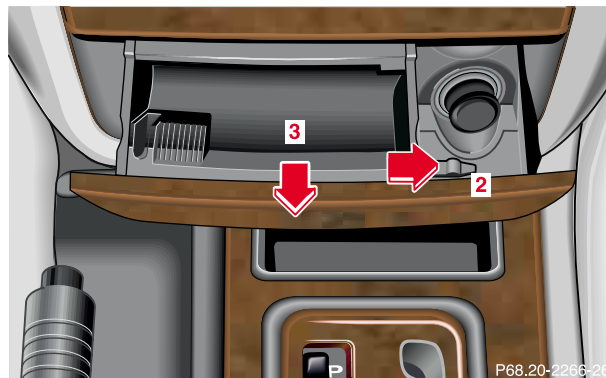

To remove ashtray insert:

Press sliding knob (2) toward the right to eject the insert. Remove insert (3) in direction of arrow.

To replace insert:

Install insert into ashtray frame and push down to engage into place.

## Rear passenger compartment



To open ashtray:  
Pull at top of cover.

To remove ashtray insert:  
Push down on catch (1) and pull out the ashtray insert.

To install insert:  
Position the insert and close the cover.

## Interior equipment

170

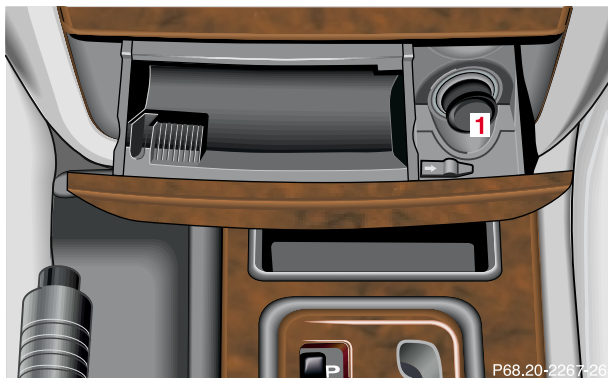
**Lighter****1** Center console lighter

Turn the electronic key in starter switch to position 1 or 2.

Push in lighter in (1); it will pop out automatically when hot.

**Warning!**

Never touch the heating element or sides of the lighter, they are extremely hot, hold at knob only.

When leaving the vehicle always remove the key from the starter switch. Do not leave children unattended in the vehicle, or with access to an unlocked vehicle. Unsupervised use of vehicle equipment may cause serious personal injury.

The lighter socket can be used to accommodate electrical accessories up to maximum 180 W.

**Floor mat****Important!**

If cloth or rubber mats are used, please remove the factory floor mats.

## Split rear seat bench

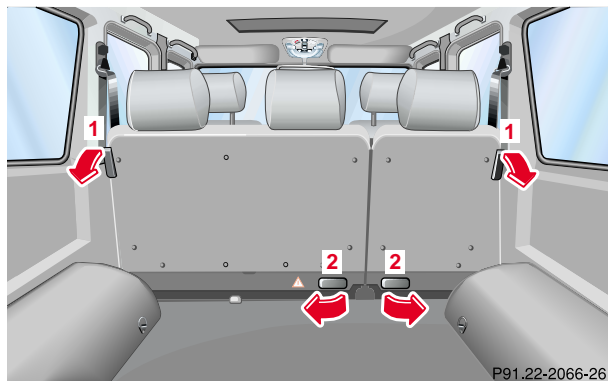

1 Lever for seat backrest sections

2 Lever for seat bench sections

The rear seat bench can be folded and lowered to increase the cargo area. The left, right or both seat backrests sections may be folded down according to need.

### Warning!

Failure to assure that seats and backrests are locked into place could result in an increased chance of injury in an accident.

Never place hands under seat or near any moving parts while a seat is being adjusted.

For safety reasons the rear seat bench must only be adjusted when the vehicle is stationary.

### Important!

Only drive with the tailgate closed as otherwise exhaust fumes may enter the vehicle interior.

### Note:

Before folding the backrest forward and the rear seat bench down, be sure that all containers in the rear cup holder are removed.

## Interior equipment

172

**Folding backrest forward**

1. Fully retract and fold down the outer head restraints and remove the center head restraint, see page 173.
2. Pull release lever (1) in direction of arrow and fold backrest forward until it locks in place.

**Folding seat bench**

1. Fold backrest forward.
2. Pull release lever (2) in direction of arrow and fold seat bench together with the backrest forward.

Note:

To attain a flat cargo area, the head restraints must be removed, see page 173.

**Returning seat bench and backrest to sitting position**

1. Fold up seat bench until it locks in place.
2. Pull release lever (1) and raise backrest until it locks in place.

Check for secure locking by pushing and pulling on the backrest.

**Warning!**

**Failure to assure that seats and backrests are locked into place could result in an increased chance of injury in an accident.**

## Rear seat head restraints

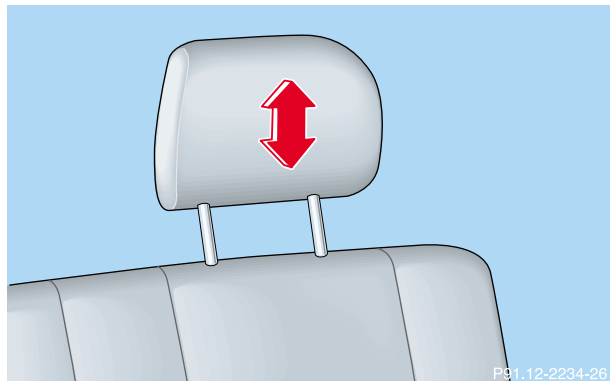

Raising: Pull up on head restraint.

Lowering: Push down on head restraint.

Adjust head restraint to support the back of the head approximately at ear level. The head restraint angle can also be adjusted manually.

Removal:

Pull out head restraint with both hands. The head restraint(s) should be stored in a secure place.

Installation:

Insert the head restraint and push it down to the stop.

Ensure proper head restraint positioning, see above.

### Warning!

**For your protection, drive only with properly positioned head restraints.**

**Adjust head restraint to support the back of the head approximately at ear level.**

**Do not drive the vehicle without the seat head restraints. Head restraints are intended to help reduce injuries during an accident.**

**Do not interchange head restraints from front and rear seats.**

### Caution!

Do not remove head restraints except when mounting seat covers, or attaining a flat cargo area with the seat bench folded. Whenever head restraints have been removed be sure to reinstall them before driving.



### Enlarged cargo area

The rear seat bench can be folded and lowered to increase the cargo area. The left, right or both seat backrests sections may be folded down according to need.

For folding and resetting seating to standard positions, see page 171.

#### Warning!

**Always lock backrest in its upright position when rear seat bench is occupied by passengers, or cargo is being carried behind the seat bench.**

**To help avoid personal injury from smaller objects flying in the occupant area during a collision or sudden maneuver, always use partition net when transporting cargo, see page 175.**

### Cargo tie-down rings

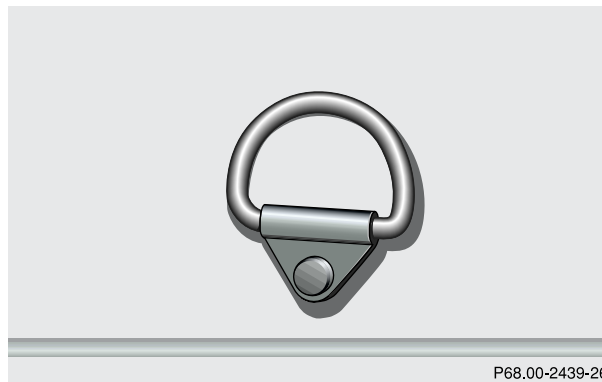

Carefully secure cargo by applying even load on all rings with rope of sufficient strength to hold down the cargo. The cargo area is provided with four tie-down anchors.

#### Caution!

While the partition net will help protect you from smaller objects, it cannot prevent the movement of large, heavier objects into the passenger area in an accident. Such items must be properly secured using the cargo tie-down rings in the cargo area floor.

### Partition net (MB Accessory)

Use of the partition net is a particularly important safety factor when the vehicle is loaded higher than the top of the seat backrests with smaller objects.

The partition net can be installed behind the backrests of the rear seat bench, or behind the front seats if the rear seat bench is folded down.

Note:

Installation can be performed by opening the rear doors.

For instructions on folding down rear seat bench, see page 171.

#### Caution!

While the partition net will help protect you from smaller objects, it cannot prevent the movement of large, heavier objects into the passenger area in an accident. Such items must be properly secured using the cargo tie-down rings in the cargo area floor.

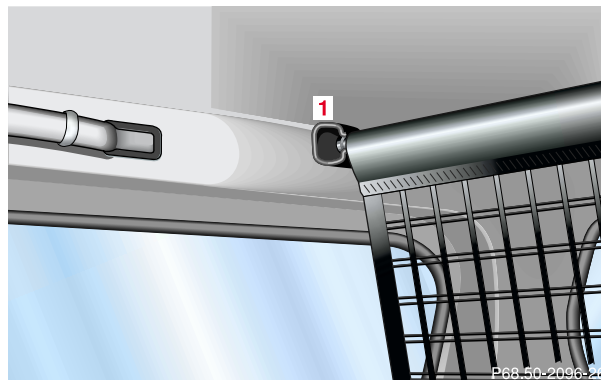

Installation behind rear seat bench:

To install, fold the rear seat bench cushion forward. It cannot be done by folding the rear seat backrest forward.

## Interior equipment

176

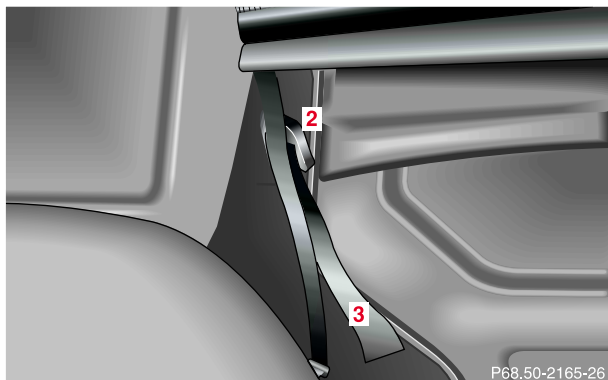

1. Engage partition net in holders (1). The lift tensioner (2) must point in driving direction (forward).

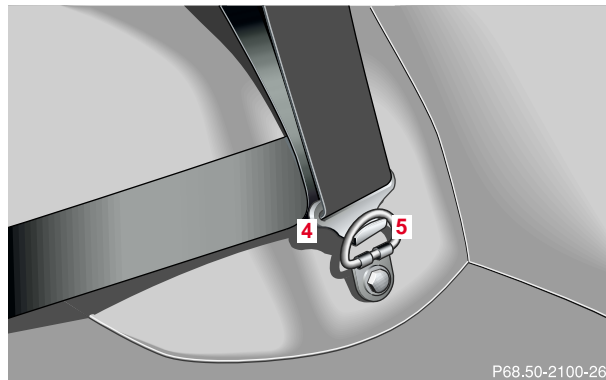

2. Set the length of the tie downs (3) and lift tensioner (2) to the rings (5).
3. Insert tie down hooks (4) in rings (5). Pull on loose ends of tie downs until net is slightly tensioned.
4. Fold up seat bench until it locks in place. The partition net will be tightened by the rear seat bench cushion.

After driving a short period, check the tension of the partition net, re-tighten if necessary.

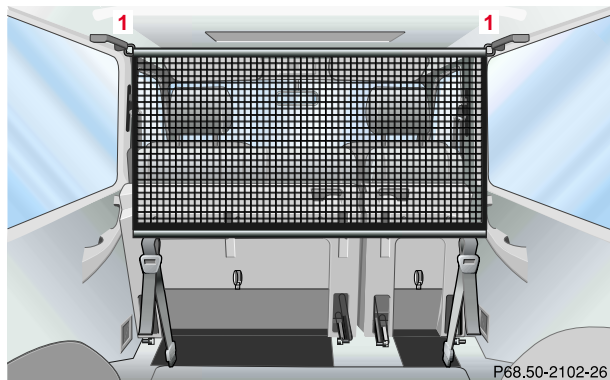

Installation behind front seats:

To install, fold rear seat bench cushion fully forward.

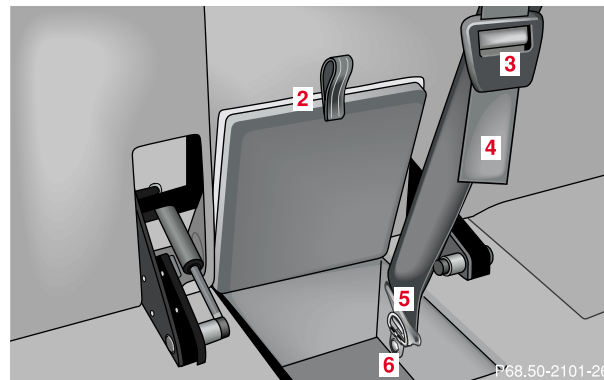

1. Open storage compartment (2) below rear seat bench.
2. Engage partition net in holders (1). The lift tensioner (3) must point in the direction of the cargo compartment.
3. Set the length of the tie downs (4) and lift tensioner (3) to the rings (6).
4. Insert tie down hooks (5) in rings (6). Pull on loose ends of tie downs until net is tight.

After driving a short period, check the tension of the partition net, re-tighten if necessary.

## Interior equipment

178

## Removal:

1. Lift tensioner upward to a horizontal position to release tensioning of strap.
2. Disengage tie down hooks from rings.
3. Remove partition net from holders.

## Storage:

1. Roll up partition net and secure it.
2. Store partition net behind rear seat bench.

## Loading instructions

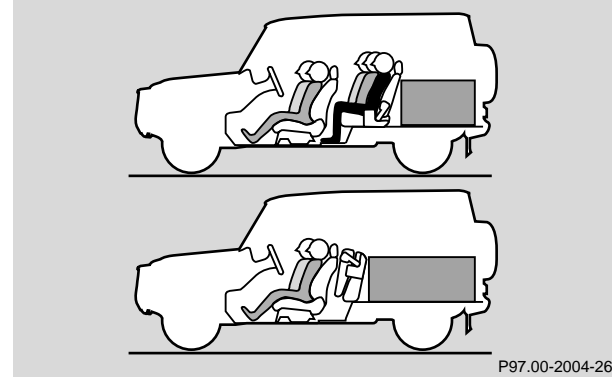

The total load weight including vehicle occupants and luggage/cargo should not exceed the vehicle capacity weight indicated on the certification label which can be found on the left door pillar.

The handling characteristics of a fully loaded vehicle depend greatly on the load distribution. It is therefore recommended to load the vehicle according to the illustrations shown, with the heaviest items being placed towards the front of the vehicle.

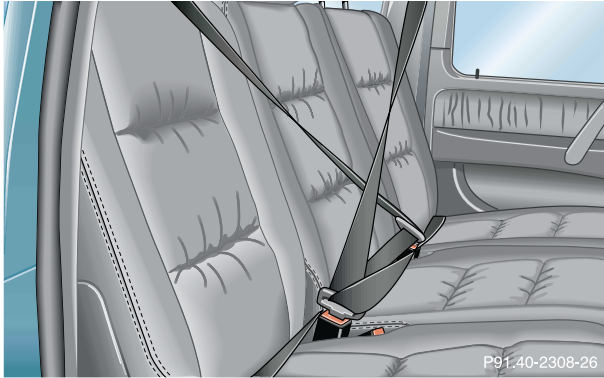

Always place items being carried against front or rear seat backrests, and fasten them as securely as possible.

The heaviest portion of the cargo should always be kept as low as possible against front or rear seat backrest since it influences the handling characteristics of the vehicle.

For additional safety when transporting cargo while the rear seats are unoccupied, fasten the outer seat belts crosswise into the opposite side buckles.

Notes:

The rear cargo area is the preferred place to carry objects. The enlarged cargo area (rear seats folded) should only be used for items which do not fit in the rear cargo area alone.

### **Warning!**

**Always fasten items being carried as securely as possible using cargo tie-down rings and fastening materials appropriate for the weight and size of the load.**

**In an accident, during hard braking or sudden maneuvers, loose items will be thrown around inside the vehicle, and can cause injury to vehicle occupants unless the items are securely fastened in the vehicle.**

**To help avoid personal injury during a collision or sudden maneuver, always use partition net when transporting cargo.**

**Never drive vehicle with the tailgate open. Deadly carbon monoxide (CO) gases may enter vehicle interior resulting in unconsciousness and death.**

## Interior equipment

180

**Parcel net in front passenger footwell**

A small convenience parcel net is located in the front passenger footwell. It is for small and light items, such as road maps, mail, etc..

**Warning!**

**Do not place heavy or fragile objects, or objects having sharp edges, in the parcel net.**

**In an accident, during hard braking or sudden maneuvers, they could be thrown around inside the vehicle, and cause injury to vehicle occupants.**

## Note:

With large objects stored in the parcel net do not slide the seat fully forward, it could damage them.

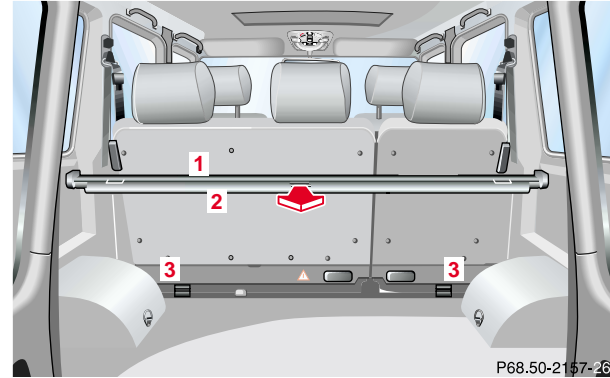
**Cargo area cover blind**

## Closing blind:

Pull blind (visual protection) (1) across luggage/cargo area, and guide into holders next to tailgate.

The luggage can be fully covered even with the rear seat bench folded forward. Pull out lower blind (2) and place into holder (3) on rear seat bench cushion.

## Opening blind:

To roll up blind, disengage blind and guide retraction by its handle.

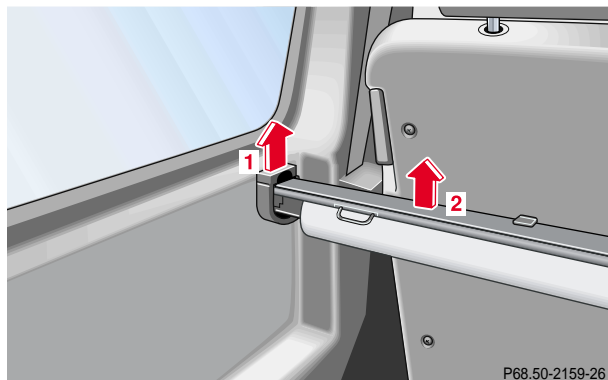

Removing blind:

Open latch (1) on right and left in direction of arrow.  
Pull blind (2) out upwards.

Installing blind:

Place blind into recesses. Press right and left sides of blind down until it locks into place.

## Roof racks

This vehicle is not intended to carry items on its roof. Thus roof rails and any roof-mounted devices must not be used.

### Warning!

**Do not load items on the roof. It may cause instability during some maneuvers which could result in an accident.**



## Interior equipment

182

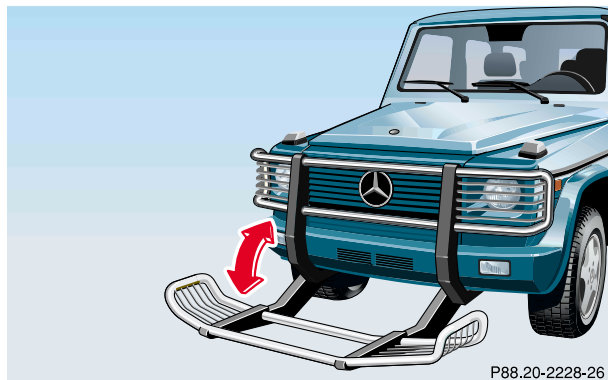
**Brush guard (MB Accessory)****Warning!**

The brush guard is designed solely to enhance the appearance of the vehicle and help protect grille and head lights from minor mishaps, either on- or off-road. Since the safety characteristics are limited in the event of an accident, brush guards are not intended to prevent injury or damage in the event of an accident. Also check state and local regulations on installation and use.

Raise and lower brush guard in an open space with plenty of room.

To help prevent personal injury when opening or closing the brush guard, use extreme caution not to trap hands or feet.

The brush guard must be in raised and locked position while driving.

**Note:**

Only lower brush guard to clean head lamps or to replace bulbs.

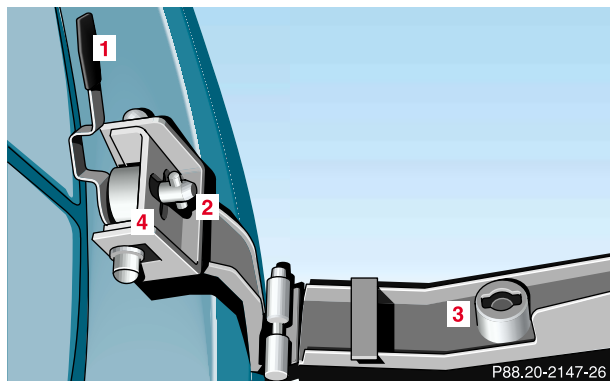

- 1 Lock and unlocking handle
- 2 Quick Lock
- 3 Lock
- 4 End stop joint

To lower brush guard:

While holding brush guard firmly, open quick lock (2) using lock and unlocking handle (1). Gently lower brush guard until it reaches its fully lowered position.

To raise and secure brush guard:

Flip up brush guard until it contacts end stop joint (4).

The quick lock stop pin (2) must engage the cross slot recess in the lock (3).

Now turn quick lock (2) so that quick lock is making contact with end stop joint (4).

Lock quick lock (2) on both sides of brush guard using lock and unlocking handle (1).

### Important!

Make sure that both quick lock stop pins (2) are seated fully in lock (3).

## Interior equipment

184

**Telephone, general****Warning!**

A driver's attention to the road must always be his/her primary focus when driving. For your safety and the safety of others, we recommend that you pull over to a safe location and stop before placing or taking a telephone call. If you choose to use the telephone while driving, please use the hands-free device and only use the telephone when road and traffic conditions permit.

Some jurisdictions prohibit the driver from using a cellular telephone while driving a vehicle.

Bear in mind that at a speed of just 30 mph (approximately 50 km/h), your vehicle is covering a distance of approximately 50 feet (approximately 14 m) every second.

Never operate radio transmitters equipped with a built-in or attached antenna (i.e. without being connected to an external antenna) from inside the vehicle while the engine is running. Doing so could lead to a malfunction of the vehicle's electronic system, possibly resulting in an accident and personal injury.

See separate instruction manual for instructions on how to operate the telephone.

**Cellular telephone****Warning!**

Some jurisdictions prohibit the driver from using a cellular telephone while driving a vehicle. Whether or not prohibited by law, for safety reasons, the driver should not use the cellular telephone while the vehicle is in motion.

Stop the vehicle in an safe location before answering or placing a call.

## Garage door opener

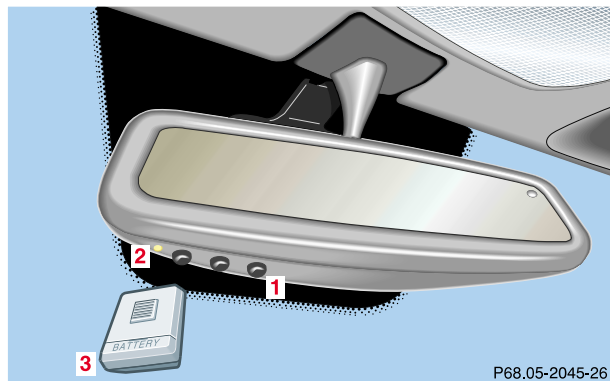

- 1 Signal transmitter keys
- 2 Indicator lamp
- 3 Hand-held remote control transmitter

The built-in remote control is capable of operating up to three separately controlled objects.

### Warning!

**When programming a garage door opener, the door moves up or down.**

**When programming or operating the remote control make sure there is no possibility of anyone being harmed by the moving door.**

Notes:

Certain types of garage door openers are incompatible with the integrated opener. If you should experience difficulties with programming the transmitter, contact your authorized Mercedes-Benz Light Truck Center, or call Mercedes-Benz Customer Assistance Center (in the USA only) at 1-800-FOR-MERCEDES, or Customer Service (in Canada) at 1-800-387-0100.

## Garage door opener

186

For operation in the USA only: This device complies with Part 15 of the FCC Rules. Operation is subject to the following two conditions:

- (1) This device may not cause harmful interference, and
- (2) this device must accept any interference received, including interference that may cause undesired operation.

Any unauthorized modification to this device could void the user's authority to operate the equipment.

**Programming or reprogramming the integrated remote control:**

1. Turn electronic key in starter switch to position 1 or 2.
2. Hold the end of the hand-held transmitter of the device you wish to train approximately 2 to 5 inches (5 cm to 12 cm) away from the surface of the integrated remote control located on the inside rear view mirror, keeping the indicator lamp (2) in view.

3. Using both hands, simultaneously push the hand-held transmitter button (3) and the desired integrated remote control button (1). Do not release the buttons until completing step 4.
4. The indicator lamp on the integrated remote control will flash, first slowly and then rapidly. When the indicator lamp flashes rapidly, both buttons may be released (the rapid flashing lamp indicates successful programming of the new frequency signal). To program the remaining two buttons, follow steps 1 through 4.

## Note:

If after repeated attempts, you do not successfully program the integrated remote control device to learn the signal of the hand-held transmitter, the garage door opener could be equipped with the "rolling code feature".

### Rolling code programming:

To train a garage door opener (or other rolling code devices) with the rolling code feature, follow these instructions after completing the “Programming” portion of this text. (A second person may make the following training procedures quicker and easier.)

1. Locate training button on the garage door opener motor head unit. Exact location and color of the button may vary by garage door opener brand. If there is difficulty locating the transmitting button, reference to garage door opener operator’s manual.
2. Press “training” button on the garage door opener motor head unit (which activated the “training light”).

Note:

Following step 2, there are 30 seconds to initiate step 3.

3. Firmly press and release the programmed integrated remote control transmit button. Press and release same button a second time to complete the training process. (Some garage door openers may require you to do this procedure a third time to complete the training.)
4. Confirm the garage door operation by pressing the programmed button on the integrated remote control transmitter.

### Canadian programming:

During programming, your hand-held transmitter may automatically stop transmitting. Continue to press and hold the integrated remote control transmitter button (note steps 1 through 4 in the “Programming” portion) while you press and re-press (“cycle”) your hand-held transmitter every two seconds until the frequency signal has been learned. The indicator lamp will flash slowly and then rapidly after several seconds upon successful training.

## Garage door opener

188

**Operation of remote control:**

1. Turn electronic key in starter switch to position 1 or 2.
2. Select and press the appropriate button to activate the remote controlled device. The integrated remote control transmitter continues to send the signal as long as the button is pressed – up to 20 seconds.

**Erasing the remote control memory:**

1. Turn electronic key in starter switch to position 1 or 2.
2. Simultaneously holding down the left and right side buttons for approximately 20 seconds, or until the control lamp blinks rapidly, will erase the codes of all three channels.

## Driving

Control and operation of radio transmitters .....	190
The first 1 000 miles (1 500 km) .....	191
Maintenance .....	191
Tele Aid .....	192
Catalytic converter .....	202
Emission control .....	203
Starter switch .....	204
Starting and turning off the engine .....	206
Automatic transmission .....	207
Parking brake .....	215

Driving instructions .....	216
Drive sensibly – save fuel .....	216
Drinking and driving .....	216
Pedals .....	216
Power assistance .....	217
Brakes .....	217
Driving off .....	218
Parking .....	219
Tires .....	219
Snow chains .....	222
Winter driving instructions .....	222
Deep water .....	224
Passenger compartment .....	225
Traveling abroad .....	225
Off-Road driving .....	226
Cruise control .....	234

Brake assist system (BAS) .....	237
Antilock brake system (ABS) .....	239
Four-wheel electronic traction system (4-ETS) .....	241
Electronic Brake Booster (EBB) .....	242
Electronic stability program (ESP) .....	243
Transfer case .....	247
Switching transfer case .....	248
A few words about differentials and differential locks .....	251
Differential locks .....	253
What you should know at the gas station .....	258
Check regularly and before a long trip .....	261



**Control and operation of radio transmitters**

## COMAND, radio and telephone

**Warning!**

Please do not forget that your primary responsibility is to drive the vehicle. Only operate the COMAND, radio or telephone<sup>1</sup> if road and traffic conditions permit.

Bear in mind that at a speed of just 30 mph (approximately 50 km/h), your vehicle is covering a distance of approximately 50 feet (approximately 14 m) every second.

<sup>1</sup> Observe all legal requirements.

## Telephones and two-way radio

**Warning!**

Never operate radio transmitters equipped with a built-in or attached antenna (i.e. without being connected to an external antenna) from inside the vehicle while the engine is running. Doing so could lead to a malfunction of the vehicle's electronic system, possibly resulting in an accident and personal injury.

Radio transmitters, such as a portable telephone or a citizens band unit should only be used inside the vehicle if they are connected to an antenna that is installed on the outside of the vehicle.

Refer to the radio transmitter operation instructions regarding use of an external antenna.

### The first 1 000 miles (1 500 km)

The more cautiously you treat your vehicle during the break-in period, the more satisfied you will be with its performance later on. Therefore, drive your vehicle during the first 1 000 miles (1 500 km) at moderate vehicle and engine speeds.

During this period, avoid heavy loads (full throttle driving) and excessive engine speeds.

Avoid accelerating by kickdown. It is not recommended to brake the vehicle by manually shifting to a lower gear. We recommend that you select positions “3”, “2” or “1” only at moderate speeds (for hill driving).

After 1 000 miles (1 500 km) speeds may be gradually increased to the permissible maximum.

### Maintenance

We strongly recommend that you have your vehicle serviced by your authorized Mercedes-Benz Light Truck Center, in accordance with the Service Booklet at the times called for by the FSS.

Failure to have the vehicle maintained in accordance with the Service Booklet at the designated times/mileage may result in vehicle damage not covered by the Mercedes-Benz Limited Warranty.

For information on the Flexible service system (FSS), see page 124.

## Tele Aid

### Important!



The initial activation of the Tele Aid system may only be performed by completing the subscriber agreement and placing an acquaintance call using the “SOS” button. Failure to complete either of these steps will result in a system that is not activated. If the system is not activated the indicator lamp in the “SOS” button stays on after turning electronic key in starter switch to position 2 and the message “TELE AID – NOT ACTIVATED” will be shown in the multifunction display for approx. 10 seconds.



If you have any questions regarding activation, please call the Response Center at 1-800-756-9018 (in the USA) or 1-888-923-8367 (in Canada).

### (Telematic Alarm Identification on Demand)

The Tele Aid system consists of three types of response; automatic and manual emergency, roadside assistance and information.

The Tele Aid system is operational providing that the vehicle’s battery is charged, properly connected, not damaged and cellular and GPS coverage is available.



The speaker volume of a Tele Aid call can be adjusted when using the volume control on the multifunction steering wheel, for raising press button  and for lowering press button .

To activate, press the “SOS” button, the Roadside Assistance button  or the Information button , depending on the type of response required.

Shortly after the completion of your Acquaintance Call, you will receive a user ID and password via first call mail. By visiting [www.mbusa.com](http://www.mbusa.com) and selecting “Tele Aid” (USA only), you will have access to account information, remote door unlock, Info Services\* profile and more.

\* Optional

### System self-check

Initially, after turning the electronic key in starter switch to position 2, malfunctions are detected and indicated (the indicator lamps in the “SOS” button, the Roadside Assistance button  and the Information button  stay on longer than 10 seconds or do not come on). The message “TELE AID – VISIT WORKSHOP” appears for approx. 10 seconds in the multifunction display.

## Important!

Always make sure that the indicator lamps in the “SOS” button, in the “Roadside Assistance” button and in the “Information” button do not remain illuminated constantly in red and the message “TELE AID – VISIT WORKSHOP” is not displayed in the multifunction display after the system self check.

If a malfunction is indicated as outlined above, have the system checked at the nearest Mercedes-Benz Center as soon as possible.

## Emergency calls

An emergency call is initiated automatically:

- following an accident in which the Emergency Tensioning Retractors (ETR’s) or airbags deploy,
- if the antitheft alarm or the tow away alarm stays on for more than 20 seconds, see pages 42 and 43.

An emergency call can also be initiated manually by opening the cover next to the inside rear view mirror labeled “SOS”, then briefly pressing the button located under the cover. See below for instructions on initiating an emergency call manually.

Once the emergency call is in progress, the indicator lamp in the “SOS” button will begin to flash. The message “EMERGENCY CALL – CONNECTING CALL” appears in the multifunction display. When the connection is established, the message “EMERGENCY CALL – CALL CONNECTED” appears in the multifunction display. All information relevant to the emergency, such as the location of the vehicle (determined by the GPS satellite location system), vehicle model, identification number and color are generated.

A voice connection between the Response Center and the occupants of the vehicle will be established automatically soon after the emergency call has been initiated. When a voice connection is established the audio system mutes and the message “TELE AID – EMERGENCY CALL ACTIVE” appears in the multifunction display. The Response Center will attempt to determine more precisely the nature of the accident provided they can speak to an occupant of the vehicle.

## Tele Aid

194

The Tele Aid system is available if:

- it has been activated and is operational. Activation requires a subscription for monitoring services and cellular air time
- the relevant cellular phone network and GPS signals are available and pass the information on to the response center.

Note:

Location of the vehicle on a map is possible if the vehicle is able to receive signals from the GPS satellite network and pass the information on to the response center.

**Warning!**

**If the indicator lamp in the “SOS” button is illuminated continuously and there was no voice connection to the Response Center established, then the Tele Aid system could not initiate an emergency call (e.g. the relevant cellular phone network is not available). The message “EMERGENCY CALL – CALL FAILED” appears in the multifunction display for approx. 10 seconds.**

**Should this occur, assistance must be summoned by other means.**

## Initiating an emergency call manually



Briefly press on cover (1) – the cover will open.



Press the SOS button (2) briefly. The indicator lamp in the SOS button (2) will flash until the emergency call is concluded. Wait for a voice connection to the Response Center.

Close the cover (1) after the emergency call is concluded.

**Warning!**

**If you feel at any way in jeopardy when in the vehicle (e.g. smoke or fire in the vehicle, vehicle in a dangerous road location), please do not wait for voice contact after you have pressed the emergency button. Carefully leave the vehicle and move to a safe location. The Response Center will automatically contact local emergency officials with the vehicle's approximate location if they receive an automatic "SOS" signal and cannot make voice contact with the vehicle occupants.**

**Roadside Assistance button **



Located below the center armrest cover is the Roadside Assistance button . Pressing and holding the button (for longer than 2 seconds) will initiate a call to a Mercedes-Benz Roadside Assistance dispatcher. The button will flash while the call is in progress. The message "ROADSIDE ASSISTANCE - CONNECTING CALL" will appear in the multifunction display. When the connection is established, the message "ROADSIDE ASSISTANCE - CALL CONNECTED" appears in the multifunction display. The Tele Aid system will transmit data generating the vehicle identification number, model, color and location (subject to availability of cellular and GPS signals).

A voice connection between the Roadside Assistance dispatcher and the occupants of the vehicle will be established. When a voice connection is established the audio system mutes and the message "TELE AID - ROADSIDE ASSISTANCE CALL ACTIVE" appears in the multifunction display. The nature of the need for assistance can then be described. The Mercedes-Benz Roadside assistance dispatcher will either dispatch a qualified Mercedes-Benz technician or arrange to tow your vehicle to the nearest Mercedes-Benz Center. For services such as labor and/or towing charges may apply. Refer to the Roadside Assistance manual for more information.

These programs are only available in the USA:

- Sign and Drive services: Services such as jump start, a few gallons of fuel or the replacement of a flat tire with the vehicle spare tire are obtainable,
- Remote Vehicle Diagnostics: This function permits the Mercedes-Benz Roadside Assistance dispatcher to download malfunction codes and actual vehicle data.

Notes:

The indicator lamp in the Roadside Assistance button  remains illuminated in red for approx. 10 seconds during the system self-check after turning electronic key in starter switch to position 2 (together with the “SOS” button and the Information button ).

See system self-check on page 192 when the indicator lamp does not light up in red or stays on longer than approximately 10 seconds.

If the indicator lamp in the Roadside Assistance button  is illuminated continuously and there was no voice connection to the Response Center established, then the Tele Aid system could not initiate an Roadside Assistance call (e.g. the relevant cellular phone network is not available). The message “ROADSIDE ASSISTANCE – CALL FAILED” appears in the multifunction display.

Roadside Assistance calls can be terminated using the  button on the multifunction steering wheel.

### Information button

Located below the center armrest cover is the Information button . Pressing and holding the button (for longer than 2 seconds) will initiate a call to the Customer Assistance Center. The button will flash while the call is in progress. The message “INFO – CONNECTING CALL” will appear in the multifunction display. When the connection is established, the message “INFO – CALL CONNECTED” appears in the multifunction display. The Tele Aid system will transmit data generating the vehicle identification number, model, color and location (subject to availability of cellular and GPS signals).

A voice connection between the Customer Assistance Center representative and the occupants of the vehicle will be established. When a voice connection is established the audio system mutes and the message “TELE AID – INFO CALL ACTIVE” appears in the multifunction display. Information regarding the operation of your vehicle, the nearest Mercedes-Benz Light Truck Center or Mercedes-Benz USA products and services is available to you.



For more details concerning Tele Aid, please visit [www.mbusa.com](http://www.mbusa.com) and use your ID and password, sent to you separately, to learn more (USA only).



## Tele Aid

198

## Notes:

The indicator lamp in the Information button  remains illuminated in red for approx. 10 seconds during the system self-check after turning electronic key in starter switch to position 2 (together with the “SOS” button and the Roadside Assistance button ).

See system self-check on page 192 when the indicator lamp does not light up in red or stays on longer than approximately 10 seconds.

If the indicator lamp in the Information button  is illuminated continuously and there was no voice connection to the Response Center established, then the Tele Aid system could not initiate an Information call (e.g. the relevant cellular phone network is not available). The message “info – CALL FAILED” appears in the multifunction display.

Information calls can be terminated using the  button on the multifunction steering wheel.

**Important!**

If the indicator lamps do not start flashing after pressing one of the buttons or remain illuminated (in red) at any time, the Tele Aid system has detected a fault or the service is not currently active, and may not initiate a call. Visit your Mercedes-Benz Light Truck Center and have the system checked or contact the Response Center at 1-800-756-9018 (in the USA) or 1-888-923-8367 (in Canada) as soon as possible.

## Upgrade Signals

Tele Aid system processes calls using the following priority.

- Automatic emergency – First priority
- Manual emergency – Second priority
- Roadside assistance – Third priority
- Information – Fourth priority

Should a higher priority call be initiated while you are connected, an upgrade (alternating) tone will be heard, and the appropriate indicator lamp will flash. If certain information such as vehicle identification number or customer information is not available, the operator may need to retransmit.

During this time you will hear a chirp and voice contact will be interrupted. Voice contact will resume once the retransmission is completed. Once a call is concluded, a chirp will be heard and the appropriate indicator lamp will stop flashing. The COMAND system operation will resume.

### **Important!**

If the indicator lamp continues to flash or the system does not reset, contact the Response Center at 1-800-756-9018 (in the USA) or 1-888-923-8367 (in Canada), or Mercedes-Benz Customer Assistance at 1-800-FOR-MERCEdes (1-800-367-6372) in the USA or Customer Service at 1-800-387-0100 in Canada.

Notes:

The indicator lamp in the respective button flashes until the call is concluded. Calls can only be terminated by a Response Center or Customer Assistance Center representative except Roadside Assistance and Information calls, which can also be terminated by pressing  button on the multifunction steering wheel.

When a Tele Aid call has been initiated, the COMAND system audio is muted and the selected mode (radio, tape or CD) pauses. The optional cellular phone (if installed) switches off. If you must use this phone, the vehicle must be parked. Disconnect the coiled cord and place the call. The navigation system (if engaged) will continue to run. The display in the instrument cluster is available for use and spoken commands are only available by pressing the RPT button on the COMAND unit. A pop-up window will appear in the COMAND display to indicate that a Tele Aid call is in progress.

**Remote door unlock**

In the case you have your vehicle locked unintentionally (e.g. key inside vehicle), and no other key is available, contact the Mercedes-Benz Response Center at 1-800-756-9018 (in the USA) or 1-888-923-8367 (in Canada). You will be asked to provide your password which you provided when you completed the subscriber agreement.

Then return to your vehicle and press tailgate lock for minimum of 20 seconds until the “SOS” button is flashing. The message “EMERGENCY CALL – CALL CONNECTED” appears in the multifunction display.

As an alternative, you may unlock the vehicle via Internet using the ID and password sent to you shortly after the completion of your Acquaintance Call.

The Response Center will then unlock your vehicle with the remote door unlocking feature.

## Notes:

The remote door unlock feature is available if the relevant cellular phone network is available.

The “SOS” button will flash and the message “EMERGENCY CALL – CALL CONNECTED” will appear in the multifunction display to indicate receipt of the door unlock command.

Once the vehicle is unlocked, a Response Center specialist will attempt to establish voice contact with the vehicle occupants.

If the tailgate lock was pressed for more than 20 seconds before door unlock authorization was received by the Response Center, you must wait 15 minutes before pressing the tailgate lock again.

## Stolen vehicle tracking services

In the event your vehicle was stolen, report the incident to the police who will issue a numbered incident report. Pass this number on to the Mercedes-Benz Response Center.

The Response Center will then attempt to covertly contact the vehicle's Tele Aid system. Once the vehicle is located, the Response Center will contact the local Law Enforcement and you. The vehicle's location will only be provided to Law Enforcement.

## Info Services (optional, except Canada)

Info Services categories include news, sports, stocks, weather and calendar reminders. Choices can be selected via [www.mbusa.com](http://www.mbusa.com) or by calling 1-800-FOR-MERCEDES.

To request Info Services, press the SVC button on the COMAND system, then select "SEND NEW REQUEST FOR INFO SERVICE". "NEW INFO SERVICE REQUEST TRANSMITTED" will appear in the COMAND display and call status messages will appear in the multifunction display.

Once information is available, the message "NEW INFO RECEIVED – READ LATER WHEN STOPPED?" will appear. Select "Yes". With the vehicle stopped in a safe location press SVC, then select "View Info Service of mm.dd.yyyy hh.mm". Messages will be retained for 30 minutes once the ignition is switched off.

## Important!

Tele Aid utilizes the cellular network for communication and the GPS (Global Positioning System) satellites for vehicle location. If either of these signals are unavailable, the Tele Aid system may not function and if this occurs, assistance must be summoned by other means.

## Warning!

**If the indicator lamp in the "SOS" button does not illuminate during or remains illuminated after the system self-check or if the message "TELE AID – VISIT WORKSHOP" appears in the multifunction display, have the system checked at the nearest Mercedes-Benz Center as soon as possible.**

## Catalytic converter

202

**Catalytic converter**

Your Mercedes-Benz is equipped with monolithic type catalytic converters, an important element in conjunction with the oxygen sensors to achieve substantial control of the pollutants in the exhaust emissions. Keep your vehicle in proper operating condition by following our recommended maintenance instructions as outlined in your Service Booklet.

**Caution!**

To prevent damage to the catalytic converters, use only premium unleaded gasoline in this vehicle.

Any noticeable irregularities in engine operation should be repaired promptly. Otherwise, excessive unburned fuel may reach the catalytic converter causing it to overheat, which could start a fire.

**Warning!**

**As with any vehicle, do not idle, park or operate this vehicle in areas where combustible materials such as grass, hay or leaves can come into contact with the hot exhaust system, as these materials could be ignited and cause a vehicle fire.**

## Emission control

Certain systems of the engine serve to keep the toxic components of the exhaust gases within permissible limits required by law.

These systems, of course, will function properly only when maintained strictly according to factory specifications. Any adjustments on the engine should, therefore, be carried out only by authorized Mercedes-Benz Light Truck Center qualified technicians. Engine adjustments should not be altered in any way. Moreover, the specified service jobs must be carried out regularly according to Mercedes-Benz servicing requirements. For details refer to the Service Booklet.

### Warning!

**Inhalation of exhaust gas is hazardous to your health. All exhaust gas contains carbon monoxide, and inhaling it can cause unconsciousness and lead to death.**

**Do not run the engine in confined areas (such as a garage) which are not properly ventilated. If you think that exhaust gas fumes are entering the vehicle while driving, have the cause determined and corrected immediately. If you must drive under these conditions, drive only with at least one window fully open.**

## Starter switch

204

## Starter switch

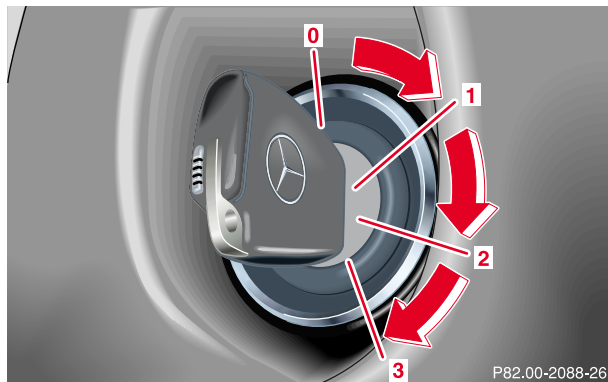

- 0** The electronic key can be withdrawn in this position only. The steering is locked when the electronic key is removed from the starter switch. If necessary, move steering wheel slightly to allow the locking mechanism to engage.

In vehicles with automatic transmission, the electronic key can be removed only with the selector lever in position “P”. After removing the electronic

key or with the electronic key in starter switch position 0 or 1 the selector lever is locked in position “P”.

- 1** Most electrical devices can be operated. For detailed information see respective subjects.
- 2** Driving position.  
Gear selector lever is unlocked.  
To move the selector lever out of position “P” firmly depress the service brake pedal.
- 3** Starting position.

See page 206 for instructions on starting and turning off the engine.

**Warning!**

**When leaving the vehicle always remove the electronic key from the starter switch, and lock the vehicle. Do not leave children unattended in the vehicle, or with access to an unlocked vehicle. Unsupervised use of vehicle equipment may cause serious personal injury.**

### Important!

If the electronic key is left in the starter switch position 0 for an extended period of time, it can no longer be turned in the lock. In this case, remove the electronic key from the starter switch and reinsert it.

### Caution!

To prevent accelerated battery discharge and a possible dead battery, always remove the electronic key from the starter switch. **Do not** leave the electronic key in the starter switch position 0.

### Notes:

A warning sound when the driver's door is opened with the electronic key in starter switch position 1 or 0.

If the electronic key cannot be turned in the starter switch, the vehicle battery may not be sufficiently charged. See battery on page 319 or jump starting on page 321.

With the engine at idle speed, the charging rate of the alternator (output) is limited.

It is therefore recommended that you turn off unnecessary electrical consumers while driving in stop-and-go traffic. This precaution helps to avoid draining of the battery.

Unnecessary strain on the battery and charging system may be minimized by turning off the following power-consuming devices, for example:

Heated seats, rear window defroster. In addition, the automatic climate air volume control should be set to the lowest position.



## Starting and turning off the engine

206

### Starting and turning off the engine

#### Before starting

Ensure that parking brake is engaged and that selector lever is in position “P” or “N”. Turn electronic key in starter switch to position 2.

#### Important!

In areas where temperatures frequently drop below -4°F (-20°C) we recommend that an engine block heater be installed. Your authorized Mercedes-Benz Light Truck Center will advise you on this subject, see page 225.

#### Starting

Do not depress accelerator. Briefly turn electronic key in starter switch clockwise to the stop and release. The starter will engage until the engine is running.

If engine will not run, and the starting procedure stops, turn electronic key completely to the left and repeat starting the engine.

After several unsuccessful attempts, have the system checked at the nearest authorized Mercedes-Benz Light Truck Center.

#### Important!

Due to the installed starter non-repeat feature, the electronic key must be turned completely to the left before attempting to start the engine again.

#### Turning off

Turn the electronic key in the starter switch to position 0 to stop the engine.

The electronic key can only be removed with the selector lever in position “P”.

## Automatic transmission



The automatic transmission selects individual gears automatically, dependent upon

- Selector lever position, see page 210
- Transfer case position “HIGH” or “LOW”
- Accelerator position
- Vehicle speed

The gear shifting process is continuously adapted, dependent on the driving style, the driving situation and the road characteristics.

Note:

For shifting differential locks, see page 253.

For shifting transfer case, see page 247.

### Important!

When parking the vehicle or before working on the vehicle with the engine running, firmly pull parking brake lever up as many notches as possible and shift the selector lever into “P”.

When starting off on a slippery surface, do not allow one drive wheel to spin for an extended period with the ESP switched off. Doing so may cause serious damage to the drive train which is not covered by the Mercedes-Benz Limited Warranty.

## Automatic transmission

208

**Driving**

The selector lever is automatically locked while in position “P”. To move the selector lever out of position “P”, the service brake pedal must be firmly depressed before the shift lock will release.

Shift selector lever to the desired position only when the engine is idling normally and the service brake is applied. Do not release the brake until ready to drive. The vehicle may otherwise start creeping when the selector lever is in drive or reverse position.

**Warning!**

**It is dangerous to shift the selector lever out of “P” or “N” if the engine speed is higher than idle speed. If your foot is not firmly on the brake pedal, the vehicle could accelerate quickly forward or in reverse. You could lose control of the vehicle and hit someone or something. Only shift into gear when the engine is idling normally and when your right foot is firmly on the brake pedal.**

**On slippery road surfaces, never downshift in order to obtain braking action. This could result in drive wheel slip and reduced vehicle control. Your vehicle’s ABS will not prevent this type of loss of control.**

**Important!**

After selecting any driving position from “N” or “P”, wait a moment to allow the gear to fully engage before accelerating, especially when the engine is cold.

**Accelerator position**

Partial throttle = early upshifting = normal acceleration

Full throttle = later upshifting = rapid acceleration

Kickdown (depressing the accelerator beyond full throttle) = downshifting to a lower gear = maximum acceleration. Once the desired speed is attained, ease up on the accelerator – the transmission shifts up again.

**Stopping**

For brief stops, e.g. at traffic lights, leave the transmission in gear and hold vehicle with the service brake.

For longer stops with the engine idling, shift into “N” or “P” and hold the vehicle with the service brake.

When stopping the vehicle on an uphill gradient, do not hold it with the accelerator, use the brake. This avoids unnecessary transmission heat build up.

## Maneuvering

To maneuver in tight areas, e.g. when pulling into a parking space, control the vehicle speed by gradually releasing the brakes. Accelerate gently and never abruptly step on the accelerator.

To rock a vehicle out of soft ground (mud or snow), alternately shift from forward to reverse, while applying slight partial throttle.

Rocking a vehicle free in this manner may cause the ABS or traction system malfunction indicator lamp to come on. Turn off and restart the engine to clear the malfunction indication.

### Warning!

**Getting out of your vehicle with the selector lever not fully engaged in position “P” is dangerous. Also, when parked on an incline, position “P” alone may not prevent your vehicle from moving, possibly hitting people or objects.**

**Always set the parking brake in addition to shifting to position “P”, see page 215 for parking brake.**

**When parked on an incline, also turn front wheel against curb.**

### Warning!

**When leaving the vehicle always remove the electronic key from the starter switch, and lock the vehicle. Do not leave children unattended in the vehicle, or with access to an unlocked vehicle. Children could move the gear selector lever from position “P”, which could result in an accident or serious injury.**

## Automatic transmission

210

## Selector lever position



1 Transfer case indicator

2 Gear range indicator

The current selector lever position is indicated in the gear range indicator display (2). The automatic gear shifting process can be adapted to specific operating conditions using the selector lever.

**P** Park position

The park position is to be used when parking the vehicle. Engage only with the vehicle stopped. The park position is not intended to serve as a brake when the vehicle is parked. Rather, the driver should always use the parking brake in addition to placing the selector lever in park to secure the vehicle.

Notes:

The electronic key can only be removed from the starter switch with the selector lever in position “P”. With the electronic key removed, the selector lever is locked in position “P”.

With a malfunction in the vehicle’s electrical system the selector lever could remain locked in position “P”. To unlock the selector lever manually, see page 327.

**R** Reverse gear

Shift to reverse gear only with the vehicle stopped.

**N Neutral**

No power is transmitted from the engine to the drive axle. When the brakes are released, the vehicle can be moved freely (pushed or towed). Do not engage “N” while driving except to coast when the vehicle is in danger of skidding (e.g. on icy roads, see winter driving instructions on page 222).

**Important!**

Coasting the vehicle, or driving for any other reason with selector lever in “N” can result in transmission damage that is not covered by the Mercedes-Benz Limited Warranty.

**D** The transmission automatically upshifts through 5th gear. Position “D” provides optimum driving characteristics under all normal operating conditions.

## Automatic transmission

212

**Gear selection for special circumstances**

The transmission gear ranges for special circumstances can be selected by pressing the selector lever to the right or the left with the selector lever in position “D”.

The gear range currently selected is indicated in the instrument cluster display.

Briefly press selector lever in the “D –” direction:  
The transmission will shift from the current gear range to the next lower gear range.

Press and hold selector lever in the “D –” direction:  
The selector lever position display will switch to the gear range currently selected by the automatic transmission.

Shifting into another gear range that allows for quicker acceleration or to slow the vehicle down is possible. Downshifts can also be performed.

**Warning!**

**On slippery road surfaces, never downshift in order to obtain braking action. This could result in drive wheel slip and reduced vehicle control. Your vehicle’s ABS will not prevent this type of loss of control.**

Note:

To avoid overrevving the engine when the selector lever is moved in “D –” direction, the transmission will not shift to a lower gear range if the engine’s revolutions per minute limit would be exceeded.

Briefly press selector lever in the “D +” direction:  
The transmission will shift from the current gear range to the next higher gear range.

Press and hold selector lever in the “D +” direction:  
The transmission will shift from the current gear range directly to gear range “D”.

**Important!**

With transmission in gear range “D”, “4” or “3”, upshifting from 1st to 2nd to 3rd gear is delayed depending on vehicle speed and engine temperature. This allows the catalytic converter to heat up more quickly to operating temperatures.

During the brief warm-up period this delayed upshift and increased engine noise might be perceived as a malfunction. However, neither the engine nor transmission are negatively affected by this mode of operation.

The delayed upshift is effective with vehicle speeds below 31 mph (50 km/h) at partial throttle and engine temperatures below 95°F (35°C).

To prevent the engine from laboring at low RPM when driving uphill gradients or with your vehicle heavily loaded, the automatic transmission will downshift when necessary to maintain engine RPM within the best torque range.

For notes on driving the vehicle in transfer case position “LOW”, see page 248.

Gear ranges:

- 4** Upshift through 4th gear only. Suitable for performance driving.
- 3** Upshift through 3rd gear only. Suitable for moderately steep hills. Since the transmission does not shift higher than 3rd gear, this gear selection will allow use of the engine’s braking power downhill.
- 2** Upshift through 2nd gear only. For driving in mountainous regions or under extreme operating conditions. This gear selection will allow use of the engine’s braking power when descending steep grades.
- 1** Use this position, which makes maximum use of the engine’s braking effect, while descending very steep or lengthy downgrades.

Note:

To avoid overrevving the engine on the rpm limit, the transmission will upshift automatically to the next higher gear range as long as the vehicle is accelerating.



## Automatic transmission

214

**Emergency operation (Limp home mode)**

If vehicle acceleration worsens or the transmission no longer shifts, the transmission is most likely operating in Limp home mode which engages when there is a malfunction of the transmission. This condition may be accompanied by the “CHECK ENGINE” malfunction indicator lamp in the instrument cluster coming on.

In this mode only the 2nd gear or reverse gear can be activated.

To engage 2nd gear or reverse:

1. Stop the vehicle.
2. Move selector lever to position “P”.
3. Turn key in starter switch to position 0.
4. Wait at least 10 seconds.
5. Restart the engine.
6. Move selector lever to position “D” (for 2nd gear), or move selector lever to position “R” (for reverse gear).

Have the transmission checked at your authorized Mercedes-Benz Light Truck Center as soon as possible.

## Parking brake

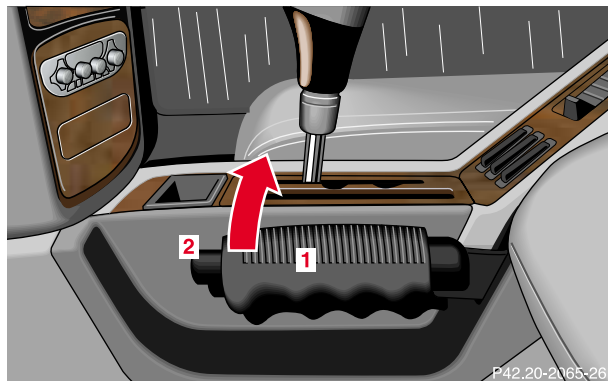

- 1 Lever
- 2 Button

To apply:  
Pull the lever (1) up as many notches as possible. When the electronic key is in starter switch position 2, the brake warning lamp  in the instrument cluster should come on brightly.

To release:  
Lift the lever (1) up slightly, press the button on the lever in and move the lever down to the stop. The brake warning lamp  in the instrument cluster should go out.

A warning sounds and the parking brake warning message appears in the multifunction display (see page 278), if you start to drive without having released the parking brake.

Also see brake warning lamp on page 266.

### Warning!

**When leaving the vehicle always remove the electronic key from the starter switch, and lock the vehicle. Do not leave children unattended in the vehicle, or with access to an unlocked vehicle. Children could release the parking brake, which could result in an accident or serious injury.**

## Driving instructions

### Drive sensibly – save fuel

Fuel consumption, to a great extent, depends on driving habits and operating conditions.

To save fuel you should:

- keep tires at the recommended inflation pressures,
- remove unnecessary loads,
- allow engine to warm up under low load use,
- avoid frequent acceleration and deceleration,
- have all maintenance work performed at regular intervals by an authorized Mercedes-Benz Light Truck Center.

Fuel consumption is also increased by driving in cold weather, in stop-and-go traffic, on short trips and in hilly country.

## Drinking and driving

### Warning!

**Drinking or taking drugs and driving can be a very dangerous combination. Even a small amount of alcohol or drugs can affect your reflexes, perceptions and judgement.**

**The possibility of a serious or even fatal accident is sharply increased when you drink or take drugs and drive.**

**Please do not drink or take drugs and drive or allow anyone to drive after drinking or taking drugs.**

## Pedals

### Warning!

**Keep driver's foot area clear at all times. Objects stored in this area may impair pedal movement.**

## Power assistance

### Warning!

**When the engine is not running, the brake and steering systems are without power assistance. Under these circumstances, a much greater effort is necessary to stop or steer the vehicle.**

## Brakes

### Warning!

**After driving in heavy rain for some time without applying the brakes or through water deep enough to wet brake components or salty road conditions, the first braking action may be somewhat reduced and increased pedal pressure may be necessary to obtain expected braking effect. Be sure to maintain a safe distance from vehicles in front.**

**Resting your foot on the brake pedal will cause excessive and premature wear of the brake pads.**

**It can also result in the brakes overheating thereby significantly reducing their effectiveness. It may not be possible to stop the vehicle in sufficient time to avoid an accident.**

Excessive use of road salt and other snow melting chemicals spread on roads during the winter months may cause a build up of moisture or residue to form on the braking components. This build up or residue could cause light corrosion of the braking components if the vehicle is parked with the brakes cold. Apply steady and even braking pressure when stopping the vehicle to warm up and dry the brake components.

### Important!

Please pay attention to the function of the brake assist system (BAS), see page 237.

The condition of the parking brake system is checked each time the vehicle is in the shop for the required maintenance service.

If the parking brake is released and the brake warning lamp in the instrument cluster stays on and there is no audible warning (EBB), the brake fluid level in the reservoir is too low.

Brake pad wear or a leak in the system may be the reason for low brake fluid in the reservoir.

Have the brake system inspected at an authorized Mercedes-Benz Light Truck Center immediately.

All checks and service work on the brake system should be carried out by an authorized Mercedes-Benz Light Truck Center.

Install only brake pads and brake fluid recommended by Mercedes-Benz.

**Warning!**

**If other than recommended brake pads are installed, or other than recommended brake fluid is used, the braking properties of the vehicle can be degraded to an extent that safe braking is substantially impaired. This could result in an accident.**

**Caution!**

When driving down long and steep grades, relieve the load on the brakes by shifting into a lower gear to use the engine's braking power. This helps prevent overheating of the brakes and reduces brake pad wear.

After hard braking, it is advisable to drive on for some time, rather than immediately parking, so the air stream will cool down the brakes faster.

**Driving off**

Apply the service brakes to test them briefly after driving off. Perform this procedure only when the road is clear of other traffic.

Warm up the engine smoothly. Do not place full load on the engine until the operating temperature has been reached.

When starting off on a slippery surface, do not allow one drive wheel to spin for an extended period with the ESP switched off. Doing so may cause serious damage to the drive train which is not covered by the Mercedes-Benz Limited Warranty.

To ensure sufficient traction during off-road driving, activate differential locks as needed, see page 253.

## Parking

### Warning!

To reduce the risk of personal injury as a result of vehicle movement, **before** turning off the engine and leaving the vehicle, always:

1. Keep right foot on the service brake pedal.
2. Pull the parking brake lever up as many notches as possible.
3. Move the selector lever to position “P”.
4. Slowly release the service brake pedal.
5. Turn front wheels towards the road curb.
6. Turn the electronic key to starter switch position 0 and remove.
7. Take the key and lock vehicle when leaving.

### Important!

It is advisable to set the parking brake whenever parking or leaving the vehicle. In addition, move selector lever to position “P”.

When parking on hills, always set the parking brake.

## Tires

### Warning!

If you feel a sudden significant vibration or ride disturbance, or you suspect that possible damage to your vehicle has occurred, you should turn on the hazard warning flashers, carefully slow down, and drive with caution to an area which is a safe distance from the roadway.

Inspect the tires and under the vehicle for possible damage. If the vehicle or tires appear unsafe, have it towed to the nearest Mercedes-Benz Light Truck Center or tire dealer for repairs.

Tread wear indicators (TWI) are required by law. These indicators are located in six places on the tread circumference and become visible at a tread depth of approximately  $\frac{1}{16}$  in (1.5 mm), at which point the tire is considered worn and should be replaced.

The tread wear indicator appears as a solid band across the tread.

Note:

For instructions on towing the vehicle, see page 324.

## Driving instructions

220

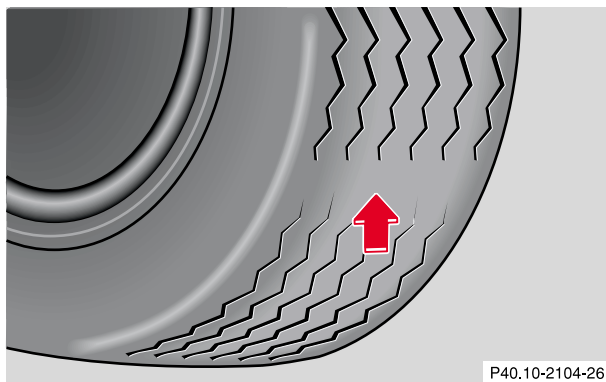

P40.10-2104-26

**Warning!**

**Do not allow your tires to wear down too far. As tread depth approaches  $\frac{1}{16}$  in (1.5 mm), the adhesion properties on a wet road are sharply reduced.**

**Depending upon the weather and/or road surface (conditions), the tire traction varies widely.**

Specified tire pressures must be maintained. This applies particularly if the tires are subjected to high loads (e.g. high speeds, heavy loads, high ambient temperatures).

**Warning!**

**Do not drive with a flat tire. A flat tire affects the ability to steer or brake the vehicle. You may lose control of the vehicle. Continued driving with a flat tire or driving at high speed with a flat tire will cause excessive heat build-up and possibly a fire.**

**Aquaplaning**

Depending on the depth of the water layer on the road, aquaplaning may occur, even at low speeds and with new tires. Reduce vehicle speed, avoid track grooves in the road and apply brakes cautiously in the rain.

## Tire traction

The safe speed on a wet, snow covered or icy road is always lower than on a dry road.

You should pay particular attention to the condition of the road whenever the outside temperatures are close to the freezing point.

### Warning!

**If ice has formed on the road, tire traction will be substantially reduced. Under such weather conditions, drive, steer and brake with extreme caution.**

We recommend M+S rated radial-ply tires with a minimum tread depth of approximately 1/8 in (4 mm) for the winter season for all four wheels to insure normal balanced handling characteristics. On packed snow, they can reduce your stopping distance as compared with summer tires. Stopping distance, however, is still considerably greater than when the road is not snow or ice covered.

## Tire speed rating

Your vehicle is factory equipped with “V”-rated tires, which have a speed rating of 150 mph (240 km/h).

An electronic speed limiter prevents your vehicle from exceeding the tire speed rating.

Despite the tire rating, local speed limits should be obeyed. Use prudent driving speeds appropriate to prevailing conditions.

### Warning!

**Even when permitted by law, never operate a vehicle at speeds greater than the maximum speed rating of the tires.**

**Exceeding the maximum speed for which tires are rated can lead to sudden tire failure causing loss of vehicle control and resulting in personal injury and possible death.**



**Snow chains**

Use only snow chains that are tested and recommended by Mercedes-Benz. Your authorized Mercedes-Benz Light Truck Center will be glad to advise you on this subject.

Snow chains should be used on all four wheels. Follow the manufacturer's mounting instructions.

Snow chains should only be driven on snow covered roads at speeds not to exceed 30 mph (50 km/h). Remove chains as soon as possible when driving on roads without snow.

**Winter driving instructions**

The most important rule for slippery or icy roads is to drive sensibly and to avoid abrupt acceleration, braking and steering maneuvers. Do not use the cruise control system under such conditions.

When the vehicle is in danger of skidding, move selector lever to position "N". Try to keep the vehicle under control by corrective steering action.

**Important!**

Avoid spinning of one drive wheel. This may cause serious damage to the drive train which is not covered by the Mercedes-Benz Limited Warranty.

To ensure sufficient traction during off-road driving, activate differential locks as needed, see page 253.

ABS, ESP and BAS are switched off automatically when the transfer case differential lock is activated.

Road salts and chemicals can adversely affect braking efficiency. Increased pedal force may become necessary to produce the normal brake effect. We therefore recommend depressing the brake pedal periodically when traveling at length on salt-strewn roads. This can bring road salt impaired braking efficiency back to normal. A prerequisite is, however, that this be done without endangering other drivers on the road.

If the vehicle is parked after being driven on salt treated roads, the braking efficiency should be tested as soon as possible after driving is resumed while observing the safety rules in the previous paragraph.

### **Warning!**

**If the vehicle becomes stuck in snow, make sure that snow is kept clear of the exhaust pipe and from around the vehicle with engine running. Otherwise, deadly carbon monoxide (CO) gases may enter vehicle interior resulting in unconsciousness and death.**

**To assure sufficient fresh air ventilation, open a window slightly on the side of the vehicle not facing the wind.**

## **Winter driving**

Have your vehicle winterized at your authorized Mercedes-Benz Light Truck Center before the onset of winter.

- Check the engine oil. Change the engine oil if the engine contains an oil which is not approved for winter operation. For viscosity (SAE/CCMC class) and filling quantity, see page 361.
- Check engine coolant anticorrosion/antifreeze concentration.
- Additive for the windshield washer and headlamp cleaning system: Add MB Concentrate "S" to a premixed windshield washer solvent/antifreeze which is formulated for below freezing temperatures see page 307.
- Test battery: Battery capacity drops with decreasing ambient temperature. A well charged battery helps to ensure that the engine can be started, even at low ambient temperatures.
- Tires: We recommend M+S rated radial-ply tires on all four wheels for the winter season. Observe permissible maximum speed for M+S rated radial-ply tires and the legal speed limit.

## Driving instructions

224

In winter operation, the maximum effectiveness of the antilock brake system (ABS), the four wheel electronic traction system (4-ETS), the electronic stability program (ESP), and electronic brake booster (EBB) can only be achieved with M+S rated radial-ply tires and/or snow chains recommended by Mercedes-Benz. Snow chains maximize performance.

For driving instructions using snow chains see page 222.

**Deep water****Caution!**

Do not drive through flooded areas or water of unknown depth. Before driving through water, determine its depth. It should not be deeper than approximately 20 inches (50 cm).

If you must drive through deep water, drive slowly to prevent water from entering the engine compartment or passenger compartment, being ingested by the air intake, possibly causing damage to electrical components or wiring, to engine or transmission that is not covered by the Mercedes-Benz Limited Warranty.

## Passenger compartment

### Warning!

**Always fasten items being carried as securely as possible.**

**In an accident, during hard braking or sudden maneuvers, loose items will be thrown around inside the vehicle, and cause injury to vehicle occupants unless the items are securely fastened in the vehicle.**

**The rear cargo area is the preferred place to carry objects.**

**Do not load items on the roof. It may cause instability during some maneuvers which could result in an accident. This vehicle is not intended to carry items on its roof. Thus roof rails and roof mounted ski or bike holders must not be used.**

## Block heater (Canada only)

The engine is equipped with a block heater.

The electrical cable may be installed at your authorized Mercedes-Benz Light Truck Center.

## Traveling abroad

Abroad, there is a widely-spread Mercedes-Benz service network at your disposal. If you plan to travel into areas which are not listed in the index of your Mercedes-Benz Light Truck Center directory, you should request pertinent information from your authorized Mercedes-Benz Light Truck Center.

**Off-Road driving**

Familiarize yourself with the vehicle characteristics and gear changing before you attempt any difficult terrain off-road driving. We recommend that you start out with easy off-road travel.

Please read this chapter carefully before you begin off-road travel.

Special driving features are available for specific kinds of operation:

- ABS, see page 239
- ESP, see page 243
- Differential lock, see page 253
- Transfer case, see page 247

Engage the transfer case in position LOW before driving under off-road conditions. For switching the transfer case in position LOW, see page 247.

Fasten items being carried as securely as possible, see page 178.

**Warning!**

**Do not load items on the roof. It may cause instability during some maneuvers which could result in an accident.**

We recommend to keep doors, tailgate, windows, and roof closed whenever driving in off-road mode.

We recommend to switch the cruise control off.

**Important!**

Adjust vehicle speed to condition of terrain. The more uneven, rutty and steeper the terrain, the lower the speed should be.

Watch out for obstacles, such as rocks, holes, tree-stumps, ruts.

Be especially careful when driving in unknown territory. It is good practice to get out of the vehicle and scout the path you intend to take.

Continuous and speedy driving in sandy soil overcomes the vehicle rolling resistance, and helps to prevent the vehicle from sinking into the ground. Switch on the differential locks, see page 253.

Do not initiate jumps with the vehicle. It interrupts the forward momentum of the vehicle.

Always drive on slopes with the engine running and the vehicle in gear.

Sand, dirt, mud and other material having friction property, can cause exceptional wear and tear as well as failure of the brakes.

In this case the brakes may be less effective or even fail when you most need them. Always clean and check the brakes following each off-road trip.

### Checklist before off-road driving

- **Engine oil level:** Check the engine oil level, see page 127 and page 304. The display “ENGINE OIL LEVEL – O.K.” must appear in the multifunction display.  
Only then is a trouble free oil supply obtained even on steep gradients with the vehicle.
- **Tires:** Check the tread depth and maintain specified tire pressure (see tire pressure label inside the fuel filler flap). Check tires for possible damage and remove foreign objects. The valve caps must be mounted.
- **Rims:** Dented or bent rims can cause tire pressure loss and damage the tire beads. For this reason, check and, if necessary, change rims before driving off-road.
- **Vehicle tool kit:** Check if the vehicle jack is functional. In all cases take the vehicle tool kit, a strong tow rope, a shovel and a small plank (to put under the vehicle jack on sandy soil) with you.

## Driving instructions

228

## Driving in steep terrain

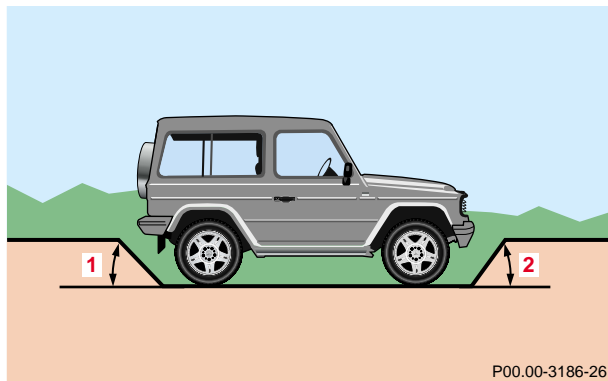

Slope angle:

1 27°

2 36°

Switch the transfer case in position LOW before starting to drive up or down steep inclines, see page 248.

If necessary activate differential locks, see page 253. ABS, BAS and ESP are switched off automatically when the differential locks are activated.

Maximum vehicle climbing ability is a 80% grade.

Driving on embankments, slopes and other steep inclines should only be done straight up or downhill, i.e. in the line of gravity.

Do not drive along the side of a slope (danger of vehicle rollover). If in doing so, the vehicle begins to show a tendency to roll, immediately steer into a line of gravity (straight up or downhill).

To help avoid the vehicle rolling over, never turn it around on steep inclines. If the vehicle cannot complete the attempted climb, back it down in reverse gear.

Utilize the engine's braking power when descending a slope, observe the engine speed (do not overrev the engine). Apply the service brake as needed.

Check the brakes after a lengthy downgrade drive.

Notes:

Avoid excessive engine speeds – drive with moderate engine speeds (max. 3000 RPM).

Select gear range “2” or “1” on the automatic transmission, see page 207.

Traction in steep terrain:

Be easy on the accelerator and watch for continuous wheel traction when driving in steep terrain.

When the differential locks are not engaged, 4-ETS helps greatly when starting out on a steep incline. The front wheels have then the tendency to slip due to the weight reduction over the front axle. The ETS recognizes the situation and limits the torque for the front wheels by braking them. Simultaneously the torque for the rear wheels is increased.

See page 241 for four wheel electronic traction system (4-ETS).

Driving across a hilltop:

To prevent the vehicle from speeding up too much after climbing a hill, decelerate just ahead of a hilltop (do not select gear range “N”). Use the momentum of the vehicle to drive across the hilltop. Driving in this manner prevents the vehicle from jumping across the hilltop and thus losing its forward momentum.

Driving downhill:

Select gear range “1” on the automatic transmission, see page 207.

Drive downhill observing the same rules as driving uphill.

Driving on embankments, slopes and other steep inclines should only be done straight up or downhill, i.e. in the line of gravity.

Do not drive along the side of a slope (danger of vehicle rollover). If in doing so, the vehicle begins to show a tendency to roll, immediately steer into a line of gravity (straight up or downhill).

Utilize the engine’s braking power when descending a slope, observe the engine speed (do not overrev the engine). Apply the service brake as needed.

The special LOW range ABS setting allows for precise and brief (cyclical) blocking of the front wheels, permitting them to dig into loose ground. Remember that the front wheels when stopped, slide across a surface, thus lose their ability to steer the vehicle.

Check the brakes after a lengthy downgrade drive.

### **Important!**

Only apply the service brake if the vehicle travels straight downhill, i.e. in the line of gravity.



## Driving instructions

230

## Driving through water

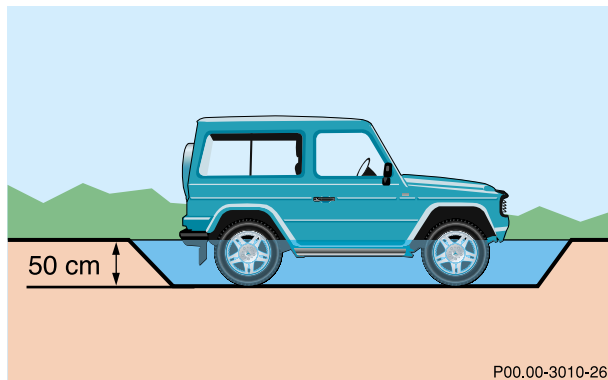

**1** 20 in (50 cm)

Before driving through water, determine its depth. It should not be deeper than approximately 20 inches (50 cm).

Switch the transfer case in position LOW before driving through water.

If necessary activate differential locks, see page 253. ABS, BAS and ESP are switched off automatically when the differential locks are activated.

Switch off the exterior lamps as well as the climate control.

Enter the water only at a shallow spot. Never take a running start. Drive slowly, avoiding a bow wave.

Do not stop vehicle immersed in water, and do not shut off the engine.

To dry the brakes, apply pressure to the brake pedal several times after leaving the water.



### **Crossing obstacles:**

Select gear range “1” on the automatic transmission, see page 207.

If necessary activate differential locks, see page 253. ABS, BAS and ESP are switched off automatically when the differential locks are activated.

Cross obstacles (e.g. tree stumps or big rocks) very slowly by aiming one of the front wheels at the center of the obstacle, and repeat same with the rear wheel.

### **Important!**

Damage on the vehicle definitely increases the chance for a subsequent accident.

Notes:

Check the vehicle clearance before crossing obstacles that possibly could damage the undercarriage.

If possible use the assistance of a second person.

Special attention is needed when crossing obstacles on a steep incline. The vehicle could slide sideways as a result of its possible slanted position.

## Driving instructions

232

**Ruts:**

Select gear range “1” on the automatic transmission, see page 207.

If necessary activate differential locks, see page 253. ABS, BAS and ESP are switched off automatically when the differential locks are activated.

A number of off-road tracks or other byways have deep ruts which can cause the undercarriage to come in contact with the ground.

Drive next to the ruts rather than through them if at all possible.

## Notes:

Check the vehicle clearance.

Damage on the vehicle definitely increases the chance for a subsequent accident.

## Returning from off-road driving

Off-road driving increases strain on the vehicle.

We recommend that you inspect the vehicle for possible damage after each off-road trip. Recognizing any damage and a subsequent timely repair reduces the chance of a possible breakdown or accident later on.

Proceed as follows:

- Disengage the differential locks, see page 253.
- Engage the transfer case in position HIGH, see page 247.
- Remove excessive dirt from tires, wheels, wheel housings, and underbody. For instance, after driving in mud, clean the radiator, chassis, engine, brakes, and wheels from extreme dirt, using a strong jet of water.
- Inspect frame, oil pan, brake hoses, etc., as well as vehicle underbody for possible damage.
- Check tires for possible damage, clean all exterior lamps, and conduct a brake test.

- Check for brush or branches caught in the undercarriage. They could increase the possibility of a fire, as well as cut fuel and/or brake lines, puncture rubber bellows of the axles or drive shafts.

### Warning!

**Never drive on pavement with activated differential locks. Engaged front axle differential locks limits ability to move around curves.**

**If you feel a sudden significant vibration or ride disturbance, or you suspect that possible damage to your vehicle has occurred, you should turn on the hazard warning flashers, carefully slow down, and drive with caution to an area which is a safe distance from the roadway.**

**Inspect the tires and under the vehicle for possible damage. If the vehicle or tires appear unsafe, have it towed to the nearest Mercedes-Benz Light Truck Center or tire dealer for repairs.**

## Driving systems

234

## Cruise control

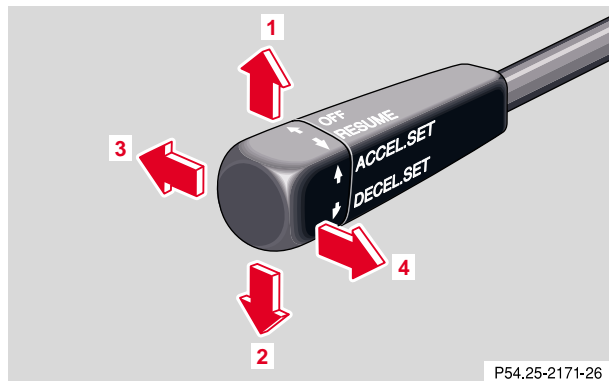

The cruise control allows you to drive in a more relaxed manner, for example over long distances, as it automatically maintains the set speed by actively regulating the throttle setting.

Any given speed above approximately 25 mph (40 km/h) can be maintained with the cruise control by operating the lever.

- 1** Accelerate and set:  
Lift lever briefly to set speed.  
Hold lever up to accelerate.
- 2** Decelerate and set:  
Depress lever briefly to set speed.  
Hold lever down to decelerate.

Normally the vehicle is accelerated to the desired speed with the accelerator.

Speed is set by briefly pushing the lever to position 1 or 2. The accelerator can then be released.

The speed can be increased (e.g. for passing) by using the accelerator. After the accelerator is released, the previously set speed will be resumed automatically.

If a set speed is to be increased or decreased slightly, e.g. to adapt to the traffic flow, hold lever in position 1 or 2 until the desired speed is reached, or briefly tip the lever in the appropriate direction for increases or decreases in 0.6 mph (1 km/h) increments. When the lever is released, the newly set speed remains.

### 3 Canceling

To cancel the cruise control, briefly push lever to position 3.

When you step on the brake pedal or the vehicle speed drops below approximately 25 mph (40 km/h), for example when driving upgrade, the cruise control will be canceled.

If the cruise control cancels by itself and remains inoperative until the engine is restarted, have the system checked at your authorized Mercedes-Benz Light Truck Center as soon as possible.

### 4 Resume

If the lever is briefly pushed to position 4 when driving at a speed exceeding approximately 25 mph (40 km/h), the vehicle resumes the speed which was set prior to the cancellation of the cruise control. The last memorized speed is canceled when the electronic key in the starter switch is turned to position 1 or 0.

### Important!

Moving gear selector lever to position “N” switches the cruise control off.

### Warning!

**Only use the cruise control if the traffic and weather conditions make it advisable to travel at a steady speed.**

- **The use of cruise control can be dangerous on winding roads or in heavy traffic because conditions do not allow safe driving at a steady speed.**
- **The use of cruise control can be dangerous on slippery roads. Rapid changes in tire adhesion can result in wheel spin and loss of control.**

**The “Resume” function should only be operated if the driver is fully aware of the previously set speed and wishes to resume this particular preset speed.**

## Notes:

If the engine does not brake the vehicle sufficiently while driving on a downgrade, the speed you set on the cruise control may be exceeded. In this case the automatic transmission shifts down (max. to 3rd gear) to maintain the set cruise control speed by using the engine's braking power.

As soon as the grade eases, the automatic transmission shifts up again dependent on the selector lever position.

Nevertheless, in some cases you may have to step on the brake pedal to slow down. In this case the cruise control is switched off.

Use the lever to resume the previously set speed.

For malfunction and warning messages, see page 272.

**Transmission in position LOW**

The cruise control should not be activated during off-road driving in transfer case position LOW. Doing so could reduce driving comfort.

## Brake assist system (BAS)

### Warning!

**BAS cannot prevent the natural laws of physics from acting on the vehicle, nor can it increase braking efficiency beyond that afforded by the condition of the vehicle brakes and tires or the traction afforded. The BAS cannot prevent accidents, including those resulting from excessive speed in turns, following another vehicle too closely, or aquaplaning. Only a safe, attentive, and skillful driver can prevent accidents. The capabilities of a BAS equipped vehicle must never be exploited in a reckless or dangerous manner which could jeopardize the user's safety or the safety of others.**

The BAS is designed to maximize the vehicle's braking capability during emergency braking maneuvers by having maximum power boost applied to the brakes more quickly in emergency braking conditions than might otherwise be afforded solely by the driver's braking style. This can help reduce braking distances over what ordinary driving and braking style might do. The BAS complements the antilock brake system (ABS).

Applying the brakes very quickly results in maximum BAS assistance.

To receive the benefit of the system you must apply continuous full braking power during the stopping sequence. Do not reduce brake pedal pressure.

Once the brake pedal is released, the BAS is deactivated.

At the instant one of the wheels is about to lock up, a slight pulsation can be felt in the brake pedal, indicating that the ABS is in the regulating mode. Keep firm and steady pressure on the brake pedal while experiencing the pulsation.





## Driving systems

238

With the BAS malfunctioning the ABS, ESP and 4-ETS are also switched off.

If the ESP warning lamp and the  malfunction indicator lamp come on permanently while the engine is running, a malfunction has been detected in either system. As a result, it is possible that now only partial engine output will be available. If the BAS malfunctions, the brake system functions in the usual manner, but without BAS.

If the charging voltage falls below 10 volts, the ESP warning lamp, the  malfunction indicator lamp come on and warning messages appears in the multifunction display, the BAS and the ESP are switched off. When the voltage is above this value again, the malfunction indicator and warning lamp should go out and the BAS is operational.

If the  malfunction indicator lamp and the ESP warning lamp stay illuminated and warning messages appears in the multifunction display, have the BAS and ESP checked at your authorized Mercedes-Benz Light Truck Center as soon as possible.

For warning messages and malfunction indicator lamps, see page 264 and page 272.

## Antilock brake system (ABS)

### Warning!

**Do not pump the brake pedal, rather use firm, steady brake pedal pressure. Pumping the brake pedal defeats the purpose for ABS and significantly reduces braking effectiveness.**

### Important!

The ABS improves steering control of the vehicle during hard braking maneuvers.

The ABS prevents the wheels from locking up above a vehicle speed of approximately 5 mph (8 km/h) independent of road surface conditions.

At the instant one of the wheels is about to lock up, a slight pulsation can be felt in the brake pedal, indicating that the ABS is in the regulating mode. Keep firm and steady pressure on the brake pedal while experiencing the pulsation.

Continuous steady brake pedal pressure results in applying the advantages of the ABS, namely braking power and ability to steer the vehicle.

In the case of an emergency brake maneuver keep continuous full pressure on the brake pedal. In this manner only can the ABS be most effective.

On slippery road surfaces, the ABS will respond even with light brake pedal pressure because of the increased likelihood of locking wheels. The pulsating brake pedal can be an indication of hazardous road conditions and functions as a reminder to take extra care while driving.

### ABS control

The ABS malfunction indicator lamp  in the instrument cluster comes on with the electronic key in starter switch position 2 and should go out with the engine running.

When the ABS malfunction indicator lamp  in the instrument cluster comes on while the engine is running, it indicates that the ABS has detected a malfunction and has switched off. In this case, the brake system functions in the usual manner, but without antilock assistance.

With the ABS malfunctioning, the BAS, ESP and 4-ETS are also switched off. The malfunction indicator lamps come on with the engine running.

## Driving systems

240

The ABS malfunction indicator lamp  also comes on, when the differential lock is engaged. The ABS is switched off, but there is no malfunction in the system.

If the charging voltage falls below 10 volts, the malfunction indicator lamp comes on and the ABS is switched off. When the voltage is above this value again, the malfunction indicator lamp should go out and the ABS is operational.

If the ABS malfunction indicator lamp stays illuminated, have the system checked at your authorized Mercedes-Benz Light Truck Center as soon as possible.

**Warning!**

**ABS cannot prevent the natural laws of physics from acting on the vehicle, nor can it increase braking or steering efficiency beyond that afforded by the condition of the vehicle brakes and tires or the traction afforded. The ABS cannot prevent accidents, including those resulting from excessive speed in turns, following another vehicle too closely, or aquaplaning. Only a safe, attentive, and skillful driver can prevent accidents. The capabilities of an ABS equipped vehicle must never be exploited in a reckless or dangerous manner which could jeopardize the user's safety or the safety of others.**

Notes:

To alert following vehicles to slippery road conditions you discover, operate your hazard warning flashers as appropriate.

Operating the vehicle on a single axle dynamometer should only be done for briefly testing the brakes. To do so, move selector lever to position "N". The engine must be shut off (electronic key in starter switch position 0 or 1).

For ABS malfunction and warning messages, see page 275.

**LOW RANGE – ABS**

During off-road driving a special low range system for the antilock brake system (ABS) is operational with transfer case in position LOW, see page 247.

An improved braking action (dig in effect) is obtained for vehicle speeds up to 37 mph (60 km/h) through a change in the ABS control function.

## Four-wheel electronic traction system (4-ETS)

With the electronic key in starter switch position 2, the warning lamp  located in the speedometer dial comes on and should go out when the engine is running.

The 4-ETS improves vehicle's ability to utilize available traction, especially under slippery road conditions. The brakes are applied to the spinning wheel and power is transferred to the wheel(s) with traction. The 4-ETS function is available between vehicle speed 0 mph (km/h) and 37 mph (60 km/h).

The 4-ETS warning lamp  starts to flash at any vehicle speed, as soon as the tires lose traction and the wheels begin to spin.

### Important!

If the 4-ETS warning lamp  flashes:

- during take-off, apply as little throttle as possible,
- while driving, ease up on the accelerator.

Adapt your speed and driving to the prevailing road conditions.

## 4-ETS Control

If the  malfunction indicator lamp and the ESP warning lamp stay illuminated and warning messages appear in the multifunction display with the engine running, a malfunction has been detected.

Have the 4-ETS checked at your authorized Mercedes-Benz Light Truck Center as soon as possible.

With the ABS malfunctioning, the 4-ETS is also switched off.

### Caution!

If the vehicle is towed with the front axle raised (see towing the vehicle on page 324), or when testing the parking brake on a brake test dynamometer, the engine must be shut off (electronic key in starter switch position 0 or 1). Otherwise, the electronic traction system will immediately be engaged and will apply the rear wheel brakes.

## Driving systems



242

Note:



In winter operation, the maximum effectiveness of the electronic traction system is only achieved with Mercedes-Benz recommended M+S rated radial-ply tires and/or snow chains.

**Electronic Brake Booster (EBB)**

The EBB enhances braking effectiveness by allowing the rear brakes to supply a greater proportion of the braking effort without a loss of vehicle stability.

If a warning tone sounds for five seconds and the symbols  BRAKE,  and  are displayed in the instrument cluster, the system has detected a malfunction and is switched off. Have the system checked immediately at an authorized Mercedes-Benz Light Truck Center. Failure to do so could result in an accident, since the enhanced braking effect is not available when the system is switched off.

Note:

When the EBB is switched off, every time the engine is started, a warning tone will sound for five seconds and the symbols  BRAKE and  will light up. In addition, whenever the brakes are applied at speeds exceeding 25 mph (40 km/h), the warning tone sounds for five seconds.

## Electronic stability program (ESP)

### Warning!

**ESP cannot prevent the natural laws of physics from acting on the vehicle, nor can it increase the traction afforded. The ESP cannot prevent accidents, including those resulting from excessive speed in turns, or aquaplaning. Only a safe, attentive, and skillful driver can prevent accidents. The capabilities of an ESP equipped vehicle must never be exploited in a reckless or dangerous manner which could jeopardize the user's safety or the safety of others.**

The ESP enhances directional control and reduces driving wheel spin of the vehicle under various driving conditions.

Over-/understeering of the vehicle is counteracted by applying brakes to the appropriate wheel to create a countervailing vehicle movement. Engine torque is also limited. The ESP warning lamp, located in the speedometer dial, starts to flash when ESP is in operation.

### Important!

If the ESP warning lamp  flashes:

- During take-off apply as little throttle as possible.
- While driving ease up on the accelerator.
- Adapt your speed and driving to the prevailing road conditions.
- Do not switch off the ESP.

### Caution!

If the vehicle is towed with the front axle raised (see towing the vehicle on page 324), the engine must be shut off (electronic key in starter switch position 0 or 1). Otherwise, the ESP will immediately be engaged and will apply the rear wheel brakes.

Notes:



The yellow ESP warning lamp  in the speedometer dial comes on with the electronic key in starter switch position 2. They should go out with the engine running.

## Driving systems

244

If the ESP warning lamp  comes on continuously and warning messages appears in the multifunction display with the engine running, a malfunction has been detected in either system. Only partial engine output will be available.

If the BAS malfunctions, the brake system functions in the usual manner, but without BAS, ESP and 4-ETS.

If the ESP warning lamp  and the  malfunction indicator lamp come on and warning messages appears in the multifunction display, have the BAS or ESP checked at your authorized Mercedes-Benz Light Truck Center as soon as possible.

With the ABS malfunctioning, the BAS, ESP and 4-ETS are also switched off.

For warning messages and malfunction indicator lamps, see page 264 and page 272.

Driving the vehicle with varied size tires will cause the wheels to rotate at different speeds, therefore the ESP may activate (yellow ESP warning lamp  in speedometer dial comes on). For this reason, all wheels, including the spare wheel, must have the same tire outside diameter.

When testing the parking brake on a brake test dynamometer, the engine must be shut off. Otherwise, the ESP will immediately be engaged and will apply the rear wheel brakes.

In winter operation, the maximum effectiveness of the ESP is only achieved with Mercedes-Benz recommended M+S rated radial-ply tires and/or snow chains.

### Synchronizing ESP

If the power supply was interrupted (battery disconnected or empty), the ESP warning lamp  and warning messages appears in the multifunction display with the engine running.

Turn steering wheel completely to the left and then to the right. The ESP warning lamp  and the warning messages in the multifunction display should go out.

## ESP control switch



ESP control switch located in center console.

To switch ESP off, press upper half of switch (1). ESP warning lamp , located in speedometer dial, comes on.

To switch ESP on again, press lower half of switch (2). ESP warning lamp , located in speedometer dial, goes out.

To improve the vehicle's traction when driving with snow chains, or starting off in deep snow, sand or gravel, or off-road driving, switch off ESP by pressing the upper half of the ESP switch. The ESP warning lamp , located in the speedometer dial, is continuously illuminated.

### Warning!

**ESP should not be switched off during normal driving other than in circumstances described above. Disabling of the system will reduce vehicle stability in standard driving maneuvers.**

**When the ESP warning lamp is illuminated continuously, the ESP is switched off.**

**Adapt your speed and driving to the prevailing road conditions.**

With the ESP system switched off, the engine torque reduction feature is cancelled. Therefore, the enhanced vehicle stability offered by ESP is unavailable.

Adapt your speed and driving to the prevailing road conditions.

If the ESP is switched off the ABS, BAS and ETS are still available.



## Driving systems

246

If the ESP is switched off, it will be automatically activated when exceeding a vehicle speed of 37 mph (60 km/h) or exceeding a severity threshold of side acceleration.

If one drive wheel loses traction and begins to spin, the brake is applied until the wheel regains sufficient traction. The traction control is available between vehicle speed 0 mph (km/h) and 37 mph (60 km/h).

Note:

Avoid spinning of one drive wheel. This may cause serious damage to the drive train which is not covered by the Mercedes-Benz Limited Warranty.

The ESP warning lamp, located in the speedometer dial, starts to flash at any vehicle speed as soon as the tires lose traction and the wheels begin to spin.

To return to the enhanced vehicle stability offered by ESP: press lower half of the switch (the ESP warning lamp in the speedometer dial goes out).

**Important!**

If the ESP warning lamp flashes:

- during take-off, apply as little throttle as possible,
- while driving, ease up on the accelerator.

## Transfer case



The switch is located in the center console.

- 1 Off-road position “LOW” (L) (approximately 1/2 speed). This position is intended for driving off-road and for steep gradients. The transmission will not upshift automatically to the next higher gear range, when driving on the rpm limit.
- 2 Road position “HIGH” (H).



- 3 Transfer case indicator
- 4 Gear range indicator

## Driving systems

248

**Switching transfer case**

Switching from “HIGH” to “LOW”:

- The shift procedure can only be performed with the engine running.
- The vehicle speed must not exceed 25 mph (40 km/h).
- Move selector lever for the automatic transmission to position “N”, see page 207.

Press the “LOW” switch (1).

Once the shift is complete, the gear position “L” is displayed in the transfer case indicator (3).

If the multifunction display shows the message “TC SHIFT CONDITIONS NOT FULFILLED”, the shift does not occur.

At least one shift condition was not met. Repeat the shift procedure.

Note:

Do not depress the accelerator when switching the automatic transmission from position “N” to “D”.

If the multifunction display shows the message “TC IN NEUTRAL”, the shift does not occur.

**Warning!**

**If TC is in neutral, the “P” position of transmission will not hold vehicle. The parking brake must be applied to hold vehicle in place.**

The transfer case is in neutral. The gear position “N” is displayed in the transfer case indicator (3). Repeat the shift procedure.

If the multifunction display shows the message “TC SHIFT – CANCELLED”, the shift did not take place. Repeat the shift procedure.

If the multifunction display shows the message “TRANSFER CASE – VISIT WORKSHOP!”, there is a malfunction in the system.

Have the vehicle checked at your authorized Mercedes-Benz Light Truck Center as soon as possible.

For malfunction and warning messages in the multifunction display, see page 272.

Note:

If the electronic key is in starter switch position 0 or 1, an alarm will sound if the transfer case is in position “N” and the drivers door is opened. Engage transfer case to gear position “HIGH” or “LOW”.

Switching from “LOW” to “HIGH”:

- The shift procedure can only be performed with the engine running.
- The vehicle speed must not exceed 40 mph (70 km/h).
- Move selector lever for the automatic transmission to position “N”, see page 207.

Press the “HIGH” switch (2).

Once the shift is complete, the gear position “H” is displayed in the transfer case indicator (3).

If the multifunction display shows the message “TC SHIFT CONDITIONS NOT FULFILLED”, the shift does not occur.

At least one shift condition was not met. Repeat the shift procedure.

Note:

Do not depress the accelerator when switching the automatic transmission from position “N” to “D”.

## Driving systems

250

If the multifunction display shows the message “TC IN NEUTRAL”, the shift does not occur.

**Warning!**

**If TC is in neutral, the “P” position of transmission will not hold vehicle. The parking brake must be applied to hold vehicle in place.**

The transfer case is in neutral. The gear position “N” is displayed in the transfer case indicator (3). Repeat the shift procedure.

If the multifunction display shows the message “TC SHIFT – CANCELLED”, the shift did not take place. Repeat the shift procedure.

If the multifunction display shows the message “TRANSFER CASE – VISIT WORKSHOP!”, there is a malfunction in the system.

Have the vehicle checked at your authorized Mercedes-Benz Light Truck Center as soon as possible.

For malfunction and warning messages in the multifunction display, see page 272.

Note:

If the electronic key is in starter switch position 0 or 1, an alarm will sound if the transfer case is in position “N” and the drivers door is opened. Engage transfer case to gear position “HIGH” or “LOW”.

### A few words about differentials and differential locks

When a vehicle negotiates a turn, wheels on the outside of the curve must travel farther and rotate faster than the inside wheels. The differential, the operation of a set of gears that allow the powered wheels in a vehicle to turn at different speeds, provides for this essential function.

The drawback is that the differential also sends most of the engine's power to the wheel with the least load or strain on it. For example, if one of a vehicle's powered wheels sits on a patch of snow and spins because there is no traction, all of the engine's power will go to that wheel because the power will take the path of least resistance. Meanwhile, the opposite wheel, sitting on dry pavement where it could get enough grip to start the vehicle moving, sits idle because it gets no power.

The Electronic Traction System (ETS) addresses this problem and provides for good control and steering ability by automatically slowing the slipping wheel and thus increasing the power to the other non-slipping drive wheels to get the vehicle moving. The ESP and ETS in this vehicle feature such intelligent limited-slip differential technology, ideally suited for on-road and

light off-road driving. The position "LOW" of the transfer case (see pages 247 and 226) also enhances off-road driving capabilities.

More extreme off-road conditions may call for another cure which is to engage a differential lock, preventing the differential from operating altogether. This vehicle offers as standard equipment three differential locks: front, transfer case (center), and rear. Each can be engaged simply by pushing a dashboard-mounted button (see pages 253 and 254 for engaging differential locks). When the transfer case (center) differential is locked, half of the engine's power is automatically distributed to the front wheels and half to the rear wheels. When the rear differential is locked, power going to the rear wheels is equally distributed, so that both rear wheels turn at the same speed and torque. When the front differential is locked, all four wheels now turn with equal power and torque. Please be aware that engaging the differential locks will significantly reduce steering ability of the vehicle.

## Driving systems

252

It is important to understand that during on-road/paved driving, differentials are absolutely required to provide essential control and steering ability of the vehicle. The differential locks, therefore, must not be engaged when driving on paved roads and should only be used when and to the extent necessary to negotiate off-road conditions not addressable by the systems (automatic ETS, ESP; manual switch position “LOW” of transfer-case) this vehicle comes equipped with.

## Differential locks



The switch is located in the center console.

- 1 Transfer case (center) differential lock
- 2 Rear axle differential lock
- 3 Front differential lock
- 4 Engagement indicator lamps (yellow)
- 5 Function indicator lamp (red)



- 6 The ESP, BAS and ABS are switched off

The differential locks can only be switched on in the following sequence.

- Transfer case differential lock
- Rear axle differential lock
- Front differential lock



## Driving systems

254

**Important!**

Do not engage the front axle differential lock when driving around tight corners as steering ability is restricted.

When the transfer case differential lock is activated, the ESP, ABS and BAS are automatically switched off. The ABS malfunction indicator lamp and the ESP warning lamp in the instrument cluster come on. Further appear alternately the messages “ESP NOT ACTIVE – LOCK ACTIVE”, “BAS NOT AVAILABLE – LOCK ACTIVE” and “ABS NOT ACTIVE – LOCK ACTIVE” in the multifunction display.

The differential locks should be engaged when driving off-road, for example:

- for driving through water or
- when driving on deep snow, icy or fouled surfaces.

For notes on off-road driving, see page 226.

**To engage differential locks:****Warning!**

**Never drive on pavement with activated differential locks.**

**Important!**

**To avoid damage to the transfer case and differential locks:**

- Engage differential locks only at low speed (walking speed, not more than 5 mph).
- Do not engage differential locks if the driving wheels are spinning.



Briefly press the switch for the differential lock required. The corresponding engagement indicator lamp (4) comes on.

The ESP warning lamp in the instrument cluster comes on and the message “ESP NOT ACTIVE – LOCK SELECTED” appears.

The function indicator lamp (5) comes on when the differential lock engagement procedure has been completed. The ABS malfunction indicator lamp and the ESP warning lamp in the instrument cluster come on. Further appear alternately the messages “ESP NOT ACTIVE – LOCK ACTIVE”, “BAS NOT AVAILABLE – LOCK ACTIVE” and “ABS NOT ACTIVE – LOCK ACTIVE” in the multifunction display.

Only apply the accelerator lightly when driving off.

## Driving systems

256

**Methods to disengage differential locks**

There are two different methods to disengage differential locks:

- Disengage differential locks in reverse order. When the rear axle differential lock is disengaged, the front axle differential lock is automatically disengaged with it.

Briefly press the previously activated switches for the differential lock. The corresponding engagement indicator lamp (4) goes out.

- If the transfer case differential lock is disengaged, all other differential locks are automatically disengaged.

Briefly press the switch (1) for the transfer case differential lock. The engagement indicator lamps (4) go out.

The function indicator lamp (5) goes out when the disengagement procedure has been completed.

Only when all function indicator lamps (5) have gone out, the ABS malfunction indicator lamp and the ESP warning lamp in the instrument cluster go out and the messages “ESP NOT ACTIVE – LOCK ACTIVE”, “BAS NOT AVAILABLE – LOCK ACTIVE” and “ABS NOT ACTIVE – LOCK ACTIVE” in the multifunction display disappear.

Now the message “ESP – NOT AVAILABLE” appears in the multifunction display and the ESP warning lamp comes on. That means the ESP, BAS and ABS functions are not active yet.

To activate the systems again drive for 3 seconds with a constant drive behavior.

Note:

If the function lamps do not go out when the differential locks are disengaged, make minor changes to the vehicles direction.

### **Important!**

When running on a (single-axle) dynamometer – no matter how briefly – the non driven axle must be raised or its drive shaft disconnected. The transfer differential lock must be engaged. Otherwise the transfer case can be damaged, which is not covered by the Mercedes-Benz Limited Warranty.

### **Warning!**

Never drive on pavement with activated differential locks.

Steering control will be strongly affected with the front differential lock activated.

ABS, BAS and ESP are switched off automatically when the transfer case differential lock is activated.

## What you should know at the gas station

258

## What you should know at the gas station

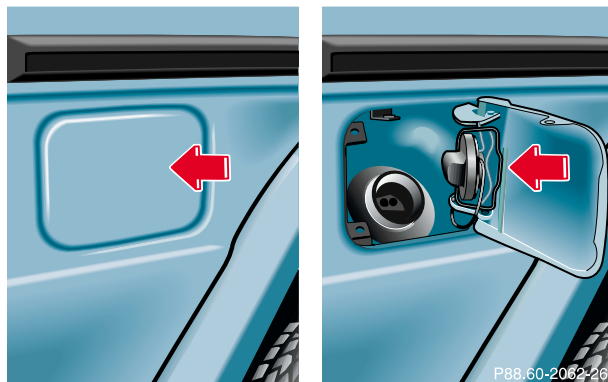

## Fuel supply

**Warning!**

**Gasoline is highly flammable and poisonous. It burns violently and can cause serious injury. Whenever you are around gasoline, avoid inhaling fumes and skin contact, extinguish all smoking materials. Never allow sparks, flame or smoking materials near gasoline!**

Open flap by pushing at rear (arrow). Turn fuel cap to the left and hold on to it until possible pressure in tank has been released, then remove cap. Failure to remove slowly could result in personal injury.

The fuel filler cap is tethered to the fuel filler neck. Do not drop the cap. It could damage the vehicle paint finish.

Manual release of fuel filler flap, see page 347.

**Important!**

When refueling vehicle make certain that no gasoline comes into contact with plastic taillamp, to prevent damaging the lens.

**Fuel**

To prevent fuel vapors from escaping into open air, fully insert filler nozzle unit.

Only fill fuel tank until the filler nozzle unit cuts out – do not top up or overfill.

### **Warning!**

**Overfilling of fuel tank may result in creating pressure in the system which could cause a gas discharge such as the gas spraying back out upon removing the filler nozzle which could cause personal injury.**

Leaving the engine running and the fuel cap open can cause the “CHECK ENGINE” lamp to illuminate.

Fuel tank capacity approximately 25.4 US gal (96.0 l). This includes approximately 5.3 US gal (20.0 l) reserve.

Use premium unleaded gasoline: Posted Octane Index 91 (Average of 96 RON/86 MON).

- **Engine oil**

Engine oil level check, see page 127 and page 304.

Fill quantity between upper and lower dipstick marking level: 2.1 US qt (2.0 l).

Recommended engine oils, see Approved Service Products sheet.

- **Coolant**

For normal replenishing, use water (potable water quality).

For further information (e.g. anticorrosion/antifreeze), see page 306 and 365.

- **Spark plugs**

Approved spark plugs, see page 360.

- **Tire pressure**

For tire pressure, refer to tire pressure label inside the fuel filler flap. See page 318 for further details.

- **Air conditioner**

R-134a refrigerant and special PAG lubricant, see page 363.

## What you should know at the gas station

260

• **Bulbs**

Front:

high and low beam: H4 60/55W 12V

fog lamp: H3 55W 12V

standing and parking lamp: T 4W 12V

turn signal lamp: PY 21W 12V (1156NA[cp 32])

Side:

side marker lamp yellow: T 4W 12V

side marker lamp red: T 4W 12V

turn signal lamp: WY 5W 12V 5W

Rear:

tail lamp: R 5W 12V

stop lamp: P 21W 12V

turn signal lamp: PY 21W 12V

backup lamp: P 21W 12V

fog lamp: P 21W 12V

license plate lamp: C 5W 12V (tubular)

## Check regularly and before a long trip

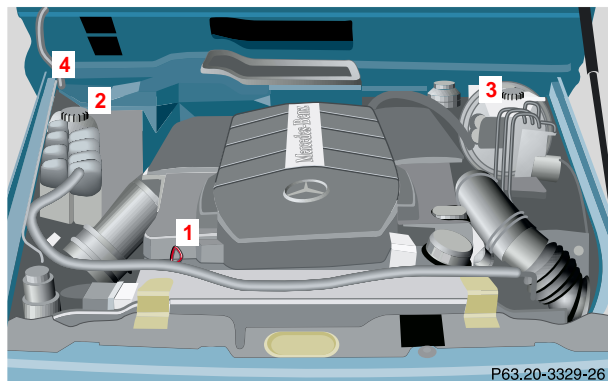

### 1 Engine oil level

See “Checking engine oil level” on page 304 and “Engine oil level indicator” on page 127.

### 2 Coolant level

See “Coolant level” on page 306.

### 3 Brake fluid

See “Brake fluid” on page 363.

### 4 Windshield washer system/ Headlamp cleaning system/ Rear window washer system

For refilling reservoir see page 307.

Opening hood, see page 302.

**Vehicle lighting:** Check function and cleanliness. For replacement of light bulbs, see “Exterior lamps” on page 328.

Exterior lamp switch, see page 129.





## Instrument cluster display

Malfunction and indicator lamps in the instrument cluster .....	264
On-board diagnostic system .....	265
Check engine malfunction indicator lamp .....	265
Brake warning lamp .....	266
Supplemental restraint system (SRS) indicator lamp .....	267
Fuel reserve warning .....	268
ABS malfunction indicator lamp .....	269
Electronic stability program (ESP) – warning lamp .....	270
Seat belt nonusage warning lamp .....	270
Malfunction and indicator lamp in the center console .....	271
AIRBAG OFF indicator lamp .....	271

Malfunction and warning messages in the multifunction display .....	272
DISPLAY DEFECTIVE (engine control unit) .....	273
DISPLAY DEFECTIVE (several systems) .....	273
BATTERY / ALTERNATOR .....	274
ANTILOCK BRAKE SYSTEM .....	275
BRAKE ASSIST .....	276
BRAKE PAD WEAR .....	277
BRAKE FLUID .....	277
PARKING BRAKE .....	278
SEAT BELT SYSTEM .....	278
ELEC. STABIL. PROG. (Electronic stability program) .....	279
COOLANT (coolant level) .....	280
COOLANT (coolant temperature) .....	281
ENGINE OIL LEVEL .....	282

LIGHTING SYSTEM .....	283
LIGHT SENSOR .....	285
DOOR .....	285
TRUNK OPEN .....	286
HOOD .....	286
TELEPHONE – FUNCTION .....	287
TELE AID .....	287
WASHER FLUID .....	288
RESTRAINT SYSTEM .....	289
KEY .....	289
FUEL RESERVE .....	290
UNDERVOLTAGE .....	290
ELECTRONIC BRAKE BOOSTER (EBB) .....	291
ENGINE AIR FILTER .....	291
TC SHIFT .....	292
TC SHIFT CONDITIONS .....	292
TC IN NEUTRAL .....	293
TRANSFER CASE .....	293

## Malfunction and indicator lamps

264

**Malfunction and indicator lamps  
in the instrument cluster**

General information:

If a bulb in the instrument cluster fails to light up during the bulb self-check when turning the key in starter switch to position 2, have it checked and replaced if necessary.

**Emission control**

Certain systems of the engine serve to keep the toxic components of the exhaust gases within permissible limits required by law.

These systems, of course, will function properly only when maintained strictly according to factory specifications. Any adjustments on the engine should, therefore, be carried out only by authorized Mercedes-Benz Light Truck Center qualified technicians. Engine adjustments should not be altered in any way. Moreover, the specified service jobs must be carried out regularly according to Mercedes-Benz servicing requirements. For details refer to the Service Booklet.

**Warning!**

**Inhalation of exhaust gas is hazardous to your health. All exhaust gas contains carbon monoxide, and inhaling it can cause unconsciousness and lead to death.**

**Do not run the engine in confined areas (such as a garage) which are not properly ventilated. If you think that exhaust gas fumes are entering the vehicle while driving, have the cause determined and corrected immediately. If you must drive under these conditions, drive only with at least one window fully open.**

## On-board diagnostic system

### Check engine malfunction indicator lamp



Engine malfunction indicator lamp. If the “CHECK ENGINE” malfunction indicator lamp comes on when the engine is running, it indicates a malfunction of the fuel management system, emission control system, systems which impact emissions, or the fuel cap is not closed tight (check the fuel cap). If the “CHECK ENGINE” lamp is illuminated continuously and the vehicle is driving normally, you may still drive the vehicle, however, in all cases, we recommend that you have the system checked at your authorized Mercedes-Benz Light Truck Center as soon as possible.

If the “CHECK ENGINE” lamp comes on continuously and/or the vehicle is not driving normally (e.g. malfunction of the fuel management system or running out of fuel), serious damage can occur to the emission system. Please contact your authorized Mercedes-Benz Light Truck Center immediately.

The Sequential Multiport Fuel Injection (SFI) control module monitors emission control components that either provide input signals to or receive output signals from the control module. Malfunctions resulting from interruptions or failure of any of these components are indicated by the “CHECK ENGINE” malfunction indicator lamp in the instrument cluster and are simultaneously stored in the SFI control module.

If the “CHECK ENGINE” malfunction indicator lamp comes on, have the system checked at your authorized Mercedes-Benz Light Truck Center as soon as possible.

With some exceptions, the control module switches off the “CHECK ENGINE” malfunction indicator lamp if the condition, causing the lamp to come on, no longer exists during three consecutive cycles.

An on-board diagnostic connector is located in passenger compartment on the driver’s side near hood lock release on the upper left of footwell, allowing the accurate identification of system malfunctions through the readout of diagnostic trouble codes.

## Malfunction and indicator lamps

266

## Brake warning lamp

BRAKE



Except Canada



Canada only

When the brake warning lamp and message appear while the engine is running, this means:

- there is insufficient brake fluid in the reservoir (engine running and parking brake released), or
- the parking brake is set (engine running).

If a warning tone sounds for 5 seconds and the warning lamps  and  are displayed in the instrument cluster, the electronic brake booster (EBB) has a malfunction and is switched off. See page 242 for notes on the electronic brake booster (EBB).

## Warning!

**Driving with the brake warning lamp illuminated can result in an accident. Have your brake system checked immediately if the brake warning lamp stays on. Do not add brake fluid before checking the brake system. Overfilling the brake fluid reservoir can result in spilling brake fluid on hot engine parts and the brake fluid catching fire. You can be seriously burned.**

## Note:

If you find that the minimum mark on the brake fluid reservoir is reached, have the brake system checked for brake pad thickness and leaks.

## Supplemental restraint system (SRS) indicator lamp

**SRS**

When turning the electronic key in starter switch to position 1 the indicator lamp “SRS” in the instrument cluster comes on. If no fault is detected, the lamp will go out after approximately 4 seconds.

When turning the electronic key in starter switch to position 2 the indicator lamp “SRS” in the instrument cluster comes on. If no fault is detected, the lamp will go out when the engine is running.

The operational readiness of the airbag system is verified by the indicator lamp “SRS” in the instrument cluster when turning the electronic key in starter switch to position 1 or 2.

After the lamp goes out, the system continues to monitor the components and circuitry of the airbag system and will indicate a malfunction by coming on again.

### Warning!

**In the event a malfunction of the “SRS” is indicated as outlined above, the “SRS” may not be operational. For your safety, we strongly recommend that you visit an authorized Mercedes-Benz Light Truck Center immediately to have the system checked; otherwise the “SRS” may not be activated when needed in an accident, which could result in serious or fatal injury, or it might deploy unexpectedly and unnecessarily which could also result in injury.**

See page 66 for notes on airbags, see page 71 for belt tensioners and page 73 for infant and child seat restraint.

## Malfunction and indicator lamps

268

## Fuel reserve warning

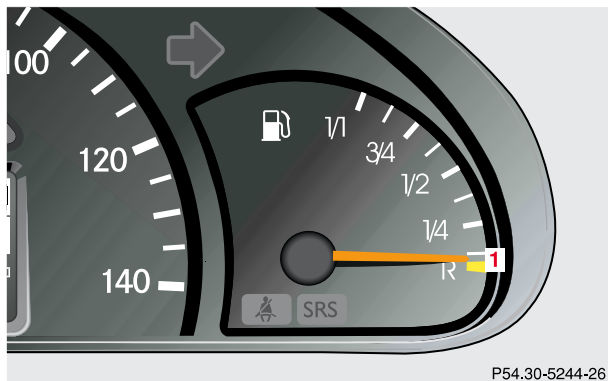
**1** Fuel reserve indicator

When the warning lamp (1) comes on after starting the engine, or if it comes on while driving, it indicates that the fuel level is down to the reserve quantity of approximately 5.3 US gal (20 liters). In addition to the warning lamp, the message “RESERVE FUEL” –“VISIT FUEL STATION” appears in the multifunction display.

See page 258 for notes on refueling the vehicle.

After refueling the vehicle, the message “1 MALFUNCTION” appears in the multifunction display when turning the electronic key in starter switch to position 2. This malfunction message has to be cleared, see page 106 for notes on the malfunction/warning message memory.

## ABS malfunction indicator lamp





The ABS malfunction indicator lamp in the instrument cluster comes on with the electronic key in starter switch position 2 and should go out with the engine running.

When the ABS malfunction indicator lamp symbol and warning in the instrument cluster remains illuminated while the engine is running, it indicates that the ABS has detected a malfunction and has switched off. In this case, the brake system functions in the usual manner, but without antilock assistance.

A malfunctioning ABS control unit can possibly affect the operation of other systems (e.g. Navigation, Automatic transmission). Be guided accordingly with respect to the use of those systems and have the system checked at your authorized Mercedes-Benz Light Truck Center as soon as possible.

With the ABS malfunctioning the BAS, ESP, EBB and 4-ETS are also switched off. The malfunction indicator lamps and malfunction messages in the multifunction display come on with the engine running.

If a warning tone sounds for 5 seconds and the warning lamps  and  are displayed in the instrument cluster, the EBB has a malfunction and is switched off. See page 242 for notes on the electronic brake booster (EBB).

If the charging voltage falls below 10 volts, the malfunction indicator lamp comes on and the ABS is switched off. When the voltage is above this value again, the malfunction indicator lamp should go out and the ABS is operational.

Have the system checked at your authorized Mercedes-Benz Light Truck Center as soon as possible. See page 239 for notes on antilock brake system (ABS).

Note:

If the transfer case differential lock is engaged the ABS warning lamp comes on and the ABS, ESP, BAS, EBB and 4-ETS are switched off. There is no malfunction in the system.



## Malfunction and indicator lamps

270

**Electronic stability program (ESP) – warning lamp**

The yellow ESP warning lamp in the speedometer dial comes on with the electronic key in starter switch position 2.

It should go out with engine running.

If the ESP malfunction indicator lamp remains illuminated with the engine running, a malfunction has been detected in the system. Pressing the accelerator pedal will require greater effort. Only partial engine output will be available.

With the ESP malfunctioning, the abs, BAS, EBB and 4-ETS are also switched off.

See electronic stability program (ESP) on page 243 if the warning lamp lights up or flashes when the vehicle is moving.

Note:

If the transfer case differential lock is engaged the ESP warning lamp comes on and the ESP, ABS, BAS and 4-ETS are switched off. There is no malfunction in the system.

**Seat belt nonusage warning lamp**

With the electronic key in starter switch position 2, the seat belt nonusage warning lamp comes on, and a warning sounds for a short time if the drivers seat belt is not fastened.

After starting the engine, the seat belt nonusage warning lamp blinks for a brief period to remind the driver and passengers to fasten seat belts.

## Malfunction and indicator lamp in the center console

### AIRBAG OFF indicator lamp

The  indicator lamp will light up for approximately 6 seconds when you turn the electronic key in starter switch to position 1 or 2.

It does not light up if there is a fault in the system.

The  indicator lamp stays lit as long as a Baby Smart™ child seat is properly installed on the front passenger seat. It indicates that the front passenger airbag is switched off.

See page 63 for BabySmart™ airbag and its deactivation system.

### Warning!

The BabySmart™ airbag deactivation system will **ONLY** work with a special child seat designed to operate with it. It will not work with child seats which are not BabySmart™ compatible.

**Never place anything between seat cushion and child seat (e.g. pillow), since it reduces the effectiveness of the deactivation system.**

**Follow the manufacturer's instructions for installation of special child seats.**

**The passenger front airbag will not deploy only if the  indicator lamp remains illuminated.**

**Please be sure to check the indicator every time you use the special system child seat. Should the light go out while the restraint is installed, please check installation. If the light remains out, do not use the BabySmart™ restraint to transport children on the front passenger seat until the system has been repaired.**

Baby Smart™ is a trademark of Siemens Automotive Corp.

## Malfunction and warning messages

272

**Malfunction and warning messages in the multifunction display**

Malfunction and warning messages for the following systems will be displayed immediately in the multifunction display.

They are divided into three categories.

Category C1:

Messages of most immediate priority.

These cannot be cleared from the instrument cluster using the reset knob on the instrument cluster (see page 84).

Categories C2 and C3:

Messages of less immediate priority.

These can be cleared from the instrument cluster using the reset knob on the instrument cluster (see page 84) and are then stored in the malfunction message memory. See page 106.

Note:

Certain malfunction and warning messages are accompanied by an audible signal.

Malfunction and warning messages in red are always accompanied by an audible signal.

Temporary messages such as “TRUNK OPEN!” will not be stored in the malfunction message memory.

**Warning!**

**All categories of messages contain important information which should be taken note of and, where malfunction indicated, addressed as soon as possible at an authorized Mercedes-Benz Light Truck Center.**

**Failure to repair condition noted may cause damage not covered by the Mercedes-Benz Limited Warranty, or result in property damage or personal injury.**

## DISPLAY DEFECTIVE (engine control unit)



Line 1	Line 2	C*
VISIT WORKSHOP!	DISPLAY FAULTY	2

\* C = Category, see page 272

This message is displayed to indicate that the information being relayed by the engine control unit is no longer complete. The display for coolant temperature gauge, tachometer, or the cruise control may have failed.

## DISPLAY DEFECTIVE (several systems)



Line 1	Line 2	C*
VISIT WORKSHOP!	DISPLAY FAULTY	2

\* C = Category, see page 272

The displays for several systems have failed. Some systems themselves may also have failed.

## Malfunction and warning messages

274

## BATTERY/ALTERNATOR



Line 1	Line 2	C*
BATTERY/ALTERNATOR	VISIT WORKSHOP!	2

\* C = Category, see page 272

This message indicates a malfunction which must be repaired immediately.

It may indicate that the poly-V-belt has broken. Should this condition occur, the poly-V-belt must be replaced before continuing to operate the vehicle. Otherwise, the engine will overheat due to an inoperative water pump which may result in damage to the engine.

Do not continue to drive the vehicle with this message displayed.

Doing so could result in serious engine damage that is not covered by the Mercedes-Benz Limited Warranty.

## ANTILOCK BRAKE SYSTEM



Line 1	Line 2	C*
ABS NOT ACTIVE	LOCK ACTIVE <sup>1</sup>	1
ABS SYSTEM	VISIT WORKSHOP! <sup>2</sup>	2
DISPLAY DEFECTIVE	VISIT WORKSHOP! <sup>3</sup>	2

\* C = Category, see page 272

- 1 Transfer case differential lock is active, the ABS is not available.
- 2 Have the brake system checked at your authorized Mercedes-Benz Light Truck Center as soon as possible.
- 3 The display or the system is malfunctioning.

See page 239 for notes on the antilock brake system (ABS).

## Malfunction and warning messages

276

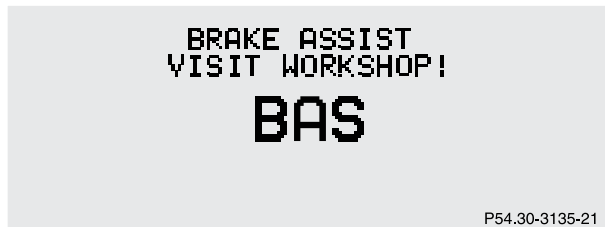
**BRAKE ASSIST**

- 1 Transfer case differential lock is active, the BAS is not available.

A malfunction has been detected in the system. The brake system functions in the usual manner, but without brake assist system (BAS), see page 237.

Line 1	Line 2	C*
BAS NOT ACTIVE	LOCK ACTIVE <sup>1</sup>	1
BRAKE ASSIST	NOT AVAILABLE!	2
BRAKE ASSIST	VISIT WORKSHOP!	2
DISPLAY DEFECTIVE	VISIT WORKSHOP!	2

\* C = Category, see page 272

## BRAKE PAD WEAR



Line 1	Line 2	C*
BRAKE PAD WEAR	VISIT WORKSHOP!	2

\* C = Category, see page 272

When this message appears during braking, it indicates that the brake pads are worn down.

Have the brake system checked at your authorized Mercedes-Benz Light Truck Center as soon as possible.

## BRAKE FLUID



Line 1	Line 2	C*
BRAKE FLUID	VISIT WORKSHOP!	2

\* C = Category, see page 272

### Warning!

**Driving with this message displayed can result in an accident. Have your brake system checked immediately. Do not add brake fluid before checking the brake system. Overfilling the brake fluid reservoir can result in spilling brake fluid on hot engine parts and the brake fluid catching fire. You can be seriously burned.**



## Malfunction and warning messages

278

## PARKING BRAKE



Line 1	Line 2	C*
PARKING BRAKE	RELEASE PARKING BRAKE!	1

\* C = Category, see page 272

## SEAT BELT SYSTEM



Line 1	Line 2	C*
SEAT BELT SYSTEM	VISIT WORKSHOP!	1
FRT. PASS. SEAT BELT	FASTEN SEAT BELT!	2
DRIVER'S SEAT BELT	FASTEN SEAT BELT!	2

\* C = Category, see page 272

## ELEC. STABIL. PROG. (Electronic stability program)



Line 1	Line 2	C*
ESP NOT ACTIVE	LOCK SELECTED <sup>1</sup>	1
ESP NOT ACTIVE	LOCK ACTIVE <sup>2</sup>	1
ELEC. STABIL. PROG.	NOT AVAILABLE! <sup>3, 4, 5, 6</sup>	2
ELEC. STABIL. PROG.	VISIT WORKSHOP! <sup>3, 7</sup>	2
DISPLAY DEFECTIVE	VISIT WORKSHOP! <sup>8</sup>	2

\* C = Category, see page 272

- Transfer case differential lock is selected, the ESP is not available, see page 243.
- Transfer case differential lock is active, the ESP is not available, see page 243.
- The enhanced vehicle stability offered by ESP and the torque reduction feature are unavailable.
- This message may be displayed if the power supply was interrupted (battery disconnected or empty). Synchronize ESP, see page 244
- The system is temporarily unavailable. The reason could be that the self-diagnosis has not been completed. The display will clear itself after driving a short distance at more than 12 mph (20 km/h).
- The system is unavailable due to low voltage, e.g. battery not being charged.
- A malfunction has been detected in the system. In case of ESP malfunction the ESP warning lamp in the instrument cluster illuminates and the ESP switch in the center console does not function. If in addition the ABS is malfunctioning, only partial engine output will be available.
- The display or the system is malfunctioning.

## Malfunction and warning messages

280

## COOLANT (coolant level)

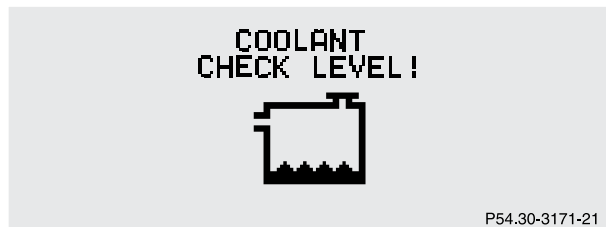

Line 1	Line 2	C*
COOLANT	CHECK LEVEL!	2

\* C = Category, see page 272

When this message appears while driving, the coolant level has dropped below the required level. If no leaks are noticeable and the engine temperature does not increase, continue to drive to the nearest service station and have coolant added to the coolant system.

The low engine coolant level warning should not be ignored. Extended driving with the symbol displayed may cause serious engine damage not covered by the Mercedes-Benz Limited Warranty.

In cases of major or frequent minor coolant loss, have the cooling system checked at your authorized Mercedes-Benz Light Truck Center as soon as possible.

Note:

Do not drive without coolant in the cooling system. The engine will overheat causing major engine damage.

Monitor the coolant temperature gauge while driving, see page 123.

See page 306 for instructions on topping up the coolant.

**Warning!**

**Do not spill antifreeze on hot engine parts. Antifreeze contains ethylene glycol which may burn if it comes into contact with hot engine parts. You can be seriously burned.**

## COOLANT (coolant temperature)

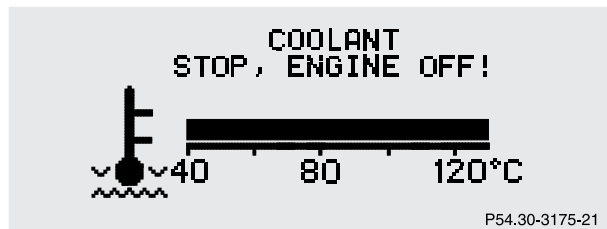

Line 1	Line 2	C*
COOLANT	STOP, ENGINE OFF! <sup>1</sup>	1
COOLANT	VISIT WORKSHOP! <sup>2</sup>	2

\* C = Category, see page 272

- 1 This may indicate that the poly-V-belt has broken. Should this condition occur, the poly-V-belt must be replaced before continuing to operate the vehicle. Otherwise, the engine will overheat due to an inoperative water pump which may result in damage to the engine. Do not continue to drive the vehicle with this message displayed. Doing so could result in serious engine damage that is not covered by the Mercedes-Benz Limited Warranty.
- 2 The cooling fan for the coolant is faulty. Observe the coolant temperature gauge. See page 123

During severe operating conditions and stop-and-go city traffic, the coolant temperature may rise close to 120°C.

The engine should not be operated with the coolant temperature above 120°C. Doing so may cause serious engine damage which is not covered by the Mercedes-Benz Limited Warranty.

### Warning!

**Driving when your engine is badly overheated can cause some fluids which may have leaked into the engine compartment to catch fire. You could be seriously burned.**

**Steam from an overheated engine can cause serious burns and can occur just by opening the engine hood. Stay away from the engine if you see or hear steam coming from it.**

**Turn off the engine, get out of the vehicle and do not stand near the vehicle until it cools down.**

## Malfunction and warning messages

282

## ENGINE OIL LEVEL

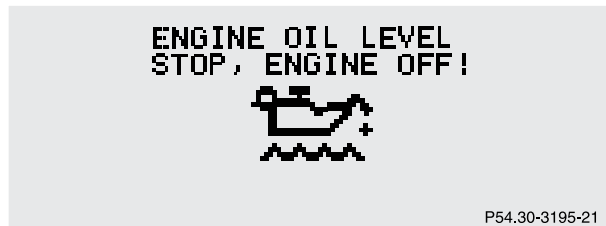

Line 1	Line 2	C*
ENGINE OIL LEVEL	CHECK LEVEL! <sup>1</sup>	2
ENGINE OIL LEVEL	STOP, ENGINE OFF! <sup>2</sup>	1
ENGINE OIL LEVEL	REDUCE OIL LEVEL <sup>3</sup>	2
ENGINE OIL	VISIT WORKSHOP! <sup>4</sup>	2
ENGINE OIL LEVEL	VISIT WORKSHOP! <sup>5</sup>	2

\* C = Category, see page 272.

1 The engine oil level must be checked immediately. See Engine oil level indicator on page 127 or checking oil level on page 304.

2 There is no oil in the engine. There is a danger of engine damage.

- 3 There is a risk of damaging the engine or catalytic converter. The engine oil level must be checked immediately. See Engine oil level indicator on page 127 or checking oil level on page 304.
- 4 The engine oil level has dropped to a critical level. Check the engine oil level immediately. See Engine oil level indicator on page 127 or checking oil level on page 304; and check the engine for visible leakage (loss of oil). It may be that there is water in the engine oil. Have the engine oil checked.
- 5 The measuring system is malfunctioning.

When the “ENGINE OIL LEVEL – CHECK LEVEL!” message appears while the engine is running and at operating temperature, the engine oil level has dropped to approximately the minimum mark on the dipstick.

When this occurs, the warning will first come on intermittently and then stay on if the oil level drops further.

If no oil leaks are noted, continue to drive to the nearest service station where the engine oil should be topped to the “full” mark on the dipstick with an approved oil.

The engine oil level warnings should not be ignored. Extended driving with the symbol displayed could result in serious engine damage that is not covered by the Mercedes-Benz Limited Warranty.

## LIGHTING SYSTEM

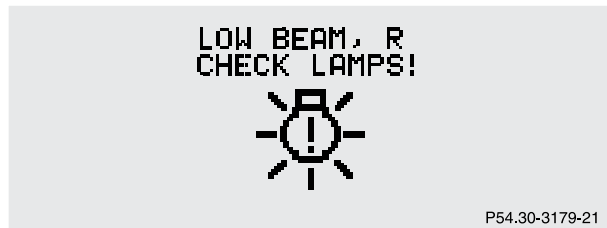

Line 1	Line 2	C*
3RD BRAKE LAMP <sup>3</sup>	CHECK LAMPS!	2
ADD. TURN SIG LAMP, RH	CHECK LAMPS!	2
ADD. TURN SIG LAMP, LH	CHECK LAMPS!	2
AUTOM. LIGHT ON	REMOVE KEY!	1
BRAKE LAMP <sup>2</sup>	VISIT WORKSHOP!	2
BRAKE LAMP, L	CHECK LAMPS!	2
BRAKE LAMP, R	CHECK LAMPS!	2
LOW BEAM, L	CHECK LAMPS!	2

Line 1	Line 2	C*
LOW BEAM, R	CHECK LAMPS!	2
VISIT WORKSHOP! <sup>1</sup>	DISPLAY DEFECTIVE	2
FRONT FOGLAMP, L	CHECK LAMPS!	2
FRONT FOGLAMP, R	CHECK LAMPS!	2
HIGH BEAM, L	CHECK LAMPS!	2
HIGH BEAM, R	CHECK LAMPS!	2
LICENSE PLATE, L	CHECK LAMPS!	2
LICENSE PLATE, R	CHECK LAMPS!	2
LIGHTS	SWITCH OFF LAMPS!	1
LEFT FRT. PARK LAMP	CHECK LAMPS SUBSTITUTE LAMP ON! <sup>4</sup>	1
RIGHT FRT. PARK LAMP	CHECK LAMPS SUBSTITUTE LAMP ON! <sup>4</sup>	1
TURN SIGNAL F, L	CHECK LAMPS SUBSTITUTE LAMP ON! <sup>4</sup>	2

## Malfunction and warning messages

284

Line 1	Line 2	C*
TURN SIGNAL F, R	CHECK LAMPS SUBSTITUTE LAMP ON! <sup>4</sup>	2
TURN SIGNAL R, L	CHECK LAMPS SUBSTITUTE LAMP ON! <sup>4</sup>	2
TURN SIGNAL R, R	CHECK LAMPS SUBSTITUTE LAMP ON! <sup>4</sup>	2
REAR FOGLAMP	CHECK LAMPS!	2
REAR FOGLAMP	TURN OFF SUBSTITUTE LAMP ON! <sup>4</sup>	2
REVERSE LAMP	CHECK LAMPS!	2
SIDE MARKER LAMP, LF	CHECK LAMPS!	2
SIDE MARKER LAMP, RF	CHECK LAMPS!	
TAIL LAMP, L	CHECK LAMP! SUBSTITUTE LAMP ON! <sup>4</sup>	2
TAIL LAMP, R	CHECK LAMP! SUBSTITUTE LAMP ON! <sup>4</sup>	2

In the case of bulb failures in certain lamps, other lamps will substitute. See page 328 for instructions on replacing bulbs.

\* C = Category, see page 272

LH: Left Hand; RH: Right Hand

F, L: Front, Left; F, R: Front, Right

R, L: Rear, Left; R, R: Rear, Right

FRT: Front

- 1 The display or the system is malfunctioning.
- 2 The brake lamps are switching on after a delay or are permanently on – visit workshop immediately.
- 3 The brake lamp comprises several light emitting diodes. The warning message will only appear if all light emitting diodes have stopped working.
- 4 Other bulbs will be brought into use as replacements when certain lamps blow.

## LAMP SENSOR

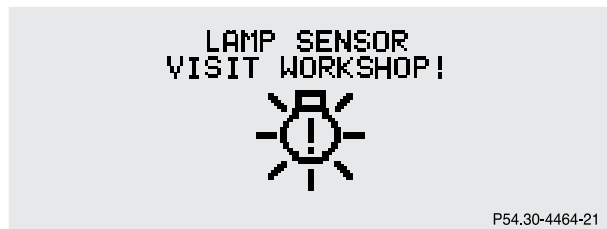

Line 1	Line 2	C*
LAMP SENSOR	VISIT WORKSHOP!	2

\* C = Category, see page 272

The headlamps will be switched on automatically if the light sensor malfunctions.

The individual setting menu "LIGHTING", "LIGHT CIRCUIT HEADLAMP MODE" can be set to "MANUAL". See page 114. It will then be possible to switch the headlamps on and off using the exterior lamp switch. See page 129 for notes on the exterior lamp switch.

## DOOR

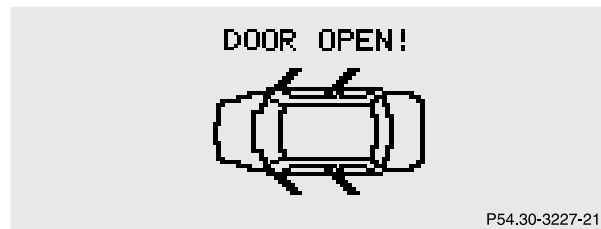

Line 1	Line 2	C*
DOOR OPEN!		1

\* C = Category, see page 272.



## Malfunction and warning messages

286

## TRUNK OPEN



Line 1	Line 2	C*
TRUNK OPEN!		2

\* C = Category, see page 272

Trunk=Tailgate

## HOOD

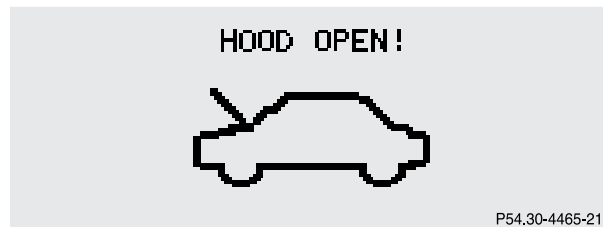

Line 1	Line 2	C*
HOOD OPEN!		2

\* C = Category, see page 272.

See page 302 for hood.

## TELEPHONE – FUNCTION

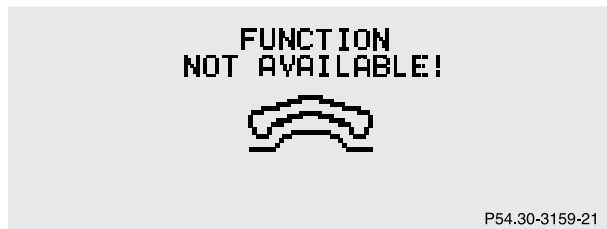

Line 1	Line 2	C*
FUNCTION	NOT AVAILABLE!	3

\* C = Category, see page 272.

The display appears if button  or  on the multifunction steering wheel is pressed and the vehicle is not equipped with a telephone.

## TELE AID



Line 1	Line 2	C*
TELE AID	VISIT WORKSHOP! <sup>1</sup>	1

\* C = Category, see page 272.

- 1 The Tele Aid system consists of three types of response; automatic and manual emergency, roadside assistance and information. With this message displayed, one or more functions may not be available.

See page 192 for notes on the Tele Aid.

If a malfunction is indicated as outlined above, have the system checked at the nearest Mercedes-Benz Center as soon as possible.

## Malfunction and warning messages

288

## WASHER FLUID

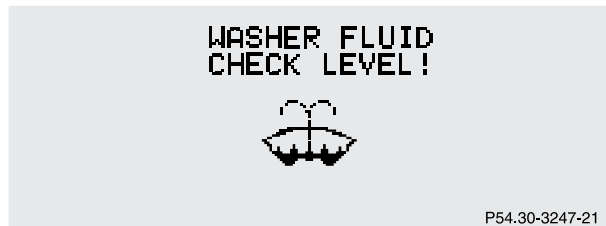

Line 1	Line 2	C*
WASHER FLUID	CHECK LEVEL!	3

\* C = Category, see page 272.

When this message appears while the engine is running, the level of the reservoir has dropped to approximately  $\frac{1}{3}$  of the total volume. The reservoir should be refilled with the prescribed mixture of MB Windshield washer concentrate and water or the concentrate and commercially available premixed windshield washer solvent/antifreeze, depending on ambient temperature, at the next opportunity. The reservoir for the windshield and headlamp washer systems is located in the engine compartment.

See windshield and headlamp washer system on page 307 for instructions on topping up the washer fluid.

## RESTRAINT SYSTEM



Line 1	Line 2	C*
RESTRAINT SYSTEM	VISIT WORKSHOP!	1
RESTRAINT SYSTEM	SERVICE	

\* C = Category, see page 272.

See page 56 for notes on the seat belts, and page 66 for notes on the airbags.

## KEY



Line 1	Line 2	C*
REPLACE KEY <sup>1</sup>	VISIT WORKSHOP!	2
AUTOM. LIGHT ON	REMOVE KEY!	1

\* C = Category, see page 272.

1 Key needs possibly to be replaced.

## Malfunction and warning messages

290

## FUEL RESERVE

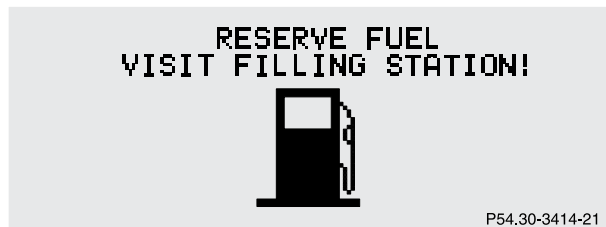

Line 1	Line 2	C*
RESERVE FUEL	VISIT FILLING STATION!	2

\* C = Category, see page 272.

## UNDERVOLTAGE

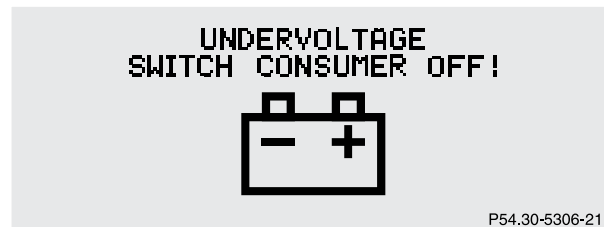

Line 1	Line 2	C*
UNDERVOLTAGE	ENGINE ON!	1
UNDERVOLTAGE	SWITCH CONSUMER OFF!	1

\* C = Category, see page 272.

## ELECTRONIC BRAKE BOOSTER (EBB)

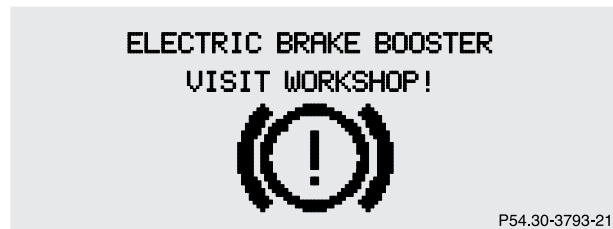

Line 1	Line 2	C*
ELECTRIC BRAKE BOOSTER	VISIT WORKSHOP!	2

\* C = Category, see page 272.

## ENGINE AIR FILTER



Line 1	Line 2	C*
ENGINE AIR FILTER <sup>1</sup>	VISIT WORKSHOP!	2

\* C = Category, see page 272.

- 1 The engine air filter is clogged and must be replaced.

## Malfunction and warning messages

292

## TC SHIFT



Line 1	Line 2	C*
TC SHIFT	CANCELLED	2

\* C = Category, see page 272.

The shift process in the transfer case was cancelled because of a malfunction. See page 248 for switching the transfer case.

## TC SHIFT CONDITIONS

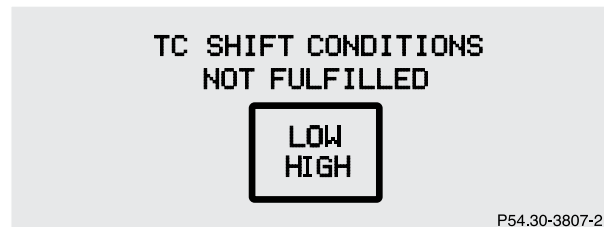

Line 1	Line 2	C*
TC SHIFT CONDITIONS	NOT FULFILLED	2

\* C = Category, see page 272.

The shift conditions for a selection process in the transfer case have not been met. See page 248 for switching the transfer case.

## TC IN NEUTRAL

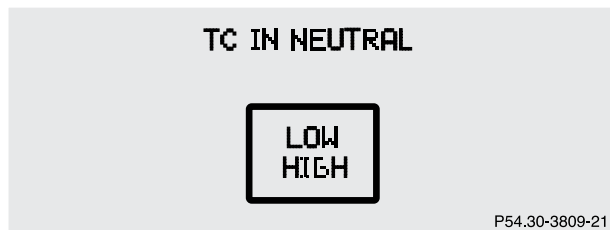

Line 1	Line 2	C*
TC IN NEUTRAL		3

\* C = Category, see page 272.

No gear has been selected in the transfer case, it is in “NEUTRAL”. Engage transfer case to gear position “HIGH” or “LOW”, see page 248 for switching the transfer case.

### Warning!

If TC is in neutral, the “P” position of transmission will not hold vehicle. The parking brake must be applied to hold vehicle in place.

## TRANSFER CASE



Line 1	Line 2	C*
TRANSFER CASE	VISIT WORKSHOP	2

\* C = Category, see page 272.

There is a malfunction in the transfer case. Have the transfer case checked immediately by a Mercedes-Benz Light Truck Center.





## Practical hints

First aid kit, vehicle tools and jack .....	296	Vehicle jack .....	308	Turn signal lamp, side .....	335
CD-changer .....	296	Wheels .....	310	Front and rear side marker lamps .....	337
Fuses .....	297	Tire replacement .....	310	Taillamp assemblies .....	339
Electrical outlet .....	301	Rotating wheels .....	311	License plate lamp .....	340
Stowing items in the vehicle .....	301	Spare wheel cover .....	312	Rear fog lamp / Backup lamp ...	341
Hood .....	302	Spare wheel .....	313	Changing batteries in the electronic key .....	343
Checking engine oil level .....	304	Changing wheels .....	314	Synchronizing remote control .....	345
Automatic transmission fluid level .....	305	Tire inflation pressure .....	318	Emergency operation of sliding/pop-up roof .....	346
Engine oil consumption .....	305	Battery .....	319	Manual release for fuel filler flap .....	347
Coolant level .....	306	Jump starting .....	321	Replacing wiper blades .....	348
Adding coolant .....	306	Towing the vehicle .....	324		
Windshield washer/headlamp cleaning system .....	307	Transmission selector lever, manually unlocking .....	327		
Windshield and headlamp washer fluid mixing ratio .....	307	Stranded vehicle .....	327		
		Exterior lamps .....	328		
		Headlamp assembly .....	329		
		Fog lamp, front .....	332		
		Turn signal lamp, front .....	334		

## First aid kit, vehicle tools and jack

296

## First aid kit, vehicle tools and jack

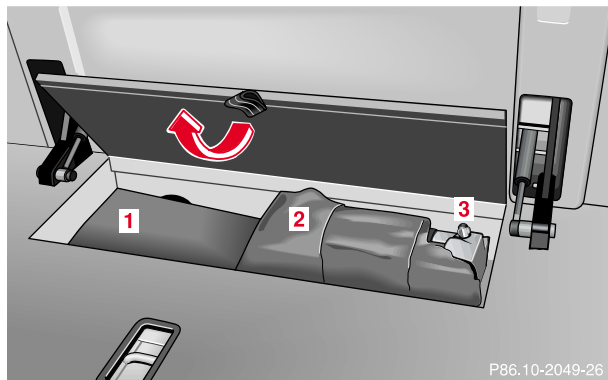

The first aid kit (1), vehicle tools (2) and jack (3) are located in the storage compartment below the rear seat bench.

For notes on folding the rear seat bench, see page 172.

## CD-changer

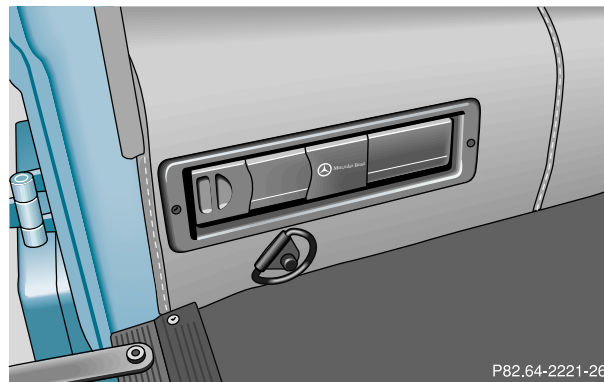

The CD-changer is located in the left side of the cargo compartment.

For instructions on the CD-changer, see separate COMAND operator's manual.

## Fuses

Before replacing a blown fuse, determine the cause of the short circuit.

Spare fuses, a fuse chart and a special fuse puller are supplied inside the fuse box cover in the passenger compartment. Observe amperage and color of fuse.

Always use a new fuse for replacement. Never attempt to repair or bridge a blown fuse.

## Fuse box in the passenger compartment

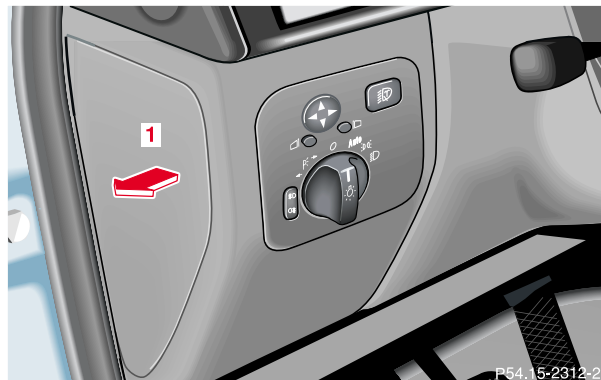

### 1 Fuse box in passenger compartment

To gain access, pry off cover (1) and remove.

## Fuses

298

## Fuse box in front passenger footwell

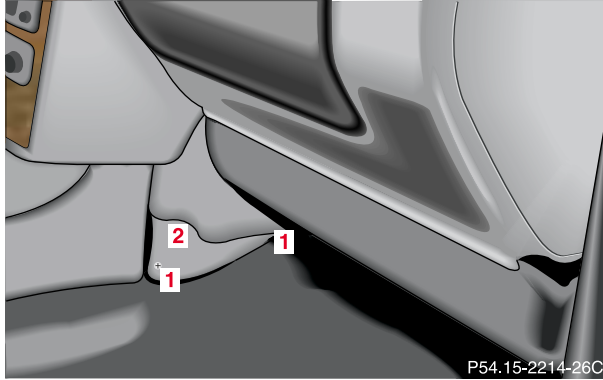

To open fuse box:

1. Unscrew mounting screws (1) and remove cover (2).

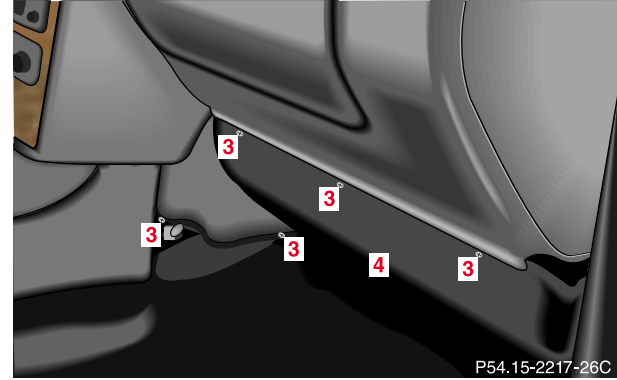

2. Unscrew mounting screws (3) and remove cover (4).

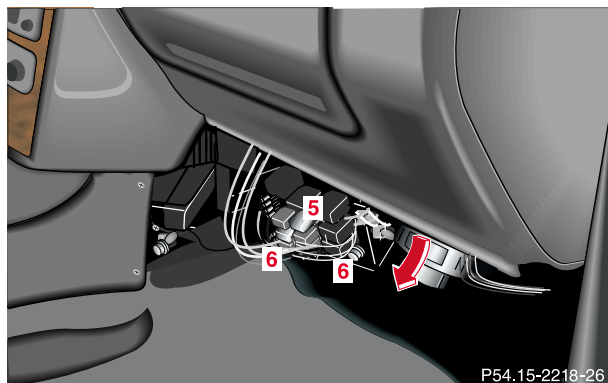

- To ease fuse replacement, remove mounting screws (6) and swing fuse box (5) slight forward.

### Fuse box in middle tunnel

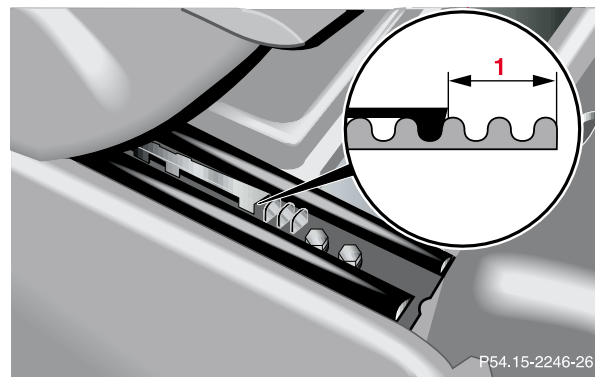

Remove both front end stops of front passenger seat tracks.

Move seat fully forward.

### Important!

When reinstalling front passenger seat track stops, place end stops in correct position. For your safety, maintain proper spacing (1).

## Fuses

300

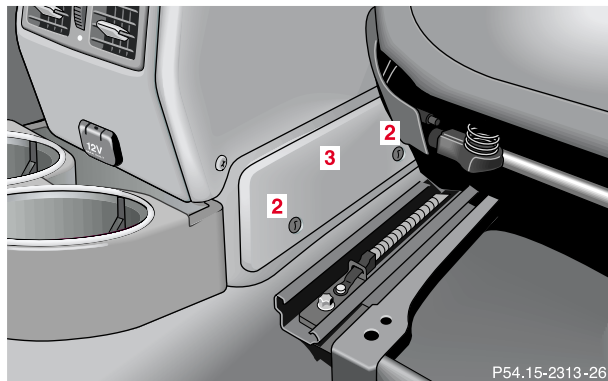

Unscrew mounting screws (2) and remove cover (3).

**Warning!**

Adjust the front passenger seat as far as possible rearward from the dashboard when the seat is occupied.

## Fuse box in battery box

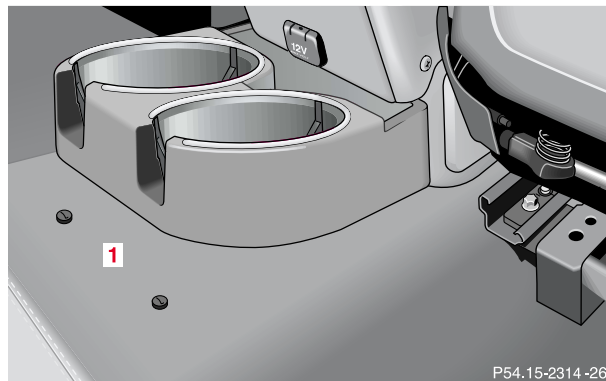
**1** Fuse box in battery box

Replacement of fuses in battery box can only be performed by a Mercedes-Benz Light Truck Center.

## Electrical outlet

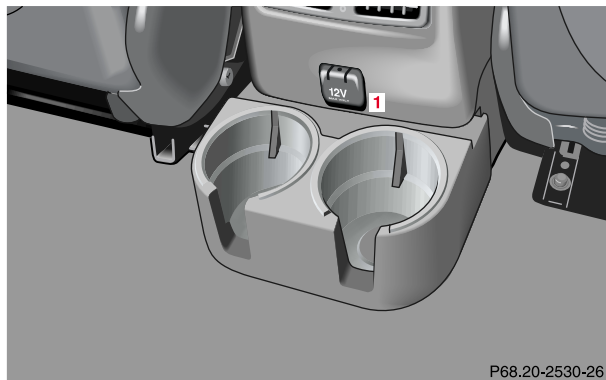

The electrical outlet (1) can be found at the rear passenger footwell.

To open:

Flip up cover and insert electrical plug (cigar lighter type).

Note:

The electrical outlets can be used to accommodate accessories (e.g. air pump, auxiliary lamps) up to maximum 180 W.

## Stowing items in the vehicle

### Warning!

To help avoid personal injury during a collision or sudden maneuver, always use partition net (optional) when transporting cargo. Always fasten items being carried as securely as possible using cargo tie-down rings and fastening materials appropriate for the weight and size of the load.



## Engine compartment

302

**Hood**

To open:

To unlock the hood, pull release lever (1) under the driver's side of the instrument panel.

**Caution!**

To avoid damage to the windshield wipers or hood, open the hood only with wipers in the parked position.

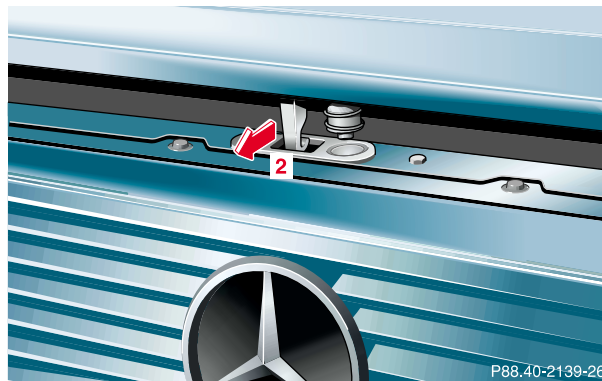

Lift hood up slightly. Pull safety hook (2) in direction of arrow and open hood.

To close:

Lower hood and let it drop into lock from a height of approximately 0.7 ft. (20 cm).

To avoid hood damage, please make sure that hood is fully closed. If not, repeat closing procedure. Do not push down on hood to attempt to fully close it.

### **Warning!**

To help prevent personal injury, stay clear of moving parts when the hood is open and the engine is running. Be sure the hood is properly closed before driving. When closing hood, use extreme caution not to catch hands or fingers.

The radiator fan may continue to run for approximately 30 seconds or even restart after the engine has been turned off. Stay clear from fan blades.

The engine is equipped with a transistorized ignition system. Because of the high voltage it is dangerous to touch any components (ignition coils, spark plug sockets, diagnostic socket) of the ignition system

- with the engine running,
- while starting the engine,
- if ignition is “on” and the engine is turned manually.

If you see flames, steam or smoke coming from the engine compartment, or if the coolant temperature gauge indicates that the engine is overheated, do not open the hood. Move away from vehicle and do not open the hood until the engine has cooled. If necessary, call a fire department.

## Engine compartment

304

## Checking engine oil level

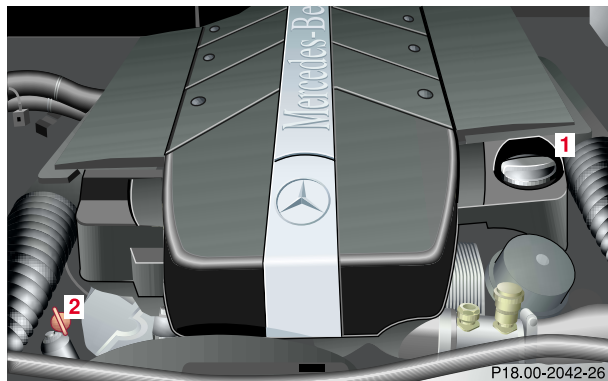

1 Oil filler cap

2 Oil dipstick

To check the engine oil level, park vehicle on level ground, with engine at normal operational temperature.

Check engine oil level approximately 5 minutes after stopping the engine, allowing for the oil to return to the oil pan.

Wipe oil dipstick clean prior to checking the engine oil level. Fully insert dipstick in tube, and remove after three seconds to obtain accurate reading.



Oil level must be between the lower (min) and upper (max) mark of the dipstick.

Fill quantity between upper and lower dipstick marking, the level is approximately 2.1 US qt (2.0 l).

Do not overfill the engine. Excessive oil must be drained or siphoned. It could cause damage to engine and catalytic converter not covered by the Mercedes-Benz Limited Warranty.

See malfunction and warning messages on page 282 if an engine oil level display appears on the multifunction indicator when the engine is running.

Note:

See page 127 for engine oil level indicator.

The oil dipstick tube allows for draining of oil by using a suction device.

### **Automatic transmission fluid level**

The transmission has a permanent fill of automatic transmission fluid.

Regular automatic transmission fluid level checks and changes are not required. For this reason the dipstick is omitted.

If you notice fluid leaks or gear shifting malfunctions, have your authorized Mercedes-Benz Light Truck Center check the transmission fluid level.

### **Engine oil consumption**

Engine oil consumption checks should only be made after the break-in period. During the break-in period, higher oil consumption may be noticed and is normal. Frequent driving at high engine speeds results in increased consumption.

## Engine compartment

306

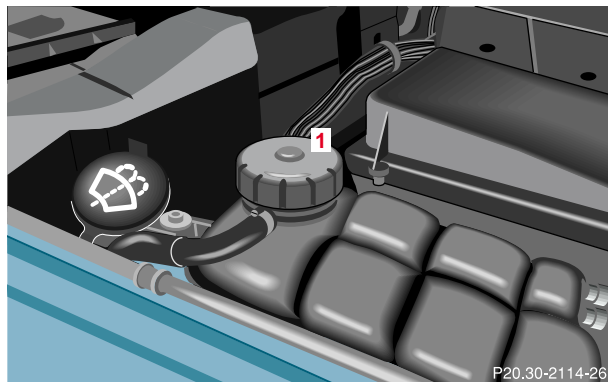
**Coolant level**

To check the coolant level, the vehicle must be parked on level ground and the engine stopped.

Check coolant level only when coolant is cold.

The coolant level should reach the COLD LEVEL mark in the reservoir.

Anticorrosion/antifreeze mixture, see page 366.

After adding coolant, close cap until you hear it click a few times.

**Adding coolant**

If coolant has to be added, a 50/50 mixture of water and MB anticorrosion/antifreeze should be added.

**Warning!**

In order to avoid possible serious burns or injury:

- Use extreme caution when opening the hood if there are any signs of steam or coolant leaking from the cooling system, or if the coolant temperature gauge indicates that the coolant is overheated.
- Do not remove pressure cap on coolant reservoir if engine temperature is above 194°F (90°C). Allow engine to cool down before removing cap. The coolant reservoir contains hot fluid and is under pressure.
- Using a rag, slowly open cap approximately 1/2 turn to relieve excess pressure. If opened immediately, scalding hot fluid and steam will be blown out under pressure.
- Do not spill antifreeze on hot engine parts. Antifreeze contains ethylene glycol which may burn if it comes into contact with hot engine parts.

## Windshield washer/headlamp cleaning system

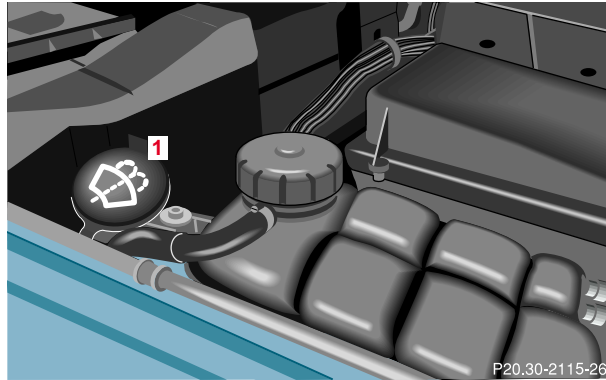

- 1 Windshield washer/headlamp cleaning/rear window wiper/washer system fluid reservoir

Capacity approximately 5.3 US qt (5.0 l).

The reservoir should be refilled with MB Windshield washer concentrate and water (or commercially available premixed windshield washer solvent/antifreeze, depending on ambient temperatures).

### Warning!

Washer solvent/antifreeze is highly flammable. Do not spill washer solvent/antifreeze on hot engine parts, because it may burn. You can be seriously burned.

### Windshield and headlamp washer fluid mixing ratio

For temperatures above freezing:

MB Windshield Washer Concentrate "S" and water

1 part "S" to 100 parts water  
(40 ml "S" to 1 gallon water).

For temperature below freezing:

MB Windshield Washer Concentrate "S" and commercially available premixed windshield washer solvent/antifreeze

1 part "S" to 100 parts solvent  
(40 ml "S" to 1 gallon solvent).

## Spare wheel, vehicle jack

308

**Jack****Warning!**

The jack is designed exclusively for jacking up the vehicle under the axle housing. To help avoid personal injury, use the jack only to lift the vehicle during a wheel change. Never get beneath the vehicle while it is supported by the jack. Keep hands and feet away from the area under the lifted vehicle. Always firmly set parking brake and block wheels before raising vehicle with jack.

Do not disengage parking brake while the vehicle is raised. Be certain that the jack is always vertical when in use, especially on hills. Always try to use the jack on level surface. Be certain that the jack is positioned correctly under the axle housing. Always lower the vehicle onto sufficient capacity jackstands before working under the vehicle.

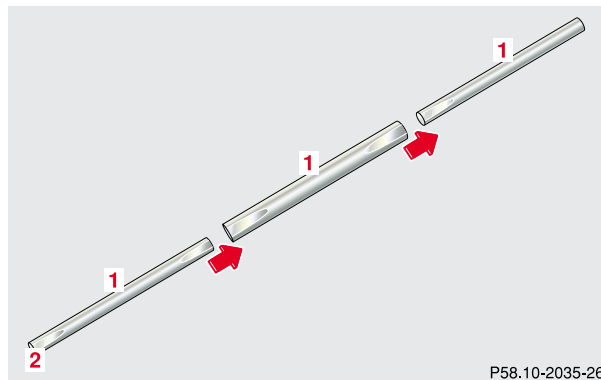

- 1 Pump handle (three pieces)
- 2 Indent for activation of release bolt (5) on jack (4)

Remove pump handle (1) from tool kit and assemble as shown above.

The vehicle tool and jack are located in the storage compartment below the rear seat bench, see page 296.

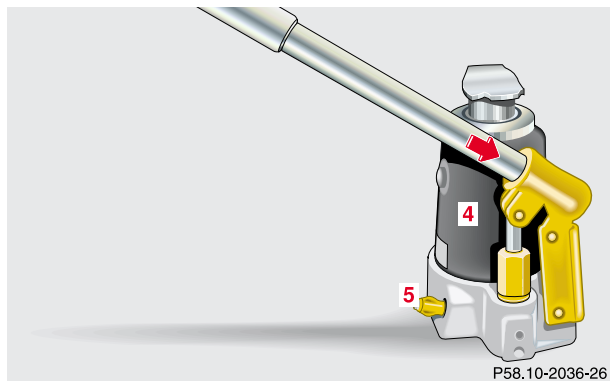

Insert pump handle in direction of arrow.

Do not turn release bolt (5) more than two turns counterclockwise when lowering vehicle, otherwise hydraulic fluid may leak out from jack.

Note:

After use, disassemble pump handle and store with jack in the designated storage compartment below the rear seat bench.



## Tires, Wheels

310

**Wheels**

Replace rims or tires with the same designation, manufacturer and type as shown on the original part. See your authorized Mercedes-Benz Light Truck Center for further information.

**Warning!**

**Do not mix different tire construction types (i.e. radial, bias, bias-belted) on your vehicle because handling may be adversely affected and may result in loss of control.**

See your authorized Mercedes-Benz Light Truck Center for information on tested and recommended rims and tires for summer and winter operation. They can also offer advice concerning tire service and purchase.

**Tire replacement**

Front and rear tires should be replaced in sets. Rims and tires must be of the correct size and type. For dimensions, see technical data on page 359.

We recommend that you break in new tires for approximately 60 miles (100 km) at moderate speed.

It is imperative that the wheel mounting bolts be fastened to a tightening torque of 97 ft.lb. (130 Nm) whenever wheels are mounted.

For rim and tire specifications, refer to technical data on page 359.

**Warning!**

**Worn, old tires can cause accidents. If the tire tread is badly worn, or if the tires have sustained damage, replace them.**

**When replacing rims, use only genuine Mercedes-Benz wheel bolts specified for the particular rim type. Failure to do so can result in the bolts loosening and possibly an accident.**

## Rotating wheels

The wheels can be rotated according to the degree of tire wear while retaining the same direction of travel.

Rotating, however, should be carried out as recommended by the tire manufacturer, before the characteristic tire wear pattern (shoulder wear on front wheels and tread center wear on rear wheels) becomes visible, as otherwise the driving properties deteriorate.

### Important!

Unidirectional tires must always be mounted with arrow on tire sidewall pointing in direction of vehicle forward movement.

### Notes:

Thoroughly clean the inner side of the wheels any time you rotate the wheels or wash the vehicle underside.

The use of retread tires is not recommended. Retread tires may adversely affect the handling characteristics and safety of the vehicle.

Dented or bent rims can cause tire pressure loss and damage to the tire beads. For this reason, check rims for damage at regular intervals. The rim flanges must be checked for wear before a tire is mounted. Remove burrs, if any.

Check and ensure proper tire inflation pressure after rotating the wheels. For tire inflation pressure see page 318.

## Tires, Wheels

312

## Spare wheel cover

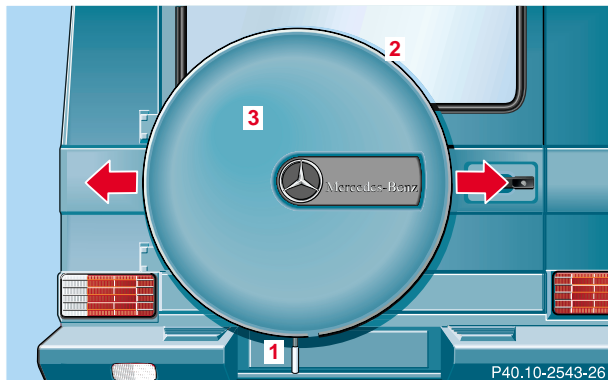

To remove spare wheel cover:

Open lock (1) with the key for spare wheel cover.

Pull the cover ring (2) slightly outwards in direction of arrows and remove.

Remove cover plate (3).

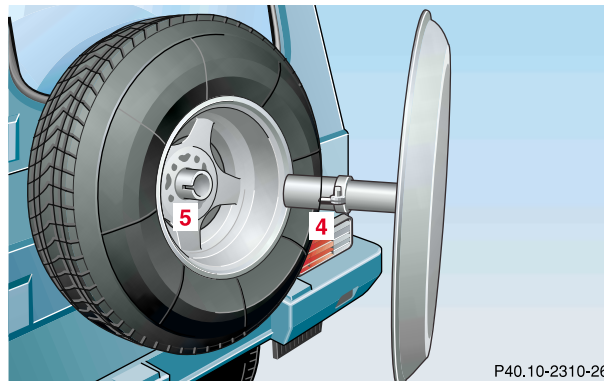

To reinstall spare wheel cover:

Ensure that catch (4) engages in recess (5) when pushing cover plate (3) on.

Keep care when mounting cover ring (2), that the lock (1) faces downwards.

Note:

Always keep the key in a safe and easily accessible place in the vehicle.

## Spare wheel

### Important!

The spare wheel rim is mounted with a full size tire of the same type as on the vehicle, and is fully functional.

In the case of a flat tire, you may use the spare wheel.

For rim and tire specifications, refer to “Technical data” on page 359.

Note:

Repair or replace damaged tire at your earliest convenience.



To gain access to spare wheel, remove spare wheel cover, see page 312.

Remove nuts (1) and take spare wheel off the spare wheel carrier.

Place the punctured wheel on the spare wheel carrier, secure it with the nuts (1) and cover it with the spare wheel cover.

Note:

For safety reasons check regularly that the spare wheel is securely fastened.

## Tires, Wheels

314

**Changing wheels****Warning!**

The jack is designed exclusively for jacking up the vehicle at the jack take-up brackets built into either side of the vehicle. To help avoid personal injury, use the jack only to lift the vehicle during a wheel change. Never get beneath the vehicle while it is supported by the jack. Keep hands and feet away from the area under the lifted vehicle. Always firmly set parking brake and block wheels before raising vehicle with jack.

Do not disengage parking brake while the vehicle is raised. Be certain that the jack is always vertical when in use, especially on hills. Always try to use the jack on level surface. Be sure that the jack arm end is fully seated in the jack take-up bracket. Always lower the vehicle onto sufficient capacity jackstands before working under the vehicle.

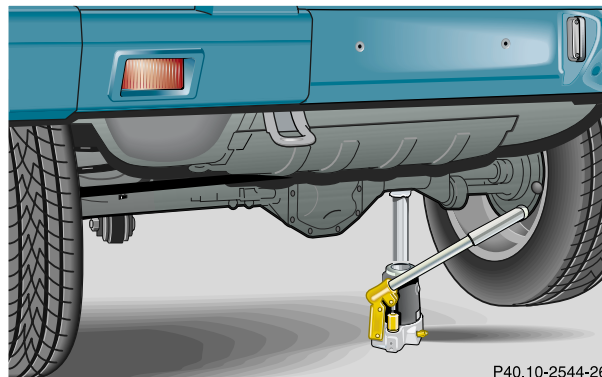

Position vehicle jack in the correct position under the axle housing when raising the vehicle.

The jack must always be in a vertical position, even on slopes.

Move vehicle to a level area which is a safe distance from the roadway.

### **Important!**

The vehicle doors lock if the left front wheel rotates with the engine running. Do not leave the engine running while changing a wheel.

1. Set parking brake and turn on hazard warning flasher.
2. Move selector lever to position “P” and turn off engine, and remove key from the starter switch. Lock steering wheel with wheels in straight ahead position.
3. Prevent vehicle from rolling away by blocking wheels with wheel chocks (not supplied with vehicle) or sizable wood block or stone. When changing a wheel on a hill, place chocks on the downhill side blocking both wheels of the other axle. On a level road, place one chock in front of and one behind the wheel that is diagonally opposite to the wheel being changed.



P40.10-2313-26

4. Using the wrench, loosen but do not yet remove the wheel bolts.

## Tires, Wheels

316

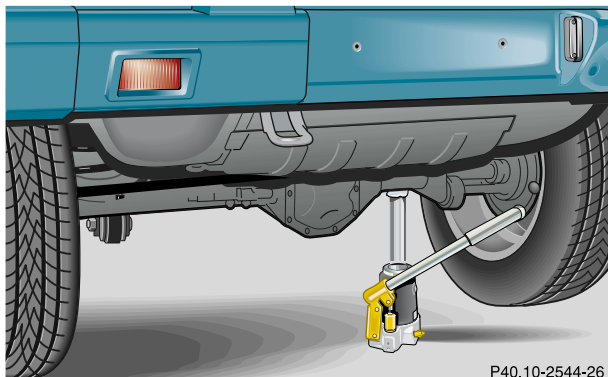

5. The jack must always be in a vertical position, even on slopes. Place jack under axle housing. Be certain the jack arm is positioned correctly under the axle housing.
6. Jack up the vehicle until the wheel is clear of the ground. Never start engine while vehicle is raised.

7. Now finish to unscrew and remove all wheel bolts. Keep bolt threads protected from dirt and sand.
8. Remove wheel. Grip wheel from the sides. Keep hands from beneath the wheels.

Clean contact surfaces of wheel and wheel hub. Install spare wheel on wheel hub. Insert wheel bolts and tighten them slightly.

9. Lower vehicle to ground. Remove jack.

Before storing the jack, it should be fully collapsed.

For proper storage of jack see page 296.



With the vehicle lowered to ground, tighten the five bolts evenly using the wrench. When tightening follow the sequence illustrated, until all bolts are tight. Observe a tightening torque of 97 ft.lb. (130 Nm).

Ensure proper tire pressure, see page 318.

### Warning!

Always replace wheel bolts that are damaged or rusted.

Never apply oil or grease to wheel bolts.

Damaged wheel hub threads should be repaired immediately.

Incorrect mounting bolts or improperly tightened mounting bolts can cause the wheel to come off. This could cause an accident. Be sure to use the correct mounting bolts.



## Tires, Wheels

318

**Tire inflation pressure**

A table (see fuel filler flap) lists the tire inflation pressures specified for Mercedes-Benz recommended tires as well as for the varying operating conditions.

**Important!**

Tire pressure changes by approximately 1.5 psi (0.1 bar) per 18°F (10°C) of air temperature change. Keep this in mind when checking tire pressure inside a garage – especially in the winter.

Example:

If garage temperature = approximately +68°F (+20°C) and ambient temperature = approximately +32°F (0°C) then the adjusted air pressure = specified air pressure +3 psi (+0.2 bar).

Tire pressures listed for light loads are minimum values offering high driving comfort. Increased inflation pressures for heavy loads produce favorable handling characteristics with lighter loads and are perfectly permissible. The ride of the vehicle, however, will become somewhat harder.

Tire temperature and pressure increase with the vehicle speed. Tire pressure should therefore only be checked and corrected on cold tires. Correct tire pressure in warm tires only if pressure has dropped below the pressure listed in the table and the respective operating conditions are taken into consideration.

An underinflated tire due to a slow leak (e.g. due to a nail in the tire) may cause damage such as tread separation, bulging etc.. Regular tire pressure checks (including the spare tire) at intervals of no more than 14 days are therefore essential.

If a tire constantly loses air, it should be inspected for damage.

The spare tire should be checked periodically for condition and inflation. Spare tire will age and become worn over time even if never used, and thus should be inspected and replaced when necessary.

#### **Warning!**

**Do not overinflate tires. Overinflating tires can result in sudden deflation (blowout) because they are more likely to become punctured or damaged by road debris, potholes etc.. Follow recommended inflation pressures.**

**Do not overload the tires by exceeding the specified vehicle capacity weight (as indicated by the label on the driver's door latch post). Overloading the tires can overheat them, possibly causing a blowout.**

## **Battery**

#### **Warning!**

**Failure to follow these instructions can result in severe injury or death.**

**Never lean over batteries while connecting, you might get injured.**

**Battery fluid contains sulfuric acid. Do not allow this fluid to come in contact with eyes, skin or clothing. In case it does, immediately flush affected area with water and seek medical help if necessary.**

**A battery will also produce hydrogen gas, which is flammable and explosive. Keep flames or sparks away from battery, avoid improper connection of jumper cables, smoking etc..**

#### **Important!**

Battery replacement information:

The maintenance-free battery is located in front of the rear seat bench and below the cup holder.

Jump starting terminals are located in the left side of the engine compartment, see page 321.

## Battery

320

The service life of the battery is dependent on its condition of charge. The battery should always be kept sufficiently charged, in order to last an optimum length of time.

**Therefore, we strongly recommend that you have the battery charge checked frequently, and corrected if necessary, especially if you use the vehicle less than approximately 200 miles (300 km) per month, mostly for short distance trips, or if it is not used for long periods of time.**

Only charge a battery with a battery charger after the battery has been disconnected from the vehicle's electrical circuit.

Always disconnect the battery negative lead first and connect last.

When removing and connecting the battery, always make sure that all electrical consumers are off and the key is in starter switch position 0. The battery must always be securely installed when the vehicle is in operation. During removal and installation always protect the disconnected battery positive (+) terminal with the cover attached to the battery.

While the engine is running the battery terminal clamps must not be loosened or detached, otherwise the generator and other electronic components would be damaged.

Note:

The gear selector lever will remain locked in position "P" and the electronic key can not be turned in the starter switch, if the vehicle battery is disconnected or discharged.

After reconnecting the battery also set the clock (see COMAND operator's manual), synchronize the electronic stability program (ESP) (see page 244) and the front seat head restraints (see page 47).

### Battery recycling

Batteries contain material that can harm the environment with improper disposal.

Large 12 Volt storage batteries contain lead.

Recycling of batteries is the preferred method of disposal.

Many states require sellers of batteries to accept old batteries for recycling.

## Jump starting

### Warning!

**Failure to follow these directions will cause damage to the electronic components, and can lead to a battery explosion and severe injury or death.**

**Never lean over batteries while connecting or jump starting, you might get injured.**

**Battery fluid contains sulfuric acid. Do not allow this fluid to come in contact with eyes, skin or clothing. In case it does, immediately flush affected area with water, and seek medical help if necessary.**

**A battery will also produce hydrogen gas, which is flammable and very explosive. Keep flames or sparks away from battery, avoid improper connection of jumper cables, smoking etc..**

**Read all instructions before proceeding.**

### Important!

A discharged battery can freeze at approximately +14°F (-10°C). In that case, it must be thawed out before jumper cables are used. Attempting to jump start a frozen battery can result in it exploding, causing personal injury.

Jumper cable specifications:

- Minimum cable cross-section of 25 mm<sup>2</sup> or approximately 2 AWG
- Maximum length of 11.5 ft. (3.5 m).

If the battery is discharged, the engine should be started with jumper cables and the (12 V) battery of another vehicle.

Only use 12 V battery to jump start your vehicle. Jump starting with more powerful battery could damage the vehicle's electrical systems, which will not be covered by the Mercedes-Benz Limited Warranty.

The battery is located in front of the rear seat bench and below the cup holder.

## Jump starting

322

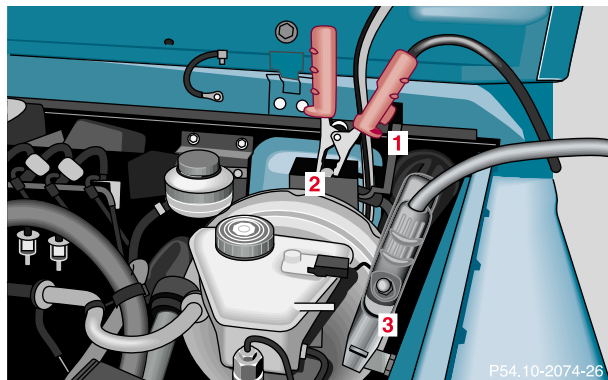

Jump starting terminals are located in the left side of the engine compartment.

- 1 Cover
- 2 Positive (+) terminal (located under cover)
- 3 Negative (-) terminal

Proceed as follows:

1. Position the vehicle with the charged battery so that the jumper cables will reach, but never let the vehicles touch. Make sure the jumper cables do not have loose or missing insulation.
2. On both vehicles:
  - Turn off engine and all lights and accessories, except hazard warning flashers or work lights.
  - Apply parking brake and shift selector lever to position “P”.

**Important!**

3. Clamp one end of the first jumper cable to the positive (+) terminal of the discharged battery and the other end to the positive (+) terminal of the charged battery. Make sure the cable clamps do not touch any other metal parts.
4. Clamp one end of the second jumper cable to the grounded negative (-) terminal of the charged battery and the final connection to the negative (-) terminal of the discharged battery.

### **Important!**

5. Start engine of the vehicle with the charged battery and run at high idle. Make sure the cables are not on or near pulleys, fans, or other parts that move when the engine is started. Allow the discharged battery to charge for a few minutes. Start engine of the disabled vehicle in the usual manner.
6. After the engine has started, remove jumper cables by exactly reversing the above installation sequence, starting with the last connection made first. When removing each clamp, make sure that it does not touch any other metal or the other clamp while the other end is still attached.

### Notes:

If engine does not run after several unsuccessful starting attempts, have it checked at the nearest authorized Mercedes-Benz Light Truck Center.

Excessive unburned fuel may damage the catalytic converter.

### Towing the vehicle

Prior to towing the vehicle with all wheels on the ground, make certain that the electronic key is in starter switch position 2.

If the electronic key is left in the starter switch position 0 for an extended period of time, it can no longer be turned in the switch. In this case, the steering is locked. To unlock, remove electronic key from starter switch and reinsert.

With the engine not running, there is no power assistance for the braking and steering systems. In this case, it is important to keep in mind that a considerably higher degree of effort is necessary to brake and steer the vehicle.

#### Notes:

The selector lever will remain locked in position “P” and the electronic key cannot be turned in the starter switch if the battery is disconnected or discharged. See battery on page 319 or jump starting on page 321.

In order to move the vehicle, shift automatic transmission to position “N”.

Transmission selector lever, manually unlocking, see page 327.

### Important!

When towing the vehicle, please, note the following:

**Towing of the vehicle should only be done using the properly installed towing eye bolt. Never attach tow cable, tow rope or tow rod to vehicle chassis, frame or suspension parts.**

**The vehicle may be towed with all wheels on the ground and the selector lever in position “N” for distances up to 30 miles (50 km) and at a speed not to exceed 30 mph (50 km/h). The key must be in starter switch position 2.**

With the automatic central locking activated and the engine running, the vehicle doors lock if the left front wheel is turning at vehicle speeds of approximately 9 mph (15 km/h) or more.

To prevent the vehicle door locks from locking, deactivate the automatic central locking. See the individual setting menu “VEHICLE” – “AUTOMATIC DOOR LOCK” on page 118.

We recommend that the vehicle be transported using flat bed equipment. This method is preferable to other types of towing.

To prevent damage during transport, do not tie down vehicle by its chassis or suspension parts.

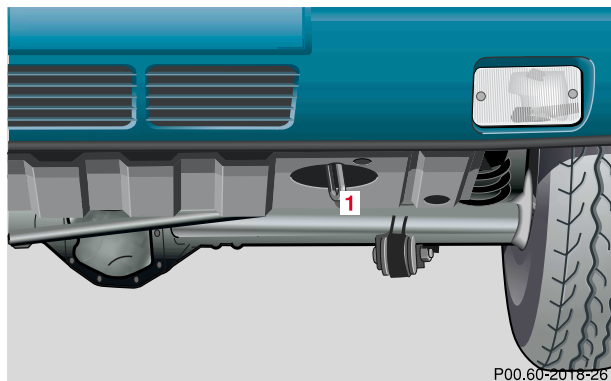

The front towing eye (1) is located on the left side below the bumper.

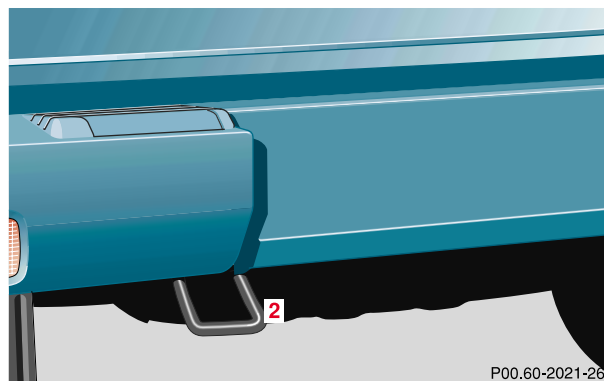

The rear towing eye (2) is located on the left side below the bumper.



## Towing

326

**Engine damage/Transmission damage,  
Electrical malfunction**

To be certain to avoid additional damage to the vehicle powertrain, however you should do the following:

Shift automatic transmission to position “N”.

**Important!**

**Vehicle may be towed for distances up to 30 miles (50 km) and at a speed not to exceed 30 mph (50 km/h).**

**For towing vehicle for distances exceeding 30 miles (50 km) or if the vehicle has a damaged transfer case, remove drive shafts to the drive axles.**

**When towing vehicle with one axle raised, the electronic key in starter switch must be in position 1.**

**With damage to front axle, raise front axle. Remove drive shaft between rear axle and transfer case.**

**With damage to rear axle, raise rear axle and tow vehicle with wheel lift or dolly placed under front wheels.**

Notes:

When removing drive shaft, place M10 nuts on bolts as distance sleeves and tighten using M8 nuts.

Always install new self-locking nuts when reinstalling the drive shaft.

**Caution!**

If the vehicle is towed with the front axle raised, the engine must be shut off (electronic key in starter switch position 1). Otherwise, the 4-ETS may become engaged which may cause loss of towing control. Switch off the tow-away alarm (see page 43) as well as the ESP (see page 245).

Note:

To signal turns while being towed with hazard warning flasher in use, turn electronic key in starter switch to position 1 and activate combination switch for left or right turn signal in usual manner. Now deactivate the hazard warning flasher, only the selected turn signal will operate. Upon canceling the turn signal, the hazard warning flasher must be activated again.

## Transmission selector lever, manually unlocking



In the case of power failure the transmission selector lever can be manually unlocked, e.g. to tow the vehicle.

To do so, insert a pin (1), e.g. ball point pen, into the covered opening below the position “D” of the shift pattern. While pushing the pin down, move selector lever from position “P”.

After removal of the pin from the opening, the cover will not close fully. Only after moving the selector lever to positions “D+” and “D-” does the cover return to its closed position.

## Stranded vehicle

Freeing a stranded vehicle, on which the wheels are dug into sand or mud, should be done with the greatest of care, especially if the vehicle is heavily loaded.

Avoid pulling the vehicle jerkily or diagonally, since it could result in damage to the chassis alignment.

Never try to free a vehicle that is still coupled to a trailer.

If possible, a vehicle equipped with trailer hitch receiver should be pulled backward in its own previously made tracks.

## Exterior lamps

### Headlamp adjustment

Correct headlamp adjustment is extremely important. Check and readjust headlamps at regular intervals and when a bulb has been replaced.

#### Warning!

**Bulbs and bulb holders can be very hot. Allow the lamp to cool down before changing a bulb.**

**Halogen lamps contain pressurized gas. A bulb can explode if you:**

- touch or move it when hot,
- drop the bulb,
- scratch the bulb.

**Wear eye and hand protection.**

### Replacing bulbs

To prevent a possible electrical short circuit, switch off lamp prior to replacing a bulb.

When replacing bulbs, install only 12 volt bulbs with the specified watt rating.

When replacing halogen bulbs do not touch glass portion of bulb with bare hands. Use plain paper or a clean cloth.

## Headlamp assembly (Halogen)

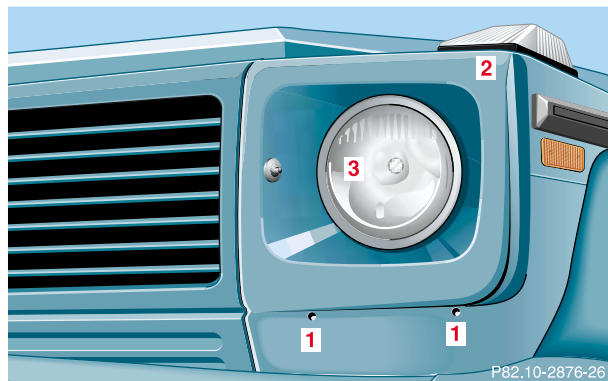

- 1 Securing screw
- 2 Head lamp trim panel
- 3 Headlamp
- 4 Headlamp-securing screw

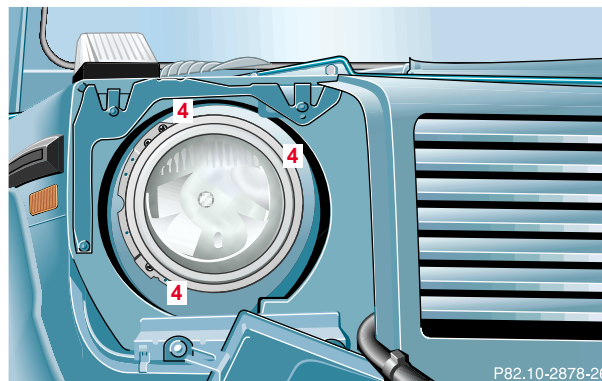

To remove headlamp:

Unscrew securing screws (1) and remove head lamp trim panel (2) and seal.

Unscrew headlamp-securing screws (4) and remove headlamp (3).

Vehicle with brush guard (MB Accessory):  
The brush guard must be lowered before the headlamp bulbs can be replaced, see page 182.

## Exterior lamps

330

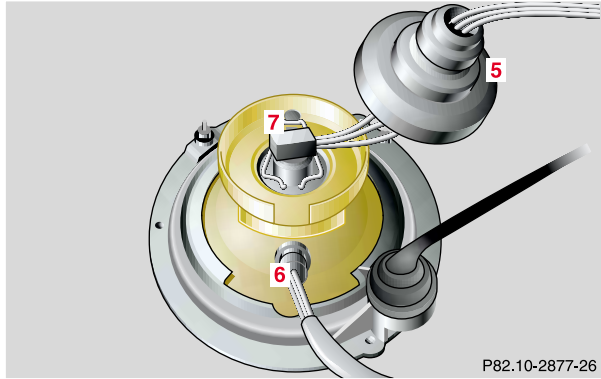

- 5 Protection cover
- 6 Electrical connector (standing- and parking lamp)
- 7 Electrical connector (high- and low beam)

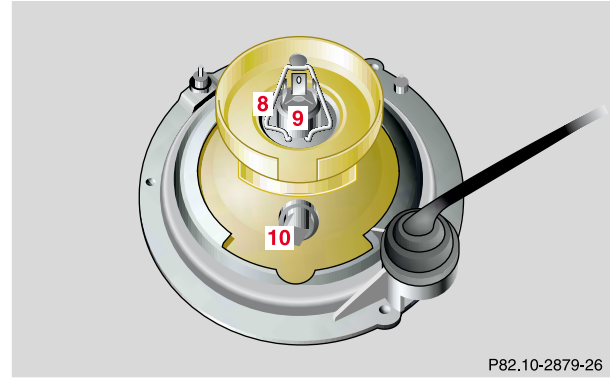

- 8 Retainer spring
- 9 Bulb for high- and low beam
- 10 Bulb socket for standing- and parking lamp

### **Bulbs for low and high beam**

H4 60/55W 12V

Remove protection cover (5) and pull off electrical connector (6).

Unclip retainer spring (8) and take out bulb (9).

Insert new bulb so that the base locates in the recess on the holder.

Clip in retainer spring (8), plug the electrical connector (6) onto the bulb (9) and press on protection cover (5).

### **Bulbs for parking and standing lamp**

T 4W 12V

Pull off electrical connector (6) from the bulb (10).

Push bulb (10) into socket, turn counterclockwise and remove.

Insert new bulb (10) in socket, push in and turn clockwise until it clicks in.

Plug electrical connector (6) onto the bulb (10).

To reinstall headlamp:

Insert headlamp (3) and screw in headlamp-securing screws (4).

Install head lamp trim panel (2) and seal and screw in securing screws (1).

## Exterior lamps

332

## Fog lamp, front

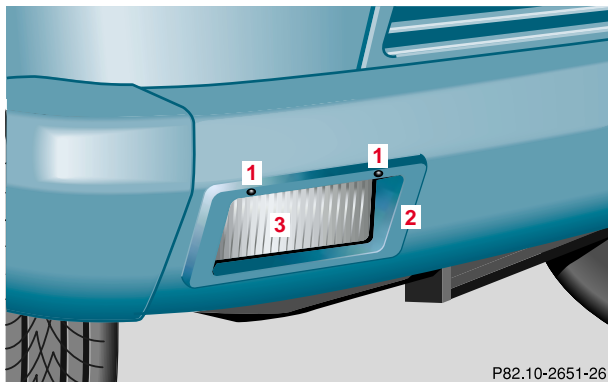

- 1 Securing screw
- 2 Fog lamp trim panel
- 3 Fog lamp
- 4 Fog lamp-securing screw
- 5 Fog lamp adjustment screw

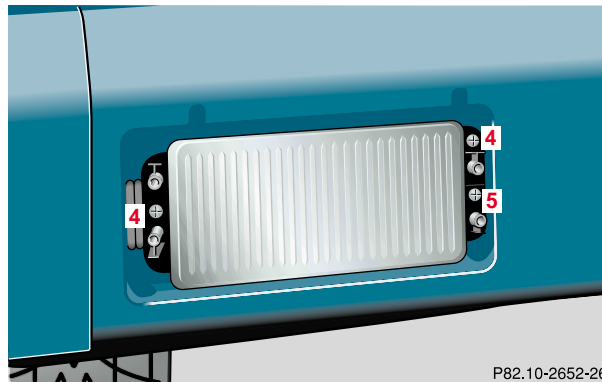

To remove fog lamp:

Unscrew securing screws (1) and remove fog lamp trim panel (2).

Unscrew fog lamp-securing screws (4) and remove fog lamp (3).

Note:

Do not turn fog lamp adjustment screw (5). In this case fog lamp must be adjusted.

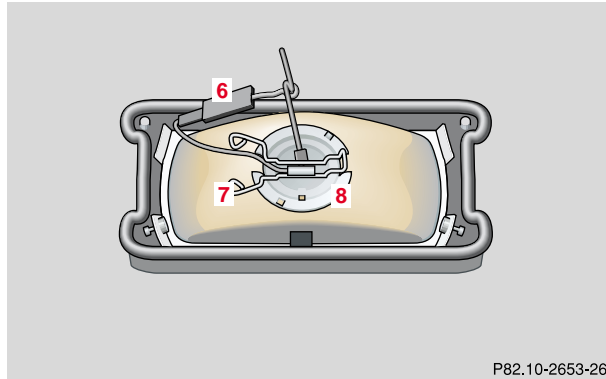

- 6 Electrical connector
- 7 Retainer spring
- 8 Bulb socket for fog lamp

Pull off electrical connector (6) and unclip retainer spring (7).

Pull out bulb socket (8).

Insert new bulb so that the base locates in the recess on the holder.

Clip in retainer spring (7) and plug the electrical connector (6) together.

To reinstall fog lamp:

Insert fog lamp (3) and screw in fog lamp-securing screws (4).

Install fog lamp trim panel (2) and screw in securing screws (1).



## Exterior lamps

334

## Turn signal lamp, front

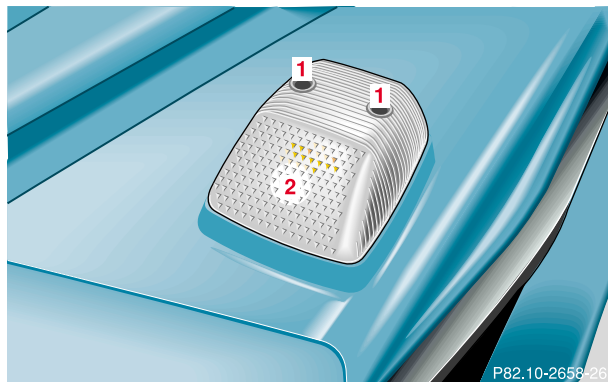

- 1 Securing screw
- 2 Turn signal lens
- 3 Bulb for turn signal lamp  
PY 21W 12V (1156NA[cp 32])

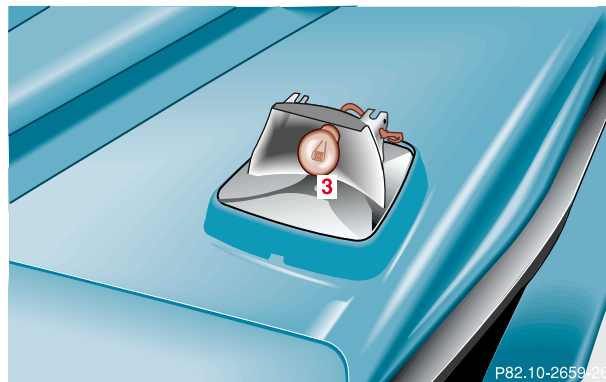

Unscrew securing screws (1) and remove turn signal lens (2).

Push bulb (3) into socket, turn counterclockwise and remove.

Insert new bulb (3) in socket, push in and turn clockwise until it clicks in.

Install turn signal lens (2) and screw in securing screws (1).

Do not overtighten the securing screws, as this could cause the turn signal lens to break.

## Turn signal lamp, side

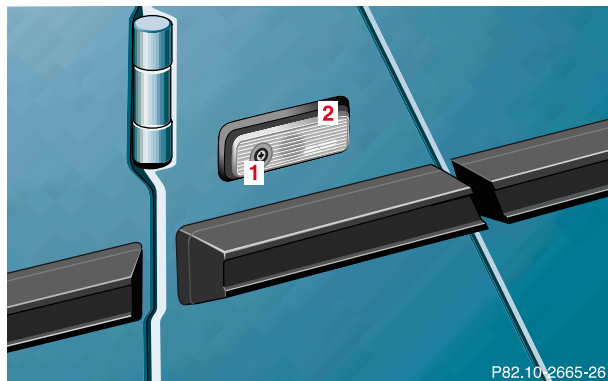

- 1 Securing screw
- 2 Turn signal lamp housing
- 3 Bulb socket for turn signal lamp, side

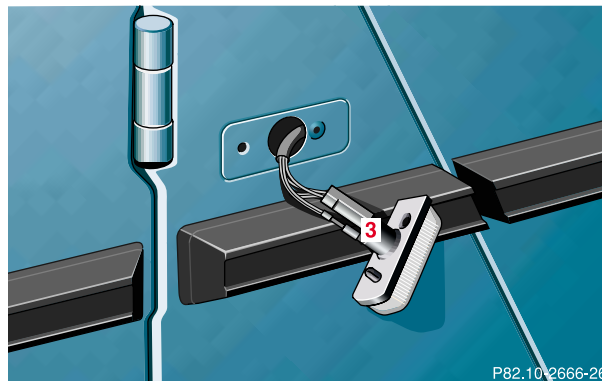

Unscrew securing screws (1) and remove turn signal lamp housing (2).  
Pull out bulb socket (3) from turn signal lamp housing (2).

## Exterior lamps

336

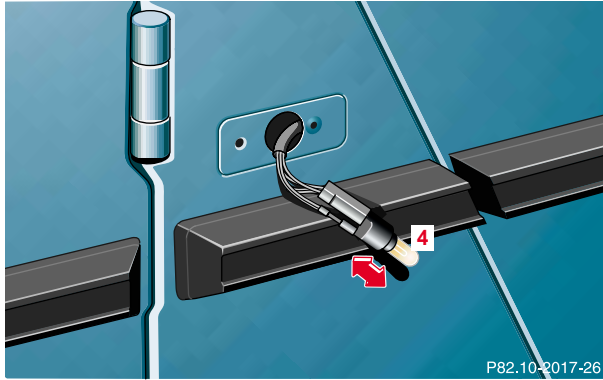

- 4** Bulb for turn signal lamp, side  
WY 5W 12V

Pull bulb (4) from bulb socket (3).

Insert new bulb in bulb socket (3).

Insert bulb socket (3) in turn signal lamp housing (2)  
and screw in securing screws (1).

Do not overtighten the securing screws, as this could  
cause the turn signal lamp housing to break.

## Front and rear side marker lamps

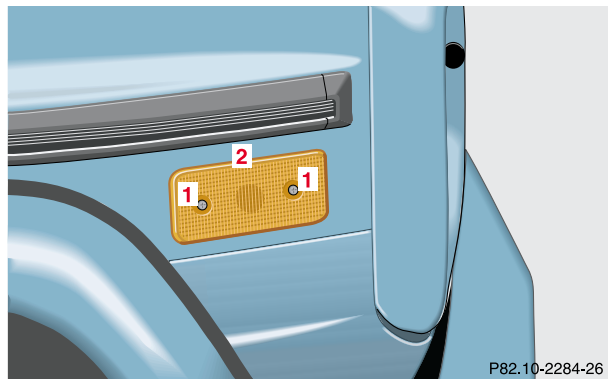

Front side marker shown.

- 1 Securing screw
- 2 Side marker lamp housing
- 3 Dust cover

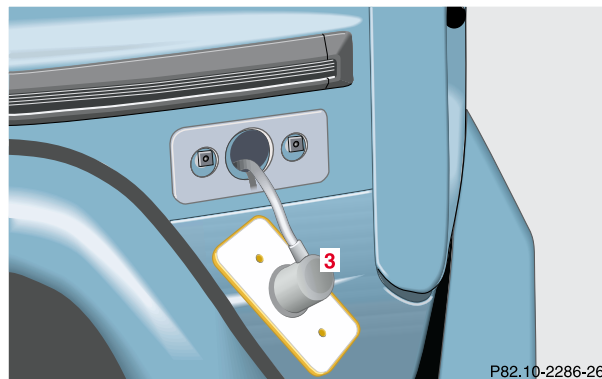

Unscrew securing screws (1) and remove side marker lamp housing (2).

Remove dust cover (3), press catch aside and pull out bulb socket from side marker lamp housing (2).

## Exterior lamps

338

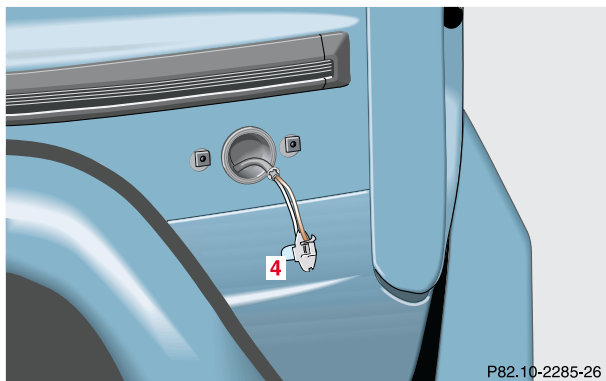

- 4** Bulb for side marker lamp  
T 4W 12V

Push bulb (4) into socket, turn counterclockwise and remove.

Insert new bulb in socket, push in and turn clockwise until it clicks in.

Insert bulb socket in side marker lamp housing (2) and screw in securing screws (1).

Do not overtighten the securing screws, as this could cause the side marker lamp housing to break.

## Taillamp assemblies

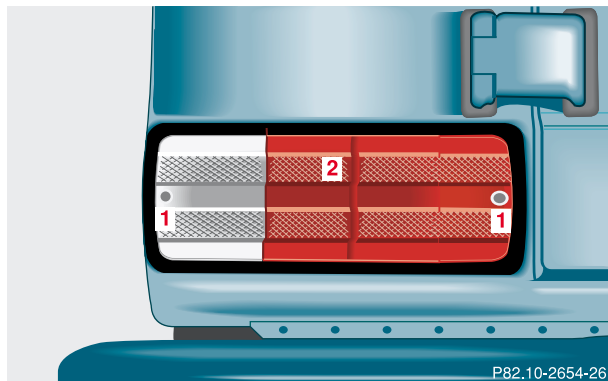

- 1 Securing screw
- 2 Lens
- 3 Bulb for turn signal lamp  
PY 21W 12V
- 4 Bulb for tail lamp,  
R 5W 12V
- 5 Stop lamp  
P 21W 12V

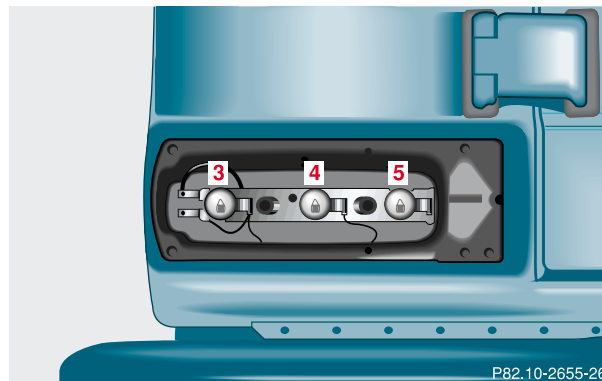

Unscrew securing screws (1) and remove lens (2).

Push bulb into socket, turn counterclockwise and remove.

Insert new bulb in socket, push in and turn clockwise until it clicks in.

Install lens (2) and screw in securing screws (1). Do not overtighten the securing screws, as this could cause the lens to break.

## Exterior lamps

340

## License plate lamp

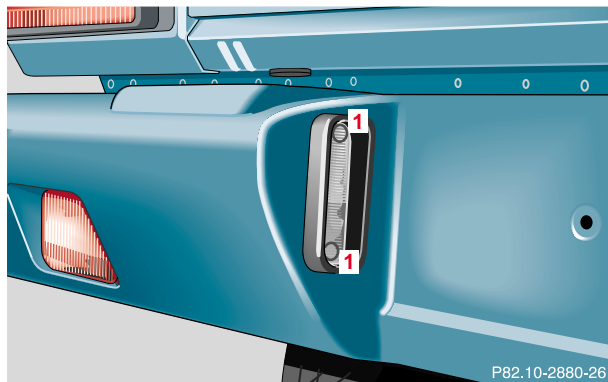
**1** Securing screws

Unscrew both securing screws (1).

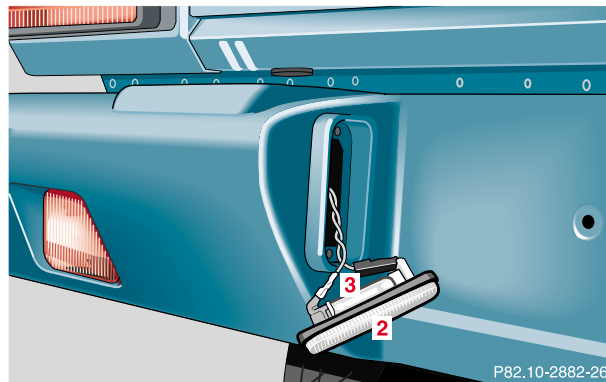
**2** License plate lamp housing**3** Bulb for license plate lamp  
C 5W 12V (tubular)

Pull out license plate lamp housing (2) and remove bulb (3).

Insert new bulb and screw in securing screws (1).  
Do not overtighten the securing screws, as this could cause the lamp housing to break.

## Rear fog lamp/Backup lamp

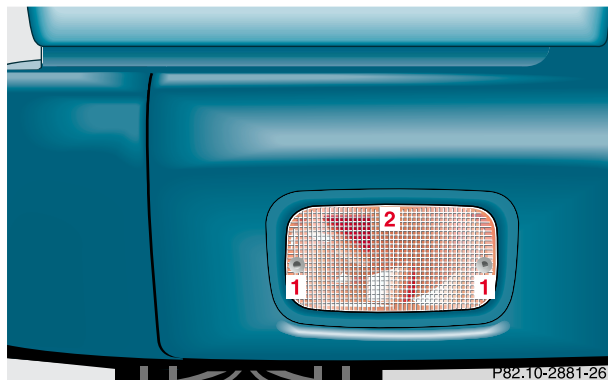

**1** Securing screws

**2** Lens

Unscrew both securing screws (1) and remove lens (2).

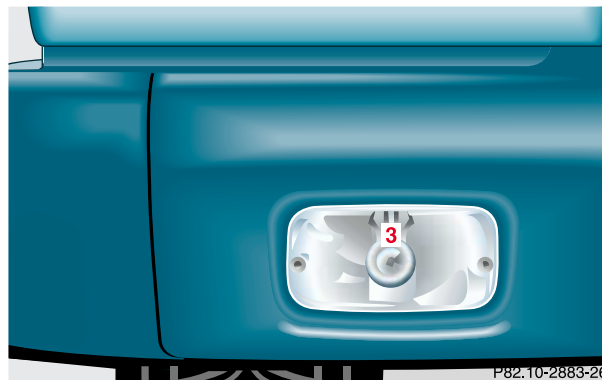

**3** Bulb for backup lamp/rear fog lamp  
P 21W 12V

Push bulb (3) into socket, turn counterclockwise and remove.

Insert new bulb in socket, push in and turn clockwise until it clicks in.

Install lens (2) and screw in securing screws (1).  
Do not overtighten the securing screws, as this could cause the lens to break.



**High mounted stop lamp**

The high mounted stop lamp (3rd brake lamp) is equipped with LEDs. The additional turn signals on the exterior mirrors are equipped with incandescent bulbs.

Have the system checked at an authorized Mercedes-Benz Light Truck Center if a malfunction occurs.

## Changing batteries in the electronic key



- 1 Transmit buttons
- 2 Lamp for battery check and function control

### Checking batteries

If one of the transmit buttons (1) is pressed, the battery check lamp (2) lights up briefly – indicating that the batteries are in order.

Change batteries if the battery check lamp (2) does not light up briefly.



### Changing batteries

Move locking tab (3) in direction of right arrow and remove mechanical key (4, left arrow).

## Electronic main key

344



Insert mechanical key (4) in side opening (5) to open latch. Press briefly (do not use mechanical key as lever) to release battery compartment.

Remove mechanical key from side opening.

Carefully remove battery compartment in direction of arrow (6).

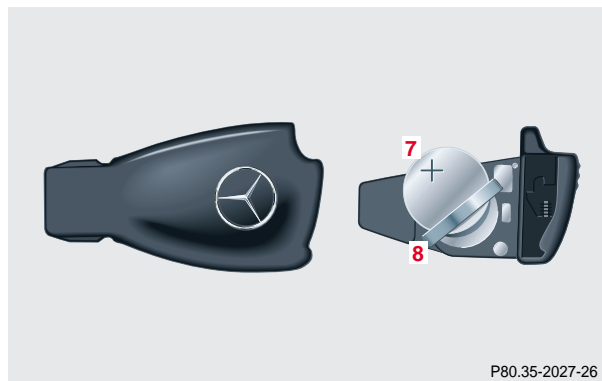

Change batteries (7), inserting new ones under contact spring (8) with plus (+) side facing up.

Return battery compartment into housing until locked in place and slide mechanical key back into electronic key.

### **Important!**

Batteries contain materials that can harm the environment if disposed of improperly. Recycling of batteries is the preferred method of disposal. For disposal, please follow manufacturer's recommendation on battery package.

Replacement Battery:  
Lithium, type CR 2025 or equivalent.

### **Synchronizing remote control**

The remote control may have to be resynchronized, if the vehicle cannot be locked or unlocked.

To synchronize insert electronic key in starter switch.

The remote control should once again be operational.

## Emergency operation of sliding/pop-up roof

346

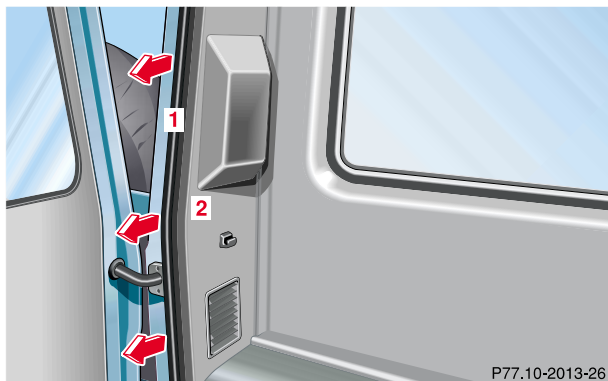
**Emergency operation of sliding/pop-up roof**

The sliding/pop-up roof can be opened or closed manually should an electrical malfunction occur. The sliding/pop-up roof drive is located behind the cargo area trim panel (2).

1. Remove edge molding (1) and trim panel (2).

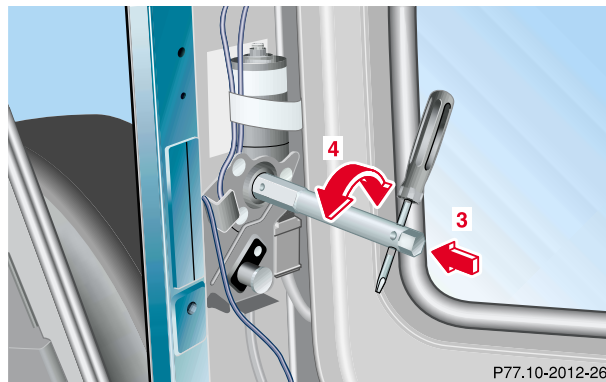

2. Place socket wrench (3) on hexagon. The sliding/pop-up roof can be moved in the desired direction (4) by turning the socket wrench. To open sliding/pop-up roof, turn clockwise. To close sliding/pop-up roof, turn counterclockwise.

## Manual release for fuel filler flap

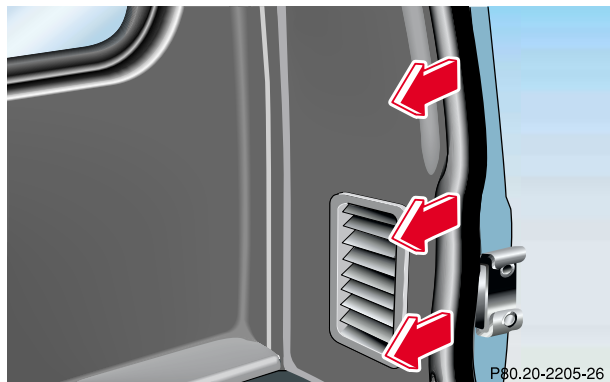

Remove edge molding and trim panel on right rear door pillar.



Pull strap (1) upwards until fuel filler flap is unlocked.

## Replacing wiper blades

348

**Replacing wiper blades**

For safety reasons, remove electronic key from starter switch before replacing the wiper blade, otherwise the motor can suddenly turn on and cause injury.

Notes:

Do not open engine hood with wiper arm folded forward.

Do not allow the wiper arm to contact the windshield glass without a wiper blade inserted. The glass may be scratched or broken.

Make certain that the wiper blade is properly installed. An improperly installed wiper blade may cause windshield damage.

The wiper with air spoiler should be mounted on the driver's side.

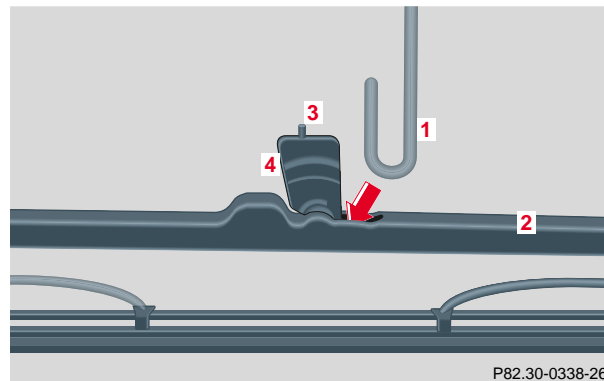
**Replacing windshield/rear window wiper blade**

Removal:

Fold wiper arm (1) forward (windshield)/rearward (rear window) and turn wiper blade (2) at a right angle to the arm. Push safety tab (3) of attachment link (4) and slide the wiper blade from the end of the wiper arm. Remove the wiper blade.

Installation:

Slide wiper blade into end of wiper arm until it locks in place.

## Vehicle care

Cleaning and care of the vehicle .....	350	Window cleaning .....	353
Power washer .....	351	Wiper blades .....	353
Tar stains .....	351	Light alloy wheels .....	353
Paintwork, painted body components .....	351	Instrument cluster .....	353
Engine cleaning .....	352	Steering wheel and gear selector lever .....	353
Vehicle washing .....	352	Cup holder .....	354
Ornamental moldings .....	352	Seat belts .....	354
Headlamps, taillamps, turn signal lenses .....	352	Headliner .....	354
		Upholstery .....	354
		Hard plastic trim items .....	354
		Plastic and rubber parts .....	354



### Cleaning and care of the vehicle

#### Warning!

**Many cleaning products can be hazardous. Some are poisonous, others are flammable. Always follow the instructions on the particular container. Always open your vehicle's doors or windows when cleaning the inside.**

**Never use fluids or solvents that are not designed for cleaning your vehicle.**

In operation, your vehicle is subjected to varying external influences which, if gone unchecked, can attack the paintwork as well as the underbody and cause lasting damage.

Such damage is caused not only by extreme and varying climatic conditions, but also by air pollution, road salt, tar, gravel and stone chipping. Grease and oil, fuel, coolant, brake fluid, bird droppings, insects, tree resins etc. should be removed immediately to avoid paint damage. Frequent washing reduces and/or eliminates the aggressiveness and potency of the above adverse influences.

More frequent washings are necessary to deal with unfavorable conditions; for example, near the ocean, in industrial areas (smoke, exhaust emissions), or during winter operation.

You should check your vehicle from time to time for stone chipping or other damage. Any damage should be repaired as soon as possible to prevent the start of corrosion.

In doing so, do not neglect the underside of the vehicle. A prerequisite for a thorough check is a washing of the underbody followed by a thorough inspection. Damaged areas need to be reundercoated.

Your vehicle has been treated at the factory with a wax-base rustproofing in the body cavities which will last for the lifetime of the vehicle. Post-production treatment is neither necessary nor recommended by Mercedes-Benz because of the possibility of incompatibility between materials used in the production process and others applied later.

We have selected car-care products and compiled recommendations which are specially matched to our vehicles and which always reflect the latest technology. You can obtain Mercedes-Benz approved car-care products at your authorized Mercedes-Benz Light Truck Center.

Scratches, corrosive deposits, corrosion or damage due to negligent or incorrect care cannot always be removed or repaired with the car-care products recommended here. In such cases it is best to seek aid at your authorized Mercedes-Benz Light Truck Center.

The following topics deal with the cleaning and care of your vehicle and give important “how-to” information as well as references to Mercedes-Benz approved car-care products.

Additional information can be found in the booklet titled “Vehicle Care Guide”.

### **Power washer**

When using a power washer for cleaning the vehicle always observe manufacturers’ operating instructions.

### **Caution!**

Never use a round nozzle to power wash tires. The intense jet of water can result in damage to the tire.

Always replace a damaged tire.

Always keep the jet of water moving across the surface. Do not aim directly at electrical parts, electrical connectors, seals, or other rubber parts.

### **Tar stains**

Quickly remove tar stains before they dry and become more difficult to remove. A tar remover is recommended.

### **Paintwork, painted body components**

Mercedes-Benz approved Paint Care should be applied when water drops on the paint surface do not “bead up”, normally in 3 to 5 months, depending on climate and washing detergent used.

Mercedes-Benz approved Paint Cleaner should be applied if paint surface shows signs of dirt embedding (i.e. loss of gloss).

Do not apply any of these products or wax if your vehicle is parked in the sun or if the hood is still hot.

Use the appropriate MB-Touch-Up Stick for quick and provisional repairs of minor paint damage (i.e. chips from stones, vehicle doors etc.).

**Cleaning and care of the vehicle**

352

**Engine cleaning**

Prior to cleaning the engine compartment make sure to protect electrical components and connectors from the intrusion of water and cleaning agents.

Corrosion protection, such as MB Anticorrosion Wax should be applied to the engine compartment after every engine cleaning. Before applying, all control linkage bushings and joints should be lubricated. The poly-V-belt and all pulleys should be protected from any wax.

**Vehicle washing**

Do not use hot water or wash your vehicle in direct sunlight. Use only a mild car wash detergent, such as Mercedes-Benz approved Car Shampoo.

Thoroughly spray the vehicle with a diffused jet of water. Direct only a very weak spray towards the ventilation intake. Use plenty of water and rinse the sponge and chamois frequently.

Rinse with clear water and thoroughly wipe dry with a chamois. Do not allow cleaning agents to dry on the finish.

Due to the width of the vehicle, prior to running the vehicle through an automatic car wash, fold back the outside mirrors to prevent them from getting damaged.

In the winter, thoroughly remove all traces of road salt as soon as possible.

When washing the underbody, do not forget to clean the inner sides of the wheels.

**Ornamental moldings**

For regular cleaning and care of very dirty chrome-plated parts, use a chrome cleaner.

**Headlamps, taillamps, turn signal lenses**

Use a mild car wash detergent, such as Mercedes-Benz approved Car Shampoo, with plenty of water.

To prevent scratches, never apply strong force and use only a soft, non-scratchy cloth when cleaning the lenses. Do not attempt to wipe dirty lenses with a dry cloth or sponge.

### **Window cleaning**

Use a window cleaning solution on all glass surfaces. An automotive glass cleaner is recommended.

Note:

For safety reasons, switch off wipers and remove key from starter switch before cleaning the windshield, otherwise the wiper motor can suddenly turn on and cause injury.

### **Wiper blades**

Clean the wiper blade inserts with a clean cloth and detergent solution.

Note:

For safety reasons, switch off wipers and remove key from starter switch before cleaning the wiper blades, otherwise the wiper motor can suddenly turn on and cause injury.

### **Light alloy wheels**

Mercedes-Benz approved Wheel Care should be used for regular cleaning of the light alloy wheels.

If possible, clean wheels once a week with Mercedes-Benz approved Wheel Care, using a soft bristle brush and a strong spray of water.

Follow instructions on container.

Note:

Use only acid-free cleaning materials. The acid could lead to corrosion or may damage the clear coat.

### **Instrument cluster**

Use a gentle dishwashing detergent or mild detergent for delicate fabrics as a washing solution. Wipe with a cloth moistened in lukewarm solution. Do not use scouring agents.

### **Steering wheel and gear selector lever**

Wipe with a damp cloth and dry thoroughly or clean with Mercedes-Benz approved Leather Care.

## Cleaning and care of the vehicle

354

**Cup holder**

Use a gentle dishwashing detergent or mild detergent for delicate fabrics as a washing solution. Wipe with a cloth moistened in lukewarm solution. Do not use scouring agents.

**Seat belts**

The webbing must not be treated with chemical cleaning agents. Use only clear, lukewarm water and soap. Do not dry the webbing at temperatures above 176°F (80°C) or in direct sunlight.

**Warning!**

**Do not bleach or dye seat belts as this may severely weaken them. In a crash they may not be able to provide adequate protection.**

**Headliner**

Clean with soft bristle brush, or use a dry-shampoo cleaner in case of excessive dirt.

**Upholstery**

Using aftermarket seat covers or wearing clothing that have the tendency to give off coloring (e.g. when wet etc.) may cause the upholstery to become permanently discolored. By lining the seats with a proper intermediate cover, contact-discoloration will be prevented.

**Leather Upholstery**

Wipe leather upholstery with a damp cloth and dry thoroughly or clean with Mercedes-Benz approved Leather Care. Exercise particular care when cleaning perforated leather as its underside should not become wet.

**Cloth Upholstery**

Clean with soft bristle brush, or use a dry-shampoo cleaner in case of excessive dirt.

**Hard plastic trim items**

Pour Mercedes-Benz approved Interior Care onto soft lint-free cloth and apply with light pressure.

**Plastic and rubber parts**

Do not use oil or wax on these parts.

## Technical data

Spare parts service .....	356	Engine oils .....	363
Warranty coverage .....	356	Engine oil additives .....	363
Identification labels .....	357	Air conditioner refrigerant .....	363
Layout of poly-V-belt drive .....	358	Brake fluid .....	363
Technical data .....	359	Premium unleaded gasoline .....	364
Fuels, coolants, lubricants etc. –		Fuel requirements .....	364
capacities .....	361	Gasoline additives .....	365
		Coolants .....	365
		Consumer information .....	367

### Spare parts service

All authorized Mercedes-Benz Light Truck Centers maintain a stock of original spare parts required for maintenance and repair work. In addition, strategically located parts distribution centers provide quick and reliable parts service.

More than 300 000 different spare parts, for Mercedes-Benz models, are available.

Mercedes-Benz original spare parts are subjected to stringent quality inspections. Each part has been specifically developed, manufactured or selected for and adapted to Mercedes-Benz vehicles.

Therefore, Mercedes-Benz original spare parts should be installed.

### Important!

The use of non-genuine parts and accessories not authorized by Mercedes-Benz could damage the vehicle which damage is not covered by the Mercedes-Benz Limited Warranty, or compromise its durability or safety.

### Warranty coverage

Your vehicle is covered under the terms of the “warranties” printed in the Service and Warranty Information booklet and your authorized Mercedes-Benz Light Truck Center will exchange or repair any defective parts originally installed on the vehicle in accordance with the terms of the following warranties:

1. New vehicle limited warranty
2. Emission system warranty
3. Emission performance warranty
4. California, Maine, Massachusetts and Vermont emission control systems warranty

Replacement parts and accessories are covered by the Mercedes-Benz Spare Parts and Accessories warranties, copies of which are available at any Mercedes-Benz Light Truck Center.

### Loss of Service and Warranty Information Booklet

Should you lose your Service and Warranty Information booklet, have your authorized Mercedes-Benz Light Truck Center arrange for a replacement. It will be mailed to you.

## Identification labels

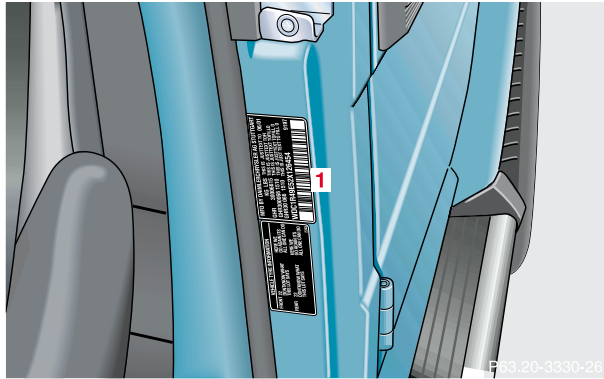

1 Certification label and Paintwork Number

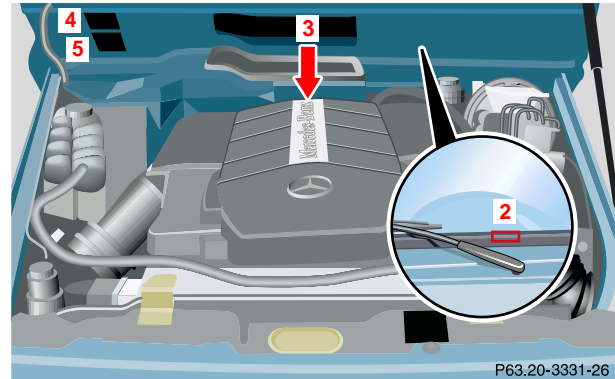

- 2 Vehicle Identification Number (VIN)
- 3 Engine number
- 4 Information label, California version
- 5 Emission control label  
Vacuum line routing for emission control system

Note:

When ordering spare parts, please specify vehicle identification and engine numbers.



## Technical data

358

## Layout of poly-V-belt drive

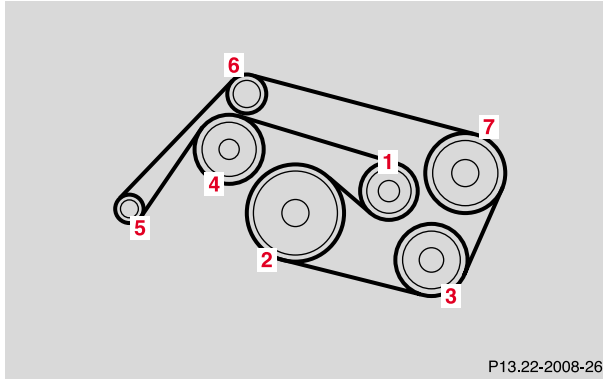

- 1 Automatic belt tensioner
- 2 Crankshaft
- 3 Air conditioner compressor
- 4 Coolant pump
- 5 Generator (alternator)
- 6 Idler pulley
- 7 Power steering pump

For dimensions of the poly-V-belt, see technical data.

## Technical data

<b>Model</b>	<b>G 500</b> (463 249) <sup>1</sup>
<b>Engine</b>	113
Mode of operation	4-stroke engine, gasoline injection
No. of cylinders	8
Bore	3.54 in (89.90 mm)
Stroke	3.31 in (84.00 mm)
Total piston displacement	303.0 cu.in. (4966 cm <sup>3</sup> )
Compression ratio	10:1
Output acc. to SAE J 1349	292 hp/5500 rpm (218 kW/5500 rpm)
Maximum torque acc. to SAE J 1349	336 ft.lb/2800 rpm (454 Nm/2800 rpm)
Maximum engine speed	6000 rpm
Firing order	1-5-4-2-6-3-7-8
Poly-V-belt	2390 mm

1 The quoted data apply only to the standard vehicle. See an authorized Mercedes-Benz Light Truck Center for the corresponding data of all special bodies and special equipment.

## Rims – Tires

<b>Model</b>	<b>G 500</b>
Rims (light alloy)	7 <sup>1</sup> / <sub>2</sub> J x18 H2 ET43
Wheel offset	1.89 in (43 mm)
All season tires: Radial-ply tires	265/60 R18 110V

## Spare wheel

Rim (standard equipment)	
Light alloy	7 <sup>1</sup> / <sub>2</sub> J x18 H2 ET43
Wheel offset	1.89 in (43 mm)

## Technical data

360

**Electrical system**

<b>Model</b>	<b>G 500</b>
Generator (alternator)	14 V/150 A
Starter motor	12V/1.7 kW
Battery	12V/90 Ah
Spark plugs	Bosch F 8 DPER Beru 14 FGH 8 DPUR X 2
Electrode gap	0.039 in (1.0 mm)
Tightening torque	15 – 22 ft.lb (20 – 30 Nm)

**Vehicle weights and ratings**

Gross Vehicle Weight Rating (GVWR) is the maximum permissible vehicle weight: 6615 lbs. (3000 kg)

Gross Vehicle Weight (GVW): comprises weight of vehicle including fuel, tools, spare wheel, installed accessories, passengers, cargo and trailer tongue. It must never exceed the GVWR.

Gross Axle Weight Rating (GAWR) is the maximum permissible axle weight:

front	3110 lbs.	(1410 kg)
rear	3965 lbs.	(1800 kg)

**Warning!**

**Do not load items on the roof. It may cause instability during some maneuvers which could result in an accident.**

**Main dimensions**

<b>Model</b>	<b>G 500</b>
Overall vehicle length (inc. spare wheel)	185.6 in (4715 mm)
Overall vehicle width (inc. rear view mirrors)	79.0 in (2007 mm)
Overall height	77.85 in (1977 mm)
Wheel base	112.2 in (2850 mm)
Ground clearance	8.3 in (211 mm)
Turning radius	523.6 in (13.3 m)
Track, front	59.6 in (1515 mm)
Track, rear	59.6 in (1515 mm)

## Fuels, coolants, lubricants etc. – capacities

Vehicle components and their respective lubricants must match. Therefore use only brands tested and recommended by us. Please refer to the Factory Approved Service Products pamphlet, or inquire at your Mercedes-Benz Light Truck Center.

<b>Fuels, coolants, lubricants etc.</b>	<b>Model G 500 Capacity</b>
Engine with oil filter (recommended engine oils)	8.5 US qt (8.0 l)
Automatic transmission (automatic transmission fluid)	9.0 US qt (8.5 l)
Transfer case (MB part no. A 001 28 03 10)	2.96 US qt (2.8 l)
Differential lock control	0.47 - 0.63 US qt (0.46 - 0.6 l)
Rear axle (Hypoid gear oil SAE 90, 85 W 90)	1.9 US qt (1.8 l)
Front axle (Hypoid gear oil SAE 90, 85 W 90)	1.5 US qt (1.4 l)
Power steering (MB Power steering fluid)	approx. 1.06 US qt (1.0 l)

## Fuels, coolants, lubricants etc. - capacities

362

**Fuels, coolants, lubricants etc.****Model G 500  
Capacity**

Front wheel hubs  
(high temperature roller bearing grease)

approx. 1.5 oz (43 g) each

Brake system  
(MB Brake fluid [DOT 4+])

approx. 0.53 US qt (0.5 l)

Windshield/headlamp washer system  
(MB Windshield washer concentrate “S” <sup>1</sup>)

approx. 7.9 US qt (7.5 l)

Cooling system  
(MB Anticorrosion/antifreeze)

approx. 12.7 US qt (12.0 l)

Fuel tank  
including a reserve of  
(Premium unleaded gasoline:  
Posted Octane 91 (Avg. of 96 RON/86 MON))

approx. 25.4 US gal (96.0 l)  
approx. 5.3 US gal (20.0 l)

Air conditioner system  
(R-134a refrigerant and special  
PAC lubricant (*Never R-12*))

- 1 Use MB Windshield Washer Concentrate “S” and water for temperatures above freezing or MB Windshield Washer Concentrate “S” and commercially available premixed windshield washer solvent/antifreeze for temperatures below freezing. Follow suggested mixing ratios, see page 307.

### Engine oils

Engine oils are specifically tested for their suitability in our engines. Therefore, use only engine oils recommended by Mercedes-Benz. Information on recommended brands is available in the Factory Approved Service Products pamphlet, or at your authorized Mercedes-Benz Light Truck Center.

Please follow Service Booklet recommendations for scheduled oil changes. Failure to do so could result in engine damage not covered by the Mercedes-Benz Limited Warranty.

### Engine oil additives

Do not blend oil additives with engine oil. They may be harmful to the engine operation.

Damage or malfunctions resulting from blending oil additives are not covered by the Mercedes-Benz Limited Warranty.

### Air conditioner refrigerant

R-134a (HFC) refrigerant and special PAG lubricating oil is used in the air conditioner system.

Never use R-12 (CFC) or mineral-based lubricating oil, otherwise damage to the system will occur.

### Brake fluid

During vehicle operation, the boiling point of the brake fluid is continuously reduced through the absorption of moisture from the atmosphere. Under extremely hard operating conditions, this moisture content can lead to the formation of bubbles in the system thus reducing the system's efficiency.

The brake fluid must therefore be replaced every two years, preferably in the spring.

It is recommended to use only brake fluid approved by Mercedes-Benz. Your authorized Mercedes-Benz Light Truck Center will provide you with additional information.

### Premium unleaded gasoline

#### Caution!

To maintain the engine's durability and performance, premium unleaded gasoline must be used. If premium unleaded is not available and low octane fuel is used, follow these precautions:

- have the fuel tank filled only partially with unleaded regular and fill up with premium unleaded as soon as possible,
- avoid full throttle driving and abrupt acceleration,
- do not exceed an engine speed of 3000 rpm, if the vehicle is loaded with a light load such as two persons and no luggage,
- do not exceed 2/3 of maximum accelerator pedal position, if the vehicle is fully loaded or operating in mountainous terrain.

### Fuel requirements

Use only Premium unleaded meeting ASTM standard D 439:

The octane number (posted at the pump) must be 91 min. It is an average of both the Research (R) octane number and the Motor (M) octane number:  $[(R+M)/2]$ . This is also known as ANTI-KNOCK INDEX.

Unleaded gasoline containing oxygenates such as Ethanol, IPA, IBA and TBA can be used provided the ratio of any one of these oxygenates to gasoline does not exceed 10%, MTBE not to exceed 15%.

The ratio of Methanol to gasoline must not exceed 3% plus additional cosolvents.

Using mixtures of Ethanol and Methanol is not allowed. Gasohol, which contains 10% Ethanol and 90% unleaded gasoline, can be used.

These blends must also meet all other fuel requirements such as resistance to spark knock, boiling range, vapor pressure etc..

## Gasoline additives

A major concern among engine manufacturers is carbon build up caused by gasoline. Mercedes-Benz recommends the use of only quality gasoline containing additives that prevent the build up of carbon deposits.

After an extended period of using fuels without such additives, carbon deposits can build up especially on the intake valves and in the combustion area, leading to engine performance problems such as:

- warm-up hesitation,
- unstable idle,
- knocking/pinging,
- misfire,
- power loss.

Do not blend other specific fuel additives with fuel. They only result in unnecessary cost, and may be harmful to the engine operation.

Damage or malfunctions resulting from poor fuel quality or from blending specific fuel additives are not covered by the Mercedes-Benz Limited Warranty.

## Coolants

The engine coolant is a mixture of water and anticorrosion/antifreeze, which provides:

- corrosion protection,
- freeze protection,
- boiling protection (by increasing the boiling point).

The cooling system was filled at the factory with a coolant providing freeze protection to approximately -35°F (-37°C) and corrosion protection.

If the antifreeze mixture is effective to -22°F (-30°C), the boiling point of the coolant in the pressurized cooling system is reached at approx. 266°F (130°C).

The coolant solution must be used year round to provide the necessary corrosion protection and increase in the boil-over protection. You should have it replaced every 3 years.

To provide the important corrosion protection, the solution must be at least 45% anticorrosion/antifreeze (equals a freeze protection to approx. - 22°F [-30°C]). If you use a solution that is more than 55% anticorrosion/antifreeze (freeze protection to approx. - 49°F [-45°C]),



## Fuels, coolants, lubricants etc.

366

the engine temperature will increase due to the lower heat transfer capability of the solution. Therefore, do not use more than this amount of anticorrosion/antifreeze.

If the coolant level is low, water and MB anticorrosion/antifreeze should be used to bring it up to the proper level (have cooling system checked for signs of leakage).

The water in the cooling system must meet minimum requirements, which are usually satisfied by normal drinking water. If you are not sure about the water quality, consult your authorized Mercedes-Benz Light Truck Center.

## Anticorrosion/antifreeze

Your vehicle contains a number of aluminum parts. The use of aluminum components in motor vehicle engines necessitates that anticorrosion/antifreeze coolant used in such engines be specifically formulated to protect the aluminum parts. (Failure to use such anticorrosion/antifreeze coolant will result in a significantly shortened service life.)

Therefore the following product is strongly recommended for use in your vehicle: Mercedes-Benz Anticorrosion/antifreeze agent.

Before the start of the winter season (or once a year in the hot southern regions), you should have the anticorrosion/antifreeze concentration checked. The coolant is also regularly checked each time you bring your vehicle to your authorized Mercedes-Benz Light Truck Center for service.

## Anticorrosion/antifreeze quantity

## Approx. freeze protection

- 35°F	- 49°F
(- 37°C)	(- 45°C)

---

5.5 US qt	6.2 US qt
(5.2 l)	(5.8 l)

## Consumer information

This has been prepared as required of all manufactures of passenger cars under Title 49, Code of U.S. Federal Regulations, Part 575 pursuant to the “National Traffic and Motor Vehicle Safety Act of 1966”.

### Uniform tire quality grading

Quality grades can be found where applicable on the tire sidewall between tread shoulder and maximum section width. For example:

Tread wear 200    Traction AA    Temperature A

All passenger vehicle tires must conform to federal safety requirements in addition to these grades.

### Treadwear

The treadwear grade is a comparative rating based on the wear rate of the tire when tested under controlled conditions on a specified government test course. For example, a tire graded 150 would wear one and one-half ( $1\frac{1}{2}$ ) times as well on the government course as a tire graded 100. The relative performance of tires depends upon the actual conditions of their use, however, and may depart significantly from the norm due to variations in driving habits, service practices and differences in road characteristics and climate.

### Traction

The traction grades, from highest to lowest are AA, A, B, and C. Those grades represent the tire’s ability to stop on wet pavement as measured under controlled conditions on specified government test surfaces of asphalt and concrete. A tire marked C may have poor traction performance.

### Warning!

**The traction grade assigned to this tire is based on straight ahead braking traction tests, and does not include acceleration, cornering, hydroplaning, or peak traction characteristics.**

## Consumer information

368

## Temperature

The temperature grades are A (the highest), B, and C, representing the tire's resistance to the generation of heat and its ability to dissipate heat when tested under controlled conditions on a specified indoor laboratory test wheel. Sustained high temperature can cause the material of the tire to degenerate and reduce tire life, and excessive temperature can lead to sudden tire failure. The grade C corresponds to a level of performance which all passenger vehicle tires must meet under the Federal Motor Vehicle Safety Standard No. 109. Grades B and A represent higher levels of performance on the laboratory test wheel than the minimum required by law.

**Warning!**

**The temperature grade for this tire is established for a tire that is properly inflated and not overloaded. Excessive speed, underinflation, or excessive loading, either separately or in combination, can cause excessive heat build up and possible tire failure.**

## Index

### A

A few words about differentials and differential locks .....	251
ABS (Antilock brake system) .....	239
LOW RANGE - ABS .....	240
Air conditioner refrigerant .....	363
Airbags .....	66
Anticorrosion/antifreeze .....	223, 306, 362, 366
Antiglare night position .....	79
ANTILOCK BRAKE SYSTEM	
Malfunction and warning message .....	275
Antilock brake system (ABS) .....	239
LOW RANGE - ABS .....	240
Antitheft alarm system .....	42
Aquaplaning .....	220
Ashtray	
Center console, front .....	168
Rear passenger compartment .....	169
Audio systems .....	96
CD Player .....	97
Radio .....	96

Automatic central locking .....	41
Automatic climate control	
Adjustable air outlets,	
rear passenger compartment .....	150
Automatic transmission .....	207
Emergency Operation .....	214
Fluid level .....	305
Selector lever position .....	210
Transmission selector lever,	
manually unlocking .....	327

### B

BabySmart™ airbag deactivation system .....	63
BAS (Brake assist system) .....	237
Battery .....	319
Battery recycling .....	320
Block heater .....	225
Brake assist system (BAS) .....	237
Brake fluid .....	217, 363
Capacity .....	362
Brakes .....	215, 217, 362, 363
Brush guard .....	182

**C**

## Capacities

Fuels, coolants, lubricants etc. .... 361

Cargo area ..... 174

Loading instructions ..... 178

Cargo area cover blind ..... 180

Cargo compartment lamps ..... 159

Cargo tie-down rings ..... 174

Catalytic converter ..... 202

## CD player

See Audio systems ..... 96

CD-changer ..... 296

Cellular telephone ..... 184

Center console ..... 20

Central locking switch ..... 40

Central locking system ..... 29

Automatic central locking ..... 41

Central locking switch ..... 40

Choosing global or selective mode ..... 31

General notes ..... 28

Locking and unlocking

driver's door manually ..... 36

Locking and unlocking

the tailgate manually ..... 38

Locking and unlocking

with remote control ..... 31

Locking the tailgate separately ..... 39

Mechanical keys ..... 33

Obtaining replacement keys ..... 27

Summer opening/convenience feature ..... 32

Vehicle keys ..... 26

Changing wheels ..... 314

Check regularly and before a long trip ..... 261

Checking engine oil level

Via oil dipstick ..... 304

Child restraint ..... 56, 73

Cleaning and care of the vehicle ..... 350

Climate control ..... 140

Adjustable air outlets,

rear passenger compartment ..... 150

Air recirculation ..... 146

Basic setting ..... 144

Defrosting ..... 145

Display and controls ..... 142

Dust filter ..... 143

Economy mode ..... 147

Residual engine heat utilization ..... 148

Special settings ..... 144

Windows fogged up on the inside ..... 145

Windows fogged up on the outside ..... 146

COMAND, radio and telephone .....	190
Combination switch .....	134
Consumer information .....	367
Control and operation of radio transmitters .....	190
Coolant level	
Adding .....	306
Checking .....	306
Coolant temperature gauge .....	123
Coolants .....	365
Anticorrosion/antifreeze quantity .....	365
Cover blind, cargo area .....	180
Cover, spare wheel .....	312
Cruise control .....	234
Cup holder	
In passenger footwell .....	167
Next to the armrest .....	166
Rear passenger footwell .....	167

## D

Deep water	
Driving instructions .....	224
Differential locks .....	253
Differential locks, disengage .....	256
Differential locks, engage .....	254

Door control panel .....	22
Door entry lamps .....	157
Doors .....	34
Drinking and driving .....	216
Drive sensibly - save fuel .....	216
Driving instructions .....	216
Driving off .....	218

## E

Easy-entry/exit feature .....	44
Electrical outlet .....	301
Electronic Brake Booster (EBB) .....	242
Electronic key .....	27
Electronic main key	
Changing batteries .....	343
Synchronizing remote control .....	345
Electronic stability program (ESP) .....	243
Control switch .....	245
Synchronizing .....	244
Electronic traction system (4-ETS) .....	241
Emergency call	
See Tele Aid .....	192
Emergency tensioning retractor (ETR) .....	65
Emergency unlocking in case of accident .....	41

## Index

372

Emission control .....	203
Emission control label .....	357
Engine compartment .....	302
Engine oil additives .....	363
Engine oil consumption .....	305
Engine oil level	
Checking .....	304
Engine oil level indicator .....	127
Engine oils .....	363
Capacities .....	361
Enlarged cargo area .....	174
ESP (Electronic stability program) .....	243
Control switch .....	245
Synchronizing .....	244
ETR (Emergency tensioning retractor) .....	65
ETS (4-ETS) .....	241
Exterior lamp switch .....	129
Daytime running lamp mode .....	131
Exterior lamps .....	328
Bulbs for low and high beam .....	331
Bulbs for parking and standing lamp .....	331
Fog lamp, front .....	332
Front and rear side marker lamps .....	337
Headlamp assembly .....	329

Headlamps .....	329, 352
High mounted stop lamp .....	342
License plate lamps .....	340
Rear fog lamp/Backup lamp .....	341
Replacing bulbs .....	328
Taillamp assemblies .....	339
Turn signal lamp, front .....	334
Turn signal lamp, side .....	335
Exterior mirror adjustment .....	80
Exterior mirror,	
front passenger side, parking position .....	82
Exterior rear view mirrors .....	80

**F**

First aid kit, vehicle tools and jack .....	296
Flexible service system (FSS) .....	124
Floor mat .....	170
Fog lamp, front .....	332
Folding backrest forward .....	172
Folding seat bench .....	172
Four wheel electronic traction system (4-ETS) .....	241
Front seat adjustment .....	45
Synchronizing head restraints and seat adjustment fore, aft .....	47

Fuel	
Gasoline additives .....	365
Premium unleaded gasoline .....	259, 362, 364
Fuel filler flap, manual release .....	347
Fuel requirements .....	364
Fuel reserve warning .....	268
Fuels, coolants, lubricants etc. - Capacities .....	361
Fuse box in battery box .....	300
Fuse box in front passenger footwell .....	298
Fuse box in middle tunnel .....	299
Fuse box in the passenger compartment .....	297
Fuses, electrical .....	297

## G

Garage door opener .....	185
Gasoline	
Additives .....	365
Fuel requirements .....	364
Premium unleaded .....	364
Glove box .....	163

## H

Hazard warning flasher switch .....	139
Head restraints	
Rear .....	173
Removal .....	173
Head restraints, front seats	
Removal and installation .....	51
Headlamp assembly	
Halogen .....	329
Headlamp cleaning system .....	133
Headlamp mode (HEADLAMPS) .....	130
Heated seats, front .....	52
Heated seats, rear .....	54
High and low beam, bulb .....	331
Hood .....	302

## I

Identification labels .....	357
Illuminated vanity mirrors .....	161
Indicator lamps in the instrument cluster .....	86



## Index

374

Individual settings .....	108
"CONVENIENCE" .....	120
"INSTRUMENT CLUSTER" .....	110
"LIGHTING" .....	114
"VEHICLE" (audio and central locking system) .....	118
Infant and child restraint system	
Installation .....	75
Infant and child restraint systems .....	73
Child seat mounts - LATCH type .....	76
Information call	
See Tele Aid .....	192
Instrument cluster .....	84
Indicator lamps .....	86
Malfunction and indicator lamps .....	264
Instruments and controls .....	18
Interior	
General notes .....	162
Interior lighting .....	156
<b>J</b>	
Jack .....	296
Jump starting .....	321

**K**

Keys, changing battery .....	343
Keys, vehicle .....	26

**L**

Lamps, exterior .....	328
Bulbs for low and high beam .....	331
Bulbs for parking and standing lamp .....	331
Fog lamp, front .....	332
Front and rear side marker lamps .....	337
Headlamp assembly .....	329
Headlamps .....	329, 352
High mounted stop lamp .....	342
License plate lamps .....	340
Rear fog lamp/Backup lamp .....	341
Replacing bulbs .....	328
Taillamp assemblies .....	339
Turn signal lamp, front .....	334
Turn signal lamp, side .....	335
Layout of poly-V-belt .....	358
Lighter .....	170
Limp home mode (Automatic transmission) .....	214
Loading instructions .....	178

Locator lighting .....	133
Locking and unlocking driver's door manually .....	36
Locking and unlocking the tailgate manually .....	38
Locking the tailgate separately .....	39
Locking the vehicle with remote control .....	31
Low and high beam, bulb .....	331
Low beams See Exterior lamp switch .....	129
LOW RANGE – ABS .....	240

## M

Maintenance .....	191
Malfunction and indicator lamps in the instrument cluster .....	264
Malfunction/warning message memory .....	106
Manual operation of sliding/pop-up roof .....	346
Memory .....	48
Mirror, exterior, parking position, front passenger side .....	82
Mirror, inside, rear view .....	79
Mirrors, vanity .....	161

Multifunction display .....	90
Coolant temperature .....	94
Engine oil level indicator .....	94
FSS .....	94
Individual settings .....	108
Tire inflation pressure monitor .....	94
Trip and main odometer .....	94
Vehicle speed .....	94
Multifunction steering wheel .....	90

## N

Navigation system .....	103
Night security illumination .....	132

## O

Off-Road driving .....	226
On-board diagnostic system .....	265
Operator's manual .....	8
Overhead control panel .....	23

**P**

Panic button .....	33
Parcel net in front passenger footwell .....	180
Parking .....	219
Parking brake .....	168, 215, 217, 219, 314
Parking lamp, bulb .....	331
Partition net .....	175
Poly-V-belt	
Layout .....	358
Power assistance .....	217
Power windows .....	151
Blocking of rear door window operation .....	153
Express opening .....	152
Opening and closing .....	32
Problems with your vehicle .....	15
Product information .....	7

**R**

Radio	
See Audio systems .....	96
Radio transmitters .....	190
Rain sensor .....	135
Rear interior lamps .....	158

Rear passenger compartment	
adjustable air outlets .....	150
Rear seat bench .....	171
Head restraints .....	173
Rear seat head restraints .....	173
Adjusting .....	173
Removal .....	173
Rear view mirrors	
Exterior .....	80
Inside .....	79
Rear window defroster .....	149
Rear window wiper/washer .....	138
Removal and installation of	
front seat head restraints .....	51
Replacement keys	
Obtaining .....	27
Replacing bulbs .....	328
Replacing wiper blade insert .....	348
Reporting safety defects .....	16
REST .....	148
Returning seat bench and	
backrest to sitting position .....	172
Roadside assistance .....	10
Roadside assistance call	
See Tele Aid .....	192
Roof racks .....	181

## S

Seat belts .....	56	Spare parts service .....	356
Fastening .....	58	Spare wheel .....	313
Seat belt nonusage warning system .....	57	Spare wheel cover .....	312
Unfastening .....	60	Split rear seat bench .....	171
Warning lamp .....	270	Rear seat head restraints .....	173
Seat belts and integrated restraint system .....	56	SRS malfunction .....	67
Seat bench .....	171	Standing lamp, bulb .....	331
Seat heater, front .....	52	Start lock-out .....	28
Seat heater, rear .....	54	Starter switch .....	204
Seats		Starting and turning off the engine .....	206
Front seat adjustment .....	45	Steering lock	
Memory function .....	48	See starter switch .....	204
Power seat .....	46	Steering wheel	
Self-test BabySmart™ without		Easy-entry/exit feature .....	44
special child seat installed .....	63	Steering wheel adjustment	
Setting the audio volume .....	122	electrical .....	78
Side marker lamps front and rear .....	337	Storage compartment	
Sliding/pop-up roof .....	154	Below the armrest .....	164
Emergency operation .....	346	In front of armrest .....	165
Express opening .....	155	Storage compartments	
Opening and closing .....	32	Glove box .....	163
Snow chains .....	222	Storing mirror positions .....	81
SOS-call		Stowing items in the vehicle .....	301
See Tele Aid .....	192	Stranded vehicle .....	327
		Sun visors .....	161
		Supplemental restraint system (SRS) .....	64

## Index

378

Switching transfer case .....	248
Synchronizing head restraints and seat adjustment fore, aft .....	47

**T**

Tailgate .....	37
Technical data .....	359
Electrical system .....	360
Main dimensions .....	360
Rims and tires .....	359
Vehicle weights and ratings .....	360
Tele Aid .....	192
Emergency calls .....	193
Information .....	197
Initiating an emergency call manually .....	195
Roadside Assistance .....	196
Telephone .....	98
Incoming call .....	102
Redialing .....	100
Telephone book .....	98
Telephone, general .....	184
Telephones and two-way radios .....	190
The first 1 000 miles (1 500 km) .....	191
Tie-down rings, cargo .....	174

Tire inflation pressure .....	318
Tire traction .....	221
Tires	
Driving instructions .....	219
Rims and tires .....	359
Rotating wheels .....	311
Tire inflation pressure .....	318
Tire replacement .....	310
Winter driving instructions .....	222
Tow-away alarm .....	43
Towing the vehicle .....	324
Stranded vehicle .....	327
Transmission selector lever, manually unlocking .....	327
Transfer case .....	247
Transmission .....	207
Transmission fluid level .....	305
Transmission selector lever, manually unlocking .....	327
Traveling abroad .....	225
Trip computer .....	104
Trunk .....	37
Turn signal lamp front, bulb .....	334
Turn signal lamp, side .....	335

## U

Unlocking the vehicle with remote control ..... 31

## V

Vanity mirrors ..... 161

### VEHICLE

(audio and central locking system) ..... 118

Vehicle jack ..... 308

Vehicle keys ..... 26

Vehicle tools ..... 296

## W

Warranty coverage ..... 356

Washing the vehicle ..... 352

What you should know at the gas station ..... 258

Wheels ..... 310

    Changing wheels ..... 314

    Light alloy wheels ..... 353

    Rims and tires ..... 359

Where to find it ..... 14

Window wiper/washer, rear ..... 138

Windshield washer/headlamp cleaning system

    Refilling ..... 307

Winter driving ..... 223

Winter driving instructions ..... 222

Wiper blade

    Replacing ..... 348



## Service and Literature

Your authorized Mercedes-Benz Light Truck Center has trained technicians and original Mercedes-Benz parts to service your vehicle properly. For expert advice and quality service, see your authorized Mercedes-Benz Light Truck Center.

If you are interested in obtaining service literature for your vehicle, please contact your authorized Mercedes-Benz Light Truck Center. We consider this the best way for you to obtain accurate information for your vehicle.

For further information you can find us on the Mercedes-Benz web-sites *www.mbusa.com* and *www.mbusi.com*.

### **Warning!**

**To help avoid personal injury, be extremely careful when performing any service work or repairs. Improper or incomplete service or the use of incorrect or inappropriate parts or materials may damage the vehicle or its equipment, which may in turn result in personal injury.**

**If you have any question about carrying out some service, turn to the advice of an authorized Mercedes-Benz Light Truck Center.**

We reserve the right to modify the technical details of the vehicle as given in the data and illustrations of this Operator's Manual. Reprinting, translation and copying, even of excerpts, is not permitted without our prior authorization in writing.

Title illustration no. P00.00-3187-26

Press time 09/21/01

GSP/SIP

Printed in Germany



