

**Jeep**<sup>®</sup>

**2011**

**OWNER'S MANUAL**

**Liberty**

## VEHICLES SOLD IN CANADA

With respect to any Vehicles Sold in Canada, the name Chrysler Group LLC shall be deemed to be deleted and the name Chrysler Canada Inc. used in substitution therefore.

### DRIVING AND ALCOHOL

Drunken driving is one of the most frequent causes of accidents.

Your driving ability can be seriously impaired with blood alcohol levels far below the legal minimum. If you are drinking, don't drive. Ride with a designated non-drinking driver, call a cab, a friend, or use public transportation.

### WARNING!

**Driving after drinking can lead to an accident. Your perceptions are less sharp, your reflexes are slower, and your judgment is impaired when you have been drinking. Never drink and then drive.**

This manual illustrates and describes the operation of features and equipment that are either standard or optional on this vehicle. This manual may also include a description of features and equipment that are no longer available or were not ordered on this vehicle. Please disregard any features and equipment described in this manual that are not on this vehicle.

Chrysler Group LLC reserves the right to make changes in design and specifications, and/or make additions to or improvements to its products without imposing any obligation upon itself to install them on products previously manufactured.

# Jeep

Jeep is a registered trademark of Chrysler Group LLC

Copyright © 2010 Chrysler Group LLC



# TABLE OF CONTENTS

SECTION		PAGE
1	INTRODUCTION .....	3
2	THINGS TO KNOW BEFORE STARTING YOUR VEHICLE .....	9
3	UNDERSTANDING THE FEATURES OF YOUR VEHICLE .....	93
4	UNDERSTANDING YOUR INSTRUMENT PANEL .....	215
5	STARTING AND OPERATING .....	309
6	WHAT TO DO IN EMERGENCIES .....	421
7	MAINTAINING YOUR VEHICLE .....	441
8	MAINTENANCE SCHEDULES .....	491
9	IF YOU NEED CONSUMER ASSISTANCE .....	507
10	INDEX .....	517



# INTRODUCTION

## CONTENTS

---

■ Introduction . . . . .	4	■ Warnings And Cautions . . . . .	7
■ Rollover Warning . . . . .	4	■ Vehicle Identification Number . . . . .	7
■ How To Use This Manual . . . . .	5	■ Vehicle Modifications/Alterations . . . . .	8

### INTRODUCTION

Congratulations on selecting your new Chrysler Group LLC vehicle. Be assured that it represents precision workmanship, distinctive styling, and high quality - all essentials that are traditional to our vehicles.

This Owner's Manual has been prepared with the assistance of service and engineering specialists to acquaint you with the operation and maintenance of your vehicle. It is supplemented by Warranty Information, and various customer-oriented documents. Please take the time to read these publications carefully. Following the instructions and recommendations in this manual will help assure safe and enjoyable operation of your vehicle.

**NOTE:** After reviewing the owner information, it should be stored in the vehicle for convenient referencing and remain with the vehicle when sold.

When it comes to service, remember that your authorized dealer knows your vehicle best, has factory-trained technicians and genuine MOPAR® parts, and cares about your satisfaction.

### ROLLOVER WARNING

Utility vehicles have a significantly higher rollover rate than other types of vehicles. This vehicle has a higher ground clearance and a higher center of gravity than many passenger cars. It is capable of performing better in a wide variety of off-road applications. Driven in an unsafe manner, all vehicles can go out of control. Because of the higher center of gravity, if this vehicle is out of control it may roll over when some other vehicles may not.

Do not attempt sharp turns, abrupt maneuvers, or other unsafe driving actions that can cause loss of vehicle

control. Failure to operate this vehicle safely may result in a collision, rollover of the vehicle, and severe or fatal injury. Drive carefully.

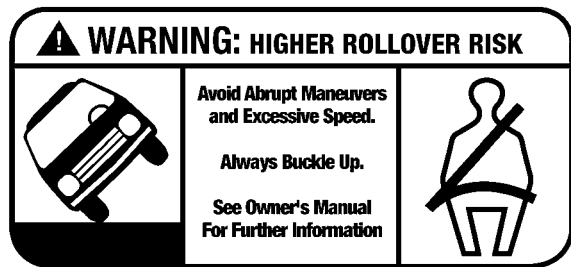

80bfe0f0

### Rollover Warning Label

Failure to use the driver and passenger seat belts provided is a major cause of severe or fatal injury. In fact, the U.S. government notes that the universal use of existing

seat belts could cut the highway death toll by 10,000 or more each year and could reduce disabling injuries by two million annually. In a rollover crash, an unbelted person is significantly more likely to die than a person wearing a seat belt. Always buckle up.

### HOW TO USE THIS MANUAL

Consult the Table of Contents to determine which section contains the information you desire.

Since the specification of your vehicle depends on the items of equipment ordered, certain descriptions and illustrations may differ from your vehicle's equipment

The detailed index at the back of this Owner's Manual contains a complete listing of all subjects.

Consult the following table for a description of the symbols that may be used on your vehicle or throughout this Owner's Manual:





## WARNINGS AND CAUTIONS

This Owner's Manual contains **WARNINGS** against operating procedures that could result in a collision or bodily injury. It also contains **CAUTIONS** against procedures that could result in damage to your vehicle. If you do not read this entire manual, you may miss important information. Observe all Warnings and Cautions.

## VEHICLE IDENTIFICATION NUMBER

The Vehicle Identification Number (VIN) is found on the left front corner of the instrument panel. The VIN is visible from outside of the vehicle through the windshield. This number also is stamped into the right front door sill (under the molding) and appears on the Automobile Information Disclosure Label affixed to a window on your vehicle, the vehicle registration, and the title.

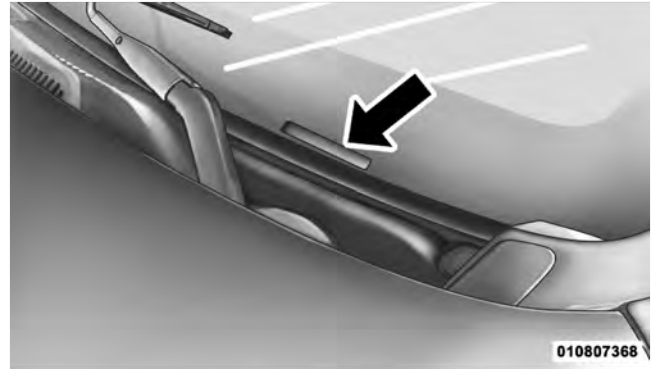

### Vehicle Identification Number

**NOTE:** It is illegal to remove or alter the VIN.

## VEHICLE MODIFICATIONS/ALTERATIONS

### **WARNING!**

Any modifications or alterations to this vehicle could seriously affect its roadworthiness and safety and may lead to a accident resulting in serious injury or death.

# THINGS TO KNOW BEFORE STARTING YOUR VEHICLE

## CONTENTS

---

■ A Word About Your Keys . . . . .	12	□ To Arm The System . . . . .	18
□ Ignition Key Removal . . . . .	12	□ To Disarm The System . . . . .	19
□ Key-In-Ignition Reminder . . . . .	14	■ Illuminated Entry . . . . .	20
■ Sentry Key® . . . . .	14	■ Remote Keyless Entry (RKE) . . . . .	20
□ Replacement Keys . . . . .	16	□ To Unlock The Doors And Liftgate . . . . .	21
□ Customer Key Programming . . . . .	16	□ To Lock The Doors And Liftgate . . . . .	22
□ General Information . . . . .	17	□ To Unlatch The Liftgate Flipper Glass . . . . .	24
■ Vehicle Security Alarm — If Equipped . . . . .	18	□ Remote Open Window Feature — If Equipped . . . . .	24
□ Rearming Of The System . . . . .	18		

## 10 THINGS TO KNOW BEFORE STARTING YOUR VEHICLE

- Using The Panic Alarm . . . . . 24
- Programming Additional Transmitters . . . . . 25
- Battery Replacement . . . . . 25
- General Information . . . . . 26
- Remote Starting System — If Equipped . . . . . 27
  - How To Use Remote Start . . . . . 27
- Door Locks . . . . . 29
  - Manual Door Locks . . . . . 29
  - Power Door Locks . . . . . 30
  - Child-Protection Door Lock System —  
Rear Doors . . . . . 33
- Windows . . . . . 35
  - Power Windows . . . . . 35
  - Wind Buffeting . . . . . 39
- Liftgate . . . . . 39
  - Liftgate Flipper Glass . . . . . 40
- Occupant Restraints . . . . . 41
  - Lap/Shoulder Belts . . . . . 44
  - Lap/Shoulder Belt Untwisting Procedure . . . . . 50
  - Seat Belt Pretensioner . . . . . 50
  - Seat Belt Lock Out . . . . . 51
  - Seat Belts In Passenger Seating Positions . . . . . 51
  - Automatic Locking Retractor Mode (ALR) —  
If Equipped . . . . . 51
  - Supplemental Active Head Restraints (AHR) . . . . . 52
  - Enhanced Seat Belt Use Reminder System  
(BeltAlert®) . . . . . 56

**THINGS TO KNOW BEFORE STARTING YOUR VEHICLE 11**

□ Energy Management Feature . . . . .	58	■ Engine Break-In Recommendations . . . . .	87
□ Seat Belts And Pregnant Women . . . . .	58	■ Safety Tips . . . . .	87
□ Seat Belt Extender . . . . .	58	□ Transporting Passengers . . . . .	87
□ Supplemental Restraint System (SRS) — Air Bags . . . . .	59	□ Exhaust Gas . . . . .	88
□ Air Bag Deployment Sensors And Controls . . .	64	□ Safety Checks You Should Make Inside The Vehicle . . . . .	89
□ Event Data Recorder (EDR) . . . . .	76	□ Periodic Safety Checks You Should Make Outside The Vehicle . . . . .	91
□ Child Restraints . . . . .	77		

## A WORD ABOUT YOUR KEYS

You can insert the double-sided keys into the locks with either side up.

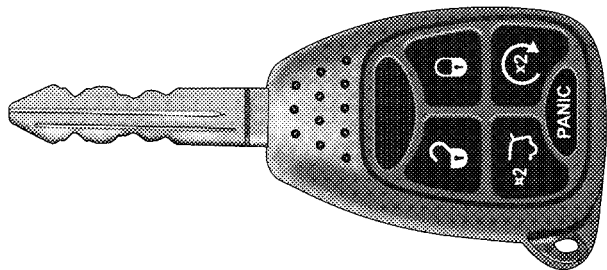

020207279

Vehicle Key

The authorized dealer that sold you your new vehicle has the key code numbers for your vehicle locks. These numbers can be used to order duplicate keys from your authorized dealer. Ask your authorized dealer for these numbers and keep them in a safe place.

## Ignition Key Removal

### Automatic Transmission

Place the shift lever in PARK. Turn the key to the ACC position and then push the key and cylinder inward slightly and rotate the key to the LOCK position. Then remove the key.

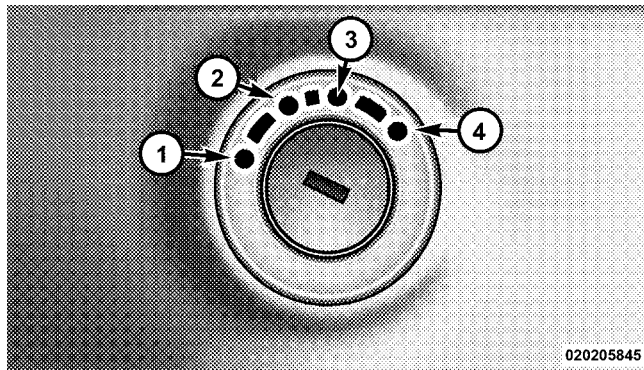

020205845

Ignition Switch Positions

1 — Lock  
2 — Acc

3 — On  
4 — Start

**NOTE:**

- For vehicles not equipped with the Electronic Vehicle Information Center (EVIC), features such as the power window switches, radio, power sunroof or Sky Slider® (if equipped), and power outlets will remain active for 45 seconds after the ignition switch is turned to the LOCK position. Opening either front door will cancel this feature.
- For vehicles equipped with the EVIC, features such as the power window switches, radio, power sunroof or Sky Slider® (if equipped), and power outlets will remain active for up to 10 minutes after the ignition switch is turned to the LOCK position. Opening either front door will cancel this feature. The time for this feature is programmable. Refer to “Electronic Vehicle Information Center (EVIC)/Personal Settings (Customer-Programmable Features)” in “Understanding Your Instrument Panel” for further information.

**WARNING!**

- **Never leave children alone in a vehicle. Leaving unattended children in a vehicle is dangerous for a number of reasons. A child or others could be seriously or fatally injured. Don't leave the keys in the ignition. A child could operate power windows, other controls, or move the vehicle.**
- **Do not leave children or animals inside parked vehicles in hot weather. Interior heat build-up may cause serious injury or death.**

**CAUTION!**

**An unlocked vehicle is an invitation to thieves. Always remove the key from the ignition, and lock all doors when leaving the vehicle unattended.**

**Key-In-Ignition Reminder**

If you open the driver's door and the key is in the ignition, a chime will sound to remind you to remove the key.

**NOTE:** The Key-In-Ignition reminder only sounds when the ignition key is placed in the LOCK or ACC position.

**SENTRY KEY®**

The Sentry Key® Immobilizer System prevents unauthorized vehicle operation by disabling the engine. The system does not need to be armed or activated. Operation is automatic, regardless of whether the vehicle is locked or unlocked.



The system uses ignition keys that have an embedded electronic chip (transponder) to prevent unauthorized vehicle operation. Therefore, only keys that are programmed to the vehicle can be used to start and operate the vehicle. The system will shut the engine off in two seconds if someone uses an invalid key to try to start the engine.

**NOTE:** A key that has not been programmed is also considered an invalid key, even if it is cut to fit the ignition switch lock cylinder for that vehicle.

During normal operation, after turning on the ignition switch, the Vehicle Security Light will turn on for three seconds for a bulb check. If the light remains on after the bulb check, it indicates that there is a problem with the electronics. In addition, if the Vehicle Security Light begins to flash after the bulb check, it indicates that

someone used an invalid key to try to start the engine. Either of these conditions will result in the engine being shut off after two seconds.

If the Vehicle Security Light turns on during normal vehicle operation (vehicle running for longer than 10 seconds), it indicates that there is a fault in the electronics. Should this occur, have the vehicle serviced as soon as possible by an authorized dealer.

### **CAUTION!**

**The Sentry Key® Immobilizer system is not compatible with some after-market remote starting systems. Use of these systems may result in vehicle starting problems and loss of security protection.**

All of the keys provided with your new vehicle have been programmed to the vehicle electronics.

## Replacement Keys

**NOTE:** Only keys that are programmed to the vehicle electronics can be used to start and operate the vehicle. Once a Sentry Key® is programmed to a vehicle, it cannot be programmed to any other vehicle.

### CAUTION!

**Always remove the Sentry Keys® from the vehicle and lock all doors when leaving the vehicle unattended.**

At the time of purchase, the original owner is provided with a four-digit Personal Identification Number (PIN). Keep the PIN in a secure location. This number is required for authorized dealer replacement of keys. Duplication of keys may be performed at an authorized dealer or by following the customer key programming

procedure. This procedure consists of programming a blank key to the vehicle electronics. A blank key is one that has never been programmed.

**NOTE:** When having the Sentry Key® Immobilizer System serviced, bring all vehicle keys with you to an authorized dealer.

## Customer Key Programming

If you have two valid Sentry Keys®, you can program new Sentry Keys® to the system by performing the following procedure:

1. Cut the additional Sentry Key® Transponder blank(s) to match the ignition switch lock cylinder key code.
2. Insert the first valid key into the ignition switch. Turn the ignition switch to the ON/RUN position for at least three seconds, but no longer than 15 seconds. Then, turn the ignition switch to the LOCK position and remove the first key.

3. Insert the second valid key into the ignition switch. Turn the ignition switch to the ON/RUN position within 15 seconds. After 10 seconds, a chime will sound. In addition, the Vehicle Security Light will begin to flash. Turn the ignition switch to the LOCK position and remove the second key.

4. Insert a blank Sentry Key® into the ignition switch. Turn the ignition switch to the ON/RUN position within 60 seconds. After 10 seconds, a single chime will sound. In addition, the Vehicle Security Light will stop flashing. To indicate that programming is complete, the Vehicle Security Light will turn on again for three seconds and then turn off.

The new Sentry Key® is programmed. **The Remote Keyless Entry (RKE) transmitter will also be programmed during this procedure.**

Repeat this procedure to program up to eight keys. If you do not have a programmed Sentry Key®, contact your authorized dealer for details.

**NOTE:** If a programmed key is lost, see your authorized dealer to have all remaining keys erased from the system's memory. This will prevent the lost key from starting your vehicle. The remaining keys must then be reprogrammed. All vehicle keys must be taken to an authorized dealer at the time of service to be reprogrammed.

### General Information

The Sentry Key® system complies with FCC rules Part 15 and with RSS-210 of Industry Canada. Operation is subject to the following conditions:

- This device may not cause harmful interference.
- This device must accept any interference that may be received, including interference that may cause undesired operation.

## VEHICLE SECURITY ALARM — IF EQUIPPED

The Vehicle Security Alarm monitors the vehicle doors, liftgate, and liftgate flipper glass for unauthorized entry and ignition for unauthorized operation. While the Vehicle Security Alarm is armed, interior switches for door locks and flipper glass are disabled.

If something triggers the alarm, the Vehicle Security Alarm will sound the horn intermittently, the headlights, park lamps and/or turn signals and the Vehicle Security Light in the instrument cluster will flash for three minutes. If the disturbance is still present (driver's door, passenger door, other doors, ignition) after three minutes, the headlights, park lamps and/or turn signals will flash for an additional 15 minutes.

**NOTE:** The Panic and Security alarms are quite different. Please take a moment to activate the Panic and the Security modes to hear the differences in the horn. In case

one should go off in the future, you will need to know which mode has been activated in order to deactivate it.

### Rearming Of The System

If something triggers the Vehicle Security Alarm, and no action is taken to disarm it, the Vehicle Security Alarm will turn off the horn after three minutes, turn off all of the visual signals after 15 minutes, and then the Vehicle Security Alarm will rearm itself.

### To Arm The System

1. Remove the key from the ignition switch and exit the vehicle.
2. Lock the doors and liftgate by pressing the power door LOCK switch or the LOCK button on the Remote Keyless Entry (RKE) transmitter.

**NOTE:** The Vehicle Security Alarm will not arm if you lock the doors with the manual door lock plungers or the driver's door lock cylinder.

3. Close all doors. The Vehicle Security Light in the instrument cluster will flash rapidly for about 16 seconds to signal that the Vehicle Security Alarm is arming. During this period, opening any door or the liftgate will cancel the arming process. If the Vehicle Security Alarm is set successfully, the Vehicle Security Light will flash at a slower rate to indicate the alarm is armed.

**NOTE:** For added security, whenever the Security Alarm is armed, the HomeLink®/Garage Door Opener (if equipped) is disabled as well.

### To Disarm The System

Either press the UNLOCK button on the RKE transmitter or insert a valid Sentry Key® into the ignition lock cylinder and turn the key to the ON/RUN position.

**NOTE:**

- Unlocking the doors with the manual door lock plungers or the driver's door lock cylinder will not disarm the Vehicle Security Alarm.

- When the Vehicle Security Alarm is armed, the interior power door lock switches will not unlock the doors.

The Vehicle Security Alarm is designed to protect your vehicle; however, you can create conditions where the Vehicle Security Alarm will give you a false alarm. If the previously described arming sequence has occurred, the Vehicle Security Alarm will arm regardless of whether you are inside or outside the vehicle. If you remain inside the vehicle and open a door, the alarm will sound. If this occurs, disarm the Vehicle Security Alarm.

### Tamper Alert

If something has triggered the Vehicle Security Alarm in your absence, the horn will sound three times and exterior lights blink three times when you unlock the doors. Check the vehicle for tampering.

## ILLUMINATED ENTRY

The courtesy lights will turn on when you use the Remote Keyless Entry (RKE) transmitter to unlock the doors or open any door.

This feature also turns on the approach lighting in the outside mirrors (if equipped). Refer to “Mirrors” in “Understanding The Features Of Your Vehicle” for further information.

The lights will fade to off after approximately 30 seconds or they will immediately fade to off once the ignition switch is turned to ON/RUN from the OFF position.

### NOTE:

- The front courtesy overhead console and door courtesy lights do not turn on if the dimmer control is in the “Dome ON” position (extreme top position).

- The Illuminated Entry system will not operate if the dimmer control is in the “Dome defeat” position (extreme bottom position).

## REMOTE KEYLESS ENTRY (RKE)

This system allows you to lock or unlock the doors and liftgate, open the liftgate flip-up window, or activate the PANIC alarm from distances up to approximately 66 ft (20 m) using a hand-held Remote Keyless Entry (RKE) transmitter. The RKE transmitter does not need to be pointed at the vehicle to activate the system. However, the line of transmission must not be blocked with metal objects when using the RKE transmitter.

**NOTE:** Inserting the key into the ignition switch disables all buttons on the RKE transmitter.

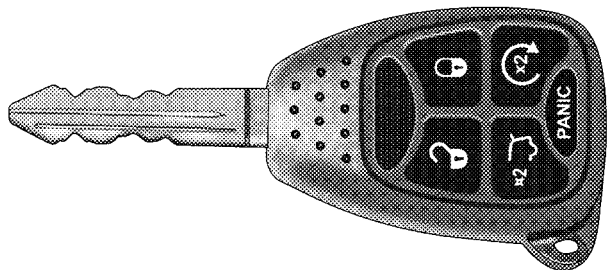

020207279

### Vehicle Key

#### To Unlock The Doors And Liftgate

Press and release the UNLOCK button on the RKE transmitter once to unlock the driver's door or twice to unlock all doors and the liftgate. The turn signal lights will flash to acknowledge the unlock signal. The illuminated entry system will also turn on.

#### Remote Key Unlock, Driver Door/All Doors First

This feature lets you program the system to unlock either the driver's door or all doors and the liftgate on the first press of the UNLOCK button on the RKE transmitter. To change the current setting, proceed as follows:

- For vehicles equipped with the Electronic Vehicle Information Center (EVIC), refer to "Electronic Vehicle Information Center (EVIC)/Personal Settings (Customer-Programmable Features)" in "Understanding Your Instrument Panel" for further information.

For vehicles not equipped with the EVIC, perform the following steps:

1. Press and hold the LOCK button on a programmed (i.e., functional) RKE transmitter for at least 4 seconds, but no longer than 10 seconds. Then, press and hold the UNLOCK button while still holding the LOCK button.
2. Release both buttons at the same time.

3. Test the feature from outside the vehicle by pressing the LOCK and UNLOCK buttons on the RKE transmitter.
4. Repeat these steps if you want to return this feature to its previous setting.

**NOTE:** Pressing the LOCK button on the RKE transmitter while you are inside the vehicle will activate the Security Alarm. Opening a door with the Security Alarm activated will cause the alarm to sound. Press the UNLOCK button to deactivate the Security Alarm.

### **Illuminated Approach — If Equipped**

This feature activates the headlights for up to 90 seconds when the doors are unlocked with the RKE transmitter. The time for this feature is programmable on vehicles equipped with the Electronic Vehicle Information Center (EVIC). Refer to “Electronic Vehicle Information Center (EVIC)/Personal Settings (Customer-Programmable Features)” in “Understanding Your Instrument Panel” for further information.

### **To Lock The Doors And Liftgate**

Press and release the LOCK button on the RKE transmitter to lock all doors and the liftgate. The turn signal lights will flash and the horn will chirp to acknowledge the lock signal.

### **Sound Horn With Lock**

This feature will cause the horn to chirp when the doors are locked with the RKE transmitter. This feature can be turned on or turned off. To change the current setting, proceed as follows:

- For vehicles equipped with the Electronic Vehicle Information Center (EVIC), refer to “Electronic Vehicle Information Center (EVIC)/Personal Settings (Customer-Programmable Features)” in “Understanding Your Instrument Panel” for further information.



- For vehicles not equipped with the EVIC, perform the following steps:
  1. Press the LOCK button on a programmed (i.e., functional) RKE transmitter for at least 4 seconds, but no longer than 10 seconds. Then, press the PANIC button while still holding the LOCK button.
  2. Release both buttons at the same time.
  3. Test the feature from outside the vehicle by pressing the LOCK button on the RKE transmitter.
  4. Repeat these steps if you want to return this feature to its previous setting.

**NOTE:** Pressing the LOCK button on the RKE transmitter while you are inside the vehicle will activate the Security Alarm. Opening a door with the Security Alarm activated will cause the alarm to sound. Press the UNLOCK button to deactivate the Security Alarm.

### Flash Lights With Lock

The feature will cause the turn signal lights to flash when the doors are locked or unlocked with the RKE transmitter. This feature can be turned on or turned off. To change the current setting, proceed as follows:

- For vehicles equipped with the Electronic Vehicle Information Center (EVIC), refer to “Electronic Vehicle Information Center (EVIC)/Personal Settings (Customer-Programmable Features)” in “Understanding Your Instrument Panel” for further information.
- For vehicles not equipped with the EVIC, perform the following steps:
  1. Press and hold the UNLOCK button on a programmed (i.e., functional) RKE transmitter for at least 4 seconds, but no longer than 10 seconds. Then, press and hold the LOCK button while still holding the UNLOCK button.
  2. Release both buttons at the same time.

## 24 THINGS TO KNOW BEFORE STARTING YOUR VEHICLE

3. Test the feature from outside the vehicle by pressing the LOCK and UNLOCK buttons on the RKE transmitter.
4. Repeat these steps if you want to return this feature to its previous setting.

**NOTE:** Pressing the LOCK button on the RKE transmitter while you are inside the vehicle will activate the Security Alarm. Opening a door with the Security Alarm activated will cause the alarm to sound. Press the UNLOCK button to deactivate the Security Alarm.

### **To Unlatch The Liftgate Flipper Glass**

Press the FLIPPER GLASS button twice to unlatch the liftgate flipper glass.

### **WARNING!**

**To avoid injury stand back when opening. Glass will automatically rise.**

### **Remote Open Window Feature — If Equipped**

This feature allows you to remotely lower both front door windows at the same time. To use this feature, press and release the UNLOCK button on the RKE transmitter and then immediately press and hold the UNLOCK button until the windows lower to the level desired or until they lower completely.

### **Using The Panic Alarm**

**NOTE:** The PANIC and Security Alarms are quite different. Please take a moment to activate the PANIC and the Security modes to hear the differences in the horn. In case one should go off in the future, you will need to know which mode has been activated in order to deactivate it.

To turn the PANIC Alarm feature ON or OFF, press and hold the PANIC button on the RKE transmitter for at least one second and release. When the PANIC Alarm is on, the headlights and turn signal lights will flash, the horn will pulse on and off, and the illuminated entry system will turn on.

The PANIC Alarm will stay on for three minutes unless you turn it off by pressing the PANIC button a second time or if the vehicle speed is 5 mph (8 km/h) or greater.

During the PANIC Mode, the door locks and Remote Keyless Entry (RKE) system will function normally. PANIC mode will not disarm the Security System on vehicles so equipped.

**NOTE:** You may need to be close to the vehicle when using the RKE transmitter to turn off the PANIC Alarm due to the radio frequency noises emitted by the system.

## Programming Additional Transmitters

Refer to Sentry Key® “Customer Key Programming.”

If you do not have a programmed RKE transmitter, contact your authorized dealer for details.

## Battery Replacement

The recommended replacement battery is CR2032.

### NOTE:

- Perchlorate Material — special handling may apply. See [www.dtsc.ca.gov/hazardouswaste/perchlorate](http://www.dtsc.ca.gov/hazardouswaste/perchlorate)
  - Do not touch the battery terminals that are on the back housing or the printed circuit board.
1. Remove the screw from the RKE transmitter case (if equipped).

## 26 THINGS TO KNOW BEFORE STARTING YOUR VEHICLE

2. With the RKE transmitter buttons facing down, use a flat blade tool to pry the two halves of the RKE transmitter case apart. Make sure not to damage the seal during removal.

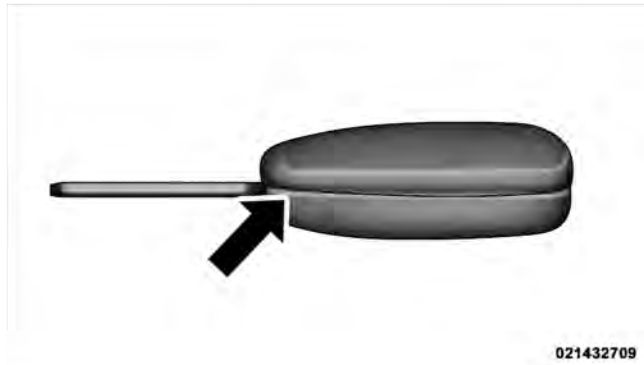

Separating Case Halves

021432709

3. Remove and replace the battery. Avoid touching the new battery with your fingers. Skin oils may cause battery deterioration. If you touch a battery, clean it with rubbing alcohol.

4. To reassemble the RKE transmitter case, snap the two halves together.

5. Reinstall and tighten the screw until snug (if equipped).

### General Information

This device complies with Part 15 of FCC rules and with RS-210 of Industry Canada. Operation is subject to the following conditions:

1. This device may not cause harmful interference.
2. This device must accept any interference that may be received including interference that may cause undesired operation.

**NOTE:** Changes or modifications not expressly approved by the party responsible for compliance could void the user's authority to operate the equipment.

If your RKE transmitter fails to operate from a normal distance, check for these two conditions:

1. Weak battery in RKE transmitter. The expected life of the battery is from one to two years.
2. Closeness to a radio transmitter such as a radio station tower, airport transmitter, and some mobile or CB radios.

### REMOTE STARTING SYSTEM — IF EQUIPPED

 This system uses the Remote Keyless Entry (RKE) transmitter to start the engine conveniently from outside the vehicle while still maintaining security. The system has a range of approximately 300 ft (91 m).

**NOTE:** The vehicle must be equipped with an automatic transmission to be equipped with Remote Start.

### How To Use Remote Start

All of the following conditions must be met before the engine will remote start:

- Shift lever in PARK.
- Doors closed.
- Hood closed.
- Liftgate closed.
- Hazard switch off.
- Brake switch inactive (brake pedal not pressed).
- Ignition key removed from ignition switch.
- Battery at an acceptable charge level.
- RKE PANIC button not pressed.

**WARNING!**

- Do not start or run an engine in a closed garage or confined area. Exhaust gas contains Carbon Monoxide (CO) which is odorless and colorless. Carbon Monoxide is poisonous and can cause serious injury or death when inhaled.
- Keep Remote Keyless Entry (RKE) transmitters away from children. Operation of the Remote Start System, windows, door locks or other controls could cause serious injury or death.

**To Enter Remote Start Mode**

 Press and release the REMOTE START button on the RKE transmitter twice within five seconds. The parking lights will flash and the horn will chirp twice (if programmed). Then, the engine will start and the vehicle will remain in the Remote Start mode for a 15-minute cycle.

**NOTE:**

- For security, power window operation and sunroof or Sky Slider® operation (if equipped) is disabled when the vehicle is in the Remote Start mode.
- The engine can be started two consecutive times (two 15-minute cycles) with the RKE transmitter. However, the ignition switch must be cycled to the ON/RUN position before you can repeat the start sequence for a third cycle.

**To Exit Remote Start Mode Without Driving The Vehicle**

Press and release the REMOTE START button one time or allow the engine to run for the entire 15-minute cycle.

**NOTE:** To avoid unintentional shut downs, the system will disable the one-time press of the REMOTE START button for two seconds after receiving a valid Remote Start request.

### To Exit Remote Start Mode And Drive The Vehicle

Before the end of the 15-minute cycle, press and release the UNLOCK button on the RKE transmitter to unlock the doors and disarm the Vehicle Security Alarm (if equipped). Then, insert the key into the ignition switch and turn the switch to the ON/RUN position.

**NOTE:** The ignition switch must be in the ON/RUN position in order to drive the vehicle.

## DOOR LOCKS

### Manual Door Locks

To lock each door, push the door lock knob on each door trim panel downward. To unlock each door, pull the door lock knob on each door trim panel upward.

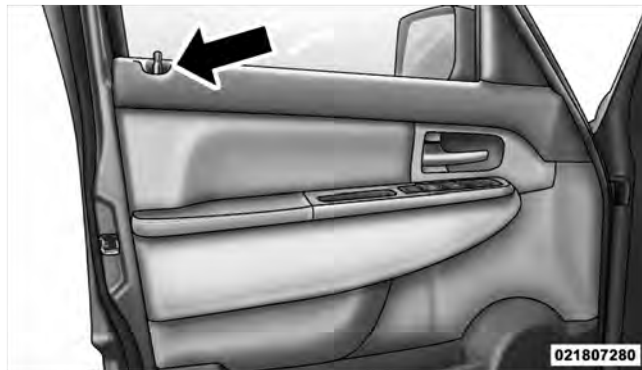

2

### Manual Lock Knob

If the door lock knob is down when you shut the door, the door will lock. Make sure the keys are not inside the vehicle before closing the door.

**NOTE:** The manual door locks will not lock or unlock the liftgate.

**WARNING!**

- For personal security and safety in the event of an accident, lock the vehicle doors as you drive as well as when you park and leave the vehicle.
- When leaving the vehicle, always remove the key from the ignition lock, and lock your vehicle. Unsupervised use of vehicle equipment may cause severe personal injuries or death.
- Never leave children alone in a vehicle. Leaving unattended children in a vehicle is dangerous for a number of reasons. A child or others could be seriously or fatally injured. Don't leave the key in the ignition. A child could operate power windows, other controls, or move the vehicle.

**Power Door Locks**

A power door lock switch is located on each of the front door trim panels. Use this switch to lock or unlock the doors and liftgate.



**Power Door Lock Switch Location**

1 - Unlock

2 - Lock



If you press the power door LOCK switch while the key is in the ignition, and any front door is open, the power locks will not operate. This prevents you from accidentally locking your keys in the vehicle. Removing the key or closing the door will allow the locks to operate. A chime will sound if the key is in the ignition switch and a door is open, as a reminder to remove the key.

### **Automatic Door Locks — If Equipped**

The doors will lock automatically if all of the following conditions are met:

1. The Automatic Door Locks feature is enabled
2. The transmission is in gear
3. All doors are closed
4. The throttle is pressed
5. The vehicle speed is above 15 mph (24 km/h)

6. The doors were not previously locked using the power door lock switch or Remote Keyless Entry (RKE) transmitter

### **Automatic Door Locks Programming — If Equipped**

The Automatic Door Locks feature can be enabled or disabled as follows:

- For vehicles equipped with the Electronic Vehicle Information Center (EVIC), refer to “Electronic Vehicle Information Center (EVIC) — If Equipped/Personal Settings (Customer-Programmable Features)” in “Understanding Your Instrument Panel” for further information.
- For vehicles not equipped with the EVIC, perform the following procedure:
  1. Close all doors and place the key in the ignition switch.

## 32 THINGS TO KNOW BEFORE STARTING YOUR VEHICLE

2. Within 15 seconds, cycle the ignition switch between LOCK and ON/RUN and then back to LOCK four times ending up in the LOCK position (do not start the engine).
3. Within 30 seconds, press the power door LOCK switch to lock the doors.
4. A single chime will indicate the completion of the programming.
5. Repeat these steps if you want to return this feature to its previous setting.

### NOTE:

- If you do not hear the chime it means that the system did not enter the programming mode and you will need to repeat the procedure.
- Use the Automatic Door Locks feature in accordance with local laws.

### Automatic Unlock Doors On Exit

The doors will unlock automatically on vehicles with power door locks if:

1. The Automatic Unlock Doors On Exit feature is enabled.
2. The transmission is in gear and the vehicle speed returned to 0 mph (0 km/h).
3. The transmission is in NEUTRAL or PARK.
4. The driver door is opened.
5. The doors were not previously unlocked.
6. The vehicle speed is 0 mph (0 km/h).

### Automatic Unlock Doors On Exit Programming

The Automatic Unlock Doors On Exit feature can be enabled or disabled as follows:

- For vehicles equipped with the Electronic Vehicle Information Center (EVIC), refer to “Electronic Vehicle Information Center (EVIC)/Personal Settings (Customer-Programmable Features)” in “Understanding Your Instrument Panel” for further information.
- For vehicles not equipped with the EVIC, perform the following procedure:
  1. Close all doors and place the key in the ignition.
  2. Cycle the ignition switch between LOCK and ON/RUN and then back to LOCK four times, ending up in the LOCK position.
  3. Press the power door UNLOCK switch to unlock the doors.

4. A single chime will indicate the completion of the programming.

Repeat these steps if you want to return this feature to its previous setting.

**NOTE:** Use the Automatic Unlock Doors On Exit feature in accordance with local laws.

### Child-Protection Door Lock System — Rear Doors

To provide a safer environment for small children riding in the rear seats, the rear doors are equipped with a Child-Protection Door Lock system.

To use the system, open each rear door, use a flat blade screwdriver (or ignition key) and rotate the dial counter-clockwise to engage the Child-Protection lock and clockwise to disengage the Child-Protection locks. When the system on a door is engaged, that door can only be

### 34 THINGS TO KNOW BEFORE STARTING YOUR VEHICLE

opened by using the outside door handle even if the inside door lock is in the unlocked position.



Child-Protection Door Lock

#### NOTE:

- When the child lock system is engaged, the door can be opened only by using the outside door handle even though the inside door lock is in the unlocked position.

- After disengaging the Child-Protection Door Lock system, always test the door from the inside to make certain it is in the desired position.
- After engaging the Child-Protection Door Lock system, always test the door from the inside to make certain it is in the desired position.
- For emergency exit with the system engaged, move the lock knob up (unlocked position), roll down the window, and open the door with the outside door handle.

#### WARNING!

**Avoid trapping anyone in a vehicle in a collision. Remember that the rear doors can only be opened from the outside when the Child-Protection locks are engaged.**

## WINDOWS

### Power Windows

The window controls on the driver's door trim panel control all the door windows.



Power Window Switches

There are single window controls on each passenger door trim panel, which operate the passenger door windows. The window controls will operate when the ignition switch is in the ON/RUN or ACC position.

### WARNING!

Never leave children in a vehicle, with the key in the ignition switch. Occupants, particularly unattended children, can become entrapped by the windows while operating the power window switches. Such entrapment may result in serious injury or death.

### Auto-Down Feature

The driver's and front passenger's (if equipped for passenger side) power window switches have an "Auto-Down" feature. Press the window switch past the first detent, release, and the window will go down automatically.

To open the window part way, press the window switch to the first detent and release it when you want the window to stop.

To stop the window from going all the way down during the Auto-Down operation, pull up on the switch briefly.

For vehicles not equipped with the Electronic Vehicle Information Center (EVIC), the power window switches will remain active for 45 seconds after the ignition switch is turned to the LOCK position. Opening either front door will cancel this feature.

For vehicles equipped with the EVIC, the power window switches will remain active for up to 10 minutes after the ignition switch is turned to the LOCK position. Opening either front door will cancel this feature. The time is programmable. Refer to “Electronic Vehicle Information Center (EVIC)/Personal Settings (Customer-programmable Features)” in “Understanding Your Instrument Panel” for further information.

### **Auto Up Feature With Anti-Pinch Protection — If Equipped**

On some models, the driver’s and front passenger’s (if equipped for passenger side) power window switches have an “Auto Up” feature. Pull the window switch fully upward to the second detent, release, and the window will go up automatically.

To stop the window from going all the way up during the Auto Up operation, push down on the switch briefly.

To close the window part way, pull the window switch up to the first detent and release when you want the window to stop.

For vehicles not equipped with the Electronic Vehicle Information Center (EVIC), the power window switches will remain active for 45 seconds after the ignition switch is turned to the LOCK position. Opening either front door will cancel this feature.

For vehicles equipped with the EVIC, the power window switches will remain active for up to 10 minutes after the ignition switch is turned to the LOCK position. Opening either front door will cancel this feature. The time is programmable. Refer to “Electronic Vehicle Information Center (EVIC)/Personal Settings (Customer-Programmable Features)” in “Understanding Your Instrument Panel” for further information.

**NOTE:**

- If the window runs into any obstacle during auto-closure, it will reverse direction and then go back down. Remove the obstacle and use the window switch again to close the window.
- Any impact due to rough road conditions may trigger the auto reverse function unexpectedly during auto-closure. If this happens, pull the switch lightly to the first detent and hold to close window manually.

**WARNING!**

**There is no anti-pinch protection when the window is almost closed. Be sure to clear all objects from the window before closing.**

**2**

**Reset**

It may be necessary at some point in time to reactivate the Auto Up feature. To do so, perform the following procedure:

1. Pull the window switch up to close the window completely and continue to hold the switch up for an additional two seconds after the window is closed.
2. Push the window switch down firmly to the second detent to open the window completely and continue to hold the switch down for an additional two seconds after the window is fully open.

### Window Lockout Button

The window lockout button on the driver's door trim panel allows you to disable the window control on the other doors. To disable the window control on the other doors, press and release the window LOCKOUT button (setting it in the down position). To enable the window controls, press and release the window LOCKOUT button again (setting it in the up position).



Window Lockout Button



## Wind Buffeting

Wind buffeting can be described as the perception of pressure on the ears or a helicopter-type sound in the ears. Your vehicle may exhibit wind buffeting with the windows down, or the sunroof or Sky Slider™ (if equipped) in certain open or partially open positions. This is a normal occurrence and can be minimized. If the buffeting occurs with the rear windows open, then open the front and rear windows together to minimize the buffeting. If the buffeting occurs with the sunroof or Sky Slider™ open, adjust the sunroof or Sky Slider™ opening to minimize the buffeting or open any window.

## LIFTGATE

To open the liftgate, pull up (squeeze) on the handle and lift.



022205927

### Liftgate Release

**NOTE:** Use the power door LOCK switch on either front door trim panel or the Remote Keyless Entry (RKE) transmitter to lock and unlock the liftgate. The manual door locks on the doors and the driver's door lock cylinder will not lock and unlock the liftgate.

**WARNING!**

Driving with the liftgate open can allow poisonous exhaust gases into your vehicle. You and your passengers could be injured by these fumes. Keep the liftgate closed when you are operating the vehicle.

**Liftgate Flipper Glass**

The liftgate flipper glass is also unlocked when the liftgate is unlocked. To open the flipper glass, push up on the window switch located on the liftgate.

**Liftgate Flipper Glass Release**

**NOTE:** To prevent accidental damage the Liftgate Flipper Glass will not open if the liftgate is ajar. Make sure the liftgate is fully closed when attempting to open the Flipper Glass.

**WARNING!**

**To avoid injury, stand back when opening. Glass may automatically rise.**

**NOTE:** If a malfunction to the liftgate latch should occur, an emergency liftgate latch release can be used to open the liftgate. The emergency liftgate latch release can be accessed through a snap-in cover located on the liftgate trim panel.

**WARNING!**

**Driving with the flipper glass open can allow poisonous exhaust gases into your vehicle. You and your passengers could be injured by these fumes. Keep the flipper glass closed when you are operating the vehicle.**

**OCCUPANT RESTRAINTS**

Some of the most important safety features in your vehicle are the restraint systems:

- Three-point lap and shoulder belts for all seating positions
- Advanced Front Air Bags for driver and front passenger
- Supplemental Active Head Restraints (AHR) located on top of the front seats (integrated into the head restraint)
- Supplemental Side Air Bag Inflatable Curtains (SABIC) for the driver and passengers seated next to a window
- An energy-absorbing steering column and steering wheel
- Knee bolsters/blockers for front seat occupants

## 42 THINGS TO KNOW BEFORE STARTING YOUR VEHICLE

- Front seat belts incorporate pretensioners that may enhance occupant protection by managing occupant energy during an impact event
- All seat belt systems (except the driver's and rear center) include Automatic Locking Retractors (ALRs), which lock the seat belt webbing into position by extending the belt all the way out and then adjusting the belt to the desired length to restrain a child seat or secure a large item in a seat — if equipped

Please pay close attention to the information in this section. It tells you how to use your restraint system properly, to keep you and your passengers as safe as possible.

If you will be carrying children too small for adult-sized seat belts, the seat belts or the Lower Anchors and Tether for CHildren (LATCH) feature also can be used to hold infant and child restraint systems. For more information on LATCH, refer to Lower Anchors and Tether for CHildren (LATCH).

**NOTE:** The Advanced Front Air Bags have a multistage inflator design. This allows the air bag to have different rates of inflation based on the severity and type of collision.

Here are some simple steps you can take to minimize the risk of harm from a deploying air bag:

1. **Children 12 years old and under should always ride buckled up in a rear seat.**

### **WARNING!**

**Infants in rear facing child restraints should never ride in the front seat of a vehicle with a passenger Advanced Front Air Bag. An air bag deployment can cause severe injury or death to infants in that position.**

Children that are not big enough to wear the vehicle seat belt properly (see section on Child Restraints) should be

secured in the rear seat in child restraints or belt-positioning booster seats. Older children who do not use child restraints or belt-positioning booster seats should ride properly buckled up in the rear seat. Never allow children to slide the shoulder belt behind them or under their arm.

If a child from 1 to 12 years old (not in a rear facing child seat) must ride in the front passenger seat, move the seat as far back as possible and use the proper child restraint. (Refer to “Child Restraints”)

You should read the instructions provided with your child restraint to make sure that you are using it properly.

**2. All occupants should always wear their lap and shoulder belts properly.**

**3. The driver and front passenger seats should be moved back as far as practical to allow the Advanced Front Air Bags room to inflate.**

**4. Do not lean against the door or window. If your vehicle has side air bags, and deployment occurs, the side air bags will inflate forcefully into the space between you and the door.**

**5. If the air bag system in this vehicle needs to be modified to accommodate a disabled person, contact the Customer Center. Phone numbers are provided under “If You Need Assistance”.**

### **WARNING!**

- **Relying on the air bags alone could lead to more severe injuries in a collision. The air bags work with your seat belt to restrain you properly. In some collisions, the air bags won't deploy at all. Always wear your seat belts even though you have air bags.**

*(Continued)*

**WARNING! (Continued)**

- **Being too close to the steering wheel or instrument panel during Advanced Front Air Bag deployment could cause serious injury, including death. Air Bags need room to inflate. Sit back, comfortably extending your arms to reach the steering wheel or instrument panel.**
- **Supplemental Side Air Bag Inflatable Curtain (SABIC) also need room to inflate. Do not lean against the door or window. Sit upright in the center of the seat.**
- **In an accident, you and your passengers can suffer much greater injuries if you are not properly buckled up. You can strike the interior of your vehicle or other passengers, or you can be thrown out of the vehicle. Always be sure you and others in your vehicle are buckled up properly.**

Buckle up even though you are an excellent driver, even on short trips. Someone on the road may be a poor driver and cause an accident that includes you. This can happen far away from home or on your own street.

Research has shown that seat belts save lives, and they can reduce the seriousness of injuries in an accident. Some of the worst injuries happen when people are thrown from the vehicle. Seat belts reduce the possibility of ejection and the risk of injury caused by striking the inside of the vehicle. Everyone in a motor vehicle should be belted at all times.

**Lap/Shoulder Belts**

All seating positions in your vehicle are equipped with lap/shoulder belts. The belt webbing retractor is designed to lock during very sudden stops or accidents. This feature allows the shoulder part of the belt to move freely with you under normal conditions. However, in an accident, the belt will lock and reduce your risk of striking the inside of the vehicle or being thrown out.

**WARNING!**

- It is dangerous to ride in a cargo area, inside or outside of a vehicle. In an accident, people riding in these areas are more likely to be seriously injured or killed.
- Do not allow people to ride in any area of your vehicle that is not equipped with seats and seat belts.
- Be sure everyone in your vehicle is in a seat and using a seat belt properly.
- Wearing a seat belt incorrectly is dangerous. Seat belts are designed to go around the large bones of your body. These are the strongest parts of your body and can take the forces of an accident the best.

*(Continued)*

**WARNING! (Continued)**

- Wearing your belt in the wrong place could make your injuries in an accident much worse. You might suffer internal injuries, or you could even slide out of part of the belt. Follow these instructions to wear your seat belt safely and to keep your passengers safe, too.
- Two people should never be belted into a single seat belt. People belted together can crash into one another in an accident, hurting one another badly. Never use a lap/shoulder belt or a lap belt for more than one person, no matter what their size.

**Lap/Shoulder Belt Operating Instructions**

1. Enter the vehicle and close the door. Sit back and adjust the seat.
2. The seat belt latch plate is located on the B-Pillar along the outboard side and rear of the seat cushion. The rear

## 46 THINGS TO KNOW BEFORE STARTING YOUR VEHICLE

seat belt latch plates are located on the C-Pillar for the outboard rear seating positions and next to your arm in the center rear seating position. Grasp the latch plate and pull out the belt. Slide the latch plate up the webbing as far as necessary to make the belt go around your lap.



Latch Plate

3. When the belt is long enough to fit, insert the latch plate into the buckle until you hear a “click.”



Latch Plate To Buckle



**WARNING!**

- A belt that is buckled into the wrong buckle will not protect you properly. The lap portion could ride too high on your body, possibly causing internal injuries. Always buckle your belt into the buckle nearest you.
- A belt that is too loose will not protect you properly. In a sudden stop, you could move too far forward, increasing the possibility of injury. Wear your seat belt snugly.

*(Continued)*

**WARNING! (Continued)**

- A belt that is worn under your arm is dangerous. Your body could strike the inside surfaces of the vehicle in an accident, increasing head and neck injury. A belt worn under the arm can cause internal injuries. Ribs aren't as strong as shoulder bones. Wear the belt over your shoulder so that your strongest bones will take the force in a collision.
- A shoulder belt placed behind you will not protect you from injury during an accident. You are more likely to hit your head in a collision if you do not wear your shoulder belt. The lap and shoulder belt are meant to be used together.

4. Position the lap belt across your thighs, below your abdomen. To remove slack in the lap belt portion, pull up a bit on the shoulder belt. To loosen the lap belt if it is too

## 48 THINGS TO KNOW BEFORE STARTING YOUR VEHICLE

tight, tilt the latch plate and pull on the lap belt. A snug belt reduces the risk of sliding under the belt in an accident.

### WARNING!

- A lap belt worn too high can increase the risk of injury in an accident. The belt forces won't be at the strong hip and pelvic bones, but across your abdomen. Always wear the lap part of your seat belt as low as possible and keep it snug.
- A twisted belt will not protect you properly. In a collision, it could even cut into you. Be sure the belt is straight. If you can't straighten a belt in your vehicle, take it to your authorized dealer immediately and have it fixed.

5. Position the shoulder belt on your chest so that it is comfortable and not resting on your neck. The retractor will withdraw any slack in the belt.



### Removing Slack From Belt

6. To release the belt, push the red button on the buckle. The belt will automatically retract to its stowed position. If necessary, slide the latch plate down the webbing to allow the belt to retract fully.

**WARNING!**

A frayed or torn belt could rip apart in an accident and leave you with no protection. Inspect the belt system periodically, checking for cuts, frays, or loose parts. Damaged parts must be replaced immediately. Do not disassemble or modify the system. Seat belt assemblies must be replaced after an accident if they have been damaged (bent retractor, torn webbing, etc.).

**Adjustable Upper Shoulder Belt Anchorage**

In the front seating positions, the shoulder belt can be adjusted upward or downward to position the belt away from your neck. Press the release button to release the anchorage, and then move it up or down to the position that fits you best.

**NOTE:** The adjustable upper shoulder belt anchorage is equipped with an Easy Up feature. This feature allows

the shoulder belt anchorage to be adjusted in the upward position without pressing the release button. To verify the shoulder belt anchorage is latched, pull downward on the shoulder belt anchorage until it is locked into position.



Adjusting Upper Shoulder Belt

As a guide, if you are shorter than average, you will prefer a lower position, and if you are taller than average, you will prefer a higher position.

### **Lap/Shoulder Belt Untwisting Procedure**

Use the following procedure to untwist a twisted lap/shoulder belt.

1. Position the latch plate as close as possible to the anchor point.
2. At about 6 to 12 in (15 to 30 cm) above the latch plate, grasp and twist the belt webbing 180 degrees to create a fold that begins immediately above the latch plate.
3. Slide the latch plate upward over the folded webbing. The folded webbing must enter the slot at the top of the latch plate.
4. Continue to slide the latch plate up until it clears the folded webbing.

### **Seat Belt Pretensioner**

The belt for driver seating position is equipped with a retractor pretensioning device, the belt for passenger seating position is equipped with both retractor and buckle pretensioning devices. These devices are designed to remove any slack from the seat belt systems in the event of a collision. These devices may improve the performance of the seat belt by assuring that the belt is tight around the occupant early in a collision. Pretensioners work for all size occupants, including those in child restraints.

**NOTE:** These devices are not a substitute for proper seat belt placement by the occupant. The seat belt must still be worn snugly and positioned properly.

The pretensioners are triggered by the Occupant Restraint Controller (ORC). Like the air bags, the pretensioners are single use items. A deployed pretensioner or a deployed air bag must be replaced immediately.

## Seat Belt Lock Out

The center rear seat belt system has a lock out feature that will not allow you to extract the center webbing unless the rear seat upper latch is engaged.

## Seat Belts In Passenger Seating Positions

The seat belts in the passenger seating positions are equipped with Automatic Locking Retractors (ALR) which are used to secure a child restraint system. For additional information, refer to “Installing Child Restraints Using The Vehicle Seat Belt” under the “Child Restraints” section. The chart below defines the type of feature for each seating position.

	Driver	Center	Passenger
First Row	N/A	N/A	ALR
Second Row	ALR	Cinching Latch Plate	ALR
Third Row	N/A	N/A	N/A

- N/A — Not Applicable

- ALR — Automatic Locking Retractor

If the passenger seating position is equipped with an ALR and is being used for normal usage:

Only pull the belt webbing out far enough to comfortably wrap around the occupant’s mid-section so as to not activate the ALR. If the ALR is activated, you will hear a ratcheting sound as the belt retracts. Allow the webbing to retract completely in this case and then carefully pull out only the amount of webbing necessary to comfortably wrap around the occupant’s mid-section. Slide the latch plate into the buckle until you hear a “click.”

## Automatic Locking Retractor Mode (ALR) — If Equipped

In this mode, the shoulder belt is automatically pre-locked. The belt will still retract to remove any slack in the shoulder belt. The Automatic Locking Mode is available on all passenger-seating positions with a combination lap/shoulder belt. Use the Automatic Locking Mode

anytime a child safety seat is installed in a seating position that has a belt with this feature. Children 12 years old and under should always be properly restrained in the rear seat.

### **How To Engage The Automatic Locking Mode**

1. Buckle the combination lap and shoulder belt.
2. Grasp the shoulder portion and pull downward until the entire belt is extracted.
3. Allow the belt to retract. As the belt retracts, you will hear a clicking sound. This indicates the safety belt is now in the Automatic Locking Mode.

### **How To Disengage The Automatic Locking Mode**

Unbuckle the combination lap/shoulder belt and allow it to retract completely to disengage the Automatic Locking Mode and activate the vehicle sensitive (emergency) locking mode.

### **WARNING!**

- **The belt and retractor assembly must be replaced if the seat belt assembly Automatic Locking Retractor (ALR) feature or any other seat belt function is not working properly when checked according to the procedures in the Service Manual.**
- **Failure to replace the belt and retractor assembly could increase the risk of injury in collisions.**

### **Supplemental Active Head Restraints (AHR)**

These head restraints are passive, deployable components, and vehicles with this equipment cannot be readily identified by any markings, only through visual inspection of the head restraint. The head restraint will be split in two halves, with the front half being soft foam and trim, the back half being decorative plastic.

### *How The Active Head Restraints (AHR) Work*

The Occupant Restraint Controller (ORC) determines whether the severity, or type of rear impact will require the Active Head Restraints (AHR) to deploy. If a rear impact requires deployment, both the driver and front passenger seat AHRs will be deployed.

When AHRs deploy during a rear impact, the front half of the head restraint extends forward to minimize the gap between the back of the occupant's head and the AHR. This system is designed to help prevent or reduce the extent of injuries to the driver and front passenger in certain types of rear impacts.

**NOTE:** The Active Head Restraints (AHR) may or may not deploy in the event of a front or side impact. However if during a front impact, a secondary rear impact occurs, the AHR may deploy based on the severity and type of the impact.

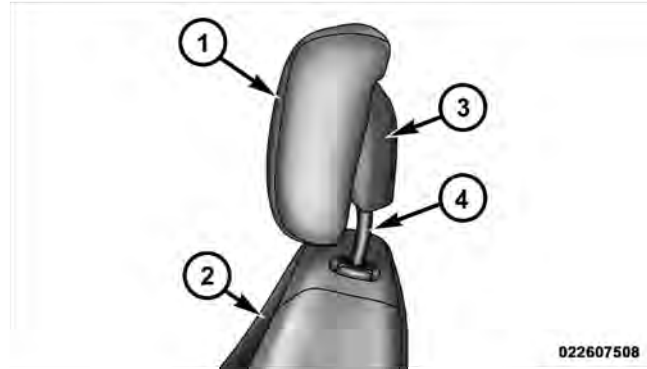

**Active Head Restraint (AHR) Components**

- |   |  |
|---|--|
| 1 — Head Restraint Front Half<br>(Soft Foam and Trim) | 3 — Head Restraint Back Half<br>(Decorative Plastic Rear<br>Cover) |
| 2 — Seatback  | 4 — Head Restraint Guide<br>Tubes                                  |

**CAUTION!**

All occupants, including the driver, should not operate a vehicle or sit in a vehicle's seat until the head restraints are placed in their proper positions in order to minimize the risk of neck injury in the event of an accident.

**NOTE:** For more information on properly adjusting and positioning the head restraint, refer to "Adjusting Active Head Restraints" in "Understanding The Features Of Your Vehicle".

**Resetting Active Head Restraints (AHR)**

If the Active Head Restraints are triggered in an accident, you must reset the head restraint on the driver's and front passenger seat. You can recognize when the Active Head Restraint has been triggered by the fact that they have moved forward (as shown in step three of the resetting procedure).

1. Grasp the deployed AHR from the rear seat.



022607492

**Hand Positioning Points On AHR**

2. Position the hands on the top of the deployed AHR at a comfortable position.
3. Pull **down** then **rearward** towards the rear of the vehicle then **down** to engage the locking mechanism.



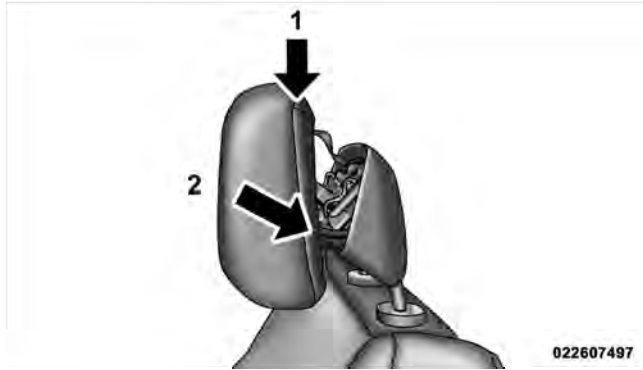

- 1 — Downward Movement
- 2 — Rearward Movement

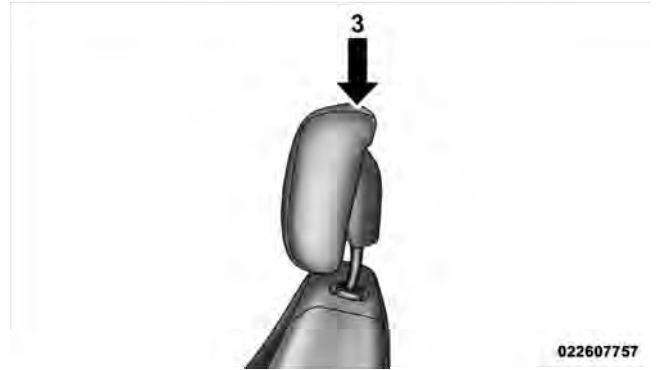

- 3 — Final Downward Movement To Engage Locking Mechanism

4. The AHR front soft foam and trim half should lock into the back decorative plastic half.



AHR In Reset Position

022607494

**NOTE:**

- If you have difficulties or problems resetting the Active Head Restraints, see an authorized dealer.

- For safety reasons, have the Active Head Restraints checked by a qualified specialist at an authorized dealer.

### Enhanced Seat Belt Use Reminder System (BeltAlert®)

BeltAlert® is a feature intended to remind the driver and front passenger (if equipped with front passenger BeltAlert®) to fasten their seat belts. This feature is active whenever the ignition is on. If the driver or front seat passenger is unbelted, the Seat Belt Reminder Light will turn on and remain on until both front seat belts are fastened. BeltAlert® triggers within 60 seconds of vehicle speed over 5 mph (8 km/h). The reminder sequence lasts for 96 seconds or until the respective seat belts are fastened. After the sequence completes, the Seat Belt Reminder Light remains illuminated until front belts are fastened. The driver should instruct all other occupants to fasten their seat belts. If a front seat belt is unbuckled while traveling at speeds greater than 5 mph (8 km/h),

BeltAlert® will chime as a single notification and illuminate the Seat Belt Reminder Light, then will proceed to the 96 second reminder sequence.

The front passenger seat BeltAlert® is not active when the front passenger seat is unoccupied. BeltAlert® may be triggered when an animal or heavy object is on the front passenger seat or when the seat is folded flat (if equipped). It is recommended that pets be restrained in the rear seat in pet harnesses or pet carriers that are secured by seat belts, and cargo is properly stowed.

BeltAlert® can be enabled or disabled by your authorized dealer or by following these steps:

**NOTE:** The following steps must occur within the first 60 seconds of the ignition switch being turned to the ON/RUN or START position. Chrysler Group LLC does not recommend deactivating BeltAlert®.

1. Turn the ignition switch to the OFF position, and buckle the driver's seat belt.
2. Turn the ignition key to the ON/RUN position (do not start the engine), and wait for the Seat Belt Reminder Light to turn off.
3. Within 60 seconds of starting the vehicle, unbuckle and then re-buckle the driver's seat belt at least three times within 10 seconds, ending with the seat belt buckled.
4. Turn the ignition key to the OFF position. A single chime will sound to signify that you have successfully completed the programming.

BeltAlert® can be reactivated by repeating this procedure.

**NOTE:** Although BeltAlert® has been deactivated, the Seat Belt Reminder Light will continue to illuminate while the driver's seat belt remains unfastened.

### Energy Management Feature

This vehicle has a safety belt system with an energy management feature in the front seating positions to help further reduce the risk of injury in the event of a head-on accident.

This safety belt system has a retractor assembly that is designed to release webbing in a controlled manner. This feature is designed to help reduce the belt force acting on the occupant's chest.

#### **WARNING!**

- **The belt and retractor assembly must be replaced if the seat belt assembly “Automatic Locking Retractor (ALR)” feature or any other seat belt function is not working properly when checked according to the procedures in the Service Manual.**
- **Failure to replace the belt and retractor assembly could increase the risk of injury in accidents.**

### Seat Belts And Pregnant Women

We recommend that pregnant women use the seat belts throughout their pregnancy. Keeping the mother safe is the best way to keep the baby safe.

Pregnant women should wear the lap part of the belt across the thighs and as snug across the hips as possible. Keep the belt low so that it does not come across the abdomen. That way the strong bones of the hips will take the force if there is an accident.

### Seat Belt Extender

If a seat belt is too short, even when fully extended, and when the adjustable upper shoulder belt anchorage (if so equipped) is in its lowest position, your authorized dealer can provide you with a seat belt extender. This extender should be used only if the existing belt is not long enough. When it is not required, remove the extender, and store it.

**WARNING!**

Using a seat belt extender when not needed can increase the risk of injury in an accident. Only use when the lap belt is not long enough when it is worn low and snug, and in the recommended seating positions. Remove and store the extender when not needed.

**Supplemental Restraint System (SRS) — Air Bags**

This vehicle has Advanced Front Air Bags for both the driver and front passenger as a supplement to the seat belt restraint systems. The driver's Advanced Front Air Bag is mounted in the steering wheel. The passenger's Advanced Front Air Bag is mounted in the instrument panel, above the glove compartment. The words SRS/AIRBAG are embossed on the air bag covers.

**NOTE:** These air bags are certified to the new Federal regulations for Advanced Air Bags.

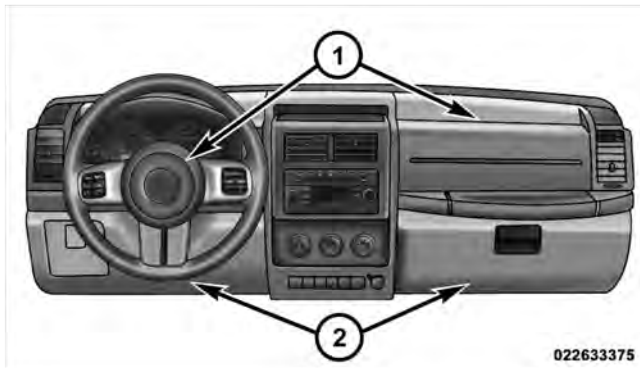
**Advanced Front Air Bag And Knee Bolster Locations**

- 1 — Driver And Passenger Advanced Front Air Bags
- 2 — Knee Bolster

The Advanced Front Air Bags have a multistage inflator design. This allows the air bag to have different rates of inflation that are based on the severity and type of collision.

## 60 THINGS TO KNOW BEFORE STARTING YOUR VEHICLE

This vehicle may be equipped with driver and/or front passenger seat track position sensors that may adjust the inflation rate of the Advanced Front Air Bags based upon seat position.

This vehicle may be equipped with a driver and/or front passenger seat belt buckle switch that detects whether the driver or front passenger seat belt is fastened. The seat belt buckle switch may adjust the inflation rate of the Advanced Front Air Bags.

This vehicle is equipped with Supplemental Side Air Bag Inflatable Curtains (SABIC) that run the entire length of the headliner to protect the driver and passengers in the first and second row sitting next to a window.



**Supplemental Side Air Bag Inflatable Curtains (SABIC) Label Location**

### NOTE:

- Air Bag covers may not be obvious in the interior trim, but they will open during air bag deployment.
- After any accident, the vehicle should be taken to an authorized dealer immediately.

## Air Bag System Components

Your vehicle may be equipped with the following air bag system components:

- Occupant Restraint Controller (ORC)
- Air Bag Warning Light
- Steering Wheel and Column
- Instrument Panel
- Knee Impact Bolster
- Driver Advanced Front Air Bag
- Passenger Advanced Front Air Bag
- Supplemental Side Air Bag Inflatable Curtains (SABIC)
- Front and Side Impact Sensors
- Front Seat Belt Pretensioners, Seat Belt Buckle Switch, and Seat Track Position Sensors

- Supplemental Active Head Restraint for Driver and Front Passenger
- Occupant Classification System (OCS)
  - Occupant Classification Module (OCM)
  - Passenger Air Bag Disable (PAD) Indicator Light
  - Weight Sensors

## Advanced Front Air Bag Features

The Advanced Front Air Bag system has multistage driver and front passenger air bags. This system provides output appropriate to the severity and type of collision as determined by the Occupant Restraint Controller (ORC), which may receive information from the front impact sensors.

The first stage inflator is triggered immediately during an impact that requires air bag deployment. This low output is used in less severe collisions. A higher energy output is used for more severe collisions.

**NOTE:** The passenger Advanced Front Air Bag may not deploy, even when the driver Advanced Front Air Bag has, if the Occupant Classification System (refer to "Occupant Classification System") has determined the passenger seat is empty or is occupied by someone that is classified in the "child" size category. This could be a child, teenager, or even an adult.

**WARNING!**

- No objects should be placed over or near the air bag on the instrument panel, because any such objects could cause harm if the vehicle is in a collision severe enough to cause the air bag to inflate.

*(Continued)*

**WARNING! (Continued)**

- Do not put anything on or around the air bag covers or attempt to manually open them. You may damage the air bags and you could be injured because the air bags may no longer be functional. These protective covers for the air bag cushions are designed to open only when the air bags are inflating.
- Do not use accessory seat covers or place objects between you and the side air bags; the performance could be adversely affected and/or objects could be pushed into you, causing serious injury.
- Do not drill, cut or tamper with the knee bolster in any way.
- Do not mount any accessories to the knee bolster such as alarm lights, stereos, citizen band radios, etc.

*(Continued)*



**WARNING! (Continued)**

- **Do not have any accessory items installed which will alter the roof, including adding a sunroof to your vehicle. Do not add roof racks that require permanent attachments (bolts or screws) for installation on the vehicle roof. Do not drill into the roof of the vehicle for any reason.**

**Supplemental Side Air Bag Inflatable Curtain (SABIC)**

SABIC air bags may offer side-impact and vehicle rollover protection to front and rear seat outboard occupants in addition to that provided by the body structure. Each air bag features inflated chambers placed adjacent to the head of each outboard occupant that reduce the potential for side-impact head injuries. The SABIC air bags deploy downward, covering both windows on the impact side.

**NOTE:**

- Should a vehicle rollover occur, the pretensioners and/or SABIC air bags on both sides of the vehicle may deploy.
- Air Bag covers may not be obvious in the interior trim, but they will open during air bag deployment.
- Being too close to the side air bags during deployment could cause you to be severely injured or killed.

The system includes side impact sensors that are calibrated to deploy the side air bags during impacts that require side air bag occupant protection.

- If your vehicle is equipped with left and right Supplemental Side Air Bag Inflatable Curtain (SABIC), do not stack luggage or other cargo up high enough to block the location of the SABIC. The area where the SABIC is located should remain free from any obstructions.

- Do not use accessory seat covers or place objects between you and the side air bags; the performance could be adversely affected and/or objects could be pushed into you, causing serious injury.
- If your vehicle is equipped with SABIC air bags, do not have any accessory items installed which will alter the roof, including adding a sunroof to your vehicle. Do not add roof racks that require permanent attachments (bolts or screws) for installation on the vehicle roof. Do not drill into the roof of the vehicle for any reason.

### **Knee Impact Bolsters**

The Knee Impact Bolsters help protect the knees of the driver and the front passenger, and position front occupants for the best interaction with the Advanced Front Air Bag.

Along with seat belts and pretensioners, Advanced Front Air Bags work with the knee bolsters to provide improved protection for the driver and front passenger. Side air bags also work with seat belts to improve occupant protection.

### **Air Bag Deployment Sensors And Controls**

#### **Occupant Restraint Controller (ORC)**

The **ORC** is part of a Federally regulated safety system required for this vehicle.

The ORC determines if deployment of the front and/or side air bags in a frontal or side collision is required. Based on the impact sensor's signals, a central electronic ORC deploys the Advanced Front Air Bags, Supplemental Side Air Bag Inflatable Curtain (SABIC), and front seat belt pretensioners, as required, depending on the severity and type of impact.

Advanced Front Air Bags are designed to provide additional protection by supplementing the seat belts in certain frontal collisions depending on the severity and type of collision. Advanced Front Air Bags are not expected to reduce the risk of injury in rear, side, or rollover collisions.

The Advanced Front Air Bags will not deploy in all frontal collisions, including some that may produce substantial vehicle damage — for example, some pole collisions, truck underrides, and angle offset collisions. On the other hand, depending on the type and location of impact, Advanced Front Air Bags may deploy in crashes with little vehicle front-end damage but that produce a severe initial deceleration.

The SABIC will not deploy in all side collisions. SABIC deployment will depend on the severity and type of collision.

Because air bag sensors measure vehicle deceleration over time, vehicle speed and damage by themselves are not good indicators of whether or not an air bag should have deployed.

Seat belts are necessary for your protection in all crashes, and also are needed to help keep you in position, away from an inflating air bag.

The ORC also monitors the readiness of the electronic parts of the air bag system whenever the ignition switch is in the START or ON/RUN positions. If the key is in the LOCK position, in the ACC position, or not in the ignition, the air bag system is not on and the air bags will not inflate.

The ORC contains a backup power supply system that may deploy the air bags even if the battery loses power or it becomes disconnected prior to deployment.



Also, the ORC turns on the “Air Bag Warning Light” for four to eight seconds for a self-check when the ignition is first turned to ON/RUN.

After the self-check, the “Air Bag Warning Light” will turn off. If the ORC detects a malfunction in any part of the system, it turns on the “Air Bag Warning Light” either momentarily or continuously. A single chime will sound if the light comes on again after initial startup.

It also includes diagnostics that will illuminate the instrument cluster Air Bag Warning Light if a malfunction is noted that could affect the air bag system. The diagnostics also record the nature of the malfunction.

### **WARNING!**

**Ignoring the Air Bag Warning Light in your instrument panel could mean you won't have the air bags to protect you in a collision. If the light does not come on as a bulb check when the ignition is first turned on, stays on after you start the vehicle, or if it comes on as you drive, have an authorized dealer service the air bag system immediately.**

### **Occupant Classification System (OCS)**

The OCS is part of a Federally regulated safety system required for this vehicle. It is designed to turn off the passenger Advanced Front Air Bag for an empty seat and for occupants classified in a category other than an adult. This could be a child, teenager, or even an adult.

**NOTE:** Children 12 years or younger should always ride buckled up in a rear seat in an appropriate child restraint.

- *Occupant Classification Module (OCM)*

The **OCM** is located beneath the front passenger seat. The OCM classifies the occupant into categories based on the measurements made by the seat weight sensors. The OCM communicates with the ORC. The ORC uses the occupant category to determine whether the passenger Advanced Front Air Bag should be turned off. It also determines the rate of air bag inflation during a collision.

- *Weight Sensors*

Your vehicle has four Weight Sensors located between the seat and the floor pan. The weight sensors measure applied weight and transfers that information to the OCM.

- *Passenger Air Bag Disable (PAD) Indicator Light*

The **PAD Indicator Light** (an amber light located in the center of the instrument panel) tells the driver and front passenger when the passenger Advanced Front Air Bag is turned off. The PAD Indicator light illuminates the words

“PASS AIR BAG OFF” to show that the passenger Advanced Front Air Bag will not inflate during a collision requiring air bag deployment. When the right front passenger seat is empty or when very light objects are placed on the seat, the passenger air bag will not inflate even though the PAD indicator light is not illuminated.



Indicator Light Location

The PAD indicator light should not be illuminated when an adult passenger is properly seated in the front passenger seat. In this case, the passenger Advanced Front Air Bag is ready to be inflated if a collision requires an air bag deployment.

For all other occupants, the PAD indicator light will be illuminated indicating that the passenger Advanced Front Air Bag is turned off and will not inflate.

**NOTE:** Even though this vehicle is equipped with an occupant classification system, children 12 years or younger should always ride buckled up in a rear seat in an appropriate child restraint (refer to “Child Restraints”).

### **WARNING!**

**Never place a rear facing infant seat in front of an air bag. A deploying passenger Advanced Front Air Bag can cause death or serious injury to a child in a rear-facing infant seat.**

<b>Passenger Air Bag Disable (PAD) System</b>		
<b>Front Passenger</b>	<b>Indicator Light</b>	<b>Air Bag Status</b>
Adult	OFF	ON
Child	ON	OFF
Grocery Bags, Heavy Briefcases and Other Relatively Light Objects	ON	OFF
Empty or Very Light Objects	OFF*	OFF
* Since the system senses weight, some small objects will turn the PAD Indicator Light on.		

Drivers and adult passengers should verify that the PAD Indicator Light is not illuminated when an adult is riding in the front passenger seat. If an adult occupant's weight is transferred to another part of the vehicle (like the door or instrument panel), the weight sensors in the seat may not properly classify the occupant. Objects lodged under the seat or between the seat and the center console can prevent the occupant's weight from being measured properly and may result in the occupant being improperly classified. Ensure that the front passenger seatback does not touch anything placed on the second row of seats because this can also affect occupant classification. Also, if you fold down the seats in the second row check to be sure they don't touch the front passenger seat.

If the front passenger seat is damaged in any way, it should only be serviced by an authorized dealer. If the seat is removed (or even if the seat attachment bolts are loosened or tightened in any way), take the vehicle to an authorized dealer.

If there is a fault present in the air bag system, the Air Bag Warning Light (a red light located in the center of the instrument cluster directly in front of the driver) will be turned on. This indicates that you should have an authorized dealer service the system immediately. The Air Bag Warning Light is turned on whenever there is a fault that can affect the operation of the air bag system. If there is a fault present in the PAD Indicator Light, the Air Bag Warning Light will be illuminated to show that the passenger Advanced Front Air Bag may be turned off until the fault is cleared. If the Air Bag Warning Light is illuminated, have an authorized dealer service the air bag system immediately. If an object is lodged under the seat and interferes with operation of the weight sensors, a fault will occur which turns on both the PAD Indicator Light and the Air Bag Warning Light. Once the lodged object is removed, the fault will be automatically cleared after a short period of time.

### **Driver And Passenger Advanced Front Air Bag Inflator Units**

The **Driver And Passenger Advanced Front Air Bag Inflator Units** are located in the center of the steering wheel and on the right side of the instrument panel. When the ORC detects a collision requiring the Advanced Front Air Bags, it signals the inflator units. A large quantity of non-toxic gas is generated to inflate the Advanced Front Air Bags. Different air bag inflation rates are possible based on collision severity and type. The steering wheel hub trim cover and the upper right side of the instrument panel separate and fold out of the way as the air bags inflate to their full size. The air bags fully inflate in about 50 to 70 milliseconds. This is about half of the time it takes to blink your eyes. The air bags then quickly deflate while helping to restrain the driver and front passenger.

The Advanced Front Air Bag gas is vented through the vent holes in the sides of the air bag. In this way, the air bags do not interfere with your control of the vehicle.

Along with seat belts and pretensioners, Advanced Front Air Bags work with the knee bolsters to provide improved protection for the driver and front passenger. Side air bags also work with seat belts to improve occupant protection.

### **Supplemental Side Air Bag Inflatable Curtains (SABIC)**

The **Supplemental Side Air Bag Inflatable Curtains (SABIC)** may deploy during rollovers and collisions where the impact is confined to a particular area of the side of the vehicle, depending on the severity and type of collision. In these events, the ORC will deploy the SABIC only on the impact side of the vehicle. Because air bag sensors estimate deceleration over time, vehicle speed



and damage by themselves are not good indicators of whether or not an air bag should have deployed.

A quantity of non-toxic gas is generated to inflate the side curtain air bag. The inflating side curtain air bag pushes the outside edge of the headliner out of the way and covers the window. The air bag inflates in about 30 milliseconds (about one quarter of the time it takes to blink your eyes) with enough force to injure you if you are not belted and seated properly, or if items are positioned in the area where the side curtain air bag inflates. This especially applies to children. The side curtain air bag is only about 3½ inches (9 cm) thick when it is inflated.

The system includes side impact sensors that are calibrated to deploy the side air bags during impacts that require air bag occupant protection.

### **WARNING!**

**If your vehicle is equipped with left and right Supplemental Side Air Bag Inflatable Curtains (SABIC), do not stack luggage or other cargo up high enough to block the location of the SABIC. The area where the SABIC is located should remain free from any obstructions.**

The front passenger seat assembly contains critical components that affect the front passenger air bag deployment. Correctly functioning front passenger seat components are critical for the Occupant Classification System (OCS) to properly classify the front passenger and calculate the proper air bag deployment. Do not make any modifications to the front passenger seat components, assembly, or to the seat cover.

## 72 THINGS TO KNOW BEFORE STARTING YOUR VEHICLE

The following requirements must be strictly adhered to:

- Do not modify the front passenger seat assembly or components in any way.
- Do not use prior or future model year seat covers not designated for the specific model being repaired. Always use the correct seat cover specified for the vehicle.
- Do not replace the seat cover with an aftermarket seat cover.
- Do not add a secondary seat cover other than those approved by Chrysler Group LLC/Mopar®.
- At no time should any Supplemental Restraint System (SRS) component or SRS related component or fastener be modified or replaced with any part except those which are approved by Chrysler Group LLC/Mopar®.

### **WARNING!**

**Unapproved modifications or service procedures to the front passenger seat assembly, its related components or seat cover may inadvertently change the air bag deployment in case of a frontal crash. This could result in death or serious injury to the front seat passenger if the vehicle is involved in a collision. A modified vehicle may not comply with required Federal Motor Vehicle Safety Standards (FMVSS) and/or Canadian Motor Vehicle Safety Standards (CMVSS).**

### **Front And Side Impact Sensors**

In front and side impacts, impact sensors can aid the ORC in determining appropriate response to impact events.

### Enhanced Accident Response System

In the event of an impact causing air bag deployment, if the communication network remains intact, and the power remains intact, depending on the nature of the event the ORC will determine whether to have the Enhanced Accident Response System perform the following functions:

- Cut off fuel to the engine.
- Flash hazard lights as long as the battery has power or until the ignition key is turned off.
- Turn on the interior lights, which remain on as long as the battery has power or until the ignition key is removed.
- Unlock the doors automatically.

### If A Deployment Occurs

The front air bags are designed to deflate immediately after deployment.

**NOTE:** Front and/or side air bags will not deploy in all collisions. This does not mean something is wrong with the air bag system.

If you do have a collision which deploys the air bags, any or all of the following may occur:

- The nylon air bag material may sometimes cause abrasions and/or skin reddening to the driver and front passenger as the air bags deploy and unfold. The abrasions are similar to friction rope burns or those you might get sliding along a carpet or gymnasium floor. They are not caused by contact with chemicals. They are not permanent and normally heal quickly. However, if you haven't healed significantly within a few days, or if you have any blistering, see your doctor immediately.
- As the air bags deflate you may see some smoke-like particles. The particles are a normal by-product of the process that generates the non-toxic gas used for air

bag inflation. These airborne particles may irritate the skin, eyes, nose, or throat. If you have skin or eye irritation, rinse the area with cool water. For nose or throat irritation, move to fresh air. If the irritation continues, see your doctor. If these particles settle on your clothing, follow the garment manufacturer's instructions for cleaning.

Do not drive your vehicle after the air bags have deployed. If you are involved in another collision, the air bags will not be in place to protect you.

**WARNING!**

Deployed air bags cannot protect you in another collision. Have the air bags, and seat belt retractor assembly replaced by an authorized dealer immediately.

**Maintaining Your Air Bag System****WARNING!**

- **Modifications to any part of the air bag system could cause it to fail when you need it. You could be injured if the air bag system is not there to protect you. Do not modify the components or wiring, including adding any kind of badges or stickers to the steering wheel hub trim cover or the upper right side of the instrument panel. Do not modify the front bumper or vehicle body structure or add aftermarket side steps or running boards.**

*(Continued)*

**WARNING! (Continued)**

- Do not attempt to modify any part of your air bag system. The air bag may inflate accidentally or may not function properly if modifications are made. Take your vehicle to an authorized dealer for any air bag system service. If your seat including your trim cover and cushion needs to be serviced in any way (including removal or loosening/tightening of seat attachment bolts), take the vehicle to your authorized dealer. Only manufacturer approved seat accessories may be used. If it is necessary to modify the air bag system for persons with disabilities, contact your authorized dealer.
- It is dangerous to try to repair any part of the air bag system yourself. Be sure to tell anyone who works on your vehicle that it has an air bag system.

**Air Bag Warning Light**

You will want to have the air bags ready to inflate for your protection in a collision. The Air Bag Warning Light monitors the internal circuits and interconnecting wiring associated with air bag system electrical components. While the air bag system is designed to be maintenance free. If any of the following occurs, have an authorized dealer service the air bag system immediately.

- The Air Bag Warning Light does not come on during the four to eight seconds when the ignition switch is first turned to the ON/RUN position.
- The Air Bag Warning Light remains on after the four to eight-second interval.
- The Air Bag Warning Light comes on intermittently or remains on while driving.

**NOTE:** If the speedometer, tachometer, or any engine related gauges are not working, the Occupant Restraint Controller (ORC) may also be disabled. The air bags may not be ready to inflate for your protection. Promptly check the fuse block for blown fuses. Refer to the label located on the inside of the fuse block cover for the proper air bag fuses. See your authorized dealer if the fuse is good.

### **Event Data Recorder (EDR)**

This vehicle is equipped with an event data recorder (EDR). The main purpose of an EDR is to record, in certain crash or near crash-like situations, such as an air bag deployment or hitting a road obstacle, data that will assist in understanding how a vehicle's systems performed. The EDR is designed to record data related to vehicle dynamics and safety systems for a short period of time, typically 30 seconds or less. The EDR in this vehicle is designed to record such data as:

- How various systems in your vehicle were operating;

- Whether or not the driver and passenger safety belts were buckled/fastened;
- How far (if at all) the driver was depressing the accelerator and/or brake pedal; and,
- How fast the vehicle was traveling.

These data can help provide a better understanding of the circumstances in which crashes and injuries occur.

**NOTE:** EDR data are recorded by your vehicle only if a non-trivial crash situation occurs; no data are recorded by the EDR under normal driving conditions and no personal data (e.g., name, gender, age, and crash location) are recorded. However, other parties, such as law enforcement, could combine the EDR data with the type of personally identifying data routinely acquired during a crash investigation.

To read data recorded by an EDR, special equipment is required, and access to the vehicle or the EDR is needed.

In addition to the vehicle manufacturer, other parties, such as law enforcement, that have the special equipment, can read the information if they have access to the vehicle or the EDR.

### **Child Restraints**

Everyone in your vehicle needs to be buckled up all the time, including babies and children. Every state in the United States and all Canadian provinces require that small children ride in proper restraint systems. This is the law, and you can be prosecuted for ignoring it.

Children 12 years or younger should ride properly buckled up in a rear seat, if available. According to crash statistics, children are safer when properly restrained in the rear seats rather than in the front.

### **WARNING!**

**In a collision, an unrestrained child, even a tiny baby, can become a projectile inside the vehicle. The force required to hold even an infant on your lap can become so great that you could not hold the child, no matter how strong you are. The child and others could be badly injured. Any child riding in your vehicle should be in a proper restraint for the child's size.**

There are different sizes and types of restraints for children from newborn size to the child almost large enough for an adult safety belt. Always check the child seat Owner's Manual to ensure you have the right seat for your child. Use the restraint that is correct for your child.

## Infants And Child Restraints

- Safety experts recommend that children ride rearward-facing in the vehicle until they are at least one year old and weigh at least 20 lbs (9 kg). Two types of child restraints can be used rearward-facing: infant carriers and “convertible” child seats.
- The infant carrier is only used rearward-facing in the vehicle. It is recommended for children who weigh up to about 20 lbs (9 kg). “Convertible” child seats can be used either rearward-facing or forward-facing in the vehicle. Convertible child seats often have a higher weight limit in the rearward-facing direction than infant carriers do, so they can be used rearward-facing by children who weigh more than 20 lbs (9 kg) but are less than one year old. Both types of child restraints are held in the vehicle by the lap/shoulder belt or the LATCH child restraint anchorage system. Refer to “Lower Anchors and Tether for Children (LATCH)”.

### WARNING!

**Rearward-facing child seats must never be used in the front seat of a vehicle with the front passenger air bag unless the air bag is turned off. An air bag deployment could cause severe injury or death to infants in this position.**

## Older Children And Child Restraints

Children who weigh more than 20 lbs (9 kg) and who are older than one year can ride forward-facing in the vehicle. Forward-facing child seats and convertible child seats used in the forward-facing direction are for children who weigh 20 to 40 lbs (9 to 18 kg) and who are older than one year. These child seats are also held in the vehicle by the lap/shoulder belt or the LATCH child restraint anchorage system. Refer to “Lower Anchors and Tether for Children (LATCH)”.



The belt-positioning booster seat is for children weighing more than 40 lbs (18 kg), but who are still too small to fit the vehicle's seat belts properly. If the child cannot sit with knees bent over the vehicle's seat cushion while the child's back is against the seatback, they should use a belt-positioning booster seat. The child and belt-positioning booster seat are held in the vehicle by the lap/shoulder belt.

### **Children Too Large For Booster Seats**

Children who are large enough to wear the shoulder belt comfortably, and whose legs are long enough to bend over the front of the seat when their back is against the seat back, should use the lap/shoulder belt in a rear seat.

- Make sure that the child is upright in the seat.
- The lap portion of the seat belt should be low on the hips and as snug as possible.

- Check belt fit periodically. A child's squirming or slouching can move the belt out of position.
- If the shoulder belt contacts the face or neck, move the child closer to the center of the vehicle. Never allow a child to put the shoulder belt under an arm or behind their back.

**NOTE:** For additional information, refer to [www.seatcheck.org](http://www.seatcheck.org) or call 1-866-SEATCHECK. Canadian residents should refer to Transport Canada's website for additional information: <http://www.tc.gc.ca/roadsafety/safedrivers/childsafety/index.htm>

**WARNING!**

- Improper installation can lead to failure of an infant or child restraint. It could come loose in a collision. The child could be badly injured or killed. Follow the manufacturer's directions exactly when installing an infant or child restraint.
- A rearward-facing infant restraint should only be used in a rear seat. A rearward-facing infant restraint in the front seat may be struck by a deploying passenger air bag, which may cause severe or fatal injury to the infant.

Here are some tips on getting the most out of your child restraint:

- Before buying any restraint system, make sure that it has a label certifying that it meets all applicable Safety Standards. Chrysler Group LLC also recommends that you try a child restraint in the vehicle seats where you will use it before you buy it.
- The restraint must be appropriate for your child's weight and height. Check the label on the restraint for weight and height limits.
- Carefully follow the instructions that come with the restraint. If you install the restraint improperly, it may not work when you need it.
- Buckle the child into the restraint exactly as the manufacturer's instructions tell you.

**WARNING!**

**When your child restraint is not in use, secure it in the vehicle with the seat belt or remove it from the vehicle. Do not leave it loose in the vehicle. In a sudden stop or accident, it could strike the occupants or seatbacks and cause serious personal injury.**

**Lower Anchors and Tether for Children (LATCH)**

Your vehicle's rear seat is equipped with the child restraint anchorage system called LATCH. The LATCH system provides for the installation of the child restraint without using the vehicle's seat belts, instead securing the child restraint using lower anchorages and upper tether straps from the child restraint to the vehicle structure.

LATCH-compatible child restraint systems are now available. However, because the lower anchorages are to be introduced over a period of years, child restraint systems having attachments for those anchorages will continue to

have features for installation using the vehicle's seat belts. Child restraints having tether straps and hooks for connection to the top tether anchorages have been available for some time. For some older child restraints, many child restraint manufacturers offer add-on tether strap kits or retrofit kits. You are urged to take advantage of all the available attachments provided with your child restraint in any vehicle.

All three rear seating positions have lower anchorages that are capable of accommodating LATCH-compatible child seats having flexible webbing mounted attachments. Child seats with fixed lower attachments must be installed in the outboard seating positions only. The center seating position will accommodate LATCH-compatible lower anchorages with flexible webbing mounted attachments only. Regardless of the specific type of lower attachment. Never install LATCH-compatible child seats such that two seats share a common lower anchorage.

If you are installing LATCH-compatible child restraints in adjacent rear seating positions, you can use the LATCH anchors or the vehicle's seat belt for the outboard position, but you must use the vehicle's seat belt at the center position. If your child restraints are not LATCH-compatible, you can only install the child restraints using the vehicle's seat belts. Please refer to "Installing The LATCH-Compatible Child Restraint System" and "Installing Child Restraints Using The Vehicle Seat Belt" for typical installation instructions.

### Installing The LATCH-Compatible Child Restraint System

We urge you to carefully follow the directions of the manufacturer when installing your child restraint. Not all child restraint systems will be installed as described here. Again, carefully follow the installation instructions that were provided with the child restraint system.

The rear seat lower anchorages are round bars, located at the rear of the seat cushion where it meets the seatback, and are just visible when you lean into the rear seat to install the child restraint. You will easily feel them if you run your finger along the intersection of the seatback and seat cushion surfaces.



Latch Anchorages

In addition, there are tether strap anchorages behind each rear seating position located on the back of the seat.

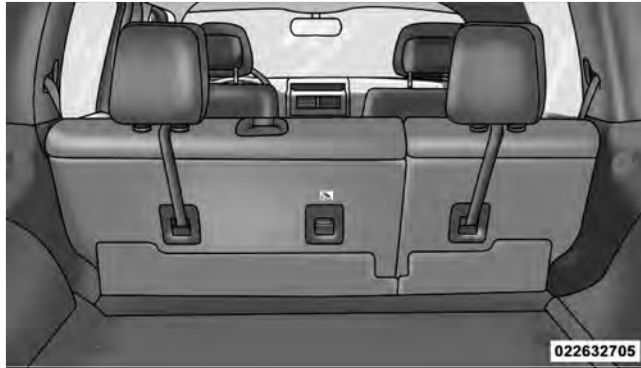

### Tether Strap Mounting

Many, but not all, restraint systems will be equipped with separate straps on each side, with each having a hook or connector for attachment to the lower anchorage and a

means of adjusting the tension in the strap. Forward-facing toddler restraints and some rear-facing infant restraints will also be equipped with a tether strap, a hook for attachment to the tether strap anchorage and a means of adjusting the tension of the strap.

You will first loosen the child seat adjusters on the lower straps and on the tether strap so that you can more easily attach the hooks or connectors to the vehicle anchorages. Next, attach the lower hooks or connectors over the top of the anchorage bars, pushing aside the seat cover material. Then, locate the tether anchorage directly behind the seat where you are placing the child restraint and attach the tether strap to the anchorage, being careful to route the tether strap to provide the most direct path between the anchor and the child restraint. For the outboard seating positions, route the tether underneath the head restraint and attach the hook to the tether anchor located on the back of the seat. Finally, tighten all three straps as you push the child restraint rearward and

downward into the seat, removing slack in the straps according to the child restraint manufacturer's instructions.

### WARNING!

**Improper installation of a child restraint to the LATCH anchorages can lead to failure of an infant or child restraint. The child could be badly injured or killed. Follow the manufacturer's directions exactly when installing an infant or child restraint.**

### Installing Child Restraints Using The Vehicle Seat Belts

The seat belts in the passenger seating positions are equipped with an Automatic Locking Retractor (ALR) or a cinching latch plate to secure a Child Restraint System (CRS). These types of seat belts are designed to keep the lap portion of the seat belt tight around the child restraint so that it is not necessary to use a locking clip. The ALR

will make a ratcheting noise if you extract the entire belt from the retractor and then allow the belt to retract into the retractor. For additional information on ALR, refer to "Automatic Locking Mode" description under "Seat Belts in Passenger Seating Positions" section. The chart below defines the seating positions with an Automatic Locking Retractor (ALR) or a cinching latch plate.

	Driver	Center	Passenger
First Row	N/A	N/A	ALR
Second Row	ALR	Cinching Latch Plate	ALR
Third Row	N/A	N/A	N/A

- N/A — Not Applicable
- ALR — Automatic Locking Retractor

To attach a child restraint tether strap:

1. To install a child restraint with ALR, first, pull enough of the seat belt webbing from the retractor to route it

through the belt path of the child restraint. Slide the latch plate into the buckle until you hear a “click.” Next, extract all the seat belt webbing out of the retractor and then allow the belt to retract into the retractor. As the belt retracts, you will hear a ratcheting sound. This indicates the safety belt is now in the Automatic Locking mode.

2. Finally, pull on any excess webbing to tighten the lap portion around the child restraint. Any seat belt system will loosen with time, so check the belt occasionally, and pull it tight if necessary.

Installing a Child Restraint with a Cinching Latch Plate:

1. To install a child restraint with a cinching latch plate, first, pull enough of the seat belt webbing from the retractor to route it through the belt path of the child. Slide the latch plate into the buckle until you hear a “click.”

2. Finally, pull on any excess webbing to tighten the lap portion around the child restraint. Any seat belt system will loosen with time, so check the belt occasionally, and pull it tight if necessary.

- In the rear seat, you may have trouble tightening the lap/shoulder belt on the child restraint because the buckle or latch plate is too close to the belt path opening on the restraint. Disconnect the latch plate from the buckle and twist the short buckle-end belt several times to shorten it. Insert the latch plate into the buckle with the release button facing out.
- If the belt still can't be tightened, or if pulling and pushing on the restraint loosens the belt, disconnect the latch plate from the buckle, turn the buckle around, and insert the latch plate into the buckle again. If you still can't make the child restraint secure, try a different seating position.

To attach a child restraint tether strap

## 86 THINGS TO KNOW BEFORE STARTING YOUR VEHICLE

- Route the tether strap to provide the most direct path for the strap between the anchor and the child seat, preferably between the head restraint posts underneath the head restraint.

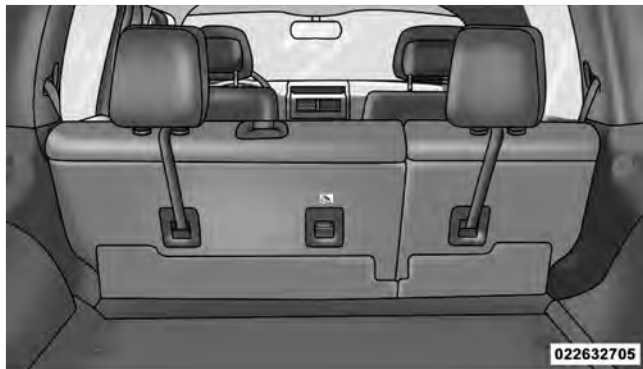

Tether Strap Mounting

### WARNING!

**An incorrectly anchored tether strap could lead to increased head motion and possible injury to the child. Use only the anchor positions directly behind the child seat to secure a child restraint top tether strap.**

### Transporting Pets

Air Bags deploying in the front seat could harm your pet. An unrestrained pet will be thrown about and possibly injured, or injure a passenger during panic braking or in an accident.

Pets should be restrained in the rear seat in pet harnesses or pet carriers that are secured by seat belts.



## ENGINE BREAK-IN RECOMMENDATIONS

A long break-in period is not required for the engine and drivetrain (transmission and axle) in your vehicle.

Drive moderately during the first 300 miles (500 km). After the initial 60 miles (100 km), speeds up to 50 or 55 mph (80 or 90 km/h) are desirable.

While cruising, brief full-throttle acceleration within the limits of local traffic laws contributes to a good break-in. Wide-open throttle acceleration in low gear can be detrimental and should be avoided.

The engine oil installed in the engine at the factory is a high-quality energy conserving type lubricant. Oil changes should be consistent with anticipated climate conditions under which vehicle operations will occur. For the recommended viscosity and quality grades, refer to "Maintenance Procedures" in "Maintaining Your Vehicle". NON-DETERGENT OR STRAIGHT MINERAL OILS MUST NEVER BE USED.

A new engine may consume some oil during its first few thousand miles (kilometers) of operation. This should be considered a normal part of the break-in and not interpreted as an indication of difficulty.

## SAFETY TIPS

### Transporting Passengers

NEVER TRANSPORT PASSENGERS IN THE CARGO AREA.

### WARNING!

- Do not leave children or animals inside parked vehicles in hot weather. Interior heat build-up may cause serious injury or death.

*(Continued)*

**WARNING! (Continued)**

- It is extremely dangerous to ride in a cargo area, inside or outside of a vehicle. In a collision, people riding in these areas are more likely to be seriously injured or killed.
- Do not allow people to ride in any area of your vehicle that is not equipped with seats and seat belts.
- Be sure everyone in your vehicle is in a seat and using a seat belt properly.

**Exhaust Gas****WARNING!**

Exhaust gases can injure or kill. They contain carbon monoxide (CO), which is colorless and odorless. Breathing it can make you unconscious and can eventually poison you. To avoid breathing (CO), follow these safety tips:

Do not run the engine in a closed garage or in confined areas any longer than needed to move your vehicle in or out of the area.

If it is necessary to sit in a parked vehicle with the engine running, adjust your heating or cooling controls to force outside air into the vehicle. Set the blower at high speed.

If you are required to drive with the trunk/liftgate open, make sure that all windows are closed and the climate control BLOWER switch is set at high speed. DO NOT use the recirculation mode.

The best protection against carbon monoxide entry into the vehicle body is a properly maintained engine exhaust system.

Whenever a change is noticed in the sound of the exhaust system, when exhaust fumes can be detected inside the vehicle, or when the underside or rear of the vehicle is damaged, have a competent mechanic inspect the complete exhaust system and adjacent body areas for broken, damaged, deteriorated, or mispositioned parts. Open seams or loose connections could permit exhaust fumes to seep into the passenger compartment. In addition, inspect the exhaust system each time the vehicle is raised for lubrication or oil change. Replace as required.

## **Safety Checks You Should Make Inside The Vehicle**

### **Seat Belts**

Inspect the belt system periodically, checking for cuts, frays, and loose parts. Damaged parts must be replaced immediately. Do not disassemble or modify the system.

Front seat belt assemblies must be replaced after a collision. Rear seat belt assemblies must be replaced after a collision if they have been damaged (i.e., bent retractor, torn webbing, etc.). If there is any question regarding belt or retractor condition, replace the belt.

### **Airbag Warning Light**

The light should come on and remain on for four to eight seconds as a bulb check when the ignition switch is first turned ON. If the light is not lit during starting, see your authorized dealer. If the light stays on, flickers, or comes on while driving, have the system checked by an authorized dealer.

### Defroster

Check operation by selecting the defrost mode and place the blower control on high speed. You should be able to feel the air directed against the windshield. See your authorized dealer for service if your defroster is inoperable.

### Floor Mat Safety Information

Always use floor mats designed to fit the footwell of your vehicle. Use only floor mats that leave the pedal area unobstructed and that are firmly secured so that they cannot slip out of position and interfere with the pedals or impair safe operation of your vehicle in other ways.

#### **WARNING!**

**Pedals that cannot move freely can cause loss of vehicle control and increase the risk of serious personal injury.**

*(Continued)*

#### **WARNING! (Continued)**

- Always make sure that floor mats are properly attached to the floor mat fasteners.
- Never place or install floor mats or other floor coverings in the vehicle that cannot be properly secured to prevent them from moving and interfering with the pedals or the ability to control the vehicle.
- Never put floor mats or other floor coverings on top of already installed floor mats. Additional floor mats and other coverings will reduce the size of the pedal area and interfere with the pedals.
- Check mounting of mats on a regular basis. Always properly reinstall and secure floor mats that have been removed for cleaning.

*(Continued)*

**WARNING! (Continued)**

- Always make sure that objects cannot fall into the driver footwell while the vehicle is moving. Objects can become trapped under the brake pedal and accelerator pedal causing a loss of vehicle control.
- If required, mounting posts must be properly installed, if not equipped from the factory. Failure to properly follow floor mat installation or mounting can cause interference with the brake pedal and accelerator pedal operation causing loss of control of the vehicle.

**Periodic Safety Checks You Should Make Outside The Vehicle****Tires**

Examine tires for excessive tread wear and uneven wear patterns. Check for stones, nails, glass, or other objects

lodged in the tread or sidewall. Inspect the tread for cuts and cracks. Inspect sidewalls for cuts, cracks and bulges. Check the wheel nuts for tightness. Check the tires (including spare) for proper cold inflation pressure.

**Lights**

Have someone observe the operation of exterior lights while you work the controls. Check turn signal and high beam indicator lights on the instrument panel.

**Door Latches**

Check for positive closing, latching, and locking.

**Fluid Leaks**

Check area under vehicle after overnight parking for fuel, engine coolant, oil, or other fluid leaks. Also, if gasoline fumes are detected or if fuel, power steering fluid, or brake fluid leaks are suspected, the cause should be located and corrected immediately.



# UNDERSTANDING THE FEATURES OF YOUR VEHICLE

## CONTENTS

---

■ Mirrors . . . . .	99	■ Uconnect™ Phone — If Equipped . . . . .	103
□ Inside Day/Night Mirror . . . . .	99	□ Operation . . . . .	105
□ Automatic Dimming Mirror — If Equipped . .	100	□ Phone Call Features . . . . .	113
□ Outside Mirrors . . . . .	101	□ Uconnect™ Phone Features . . . . .	116
□ Power Mirrors . . . . .	101	□ Advanced Phone Connectivity . . . . .	120
□ Heated Mirrors — If Equipped . . . . .	102	□ Things You Should Know About Your Uconnect™ Phone . . . . .	122
□ Illuminated Vanity Mirrors — If Equipped . .	102	□ General Information . . . . .	133
□ Sun Visor “Slide-On-Rod” Feature — If Equipped . . . . .	103		

- Voice Command — If Equipped . . . . . 133
  - Voice Command System Operation . . . . . 133
  - Commands . . . . . 134
  - Voice Training . . . . . 138
- Seats . . . . . 138
  - Driver's Power Seat — If Equipped . . . . . 139
  - Heated Seats — If Equipped . . . . . 140
  - Manual Front Seat Adjustments . . . . . 142
  - Front Seat — Manual Recline . . . . . 143
  - Manual Lumbar Support — If Equipped . . . . . 144
  - Fold-Flat Front Passenger Seat — If Equipped . . . . . 144
  - Head Restraints . . . . . 145
  - 60/40 Split Folding Rear Seat With Fold-Flat Feature . . . . . 149
- Driver Memory Seat — If Equipped . . . . . 151
  - Programming The Memory Feature . . . . . 152
  - Linking And Unlinking The Remote Keyless Entry Transmitter To Memory . . . . . 153
  - Memory Position Recall . . . . . 154
  - Easy Entry/Exit Seat (Available With Memory Seat Only) . . . . . 154
- To Open And Close The Hood . . . . . 156
- Lights . . . . . 158
  - Multifunction Lever . . . . . 158
  - Headlights And Parking Lights . . . . . 158
  - Automatic Headlights — If Equipped . . . . . 159



- Headlights With Wipers (Available With Automatic Headlights Only) . . . . . 160
- Headlight Time Delay — If Equipped . . . . . 160
- Daytime Running Lights — If Equipped . . . . . 161
- Lights-On Reminder . . . . . 161
- Fog Lights — If Equipped . . . . . 161
- Turn Signals . . . . . 162
- High/Low Beam Switch . . . . . 162
- Flash-To-Pass . . . . . 162
- Instrument Panel Dimmer . . . . . 163
- Map/Reading Lights . . . . . 163
- Cargo Light . . . . . 164
- Battery Saver Feature . . . . . 164

- Windshield Wipers And Washers . . . . . 164
  - Windshield Wiper Operation . . . . . 165
  - Intermittent Wiper System . . . . . 166
  - Windshield Washers . . . . . 167
  - Mist Feature . . . . . 168
  - Rain Sensing Wipers — If Equipped . . . . . 168
  - Headlights With Wipers (Available With Automatic Headlights Only) . . . . . 170
- Tilt Steering Column . . . . . 170
- Electronic Speed Control — If Equipped . . . . . 171
  - To Activate . . . . . 172
  - To Set A Desired Speed . . . . . 173
  - To Deactivate . . . . . 173

- To Resume Speed . . . . . 173
- To Vary The Speed Setting . . . . . 173
- To Accelerate For Passing . . . . . 174
- Parksense® Rear Park Assist — If Equipped . . . 175
  - Parksense® Sensors . . . . . 175
  - Parksense® Warning Display . . . . . 175
  - Parksense® Display . . . . . 176
  - Enabling And Disabling Parksense® . . . . . 180
  - Service The Parksense® Rear Park Assist System . . . . . 180
  - Cleaning The Parksense® System . . . . . 181
  - Parksense® System Usage Precautions . . . . . 181
- Garage Door Opener — If Equipped . . . . . 183
  - Programming HomeLink® . . . . . 184
  - Gate Operator/Canadian Programming . . . . 187
  - Using HomeLink® . . . . . 188
  - Reprogramming A Single HomeLink® Button . . . . . 188
  - Security . . . . . 188
  - Troubleshooting Tips . . . . . 188
  - General Information . . . . . 189
- Power Sunroof — If Equipped . . . . . 190
  - Opening Sunroof — Express . . . . . 191
  - Opening Sunroof — Manual Mode . . . . . 191
  - Closing Sunroof — Express . . . . . 191

□ Closing Sunroof — Manual Mode . . . . .	191	□ Opening The Sky Slider™ . . . . .	196
□ Pinch Protect Feature . . . . .	191	□ Closing The Sky Slider™ . . . . .	196
□ Pinch Protect Override . . . . .	192	□ Anti-Pinch Protect Feature . . . . .	197
□ Venting Sunroof — Express . . . . .	192	□ Wind Buffeting . . . . .	197
□ Sunshade Operation . . . . .	192	□ Sky Slider™ Maintenance . . . . .	198
□ Wind Buffeting . . . . .	192	■ Electrical Power Outlet . . . . .	198
□ Sunroof Maintenance . . . . .	192	■ Cupholders . . . . .	201
□ Ignition Off Operation . . . . .	193	■ Storage . . . . .	202
■ Sky Slider™ Full Length Open Roof — If Equipped . . . . .	193	□ Glove Box Storage Compartment . . . . .	202
□ Sky Slider™ Usage Precautions . . . . .	193	□ Front Storage Compartment . . . . .	202
□ Sky Slider™ Control . . . . .	195	□ Console Storage Compartment . . . . .	203

■ Cargo Area Features . . . . .	204	■ Rear Window Features . . . . .	210
□ Cargo Load Floor . . . . .	204	□ Rear Window Wiper/Washer . . . . .	210
		□ Rear Window Defroster . . . . .	211
		■ Roof Luggage Rack — If Equipped . . . . .	212

## MIRRORS

### Inside Day/Night Mirror

A two-point pivot system allows for horizontal and vertical mirror adjustment. Adjust the mirror to center on the view through the rear window.

Headlight glare can be reduced by moving the small control under the mirror to the night position (toward the rear of vehicle). The mirror should be adjusted while set in the day position (toward the windshield).

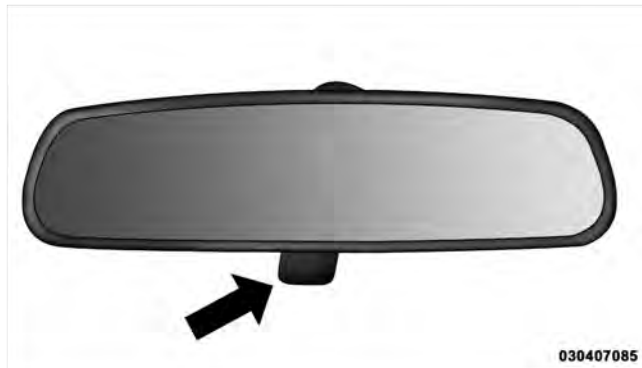
**3**

Adjusting Rearview Mirror

### Automatic Dimming Mirror — If Equipped

This mirror automatically adjusts for headlight glare from vehicles behind you. You can turn the feature on or off by pressing the button at the base of the mirror. A light to the left of the button will illuminate to indicate when the dimming feature is activated. The sensor to the right of the button does not illuminate.



Automatic Dimming Mirror

#### **CAUTION!**

To avoid damage to the mirror during cleaning, never spray any cleaning solution directly onto the mirror. Apply the solution onto a clean cloth and wipe the mirror clean.

## Outside Mirrors

To receive maximum benefit, adjust the outside mirror(s) to center on the adjacent lane of traffic and a slight overlap of the view obtained from the inside mirror.

**NOTE:** The passenger side convex outside mirror will give a much wider view to the rear, and especially of the lane next to your vehicle.

### WARNING!

Vehicles and other objects seen in the passenger side convex mirror will look smaller and farther away than they really are. Relying too much on your passenger side convex mirror could cause you to collide with another vehicle or other object. Use your inside mirror when judging the size or distance of a vehicle seen in the passenger side convex mirror.

## Power Mirrors

The power mirror switch is located on the driver's door trim panel.



Power Mirror Switch

- 1 — Mirror Direction Control
- 2 — Left and Right Mirror Select

### Models With Express Window Feature

Press and release the mirror select button marked L (left) or R (right) and then press one of the four arrow buttons to move the mirror in the direction the arrow is pointing. The selection will time out after 30 seconds of inactivity to guard against accidentally moving a mirror position following an adjustment.

**NOTE:** For vehicles equipped with Driver Memory Seat, you can use your Remote Keyless Entry (RKE) transmitter or the memory switch on the instrument panel to return the power mirrors to pre-programmed positions. Refer to “Driver Memory Seat” in “Understanding The Features Of Your Vehicle” for further information.

### Models Without Express Window Feature

Press the mirror select button marked L (left) or R (right) and then press one of the four arrow buttons to move the mirror in the direction the arrow is pointing.

### Heated Mirrors — If Equipped



These mirrors are heated to melt frost or ice. This feature is activated whenever you turn on the rear window defroster. Refer to “Rear Window Features” in “Understanding The Features of Your Vehicle” for further information.

### Illuminated Vanity Mirrors — If Equipped

An illuminated vanity mirror is on each sun visor. To use the mirror, rotate the sun visor down and swing the mirror cover upward. The lights will turn on automatically. Closing the mirror cover will turn off the light.



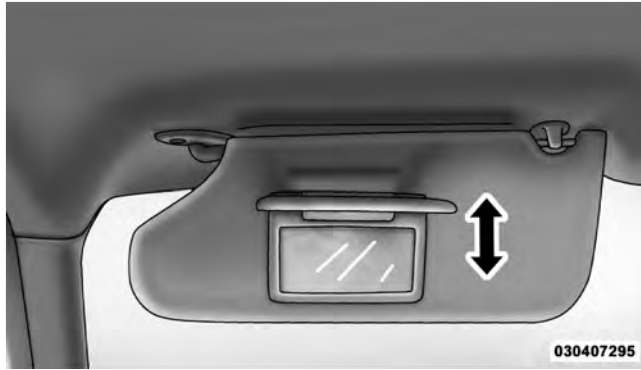

### Illuminated Vanity Mirror

### Sun Visor “Slide-On-Rod” Feature — If Equipped

The sun visor “Slide-On-Rod” feature allows for additional flexibility in positioning the sun visor to block out the sun.

1. Fold down the sun visor.

2. Unclip the visor from the center clip.

3. Pull the sun visor toward the inside rearview mirror to extend it.

### Uconnect™ Phone — IF EQUIPPED

Uconnect™ Phone is a voice-activated, hands-free, in-vehicle communications system. Uconnect™ Phone allows you to dial a phone number with your mobile phone using simple voice commands (e.g., “Call” ... “Mike” ... “Work” or “Dial” ... “248-555-1212”). Your mobile phone’s audio is transmitted through your vehicle’s audio system; the system will automatically mute your radio when using the Uconnect™ Phone.

**NOTE:** The Uconnect™ Phone requires a mobile phone equipped with the Bluetooth® “Hands-Free Profile”, Version 0.96 or higher. See the Uconnect™ website for supported phones.

For Uconnect™ customer support, visit the following websites:

- [www.chrysler.com/uconnect](http://www.chrysler.com/uconnect)
- [www.dodge.com/uconnect](http://www.dodge.com/uconnect)
- [www.jeep.com/uconnect](http://www.jeep.com/uconnect)
- or call 1-877-855-8400

Uconnect™ Phone allows you to transfer calls between the system and your mobile phone as you enter or exit your vehicle and enables you to mute the system's microphone for private conversation.

The Uconnect™ Phone is driven through your Bluetooth® "Hands-Free Profile" mobile phone. Uconnect™ features Bluetooth® technology - the global standard that enables different electronic devices to connect to each other without wires or a docking station, so Uconnect™ Phone works no matter where you stow your



mobile phone (be it your purse, pocket, or briefcase), as long as your phone is turned on and has been paired to the vehicle's Uconnect™ Phone. The Uconnect™ Phone allows up to seven mobile phones to be linked to the system. Only one linked (or paired) mobile phone can be used with the system at a time. The system is available in English, Spanish, or French languages.

### **WARNING!**

**Any voice commanded system should be used only in safe driving conditions following local laws and phone use. All attention should be kept on the roadway ahead. Failure to do so may result in a collision causing serious injury or death.**

### *Uconnect™ Phone Button*



The radio or steering wheel controls (if equipped) will contain the two control buttons (Uconnect™ Phone  button and Voice Command ( VR button) that will enable you to access the system. When you press the button you will hear the word Uconnect™ followed by a BEEP. The beep is your signal to give a command.

### *Voice Command Button*

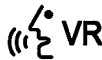

Actual button location may vary with the radio. The individual buttons are described in the “Operation” section.

The Uconnect™ Phone can be used with any Hands-Free Profile certified Bluetooth® mobile phone. See the Uconnect™ website for supported phones. Refer to your mobile service provider or the phone manufacturer for details.

The Uconnect™ Phone is fully integrated with the vehicle’s audio system. The volume of the Uconnect™ Phone can be adjusted either from the radio volume control knob or from the steering wheel radio control (right switch), if so equipped.

The radio display will be used for visual prompts from the Uconnect™ Phone such as “CELL” or caller ID on certain radios.

### **Operation**

Voice commands can be used to operate the Uconnect™ Phone and to navigate through the Uconnect™ Phone menu structure. Voice commands are required after most Uconnect™ Phone prompts. You will be prompted for a specific command and then guided through the available options.

- Prior to giving a voice command, one must wait for the beep, which follows the “Ready” prompt or another prompt.



- For certain operations, compound commands can be used. For example, instead of saying “Setup” and then “Pair a Device”, the following compound command can be said: “Pair a Bluetooth® Device”.
- For each feature explanation in this section, only the compound form of the voice command is given. You can also break the commands into parts and say each part of the command when you are asked for it. For example, you can use the compound form voice command “Phonebook New Entry”, or you can break the compound form command into two voice commands: “Phonebook” and “New Entry”. Please remember, the Uconnect™ Phone works best when you talk in a normal conversational tone, as if speaking to someone sitting a few feet/meters away from you.

### Voice Command Tree

Refer to “Voice Tree” in this section.

### Help Command

If you need assistance at any prompt, or if you want to know your options at any prompt, say “Help” following the beep. The Uconnect™ Phone will play some of the options at any prompt if you ask for help.

To activate the Uconnect™ Phone, simply press the  button and follow the audible prompts for directions. Uconnect™ Phone sessions begin with a press of the  button on the radio control head.

### Cancel Command

At any prompt, after the beep, you can say “Cancel” and you will be returned to the main menu. However, in a few instances the system will take you back to the previous menu.

### Pair (Link) Uconnect™ Phone To A Mobile Phone

To begin using your Uconnect™ Phone, you must pair your compatible Bluetooth® enabled mobile phone.

To complete the pairing process, you will need to reference your mobile phone Owner's Manual. The Uconnect™ website may also provide detailed instructions for pairing.

The following are general phone to Uconnect™ Phone pairing instructions:

- Press the  button to begin.
- After the "Ready" prompt and the following beep, say "Device Pairing".
- When prompted, after the beep, say "Pair a Device" and follow the audible prompts.
- You will be asked to say a four-digit Personal Identification Number (PIN), which you will later need to enter into your mobile phone. You can enter any four-digit PIN. You will not need to remember this PIN after the initial pairing process.
- For identification purposes, you will be prompted to give the Uconnect™ Phone a name for your mobile phone. Each mobile phone that is paired should be given a unique phone name.
- You will then be asked to give your mobile phone a priority level between one and seven, with one being the highest priority. You can pair up to seven mobile phones to your Uconnect™ Phone. However, at any given time, only one mobile phone can be in use, connected to your Uconnect™ System. The priority allows the Uconnect™ Phone to know which mobile phone to use if multiple mobile phones are in the vehicle at the same time. For example, if priority three and priority five phones are present in the vehicle, the Uconnect™ Phone will use the priority three mobile phone when you make a call. You can select to use a lower priority mobile phone at any time (refer to "Advanced Phone Connectivity" in this section).

### Dial By Saying A Number

- Press the  button to begin.
- After the “Ready” prompt and the following beep, say “Dial”.
- The system will prompt you to say the number you want to call.
- For example, you can say “234-567-8901”.
- The Uconnect™ Phone will confirm the phone number and then dial. The number will appear in the display of certain radios.

### Call By Saying A Name

- Press the  button to begin.
- After the “Ready” prompt and the following beep, say “Call”.

- The system will prompt you to say the name of the person you want to call.
- After the “Ready” prompt and the following beep, say the name of the person you want to call. For example, you can say “John Doe”, where John Doe is a previously stored name entry in the Uconnect™ phonebook or downloaded phonebook. To learn how to store a name in the phonebook, refer to “Add Names to Your Uconnect™ Phonebook”, in the phonebook.
- The Uconnect™ system will confirm the name and then dial the corresponding phone number, which may appear in the display of certain radios.

### Add Names To Your Uconnect™ Phonebook

**NOTE:** Adding names to the Uconnect™ Phonebook is recommended when the vehicle is not in motion.

- Press the  button to begin.

- After the “Ready” prompt and the following beep, say “Phonebook New Entry”.
- When prompted, say the name of the new entry. Use of long names helps the Voice Command and it is recommended. For example, say “Robert Smith” or “Robert” instead of “Bob”.
- When prompted, enter the number designation (e.g., “Home”, “Work”, “Mobile”, or “Other”). This will allow you to store multiple numbers for each phonebook entry, if desired.
- When prompted, recite the phone number for the phonebook entry that you are adding.

After you are finished adding an entry into the phonebook, you will be given the opportunity to add more phone numbers to the current entry or to return to the main menu.

The Uconnect™ Phone will allow you to enter up to 32 names in the phonebook with each name having up to four associated phone numbers and designations. Each language has a separate 32-name phonebook accessible only in that language. In addition, if equipped and supported by your phone, Uconnect™ Phone automatically downloads your mobile phone’s phonebook.

### **Phonebook Download – Automatic Phonebook Transfer From Mobile Phone**

If equipped and specifically supported by your phone, Uconnect™ Phone automatically downloads names (text names) and number entries from your mobile phone’s phonebook. Specific Bluetooth® Phones with Phone Book Access Profile may support this feature. See Uconnect™ website for supported phones.

- To call a name from the Uconnect™ Phonebook or downloaded Phonebook, follow the procedure in “Call by Saying a Name” section.

- Automatic download and update, if supported, begins as soon as the Bluetooth® wireless phone connection is made to the Uconnect™ Phone, for example, after you start the vehicle.
- A maximum of 1000 entries per phone will be downloaded and updated every time a phone is connected to the Uconnect™ Phone.
- Depending on the maximum number of entries downloaded, there may be a short delay before the latest downloaded names can be used. Until then, if available, the previously downloaded phonebook is available for use.
- Only the phonebook of the currently connected mobile phone is accessible.
- Only the mobile phone's phonebook is downloaded. SIM card phonebook is not part of the Mobile phonebook.
- This downloaded phonebook cannot be edited or deleted on the Uconnect™ Phone. These can only be edited on the mobile phone. The changes are transferred and updated to Uconnect™ Phone on the next phone connection.

### **Edit Uconnect™ Phonebook Entries**

#### **NOTE:**

- Editing names in the phonebook is recommended when the vehicle is not in motion.
- Automatic downloaded phonebook entries cannot be deleted or edited.
- Press the  button to begin.
- After the “Ready” prompt and the following beep, say “Phonebook Edit Entry”.
- You will then be asked for the name of the phonebook entry that you wish to edit.





- Next, choose the number designation (home, work, mobile, or other) that you wish to edit.
- When prompted, recite the new phone number for the phonebook entry that you are editing.

After you are finished editing an entry in the phonebook, you will be given the opportunity to edit another entry in the phonebook, call the number you just edited, or return to the main menu.

“Phonebook Edit Entry” can be used to add another phone number to a name entry that already exists in the phonebook. For example, the entry John Doe may have a mobile and a home number, but you can add “John Doe’s” work number later using the “Phonebook Edit Entry” feature.

### Delete Uconnect™ Phonebook Entry

**NOTE:** Editing phonebook entries is recommended when the vehicle is not in motion.

- Press the  button to begin.
- After the “Ready” prompt and the following beep, say “Phonebook Delete”.
- After you enter the Phonebook Delete menu, you will then be asked for the name of the entry that you wish to delete. You can either say the name of a phonebook entry that you wish to delete or you can say “List Names” to hear a list of the entries in the phonebook from which you choose. To select one of the entries from the list, press the  button while the Uconnect™ Phone is playing the desired entry and say “Delete”.
- After you enter the name, the Uconnect™ Phone will ask you which designation you wish to delete: home, work, mobile, other, or all. Say the designation you wish to delete.



- Note that only the phonebook entry in the current language is deleted.
- Automatic downloaded phonebook entries cannot be deleted or edited.

### Delete/Eraser "All" Uconnect™ Phonebook Entries

- Press the  button to begin.
- After the "Ready" prompt and the following beep, say "Phonebook Erase All".
- The Uconnect™ Phone will ask you to verify that you wish to delete all the entries from the phonebook.
- After confirmation, the phonebook entries will be deleted.
- Note that only the phonebook in the current language is deleted.

- Automatic downloaded phonebook entries cannot be deleted or edited.

### List All Names In The Uconnect™ Phonebook

- Press the  button to begin.
- After the "Ready" prompt and the following beep, say "Phonebook List Names".
- The Uconnect™ Phone will play the names of all the phonebook entries, including the downloaded phonebook entries, if available.
- To call one of the names in the list, press the  button during the playing of the desired name, and say "Call".

**NOTE:** The user can also exercise "Edit" or "Delete" operations at this point.



- The Uconnect™ Phone will then prompt you as to the number designation you wish to call.

- The selected number will be dialed.

### Phone Call Features

The following features can be accessed through the Uconnect™ Phone if the feature(s) are available on your mobile service plan. For example, if your mobile service plan provides three-way calling, this feature can be accessed through the Uconnect™ Phone. Check with your mobile service provider for the features that you have.

#### Answer Or Reject An Incoming Call — No Call Currently In Progress

When you receive a call on your mobile phone, the Uconnect™ Phone will interrupt the vehicle audio system, if on, and will ask if you would like to answer the call. Press the  button to accept the call. To reject the call, press and hold the  button until you hear a single beep, indicating that the incoming call was rejected.

#### Answer Or Reject An Incoming Call — Call Currently In Progress

If a call is currently in progress and you have another incoming call, you will hear the same network tones for call waiting that you normally hear when using your mobile phone. Press the  button to place the current call on hold and answer the incoming call.



**NOTE:** The Uconnect™ Phone compatible phones in the market today do not support rejecting an incoming call when another call is in progress. Therefore, the user can only answer an incoming call or ignore it.

#### Making A Second Call While Current Call Is In Progress

To make a second call while you are currently on a call, press the  button and say “Dial” or “Call” followed by the phone number or phonebook entry you wish to call. The first call will be on hold while the second call is

in progress. To go back to the first call, refer to “Toggling Between Calls” in this section. To combine two calls, refer to “Conference Call” in this section.

### **Place/Retrieve A Call From Hold**

To put a call on hold, press the  button until you hear a single beep. This indicates that the call is on hold. To bring the call back from hold, press and hold the  button until you hear a single beep.



### **Toggling Between Calls**

If two calls are in progress (one active and one on hold), press the  button until you hear a single beep, indicating that the active and hold status of the two calls have switched. Only one call can be placed on hold at a time.



### **Conference Call**

When two calls are in progress (one active and one on hold), press and hold the  button until you hear a double beep indicating that the two calls have been joined into one conference call.

### **Three-Way Calling**

To initiate three-way calling, press the  button while a call is in progress, and make a second phone call, as described under “Making a Second Call While Current Call is in Progress”. After the second call has established, press and hold the  button until you hear a double beep, indicating that the two calls have been joined into one conference call.

### Call Termination

To end a call in progress, momentarily press the  button. Only the active call(s) will be terminated and if there is a call on hold, it will become the new active call. If the active call is terminated by the phone far end, a call on hold may not become active automatically. This is cell phone-dependent. To bring the call back from hold, press and hold the  button until you hear a single beep.

### Redial

- Press the  button to begin.
- After the “Ready” prompt and the following beep, say “Redial”.
- The Uconnect™ Phone will call the last number that was dialed from your mobile phone.

**NOTE:** This may not be the last number dialed from the Uconnect™ Phone.

### Call Continuation

Call continuation is the progression of a phone call on the Uconnect™ Phone after the vehicle ignition key has been switched to OFF. Call continuation functionality available on the vehicle can be any one of three types:

- After the ignition key is switched to OFF, a call can continue on the Uconnect™ Phone either until the call ends, or until the vehicle battery condition dictates cessation of the call on the Uconnect™ Phone and transfer of the call to the mobile phone.
- After the ignition key is switched to OFF, a call can continue on the Uconnect™ Phone for a certain duration, after which the call is automatically transferred from the Uconnect™ Phone to the mobile phone.
- An active call is automatically transferred to the mobile phone after the ignition key is switched to OFF.

## Uconnect™ Phone Features

### Language Selection

To change the language that the Uconnect™ Phone is using:

- Press the  button to begin.
- After the “Ready” prompt and the following beep, say the name of the language you wish to switch to English, Espanol, or Francais.
- Continue to follow the system prompts to complete the language selection.

After selecting one of the languages, all prompts and voice commands will be in that language.

**NOTE:** After every Uconnect™ Phone language change operation, only the language-specific 32-name phone-book is usable. The paired phone name is not language-specific and is usable across all languages.

### Emergency Assistance

If you are in an emergency and the mobile phone is reachable:

- Pick up the phone and manually dial the emergency number for your area.

If the phone is not reachable and the Uconnect™ Phone is operational, you may reach the emergency number as follows:

- Press the  button to begin.
- After the “Ready” prompt and the following beep, say “Emergency” and the Uconnect™ Phone will instruct the paired mobile phone to call the emergency number. This feature is supported in the U.S., Canada, and Mexico.

### NOTE:

- The emergency number dialed is based on the country where the vehicle is purchased (911 for the U.S. and

Canada and 060 for Mexico). The number dialed may not be applicable with the available mobile service and area.

- If supported, this number may be programmable on some systems. To do this, press the  button and say “Setup”, followed by “Emergency”.
- The Uconnect™ Phone does slightly lower your chances of successfully making a phone call as to that for the mobile phone directly.

### WARNING!

To use your Uconnect™ Phone System in an emergency, your mobile phone must be:

- turned on,
- paired to the Uconnect™ System,
- and have network coverage.

### Towing Assistance

If you need towing assistance:

- Press the  button to begin.
- After the “Ready” prompt and the following beep, say “Towing Assistance”.

### NOTE:

- The towing assistance number dialed is based on the country where the vehicle is purchased (1-800-528-2069 for the U.S., 1-877-213-4525 for Canada, 55-14-3454 for Mexico City and 1-800-712-3040 for outside Mexico City in Mexico). Please refer to the 24-Hour “Towing Assistance” coverage details on the DVD in the Warranty Information Booklet and the 24-Hour Towing Assistance references.
- If supported, this number may be programmable on some systems. To do this, press the  button and say “Setup”, followed by “Towing Assistance”.

### **Paging**

To learn how to page, refer to “Working with Automated Systems”. Paging works properly except for pagers of certain companies, which time out a little too soon to work properly with the Uconnect™ Phone.



### **Voice Mail Calling**

To learn how to access your voice mail, refer to “Working with Automated Systems”.

### **Working With Automated Systems**

This method is used in instances where one generally has to press numbers on the mobile phone keypad while navigating through an automated telephone system.

You can use your Uconnect™ Phone to access a voice mail system or an automated service, such as a paging service or automated customer service line. Some services require immediate response selection. In some instances, that may be too quick for use of the Uconnect™ Phone.

When calling a number with your Uconnect™ Phone that normally requires you to enter in a touch-tone sequence on your mobile phone keypad, you can press the VR button and say the sequence you wish to enter, followed by the word “Send”. For example, if required to enter your PIN followed with a pound, (3 7 4 6 #), you can press the VR button and say, “3 7 4 6 # Send”. Saying a number, or sequence of numbers, followed by “Send”, is also to be used for navigating through an automated customer service center menu structure, and to leave a number on a pager.

You can also send stored Uconnect™ phonebook entries as tones for fast and easy access to voice mail and pager entries. To use this feature, dial the number you wish to call and then press the VR button and say, “Send.” The system will prompt you to enter the name or number and say the name of the phonebook entry you wish to send.



The Uconnect™ Phone will then send the corresponding phone number associated with the phonebook entry, as tones over the phone.

**NOTE:**

- You may not hear all of the tones due to mobile phone network configurations. This is normal.
- Some paging and voice mail systems have system time out settings that are too short and may not allow the use of this feature.

**Barge In — Overriding Prompts**

The “Voice Command” button can be used when you wish to skip part of a prompt and issue your voice command immediately. For example, if a prompt is asking “Would you like to pair a phone, clear a...,” you could press the  button and say, “Pair a Phone” to select that option without having to listen to the rest of the voice prompt.

**Turning Confirmation Prompts ON/OFF**

Turning confirmation prompts off will stop the system from confirming your choices (e.g., the Uconnect™ Phone will not repeat a phone number before you dial it).

- Press the  button to begin.
- After the “Ready” prompt and the following beep, say one of the following:
  - “Setup Confirmation Prompts On”
  - “Setup Confirmation Prompts Off”

**Phone And Network Status Indicators**

If available on the radio and/or on a premium display such as the instrument panel cluster, and supported by your mobile phone, the Uconnect™ Phone will provide notification to inform you of your phone and network status when you are attempting to make a phone call using Uconnect™ Phone. The status is given for network signal strength, phone battery strength, etc.

### Dialing Using The Mobile Phone Keypad

You can dial a phone number with your mobile phone keypad and still use the Uconnect™ Phone (while dialing via the mobile phone keypad, the user must exercise caution and take precautionary safety measures). By dialing a number with your paired Bluetooth® mobile phone, the audio will be played through your vehicle's audio system. The Uconnect™ Phone will work the same as if you dial the number using Voice Command.

**NOTE:** Certain brands of mobile phones do not send the dial ring to the Uconnect™ Phone to play it on the vehicle audio system, so you will not hear it. Under this situation, after successfully dialing a number the user may feel that the call did not go through even though the call is in progress. Once your call is answered, you will hear the audio.

### Mute/Un-Mute (Mute OFF)

When you mute the Uconnect™ Phone, you will still be able to hear the conversation coming from the other party, but the other party will not be able to hear you. In order to mute the Uconnect™ Phone:

- Press the  VR button.
- Following the beep, say "Mute".

In order to un-mute the Uconnect™ Phone:

- Press the  VR button.
- Following the beep, say "Mute off".

### Advanced Phone Connectivity

#### Transfer Call To And From Mobile Phone

The Uconnect™ Phone allows ongoing calls to be transferred from your mobile phone to the Uconnect™ Phone without terminating the call. To transfer an ongoing call

from your Uconnect™ Phone paired mobile phone to the Uconnect™ Phone or vice versa, press the  button and say “Transfer Call”.

### **Connect Or Disconnect Link Between The Uconnect™ Phone And Mobile Phone**

Your mobile phone can be paired with many different electronic devices, but can only be actively “connected” with one electronic device at a time.

If you would like to connect or disconnect the Bluetooth® connection between your mobile phone and the Uconnect™ Phone System, follow the instructions described in your mobile phone User’s Manual.



### **List Paired Mobile Phone Names**

- Press the  button to begin.
- After the “Ready” prompt and the following beep, say “Setup Phone Pairing”.

- When prompted, say “List Phones”.
- The Uconnect™ Phone will play the phone names of all paired mobile phones in order from the highest to the lowest priority. To “Select” or “Delete” a paired phone being announced, press the  button and say “Select” or “Delete”. Also, see the next two sections for an alternate way to “Select” or “Delete” a paired phone.



### **Select Another Mobile Phone**

This feature allows you to select and start using another phone paired with the Uconnect™ Phone.

- Press the  button to begin.
- After the “Ready” prompt and the following beep, say “Setup Select Phone” and follow the prompts.
- You can also press the  button at any time while the list is being played, and then choose the phone that you wish to select.

- The selected phone will be used for the next phone call. If the selected phone is not available, the Uconnect™ Phone will return to using the highest priority phone present in or near (approximately within 30 ft (9 m)) the vehicle.

### Delete Uconnect™ Phone Paired Mobile Phones

- Press the  button to begin.
- After the “Ready” prompt and the following beep, say “Setup Phone Pairing”.
- At the next prompt, say “Delete” and follow the prompts.
- You can also press the  button at any time while the list is being played, and then choose the phone you wish to delete.

### Things You Should Know About Your Uconnect™ Phone



#### Uconnect™ Phone Tutorial

To hear a brief tutorial of the system features, press the  button and say “Uconnect™ Tutorial.”

#### Voice Training

For users experiencing difficulty with the system recognizing their voice commands or numbers, the Uconnect™ Phone Voice Training feature may be used. To enter this training mode, follow one of the two following procedures:

From outside the Uconnect™ Phone mode (e.g., from radio mode):

- Press and hold the  button for five seconds until the session begins, or,
- Press the  button and say the “Voice Training, System Training, or Start Voice Training” command.

You can either press the Uconnect™ Phone button to restore the factory setting or repeat the words and phrases when prompted by the Uconnect™ Phone. For best results, the Voice Training session should be completed when the vehicle is parked with the engine running, all windows closed, and the blower fan switched off.

This procedure may be repeated with a new user. The system will adapt to the last trained voice only.

### Reset

- press the  button.
- After the “Ready” prompt, and the following beep, say “Setup”, then “Reset”.

This will delete all phone pairing, phone book entries, and other settings in all language modes. The System will prompt you before resetting to factory settings.

### Voice Command

- For best performance, adjust the rearview mirror to provide at least ½ in (1 cm) gap between the overhead console (if equipped) and the mirror.
- Always wait for the beep before speaking.
- Speak normally, without pausing, just as you would speak to a person sitting a few feet/meters away from you.
- Make sure that no one other than you is speaking during a Voice Command period.
- Performance is maximized under:
  - low-to-medium blower setting,
  - low-to-medium vehicle speed,
  - low road noise,
  - smooth road surface,

- fully closed windows,
- dry weather condition.
- Even though the system is designed for users speaking in North American English, French, and Spanish accents, the system may not always work for some.
- When navigating through an automated system such as voice mail, or when sending a page, at the end of speaking the digit string, make sure to say “Send”.
- Storing names in the phonebook when the vehicle is not in motion is recommended.
- It is not recommended to store similar sounding names in the Uconnect™ Phonebook.
- Phonebook (Downloaded and Uconnect™ Phone Local) name recognition rate is optimized when the entries are not similar.
- Numbers must be spoken in single digits. “800” must be spoken “eight-zero-zero” not “eight hundred”.
- You can say “O” (letter “O”) for “0” (zero).
- Even though international dialing for most number combinations is supported, some shortcut dialing number combinations may not be supported.
- In a convertible vehicle, system performance may be compromised with the convertible top down.

### **Far End Audio Performance**

- Audio quality is maximized under:
  - low-to-medium blower setting,
  - low-to-medium vehicle speed,
  - low road noise,
  - smooth road surface,

- fully closed windows,
- dry weather conditions, and
- operation from the driver's seat.
- Performance, such as audio clarity, echo, and loudness to a large degree rely on the phone and network, and not the Uconnect™ Phone.
- Echo at the phone far end can sometimes be reduced by lowering the in-vehicle audio volume.
- In a convertible vehicle, system performance may be compromised with the convertible top down.

### Recent Calls

If your phone supports “Automatic Phonebook Download”, Uconnect™ Phone can list your Outgoing, Incoming and Missed Calls.

### SMS

Uconnect™ Phone can read or send new messages on your phone.

#### *Read Messages:*

If you receive a new text message while your phone is connected to Uconnect™ Phone, an announcement will be made to notify you that you have a new text message. If you wish to hear the new message:

- Press the  button.
- After the “Ready” prompt and the following beep, say “SMS Read” or “Read Messages.”
- Uconnect™ Phone will play the new text message for you.

After reading a message, you can “Reply” or “Forward” the message using Uconnect™ Phone.

**Send Messages:**

You can send messages using Uconnect™ Phone. To send a new message:

- Press the  button.
- After the “Ready” prompt and the following beep, say “SMS Send” or “Send Message.”
- You can either say the message you wish to send or say “List Messages.” There are 20 preset messages.

To send a message, press the  button while the system is listing the message and say “Send.”

Uconnect™ Phone will prompt you to say the name or number of the person you wish to send the message to.

List of Preset Messages:

1. Yes
2. No

3. Where are you?
4. I need more direction.
5. L O L
6. Why
7. I love you
8. Call me
9. Call me later
10. Thanks
11. See You in 15 minutes
12. I am on my way
13. I’ll be late
14. Are you there yet?
15. Where are we meeting?



16. Can this wait?
17. Bye for now
18. When can we meet
19. Send number to call
20. Start without me

#### *Turn SMS Incoming Announcement ON/OFF*

Turning the SMS Incoming Announcement OFF will stop the system from announcing the new incoming messages.

- Press the  button.
- After the “Ready” prompt and the following beep, say “Setup, SMS Incoming Message Announcement,” you will then be given a choice to change it.

#### **Bluetooth® Communication Link**

Mobile phones have been found to lose connection to the Uconnect™ Phone. When this happens, the connection can generally be reestablished by switching the phone off/on. Your mobile phone is recommended to remain in Bluetooth® ON mode.

#### **Power-Up**

After switching the ignition key from OFF to either the ON or ACC position, or after a language change, you must wait at least fifteen seconds prior to using the system.

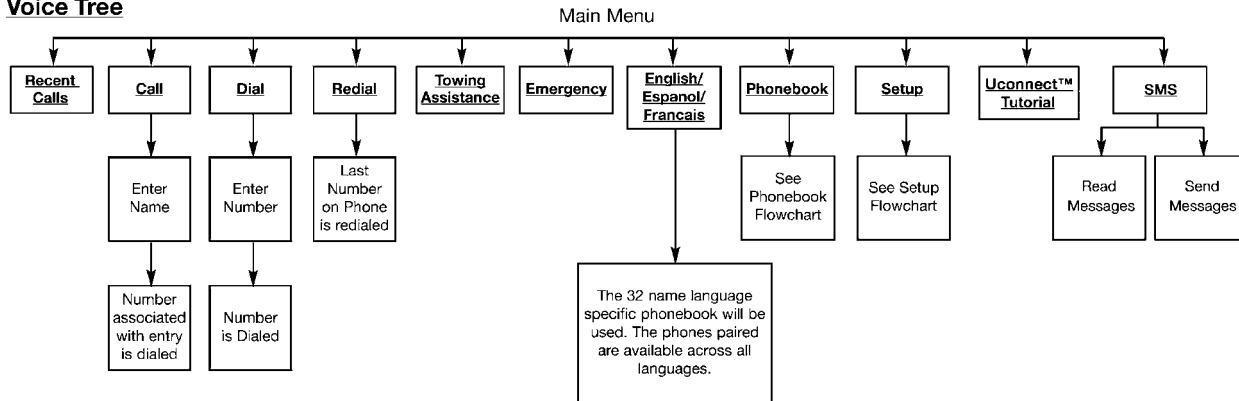
**Voice Tree**

**Note:** Available Voice commands are shown in bold face and are underlined.

**Voice Tree – Phonebook**

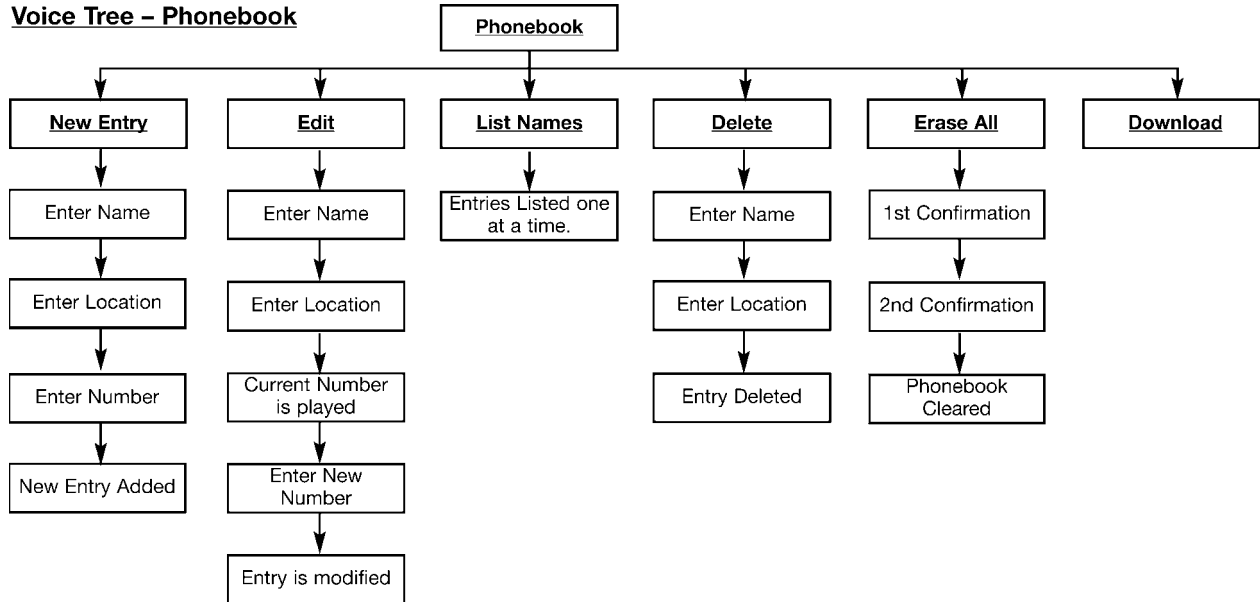

**Note:** Available Voice commands are shown in bold face and are underlined.

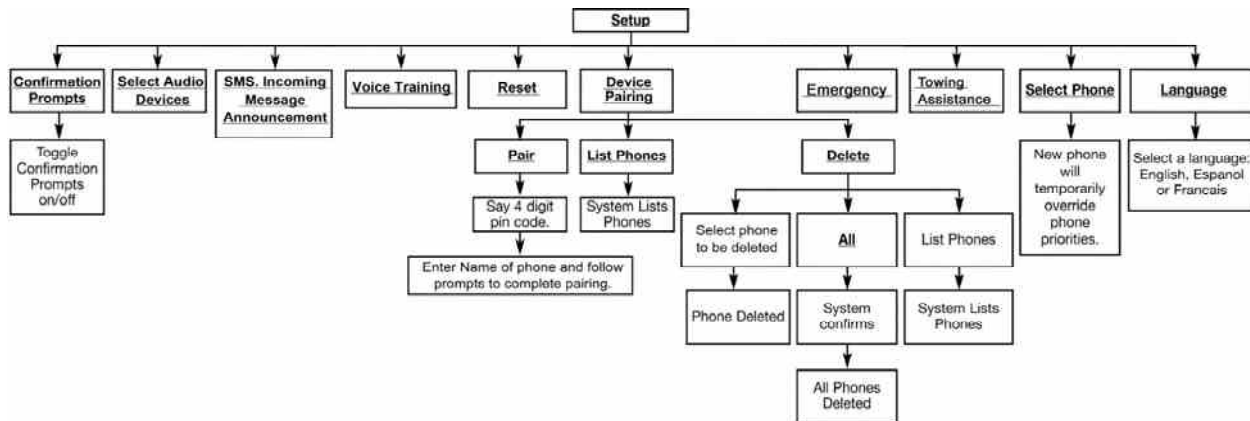
Voice Tree – Setup

Note: Available Voice commands are shown in bold face and are underlined.

030605540

Voice Commands	
Primary	Alternate(s)
zero	
one	
two	
three	
four	
five	
six	
seven	
eight	
nine	
star (*)	
plus (+)	
pound (#)	
add location	
all	

Voice Commands	
Primary	Alternate(s)
call	
cancel	
confirmation prompts	
continue	
delete	
dial	
download	
edit	
emergency	
English	
erase all	
Espanol	
Francais	
help	
home	

Voice Commands	
Primary	Alternate(s)
language	
list names	
list phones	
mobile	
mute	
mute off	
new entry	
no	
other	
pair a phone	
phone pairing	pairing
phonebook	phone book
previous	
record again	
redial	

Voice Commands	
Primary	Alternate(s)
return to main menu	return or main menu
select phone	select
send	
set up	phone settings or phone set up
towing assistance	
transfer call	
Uconnect™ Tutorial	
try again	
voice training	
work	
yes	

## General Information

This device complies with Part 15 of the FCC rules and RSS 210 of Industry Canada. Operation is subject to the following conditions:

- Changes or modifications not expressly approved by the party responsible for compliance could void the user's authority to operate the equipment.
- This device may not cause harmful interference.
- This device must accept any interference received, including interference that may cause undesired operation.

## VOICE COMMAND — IF EQUIPPED

### Voice Command System Operation

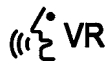

This Voice Command system allows you to control your AM, FM radio, satellite radio, disc player, and a memo recorder.

**NOTE:** Take care to speak into the Voice Interface System as calmly and normally as possible. The ability of the Voice Interface System to recognize user voice commands may be negatively affected by rapid speaking or a raised voice level.

### WARNING!

**Any voice commanded system should be used only in safe driving conditions following local laws. All attention should be kept on the roadway ahead. Failure to do so may result in a collision causing serious injury or death.**

When you press the Voice Command  button, you will hear a beep. The beep is your signal to give a command.

**NOTE:** If you do not say a command within a few seconds, the system will present you with a list of options.

If you ever wish to interrupt the system while it lists options, press the Voice Command  button, listen for the beep, and say your command.

Pressing the Voice Command  button while the system is speaking is known as “barging in.” The system will be interrupted, and after the beep, you can add or change commands. This will become helpful once you start to learn the options.

**NOTE:** At any time, you can say the words “Cancel”, “Help” or “Main Menu”.

These commands are universal and can be used from any menu. All other commands can be used depending upon the active application.

When using this system, you should speak clearly and at a normal speaking volume.

The system will best recognize your speech if the windows are closed, and the heater/air conditioning fan is set to low.

At any point, if the system does not recognize one of your commands, you will be prompted to repeat it.

To hear the first available Menu, press the Voice Command  button and say “Help” or “Main Menu”.

### **Commands**

The Voice Command system understands two types of commands. Universal commands are available at all times. Local commands are available if the supported radio mode is active.

### **Changing the Volume**

1. Start a dialogue by pressing the Voice Command  button.



2. Say a command (e.g., “Help”).
3. Use the ON/OFF VOLUME rotary knob to adjust the volume to a comfortable level while the Voice Command system is speaking. Please note the volume setting for Voice Command is different than the audio system.

### Main Menu

Start a dialogue by pressing the Voice Command  button. You may say “Main Menu” to switch to the main menu.

In this mode, you can say the following commands:

- “Radio” (to switch to the radio mode)
- “Disc” (to switch to the disc mode)
- “Memo” (to switch to the memo recorder)
- “Setup” (to switch to system setup)

### Radio AM

To switch to the AM band, say “AM” or “Radio AM”. In this mode, you may say the following commands:

- “Frequency #” (to change the frequency)
- “Next Station” (to select the next station)
- “Previous Station” (to select the previous station)
- “Radio Menu” (to switch to the radio menu)
- “Main Menu” (to switch to the main menu)

### Radio FM

To switch to the FM band, say “FM” or “Radio FM”. In this mode, you may say the following commands:

- “Frequency #” (to change the frequency)
- “Next Station” (to select the next station)
- “Previous Station” (to select the previous station)

- “Menu Radio” (to switch to the radio menu)
- “Main Menu” (to switch to the main menu)

### Satellite Radio

To switch to satellite radio mode, say “Sat” or “Satellite Radio”. In this mode, you may say the following commands:

- “Channel Number” (to change the channel by its spoken number)
- “Next Channel” (to select the next channel)
- “Previous Channel” (to select the previous channel)
- “List Channel” (to hear a list of available channels)
- “Select Name” (to say the name of a channel)
- “Menu Radio” (to switch to the radio menu)
- “Main Menu” (to switch to the main menu)

### Disc

To switch to the disc mode, say “Disc”. In this mode, you may say the following commands:

- “Track” (#) (to change the track)
- “Next Track” (to play the next track)
- “Previous Track” (to play the previous track)
- “Main Menu” (to switch to the main menu)

### Memo

To switch to the voice recorder mode, say “Memo”. In this mode, you may say the following commands:

- “New Memo” (to record a new memo) — During the recording, you may press the Voice Command ( VR button to stop recording. You proceed by saying one of the following commands:
  - “Save” (to save the memo)

- “Continue” (to continue recording)
- “Delete” (to delete the recording)
- “Play Memos” (to play previously recorded memos)
  - During the playback you may press the Voice Command (Ⓜ️) button to stop playing memos. You proceed by saying one of the following commands:
    - “Repeat” (to repeat a memo)
    - “Next” (to play the next memo)
    - “Previous” (to play the previous memo)
    - “Delete” (to delete a memo)
- “Delete All” (to delete all memos)

### Setup

To switch to system setup, you may say on of the following:

- “Change to setup”

- “Switch to system setup”
- “Change to setup”
- “Main menu setup” or
- “Switch to setup”

In this mode, you may say the following commands:

- “Language English”
- “Language French”
- “Language Spanish”
- “Tutorial”
- “Voice Training”

**NOTE:** Keep in mind that you have to press the Voice Command (Ⓜ️) button first and wait for the beep before speaking the “Barge In” commands.

## Voice Training

For users experiencing difficulty with the system recognizing their voice commands or numbers the Uconnect™ Voice “Voice Training” feature may be used.

1. Press the Voice Command  button, say “System Setup” and once you are in that menu then say “Voice Training.” This will train your own voice to the system and will improve recognition.
2. Repeat the words and phrases when prompted by Uconnect™ Voice. For best results, the “Voice Training” session should be completed when the vehicle is parked, engine running, all windows closed, and the blower fan switched off. This procedure may be repeated with a new user. The system will adapt to the last trained voice only.

## SEATS

Seats are a part of the Occupant Restraint System of the vehicle.

### WARNING!

- **It is dangerous to ride in a cargo area, inside or outside of a vehicle. In a collision, people riding in these areas are more likely to be seriously injured or killed.**
- **Do not allow people to ride in any area of your vehicle that is not equipped with seats and seat belts. In a collision, people riding in these areas are more likely to be seriously injured or killed.**
- **Be sure everyone in your vehicle is in a seat and using a seat belt properly.**

### Driver's Power Seat — If Equipped

The power seat switch is located on the outboard side of the seat near the floor. Use this switch to move the seat up or down, forward or rearward or to tilt the seat.

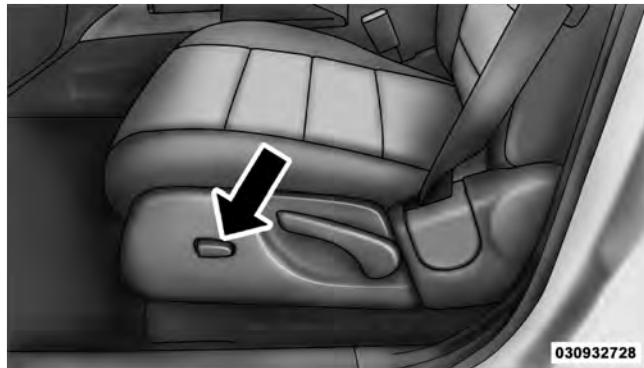

Power Seat Switch

### Adjusting The Seat Forward Or Rearward

The seat can be adjusted both forward and rearward. Push the seat switch forward or rearward, the seat will move in the direction of the switch. Release the switch when you have reached the desired position.

### Adjusting The Seat Up Or Down

The height of the seats can be adjusted up or down. Pull upward or push downward on the seat switch, the seat will move in the direction of the switch. Release the switch when you have reached the desired position.

### Tilting The Seat Up Or Down

The angle of the seat cushion can be adjusted in four directions. Pull upward or push downward on the front or rear of the seat switch, the front or rear of the seat cushion will move in the direction of the switch. Release the switch when you have reached the desired position.

**Passenger Power Seat — If Equipped**

Vehicle's equipped with passenger power seats can only be adjusted forward and backward.

**WARNING!**

- Adjusting a seat while driving may be dangerous. Moving a seat while driving could result in loss of control which could cause a collision and serious injury or death.
- Seats should be adjusted before fastening the seat belts and while the vehicle is parked. Serious injury or death could result from a poorly adjusted seat belt.
- Do not ride with the seatback reclined so that the shoulder belt is no longer resting against your chest. In a collision you could slide under the seat belt, which could result in serious injury or death.

**CAUTION!**

Do not place any article under a power seat or impede its ability to move as it may cause damage to the seat controls. Seat travel may become limited if movement is stopped by an obstruction in the seat's path.

**Heated Seats — If Equipped**

On some models, the front driver and passenger seats may be equipped with heaters in both the seat cushions and seatbacks.

There are two heated seat switches that allow the driver and passenger to operate the seats independently. The controls for each seat are located on a switch bank near the bottom center of the instrument panel.

You can choose from HIGH, LOW or OFF heat settings. Amber indicator lights in each switch indicate the level of heat in use. Two indicator lights will illuminate for HIGH, one for LOW and none for OFF.



Press the switch once to select HIGH-level heating. Press the switch a second time to select LOW-level heating. Press the switch a third time to shut the heating elements OFF.

When the HIGH-level setting is selected, the heater will provide a boosted heat level during the first four minutes of operation. Then, the heat output will drop to the normal HIGH-level. If the HIGH-level setting is selected, the system will automatically switch to LOW-level after approximately 30 minutes of continuous operation. At that time, the number of illuminated LEDs changes from two to one, indicating the change. The LOW-level setting will turn OFF automatically after approximately 30 minutes.

**NOTE:** When a heat setting is selected, heat will be felt within two to five minutes.

### WARNING!

- **Persons who are unable to feel pain to the skin because of advanced age, chronic illness, diabetes, spinal cord injury, medication, alcohol use, exhaustion or other physical condition must exercise care when using the seat heater. It may cause burns even at low temperatures, especially if used for long periods of time.**
- **Do not place anything on the seat that insulates against heat, such as a blanket or cushion. This may cause the seat heater to overheat. Sitting in a seat that has been overheated could cause serious burns due to the increased surface temperature of the seat.**

### Manual Front Seat Adjustments

For models equipped with manual seats, the driver and passenger seats can be adjusted forward or rearward by using a bar by the front of the seat cushion, near the floor.

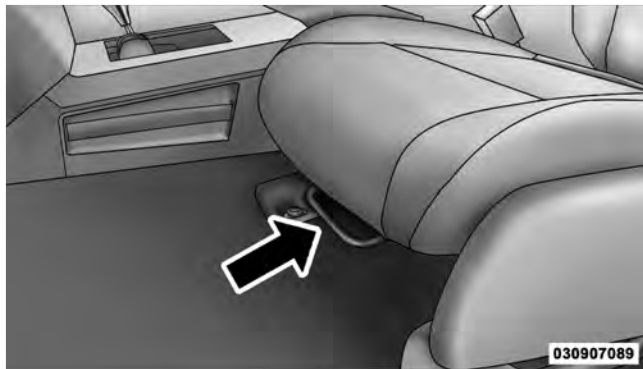

Manual Seat Adjustment

While sitting in the seat, lift up on the bar and move the seat forward or rearward. Release the bar once you have reached the desired position. Then, using body pressure, move forward and rearward on the seat to be sure that the seat adjusters have latched.

#### WARNING!

- Adjusting a seat while driving may be dangerous. Moving a seat while driving could result in loss of control which could cause a collision and serious injury or death.
- Seats should be adjusted before fastening the seat belts and while the vehicle is parked. Serious injury or death could result from a poorly adjusted seat belt.



### Front Seat — Manual Recline

To recline the seatback, lean forward slightly and lift the lever. Then lean back to the position desired and release the lever. To return the seatback to its normal upright position, lean forward and lift the lever. Release the lever once the seatback is in the upright position.

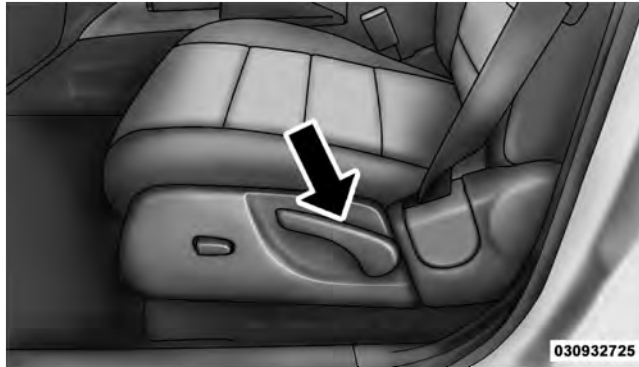

Recline Lever

### WARNING!

**Do not ride with the seatback reclined so that the shoulder belt is no longer resting against your chest. In a collision you could slide under the seat belt, which could result in serious injury or death.**

### Manual Lumbar Support — If Equipped

For models equipped with manual lumbar the support lever is located on the inboard side of the seat. Turn the lever downward to increase and upward to decrease the desired amount of lumbar support.



Lumbar Support Lever

### Fold-Flat Front Passenger Seat — If Equipped

This feature allows the front passenger seatback to fold flat for extended cargo space. Some fold flat seats also have a hardback surface that you can use as a work surface when the seat is folded flat. Pull up on the lever to fold down the seatback.

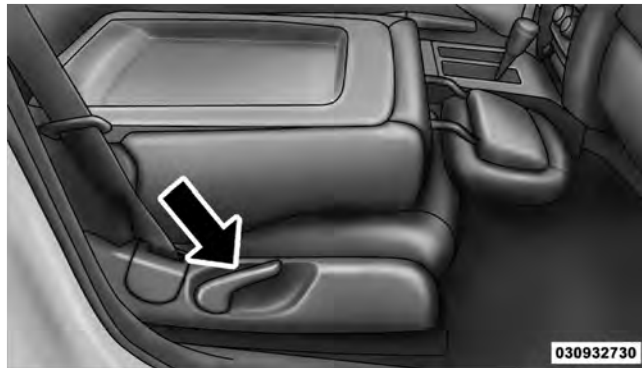

Fold-Flat Passenger Seat

## Head Restraints

Head restraints are designed to reduce the risk of injury by restricting head movement in the event of a rear impact. Head restraints should be adjusted so that the top of the head restraint is located above the top of your ear.

### WARNING!

**The head restraints for all occupants must be properly adjusted prior to operating the vehicle or occupying a seat. Head restraints should never be adjusted while the vehicle is in motion. Driving a vehicle with the head restraints improperly adjusted or removed could cause serious injury or death in the event of a collision.**

## Active Head Restraints — Front Seats

Active Head Restraints are passive, deployable components, and vehicles with this equipment cannot be readily identified by any markings, only through visual inspection of the head restraint. The head restraint will be split in two halves, with the front half being soft foam and trim, the back half being decorative plastic.

When AHRs deploy during a rear impact, the front half of the head restraint extends forward to minimize the gap between the back of the occupant's head and the AHR. This system is designed to help prevent or reduce the extent of injuries to the driver and front passenger in certain types of rear impacts. Refer to "Occupant Restraints" in "Things To Know Before Starting Your Vehicle" for further information.

To raise the head restraint, pull upward on the head restraint. To lower the head restraint, press the adjustment button, located at the base of the head restraint, and push downward on the head restraint.

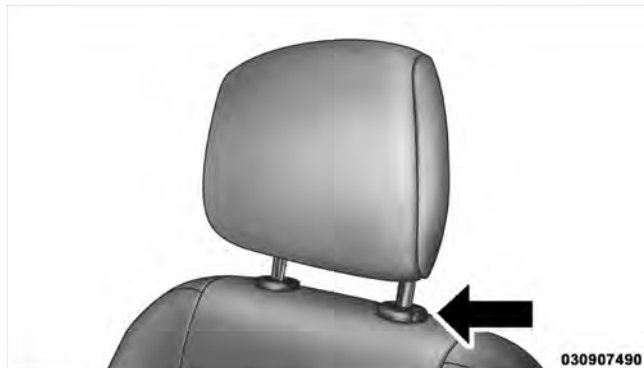

030907490

Adjustment Button

For comfort the Active Head Restraints can be tilted forward and backward. To tilt the head restraint closer to the back of your head, pull forward on the bottom of the head restraint. Push rearward on the bottom of the head restraint to move the head restraint away from your head.



022607494

Active Head Restraint (Normal Position)

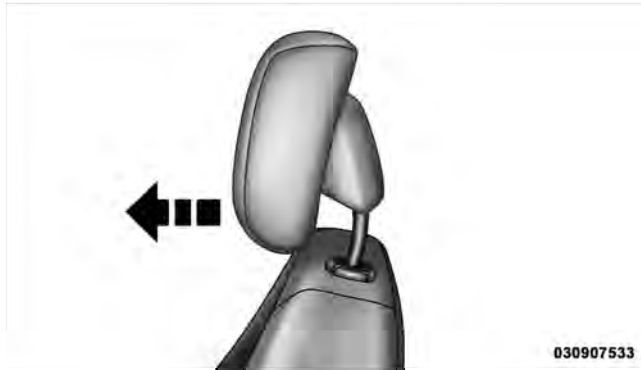

030907533

Active Head Restraint (Tilted)

**NOTE:**

- The head restraints should only be removed by qualified technicians, for service purposes only. If either of the head restraints require removal, see your authorized dealer.

- In the event of deployment of an Active Head Restraint, refer to “Occupant Restraints/Resetting Active Head Restraints (AHR)” in “Things To Know Before Starting Your Vehicle” for further information.

**WARNING!**

- Do not place items over the top of the Active Head Restraint, such as coats, seat covers or portable DVD players. These items may interfere with the operation of the Active Head Restraint in the event of a collision and could result in serious injury or death.

*(Continued)*

**WARNING! (Continued)**

- Active Head Restraints may be deployed if they are struck by an object such as a hand, foot or loose cargo. To avoid accidental deployment of the Active Head Restraint ensure that all cargo is secured, as loose cargo could contact the Active Head Restraint during sudden stops. Failure to follow this warning could cause personal injury if the Active Head Restraint is deployed.

**Rear Head Restraints**

The two outboard seats are equipped with adjustable head restraints. To raise the head restraint, pull upward on the head restraint. To lower the head restraint, press the adjustment button, located on the base of the head restraint, and push downward on the head restraint.

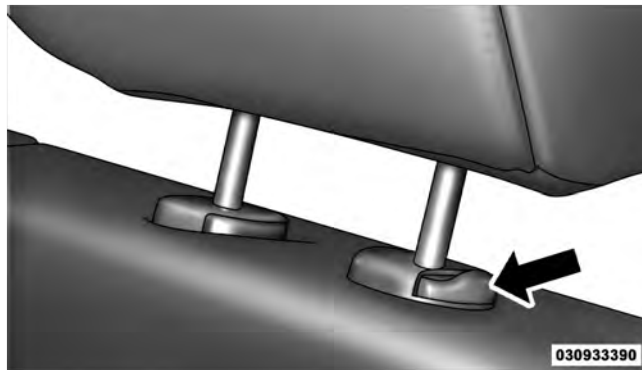
**Adjustment Button****NOTE:**

- The head restraints should only be removed by qualified technicians, for service purposes only. If either of the head restraints require removal, see your authorized dealer.

- Refer to “Occupant Restraints” in “Things To Know Before Starting Your Vehicle” for information on tether routing.

**WARNING!**

Driving a vehicle with the head restraints removed or improperly adjusted could cause serious injury or death in the event of a collision. The head restraints should be checked prior to operating the vehicle and never adjusted while the vehicle is in motion.

### 60/40 Split Folding Rear Seat With Fold-Flat Feature

To provide additional storage area, each rear seat can be folded flat. This allows for extended cargo space and still maintains some rear seating room.

**NOTE:** Prior to folding the rear seat, it may be necessary to position the front seat to its mid-track position. Also,

be sure that the front seats are fully upright and positioned forward. This will allow the rear seat to fold down easily.

**WARNING!**

- It is extremely dangerous to ride in a cargo area, inside or outside of a vehicle. In a collision, people riding in these areas are more likely to be seriously injured or killed.
- Do not allow people to ride in any area of your vehicle that is not equipped with seats and seat belts.
- Be sure everyone in your vehicle is in a seat and using a seat belt properly.

### To Lower The Rear Seat

1. Locate the release strap on the lower outboard side of each rear seatback.

2. Pull the release strap (toward the front of the vehicle).

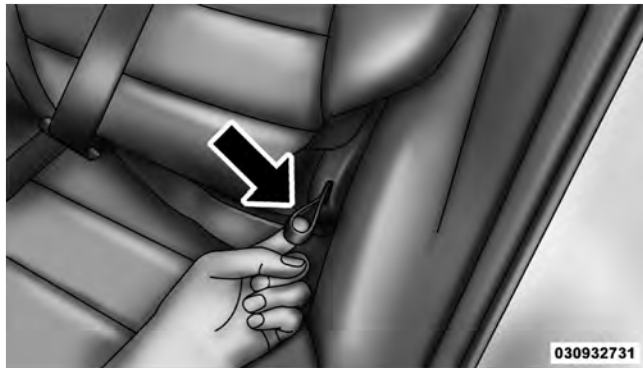

**Rear Seat Release Strap**

3. Fold the rear seat completely forward.
4. If desired, push down on the seatback to lock it in the folded position.

### To Raise The Rear Seat

**NOTE:** If interference from the cargo area prevents the seatback from fully locking, you will have difficulty returning the seat to its proper position.

1. If locked in the folded position, pull the release strap (toward the front of the vehicle).
2. Raise the seatback and lock it into place.

### **WARNING!**

**Be certain that the seatback is securely locked into position. If the seatback is not securely locked into position the seat will not provide the proper stability for child seats and/or passengers. An improperly latched seat could cause serious injury.**



## Recliner Adjustment

The rear seatback also reclines for additional passenger comfort. Pull the release strap while sitting in the rear seat to recline the seatback.

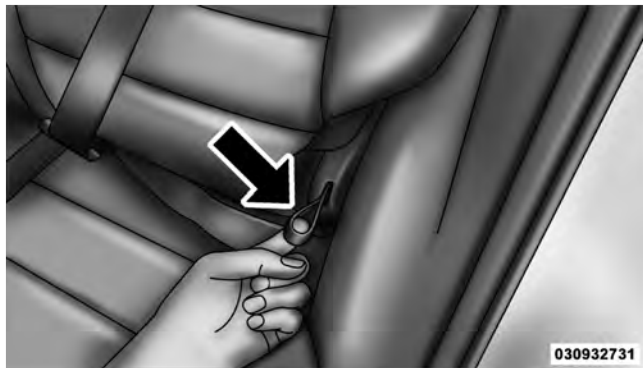

Rear Seatback Release Strap

## WARNING!

**Do not ride with the seatback reclined so that the shoulder belt is no longer resting against your chest. In a collision you could slide under the seat belt, which could result in serious injury or death.**

3

## DRIVER MEMORY SEAT — IF EQUIPPED

This feature allows the driver to store up to two different memory profiles, for easy recall through a memory switch. Each memory profile contains desired position settings for the driver seat and side mirrors and a set of desired radio station presets.

The memory switch is located on the instrument panel to the left of the steering column. The switch contains a S (SET) button to activate the memory save function. It also contains a rocker switch labeled with the number (1) and the number (2). The rocker switch allows the driver to

recall either of the two pre-programmed memory profiles by pressing the appropriate side of the switch.

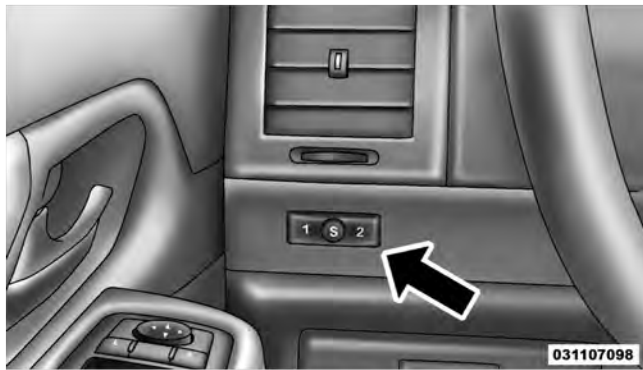

Driver Memory Switch

### Programming The Memory Feature

To create a new memory profile, perform the following:

**NOTE:** Saving a new memory profile will erase an existing profile from memory.

1. Turn the ignition ON.
2. Adjust all memory profile settings to desired preferences (i.e., seat, side mirror and radio station presets).
3. Press and release the SET button on the memory switch, then press the side of the rocker switch labeled (1) within five seconds. The Electronic Vehicle Information Center (EVIC), if equipped, will display which memory position is being set.

If desired, a second memory profile can be stored into memory as follows:

1. Turn the ignition ON.
2. Adjust all memory profile settings to desired preferences (i.e., seat, side mirror and radio station presets).

3. Press and release the SET button on the memory switch, then press the side of the rocker switch labeled (2) within five seconds. The EVIC, if equipped, will display which memory position is being set.

**NOTE:**

- For vehicles equipped with an automatic transmission, memory profiles can be set without the vehicle in PARK, but the vehicle must be in PARK to recall a memory profile.
- For vehicles equipped with a manual transmission, the vehicle speed must be at 0 mph (0 km/h) to recall a memory profile.
- The Recall Memory with Remote Key Unlock feature can be turned on and off through the EVIC, if equipped. Refer to “Electronic Vehicle Information Center (EVIC)/Customer-Programmable Features” in “Understanding Your Instrument Panel” for further information.

**Linking And Unlinking The Remote Keyless Entry Transmitter To Memory**

Your Remote Keyless Entry (RKE) transmitters can be programmed to recall one of two pre-programmed memory profiles with a press of the UNLOCK button on the RKE transmitter.

To program your RKE transmitters, perform the following:

1. Remove the key from the ignition.
2. Select the desired memory profile 1 or 2.
3. Press and release the SET button on the memory switch, then within five seconds press and release the side of the rocker switch labeled 1 or 2 accordingly. “Memory Profile Set” (1 or 2) will display in the EVIC, if equipped.
4. Press and release the LOCK button on the RKE transmitter within 10 seconds.

**NOTE:** Your RKE transmitters can be unlinked to the memory setting by pressing the SET button followed by the UNLOCK button on the RKE transmitter in Step 4 above.

### **Memory Position Recall**

**NOTE:**

- For vehicles equipped with an automatic transmission, the vehicle must be in PARK to recall memory positions. If a recall is attempted when the vehicle is not in PARK, a message will display in the EVIC, if equipped.
- For vehicles equipped with a manual transmission, the vehicle speed must be at 0 mph (0 km/h) to recall memory positions. If a recall is attempted with the vehicle speed above 0 mph (0 km/h), a message will display in the EVIC, if equipped.

To recall the memory settings for driver one, press MEMORY button number 1 or the UNLOCK button on the RKE transmitter linked to memory position 1.

To recall the memory setting for driver two, press MEMORY button number 2 or the UNLOCK button on the RKE transmitter linked to memory position 2.

A recall can be cancelled by pressing any of the MEMORY buttons (S, 1, or 2) during a recall. When a recall is cancelled, the driver seat will stop moving. A delay of one second will occur before another recall can be selected.

### **Easy Entry/Exit Seat (Available With Memory Seat Only)**

This feature provides automatic driver seat positioning to enhance driver mobility when entering and exiting the vehicle.

The distance the driver seat moves depends on where you have the driver seat positioned when you remove the key from the ignition switch.

- When you remove the key from the ignition switch, the driver seat will move about 2.4 in (60 mm) rearward if the driver's seat position is greater than or equal to 2.7 in (68 mm) forward of the rear stop. The seat will return to its previously set position when you insert the key into the ignition switch and turn it out of the LOCK position.
- When you remove the key from the ignition switch, the driver seat will move to a position 0.3 in (8 mm) forward of the rear stop if the driver's seat position is between 0.9 in and 2.7 in (23 mm and 68 mm) forward of the rear stop. The seat will return to its previously

set position when you insert the key into the ignition switch and turn it out of the LOCK position.

- The Easy Entry/Easy Exit feature is disabled when the driver's seat position is less than 0.9 in (23 mm) forward of the rear stop. At this position, there is no benefit to the driver by moving the seat for Easy Exit or Easy Entry.

Each stored memory setting will have an associated Easy Entry and Easy Exit position.

**NOTE:** The Easy Entry/Easy Exit feature can be turned on or off through the programmable features in the EVIC. Refer to "Electronic Vehicle Information Center (EVIC)/Customer-Programmable Features" in "Understanding Your Instrument Panel" for further information.

## TO OPEN AND CLOSE THE HOOD

Two latches must be released to open the hood.

1. Pull the hood release lever located under the left side of the instrument panel.

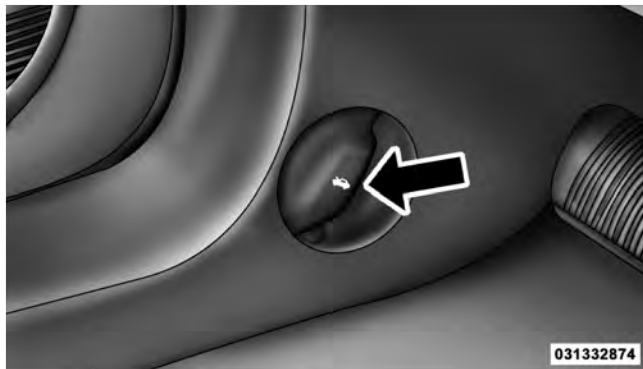

Hood Release

2. Outside of the vehicle, locate the safety latch lever between the grille and hood opening (left of center when facing hood). Push the safety latch lever to the right and then raise the hood.



Underhood Safety Latch

Use the hood prop rod to secure the hood in the open position. Place the upper end of the prop rod in the hole on the underside of the hood.

### CAUTION!

To prevent possible damage:

- Before closing hood, make sure the hood prop rod is fully seated into its storage retaining clips.
- Lower the hood to approximately 6 in (15.2 cm) above the closed position and drop the hood to latch it.
- Never drive your vehicle unless the hood is fully closed, with both latches engaged.

### WARNING!

Be sure the hood is fully latched before driving your vehicle. If the hood is not fully latched, it could open when the vehicle is in motion and block your vision. Failure to follow this warning could result in serious injury or death.

## LIGHTS

### Multifunction Lever

The multifunction lever on the left side of the steering column controls the operation of the headlamps, parking lights, turn signal lights, instrument panel lights, instrument panel light dimming, interior lights and fog lights (if equipped).



031407552

Multifunction Lever

### Headlights And Parking Lights

Turn the end of the multifunction lever to the first detent for parking light operation. Turn the end of the lever to the second detent for headlight operation.



031407553

Headlight Switch



### Automatic Headlights — If Equipped

This system automatically turns the headlights on or off according to ambient light levels. To turn the system on, turn the end of the multifunction lever to the AUTO position (third detent). When the system is on, the Headlight Time Delay feature is also on. This means the headlights will stay on for up to 90 seconds after you turn the ignition switch to the LOCK position. To turn the Automatic System off, turn the end of the multifunction lever out of the AUTO position.



Headlight Switch

**NOTE:** The engine must be running before the headlights will turn on in the Automatic mode.

## **Headlights With Wipers (Available With Automatic Headlights Only)**

When this feature is active, the headlights will turn on approximately 10 seconds after the wipers are turned on if the multifunction lever is placed in the AUTO position. In addition, the headlights will turn off when the wipers are turned off if they were turned on by this feature.

The Headlights with Wipers feature can be turned on or off through the Electronic Vehicle Information Center (EVIC) — if equipped. Refer to “Electronic Vehicle Information Center (EVIC)/Customer-Programmable Features” in “Understanding Your Instrument Panel” for further information.

### **Headlight Time Delay — If Equipped**

This feature is particularly useful when exiting your vehicle in an unlit area. It provides the safety of headlight illumination for about 90 seconds after turning the ignition switch to the LOCK position.

To activate the delay, turn the ignition switch to the LOCK position while the headlights are still on. Then, turn off the headlights within 45 seconds. The delay interval begins when you turn off the headlights. Only the headlights will illuminate during this time.

If you turn the headlights, or parking lights, or ignition switch ON again, the system will cancel the delay.

If you turn the headlights off before the ignition, they will turn off in the normal manner.

The Headlight delay time is programmable on vehicles equipped with the Electronic Vehicle Information Center (EVIC). Refer to “Electronic Vehicle Information Center (EVIC)/Customer-Programmable Features” in “Understanding Your Instrument Panel” for further information.

### Daytime Running Lights — If Equipped

The headlights will turn on as Daytime Running Lights (DRL) and operate at lower intensity whenever the ignition is ON, the engine is running, the headlight switch is off, the parking brake is released and the shift lever is in any position except PARK.

### Lights-On Reminder

If the headlights or parking lights are on after the ignition is turned to the LOCK position, a chime will sound to alert the driver when the driver's door is opened.

### Fog Lights — If Equipped

 To activate the front fog lights, turn on the parking lights or the low beam headlights and pull out on the end of the multifunction lever.



### Front Fog Light Control

**NOTE:** The front fog lights will only operate with the headlights on low beam. Selecting high beam headlights will turn off the front fog lights.

## Turn Signals

Move the multifunction lever up or down and the arrows on each side of the instrument cluster flash to show proper operation of the front and rear turn signal lights.



Turn Signal Control

**NOTE:** If either light remains on and does not flash, or there is a very fast flash rate, check for a defective outside light bulb. If an indicator fails to light when the lever is moved, it would suggest that the indicator bulb is defective.

## Lane Change Assist

Tap the lever up or down once, without moving beyond the detent, and the turn signal (right or left) will flash three times then automatically turn off.

## High/Low Beam Switch

Push the multifunction lever away from you to switch the headlights to high beam. Pull the multifunction lever toward you, to switch the headlights back to low beam.

## Flash-To-Pass

You can signal another vehicle with your headlights by lightly pulling the multifunction lever toward you. This will turn on the high beam headlights until the lever is released.

**NOTE:** If the multifunction lever is held in the flash-to-pass position for more than 15 seconds, the high beams will shut off. If this occurs, wait 30 seconds before activating the flash-to-pass function again.

### Instrument Panel Dimmer

Rotate the center portion of the lever to the extreme bottom position to fully dim the instrument panel lights and prevent the interior lights from illuminating when a door is opened.

Rotate the center portion of the lever up to increase the brightness of the instrument panel lights when the parking lights or headlights are on.

Rotate the center portion of the lever upward to the next detent position to brighten the odometer and radio when the parking lights or headlights are on.

Rotate the center portion of the lever upward to the last detent to turn on the interior lighting.



Dimmer Control

### Map/Reading Lights

These lights are mounted between the sun visors on the overhead console and above the rear doors by the grab handles. Each light is turned on by pressing the lens. Press the lens a second time to turn off the light. These lights also turn on when a door is opened, or when the

UNLOCK button on the Remote Keyless Entry (RKE) transmitter is pressed, or when the dimmer control is turned completely upward to the second detent.

### Cargo Light

The cargo light is mounted in the headliner above the rear cargo area. This light will turn on when you open the liftgate or any door, or if you press the UNLOCK button on the RKE transmitter, or rotate the dimmer control on the multifunction lever completely upward to the second detent.

### Battery Saver Feature

To protect the battery, the interior lights will turn off automatically 10 minutes after the ignition switch is moved to the LOCK position. This will occur if the interior lights were switched on manually or are on because a door is open.

## WINDSHIELD WIPERS AND WASHERS

The windshield wiper/washer control lever is located on the right side of the steering column. The front wipers are operated by rotating a switch, located at the end of the lever. For information on using the rear window wiper/washer, refer to “Rear Window Features” in “Understanding The Features Of Your Vehicle”.



036407502

Wiper/Washer Lever

## Windshield Wiper Operation

Rotate the end of the lever upward to the second detent past the intermittent settings for low-speed wiper operation.

Rotate the end of the lever upward to the third detent past the intermittent settings for high-speed wiper operation.



031507503

Front Wiper Control

**NOTE:** The wipers will automatically return to the “park” position if you turn OFF the ignition switch while they are operating. The wipers will resume operation when you turn the ignition switch back to the ON position.

### CAUTION!

- Turn the windshield wipers off when driving through an automatic car wash. Damage to the windshield wipers may result if the wiper control is left in any position other than off.
- In cold weather, always turn off the wiper switch and allow the wipers to return to the “Park” position before turning off the engine. If the wiper switch is left on and the wipers freeze to the windshield, damage to the wiper motor may occur when the vehicle is restarted.

*(Continued)*

**CAUTION! (Continued)**

- Always remove any buildup of snow that prevents the windshield wiper blades from returning to the off position. If the windshield wiper control is turned off and the blades cannot return to the off position, damage to the wiper motor may occur.

**Intermittent Wiper System**

Use the intermittent wiper system when weather conditions make a single wiping cycle with a variable pause between cycles desirable. Rotate the end of the windshield wiper/washer control lever to the first detent, and then turn the end of the lever to select the desired delay interval.



031507503

**Front Wiper Control**



There are five delay settings, which allow you to regulate the wipe interval from a minimum of one cycle every second to a maximum of approximately 36 seconds between cycles or from a minimum of one cycle every second to a maximum of approximately 18 seconds between cycles at vehicle speeds greater than 10 mph (16 km/h).

**NOTE:** The wiper delay times depend on vehicle speed. If the vehicle is moving less than 10 mph (16 km/h), delay times will be doubled.

### **Windshield Washers**

To use the washer, pull the windshield wiper/washer control lever toward you and hold it for as long as washer spray is desired (for a maximum of 10 seconds).

If you activate the washer while the wiper control is in the delay range, the wipers will operate in low-speed for two or three wipe cycles after releasing the lever and then resume the intermittent interval previously selected.

If you activate the washer while the wiper control is in the off position, the wipers will operate for two or three wipe cycles and then turn off.

### **WARNING!**

**Sudden loss of visibility through the windshield could lead to a collision. You might not see other vehicles or other obstacles. To avoid sudden icing of the windshield during freezing weather, warm the windshield with defroster before and during windshield washer use.**

### Mist Feature

Push downward on the windshield wiper/washer control lever to activate a single wipe cycle to clear the windshield of road mist or spray from a passing vehicle. The wipers will continue to operate until you release the lever.



Mist Control

### Rain Sensing Wipers — If Equipped

This feature senses moisture on the windshield and automatically activates the wipers for the driver. This feature is especially useful for road splash or overspray from the windshield washers of the vehicle ahead. Rotate the end of the windshield wiper/washer control lever to one of the five intermittent wiper settings to activate this feature.

The sensitivity of the system is adjustable from the windshield wiper/washer control lever. Wiper delay position 1 is the least sensitive and wiper delay position 5 is the most sensitive. Choose position 3 for normal rain conditions. Choose position 2 or 1 if you desire less wiper sensitivity. Choose position 4 or 5 if you desire more sensitivity. Place the lever in the off position when not using the system.

**NOTE:**

- The rain-sensing feature will not operate when the wiper speed is in the low or high position.
- The rain-sensing feature may not function properly when ice or dried salt water is present on the windshield.
- Use of Rain-X® or products containing wax or silicone may reduce rain sensor performance.
- The rain-sensing feature can be turned on and off through the Electronic Vehicle Information Center (EVIC) — if equipped. Refer to “Electronic Vehicle Information Center (EVIC)/Personal Settings (Customer-Programmable Features)” in “Understanding Your Instrument Panel” for further information.

The rain-sensing system has protective features for the wiper blades and arms. It will not operate under the following conditions:

- **Low Temperature Wipe Inhibit** — The rain-sensing feature will not operate when the ignition is first switched ON, the vehicle is stationary, and the outside temperature is below 32° F (0° C). If the wiper control is moved, the vehicle speed becomes greater than 0 mph (0 km/h), or the outside temperature rises above freezing the rain-sensing feature will then operate.
- **Neutral Wipe Inhibit** — The rain-sensing feature will not operate when the ignition is ON, and the shift lever is in the NEUTRAL position, and the vehicle speed is less than 5 mph (8 km/h), unless the wiper control is moved or the shift lever is moved out of the NEUTRAL position.

- **Remote Start Wipe Inhibit (Vehicles Equipped with Remote Start System)** — The rain-sensing feature will not operate when the vehicle is in remote start mode. This feature will return to normal operation once remote start mode is exited. Refer to “Remote Start System” in “Things To Know Before Starting Your Vehicle” for further information.

### **Headlights With Wipers (Available With Automatic Headlights Only)**

When this feature is active, the headlights will turn on approximately 10 seconds after the wipers are turned on if the multifunction lever (on the left side of the steering column) is placed in the AUTO position. In addition, the headlights will turn off when the wipers are turned off if they were turned on by this feature.

The Headlights with Wipers feature can be turned on or off through the Electronic Vehicle Information Center (EVIC) — if equipped. Refer to “Electronic Vehicle Information Center (EVIC)/Personal Settings (Customer-Programmable Features)” in “Understanding Your Instrument Panel” for further information.

### **TILT STEERING COLUMN**

This feature allows you to tilt the steering column upward or downward. The tilt control handle is located below the steering wheel at the end of the steering column.

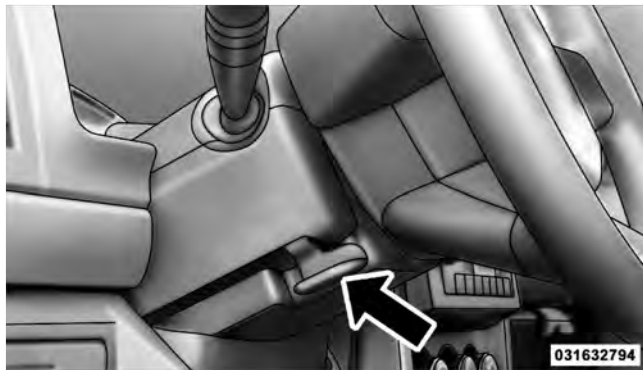

### Tilt Steering Control Handle

To unlock the steering column, push the control handle downward. To tilt the steering column, move the steering wheel upward or downward as desired. To lock the steering column in position, pull the control handle upward until it is fully engaged.

### WARNING!

Do not adjust the steering column while driving. Adjusting the steering column while driving or driving with the steering column unlocked, could cause the driver to lose control of the vehicle. Be sure the steering column is locked before driving your vehicle. Failure to follow this warning may result in serious injury or death.

3

### ELECTRONIC SPEED CONTROL — IF EQUIPPED

When engaged, the Electronic Speed Control takes over accelerator operations at speeds greater than 25 mph (40 km/h).

The Electronic Speed Control buttons are located on the right side of the steering wheel.

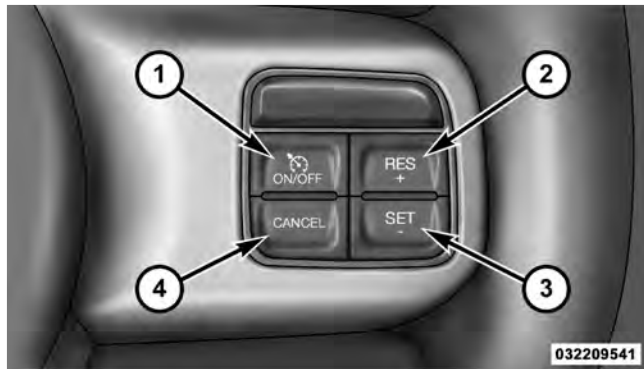

1 — ON/OFF  
4 — CANCEL

2 — RES +  
3 — SET -

**NOTE:** In order to ensure proper operation, the Electronic Speed Control System has been designed to shut down if multiple Speed Control functions are operated at

the same time. If this occurs, the Electronic Speed Control System can be reactivated by pushing the Electronic Speed Control ON/OFF button and resetting the desired vehicle set speed.

### To Activate

Push the ON/OFF button. The Cruise Indicator Light in the instrument cluster will illuminate. To turn the system off, push the ON/OFF button a second time. The Cruise Indicator Light will turn off. The system should be turned off when not in use.

### WARNING!

Leaving the Electronic Speed Control system on when not in use is dangerous. You could accidentally set the system or cause it to go faster than you want. You could lose control and have an accident. Always leave the system OFF when you are not using it.

**To Set A Desired Speed**

Turn the Electronic Speed Control ON. When the vehicle has reached the desired speed, press the SET (-) button and release. Release the accelerator and the vehicle will operate at the selected speed.

**NOTE:** The vehicle should be traveling at a steady speed and on level ground before pressing the SET button.

**To Deactivate**

A soft tap on the brake pedal, pushing the CANCEL button, or normal brake pressure while slowing the vehicle will deactivate Electronic Speed Control without erasing the set speed memory. Pressing the ON/OFF button or turning the ignition switch OFF erases the set speed memory.

**To Resume Speed**

To resume a previously set speed, push the RES (+) button and release. Resume can be used at any speed above 20 mph (32 km/h).

**To Vary The Speed Setting**

When the Electronic Speed Control is set, you can increase speed by pushing the RES (+) button. If the button is continually pressed, the set speed will continue to increase until the button is released, then the new set speed will be established.

Pressing the RES (+) button once will result in a 1 mph (2 km/h) increase in set speed. Each subsequent tap of the button results in an increase of 1 mph (2 km/h).

To decrease speed while the Electronic Speed Control is set, push the SET (-) button. If the button is continually held in the SET (-) position, the set speed will continue to decrease until the button is released. Release the button when the desired speed is reached, and the new set speed will be established.

Pressing the SET (-) button once will result in a 1 mph (2 km/h) decrease in set speed. Each subsequent tap of the button results in a decrease of 1 mph (2 km/h).

### **To Accelerate For Passing**

Press the accelerator as you would normally. When the pedal is released, the vehicle will return to the set speed.

### **Using Electronic Speed Control On Hills**

The transmission may downshift on hills to maintain the vehicle set speed.

**NOTE:** The Electronic Speed Control system maintains speed up and down hills. A slight speed change on moderate hills is normal.

On steep hills, a greater speed loss or gain may occur so it may be preferable to drive without Electronic Speed Control.

### **WARNING!**

**Electronic Speed Control can be dangerous where the system cannot maintain a constant speed. Your vehicle could go too fast for the conditions, and you could lose control and have an accident. Do not use Electronic Speed Control in heavy traffic or on roads that are winding, icy, snow-covered or slippery.**



## **PARKSENSE® REAR PARK ASSIST — IF EQUIPPED**

The ParkSense® Rear Park Assist system provides visual and audible indications of the distance between the rear fascia and a detected obstacle when backing up, e.g. during a parking maneuver. Refer to ParkSense® System Usage Precautions for limitations of this system and recommendations.

ParkSense® will retain the last system state (enabled or disabled) from the last ignition cycle when the ignition is changed to the ON/RUN position.

ParkSense® can be active only when the shift lever is in REVERSE. If ParkSense® is enabled at this shift lever position, the system will remain active until the vehicle speed is increased to approximately 11 mph (18 km/h) or above. The system will become active again if the vehicle speed is decreased to speeds less than approximately 10 mph (16 km/h).

## **ParkSense® Sensors**

The four ParkSense® sensors, located in the rear fascia/bumper, monitor the area behind the vehicle that is within the sensors' field of view. The sensors can detect obstacles from approximately 12 in (30 cm) up to 79 in (200 cm) from the rear fascia/bumper in the horizontal direction, depending on the location, type and orientation of the obstacle.

## **ParkSense® Warning Display**

The ParkSense® Warning screen will only be displayed if Sound and Display is selected from the Customer-Programmable Features section of the Electronic Vehicle Information Center (EVIC). Refer to “Electronic Vehicle Information Center (EVIC)/Personal Settings (Customer-Programmable Features)” in “Understanding Your Instrument Panel” for further information.

The ParkSense® Warning Display is located in the Instrument cluster's EVIC display. It provides both visual and audible warnings to indicate the distance between the rear fascia/bumper and the detected obstacle.



ParkSense® Warning Display

### ParkSense® Display

When the vehicle is in REVERSE, the warning display will turn ON indicating the system status.



Park Assist ON



**Park Assist Off**

The system will indicate a detected obstacle by showing three solid arcs and will produce a one-half second tone. As the vehicle moves closer to the object the EVIC display will show fewer arcs and the sound tone will change from slow, to fast, to continuous.



**Slow Tone**



Fast Tone



Continuous Tone

The vehicle is close to the obstacle when the EVIC display shows one flashing arc and sounds a continuous tone. The following chart shows the warning alert operation when the system is detecting an obstacle:

WARNING ALERTS					
Rear Distance (in/cm)	Greater than 79 in (200 cm)	79-39 in (200-100 cm)	39-25 in (100-65 cm)	25-12 in (65-30 cm)	Less than 12 in (30 cm)
Audible Alert Chime	None	Single 1/2 Second Tone	Slow	Fast	Continuous
Display Message	Park Assist ON	Warning Object Detected	Warning Object Detected	Warning Object Detected	Warning Object Detected
Arcs	None	3 Solid (Continuous)	3 Slow Flashing	2 Slow Flashing	1 Slow Flashing
Radio Mute	No	Yes	Yes	Yes	Yes

**NOTE:** ParkSense® will MUTE the radio, if on, when the system is sounding an audio tone.

## Enabling And Disabling ParkSense®

ParkSense® can be enabled and disabled with a switch located in the switch bank of the instrument panel or through the Customer-Programmable Features section of the EVIC. The available choices are: OFF, Sound Only, or Sound and Display. Refer to “Electronic Vehicle Information Center (EVIC)/Personal Settings (Customer-Programmable Features)” in “Understanding Your Instrument Panel” for further information.



When the ParkSense® switch is pressed to disable the system, the instrument cluster will display the “PARK ASSIST OFF” message for approximately five seconds. Refer to “Electronic Vehicle Information Center (EVIC)” in “Understanding Your Instrument Panel” for further information. When the shift lever is moved to REVERSE and the system is disabled, the EVIC will display the “PARK ASSIST OFF” message for as long as the vehicle is in REVERSE.

The ParkSense® switch LED will be ON when ParkSense® is disabled or defective. The ParkSense® switch LED will be OFF when the system is enabled.

## Service The ParkSense® Rear Park Assist System

When the ParkSense® Rear Park Assist System is malfunctioning, the instrument cluster will actuate a single chime, once per ignition cycle, and it will display the “SERVICE PARK ASSIST SYSTEM” message. Refer to “Electronic Vehicle Information Center (EVIC)” in “Understanding Your Instrument Panel” for further information. When the shift lever is moved to REVERSE and the system has detected a faulted condition, the EVIC will display the “SERVICE PARK ASSIST SYSTEM” message for as long as the vehicle is in REVERSE. Under this condition, ParkSense® will not operate.

If “SERVICE PARK ASSIST SYSTEM” appears in the EVIC, see your authorized dealer.

### **Cleaning The ParkSense® System**

Clean the ParkSense® sensors with water, car wash soap and a soft cloth. Do not use rough or hard cloths. Do not scratch or poke the sensors. Otherwise, you could damage the sensors.

### **ParkSense® System Usage Precautions**

#### **NOTE:**

- Ensure that the rear bumper is free of snow, ice, mud, dirt and debris to keep the ParkSense® system operating properly.
- Jackhammers, large trucks, and other vibrations could affect the performance of ParkSense®.
- When you turn ParkSense® off, the instrument cluster will display “PARK ASSIST OFF.” Furthermore, once you turn ParkSense® off, it remains off until you turn it on again, even if you cycle the ignition key.

- When you move the shift lever to the REVERSE position and ParkSense® is turned off, the instrument cluster will display “PARK ASSIST OFF” message for as long as the vehicle is in REVERSE.
- ParkSense®, when on, will MUTE the radio when it is sounding a tone.
- Clean the ParkSense® sensors regularly, taking care not to scratch or damage them. The sensors must not be covered with ice, snow, slush, mud, dirt or debris. Failure to do so can result in the system not working properly. The ParkSense® system might not detect an obstacle behind the fascia/bumper, or it could provide a false indication that an obstacle is behind the fascia/bumper.
- Objects such as bicycle carriers, trailer hitches, etc., must not be placed within 12 in (30 cm) from the rear fascia/bumper while driving the vehicle. Failure to do so can result in the system misinterpreting a close

object as a sensor problem, causing the “SERVICE PARK ASSIST SYSTEM” message to be displayed in the EVIC.

**CAUTION!**

- ParkSense® is only a parking aid and it is unable to recognize every obstacle, including small obstacles. Parking curbs might be temporarily detected or not detected at all. Obstacles located above or below the sensors will not be detected when they are in close proximity.
- The vehicle must be driven slowly when using ParkSense® in order to be able to stop in time when an obstacle is detected. It is recommended that the driver looks over his/her shoulder when using ParkSense®.

**WARNING!**

- Drivers must be careful when backing up even when using the ParkSense® Rear Park Assist System. Always check carefully behind your vehicle, look behind you, and be sure to check for pedestrians, animals, other vehicles, obstructions, and blind spots before backing up. You are responsible for safety and must continue to pay attention to your surroundings. Failure to do so can result in serious injury or death.

*(Continued)*



**WARNING! (Continued)**

- Before using the ParkSense® Rear Park Assist System, it is strongly recommended that the ball mount and hitch ball assembly is disconnected from the vehicle when the vehicle is not used for towing. Failure to do so can result in injury or damage to vehicles or obstacles because the hitch ball will be much closer to the obstacle than the rear fascia when the warning display turns on the single flashing arc and sounds the continuous tone. Also, the sensors could detect the ball mount and hitch ball assembly, depending on its size and shape, giving a false indication that an obstacle is behind the vehicle.

**GARAGE DOOR OPENER — IF EQUIPPED**

HomeLink® replaces up to three remote controls (hand-held transmitters) that operate devices such as garage

door openers, motorized gates, lighting or home security systems. The HomeLink® unit operates off your vehicle's battery.

The HomeLink® buttons that are located in the headliner or sun visor designate the three different HomeLink® channels.

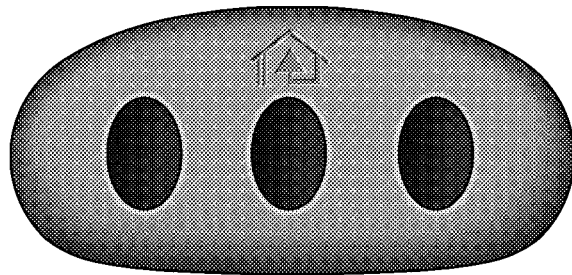
**3**

HomeLink® Buttons

81cb44fe

**NOTE:** HomeLink® is disabled when the Vehicle Security Alarm is active.

### **WARNING!**

- Your motorized door or gate will open and close while you are training the Universal Transceiver. Do not train the transceiver if people, pets or other objects are in the path of the door or gate. Only use this transceiver with a garage door opener that has a “stop and reverse” feature as required by Federal safety standards. This includes most garage door opener models manufactured after 1982. Do not use a garage door opener without these safety features. Call toll-free 1-800-355-3515 or, on the Internet at [www.HomeLink.com](http://www.HomeLink.com) for safety information or assistance.

*(Continued)*

### **WARNING! (Continued)**

- Vehicle exhaust contains carbon monoxide, a dangerous gas. Do not run your vehicle in the garage while training the transceiver. Exhaust gas can cause serious injury or death.

## **Programming HomeLink®**

### **Before You Begin**

If you have not trained any of the HomeLink® buttons, erase all channels before you begin training.

To do this, press and hold the two outside buttons for 20 seconds until the red indicator flashes.

It is recommended that a new battery be placed in the handheld transmitter of the device that is being copied to HomeLink® for more efficient training and accurate transmission of the radio-frequency signal.

Your vehicle should be parked outside of the garage when programming.

1. Turn the ignition switch to the ON/RUN position.
2. Hold the battery side of the handheld transmitter away from the HomeLink® button you wish to program.

Place the handheld transmitter 1–3 in (3-8 cm) away from the HomeLink® button you wish to program while keeping the indicator light in view.

3. Simultaneously press and hold both the chosen HomeLink® button and the handheld transmitter button until the HomeLink® indicator changes from a slow to a rapidly blinking light, then release both the HomeLink® and handheld transmitter buttons.

Watch for the HomeLink® indicator to change flash rates. When it changes, it is programmed. It may take up to 30 seconds or longer in rare cases. The garage door may open and close while you train.

**NOTE:**

- Some gate operators and garage door openers may require you to replace Step 3 with procedures noted in the “Gate Operator/Canadian Programming” section.
  - After training a HomeLink® channel, if the garage door does not operate with HomeLink® and the garage door opener was manufactured after 1995, the garage door opener may have a rolling code. If so, proceed to Step 5 “Programming A Rolling Code System.”
4. Press and hold the just-trained HomeLink® button and observe the indicator light.

If the indicator light stays on constantly, programming is complete and the garage door (or device) should activate when the HomeLink® button is pressed.

If the indicator light blinks rapidly for two seconds, and then turns to a constant light, continue with programming for a Rolling Code.

### 5. Programming A Rolling Code System

At the garage door opener motor (in the garage), locate the "Learn" or "Training" button.

This can usually be found where the hanging antenna wire is attached to the garage door opener motor (it is NOT the button normally used to open and close the door).

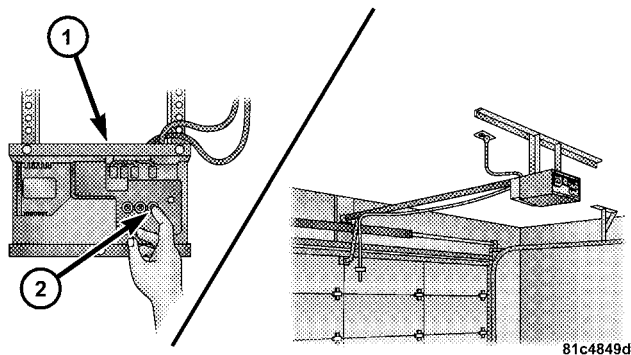

- 1 — Garage Door Opener  
2 — Training Button

6. Firmly press and release the LEARN or TRAINING button. The name and color of the button may vary by manufacturer.

**NOTE:** You have 30 seconds in which to initiate the next step after the LEARN button has been pressed.

7. Return to the vehicle and press the programmed HomeLink® button twice (holding the button for two seconds each time). If the device is plugged in and activates, programming is complete.

If the device does not activate, press the button a third time (for two seconds) to complete the training.

If you have any problems, or require assistance, please call toll-free 1-800-355-3515 or, on the Internet at [www.HomeLink.com](http://www.HomeLink.com) for information or assistance.

To program the remaining two HomeLink® buttons, repeat each step for each remaining button. DO NOT erase the channels.

### **Gate Operator/Canadian Programming**

Canadian radio-frequency laws require transmitter signals to “time-out” (or quit) after several seconds of transmission – which may not be long enough for HomeLink® to pick up the signal during programming.

Similar to this Canadian law, some U.S. gate operators are designed to “time-out” in the same manner.

It may be helpful to unplug the device during the cycling process to prevent possible overheating of the garage door or gate motor.

If you are having difficulties programming a garage door opener or a gate operator, replace “Programming HomeLink®” Step 3 with the following:

**3. Continue to press and hold the HomeLink® button, while you press and release (“cycle”), your handheld transmitter every two seconds until HomeLink® has successfully accepted the frequency signal. The indicator light will flash slowly and then rapidly when fully trained.**

If you unplugged the device for training, plug it back in at this time.

Then proceed with Step 4 under “Programming HomeLink®” earlier in this section.

### Using HomeLink®

To operate, press and release the programmed HomeLink® button. Activation will now occur for the trained device (i.e., garage door opener, gate operator, Security system, entry door lock, home/office lighting, etc.). The handheld transmitter of the device may also be used at any time.

### Reprogramming A Single HomeLink® Button

To reprogram a channel that has been previously trained, follow these steps:

1. Turn the ignition switch to the ON/RUN position.
2. Press and hold the desired HomeLink® button until the indicator light begins to flash after 20 seconds. **Do not release the button.**

3. **Without releasing the button**, proceed with Programming HomeLink® Step 2 and follow all remaining steps.

### Security

It is advised to erase all channels before you sell or turn in your vehicle.

To do this, press and hold the two outside buttons for 20 seconds until the red indicator flashes. Note that all channels will be erased. Individual channels cannot be erased.

The HomeLink® Universal Transceiver is disabled when the Vehicle Security Alarm is active.

### Troubleshooting Tips

If you are having trouble programming HomeLink®, here are some of the most common solutions:

- Replace the battery in the original transmitter.

- Press the LEARN button on the Garage Door Opener to complete the training for a Rolling Code.
- Did you unplug the device for training, and remember to plug it back in?

If you have any problems, or require assistance, please call toll-free 1-800-355-3515 or, on the Internet at [www.HomeLink.com](http://www.HomeLink.com) for information or assistance.

### General Information

This device complies with FCC rules Part 15 and Industry Canada RSS-210. Operation is subject to the following two conditions:

1. This device may not cause harmful interference.

2. This device must accept any interference that may be received including interference that may cause undesired operation.

**NOTE:** The transmitter has been tested and it complies with FCC and IC rules. Changes or modifications not expressly approved by the party responsible for compliance could void the user's authority to operate the device.

The term IC before the certification/registration number only signifies that Industry Canada technical specifications were met.

## POWER SUNROOF — IF EQUIPPED

The power sunroof switch is located between the sun visors on the overhead console.

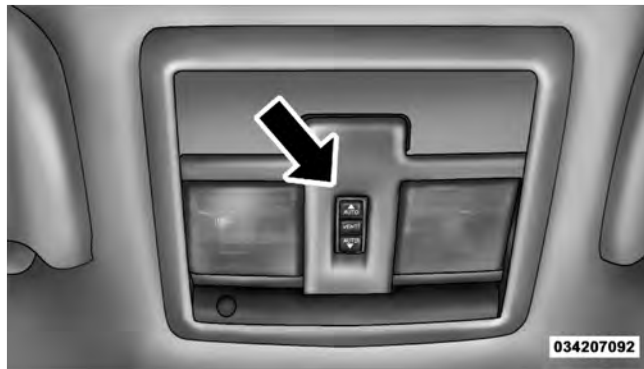

Power Sunroof Switch

### WARNING!

- Never leave unattended children in a vehicle with the key in the ignition switch. Occupants, particularly unattended children, can become entrapped by the power sunroof while operating the power sunroof switch. Such entrapment may result in serious injury or death.
- In a collision, there is a greater risk of being thrown from a vehicle with an open sunroof. You could also be seriously injured or killed. Always fasten your seat belt properly and make sure all passengers are properly secured too.
- Do not allow small children to operate the sunroof. Never allow your fingers, other body parts, or any object to project through the sunroof opening. Injury may result.



**Opening Sunroof — Express**

Press the switch rearward and release it within one-half second and the sunroof will open automatically from any position. The sunroof will open fully and stop automatically. This is called “Express Open”. During Express Open operation, any movement of the sunroof switch will stop the sunroof.

**Opening Sunroof — Manual Mode**

To open the sunroof, press and hold the switch rearward to full open. Any release of the switch will stop the movement and the sunroof will remain in a partially opened condition until the switch is pushed and held rearward again.

**Closing Sunroof — Express**

Press the switch forward and release it within one-half second and the sunroof will close automatically from any

position. The sunroof will close fully and stop automatically. This is called “Express Close”. During Express Close operation, any movement of the switch will stop the sunroof.

**Closing Sunroof — Manual Mode**

To close the sunroof, press and hold the switch in the forward position. Any release of the switch will stop the movement and the sunroof will remain in a partially closed condition until the switch is pushed and held forward again.

**Pinch Protect Feature**

This feature will detect an obstruction in the opening of the sunroof during Express Close operation. If an obstruction in the path of the sunroof is detected, the sunroof will automatically retract. Remove the obstruction if this occurs. Next, press the switch forward and release to Express Close.

### **Pinch Protect Override**

If a known obstruction (ice, debris, etc.) prevents closing and moves the sunroof in the opposite direction, press the switch forward and hold. This allows the sunroof to move towards the closed position.

**NOTE:** Pinch protection is disabled while the switch is pressed.

### **Venting Sunroof — Express**

Press and release the "Vent" button within one-half second and the sunroof will open to the vent position. This is called "Express Vent", and it will occur regardless of sunroof position. During Express Vent operation, any movement of the switch will stop the sunroof.

### **Sunshade Operation**

The sunshade can be opened manually. However, the sunshade will open automatically as the sunroof opens.

**NOTE:** The sunshade cannot be closed if the sunroof is open.

### **Wind Buffeting**

Wind buffeting can be described as the perception of pressure on the ears or a helicopter-type sound in the ears. Your vehicle may exhibit wind buffeting with the windows down, or the sunroof (if equipped) is in certain open or partially open positions. This is a normal occurrence and can be minimized. If the buffeting occurs with the rear windows open, then open the front and rear windows together to minimize the buffeting. If the buffeting occurs with the sunroof open, adjust the sunroof opening to minimize the buffeting or open any window.

### **Sunroof Maintenance**

Use only a non-abrasive cleaner and a soft cloth to clean the glass panel.

## Ignition Off Operation

For vehicles not equipped with the Electronic Vehicle Information Center (EVIC), the power sunroof switch will remain active for 45 seconds after the ignition switch is turned to the LOCK position. Opening either front door will cancel this feature.

For vehicles equipped with the EVIC, the power sunroof switch will remain active for up to approximately ten minutes after the ignition switch is turned to the LOCK position. Opening either front door will cancel this feature. The time is programmable. Refer to “Electronic Vehicle Information Center (EVIC)/Personal Settings (Customer-Programmable Features)” in “Understanding Your Instrument Panel” for further information.

## SKY SLIDER™ FULL LENGTH OPEN ROOF — IF EQUIPPED

The Sky Slider™ is a full-length, soft-top, power roof that opens front to rear or rear to front.

## Sky Slider™ Usage Precautions

### NOTE:

- The system will not operate when ambient temperature is at  $-4^{\circ}\text{F}$  ( $-20^{\circ}\text{C}$ ) or lower.
- The system will not operate at vehicle speeds of 86 mph (138 km/h) or above.
- Opening and closing the Sky Slider™ repeatedly without the engine running may run the battery down.

### CAUTION!

**Failure to follow these cautions can cause damage to the Sky Slider™ vehicle contents, and the vehicle interior:**

- **Never attempt to open or close the Sky Slider™ when it is frozen. Wait until the Sky Slider™ is thawed before operating.**

*(Continued)*

**CAUTION! (Continued)**

- Opening the Sky Slider™ when damp, wet, or dirty can cause stains, mildew, and damage to the soft-top material and the inside of your vehicle. Make sure the Sky Slider™ is dry before opening.
- Always close the Sky Slider™ when leaving your vehicle, damage to the vehicle interior can occur.
- Do not leave the Sky Slider™ open for several weeks at a time. Close it occasionally to prevent discoloration in the folds of the fabric and to allow the creases to smooth out. This is especially important if the Sky Slider™ was opened when not completely dry.

**WARNING!**

Failure to follow these warnings can result in injuries that are serious or fatal to you, your passengers, and others around you:

- In an accident, there is a greater risk of being thrown from a vehicle with the Sky Slider™ open. Always fasten your seat belt properly and make sure all passengers are properly secured too.
- Before operating the Sky Slider™ make sure that no moving parts of the Sky Slider™ can injure a person or animal.
- Never place any extremities (hands, feet, etc.) near the Sky Slider™ components or the roof area while operating the Sky Slider™.

*(Continued)*

**WARNING! (Continued)**

- If potential danger exists while opening or closing the Sky Slider™ in Automatic Mode, press and release the switch immediately to interrupt the operation.
- If potential danger exists while opening or closing the Sky Slider™ in Operator Mode, release the switch immediately to interrupt the operation.
- Do not allow small children to operate the Sky Slider™.
- Never leave children in a vehicle, with the key in the ignition switch. Occupants, particularly unattended children, can become entrapped by the Sky Slider™ while operating the Sky Slider™ switch. Such entrapment may result in serious injury or death.

**Sky Slider™ Control**

The Sky Slider™ switch is located between the sun visors on the overhead console.

**3**

Sky Slider™ Switch

**NOTE:** The Sky Slider™ switch will operate when the ignition switch is turned to the ON or ACC position.

## Opening The Sky Slider™

### Using Automatic Mode

Press the switch rearward and release it within one-half second and the Sky Slider™ will open from the front and move automatically toward the rear of the vehicle.

Press the switch forward and release it within one-half second and the Sky Slider™ will open from the rear and move automatically toward the front of the vehicle.

### NOTE:

- During operation, any movement of the Sky Slider™ switch will stop the Sky Slider™ roof.
- To resume the operation from a partially open position, press and release the switch a second time.
- The Sky Slider™ will not open from the front and the rear at the same time. The Sky Slider™ must close fully before opening it from the opposite end.

### Using Operator Mode

Press the switch rearward and hold it, the Sky Slider™ will open from the front and move toward the rear of the vehicle.

Press the switch forward and hold it, the Sky Slider™ will open from the rear and move toward the front of the vehicle.

**NOTE:** During operation, any movement of the Sky Slider™ switch will stop the Sky Slider™ roof.

## Closing The Sky Slider™

### Using Automatic Mode

Press and release the button in the center of the switch and the Sky Slider™ will close automatically from any position.

### Using Operator Mode

If the Sky Slider™ is open from the front, press the switch forward and hold it, the Sky Slider™ will move forward. Release the switch to stop the Sky Slider™ travel at any point.

If the Sky Slider™ is open from the rear, press the switch rearward and hold it and the Sky Slider™ will move rearward. Release the switch to stop the Sky Slider™ travel at any point.

### Manual Override

The Sky Slider™ drive motors are mounted to the roof above the cargo lamp. In the event that your vehicle loses battery power, you can close the Sky Slider™ by turning the drive gears in the appropriate motor with a 6 mm Allen wrench. To do so, you must first remove the cargo lamp from the headliner. Then, insert the wrench into the “Allen” shaped hole in the appropriate motor and turn the wrench clockwise until the top closes

completely. The left motor facing forward will close the top when it is open from the rear of the vehicle. The right motor will close the top when it is open from the front of the vehicle.

### Anti-Pinch Protect Feature

The Sky Slider™ will retract automatically if it detects an obstruction while closing. If this occurs, remove the obstruction and use the switch again to close the Sky Slider™.

#### WARNING!

**There is no anti-pinch protection when the Sky Slider™ is almost closed. Be sure to clear all objects from the Sky Slider™ before closing.**

### Wind Buffeting

Wind buffeting can be described as the perception of pressure on the ears or a helicopter-type sound in the

ears. Your vehicle may exhibit wind buffeting with the windows down, or the Sky Slider™ in certain open or partially open positions. This is a normal occurrence and can be minimized. If the buffeting occurs with the rear windows open, then open the front and rear windows together to minimize the buffeting. If the buffeting occurs with the Sky Slider™ open, adjust the Sky Slider™ opening to minimize the buffeting or open any window.

### Sky Slider™ Maintenance

Refer to “Sky Slider™ Top Care” in “Maintaining Your Vehicle” for further information.

### ELECTRICAL POWER OUTLET

Your vehicle is equipped with a fused 12 Volt (13 Amp) power outlet. This power outlet is located on the instrument panel, below the climate controls. It has power available when the ignition switch is in the ON or ACC position.



Front Power Outlet

Insert the cigar lighter or accessory plug into the outlet for use to ensure proper operation.

**NOTE:** To ensure proper operation a MOPAR® knob and element must be used.



**CAUTION!**

- Do not exceed the maximum power of 160 Watts (13 Amps) at 12 Volts. If the 160 Watt (13 Amp) power rating is exceeded the fuse protecting the system will need to be replaced.
- Power outlets are designed for accessory plugs only. Do not insert any other object in the power outlets as this will damage the outlet and blow the fuse. Improper use of the power outlet can cause damage not covered by your warranty.

**Power Outlet Fuse Location**

M7 Fuse 20 A Yellow Cigar Lighter Instrument Panel

**WARNING!**

To avoid serious injury or death:

*(Continued)*

**WARNING! (Continued)**

- Only devices designed for use in this type of outlet should be inserted into any 12 Volt outlet.
- Do not touch with wet hands.
- Close the lid when not in use and while driving the vehicle.
- If this outlet is mishandled, it may cause an electric shock and failure.

**CAUTION!**

- Many accessories that can be plugged in draw power from the vehicle's battery, even when not in use (i.e., cellular phones, etc.). Eventually, if plugged in long enough, the vehicle's battery will discharge sufficiently to degrade battery life and/or prevent the engine from starting.

*(Continued)*

**CAUTION! (Continued)**

- Accessories that draw higher power (i.e., coolers, vacuum cleaners, lights, etc.) will degrade the battery even more quickly. Only use these intermittently and with greater caution.
- After the use of high power draw accessories, or long periods of the vehicle not being started (with accessories still plugged in), the vehicle must be driven a sufficient length of time to allow the alternator to recharge the vehicle's battery.
- Power outlets are designed for accessory plugs only. Do not hang any type of accessory or accessory bracket from the plug.

## CUPHOLDERS

There are two cupholders for the front seat passengers, located in the center console.



Front Cupholders

The rear passengers have cupholders at the rear of the center console.

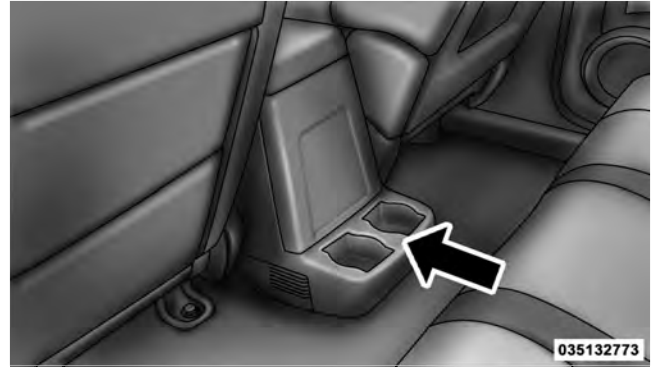

Rear Cupholders

## STORAGE

### Glove Box Storage Compartment

The glove box storage compartment is located on the right side of the instrument panel. Pull outward on the latch to open the storage compartment.



Glove Box Storage Compartment

### Front Storage Compartment

The front storage compartment (located on the left side of the instrument panel) can hold cell phones, PDAs, and other small items.



Front Storage Compartment

### Console Storage Compartment

To open, press the latch and lift the cover.

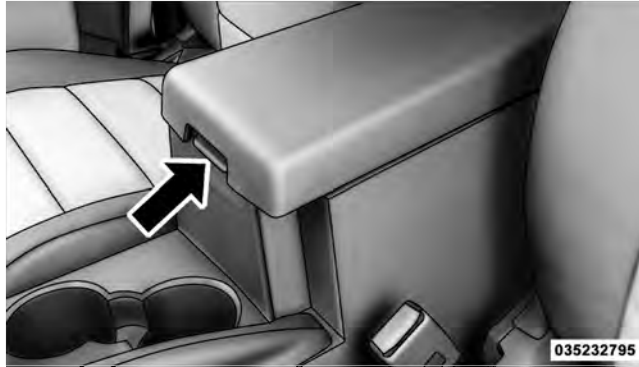

Center Console



Removable Storage Tray

**WARNING!**

Do not operate this vehicle with a console compartment lid in the open position. Cellular phones, music players, and other handheld electronic devices should be stowed while driving. Use of these devices while driving can cause an accident due to distraction, resulting in death or injury.

**CARGO AREA FEATURES****Cargo Load Floor**

The cargo load floor system has a load capacity of 400 lbs (181 kg). The load floor has a built-in storage bin that can hold a variety of items. The underside of the storage bin cover also contains a plastic lined tray. The cover can be installed with either side facing up for added utility.

To provide additional storage area, each rear seat can be folded flat. This allows for extended cargo space and still maintains some rear seating room. Refer to “Seats” in “Understanding the Features of Your Vehicle” for further information.

**Accessing The Storage Bin**

**NOTE:** The spring-loaded latches that retain the storage bin cover to the cargo load floor should not be used as cargo tie-downs.

1. Flip the spring-loaded latch pull-loops up.

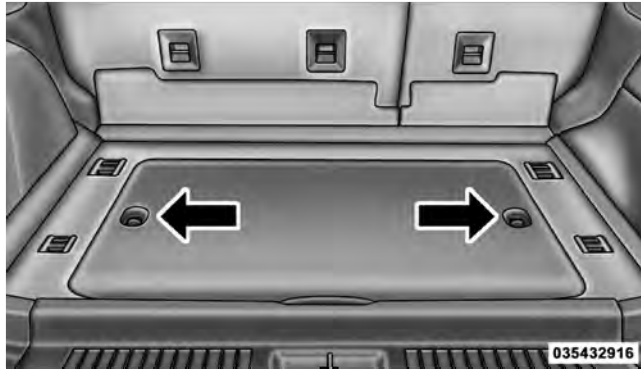

Cargo Load Floor Loops

2. Pull the loops upward and twist them one-quarter turn so that they are parallel to the slots in the storage bin cover.
3. Lift the cover upward over the loops.

4. Turn over the cover and reinstall it.

**NOTE:** You can install the cover with either side facing upward.

5. With the cover seated in the floor, pull upward on loops and twist them one-quarter turn so that they are no longer parallel to the slots in the cover.
6. Flip the loops down.

3

### WARNING!

A loose storage bin cover thrown forward in a accident or hard stop could endanger the occupants of the vehicle. Always latch the storage bin cover to the cargo load floor with the spring-loaded latches when not accessing the storage bin.

### Cargo Tie-Down Hooks And Loops

The tie-downs located on cargo area floor should be used to secure loads safely when the vehicle is moving.

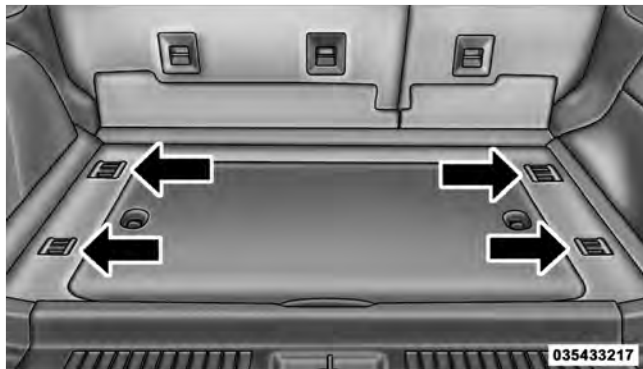

Cargo Tie-Down Hooks

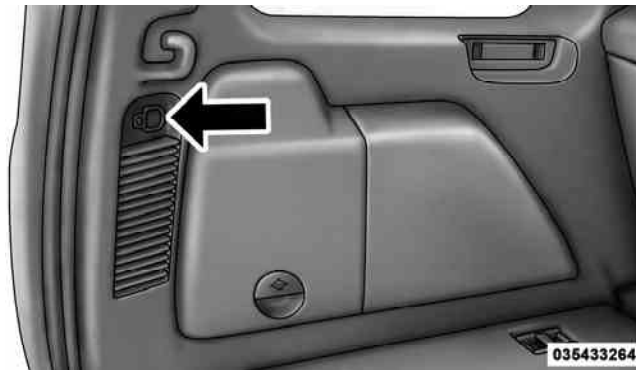

Cargo Tie-Down Loops

Cargo tie-down loops are located on the trim panels.



**WARNING!**

- Cargo tie-downs are not safe anchors for a child seat tether strap. In a sudden stop or accident, a tie-down could pull loose and allow the child seat to come loose. A child could be badly injured. Use only the anchors provided for child seat tethers.
- To help protect against personal injury, passengers should not be seated in the rear cargo area. The rear cargo space is intended for load carrying purposes only, not for passengers, who should sit in seats and use seat belts.

**WARNING!**

The weight and position of cargo and passengers can change the vehicle center of gravity and vehicle handling. To avoid loss of control resulting in personal injury, follow these guidelines for loading your vehicle:

- Do not carry loads that exceed the load limits described on the label attached to the left door or left door center pillar.
- Always place cargo evenly on the cargo floor. Put heavier objects as low and as far forward as possible.
- Place as much cargo as possible in front of the rear axle. Too much weight or improperly placed weight over or behind the rear axle can cause the vehicle to sway.

*(Continued)*

**WARNING! (Continued)**

- **Do not pile luggage or cargo higher than the top of the seatback. This could impair visibility or become a dangerous projectile in a sudden stop or accident.**

**Retractable Cargo Area Cover — If Equipped**

**NOTE:** The purpose of this cover is for privacy, not to secure loads. It will not prevent cargo from shifting or protect passengers from loose cargo.

The removable retractable cargo area cover mounts in the cargo area behind the top of the rear seats.

The cover, when extended, covers the cargo area to keep items out of sight. Notches in the trim panels near the liftgate opening secure the extended cover in place.

The cover rolls away neatly inside its housing when not in use. You can also remove the cover from the vehicle to make more room in the cargo area.

To install the cover, position it in the vehicle so that the flat side of the housing faces upward. Then, insert either the left or the right spring-loaded post (located on the ends of the cover housing) into either of the left or the right attachment points shown.

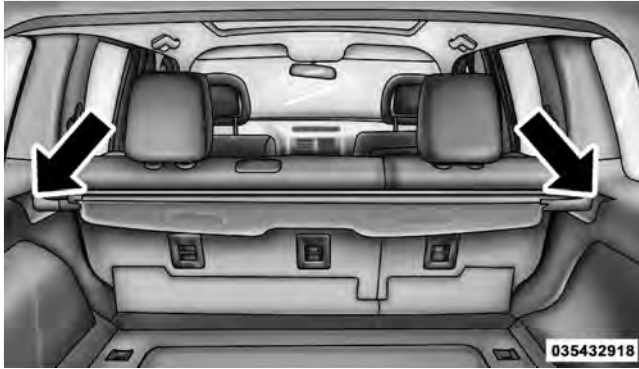

### Installing Retractable Cargo Area Cover

Then, insert the spring-loaded post on the opposite end of the cover housing into the attachment point on the opposite side of the vehicle.

Next, grab the cover handle and pull the cover toward you. As the cover nears the liftgate opening, guide the rear attachment posts (on both ends of the cover) into the notches in the trim panels. Then, lower the cover to position the posts into the bottom of the notches and release the handle.

**3**

### Positioning Retractable Cargo Area Cover

**WARNING!**

In a collision, a cargo cover loose in the vehicle could cause injury. It could fly around in a sudden stop and strike someone in the vehicle. Do not store the cargo cover on the cargo floor or in the passenger compartment. Remove the cover from the vehicle when taken from its mounting. Do not store in the vehicle.

**REAR WINDOW FEATURES****Rear Window Wiper/Washer**

The rear wiper/washer is controlled by a rotary switch located on the control lever. The control lever is located on the right side of the steering column.



031507505

**Rear Wiper/Washer Control**

-  Rotate the switch upward to the first detent position for rear wiper operation.

**NOTE:** The rear wiper operates in an intermittent mode only.



Rotate the switch upward past the first detent to activate the rear washer. The washer pump will continue to operate as long as the switch is held (for a maximum of 10 seconds). Upon release, the wiper will cycle two times before returning to the set position.

If the rear wiper is operating when the ignition is turned OFF, the wiper will automatically return to the “park” position. When the vehicle is restarted, the wiper will resume function at whichever position the switch is set.

**NOTE:** The rear wiper and the rear washer will not operate if the liftgate flipper glass is open.

### Rear Window Defroster



The rear window defroster button is located on the climate control (Mode) knob. Press this button to turn on the rear window defroster and the heated outside mirrors. An indicator in the button will illuminate when the rear window defroster is on. The rear window

defroster automatically turns off after approximately 10 minutes. For an additional five minutes of operation, press the button a second time.

**NOTE:** To prevent excessive battery drain, use the rear window defroster only when the engine is operating.

### CAUTION!

**Failure to follow these cautions can cause damage to the heating elements:**

- Use care when washing the inside of the rear window. Do not use abrasive window cleaners on the interior surface of the window. Use a soft cloth and a mild washing solution, wiping parallel to the heating elements. Labels can be peeled off after soaking with warm water.

*(Continued)*

**CAUTION! (Continued)**

- Do not use scrapers, sharp instruments, or abrasive window cleaners on the interior surface of the window.
- Keep all objects a safe distance from the window.

**ROOF LUGGAGE RACK — IF EQUIPPED**

**NOTE:** Roof rack and crossbars cannot be used on vehicles equipped with Skyslider®.

The load carried on the roof, when equipped with a luggage rack, must not exceed 150 lbs (68 kg), and it should be uniformly distributed over the cargo area.

Crossbars should always be used whenever cargo is placed on the roof rack. Check the straps frequently to be sure that the load remains securely attached.

**NOTE:** Crossbars are offered by MOPAR® accessories.

External racks do not increase the total load carrying capacity of the vehicle. Be sure that the total occupant and luggage load inside the vehicle, plus the load on the luggage rack, do not exceed the maximum vehicle load capacity.

**CAUTION!**

- To avoid damage to the roof rack and vehicle, do not exceed the maximum roof rack load capacity. Always distribute heavy loads as evenly as possible and secure the load appropriately.
- Long loads, which extend over the windshield, such as wood panels or surfboards, should be secured to both the front and rear of the vehicle.
- Place a blanket or other protection between the surface of the roof and the load.
- Travel at reduced speeds and turn corners carefully when carrying large or heavy loads on the roof rack. Wind forces, due to natural causes or nearby truck traffic, can add sudden upward loads. This is especially true on large flat loads and may result in damage to the cargo or your vehicle.

**WARNING!**

Cargo must be securely tied down before driving your vehicle. Improperly secured loads can fly off the vehicle, particularly at high speeds, resulting in personal injury or property damage. Follow the roof rack cautions when carrying cargo on your roof rack.





# UNDERSTANDING YOUR INSTRUMENT PANEL

## CONTENTS

---

- Instrument Panel Features . . . . . 218
- Instrument Cluster . . . . . 219
- Instrument Cluster Descriptions . . . . . 220
- Electronic Vehicle Information Center (EVIC) —  
If Equipped . . . . . 235
  - Electronic Vehicle Information Center (EVIC)  
Displays . . . . . 237
  - Oil Change Required . . . . . 239
  - Trip Functions . . . . . 240
  - Compass Display / ECO  
(Fuel Saver Mode) — If Equipped . . . . . 241
  - Personal Settings  
(Customer-Programmable Features) . . . . . 244
- Media Center 230 (REQ) — AM/FM Stereo  
Radio And 6-Disc CD/DVD Changer  
(MP3/WMA AUX Jack) . . . . . 248
  - Operating Instructions - Radio Mode . . . . . 249
  - Operation Instructions - (Disc Mode For CD  
And MP3/WMA Audio Play, DVD-Video) . . . . . 257
  - Notes On Playing MP3/WMA Files . . . . . 259

- List Button  
(Disc Mode For MP3/WMA Play) . . . . . 261
- Info Button  
(Disc Mode For MP3/WMA Play) . . . . . 261
- Uconnect™ Multimedia (Satellite Radio) — If  
Equipped . . . . . 264
- Media Center 730N/430/430N (RHR/RER/  
RBZ/RHB) CD/DVD/HDD/NAV —  
If Equipped . . . . . 268
  - Operating Instructions (Voice Command  
System) — If Equipped . . . . . 268
  - Operating Instructions  
(Uconnect™ Phone) — If Equipped . . . . . 268
- Media Center 130 (Sales Code RES) . . . . . 268
  - Operating Instructions — Radio Mode . . . . . 269
  - Operation Instructions —  
CD Mode For CD And MP3 Audio Play . . . . . 272
  - Notes On Playing MP3 Files . . . . . 274
  - Operation Instructions - Auxiliary Mode . . . . . 276
- Media Center 130 With Satellite Radio  
(Sales Code RES+RSC). . . . . 277
  - Operating Instructions — Radio Mode . . . . . 277
  - Operation Instructions — CD Mode For CD  
And MP3 Audio Play . . . . . 283
  - Notes On Playing MP3 Files . . . . . 285
  - List Button (CD Mode For MP3 Play) . . . . . 288
  - Info Button (CD Mode For MP3 Play) . . . . . 288
  - Uconnect™ Multimedia (Satellite Radio) —  
If Equipped . . . . . 289

■ Steering Wheel Audio Controls . . . . .	293	■ Climate Controls . . . . .	295
□ Radio Operation . . . . .	294	□ Manual Heating And Air Conditioning . . . . .	296
□ CD Player . . . . .	294	□ Automatic Temperature Control (ATC) — If Equipped . . . . .	300
■ CD/DVD Disc Maintenance . . . . .	295	□ Operating Tips . . . . .	305
■ Radio Operation And Mobile Phones . . . . .	295		

## INSTRUMENT PANEL FEATURES

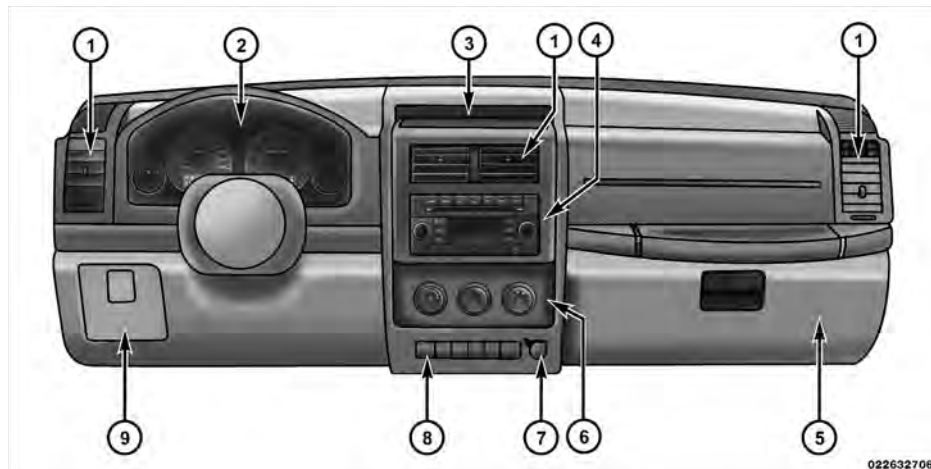

- 1 — Air Outlet
- 2 — Instrument Cluster
- 3 — Storage Tray

- 4 — Radio
- 5 — Glove Compartment
- 6 — Climate Control

- 7 — Power Outlet
- 8 — Lower Switch Bank
- 9 — Storage Bin (if equipped)

INSTRUMENT CLUSTER

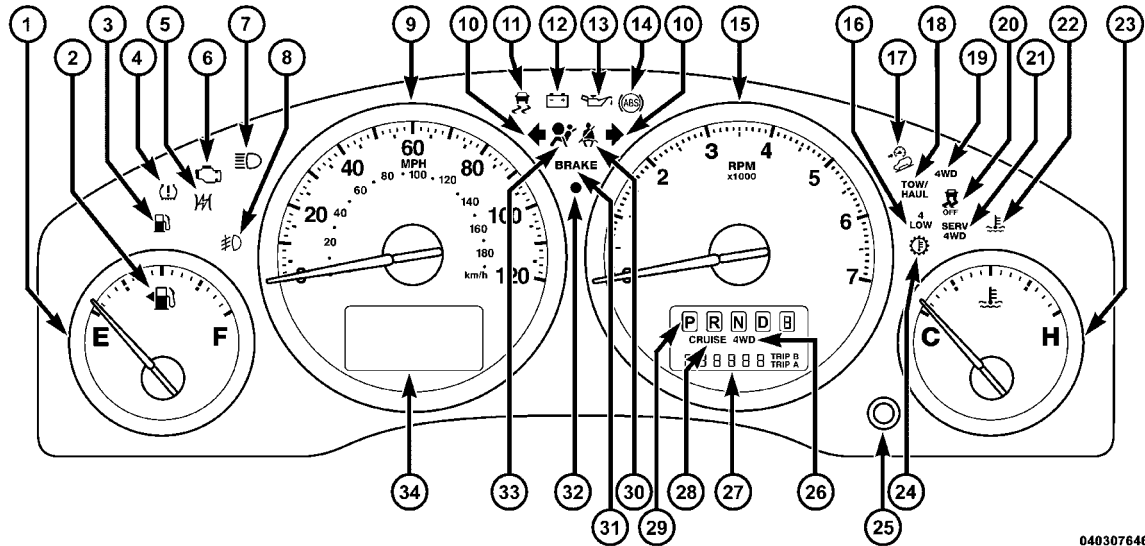

## INSTRUMENT CLUSTER DESCRIPTIONS

### 1. *Fuel Gauge*

The fuel gauge shows level of fuel in tank when ignition switch is in the ON/RUN position.

### 2. *Fuel Door Reminder*



This symbol indicates the side of the vehicle where the fuel cap is located.

### 3. *Low Fuel Light*



This indicator lights when the fuel level drops to approximately one-eighth tank.

### 4. *Tire Pressure Monitoring Telltale Light*



Each tire, including the spare (if provided), should be checked monthly when cold and inflated to the inflation pressure recommended

by the vehicle manufacturer on the vehicle placard or tire inflation pressure label. (If your vehicle has tires of a different size than the size indicated on the vehicle placard or tire inflation pressure label, you should determine the proper tire inflation pressure for those tires.)

As an added safety feature, your vehicle has been equipped with a Tire Pressure Monitoring System (TPMS) that illuminates a low tire pressure telltale when one or more of your tires is significantly under-inflated. Accordingly, when the low tire pressure telltale illuminates, you should stop and check your tires as soon as possible, and inflate them to the proper pressure. Driving on a significantly under-inflated tire causes the tire to overheat and can lead to tire failure. Under-inflation also reduces fuel efficiency and tire tread life, and may affect the vehicle's handling and stopping ability.

Please note that the TPMS is not a substitute for proper tire maintenance, and it is the driver's responsibility to maintain correct tire pressure, even if under-inflation has not reached the level to trigger illumination of the TPMS low tire pressure telltale.

Your vehicle has also been equipped with a TPMS malfunction indicator to indicate when the system is not operating properly. The TPMS malfunction indicator is combined with the low tire pressure telltale. When the system detects a malfunction, the telltale will flash for approximately one minute and then remain continuously illuminated. This sequence will continue upon subsequent vehicle start-ups as long as the malfunction exists. When the malfunction indicator is illuminated, the system may not be able to detect or signal low tire pressure as intended. TPMS malfunctions may occur for a variety of reasons, including the installation of replacement or alternate tires or wheels on the vehicle that prevent the TPMS from functioning properly. Always check the

TPMS malfunction telltale after replacing one or more tires or wheels on your vehicle, to ensure that the replacement or alternate tires and wheels allow the TPMS to continue to function properly.

### CAUTION!

**The TPMS has been optimized for the original equipment tires and wheels. TPMS pressures and warning have been established for the tire size equipped on your vehicle. Undesirable system operation or sensor damage may result when using replacement equipment that is not of the same size, type, and/or style. Aftermarket wheels can cause sensor damage. Do not use tire sealant from a can or balance beads if your vehicle is equipped with a TPMS, as damage to the sensors may result.**

### 5. *Electronic Throttle Control (ETC) Light*



This light informs you of a problem with the Electronic Throttle Control (ETC) system. If a problem is detected, the light will come on while the engine is running. Cycle the ignition key when the vehicle has completely stopped and the shift lever is placed in the PARK position. The light should turn off. If the light remains lit with the engine running, your vehicle will usually be drivable; however, see an authorized dealer for service as soon as possible. If the light is flashing when the engine is running, immediate service is required and you may experience reduced performance, an elevated/rough idle or engine stall and your vehicle may require towing. The light will come on when the ignition is first turned to ON/RUN and remain on briefly as a bulb check. If the light does not come on during starting, have the system checked by an authorized dealer.

### 6. *Malfunction Indicator Light (MIL)*



The Malfunction Indicator Light (MIL) is part of an onboard diagnostic system, called OBD, that monitors engine and automatic transmission control systems. The light will illuminate when the key is in the ON/RUN position, before engine start. If the bulb does not come on when turning the key from OFF to ON/RUN, have the condition checked promptly.

Certain conditions, such as a loose or missing gas cap, poor fuel quality, etc., may illuminate the MIL after engine start. The vehicle should be serviced if the light stays on through several of your typical driving cycles. In most situations, the vehicle will drive normally and will not require towing.



**CAUTION!**

Prolonged driving with the MIL on could cause damage to the engine control system. It also could affect fuel economy and drivability. If the MIL is flashing, severe catalytic converter damage and power loss will soon occur. Immediate service is required.

**WARNING!**

A malfunctioning catalytic converter, as referenced above, can reach higher temperatures than in normal operating conditions. This can cause a fire if you drive slowly or park over flammable substances such as dry plants, wood, cardboard, etc. This could result in death or serious injury to the driver, occupants or others.

**7. High Beam Indicator**

This indicator shows that the high beam headlights are on. Pull the multifunction control lever on the left side of the steering column toward you to switch to low beam.

**8. Front Fog Light Indicator — If Equipped**

This indicator will illuminate when the front fog lights are on.

**9. Speedometer**

Shows the vehicle speed in Miles Per Hour (MPH) or kilometers per hour (km/h).

**10. Turn Signal Indicators**

The arrow will flash with the exterior turn signal when the turn signal lever is operated.

If the vehicle electronics sense that the vehicle is driven more than 1 mile (1.6 km) with either turn signal on, a continuous chime will sound to alert you to turn the signals off. If either indicator flashes at a rapid rate, check for a defective outside light bulb.

### 11. *Electronic Stability Control (ESC) Activation/ Malfunction Indicator Light — If Equipped*



The “ESC Activation/Malfunction Indicator Light” in the instrument cluster will come on when the ignition switch is turned to the ON/RUN position. It should go out with the engine running. If the “ESC Activation/Malfunction Indicator Light” comes on continuously with the engine running, a malfunction has been detected in the ESC system. If this light remains on after several ignition cycles, and the vehicle has been driven several miles (kilometers) at speeds greater than 30 mph (48 km/h), see your authorized dealer as soon as possible to have the problem diagnosed and corrected.

### NOTE:

- The “ESC Off Indicator Light” and the “ESC Activation/Malfunction Indicator Light” come on momentarily each time the ignition switch is turned to ON/RUN.
- Each time the ignition is turned to ON/RUN, the ESC system will be ON, even if it was turned off previously.
- The ESC system will make buzzing or clicking sounds when it is active. This is normal; the sounds will stop when ESC becomes inactive following the maneuver that caused the ESC activation.

### 12. *Charging System Light*



This light shows the status of the electrical charging system. The light should come on when the ignition switch is first turned to ON/RUN and remain on briefly as a bulb check. If the light stays on or comes on while driving, turn off some of the vehicle’s non-essential electrical devices or increase engine speed (if at idle). If

the charging system light remains on, it means that the vehicle is experiencing a problem with the charging system. Obtain SERVICE IMMEDIATELY. See an authorized dealer.

If jump starting is required, refer to “Jump Starting Procedures” in “What To Do In Emergencies”.

### 13. Oil Pressure Warning Light

 This light indicates low engine oil pressure. The light should turn on momentarily when the engine is started. If the light turns on while driving, stop the vehicle and shut off the engine as soon as possible. A chime will sound for four minutes when this light turns on.

Do not operate the vehicle until the cause is corrected. This light does not indicate how much oil is in the engine. The engine oil level must be checked under the hood.

### 14. Anti-Lock Brake (ABS) Light



This light monitors the Anti-Lock Brake System (ABS). The light will turn on when the ignition switch is turned to the ON/RUN position and may stay on for as long as four seconds.

If the ABS light remains on or turns on while driving, it indicates that the Anti-Lock portion of the brake system is not functioning and that service is required. However, the conventional brake system will continue to operate normally if the BRAKE warning light is not on.

If the ABS light is on, the brake system should be serviced as soon as possible to restore the benefits of Anti-Lock brakes. If the ABS light does not turn on when the ignition switch is turned to the ON/RUN position, have the light inspected by an authorized dealer.

### 15. Tachometer

This gauge measures engine revolutions-per-minute (RPM x 1000). When the engine RPM are kept within the

green area, you are driving the vehicle in a fuel efficient manner. Before the pointer reaches the red area, ease up on the accelerator to prevent engine damage.

#### 16. 4WD LOW Indicator — If Equipped

**4  
LOW** This light alerts the driver that the vehicle is in the 4WD LOW mode. In this mode, the front driveshaft and rear driveshaft are mechanically locked together forcing the front and rear wheels to rotate at the same speed.

#### 17. Hill Descent Control Indicator — If Equipped

 The symbol indicates the status of the Hill Descent Control (HDC) feature. The lamp will be on solid when HDC is armed. HDC can only be armed when the transfer case is in the “4WD LOW” position and the vehicle speed is less than 30 mph (48 km/h). If these conditions are not met while attempting to use the HDC feature, the HDC indicator light will flash on/off.

#### 18. TOW/HAUL Indicator — If Equipped

**TOW/  
HAUL**

This light will illuminate when selecting TOW/HAUL. The TOW/HAUL button is located on the gearshift bezel.

#### 19. 4WD Indicator — Vehicles Equipped with Command-Trac®

**4WD**

This light alerts the driver that the vehicle is in the four-wheel drive mode. In this mode, the front driveshaft and rear driveshaft are mechanically locked together forcing the front and rear wheels to rotate at the same speed.

#### 20. Electronic Stability Control (ESC) OFF Indicator Light — If Equipped

  
**OFF**

This light indicates the Electronic Stability Control (ESC) is off.

**21. SERV (Service) 4WD Indicator Light — If Equipped****SERV  
4WD**

The “SERV 4WD Indicator Light” will turn on when the ignition key is turned to the ON/RUN position and it will stay on for two seconds. If the light stays on or turns on during driving, it means that the 4WD system is not functioning properly and that service is required.

**22. Engine Temperature Warning Light**

This light warns of an overheated engine condition. As temperatures rise and the gauge approaches **H**, this indicator will illuminate and a single chime will sound after reaching a set threshold. Further overheating will cause the temperature gauge to pass **H**, the indicator will continuously flash and a continuous chime will occur until the engine is allowed to cool.

If the light turns on while driving, safely pull over and stop the vehicle. If the A/C system is on, turn it off. Also, shift the transmission into NEUTRAL and idle the vehicle. If the temperature reading does not return to normal, turn the engine off immediately and call for service. Refer to “If Your Engine Overheats” in “What To Do In Emergencies” for further information.

**23. Temperature Gauge**

The temperature gauge shows engine coolant temperature. Any reading within the normal range indicates that the engine cooling system is operating satisfactorily.

The gauge pointer will likely indicate a higher temperature when driving in hot weather, up mountain grades, or when towing a trailer. It should not be allowed to exceed the upper limits of the normal operating range.

**CAUTION!**

Driving with a hot engine cooling system could damage your vehicle. If the temperature gauge reads "H" pull over and stop the vehicle. Idle the vehicle with the air conditioner turned off until the pointer drops back into the normal range. If the pointer remains on the "H" and you hear continuous chimes, turn the engine off immediately and call an authorized dealership for service.

**WARNING!**

A hot engine cooling system is dangerous. You or others could be badly burned by steam or boiling coolant. You may want to call an authorized dealership for service if your vehicle overheats. If you decide to look under the hood yourself, see "Maintaining Your Vehicle". Follow the warnings under the Cooling System Pressure Cap paragraph.

*24. Transmission Temperature Warning Light — If Equipped*



This light indicates that the transmission fluid temperature is running hot. This may occur with severe usage, such as trailer towing. If this light turns on, safely pull over and stop the vehicle. Then, shift the transmission into NEUTRAL and run the engine at idle or faster until the light turns off.

**CAUTION!**

Continuous driving with the Transmission Temperature Warning Light illuminated will eventually cause severe transmission damage or transmission failure.

**WARNING!**

If the Transmission Temperature Warning Light is illuminated and you continue operating the vehicle, in some circumstances you could cause the fluid to boil over, come in contact with hot engine or exhaust components and cause a fire.

## 25. *Odometer / Trip Odometer / ECO (Fuel Saver Indicator) Button*

### *Changing the Display*

Press this button to change the display from odometer to either of the two trip odometer settings or the “ECO” display. Trip A or Trip B will appear when in the trip odometer mode. On vehicles equipped with a Base Cluster, press and release it once again to display the outside temperature. On vehicles equipped with a Mid Line Cluster, press and release it once again to display the outside temperature and compass heading in the screen below the speedometer. Refer to “Electronic Vehicle Information Center (EVIC) — If Equipped” for details.

### *Resetting the Trip Odometer*

Display the trip mileage that you want to reset, “Trip A” or “Trip B.” Then push and hold the button (approximately two seconds) until the display resets to 0. The odometer must be in Trip Mode to reset the trip odometer.

## 26. 4WD Indicator — Vehicles Equipped with Selec-Trac® II

This light alerts the driver that the vehicle is in the full-time four-wheel drive auto mode. In this mode, the system operates with a normal torque split of 42% front axle and 58% rear axle. It can redirect up to 100% of torque to the front or rear axle, if necessary.

## 27. Odometer Display/Trip Odometer Display

The odometer display shows the total distance the vehicle has been driven. The trip odometer shows individual trip mileage. Refer to “Trip Odometer button” for additional information.

**NOTE:** U.S. Federal regulations require that upon transfer of vehicle ownership, the seller certify to the purchaser the correct mileage that the vehicle has been driven. If your odometer needs to be repaired or serviced, the repair technician should leave the odometer reading the same as it was before the repair or service. If s/he

cannot do so, then the odometer must be set at zero, and a sticker must be placed in the door jamb stating what the mileage was before the repair or service. It is a good idea for you to make a record of the odometer reading before the repair/service, so that you can be sure that it is properly reset, or that the door jamb sticker is accurate if the odometer must be reset at zero.

### Vehicle Odometer Messages

When the appropriate conditions exist, the following messages will display in the odometer:

<b>ECO</b> . . . . .	Fuel Saver Indicator Off
<b>ECO-ON</b> . . . . .	Fuel Saver Indicator On
<b>door</b> . . . . .	Door Ajar
<b>gATE</b> . . . . .	Liftgate Ajar
<b>gLASS</b> . . . . .	Flipper Glass Ajar
<b>LoW tirE</b> . . . . .	Low Tire Pressure
<b>gASCAP</b> . . . . .	Fuel Cap Fault
<b>noFUSE</b> . . . . .	Fuse Fault
<b>CHAngE OIL</b> . . . . .	Oil Change Required



On vehicles equipped with a Premium Instrument Cluster, this display shows the Electronic Vehicle Information Center (EVIC) messages when the appropriate conditions exist. Refer to Electronic Vehicle Information Center (EVIC) for further information.

#### *ECO / ECO-ON (Fuel Saver Indicator) — If Equipped*

The ECO-ON indicator will illuminate when you are driving in a fuel efficient manner and can be used to modify driving habits in order to increase fuel economy. The ECO display will toggle between ECO and ECO-ON depending on driving habits and vehicle usage. Press the Odometer / Trip Odometer / ECO (Fuel Saver Indicator) button to change the display from odometer to either of the two trip odometer settings or the “ECO” display.

#### *LoW tirE*

When the appropriate condition exists, the odometer display will toggle between LoW and tirE for three cycles.

#### *gASCAP Message*

If the vehicle diagnostic system determines that the fuel filler cap is loose, improperly installed, or damaged, the words “gASCAP” will display in the odometer display area. If this occurs, tighten the fuel filler cap properly and press the odometer reset button to turn off the message. If the problem continues, the message will appear the next time the vehicle is started.

A loose, improperly installed, or damaged fuel filler cap may also turn on the Malfunction Indicator Light (MIL).

#### *noFUSE*

If the vehicle diagnostic system determines that the Ignition Off Draw (IOD) fuse is improperly installed, or damaged, a “noFUSE” message will display in the odometer display area. For further information on fuses and fuse locations refer to “Fuses” in “Maintaining Your Vehicle”.

### *CHAngE OIL Message (Base And Mid Line Clusters Only)*

Your vehicle is equipped with an engine oil change indicator system. The “CHAngE OIL” message will flash in the instrument cluster odometer for approximately 12 seconds after a single chime has sounded to indicate the next scheduled oil change interval. The engine oil change indicator system is duty cycle based, which means the engine oil change interval may fluctuate dependent upon your personal driving style.

Unless reset, this message will continue to display each time you turn the ignition switch to the ON/RUN position. To turn off the message temporarily, press and release the Trip Odometer button on the instrument cluster. To reset the oil change indicator system (after performing the scheduled maintenance) perform the following procedure:

1. Turn the ignition switch to the ON/RUN position.  
**Do not start the engine.**

2. Fully depress the accelerator pedal slowly three times within 10 seconds.
3. Turn the ignition switch to the LOCK position.

**NOTE:** If the indicator message illuminates when you start the vehicle, the oil change indicator system did not reset. If necessary, repeat this procedure.

### *28. Cruise Indicator — If Equipped*

**CRUISE** This indicator lights when the electronic speed control system is turned on.

### *29. Shift Lever Indicator*

The Shift Lever Indicator is self-contained within the instrument cluster. It displays the gear position of the automatic transmission.

### *30. Seat Belt Reminder Light*



When the ignition switch is first turned to ON/RUN, this light will turn on for four to eight seconds as a bulb check. During the bulb check, if

the driver's seat belt is unbuckled, a chime will sound. After the bulb check or when driving, if the driver seat belt remains unbuckled, the Seat Belt Warning Light will flash or remain on continuously. Refer to "Occupant Restraints" in "Things To Know Before Starting Your Vehicle" for further information.

### 31. Brake Warning Light

**BRAKE** This light monitors various brake functions, including brake fluid level and parking brake application. If the brake light turns on it may indicate that the parking brake is applied, that the brake fluid level is low, or that there is a problem with the anti-lock brake system reservoir.

If the light remains on when the parking brake has been disengaged, and the fluid level is at the full mark on the master cylinder reservoir, it indicates a possible brake hydraulic system malfunction or that a problem with the Brake Booster has been detected by the Anti-Lock Brake

System (ABS) / Electronic Stability Control (ESC) system. In this case, the light will remain on until the condition has been corrected. If the problem is related to the brake booster, the ABS pump will run when applying the brake and a brake pedal pulsation may be felt during each stop.

The dual brake system provides a reserve braking capacity in the event of a failure to a portion of the hydraulic system. A leak in either half of the dual brake system is indicated by the Brake Warning Light, which will turn on when the brake fluid level in the master cylinder has dropped below a specified level.

The light will remain on until the cause is corrected.

**NOTE:** The light may flash momentarily during sharp cornering maneuvers, which change fluid level conditions. The vehicle should have service performed, and the brake fluid level checked.

If brake failure is indicated, immediate repair is necessary.

**WARNING!**

**Driving a vehicle with the red brake light on is dangerous. Part of the brake system may have failed. It will take longer to stop the vehicle. You could have a collision. Have the vehicle checked immediately.**

Vehicles equipped with the Anti-Lock Brake System (ABS), are also equipped with Electronic Brake Force Distribution (EBD). In the event of an EBD failure, the Brake Warning Light will turn on along with the ABS Light. Immediate repair to the ABS system is required.

Operation of the Brake Warning Light can be checked by turning the ignition switch from the OFF position to the ON/RUN position. The light should illuminate for approximately two seconds. The light should then turn off

unless the parking brake is applied or a brake fault is detected. If the light does not illuminate, have the light inspected by an authorized dealer.

The light also will turn on when the parking brake is applied with the ignition switch in the ON/RUN position.

**NOTE:** This light shows only that the parking brake is applied. It does not show the degree of brake application.

### 32. *Vehicle Security Light — If Equipped*

 This light will flash rapidly for approximately 16 seconds when the vehicle security system is arming and then flash slowly when the system is armed. The light will also turn on for about three seconds when the ignition is first turned to ON/RUN.

### 33. Airbag Warning Light



This light will turn on for four to eight seconds as a bulb check when the ignition switch is first turned to ON/RUN. If the light is either not on during starting, stays on, or turns on while driving, have the system inspected at an authorized dealer as soon as possible. Refer to “Occupant Restraints” in “Things To Know Before Starting Your Vehicle” for further information.

### 34. Electronic Vehicle Information Center (EVIC) / Compass Display — If Equipped

On vehicles equipped with a Premium Cluster, this display shows the Electronic Vehicle Information Center (EVIC) messages when the appropriate conditions exist. Refer to “Electronic Vehicle Information Center (EVIC) — If Equipped” for further information.

On vehicles equipped with a Mid Line Cluster, this display shows the compass heading (N, S, E, W, NE, NW, SE, and SW) and the outside temperature.

## ELECTRONIC VEHICLE INFORMATION CENTER (EVIC) — IF EQUIPPED

The Electronic Vehicle Information Center (EVIC) features a driver-interactive display that is located in the instrument cluster.

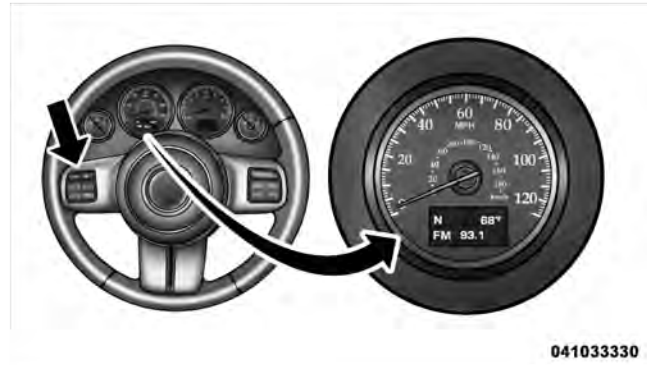

041033330

Electronic Vehicle Information Center (EVIC)

This system conveniently allows the driver to select a variety of useful information by pressing the switches mounted on the steering wheel. The EVIC consists of the following:

- System Status
- Vehicle Information Warning Message Displays
- Tire Pressure Monitor System (if equipped)
- Personal Settings (Customer-Programmable Features)
- Compass Display
- Outside Temperature Display
- Trip Computer Functions
- Uconnect™ gps system screens (if equipped)
- Audio Mode Display

The system allows the driver to select information by pressing the following buttons mounted on the steering wheel:

**041035449****EVIC Steering Wheel Buttons**

**MENU Button**

**MENU** Press and release the MENU button and the mode displayed will change between Trip Functions, Uconnect™ gps (if equipped), System Status, and Personal Settings.

**DOWN Button**

Press and release the DOWN button to scroll downward through the main menus and sub-menus.

**FUNCTION SELECT Button**

Press the FUNCTION SELECT button to accept a selection. Also, the FUNCTION SELECT button changes the current CD track being played (if equipped) when the EVIC is in the Compass/Temp/Audio screen.

**COMPASS Button**

Press and release the COMPASS/TEMPERATURE button to display one of eight compass readings and the outside temperature.

**Electronic Vehicle Information Center (EVIC) Displays**

When the appropriate conditions exist, the EVIC displays the following messages:

- Turn Signal On (with a continuous warning chime)
- Left Front Turn Signal Light Out (with a single chime)
- Left Rear Turn Signal Light Out (with a single chime)
- Right Front Turn Signal Light Out (with a single chime)
- Right Rear Turn Signal Light Out (with a single chime)
- RKE Battery Low (with a single chime)

- Memory #1/#2 Profile Set
- Memory #1/#2 Profile Recall
- Memory System Disabled – Vehicle Not in Park (with a single chime) — automatic transmission
- Memory System Disabled – Vehicle in Motion (with a single chime) — manual transmission
- Memory System Disabled – Seat Belt Buckled (with a single chime)
- Personal Settings Not Available – Vehicle Not in Park — automatic transmission
- Personal Settings Not Available – Vehicle in Motion — manual transmission
- Left/Right Front Door Ajar (one or more doors open, with a single chime if speed is above 1 mph (1.6 km/h))
- Left/Right Rear Door Ajar (one or more doors open, with a single chime if speed is above 1 mph (1.6 km/h))
- Door(s) Ajar (with a single chime if vehicle is in motion)
- Liftgate Ajar (with a single chime)
- Left Front Low Pressure (with a single chime). Refer to “Tire Pressure Monitoring System” in “Starting And Operating”.
- Left Rear Low Pressure (with a single chime). Refer to “Tire Pressure Monitoring System” in “Starting And Operating”.
- Right Front Low Pressure (with a single chime). Refer to “Tire Pressure Monitoring System” in “Starting And Operating”.



- Right Rear Low Pressure (with a single chime). Refer to “Tire Pressure Monitoring System” in “Starting And Operating”.
- Check TPM System (with a single chime). Refer to “Tire Pressure Monitoring System” in “Starting And Operating”.
- Check Gascap (refer to “Adding Fuel” in “Starting And Operating” for more details)
- Service Park Assist System (with a single chime)
- Oil Change Required (with a single chime)
- ECO (Fuel Saver Indicator) — if equipped

### Oil Change Required

Your vehicle is equipped with an engine oil change indicator system. The “Oil Change Required” message will flash in the EVIC display for approximately 10 seconds after a single chime has sounded to indicate the next

scheduled oil change interval. The engine oil change indicator system is duty cycle based, which means the engine oil change interval may fluctuate dependent upon your personal driving style.

Unless reset, this message will continue to display each time you turn the ignition switch to the ON position. To turn off the message temporarily, press and release the FUNCTION SELECT button. To reset the oil change indicator system (after performing the scheduled maintenance), perform the following procedure:

1. Turn the ignition switch to the ON position. **Do not start the engine.**
2. Fully depress the accelerator pedal slowly three times within 10 seconds.
3. Turn the ignition switch to the LOCK position.

**NOTE:** If the indicator message illuminates when you start the vehicle, the oil change indicator system did not reset. If necessary, repeat this procedure.

### **Trip Functions**

Press and until one of the following Trip Functions displays in the EVIC:

- Average Fuel Economy
- Distance To Empty
- Elapsed Time
- Display Units of Measure in

Press the SCROLL button to cycle through all the Trip Computer functions.

The Trip Functions mode displays the following information:

- *Average Fuel Economy*

Shows the average fuel economy since the last reset. When the fuel economy is reset, the display will read “RESET” or show dashes for two seconds. Then, the history information will be erased, and the averaging will continue from the last fuel average reading before the reset.

- *Distance To Empty (DTE)*

Shows the estimated distance that can be traveled with the fuel remaining in the tank. This estimated distance is determined by a weighted average of the instantaneous and average fuel economy, according to the current fuel tank level. DTE cannot be reset through the FUNCTION SELECT button.

**NOTE:** Significant changes in driving style or vehicle loading will greatly affect the actual drivable distance of the vehicle, regardless of the DTE displayed value.

When the DTE value is less than 30 miles (48 km) estimated driving distance, the DTE display will change to a text display of "LOW FUEL." This display will continue until the vehicle runs out of fuel. Adding a significant amount of fuel to the vehicle will turn off the "LOW FUEL" text and a new DTE value will display.

- *Elapsed Time*

Shows the total elapsed time of travel since the last reset when the ignition switch is in the ACC position. Elapsed time will increment when the ignition switch is in the ON or START position.

- *Display Units of Measure in:*

To make your selection, press and release the FUNCTION SELECT button until "ENGLISH" or "METRIC" appears.

### To Reset The Display

Reset will only occur while a resettable function is being displayed. Press and release the FUNCTION SELECT button once to clear the resettable function being displayed. To reset all resettable functions, press and release the FUNCTION SELECT button a second time within three seconds of resetting the currently displayed function (reset ALL will display during this three-second window).

### Compass Display / ECO (Fuel Saver Mode) — If Equipped



COMPASS  
Button

The compass readings indicate the direction the vehicle is facing. Press and release the COMPASS button to display one of eight compass readings and the outside temperature.

**NOTE:** The system will display the last known outside temperature when starting the vehicle and may need to

be driven several minutes before the updated temperature is displayed. Engine temperature can also affect the displayed temperature; therefore, temperature readings are not updated when the vehicle is not moving.

### **ECO (Fuel Saver Mode) — If Equipped**

The ECO message will display below the outside temperature in the EVIC display. This message will appear whenever you are driving in a fuel efficient manner.

This feature allows you to monitor when you are driving in a fuel efficient manner, and it can be used to modify driving habits in order to increase fuel economy.

### **Automatic Compass Calibration**

This compass is self-calibrating, which eliminates the need to set the compass manually. When the vehicle is new, the compass may appear erratic and the EVIC will display “CAL” until the compass is calibrated. You may also calibrate the compass by completing one or more 360-degree turns (in an area free from large metal or

metallic objects) until the “CAL” message displayed in the EVIC turns off. The compass will now function normally.

**NOTE:** A good calibration requires a level surface and an environment free from large metallic objects such as buildings, bridges, underground cables, railroad tracks, etc.

### **Manual Compass Calibration**

If the compass appears erratic and the “CAL” indicator does not appear in the EVIC display, you must put the compass into the Calibration Mode manually as follows:

1. Start the engine. Leave the shift lever in PARK in order to enter the EVIC Programming Menus.
2. Press the MENU button until the Personal Settings (Customer-Programmable Features) menu displays in the EVIC.

3. Press the SCROLL button until “Calibrate Compass” displays in the EVIC.
4. Press and release the FUNCTION SELECT button to start the calibration. The “CAL” indicator will display in the EVIC.
5. Complete one or more 360-degree turns (in an area free from large metal or metallic objects) until the “CAL” indicator turns off. The compass will now function normally.

### Compass Variance

Compass Variance is the difference between Magnetic North and Geographic North. To compensate for the differences, the variance should be set for the zone where the vehicle is driven, per the zone map. Once properly set, the compass will automatically compensate for the differences and provide the most accurate compass heading.

**NOTE:** Magnetic materials should be kept away from the top of the right rear quarter window. This is where the compass sensor is located.

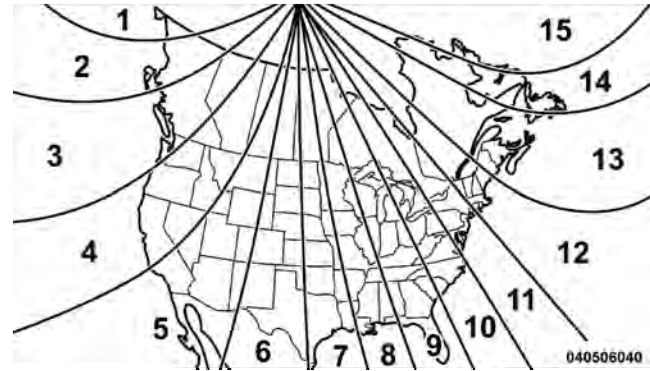

Compass Variance Map

1. Turn the ignition switch ON.

2. Press the MENU button until the Personal Settings (Customer-Programmable Features) menu displays in the EVIC.
3. Press the SCROLL button until "Compass Variance" displays in the EVIC.
4. Press and release the FUNCTION SELECT button until the proper variance zone is selected according to the map.
5. Press and release the COMPASS button to exit.

### **Personal Settings (Customer-Programmable Features)**

Personal Settings allows the driver to set and recall features when the vehicle speed is at 0 mph (0 km/h) (manual transmission) or when the shift lever is in PARK (auto transmission).

Press and release the MENU button until Personal Settings displays in the EVIC then press the FUNCTION SELECT button.

Use the SCROLL button to display one of the following choices:

#### **Language**

When in this display you may select one of five languages for all display nomenclature, including the trip functions and the navigation system (if equipped). Press the FUNCTION SELECT button while in this display to select English, Espanol, Deutsch, Italiano, or Francais. Then, as you continue, the information will display in the selected language.

#### **Lock Doors Automatically at 15 mph (24 km/h)**

When on is selected, all doors will lock automatically when the vehicle reaches a speed of 15 mph (24 km/h). To make your selection, press and release the FUNCTION SELECT button until "ON" or "OFF" appears.

#### **Unlock Doors Automatically on Exit**

When ON is selected, all doors will unlock when the vehicle is stopped and the transmission is in the PARK or

NEUTRAL position and the driver's door is opened. To make your selection, press and release the FUNCTION SELECT button until "ON" or "OFF" appears.

### **Remote Key Unlock**

When **Driver Door 1st Press** is selected, only the driver's door will unlock on the first press of the Remote Keyless Entry (RKE) transmitter UNLOCK button. When **Driver Door 1st Press** is selected, you must press the RKE transmitter UNLOCK button twice to unlock the passenger's doors. When **All Doors 1st Press** is selected, all of the doors will unlock on the first press of the RKE transmitter UNLOCK button. To make your selection, press and release the FUNCTION SELECT button until "Driver Door 1st Press" or "All Doors 1st Press" appears.

### **Recall Memory with Remote Key Unlock — If Equipped**

When on is selected, you can use your RKE transmitter to recall one of two pre-programmed memory profiles. Each

memory profile contains desired position settings for the driver seat, side mirror, adjustable pedals (if equipped), power tilt and telescopic steering column (if equipped), and a set of desired radio station presets. When OFF is selected, only the memory switch on the driver's door panel will recall memory profiles. To make your selection, press and release the FUNCTION SELECT button until "ON" or "OFF" appears. Refer to "Driver Memory Seat" in "Understanding The Features Of Your Vehicle" for more information.

### **Sound Horn with Remote Key Lock**

When on is selected, a short horn sound will occur when the RKE transmitter LOCK button is pressed. This feature may be selected with or without the Flash Lights with Remote Key Lock feature. To make your selection, press and release the FUNCTION SELECT button until "On" or "Off" appears.

### **Automatically Move Seat Back on Exit — If Equipped**

This feature provides automatic driver seat positioning to enhance driver mobility when entering and exiting the vehicle. To make your selection, press and release the FUNCTION SELECT button until “On” or “Off” appears.

**NOTE:** The seat will return to the memorized seat location (if Recall Memory with Remote Key Unlock is set to ON) when the RKE transmitter is used to unlock the door. Refer to “Driver Memory Seat” in “Understanding The Features Of Your Vehicle” for further information.

### **Flash Lights with Remote Key Lock**

When on is selected, the front and rear turn signals will flash when the doors are locked or unlocked with the RKE transmitter. This feature may be selected with or without the sound horn on lock feature selected. To make your selection, press and release the FUNCTION SELECT button until “ON” or “OFF” appears.

### **Headlights On with Wipers (Available with Auto Headlights Only)**

When on is selected, and the headlight switch is in the AUTO position, the headlights will turn on approximately 10 seconds after the wipers are turned on. If the headlights were turned on by this feature they will also turn off when the wipers are turned off. To make your selection, press and release the FUNCTION SELECT button until “ON” or “OFF” appears.

**NOTE:** Turning the headlights on during the daytime causes the instrument panel lights to dim. To increase the brightness, refer to “Lights” in “Understanding The Features Of Your Vehicle.”

### **Delay Turning Headlights Off**

When this feature is selected, the driver can choose to have the headlights remain on for 0, 30, 60, or 90 seconds when exiting the vehicle. To make your selection, press and release the FUNCTION SELECT button until “0,” “30,” “60,” or “90” appears.



### **Turn Headlights On with Remote Key Unlock**

When this feature is selected, the headlights will activate and remain on for up to 90 seconds when the doors are unlocked with the RKE transmitter. To make your selection, press and release the FUNCTION SELECT button until “OFF,” “30 sec.,” “60 sec.,” or “90 sec.” appears.

### **Delay Power Off to Accessories Until Exit**

When this feature is selected, the power window switches, radio, hands-free system (if equipped), DVD video system (if equipped), power sunroof (if equipped), and power outlets will remain active for up to 10 minutes after the ignition switch is turned to the LOCK position. Opening either front vehicle door will cancel this feature. To make your selection, press and release the FUNCTION SELECT button until “OFF,” “45 sec.,” “5 min.,” or “10 min.” appears.

### **Illumination Approach**

When this feature is selected, the headlights will activate and remain on for up to 90 seconds when the doors are unlocked with the RKE transmitter. To make your selection, press and hold the FUNCTION SELECT button until “OFF,” “30 sec.,” “60 sec.,” or “90 sec.” appears.

### **Enable/Disable the Rear Park Assist System**

The Rear Park Assist system will scan for objects behind the vehicle when the transmission is in the REVERSE position and the vehicle speed is less than 11 mph (18 km/h). The system can be enabled with Sound Only, Sound and Display, or turned OFF through the EVIC, to make your selection, press and release the FUNCTION SELECT button. Refer to “Rear Park Assist System” in “Understanding The Features Of Your Vehicle” for system function and operating information.

### Hill Start Assist (HSA) — If Equipped

When on is selected, the HSA system is active. Refer to “Electronic Brake Control System” in “Starting And Operating” for system function and operating information. To make your selection, press and release the FUNCTION SELECT button until “ON” or “OFF” appears.

### Display Fuel Saver — If Equipped

The “ECO” message is located in the Compass/Temperature display; this message can be turned on or off. To make your selection, press and release the FUNCTION SELECT button until “ON” or “OFF” appears.

### Compass Variance

Refer to “Compass Display” for more information.

### Calibrate Compass

Refer to “Compass Display” for more information.

### MEDIA CENTER 230 (REQ) — AM/FM STEREO RADIO AND 6-DISC CD/DVD CHANGER (MP3/WMA AUX JACK)

**NOTE:** The radio sales code is located on the lower right side of the radio faceplate.

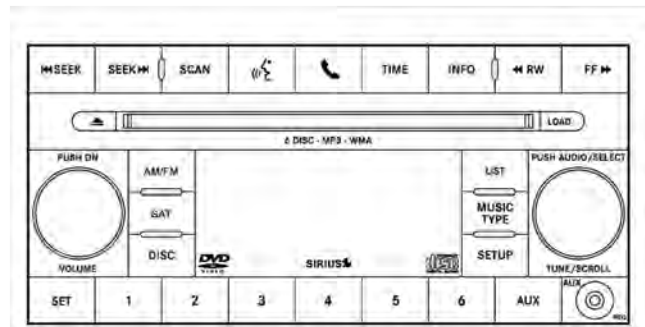

042040029

Media Center 230 (REQ)

## Operating Instructions - Radio Mode

**NOTE:** The ignition switch must be in the ON or ACC position to operate the radio.

### Power Switch/Volume Control (Rotary)

Push the ON/VOLUME control knob to turn on the radio. Press the ON/VOLUME control knob a second time to turn off the radio.

### Electronic Volume Control

The electronic volume control turns continuously (360 degrees) in either direction without stopping. Turning the ON/VOLUME control knob to the right increases the volume and to the left decreases it.

When the audio system is turned ON, the sound will be set at the same volume level as last played.

### SEEK Buttons

Press and release the SEEK buttons to search for the next listenable station in AM/FM mode. Press the right switch to seek up and the left switch to seek down. The radio will remain tuned to the new station until you make another selection. Holding either button will bypass stations without stopping until you release it.

### SCAN Button

Pressing the SCAN button causes the tuner to search for the next listenable station in AM, FM or Satellite (if equipped) frequencies, pausing for five seconds at each listenable station before continuing to the next. To stop the search, press the SCAN button a second time.

### Voice Command Button Uconnect™ Phone — If Equipped

Press this button to operate the Uconnect™ Phone feature (if equipped). Refer to “Voice Command in the Uconnect™ User Manual located on the DVD for further details.

If your vehicle is not equipped with or this feature is not available on your vehicle, a “Not Equipped With Uconnect Phone” message will display on the radio screen.

### **Phone Button Uconnect™ Phone — If Equipped**

Press this button to operate the Uconnect™ Phone feature (if equipped). Refer to “Uconnect™ Phone” in the Uconnect™ User Manual located on the DVD for further details.

If your vehicle is not equipped with or this feature is not available on your vehicle, a “Not Equipped With Uconnect Phone” message will display on the radio screen.

### **TIME Button**

Press the TIME button to alternate locations of the time and frequency display.

### **Clock Setting Procedure**

1. Press and hold the TIME button until the hours blink.
2. Adjust the hours by turning the right side TUNE/SCROLL control knob.
3. After adjusting the hours, press the right side TUNE/SCROLL control knob to set the minutes. The minutes will begin to blink.
4. Adjust the minutes using the right side TUNE/SCROLL control knob. Press the TUNE/SCROLL control knob to save the time change.
5. To exit, press any button/knob or wait five seconds.

The clock can also be set by pressing the SETUP button and selecting the “SET HOME CLOCK” entry. Once in this display follow the above procedure, starting at step 2.

**INFO Button**

Press the INFO button for an RDS station (one with call letters displayed). The radio will return a Radio Text message broadcast from an FM station (FM mode only).

**RW/FF**

Pressing the RW (Rewind) or FF (Fast Forward) buttons causes the tuner to search for the next frequency in the direction of the arrows. This feature operates in AM, FM or Satellite (if equipped) frequencies.

**TUNE Control**

Turn the rotary TUNE/SCROLL control knob clockwise to increase or counterclockwise to decrease the frequency.

**Setting the Tone, Balance, and Fade**

Push the rotary TUNE/SCROLL control knob and BASS will display. Turn the TUNE/SCROLL control knob to the right or left to increase or decrease the bass tones.

Push the rotary TUNE/SCROLL control knob a second time and MID will display. Turn the TUNE/SCROLL control knob to the right or left to increase or decrease the mid-range tones.

Push the rotary TUNE/SCROLL control knob a third time and TREBLE will display. Turn the TUNE/SCROLL control knob to the right or left to increase or decrease the treble tones.

Push the rotary TUNE/SCROLL control knob a fourth time and BALANCE will display. Turn the TUNE/SCROLL control knob to the right or left to adjust the sound level from the right or left side speakers.

Push the rotary TUNE/SCROLL control knob a fifth time and FADE will display. Turn the TUNE/SCROLL control knob to the left or right to adjust the sound level between the front and rear speakers.

Push the rotary TUNE/SCROLL control knob again to exit setting tone, balance, and fade.

**MUSIC TYPE Button**

Pressing this button once will turn on the Music Type mode for five seconds. Pressing the MUSIC TYPE button or turning the TUNE/SCROLL control knob within five seconds will allow the program format type to be selected. Many radio stations do not currently broadcast Music Type information.

Toggle the MUSIC TYPE button to select the following format types:

<b>Program Type</b>	<b>16-Digit Character Display</b>
No program type or undefined	None
Adult Hits	Adlt Hit
Classical	Classicl
Classic Rock	Cls Rock
College	College
Country	Country
Foreign Language	Language

<b>Program Type</b>	<b>16-Digit Character Display</b>
Information	Inform
Jazz	Jazz
News	News
Nostalgia	Nostalgia
Oldies	Oldies
Personality	Persnlty
Public	Public
Rhythm and Blues	R & B
Religious Music	Rel Musc
Religious Talk	Rel Talk
Rock	Rock
Soft	Soft
Soft Rock	Soft Rck
Soft Rhythm and Blues	Soft R & B
Sports	Sports
Talk	Talk

Program Type	16-Digit Character Display
Top 40	Top 40
Weather	Weather

By pressing the SEEK button when the Music Type icon is displayed, the radio will be tuned to the next frequency station with the same selected Music Type name. The Music Type function only operates when in the FM mode.

If a preset button is activated while in the Music Type (Program Type) mode, the Music Type mode will be exited and the radio will tune to the preset station.

### SETUP Button

Pressing the SETUP button allows you to select between the following items:

**NOTE:** Turn the TUNE/SCROLL control knob to scroll through the entries. Push the AUDIO/SELECT button to select an entry and make changes.

- **DVD Enter** - When the disc is in DVD Menu mode, selecting DVD Enter will allow you to play the current highlighted selection. Use the remote control to scroll up and down the menu (if equipped).



- **DISC Play/Pause** - You can toggle between playing the DVD and pausing the DVD by pushing the SELECT button (if equipped).

- **DVD Play Options** - Selecting the DVD Play Options will display the following:
  - Subtitle – Repeatedly pressing SELECT will switch subtitles to different subtitle languages that are available on the disc (if equipped).
  - Audio Stream – Repeatedly pressing SELECT will switch to different audio languages (if supported on the disc) (if equipped).

- **Angle** – Repeatedly pressing SELECT will change the viewing angle if supported by the DVD disc (if equipped).

**NOTE:**

- The available selections for each of the above entries varies depending upon the disc.
- These selections can only be made while playing a DVD.
- **VES™ Power** - Allows you to turn VES™ ON and OFF (if equipped).
- **VES™ Lock** - Locks out rear VES™ remote controls (if equipped).
- **VES™ CH1/CH2** - Allows the user to change the mode of either the IR1 or IR2 wireless headphones by pressing the AUDIO/SELECT button (if equipped).

- **Set Home Clock** - Pressing the SELECT button allows you to set the clock. Turn the TUNE/SCROLL control knob to adjust the hours and then press and turn the TUNE/SCROLL control knob to adjust the minutes. Press the TUNE/SCROLL control knob again to save changes.

- **Player Defaults** - Selecting this item will allow the user to scroll through the following items and set defaults according to customer preference.

**Menu Language — If Equipped**

Selecting this item will allow the user to choose the default startup DVD menu language (effective only if language supported by disc). If you want to select a language not listed, then scroll down and select "other." Enter the four-digit country code using the TUNE/SCROLL control knob to scroll up and down to select the number and then push to select.



***Audio Language — If Equipped***

Selecting this item allows you to choose a default audio language (effective only if the language is supported by the disc). You can select a language not listed by scrolling down and selecting "other." Enter the country code using the TUNE/SCROLL control knob to scroll up and down to select the number and then push to select.

***Subtitle Language — If Equipped***

Selecting this item allows you to choose a default subtitle language (effective only if the language is supported by the disc). You can select a language not listed by scrolling down and selecting "other." Enter the country code using the TUNE/SCROLL control knob to scroll up and down to select the number and then push to select.

***Subtitles — If Equipped***

Selecting this item allows you to choose between subtitle Off or On.

***Audio DRC — If Equipped***

Selecting this item allows you to limit maximum audio dynamic range. The default is set to "High," and under this setting, dialogues will play at 11 db higher than if the setting is "Normal."

***Aspect Ratio — If Equipped***

Selecting this item allows you to choose between wide screen, pan scan, and letter box.

***AutoPlay — If Equipped***

When this is set to On and a DVD video is inserted, it will bypass the DVD menu screen and automatically play the movie. In some rare cases, the DVD player may not auto-play the main title. In such cases, use the MENU button on the remote control to select desired title to play.

**NOTE:** The user will have to set these defaults before loading a disc. If changes are made to these settings after a disc is loaded, changes will not be effective. Also, the defaults are effective only if the disc supports the customer-preferred settings.

### **AM and FM Buttons**

Press the buttons to select AM or FM mode.

### **SET Button — To Set the Pushbutton Memory**

When you are receiving a station that you wish to commit to pushbutton memory, press the SET button. The symbol SET 1 will now show in the display window. Select the button (1-6) you wish to lock onto this station and press and release that button. If a button is not selected within five seconds after pressing the SET button, the station will continue to play but will not be stored into pushbutton memory.

You may add a second station to each pushbutton by repeating the above procedure with this exception: Press the SET button twice and SET 2 will show in the display window. Each button can be set for SET 1 and SET 2 in both AM and FM. This allows a total of 12 AM, 12 FM, and 12 Satellite (if equipped) stations to be stored into pushbutton memory. The stations stored in SET 2 memory can be selected by pressing the pushbutton twice.

Every time a preset button is used, a corresponding button number will display.

### **Buttons 1 - 6**

These buttons tune the radio to the stations that you commit to pushbutton memory {12 AM, 12 FM, and 12 Satellite (if equipped) stations}.

### **DISC Button**

Pressing the DISC button will allow you to switch from AM/FM modes to Disc modes.

**Operation Instructions - (DISC MODE for CD and MP3/WMA Audio Play, DVD-VIDEO)**

The radio DVD player and many DVD discs are coded by geographic region. These region codes must match in order for the disc to play. If the region code for the DVD disc does not match the region code for the radio DVD player, it will not play the disc. Customers may take their vehicle to an authorized dealer to change the region code of the player a maximum of five times.

**CAUTION!**

The radio may shut down during extremely hot conditions. When this occurs, the radio will indicate "Disc Hot" and shut off until a safe temperature is reached. This shutdown is necessary to protect the optics of the DVD player and other radio internal components.

**NOTE:** The ignition switch must be in the ON or ACC position to operate the radio.

**LOAD Button — Loading Compact Disc(s)**

Press the LOAD button and the pushbutton with the corresponding number (1-6) where the CD is being loaded. The radio will display PLEASE WAIT and prompt when to INSERT DISC. After the radio displays "INSERT DISC," insert the CD into the player.

Radio display will show "LOADING DISC" when the disc is loading and "READING DISC" when the radio is reading the disc.

**CAUTION!**

This CD player will accept 4-3/4 in (12 cm) discs only. The use of other sized discs may damage the CD player mechanism.

**Eject Button — Ejecting Compact Disc(s)**

Press the EJECT button and the pushbutton with the corresponding number (1-6) where the CD was loaded and the disc will unload and move to the entrance for easy removal. Radio display will show "EJECTING DISC" when the disc is being ejected and prompt the user to remove the disc.

Press and hold the EJECT button for five seconds and all CDs will be ejected from the radio.

The disc can be ejected with the radio and ignition OFF.

**SEEK Button (CD MODE)**

Press the right SEEK button for the next selection on the CD. Press the left SEEK button to return to the beginning of the current selection, or return to the beginning of the previous selection if the CD is within the first second of the current selection. Pressing and holding the SEEK button will allow you to scroll through the tracks faster in CD and MP3/MWA modes.

**SCAN Button (CD MODE)**

Press the SCAN button to scan through each track on the CD currently playing.

**TIME Button (CD MODE)**

Press this button to change the display from a large CD playing time display to a small CD playing time display.

**RW/FF (CD MODE)**

Press and hold FF (Fast Forward) and the CD player will begin to fast forward until FF is released, or RW or another CD button is pressed. The RW (Rewind) button works in a similar manner.

**AM or FM Button (CD MODE)**

Switches the radio into the AM or FM radio mode.

### Notes On Playing MP3/WMA Files

The radio can play MP3/WMA files; however, acceptable MP3/WMA file recording media and formats are limited. When writing MP3/WMA files, pay attention to the following restrictions.

### Supported Media (Disc Types)

The MP3/WMA file recording media supported by the radio are CDDA, CD-R, CD-RW, MP3, WMA, DVD Video, DVD-R, DVD-RW, DVD+R, DVD+RW, and CDDA+MP3.

### Supported Medium Formats (File Systems)

The medium formats supported by the radio are ISO 9660 Level 1 and Level 2 and includes the Joliet extension. When reading discs recorded using formats other than ISO 9660 Level 1 and Level 2, the radio may fail to read files properly and may be unable to play the file normally. UDF and Apple HFS formats are not supported.

The radio uses the following limits for file systems:

- Maximum number of directory levels: 8
- Maximum number of files: 255
- Maximum number of folders: 100
- Maximum number of characters in file/folder names:
  - Level 1: 12 (including a separator "." and a three-character extension)
  - Level 2: 31 (including a separator "." and a three-character extension)

Multisession disc formats are supported by the radio. Multisession discs may contain combinations of normal CD audio tracks and computer files (including MP3/WMA files). Discs created with an option such as "keep disc open after writing" are most likely multisession discs. The use of multisession for CD audio or MP3/WMA playback may result in longer disc loading times.

If a disc contains multi-formats, such as CD audio and MP3/WMA tracks, the radio will only play the MP3/WMA tracks on that disc.

### Supported MP3/WMA File Formats

The radio will recognize only files with the \*.MP3/WMA extension as MP3/WMA files. Non-MP3/WMA files named with the \*.MP3/WMA extension may cause playback problems. The radio is designed to recognize the file as an invalid MP3/WMA and will not play the file.

When using the MP3/WMA encoder to compress audio data to an MP3/WMA file, the bit rate and sampling frequencies in the following table are supported. In addition, variable bit rates (VBR) are also supported. The majority of MP3/WMA files use a 44.1 kHz sampling rate and a 192, 160, 128, 96 or VBR bit rates.

MPEG Specification	Sampling Frequency (kHz)	Bit Rate (kbps)
MPEG-1 Audio Layer 3	48, 44.1, 32	320, 256, 224, 192, 160, 128, 112, 96, 80, 64, 56, 48
MPEG-2 Audio Layer 3	24, 22.05, 16	160, 128, 144, 112, 96, 80, 64, 56, 48

WMA Specification	Sampling Frequency (kHz)	Bit Rate (kbps)
WMA	44.1 and 48	48, 64, 96, 128, 160, 192 VBR

ID3 Tag information for artist, song title, and album title are supported for ID3 version 1 tags. ID3 version 2 is not supported by the radios.

Playlist files are not supported. MP3 Pro files are not supported.

### Playback of MP3/WMA Files

When a medium containing MP3/WMA data is loaded, the radio checks all files on the medium. If the medium contains a lot of folders or files, the radio will take more time to start playing the MP3/WMA files.

Loading times for playback of MP3/WMA files may be affected by the following:

- Media - CD-RW media may take longer to load than CD-R media
- Medium formats - Multisession discs may take longer to load than non-multisession discs
- Number of files and folders - Loading times will increase with more files and folders

To increase the speed of disc loading, it is recommended to use CD-R media and single-session discs. To create a single-session disc, enable the “Disc at Once” option before writing to the disc.

### LIST Button (DISC Mode for MP3/WMA Play)

Pressing the LIST button will bring up a list of all folders on the disc. Scrolling up or down the list is done by turning the TUNE/SCROLL control knob. Selecting a folder by pressing the TUNE/SCROLL control knob will begin playing the files contained in that folder (or the next folder in sequence if the selection does not contain playable files).

The folder list will time out after five seconds.

### INFO Button (DISC Mode for MP3/WMA Play)

Pressing the INFO button repeatedly will scroll through the following TAG information: Song Title, Artist, File Name, and Folder Name (if available).

Press the INFO button once more to return to “elapsed time” priority mode.

Press and hold the INFO button for three seconds or more and radio will display song titles for each file.

Press and hold the INFO button again for three seconds to return to "elapsed time" display.

### **Operation Instructions - Auxiliary Mode**

The auxiliary (AUX) jack is an audio input jack which allows the user to plug in a portable device such as an MP3/WMA player, cassette player, or microphone and utilize the vehicle's audio system to amplify the source and play through the vehicle speakers.

Pressing the AUX button will change the mode to auxiliary device if the AUX jack is connected.

**NOTE:** The AUX device must be turned on and the device's volume set to the proper level. If the AUX audio is not loud enough, turn the device's volume up. If the AUX audio sounds distorted, turn the device's volume down.

### **SEEK Button (Auxiliary Mode)**

No function.

### **SCAN Button (Auxiliary Mode)**

No function.

### **EJECT Button (Auxiliary Mode)**

No function.



### **TIME Button (Auxiliary Mode)**

Press the TIME button to change the display from elapsed playing time to time of day. The time of day will display for five seconds.

### **RW/FF (Auxiliary Mode)**

No function.

### **SET Button (Auxiliary Mode)**

No function.



**Operating Instructions — Voice Command System (If Equipped)**

For the radio, Refer to “Voice Command” in the Uconnect™ User Manual located on the DVD for further details.

**Operating Instructions - Uconnect™ Phone (If Equipped)**

Refer to “Uconnect™ Phone” in the Uconnect™ User Manual located on the DVD for further details.

**Operating Instructions - Video Entertainment System (VES)™ (If Equipped)**

Refer to “Video Entertainment System (VES)™” in the Uconnect™ User Manual located on the DVD for further details.

***Dolby®***

Manufactured under license from Dolby® Laboratories. “Dolby®” and the double-D symbol are trademarks of Dolby® Laboratories.

***Macrovision***

This product incorporates copyright protection technology that is protected by U.S. patents and other intellectual property rights. Use of this copyright protection technology must be authorized by Macrovision, and is intended for home and other limited viewing uses only, unless otherwise authorized by Macrovision. Reverse engineering or disassembly is prohibited.

***DTSTM***

“DTSTM” and “DTSTM 2.0” are trademarks of Digital Theater Systems, Inc.

### **Uconnect™ Multimedia (Satellite Radio) — If Equipped**

Satellite radio uses direct satellite-to-receiver broadcasting technology to provide clear digital sound, coast to coast. The subscription service provider is Sirius Satellite Radio. This service offers over 130 channels of music, sports, news, entertainment, and programming for children, directly from its satellites and broadcasting studios.

**NOTE:** Sirius service is not available in Hawaii and has limited coverage in Alaska.

#### **System Activation**

Sirius Satellite Radio service is pre-activated, and you may begin listening immediately to the one year of audio service that is included with the factory-installed satellite radio system in your vehicle. Sirius will supply a welcome kit that contains general information, including how to setup your on-line listening account. For further information, call the toll-free number 888-539-7474, or

visit the Sirius web site at [www.sirius.com](http://www.sirius.com), or at [www.siriuscanada.ca](http://www.siriuscanada.ca) for Canadian residents.

#### **Electronic Serial Number/Sirius Identification Number (ESN/SID)**

Please have the following information available when calling:

1. The Electronic Serial Number/Sirius Identification Number (ESN/SID).
2. Your Vehicle Identification Number.

To access the ESN/SID, refer to the following steps:

#### **ESN/SID Access**

With the ignition switch in the ON/RUN or ACC position and the radio on, press the SETUP button and scroll using the TUNE/SCROLL control knob until Sirius ID is selected. Press the TUNE/SCROLL control knob and the

Sirius ID number will display. The Sirius ID number display will time out in two minutes. Press any button on the radio to exit this screen.

### **Selecting Uconnect™ Multimedia (Satellite) Mode**

Press the SAT button until "SAT" appears in the display. A CD may remain in the radio while in the Satellite radio mode.

### **Satellite Antenna**

To ensure optimum reception, do not place items on the roof around the rooftop antenna location. Metal objects placed within the line of sight of the antenna will cause decreased performance. Larger luggage items such as bikes should be placed as far rearward as possible, within the loading design of the rack. Do not place items directly on or above the antenna.

### **Reception Quality**

Satellite reception may be interrupted due to one of the following reasons:

- The vehicle is parked in an underground parking structure or under a physical obstacle.
- Dense tree coverage may interrupt reception in the form of short audio mutes.
- Driving under wide bridges or along tall buildings can cause intermittent reception.
- Placing objects over or too close to the antenna can cause signal blockage.

### **Operating Instructions - Uconnect™ Multimedia (Satellite) Mode**

**NOTE:** The ignition switch must be in the ON/RUN or ACC position to operate the radio.

**SEEK Buttons**

Press and release the SEEK buttons to search for the next channel in Satellite mode. Press the right switch to seek up and the left switch to seek down. The radio will remain tuned to the new channel until you make another selection. Holding either button will bypass channels without stopping until you release it.

**SCAN Button**

Pressing the SCAN button causes the tuner to search for the next channel, pausing for eight seconds before continuing to the next. To stop the search, press the SCAN button a second time.

**INFO Button**

Pressing the INFO button will cycle the display information between Artist, Song Title, and Composer (if available). Also, pressing and holding the INFO button for an additional three seconds will make the radio display the Song Title all of the time (press and hold again to return to normal display).

**RW/FF**

Pressing the RW (Rewind) or FF (Fast Forward) buttons causes the tuner to search for the next channel in the direction of the arrows.

**TUNE Control (Rotary)**

Turn the rotary TUNE/SCROLL control knob clockwise to increase or counterclockwise to decrease the channel.

**MUSIC TYPE Button**

Pressing this button once will turn on the Music Type mode for five seconds. Pressing the MUSIC TYPE button or turning the TUNE/SCROLL control knob within five seconds will allow the program format type to be selected.

Toggle the MUSIC TYPE button again to select the music type.

By pressing the SEEK button when the Music Type function is active, the radio will be tuned to the next channel with the same selected Music Type name.

If a preset button is activated while in the Music Type (Program Type) mode, the Music Type mode will be exited and the radio will tune to the preset channel.

### **SETUP Button**

Pressing the SETUP button allows you to select the following items:

- Display Sirius ID number — Press the AUDIO/SELECT button to display the Sirius ID number. This number is used to activate, deactivate, or change the Sirius subscription.

### **SET Button – To Set the Pushbutton Memory**

When you are receiving a channel that you wish to commit to pushbutton memory, press the SET button. The symbol SET 1 will now show in the display window.

Select the button (1-6) you wish to lock onto this channel and press and release that button. If a button is not selected within five seconds after pressing the SET button, the channel will continue to play but will not be stored into pushbutton memory.

You may add a second channel to each pushbutton by repeating the above procedure with this exception: Press the SET button twice and SET 2 will show in the display window. Each button can be set for SET 1 and SET 2. This allows a total of 12 Satellite channels to be stored into pushbutton memory. The channels stored in SET 2 memory can be selected by pressing the pushbutton twice.

Every time a preset button is used, a corresponding button number will display.

### **Buttons 1 - 6**

These buttons tune the radio to the channels that you commit to pushbutton memory (12 Satellite stations).

## MEDIA CENTER 730N/430/430N (RHR/RER/RBZ/ RHB) CD/DVD/HDD/NAV — IF EQUIPPED

**NOTE:** The sales code is located on the lower right side of the unit's faceplate.

Refer to your Uconnect™ Multimedia RHR, RER, RBZ or RHB user's manual for detailed operating instructions.

### Operating Instructions (Voice Command System) — If Equipped

Refer to "Voice Command" in the Uconnect™ User Manual located on the DVD for further details.

### Operating Instructions (Uconnect™ Phone) — If Equipped

Refer to "Uconnect™ Phone" in the Uconnect™ User Manual located on the DVD for further details.

## MEDIA CENTER 130 (SALES CODE RES)

**NOTE:** The radio sales code is located on the lower right side of the radio faceplate.

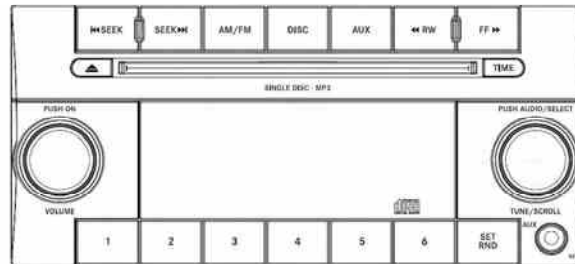

042305232

Media Center 130 (RES)

## Operating Instructions — Radio Mode

**NOTE:** The ignition switch must be in the ON or ACC position to operate the radio.

### Power Switch/Volume Control (Rotary)

Push the ON/VOLUME control knob to turn on the radio. Push the ON/VOLUME control knob a second time to turn off the radio.

### Electronic Volume Control

The electronic volume control turns continuously (360 degrees) in either direction, without stopping. Turning the ON/VOLUME control knob to the right increases the volume, and to the left decreases it.

When the audio system is turned on, the sound will be set at the same volume level as last played.

### SEEK Buttons

Press and release the SEEK buttons to search for the next listenable station in AM/FM mode. Press the right switch to seek up and the left switch to seek down. The radio will remain tuned to the new station until you make another selection. Holding either button will bypass stations without stopping, until you release it.

### TIME Button

Press the TIME button to alternate display of the time and radio frequency.

### Clock Setting Procedure

1. Press and hold the TIME button until the hours blink.
2. Adjust the hours by turning the right side TUNE/SCROLL control knob.
3. After adjusting the hours, press the right side TUNE/SCROLL control knob to set the minutes. The minutes will begin to blink.

4. Adjust the minutes using the right side TUNE/SCROLL control knob. Press the TUNE/SCROLL control knob to save time change.

5. To exit, press any button/knob, or wait five seconds.

### **RW/FF**

Pressing the RW (Rewind) or FF (Fast Forward) buttons causes the tuner to search for the next frequency in the direction of the arrows. This feature operates in either AM or FM frequencies.

### **TUNE Control**

Turn the rotary TUNE/SCROLL control knob clockwise to increase or counterclockwise to decrease the frequency.

### **Setting the Tone, Balance, and Fade**

Push the rotary TUNE/SCROLL control knob and BASS will display. Turn the TUNE/SCROLL control knob to the right or left to increase or decrease the bass tones.

Push the rotary TUNE/SCROLL control knob a second time and MID will display. Turn the TUNE/SCROLL control knob to the right or left to increase or decrease the mid-range tones.

Push the rotary TUNE/SCROLL control knob a third time and TREBLE will display. Turn the TUNE/SCROLL control knob to the right or left to increase or decrease the treble tones.

Push the rotary TUNE/SCROLL control knob a fourth time and BALANCE will display. Turn the TUNE/SCROLL control knob to the right or left to adjust the sound level from the right or left side speakers.

Push the rotary TUNE/SCROLL control knob a fifth time and FADE will display. Turn the TUNE/SCROLL control knob to the left or right to adjust the sound level between the front and rear speakers.



Push the rotary TUNE/SCROLL control knob again to exit setting tone, balance, and fade.

### **AM/FM Button**

Press the buttons to select either AM or FM mode.

### **SET/RND Button — To Set the Pushbutton Memory**

When you are receiving a station that you wish to commit to pushbutton memory, press the SET/RND button. The symbol SET 1 will now show in the display window. Select the button (1 to 6) you wish to lock onto this station and press and release that button. If a button is not selected within five seconds after pressing the SET/RND button, the station will continue to play but will not be stored into pushbutton memory.

You may add a second station to each pushbutton by repeating the above procedure with this exception: Press the SET/RND button twice and SET 2 will show in the display window. Each button can be set for SET 1 and SET 2 in both AM and FM. This allows a total of 12 AM and 12 FM stations to be stored into pushbutton memory. The stations stored in SET 2 memory can be selected by pressing the pushbutton twice.

Every time a preset button is used, a corresponding button number will display.

### **Buttons 1 - 6**

These buttons tune the radio to the stations that you commit to pushbutton memory (12 AM and 12 FM stations).

### **DISC Button**

Pressing the DISC button will allow you to switch from AM/FM modes to Disc modes.

## Operation Instructions — CD MODE For CD And MP3 Audio Play

### NOTE:

- The ignition switch must be in the ON or ACC position to operate the radio.
- This radio is capable of playing compact discs (CD), recordable compact discs (CD-R), rewritable compact discs (CD-RW), compact discs with MP3 tracks and multisession compact discs with CD and MP3 tracks.

### Inserting Compact Disc(s)

Gently insert one CD into the CD player with the CD label facing up. The CD will automatically be pulled into the CD player and the CD icon will illuminate on the radio display. If a CD does not go into the slot more than 1.0 in (2.5 cm), a disc may already be loaded and must be ejected before a new disc can be loaded.

If you insert a disc with the ignition ON and the radio ON, the unit will switch from radio to CD mode and begin to play when you insert the disc. The display will show the track number, and index time in minutes and seconds. Play will begin at the start of track 1.

### CAUTION!

- **This CD player will accept 4-3/4 in (12 cm) discs only. The use of other sized discs may damage the CD player mechanism.**
- **Do not use adhesive labels. These labels can peel away and jam the player mechanism.**
- **RES is a single CD player. Do not attempt to insert a second CD if one is already loaded.**
- **Dual-media disc types (one side is a DVD, the other side is a CD) should not be used, and they can cause damage to the player.**

**EJECT Button - Ejecting a CD**

Press the EJECT button to eject the CD.



If you have ejected a disc and have not removed it within 10 seconds, it will be reloaded. If the CD is not removed, the radio will reinsert the CD but will not play it.

A disc can be ejected with the radio and ignition OFF.

**NOTE:** Ejecting with the ignition OFF is not allowed on convertible or soft-top models (if equipped).

**SEEK Button**

Press the right SEEK button for the next selection on the CD. Press the left SEEK button to return to the beginning of the current selection, or return to the beginning of the previous selection if the CD is within the first second of the current selection. Pressing and holding the SEEK button will allow faster scrolling through the tracks in CD and MP3 modes.

**TIME Button**

Press this button to change the display from a large CD playing time display to a small CD playing time display.

**RW/FF**

Press and hold the FF (Fast Forward) button and the CD player will begin to fast forward until FF is released, or RW or another CD button is pressed. The RW (Reverse) button works in a similar manner.

**AM/FM Button**

Press the button to select either AM or FM mode.

**SET/RND Button (Random Play Button)**

Press this button while the CD is playing to activate Random Play. This feature plays the selections on the compact disc in random order to provide an interesting change of pace.

Press the right SEEK button to move to the next randomly selected track.

Press the RND button a second time to stop Random Play.

**Notes on Playing MP3 Files**

The radio can play MP3 files; however, acceptable MP3 file recording media and formats are limited. When writing MP3 files, pay attention to the following restrictions.

**Supported Media (Disc Types)**

The MP3 file recording media supported by the radio are CDDA, CD-R, CD-RW, MP3, and CDDA+MP3.

**Supported Medium Formats (File Systems)**

The medium formats supported by the radio are ISO 9660 Level 1 and Level 2 and includes the Joliet extension. When reading discs recorded using formats other than ISO 9660 Level 1 and Level 2, the radio may fail to read files properly and may be unable to play the file normally. UDF and Apple HFS formats are not supported.

The radio uses the following limits for file systems:

- Maximum number of folder levels: 8
- Maximum number of files: 255
- Maximum number of folders. (The radio display of file names and folder names is limited. For large numbers of files and/or folders, the radio may be unable to display the file name and folder name, and will assign a number instead. With a maximum number of files, exceeding 20 folders will result in this display. With 200 files, exceeding 50 folders will result in this display.)

- Maximum number of characters in file/folder names:
  - Level 1: 12 (including a separator "." and a three-character extension)
  - Level 2: 31 (including a separator "." and a three-character extension)

Multisession disc formats are supported by the radio. Multisession discs may contain combinations of normal CD audio tracks and computer files (including MP3 files). Discs created with an option such as "keep disc open after writing" are most likely multisession discs. The use of multisession for CD audio or MP3 playback may result in longer disc loading times.

### Supported MP3 File Formats

The radio will recognize only files with the \*.MP3 extension as MP3 files. Non-MP3 files named with the \*.MP3 extension may cause playback problems. The radio is designed to recognize the file as an invalid MP3 and will not play the file.

When using the MP3 encoder to compress audio data to an MP3 file, the bit rate and sampling frequencies in the following table are supported. In addition, variable bit rates (VBR) are also supported. The majority of MP3 files use a 44.1 kHz sampling rate and a 192, 160, 128, 96 or VBR bit rate.

MPEG Specification	Sampling Frequency (kHz)	Bit Rate (kbps)
MPEG-1 Audio Layer 3	48, 44.1, 32	320, 256, 224, 192, 160, 128, 112, 96, 80, 64, 56, 48, 40, 32
MPEG-2 Audio Layer 3	24, 22.05, 16	160, 128, 144, 112, 96, 80, 64, 56, 48, 40, 32, 24, 16, 8

ID3 Tag information for artist, song title, and album title are supported for version 1 ID3 tags. ID3 version 2 is not supported by the radios.

Playlist files are not supported. MP3 Pro files are not supported.

### **Playback of MP3 Files**

When a medium containing MP3 data is loaded, the radio checks all files on the medium. If the medium contains a lot of folders or files, the radio will take more time to start playing the MP3 files.

Loading times for playback of MP3 files may be affected by the following:

- Media - CD-RW media may take longer to load than CD-R media
- Medium formats - Multisession discs may take longer to load than non-multisession discs
- Number of files and folders - Loading times will increase with more files and folders

To increase the speed of disc loading, it is recommended to use CD-R media and single-session discs. To create a single-session disc, enable the “Disc at Once” option before writing to the disc.

### **Operation Instructions - Auxiliary Mode**

The auxiliary (AUX) jack is an audio input jack, which allows the user to plug in a portable device, such as an MP3 player, or cassette player, and utilize the vehicle’s audio system to amplify the source and play through the vehicle speakers.

Pressing the DISC/AUX button will change the mode to auxiliary device if the AUX jack is connected.

**NOTE:** The AUX device must be turned on and the device’s volume set to proper level. If the AUX audio is not loud enough, turn the device’s volume up. If the AUX audio sounds distorted, turn the device’s volume down.

**TIME Button (Auxiliary Mode)**

Press this button to change the display to time of day. The time of day will display for five seconds (when ignition is OFF).

**MEDIA CENTER 130 WITH SATELLITE RADIO (SALES CODE RES+RSC)**

**NOTE:** The radio sales code is located on the lower right side of the radio faceplate.

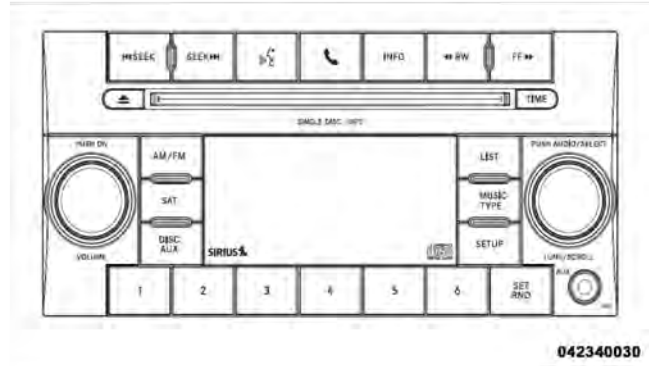

**Media Center 130 (RES/RSC)  
Operating Instructions — Radio Mode**

**NOTE:** The ignition switch must be in the ON or ACC position to operate the radio.

**Power Switch/Volume Control (Rotary)**

Push the ON/VOLUME control knob to turn on the radio. Push the ON/VOLUME control knob a second time to turn off the radio.

**Electronic Volume Control**

The electronic volume control turns continuously (360 degrees) in either direction without stopping. Turning the ON/VOLUME control knob to the right increases the volume and to the left decreases it.

When the audio system is turned on, the sound will be set at the same volume level as last played.

**SEEK Buttons**

Press and release the SEEK buttons to search for the next listenable station in AM/FM mode. Press the right switch to seek up and the left switch to seek down. The radio will remain tuned to the new station until you make another selection. Holding either button will bypass stations without stopping until you release it.

**Voice Command System (Radio) — If Equipped**

Refer to “Voice Command” in “Understanding The Features If Your Vehicle”.

**Voice Command Button Uconnect™ Phone — If Equipped**

Press this button to operate the Uconnect™ Phone feature (if equipped). Refer to “Uconnect™ Phone” in “Understanding The Features If Your Vehicle”.

If your vehicle is not equipped with or this feature is not available on your vehicle, a “Not Equipped With Uconnect Phone” message will display on the radio screen.

**Phone Button Uconnect™ Phone — If Equipped**

Press this button to operate the Uconnect™ Phone feature (if equipped). Refer to “Uconnect™ Phone” in “Understanding The Features If Your Vehicle”.



If your vehicle is not equipped with or this feature is not available on your vehicle, a “Not Equipped With Uconnect Phone” message will display on the radio screen.

### **TIME Button**

Press the TIME button to alternate display of the time and radio frequency.

### **Clock Setting Procedure**

1. Press and hold the TIME button until the hours blink.
2. Adjust the hours by turning the right side TUNE/SCROLL control knob.
3. After adjusting the hours, press the right side TUNE/SCROLL control knob to set the minutes. The minutes will begin to blink.
4. Adjust the minutes using the right side TUNE/SCROLL control knob. Press the TUNE/SCROLL control knob to save time change.

5. To exit, press any button/knob or wait five seconds.

The clock can also be set by pressing the SETUP button. For vehicles equipped with satellite radio, press the SETUP button, use the TUNE/SCROLL control to select SET CLOCK, and then follow the above procedure, starting at Step 2. For vehicles not equipped with satellite radio, press the SETUP button and then follow the above procedure, starting at Step 2.

### **INFO Button**

Press the INFO button for an RDS station (one with call letters displayed). The radio will return a Radio Text message broadcast from an FM station (FM mode only).

### **RW/FF**

Pressing the RW (Rewind) or FF (Fast Forward) buttons causes the tuner to search for the next frequency in the direction of the arrows. This feature operates in either AM or FM frequencies.

**TUNE Control**

Turn the rotary TUNE/SCROLL control knob clockwise to increase or counterclockwise to decrease the frequency.

**Setting the Tone, Balance, and Fade**

Push the rotary TUNE/SCROLL control knob and BASS will display. Turn the TUNE/SCROLL control knob to the right or left to increase or decrease the bass tones.

Push the rotary TUNE/SCROLL control knob a second time and MID will display. Turn the TUNE/SCROLL control knob to the right or left to increase or decrease the mid-range tones.

Push the rotary TUNE/SCROLL control knob a third time and TREBLE will display. Turn the TUNE/SCROLL control knob to the right or left to increase or decrease the treble tones.

Push the rotary TUNE/SCROLL control knob a fourth time and BALANCE will display. Turn the TUNE/SCROLL control knob to the right or left to adjust the sound level from the right or left side speakers.

Push the rotary TUNE/SCROLL control knob a fifth time and FADE will display. Turn the TUNE/SCROLL control knob to the left or right to adjust the sound level between the front and rear speakers.

Push the rotary TUNE/SCROLL control knob again to exit setting tone, balance, and fade.

**MUSIC TYPE Button**

Pressing this button once will turn on the Music Type mode for five seconds. Pressing the MUSIC TYPE button or turning the TUNE/SCROLL control knob within five seconds will allow the program format type to be selected. Many radio stations do not currently broadcast Music Type information.

Toggle the MUSIC TYPE button to select the following format types:

<b>Program Type</b>	<b>16-Digit Character Display</b>
No program type or undefined	None
Adult Hits	Adlt Hit
Classical	Classicl
Classic Rock	Cls Rock
College	College
Country	Country
Foreign Language	Language
Information	Inform
Jazz	Jazz
News	News
Nostalgia	Nostalgia
Oldies	Oldies
Personality	Persnlty

<b>Program Type</b>	<b>16-Digit Character Display</b>
Public	Public
Rhythm and Blues	R & B
Religious Music	Rel Musc
Religious Talk	Rel Talk
Rock	Rock
Soft	Soft
Soft Rock	Soft Rck
Soft Rhythm and Blues	Soft R&B
Sports	Sports
Talk	Talk
Top 40	Top 40
Weather	Weather

By pressing the SEEK button when the Music Type icon is displayed, the radio will be tuned to the next frequency station with the same selected Music Type name. The Music Type function only operates when in the FM mode.

If a preset button is activated while in the Music Type (Program Type) mode, the Music Type mode will be exited and the radio will tune to the preset station.

### **SETUP Button**

Pressing the SETUP button allows you to select between the following items:

- **Set Clock** — Pressing the SELECT button will allow you to set the clock. Adjust the hours by turning the TUNE/SCROLL control knob. After adjusting the hours, press the TUNE/SCROLL control knob to set the minutes. The minutes will begin to blink. Adjust the minutes using the right side TUNE/SCROLL control knob. Press the TUNE/SCROLL control knob to save time change.

### **AM/FM Button**

Press the button to select either AM or FM mode.

### **SET/RND Button — To Set the Pushbutton Memory**

When you are receiving a station that you wish to commit to pushbutton memory, press the SET/RND button. The symbol SET 1 will now show in the display window. Select the button (1–6) you wish to lock onto this station and press and release that button. If a button is not selected within five seconds after pressing the SET/RND button, the station will continue to play but will not be stored into pushbutton memory.

You may add a second station to each pushbutton by repeating the above procedure with this exception: Press the SET/RND button twice and SET 2 will show in the display window. Each button can be set for SET 1 and SET 2 in both AM and FM. This allows a total of 12 AM and 12 FM stations to be stored into pushbutton memory. The stations stored in SET 2 memory can be selected by pressing the pushbutton twice.

Every time a preset button is used, a corresponding button number will display.

### **Buttons 1 - 6**

These buttons tune the radio to the stations that you commit to pushbutton memory (12 AM and 12 FM stations).

### **DISC/AUX Button**

Pressing the DISC/AUX button will allow you to switch from AM/FM modes to DISC/AUX mode.

### **Operation Instructions — CD MODE for CD and MP3 Audio Play**

#### **NOTE:**

- The ignition switch must be in the ON or ACC position to operate the radio.

- This radio is capable of playing compact discs (CD), recordable compact discs (CD-R), rewritable compact discs (CD-RW), compact discs with MP3 tracks and multisession compact discs with CD and MP3 tracks.

### **Inserting Compact Disc(s)**

Gently insert one CD into the CD player with the CD label facing up. The CD will automatically be pulled into the CD player and the CD icon will illuminate on the radio display. If a CD does not go into the slot more than 1.0 in (2.5 cm), a disc may already be loaded and must be ejected before a new disc can be loaded.

If you insert a disc with the ignition ON and the radio ON, the unit will switch from radio to CD mode and begin to play when you insert the disc. The display will show the track number, and index time in minutes and seconds. Play will begin at the start of track 1.

**CAUTION!**

- This CD player will accept 4-3/4 in (12 cm) discs only. The use of other sized discs may damage the CD player mechanism.
- Do not use adhesive labels. These labels can peel away and jam the player mechanism.
- RES is a single CD player. Do not attempt to insert a second CD if one is already loaded.
- Dual-media disc types (one side is a DVD, the other side is a CD) should not be used, and they can cause damage to the player.

**EJECT Button - Ejecting a CD**

Press the EJECT button to eject the CD.



If you have ejected a disc and have not removed it within 10 seconds, it will be reloaded. If the CD is not removed, the radio will reinsert the CD but will not play it.

A disc can be ejected with the radio and ignition OFF.

**NOTE:** Ejecting with the ignition OFF is not allowed on convertible or soft-top models (if equipped).

**SEEK Button**

Press the right SEEK button for the next selection on the CD. Press the left SEEK button to return to the beginning of the current selection, or return to the beginning of the previous selection if the CD is within the first second of the current selection. Pressing and holding the SEEK button will allow faster scrolling through the tracks in CD and MP3 modes.

**TIME Button**

Press this button to change the display from a large CD playing time display to a small CD playing time display.

**RW/FF**

Press and hold FF (Fast Forward) and the CD player will begin to fast forward until FF is released or RW or another CD button is pressed. The RW (Reverse) button works in a similar manner.

**AM/FM Button**

Press the button to select either AM or FM mode.

**SET/RND Button (Random Play Button)**

Press this button while the CD is playing to activate Random Play. This feature plays the selections on the compact disc in random order to provide an interesting change of pace.

Press the right SEEK button to move to the next randomly selected track.

Press the SET/RND button a second time to stop Random Play.

**Notes On Playing MP3 Files**

The radio can play MP3 files; however, acceptable MP3 file recording media and formats are limited. When writing MP3 files, pay attention to the following restrictions.

**Supported Media (Disc Types)**

The MP3 file recording media supported by the radio are CDDA, CD-R, CD-RW, MP3, and CDDA+MP3.

**Supported Medium Formats (File Systems)**

The medium formats supported by the radio are ISO 9660 Level 1 and Level 2 and includes the Joliet extension. When reading discs recorded using formats other than ISO 9660 Level 1 and Level 2, the radio may fail to read files properly and may be unable to play the file normally. UDF and Apple HFS formats are not supported.

The radio uses the following limits for file systems:

- Maximum number of folder levels: 8

- Maximum number of files: 255
- Maximum number of folders. (The radio display of file names and folder names is limited. For large numbers of files and/or folders, the radio may be unable to display the file name and folder name and will assign a number instead. With a maximum number of files, exceeding 20 folders will result in this display. With 200 files, exceeding 50 folders will result in this display.)
- Maximum number of characters in file/folder names:
  - Level 1: 12 (including a separator "." and a three-character extension)
  - Level 2: 31 (including a separator "." and a three-character extension)

Multisession disc formats are supported by the radio. Multisession discs may contain combinations of normal CD audio tracks and computer files (including MP3 files). Discs created with an option such as "keep disc open after writing" are most likely multisession discs. The use of multisession for CD audio or MP3 playback may result in longer disc loading times.

### **Supported MP3 File Formats**

The radio will recognize only files with the \*.MP3 extension as MP3 files. Non-MP3 files named with the \*.MP3 extension may cause playback problems. The radio is designed to recognize the file as an invalid MP3 and will not play the file.

When using the MP3 encoder to compress audio data to an MP3 file, the bit rate and sampling frequencies in the following table are supported. In addition, variable bit



rates (VBR) are also supported. The majority of MP3 files use a 44.1 kHz sampling rate and a 192, 160, 128, 96 or VBR bit rates.

MPEG Specification	Sampling Frequency (kHz)	Bit Rate (kbps)
MPEG-1 Audio Layer 3	48, 44.1, 32	320, 256, 224, 192, 160, 128, 112, 96, 80, 64, 56, 48, 40, 32
MPEG-2 Audio Layer 3	24, 22.05, 16	160, 128, 144, 112, 96, 80, 64, 56, 48, 40, 32, 24, 16, 8

ID3 Tag information for artist, song title, and album title are supported for version 1 ID3 tags. ID3 version 2 is not supported by the radios.

Playlist files are not supported. MP3 Pro files are not supported.

### Playback of MP3 Files

When a medium containing MP3 data is loaded, the radio checks all files on the medium. If the medium contains a lot of folders or files, the radio will take more time to start playing the MP3 files.

Loading times for playback of MP3 files may be affected by the following:

- Media - CD-RW media may take longer to load than CD-R media
- Medium formats - Multisession discs may take longer to load than non-multisession discs
- Number of files and folders - Loading times will increase with more files and folders

To increase the speed of disc loading, it is recommended to use CD-R media and single-session discs. To create a single-session disc, enable the “Disc at Once” option before writing to the disc.

**LIST Button (CD Mode for MP3 Play)**

Pressing the LIST button will bring up a list of all folders on the disc. Scrolling up or down the list is done by turning the TUNE/SCROLL control knob. Selecting a folder by pressing the TUNE/SCROLL control knob will begin playing the files contained in that folder (or the next folder in sequence if the selection does not contain playable files).

The folder list will time out after five seconds.

**INFO Button (CD Mode for MP3 Play)**

Pressing the INFO button repeatedly will scroll through the following TAG information: Song Title, Artist, File Name, and Folder Name (if available).

Press the INFO button once more to return to "elapsed time" priority mode.

Press and hold the INFO button for three seconds or more and the radio will display song titles for each file.

Press and hold the INFO button again for three seconds to return to "elapsed time" display.

**Operation Instructions - Auxiliary Mode**

The auxiliary (AUX) jack is an audio input jack which allows the user to plug in a portable device such as an MP3 player or cassette player and utilize the vehicle's audio system to amplify the source and play through the vehicle speakers.

Pressing the AUX button will change the mode to auxiliary device if the AUX jack is connected.

**NOTE:** The AUX device must be turned on and the device's volume set to the proper level. If the AUX audio is not loud enough, turn the device's volume up. If the AUX audio sounds distorted, turn the device's volume down.

**TIME Button (Auxiliary Mode)**

Press this button to change the display to time of day. The time of day will display for five seconds (when the ignition is OFF).

**Uconnect™ Multimedia (Satellite Radio) — If Equipped**

Satellite radio uses direct satellite-to-receiver broadcasting technology to provide clear digital sound, coast to coast. The subscription service provider is Sirius Satellite Radio. This service offers over 130 channels of music, sports, news, entertainment, and programming for children, directly from its satellites and broadcasting studios.

**NOTE:** Sirius service is not available in Hawaii and has limited coverage in Alaska.

**System Activation**

Sirius Satellite Radio service is pre-activated, and you may begin listening immediately to the one year of audio service that is included with the factory-installed satellite

radio system in your vehicle. Sirius will supply a welcome kit that contains general information, including how to setup your on-line listening account. For further information, call the toll-free number 888-539-7474, or visit the Sirius web site at [www.sirius.com](http://www.sirius.com), or at [www.siriuscanada.ca](http://www.siriuscanada.ca) for Canadian residents.

**Electronic Serial Number/Sirius Identification Number (ESN/SID)**

Please have the following information available when calling:

1. The Electronic Serial Number/Sirius Identification Number (ESN/SID).
2. Your Vehicle Identification Number.

To access the ESN/SID, refer to the following steps:

**ESN/SID Access**

With the ignition switch in the ON/RUN or ACC position and the radio on, press the SETUP button and scroll

using the TUNE/SCROLL control knob until Sirius ID is selected. Press the TUNE/SCROLL control knob and the Sirius ID number will display. The Sirius ID number display will time out in two minutes. Press any button on the radio to exit this screen.

### **Selecting Uconnect™ Multimedia (Satellite) Mode**

Press the SAT button until "SAT" appears in the display. A CD may remain in the radio while in the Satellite radio mode.

### **Satellite Antenna**

To ensure optimum reception, do not place items on the roof around the rooftop antenna location. Metal objects placed within the line of sight of the antenna will cause decreased performance. Larger luggage items such as bikes should be placed as far rearward as possible, within the loading design of the rack. Do not place items directly on or above the antenna.

### **Reception Quality**

Satellite reception may be interrupted due to one of the following reasons:

- The vehicle is parked in an underground parking structure or under a physical obstacle.
- Dense tree coverage may interrupt reception in the form of short audio mutes.
- Driving under wide bridges or along tall buildings can cause intermittent reception.
- Placing objects over or too close to the antenna can cause signal blockage.

### **Operating Instructions - Uconnect™ Multimedia (Satellite) Mode**

**NOTE:** The ignition switch must be in the ON/RUN or ACC position to operate the radio.

**SEEK Buttons**

Press and release the SEEK buttons to search for the next channel in Satellite mode. Press the right switch to seek up and the left switch to seek down. The radio will remain tuned to the new channel until you make another selection. Holding either button will bypass channels without stopping until you release it.

**SCAN Button**

Pressing the SCAN button causes the tuner to search for the next channel, pausing for eight seconds before continuing to the next. To stop the search, press the SCAN button a second time.

**INFO Button**

Pressing the INFO button will cycle the display information between Artist, Song Title, and Composer (if available). Also, pressing and holding the INFO button for an additional three seconds will make the radio display the Song Title all of the time (press and hold again to return to normal display).

**RW/FF**

Pressing the RW (Rewind) or FF (Fast Forward) buttons causes the tuner to search for the next channel in the direction of the arrows.

**TUNE Control (Rotary)**

Turn the rotary TUNE/SCROLL control knob clockwise to increase or counterclockwise to decrease the channel.

**MUSIC TYPE Button**

Pressing this button once will turn on the Music Type mode for five seconds. Pressing the MUSIC TYPE button or turning the TUNE/SCROLL control knob within five seconds will allow the program format type to be selected.

Toggle the MUSIC TYPE button again to select the music type.

By pressing the SEEK button when the Music Type function is active, the radio will be tuned to the next channel with the same selected Music Type name.

If a preset button is activated while in the Music Type (Program Type) mode, the Music Type mode will be exited and the radio will tune to the preset channel.

### **SETUP Button**

Pressing the SETUP button allows you to select the following items:

- Display Sirius ID number — Press the AUDIO/SELECT button to display the Sirius ID number. This number is used to activate, deactivate, or change the Sirius subscription.

### **SET Button – To Set the Pushbutton Memory**

When you are receiving a channel that you wish to commit to pushbutton memory, press the SET button. The symbol SET 1 will now show in the display window.

Select the button (1-6) you wish to lock onto this channel and press and release that button. If a button is not selected within five seconds after pressing the SET button, the channel will continue to play but will not be stored into pushbutton memory.

You may add a second channel to each pushbutton by repeating the above procedure with this exception: Press the SET button twice and SET 2 will show in the display window. Each button can be set for SET 1 and SET 2. This allows a total of 12 Satellite channels to be stored into pushbutton memory. The channels stored in SET 2 memory can be selected by pressing the pushbutton twice.

Every time a preset button is used, a corresponding button number will display.

### **Buttons 1 - 6**

These buttons tune the radio to the channels that you commit to pushbutton memory (12 Satellite stations).

## Operating Instructions - Uconnect™ Phone (If Equipped)

Refer to “Uconnect™ Phone” in “Understanding The Features If Your Vehicle”.

### STEERING WHEEL AUDIO CONTROLS

The remote sound system controls are located on the rear surface of the steering wheel. Reach behind the wheel to access the switches.



### Remote Sound System Controls (Back View Of Steering Wheel)

The right-hand control is a rocker-type switch with a pushbutton in the center and controls the volume and mode of the sound system. Pressing the top of the rocker switch will increase the volume, and pressing the bottom of the rocker switch will decrease the volume.

Pressing the center button will make the radio switch between the various modes available (AM/FM/SAT/CD/HDD/AUX/VES, etc.).

The left-hand control is a rocker-type switch with a pushbutton in the center. The function of the left-hand control is different depending on which mode you are in.

The following describes the left-hand control operation in each mode.

### **Radio Operation**

Pressing the top of the switch will “Seek” up for the next listenable station and pressing the bottom of the switch will “Seek” down for the next listenable station.

The button located in the center of the left-hand control will tune to the next preset station that you have programmed in the radio preset pushbutton.

### **CD Player**

Pressing the top of the switch once will go to the next track on the CD. Pressing the bottom of the switch once will go to the beginning of the current track, or to the beginning of the previous track if it is within one second after the current track begins to play.

If you press the switch up or down twice, it plays the second track; three times, it will play the third, etc.

The center button on the left side rocker switch has no function for a single-disc CD player. However, when a multiple-disc CD player is equipped on the vehicle, the center button will select the next available CD in the player.



### CD/DVD DISC MAINTENANCE

To keep a CD/DVD in good condition, take the following precautions:

1. Handle the disc by its edge; avoid touching the surface.
2. If the disc is stained, clean the surface with a soft cloth, wiping from center to edge.
3. Do not apply paper or tape to the disc; avoid scratching the disc.
4. Do not use solvents such as benzene, thinner, cleaners, or anti-static sprays.
5. Store the disc in its case after playing.
6. Do not expose the disc to direct sunlight.
7. Do not store the disc where temperatures may become too high.

**NOTE:** If you experience difficulty in playing a particular disc, it may be damaged (i.e., scratched, reflective coating removed, a hair, moisture or dew on the disc) oversized, or have protection encoding. Try a known good disc before considering disc player service.

### RADIO OPERATION AND MOBILE PHONES

Under certain conditions, the mobile phone being on in your vehicle can cause erratic or noisy performance from your radio. This condition may be lessened or eliminated by relocating the mobile phone antenna. This condition is not harmful to the radio. If your radio performance does not satisfactorily “clear” by the repositioning of the antenna, it is recommended that the radio volume be turned down or off during mobile phone operation when not using Uconnect™ (if equipped).

### CLIMATE CONTROLS

The air conditioning and heating system is designed to make you comfortable in all types of weather.

## Manual Heating And Air Conditioning



045607535

### Manual Temperature Control

The Manual Temperature Controls consist of a series of outer rotary dials and inner push knobs.

### Blower Control



045607539

Rotate this control to regulate the amount of air forced through the ventilation system in any mode. The blower speed increases as you move the control to the right from the "O" (OFF) position. There are seven blower speeds.

### Temperature Control



045607540

Rotate this control to regulate the temperature of the air inside the passenger compartment. Rotating the dial left into the blue area of the scale indicates cooler temperatures, while rotating right into the red area indicates warmer temperatures.

**NOTE:** If your air conditioning performance seems lower than expected, check the front of the A/C condenser located in front of the radiator for an accumulation of dirt or insects. Clean with a gentle water spray from behind the radiator and through the condenser. Fabric front fascia protectors may reduce airflow to the condenser, reducing air conditioning performance.

### Mode Control (Air Direction)



045607541

receive from that mode.

Rotate this control to choose from several patterns of air distribution. You can select either a primary mode as identified by the symbols on the control, or a blend of two of these modes. The closer the setting is to a particular symbol, the more air distribution you

### *Panel*

 Air is directed through the outlets in the instrument panel. These outlets can be adjusted to direct airflow.

**NOTE:** The center instrument panel outlets can be aimed so that they are directed toward the rear seat passengers for maximum airflow to the rear.

### *Bi-Level*

 Air is directed through the panel and floor outlets.

**NOTE:** For all settings, except full cold or full hot, there is a difference in temperature between the upper and lower outlets. The warmer air flows to the floor outlets. This feature gives improved comfort during sunny but cool conditions.

### *Floor*

 Air is directed through the floor outlets with a small amount flowing through the defrost and side window demist outlets.

### *Mix*

 Air is directed through the floor, defrost, and side window demist outlets. This setting works best in cold or snowy conditions that require extra heat to the windshield. This setting is good for maintaining comfort while reducing moisture on the windshield.

### *Defrost*

 Air is directed through the windshield and side window demist outlets. Use this mode with maximum blower and temperature settings for best windshield and side window defrosting.

### **NOTE:**

- The air conditioning compressor operates in Mix, Defrost, or a blend of these modes, even if the Air Conditioning (A/C) button is not pressed. This dehumidifies the air to help dry the windshield. To improve fuel economy, use these modes only when necessary.
- For information on operating the Rear Defrost, refer to “Rear Window Features” in “Understanding The Features Of Your Vehicle”.

### *Recirculation Control*

 Pressing the Recirculation Control button will put the system in recirculation mode. This can be used when outside conditions such as smoke, odors, dust, or high humidity are present. Activating recirculation will cause the LED in the control button to illuminate. After ten minutes, the system will return to normal mode function and the LED will turn off.

**NOTE:**

- Continuous use of the Recirculation mode may make the inside air stuffy and window fogging may occur. Extended use of this mode is not recommended.
- The use of the Recirculation mode in cold or damp weather will cause windows to fog on the inside, because of moisture buildup inside the vehicle. Select the outside air position for maximum defogging.
- The A/C will engage automatically to prevent fogging when the recirculation button is pressed and the mode control is set to panel or panel / floor.
- The A/C can be deselected manually without disturbing the mode control selection.
- When the ignition switch is turned to the LOCK position, the recirculation feature will be cancelled.

**Air Conditioning Control**

Press this button to engage the Air Conditioning. A light will illuminate when the Air Conditioning system is engaged. Rotating the dial left into the blue area of the scale indicates cooler temperatures, while rotating right into the red area indicates warmer temperatures.

**NOTE:** The air conditioning compressor will not engage until the engine has been running for about 10 seconds.

- **MAX A/C**

For maximum cooling use the A/C and recirculation buttons at the same time.

- **ECONOMY MODE**

If economy mode is desired, press the A/C button to turn OFF the indicator light and the A/C compressor. Then, move the temperature control to the desired temperature.

## Automatic Temperature Control (ATC) — If Equipped



045639060

### Automatic Temperature Control

#### Automatic Operation

The Automatic Temperature Control system automatically maintains the climate in the cabin of the vehicle at the comfort levels desired by the driver and passenger.

Operation of the system is quite simple.

1. Turn the Mode Control knob (on the right) and the Blower Control knob (on the left) to AUTO.

**NOTE:** The AUTO position performs best for front seat occupants only.



045639081

2. Dial in the temperature you would like the system to maintain by rotating the Temperature Control knob. Once the comfort level is selected, the system will maintain that level automatically using the heating system. Should the desired comfort level require air conditioning, the system will automatically make the adjustment.

You will experience the greatest efficiency by simply allowing the system to function automatically. Selecting the "O" (OFF) position on the blower control stops the system completely and closes the outside air intake.

The recommended setting for maximum comfort is 72°F (22°C) for the average person; however, this may vary.

**NOTE:**

- The temperature setting can be adjusted at anytime without affecting automatic operation.
- Pressing the Air Conditioning Control button while in AUTO mode will cause the LED in the control button to flash three times and then turn off. This indicates that the system is in AUTO mode and requesting the air conditioning is not necessary.
- If your air conditioning performance seems lower than expected, check the front of the A/C condenser located in front of the radiator for an accumulation of dirt or insects. Clean with a gentle water spray from behind the radiator and through the condenser. Fabric front fascia protectors may reduce airflow to the condenser, reducing air conditioning performance.

**Blower Control**



045633296

For full automatic operation or for automatic blower operation, turn the knob to the AUTO position. In manual mode there are six blower speeds that can be individual selected. In off position the blower will shut off.

**Manual Operation**

This system offers a full complement of manual override features, which consist of Blower Preferred Automatic, Mode Preferred Automatic, or Blower and Mode Preferred Automatic. This means the operator can override the blower, the mode, or both. There is a manual blower range for times when the AUTO setting is not desired. The blower can be set to any fixed blower speed by rotating the Blower Control knob (on the left).

**NOTE:** Please read the Automatic Temperature Control Operation Chart that follows for details.

Automatic Temperature Control Operation		The system will...				
Operation	How	Blower Control	Mode Control	Air Temperature Control	Air Recirculation Control	A/C Operation
Full Automatic Operation	Set blower knob to Auto. Set mode knob to Auto. Set temperature knobs for comfort.	Automatic	Automatic	Automatic	Automatic but can be overridden for 10 minutes at a time.	Automatic
Blower Preferred Automatic	Set blower knob to any desired airflow level other than Auto. Set mode knob to Auto. Set temperature knobs for comfort.	User selectable to any speed.	Automatic	Automatic	Automatic but can be overridden for 10 minutes at a time.	Automatic
Mode Preferred Automatic	Set mode knob to any desired air delivery point other than Auto. Set blower knob to Auto. Set temperature knobs for comfort.	Automatic	User selectable to any air delivery point.	Automatic	User selectable outside or recirculated.	User selectable A/C on or off.
Blower and Mode Preferred Automatic	Set blower knob to any desired airflow level other than Auto. Set mode knob to any desired air delivery point other than Auto. Set temperature knobs for comfort.	User selectable to any speed.	User selectable to any air delivery point.	Automatic	User selectable outside or recirculated.	User selectable A/C on or off.



The operator can override the AUTO mode setting to change airflow distribution by rotating the Mode Control knob (on the right) to one of the following positions.

- *Panel*

 Air is directed through the outlets in the instrument panel. These outlets can be adjusted to direct airflow.

**NOTE:** The center instrument panel outlets can be aimed so that they are directed toward the rear seat passengers for maximum airflow to the rear.

- *Bi-Level*

 Air is directed through the panel and floor outlets.

**NOTE:** For all settings, except full cold or full hot, there is a difference in temperature between the upper and lower outlets. The warmer air flows to the floor outlets. This feature gives improved comfort during sunny but cool conditions.

- *Floor*

 Air is directed through the floor outlets with a small amount flowing through the defrost and side window demist outlets.

- *Mix*

 Air is directed through the floor, defrost, and side window demist outlets. This setting works best in cold or snowy conditions that require extra heat to the windshield. This setting is good for maintaining comfort while reducing moisture on the windshield.

- *Defrost*

 Air is directed through the windshield and side window demist outlets. Use this mode with maximum blower and temperature settings for best windshield and side window defrosting.

- *Air Conditioner Control*



Press this button to turn on the air conditioning during manual operation only. When the air conditioning is turned on, cool dehumidified air will flow through the outlets selected with the Mode control dial. Press this button a second time to turn OFF the air conditioning. An LED in the button illuminates when manual compressor operation is selected.

- *Recirculation Control*



The system will automatically control recirculation. However, pressing the Recirculation Control button will temporarily put the system in recirculation mode (ten minutes). This can be used when outside conditions such as smoke, odors, dust, or high humidity are present. Activating recirculation will cause the LED in the control button to illuminate. After ten minutes, the system will return to normal AUTO mode function and the LED will turn off.

**NOTE:**

- When the ignition switch is turned to the LOCK position, the recirculation feature will be cancelled.
- In cold weather, use of the Recirculation mode may lead to excessive window fogging. The Recirculation mode is not allowed in the floor, defrost, or defrost/floor mode in order to improve window clearing. Recirculation will be disabled automatically if these modes are selected.
- Extended use of recirculation may cause the windows to fog. If the interior of the windows begins to fog, press the Recirculation button to return to outside air. Some temp/humidity conditions will cause captured interior air to condense on windows and hamper visibility. For this reason, the system will not allow Recirculation to be selected while in floor, defrost, or defrost/floor mode. Attempting to use the recirculation while in these modes will cause the LED in the control button to blink and then turn off.

- Most of the time, when in Automatic Operation, you can temporarily put the system into Recirculation Mode by pressing the Recirculation button. However, under certain conditions, while in Automatic Mode, the system is blowing air out the defrost vents. When these conditions are present, and the Recirculation button is pressed, the indicator will flash and then turn off. This tells you that you are unable to go into Recirculation Mode at this time. If you would like the system to go into Recirculation Mode, you must first move the Mode knob to Panel, Panel/Floor and then press the Recirculation button. This feature reduces the possibility of window fogging.

### Operating Tips

**NOTE:** Refer to the chart at the end of this section for suggested control settings for various weather conditions.

### Summer Operation

The engine cooling system in air-conditioned vehicles must be protected with a high-quality antifreeze coolant to provide proper corrosion protection and to protect against engine overheating. A solution of 50% ethylene glycol antifreeze coolant and 50% water is recommended. Refer to “Maintenance Procedures” in “Maintaining Your Vehicle” for proper coolant selection.

### Winter Operation

Use of the air Recirculation Mode during winter months is not recommended because it may cause window fogging.

### Vacation Storage

Anytime you store your vehicle, or keep it out of service (i.e., vacation) for two weeks or more, run the air conditioning system at idle for about five minutes in the fresh air and high blower settings. This will ensure adequate system lubrication to minimize the possibility of compressor damage when the system is started again.

### Window Fogging

Interior fogging on the windshield can be quickly removed by turning the mode selector to Defrost. The Defrost/Floor mode can be used to maintain a clear windshield and provide sufficient heating. If side window fogging becomes a problem, increase blower speed. Vehicle windows tend to fog on the inside in mild but rainy or humid weather.

**NOTE:** Recirculate without A/C should not be used for long periods as fogging may occur.

### Side Window Demisters

A side window demister outlet is located at each end of the instrument panel. These non-adjustable outlets direct air toward the side windows when the system is in the FLOOR, MIX, or DEFROST mode. The air is directed at the area of the windows through which you view the outside mirrors.











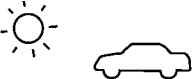









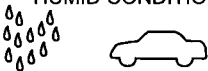

### Outside Air Intake

Make sure the air intake, located directly in front of the windshield, is free of obstructions such as leaves. Leaves collected in the air intake may reduce airflow, and if they enter the plenum, they could plug the water drains. In winter months, make sure the air intake is clear of ice, slush, and snow.

### A/C Air Filter — If Equipped

The A/C Filter prevents most dust and pollen from entering the cabin. The filter acts on air coming from outside the vehicle and recirculated air within the passenger compartment. Refer to “Maintenance Procedures” in “Maintaining Your Vehicle” for A/C Air Filter service information or see your authorized dealer for service. Refer to “Maintenance Schedules” for filter service intervals.

## Control Setting Suggestions for Various Weather Conditions

WEATHER	CONTROL SETTINGS
<p>HOT WEATHER AND VEHICLE INTERIOR IS VERY HOT</p> 	<p>Open the windows, start the vehicle, press the  button to turn recirculate off. Set the Fan control to the high position (full clockwise). Press the A/C button. Set the Mode control at or between  and . Set the temperature control to full cool. After the hot air is pushed from the vehicle press the  button to turn recirculate on and roll up the windows. Once you are comfortable, press the  button to turn recirculate off and adjust the temperature control for comfort.</p>
<p>WARM WEATHER</p> 	<p>Press the  button to turn recirculate off. If it's sunny, set the Mode control at or near  and turn the air conditioning on. If it's cloudy or dark, set the Mode control at or near .</p>
<p>COOL OR COLD HUMID CONDITIONS</p> 	<p>Press the  button to turn recirculate off. If it's sunny, set the Mode control at or between  and  then turn the air conditioning on. If it's cloudy or dark, set the Mode control at or near  and turn the air conditioning on. If the windows begin to fog, set Mode control at or between  and .</p>
<p>COLD DRY CONDITIONS</p> 	<p>Set the Mode control at or near . If it is sunny, you may want more upper air. In this case, set the Mode control at or between  and . In very cold weather, if you need extra heat at the windshield, set the Mode control at or near the .</p>

045606725



# STARTING AND OPERATING

## CONTENTS

---

- Starting Procedures . . . . . 313
  - Normal Starting . . . . . 313
  - Extreme Cold Weather  
(Below -20°F Or -29°C) . . . . . 314
  - If Engine Fails To Start . . . . . 314
  - After Starting . . . . . 315
- Engine Block Heater — If Equipped . . . . . 315
- Automatic Transmission . . . . . 316
  - Key Ignition Park Interlock . . . . . 316
  - Brake/Transmission Shift Interlock System . . . 317
  - Four-Speed Automatic Transmission . . . . . 317
  - Gear Ranges . . . . . 317
- Four-Wheel Drive Operation . . . . . 321
  - Command-Trac II® Transfer Case –  
If Equipped . . . . . 321
  - Selec-Trac® II Transfer Case – If Equipped . . . 327
- On-Road Driving Tips . . . . . 333

- Off-Road Driving Tips . . . . . 333
  - When To Use 4WD Low Range . . . . . 333
  - Driving Through Water . . . . . 334
  - Driving In Snow, Mud And Sand . . . . . 335
  - Hill Climbing . . . . . 335
  - Traction Downhill . . . . . 336
  - After Driving Off-Road . . . . . 336
- Power Steering . . . . . 337
  - Power Steering Fluid Check . . . . . 339
- Parking Brake . . . . . 339
- Anti-Lock Brake System . . . . . 342
- Electronic Brake Control System . . . . . 344
  - Anti-Lock Brake System (ABS) . . . . . 344
  - Traction Control System (TCS) . . . . . 345
  - Brake Assist System (BAS) . . . . . 346
  - Electronic Roll Mitigation (ERM) . . . . . 347
  - Hill Start Assist (HSA) . . . . . 347
  - Hill Descent Control (HDC) – If Equipped . . . 350
  - Electronic Stability Control (ESC) . . . . . 352
  - ESC Activation/Malfunction Indicator Light  
And ESC Off Indicator Light . . . . . 356
- Tire Safety Information . . . . . 357
  - Tire Markings . . . . . 357
  - Tire Identification Number (TIN) . . . . . 360
  - Tire Terminology And Definitions . . . . . 361
  - Tire Loading And Tire Pressure . . . . . 362



■ Tires — General Information . . . . .	366	□ Replacement Tires . . . . .	374
□ Tire Pressure . . . . .	366	■ Tire Chains . . . . .	375
□ Tire Inflation Pressures . . . . .	367	■ Tire Rotation Recommendations . . . . .	377
□ Tire Pressures For High Speed Operation . . .	369	■ Tire Pressure Monitor System (TPMS) . . . . .	378
□ Radial-Ply Tires . . . . .	369	□ Base System . . . . .	380
□ Spare Tire Matching Original Equipped Tire And Wheel – If Equipped . . . . .	369	□ Premium System – If Equipped . . . . .	383
□ Compact Spare Tire – If Equipped . . . . .	370	□ General Information . . . . .	388
□ Full Size Spare – If Equipped . . . . .	371	■ Fuel Requirements . . . . .	388
□ Limited-Use Spare – If Equipped . . . . .	371	□ Reformulated Gasoline . . . . .	389
□ Tire Spinning . . . . .	372	□ Gasoline/Oxygenate Blends . . . . .	389
□ Tread Wear Indicators . . . . .	372	□ E-85 Usage In Non-Flex Fuel Vehicles . . . . .	390
□ Life Of Tire . . . . .	373	□ MMT In Gasoline . . . . .	390
		□ Materials Added To Fuel . . . . .	391

## 312 STARTING AND OPERATING

- Fuel System Cautions . . . . . 391
- Carbon Monoxide Warnings . . . . . 392
- Adding Fuel . . . . . 393
  - Fuel Filler Cap (Gas Cap) . . . . . 393
  - Loose Fuel Filler Cap Message . . . . . 394
- Vehicle Loading . . . . . 395
  - Certification Label . . . . . 395
- Trailer Towing . . . . . 397
  - Common Towing Definitions . . . . . 397
  - Trailer Hitch Classification . . . . . 402
  - Trailer Towing Weights  
(Maximum Trailer Weight Ratings) . . . . . 403
  - Trailer And Tongue Weight . . . . . 405
  - Towing Requirements . . . . . 406
  - Towing Tips . . . . . 411
- Recreational Towing  
(Behind Motorhome, Etc.) . . . . . 413
  - Towing This Vehicle Behind  
Another Vehicle . . . . . 413
  - Recreational Towing — Two-Wheel Drive  
Models . . . . . 414
  - Recreational Towing — Four-Wheel Drive  
Models . . . . . 415

## STARTING PROCEDURES

Before starting your vehicle, adjust your seat, adjust both inside and outside mirrors, and fasten your seat belts.

### WARNING!

**Never leave children alone in a vehicle. Leaving children in a vehicle unattended is dangerous for a number of reasons. A child or others could be seriously or fatally injured. Do not leave the keys in the ignition. A child could operate power windows, other controls, or move the vehicle.**

Start the engine with the shift lever in the NEUTRAL or PARK position. Apply the brake before shifting to any driving range.

## Normal Starting

**NOTE:** Normal starting of either a cold or a warm engine is obtained without pumping or pressing the accelerator pedal.

Turn the ignition switch to the START position and release when the engine starts. If the engine fails to start within 10 seconds, turn the ignition switch to the LOCK position, wait 10 to 15 seconds, then repeat the “Normal Starting” procedure.

## Tip Start Feature

Turn the ignition switch to START position and release it as soon as the starter engages. The starter motor will continue to run, but will automatically disengage itself when the engine is running. If the engine fails to start, the starter will disengage automatically in 10 seconds. If this occurs, turn the ignition switch to the LOCK position, wait 10 to 15 seconds, then repeat the “Normal Starting” procedure.

**Extreme Cold Weather (below  $-20^{\circ}\text{F}$  or  $-29^{\circ}\text{C}$ )**

To ensure reliable starting at these temperatures, use of an externally powered electric engine block heater (available from your authorized dealer) is recommended.

**If Engine Fails To Start****WARNING!**

- Never pour fuel or other flammable liquids into the throttle body air inlet opening in an attempt to start the vehicle. This could result in a flash fire causing serious personal injury.

*(Continued)*

**WARNING! (Continued)**

- Do not attempt to push or tow your vehicle to get it started. Vehicles equipped with an automatic transmission cannot be started this way. Unburned fuel could enter the catalytic converter and once the engine has started, ignite and damage the converter and vehicle. If the vehicle has a discharged battery, booster cables may be used to obtain a start from a booster battery or the battery in another vehicle. This type of start can be dangerous if done improperly. Refer to "Jump Starting" in "What To Do In Emergencies" for further information.

### With Tip Start

If the engine fails to start after you have followed the “Normal Starting” or “Extreme Cold Weather” procedures, it may be flooded. To clear any excess fuel, press the accelerator pedal all the way to the floor and hold it. Then, turn the ignition switch to the START position and release it as soon as the starter engages. The starter motor will disengage automatically in 10 seconds. Once this occurs, release the accelerator pedal, turn the ignition switch to the LOCK position, wait 10 to 15 seconds, then repeat the “Normal Starting” procedure.

#### CAUTION!

To prevent damage to the starter, wait 10 to 15 seconds before trying again.

### After Starting

The idle speed will automatically decrease as the engine warms up.

### ENGINE BLOCK HEATER — IF EQUIPPED

The engine block heater warms the engine, and permits quicker starts in cold weather. Connect the cord to a standard 110-115 Volt AC electrical outlet with a grounded three-wire extension cord.

The engine block heater cord is found under the hood clipped to the heater line on the left side of the engine.

The engine block heater must be plugged in at least one hour to have an adequate warming effect on the engine.

#### WARNING!

Remember to disconnect the engine block heater cord before driving. Damage to the 110-115 Volt AC electrical cord could cause electrocution.

**AUTOMATIC TRANSMISSION****CAUTION!**

Damage to the transmission may occur if the following precautions are not observed:

- Shift into PARK only after the vehicle has come to a complete stop.
- Shift into or out of REVERSE only after the vehicle has come to a complete stop and the engine is at idle speed.
- Do not shift from REVERSE, PARK, or NEUTRAL into any forward gear when the engine is above idle speed.
- Before shifting into any gear, make sure your foot is firmly on the brake pedal.

**WARNING!**

It is dangerous to move the shift lever out of PARK or NEUTRAL if the engine speed is higher than idle speed. If your foot is not firmly on the brake pedal, the vehicle could accelerate quickly forward or in reverse. You could lose control of the vehicle and hit someone or something. Only shift into gear when the engine is idling normally and when your foot is firmly on the brake pedal.

**Key Ignition Park Interlock**

This vehicle is equipped with a Key Ignition Park Interlock which requires the shift lever to be placed in PARK prior to rotating the key to the LOCK position. The key can only be removed from the ignition when the ignition is in the LOCK position. Once the key is removed, the shift lever is locked in PARK.

### Brake/Transmission Shift Interlock System

This vehicle is equipped with a Brake Transmission Shift Interlock System (BTSI) that holds the shift lever in the PARK position when the ignition switch is in the LOCK position. To move the shift lever out of the PARK position, the ignition switch must be turned to the ON or START position (engine running or not) and the brake pedal must be pressed.

### Four-Speed Automatic Transmission

**NOTE:** Under extreme cold temperatures (-6°F (-21°C) and when in DRIVE, transmission operation may be briefly limited to only second gear operation. Normal operation will resume once the transmission temperature has risen to a suitable level.

Shifting from DRIVE to PARK or REVERSE should be done only after the accelerator pedal is released and the vehicle is stopped. Be sure to keep your foot on the brake when moving the shift lever between these gears.



Shift Lever

### Gear Ranges

#### PARK

This range supplements the parking brake by locking the transmission. The engine can be started in this range. Never use PARK while the vehicle is in motion. Apply

the parking brake when leaving the vehicle in this range. Always apply the parking brake first, then place the shift lever in the PARK position.

### **WARNING!**

- Never use the PARK position as a substitute for the parking brake. Always apply the parking brake fully when parked to guard against vehicle movement and possible injury or damage.
- It is dangerous to move the shift lever out of PARK or NEUTRAL if the engine speed is higher than idle speed. If your foot is not firmly on the brake pedal, the vehicle could accelerate quickly forward or in reverse. You could lose control of the vehicle and hit someone or something. Only shift into gear when the engine is idling normally and when your right foot is firmly on the brake pedal.

### **REVERSE**

This range is for moving the vehicle rearward. Use this range only after the vehicle has come to a complete stop.

### **NEUTRAL**

This range is used when the vehicle is standing for prolonged periods with the engine running. The engine may be started in this range. Set the parking brake and shift the transmission into PARK if you must leave the vehicle.

**NOTE:** Towing the vehicle, coasting, or driving for any other reason with shift lever in NEUTRAL can result in severe transmission damage. Refer to “Recreational Towing” in “Starting and Operating” and “Towing a Disabled Vehicle” in “What To Do In Emergencies” for further information.

### **DRIVE**

This range is used for most city and highway driving.



## 2 (Second)

This range is used for moderate grades and to assist braking on dry pavement or in mud and snow. Begins at a stop in low gear with automatic upshift into second gear. Will not shift into third gear.

## 1 (First)

This range is used for hard pulling at low speeds in mud, sand, snow, or on steep grades. Begins and stays in low gear with no upshift. Provides engine compression braking at low speeds.

## Overdrive Operation

The overdrive automatic transmission contains an electronically controlled fourth gear (OVERDRIVE). The transmission will automatically shift from third gear into OVERDRIVE if the following conditions are present:

- the shift lever is in DRIVE

- vehicle speed is above approximately 30 mph (48 km/h)
- the TOW/HAUL button has not been activated

The transmission will downshift from OVERDRIVE to DRIVE if the accelerator pedal is fully pressed at vehicle speeds above approximately 35 mph (56 km/h).

## When To Use TOW/HAUL Mode

When driving in hilly areas, towing a trailer, carrying a heavy load, etc., and frequent transmission shifting occurs, press the TOW/HAUL button. This will improve performance and reduce the potential for transmission overheating or failure due to excessive shifting. When operating in TOW/HAUL mode, the transmission will shift into third gear.

**NOTE:** TOW/HAUL mode locks out Overdrive.

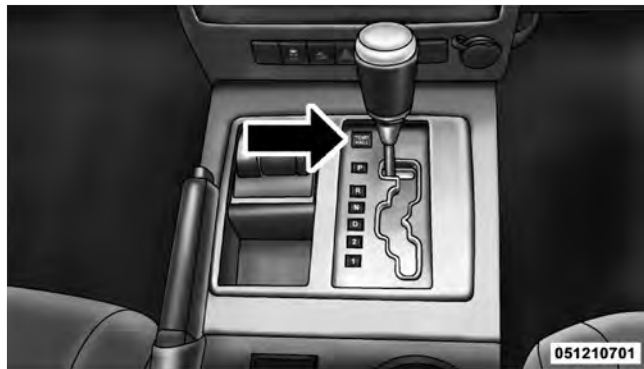

#### **Tow/Haul Button**

The “TOW/HAUL Indicator Light” will illuminate in the instrument cluster to indicate when the switch has been activated. Pressing the switch a second time restores normal operation. If the TOW/HAUL mode is desired, the switch must be pressed each time the engine is started.

#### **Transmission Limp Home Mode**

Transmission function is monitored for abnormal conditions. If a condition is detected that could result in transmission damage, the Transmission Limp Home Mode will be engaged. In this mode, the transmission will remain in second gear in any forward driving range.

To reset the transmission, use the following procedure:

1. Stop the vehicle.
2. Move the shift lever into the PARK position.
3. Turn the engine off and turn the key to the LOCK position.
4. Wait approximately 10 seconds, then restart the engine.
5. Move the shift lever into the desired gear range.

If the problem is no longer detected, the transmission will return to normal operation. If the problem persists, PARK, REVERSE, and NEUTRAL will continue to operate. Only second gear range will operate in the DRIVE position. Have the transmission checked at your authorized dealer as soon as possible.

### **Torque Converter Clutch**

A feature designed to improve fuel economy has been added to the automatic transmission of this vehicle. A clutch within the torque converter engages automatically at calibrated speeds. This may result in a slightly different feeling or response during normal operation in high gear. When the vehicle speed drops or during acceleration, the clutch automatically and smoothly disengages.

## **FOUR-WHEEL DRIVE OPERATION**

### **Command-Trac II® Transfer Case – If Equipped**

#### **Operating Information And Precautions**

The Command-Trac II® transfer case provides four positions:

- Two-wheel drive (2WD) high range
- Four-wheel drive (4WD LOCK) high range
- Four-wheel drive (4WD LOW) low range
- Neutral (N)

This transfer case is intended to be driven in the two-wheel drive position (2WD) for normal street and highway conditions such as dry hard-surfaced roads.

When additional traction is required, select the transfer case 4WD LOCK position or 4WD LOW position. This

position locks the front driveshaft and rear driveshaft together and forces the front and rear wheels to rotate at the same speed.

Use the transfer case NEUTRAL position for recreational towing only. Refer to “Recreational Towing” in “Starting and Operating” for further information.

**CAUTION!**

- Do not attempt to make a shift while only the front wheels or rear wheels are spinning. The MP1522 Command-Trac® transfer case is not equipped with a synchronizer and therefore the speed of the front driveshaft and rear driveshaft must be equal for the shift to take place. Shifting while only the front wheels or rear wheels are spinning can cause damage to the transfer case.

*(Continued)*

**CAUTION! (Continued)**

- The 4WD LOCK position and 4WD LOW position are intended for loose or slippery road surfaces only. Driving in these positions on dry hard-surfaced roads may cause increased tire wear and damage to the driveline components.
- When operating your vehicle in 4WD LOW, the engine speed is approximately three times that of the 2WD position or 4WD LOCK position at a given road speed. Take care not to over-speed the engine and do not exceed 25 mph (40 km/h).
- Proper operation of four-wheel drive vehicles depends on tires of equal size, type, and circumference on each wheel. Any difference in tire size can cause damage to the transfer case. Tire rotation schedule should be followed to balance tire wear.

**WARNING!**

- You or others could be injured if you leave the vehicle unattended with the transfer case in the NEUTRAL position without first fully engaging the parking brake. The transfer case NEUTRAL position disengages both the front driveshaft and rear driveshaft from the powertrain and it will allow the vehicle to move even if the transmission is in PARK. The parking brake should always be applied when the driver is not in the vehicle.
- Always engage the parking brake when powering down the vehicle if the “SERV 4WD Warning Light” is illuminated. Not engaging the parking brake may allow the vehicle to roll, which may cause personal injury.

*(Continued)*

**WARNING! (Continued)**

- Since four-wheel drive provides improved traction, there is a tendency to exceed safe turning and stopping speeds. Do not go faster than road conditions permit. You or others could be injured.

### Shift Positions

The transfer case switch is located on the center console next to the shift lever.

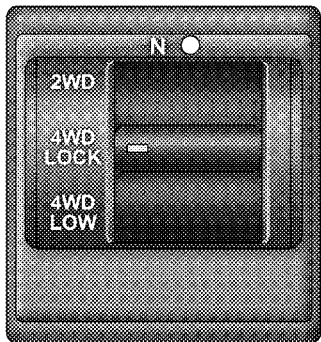

Transfer Case Switch

81c686ba

### 2WD

Rear Wheel Drive High Range - This range is used for normal street and highway driving on dry hard-surfaced roads.

### 4WD Lock

Four-Wheel Drive High Range - This range locks the front driveshaft and rear driveshaft together forcing the front and rear wheels to rotate at the same speed. Additional traction for loose or slippery road surfaces only.

### 4WD Low

Four-Wheel Drive Low Range - This range provides low speed four-wheel drive. Locks the front driveshaft and rear driveshaft together forcing the front and rear wheels to rotate at the same speed. Additional traction and maximum pulling power for loose or slippery road surfaces only. Do not exceed 25 mph (40 km/h).

N

Neutral - This range disengages both the front driveshaft and rear driveshaft from the powertrain. To be used for flat towing behind another vehicle. Refer to “Recreational Towing” in “Starting and Operating” for further information.

### Transfer Case Position Indicator Lights

The four-wheel drive indicator lights (4WD and 4 LOW) are located in the instrument cluster. The NEUTRAL indicator light is located on the transfer case switch. If there is no indicator light on or flashing, the transfer case position is two-wheel drive (2WD). If the indicator light is on, the desired position (4WD LOCK, 4WD LOW, or NEUTRAL) has been obtained.

#### *If One Or More Shift Requirements Are Not Met:*

- An indicator light will flash.
- The transfer case **will not** shift.

**NOTE:** The “SERV 4WD Warning Light” monitors the electric shift four-wheel drive system. If this light remains on after engine start up, or it illuminates during driving, it means that the four-wheel drive system is not functioning properly and that service is required.

### Shifting Procedures

**NOTE:** If any of the requirements to select a new transfer case position have not been met, the transfer case will not shift, the indicator light for the previous position will remain on, and the newly selected position indicator light will continue to flash until all the requirements for the selected position have been met. To retry a shift, move the transfer case switch back to the original position, make certain all shift requirements have been met, wait five seconds, and try the shift again.

#### *2WD To 4WD Lock*

Move the transfer case switch to the desired position. Shifts between 2WD and 4WD LOCK can be done with

the vehicle stopped or in motion. With the vehicle in motion, the transfer case will engage/disengage faster if you momentarily release the accelerator pedal after moving the transfer case switch. If the vehicle is stopped, the ignition switch must be in the ON position with the engine either OFF or RUNNING. This shift cannot be completed if the ignition switch is in the ACC position.

**NOTE:** The four-wheel drive system will not allow shifts between 2WD and 4WD LOCK if the rear wheels are spinning (no traction). In this situation, the selected position indicator light will flash and the original position indicator light will remain ON. At this time, reduce speed and stop spinning the wheels to complete the shift. There may be a delay up to 10 seconds for the shift to complete after the wheels have stopped spinning.

Delayed shifting out of 4WD LOCK may be experienced due to uneven tire wear, low tire pressure, or excessive loading.

#### *4WD Lock To 4WD Low*

When shifting into or out of 4WD LOW, some gear noise may be heard. This noise is normal and is not detrimental to the vehicle or its occupants.

Shifting can be performed with the vehicle rolling 2 to 3 mph (3 to 5 km/h) using the "Preferred Procedure" or completely stopped using the "Alternate Procedure."

#### *Preferred Procedure*

1. With the engine RUNNING, slow the vehicle speed to 2 to 3 mph (3 to 5 km/h).
2. Shift the transmission into NEUTRAL.
3. While still rolling, move the transfer case switch to the desired position.
4. After the desired position indicator light is ON (not flashing), shift the transmission into gear.



### *Alternate Procedure*

1. Bring the vehicle to a complete stop.
2. With the ignition switch in the ON position, and the engine OFF or RUNNING, shift the transmission into NEUTRAL.
3. Move the transfer case switch to the desired position.
4. After the desired position indicator light is on (not flashing), shift the transmission into gear.

**NOTE:** Steps 1 and 2 in the “Preferred Procedure” and the “Alternate Procedure” are requirements for shifting the transfer case. If these requirements are not met prior to attempting the shift or while the shift attempt is in process, then the indicator light will flash, and the current transfer case position will be maintained. To retry a shift, move the transfer case switch back to the original position, make certain all shift requirements have been met, wait five seconds, and try the shift again.

The ignition switch must be in the ON position for a shift to take place and for the position indicator lights to be operable. If the ignition switch is not in the ON position, then the shift will not take place and no position indicator lights will be on or flashing.

### **Selec-Trac® II Transfer Case – If Equipped**

#### **Operating Information And Precautions**

The Selec-Trac® II active on-demand transfer case provides four positions:

- Two-wheel drive (2WD) high range
- Four-wheel drive Auto (4WD AUTO) high range
- Neutral (N)
- Four-wheel drive (4WD) low range

This transfer case is intended to be driven in either the two-wheel drive position (2WD) or the four-wheel drive Auto position (4WD AUTO) for normal street and highway conditions such as dry hard-surfaced roads.

For added capability when traversing steep grades, rough terrain, or extremely poor traction surfaces, select the transfer case 4WD LOW position. This position locks the front driveshaft and rear driveshaft together and forces the front and rear wheels to rotate at the same speed while multiplying engine torque.

Use the transfer case NEUTRAL position for recreational towing only. Refer to "Recreational Towing" in "Starting and Operating" for further information.

### CAUTION!

- The 4WD LOW position is intended for loose or slippery road surfaces only. Driving in this position on dry hard-surfaced roads may cause increased tire wear and damage to the driveline components.
- When operating your vehicle in 4WD LOW, the engine speed is approximately three times that of the 2WD position or 4WD AUTO position at a given road speed. Take care not to over-speed the engine and do not exceed 25 mph (40 km/h).
- Proper operation of four-wheel drive vehicles depends on tires of equal size, type, and circumference on each wheel. Any difference in tire size can cause damage to the transfer case. Tire rotation schedule should be followed to balance tire wear.

**WARNING!**

- You or others could be injured if you leave the vehicle unattended with the transfer case in the NEUTRAL position without first fully engaging the parking brake. The transfer case NEUTRAL position disengages both the front driveshaft and rear driveshaft from the powertrain and it will allow the vehicle to move despite the transmission position. The parking brake should always be applied when the driver is not in the vehicle.
- Always engage the parking brake when powering down the vehicle if the “SERV 4WD Warning Light” is illuminated. Not engaging the parking brake may allow the vehicle to roll, which may cause personal injury.

*(Continued)*

**WARNING! (Continued)**

- Since four-wheel drive provides improved traction, there is a tendency to exceed safe turning and stopping speeds. Do not go faster than road conditions permit. You or others could be injured.

## Shift Positions

The transfer case switch is located on the center console next to the shift lever.

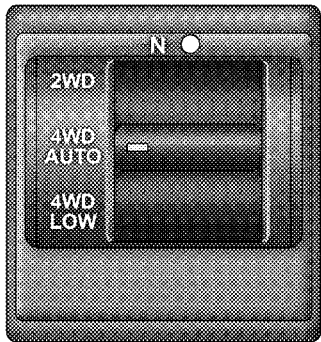

81c357ca

**Transfer Case Switch**

### **2WD**

Rear Wheel Drive High Range - This range is for normal street and highway driving on dry hard-surfaced roads.

### **4WD Auto**

Four-Wheel Drive Auto High Range – This active on-demand range makes available optimum traction for a wide range of conditions, while maximizing driver convenience. This position is always in four-wheel drive mode, with a normal 42% front axle, 58% rear axle torque split. The system also anticipates and prevents slip by redirecting torque as necessary, up to 100% to the front or rear axle, if needed.

### **4WD Low**

Four-Wheel Drive Low Range - This range is for low speed four-wheel drive. Locks the front driveshaft and rear driveshaft together forcing the front and rear wheels to rotate at the same speed. Additional traction and maximum pulling power for loose or slippery road surfaces only. Do not exceed 25 mph (40 km/h).

N

Neutral - This range disengages both the front driveshaft and rear driveshaft from the powertrain. To be used for flat towing behind another vehicle. Refer to “Recreational Towing” in “Starting and Operating” for further information.

### Transfer Case Position Indicator Lights

The four-wheel drive indicator lights (4WD, 4 LOW) are located in the instrument cluster. The NEUTRAL indicator light is located on the transfer case switch. If there is no indicator light on or flashing, the transfer case position is two-wheel drive (2WD). If the indicator light is on, the desired position (4WD AUTO, 4WD LOW, or NEUTRAL) has been obtained.

#### *If One Or More Shift Requirements Are Not Met:*

- An indicator light will flash.
- The transfer case **will not** shift.

**NOTE:** The “SERV 4WD Warning Light” monitors the electric shift four-wheel drive system. If this light remains on after engine start up, or it illuminates during driving, it means that the four-wheel drive system is not functioning properly and that service is required.

### Shifting Procedures

**NOTE:** If any of the requirements to select a new transfer case position have not been met, the transfer case will not shift, the indicator light for the previous position will remain on, and the newly selected position indicator light will continue to flash until all the requirements for the selected position have been met. To retry a shift, move the transfer case switch back to the original position, make certain all shift requirements have been met, wait five seconds, and try the shift again.

#### *2WD To 4WD Auto*

Move the transfer case switch to the desired position. Shifts between 2WD and 4WD Auto can be done with the

vehicle stopped or in motion. If the vehicle is stopped, the ignition switch must be in the ON position with the engine either OFF or RUNNING. This shift cannot be completed if the ignition switch is in the ACC position.

### *2WD Or 4WD Auto To 4WD Low*

When shifting into or out of 4WD LOW, some gear noise may be heard. This noise is normal and is not detrimental to the vehicle or its occupants.

Shifting can be performed with the vehicle rolling 2 to 3 mph (3 to 5 km/h) using the "Preferred Procedure" or completely stopped using the "Alternate Procedure."

#### *Preferred Procedure*

1. With the engine RUNNING, slow the vehicle speed to 2 to 3 mph (3 to 5 km/h).
2. Shift the transmission into NEUTRAL.

3. While still rolling, move the transfer case switch to the desired position.
4. After the desired position indicator light is on (not flashing), shift the transmission into gear.

#### *Alternate Procedure*

1. Bring the vehicle to a complete stop.
2. With the ignition switch in the ON position and the engine OFF or RUNNING, shift the transmission into NEUTRAL.
3. Move the transfer case switch to the desired position.
4. After the desired position indicator light is on (not flashing), shift the transmission into gear.

**NOTE:** Steps 1 and 2 in the "Preferred Procedure" and the "Alternate Procedure" are requirements for shifting the transfer case. If these requirements are not met prior to attempting the shift or while the shift attempt is in

process, then the indicator light will flash, and the current transfer case position will be maintained. To retry a shift, move the transfer case switch back to the original position, make certain all shift requirements have been met, wait five seconds, and try the shift again.

The ignition switch must be in the ON position for a shift to take place and for the position indicator lights to be operable. If the ignition switch is not in the ON position, the shift will not take place, and no position indicator lights will be on or flashing.

### **ON-ROAD DRIVING TIPS**

Utility vehicles have higher ground clearance and a narrower track to make them capable of performing in a wide variety of off-road applications. Specific design characteristics give them a higher center of gravity than ordinary cars.

An advantage of the higher ground clearance is a better view of the road, allowing you to anticipate problems.

They are not designed for cornering at the same speeds as conventional two-wheel drive vehicles any more than low-slung sports cars are designed to perform satisfactorily in off-road conditions. If at all possible, avoid sharp turns or abrupt maneuvers. As with other vehicles of this type, failure to operate this vehicle correctly may result in loss of control or vehicle rollover.

### **OFF-ROAD DRIVING TIPS**

#### **When To Use 4WD LOW Range**

When off-road driving, shift to 4WD LOW for additional traction and control on slippery or difficult terrain, ascending or descending steep hills, and to increase low-speed pulling power. This range should be limited to extreme situations such as deep snow, mud, or sand where additional low speed pulling power is needed. Vehicle speeds in excess of 25 mph (40 km/h) should be avoided when in 4WD LOW range.

## Driving Through Water

Although your vehicle is capable of driving through water, there are a number of precautions that must be considered before entering the water:

### CAUTION!

**When driving through water, do not exceed 5 mph (8 km/h). Always check water depth before entering as a precaution, and check all fluids afterward. Driving through water may cause damage that may not be covered by the new vehicle limited warranty.**

Driving through water more than a few inches/centimeters deep will require extra caution to ensure safety and prevent damage to your vehicle. If you must drive through water, try to determine the depth and the bottom condition (and location of any obstacles) prior to

entering. Proceed with caution and maintain a steady controlled speed less than 5 mph (8 km/h) in deep water to minimize wave effects.

### *Flowing Water*

If the water is swift flowing and rising (as in storm run-off) avoid crossing until the water level recedes and/or the flow rate is reduced. If you must cross flowing-water, avoid depths in excess of 9 in (22 cm). The flowing water can erode the streambed causing your vehicle to sink into deeper water. Determine exit point(s) that are downstream of your entry point to allow for drifting.

### *Standing Water*

Avoid driving in standing water deeper than 20 in (51 cm), and reduce speed appropriately to minimize wave effects. Maximum speed in 20 in (51 cm) of water is less than 5 mph (8 km/h).



### *Maintenance*

After driving through deep water, inspect your vehicle fluids and lubricants (engine, transmission, axle, transfer case) to assure they have not been contaminated. Contaminated fluids and lubricants (milky, foamy in appearance) should be flushed/changed as soon as possible to prevent component damage.

### **Driving In Snow, Mud And Sand**

In heavy snow, when pulling a load, or for additional control at slower speeds, shift the transmission to a low gear and shift the transfer case to 4WD LOW if necessary. Refer to “Four-Wheel Drive Operation” in “Starting and Operating” for further information. Do not shift to a lower gear than necessary to maintain headway. Over-revving the engine can spin the wheels and traction will be lost.

Avoid abrupt downshifts on icy or slippery roads because engine braking may cause skidding and loss of control.

### **Hill Climbing**

**NOTE:** Before attempting to climb a hill, determine the conditions at the crest and/or on the other side.

**Before climbing a steep hill,** shift the transmission to a lower gear and shift the transfer case to 4WD LOW. Use first gear and 4WD LOW for very steep hills.

**If you stall or begin to lose headway** while climbing a steep hill, allow your vehicle to come to a stop and immediately apply the brakes. Restart the engine and shift to REVERSE. Back slowly down the hill allowing the compression braking of the engine to help regulate your speed. If the brakes are required to control vehicle speed, apply them lightly and avoid locking or skidding the tires.

**WARNING!**

If the engine stalls or you lose headway or cannot make it to the top of a steep hill or grade, never attempt to turn around. To do so may result in tipping and rolling the vehicle. Always back straight down a hill in REVERSE gear carefully. Never back down a hill in NEUTRAL using only the brake.

**Remember, never drive diagonally across a hill - drive straight up or down.**

If the wheels start to slip as you approach the crest of a hill, ease off the accelerator and maintain headway by turning the front wheels slowly left and right. This may provide a fresh “bite” into the surface and will usually provide traction to complete the climb.

**Traction Downhill**

Shift the transmission into a low gear and the transfer case to 4WD LOW range. Let the vehicle go slowly down the hill with all four wheels turning against engine compression drag. This will permit you to control the vehicle speed and direction.

When descending mountains or hills, repeated braking can cause brake fade with loss of braking control. Avoid repeated heavy braking by downshifting the transmission whenever possible.

**After Driving Off-Road**

Off-road operation puts more stress on your vehicle than does most on-road driving. After going off-road, it is always a good idea to check for damage. That way you can get any problems taken care of right away and have your vehicle ready when you need it.

- Completely inspect the underbody of your vehicle. Check tires, body structure, steering, suspension, and exhaust system for damage.
- Inspect the radiator for mud and debris and clean as required.
- Check threaded fasteners for looseness, particularly on the chassis, drivetrain components, steering, and suspension. Retighten them, if required, and torque to the values specified in the Service Manual.
- Check for accumulations of plants or brush. These things could be a fire hazard. They might hide damage to fuel lines, brake hoses, axle pinion seals, and propeller shafts.
- After extended operation in mud, sand, water, or similar dirty conditions, have the radiator, fan, brake rotors, wheels, brake linings, and axle yokes inspected and cleaned as soon as possible.

### WARNING!

**Abrasive material in any part of the brakes may cause excessive wear or unpredictable braking. You might not have full braking power when you need it to prevent a collision. If you have been operating your vehicle in dirty conditions, get your brakes checked and cleaned as necessary.**

- If you experience unusual vibration after driving in mud, slush or similar conditions, check the wheels for impacted material. Impacted material can cause a wheel imbalance and freeing the wheels of it will correct the situation.

### POWER STEERING

The standard power steering system will give you good vehicle response and increased ease of maneuverability in tight spaces. The system will provide mechanical steering capability if power assist is lost.

If for some reason the power assist is interrupted, it will still be possible to steer your vehicle. Under these conditions, you will observe a substantial increase in steering effort, especially at very low vehicle speeds and during parking maneuvers.

**NOTE:**

- Increased noise levels at the end of the steering wheel travel are considered normal and do not indicate that there is a problem with the power steering system.
- Upon initial start-up in cold weather, the power steering pump may make noise for a short amount of time. This is due to the cold, thick fluid in the steering system. This noise should be considered normal, and it does not in any way damage the steering system.

**WARNING!**

**Continued operation with reduced power steering assist could pose a safety risk to yourself and others. Service should be obtained as soon as possible.**

**CAUTION!**

**Prolonged operation of the steering system at the end of the steering wheel travel will increase the steering fluid temperature and it should be avoided when possible. Damage to the power steering pump may occur.**

### Power Steering Fluid Check

Checking the power steering fluid level at a defined service interval is not required. The fluid should only be checked if a leak is suspected, abnormal noises are apparent, and/or the system is not functioning as anticipated. Coordinate inspection efforts through an authorized dealer.

#### CAUTION!

**Do not use chemical flushes in your power steering system as the chemicals can damage your power steering components. Such damage is not covered by the New Vehicle Limited Warranty.**

#### WARNING!

**Fluid level should be checked on a level surface and with the engine off to prevent injury from moving parts and to ensure accurate fluid level reading. Do not overfill. Use only manufacturer's recommended power steering fluid.**

If necessary, add fluid to restore to the proper indicated level. With a clean cloth, wipe any spilled fluid from all surfaces. Refer to "Fluids, Lubricants, and Genuine Parts" in "Maintaining Your Vehicle" for further information.

### PARKING BRAKE

Before leaving the vehicle, make sure that the parking brake is fully applied. Also, be certain to leave the transmission in PARK.

The parking brake lever is located in the center console. To apply the parking brake, pull the lever up as firmly as possible. To release the parking brake, pull the lever up slightly, press the center button, then lower the lever completely.



Parking Brake

When the parking brake is applied with the ignition switch ON, the “Brake Warning Light” in the instrument cluster will illuminate.

**NOTE:**

- When the parking brake is applied and the transmission is placed in gear, the “Brake Warning Light” will flash. If vehicle speed is detected, a chime will sound to alert the driver. Fully release the parking brake before attempting to move the vehicle.
- This light only shows that the parking brake is applied. It does not show the degree of brake application.

When parking on a hill, it is important to turn the front wheels toward the curb on a downhill grade and away from the curb on an uphill grade. Apply the parking brake before placing the shift lever in PARK, otherwise the load on the transmission locking mechanism may

make it difficult to move the shift lever out of PARK. The parking brake should always be applied whenever the driver is not in the vehicle.

### **WARNING!**

- Never use the PARK position as a substitute for the parking brake. Always apply the parking brake fully when parked to guard against vehicle movement and possible injury or damage.
- Never leave children alone in a vehicle. Leaving unattended children in a vehicle is dangerous for a number of reasons. A child or others could be seriously or fatally injured.
- Do not leave the key in the ignition. A child could operate power windows, other controls, or move the vehicle.

*(Continued)*

### **WARNING! (Continued)**

- Be sure the parking brake is fully disengaged before driving; failure to do so can lead to brake failure and a collision.
- Always fully apply the parking brake when leaving your vehicle or it may roll and cause damage or injury. Also, be certain to leave the transmission in PARK. Failure to do so may cause the vehicle to roll and cause damage or injury.

### **CAUTION!**

If the "Brake Warning Light" remains on with the parking brake released, a brake system malfunction is indicated. Have the brake system serviced by an authorized dealer immediately.

## ANTI-LOCK BRAKE SYSTEM

The Anti-Lock Brake System (ABS) is designed to aid the driver in maintaining vehicle control under adverse braking conditions. The system operates with a separate computer to modulate hydraulic pressure, to prevent wheel lock-up and help avoid skidding on slippery surfaces.

All vehicle wheels and tires must be the same size and type, and tires must be properly inflated, to produce accurate signals for the computer.

### WARNING!

Significant over or under-inflation of tires or mixing sizes of tires or wheels on the vehicle can lead to loss of braking effectiveness.

The ABS conducts a low-speed self-test at about 12 mph (20 km/h). If you have your foot lightly on the brake while this test is occurring, you may feel slight pedal movement. The movement can be more apparent on ice and snow. This is normal.

The ABS pump motor runs during the self-test at 12 mph (20 km/h) and during an ABS stop. The pump motor makes a low humming noise during operation, which is normal.

### WARNING!

- Pumping of the Anti-Lock Brakes will diminish their effectiveness and may lead to a collision. Pumping makes the stopping distance longer. Just press firmly on your brake pedal when you need to slow down or stop.

*(Continued)*



**WARNING! (Continued)**

- The ABS cannot prevent the natural laws of physics from acting on the vehicle, nor can it increase braking or steering efficiency beyond that afforded by the condition of the vehicle brakes and tires or the traction afforded.
- The ABS cannot prevent collisions, including those resulting from excessive speed in turns, following another vehicle too closely, or hydroplaning.
- The capabilities of an ABS equipped vehicle must never be exploited in a reckless or dangerous manner, which could jeopardize the user's safety or the safety of others.

**CAUTION!**

The ABS is subject to possible detrimental effects of electronic interference caused by improperly installed aftermarket radios or telephones.

**NOTE:** During severe braking conditions, a pulsing sensation may occur and a clicking noise will be heard. This is normal, indicating that the ABS is functioning.

- Do not "ride" the brakes by resting your foot on the pedal. This could overheat the brakes and result in unpredictable braking action, longer stopping distances, or brake damage.
- When descending mountains or hills, repeated braking can cause brake fade with loss of braking control. Avoid repeated heavy braking by downshifting the transmission or locking out overdrive whenever possible.

- Engines may idle at higher speeds during warm-up, which could cause rear wheels to spin and result in loss of vehicle control. Be especially careful while driving on slippery roads, in close-quarter maneuvering, parking, or stopping.
- Do not drive too fast for road conditions, especially when roads are wet or slushy. A wedge of water can build up between the tire tread and the road. This hydroplaning action can cause loss of traction, braking ability, and control.
- After going through deep water or a car wash, brakes may become wet, resulting in decreased performance and unpredictable braking action. Dry the brakes by gentle, intermittent pedal action while driving at very slow speeds.

## **ELECTRONIC BRAKE CONTROL SYSTEM**

Your vehicle is equipped with an advanced electronic brake control system commonly referred to as ESC. This system includes Anti-Lock Brake System (ABS), Traction Control System (TCS), Brake Assist System (BAS), Hill Start Assist (HSA), Electronic Roll Mitigation (ERM), and Electronic Stability Control (ESC). These systems work together to enhance both vehicle stability and control in various driving conditions.

Two additional electronic brake control system options are Hill Descent Control (HDC) and Trailer Sway Control (TSC). Your vehicle may be equipped with one or both of these options.

## **Anti-Lock Brake System (ABS)**

This system aids the driver in maintaining vehicle control under adverse braking conditions. The system controls hydraulic brake pressure to prevent wheel lock-up to

help avoid skidding on slippery surfaces during braking. Refer to “Anti-Lock Brake System” in “Starting and Operating” for further information.

### **WARNING!**

**The Anti-Lock Brake System (ABS) cannot prevent the natural laws of physics from acting on the vehicle, nor can it increase the traction afforded by prevailing road conditions. ABS cannot prevent collisions, including those resulting from excessive speed in turns, driving on very slippery surfaces, or hydroplaning. The capabilities of an ABS-equipped vehicle must never be exploited in a reckless or dangerous manner, which could jeopardize the user’s safety or the safety of others.**

### **Traction Control System (TCS)**

This system monitors the amount of wheel spin of each of the driven wheels. If wheel spin is detected, brake pressure is applied to the slipping wheel(s) and engine power is reduced to provide enhanced acceleration and stability. A feature of the TCS system functions similar to a limited slip differential and controls the wheel spin across a driven axle. If one wheel on a driven axle is spinning faster than the other, the system will apply the brake of the spinning wheel. This will allow more engine torque to be applied to the wheel that is not spinning. This feature remains active even if TCS and ESC are in the “Partial Off” mode or the “Full Off” mode. Refer to “Electronic Stability Control (ESC)” in this section for further information.

### **Brake Assist System (BAS)**

The BAS is designed to optimize the vehicle's braking capability during emergency braking maneuvers. The system detects an emergency braking situation by sensing the rate and amount of brake application and then applies optimum pressure to the brakes. This can help reduce braking distances. The BAS complements the anti-lock brake system (ABS). Applying the brakes very quickly results in the best BAS assistance. To receive the benefit of the system, you must apply continuous braking pressure during the stopping sequence, (do not "pump" the brakes). Do not reduce brake pedal pressure unless braking is no longer desired. Once the brake pedal is released, the BAS is deactivated.

#### **WARNING!**

**The Brake Assist System (BAS) cannot prevent the natural laws of physics from acting on the vehicle, nor can it increase the traction afforded by prevailing road conditions. BAS cannot prevent collisions, including those resulting from excessive speed in turns, driving on very slippery surfaces, or hydroplaning. The capabilities of a BAS-equipped vehicle must never be exploited in a reckless or dangerous manner, which could jeopardize the user's safety or the safety of others.**

## Electronic Roll Mitigation (ERM)

This system anticipates the potential for wheel lift by monitoring the driver's steering wheel input and the speed of the vehicle. When ERM determines that the rate of change of the steering wheel angle and vehicle's speed are sufficient to potentially cause wheel lift, it then applies the appropriate brake and may also reduce engine power to lessen the chance that wheel lift will occur. ERM will only intervene during very severe or evasive driving maneuvers. ERM can only reduce the chance of wheel lift occurring during severe or evasive driving maneuvers. It cannot prevent wheel lift due to other factors, such as road conditions, leaving the roadway, or striking objects or other vehicles.

**NOTE:** ERM is disabled anytime the ESC is in "Full Off" mode. Refer to Electronic Stability Control (ESC) for a complete explanation of the available ESC modes.

## WARNING!

**Many factors, such as vehicle loading, road conditions, and driving conditions, influence the chance that wheel lift or rollover may occur. Electronic Roll Mitigation (ERM) cannot prevent all wheel lift or rollovers, especially those that involve leaving the roadway or striking objects or other vehicles. The capabilities of an ERM-equipped vehicle must never be exploited in a reckless or dangerous manner, which could jeopardize the user's safety or the safety of others.**

## Hill Start Assist (HSA)

The HSA system is designed to help the driver accelerate the vehicle from a complete stop while on an incline. If the driver releases the brake while stopped on an incline, HSA will continue to hold the brake pressure for a short period. If the driver does not apply the throttle before this

time expires, the system will release brake pressure and the vehicle will roll down the hill as normal. The system will release brake pressure in proportion to amount of throttle applied.

The following conditions must be met in order for HSA to activate:

- The vehicle must be stopped.
- The vehicle must be on a 7% or greater incline.
- The gear selection must match vehicle uphill direction (i.e., vehicle facing uphill is in forward gear; vehicle backing uphill is in REVERSE gear).
- For vehicles equipped with an automatic transmission, the HSA will work in REVERSE gear and all forward gears. The system will not activate if the transmission is in PARK.

### **WARNING!**

**There may be situations where the Hill Start Assist (HSA) will not activate and slight rolling may occur, such as on minor hills (i.e., less than 7%), or with a loaded vehicle, or while pulling a trailer. HSA is not a substitute for active driving involvement. It is always the driver's responsibility to be attentive to distance to other vehicles, people, and objects, and most importantly brake operation to ensure safe operation of the vehicle under all road conditions. Your complete attention is always required while driving to maintain safe control of your vehicle. Failure to follow these warnings can result in a collision or serious personal injury.**

### **Towing With HSA**

HSA will provide assistance during acceleration on an incline while towing a trailer.

**WARNING!**

- If you use a trailer brake controller with your trailer, the trailer brakes may be activated and deactivated with the brake switch. If so, there may not be enough brake pressure to hold both the vehicle and the trailer on a hill when the brake pedal is released. In order to avoid rolling down an incline while resuming acceleration, manually activate the trailer brake or apply more vehicle brake pressure prior to releasing the brake pedal.
- HSA is not a parking brake. Always apply the parking brake fully when leaving your vehicle. Also, be certain to leave the transmission in PARK.
- Failure to follow these warnings can result in a collision or serious personal injury.

**Disabling And Enabling HSA**

This feature can be turned on or turned off. To change the current setting, proceed as follows:

For vehicles equipped with the Electronic Vehicle Information Center (EVIC), refer to “Hill Start Assist,” under “Personal Settings (Customer Programmable Features),” under “Electronic Vehicle Information Center (EVIC)” in “Understanding Your Instrument Panel” for further information.

For vehicles not equipped with the EVIC, perform the following steps:

**NOTE:** You must complete Steps 1 through 8 within 90 seconds.

1. Center the steering wheel (front wheels pointing straight forward).
2. Shift the transmission into PARK.

3. Apply the parking brake.
4. Start the engine.
5. Rotate the steering wheel one-half turn to the left.
6. Press the “ESC Off” button located in the lower switch bank below the climate control four times within twenty seconds. The “ESC Off Indicator Light” should turn on and turn off two times.
7. Rotate the steering wheel back to center and then an additional one-half turn to the right.
8. Turn the ignition switch to the OFF position and then back to the ON position. If the sequence was completed properly, the “ESC Off Indicator Light” will blink several times to confirm HSA is disabled.
9. Repeat these steps if you want to return this feature to its previous setting.

### Hill Descent Control (HDC) – If Equipped

HDC is only intended for low speed off-road driving. HDC maintains vehicle speed while descending hills in off-road driving conditions by applying the brakes when necessary.

When enabled, HDC senses the terrain and activates when the vehicle is descending a hill. HDC speed may be adjusted by the driver to suit the driving conditions. The speed corresponds to the transmission gear selected.

Gear	Approximate HDC Set Speed
1st	1 mph (1.5 km/h)
2nd	3 mph (4.5 km/h)
DRIVE	7.5 mph (12 km/h)
REVERSE	1 mph (1.5 km/h)
NEUTRAL	3 mph (4.5 km/h)

However, the driver can override HDC operation by applying the brake to slow the vehicle down below the HDC control speed. If more speed is desired during HDC



control, the accelerator pedal will increase vehicle speed in the usual manner. When either the brake or the accelerator is released, HDC will control the vehicle at the original set speed.

**NOTE:** HDC is available on vehicles equipped with the MP1522 transfer case.

- The transfer case must be in 4WD LOW range to enable HDC.
- HDC is enabled only when the “Hill Descent Control Indicator Light” in the instrument cluster is on solid.
- HDC will NOT activate when the automatic transmission is in PARK.
- HDC will NOT activate on level ground.
- HDC will NOT activate at vehicle speeds above 30 mph (50 km/h).

The “Hill Descent” button is located in the lower switch bank below the climate control.

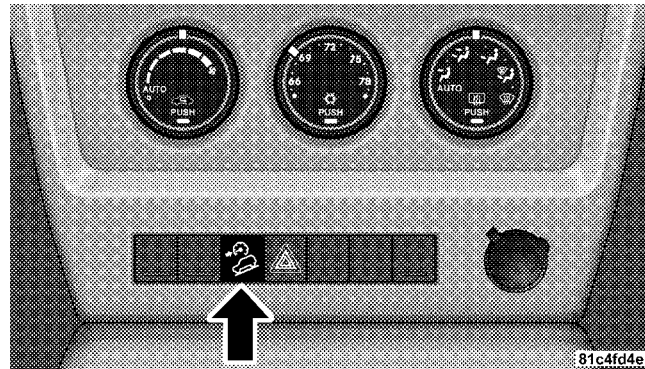

Hill Descent Button

### Enabling HDC

1. Shift the transfer case into 4WD LOW range. Refer to “Four-Wheel Drive Operation” in “Starting and Operating” for further information.

2. Press the “Hill Descent” button. The “Hill Descent Control Indicator Light” in the instrument cluster will turn on solid.

**NOTE:** If the transfer case is not in 4WD LOW range, the “Hill Descent Control Indicator Light” will flash for five seconds and HDC will not be enabled.

### *Disabling HDC*

1. Press the “Hill Descent” button or shift the transfer case out of 4WD LOW range. The “Hill Descent Control Indicator” light in the instrument cluster will turn off.

### **Electronic Stability Control (ESC)**

This system enhances directional control and stability of the vehicle under various driving conditions. ESC corrects for oversteering or understeering of the vehicle by applying the brake of the appropriate wheel to assist in

counteracting the oversteer or understeer condition. Engine power may also be reduced to help the vehicle maintain the desired path.

ESC uses sensors in the vehicle to determine the vehicle path intended by the driver and compares it to the actual path of the vehicle. When the actual path does not match the intended path, ESC applies the brake of the appropriate wheel to assist in counteracting the oversteer or understeer condition.

- Oversteer - when the vehicle is turning more than appropriate for the steering wheel position.
- Understeer - when the vehicle is turning less than appropriate for the steering wheel position.

The “ESC Activation/Malfunction Indicator Light” located in the instrument cluster will start to flash as soon as the tires lose traction and the ESC system becomes active. The “ESC Activation/Malfunction Indicator

Light” also flashes when the TCS is active. If the “ESC Activation/Malfunction Indicator Light” begins to flash during acceleration, ease up on the accelerator and apply as little throttle as possible. Be sure to adapt your speed and driving to the prevailing road conditions.

### WARNING!

The Electronic Stability Control (ESC) cannot prevent the natural laws of physics from acting on the vehicle, nor can it increase the traction afforded by prevailing road conditions. ESC cannot prevent collisions, including those resulting from excessive speed in turns, driving on very slippery surfaces, or hydroplaning. The capabilities of an ESC equipped vehicle must never be exploited in a reckless or dangerous manner which could jeopardize the user’s safety or the safety of others.

### ESC Operating Modes

Depending upon model and mode of operation, the ESC system has up to three operating modes: “ESC On” “Partial Off,” and “Full Off.”

#### *ESC On – Two-Wheel Drive Vehicles And Four-Wheel Drive Vehicles In 2WD And 4WD High Range*

This is the normal operating mode for ESC when operating a two-wheel drive vehicle. It is also the normal mode for operating a four-wheel drive vehicle in 2WD or 4WD HIGH range. The ESC system will be in “ESC On” mode whenever the vehicle is started or the transfer case (if equipped) is shifted out of 4WD LOW range. This mode should be used for most driving situations. ESC should only be turned to “Partial Off” or “Full Off” for specific reasons as noted. Refer to “Partial Off” and to “Full Off” for additional information.

*Partial Off – Two-Wheel Drive Vehicles And Four-Wheel Drive Vehicles In 2WD And 4WD High Range*

The “Partial Off” mode is intended for driving in deep snow, sand, or gravel. This mode raises the threshold for TCS and ESC activation, which allows for more wheel spin than what ESC normally allows.

The “ESC Off” button is located in the lower switch bank below the climate control. To enter the “Partial Off” mode, momentarily press the “ESC Off” button and the “ESC Activation/Malfunction Indicator Light” will illuminate. To turn the ESC on again, momentarily press the “ESC Off” button and the “ESC Activation/Malfunction Indicator Light” will turn off. This will restore the normal “ESC On” mode of operation.

**NOTE:** To improve the vehicle’s traction when driving with snow chains, or when starting off in deep snow, sand, or gravel, it may be desirable to switch to the “Partial Off” mode by momentarily pressing the “ESC Off” button. Once the situation requiring “Partial Off” mode is overcome, turn ESC back on by momentarily pressing the “ESC Off” button. This may be done while the vehicle is in motion.

*Full Off – Four-Wheel Drive Vehicles In 4WD High And 4WD Low Range*

The “Full Off” mode is intended for off-highway and off-road use when ESC stability features could inhibit vehicle maneuverability due to trail conditions.

The “ESC Off” button is located in the lower switch bank below the climate control panel. To enter “Full Off” mode, press and hold the “ESC Off” button for five seconds while the vehicle is stopped with the engine running. After five seconds, the “ESC Activation/

Malfunction Indicator Light” will illuminate and an “ESC OFF” message will appear in the odometer. Press and release the trip odometer button located on the instrument cluster to turn off this message.

In this mode, ESC and TCS are turned off (except for the “limited slip” feature described in the TCS section) until the vehicle reaches a speed of 40 mph (64 km/k). At speeds over 40 mph (64 km/k), the system automatically switches to “Partial Off” mode, described above. When the vehicle speed returns to less than 35 mph (56 km/h), the ESC system will return to “Full Off” mode. The “ESC Activation/Malfunction Indicator Light” is always illuminated when ESC is off. To turn ESC on again, momentarily press the “ESC Off” button. This will restore the normal “ESC On” mode of operation.

**NOTE:**

- “Full Off” is the only operating mode for ESC in 4WD LOW range. The ESC system will be in this mode whenever the vehicle is started in 4WD LOW range or the transfer case is shifted into 4WD LOW range.
- The “ESC OFF” message will display and a chime will sound when the shift lever is moved from any position to the PARK position and then moved out of the PARK position. This will occur even if the message was cleared previously.

**WARNING!**

**With the ESC switched off, the enhanced vehicle stability offered by ESC is unavailable. In an emergency evasive maneuver, the ESC system will not engage to assist in maintaining stability. “Full Off” mode is only intended for off-highway or off-road use.**

## ESC Activation/Malfunction Indicator Light And ESC OFF Indicator Light



The “ESC Activation/Malfunction Indicator Light” in the instrument cluster will come on when the ignition switch is turned to the ON position. It should go out with the engine running. If the “ESC Activation/Malfunction Indicator Light” comes on continuously with the engine running, a malfunction has been detected in the ESC system. If this light remains on after several ignition cycles, and the vehicle has been driven several miles (kilometers) at speeds greater than 30 mph (48 km/h), see your authorized dealer as soon as possible to have the problem diagnosed and corrected.

The “ESC Activation/Malfunction Indicator Light” (located in the instrument cluster) starts to flash as soon as the tires lose traction and the ESC system becomes active. The “ESC Activation/Malfunction Indicator Light” also flashes when TCS is active. If the “ESC Activation/

Malfunction Indicator Light” begins to flash during acceleration, ease up on the accelerator and apply as little throttle as possible. Be sure to adapt your speed and driving to the prevailing road conditions.

### NOTE:

- The “ESC Activation/Malfunction Indicator Light” and the “ESC OFF Indicator Light” come on momentarily each time the ignition switch is turned ON.
- Each time the ignition is turned ON, the ESC system will be ON even if it was turned off previously.
- The ESC system will make buzzing or clicking sounds when it is active. This is normal; the sounds will stop when ESC becomes inactive following the maneuver that caused the ESC activation.



The “ESC OFF Indicator Light” indicates the Electronic Stability Control (ESC) is off.

## TIRE SAFETY INFORMATION

### Tire Markings

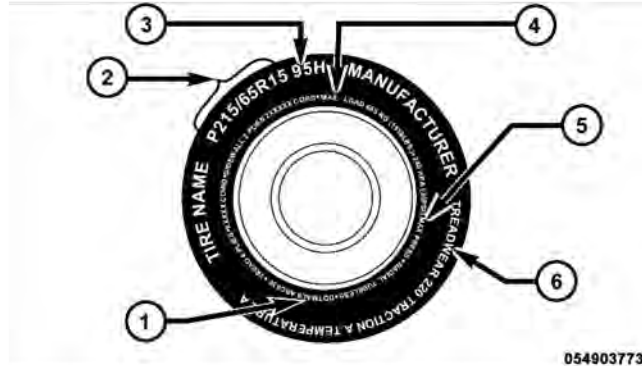

054903773

1 — U.S. DOT Safety Standards Code (TIN)  
2 — Size Designation  
3 — Service Description

4 — Maximum Load  
5 — Maximum Pressure  
6 — Treadwear, Traction and Temperature Grades

### NOTE:

- P (Passenger) - Metric tire sizing is based on U.S. design standards. P-Metric tires have the letter "P" molded into the sidewall preceding the size designation. Example: P215/65R15 95H.
- European-Metric tire sizing is based on European design standards. Tires designed to this standard have the tire size molded into the sidewall beginning with the section width. The letter "P" is absent from this tire size designation. Example: 215/65R15 96H.
- LT (Light Truck) - Metric tire sizing is based on U.S. design standards. The size designation for LT-Metric tires is the same as for P-Metric tires except for the letters "LT" that are molded into the sidewall preceding the size designation. Example: LT235/85R16.
- Temporary spare tires are high-pressure compact spares designed for temporary emergency use only.

Tires designed to this standard have the letter "T" molded into the sidewall preceding the size designation. Example: T145/80D18 103M.

- High flotation tire sizing is based on U.S. design standards and it begins with the tire diameter molded into the sidewall. Example: 31x10.5 R15 LT.

### Tire Sizing Chart

EXAMPLE:
<b>Size Designation:</b>
<p><b>P</b> = Passenger car tire size based on U.S. design standards  <b>"...blank..."</b> = Passenger car tire based on European design standards  <b>LT</b> = Light truck tire based on U.S. design standards  <b>T</b> = Temporary spare tire  <b>31</b> = Overall diameter in inches (in)  <b>215</b> = Section width in millimeters (mm)  <b>65</b> = Aspect ratio in percent (%)              — Ratio of section height to section width of tire  <b>10.5</b> = Section width in inches (in)  <b>R</b> = Construction code              — "R" means radial construction              —"D" means diagonal or bias construction  <b>15</b> = Rim diameter in inches (in)</p>



## EXAMPLE:

**Service Description:**

**95** = Load Index

— A numerical code associated with the maximum load a tire can carry

**H** = Speed Symbol

— A symbol indicating the range of speeds at which a tire can carry a load corresponding to its load index under certain operating conditions

— The maximum speed corresponding to the speed symbol should only be achieved under specified operating conditions (i.e., tire pressure, vehicle loading, road conditions, and posted speed limits)

**Load Identification:**

"...blank..." = Absence of any text on the sidewall of the tire indicates a Standard Load (SL) tire

**Extra Load (XL)** = Extra load (or reinforced) tire

**Light Load** = Light load tire

**C, D, E** = Load range associated with the maximum load a tire can carry at a specified pressure

**Maximum Load** — Maximum load indicates the maximum load this tire is designed to carry

**Maximum Pressure** — Maximum pressure indicates the maximum permissible cold tire inflation pressure for this tire

**Tire Identification Number (TIN)**

The TIN may be found on one or both sides of the tire, however, the date code may only be on one side. Tires with white sidewalls will have the full TIN, including the date code, located on the white sidewall side of the tire.

Look for the TIN on the outboard side of black sidewall tires as mounted on the vehicle. If the TIN is not found on the outboard side, then you will find it on the inboard side of the tire.

**EXAMPLE:****DOT MA L9 ABCD 0301**

**DOT** = Department of Transportation

— This symbol certifies that the tire is in compliance with the U.S. Department of Transportation tire safety standards and is approved for highway use

**MA** = Code representing the tire manufacturing location (two digits)

**L9** = Code representing the tire size (two digits)

**ABCD** = Code used by the tire manufacturer (one to four digits)

**03** = Number representing the week in which the tire was manufactured (two digits)

—03 means the 3rd week.

**01** = Number representing the year in which the tire was manufactured (two digits)

—01 means the year 2001

— Prior to July 2000, tire manufacturers were only required to have one number to represent the year in which the tire was manufactured. Example: 031 could represent the 3rd week of 1981 or 1991

## Tire Terminology And Definitions

Term	Definition
<b>B-Pillar</b>	The vehicle B-Pillar is a structural member of the body located between the front and rear door (of a four-door vehicle) running from the sill to the roof.
<b>Cold Tire Pressure</b>	Cold tire inflation pressure is defined as the tire pressure after the vehicle has not been driven for at least 3 hours, or driven less than 1 mile (1.6 km) after sitting for a three hour period. Inflation pressure is measured in units of PSI (pounds per square inch) or KPa (kilopascals).
<b>Maximum Inflation Pressure</b>	The maximum inflation pressure is the maximum permissible cold tire inflation pressure for this tire. The max inflation pressure is molded into the sidewall.
<b>Recommended Inflation Pressure</b>	Vehicle manufacturer's recommended tire inflation pressure as shown on the tire placard.
<b>Tire Placard</b>	A paper label permanently attached to the vehicle showing the vehicle's loading capacity, the original equipment tire size and the recommended inflation pressure.

## Tire Loading And Tire Pressure

### Tire Placard Location

**NOTE:** The proper cold tire inflation pressure is listed on the driver's side B-Pillar.

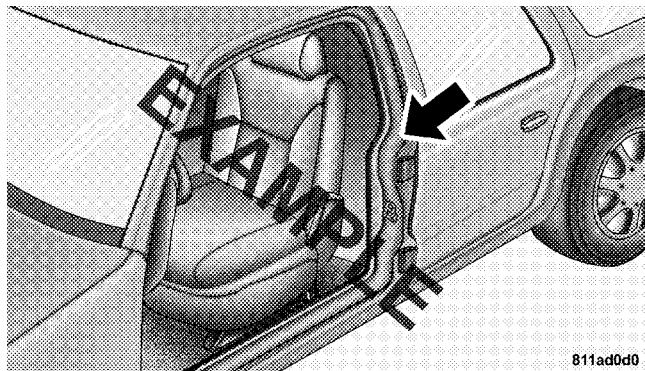

Tire Placard Location

### Tire And Loading Information Placard

**TIRE AND LOADING INFORMATION**

SEATING CAPACITY - TOTAL 5 FRONT 2 REAR 3

THE COMBINED WEIGHT OF OCCUPANTS AND CARGO SHOULD NEVER EXCEED XXX KG OR XXX LBS.

TIRE	FRONT	REAR	SPARE
ORIGINAL TIRE SIZE	P195/70R14	P195/70R14	T125/70D15
COLD TIRE INFLATION PRESSURE	200kPa, 29PSI	200kPa, 29PSI	420kPa, 60PSI

SEE OWNER'S MANUAL FOR ADDITIONAL INFORMATION  4N109268

811b5a9a

Tire and Loading Information Placard

This placard tells you important information about the:

- 1) number of people that can be carried in the vehicle
- 2) total weight your vehicle can carry
- 3) tire size designed for your vehicle
- 4) cold tire inflation pressures for the front, rear, and spare tires.

### **Loading**

The vehicle maximum load on the tire must not exceed the load carrying capacity of the tire on your vehicle. You will not exceed the tire's load carrying capacity if you adhere to the loading conditions, tire size, and cold tire inflation pressures specified on the Tire and Loading Information placard and in the "Vehicle Loading" section of this manual.

**NOTE:** Under a maximum loaded vehicle condition, gross axle weight ratings (GAWRs) for the front and rear

axles must not be exceeded. For further information on GAWRs, vehicle loading, and trailer towing, refer to "Vehicle Loading" in this section.

To determine the maximum loading conditions of your vehicle, locate the statement "The combined weight of occupants and cargo should never exceed XXX lbs or XXX kg" on the Tire and Loading Information placard. The combined weight of occupants, cargo/luggage and trailer tongue weight (if applicable) should never exceed the weight referenced here.

### *Steps For Determining Correct Load Limit*

1. Locate the statement "The combined weight of occupants and cargo should never exceed XXX lbs or XXX kg" on your vehicle's placard.
2. Determine the combined weight of the driver and passengers that will be riding in your vehicle.

3. Subtract the combined weight of the driver and passengers from XXX lbs or XXX kg.
  4. The resulting figure equals the available amount of cargo and luggage load capacity. For example, if “XXX” amount equals 1,400 lbs (635 kg) and there will be five 150 lb (68 kg) passengers in your vehicle, the amount of available cargo and luggage load capacity is 650 lbs (295 kg) (since  $5 \times 150 = 750$ , and  $1400 - 750 = 650$  lbs [295 kg]).
  5. Determine the combined weight of luggage and cargo being loaded on the vehicle. That weight may not safely exceed the available cargo and luggage load capacity calculated in Step 4.
  6. If your vehicle will be towing a trailer, load from your trailer will be transferred to your vehicle. Consult this manual to determine how this reduces the available cargo and luggage load capacity of your vehicle.
- NOTE:**
- The following table shows examples on how to calculate total load, cargo/luggage, and towing capacities of your vehicle with varying seating configurations and number and size of occupants. This table is for illustration purposes only and may not be accurate for the seating and load carry capacity of your vehicle.
  - For the following example, the combined weight of occupants and cargo should never exceed 865 lbs (392 kg).

Occupants			Combined weight of occupants and cargo from Tire Placard	MINUS	Combined Occupant's weight	=	AVAILABLE Cargo/Luggage and Trailer Tongue Weight
TOTAL	FRONT	REAR					
<u>EXAMPLE 1</u>			865 lbs	minus	670 lbs	=	195 lbs
5	2	3					
<u>EXAMPLE 2</u>			865 lbs	minus	540 lbs	=	325 lbs
3	2	1					
<u>EXAMPLE 3</u>			865 lbs	minus	400 lbs	=	465 lbs
2	2	0					

Occupant 1: 200 lbs  
 Occupant 2: 130 lbs  
 Occupant 3: 160 lbs  
 Occupant 4: 100 lbs  
 Occupant 5: 80 lbs  
 TOTAL WEIGHT: 670 lbs

Occupant 1: 210 lbs  
 Occupant 2: 180 lbs  
 Occupant 3: 150 lbs  
 TOTAL WEIGHT: 540 lbs

Occupant 1: 200 lbs  
 Occupant 2: 200 lbs  
 TOTAL WEIGHT: 400 lbs

**WARNING!**

Overloading of your tires is dangerous. Overloading can cause tire failure, affect vehicle handling, and increase your stopping distance. Use tires of the recommended load capacity for your vehicle. Never overload them.

**TIRES — GENERAL INFORMATION****Tire Pressure**

Proper tire inflation pressure is essential to the safe and satisfactory operation of your vehicle. Three primary areas are affected by improper tire pressure:

**Safety****WARNING!**

- Improperly inflated tires are dangerous and can cause collisions.
- Under-inflation increases tire flexing and can result in over-heating and tire failure.
- Over-inflation reduces a tire's ability to cushion shock. Objects on the road and chuckholes can cause damage that result in tire failure.
- Over-inflated or under-inflated tires can affect vehicle handling and can fail suddenly, resulting in loss of vehicle control.
- Unequal tire pressures can cause steering problems. You could lose control of your vehicle.

*(Continued)*



**WARNING! (Continued)**

- Unequal tire pressures from one side of the vehicle to the other can cause the vehicle to drift to the right or left.
- Always drive with each tire inflated to the recommended cold tire inflation pressure.

**Economy**

Improper inflation pressures can cause uneven wear patterns to develop across the tire tread. These abnormal wear patterns will reduce tread life resulting in a need for earlier tire replacement. Under-inflation also increases tire rolling resistance resulting in higher fuel consumption.

**Ride Comfort And Vehicle Stability**

Proper tire inflation contributes to a comfortable ride. Over-inflation produces a jarring and uncomfortable ride. Both under-inflation and over-inflation affect the

stability of the vehicle and can produce a feeling of sluggish response or over responsiveness in the steering.

Unequal tire pressures can cause erratic and unpredictable steering response.

Unequal tire pressure from side to side may cause the vehicle to drift left or right.

**Tire Inflation Pressures**

The proper cold tire inflation pressure is listed on the driver's side "B" Pillar or rear edge of the driver's side door.

The pressure should be checked and adjusted, as well as inspected for signs of tire wear or visible damage, at least once a month. Use a good quality pocket-type gauge to check tire pressure. Do not make a visual judgement when determining proper inflation. Radial tires may look properly inflated even when they are under-inflated.

**CAUTION!**

**After inspecting or adjusting the tire pressure, always reinstall the valve stem cap. This will prevent moisture and dirt from entering the valve stem, which could damage it.**

Inflation pressures specified on the placard are always cold tire inflation pressure. Cold tire inflation pressure is defined as the tire pressure after the vehicle has not been driven for at least three hours, or driven less than 1 mile (1.6 km) after a three-hour period. The cold tire inflation pressure must not exceed the maximum inflation pressure molded into the tire sidewall.

Check tire pressures more often if subject to a wide range of outdoor temperatures, as tire pressures vary with temperature changes.

Tire pressures change by approximately 1 psi (7 kPa) per 12°F (7°C) of air temperature change. Keep this in mind when checking tire pressure inside a garage, especially in the winter.

Example: If garage temperature = 68°F (20°C) and the outside temperature = 32°F (0°C) then the cold tire inflation pressure should be increased by 3 psi (21 kPa), which equals 1 psi (7 kPa) for every 12°F (7°C) for this outside temperature condition.

Tire pressure may increase from 2 to 6 psi (13 to 40 kPa) during operation. DO NOT reduce this normal pressure build-up, or your tire pressure will be too low.

## Tire Pressures For High Speed Operation

The manufacturer advocates driving at safe speeds within posted speed limits. Where speed limits or conditions are such that the vehicle can be driven at high speeds, maintaining correct tire inflation pressure is very important. Increased tire pressure and reduced vehicle loading may be required for high-speed vehicle operation. Refer to original equipment or an authorized tire dealer for recommended safe operating speeds, loading and cold tire inflation pressures.

### WARNING!

High speed driving with your vehicle at or above maximum load is dangerous. The added strain on your tires could cause them to fail. You could have a serious collision. Do not drive a vehicle loaded to the maximum capacity at continuous speeds above 75 mph (120 km/h).

## Radial-Ply Tires

### WARNING!

Combining radial ply tires with other types of tires on your vehicle will cause your vehicle to handle poorly. The instability could cause a collision. Always use radial tires in sets of four. Never combine them with other types of tires.

Cuts and punctures in radial tires are repairable only in the tread area because of sidewall flexing. Consult your authorized dealer for radial tire repairs.

## Spare Tire Matching Original Equipped Tire And Wheel – If Equipped

Your vehicle may be equivalent with a spare tire and wheel in look and function as the original equipment tire and wheel found on the front or rear axle of your vehicle. This spare tire may be used in the tire rotation for your

vehicle. If your vehicle has this option refer to an authorized tire dealer for the recommended tire rotation pattern.

If your vehicle is not equipped with an original equipment tire and wheel as a spare, a non-matching temporary emergency use spare may be equipped with your vehicle. Temporary use spares are engineered to be used only with your vehicle. Your vehicle may be equipped with one of the following types of non-matching temporary use spares; compact, full size, or limited-use. Do not install more than one non-matching temporary use spare tire/wheel on the vehicle at any given time.

### **CAUTION!**

**Because of the reduced ground clearance, do not take your vehicle through an automatic car wash with a compact, full size or limited-use temporary spare installed. Damage to the vehicle may result.**

### **Compact Spare Tire – If Equipped**

The compact spare is for temporary emergency use only. You can identify if your vehicle is equipped with a compact spare by looking at the spare tire description on the Tire and Loading Information Placard located on the driver's side door opening or on the sidewall of the tire. Compact spare tire descriptions begin with the letter "T" or "S" preceding the size designation. Example: T145/80D18 103M.

T, S = Temporary Spare Tire

Since this tire has limited tread life the original equipment tire should be repaired (or replaced) and reinstalled on your vehicle at the first opportunity.

Do not install a wheel cover or attempt to mount a conventional tire on the compact spare wheel, since the wheel is designed specifically for the compact spare tire. Do not install more than one compact spare tire and wheel on the vehicle at any given time.

**WARNING!**

Compact spares are for temporary emergency use only. With these spares, do not drive more than 50 mph (80 km/h). Temporary use spares have limited tread life. When the tread is worn to the tread wear indicators, the temporary use spare tire needs to be replaced. Be sure to follow the warnings, which apply to your spare. Failure to do so could result in spare tire failure and loss of vehicle control.

**Full Size Spare – If Equipped**

The full size spare is for temporary emergency use only. This tire may look like the original equipped tire on the front or rear axle of your vehicle, but it is not. This spare tire may have limited tread life. When the tread is worn to the tread wear indicators, the temporary use full size spare tire needs to be replaced. Since it is not the same as

your original equipment tire, replace (or repair) the original equipment tire and reinstall on the vehicle at the first opportunity.

**Limited-Use Spare – If Equipped**

The limited-use spare tire is for temporary emergency use only. This tire is identified by a label located on the limited-use spare wheel. This label contains the driving limitations for this spare. This tire may look like the original equipped tire on the front or rear axle of your vehicle, but it is not. Installation of this limited-use spare tire affects vehicle handling. Since it is not the same as your original equipment tire, replace (or repair) the original equipment tire and reinstall on the vehicle at the first opportunity.

**WARNING!**

Limited-use spares are for emergency use only. Installation of this limited-use spare tire affects vehicle handling. With this tire, do not drive more than the speed listed on the limit-use spare wheel. Keep inflated to the cold tire inflation pressure listed on your Tire and Loading Information Placard located on the driver's side door opening. Replace (or repair) the original equipment tire at the first opportunity and reinstall it on your vehicle. Failure to do so could result in loss of vehicle control.

**Tire Spinning**

When stuck in mud, sand, snow, or ice conditions, do not spin your vehicle's wheels above 30 mph (48 km/h).

**WARNING!**

Fast spinning tires can be dangerous. Forces generated by excessive wheel speeds may cause tire damage or failure. A tire could explode and injure someone. Do not spin your vehicle's wheels faster than 30 mph (48 km/h) when you are stuck, and do not let anyone near a spinning wheel no matter what the speed.

**Tread Wear Indicators**

Tread wear indicators are in the original equipment tires to help you in determining when your tires should be replaced.

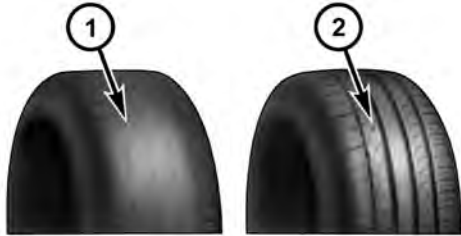

055007576

- 1 — Worn Tire  
2 — New Tire

These indicators are molded into the bottom of the tread grooves. They will appear as bands when the tread depth becomes 1/16 in (2 mm). When the tread is worn to the tread wear indicators, the tire should be replaced.

### CAUTION!

Proper operation of four-wheel drive vehicles depends on tires of equal size, type and circumference on each wheel. Any difference in tire size can cause damage to the transfer case. Tire rotation schedule should be followed to balance tire wear.

### Life Of Tire

The service life of a tire is dependent upon various factors including but not limited to:

- Driving style
- Tire pressure
- Distance driven

**WARNING!**

**Tires and the spare tire should be replaced after six years, regardless of the remaining tread. Failure to follow this warning can result in sudden tire failure. You could lose control and have a collision resulting in serious injury or death.**

Keep dismounted tires in a cool, dry place with as little exposure to light as possible. Protect tires from contact with oil, grease, and gasoline.

**Replacement Tires**

The tires on your new vehicle provide a balance of many characteristics. They should be inspected regularly for wear and correct cold tire inflation pressure. The manufacturer strongly recommends that you use tires equivalent to the originals in size, quality and performance when replacement is needed. (Refer to the paragraph on "Tread Wear Indicators"). Refer to the "Tire and Loading

Information" placard for the size designation of your tire. The Load Index and Speed Symbol for your tire will be found on the original equipment tire sidewall. See the Tire Sizing Chart example found in the Tire Safety Information section of this manual for more information relating to the Load Index and Speed Symbol of a tire.

It is recommended to replace the two front tires or two rear tires as a pair. Replacing just one tire can seriously affect your vehicle's handling. If you ever replace a wheel, make sure that the wheel's specifications match those of the original wheels.

It is recommended you contact your original equipment or an authorized tire dealer with any questions you may have on tire specifications or capability. Failure to use equivalent replacement tires may adversely affect the safety, handling, and ride of your vehicle.



**WARNING!**

- Do not use a tire, wheel size or rating other than that specified for your vehicle. Some combinations of unapproved tires and wheels may change suspension dimensions and performance characteristics, resulting in changes to steering, handling, and braking of your vehicle. This can cause unpredictable handling and stress to steering and suspension components. You could lose control and have a collision resulting in serious injury or death. Use only the tire and wheel sizes with load ratings approved for your vehicle.
- Never use a tire with a smaller load index or capacity than what was originally equipped on your vehicle. Using a tire with a smaller load index could result in tire overloading and failure. You could lose control and have a collision.

*(Continued)*

**WARNING! (Continued)**

- Failure to equip your vehicle with tires having adequate speed capability can result in sudden tire failure and loss of vehicle control.

**CAUTION!**

Replacing original tires with tires of a different size may result in false speedometer and odometer readings.

**TIRE CHAINS**

Use only compact chains, or other traction aids that meet SAE type "Class S" specifications. Chains must be the proper size for the vehicle, as recommended by the chain manufacturer. In addition, only install tire chains on P225/75R16 or smaller tires.

**CAUTION!**

To avoid damage to your vehicle, tires, or chains, observe the following precautions:

- Do not use tire chains on vehicles equipped with tires other than P225/75R16 or smaller tires. There may not be adequate clearance for the chains and you are risking structural or body damage to your vehicle.
- Because of limited chain clearance between tires and other suspension components, it is important that only chains in good condition are used. Broken chains can cause serious vehicle damage. Stop the vehicle immediately if noise occurs that could suggest chain breakage. Remove the damaged parts of the chain before further use.

*(Continued)*

**CAUTION! (Continued)**

- Install chains on the rear wheels as tightly as possible and then retighten after driving about ½ mile (0.8 km).
- Do not exceed 45 mph (72 km/h).
- Drive cautiously and avoid severe turns and large bumps, especially with a loaded vehicle.
- Use on Rear Wheels only.
- Do not drive for a prolonged period on dry pavement.
- Observe the tire chain manufacturer's instructions on method of installation, operating speed, and conditions for use. Always use the lower suggested operating speed of the chain manufacturer if different from the speed recommended by the manufacturer.

These cautions apply to all chain traction devices, including link and cable (radial) chains.

### TIRE ROTATION RECOMMENDATIONS

The tires on the front and rear of your vehicle operate at different loads and perform different steering, handling, and braking functions. For these reasons, they wear at unequal rates.

These effects can be reduced by timely rotation of tires. The benefits of rotation are especially worthwhile with aggressive tread designs such as those on On/Off Road type tires. Rotation will increase tread life, help to maintain mud, snow, and wet traction levels, and contribute to a smooth, quiet ride.

Refer to the “Maintenance Schedule” for the proper maintenance intervals. The reasons for any rapid or unusual wear should be corrected prior to rotation being performed.

The suggested rotation method is the “forward-cross” shown in the following diagram. This rotation pattern does not apply to some directional tires that must not be reversed.

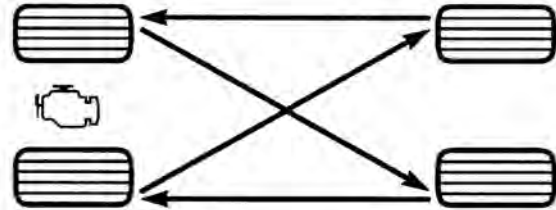

055703771

Tire Rotation

**CAUTION!**

**Proper operation of four-wheel drive vehicles depends on tires of equal size, type and circumference on each wheel. Any difference in tire size can cause damage to the transfer case. Tire rotation schedule should be followed to balance tire wear.**

**TIRE PRESSURE MONITOR SYSTEM (TPMS)**

The Tire Pressure Monitor System (TPMS) will warn the driver of a low tire pressure based on the vehicle recommended cold placard pressure.

The tire pressure will vary with temperature by about 1 psi (6.9 kPa) for every 12°F (6.5°C). This means that when the outside temperature decreases, the tire pressure will decrease. Tire pressure should always be set based on cold inflation tire pressure. This is defined as the tire pressure after the vehicle has not been driven for at least three hours, or driven less than 1 mile (1.6 km) after a

three hour period. The cold tire inflation pressure must not exceed the maximum inflation pressure molded into the tire sidewall. Refer to “Tires – General Information” in “Starting and Operating” for information on how to properly inflate the vehicle’s tires. The tire pressure will also increase as the vehicle is driven. This is normal and there should be no adjustment for this increased pressure.

The TPMS will warn the driver of a low tire pressure if the tire pressure falls below the low-pressure warning limit for any reason, including low temperature effects and natural pressure loss through the tire.

The TPMS will continue to warn the driver of low tire pressure as long as the condition exists, and will not turn off until the tire pressure is at or above the recommended cold placard pressure. Once the low tire pressure warning (Tire Pressure Monitoring Telltale Light) illuminates, you must increase the tire pressure to the recommended

cold placard pressure in order for the “Tire Pressure Monitoring Telltale Light” to turn off. The system will automatically update and the “Tire Pressure Monitoring Telltale Light” will turn off once the system receives the updated tire pressures. The vehicle may need to be driven for up to 20 minutes above 15 mph (24 km/h) in order for the TPMS to receive this information.

For example, your vehicle may have a recommended cold (parked for more than three hours) placard pressure of 33 psi (227 kPa). If the ambient temperature is 68°F (20°C) and the measured tire pressure is 28 psi (193 kPa), a temperature drop to 20°F (-7°C) will decrease the tire pressure to approximately 24 psi (165 kPa). This tire pressure is low enough to turn ON the “Tire Pressure Monitoring Telltale Light.” Driving the vehicle may cause the tire pressure to rise to approximately 28 psi (193 kPa), but the “Tire Pressure Monitoring Telltale Light” will still be on. In this situation, the “Tire Pressure Monitoring

Telltale Light” will turn off only after the tires are inflated to the vehicle’s recommended cold placard pressure value.

### CAUTION!

- **The TPMS has been optimized for the original equipment tires and wheels. TPMS pressures and warning have been established for the tire size equipped on your vehicle. Undesirable system operation or sensor damage may result when using replacement equipment that is not of the same size, type, and/or style. Aftermarket wheels can cause sensor damage. Do not use aftermarket tire sealants or balance beads if your vehicle is equipped with a TPMS, as damage to the sensors may result.**

*(Continued)*

**CAUTION! (Continued)**

- After inspecting or adjusting the tire pressure, always reinstall the valve stem cap. This will prevent moisture and dirt from entering the valve stem, which could damage the Tire Pressure Monitoring Sensor.

**NOTE:**

- The TPMS is not intended to replace normal tire care and maintenance, or to provide warning of a tire failure or condition.
- The TPMS should not be used as a tire pressure gauge while adjusting your tire pressure.
- Driving on a significantly under-inflated tire causes the tire to overheat and can lead to tire failure. Under-inflation also reduces fuel efficiency and tire tread life, and may affect the vehicle's handling and stopping ability.

- The TPMS is not a substitute for proper tire maintenance, and it is the driver's responsibility to maintain correct tire pressure using an accurate tire pressure gauge, even if under-inflation has not reached the level to trigger illumination of the "Tire Pressure Monitoring Telltale Light."
- Seasonal temperature changes will affect tire pressure, and the TPMS will monitor the actual tire pressure in the tire.

**Base System**

The Tire Pressure Monitor System (TPMS) uses wireless technology with wheel rim mounted electronic sensors to monitor tire pressure levels. Sensors, mounted to each wheel as part of the valve stem, transmit tire pressure readings to the receiver module.

**NOTE:** It is particularly important for you to check the tire pressure in all of the tires on your vehicle monthly and to maintain the proper pressure.

The TPMS consists of the following components:

- Receiver Module
- Four Tire Pressure Monitoring Sensors
- Tire Pressure Monitoring Telltale Light

The matching full-size spare wheel and tire assembly (if equipped) has a tire pressure monitoring sensor. The matching full-size spare can be used in place of any of the four road tires. The TPMS will only monitor the pressure in the full-size spare when it is used in place of a road tire. Otherwise, a spare with a pressure below the low-pressure limit will not cause the “Tire Pressure Monitoring Telltale Light” to illuminate or the chime to sound.

### **Tire Pressure Monitoring Low Pressure Warnings**



The “Tire Pressure Monitoring Telltale Light” will illuminate in the instrument cluster and a chime will sound when tire pressure is low in one or more of the four active road tires. Should this occur, you should stop as soon as possible, check the inflation pressure of each tire on your vehicle, and inflate each tire to the vehicle’s recommended cold placard pressure value. Once the system receives the updated tire pressures, the system will automatically update and the “Tire Pressure Monitoring Telltale Light” will turn off. The vehicle may need to be driven for up to 20 minutes above 15 mph (24 km/h) in order for the TPMS to receive this information.

### **Check TPMS Warning**

When a system fault is detected, the “Tire Pressure Monitoring Telltale Light” will flash on and off for 75 seconds and then remain on solid. The system fault will also sound a chime. If the ignition key is cycled, this

sequence will repeat, providing the system fault still exists. The “Tire Pressure Monitoring Telltale Light” will turn off when the fault condition no longer exists. A system fault can occur due to any of the following:

1. Jamming due to electronic devices or driving next to facilities emitting the same radio frequencies as the TPMS sensors.
2. Installing some form of aftermarket window tinting that affects radio wave signals.
3. Lots of snow or ice around the wheels or wheel housings.
4. Using tire chains on the vehicle.
5. Using wheels/tires not equipped with TPMS sensors.

### *Vehicles With Full-Size Spare*

1. The matching full-size spare wheel and tire assembly has a tire pressure monitoring sensor that can be monitored by the TPMS.
2. If you install the full-size spare in place of a road tire that has a pressure below the low-pressure warning limit, a chime will sound and the “TPMS Telltale Light” will turn on upon the next ignition key cycle.
3. Driving the vehicle for up to 20 minutes above 15 mph (24 km/h) will turn off the “TPMS Telltale Light,” as long as no tire pressure is below the low-pressure warning limit in any of the four active road tires.

### *Vehicles With Compact Spare*

1. The compact spare tire does not have a tire pressure monitoring sensor. Therefore, the TPMS will not monitor the pressure in the compact spare tire.



2. If you install the compact spare tire in place of a road tire that has a pressure below the low-pressure warning limit, a chime will sound and the “TPMS Telltale Light” will turn on upon the next ignition key cycle.
3. After driving the vehicle for up to 20 minutes above 15 mph (24 km/h), the “TPMS Telltale Light” will flash on and off for 75 seconds and then remain on solid.
4. For each subsequent ignition key cycle, a chime will sound and the “TPMS Telltale Light” will flash on and off for 75 seconds and then remain on solid.
5. Once you repair or replace the original road tire and reinstall it on the vehicle in place of the compact spare, the TPMS will update automatically and the “TPMS Telltale Light” will turn off, as long as no tire pressure is below the low-pressure warning limit in any of the four active road tires. The vehicle may need to be driven for up to 20 minutes above 15 mph (24 km/h) in order for the TPMS to receive this information.

### **Premium System – If Equipped**

The Tire Pressure Monitor System (TPMS) uses wireless technology with wheel rim mounted electronic sensors to monitor tire pressure levels. Sensors, mounted to each wheel as part of the valve stem, transmit tire pressure readings to the receiver module.

**NOTE:** It is particularly important for you to check the tire pressure in all of the tires on your vehicle monthly and to maintain the proper pressure.

The TPMS consists of the following components:

- Receiver Module
- Four Tire Pressure Monitoring Sensors
- Three Trigger Modules (mounted in three of the four wheel-wells)

- Various Tire Pressure Monitoring System messages, which display in the Electronic Vehicle Information Center (EVIC)
- Tire Pressure Monitoring Telltale Light

The matching full size spare wheel and tire assembly (if equipped) has a tire pressure monitoring sensor. The full size spare can be used in place of any of the four road tires. A spare with a pressure below the low-pressure limit will not cause the “Tire Pressure Monitoring Telltale Light” to illuminate or the chime to sound. However, it will cause a “SPARE LOW PRESSURE” message to display in the EVIC.

### Tire Pressure Monitoring Low Pressure Warnings

 The “Tire Pressure Monitoring Telltale Light” will illuminate in the instrument cluster and a chime will sound when tire pressure is low in one or more of the four active road tires. In addition, the Electronic Vehicle Information Center (EVIC) will display a graphic showing the pressure values of each tire with the low tire pressure values flashing.

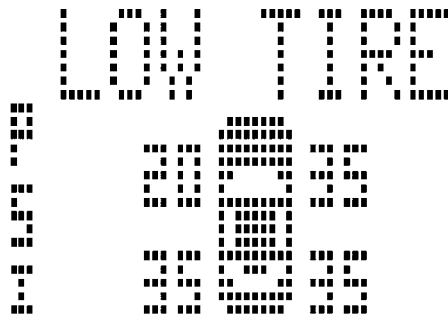

Should this occur, you should stop as soon as possible and inflate the tires with low pressure (those flashing in the EVIC graphic) to the vehicle's recommended cold placard pressure value. Once the system receives the updated tire pressures, the system will automatically update, the graphic display in the EVIC will stop flashing, and the "Tire Pressure Monitoring Telltale Light" will turn off. The vehicle may need to be driven for up to 20 minutes above 15 mph (24 km/h) in order for the TPMS to receive this information.

### Check TPMS Warning

When a system fault is detected, the "Tire Pressure Monitoring Telltale Light" will flash on and off for 75 seconds and then remain on solid. The system fault will also sound a chime. In addition, the EVIC will display a "CHECK TPM SYSTEM" message for three

seconds and then display dashes (- -) in place of the pressure value to indicate which sensor is not being received.

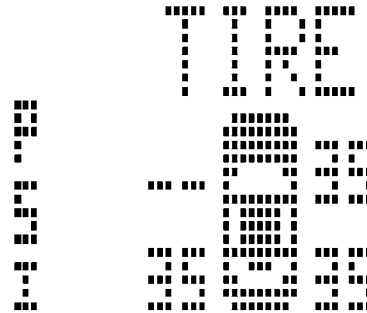

If the ignition key is cycled, this sequence will repeat, providing the system fault still exists. If the system fault no longer exists, the "Tire Pressure Monitoring Telltale Light" will no longer flash, and the "CHECK TPM SYSTEM" message will no longer display, and a pressure value will display in place of the dashes. A system fault can occur due to any of the following:

1. Jamming due to electronic devices or driving next to facilities emitting the same radio frequencies as the TPMS sensors.
2. Installing some form of aftermarket window tinting that affects radio wave signals.
3. Lots of snow or ice around the wheels or wheel housings.
4. Using tire chains on the vehicle.
5. Using wheels/tires not equipped with TPMS sensors.

### *Vehicles With Full-Size Spare*

1. The matching full size spare wheel and tire assembly has a tire pressure monitoring sensor that can be monitored by the TPMS.
2. If you install the full size spare in place of a road tire that has a pressure below the low-pressure warning limit, a chime will sound and the "TPMS Telltale Light" will turn on upon the next ignition key cycle. In addition, the EVIC will display a Low Pressure message and a graphic showing the low tire pressure value flashing.
3. After driving the vehicle for up to 20 minutes above 15 mph (24 km/h) the "TPMS Telltale Light" will turn OFF, as long as no tire pressure is below the low-pressure warning limit in any of the four active road tires.
4. The EVIC will display a graphic showing the tire pressure value in place of the flashing low tire pressure

value. The EVIC will also display a "SPARE LOW PRESSURE" message to remind you to service the flat tire.

### *Vehicles With Compact Spare*

1. The compact spare tire does not have a tire pressure monitoring sensor. Therefore, the TPMS will not monitor the pressure in the compact spare tire.
2. If you install the compact spare tire in place of a road tire that has a pressure below the low-pressure warning limit, upon the next ignition key cycle, the "TPMS Telltale Light" will remain on and a chime will sound. In addition, the graphic in the EVIC will still display a flashing pressure value.
3. After driving the vehicle for up to 20 minutes above 15 mph (24 km/h), the "TPMS Telltale Light" will flash on and off for 75 seconds and then remain on solid. In

addition, the EVIC will display a "CHECK TPM SYSTEM" message for three seconds and then display dashes (- -) in place of the pressure value.

4. For each subsequent ignition key cycle, a chime will sound, the "TPMS Telltale Light" will flash on and off for 75 seconds and then remain on solid, and the EVIC will display a "CHECK TPM SYSTEM" message for three seconds and then display dashes (- -) in place of the pressure value.
5. Once you repair or replace the original road tire and reinstall it on the vehicle in place of the compact spare, the TPMS will update automatically. In addition, the "TPMS Telltale Light" will turn off and the graphic in the EVIC will display a new pressure value instead of dashes (- -), as long as no tire pressure is below the low-pressure warning limit in any of the four active road tires. The

vehicle may need to be driven for up to 20 minutes above 15 mph (24 km/h) in order for the TPMS to receive this information.

### General Information

This device complies with Part 15 of the FCC rules and RSS 210 of Industry Canada. Operation is subject to the following conditions:

- This device may not cause harmful interference.
- This device must accept any interference received, including interference that may cause undesired operation.

The tire pressure sensors are covered under one of the following licenses:

United States . . . . . KR5S120123  
 Canada . . . . . 2671-S120123

### FUEL REQUIREMENTS



All engines are designed to meet all emissions regulations and provide excellent fuel economy and performance when using high quality unleaded “regular” gasoline having an octane rating of 87. The use of premium gasoline is not recommended, as it will not provide any benefit over regular gasoline in these engines.

Light spark knock at low engine speeds is not harmful to your engine. However, continued heavy spark knock at high speeds can cause damage and immediate service is required. Poor quality gasoline can cause problems such as hard starting, stalling, and hesitations. If you experience these symptoms, try another brand of gasoline before considering service for the vehicle.

Over 40 auto manufacturers worldwide have issued and endorsed consistent gasoline specifications (the Worldwide Fuel Charter, WWFC) which define fuel properties necessary to deliver enhanced emissions, performance, and durability for your vehicle. The manufacturer recommends the use of gasoline that meets the WWFC specifications if they are available.

### **Reformulated Gasoline**

Many areas of the country require the use of cleaner burning gasoline referred to as “Reformulated Gasoline.” Reformulated gasolines contain oxygenates, and are specifically blended to reduce vehicle emissions and improve air quality.

The manufacturer supports the use of reformulated gasolines. Properly blended reformulated gasolines will provide excellent performance and durability of engine and fuel system components.

### **Gasoline/Oxygenate Blends**

Some fuel suppliers blend unleaded gasoline with oxygenates such as Ethanol. Fuels blended with oxygenates may be used in your vehicle.

#### **CAUTION!**

**DO NOT use gasoline containing Methanol or gasoline containing more than 10% Ethanol. Use of these blends may result in starting and driveability problems, damage critical fuel system components, cause emissions to exceed the applicable standard, and/or cause the “Malfunction Indicator Light” to illuminate. Pump labels should clearly communicate if a fuel contains greater than 10% Ethanol.**

Problems that result from using gasoline containing Methanol or gasoline containing more than 10% Ethanol are not the responsibility of the manufacturer and may not be covered under warranty.

### **E-85 Usage In Non-Flex Fuel Vehicles**

Non-FFV vehicles are compatible with gasoline containing 10% ethanol (E10). Gasoline with higher ethanol content may void the vehicle's warranty.

If a Non-FFV vehicle is inadvertently fueled with E-85 fuel, the engine will have some or all of these symptoms:

- operate in a lean mode
- OBD II "Malfunction Indicator Light" on
- poor engine performance
- poor cold start and cold drivability
- increased risk for fuel system component corrosion

To fix a Non-FFV vehicle inadvertently fueled once with E-85 perform the following:

- drain the fuel tank (see your authorized dealer)
- change the engine oil and oil filter

- disconnect and reconnect the battery to reset the engine controller memory

More extensive repairs will be required for prolonged exposure to E-85 fuel.

### **MMT In Gasoline**

MMT is a manganese containing metallic additive that is blended into some gasoline to increase octane. Gasoline blended with MMT provides no performance advantage beyond gasoline of the same octane number without MMT. Gasoline blended with MMT reduces spark plug life and reduces emission system performance in some vehicles. The manufacturer recommends that gasoline without MMT be used in your vehicle. The MMT content of gasoline may not be indicated on the gasoline pump; therefore, you should ask your gasoline retailer whether the gasoline contains MMT. It is even more important to look for gasolines without MMT in Canada, because



MMT can be used at levels higher than those allowed in the United States. MMT is prohibited in Federal and California reformulated gasoline.

### Materials Added To Fuel

All gasoline sold in the United States is required to contain effective detergent additives. Use of additional detergents or other additives is not needed under normal conditions and they would result in additional cost. Therefore, you should not have to add anything to the fuel.

### Fuel System Cautions

#### CAUTION!

Use the following guidelines to maintain your vehicle's performance:

*(Continued)*

#### CAUTION! (Continued)

- The use of leaded gas is prohibited by Federal law. Using leaded gasoline can impair engine performance, and damage the emission control system.
- An out-of-tune engine, or certain fuel or ignition malfunctions, can cause the catalytic converter to overheat. If you notice a pungent burning odor or some light smoke, your engine may be out of tune or malfunctioning and may require immediate service. Contact your authorized dealer for service assistance.
- The use of fuel additives, which are now being sold as octane enhancers, is not recommended. Most of these products contain high concentrations of methanol. Fuel system damage or vehicle performance problems resulting from the use of such fuels or additives is not the responsibility of the manufacturer.

**NOTE:** Intentional tampering with emissions control systems can result in civil penalties being assessed against you.

### Carbon Monoxide Warnings

#### **WARNING!**

Carbon monoxide (CO) in exhaust gases is deadly. Follow the precautions below to prevent carbon monoxide poisoning.

*(Continued)*

#### **WARNING! (Continued)**

- Do not inhale exhaust gases. They contain carbon monoxide, a colorless and odorless gas, which can kill. Never run the engine in a closed area, such as a garage, and never sit in a parked vehicle with the engine running for an extended period. If the vehicle is stopped in an open area with the engine running for more than a short period, adjust the ventilation system to force fresh, outside air into the vehicle.
- Guard against carbon monoxide with proper maintenance. Have the exhaust system inspected every time the vehicle is raised. Have any abnormal conditions repaired promptly. Until repaired, drive with all side windows fully open.
- Keep the liftgate closed when driving your vehicle to prevent carbon monoxide and other poisonous exhaust gases from entering the vehicle.

## ADDING FUEL

### Fuel Filler Cap (Gas Cap)

The gas cap is located behind the fuel filler door, on the driver's side of the vehicle. If the gas cap is lost or damaged, be sure the replacement cap has been designed for use with this vehicle.

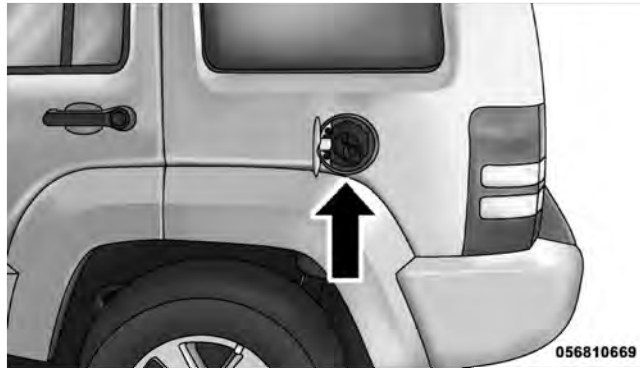

Fuel Filler Cap

### CAUTION!

- Damage to the fuel system or emission control system could result from using an improper fuel cap (gas cap). A poorly fitting cap could let impurities into the fuel system. Also, a poorly fitting aftermarket cap can cause the "Malfunction Indicator Light (MIL)" to illuminate, due to fuel vapors escaping from the system.
- A poorly fitting gas cap may cause the MIL to turn on.
- To avoid fuel spillage and overfilling, do not "top off" the fuel tank after filling.

**WARNING!**

- Never have any smoking materials lit in or near the vehicle when the gas cap is removed or the tank is being filled.
- Never add fuel when the engine is running. This is in violation of most state and federal fire regulations and may cause the MIL to turn on.
- A fire may result if gasoline is pumped into a portable container that is inside of a vehicle. You could be burned. Always place gas containers on the ground while filling.

**NOTE:**

- When the fuel nozzle “clicks” or shuts off, the fuel tank is full.
- Tighten the gas cap about one quarter turn until you hear one click. This is an indication that the cap is properly tightened.

- If the gas cap is not tightened properly, the MIL will come on. Be sure the gas cap is tightened every time the vehicle is refueled.

**Loose Fuel Filler Cap Message**

If the vehicle diagnostic system determines that the fuel filler cap is loose, improperly installed, or damaged, a “GASCAP” message will display in the odometer or a “CHECK GASCAP” message will be displayed in the Electronic Vehicle Information Center (EVIC). Refer to “Electronic Vehicle Information Center (EVIC)” in “Understanding Your Instrument Panel” for further review. Tighten the fuel filler cap until a “clicking” sound is heard. This is an indication that the fuel filler cap is properly tightened. Refer to “Onboard Diagnostic System” in “Maintaining Your Vehicle” for further information.

## VEHICLE LOADING

### Certification Label

As required by National Highway Traffic Safety Administration regulations, your vehicle has a certification label affixed to the driver's side door or B-Pillar.

This label contains the month and year of manufacture, Gross Vehicle Weight Rating (GVWR), Gross Axle Weight Rating (GAWR) front and rear, and Vehicle Identification Number (VIN). A Month-Day-Hour (MDH) number is included on this label and indicates the month, day, and hour of manufacture. The bar code that appears on the bottom of the label is your VIN.

### Gross Vehicle Weight Rating (GVWR)

The GVWR is the total permissible weight of your vehicle including driver, passengers, vehicle, options, trailer tongue weight, and cargo. The label also specifies maximum capacities of front and rear axle systems (GAWR). Total load must be limited, so GVWR, and front and rear GAWR are not exceeded.

### Payload

The payload of a vehicle is defined as the allowable load weight a truck or any given vehicle can carry, including the weight of the driver, all passengers, options and cargo.

### Gross Axle Weight Rating (GAWR)

The GAWR is the maximum permissible load on the front and rear axles. The load must be distributed in the cargo area so that the GAWR of each axle is not exceeded.

Each axle's GAWR is determined by the components in the system with the lowest load carrying capacity (axle, springs, tires, or wheels). Heavier axles or suspension components, sometimes specified by purchasers for increased durability, does not necessarily increase the vehicle's GVWR.

### **Tire Size**

The tire size on the label represents the actual tire size on your vehicle. Replacement tires must be equal to the load capacity of this tire size.

### **Rim Size**

This is the rim size that is appropriate for the tire size listed.

### **Inflation Pressure**

This is the cold tire inflation pressure for your vehicle for all loading conditions up to full GAWR.

### **Curb Weight**

The curb weight of a vehicle is defined as the total weight of the vehicle with all fluids, including vehicle fuel, at full capacity conditions, and with no occupants or cargo loaded into the vehicle. The front and rear curb weight values are determined by weighing your vehicle on a commercial scale before any occupants or cargo are added.

### **Loading**

The actual total weight and the weight of the front and rear of your vehicle at the ground can best be determined by weighing it when it is loaded and ready for operation.

The entire vehicle should first be weighed on a commercial scale to ensure that the GVWR has not been exceeded. The weight on the front and rear of the vehicle should then be determined separately to be sure that the load is properly distributed over front and rear axle. Weighing the vehicle may show that the GAWR of either

the front or rear axles has been exceeded, but the total load is within the specified GVWR. If so, weight must be shifted from front to rear, or rear to front, as appropriate until the specified weight limitations are met. Store the heavier items down low and be sure that the weight is distributed equally. Stow all loose items securely before driving.

Improper weight distributions can have an adverse affect on the way your vehicle steers and handles, and the way the brakes operate.

### **CAUTION!**

**Do not load your vehicle any heavier than the GVWR or the maximum front and rear GAWR. If you do, parts on your vehicle can break, or it can change the way your vehicle handles. This could cause you to lose control. Also, overloading can shorten the life of your vehicle.**

## **TRAILER TOWING**

In this section, you will find safety tips and information on limits to the type of towing you can reasonably do with your vehicle. Before towing a trailer, carefully review this information to tow your load as efficiently and safely as possible.

To maintain warranty coverage, follow the requirements and recommendations in this manual concerning vehicles used for trailer towing.

### **Common Towing Definitions**

The following trailer towing related definitions will assist you in understanding the following information:

#### **Gross Vehicle Weight Rating (GVWR)**

The GVWR is the total allowable weight of your vehicle. This includes driver, passengers, cargo, and tongue weight. The total load must be limited so that you do not

exceed the GVWR. Refer to “Vehicle Loading/Vehicle Certification Label” in “Starting and Operating” for further information.

### **Gross Trailer Weight (GTW)**

The GTW is the weight of the trailer plus the weight of all cargo, consumables, and equipment (permanent or temporary) loaded in or on the trailer in its “loaded and ready for operation” condition.

The recommended way to measure GTW is to put your fully loaded trailer on a vehicle scale. The entire weight of the trailer must be supported by the scale.

#### **WARNING!**

If the Gross Trailer Weight (GTW) is 3,500 lbs (1 587 kg) or more, it is mandatory to use a weight-distributing hitch to ensure stable handling of your vehicle. If you use a standard weight-carrying hitch, you could lose control of your vehicle and cause a collision.

### **Gross Combination Weight Rating (GCWR)**

The GCWR is the total permissible weight of your vehicle and trailer when weighed in combination.

**NOTE:** The GCWR rating includes a 150 lbs (68 kg) allowance for the presence of a driver.

### **Gross Axle Weight Rating (GAWR)**

The GAWR is the maximum capacity of the front and rear axles. Distribute the load over the front and rear axles evenly. Make sure that you do not exceed either front or rear GAWR. Refer to “Vehicle Loading/Vehicle Certification Label” in “Starting and Operating” for further information.

#### **WARNING!**

It is important that you do not exceed the maximum front or rear GAWR. A dangerous driving condition can result if either rating is exceeded. You could lose control of the vehicle and have a collision.



### **Tongue Weight (TW)**

The tongue weight is the downward force exerted on the hitch ball by the trailer. In most cases, it should not be less than 10% or more than 15% of the trailer load. You must consider this as part of the load on your vehicle.

### **Frontal Area**

The frontal area is the maximum height multiplied by the maximum width of the front of a trailer.

### **Trailer Sway Control – Mechanical**

The trailer sway control is a telescoping link that can be installed between the hitch receiver and the trailer tongue that typically provides adjustable friction associated with the telescoping motion to dampen any unwanted trailer swaying motions while traveling.

### **Weight-Carrying Hitch**

A weight-carrying hitch supports the trailer tongue weight, just as if it were luggage located at a hitch ball or some other connecting point of the vehicle. These kinds

of hitches are the most popular on the market today and they are commonly used to tow small- and medium-sized trailers.

### **Weight-Distributing Hitch**

A weight-distributing system works by applying leverage through spring (load) bars. They are typically used for heavier loads, to distribute trailer tongue weight to the tow vehicle's front axle and the trailer axle(s). When used in accordance with the manufacturers' directions, it provides for a more level ride, offering more consistent steering and brake control thereby enhancing towing safety. The addition of a friction/hydraulic sway control also dampens sway caused by traffic and crosswinds and contributes positively to tow vehicle and trailer stability. Trailer sway control and a weight distributing (load equalizing) hitch are recommended for heavier Tongue Weights (TW) and may be required depending on Vehicle and Trailer configuration/loading to comply with Gross Axle Weight Rating (GAWR) requirements.

**WARNING!**

- An improperly adjusted Weight Distributing Hitch system may reduce handling, stability, braking performance, and could result in a collision.
- Weight Distributing Systems may not be compatible with Surge Brake Couplers. Consult with your hitch and trailer manufacturer or a reputable Recreational Vehicle dealer for additional information.

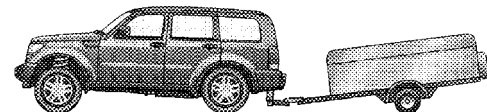

057005576

**Without Weight Distributing Hitch (Incorrect)**

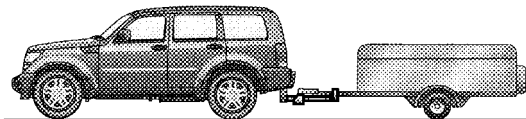

057005577

With Weight Distributing Hitch (Correct)

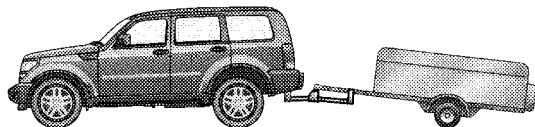

057005578

Improper Adjustment of Weight-Distributing Hitch  
(Incorrect)

### Trailer Hitch Classification

Your vehicle is capable of towing trailers up to 2,000 lbs (907 kg) without added equipment or alterations to the standard equipment. Your vehicle may be factory equipped for safe towing of trailers weighing over 2,000 lbs (907 kg) with the optional Trailer Tow Prep Package. See your authorized dealer for package content.

The following chart provides the industry standard for the maximum trailer weight a given trailer hitch class can tow. This should be used to assist you in selecting the correct trailer hitch for your intended towing condition. Refer to the “Trailer Towing Weights (Maximum Trailer Weight Ratings)” chart for the Max. GTW towable for your given drivetrain.

Trailer Hitch Classification Definitions	
Class	Max. Trailer Hitch Industry Standards
Class I - Light Duty	2,000 lbs (907 kg)
Class II - Medium Duty	3,500 lbs (1 587 kg)
Class III - Heavy Duty	5,000 lbs (2 268 kg)
Class IV - Extra Heavy Duty	10,000 lbs (4 540 kg)
Refer to the “Trailer Towing Weights (Maximum Trailer Weight Ratings)” chart for the Maximum Gross Trailer Weight (GTW) towable for your given drivetrain.	

All trailer hitches should be professionally installed on your vehicle.

### Trailer Towing Weights (Maximum Trailer Weight Ratings)

The following chart provides the maximum trailer weight ratings towable for your given drivetrain.

Engine/ Transmission	Model	Frontal Area	Max. GTW (Gross Trailer Wt.)	Max. Tongue Wt. (See Note)
3.7L/Automatic	4x2	32 sq ft (2.97 sq m)	2,000 lbs (907 kg)	200 lbs (91 kg)
3.7L/Automatic	4x4	32 sq ft (2.97 sq m)	2,000 lbs (907 kg)	200 lbs (91 kg)

Refer to local laws for maximum trailer towing speeds.

**NOTE:** The trailer tongue weight must be considered as part of the combined weight of occupants and cargo (ie. the GVWR), and the GVWR should never exceed the weight referenced on the Tire and Loading Information placard. Refer to "Tire Safety Information" in "Starting and Operating" for further information.

### When Towing Trailers With Gross Trailer Weight (GTW) Between 3,500 Lbs (1 588 kg) And 5,000 Lbs (2 268 kg)

The following chart provides maximum trailer weight ratings towable for the following engine/transmission combinations, **ONLY** if using a weight distributing hitch.

Engine/ Transmission	Model	Frontal Area	Max. GTW (Gross Trailer Wt.)	Max. Tongue Wt. (See Note)
3.7L/ Automatic w/Trailer Tow Package	4x2	64 sq ft (5.94 sq m)	5,000 lbs (2 268 kg)	500 lbs (227 kg)
3.7L/ Automatic w/Trailer Tow package	4x4	64 sq ft (5.94 sq m)	5,000 lbs (2 268 kg)	500 lbs (227 kg)

Refer to local laws for maximum trailer towing speeds.

**NOTE:** The trailer tongue weight must be considered as part of the combined weight of occupants and cargo (ie. the GVWR), and the GVWR should never exceed the weight referenced on the Tire and Loading Information placard. Refer to "Tire Safety Information" in "Starting and Operating" for further information.

## Trailer And Tongue Weight

Always load a trailer with 60% to 65% of the weight in the front of the trailer. This places 10% to 15% of the Gross Trailer Weight (GTW) on the tow hitch of your vehicle. Loads balanced over the wheels or heavier in the rear can cause the trailer to sway **severely** side to side which will cause loss of control of vehicle and trailer. Failure to load trailers heavier in front is the cause of many trailer collisions.

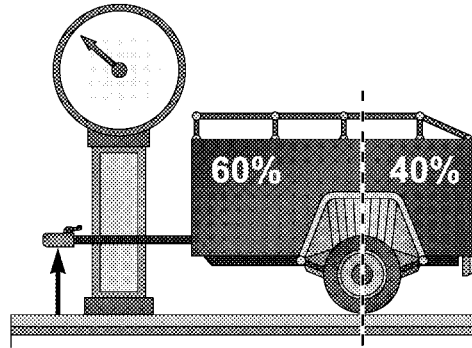

057003767

5

Consider the following items when computing the weight on the rear axle of the vehicle:

- The tongue weight of the trailer.
- The weight of any other type of cargo or equipment put in or on your vehicle.
- The weight of the driver and all passengers.

**NOTE:** Remember that everything put into or on the trailer adds to the load on your vehicle. Also, additional factory-installed options, or authorized dealer-installed options, must be considered as part of the total load on your vehicle. Refer to the “Tire and Loading Information” placard for the maximum combined weight of occupants and cargo for your vehicle.

### Towing Requirements

To promote proper break-in of your new vehicle drive-train components, the following guidelines are recommended:

#### CAUTION!

- Do not tow a trailer at all during the first 500 miles (805 km) the new vehicle is driven. The engine, axle or other parts could be damaged.

*(Continued)*

#### CAUTION! (Continued)

- Then, during the first 500 miles (805 km) that a trailer is towed, do not drive over 50 mph (80 km/h) and do not make starts at full throttle. This helps the engine and other parts of the vehicle wear in at the heavier loads.

#### WARNING!

Improper towing can lead to a collision. Follow these guidelines to make your trailer towing as safe as possible:

*(Continued)*



**WARNING! (Continued)**

- Make certain that the load is secured in the trailer and that it will not shift during travel. When trailering cargo that is not fully secured, dynamic load shifts can occur that may be difficult for the driver to control. You could lose control of your vehicle and have a collision.
- When hauling cargo, or towing a trailer, do not overload your vehicle or trailer. Overloading can cause a loss of control, poor performance, or damage to brakes, axle, engine, transmission, steering, suspension, chassis structure, or tires.
- Safety chains must always be used between your vehicle and trailer. Always connect the chains to the frame or hook retainers of the vehicle hitch. Cross the chains under the trailer tongue and allow enough slack for turning corners.

*(Continued)*

**WARNING! (Continued)**

- Vehicles with trailers should not be parked on a grade. When parking, apply the parking brake on the tow vehicle. Put the tow vehicle transmission in PARK. Always, block or "chock" the trailer wheels.
- GCWR must not be exceeded.
- Total weight must be distributed between the tow vehicle and the trailer such that the following four ratings are not exceeded:
  1. GVWR
  2. GTW
  3. GAWR
  4. Tongue weight rating for the trailer hitch utilized (This requirement may limit the ability to always achieve the 10% to 15% range of tongue weight as a percentage of total trailer weight).

### Towing Requirements – Tires

- Do not attempt to tow a trailer while using a compact spare tire.
- Proper tire inflation pressures are essential to the safe and satisfactory operation of your vehicle. Refer to “Tires – General Information” in “Starting and Operating” for information on tire pressures and for proper tire inflation procedures.
- Check the trailer tires for proper tire inflation pressures before trailer usage.
- Check for signs of tire wear or visible tire damage before towing a trailer. Refer to “Tires – General Information” in “Starting and Operating” for information on tread wear indicators and for the proper inspection procedure.
- When replacing tires, refer to “Tires – General Information” in “Starting and Operating” for information

on replacement tires and for the proper tire replacement procedures. Replacing tires with a higher load carrying capacity will not increase the vehicle’s GVWR and GAWR limits.

### Towing Requirements – Trailer Brakes

- Do **not** interconnect the hydraulic brake system or vacuum system of your vehicle with that of the trailer. This could cause inadequate braking and possible personal injury.
- An electronically actuated trailer brake controller is required when towing a trailer with electronically actuated brakes. When towing a trailer equipped with a hydraulic surge actuated brake system, an electronic brake controller is not required.
- Trailer brakes are recommended for trailers over 1,000 lbs (454 kg) and required for trailers in excess of 2,000 lbs (907 kg).

**CAUTION!**

If the trailer weighs more than 1,000 lbs (454 kg) loaded, it should have its own brakes, and they should be of adequate capacity. Failure to do this could lead to accelerated brake lining wear, higher brake pedal effort, and longer stopping distances.

**WARNING!**

- Do not connect trailer brakes to your vehicle's hydraulic brake lines. It can overload your brake system and cause it to fail. You might not have brakes when you need them and could have a collision.

*(Continued)*

**WARNING! (Continued)**

- Towing any trailer will increase your stopping distance. When towing you should allow for additional space between your vehicle and the vehicle in front of you. Failure to do so could result in a collision.

**Towing Requirements – Trailer Lights And Wiring**

Whenever you pull a trailer, regardless of the trailer size, stoplights and turn signals on the trailer are required for motoring safety.

The Trailer Tow Package may include a four and seven-pin wiring harness. Use a factory approved trailer harness and connector.

**NOTE:** Do not cut or splice wiring into the vehicles wiring harness.

## 410 STARTING AND OPERATING

The electrical connections are all complete to the vehicle but you must mate the harness to a trailer connector. Refer to the following illustrations.

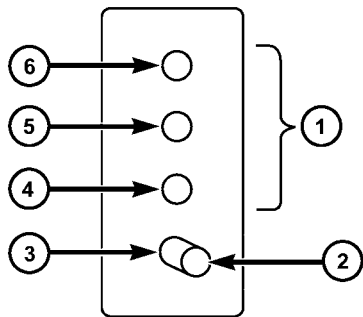

**Four-Pin Connector**

057003766

- |                 |                     |
|-----------------|---------------------|
| 1 — Female Pins | 4 — Park            |
| 2 — Male Pin    | 5 — Left Stop/Turn  |
| 3 — Ground      | 6 — Right Stop/Turn |

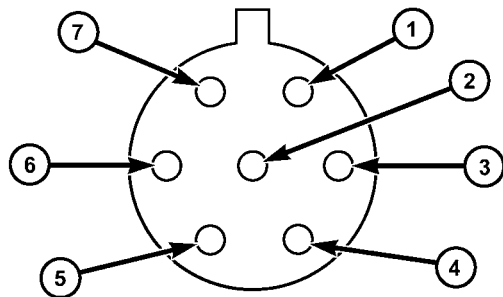

**Seven-Pin Connector**

057003765

- |                     |                    |
|---------------------|--------------------|
| 1 — Battery         | 5 — Ground         |
| 2 — Backup Lamps    | 6 — Left Stop/Turn |
| 3 — Right Stop/Turn | 7 — Running Lamps  |
| 4 — Electric Brakes |                    |

## Towing Tips

Before setting out on a trip, practice turning, stopping, and backing the trailer in an area located away from heavy traffic.

## Automatic Transmission

The “D” range can be selected when towing. However, if frequent shifting occurs while in this range, you will want to activate the TOW/HAUL feature. Refer to “Automatic Transmission” in “Starting and Operating” for further information.

**NOTE:** Using the TOW/HAUL feature while operating the vehicle under heavy operating conditions will improve performance and extend transmission life by reducing excessive shifting and heat build up. This action will also provide better engine braking.

If you REGULARLY tow a trailer for more than 45 minutes of continuous operation, then change the automatic transmission fluid and filter according to the interval specified for “police, taxi, fleet, or frequent trailer towing.” Refer to “Maintenance Schedule” for the proper maintenance intervals.

## TOW/HAUL

To reduce potential for automatic transmission overheating, press the TOW HAUL button when driving in hilly areas or shift the transmission to Drive position “2” on more severe grades. Refer to “Automatic Transmission” in “Starting and Operating” for further information.

### Electronic Speed Control – If Equipped

- Do not use in hilly terrain or with heavy loads.
- When using the speed control, if you experience speed drops greater than 10 mph (16 km/h), disengage until you can get back to cruising speed.
- Use speed control in flat terrain and with light loads to maximize fuel efficiency.

### Cooling System

To reduce potential for engine and transmission overheating, take the following actions:

#### – *City Driving*

When stopped for short periods of time, shift the transmission into NEUTRAL and increase engine idle speed.

#### – *Highway Driving*

Reduce speed.

#### – *Air Conditioning*

Turn off temporarily.

**RECREATIONAL TOWING (BEHIND MOTORHOME, ETC.)****Towing This Vehicle Behind Another Vehicle**

Towing Condition	Wheel OFF the Ground	Two-Wheel Drive Models	Four-Wheel Drive Models
Flat Tow	NONE	<b>NOT ALLOWED</b>	<i>See Instructions</i> <ul style="list-style-type: none"> <li>• Transmission in PARK</li> <li>• Transfer case in NEUTRAL (N)</li> <li>• Tow in forward direction</li> </ul>
Dolly Tow	Front	<b>NOT ALLOWED</b>	<b>NOT ALLOWED</b>
	Rear	OK	<b>NOT ALLOWED</b>
On Trailer	ALL	OK	OK

### Recreational Towing — Two-Wheel Drive Models

Recreational towing is allowed if the rear wheels are **OFF** the ground. This may be accomplished using a tow dolly or vehicle trailer. If using a tow dolly, follow this procedure:

1. Properly secure the dolly to the tow vehicle, following the dolly manufacturer's instructions.
2. Drive the rear wheels onto the tow dolly.
3. Firmly set the parking brake. Place the transmission in PARK.
4. Properly secure the rear wheels to the dolly, following the dolly manufacturer's instructions.
5. Turn the ignition switch to the unlocked OFF position.
6. Install a suitable clamping device, designed for towing, to secure the front wheels in the straight position.

7. Disconnect the negative battery cable and secure it away from the battery post.

**Flat towing (with all four wheels on the ground) is allowed ONLY if the driveshaft is removed.** Towing with the rear wheels on the ground while the driveshaft is connected will result in severe transmission damage.

#### WARNING!

**If the driveshaft is removed, the vehicle can roll even if the transmission is in PARK, which could cause serious injury or death.**

The parking brake **must** be firmly engaged **and the wheels chocked** during driveshaft removal and installation. The parking brake must **remain** engaged unless the vehicle is securely and properly connected to the tow vehicle, or the driveshaft is completely reinstalled. See your authorized dealer for proper driveshaft removal



and reinstallation procedures, including flange orientation/alignment, use of thread-locking compound, proper bolt torque specifications, etc.

### CAUTION!

Towing with the rear wheels on the ground (while the driveshaft is connected) will cause severe transmission damage. Damage from improper towing is not covered under the New Vehicle Limited Warranty.

### Recreational Towing — Four-Wheel Drive Models

The transfer case must be shifted into NEUTRAL (N) and the transmission must be placed in PARK for recreational towing. The NEUTRAL (N) selection button is adjacent to the transfer case selector switch. Shifts into and out of transfer case NEUTRAL (N) can take place with the selector switch in any mode position.

### CAUTION!

- Front or rear wheel lifts should not be used. Internal damage to the transmission or transfer case will occur if a front or rear wheel lift is used when recreational towing.
- Tow only in a forward direction. Towing this vehicle backwards can cause severe damage to the transfer case.
- The transmission must be placed in PARK for recreational towing.
- Before recreational towing, perform the procedure outlined under “Shifting into NEUTRAL (N)” to be certain that the transfer case is fully in NEUTRAL (N). Otherwise, internal damage will result.
- Failure to follow these procedures can cause severe transmission and/or transfer case damage.
- Do not use a bumper-mounted clamp-on tow bar on your vehicle. The bumper face bar will be damaged.

## Shifting Into NEUTRAL (N)

**WARNING!**

You or others could be injured if you leave the vehicle unattended with the transfer case in the NEUTRAL (N) position without first fully engaging the parking brake. The transfer case NEUTRAL (N) position disengages both the front and rear drive-shafts from the powertrain and will allow the vehicle to move, even if the transmission is in PARK. The parking brake should always be applied when the driver is not in the vehicle.

Use the following procedure to prepare your vehicle for recreational towing.

**CAUTION!**

It is necessary to follow these steps to be certain that the transfer case is fully in NEUTRAL (N) before recreational towing to prevent damage to internal parts.

1. Bring the vehicle to a complete stop and shift the transmission to PARK.
2. Turn OFF the ignition.
3. Turn the ignition switch to the ON/RUN position, but do not start the engine.
4. Press and hold the brake pedal.
5. Shift the transmission into NEUTRAL.
6. Using the point of a ballpoint pen or similar object, press and hold the recessed transfer case N (Neutral)

button (located above the selector switch) for four seconds, until the light behind the N symbol starts to blink, indicating shift in progress. The light will stop blinking (stay on solid) when the shift to N (Neutral) is complete.

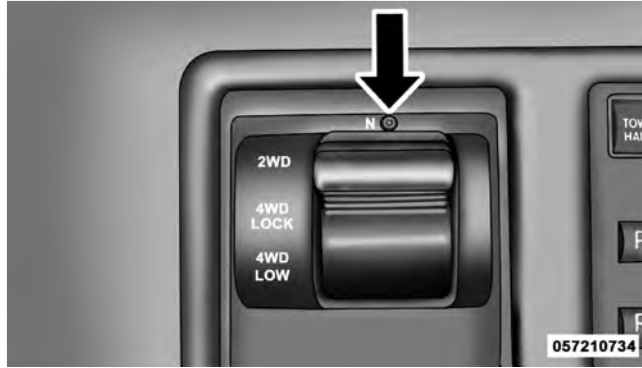

**Neutral Switch**

7. After the shift is completed and the NEUTRAL light comes on, release the NEUTRAL button.

8. Start the engine.
9. Shift the transmission into REVERSE.
10. Release the brake pedal for five seconds and ensure that there is no vehicle movement.
11. Turn OFF the engine and leave the ignition switch in the unlocked OFF position.
12. Firmly apply the parking brake.
13. Shift the transmission into PARK.

### CAUTION!

Damage to the transmission may occur if the transmission is shifted into PARK with the transfer case in NEUTRAL (N) and the engine running. With the transfer case in NEUTRAL (N) ensure that the engine is off prior to shifting the transmission into PARK.

14. Attach the vehicle to the tow vehicle using a suitable tow bar.
15. Release the parking brake.
16. Disconnect the negative battery cable, and secure it away from the negative battery post.

**NOTE:**

- Steps 1 through 5 are requirements that must be met prior to pressing the NEUTRAL (N) button, and must continue to be met until the four seconds elapse and the shift has been completed. If any of these requirements are not met prior to pressing the NEUTRAL (N) button or are no longer met during the four second timer, then the NEUTRAL (N) indicator light will flash continuously until all requirements are met or until the NEUTRAL (N) button is released.
- The ignition switch must be in the ON/RUN position for a shift to take place and for the position indicator

lights to be operable. If the ignition switch is not in the ON/RUN position, the shift will not take place and no position indicator lights will be on or flashing.

- A flashing NEUTRAL (N) position indicator light indicates that shift requirements have not been met.

**Shifting Out Of NEUTRAL (N)**

Use the following procedure to prepare your vehicle for normal usage.

1. Bring the vehicle to a complete stop, leaving it connected to the tow vehicle.
2. Firmly apply the parking brake.
3. Reconnect the negative battery cable.
4. Turn the ignition switch to the LOCK/OFF position (if it has been moved or the engine has been started).
5. Turn the ignition switch to the ON/RUN position, but do not start the engine.

6. Press and hold the brake pedal.
7. Shift the transmission into NEUTRAL.
8. Using the point of a ballpoint pen or similar object, press and hold the recessed transfer case N (Neutral) button (located above the selector switch) for one second.

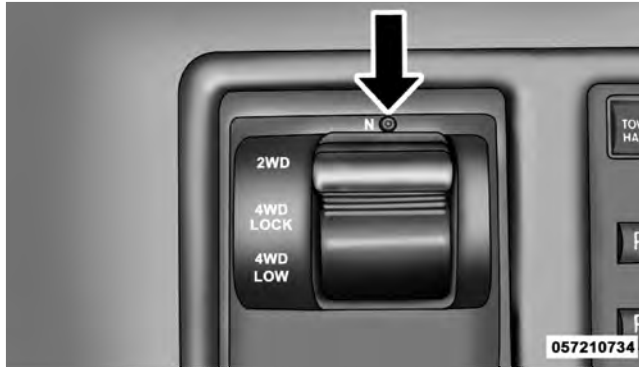

Neutral Switch

9. After the N (Neutral) indicator light turns off, release the N (Neutral) button.
  10. After the N (Neutral) button has been released, the transfer case will shift to the position indicated by the selector switch.
- NOTE:** When shifting out of transfer case N (Neutral), turning the engine OFF may be required to avoid gear clash.
11. Shift the transmission into PARK.
  12. Release the brake pedal.
  13. Disconnect vehicle from the tow vehicle.
  14. Start the engine.
  15. Press and hold the brake pedal.
  16. Release the parking brake.

17. Shift the transmission into DRIVE, release the brake pedal, and check that the vehicle operates normally.

**NOTE:**

- Steps 1 through 7 are requirements that must be met prior to pressing the NEUTRAL (Neutral) button, and must continue to be met until the shift has been completed. If any of these requirements are not met prior to pressing the NEUTRAL (N) button or are no longer met during the shift, the NEUTRAL (N) indicator light will flash continuously until all requirements are met or until the NEUTRAL (N) button is released.
- The ignition switch must be in the ON/RUN position for a shift to take place and for the position indicator lights to be operable. If the ignition switch is not in the ON/RUN position, the shift will not take place and no position indicator lights will be on or flashing.
- A flashing NEUTRAL (N) position indicator light indicates that shift requirements have not been met.

# WHAT TO DO IN EMERGENCIES

## CONTENTS

---

■ Hazard Warning Flashers . . . . .	422	■ Jump-Starting Procedures . . . . .	430
■ If Your Engine Overheats . . . . .	422	□ Preparations For Jump-Start . . . . .	430
■ Jacking And Tire Changing . . . . .	423	□ Jump-Starting Procedure . . . . .	432
□ Jack Location . . . . .	424	■ Freeing A Stuck Vehicle . . . . .	434
□ Spare Tire Stowage . . . . .	424	■ Shift Lever Override . . . . .	435
□ Spare Tire Removal . . . . .	425	■ Towing A Disabled Vehicle . . . . .	436
□ Preparations For Jacking . . . . .	426	□ Towing Without The Ignition Key FOB . . . . .	438
□ Jacking Instructions . . . . .	426	□ Two-Wheel Drive Models . . . . .	438
		□ Four-Wheel Drive Models . . . . .	440

## HAZARD WARNING FLASHERS

The Hazard Warning flasher switch is located in the switch bank below the climate controls.

 Press the switch to turn on the Hazard Warning flasher. When the switch is activated, all directional turn signals will flash on and off to warn oncoming traffic of an emergency. Press the switch a second time to turn off the Hazard Warning flashers.

This is an emergency warning system and it should not be used when the vehicle is in motion. Use it when your vehicle is disabled and it is creating a safety hazard for other motorists.

When you must leave the vehicle to seek assistance, the Hazard Warning flashers will continue to operate even though the ignition is placed in the OFF position.

**NOTE:** With extended use the Hazard Warning flashers may wear down your battery.

## IF YOUR ENGINE OVERHEATS

In any of the following situations, you can reduce the potential for overheating your engine by taking the appropriate action.

- On the highways — slow down.
- In city traffic — while stopped, put transmission in NEUTRAL, but do not increase engine idle speed.

### CAUTION!

**Driving with a hot cooling system could damage your vehicle. If the temperature gauge reads “H,” pull over and stop the vehicle. Idle the vehicle with the air conditioner turned off until the pointer drops back into the normal range. If the pointer remains on the “H” and you hear continuous chimes, turn the engine off immediately and call for service.**



**NOTE:** There are steps that you can take to slow down an impending overheat condition:

- If your air conditioner (A/C) is on, turn it off. The A/C system adds heat to the engine cooling system and turning the A/C off can help remove this heat.
- You can also turn the temperature control to maximum heat, the mode control to floor and the blower control to high. This allows the heater core to act as a supplement to the radiator and aids in removing heat from the engine cooling system.

### **WARNING!**

You or others can be badly burned by hot engine coolant (antifreeze) or steam from your radiator. If you see or hear steam coming from under the hood, do not open the hood until the radiator has had time to cool. Never try to open a cooling system pressure cap when the radiator or coolant bottle is hot.

## **JACKING AND TIRE CHANGING**

### **WARNING!**

- Do not attempt to change a tire on the side of the vehicle close to moving traffic. Pull far enough off the road to avoid the danger of being hit when operating the jack or changing the wheel.
- Being under a jacked-up vehicle is dangerous. The vehicle could slip off the jack and fall on you. You could be crushed. Never put any part of your body under a vehicle that is on a jack.
- Never start or run the engine while the vehicle is on a jack. If you need to get under a raised vehicle, take it to a service center where it can be raised on a lift.

*(Continued)*

**WARNING! (Continued)**

- The jack is designed to be used as a tool for changing tires only. The jack should not be used to lift the vehicle for service purposes. The vehicle should be jacked on a firm level surface only. Avoid ice or slippery areas.

**Jack Location**

The scissor-type jack and tire changing tools are located in the cargo compartment behind a trim cover on the left rear trim panel. The latch is located at the bottom of the trim cover.

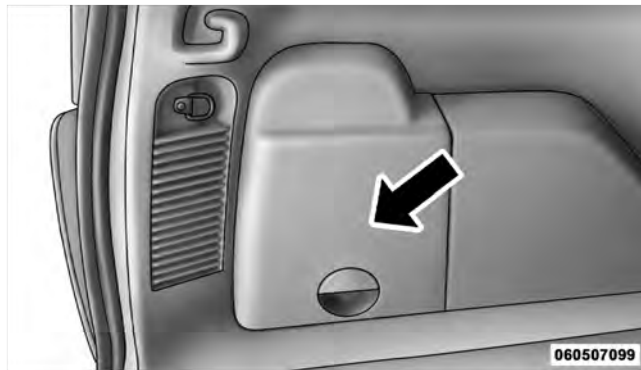

Jack Storage Location

**Spare Tire Stowage**

The spare tire is stowed underneath the rear of the vehicle and is held in place by a cable winch mechanism.

## Spare Tire Removal

Fit the jack handle extension over the drive nut located in the rear cargo area inside the vehicle. Use the lug wrench to rotate the nut counterclockwise until the spare is on the ground with enough slack in the cable to allow you to pull the tire out from under the vehicle.

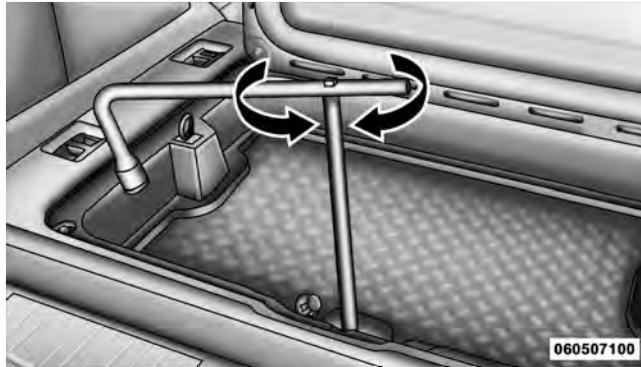

Lowering/Raising Spare Tire

## CAUTION!

The winch mechanism is designed for use with the jack extension tube only. Use of an air wrench or other power tools is not recommended and they can damage the winch.

When the spare is clear, tilt the retainer at the end of the cable, and pull it through the center of the wheel.

**NOTE:** Refer to “Compact Spare Tire” under “Tires-General Information” in “Starting And Operating” for information about the compact spare tire, its use, and operation.

## Preparations For Jacking

1. Park the vehicle on a firm level surface as far from the edge of the roadway as possible. Avoid icy or slippery areas.

### WARNING!

**Do not attempt to change a tire on the side of the vehicle close to moving traffic, pull far enough off the road to avoid being hit when operating the jack or changing the wheel.**

2. Turn on the Hazard Warning flasher.
3. Set the parking brake.
4. Place the shift lever into PARK (automatic transmission) or REVERSE (manual transmission).
5. Turn the ignition to the LOCK position.



6. Block both the front and rear of the wheel diagonally opposite of the jacking position. For example, if changing the right front tire, block the left rear wheel.

**NOTE:** Passengers should not remain in the vehicle when the vehicle is being jacked.

## Jacking Instructions

### WARNING!

**Carefully follow these tire changing warnings to help prevent personal injury or damage to your vehicle:**

- **Always park on a firm, level surface as far from the edge of the roadway as possible before raising the vehicle.**

*(Continued)*

**WARNING! (Continued)**

- Turn on the Hazard Warning flasher.
- Block the wheel diagonally opposite the wheel to be raised.
- Set the parking brake firmly and set an automatic transmission in **PARK**; a manual transmission in **REVERSE**.
- Never start or run the engine with the vehicle on a jack.
- Do not let anyone sit in the vehicle when it is on a jack.
- Do not get under the vehicle when it is on a jack.
- Only use the jack in the positions indicated and for lifting this vehicle during a tire change.
- If working on or near a roadway, be extremely careful of motor traffic.



Jack Warning Label

**CAUTION!**

Do not attempt to raise the vehicle by jacking on locations other than those indicated in the Jacking Instructions for this vehicle.

1. Remove spare tire.
2. Remove jack and tools from mounting bracket. Assemble the tools by connecting the driver to the extension, and then to the lug wrench.

3. Loosen (but do not remove) the wheel lug nuts by turning them to the left one turn while the wheel is still on the ground.

4. Locate the jack as shown. For the front tires, place it (rearward) of the notch on the body weld seam behind wheel to be changed.



Front Jacking Location

For the rear tires, place it under the axle by the wheel to be changed.

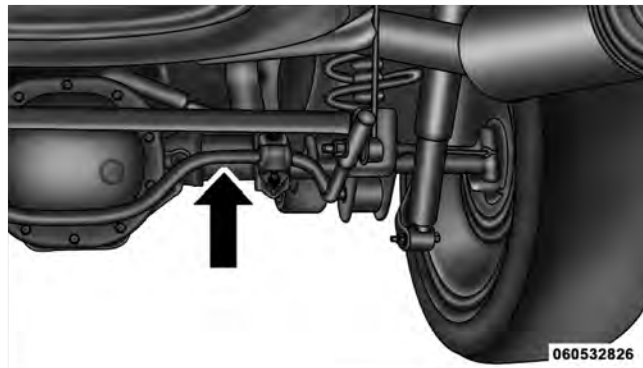

Rear Jacking Location

Position the jack handle on the jack. **Do not raise the vehicle until you are sure the jack is fully engaged.**

5. Raise the vehicle by turning the jack screw to the right. Raise the vehicle only until the tire just clears the surface

and enough clearance is obtained to install the spare tire. Minimum tire lift provides maximum stability.

**WARNING!**

**Raising the vehicle higher than necessary can make the vehicle less stable and cause a collision. It could slip off the jack and hurt someone near it. Raise the vehicle only enough to remove the tire.**

6. Remove the lug nuts and wheel.
7. Position the spare wheel/tire on the vehicle and install lug nuts with the cone-shaped end toward the wheel. Lightly tighten the nuts.

**WARNING!**

**To avoid the risk of forcing the vehicle off the jack, do not tighten the wheel nuts fully until the vehicle has been lowered.**

8. Lower the vehicle by turning the jack screw to the left, and remove the jack.

9. Finish tightening the lug nuts. Push down on the wrench while tightening for increased leverage. Alternate nuts until each nut has been tightened twice. The correct wheel nut tightness is 95 ft lb (130 N·m). If in doubt about the correct tightness, have them checked with a torque wrench by your authorized dealer or at a service station.

10. Lower the jack to its fully closed position.

11. Secure the tire, jack, and tools in their proper locations.

**WARNING!**

**A loose tire or jack, thrown forward in a collision or hard stop, could endanger the occupants of the vehicle. Always stow the jack parts and the spare tire in the places provided.**

12. Remove blocks from wheels.

### **JUMP-STARTING PROCEDURES**

If your vehicle has a discharged battery it can be jump-started using a set of jumper cables and a battery in another vehicle or by using a portable battery booster pack. Jump-starting can be dangerous if done improperly so please follow the procedures in this section carefully.

**NOTE:** When using a portable battery booster pack follow the manufacturer's operating instructions and precautions.

#### **CAUTION!**

**Do not use a portable battery booster pack or any other booster source with a system voltage greater than 12 Volts or damage to the battery, starter motor, alternator or electrical system may occur.**

#### **WARNING!**

**Do not attempt jump-starting if the battery is frozen. It could rupture or explode and cause personal injury.**

### **Preparations For Jump-Start**

The battery in your vehicle is located in the front of the engine compartment, behind the left headlight assembly.

**NOTE:** The positive battery post is covered with a protective cap. Lift up on the cap to gain access to the positive battery post.





Positive Battery Post

### WARNING!

- Take care to avoid the radiator cooling fan whenever the hood is raised. It can start anytime the ignition switch is on. You can be injured by moving fan blades.
- Remove any metal jewelry such as watch bands or bracelets that might make an inadvertent electrical contact. You could be seriously injured.
- Batteries contain sulfuric acid that can burn your skin or eyes and generate hydrogen gas which is flammable and explosive. Keep open flames or sparks away from the battery.

1. Set the parking brake, shift the automatic transmission into PARK and turn the ignition to LOCK.
2. Turn off the heater, radio, and all unnecessary electrical accessories.

3. If using another vehicle to jump-start the battery, park the vehicle within the jumper cables reach, set the parking brake and make sure the ignition is OFF.

**WARNING!**

Do not allow vehicles to touch each other as this could establish a ground connection and personal injury could result.

**Jump-Starting Procedure****WARNING!**

Failure to follow this procedure could result in personal injury or property damage due to battery explosion.

**CAUTION!**

Failure to follow these procedures could result in damage to the charging system of the booster vehicle or the discharged vehicle.

1. Connect the positive (+) end of the jumper cable to the positive (+) post of the discharged vehicle.
2. Connect the opposite end of the positive (+) jumper cable to the positive (+) post of the booster battery.
3. Connect the negative end (-) of the jumper cable to the negative (-) post of the booster battery.
4. Connect the opposite end of the negative (-) jumper cable to a good engine ground (exposed metal part of the discharged vehicle's engine) away from the battery and the fuel injection system.

**WARNING!**

**Do not connect the cable to the negative post (-) of the discharged battery. The resulting electrical spark could cause the battery to explode and could result in personal injury.**

5. Start the engine in the vehicle that has the booster battery, let the engine idle a few minutes, and then start the engine in the vehicle with the discharged battery.

Once the engine is started, remove the jumper cables in the reverse sequence:

6. Disconnect the negative (-) jumper cable from the engine ground of the vehicle with the discharged battery.
7. Disconnect the negative end (-) of the jumper cable from the negative (-) post of the booster battery.

8. Disconnect the opposite end of the positive (+) jumper cable from the positive (+) post of the booster battery.
9. Disconnect the positive (+) end of the jumper cable from the positive (+) post of the discharged vehicle.

If frequent jump-starting is required to start your vehicle you should have the battery and charging system inspected at your authorized dealer.

**CAUTION!**

**Accessories that can be plugged into the vehicle power outlets draw power from the vehicle's battery, even when not in use (i.e., cellular phones, etc.). Eventually, if plugged in long enough, the vehicle's battery will discharge sufficiently to degrade battery life and/or prevent the engine from starting.**

### **FREEING A STUCK VEHICLE**

If your vehicle becomes stuck in mud, sand or snow, it can often be moved by a rocking motion. Turn your steering wheel right and left to clear the area around the front wheels. Then shift back and forth between DRIVE and REVERSE. Using minimal accelerator pedal pressure to maintain the rocking motion, without spinning the wheels, is most effective.

#### **CAUTION!**

Racing the engine or spinning the wheels may lead to transmission overheating and failure. Allow the engine to idle with the shift lever in NEUTRAL for at least one minute after every five rocking-motion cycles. This will minimize overheating and reduce the risk of transmission failure during prolonged efforts to free a stuck vehicle.

**NOTE:** If your vehicle is equipped with Traction Control or Electronic Stability Control (ESC), turn the system OFF before attempting to “rock” the vehicle.

#### **CAUTION!**

- When “rocking” a stuck vehicle by moving between DRIVE and REVERSE, do not spin the wheels faster than 15 mph (24 km/h), or drivetrain damage may result.
- Revving the engine or spinning the wheels too fast may lead to transmission overheating and failure. It can also damage the tires. Do not spin the wheels above 30 mph (48 km/h) while in gear (no transmission shifting occurring).

**WARNING!**

Fast spinning tires can be dangerous. Forces generated by excessive wheel speeds may cause damage, or even failure, of the axle and tires. A tire could explode and injure someone. Do not spin your vehicle's wheels faster than 30 mph (48 km/h) or for longer than 30 seconds continuously without stopping when you are stuck and do not let anyone near a spinning wheel, no matter what the speed.

**SHIFT LEVER OVERRIDE**

If a malfunction occurs and the shift lever cannot be moved out of the PARK position, you can use the following procedure to temporarily move the shift lever:

1. Firmly set the parking brake.
2. Using a screwdriver or similar tool, carefully remove the shift lever override access cover, located on the PRNDL bezel.

3. Turn the ignition to the ON/RUN position without starting the engine.
4. Press and maintain firm pressure on the brake pedal.
5. Using a screwdriver, reach into the opening and press and hold the shift override lever down.
6. Move the shift lever into the NEUTRAL position.
7. The vehicle may then be started in NEUTRAL.
8. Reinstall the shift lever override access cover.

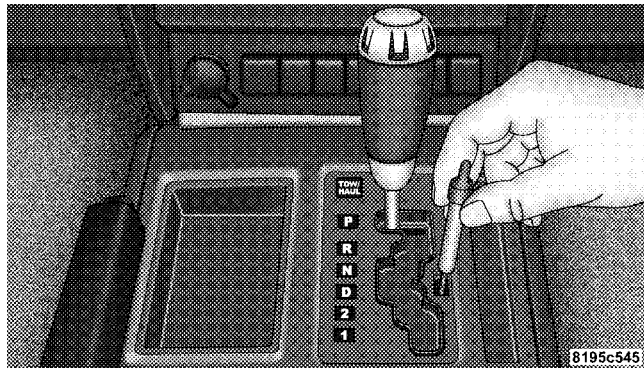

Shift Lever Override Access

### TOWING A DISABLED VEHICLE

This section describes procedures for towing a disabled vehicle using a commercial wrecker service. If the transmission and drivetrain are operable, disabled vehicles may also be towed as described under “Recreational Towing” in the “Starting And Operating” section.

Towing Condition	Wheels OFF the Ground	2WD Models	4WD Models
Flat Tow	NONE	<p><u>If transmission is operable:</u></p> <ul style="list-style-type: none"> <li>• Transmission in <b>NEUTRAL</b></li> <li>• 30 mph <b>max speed</b>(48 km/h)</li> <li>• 15 miles (24 km) <b>max distance</b></li> </ul>	<p>See instructions in “Recreational Towing” under “Starting and Operating”</p> <ul style="list-style-type: none"> <li>• Transmission in <b>PARK</b></li> <li>• Transfer Case in <b>NEUTRAL</b></li> <li>• Tow in <b>forward</b> direction</li> </ul>
Wheel Lift or Dolly Tow	Front		<b>NOT ALLOWED</b>
	Rear	OK	<b>NOT ALLOWED</b>
Flatbed	<b>ALL</b>	<b>BEST METHOD</b>	<b>BEST METHOD</b>

Proper towing or lifting equipment is required to prevent damage to your vehicle. Use only tow bars and other equipment designed for the purpose, following equipment manufacturer’s instructions. Use of safety chains is mandatory. Attach a tow bar or other towing device to

main structural members of the vehicle, not to bumpers or associated brackets. State and local laws applying to vehicles under tow must be observed.

If you must use the accessories (wipers, defrosters, etc.) while being towed, the ignition must be in the ON/RUN position, not the ACC position.

If the vehicle's battery is discharged, refer to "Shift Lever Override" in "What To Do In Emergencies" for instructions on shifting the automatic transmission out of the PARK position for towing.

### CAUTION!

- Do not attempt to use sling type equipment when towing. When securing the vehicle to a flat bed truck, do not attach to front or rear suspension components. Damage to your vehicle may result from improper towing.
- If the vehicle being towed requires steering, the ignition must be in the ON/RUN or ACC position, not in the LOCK position.

### Towing Without The Ignition Key Fob

Special care must be taken when the vehicle is towed with the ignition in the LOCK/OFF position. The only approved method of towing without the ignition key is with a flatbed truck. Proper towing equipment is necessary to prevent damage to the vehicle.

### Two-Wheel Drive Models

The manufacturer recommends towing your vehicle with all four wheels **OFF** the ground using a flatbed.

If flatbed equipment is not available, and the transmission is operable, the vehicle may be towed (with rear wheels on the ground) with the transmission in **NEUTRAL**. Speed must not exceed 30 mph (48 km/h) and the distance must not exceed 15 miles (24 km).



**CAUTION!**

Towing faster than 30 mph (48 km/h) or farther than 15 miles (24 km) with rear wheels on the ground can cause severe damage to the transmission. Such damage is not covered by the New Vehicle Limited Warranty.

If the transmission is not operable, or the vehicle must be towed faster than 30 mph (48 km/h) or farther than 15 miles (24 km), tow with the rear wheels **OFF** the ground (on a flatbed, or with the rear wheels raised using a wheel lift or towing dolly), or remove the driveshaft.

**WARNING!**

If the driveshaft is removed, the vehicle can roll even if the transmission is in PARK, which could cause serious injury or death.

The parking brake **must** be firmly engaged **and the wheels chocked** during driveshaft removal and installation. The parking brake must **remain** engaged unless the vehicle is securely and properly connected to the tow vehicle, or the driveshaft is completely reinstalled. See your authorized dealer for proper driveshaft removal and reinstallation procedures, including flange orientation/alignment, use of thread-locking compound, proper bolt torque specifications, etc.

### Four-Wheel Drive Models

The manufacturer recommends towing with all wheels **OFF** the ground. Acceptable methods are to tow the vehicle on a flatbed or with one end of vehicle raised and the opposite end on a towing dolly.

If flatbed equipment is not available, and the transfer case is operable, the vehicle may be towed (in the forward direction, with **ALL** wheels on the ground), **IF** the transfer case is in **NEUTRAL** and the transmission is in **PARK**. Refer to “Recreational Towing” in “Starting And Operating” for detailed instructions.

### CAUTION!

- **Front or rear wheel lifts should not be used. Internal damage to the transmission or transfer case will occur if a front or rear wheel lift is used when towing.**
- **Failure to follow these towing methods can cause severe damage to the transmission and/or transfer case. Such damage is not covered by the New Vehicle Limited Warranty.**

# MAINTAINING YOUR VEHICLE

## CONTENTS

---

■ Engine Compartment — 3.7L . . . . .	443	□ Engine Oil Filter . . . . .	450
■ Onboard Diagnostic System — OBD II . . . . .	444	□ Engine Air Cleaner Filter . . . . .	450
□ Loose Fuel Filler Cap Message . . . . .	444	□ Maintenance-Free Battery . . . . .	451
■ Emissions Inspection And Maintenance Programs . . . . .	445	□ Air Conditioner Maintenance . . . . .	453
■ Replacement Parts . . . . .	446	□ A/C Air Filter – If Equipped . . . . .	454
■ Dealer Service . . . . .	447	□ Body Lubrication . . . . .	454
■ Maintenance Procedures . . . . .	447	□ Windshield Wiper Blades . . . . .	455
□ Engine Oil . . . . .	448	□ Adding Washer Fluid . . . . .	455
		□ Exhaust System . . . . .	456

## 442 MAINTAINING YOUR VEHICLE

- Cooling System . . . . . 458
- Brake System . . . . . 464
- Automatic Transmission . . . . . 466
- Transfer Case . . . . . 468
- Front/Rear Axle Fluid . . . . . 469
- Sky Slider™ Top Care . . . . . 470
- Appearance Care And Protection From Corrosion . . . . . 472
- Fuses . . . . . 478
  - Totally Integrated Power Module . . . . . 478
- Replacement Bulbs . . . . . 484
  - Bulb Replacement . . . . . 484
    - Headlamp . . . . . 484
    - Front Turn Signal And Front Side Marker Lamp . . . . . 485
    - Front Fog Lamp . . . . . 485
    - Rear Tail/Stop, Turn Signal, And Back-Up Lamp . . . . . 486
  - Fluid Capacities . . . . . 487
  - Fluids, Lubricants, And Genuine Parts . . . . . 488
    - Engine . . . . . 488
    - Chassis . . . . . 489

## ENGINE COMPARTMENT — 3.7L

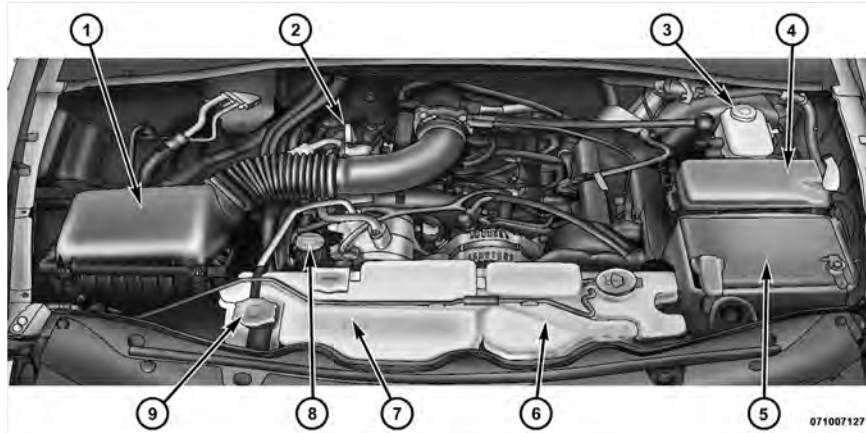

- 1 — Air Cleaner Filter
- 2 — Engine Oil Dipstick
- 3 — Brake Fluid Reservoir
- 4 — Integrated Power Module (Fuses)
- 5 — Battery

- 6 — Washer Fluid Reservoir
- 7 — Engine Coolant Reservoir
- 8 — Engine Oil Fill
- 9 — Coolant Pressure Cap

## ONBOARD DIAGNOSTIC SYSTEM — OBD II

Your vehicle is equipped with a sophisticated onboard diagnostic system called OBD II. This system monitors the performance of the emissions, engine, and automatic transmission control systems. When these systems are operating properly, your vehicle will provide excellent performance and fuel economy, as well as engine emissions well within current government regulations.

If any of these systems require service, the OBD II system will turn on the “Malfunction Indicator Light (MIL).” It will also store diagnostic codes and other information to assist your service technician in making repairs. Although your vehicle will usually be drivable and not need towing, see your authorized dealer for service as soon as possible.

### CAUTION!

- **Prolonged driving with the MIL on could cause further damage to the emission control system. It could also affect fuel economy and drivability. The vehicle must be serviced before any emissions tests can be performed.**
- **If the MIL is flashing while the engine is running, severe catalytic converter damage and power loss will soon occur. Immediate service is required.**

### Loose Fuel Filler Cap Message

If the vehicle diagnostic system determines that the fuel filler cap is loose, improperly installed, or damaged, a “gASCAP” message will display in the odometer or a “CHECK gASCAP” message will be displayed in the Electronic Vehicle Information Center (EVIC). Refer to

“Electronic Vehicle Information Center (EVIC)” in “Understanding Your Instrument Panel” for further information. Tighten the gas cap until a “clicking” sound is heard. This is an indication that the gas cap is properly tightened.

Press the odometer reset button to turn the message off. If the problem persists, the message will appear the next time the vehicle is started. This might indicate a damaged cap. If the problem is detected twice in a row, the system will turn on the MIL. Resolving the problem will turn the MIL light off.

## EMISSIONS INSPECTION AND MAINTENANCE PROGRAMS

In some localities, it may be a legal requirement to pass an inspection of your vehicle’s emissions control system. Failure to pass could prevent vehicle registration.



For states that require an Inspection and Maintenance (I/M), this check verifies the “Malfunction Indicator Light (MIL)” is functioning and is not on when the engine is running, and that the OBD II system is ready for testing.

Normally, the OBD II system will be ready. The OBD II system may **not** be ready if your vehicle was recently serviced, recently had a dead battery or a battery replacement. If the OBD II system should be determined not ready for the I/M test, your vehicle may fail the test.

Your vehicle has a simple ignition key-actuated test, which you can use prior to going to the test station. To check if your vehicle’s OBD II system is ready, you must do the following:

1. Turn the ignition switch to the ON position, but do not crank or start the engine.
2. If you crank or start the engine, you will have to start this test over.

3. As soon as you turn the ignition switch to the ON position, you will see the MIL symbol come on as part of a normal bulb check.

4. Approximately 15 seconds later, one of two things will happen:

a. The MIL will flash for about 10 seconds and then return to being fully illuminated until you turn OFF the ignition or start the engine. This means that your vehicle's OBD II system is **not ready** and you should **not** proceed to the I/M station.

b. The MIL will not flash at all and will remain fully illuminated until you turn OFF the ignition or start the engine. This means that your vehicle's OBD II system is **ready** and you can proceed to the I/M station.

If your OBD II system is **not ready**, you should see your authorized dealer or repair facility. If your vehicle was recently serviced or had a battery failure or replacement,

you may need to do nothing more than drive your vehicle as you normally would in order for your OBD II system to update. A recheck with the above test routine may then indicate that the system is now ready.

Regardless of whether your vehicle's OBD II system is ready or not, if the MIL is illuminated during normal vehicle operation you should have your vehicle serviced before going to the I/M station. The I/M station can fail your vehicle because the MIL is on with the engine running.

## REPLACEMENT PARTS

Use of genuine MOPAR® parts for normal/scheduled maintenance and repairs is highly recommended to ensure the designed performance. Damage or failures caused by the use of non-MOPAR® parts for maintenance and repairs will not be covered by the manufacturer's warranty.



## DEALER SERVICE

Your authorized dealer has the qualified service personnel, special tools, and equipment to perform all service operations in an expert manner. Service Manuals are available which include detailed service information for your vehicle. Refer to these Service Manuals before attempting any procedure yourself.

**NOTE:** Intentional tampering with emissions control systems may void your warranty and could result in civil penalties being assessed against you.

### WARNING!

You can be badly injured working on or around a motor vehicle. Only do service work for which you have the knowledge and the proper equipment. If you have any doubt about your ability to perform a service job, take your vehicle to a competent mechanic.

## MAINTENANCE PROCEDURES

The pages that follow contain the **required** maintenance services determined by the engineers who designed your vehicle.

Besides those maintenance items specified in the fixed maintenance schedule, there are other components which may require servicing or replacement in the future.

### CAUTION!

- Failure to properly maintain your vehicle or perform repairs and service when necessary could result in more costly repairs, damage to other components or negatively impact vehicle performance. Immediately have potential malfunctions examined by an authorized Chrysler Group LLC dealership or qualified repair center.

*(Continued)*

**CAUTION! (Continued)**

- **Your vehicle has been built with improved fluids that protect the performance and durability of your vehicle and also allow extended maintenance intervals. Do not use chemical flushes in these components as the chemicals can damage your engine, transmission, power steering or air conditioning. Such damage is not covered by the New Vehicle Limited Warranty. If a flush is needed because of component malfunction, use only the specified fluid for the flushing procedure.**

**Engine Oil****Checking Oil Level**

To assure proper engine lubrication, the engine oil must be maintained at the correct level. Check the oil level at regular intervals, such as every fuel stop. The best time to check the engine oil level is about five minutes after a fully warmed up engine is shut off.

Checking the oil while the vehicle is on level ground will improve the accuracy of the oil level readings. Always maintain the oil level within the SAFE zone on the dipstick. Adding 1 quart (0.9 L) of oil when the reading is at the bottom of the SAFE zone will result in a reading at the top of the safe zone on these engines.

**CAUTION!**

**Overfilling or underfilling the crankcase will cause aeration or loss of oil pressure. This could damage your engine.**

**Change Engine Oil**

The oil change indicator system will remind you that it is time to take your vehicle in for scheduled maintenance. Refer to the "Maintenance Schedule" for further information.

**NOTE:** Under no circumstances should oil change intervals exceed 8,000 miles (13 000 km) or six months, whichever occurs first.

### Engine Oil Selection

For best performance and maximum protection under all types of operating conditions, the manufacturer recommends engine oils that are API Certified and meet the requirements of Chrysler Material Standard MS-6395.

### American Petroleum Institute (API) Engine Oil Identification Symbol



This symbol means that the oil has been certified by the American Petroleum Institute (API). The manufacturer only recommends API Certified engine oils.

### CAUTION!

**Do not use chemical flushes in your engine oil as the chemicals can damage your engine. Such damage is not covered by the New Vehicle Limited Warranty.**

### Engine Oil Viscosity

SAE 5W-20 engine oil is recommended for all operating temperatures. This engine oil improves low temperature starting and vehicle fuel economy. The engine oil filler cap also shows the recommended engine oil viscosity for your engine. For information on engine oil filler cap location, refer to “Engine Compartment” in “Maintaining Your Vehicle” for further information.

Lubricants which do not have both the engine oil certification mark and the correct SAE viscosity grade number should not be used.

### **Synthetic Engine Oils**

You may use synthetic engine oils provided the recommended oil quality requirements are met, and the recommended maintenance intervals for oil and filter changes are followed.

### **Materials Added To Engine Oil**

Do not add any supplemental additives, other than leak detection dyes, to your engine oil. Engine oil is an engineered product and its performance may be impaired by supplemental additives.

### **Disposing Of Used Engine Oil And Oil Filters**

Care should be taken in disposing of used engine oil and oil filters from your vehicle. Used oil and oil filters, indiscriminately discarded, can present a problem to the environment. Contact your authorized dealer, service station, or governmental agency for advice on how and where used oil and oil filters can be safely discarded in your area.

### **Engine Oil Filter**

The engine oil filter should be replaced with a new filter at every engine oil change.

**NOTE:** For best access to the oil filter, a drive on hoist should be used instead of a chassis hoist (3.7L Only).

### **Engine Oil Filter Selection**

All of this manufacturer's engines have a full-flow type disposable oil filter. Use a filter of this type for replacement. The quality of replacement filters varies considerably. Only high-quality filters should be used to assure most efficient service. MOPAR® engine oil filters are high-quality oil filters and are recommended.

### **Engine Air Cleaner Filter**

Refer to the "Maintenance Schedule" for the proper maintenance intervals.

**NOTE:** Be sure to follow the "dusty or off-road conditions" maintenance interval if applicable.

**WARNING!**

The air induction system (air cleaner, hoses, etc.) can provide a measure of protection in the case of engine backfire. Do not remove the air induction system (air cleaner, hoses, etc.) unless such removal is necessary for repair or maintenance. Make sure that no one is near the engine compartment before starting the vehicle with the air induction system (air cleaner, hoses, etc.) removed. Failure to do so can result in serious personal injury.

**Engine Air Cleaner Filter Selection**

The quality of replacement engine air cleaner filters varies considerably. Only high quality filters should be used to assure most efficient service. MOPAR® engine air cleaner filters are a high quality filter and are recommended.

**Maintenance-Free Battery**

Your vehicle is equipped with a maintenance-free battery. You will never have to add water, nor is periodic maintenance required.

**WARNING!**

- Battery fluid is a corrosive acid solution and can burn or even blind you. Do not allow battery fluid to contact your eyes, skin, or clothing. Do not lean over a battery when attaching clamps. If acid splashes in eyes or on skin, flush the area immediately with large amounts of water. Refer to "Jump-Starting Procedures" in "What To Do In Emergencies" for further information.

*(Continued)*

**WARNING! (Continued)**

- Battery gas is flammable and explosive. Keep flame or sparks away from the battery. Do not use a booster battery or any other booster source with an output greater than 12 Volts. Do not allow cable clamps to touch each other.
- Battery posts, terminals, and related accessories contain lead and lead compounds. Wash hands after handling.

**CAUTION!**

- It is essential when replacing the cables on the battery that the positive cable is attached to the positive post and the negative cable is attached to the negative post. Battery posts are marked positive (+) and negative (-) and are identified on the battery case. Cable clamps should be tight on the terminal posts and free of corrosion.
- If a "fast charger" is used while the battery is in the vehicle, disconnect both vehicle battery cables before connecting the charger to the battery. Do not use a "fast charger" to provide starting voltage.

### **Air Conditioner Maintenance**

For best possible performance, your air conditioner should be checked and serviced by an authorized dealer at the start of each warm season. This service should include cleaning of the condenser fins and a performance test. Drive belt tension should also be checked at this time.

#### **CAUTION!**

Do not use chemical flushes in your air conditioning system as the chemicals can damage your air conditioning components. Such damage is not covered by the New Vehicle Limited Warranty.

#### **WARNING!**

- Use only refrigerants and compressor lubricants approved by the manufacturer for your air conditioning system. Some unapproved refrigerants are flammable and can explode, injuring you. Other unapproved refrigerants or lubricants can cause the system to fail, requiring costly repairs. Refer to Warranty Information Book, located on the DVD, for further warranty information.
- The air conditioning system contains refrigerant under high pressure. To avoid risk of personal injury or damage to the system, adding refrigerant or any repair requiring lines to be disconnected should be done by an experienced technician.

### Refrigerant Recovery And Recycling

R-134a air conditioning refrigerant is a hydrofluorocarbon (HFC) that is endorsed by the Environmental Protection Agency and is an ozone-saving product. However, the manufacturer recommends that air conditioning service be performed by an authorized dealer or other service facilities using recovery and recycling equipment.

**NOTE:** Use only manufacturer approved A/C System Sealers, Stop Leak Products, Seal Conditioners, Compressor Oil, and Refrigerants.

### A/C Air Filter – If Equipped

Refer to the “Maintenance Schedule” for the proper maintenance intervals.

#### **WARNING!**

**Do not remove the A/C Air Filter while the blower is operating or personal injury may result.**

### Body Lubrication

Locks and all body pivot points, including such items as seat tracks, door hinge pivot points and rollers, liftgate, tailgate, sliding doors and hood hinges, should be lubricated periodically with a lithium based grease, such as MOPAR® Spray White Lube or equivalent, to assure quiet, easy operation and to protect against rust and wear. Prior to the application of any lubricant, the parts concerned should be wiped clean to remove dust and grit; after lubricating excess oil and grease should be removed. Particular attention should also be given to hood latching components to ensure proper function. When performing other underhood services, the hood latch, release mechanism and safety catch should be cleaned and lubricated.

The external lock cylinders should be lubricated twice a year, preferably in the Fall and Spring. Apply a small



amount of a high quality lubricant, such as MOPAR® Lock Cylinder Lubricant or equivalent, directly into the lock cylinder.

### Windshield Wiper Blades

Clean the rubber edges of the wiper blades and the windshield periodically with a sponge or soft cloth and a mild non-abrasive cleaner or use the washer solvent. This will remove accumulations of salt or road film.

Operation of the wipers on dry glass for long periods may cause deterioration of the wiper blades. Always use washer fluid when using the wipers to remove salt or dirt from a dry windshield.

Avoid using the wiper blades to remove frost or ice from the windshield. Keep the blade rubber out of contact with petroleum products such as engine oil, gasoline, etc.

**NOTE:** Life expectancy of wiper blades varies depending on geographical area and frequency of use. Poor

performance of blades may be present with chattering, marks, water lines or wet spots. If any of these conditions are present, clean the wiper blades or replace as necessary.

### Adding Washer Fluid

The windshield and rear window washers share the same fluid reservoir. The fluid reservoir is located in the front of the engine compartment. Be sure to check the fluid level in the reservoir at regular intervals. Fill the reservoir with windshield washer solvent (not radiator antifreeze) and operate the system for a few seconds to flush out the residual water.

When refilling the washer fluid reservoir, take some washer fluid and apply it to a cloth or towel and wipe clean the wiper blades, this will help blade performance.

To prevent freeze-up of your windshield washer system in cold weather, select a solution or mixture that meets or

exceeds the temperature range of your climate. This rating information can be found on most washer fluid containers.

### **WARNING!**

**Commercially available windshield washer solvents are flammable. They could ignite and burn you. Care must be exercised when filling or working around the washer solution.**

### **Exhaust System**

The best protection against carbon monoxide entry into the vehicle body is a properly maintained engine exhaust system.

If you notice a change in the sound of the exhaust system; or if the exhaust fumes can be detected inside the vehicle; or when the underside or rear of the vehicle is damaged;

have an authorized technician inspect the complete exhaust system and adjacent body areas for broken, damaged, deteriorated, or mispositioned parts. Open seams or loose connections could permit exhaust fumes to seep into the passenger compartment. In addition, inspect the exhaust system each time the vehicle is raised for lubrication or oil change. Replace as required.

### **WARNING!**

- **Exhaust gases can injure or kill. They contain carbon monoxide (CO), which is colorless and odorless. Breathing it can make you unconscious and can eventually poison you. To avoid breathing CO, refer to "Safety Tips/Exhaust Gas" in "Things To Know Before Starting Your Vehicle" for further information.**

*(Continued)*

**WARNING! (Continued)**

- A hot exhaust system can start a fire if you park over materials that can burn. Such materials might be grass or leaves coming into contact with your exhaust system. Do not park or operate your vehicle in areas where your exhaust system can contact anything that can burn.

**CAUTION!**

- The catalytic converter requires the use of unleaded fuel only. Leaded gasoline will destroy the effectiveness of the catalyst as an emissions control device and may seriously reduce engine performance and cause serious damage to the engine.

*(Continued)*

**CAUTION! (Continued)**

- Damage to the catalytic converter can result if your vehicle is not kept in proper operating condition. In the event of engine malfunction, particularly involving engine misfire or other apparent loss of performance, have your vehicle serviced promptly. Continued operation of your vehicle with a severe malfunction could cause the converter to overheat, resulting in possible damage to the converter and vehicle.

Under normal operating conditions, the catalytic converter will not require maintenance. However, it is important to keep the engine properly tuned to assure proper catalyst operation and prevent possible catalyst damage.

**NOTE:** Intentional tampering with emissions control systems can result in civil penalties being assessed against you.

In unusual situations involving grossly malfunctioning engine operation, a scorching odor may suggest severe and abnormal catalyst overheating. If this occurs, stop the vehicle, turn off the engine and allow it to cool. Service, including a tune-up to manufacturer's specifications, should be obtained immediately.

To minimize the possibility of catalytic converter damage:

- Do not shut off the engine or interrupt the ignition, when the transmission is in gear and the vehicle is in motion.
- Do not try to start the engine by pushing or towing the vehicle.

- Do not idle the engine with any spark plug wires disconnected or removed, such as when diagnostic testing, or for prolonged periods during very rough idle or malfunctioning operating conditions.

### Cooling System

#### **WARNING!**

- **You or others can be badly burned by hot coolant or steam from your radiator. If you see or hear steam coming from under the hood, do not open the hood until the radiator has had time to cool. Never try to open a cooling system pressure cap when the radiator is hot.**

### Engine Coolant Checks

Check the engine coolant (antifreeze) protection every 12 months (before the onset of freezing weather, where applicable). If the engine coolant (antifreeze) is dirty or

rusty in appearance, the system should be drained, flushed, and refilled with fresh coolant. Check the front of the A/C condenser (if equipped) or radiator for any accumulation of bugs, leaves, etc. If dirty, clean by gently spraying water from a garden hose vertically down the face of the A/C condenser (if equipped) or the back of the radiator core.

Check the engine cooling system hoses for brittle rubber, cracking, tears, cuts, and tightness of the connection at the coolant recovery bottle and radiator. Inspect the entire system for leaks.

With the engine at normal operating temperature (but not running), check the cooling system pressure cap for proper vacuum sealing by draining a small amount of engine coolant (antifreeze) from the radiator drain cock. If the cap is sealing properly, the engine coolant (antifreeze) will begin to drain from the coolant recovery

bottle. **DO NOT REMOVE THE COOLANT PRESSURE CAP WHEN THE COOLING SYSTEM IS HOT.**

### **Cooling System – Drain, Flush, And Refill**

If the engine coolant (antifreeze) is dirty or contains a considerable amount of sediment, clean and flush with a reliable cooling system cleaner. Follow with a thorough rinsing to remove all deposits and chemicals. Properly dispose of the old engine coolant (antifreeze).

Refer to the “Maintenance Schedule” for the proper maintenance intervals.

### **Selection Of Engine Coolant**

Use only the manufacturer’s recommended engine coolant (antifreeze). Refer to “Fluids, Lubricants, and Genuine Parts” in “Maintaining Your Vehicle” for further information.

**CAUTION!**

- **Mixing of engine coolant (antifreeze) other than specified HOAT engine coolant (antifreeze), may result in engine damage and may decrease corrosion protection. If a non-HOAT engine coolant (antifreeze) is introduced into the cooling system in an emergency, it should be replaced with the specified engine coolant (antifreeze) as soon as possible.**
- **Do not use water alone or alcohol-based engine coolant (antifreeze) products. Do not use additional rust inhibitors or antirust products, as they may not be compatible with the radiator engine coolant and may plug the radiator.**
- **This vehicle has not been designed for use with Propylene Glycol based engine coolant (antifreeze). Use of Propylene Glycol based engine coolant (antifreeze) is not recommended.**

**Adding Engine Coolant**

Your vehicle has been built with an improved engine coolant (antifreeze) that allows extended maintenance intervals. This engine coolant (antifreeze) can be used up to five years or 104,000 miles (169 000 km) before replacement. To prevent reducing this extended maintenance period, it is important that you use the same engine coolant (antifreeze) throughout the life of your vehicle.

Please review these recommendations for using Hybrid Organic Additive Technology (HOAT) engine coolant (antifreeze). When adding engine coolant (antifreeze):

- The manufacturer recommends using MOPAR® Antifreeze/Coolant 5 Year/100,000 Mile Formula HOAT (Hybrid Organic Additive Technology) or equivalent.

- Mix a minimum solution of 50% HOAT engine coolant and distilled water. Use higher concentrations (not to exceed 70%) if temperatures below  $-34^{\circ}\text{F}$  ( $-37^{\circ}\text{C}$ ) are anticipated.
- Use only high purity water such as distilled or deionized water when mixing the water/engine coolant (antifreeze) solution. The use of lower quality water will reduce the amount of corrosion protection in the engine cooling system.

Please note that it is the owner's responsibility to maintain the proper level of protection against freezing according to the temperatures occurring in the area where the vehicle is operated.

**NOTE:** Mixing engine coolant (antifreeze) types will decrease the life of the engine coolant (antifreeze) and will require more frequent coolant changes.

### Cooling System Pressure Cap

The cap must be fully tightened to prevent loss of coolant, and to ensure that coolant will return to the radiator from the coolant recovery bottle.

The cap should be inspected and cleaned if there is any accumulation of foreign material on the sealing surfaces.

#### **WARNING!**

- **The warning words "DO NOT OPEN HOT" on the cooling system pressure cap are a safety precaution. Never add engine coolant (antifreeze) when the engine is overheated. Do not loosen or remove the cap to cool an overheated engine. Heat causes pressure to build up in the cooling system. To prevent scalding or injury, do not remove the pressure cap while the system is hot or under pressure.**

*(Continued)*

**WARNING! (Continued)**

- **Do not use a pressure cap other than the one specified for your vehicle. Personal injury or engine damage may result.**

**Disposal Of Used Engine Coolant**

Used ethylene glycol based engine coolant (antifreeze) is a regulated substance requiring proper disposal. Check with your local authorities to determine the disposal rules for your community. To prevent ingestion by animals or children, do not store ethylene glycol based engine coolant (antifreeze) in open containers or allow it to remain in puddles on the ground. If ingested by a child or pet, seek emergency assistance immediately. Clean up any ground spills immediately.

**Engine Coolant Level**

The coolant bottle provides a quick visual method for determining that the coolant level is adequate. With the engine idling, and warm to normal operating temperature, the level of the engine coolant (antifreeze) in the bottle should be between the ranges indicated on the bottle.

The radiator normally remains completely full, so there is no need to remove the radiator cap unless checking for coolant freeze point or replacing engine coolant (antifreeze). Advise your service attendant of this. As long as the engine operating temperature is satisfactory, the coolant bottle need only be checked once a month.

When additional engine coolant (antifreeze) is needed to maintain the proper level, it should be added to the coolant bottle. Do not overfill.



## Points To Remember

**NOTE:** When the vehicle is stopped after a few miles/kilometers of operation, you may observe vapor coming from the front of the engine compartment. This is normally a result of moisture from rain, snow, or high humidity accumulating on the radiator and being vaporized when the thermostat opens, allowing hot engine coolant (antifreeze) to enter the radiator.

If an examination of your engine compartment shows no evidence of radiator or hose leaks, the vehicle may be safely driven. The vapor will soon dissipate.

- Do not overfill the coolant bottle.
- Check coolant freeze point in the radiator and in the coolant recovery bottle. If engine coolant (antifreeze) needs to be added, contents of coolant recovery bottle must also be protected against freezing.
- If frequent engine coolant (antifreeze) additions are required, or if the level in the coolant recovery bottle does not drop when the engine cools, the cooling system should be pressure tested for leaks.
- Maintain engine coolant (antifreeze) concentration at 50% HOAT engine coolant (antifreeze) (minimum) and distilled water for proper corrosion protection of your engine, which contains aluminum components.
- Make sure that the radiator and coolant recovery bottle hoses are not kinked or obstructed.
- Keep the front of the radiator clean. If your vehicle is equipped with air conditioning, keep the front of the condenser clean.

- Do not change the thermostat for Summer or Winter operation. If replacement is ever necessary, install **ONLY** the correct type thermostat. Other designs may result in unsatisfactory cooling performance, poor gas mileage, and increased emissions.

### Brake System

In order to assure brake system performance, all brake system components should be inspected periodically. Refer to the “Maintenance Schedule” for the proper maintenance intervals.

#### **WARNING!**

**Riding the brakes can lead to brake failure and possibly a collision. Driving with your foot resting or riding on the brake pedal can result in abnormally high brake temperatures, excessive lining wear, and possible brake damage. You would not have your full braking capacity in an emergency.**

### Brake Master Cylinder

The fluid in the master cylinder should be checked when performing under hood services or immediately if the “Brake Warning Light” is illuminated.

Be sure to clean the top of the master cylinder area before removing the cap. If necessary, add fluid to bring the fluid level up to the requirements described on the brake fluid reservoir. With disc brakes, fluid level can be expected to fall as the brake pads wear. Brake fluid level should be checked when pads are replaced. However, low fluid level may be caused by a leak and a checkup may be needed.

Use only manufacturer’s recommended brake fluid. Refer to “Fluids, Lubricants, and Genuine Parts” in “Maintaining Your Vehicle” for further information.

**WARNING!**

- Use only manufacturer's recommended brake fluid. Refer to "Fluids, Lubricants, and Genuine Parts" in "Maintaining Your Vehicle" for further information. Using the wrong type of brake fluid can severely damage your brake system and/or impair its performance. The proper type of brake fluid for your vehicle is also identified on the original factory installed hydraulic master cylinder reservoir.

*(Continued)*

**WARNING! (Continued)**

- To avoid contamination from foreign matter or moisture, use only new brake fluid or fluid that has been in a tightly closed container. Keep the master cylinder reservoir cap secured at all times. Brake fluid in an open container absorbs moisture from the air resulting in a lower boiling point. This may cause it to boil unexpectedly during hard or prolonged braking, resulting in sudden brake failure. This could result in a collision.
- Overfilling the brake fluid reservoir can result in spilling brake fluid on hot engine parts, causing the brake fluid to catch fire. Brake fluid can also damage painted and vinyl surfaces, care should be taken to avoid its contact with these surfaces.

*(Continued)*

**WARNING! (Continued)**

- Do not allow petroleum based fluid to contaminate the brake fluid. Brake seal components could be damaged, causing partial or complete brake failure. This could result in a collision.

**Automatic Transmission****Selection Of Lubricant**

It is important that the proper lubricant is used in the transmission to assure optimum transmission performance. Use only manufacturer's recommended transmission fluid. Refer to "Fluids, Lubricants, and Genuine Parts" in "Maintaining Your Vehicle" for further information. It is important that the transmission fluid be maintained at the prescribed level using the recommended fluid.

**CAUTION!**

Using a transmission fluid other than the manufacturer's recommended fluid may cause deterioration in transmission shift quality and/or torque converter shudder. Using a transmission fluid other than the manufacturer's recommended fluid will result in more frequent fluid and filter changes. Refer to "Fluids, Lubricants, and Genuine Parts" in "Maintaining Your Vehicle" for further information.

**Special Additives**

The manufacturer strongly recommends against the addition of any additives to the transmission. The only exception to this policy is the use of special dyes to aid in detecting fluid leaks. The use of transmission sealers should be avoided as they may adversely affect seals.

**CAUTION!**

Do not use chemical flushes in your transmission as the chemicals can damage your transmission components. Such damage is not covered by the New Vehicle Limited Warranty.

**Fluid Level Check**

Your vehicle is equipped with a capped transmission oil fill tube that is sealed and it should not be tampered with. Your authorized dealer has the proper tools to ensure that the fluid level is set properly.

**CAUTION!**

Using a transmission fluid other than the manufacturer's recommended fluid may cause deterioration in transmission shift quality and/or torque converter shudder. Using a transmission fluid other than that recommended by the manufacturer will result in more frequent fluid and filter changes. Refer to "Fluids, Lubricants, and Genuine Parts" in "Maintaining Your Vehicle" for further information.

**Fluid And Filter Changes**

Refer to the "Maintenance Schedule" for the proper maintenance intervals.

In addition, change the fluid and filter if the transmission is disassembled for any reason.

## Transfer Case

### Fluid Level Check

The fluid level should be to the bottom edge of the fill hole (1) when the vehicle is in a level position.

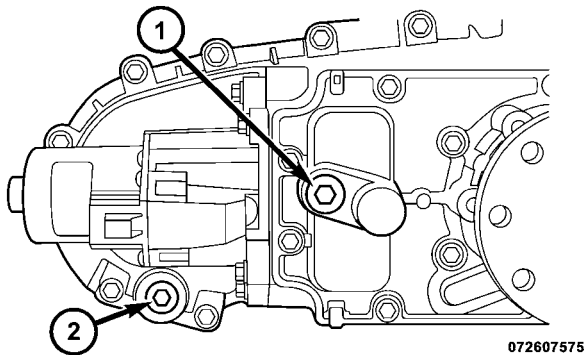

072607575

- 1 — Fill Plug  
2 — Drain Plug

### Adding Fluid

Fluid should be added only to fill hole until fluid begins to run out of the hole.

### Draining Fluid

First remove the fill plug (1), then the drain plug (2). Recommended tightening torque for the drain and fill plugs is 15–25 ft lbs (20–34 N·m).

### CAUTION!

Do not over-tighten the plugs. You could damage them and cause a leak.

### Lubricant Selection

Use only manufacturer's recommended fluid. Refer to "Fluids, Lubricants, and Genuine Parts" in "Maintaining Your Vehicle" for further information.

### Frequency Of Fluid Change

Under normal operating conditions, the fluid installed at the factory will give satisfactory lubrication for the life of the vehicle. Fluid changes are not necessary unless the fluid becomes contaminated with water. Change the fluid immediately if contaminated with water.

### Front/Rear Axle Fluid

For normal service, periodic fluid level checks are not required. When the vehicle is serviced for other reasons the exterior surfaces of the axle assembly should be inspected. If gear oil leakage is suspected inspect the fluid level. Refer to "Fluids, Lubricants, and Genuine Parts" in "Maintaining Your Vehicle" for further information.

### Fluid Level Check

- Front axle lubricant should be at the bottom edge of the oil fill hole when the vehicle is in a level position.

- Rear axle lubricant should be 0.5 in (11 mm) below the bottom edge of the oil fill hole when the vehicle is in a level position.

### Adding Fluid

Add lubricant only at the fill hole and only to the level specified above.

### Lubricant Selection

Use only manufacturer's recommended lubricant. Refer to "Fluids, Lubricants, and Genuine Parts" in "Maintaining Your Vehicle" for further information.

### Frequency Of Fluid Change

Under normal operating conditions, the lubricant installed at the factory will give satisfactory lubrication for the life of the vehicle. Lubricant changes are not necessary unless the lubricant becomes contaminated with water. Change the lubricant immediately if contaminated with water.

### **Sky Slider™ Top Care**

Immediate removal of any contaminant is recommended. Regular washing of the top will enhance its life and appearance, and make successive cleaning easier. Do not subject the top to excessive heat. Frequently vacuum the top and tracks. Periodically wipe dust and dirt from the top and inside of the tracks by hand with an alcohol dampened cloth.

#### **Washing**

Hand washing or an automatic car wash with a soft cloth system is preferred.

#### **CAUTION!**

**Avoid pointing a high-pressure hand held spray wand directly at the sides of the top, as this can damage the seal and force water past the weather strips.**

### **General Cleaning**

Careful vacuuming of the top before washing is helpful in removing dust and other foreign particles.

#### *If Hand Washing:*

- Wash in partial shade instead of direct sun.
- Wet the entire vehicle before washing the top.
- Wash the top with a soft, natural bristle scrub brush, and a mild soap solution such as liquid dish washing soap. Do not use detergent.
- Scrub in all directions, covering an area of about two square feet at a time. Avoid heavy scrubbing.
- Rinse the entire vehicle with water to remove all soap and dirt from the top fabric and to prevent streaking on painted and chrome surfaces.



- Allow the top to dry before opening. Vacuuming the top with a wet/dry shop vacuum will decrease the tops drying time, ensure removal of all dirt, and delete streaks in the material.
- Multiple cleanings may be necessary to remove stubborn stains. If stains persist, contact your local authorized dealership for further suggestions.

**CAUTION!**

Never use an abrasive type cleaner or bleaches. Cleaners should not contain silicones, organic solvents, petroleum distillates, or plasticizers. Always wait until the top is thoroughly dry before opening it.

**Additional Cleaning Procedure**

For additional cleaning assistance in removing stubborn stains, apply MOPAR® Convertible Cloth Top Cleaner or

equivalent to the complete stain, extending 2 in (50 mm) beyond the stain. With a soft bristle brush, scrub in all directions over the stain. Avoid heavy scrubbing. Rinse the area with warm water. If the stain is still apparent, repeat the cleaning procedure. When the stain is no longer showing, rinse the complete top with warm water. Let the top dry before opening it.

**Protection**

For appearance purposes, you may wish to protect the acrylic (cloth) top periodically. A fabric protectant such as Scotchguard® is suggested. The top should be clean and dry before application of the protectant.

**CAUTION!**

Avoid getting Scotchguard® on the surrounding weather strips, moldings, paint, or glass. Damage to these items might occur.

### **Weather Strip Care**

Lubricate the weather strips periodically with MOPAR® Weather Strip Lubricant or equivalent, to keep them soft and pliable.

### **Appearance Care And Protection From Corrosion**

#### **Protection Of Body And Paint From Corrosion**

Vehicle body care requirements vary according to geographic locations and usage. Chemicals that make roads passable in snow and ice and those that are sprayed on trees and road surfaces during other seasons are highly corrosive to the metal in your vehicle. Outside parking, which exposes your vehicle to airborne contaminants, road surfaces on which the vehicle is operated, extreme hot or cold weather and other extreme conditions will have an adverse effect on paint, metal trim, and underbody protection.

The following maintenance recommendations will enable you to obtain maximum benefit from the corrosion resistance built into your vehicle.

#### **What Causes Corrosion?**

Corrosion is the result of deterioration or removal of paint and protective coatings from your vehicle.

The most common causes are:

- Road salt, dirt, and moisture accumulation.
- Stone and gravel impact.
- Insects, tree sap, and tar.
- Salt in the air near seacoast localities.
- Atmospheric fallout/industrial pollutants.

## Washing

- Wash your vehicle regularly. Always wash your vehicle in the shade using MOPAR® Car Wash or equivalent, or a mild car wash soap, and rinse the panels completely with clear water.
- If insects, tar, or other similar deposits have accumulated on your vehicle, use MOPAR® Super Kleen Bug and Tar Remover or equivalent to remove.
- Use a high quality cleaner wax, such as MOPAR® Cleaner Wax or equivalent, to remove road film, stains, and to protect your paint finish. Take care never to scratch the paint.
- Avoid using abrasive compounds and power buffing that may diminish the gloss or thin out the paint finish.

### CAUTION!

- Do not use abrasive or strong cleaning materials such as steel wool or scouring powder, which will scratch metal and painted surfaces.
- Use of power washers exceeding 1,200 psi (8 274 kPa) can result in damage or removal of paint and decals.

## Special Care

- If you drive on salted or dusty roads or if you drive near the ocean, hose off the undercarriage at least once a month.
- It is important that the drain holes in the lower edges of the doors, rocker panels, and tailgate must be kept clear and open.

- If you detect any stone chips or scratches in the paint, touch them up immediately. The cost of such repairs is considered the responsibility of the owner.
- If your vehicle is damaged due to a collision or similar cause, which destroys the paint and protective coating, have your vehicle repaired as soon as possible. The cost of such repairs is considered the responsibility of the owner.
- If you carry special cargo such as chemicals, fertilizers, de-icer salt, etc., assure that such materials are well packaged and sealed.
- If a lot of driving is done on gravel roads, consider mud or stone shields behind each wheel.
- Use MOPAR® Touch Up Paint or equivalent on scratches or chips as soon as possible. Your authorized dealer has touch up paint to match the color of your vehicle.

### **Wheel And Wheel Trim Care**

All wheels and wheel trim, especially aluminum and chrome-plated wheels should be cleaned regularly with mild soap and water to prevent corrosion. To remove heavy soil and/or excessive brake dust, use MOPAR® Wheel Cleaner or equivalent, or select a nonabrasive, non-acidic cleaner. Do not use scouring pads, steel wool, a bristle brush, or metal polishes. Only MOPAR® cleaners or equivalent are recommended. Do not use oven cleaner. Avoid automatic car washes that use acidic solutions or harsh brushes that may damage the wheels' protective finish.

### **Stain Repel Fabric Cleaning Procedure – If Equipped**

Stain Repel seats may be cleaned in the following manner:

- Remove as much of the stain as possible by blotting with a clean, dry towel.
- Blot any remaining stain with a clean, damp towel.

- For tough stains, apply MOPAR® Total Clean or equivalent, or a mild soap solution to a clean, damp cloth and remove the stain. Use a fresh, damp towel to remove soap residue.
- For grease stains, apply MOPAR® Multi-Purpose Cleaner or equivalent to a clean, damp cloth and remove the stain. Use a fresh, damp towel to remove soap residue.
- Do not use any harsh solvents or any other form of protectants on Stain Repel products.

## Interior Care

### *Instrument Panel Cover*

The instrument panel cover has a low glare surface, which minimizes reflections in the windshield. Do not use protectants or other products, which may cause undesirable reflections. Use soap and warm water to restore the low glare surface.

### *Cleaning Interior Trim*

Clean interior trim with a damp cloth and MOPAR® Total Clean or equivalent, and if necessary, follow with MOPAR® Spot & Stain Remover or equivalent. Do not use harsh cleaners or Armor All®. Use MOPAR® Total Clean or equivalent to clean vinyl upholstery.

### *Cleaning Leather Upholstery*

MOPAR® Total Clean or equivalent is specifically recommended for leather upholstery.

Your leather upholstery can be best preserved by regular cleaning with a damp soft cloth. Small particles of dirt can act as an abrasive and damage the leather upholstery and should be removed promptly with a damp cloth. Stubborn soils can be removed easily with a soft cloth and MOPAR® Total Clean or equivalent. Care should be taken to avoid soaking leather upholstery with any liquid. Please do not use polishes, oils, cleaning fluids, solvents, detergents, or ammonia-based cleaners to clean

leather upholstery. Application of a leather conditioner is not required to maintain the original condition.

**WARNING!**

**Do not use volatile solvents for cleaning purposes. Many are potentially flammable, and if used in closed areas they may cause respiratory harm.**

**Cleaning Headlights**

Your vehicle has plastic headlights that are lighter and less susceptible to stone breakage than glass headlights.

Plastic is not as scratch resistant as glass and therefore different lens cleaning procedures must be followed.

To minimize the possibility of scratching the lenses and reducing light output, avoid wiping with a dry cloth. To remove road dirt, wash with a mild soap solution followed by rinsing.

Do not use abrasive cleaning components, solvents, steel wool or other aggressive material to clean the lenses.

**Glass Surfaces**

All glass surfaces should be cleaned on a regular basis with MOPAR® Glass Cleaner or any commercial household-type glass cleaner. Never use an abrasive type cleaner. Use caution when cleaning the inside rear window equipped with electric defrosters or the right rear quarter window equipped with the radio antenna. Do not use scrapers or other sharp instruments, which may scratch the elements.

When cleaning the rear view mirror, spray cleaner on the towel or rag that you are using. Do not spray cleaner directly on the mirror.

### **Cleaning Plastic Instrument Cluster Lenses**

The lenses in front of the instruments in this vehicle are molded in clear plastic. When cleaning the lenses, care must be taken to avoid scratching the plastic.

1. Clean with a wet soft rag. A mild soap solution may be used, but do not use high alcohol content or abrasive cleaners. If soap is used, wipe clean with a clean damp rag.
2. Dry with a soft cloth.

### **Seat Belt Maintenance**

Do not bleach, dye, or clean the seat belts with chemical solvents or abrasive cleaners. This will weaken the fabric. Sun damage can also weaken the fabric.

If the seat belts need cleaning, use a mild soap solution or lukewarm water. Dry with a soft cloth. Do not remove the seat belts from the car to wash them. Dry with a soft cloth.

Replace the seat belts if they appear frayed or worn or if the buckles do not work properly.

## FUSES

### Totally Integrated Power Module

The Totally Integrated Power Module is located in the engine compartment near the battery. This center contains cartridge fuses, mini-fuses and relays. A label that identifies each component is printed on the inside of the cover.

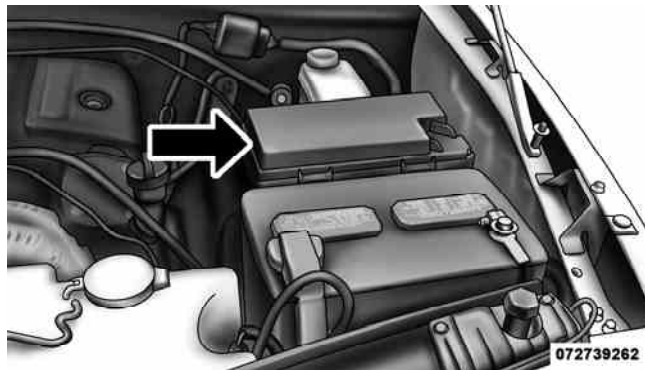

Totally Integrated Power Module

Cavity	Cartridge Fuse	Mini-Fuse	Description
J1	—	—	—
J2	30 Amp Pink	—	Transfer Case Module – If Equipped
J3	—	—	—
J4	25 Amp Natural	—	Driver Door Node
J5	25 Amp Natural	—	Passenger Door Node
J6	40 Amp Green	—	Antilock Brakes Pump/Stability Control System – If Equipped
J7	30 Amp Pink	—	Antilock Brakes Valve/Stability Control System – If Equipped



Cavity	Cartridge Fuse	Mini-Fuse	Description
J8	40 Amp Green	—	Power Seats – If Equipped
J9	—	—	—
J10	—	—	—
J11	30 Amp Pink	—	Thatchm Lock/Unlock – If Equipped
J13	60 Amp Yellow	—	Ignition Off Draw
J14	40 Amp Green	—	Rear Defroster – If Equipped
J15	40 Amp Green	—	Front Blower
J17	40 Amp Green	—	Starter Solenoid
J18	20 Amp Blue	—	Powertrain Control Module

Cavity	Cartridge Fuse	Mini-Fuse	Description
J19	60 Amp Yellow	—	Radiator Fan
J20	30 Amp Pink	—	Front Wiper
J21	20 Amp Blue	—	Front Washer/Rear Washer – If Equipped
J22	25 Amp Natural	—	Sunroof Module – If Equipped
M1	—	15 Amp Blue	Stop Light Switch Feed – Rear Center Brake Lamp
M2	—	20 Amp Yellow	Trailer Lighting – If Equipped
M3	—	20 Amp Yellow	Frt/Rr Axle Lockers – If Equipped
M4	—	10 Amp Red	Trailer Tow – If Equipped

Cavity	Cartridge Fuse	Mini-Fuse	Description
M5	—	25 Amp Natural	Power Inverter – If Equipped
M6	—	20 Amp Yellow	Rain Sensor – If Equipped
M7	—	20 Amp Yellow	Cigar Lighter
M8	—	20 Amp Yellow	Front Heated Seats – If Equipped
M9	—	—	—
M10	—	15 Amp Blue	Ignition Off Draw - Vehicle Entertainment System, Satellite Digital Receiver, DVD, Hands Free Module, Radio, Antenna, Universal Garage Door Opener – If Equipped/Vanity Light

Cavity	Cartridge Fuse	Mini-Fuse	Description
M11	—	10 Amp Red	Climate Control System – If Equipped
M12	—	30 Amp Green	Radio/Amplifier – If Equipped
M13	—	20 Amp Yellow	Instrument Cluster/Wireless Control Module/Multifunction Control Switch, Siren – If Equipped
M14	—	20 Amp Yellow	Trailer Tow (Export Only) – If Equipped
M15	—	20 Amp Yellow	Instrument Cluster/Rear View Mirror/Tire Pressure Monitor/Transfer Case Module – If Equipped/Glow Plugs – If Equipped

Cavity	Cartridge Fuse	Mini-Fuse	Description
M16	—	10 Amp Red	Airbag Module
M17	—	15 Amp Blue	Exterior Lighting – Left Front Park and Side Marker, Left Tail and Running, License Lights
M18	—	15 Amp Blue	Exterior Lighting – Right Front Park and Side Marker, Right Tail and Running Lights
M19	—	25 Amp Natural	Automatic Shutdown #1 and #2

Cavity	Cartridge Fuse	Mini-Fuse	Description
M20	—	15 Amp Blue	Interior Lighting/Steering Wheel Switches – If Equipped/Switch Bank/Steering Column Module – If Equipped
M21	—	20 Amp Yellow	Automatic Shutdown #3
M22	—	10 Amp Red	Right Horn (Hi/Low)
M23	—	10 Amp Red	Left Horn (Hi/Low)
M24	—	25 Amp Natural	Rear Wiper – If Equipped
M25	—	20 Amp Yellow	Fuel Pump, Diesel Lift Pump – If Equipped

Cavity	Cartridge Fuse	Mini-Fuse	Description
M26	—	10 Amp Red	Power Mirror Switch/ Driver Window Switch
M27	—	10 Amp Red	Ignition Switch/ Wireless Control Module/Steering Col- umn Lock – If Equipped
M28	—	10 Amp Red	Powertrain Control Module
M29	—	10 Amp Red	Occupant Classification Module
M30	—	15 Amp Blue	Rear Wiper Module – If Equipped/Power Folding Mirror – If Equipped/Diagnostic Link

Cavity	Cartridge Fuse	Mini-Fuse	Description
M31	—	20 Amp Yellow	Back-Up Lights
M32	—	10 Amp Red	Airbag Module
M33	—	10 Amp Red	Powertrain Control Module
M34	—	10 Amp Red	Park Assist Module – If Equipped/Climate Control System Mod- ule – If Equipped/ Compass Module – If Equipped/Cabin Heater – If Equipped/ Diesel Rad Fan – If Equipped
M35	—	10 Amp Red	Heated Mirrors – If Equipped

Cavity	Cartridge Fuse	Mini-Fuse	Description
M36	—	—	—
M37	—	10 Amp Red	Antilock Brakes/ Stability Control System Module/Stop Light Switch/Fuel Pump Relay
M38	—	25 Amp Natural	Door and Liftgate Lock/Unlock Motors

### CAUTION!

- When installing the Integrated Power Module cover, it is important to ensure the cover is properly positioned and fully latched. Failure to do so may allow water to get into the Integrated Power Module, and possibly result in an electrical system failure.
- When replacing a blown fuse, it is important to use only a fuse having the correct amperage rating. The use of a fuse with a rating other than indicated may result in a dangerous electrical system overload. If a properly rated fuse continues to blow, it indicates a problem in the circuit that must be corrected.

**REPLACEMENT BULBS****LIGHT BULBS – Interior**

	<b>Bulb No.</b>
Cargo Lamp . . . . .	TL212-2
Overhead Console Lamp . . . . .	PLW214-2A
Reading Lamp . . . . .	WL212-2

**LIGHT BULBS – Exterior**

	<b>Bulb No.</b>
Headlamp . . . . .	9008 H13
Front Park/Turn Signal Lamp . . . . .	3757AK
Front Side Marker Lamp . . . . .	168
Back-Up Lamp . . . . .	3157K
Center High Mounted Stop Lamp (CHMSL) . . . . .	LED (serviced at an authorized dealer)
Fog Lamp . . . . .	H10 9145
License Plate Lamp . . . . .	168
Rear Tail/Stop . . . . .	3157K
Rear Turn Signal Lamp . . . . .	3757AK

**BULB REPLACEMENT****Headlamp**

1. Open the hood.
2. Reach behind the headlamp housing to access the headlamp bulb lock ring.
3. Firmly grasp the lock ring and rotate it counterclockwise to unlock it.
4. Remove the bulb and connector assembly from the headlamp housing.
5. Disconnect the bulb from the electrical connector and then connect the replacement bulb.

**CAUTION!**

**Do not touch the new bulb with your fingers. Oil contamination will severely shorten bulb life. If the bulb comes in contact with any oily surface, clean the bulb with rubbing alcohol.**

6. Install the bulb and connector assembly into the headlamp housing and rotate the lock ring clockwise to lock it in place.
7. Close the hood.

**Front Turn Signal And Front Side Marker Lamp**

1. Turn the steering wheel all the way to the right to access the left front turn signal or side marker. Turn the steering wheel all the way to the left to access the right front turn signal or side marker.
2. Remove three push-pins from the wheel-well liner.

3. Gently flex the wheel-well liner forward to access the bulb.
4. Rotate the bulb's socket counterclockwise, and remove the bulb and socket assembly from the housing.
5. Pull the bulb out of the socket and insert the replacement bulb.
6. Install the bulb and socket assembly into the housing, and rotate the socket clockwise to lock it in place.
7. Reposition the wheel-well liner and install the push-pins.

**Front Fog Lamp**

1. Open the hood.
2. Reach behind the headlamp housing to access the bulb.

3. Rotate the bulb's socket counterclockwise, and remove the bulb and socket assembly from the fog lamp housing.
4. Pull the bulb out of the socket and insert the replacement bulb.

**CAUTION!**

**Do not touch the new bulb with your fingers. Oil contamination will severely shorten bulb life. If the bulb comes in contact with any oily surface, clean the bulb with rubbing alcohol.**

5. Install the bulb and socket assembly into the fog lamp housing, and rotate the connector clockwise to lock it in place.
6. Close the hood.

**Rear Tail/Stop, Turn Signal, And Back-Up Lamp**

1. Open the liftgate.

2. Remove the screws that fasten the taillamp housing to the vehicle.
3. Pull the taillamp housing straight back to separate it from the vehicle.
4. Disconnect the electrical connector.
5. Remove the two screws that fasten the back plate to the taillamp housing.
6. Separate the back plate from the taillamp housing.
7. Pull the appropriate bulb(s) out of the back plate and insert the replacement bulb(s).
8. Install the back plate and screws into the taillamp housing.
9. Connect the electrical connector.
10. Install the taillamp housing and screws.
11. Close the liftgate.



**FLUID CAPACITIES**

	<b>U.S.</b>	<b>Metric</b>
<b>Fuel (Approximate)</b>	19.5 Gallons	73.8 Liters
<b>Engine Oil with Filter</b>		
3.7 Liter Engine (SAE 5W-20, API Certified)	5 Quarts	4.7 Liters
<b>Cooling System *</b>		
3.7 Liter Engine (MOPAR® Antifreeze/Engine Coolant 5 Year/100,000 Mile Formula or equivalent)	14 Quarts	13.3 Liters
* Includes heater and coolant recovery bottle filled to MAX level.		

**FLUIDS, LUBRICANTS, AND GENUINE PARTS****Engine**

<b>Component</b>	<b>Fluid, Lubricant, or Genuine Part</b>
Engine Coolant	MOPAR® Antifreeze/Coolant 5 Year/100,000 Mile Formula HOAT (Hybrid Organic Additive Technology) or equivalent.
Engine Oil	Use API Certified SAE 5W-20 Engine Oil, meeting the requirements of Chrysler Material Standard MS-6395. Refer to your engine oil filler cap for correct SAE grade.
Engine Oil Filter	MOPAR® Engine Oil Filter or equivalent.
Spark Plugs	ZFR6F-11G (Gap 0.043 in [1.1 mm])
Fuel Selection	87 Octane

## Chassis

Component	Fluid, Lubricant, or Genuine Part
Automatic Transmission	MOPAR® ATF+4® Automatic Transmission Fluid or equivalent licensed ATF+4® product.
Transfer Case	MOPAR® ATF+4® Automatic Transmission Fluid or equivalent licensed ATF+4® product.
Front Axle	SAE 80W-90 Multi-Purpose Type, GL-5 Gear Lubricant or equivalent.
Rear Axle	SAE 75W-90 Gear Lubricant or equivalent.
Brake Master Cylinder	MOPAR® DOT 3 Brake Fluid, SAE J1703 should be used. If DOT 3, SAE J1703 brake fluid is not available, then DOT 4 is acceptable. Use only recommended brake fluids.
Power Steering Reservoir	MOPAR® Power Steering Fluid +4, MOPAR® ATF+4® Automatic Transmission Fluid or equivalent licensed ATF+4® product.



---

# MAINTENANCE SCHEDULES

## CONTENTS

---

■	Maintenance Schedule . . . . .	492
□	Required Maintenance Intervals . . . . .	494

## MAINTENANCE SCHEDULE

The Scheduled Maintenance services listed in this manual must be done at the times or mileages specified to protect your vehicle warranty and ensure the best vehicle performance and reliability. More frequent maintenance may be needed for vehicles in severe operating conditions, such as dusty areas and very short trip driving. Inspection and service should also be done anytime a malfunction is suspected.

The oil change indicator system will remind you that it is time to take your vehicle in for scheduled maintenance.

On Electronic Vehicle Information Center (EVIC) equipped vehicles “Oil Change Required” will be displayed in the EVIC and a single chime will sound, indicating that an oil change is necessary.

On Non-EVIC equipped vehicles “Change Oil” will flash in the instrument cluster odometer and a single chime will sound, indicating that an oil change is necessary.

Based on engine operation conditions the oil change indicator message will illuminate, this means that service is required for your vehicle. Have your vehicle serviced as soon as possible, within the next 500 miles (805 km).

**NOTE:**

- The oil change indicator message will not monitor the time since the last oil change. Change your vehicle's oil if it has been six months since your last oil change even if the oil change indicator message is NOT illuminated.
- Change your engine oil more often if you drive your vehicle off-road for an extended period of time.
- Under no circumstances should oil change intervals exceed 8,000 miles (13 000 km) or six months, whichever comes first.

Your authorized dealer will reset the oil change indicator message after completing the scheduled oil change. If a scheduled oil change is performed by someone other than your authorized dealer, the message can be reset by

referring to the steps described under "Electronic Vehicle Information Center (EVIC)/Oil Change Required" in "Understanding Your Instrument Panel" or under "Instrument Cluster Description/Odometer/Trip Odometer" in "Understanding Your Instrument Panel" for further information.

*At Each Stop For Fuel*

- Check the engine oil level about five minutes after a fully warmed engine is shut off. Checking the oil level while the vehicle is on level ground will improve the accuracy of the oil level reading. Add oil only when the level is at or below the ADD or MIN mark.
- Check the windshield washer solvent and add if required.

*Once A Month*

- Check tire pressure and look for unusual wear or damage.
- Inspect the battery and clean and tighten the terminals as required.
- Check the fluid levels of the coolant reservoir and the brake master cylinder, add as needed.
- Check all lights and other electrical items for correct operation.

*At Each Oil Change*

- Change the engine oil filter.
- Inspect the brake hoses and lines.

**CAUTION!**

- **Failure to perform the required maintenance items may result in damage to the vehicle.**
- **Proper operation of four-wheel drive vehicles depends on tires of equal size, type and circumference on each wheel. Any difference in tire size can cause damage to the transfer case. Tire rotation schedule should be followed to balance tire wear.**

**Required Maintenance Intervals**

Refer to the Maintenance Schedules on the following pages for the required maintenance intervals.



**8,000 Miles (13,000 km) or 6 Months Maintenance Service Schedule**

- Change the engine oil and engine oil filter.
- Rotate the tires, rotate at the first sign of irregular wear, even if it occurs before 8,000 miles (13 000 km).

\_\_\_\_\_  
Odometer Reading Date

\_\_\_\_\_  
Repair Order # Dealer Code

\_\_\_\_\_  
Signature, Authorized Service Center

**16,000 Miles (26,000 km) or 12 Months Maintenance Service Schedule**

- Change the engine oil and engine oil filter.
- Rotate the tires, rotate at the first sign of irregular wear, even if it occurs before 16,000 miles (26 000 km).
- If using your vehicle for any of the following: Dusty or off-road conditions. Inspect the engine air cleaner filter; replace if necessary.
- Inspect the brake linings, replace if necessary.
- Inspect exhaust system. Perform the first inspection at 16,000 miles (26 000 km) or 12 months.
- Inspect the front suspension, tie rod ends and boot seals for cracks or leaks and all parts for damage, wear, improper looseness or end play; replace if necessary.

\_\_\_\_\_  
Odometer Reading Date

\_\_\_\_\_  
Repair Order # Dealer Code

\_\_\_\_\_  
Signature, Authorized Service Center

**24,000 Miles (39,000 km) or 18 Months Maintenance Service Schedule**

- Change the engine oil and engine oil filter.
- Rotate the tires, rotate at the first sign of irregular wear, even if it occurs before 24,000 miles (39 000 km).
- Inspect the CV joints.
- Inspect exhaust system.
- Inspect the front and rear axle fluid, change if using your vehicle for police, taxi, fleet, off-road or frequent trailer towing.

\_\_\_\_\_  
Odometer Reading Date

\_\_\_\_\_  
Repair Order # Dealer Code

\_\_\_\_\_  
Signature, Authorized Service Center

**32,000 Miles (52,000 km) or 24 Months Maintenance Service Schedule**

- Change the engine oil and engine oil filter.
- Rotate the tires, rotate at the first sign of irregular wear, even if it occurs before 32,000 miles (52 000 km).
- Replace the engine air cleaner filter.
- Replace the spark plugs (3.7L Engine).
- Adjust parking brake on vehicles equipped with four-wheel disc brakes.
- Inspect the transfer case fluid.
- Inspect the brake linings, replace if necessary.
- Inspect the front suspension, tie rod ends and boot seals for cracks or leaks and all parts for damage, wear, improper looseness or end play; replace if necessary.

\_\_\_\_\_  
Odometer Reading Date

\_\_\_\_\_  
Repair Order # Dealer Code

\_\_\_\_\_  
Signature, Authorized Service Center

**40,000 Miles (65,000 km) or 30 Months Maintenance Service Schedule**

- Change the engine oil and engine oil filter.
- Rotate the tires, rotate at the first sign of irregular wear, even if it occurs before 40,000 miles (65 000 km).

\_\_\_\_\_  
Odometer Reading Date

\_\_\_\_\_  
Repair Order # Dealer Code

\_\_\_\_\_  
Signature, Authorized Service Center

**48,000 Miles (78,000 km) or 36 Months Maintenance Service Schedule**

- Change the engine oil and engine oil filter.
- Rotate the tires, rotate at the first sign of irregular wear, even if it occurs before 48,000 miles (78 000 km).
- If using your vehicle for any of the following: Dusty or off-road conditions. Inspect the engine air cleaner filter; replace if necessary.
- Inspect the brake linings, replace if necessary.
- Inspect the CV joints.
- Inspect exhaust system.
- Inspect the front suspension, tie rod ends and boot seals for cracks or leaks and all parts for damage, wear, improper looseness or end play; replace if necessary.
- Inspect the front and rear axle fluid, change if using your vehicle for police, taxi, fleet, off-road or frequent trailer towing.

\_\_\_\_\_  
Odometer Reading Date

\_\_\_\_\_  
Repair Order # Dealer Code

\_\_\_\_\_  
Signature, Authorized Service Center

**56,000 Miles (91,000 km) or 42 Months Maintenance Service Schedule**

- Change the engine oil and engine oil filter.
- Rotate the tires, rotate at the first sign of irregular wear, even if it occurs before 56,000 miles (91 000 km).

\_\_\_\_\_  
Odometer Reading Date

\_\_\_\_\_  
Repair Order # Dealer Code

\_\_\_\_\_  
Signature, Authorized Service Center

**64,000 Miles (104,000 km) or 48 Months Maintenance Service Schedule**

- Change the engine oil and engine oil filter.
- Rotate the tires, rotate at the first sign of irregular wear, even if it occurs before 64,000 miles (104 000 km).
- Replace the engine air cleaner filter.
- Replace the ignition cables (3.7L Engine).
- Replace the spark plugs (3.7L Engine).
- Adjust parking brake on vehicles equipped with four-wheel disc brakes.
- Inspect the brake linings; replace if necessary.
- Change the automatic transmission fluid and filter(s) if using your vehicle for any of the following: police, taxi, fleet, or frequent trailer towing.
- Change the transfer case fluid if using your vehicle for any of the following: police, taxi, fleet, or frequent trailer towing.
- Inspect the front suspension, tie rod ends and boot seals for cracks or leaks and all parts for damage, wear, improper looseness or end play; replace if necessary.

\_\_\_\_\_  
Odometer Reading Date

\_\_\_\_\_  
Repair Order # Dealer Code

\_\_\_\_\_  
Signature, Authorized Service Center

**72,000 Miles (117,000 km) or 54 Months Maintenance Service Schedule**

- Change the engine oil and engine oil filter.
- Rotate the tires, rotate at the first sign of irregular wear, even if it occurs before 72,000 miles (117 000 km).
- Inspect the CV joints.
- Inspect exhaust system.
- Inspect the front and rear axle fluid, change if using your vehicle for police, taxi, fleet, off-road or frequent trailer towing.

\_\_\_\_\_  
Odometer Reading Date

\_\_\_\_\_  
Repair Order # Dealer Code

\_\_\_\_\_  
Signature, Authorized Service Center

**80,000 Miles (130,000 km) or 60 Months Maintenance Service Schedule**

- Change the engine oil and engine oil filter.
- Rotate the tires, rotate at the first sign of irregular wear, even if it occurs before 80,000 miles (130 000 km).
- If using your vehicle for any of the following: Dusty or off-road conditions. Inspect the engine air cleaner filter; replace if necessary.
- Flush and replace the engine coolant at 60 months or 104,000 miles (169 000 km) whichever comes first.
- Inspect the brake linings, replace if necessary.
- Inspect the front suspension, tie rod ends and boot seals for cracks or leaks and all parts for damage, wear, improper looseness or end play; replace if necessary.

\_\_\_\_\_  
Odometer Reading Date

\_\_\_\_\_  
Repair Order # Dealer Code

\_\_\_\_\_  
Signature, Authorized Service Center

**88,000 Miles (143,000 km) or  
66 Months Maintenance  
Service Schedule**

- Change the engine oil and engine oil filter.
- Rotate the tires, rotate at the first sign of irregular wear, even if it occurs before 88,000 miles (143 000 km).

---

Odometer Reading

Date

---

Repair Order #

Dealer Code

---

Signature, Authorized Service Center

**96,000 Miles (156,000 km) or 72 Months Maintenance Service Schedule**

- Change the engine oil and engine oil filter.
- Rotate the tires, rotate at the first sign of irregular wear, even if it occurs before 96,000 miles (156 000 km).
- Replace the engine air cleaner filter.
- Replace the spark plugs (3.7L Engine).
- Inspect and replace PCV valve if necessary.†
- Adjust parking brake on vehicles equipped with four-wheel disc brakes.
- Inspect the transfer case fluid.
- Inspect the brake linings, replace if necessary.
- Inspect the CV joints.
- Inspect exhaust system.
- Inspect the front suspension, tie rod ends and boot seals for cracks or leaks and all parts for damage, wear, improper looseness or end play; replace if necessary.
- Inspect the front and rear axle fluid, change if using your vehicle for police, taxi, fleet, off-road or frequent trailer towing.

\_\_\_\_\_

Odometer Reading Date

\_\_\_\_\_

Repair Order # Dealer Code

\_\_\_\_\_

Signature, Authorized Service Center

**104,000 Miles (169,000 km) or 78 Months Maintenance Service Schedule**

- Change the engine oil and engine oil filter.
- Rotate the tires, rotate at the first sign of irregular wear, even if it occurs before 104,000 miles (169 000 km).
- Flush and replace the engine coolant at 104,000 miles (169 000 km) or 60 months whichever comes first.

\_\_\_\_\_  
 Odometer Reading Date

\_\_\_\_\_  
 Repair Order # Dealer Code

\_\_\_\_\_  
 Signature, Authorized Service Center

**112,000 Miles (182,000 km) or 84 Months Maintenance Service Schedule**

- Change the engine oil and engine oil filter.
- Rotate the tires, rotate at the first sign of irregular wear, even if it occurs before 112,000 miles (182 000 km).
- If using your vehicle for any of the following: Dusty or off-road conditions. Inspect the engine air cleaner filter; replace if necessary.
- Inspect the brake linings, replace if necessary.
- Inspect the front suspension, tie rod ends and boot seals for cracks or leaks and all parts for damage, wear, improper looseness or end play; replace if necessary.

\_\_\_\_\_  
 Odometer Reading Date

\_\_\_\_\_  
 Repair Order # Dealer Code

\_\_\_\_\_  
 Signature, Authorized Service Center



## 120,000 Miles (195,000 km) or 90 Months Maintenance Service Schedule

- Change the engine oil and engine oil filter.
- Rotate the tires, rotate at the first sign of irregular wear, even if it occurs before 120,000 miles (195 000 km).
- Inspect the CV joints.
- Inspect exhaust system.
- Inspect the front and rear axle fluid, change if using your vehicle for police, taxi, fleet, off-road or frequent trailer towing.
- Change the automatic transmission fluid and filter(s).
- Replace the accessory drive belt(s).

\_\_\_\_\_ Date

\_\_\_\_\_ Dealer Code

\_\_\_\_\_ Signature, Authorized Service Center

**128,000 Miles (208,000 km) or 96 Months Maintenance Service Schedule**

- Change the engine oil and engine oil filter.
- Rotate the tires, rotate at the first sign of irregular wear, even if it occurs before 128,000 miles (208 000 km).
- Replace the engine air cleaner filter.
- Replace the ignition cables (3.7L Engine).
- Replace the spark plugs (3.7L Engine).
- Adjust parking brake on vehicles equipped with four-wheel disc brakes.
- Change the transfer case fluid if using your vehicle for any of the following: police, taxi, fleet, or frequent trailer towing.
- Inspect the brake linings, replace if necessary.
- Inspect the front suspension, tie rod ends and boot seals for cracks or leaks and all parts for damage, wear, improper looseness or end play; replace if necessary.

\_\_\_\_\_ Date

Odometer Reading

\_\_\_\_\_ Dealer Code

Repair Order #

\_\_\_\_\_

Signature, Authorized Service Center

**136,000 Miles (221,000 km) or 102 Months Maintenance Service Schedule**

- Change the engine oil and engine oil filter.
- Rotate the tires, rotate at the first sign of irregular wear, even if it occurs before 136,000 miles (221 000 km).

\_\_\_\_\_ Date

Odometer Reading

\_\_\_\_\_ Dealer Code

Repair Order #

\_\_\_\_\_

Signature, Authorized Service Center

### 144,000 Miles (234,000 km) or 108 Months Maintenance Service Schedule

- Change the engine oil and engine oil filter.
- Rotate the tires, rotate at the first sign of irregular wear, even if it occurs before 144,000 miles (234 000 km).
- If using your vehicle for any of the following: Dusty or off-road conditions. Inspect the engine air cleaner filter; replace if necessary.
- Inspect the brake linings, replace if necessary.
- Inspect the CV joints.
- Inspect exhaust system.
- Inspect the front suspension, tie rod ends and boot seals for cracks or leaks and all parts for damage, wear, improper looseness or end play; replace if necessary.
- Inspect the front and rear axle fluid, change if using your vehicle for police, taxi, fleet, off-road or frequent trailer towing.

\_\_\_\_\_ Date  
Odometer Reading

\_\_\_\_\_ Dealer Code  
Repair Order #

\_\_\_\_\_  
Signature, Authorized Service Center

### 152,000 Miles (247,000 km) or 114 Months Maintenance Service Schedule

- Change the engine oil and engine oil filter.
- Rotate the tires, rotate at the first sign of irregular wear, even if it occurs before 152,000 miles (247 000 km).

\_\_\_\_\_ Date  
Odometer Reading

\_\_\_\_\_ Dealer Code  
Repair Order #

\_\_\_\_\_  
Signature, Authorized Service Center

## 506 MAINTENANCE SCHEDULES

† This maintenance is recommended by the manufacturer to the owner, but is not required to maintain emissions warranty.

**WARNING!**

- You can be badly injured working on or around a motor vehicle. Do only service work for which you have the knowledge and the right equipment. If you have any doubt about your ability to perform a service job, take your vehicle to a competent mechanic.
- Failure to properly inspect and maintain your vehicle could result in a component malfunction and effect vehicle handling and performance. This could cause an accident.

# IF YOU NEED CONSUMER ASSISTANCE

## CONTENTS

---

■ Suggestions For Obtaining Service For Your Vehicle. . . . .	509	□ Customer Assistance For The Hearing Or Speech Impaired (TDD/TTY) . . . . .	511
□ Prepare For The Appointment . . . . .	509	□ Service Contract . . . . .	511
□ Prepare A List . . . . .	509	■ Warranty Information . . . . .	512
□ Be Reasonable With Requests . . . . .	509	■ MOPAR® Parts . . . . .	512
■ If You Need Assistance . . . . .	509	■ Reporting Safety Defects . . . . .	512
□ Chrysler Group LLC Customer Center . . . . .	510	□ In The 50 United States And Washington, D.C. . . . .	512
□ Chrysler Canada Inc. Customer Center . . . . .	510	□ In Canada . . . . .	513
□ In Mexico Contact . . . . .	510	■ Publication Order Forms . . . . .	513

■ Department Of Transportation Uniform Tire		
Quality Grades . . . . .	515	
□ Treadwear . . . . .	515	
		□ Traction Grades . . . . . 515
		□ Temperature Grades . . . . . 516

## **SUGGESTIONS FOR OBTAINING SERVICE FOR YOUR VEHICLE**

### **Prepare For The Appointment**

If you're having warranty work done, be sure to have the right papers with you. Take your warranty folder. All work to be performed may not be covered by the warranty. Discuss additional charges with the service manager. Keep a maintenance log of your vehicle's service history. This can often provide a clue to the current problem.

### **Prepare A List**

Make a written list of your vehicle's problems or the specific work you want done. If you've had an accident or work done that is not on your maintenance log, let the service advisor know.

### **Be Reasonable With Requests**

If you list a number of items and you must have your vehicle by the end of the day, discuss the situation with

the service advisor and list the items in order of priority. At many authorized dealers, you may obtain a rental vehicle at a minimal daily charge. If you need a rental, it is advisable to make these arrangements when you call for an appointment.

### **IF YOU NEED ASSISTANCE**

The manufacturer and its authorized dealers are vitally interested in your satisfaction. We want you to be happy with our products and services.

Warranty service must be done by an authorized dealer. We strongly recommend that you take the vehicle to an authorized dealer. They know your vehicle the best, and are most concerned that you get prompt and high quality service. The manufacturer's authorized dealers have the facilities, factory-trained technicians, special tools, and the latest information to ensure the vehicle is fixed correctly and in a timely manner.

This is why you should always talk to an authorized dealer's service manager first. Most matters can be resolved with this process.

- If for some reason you are still not satisfied, talk to the general manager or owner of the authorized dealership. They want to know if you need assistance.
- If an authorized dealership is unable to resolve the concern, you may contact the manufacturer's customer center.

Any communication to the manufacturer's customer center should include the following information:

- Owner's name and address
- Owner's telephone number (home and office)
- Authorized dealership name
- Vehicle Identification Number (VIN)
- Vehicle delivery date and mileage

**Chrysler Group LLC Customer Center**

P.O. Box 21-8004

Auburn Hills, MI 48321-8004

Phone: (877) 426-5337

**Chrysler Canada Inc. Customer Center**

P.O. Box 1621

Windsor, Ontario N9A 4H6

Phone: (800) 465-2001 English / (800) 387-9983 French

**In Mexico contact:**

Av. Prolongacion Paseo de la Reforma, 1240

Sante Fe C.P. 05109

Mexico, D. F.

In Mexico City: 5081-7568

Outside Mexico City: 1-800-505-1300



### **Customer Assistance For The Hearing Or Speech Impaired (TDD/TTY)**

To assist customers who have hearing difficulties, the manufacturer has installed special TDD (Telecommunication Devices for the Deaf) equipment at its customer center. Any hearing or speech impaired customer, who has access to a TDD or a conventional teletypewriter (TTY) in the United States, can communicate with the manufacturer by dialing 1-800-380-CHRY.

Canadian residents with hearing difficulties that require assistance can use the special needs relay service offered by Bell Canada. For TTY teletypewriter users, dial 711 and for Voice callers, dial 1 800 855-0511 to connect with a Bell Relay Service operator.

### **Service Contract**

You may have purchased a service contract for a vehicle to help protect you from the high cost of unexpected repairs after the manufacturer's New Vehicle Limited Warranty expires. The manufacturer stands behind only

the manufacturer's service contracts. If you purchased a manufacturer's service contract, you will receive Plan Provisions and an Owner Identification Card in the mail within three weeks of the vehicle delivery date. If you have any questions about the service contract, call the manufacturer's Service Contract National Customer Hotline at 1-800-521-9922 (Canadian residents, call (800) 465-2001 English / (800) 387-9983 French).

The manufacturer will not stand behind any service contract that is not the manufacturer's service contract. It is not responsible for any service contract other than the manufacturer's service contract. If you purchased a service contract that is not a manufacturer's service contract, and you require service after the manufacturer's New Vehicle Limited Warranty expires, please refer to the contract documents, and contact the person listed in those documents.

We appreciate that you have made a major investment when you purchased the vehicle. An authorized dealer has also made a major investment in facilities, tools, and training to assure that you are absolutely delighted with the ownership experience. You'll be pleased with their sincere efforts to resolve any warranty issues or related concerns.

**WARNING!**

Engine exhaust, some of its constituents, and certain vehicle components contain, or emit, chemicals known to the State of California to cause cancer and birth defects, or other reproductive harm. In addition, certain fluids contained in vehicles and certain products of component wear contain, or emit, chemicals known to the State of California to cause cancer and birth defects, or other reproductive harm.

**WARRANTY INFORMATION**

See the Warranty Information Booklet, located on the DVD, for the terms and provisions of Chrysler Group LLC warranties applicable to this vehicle and market.

**MOPAR® PARTS**

MOPAR® fluids, lubricants, parts, and accessories are available from an authorized dealer. They are recommended for your vehicle in order to help keep the vehicle operating at its best.

**REPORTING SAFETY DEFECTS**

**In the 50 United States and Washington, D.C.**

If you believe that your vehicle has a defect that could cause a crash or cause injury or death, you should immediately inform the National Highway Traffic Safety Administration (NHTSA) in addition to notifying the manufacturer.

If NHTSA receives similar complaints, it may open an investigation, and if it finds that a safety defect exists in a group of vehicles, it may order a recall and remedy campaign. However, NHTSA cannot become involved in individual problems between you, your authorized dealer, and the manufacturer.

To contact NHTSA, you may either call the Auto Safety Hotline toll free at 1-888-327-4236 (TTY: 1-800-424-9153), or go to <http://www.safercar.gov>; or write to: Administrator, NHTSA, 1200 New Jersey Avenue, SE., West Building, Washington, D.C. 20590. You can also obtain other information about motor vehicle safety from <http://www.safercar.gov>.

### **In Canada**

If you believe that your vehicle has a safety defect, you should contact the Customer Service Department immediately. Canadian customers who wish to report a safety defect to the Canadian government should contact Transport Canada, Motor Vehicle Defect Investigations and Recalls at 1-800-333-0510 or go to <http://www.tc.gc.ca/roadsafety/>

### **PUBLICATION ORDER FORMS**

To order the following manuals, you may use either the website or the phone numbers listed below. Visa, Mastercard, American Express, and Discover orders are accepted. If you prefer mailing your payment, please call for an order form.

**NOTE:** A street address is required when ordering manuals (no P.O. Boxes).

- *Service Manuals*

These comprehensive Service Manuals provide the information that students and professional technicians need in diagnosing/troubleshooting, problem solving, maintaining, servicing, and repairing Chrysler Group LLC vehicles. A complete working knowledge of the vehicle, system, and/or components is written in straightforward language with illustrations, diagrams, and charts.

- *Diagnostic Procedure Manuals*

Diagnostic Procedure Manuals are filled with diagrams, charts and detailed illustrations. These practical manuals make it easy for students and technicians to find and fix problems on computer-controlled vehicle systems and features. They show exactly how to find and correct problems the first time, using step-by-step troubleshooting and drivability procedures, proven diagnostic tests and a complete list of all tools and equipment.

- *Owner's Manuals*

These Owner's Manuals have been prepared with the assistance of service and engineering specialists to acquaint you with specific Chrysler Group LLC vehicles. Included are starting, operating, emergency and maintenance procedures as well as specifications, capabilities and safety tips.

*Call toll free at:*

- 1-800-890-4038 (U.S.)
- 1-800-387-1143 (Canada)

Or

*Visit us on the Worldwide Web at:*

- [www.techauthority.com](http://www.techauthority.com)

## DEPARTMENT OF TRANSPORTATION UNIFORM TIRE QUALITY GRADES

The following tire grading categories were established by the National Highway Traffic Safety Administration. The specific grade rating assigned by the tire's manufacturer in each category is shown on the sidewall of the tires on your vehicle.

All passenger car tires must conform to Federal safety requirements in addition to these grades.

### Treadwear

The Treadwear grade is a comparative rating, based on the wear rate of the tire when tested under controlled conditions on a specified government test course. For example, a tire graded 150 would wear one and one-half times as well on the government course as a tire graded 100. The relative performance of tires depends upon the actual conditions of their use, however, and may depart

significantly from the norm due to variations in driving habits, service practices, and differences in road characteristics and climate.

### Traction Grades

The Traction grades, from highest to lowest, are AA, A, B, and C. These grades represent the tire's ability to stop on wet pavement, as measured under controlled conditions on specified government test surfaces of asphalt and concrete. A tire marked C may have poor traction performance.

### WARNING!

**The traction grade assigned to this tire is based on straight-ahead braking traction tests, and does not include acceleration, cornering, hydroplaning, or peak traction characteristics.**

### Temperature Grades

The temperature grades are A (the highest), B, and C, representing the tire's resistance to the generation of heat and its ability to dissipate heat, when tested under controlled conditions on a specified indoor laboratory test wheel. Sustained high temperature can cause the material of the tire to degenerate and reduce tire life, and excessive temperature can lead to sudden tire failure. The grade C corresponds to a level of performance, which all passenger car tires must meet under the Federal Motor Vehicle Safety Standard No. 109. Grades B and A represent higher levels of performance on the laboratory test wheel, than the minimum required by law.

#### **WARNING!**

**The temperature grade for this tire is established for a tire that is properly inflated and not overloaded. Excessive speed, under-inflation, or excessive loading, either separately or in combination, can cause heat buildup and possible tire failure.**

---

# INDEX

About Your Brakes . . . . .	339	Airbag, Window (Side Curtain) . . . . .	63
ABS (Anti-Lock Brake System) . . . . .	342,344	Alarm (Security Alarm) . . . . .	18,234
Adding Engine Coolant (Antifreeze) . . . . .	460	Alarm System (Security Alarm) . . . . .	18
Adding Fuel . . . . .	393	Alarm, Panic . . . . .	24
Additives, Fuel . . . . .	391	Alterations/Modifications, Vehicle . . . . .	8
Air Cleaner, Engine (Engine Air Cleaner Filter) . . . . .	450	Antenna, Satellite Radio . . . . .	265,290
Air Conditioner Maintenance . . . . .	453	Anti-Lock Brake System (ABS) . . . . .	342,344
Air Conditioning . . . . .	296	Anti-Lock Warning Light . . . . .	225
Air Conditioning Controls . . . . .	296	Anti-Theft Security Alarm (Theft Alarm) . . . . .	18
Air Conditioning Filter . . . . .	306,454	Anti-Theft System . . . . .	234
Air Conditioning Refrigerant . . . . .	453,454	Antifreeze (Engine Coolant) . . . . .	459,487
Air Conditioning System . . . . .	296,300,453	Disposal . . . . .	462
Air Conditioning, Operating Tips . . . . .	307	Appearance Care . . . . .	472
Air Filter . . . . .	450	Arming Theft System (Security Alarm) . . . . .	18
Air Pressure, Tires . . . . .	367	Assist, Hill Start . . . . .	347
Airbag . . . . .	59	Assistance Towing . . . . .	117
Airbag Deployment . . . . .	73	Auto Down Power Windows . . . . .	35
Airbag Light . . . . .	66,75,89,235	Auto Unlock, Doors . . . . .	32
Airbag Maintenance . . . . .	74	Automatic Dimming Mirror . . . . .	100



Automatic Door Locks . . . . .	31,32	B-Pillar Location . . . . .	362
Automatic Headlights . . . . .	159	Battery . . . . .	451
Automatic Oil Change Indicator . . . . .	232,239	Keyless Transmitter Replacement (RKE) . . . . .	25
Automatic Temperature Control (ATC) . . . . .	300	Belts, Seat . . . . .	44,89
Automatic Transaxle . . . . .	316	Body Mechanism Lubrication . . . . .	454
Special Additives . . . . .	466	Brake Assist System . . . . .	346
Automatic Transmission . . . . .	317,466,467	Brake Control System, Electronic . . . . .	344
Adding Fluid . . . . .	467,489	Brake Fluid . . . . .	489
Fluid and Filter Changes . . . . .	466,467	Brake System . . . . .	464
Fluid Change . . . . .	467	Anti-Lock (ABS) . . . . .	342,344
Fluid Level Check . . . . .	467	Fluid Check . . . . .	464,489
Fluid Type . . . . .	466,489	Master Cylinder . . . . .	464
Gear Ranges . . . . .	317	Parking . . . . .	339
Special Additives . . . . .	466	Warning Light . . . . .	233
Torque Converter . . . . .	321	Brake, Parking . . . . .	339
Auxiliary Electrical Outlet (Power Outlet) . . . . .	198	Brake/Transmission Interlock . . . . .	317
Auxiliary Power Outlet . . . . .	198	Brakes . . . . .	464
Axle Fluid . . . . .	489	Break-In Recommendations, New Vehicle . . . . .	87
Axle Lubrication (Axle Fluid) . . . . .	489	Bulb Replacement . . . . .	484

Bulbs, Light . . . . .	91,484	Cellular Phone . . . . .	103,295
Calibration, Compass . . . . .	242	Certification Label . . . . .	395
Capacities, Fluid . . . . .	487	Changing A Flat Tire . . . . .	423
Caps, Filler		Chart, Tire Sizing . . . . .	358
Fuel . . . . .	393	Check Engine Light	
Oil (Engine) . . . . .	449	(Malfunction Indicator Light) . . . . .	222,445
Power Steering . . . . .	339	Checking Your Vehicle For Safety . . . . .	87
Radiator (Coolant Pressure) . . . . .	461	Checks, Safety . . . . .	87
Car Washes . . . . .	473	Child Restraint . . . . .	77,78,82,84
Carbon Monoxide Warning . . . . .	88,392	Child Restraint Tether Anchors . . . . .	81,82
Cargo (Vehicle Loading) . . . . .	395	Child Safety Locks . . . . .	33
Cargo Area Cover . . . . .	208	Clean Air Gasoline . . . . .	389
Cargo Area Features . . . . .	204	Cleaning	
Cargo Compartment . . . . .	204	Windshield Wiper Blades . . . . .	455
Light . . . . .	164	Climate Control . . . . .	295
Cargo Light . . . . .	164	Clock . . . . .	250,269,279
Cargo Load Floor . . . . .	204	Coin Holder . . . . .	203
Cargo Tie-Downs . . . . .	206	Cold Weather Operation . . . . .	314
		Command-Trac Operation . . . . .	321

Compact Disc (CD) Maintenance . . . . .	295	Selection of Coolant (Antifreeze) . . . . .	459,487,488
Compact Spare Tire . . . . .	370	Corrosion Protection . . . . .	472
Compass . . . . .	241	Cruise Light . . . . .	232
Compass Calibration . . . . .	242	Cupholders . . . . .	201
Compass Variance . . . . .	243	Customer Assistance . . . . .	509
Computer, Trip/Travel . . . . .	240		
Console . . . . .	203	Data Recorder, Event . . . . .	76
Console, Floor . . . . .	203	Daytime Running Lights . . . . .	161
Contract, Service . . . . .	511	Dealer Service . . . . .	447
Coolant Pressure Cap (Radiator Cap) . . . . .	461	Defroster, Rear Window . . . . .	211
Cooling System . . . . .	458	Defroster, Windshield . . . . .	90,298,303
Adding Coolant (Antifreeze) . . . . .	460	Delay (Intermittent) Wipers . . . . .	166
Coolant Capacity . . . . .	487	Diagnostic System, Onboard . . . . .	444
Coolant Level . . . . .	458,462	Dimmer Switch, Headlight . . . . .	162
Disposal of Used Coolant . . . . .	462	Dipsticks	
Drain, Flush, and Refill . . . . .	459	Oil (Engine) . . . . .	448
Inspection . . . . .	462	Power Steering . . . . .	339
Points to Remember . . . . .	463	Disabled Vehicle Towing . . . . .	436
Pressure Cap . . . . .	461		

Disposal		Brake Assist System . . . . .	346
Antifreeze (Engine Coolant) . . . . .	462	Electronic Roll Mitigation . . . . .	347
Engine Oil . . . . .	450	Traction Control System . . . . .	345
Door Locks . . . . .	29	Electronic Roll Mitigation (ERM) . . . . .	347
Door Locks, Automatic . . . . .	31	Electronic Speed Control (Cruise Control) . . . . .	171
Door Opener, Garage . . . . .	183	Electronic Stability Control (ESC) . . . . .	352
Driving . . . . .	333	Electronic Vehicle Information Center (EVIC) . . . . .	235
Off-Pavement . . . . .	333	Emergency, In Case of	
Off-Road . . . . .	333	Hazard Warning Flasher . . . . .	422
On Hills . . . . .	333	Jacking . . . . .	423
Through Flowing, Rising, or Shallow		Jump Starting . . . . .	430
Standing Water . . . . .	333	Overheating . . . . .	422
When to Use Low Range . . . . .	333	Emission Control System Maintenance . . . . .	445
Electric Remote Mirrors . . . . .	101	Engine . . . . .	443
Electrical Outlet, Auxiliary (Power Outlet) . . . . .	198	Air Cleaner . . . . .	450
Electrical Power Outlets . . . . .	198	Block Heater . . . . .	315
Electronic Brake Control System . . . . .	344	Break-In Recommendations . . . . .	87
Anti-Lock Brake System . . . . .	344	Checking Oil Level . . . . .	448
		Compartment . . . . .	443

Coolant (Antifreeze) . . . . .	458,488	Engine Oil Viscosity Chart . . . . .	449
Cooling . . . . .	458	Enhanced Accident Response Feature . . . . .	73
Exhaust Gas Caution . . . . .	88,392	Entry System, Illuminated . . . . .	20
Fails to Start . . . . .	314	Ethanol . . . . .	389
Flooded, Starting . . . . .	314	Event Data Recorder . . . . .	76
Fuel Requirements . . . . .	388	Exhaust Gas Caution . . . . .	88,392
Jump Starting . . . . .	430	Exhaust System . . . . .	88,456
Oil . . . . .	448,487,488	Exterior Finish Care . . . . .	473
Oil Change Interval . . . . .	232,239,448	Exterior Lights . . . . .	91
Oil Filler Cap . . . . .	449	Fabric Care . . . . .	475
Oil Filter . . . . .	450	Filters	
Oil Filter Disposal . . . . .	450	Air Cleaner . . . . .	450
Oil Selection . . . . .	449,487	Air Conditioning . . . . .	306,454
Oil Synthetic . . . . .	450	Engine Oil . . . . .	450,488
Overheating . . . . .	422	Engine Oil Disposal . . . . .	450
Starting . . . . .	313	Finish Care . . . . .	473
Temperature Gauge . . . . .	227	Flash-To-Pass . . . . .	162
Engine Oil Viscosity . . . . .	449		

Flashers		Four Wheel Drive	
Hazard Warning	422	Shifting	321,324,327,330
Turn Signal	91,162,223,485,486	Systems	321,327
Flipper Glass, Liftgate	40	Four Wheel Drive Operation	321
Flooded Engine Starting	314	Freeing A Stuck Vehicle	434
Floor Console	203	Front Axle (Differential)	469
Fluid Capacities	487	Fuel	388
Fluid Leaks	91	Additives	391
Fluid Level Checks	468,469	Clean Air	389
Automatic Transmission	466	Ethanol	389
Brake	464	Filler Cap (Gas Cap)	393
Cooling System	458	Gasoline	388
Engine Oil	448	Gauge	220
Power Steering	339	Materials Added	391
Fluid, Brake	489	Methanol	389
Fluids, Lubricants and Genuine Parts	488	Octane Rating	388,488
Fog Light Service	485	Requirements	388
Fog Lights	158,161,223,485	Specifications	488
Folding Rear Seat	149	Tank Capacity	487

Fuses . . . . .	478	Gross Axle Weight Rating . . . . .	395,398
Garage Door Opener (HomeLink®) . . . . .	183	Gross Vehicle Weight Rating . . . . .	395,397
Gas Cap (Fuel Filler Cap) . . . . .	393,394,444	GVWR . . . . .	395
Gas Gauge (Fuel Gauge) . . . . .	220	Hands-Free Phone (Uconnect™) . . . . .	103
Gasoline (Fuel) . . . . .	388	Hazard	
Gasoline, Clean Air . . . . .	389	Driving Through Flowing, Rising, or Shallow	
Gasoline, Reformulated . . . . .	389	Standing Water . . . . .	333
Gauges		Hazard Warning Flasher . . . . .	422
Coolant Temperature . . . . .	227	Head Restraints . . . . .	145
Fuel . . . . .	220	Head Rests . . . . .	145
Odometer . . . . .	230	Headlights . . . . .	158
Speedometer . . . . .	223	Automatic . . . . .	159
Tachometer . . . . .	225	Bulb Replacement . . . . .	484
Gear Ranges . . . . .	317	Cleaning . . . . .	476
Gear Select Lever Override . . . . .	435	Delay . . . . .	160
General Information . . . . .	17,26,133,388	High Beam/Low Beam Select Switch . . . . .	162
General Maintenance . . . . .	447	Lights On Reminder . . . . .	161
Glass Cleaning . . . . .	476	On With Wipers . . . . .	160,170

Passing . . . . .	162	Ignition . . . . .	12
Replacing . . . . .	484	Key . . . . .	12
Switch . . . . .	158	Ignition Key Removal . . . . .	12
Time Delay . . . . .	160	Illuminated Entry . . . . .	20
Heated Mirrors . . . . .	102	Immobilizer (Sentry Key) . . . . .	14
Heated Seats . . . . .	140	Infant Restraint . . . . .	77,78
Heater . . . . .	296	Inflation Pressure Tires . . . . .	367
Heater, Engine Block . . . . .	315	Information Center, Vehicle . . . . .	235
High Beam Indicator . . . . .	223	Inside Rearview Mirror . . . . .	99
High Beam/Low Beam Select (Dimmer) Switch . . . . .	162	Instrument Cluster . . . . .	219,220
Hill Descent Control . . . . .	350	Instrument Panel and Controls . . . . .	218
Hill Descent Control Indicator . . . . .	226,350	Instrument Panel Cover . . . . .	475
Hill Start Assist . . . . .	347	Instrument Panel Lens Cleaning . . . . .	477
Hitches		Integrated Power Module (Fuses) . . . . .	478
Trailer Towing . . . . .	402	Interior Appearance Care . . . . .	475
Holder, Coin . . . . .	203	Interior Lighting . . . . .	158
Holder, Cup . . . . .	201	Intermittent Wipers (Delay Wipers) . . . . .	166
HomeLink® (Garage Door Opener) Transmitter . . . . .	183	Introduction . . . . .	4
Hood Release . . . . .	156		



- Jack Location . . . . . 424
- Jack Operation . . . . . 423,426
- Jacking Instructions . . . . . 426
- Jump Starting . . . . . 430
  
- Key-In Reminder . . . . . 14
- Key, Programming . . . . . 16
- Key, Replacement . . . . . 16
- Key, Sentry (Immobilizer) . . . . . 14
- Keyless Entry System . . . . . 20
- Keys . . . . . 12
  
- Lane Change and Turn Signals . . . . . 162
- Lane Change Assist . . . . . 162
- Lap/Shoulder Belts . . . . . 44
- LATCH  
(Lower Anchors and Tether for Children) . . . . . 81,82
- Latches . . . . . 91
  - Hood . . . . . 156
  
- Lead Free Gasoline . . . . . 388
- Leaks, Fluid . . . . . 91
- Life of Tires . . . . . 373
- Liftgate . . . . . 39
- Liftgate Flipper Glass . . . . . 40
- Light Bulbs . . . . . 91,484
- Lights . . . . . 91,158
  - Airbag . . . . . 66,75,89,235
  - Anti-Lock . . . . . 225
  - Automatic Headlights . . . . . 159
  - Back-Up . . . . . 486
  - Battery Saver . . . . . 164
  - Brake Assist Warning . . . . . 356
  - Brake Warning . . . . . 233
  - Bulb Replacement . . . . . 484
  - Cargo . . . . . 164
  - Cruise . . . . . 232
  - Daytime Running . . . . . 161
  - Dimmer Switch, Headlight . . . . . 158,162

Electronic Stability Program (ESP) Indicator . . .	356	Oil Pressure . . . . .	225
Engine Temperature Warning . . . . .	227	Park . . . . .	158
Exterior . . . . .	91	Passing . . . . .	162
Fog . . . . .	161,223,485	Rear Servicing . . . . .	486
Four-Wheel Drive Indicator . . . . .	226,227,230,325,331	Rear Tail . . . . .	486
Hazard Warning Flasher . . . . .	422	Seat Belt Reminder . . . . .	232
Headlight Switch . . . . .	158	Service . . . . .	484
Headlights . . . . .	158,484	Service Engine Soon (Malfunction Indicator) . . . . .	222
Headlights On Reminder . . . . .	161	Side Marker . . . . .	485
Headlights On With Wipers . . . . .	160,170	Tire Pressure Monitoring (TPMS) . . . . .	220,378
High Beam . . . . .	162,223	Tow/Haul Indicator . . . . .	226
High Beam Indicator . . . . .	223	Traction Control . . . . .	356
High Beam/Low Beam Select . . . . .	162	Transfer Case . . . . .	325,331
Hill Descent Control Indicator . . . . .	226,350	Turn Signal . . . . .	91,158,162,485,486
Illuminated Entry . . . . .	20	Vanity Mirror . . . . .	102
Instrument Cluster . . . . .	158,220	Voltage . . . . .	224
Lights On Reminder . . . . .	161	Warning (Instrument Cluster Description) . . .	220
Low Fuel . . . . .	220	Load Floor, Cargo . . . . .	204
Malfunction Indicator (Check Engine) . . . . .	222		

Loading Vehicle . . . . .	395	Maintenance, Sunroof . . . . .	192
Tires . . . . .	362	Malfunction Indicator Light (Check Engine) . .	222,445
Locks . . . . .	29	Manual Transmission	
Auto Unlock . . . . .	32	Lubricant Selection . . . . .	489
Automatic Door . . . . .	31	Manual, Service . . . . .	513
Child Protection . . . . .	33	Marker Lights, Side . . . . .	485
Door . . . . .	29	Master Cylinder (Brakes) . . . . .	464
Power Door . . . . .	30	Memory Feature (Memory Seat) . . . . .	151
Low Tire Pressure System . . . . .	378	Memory Seat . . . . .	151
Lower Anchors and Tether for CHildren		Memory Seats and Radio . . . . .	151
(LATCH) . . . . .	81,82	Methanol . . . . .	389
Lubrication, Body . . . . .	454	Mini-Trip Computer . . . . .	240
Luggage Carrier . . . . .	212	Mirrors . . . . .	99
Lumbar Support . . . . .	144	Automatic Dimming . . . . .	100
Maintenance Free Battery . . . . .	451	Electric Powered . . . . .	101
Maintenance Procedures . . . . .	447	Electric Remote . . . . .	101
Maintenance Schedule . . . . .	492	Heated . . . . .	102
Maintenance, General . . . . .	447	Outside . . . . .	101
		Rearview . . . . .	99

Vanity	102	Oil, Engine	448,488
Modifications/Alterations, Vehicle	8	Capacity	487
Monitor, Tire Pressure System	378	Change Interval	232,239,448
Mopar Parts	446,512	Checking	448
MTBE/ETBE	389	Dipstick	448
Multi-Function Control Lever	158	Disposal	450
		Filter	450,488
New Vehicle Break-In Period	87	Filter Disposal	450
		Identification Logo	449
Occupant Restraints	41	Materials Added to	450
Occupant Restraints (Sedan)	63	Recommendation	449,487
Octane Rating, Gasoline (Fuel)	388,488	Synthetic	450
Odometer		Viscosity	449,487
Trip	229	Onboard Diagnostic System	444,445
Off-Pavement Driving (Off-Road)	333	Opener, Garage Door (HomeLink®)	183
Off-Road Driving (Off-Pavement)	333	Operating Precautions	444
Oil Change Indicator	232,239	Operator Manual (Owner's Manual)	5
Oil Change Indicator, Reset	232,239	Outside Rearview Mirrors	101
Oil Filter, Change	450	Overdrive	232,319

Overdrive OFF Switch . . . . .	319	Power	
Overheating, Engine . . . . .	228,422	Door Locks . . . . .	30
Owner's Manual (Operator Manual) . . . . .	5,513	Mirrors . . . . .	101
		Seats . . . . .	139
Paint Care . . . . .	472	Steering . . . . .	337,339
Paint Damage . . . . .	472	Sunroof . . . . .	190
Panic Alarm . . . . .	24	Sunroof (Sky Slider) . . . . .	193,470
Park Sense System, Rear . . . . .	175	Windows . . . . .	35
Parking Brake . . . . .	339	Power Steering Fluid . . . . .	489
Parking On Hill . . . . .	339	Pregnant Women and Seat Belts . . . . .	58
Passing Light . . . . .	162	Preparation for Jacking . . . . .	426
Personal Settings . . . . .	244	Pretensioners	
Pets . . . . .	86	Seat Belts . . . . .	50
Pets, Transporting . . . . .	86	Programmable Electronic Features . . . . .	244
Phone, Cellular . . . . .	103	Programming Transmitters	
Phone, Hands-Free (Uconnect™) . . . . .	103	(Remote Keyless Entry) . . . . .	20
Placard, Tire and Loading Information . . . . .	362	Radial Ply Tires . . . . .	369
Polishing and Waxing . . . . .	473	Radiator Cap (Coolant Pressure Cap) . . . . .	461

Radio Operation	295	Remote Control	
Rain Sensitive Wiper System	168	Starting System	27
Rear Axle (Differential)	469	Remote Keyless Entry (RKE)	20
Rear Park Sense System	175	Remote Sound System (Radio) Controls	293
Rear Seat, Folding	149	Remote Starting System	27
Rear Window Defroster	211	Replacement Bulbs	484
Rear Window Features	210	Replacement Keys	16
Rear Wiper/Washer	210	Replacement Parts	446
Rearview Mirrors	99	Replacement Tires	374
Reclining Front Seats	143	Reporting Safety Defects	512
Recorder, Event Data	76	Resetting Oil Change Indicator	232,239
Recreational Towing	413	Restraint, Head	145
Shifting into Transfer Case Neutral (N)	416	Restraints, Child	77
Shifting out of Transfer Case Neutral (N)	418	Restraints, Occupant	41
Reformulated Gasoline	389	Retractable Cargo Area Cover	208
Refrigerant	454	Roll Over Warning	4
Release, Hood	156	Roof	
Reminder, Lights On	161	Sky Slider Power	193,470
Reminder, Seat Belt	56	Roof Type Carrier	212

Rotation, Tires . . . . .	377	Pretensioners . . . . .	50
Safety Checks Inside Vehicle . . . . .	89	Reminder . . . . .	232
Safety Checks Outside Vehicle . . . . .	91	Shoulder Belt Anchorage . . . . .	49
Safety Defects, Reporting . . . . .	512	Untwisting Procedure . . . . .	50
Safety Information, Tire . . . . .	357	Seats . . . . .	138
Safety Tips . . . . .	87	Adjustment . . . . .	138
Safety, Exhaust Gas . . . . .	88	Easy Entry . . . . .	154
Satellite Radio Antenna . . . . .	265,290	Head Restraints . . . . .	145
Schedule, Maintenance . . . . .	492	Heated . . . . .	140
Seat Belt Maintenance . . . . .	477	Height Adjustment . . . . .	139
Seat Belt Reminder . . . . .	56	Lumbar Support . . . . .	144
Seat Belts . . . . .	44,89	Memory . . . . .	151
Adjustable Upper Shoulder Anchorage . . . . .	49	Power . . . . .	139
And Pregnant Women . . . . .	58	Rear Folding . . . . .	149
Child Restraint . . . . .	77,84	Reclining . . . . .	143
Extender . . . . .	58	Seatback Release . . . . .	149
Front Seat . . . . .	44	Tilting . . . . .	139
Inspection . . . . .	89	Security Alarm (Theft Alarm) . . . . .	18,234
		Selec-Trac Operation . . . . .	327

- Selection of Coolant (Antifreeze) . . . . . 459,488
- Selection of Oil . . . . . 449
- Sentry Key (Immobilizer) . . . . . 14
- Sentry Key Programming . . . . . 16
- Sentry Key Replacement . . . . . 16
- Service Assistance . . . . . 509
- Service Contract . . . . . 511
- Service Engine Soon Light  
(Malfunction Indicator) . . . . . 222
- Service Manuals . . . . . 513
- Setting the Clock . . . . . 250,269,279
- Settings, Personal . . . . . 244
- Shift Lever Override . . . . . 435
- Shifting
  - Automatic Transmission . . . . . 317
  - Transfer Case . . . . . 321,324,327,330
- Shoulder Belts . . . . . 44
- Side View Mirror Adjustment . . . . . 101
- Side Window Demisters (Defrosters) . . . . . 306
- Signals, Turn . . . . . 91,162,223,485,486
- Sky Slider Power Roof . . . . . 193,470
- Snow Chains (Tire Chains) . . . . . 375
- Spare Tire . . . . . 370,371,424
- Spark Plugs . . . . . 488
- Specifications
  - Fuel (Gasoline) . . . . . 488
  - Oil . . . . . 449,488
- Speed Control (Cruise Control) . . . . . 171
- Speedometer . . . . . 223
- Starting . . . . . 27,313
  - Cold Weather . . . . . 314
  - Engine Block Heater . . . . . 315
  - Engine Fails to Start . . . . . 314
  - Remote . . . . . 27
- Starting and Operating . . . . . 313
- Starting Procedures . . . . . 313



Steering		Tachometer . . . . .	225
Power . . . . .	337,339	Temperature Control, Automatic (ATC) . . . . .	300
Tilt Column . . . . .	170	Temperature Gauge, Engine Coolant . . . . .	227
Wheel, Tilt . . . . .	170	Tether Anchor, Child Restraint . . . . .	81
Steering Wheel Audio Controls . . . . .	293	Theft Alarm (Security Alarm) . . . . .	18
Steering Wheel Mounted Sound		Theft System (Security Alarm) . . . . .	18
System Controls . . . . .	293	Tie Down Hooks, Cargo . . . . .	206
Storage . . . . .	202	Tilt Steering Column . . . . .	170
Storage Bin . . . . .	202	Time Delay, Headlight . . . . .	160
Storage, Vehicle . . . . .	305	Tip Start . . . . .	313
Stuck, Freeing . . . . .	434	Tire and Loading Information Placard . . . . .	362
Sun Roof . . . . .	190	Tire Identification Number (TIN) . . . . .	360
Sun Roof (Sky Slider Power) . . . . .	193,470	Tire Markings . . . . .	357
Sun Visor Extension . . . . .	103	Tire Safety Information . . . . .	357
Sunroof Maintenance . . . . .	192	Tires . . . . .	91,366,515
Supplemental Restraint System - Airbag . . . . .	59	Air Pressure . . . . .	367
Synthetic Engine Oil . . . . .	450	Chains . . . . .	375
System, Remote Starting . . . . .	27	Changing . . . . .	423
		Compact Spare . . . . .	370

General Information . . . . .	366	Torque Converter Clutch . . . . .	321
High Speed . . . . .	369	Tow/Haul Indicator Light . . . . .	226
Inflation Pressures . . . . .	367	Towing . . . . .	397,436
Jacking . . . . .	423	24-Hour Towing Assistance . . . . .	117
Life of Tires . . . . .	373	Disabled Vehicle . . . . .	436
Load Capacity . . . . .	362,363	Guide . . . . .	403
Pressure Monitor System (TPMS) . . . . .	378	Recreational . . . . .	413
Pressure Warning Light . . . . .	220	Weight . . . . .	403
Quality Grading . . . . .	515	Towing Assistance . . . . .	117
Radial . . . . .	369	Traction Control . . . . .	345
Replacement . . . . .	374	Trailer Towing . . . . .	397
Rotation . . . . .	377	Cooling System Tips . . . . .	412
Safety . . . . .	357	Hitches . . . . .	402
Sizes . . . . .	358	Minimum Requirements . . . . .	406
Spare Tire . . . . .	424	Trailer and Tongue Weight . . . . .	405
Spinning . . . . .	372	Wiring . . . . .	409
Tread Wear Indicators . . . . .	372	Trailer Towing Guide . . . . .	403
To Open Hood . . . . .	156	Trailer Weight . . . . .	403
Tongue Weight/Trailer Weight . . . . .	405		

Transaxle . . . . .	316	Trip Odometer Reset Button . . . . .	229
Automatic . . . . .	316	Turn Signals . . . . .	158,162,223,485,486
Operation . . . . .	316	Uconnect™ (Hands-Free Phone) . . . . .	103
Transfer Case . . . . .	468	Uniform Tire Quality Grades . . . . .	515
Fluid . . . . .	468,489	Universal Transmitter . . . . .	183
Four-Wheel-Drive Operation . . . . .	321	Unleaded Gasoline . . . . .	388
Maintenance . . . . .	468	Untwisting Procedure, Seat Belt . . . . .	50
Transmission . . . . .	317	Upholstery Care . . . . .	475
Automatic . . . . .	317	Vanity Mirrors . . . . .	102
Fluid . . . . .	489	Variance, Compass . . . . .	243
Maintenance . . . . .	466	Vehicle Certification Label . . . . .	395
Transmitter Battery Service (Remote Keyless Entry) . . . . .	25	Vehicle Identification Number (VIN) . . . . .	7
Transmitter Programming (Remote Keyless Entry) . . . . .	20	Vehicle Loading . . . . .	363,395
Transmitter, Garage Door Opener (HomeLink®) . . . . .	183	Vehicle Modifications/Alterations . . . . .	8
Transmitter, Remote Keyless Entry (RKE) . . . . .	20	Vehicle Storage . . . . .	305
Tread Wear Indicators . . . . .	372	Vehicle Theft Alarm (Security Alarm) . . . . .	18
Trip Odometer . . . . .	230	Viscosity, Engine Oil . . . . .	449

Voice Recognition System (VR) . . . . .	133	Wind Buffeting . . . . .	39,192,197
Warning Flasher, Hazard . . . . .	422	Window Fogging . . . . .	306
Warning Lights (Instrument Cluster Description) . . . . .	220	Windows . . . . .	35
Warning, Roll Over . . . . .	4	Power . . . . .	35
Warnings and Cautions . . . . .	7	Windshield Defroster . . . . .	90,298,303
Warranty Information . . . . .	512	Windshield Washers . . . . .	164,167,455
Washers, Windshield . . . . .	164,167,455	Fluid . . . . .	455
Water		Windshield Wiper Blades . . . . .	455
Driving Through . . . . .	333	Windshield Wipers . . . . .	164
Waxing and Polishing . . . . .	473	Wiper Blade Replacement . . . . .	455
Wheel and Wheel Trim . . . . .	474	Wiper, Delay . . . . .	166
Wheel and Wheel Trim Care . . . . .	474	Wiper, Rear . . . . .	210
		Wipers, Intermittent . . . . .	166
		Wipers, Rain Sensitive . . . . .	168

## **INSTALLATION OF RADIO TRANSMITTING EQUIPMENT**

Special design considerations are incorporated into this vehicle's electronic system to provide immunity to radio frequency signals. Mobile two-way radios and telephone equipment must be installed properly by trained personnel. The following must be observed during installation.

The positive power connection should be made directly to the battery and fused as close to the battery as possible. The negative power connection should be made to body sheet metal adjacent to the negative battery connection. This connection should not be fused.

Antennas for two-way radios should be mounted on the roof or the rear area of the vehicle. Care should be used in mounting antennas with magnet bases. Magnets may affect the accuracy or operation of the compass on vehicles so equipped.

The antenna cable should be as short as practical and routed away from the vehicle wiring when possible. Use only fully shielded coaxial cable.

Carefully match the antenna and cable to the radio to ensure a low Standing Wave Ratio (SWR).

Mobile radio equipment with output power greater than normal may require special precautions.

All installations should be checked for possible interference between the communications equipment and the vehicle's electronic systems.



STICK WITH THE SPECIALISTS®

Chrysler Group LLC

11KK74-126-AG



Seventh Edition

Printing in U.S.A.