

Jeep[®]

2011

Grand Cherokee

OWNER'S MANUAL

VEHICLES SOLD IN CANADA

With respect to any Vehicles Sold in Canada, the name Chrysler Group LLC shall be deemed to be deleted and the name Chrysler Canada Inc. used in substitution therefore.

DRIVING AND ALCOHOL

Drunken driving is one of the most frequent causes of accidents.

Your driving ability can be seriously impaired with blood alcohol levels far below the legal minimum. If you are drinking, don't drive. Ride with a designated non-drinking driver, call a cab, a friend, or use public transportation.

WARNING!

Driving after drinking can lead to an accident. Your perceptions are less sharp, your reflexes are slower, and your judgment is impaired when you have been drinking. Never drink and then drive.

This manual illustrates and describes the operation of features and equipment that are either standard or optional on this vehicle. This manual may also include a description of features and equipment that are no longer available or were not ordered on this vehicle. Please disregard any features and equipment described in this manual that are not on this vehicle.

Chrysler Group LLC reserves the right to make changes in design and specifications, and/or make additions to or improvements to its products without imposing any obligation upon itself to install them on products previously manufactured.

Jeep

Jeep is a registered trademark of Chrysler Group LLC

Copyright © 2010 Chrysler Group LLC



TABLE OF CONTENTS

SECTION		PAGE	
1	INTRODUCTION	3	1
2	THINGS TO KNOW BEFORE STARTING YOUR VEHICLE	11	2
3	UNDERSTANDING THE FEATURES OF YOUR VEHICLE	101	3
4	UNDERSTANDING YOUR INSTRUMENT PANEL	243	4
5	STARTING AND OPERATING	337	5
6	WHAT TO DO IN EMERGENCIES	461	6
7	MAINTAINING YOUR VEHICLE	481	7
8	MAINTENANCE SCHEDULES	537	8
9	IF YOU NEED CONSUMER ASSISTANCE	553	9
10	INDEX	563	10

INTRODUCTION

CONTENTS

■ Introduction	4	■ Warnings And Cautions	8
■ Rollover Warning	5	■ Vehicle Identification Number	8
■ How To Use This Manual	6	■ Vehicle Modifications/Alterations	9

INTRODUCTION

Congratulations on selecting your new Chrysler Group LLC vehicle. Be assured that it represents precision workmanship, distinctive styling, and high quality - all essentials that are traditional to our vehicles.

This is a specialized utility vehicle, it can go places and perform tasks for which conventional two-wheel drive enclosed vehicles were not intended. It handles and maneuvers differently from many passenger cars both on-road and off-road, so take time to become familiar with your vehicle.

The two-wheel drive utility vehicle was designed for on-road use only. It is not intended for off-road driving or use in other severe conditions suited for a four-wheel drive vehicle.

Before you start to drive this vehicle, read the Owner's Manual. Be sure you are familiar with all vehicle controls, particularly those used for braking, steering, transmission,

and transfer case shifting. Learn how your vehicle handles on different road surfaces. Your driving skills will improve with experience. When driving off-road or working the vehicle, don't overload the vehicle or expect the vehicle to overcome the natural laws of physics. Always observe federal, state, provincial and local laws wherever you drive.

As with other vehicles of this type, failure to operate this vehicle correctly may result in loss of control or a collision. Refer to "On-Road/Off-Road Driving Tips" in "Starting And Operating" for further information.

This Owner's Manual has been prepared with the assistance of service and engineering specialists to acquaint you with the operation and maintenance of your vehicle. It is supplemented by Warranty Information, and various customer-oriented documents. Please take the time to read these publications carefully. Following the instructions and recommendations in this manual will help assure safe and enjoyable operation of your vehicle.

NOTE: After reviewing the owner information, it should be stored in the vehicle for convenient referencing and remain with the vehicle when sold.

When it comes to service, remember that your authorized dealer knows your vehicle best, has factory-trained technicians and genuine MOPAR® parts, and cares about your satisfaction.

ROLLOVER WARNING

Utility vehicles have a significantly higher rollover rate than other types of vehicles. This vehicle has a higher ground clearance and a higher center of gravity than many passenger cars. It is capable of performing better in a wide variety of off-road applications. Driven in an unsafe manner, all vehicles can go out of control. Because of the higher center of gravity, if this vehicle is out of control it may roll over when some other vehicles may not.

Do not attempt sharp turns, abrupt maneuvers, or other unsafe driving actions that can cause loss of vehicle control. Failure to operate this vehicle safely may result in a collision, rollover of the vehicle, and severe or fatal injury. Drive carefully.

1

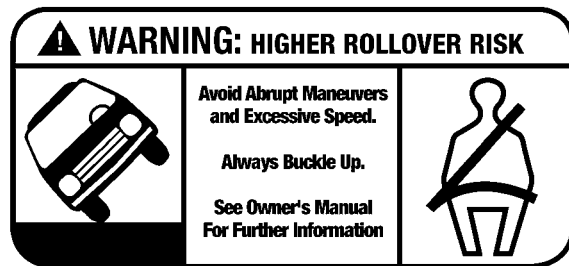

80bfe0f0

Rollover Warning Label

Failure to use the driver and passenger seat belts provided is a major cause of severe or fatal injury. In fact, the U.S. government notes that the universal use of existing seat belts could cut the highway death toll by 10,000 or more each year and could reduce disabling injuries by two million annually. In a rollover crash, an unbelted person is significantly more likely to die than a person wearing a seat belt. Always buckle up.

HOW TO USE THIS MANUAL

Consult the Table of Contents to determine which section contains the information you desire.

Since the specification of your vehicle depends on the items of equipment ordered, certain descriptions and illustrations may differ from your vehicle's equipment

The detailed index at the back of this Owner's Manual contains a complete listing of all subjects.

Consult the following table for a description of the symbols that may be used on your vehicle or throughout this Owner's Manual:

 WATER IN FUEL	 REAR WINDOW WIPER	 WINDSHIELD WIPER INTERMITTENT	 EXTERIOR BULB FAILURE	 HIGH BEAM	 TURN SIGNALS	 UPPER AIR OUTLET	 HEATED SEAT LOW	 DOOR LOCK	 ADJUSTABLE PEDALS	 ELECTRONIC SPEED CONTROL	 ESP BAS ELECTRONIC STABILITY PROGRAM / BRAKE ASSIST SYSTEM
 FUEL	 REAR WINDOW INTERMITTENT WIPER	 WINDSHIELD WASHER	 MASTER LIGHTING SWITCH	 LOW BEAM	 12V AC POWER (POWER OUTLET)	 UPPER AND LOWER AIR OUTLET	 HEATED SEAT HIGH	 WINDOW LIFT	 TIRES PRESSURE MONITOR	 HILL DESCENT CONTROL	 BRAKE SYSTEM WARNING PARKING BRAKE
 FUEL FILLER SIDE	 REAR WINDOW WASHER	 WINDSHIELD WASHER FLUID LEVEL	 DOME LIGHT	 FRONT FOG LIGHT	 HOOD RELEASE	 LOWER AIR OUTLET	 RECIRCULATION	 CONVERSION WINDOW DOWN	 ELECTRONIC STABILITY CONTROL	 AWD!	 ABS ANTI-LOCK BRAKING SYSTEM
 ENGINE OIL	 REAR WINDOW DEFROST	 WINDSHIELD, ELECTRICALLY HEATED	 PARK LIGHTS	 REAR FOG LAMP	 LIFTGATE RELEASE AND LIFTGATE OPEN	 DEFROST AND LOWER AIR OUTLET	 VENTILATING FAN	 WINDOW LOCK	 ELECTRONIC THROTTLE CONTROL	 4WD!	 BRAKE SYSTEM WARNING PARKING BRAKE
 BATTERY CHARGING	 HEATED MIRROR	 WINDSHIELD DEFROST	 INSTRUMENT PANEL ILLUMINATION	 SEAT BELT	 SLIDING DOOR	 TRUNK / DECK RELEASE	 AIR CONDITIONING	 CHILD SEAT TETHER ANCHOR	 VOICE RECOGNITION BUTTON	 WARNING	 TOW / HAUL
 BLOW FLUID	 POWER STEERING FLUID	 WINDSHIELD WIPER AND WASHER	 SRS AIRBAG	 AIRBAG	 SLIDING DOOR	 EMERGENCY RELEASE HANDLE	 LIGHTER	 LOWER ANCHORS AND TETHER FOR CHILDREN (LATCH)	 DISCONNECT BUTTON	 HAZARD	 4 LOW FOUR WHEEL DRIVE LOW
 MALFUNCTION INDICATOR LIGHT	 TRANS OIL TEMP	 ENGINE COOLANT TEMPERATURE	 SUPPLEMENTAL RESTRAINT SYSTEM	 PASSENGER AIRBAG OFF	 DOOR AJAR	 CONVERTIBLE TOP DOWN	 CONVERTIBLE TOP UP	 HORN	 SEE OWNER'S MANUAL ISD	 A/C PUSH AIR CONDITIONER	 OFF ELECTRONIC STABILITY CONTROL OFF

WARNINGS AND CAUTIONS

This Owner's Manual contains **WARNINGS** against operating procedures that could result in a collision or bodily injury. It also contains **CAUTIONS** against procedures that could result in damage to your vehicle. If you do not read this entire manual, you may miss important information. Observe all Warnings and Cautions.

VEHICLE IDENTIFICATION NUMBER

The Vehicle Identification Number (VIN) is found on a label located on the left front corner of the instrument panel pad, visible from outside of the vehicle through the windshield. This number also appears on the Automobile Information Disclosure Label affixed to a window on your vehicle. Save this label for a convenient record of your vehicle identification number and optional equipment.

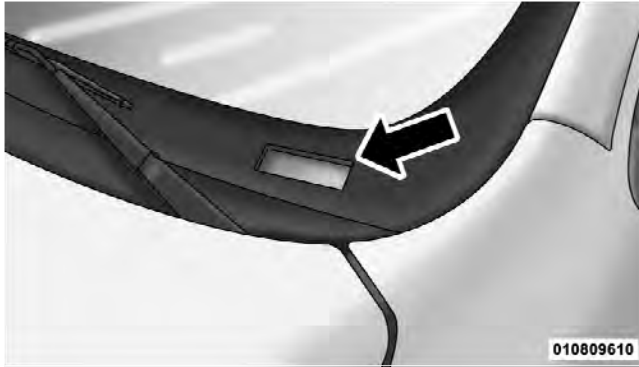

VIN Location

NOTE: It is illegal to remove or alter the VIN.

VEHICLE MODIFICATIONS/ALTERATIONS

WARNING!

Any modifications or alterations to this vehicle could seriously affect its roadworthiness and safety and may lead to a accident resulting in serious injury or death.

THINGS TO KNOW BEFORE STARTING YOUR VEHICLE

CONTENTS

■ A Word About Your Keys	14	■ Vehicle Security Alarm — If Equipped	21
□ Wireless Ignition Node (WIN)	14	□ Rearming The System	21
□ Key FOB	15	□ To Arm The System	21
□ Removing Key FOB From Ignition	16	□ To Disarm The System	22
□ Key-In-Ignition Reminder	18	■ Illuminated Entry	23
■ Sentry Key®	19	■ Remote Keyless Entry (RKE)	23
□ Replacement Keys	20	□ To Unlock The Doors	24
□ Customer Key Programming	20	□ To Lock The Doors	25
□ General Information	20		

12 THINGS TO KNOW BEFORE STARTING YOUR VEHICLE

- Remote Open Window Feature —
If Equipped 25
- Using The Panic Alarm 26
- Programming Additional Transmitters 26
- Transmitter Battery Replacement 26
- General Information 28
- Remote Starting System — If Equipped 29
 - How To Use Remote Start 29
- Door Locks 33
 - Power Door Locks 34
 - Child-Protection Door Lock System —
Rear Doors 35
- Keyless Enter-N-Go 36
- Windows 41
 - Power Windows 41
 - Wind Buffeting 44
- Liftgate 44
 - Liftgate Flipper Glass 45
 - Power Liftgate — If Equipped 46
- Occupant Restraints 48
 - Lap/Shoulder Belts 52
 - Lap/Shoulder Belt Operating Instructions 53
 - Lap/Shoulder Belt Untwisting Procedure 57
 - Adjustable Upper Shoulder Belt Anchorage 57
 - Energy Management Feature 58
 - Seat Belts In Passenger Seating Positions 59

□ Automatic Locking Retractor Mode (ALR) — If Equipped	60
□ Seat Belt Pretensioners	61
□ Supplemental Active Head Restraints (AHR)	61
□ Enhanced Seat Belt Use Reminder System (BeltAlert®)	65
□ Seatbelt Lock Out	67
□ Seat Belts And Pregnant Women	67
□ Seat Belt Extender	67
□ Supplemental Restraint System (SRS) — Airbags	68
□ Advanced Front Airbag Features	70

THINGS TO KNOW BEFORE STARTING YOUR VEHICLE 13

□ Airbag Deployment Sensors And Controls . . .	74
□ Event Data Recorder (EDR)	81
□ Child Restraints	82
■ Engine Break-In Recommendations	95
■ Safety Tips	96
□ Transporting Passengers	96
□ Exhaust Gas	97
□ Safety Checks You Should Make Inside The Vehicle	98
□ Periodic Safety Checks You Should Make Outside The Vehicle	100

A WORD ABOUT YOUR KEYS

Your vehicle uses a keyless ignition system. This system consists of a Key Fob with Remote Keyless Entry (RKE) transmitter and a Wireless Ignition Node (WIN) with integral ignition switch. You can insert the Key Fob into the ignition switch with either side up.

Keyless Enter-N-Go Feature

This vehicle is equipped with the Keyless Enter-N-Go feature, refer to “Starting Procedures” in “Starting And Operating” for further information.

Wireless Ignition Node (WIN)

The Wireless Ignition Node (WIN) operates similar to an ignition switch. It has four operating positions, three of which are detented and one spring-loaded. The detented positions are OFF, ACC, and ON/RUN. The START position is a spring-loaded momentary contact position. When released from the START position, the switch automatically returns to the detented ON/RUN position.

NOTE: With the Keyless Enter-N-Go feature, the Electronic Vehicle Information Center (EVIC) will display the ignition switch position (OFF/ACC/RUN). Refer to “Electronic Vehicle Information Center (EVIC)” in “Understanding Your Instrument Panel” for further information.

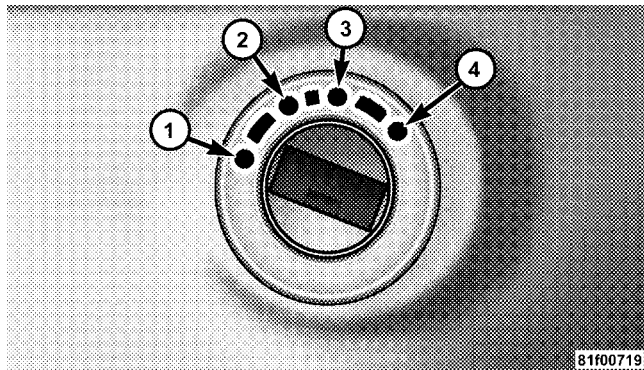

Wireless Ignition Node (WIN)

- 1 — OFF
- 2 — ACC (ACCESSORY)
- 3 — ON/RUN
- 4 — START

Key Fob

The Key Fob operates the ignition switch. Insert the square end of the key fob into the ignition switch located on the instrument panel and rotate to the desired position. It also contains the Remote Keyless Entry (RKE) transmitter and an emergency key, which stores in the rear of the Key Fob.

The emergency key allows for entry into the vehicle on the driver's side should the battery in the vehicle or the RKE transmitter go dead. The emergency key is also for locking the glove box. You can keep the emergency key with you when valet parking.

NOTE: Entering a vehicle using the emergency key with the theft alarm armed, will result in the alarm sounding. Insert the Key Fob (even if the Key Fob battery is dead) into the ignition switch to disarm theft alarm.

To remove the emergency key, slide the mechanical latch at the top of the Key Fob sideways with your thumb and then pull the key out with your other hand.

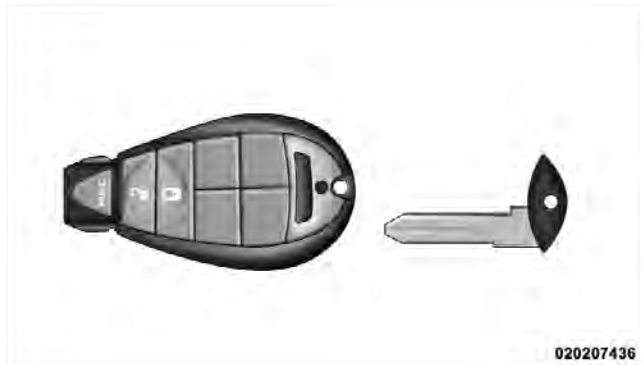

Emergency Key Removal

NOTE: You can insert the double-sided emergency key into the lock cylinders with either side up.

Removing Key Fob From Ignition

Place the shift lever in PARK. Turn the Key Fob to the OFF position and then remove the Key Fob.

With the Keyless Enter-N-Go feature, the EVIC will display the ignition switch position “OFF/ACC/RUN”. Refer to “Electronic Vehicle Information Center (EVIC)” in “Understanding Your Instrument Panel” for further information.

NOTE:

- If you try to remove the Key Fob before you place the shift lever in PARK, it may become trapped temporarily in the ignition switch. If this occurs, rotate the key to the right slightly, then remove the Key Fob as described. If a malfunction occurs, the system will trap the key in the ignition switch to warn you that this safety feature is inoperable. The engine can be started and stopped, but the Key Fob cannot be removed until you obtain service.

- The power window switches, radio, power sunroof (if equipped), and power outlets will remain active for up to 10 minutes after the ignition switch is turned to the OFF position. Opening either front door will cancel this feature. The time for this feature is programmable. Refer to “Electronic Vehicle Information Center (EVIC)/Personal Settings (Customer-Programmable Features)” in “Understanding Your Instrument Panel” for further information.

CAUTION!

- **If your vehicle battery becomes low or dead, your Key Fob will become locked in the ignition.**
- **Do not attempt to remove the Key Fob while in this condition, damage could occur to the Key Fob or ignition module. Only remove the emergency key for locking and unlocking the doors.**
- **Leave the Key Fob in the ignition and either:**
 - **Jump Start the vehicle.**
 - **Charge the battery.**
 - **Contact your dealer for assistance on how to remove the Key Fob using the manual over ride method.**

WARNING!

- **Never leave children alone in a vehicle. Leaving unattended children in a vehicle is dangerous for a number of reasons. A child or others could be seriously or fatally injured. Do not leave the Key Fob in the ignition or Keyless Enter-N-Go in the ACC or ON/RUN mode. A child could operate power windows, other controls, or move the vehicle.**
- **Do not leave children or animals inside parked vehicles in hot weather. Interior heat build-up may cause serious injury or death.**

CAUTION!

An unlocked car is an invitation to thieves. Always remove Key Fob from the ignition and lock all doors when leaving the vehicle unattended.

Key-In-Ignition Reminder

Opening the driver's door when the Key Fob is in the ignition and the ignition switch position is OFF or ACC, sounds a signal to remind you to remove the Key Fob.

NOTE: The Key-In-Ignition reminder only sounds when the Key Fob is placed in the OFF or ACC ignition position.

With the Keyless Enter-N-Go feature, opening the driver's door when the vehicle's ignition switch is placed in ACC or ON/RUN (engine stopped) will cause the reminder chime to sound. Refer to "Starting Procedures" in "Starting And Operating" for further information.

SENTRY KEY®

The Sentry Key® Immobilizer system prevents unauthorized vehicle operation by disabling the engine. The system does not need to be armed or activated. Operation is automatic, regardless of whether the vehicle is locked or unlocked.

The system uses the factory-mated Key Fob with Remote Keyless Entry (RKE) transmitter and Wireless Ignition Node (WIN) to prevent unauthorized vehicle operation. Therefore, only Key Fobs that are programmed to the vehicle can be used to start and operate the vehicle. The system will shut the engine off in two seconds if an invalid Key Fob is used to start the engine.

After turning the ignition switch to the ON/RUN position, the Vehicle Security Light will turn on for three seconds for a bulb check. If the light remains on after the bulb check, it indicates that there is a problem with the electronics. In addition, if the light begins to flash after

the bulb check, it indicates that someone used an invalid Key Fob to start the engine. Either of these conditions will result in the engine being shut off after two seconds.

If the Vehicle Security Light turns on during normal vehicle operation (vehicle running for longer than 10 seconds), it indicates that there is a fault in the electronics. Should this occur, have the vehicle serviced as soon as possible by an authorized dealer.

CAUTION!

The Sentry Key® Immobilizer system is not compatible with some after-market remote starting systems. Use of these systems may result in vehicle starting problems and loss of security protection.

All of the Key Fobs provided with your new vehicle have been programmed to the vehicle electronics.

Replacement Keys

NOTE: Only Key Fobs that are programmed to the vehicle electronics can be used to start and operate the vehicle. Once a Key Fob is programmed to a vehicle, it cannot be programmed to any other vehicle.

CAUTION!

- Always remove the Key Fobs from the vehicle and lock all doors when leaving the vehicle unattended.
- With Keyless Enter-N-Go, always remember to place the ignition in OFF.

At the time of purchase, the original owner is provided with a four-digit Personal Identification Number (PIN). Keep the PIN in a secure location. This number is required for authorized dealer replacement of Key Fobs.

Duplication of Key Fobs may be performed at an authorized dealer, this procedure consists of programming a blank Key Fob to the vehicle electronics. A blank Key Fob is one that has never been programmed.

NOTE: When having the Sentry Key® Immobilizer system serviced, bring all vehicle Key Fobs with you to the authorized dealer.

Customer Key Programming

Programming Key Fobs or RKE transmitters may be performed at an authorized dealer.

General Information

The Sentry Key® system complies with FCC rules Part 15 and with RSS-210 of Industry Canada. Operation is subject to the following conditions:

- This device may not cause harmful interference.

- This device must accept any interference that may be received, including interference that may cause undesired operation.

VEHICLE SECURITY ALARM — IF EQUIPPED

This Vehicle Security Alarm monitors the vehicle doors, liftgate, liftgate flipper glass, and ignition for unauthorized operation. When the alarm is activated, the interior switches for door locks, power liftgate and flipper glass are disabled. The Vehicle Security Alarm provides both audio and visual signals, the horn will sound, the headlights, park lamps and/or turn signals will flash repeatedly for three minutes. If the disturbance is still present (driver's door, passenger door, other doors, ignition) after three minutes, the headlights, park lamps and/or turn signals will flash for an additional 15 minutes.

NOTE: The Panic and Security alarms are quite different. Please take a moment to activate the Panic and the Security modes to hear the differences in the horn. In case

one should go off in the future, you will need to know which mode has been activated in order to deactivate it.

Rearming The System

If something triggers the alarm, and no action is taken to disarm it, the Vehicle Security Alarm will turn off the horn after three minutes, turn off all of the visual signals after 15 minutes, and then the Vehicle Security Alarm will rearm itself.

To Arm The System

Vehicles Not Equipped With Keyless Enter-N-Go

The alarm will set when you use the Remote Keyless Entry (RKE) transmitter to lock the doors and liftgate, or when you use the power door lock switch while the door is open. After all the doors are locked and closed, the Vehicle Security Light (located in the instrument cluster) will flash rapidly for about 16 seconds to signal that the Vehicle Security Alarm is arming. During this 16 second arming period, opening any door or the liftgate will

cancel the arming. If the Vehicle Security Alarm successfully arms, the Vehicle Security Light will flash at a slower rate to indicate the alarm is set.

Vehicles Equipped With Keyless Enter-N-Go

Press the Keyless Enter-N-Go Start/Stop button until the Electronic Vehicle Information Center (EVIC) indicates that the vehicle ignition is "OFF" (refer to "Starting Procedures" in "Starting And Operating" for further information). Then either press the power door LOCK switch while the driver or passenger door is open, press the lock button on the front driver or passenger door handle with a valid key fob in range, or press the Remote Keyless Entry (RKE) transmitter LOCK button (refer to "Keyless Enter-N-Go" in "Things To Know Before Starting Your Vehicle" for further information).

To Disarm The System

Vehicles Not Equipped With Keyless Enter-N-Go

To disarm the Vehicle Security Alarm, you will need to press the UNLOCK button on the RKE transmitter or turn the ignition switch to the ON/RUN position. If something has triggered the Vehicle Security Alarm in your absence, the horn will sound three times when you unlock the doors. Check the vehicle for tampering.

The Vehicle Security Alarm is designed to protect your vehicle; however, you can create conditions where the Vehicle Security Alarm will arm unexpectedly. If you remain in the vehicle and lock the doors with the RKE transmitter, once the Vehicle Security Alarm is armed (after 16 seconds), when you pull the door handle to exit, the alarm will sound. If this occurs, press the UNLOCK button on the RKE transmitter to disarm the Vehicle Security Alarm. You may also accidentally sound the Vehicle Security Alarm by unlocking the driver's door with the key and then opening the door.

Vehicles Equipped With Keyless Enter-N-Go

Either press the UNLOCK button on the RKE transmitter, pull on the front driver or passenger door handle (refer to “Keyless Enter-N-Go” in “Things To Know Before Starting Your Vehicle” for further information) with a valid key fob in range, or press the Keyless Enter-N-Go Start/Stop button (requires at least one valid Key Fob in the vehicle), or insert a valid Key Fob into the ignition switch (if the Start/Stop button is removed) and rotate it to the ON/RUN position.

ILLUMINATED ENTRY

The interior lights come on when you open any door or use the Remote Keyless Entry (RKE) transmitter to unlock any door. They will remain on for approximately 30 seconds after all doors are closed then fade to off.

The lights also will fade to off if you turn on the ignition after you close all the doors. Refer to “Electronic Vehicle Information Center (EVIC)/Personal Settings (Customer-Programmable Features)” in “Understanding Your Instrument Panel” for further information.

NOTE: None of the courtesy lights will operate if the dimmer control is in the “defeat” position (extreme downward position), unless the overhead map/reading lights are turned on manually.

REMOTE KEYLESS ENTRY (RKE)

This system allows you to lock or unlock the doors and liftgate, or activate the panic alarm, from distances up to approximately 66 ft (20 m) using a hand-held Key Fob with RKE transmitter. The RKE transmitter does not need to be pointed at the vehicle to activate the system.

NOTE: Inserting the Key Fob with RKE transmitter into the ignition switch disables the system from responding to any button presses from that RKE transmitter. Driving at speeds 5 mph (8 km/h) and above disables the system from responding to all RKE transmitter buttons for all RKE transmitters.



Key Fob with Four-Button RKE Transmitter

To Unlock The Doors

Press and release the UNLOCK button on the RKE transmitter once to unlock the driver's door or twice to unlock all doors. The turn signal lamps will flash to acknowledge the unlock signal. The illuminated entry system will also turn on.

Refer to "Keyless Enter-N-Go" under "Things To Know Before Starting Your Vehicle" for further information.

Remote Key Unlock, Driver Door/All Doors First Press

This feature lets you program the system to unlock either the driver's door or all doors, on the first press of the UNLOCK button on the RKE transmitter. To change the current setting, refer to "Electronic Vehicle Information Center (EVIC)/Personal Settings (Customer-Programmable Features)" in "Understanding Your Instrument Panel" for further information.

Flash Lamps With Remote Key Lock

This feature will cause the turn signal lamps to flash when the doors are locked or unlocked with the RKE transmitter. This feature can be turned on or off. To change the current setting, refer to “Electronic Vehicle Information Center (EVIC)/Personal Settings (Customer-Programmable Features)” in “Understanding Your Instrument Panel” for further information.

Turn Headlights On With Remote Key Unlock

This feature activates the headlights for up to 90 seconds when the doors are unlocked with the RKE transmitter. The time for this feature is programmable on vehicles equipped with the Electronic Vehicle Information Center (EVIC). Refer to “Electronic Vehicle Information Center (EVIC)/Personal Settings (Customer-Programmable Features)” in “Understanding Your Instrument Panel” for further information.

To Lock The Doors

Press and release the LOCK button on the RKE transmitter to lock all doors. The turn signal lamps will flash and the horn will chirp to acknowledge the signal.

Refer to “Keyless Enter-N-Go” under “Things To Know Before Starting Your Vehicle” for further information.

Sound Horn With Remote Key Lock

This feature will cause the horn to chirp when the doors are locked with the RKE transmitter or the Passive Entry feature. The horn chirp feature can be turned on or off. To change the current setting, refer to “Electronic Vehicle Information Center (EVIC)/Personal Settings (Customer-Programmable Features)” in “Understanding Your Instrument Panel” for further information.

Remote Open Window Feature — If Equipped

This feature allows you to remotely lower both front door windows at the same time. To use this feature, press and release the UNLOCK button on the RKE transmitter and

then immediately press and hold the UNLOCK button until the windows lower to the level desired or until they lower completely.

Using The Panic Alarm

To turn the Panic Alarm feature on or off, press and hold the PANIC button on the RKE transmitter for at least one second and release. When the Panic Alarm is on, the headlights and park lamps will flash, the horn will pulse on and off, and the interior lights will turn on.

The Panic Alarm will stay on for three minutes unless you turn it off by either pressing the PANIC button a second time, or drive the vehicle at a speed of 15 mph (24 km/h) or greater.

NOTE: The interior lights will turn off if you turn the ignition switch to the ACC or ON/RUN position while the Panic Alarm is activated. However, the exterior lamps and horn will remain on.

Programming Additional Transmitters

Programming Key Fobs or RKE transmitters may be performed at an authorized dealer.

Transmitter Battery Replacement

The recommended replacement battery is one CR2032 battery.

NOTE:

- Perchlorate Material — special handling may apply. See www.dtsc.ca.gov/hazardouswaste/perchlorate
- Do not touch the battery terminals that are on the back housing or the printed circuit board.

1. Remove the emergency key by sliding the mechanical latch at the top of the RKE transmitter sideways with your thumb and then pull the key out with your other hand.

2. Insert the tip of the emergency key or a #2 flat blade screwdriver into the slot and gently pry the two halves of the RKE transmitter apart. Make sure not to damage the seal during removal.

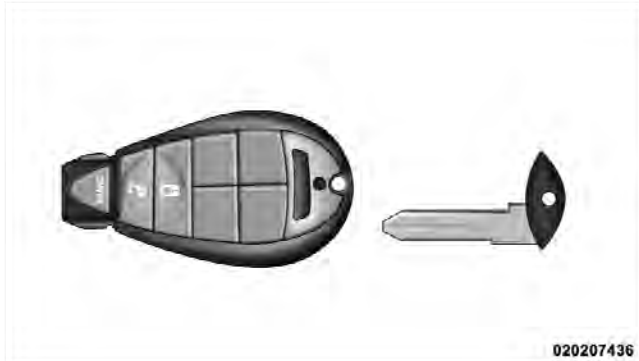

Emergency Key Removal

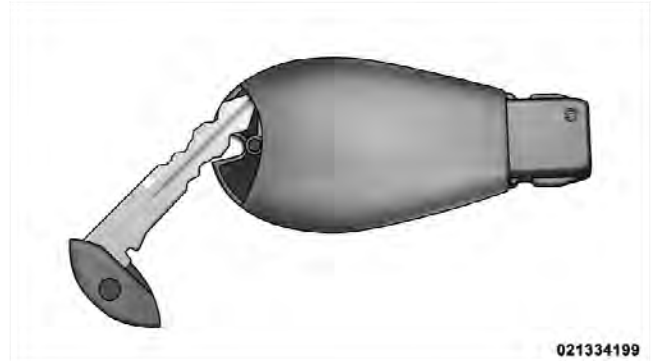

Inserting Emergency Key Into Slot

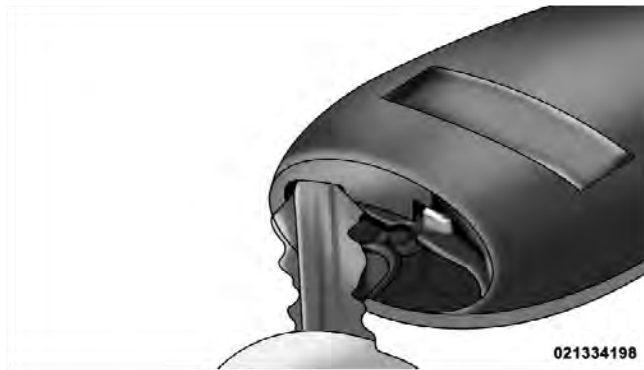

Separating RKE Transmitter

3. Remove and replace the battery. When replacing the battery, match the + sign on the battery to the + sign on the inside of the battery clip, located on the back cover. Avoid touching the new battery with your fingers. Skin oils may cause battery deterioration. If you touch a battery, clean it with rubbing alcohol.

4. To assemble the RKE transmitter case, snap the two halves together.

General Information

This device complies with part 15 of the FCC rules and RSS 210 of Industry Canada. Operation is subject to the following conditions:

- This device may not cause harmful interference.
- This device must accept any interference received, including interference that may cause undesired operation.

NOTE: Changes or modifications not expressly approved by the party responsible for compliance could void the user's authority to operate the equipment.

If your RKE transmitter fails to operate from a normal distance, check for these two conditions:

1. A weak battery in the RKE transmitter. The expected life of the battery is a minimum of three years.
2. Closeness to a radio transmitter such as a radio station tower, airport transmitter, and some mobile or CB radios.

REMOTE STARTING SYSTEM — IF EQUIPPED

 This system uses the Remote Keyless Entry (RKE) transmitter to start the engine conveniently from outside the vehicle while still maintaining security. The system has a range of approximately 300 ft (91 m).

NOTE: The vehicle must be equipped with an automatic transmission to be equipped with Remote Start.

How To Use Remote Start

All of the following conditions must be met before the engine will remote start:

- Shift lever in PARK
- Doors closed
- Hood closed
- Liftgate/Flipper Glass closed
- Hazard switch off
- Brake switch inactive (brake pedal not pressed)
- Ignition key removed from ignition switch
- Battery at an acceptable charge level
- RKE PANIC button not pressed

WARNING!

- Do not start or run an engine in a closed garage or confined area. Exhaust gas contains Carbon Monoxide (CO) which is odorless and colorless. Carbon Monoxide is poisonous and can cause serious injury or death when inhaled.
- Keep Remote Keyless Entry (RKE) transmitters away from children. Operation of the Remote Start System, windows, door locks or other controls could cause serious injury or death.

Remote Start Abort Message On Electronic Vehicle Information Center (EVIC) — If Equipped

The following messages will display in the EVIC if the vehicle fails to remote start or exits remote start prematurely:

- Remote Start Aborted — Door Ajar

- Remote Start Aborted — Hood Ajar
- Remote Start Aborted — Fuel Low
- Remote Start Aborted — System Fault
- Remote Start Disabled — Start Vehicle to Reset

The EVIC message stays active until the ignition is turned to the ON/RUN position.

To Enter Remote Start Mode

Press and release the REMOTE START button on the RKE transmitter twice, within five seconds. The vehicle doors will lock, the parking lights will flash and the horn will chirp twice (if programmed). Then, the engine will start and the vehicle will remain in the Remote Start mode for a 15 minute cycle.

NOTE:

- If an engine fault is present or fuel level is low, the vehicle will start and then shutdown in 10 seconds.
- The park lamps will turn on and remain on during Remote Start mode.
- For security, power window and power sunroof operation (if equipped) are disabled when the vehicle is in the Remote Start mode.
- The engine can be started two consecutive times with the RKE transmitter. However, the ignition must be cycled by pushing the START/STOP button twice (or the ignition switch must be cycled to the ON/RUN position) before you can repeat the start sequence for a third cycle.

To Exit Remote Start Mode Without Driving The Vehicle

Press and release the REMOTE START button one time or allow the engine to run for the entire 15 minute cycle.

NOTE: To avoid unintentional shutdowns, the system will disable the one time press of the REMOTE START button for two seconds after receiving a valid Remote Start request.

To Exit Remote Start Mode And Drive The Vehicle

Before the end of 15 minute cycle, press and release the UNLOCK button on the RKE transmitter to unlock the doors and disarm the Vehicle Security Alarm (if equipped). Then, prior to the end of the 15 minute cycle, press and release the START/STOP button. If the START/STOP button is not present, insert the Key Fob into the ignition switch and turn the switch to the ON/RUN position.

NOTE:

- For vehicles not equipped with Keyless Enter-N-Go feature, the ignition switch must be in the ON/RUN position in order to drive the vehicle.
- For vehicles not equipped with Keyless Enter-N-Go feature, the message “Remote Start Active — Insert Key and Turn To Run” will display in the EVIC until you insert the key. Refer to “Electronic Vehicle Information Center (EVIC)” for further information.
- For vehicles equipped with Keyless Enter-N-Go feature, the message “Push Start Button” will display in the EVIC until you push the START button.

Remote Start Comfort Systems — If Equipped

When remote start is activated, the heated steering wheel, and driver heated seat features will automatically turn on in cold weather. In warm weather, the driver vented seat feature will automatically turn on when the remote start is activated. These features will stay on through the duration of remote start or until the ignition switch is turned to the ON/RUN position.

The Remote Start Comfort System can be activated and deactivated through the Electronic Vehicle Information Center (EVIC). For more information on Remote Start Comfort System operation refer to “Electronic Vehicle Information Center (EVIC)/Customer-Programmable Features (SETUP)” in “Understanding Your Instrument Panel”.

DOOR LOCKS

The power door locks can be manually locked or unlocked from inside the vehicle by using the door lock knob. If the lock knob is down when the door is closed, the door will lock. Therefore, make sure the key is not inside the vehicle before closing the door.



Manual Door Lock Knob

WARNING!

- For personal security and safety in the event of an accident, lock the vehicle doors when you drive, as well as when you park and leave the vehicle.
- When leaving the vehicle, always remove the key from the ignition and lock your vehicle. Do not leave unattended children in the vehicle, or with access to an unlocked vehicle. Unsupervised use of vehicle equipment may cause severe personal injuries or death.

Power Door Locks

The power door lock switch is located on each front door panel. Press the switch to lock or unlock the doors.



Power Door Lock Switch

If the lock knob is down when the door is closed, the door will lock. Therefore, make sure the Key Fob is not inside the vehicle before closing the door.

If you press the door lock switch while the Key Fob is in the ignition switch and the driver's door is open, the doors will not lock.

If a rear door is locked, it cannot be opened from inside the vehicle without first unlocking the door. The door may be unlocked manually by raising the lock knob.

Automatic Door Locks — If Equipped

If this feature is selected, your door locks will lock automatically when the vehicle speed is above 15 mph (24 km/h) and all doors are closed. This feature will reset whenever a door is opened.

This feature is selectable and can be turned on or off. Refer to “Electronic Vehicle Information Center (EVIC)/ Personal Settings (Customer-Programmable Features)” in “Understanding Your Instrument Panel” for further information.

Automatic Unlock On Exit Feature — If Equipped

If Auto Unlock is enabled, this feature will unlock all the doors when the driver's door is opened if the vehicle is stopped and in PARK or NEUTRAL. Refer to "Electronic Vehicle Information Center (EVIC)/Personal Settings (Customer-Programmable Features)" in "Understanding Your Instrument Panel" for further information.

Child-Protection Door Lock System — Rear Doors

To provide a safer environment for small children riding in the rear seats, the rear doors are equipped with Child-Protection Door Lock system.

To Engage Or Disengage The Child-Protection Door Lock System

1. Open the rear door.

2. Insert the tip of the emergency key into the lock and rotate to the LOCK or UNLOCK position.
3. Repeat steps 1 and 2 for the opposite rear door.



Child-Protection Door Lock Location



Child-Protection Door Lock Function

WARNING!

Avoid trapping anyone in a vehicle in a collision. Remember that the rear doors can only be opened from the outside when the Child-Protection locks are engaged (locked).

NOTE: For emergency exit from the rear seats when the Child-Protection Door Lock System is engaged, manually raise the door lock knob to the unlocked position, roll down the window, and open the door using the outside door handle.

KEYLESS ENTER-N-GO

The Passive Entry system is an enhancement to the vehicle's Remote Keyless Entry (RKE) system and a feature of Keyless Enter-N-Go. This feature allows you to lock and unlock the vehicle's door(s) without having to press the RKE transmitter lock or unlock buttons.

NOTE:

- Passive Entry may be programmed ON/OFF, refer to "Electronic Vehicle Information Center (EVIC)/ Personal Settings (Customer-Programmable Features)" in "Understanding Your Instrument Panel" for further information.

- If a passive entry door handle has not been used for 72 hours, the passive entry feature for the handle may time out. Pulling the deactivated front door handle will reactivate the door handle's passive entry feature.
- If wearing gloves on your hands, or if it has been raining on the passive entry door handle, the unlock sensitivity can be affected, resulting in a slower response time.
- If you unlock the doors using the passive entry door handles, but do NOT pull the handle, the doors will automatically lock after 60 seconds.

To Unlock From The Driver's Side:

With a valid Passive Entry RKE transmitter within 5 ft (1.5 m) of the driver's door handle, grab the driver's front door handle to unlock the driver's door automatically. The interior door panel lock knob will raise when the door is unlocked.

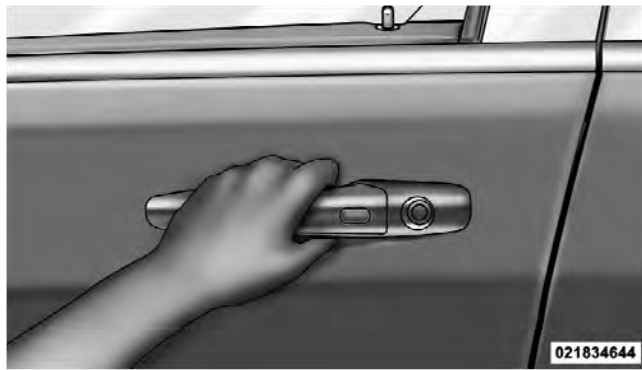

Grabbing The Driver's Door Handle

NOTE: If "Unlock All Doors 1st Press" is programmed all doors will unlock when you grab hold of the driver's front door handle. To select between "Unlock Driver Door 1st Press" and "Unlock All Doors 1st Press", refer to "Electronic Vehicle Information Center (EVIC)/Personal Settings (Customer-Programmable Features)" in "Understanding Your Instrument Panel" for further information.

To Unlock From The Passenger Side:

With a valid Passive Entry RKE transmitter within 5 ft (1.5 m) of the passenger door handle, grab the front passenger door handle to unlock all four doors automatically. The interior door panel lock knob will raise when the door is unlocked.

NOTE: All doors will unlock when the front passenger door handle is grabbed regardless of the driver's door unlock preference setting ("Unlock Driver Door 1st Press" or "Unlock All Doors 1st Press").

Preventing Inadvertent Locking Of Passive Entry RKE Transmitter In Vehicle

To minimize the possibility of unintentionally locking a Passive Entry RKE transmitter inside your vehicle, the Passive Entry system is equipped with an automatic door unlock feature which will function if there is no Key Fob present in the ignition.

If one of the vehicle doors is open and the door panel switch is used to lock the vehicle, once all open doors have been closed, the vehicle checks the inside and outside of the vehicle for any valid Passive Entry RKE transmitters. If one of the vehicle's Passive Entry RKE transmitters is detected inside the vehicle, and no other valid Passive Entry RKE transmitters is detected outside the vehicle, the Passive Entry System automatically unlocks all vehicle doors and chirps the horn three times (on the third attempt ALL doors will lock and the Passive Entry RKE transmitter can be locked in the vehicle).

To Enter The Liftgate

With a valid Passive Entry RKE transmitter within 3 ft (1.0 m) of the liftgate, press the button on the right side of the chrome accent bar, which is located on the liftgate below the flipper glass to lock or unlock the vehicle.



Liftgate Passive Entry Button

NOTE: If "Unlock All Doors 1st Press" is programmed in EVIC, all doors will unlock when you push the button on the liftgate. If "Unlock Driver Door 1st press" is programmed in EVIC, the liftgate and Flipper glass will unlock when you press the button on the liftgate. For further information, refer to "Electronic Vehicle Information Center (EVIC)/Personal Settings (Customer-Programmable Features)" in "Understanding Your Instrument Panel".

To Lock The Vehicle's Doors

The front door handles have LOCK buttons located on the outside of the handle.



Outside Door Handle Lock Button

With one of the vehicle's Passive Entry RKE transmitters within 5 ft (1.5 m) of the driver or passenger front door handle, press the door handle LOCK button to lock all four doors and liftgate.

NOTE:

- After pressing the door handle LOCK button, you must wait two seconds before you can lock or unlock the doors, using either passive entry door handle. This is done to allow you to check if the vehicle is locked by pulling the door handle, without the vehicle reacting and unlocking.
- The passive entry system will not operate if the RKE transmitter battery is dead.

The vehicle doors can also be locked by using the RKE transmitter lock button or the lock button located on the vehicle's interior door panel.

WINDOWS

Power Windows

The power window controls are located on the driver's door trim panel. There is a single switch on the front passenger door and rear doors which operate the front passenger and rear passenger door windows. The window controls will operate only when the ignition switch is in the ON/RUN or ACC position.



2

Power Window Switches

The power window switches remain active for up to 10 minutes after the ignition switch has been turned OFF. Opening a vehicle front door will cancel this feature.

WARNING!

Never leave children in a vehicle with the key in the ignition switch or leave a vehicle with Keyless Enter-Go in the ACC or ON/RUN position. Occupants, particularly unattended children, can become entrapped by the windows while operating the power window switches. Such entrapment may result in serious injury or death.

Auto-Down

Both the driver and front passenger window switches have an “Auto-Down” feature. Press the window switch past the first detent, release, and the window will go down automatically. To cancel the “Auto-Down” movement, operate the switch in either the up or down direction and release the switch.

To open the window part way, press to the first detent and release it when you want the window to stop.

The power window switches remain active for 10 minutes after the ignition has been turned OFF. Opening either front door will cancel this feature.

Auto Up Feature With Anti-Pinch Protection — Driver And Front Passenger Door Only

Lift the window switch fully upward to the second detent, release, and the window will go up automatically.

To stop the window from going all the way up during the Auto Up operation, push down on the switch briefly.

To close the window part way, lift the window switch to the first detent and release when you want the window to stop.

NOTE: If the window runs into any obstacle during Auto Up it will reverse direction and then go back down. Remove the obstacle and use the window switch again to close the window. Any impact due to rough road conditions may trigger the auto reverse function unexpectedly

during Auto Up. If this happens, pull the switch lightly to the first detent and hold it to close the window manually.

WARNING!

There is no anti-pinch protection when the window is almost closed. Be sure to clear all objects from the window before closing.

Resetting The Auto Up Feature

Should the Auto Up feature stop working, the window probably needs to be reset. To reset Auto Up:

1. Pull the window switch up to close the window completely and continue to hold the switch up for an additional two seconds after the window is closed.
2. Push the window switch down firmly to the second detent to open the window completely and continue to hold the switch down for an additional two seconds after the window is fully open.

Window Lockout Button

The Window Lockout button on the driver's door allows you to disable the window controls on the rear doors. To disable the window controls on the rear doors, press the Window Lockout button. To enable the window controls, press the Window Lockout button again.

2



Window Lockout Button

Wind Buffeting

Wind buffeting can be described as the perception of pressure on the ears or a helicopter-type sound in the ears. Your vehicle may exhibit wind buffeting with the windows down, or the sunroof (if equipped) in certain open or partially open positions. This is a normal occurrence and can be minimized. If the buffeting occurs with the sunroof open, adjust the sunroof opening to minimize the buffeting.

LIFTGATE

To open the liftgate, pull up on the handle and lift. Manually unlocking the vehicle doors with the plunger or a key in the lock cylinder will not unlock the liftgate.



Liftgate Release

WARNING!

Driving with the liftgate open can allow poisonous exhaust gases into your vehicle. You and your passengers could be injured by these fumes. Keep the liftgate closed when you are operating the vehicle.

Liftgate Flipper Glass

The liftgate flipper glass is also unlocked when the liftgate is unlocked. To open the flipper glass, push up on the window switch located on the liftgate.



022209771

Liftgate Glass Release

Once the liftgate flipper glass has been opened, connection to the rear window wiper is interrupted, preventing activation of the rear wiper blade while the flipper glass is open.

NOTE: If a malfunction to the liftgate latch should occur, an emergency liftgate latch release can be used to open the liftgate. The emergency liftgate latch release can be accessed through a snap-in cover located on the liftgate trim panel.

WARNING!

Driving with the flipper glass open can allow poisonous exhaust gases into your vehicle. You and your passengers could be injured by these fumes. Keep the flipper glass closed when you are operating the vehicle.

Power Liftgate — If Equipped



The power liftgate may be opened by pulling up on the liftgate handle or by pressing the LIFTGATE button on the Remote Keyless Entry (RKE) transmitter. Press the LIFTGATE button on the RKE transmitter twice within five seconds, to open the power liftgate. Once the liftgate is open, pressing the button twice within five seconds a second time will close the liftgate.

The power liftgate may also be opened or closed by pressing the LIFTGATE button located on the front overhead console, or closed by pressing the LIFTGATE button located on left rear trim, near the liftgate opening. Pressing the LIFTGATE button located on left rear trim once will close the liftgate only, this button cannot be used to open the liftgate.

To operate the power liftgate manually in the open direction, pull the liftgate handle once to initiate a power cycle and then pull the handle a second time to put liftgate into manual mode.

When the LIFTGATE button on the RKE transmitter is pressed two times, the turn signals will flash twice to signal that the liftgate is opening or closing (if Flash Lamps with Lock is enabled in the EVIC) and the liftgate chime will be audible. For further information, refer to "Customer-Programmable Features (System Setup)/ Electronic Vehicle Information Center (EVIC)" in "Understanding Your Instrument Panel".

NOTE: In the event of a power malfunction to the liftgate, an emergency liftgate latch release can be used to open the liftgate. The emergency liftgate latch release can be accessed through a snap-in cover located on the liftgate trim panel.

WARNING!

During power operation, personal injury or cargo damage may occur. Ensure the liftgate travel path is clear. Make sure the liftgate is closed and latched before driving away.

NOTE:

- If anything obstructs the power liftgate while it is closing or opening, the liftgate will automatically reverse to the closed or open position, provided it meets sufficient resistance.
- There are also pinch sensors attached to the side of the liftgate. Light pressure anywhere along these strips will cause the liftgate to return to the open position.
- The power liftgate must be in the full open position for rear liftgate close button or overhead console close

button to operate. If the liftgate is not fully open, press the Liftgate button on the Key Fob to fully open the liftgate, and then press it again to close.

- If the liftgate handle is pulled while the power liftgate is closing, the liftgate will reverse to the full open position.
- If the liftgate handle is pulled while the power liftgate is opening, the liftgate motor will disengage to allow manual operation.
- The power liftgate buttons will not operate if the vehicle is in gear or the vehicle speed is above 0 mph (0 km/h).
- The power liftgate will not operate in temperatures below -22°F (-30°C) or temperatures above 150°F (65°C). Be sure to remove any buildup of snow or ice from the liftgate before pressing any of the power liftgate switches.

48 THINGS TO KNOW BEFORE STARTING YOUR VEHICLE

- If the power liftgate encounters multiple obstructions within the same cycle, the system will automatically stop and the liftgate must be opened or closed manually.
- If your liftgate is power closing and you put the vehicle in gear, the liftgate will continue to power close. However, vehicle movement may result in a detection of an obstruction.

WARNING!

- **Driving with the liftgate open can allow poisonous exhaust gases into your vehicle. You and your passengers could be injured by these fumes. Keep the liftgate closed when you are operating the vehicle.**

(Continued)

WARNING! (Continued)

- **If you are required to drive with the liftgate open, make sure that all windows are closed, and the climate control blower switch is set at high speed. Do not use the recirculation mode.**

Gas props support the liftgate in the open position. However, because the gas pressure drops with temperature, it may be necessary to assist the props when opening the liftgate in cold weather.

OCCUPANT RESTRAINTS

Some of the most important safety features in your vehicle are the restraint systems:

- Three-point lap and shoulder belts for the driver and all passengers
- Advanced Front Airbags for driver and front passenger

- Supplemental Active Head Restraints (AHR) located on top of the front seats (integrated into the head restraint)
- Supplemental Side Airbag Inflatable Curtains (SABIC) for the driver and passengers seated next to a window
- Supplemental Seat-Mounted Side Airbags (SAB)
- An energy-absorbing steering column and steering wheel
- Knee bolsters for front seat occupants
- Front seat belts incorporate pretensioners that may enhance occupant protection by managing occupant energy during an impact event
- All seat belt systems (except the driver's) include Automatic Locking Retractors (ALRs), which lock the seat belt webbing into position by extending the belt

all the way out and then adjusting the belt to the desired length to restrain a child seat or secure a large item in a seat — if equipped

Please pay close attention to the information in this section. It tells you how to use your restraint system properly, to keep you and your passengers as safe as possible.

If you will be carrying children too small for adult-sized seat belts, the seat belts or the Lower Anchors and Tether for CHildren (LATCH) feature also can be used to hold infant and child restraint systems. For more information on LATCH, see Lower Anchors and Tether for CHildren (LATCH).

NOTE: The Advanced Front Airbags have a multistage inflator design. This allows the airbag to have different rates of inflation based on the severity and type of collision.

Here are some simple steps you can take to minimize the risk of harm from a deploying airbag:

1. **Children 12 years old and under should always ride buckled up in a rear seat.**

WARNING!

Infants in rear facing child restraints should never ride in the front seat of a vehicle with a passenger Advanced Front Airbag. An airbag deployment can cause severe injury or death to infants in that position.

Children that are not big enough to wear the vehicle seat belt properly (see section on Child Restraints) should be secured in the rear seat in child restraints or belt-positioning booster seats. Older children who do not use child restraints or belt-positioning booster seats should

ride properly buckled up in the rear seat. Never allow children to slide the shoulder belt behind them or under their arm.

If a child from 1 to 12 years old (not in a rear facing child seat) must ride in the front passenger seat, move the seat as far back as possible and use the proper child restraint. (Refer to “Child Restraints”)

You should read the instructions provided with your child restraint to make sure that you are using it properly.

2. **All occupants should always wear their lap and shoulder belts properly.**
3. **The driver and front passenger seats should be moved back as far as practical to allow the Advanced Front Airbags room to inflate.**

4. Do not lean against the door or window. If your vehicle has side airbags, and deployment occurs, the side airbags will inflate forcefully into the space between you and the door.

5. If the airbag system in this vehicle needs to be modified to accommodate a disabled person, contact the Customer Center. Phone numbers are provided under "If You Need Assistance".

WARNING!

- Relying on the airbags alone could lead to more severe injuries in a collision. The airbags work with your seat belt to restrain you properly. In some collisions, the airbags won't deploy at all. Always wear your seat belts even though you have airbags.

(Continued)

WARNING! (Continued)

- Being too close to the steering wheel or instrument panel during Advanced Front Airbag deployment could cause serious injury, including death. Airbags need room to inflate. Sit back, comfortably extending your arms to reach the steering wheel or instrument panel.
- Supplemental Side Airbag Inflatable Curtain (SABIC) and Seat-Mounted Side Airbags (SAB) also need room to inflate. Do not lean against the door or window. Sit upright in the center of the seat.
- In an accident, you and your passengers can suffer much greater injuries if you are not properly buckled up. You can strike the interior of your vehicle or other passengers, or you can be thrown out of the vehicle. Always be sure you and others in your vehicle are buckled up properly.

Buckle up even though you are an excellent driver, even on short trips. Someone on the road may be a poor driver and cause an accident that includes you. This can happen far away from home or on your own street.

Research has shown that seat belts save lives, and they can reduce the seriousness of injuries in an accident. Some of the worst injuries happen when people are thrown from the vehicle. Seat belts reduce the possibility of ejection and the risk of injury caused by striking the inside of the vehicle. Everyone in a motor vehicle should be belted at all times.

Lap/Shoulder Belts

All seating positions in your vehicle are equipped with lap/shoulder belts. The belt webbing retractor is designed to lock during very sudden stops or accidents. This feature allows the shoulder part of the belt to move freely with you under normal conditions. However, in an accident the belt will lock and reduce the risk of you striking the inside of the vehicle or being thrown out.

WARNING!

- **Wearing a seat belt incorrectly is dangerous. Seat belts are designed to go around the large bones of your body. These are the strongest parts of your body and can take the forces of an accident the best. Wearing your belt in the wrong place could make your injuries in an accident much worse. You might suffer internal injuries, or you could even slide out of part of the belt. Follow these instructions to wear your seat belt safely and to keep your passengers safe, too.**
- **Two people should never be belted into a single seat belt. People belted together can crash into one another in an accident, hurting one another badly. Never use a lap/shoulder belt or a lap belt for more than one person, no matter what their size.**

(Continued)

WARNING! (Continued)

- It is dangerous to ride in a cargo area, inside or outside of a vehicle. In an accident, people riding in these areas are more likely to be seriously injured or killed.
- Do not allow people to ride in any area of your vehicle that is not equipped with seats and seat belts.
- Be sure everyone in your vehicle is in a seat and using a seat belt properly.

Lap/Shoulder Belt Operating Instructions

1. Enter the vehicle and close the door. Sit back and adjust the seat.

2. The seat belt latch plate is above the back of your seat. Grasp the latch plate and pull out the belt. Slide the latch plate up the webbing as far as necessary to make the belt go around your lap.



Latch Plate

54 THINGS TO KNOW BEFORE STARTING YOUR VEHICLE

3. When the belt is long enough to fit, insert the latch plate into the buckle until you hear a “click.”



Latch Plate to Buckle

WARNING!

- A belt that is buckled into the wrong buckle will not protect you properly. The lap portion could ride too high on your body, possibly causing internal injuries. Always buckle your belt into the buckle nearest you.
- A belt that is too loose will not protect you properly. In a sudden stop you could move too far forward, increasing the possibility of injury. Wear your seat belt snugly.

(Continued)

WARNING! (Continued)

- A belt that is worn under your arm is dangerous. Your body could strike the inside surfaces of the vehicle in an accident, increasing head and neck injury. A belt worn under the arm can cause internal injuries. Ribs aren't as strong as shoulder bones. Wear the belt over your shoulder so that your strongest bones will take the force in a collision.
- A shoulder belt placed behind you will not protect you from injury during an accident. You are more likely to hit your head in a collision if you do not wear your shoulder belt. The lap and shoulder belt are meant to be used together.

4. Position the lap belt across your thighs, below your abdomen. To remove slack in the lap portion, pull up a bit on the shoulder belt. To loosen the lap belt if it is too tight, tilt the latch plate and pull on the lap belt. A snug belt reduces the risk of sliding under the belt in an accident.

WARNING!

- A lap belt worn too high can increase the risk of injury in an accident. The belt forces won't be at the strong hip and pelvic bones, but across your abdomen. Always wear the lap part of your seat belt as low as possible and keep it snug.
- A twisted belt will not protect you properly. In a collision, it could even cut into you. Be sure the belt is straight. If you can't straighten a belt in your vehicle, take it to your authorized dealer immediately and have it fixed.

56 THINGS TO KNOW BEFORE STARTING YOUR VEHICLE

5. Position the shoulder belt on your chest so that it is comfortable and not resting on your neck. The retractor will withdraw any slack in the belt.



Removing Slack from Belt

6. To release the belt, push the red button on the buckle. The belt will automatically retract to its stowed position. If necessary, slide the latch plate down the webbing to allow it to retract fully.

WARNING!

A frayed or torn belt could rip apart in an accident and leave you with no protection. Inspect the belt system periodically, checking for cuts, frays, or loose parts. Damaged parts must be replaced immediately. Do not disassemble or modify the system. Seat belt assemblies must be replaced after an accident if they have been damaged (bent retractor, torn webbing, etc.).

Lap/Shoulder Belt Untwisting Procedure

Use the following procedure to untwist a twisted lap/shoulder belt.

1. Position the latch plate as close as possible to the anchor point.
2. At about 6 to 12 in (15 to 30 cm) above the latch plate, grasp and twist the belt webbing 180 degrees to create a fold that begins immediately above the latch plate.
3. Slide the latch plate upward over the folded webbing. The folded webbing must enter the slot at the top of the latch plate.
4. Continue to slide the latch plate up until it clears the folded webbing.

Adjustable Upper Shoulder Belt Anchorage

In the front seating positions, the shoulder belt can be adjusted upward or downward to position the belt away from your neck. Press the release button to release the anchorage, and then move it up or down to the position that fits you best.

2



Adjusting Upper Shoulder Belt

As a guide, if you are shorter than average, you will prefer a lower position, and if you are taller than average, you will prefer a higher position. When you release the button, verify the shoulder belt anchorage is latched by pulling downward on the shoulder belt anchorage until it is locked into position.

NOTE: The adjustable upper shoulder belt anchorage is equipped with an Easy Up feature. This feature allows the shoulder belt anchorage to be adjusted in the upward position without pushing the release button. To verify the shoulder belt anchorage is latched, pull downward on the shoulder belt anchorage until it is locked into position.

Energy Management Feature

This vehicle has a safety belt system with an Energy Management feature in the front seating positions to help further reduce the risk of injury in the event of a head-on accident.

This safety belt system has a retractor assembly that is designed to release webbing in a controlled manner. This feature is designed to help reduce the belt force acting on the occupant's chest.

WARNING!

- **The belt and retractor assembly must be replaced if the seat belt assembly Automatic Locking Retractor (ALR) feature or any other seat belt function is not working properly when checked according to the procedures in the Service Manual.**
- **Failure to replace the belt and retractor assembly could increase the risk of injury in accidents.**

Seat Belts In Passenger Seating Positions

The seat belts in the passenger seating positions are equipped with Automatic Locking Retractors (ALR) which are used to secure a child restraint system. For additional information refer to “Installing Child Restraints Using The Vehicle Seat Belt” under the “Child Restraints” section. The chart below defines the type of feature for each seating position.

	Driver	Center	Passenger
First Row	N/A	N/A	ALR
Second Row	ALR	ALR	ALR
Third Row	N/A	N/A	N/A

- N/A — Not Applicable
- ALR — Automatic Locking Retractor

If the passenger seating position is equipped with an ALR and is being used for normal usage:

Only pull the belt webbing out far enough to comfortably wrap around the occupants mid-section so as to not activate the ALR. If the ALR is activated you will hear a ratcheting sound as the belt retracts. Allow the webbing to retract completely in this case and then carefully pull out only the amount of webbing necessary to comfortably wrap around the occupants mid-section. Slide the latch plate into the buckle until you hear a “click.”

Automatic Locking Retractor Mode (ALR) — If Equipped

In this mode, the shoulder belt is automatically pre-locked. The belt will still retract to remove any slack in the shoulder belt. The Automatic Locking Mode is available on all passenger-seating positions with a combination lap/shoulder belt. Use the Automatic Locking Mode anytime a child safety seat is installed in a seating position that has a belt with this feature. Children 12 years old and under should always be properly restrained in the rear seat.

How To Engage The Automatic Locking Mode

1. Buckle the combination lap and shoulder belt.
2. Grasp the shoulder portion and pull downward until the entire belt is extracted.

3. Allow the belt to retract. As the belt retracts, you will hear a clicking sound. This indicates the safety belt is now in the Automatic Locking Mode.

How To Disengage The Automatic Locking Mode

Unbuckle the combination lap/shoulder belt and allow it to retract completely to disengage the Automatic Locking Mode and activate the vehicle sensitive (emergency) locking mode.

WARNING!

- The belt and retractor assembly must be replaced if the seat belt assembly Automatic Locking Retractor (ALR) feature or any other seat belt function is not working properly when checked according to the procedures in the Service Manual.
- Failure to replace the belt and retractor assembly could increase the risk of injury in collisions.

Seat Belt Pretensioners

The seat belts for both front seating positions are equipped with pretensioning devices that are designed to remove slack from the seat belt in the event of an accident. These devices may improve the performance of the seat belt by assuring that the belt is tight about the occupant early in an accident. Pretensioners work for all size occupants, including those in child restraints.

NOTE: These devices are not a substitute for proper seat belt placement by the occupant. The seat belt still must be worn snugly and positioned properly.

The pretensioners are triggered by the Occupant Restraint Controller (ORC). Like the airbags, the pretensioners are single use items. A deployed pretensioner or a deployed airbag must be replaced immediately.

Supplemental Active Head Restraints (AHR)

These head restraints are passive, deployable components, and vehicles with this equipment cannot be readily identified by any markings, only through visual inspection of the head restraint. The head restraint will be split in two halves, with the front half being soft foam and trim, the back half being decorative plastic.

How the Active Head Restraints (AHR) Work

The Occupant Restraint Controller (ORC) determines whether the severity, or type of rear impact will require the Active Head Restraints (AHR) to deploy. If a rear impact requires deployment, both the driver and front passenger seat AHRs will be deployed.

62 THINGS TO KNOW BEFORE STARTING YOUR VEHICLE

When AHRs deploy during a rear impact, the front half of the head restraint extends forward to minimize the gap between the back of the occupant's head and the AHR. This system is designed to help prevent or reduce the extent of injuries to the driver and front passenger in certain types of rear impacts.

NOTE: The Active Head Restraints (AHR) may or may not deploy in the event of a front or side impact. However if during a front impact, a secondary rear impact occurs, the AHR may deploy based on the severity and type of the impact.



Active Head Restraint (AHR) Components

- | | |
|---|--|
| 1 — Head Restraint Front Half
(Soft Foam and Trim) | 3 — Head Restraint Back Half
(Decorative Plastic Rear
Cover) |
| 2 — Seatback | 4 — Head Restraint Guide
Tubes |

CAUTION!

All occupants, including the driver, should not operate a vehicle or sit in a vehicle's seat until the head restraints are placed in their proper positions in order to minimize the risk of neck injury in the event of an accident.

NOTE: For more information on properly adjusting and positioning the head restraint, refer to "Adjusting Active Head Restraints" in "Understanding The Features Of Your Vehicle".

Resetting Active Head Restraints (AHR)

If the Active Head Restraints are triggered in an accident, you must reset the head restraint on the driver's and front passenger seat. You can recognize when the Active Head Restraint has been triggered by the fact that they have moved forward (as shown in step three of the resetting procedure).

1. Grasp the deployed AHR from the rear seat.



Hand Positioning Points On AHR

2. Position the hands on the top of the deployed AHR at a comfortable position.

64 THINGS TO KNOW BEFORE STARTING YOUR VEHICLE

3. Pull **down** then **rearward** towards the rear of the vehicle then **down** to engage the locking mechanism.

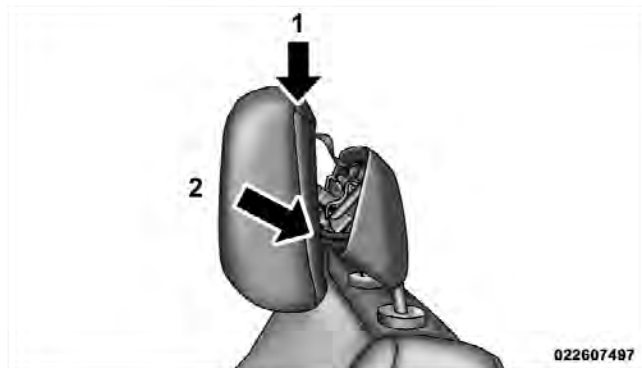

- 1 — Downward Movement
- 2 — Rearward Movement



3 — Final Downward Movement To Engage Locking Mechanism

4. The AHR front soft foam and trim half should lock into the back decorative plastic half.



022607494

AHR In Reset Position**NOTE:**

- If you have difficulties or problems resetting the Active Head Restraints, see an authorized dealer.
- For safety reasons, have the Active Head Restraints checked by a qualified specialist at an authorized dealer.

Enhanced Seat Belt Use Reminder System (BeltAlert®)

BeltAlert® is a feature intended to remind the driver and front passenger (if equipped with front passenger BeltAlert®) to fasten their seatbelts. This feature is active whenever the ignition is on. If the driver or front seat passenger is unbelted, the Seat Belt Reminder Light will turn on and remain on until both front seatbelts are fastened. BeltAlert® triggers within 60 seconds of vehicle speed over 5 mph (8 km/h). The reminder sequence lasts for 96 seconds or until the respective seatbelts are fastened. After the sequence completes, the Seat Belt Reminder Light remains illuminated until front belts are fastened. The driver should instruct all other occupants to fasten their seatbelts. If a front seatbelt is unbuckled while traveling at speeds greater than 5 mph (8 km/h), BeltAlert® will chime as a single notification and illuminate the Seat Belt Reminder Light, then will proceed to the 96 second reminder sequence.

The front passenger seat BeltAlert® is not active when the front passenger seat is unoccupied. BeltAlert® may be triggered when an animal or heavy object is on the front passenger seat or when the seat is folded flat (if equipped). It is recommended that pets be restrained in the rear seat in pet harnesses or pet carriers that are secured by seat belts, and cargo is properly stowed.

BeltAlert® can be enabled or disabled by your authorized dealer or by following these steps:

NOTE: The following steps must occur within the first 60 seconds of the ignition switch being turned to the ON/RUN or START position. Chrysler Group LLC does not recommend deactivating BeltAlert®.

1. With all doors closed, and the ignition switch in any position except ON/RUN or START, buckle the driver's seatbelt.

2. Turn the ignition key to the ACC or ON/RUN position (do not start the engine), and wait for the Seat Belt Reminder Light to turn off.

3. Within 60 seconds of starting the vehicle, unbuckle and then re-buckle the driver's seat belt at least three times within 10 seconds, ending with the seat belt buckled.

4. Turn the ignition key to the OFF position. A single chime will sound to signify that you have successfully completed the programming.

NOTE: Watch for the Seat Belt Reminder Light to turn on while the seat belt retracts and turn off while re-buckling the seat belt.

BeltAlert® can be reactivated by repeating this procedure.

NOTE: Although BeltAlert® has been deactivated, the Seat Belt Reminder Light will continue to illuminate while the driver's or front passenger's (if equipped with belt alert) seat belt remains unfastened.

Seatbelt Lock Out

The center rear seat belt system has a lock out feature that will not allow you to extract the center webbing unless the rear seat upper latch is engaged.

Seat Belts And Pregnant Women

We recommend that pregnant women use the seat belts throughout their pregnancy. Keeping the mother safe is the best way to keep the baby safe.

Pregnant women should wear the lap part of the belt across the thighs and as snug across the hips as possible. Keep the belt low so that it does not come across the abdomen. That way the strong bones of the hips will take the force if there is an accident.

Seat Belt Extender

If a seat belt is too short, even when fully extended and when the adjustable upper shoulder belt anchorage (if equipped) is in its lowest position, your authorized dealer can provide you with a seat belt extender. This extender should be used only if the existing belt is not long enough. When it is not required, remove the extender and store it.

WARNING!

Using a seat belt extender when not needed can increase the risk of injury in an accident. Only use when the lap belt is not long enough when it is worn low and snug, and in the recommended seating positions. Remove and store the extender when not needed.

Supplemental Restraint System (SRS) — Airbags

This vehicle has Advanced Front Airbags for both the driver and front passenger as a supplement to the seat belt restraint systems. The driver's Advanced Front Airbag is mounted in the center of the steering wheel. The passenger's Advanced Front Airbag is mounted in the instrument panel, above the glove compartment. The words SRS AIRBAG are embossed on the airbag covers.

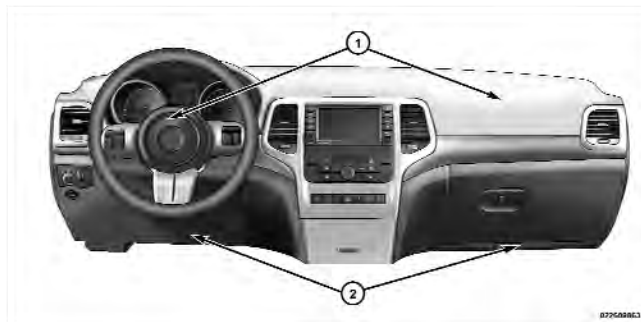

Advanced Front Airbag And Knee Bolster Locations

- 1 — Driver And Passenger Advanced Front Airbags
- 2 — Knee Bolster

NOTE: These airbags are certified to the new Federal regulations for Advanced Airbags.

The Advanced Front Airbags have a multistage inflator design. This allows the airbag to have different rates of inflation based on the severity and type of collision.

This vehicle may be equipped with driver and/or front passenger seat track position sensors that may adjust the inflation rate of the Advanced Front Airbags based upon seat position.

This vehicle may be equipped with a driver and/or front passenger seat belt buckle switch that detects whether the driver or front passenger seat belt is fastened. The seat belt buckle switch may adjust the inflation rate of the Advanced Front Airbags.

This vehicle is equipped with Supplemental Side Airbag Inflatable Curtains (SABIC) to protect the driver, front, and rear passengers sitting next to a window. The SABIC airbags, are located above the side windows and their covers are also labeled: SRS AIRBAG.

This vehicle is equipped with Supplemental Seat-Mounted Side Airbags (SAB) to provide enhanced protection for an occupant during a side impact. The Supplemental Seat-Mounted Side Airbags are located in the outboard side of the front seats.

NOTE:

- Airbag covers may not be obvious in the interior trim; but they will open during airbag deployment.
- After any accident, the vehicle should be taken to an authorized dealer immediately.

Airbag System Components

Your vehicle may be equipped with the following airbag system components:

- Occupant Restraint Controller (ORC)
- Airbag Warning Light
- Steering Wheel and Column
- Instrument Panel
- Knee Impact Bolster
- Driver Advanced Front Airbag
- Passenger Advanced Front Airbag
- Supplemental Seat-Mounted Side Airbags (SAB)
- Supplemental Side Airbag Inflatable Curtains (SABIC)
- Front and Side Impact Sensors

- Front Seat Belt Pretensioners, Seat Belt Buckle Switch, and Seat Track Position Sensors
- Supplemental Active Head Restraint for Driver and Front Passenger

Advanced Front Airbag Features

The Advanced Front Airbag system has multistage driver and front passenger airbags. This system provides output appropriate to the severity and type of collision as determined by the Occupant Restraint Controller (ORC), which may receive information from the front impact sensors.

The first stage inflator is triggered immediately during an impact that requires airbag deployment. This low output is used in less severe collisions. A higher energy output is used for more severe collisions.

WARNING!

- No objects should be placed over or near the airbag on the instrument panel, because any such objects could cause harm if the vehicle is in a collision severe enough to cause the airbag to inflate.
- Do not put anything on or around the airbag covers or attempt to open them manually. You may damage the airbags and you could be injured because the airbags may no longer be functional. The protective covers for the airbag cushions are designed to open only when the airbags are inflating.
- Do not drill, cut or tamper with the knee bolster in any way.
- Do not mount any accessories to the knee bolster such as alarm lights, stereos, citizen band radios, etc.

Supplemental Seat-Mounted Side Airbags (SAB)

Supplemental Seat-Mounted Side Airbags may provide enhanced protection to help protect an occupant during a side impact. The Supplemental Seat-Mounted Side Airbag is marked with an airbag label sewn into the out-board side of the front seats.

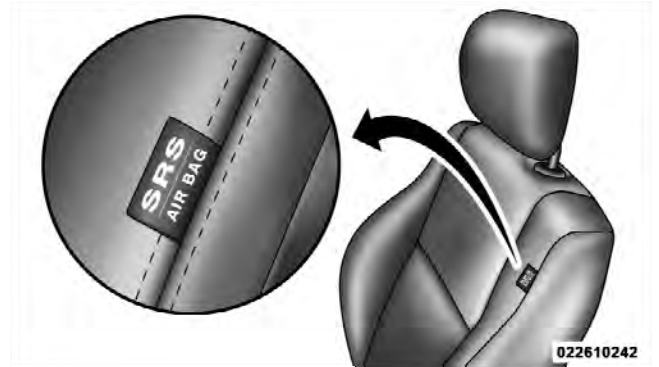
2

Supplemental Seat-Mounted Side Airbag Label

72 THINGS TO KNOW BEFORE STARTING YOUR VEHICLE

When the airbag deploys, it opens the seam between the front and side of the seat's trim cover. Each airbag deploys independently, that is a left side impact deploys the left airbag only and a right-side impact deploys only the right airbag.

Supplemental Side Airbag Inflatable Curtain (SABIC)

SABIC airbags may offer side-impact and vehicle rollover protection to front and rear seat outboard occupants in addition to that provided by the body structure. Each airbag features inflated chambers placed adjacent to the head of each outboard occupant that reduce the potential for side-impact head injuries. The curtains deploy downward, covering both windows on the impact side.



Supplemental Side Airbag Inflatable Curtain (SABIC) Label Location

NOTE:

- Airbag covers may not be obvious in the interior trim; but they will open during airbag deployment.

- Being too close to the SAB and SABIC airbags during deployment could cause you to be severely injured or killed.
- Should a vehicle rollover occur, the pretensioners, SAB and/or SABIC airbags on both sides of the vehicle may deploy.

The system includes side impact sensors adjacent to both front and rear seat occupants that are calibrated to deploy the Supplemental Seat-Mounted Side Airbags and SABIC airbags during impacts that require side airbag occupant protection.

WARNING!

- **If your vehicle is equipped with left and right Supplemental Side Airbag Inflatable Curtain (SABIC), do not stack luggage or other cargo up high enough to block the location of the SABIC. The area where the SABIC is located should remain free from any obstructions.**
- **Do not use accessory seat covers or place objects between you and the side airbags; the performance could be adversely affected and/or objects could be pushed into you, causing serious injury.**

WARNING! (Continued)

- If your vehicle is equipped with SABIC airbags, do not have any accessory items installed which will alter the roof, including adding a sunroof to your vehicle. Do not add roof racks that require permanent attachments (bolts or screws) for installation on the vehicle roof. Do not drill into the roof of the vehicle for any reason.

Knee Impact Bolsters

The Knee Impact Bolsters help protect the knees of the driver and the front passenger, and position front occupants for the best interaction with the Advanced Front Airbags.

Along with seat belts and pretensioners, Advanced Front Airbags work with the knee bolsters to provide improved protection for the driver and front passenger. Side airbags also work with seat belts to improve occupant protection.

Airbag Deployment Sensors And Controls**Occupant Restraint Controller (ORC)**

The ORC is part of a Federally regulated safety system required for this vehicle.

The ORC determines if deployment of the front and/or side airbags in a frontal or side collision is required. Based on the impact sensors signals, a central electronic ORC deploys the Advanced Front Airbags, SABIC airbags, SAB airbags, and front seat belt pretensioners, as required, depending on the severity and type of impact.

Advanced Front Airbags are designed to provide additional protection by supplementing the seat belts in certain frontal collisions depending on the severity and type of collision. Advanced Front Airbags are not expected to reduce the risk of injury in rear, side, or rollover collisions.

The Advanced Front Airbags will not deploy in all frontal collisions, including some that may produce substantial vehicle damage — for example, some pole collisions, truck underrides, and angle offset collisions. On the other hand, depending on the type and location of impact, Advanced Front Airbags may deploy in crashes with little vehicle front-end damage but that produce a severe initial deceleration.

The side airbags will not deploy in all side collisions. Side airbag deployment will depend on the severity and type of collision.

Because airbag sensors measure vehicle deceleration over time, vehicle speed and damage by themselves are not good indicators of whether or not an airbag should have deployed.

Seat belts are necessary for your protection in all accidents, and also are needed to help keep you in position, away from an inflating airbag.

The ORC monitors the readiness of the electronic parts of the airbag system whenever the ignition switch is in the START or ON/RUN position. If the key is in the OFF position, in the ACC position, or not in the ignition, the airbag system is not on and the airbags will not inflate.

The ORC contains a backup power supply system that may deploy the airbags even if the battery loses power or it becomes disconnected prior to deployment.



Also, the ORC turns on the Airbag Warning Light in the instrument panel for approximately four to eight seconds for a self-check when the ignition is first turned on. After the self-check, the Airbag Warning Light will turn off. If the ORC detects a malfunction in any part of the system, it turns on the Airbag Warning Light, either momentarily or continuously. A single chime will sound if the light comes on again after initial startup.

It also includes diagnostics that will illuminate the instrument cluster Airbag Warning Light if a malfunction is noted that could affect the airbag system. The diagnostics also record the nature of the malfunction.

WARNING!

Ignoring the Airbag Warning Light in your instrument panel could mean you won't have the airbags to protect you in a collision. If the light does not come on as a bulb check when the ignition is first turned on, stays on after you start the vehicle, or if it comes on as you drive, have an authorized dealer service the airbag system immediately.

Driver And Passenger Advanced Front Airbag Inflator Units

The Driver and Passenger Advanced Front Airbag Inflator Units are located in the center of the steering wheel and the right side of the instrument panel. When the

ORC detects a collision requiring the Advanced Front Airbags, it signals the inflator units. A large quantity of non-toxic gas is generated to inflate the Advanced Front Airbags. Different airbag inflation rates are possible, based on the collision type and severity. The steering wheel hub trim cover and the upper right side of the instrument panel separate and fold out of the way as the airbags inflate to their full size. The airbags fully inflate in about 50 to 70 milliseconds. This is about half of the time it takes to blink your eyes. The airbags then quickly deflate while helping to restrain the driver and front passenger.

The Advanced Front Airbag gas is vented through the vent holes in the sides of the airbag. In this way, the airbags do not interfere with your control of the vehicle.

Supplemental Seat-Mounted Side Airbag (SAB) Inflator Units

The Supplemental Seat-Mounted Side Airbags are designed to activate only in certain side collisions.

The ORC determines if a side collision requires the side airbags to inflate based on the severity and type of collision.

Based on the severity and type of collision, the side airbag inflator on the crash side of the vehicle may be triggered, releasing a quantity of non-toxic gas. The inflating SAB exits through the seat seam into the space between the occupant and the door. The SAB fully inflates in about 10 milliseconds. The side airbag moves at a very high speed and with such a high force, that it could injure you if you are not seated properly, or if items are positioned in the area where the side airbag inflates. This especially applies to children.

Supplemental Side Airbag Inflatable Curtain (SABIC) Inflator Units

During collisions where the impact is confined to a particular area of the side of the vehicle, the ORC may deploy the SABIC airbags, depending on the severity and type of collision. In these events, the ORC will deploy the SABIC only on the impact side of the vehicle.

A quantity of non-toxic gas is generated to inflate the SABIC. The inflating SABIC pushes the outside edge of the headliner out of the way and covers the window. The SABIC inflates in about 30 milliseconds (about one-quarter of the time that it takes to blink your eyes) with enough force to injure you if you are not belted and seated properly, or if items are positioned in the area where the SABIC inflates. This especially applies to children. The SABIC is only about 3-1/2 in (9 cm) thick when it is inflated.

Because airbag sensors estimate deceleration over time, vehicle speed and damage are not good indicators of whether or not an airbag should have deployed.

NOTE: In a rollover the pretensioners, SAB and/or SABIC airbags may deploy on both sides of the vehicle.

Front And Side Impact Sensors

In front and side impacts, front and side impact sensors can aid the ORC in determining the appropriate response to certain impact events.

Enhanced Accident Response System

In the event of an impact causing airbag deployment, if the communication network remains intact, and the power remains intact, depending on the nature of the event the ORC will determine whether to have the Enhanced Accident Response System perform the following functions:

- Cut off fuel to the engine.

- Flash hazard lights as long as the battery has power or until the ignition key is turned off.
- Turn on the interior lights, which remain on as long as the battery has power or until the ignition key is removed.
- Unlock the doors automatically.

If A Deployment Occurs

The Advanced Front Airbags are designed to deflate immediately after deployment.

NOTE: Front and/or side airbags will not deploy in all collisions. This does not mean something is wrong with the airbag system.

If you do have a collision which deploys the airbags, any or all of the following may occur:

- The nylon airbag material may sometimes cause abrasions and/or skin reddening to the driver and front

passenger as the airbags deploy and unfold. The abrasions are similar to friction rope burns or those you might get sliding along a carpet or gymnasium floor. They are not caused by contact with chemicals. They are not permanent and normally heal quickly. However, if you haven't healed significantly within a few days, or if you have any blistering, see your doctor immediately.

- As the airbags deflate, you may see some smoke-like particles. The particles are a normal by-product of the process that generates the non-toxic gas used for airbag inflation. These airborne particles may irritate the skin, eyes, nose, or throat. If you have skin or eye irritation, rinse the area with cool water. For nose or throat irritation, move to fresh air. If the irritation continues, see your doctor. If these particles settle on your clothing, follow the garment manufacturer's instructions for cleaning.

Do not drive your vehicle after the airbags have deployed. If you are involved in another collision, the airbags will not be in place to protect you.

WARNING!

Deployed airbags and seat belt pretensioners cannot protect you in another collision. Have the airbags, seat belt pretensioners, and the front seat belt retractor assemblies replaced by an authorized dealer immediately. Also, have the Occupant Restraint Controller (ORC) system serviced as well.

Maintaining Your Airbag System

WARNING!

- Modifications to any part of the airbag system could cause it to fail when you need it. You could be injured if the airbag system is not there to protect you. Do not modify the components or wiring, including adding any kind of badges or stickers to the steering wheel hub trim cover or the upper right side of the instrument panel. Do not modify the front bumper, vehicle body structure, or add aftermarket side steps or running boards.
- It is dangerous to try to repair any part of the airbag system yourself. Be sure to tell anyone who works on your vehicle that it has an airbag system.

(Continued)

WARNING! (Continued)

- Do not attempt to modify any part of your airbag system. The airbag may inflate accidentally or may not function properly if modifications are made. Take your vehicle to an authorized dealer for any airbag system service. If your seat, including your trim cover and cushion, needs to be serviced in any way (including removal or loosening/tightening of seat attachment bolts), take the vehicle to your authorized dealer. Only manufacturer approved seat accessories may be used. If it is necessary to modify the airbag system for persons with disabilities, contact your authorized dealer.

Airbag Warning Light



You will want to have the airbags ready to inflate for your protection in a collision. The Airbag Warning Light monitors the internal circuits and interconnecting wiring associated with airbag system electrical components. While the airbag system is designed to be maintenance free, if any of the following occurs, have an authorized dealer service the airbag system immediately.

- The Airbag Warning Light does not come on during the four to eight seconds when the ignition switch is first turned to the ON/RUN position.
- The Airbag Warning Light remains on after the four to eight-second interval.
- The Airbag Warning Light comes on intermittently or remains on while driving.

NOTE: If the speedometer, tachometer, or any engine related gauges are not working, the Occupant Restraint Controller (ORC) may also be disabled. The airbags may not be ready to inflate for your protection. Promptly check the fuse block for blown fuses. Refer to the label located on the inside of the fuse block cover for the proper airbag fuses. See your authorized dealer if the fuse is good.

Event Data Recorder (EDR)

This vehicle is equipped with an event data recorder (EDR). The main purpose of an EDR is to record, in certain crash or near crash-like situations, such as an air bag deployment or hitting a road obstacle, data that will assist in understanding how a vehicle's systems performed. The EDR is designed to record data related to vehicle dynamics and safety systems for a short period of time, typically 30 seconds or less. The EDR in this vehicle is designed to record such data as:

- How various systems in your vehicle were operating;

- Whether or not the driver and passenger safety belts were buckled/fastened;
- How far (if at all) the driver was depressing the accelerator and/or brake pedal; and,
- How fast the vehicle was traveling.

These data can help provide a better understanding of the circumstances in which crashes and injuries occur.

NOTE: EDR data are recorded by your vehicle only if a non-trivial crash situation occurs; no data are recorded by the EDR under normal driving conditions and no personal data (e.g. name, gender, age, and crash location) are recorded. However, other parties, such as law enforcement, could combine the EDR data with the type of personally identifying data routinely acquired during a crash investigation.

To read data recorded by an EDR, special equipment is required, and access to the vehicle or the EDR is needed. In addition to the vehicle manufacturer, other parties such as law enforcement, that have the special equipment, can read the information if they have access to the vehicle or the EDR.

Child Restraints

Everyone in your vehicle needs to be buckled up all the time, including babies and children. Every state in the United States, and all Canadian provinces, require that small children ride in proper restraint systems. This is the law, and you can be prosecuted for ignoring it.

Children 12 years and under should ride properly buckled up in a rear seat, if available. According to crash statistics, children are safer when properly restrained in the rear seats rather than in the front.

There are different sizes and types of restraints for children from newborn size to the child almost large enough for an adult safety belt. Always check the child seat Owner's Manual to ensure you have the right seat for your child. Use the restraint that is correct for your child.

WARNING!

In a collision, an unrestrained child, even a tiny baby, can become a projectile inside the vehicle. The force required to hold even an infant on your lap can become so great that you could not hold the child, no matter how strong you are. The child and others could be badly injured. Any child riding in your vehicle should be in a proper restraint for the child's size.

Infants And Child Restraints

- Safety experts recommend that children ride rearward-facing in the vehicle until they are at least one year old and weigh at least 20 lbs (9 kg). Two types of child restraints can be used rearward-facing: infant carriers and convertible child seats.
- The infant carrier is only used rearward-facing in the vehicle. It is recommended for children who weigh up to about 20 lbs (9 kg). Convertible child seats often have a higher weight limit in the rearward-facing direction than infant carriers do, so they can be used rearward-facing by children who weigh more than 20 lbs (9 kg) but are less than one year old. Both types of child restraints are held in the vehicle by the lap/shoulder belt or the LATCH child restraint anchorage system (Refer to LATCH — Child Seat Anchorage System.)

WARNING!

- **Rearward-facing child seats must never be used in the front seat of a vehicle with the front passenger airbag unless the airbag is turned off. An airbag deployment could cause severe injury or death to infants in this position.**
- **Improper installation can lead to failure of an infant or child restraint. It could come loose in a collision. The child could be badly injured or killed. Follow the manufacturer's directions exactly when installing an infant or child restraint.**
- **A rearward-facing infant restraint should only be used in a rear seat. A rearward-facing infant restraint in the front seat may be struck by a deploying passenger airbag which may cause severe or fatal injury to the infant.**

Here are some tips for getting the most out of your child restraint:

- Before buying any restraint system, make sure that it has a label certifying that it meets all applicable Safety Standards. Chrysler Group LLC also recommends that you try a child restraint in the vehicle seats where you will use it before you buy it.
- The restraint must be appropriate for your child's weight and height. Check the label on the restraint for weight and height limits.
- Carefully follow the instructions that come with the restraint. If you install the restraint improperly, it may not work when you need it.
- The second row seating positions are equipped with Automatic Locking Retractors (ALR). To install child restraint seats pull the belt from the retractor until there is enough allowance to pass it through the child

restraint and slide the latch plate into the buckle. Then, pull the shoulder belt until it is fully extended from the retractor. Allow the belt to return into the retractor, pulling on the excess webbing to tighten the lap portion around the child restraint. For additional information refer to "Automatic Locking Retractors Mode" earlier in the Occupant Restraints Section of the owners' manual.

- Buckle the child into the restraint exactly as the manufacturer's instructions tell you.

WARNING!

When your child restraint is not in use, secure it in the vehicle with the seat belt or remove it from the vehicle. Do not leave it loose in the vehicle. In a sudden stop or accident, it could strike the occupants or seatbacks and cause serious personal injury.

NOTE: For additional information, refer to www.seatcheck.org or call 1-866-SEATCHECK. Canadian residents, should refer to Transport Canada's website for additional information. <http://www.tc.gc.ca/roadsafety/safedrivers/childsafety/index.htm>

Older Children And Child Restraints

Children who weigh more than 20 lbs (9 kg), and who are older than one year, can ride forward-facing in the vehicle. Forward-facing child seats and convertible child seats used in the forward-facing direction are for children who weigh 20 to 40 lbs (9 to 18 kg), and who are older than one year. These child seats are also held in the vehicle by the lap/shoulder belt or the LATCH child restraint anchorage system (Refer to LATCH — Child Seat Anchorage System.)

The belt-positioning booster seat is for children weighing more than 40 lbs (18 kg), but who are still too small to fit the vehicle's seat belts properly. If the child cannot sit with knees bent over the vehicle's seat cushion while the child's back is against the seatback, they should use a belt-positioning booster seat. The child and belt-positioning booster seat are held in the vehicle by the lap/shoulder belt.

Children Too Large For Booster Seats

Children who are large enough to wear the shoulder belt comfortably, and whose legs are long enough to bend over the front of the seat when their back is against the seatback, should use the lap/shoulder belt in a rear seat.

- Make sure that the child is upright in the seat.
- The lap portion should be low on the hips and as snug as possible.

- Check belt fit periodically. A child's squirming or slouching can move the belt out of position.
- If the shoulder belt contacts the face or neck, move the child closer to the center of the vehicle. Never allow a child to put the shoulder belt under an arm or behind the back.

Lower Anchors and Tether for CHildren (LATCH)

Your vehicle's rear seat is equipped with the child restraint anchorage system called LATCH. The LATCH system provides for the installation of the child restraint without using the vehicle's seat belts, instead securing the child restraint using lower anchorages and upper tether straps from the child restraint to the vehicle structure.

LATCH-compatible child restraint systems are now available. However, because the lower anchorages are to be introduced over a period of years, child restraint systems having attachments for those anchorages will continue to also have features for installation using the vehicle's seat belts. Child restraints having tether straps and hooks for connection to the top tether anchorages, have been available for some time. For some older child restraints, many child restraint manufacturers offer add-on tether strap kits or retro-fit kits. You are urged to take advantage of all the available attachments provided with your child restraint in any vehicle.

NOTE: When using the LATCH attaching system to install a child restraint, please ensure that all seat belts not being used for occupant restraints are stowed and out of reach of children. Remind all children in the vehicle that the seat belts are not toys and should not be played with, and never leave your child unattended in the vehicle.



The rear outboard seating positions have lower anchorages capable of accommodating LATCH-compatible child seats having flexible, webbing-mounted lower attachments and child seats with fixed lower attachments. The rear seat lower anchors can be readily identified by the symbol located on the seatback directly above the anchorages and are just visible when you lean into the rear seat to install the child restraint. You will easily feel them if you run your finger along the intersection of the seatback and seat cushion surfaces. The vehicle's seat belt must be used for the center position. Regardless of the specific type of lower attachment, never install LATCH-compatible child seats such that two seats share a common lower anchorage.

If you are installing LATCH-compatible child restraints in adjacent rear seating positions, you can use the LATCH anchors or the vehicle's seat belt for the outboard position, but you must use the vehicle's seat belt at the center position. If your child restraints are not LATCH-compatible, you can only install the child restraints using the vehicle's seat belts. For typical installation instructions, refer to "Installing The LATCH-Compatible Child Restraint System".

Installing The LATCH-Compatible Child Restraint System

We urge you to carefully follow the directions of the manufacturer when installing your child restraint. Not all child restraint systems will be installed as described here. Again, carefully follow the installation instructions that were provided with the child restraint system.

The rear seat lower anchorages are round bars, located at the rear of the seat cushion where it meets the seatback, and are just visible when you lean into the rear seat to install the child restraint. You will easily feel them if you run your finger along the intersection of the seatback and seat cushion surfaces.

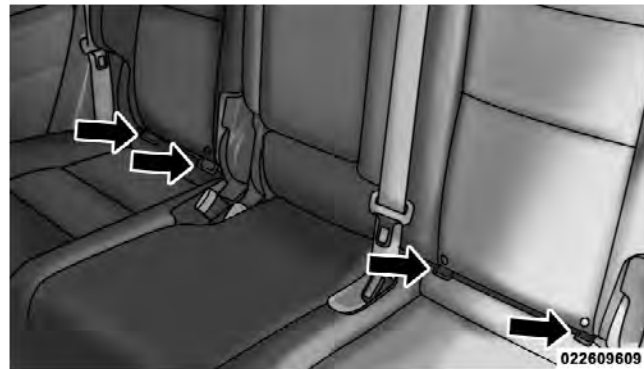

Latch Anchorages

In addition, there are top tether strap anchorages behind each rear seating position located on the back of the seat. To access the top tether strap anchorages behind the rear seat, pull the carpeted floor panel away from the seat back, this will expose the top tether strap anchorages.



Pulling Down The Carpet Floor Panel
To Access Top Tether Strap

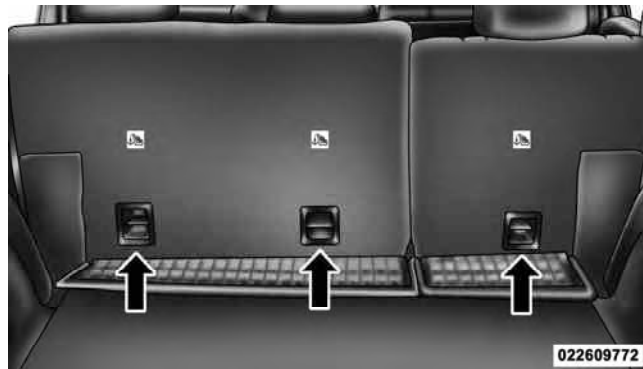

Top Tether Strap Anchorage (Located on Seatback)

WARNING!

Do not use the cargo tie downs located on the load floor. Improper usage of the tether can lead to a failure of an infant or child restraint. The child could be badly injured or killed.

Many, but not all restraint systems will be equipped with separate straps on each side, with each having a hook or connector for attachment to the lower anchorage and a means of adjusting the tension in the strap. Forward-facing toddler restraints and some rear-facing infant restraints will also be equipped with a tether strap, a hook for attachment to the tether strap anchorage and a means of adjusting the tension of the strap.

First, loosen the child seat adjusters on the lower straps and on the tether strap so that you can more easily attach the hooks or connectors to the vehicle anchorages. Next, attach the lower hooks or connectors over the top of the anchorage bars, pushing aside the seat cover material. Then, locate the tether anchorage directly behind the seat where you are placing the child restraint and attach the tether strap to the anchorage, being careful to route the tether strap to provide the most direct path between the

anchor and the child restraint. **There are three top tether anchorages located on the back of the seat, behind the gap panel. They are not visible until you fold the gap panel down. Do not use the cargo tie down hooks located on the floor behind the seat.** Finally, tighten all three straps as you push the child restraint rearward and downward into the seat, removing slack in the straps according to the child restraint manufacturer's instructions.

WARNING!

Improper installation of a child restraint to the LATCH anchorages can lead to failure of an infant or child restraint. The child could be badly injured or killed. Follow the manufacturer's directions exactly when installing an infant or child restraint.

Installing Child Restraints Using The Vehicle Seat Belts

The passenger seat belts are equipped with either cinching latch plates or Automatic Locking Retractors (ALR), which are designed to keep the lap portion tight around the child restraint so that it is not necessary to use a locking clip. If the seat belt has a cinching latch plate, pulling up on the shoulder portion of the lap/shoulder belt will tighten the belt. The cinching latch plate will keep the belt tight; however, any seat belt system will loosen with time, so check the belt occasionally and pull it tight if necessary.

For seat belts having an Automatic Locking Retractor (ALR), pull the belt from the retractor until there is enough allowance to pass it through the child restraint and slide the latch plate into the buckle. Then, pull the belt until it is fully extended from the retractor. Allow the belt to return into the retractor, pulling on the excess webbing to tighten the lap portion around the child restraint. Refer to “Automatic Locking Mode”.

92 THINGS TO KNOW BEFORE STARTING YOUR VEHICLE

To attach a child restraint tether strap:

For rearward facing infant seats secured in the center seat position with the vehicle seat belts, the rear center seat position has an armrest tether that secures the arm rest in the upward position. To access the center seat arm rest tether first lower the arm rest. The tether is located behind the armrest and hooked onto the plastic seat backing. To access the center seat arm rest tether first lower the arm rest. The tether is located behind the armrest and hooked onto the plastic seat backing.



Center Seat Position Arm Rest Tether

Pull down on the tether to unhook it from the plastic seat backing, then raise the armrest and attach the tether hook to the strap located on the front of the arm rest.

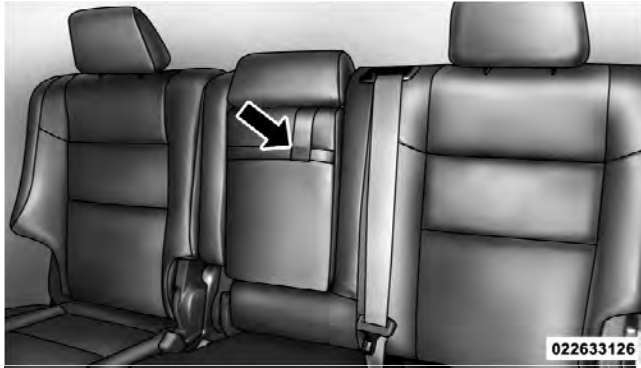

Center Seat Position Arm Rest Tether Attached

For center seating position route the tether strap over the seatback and headrest then attach the hook to the tether anchor located on the back of the seat. For the outboard seating positions, route the tether under the head rests, and attach the hook to the top tether anchor located on the back of the seat. To access the top tether strap

anchorages behind the rear seat, pull the carpeted floor panel away from the seat back, this will expose the top tether strap anchorages.



Pulling Down The Carpet Floor Panel To Access Top Tether Strap

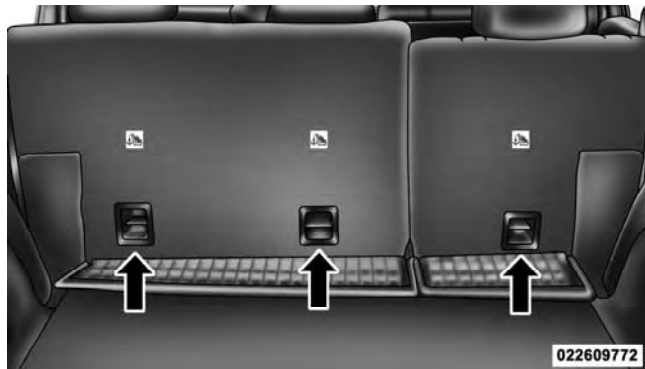

Top Tether Strap Anchorage (Located on Seatback)

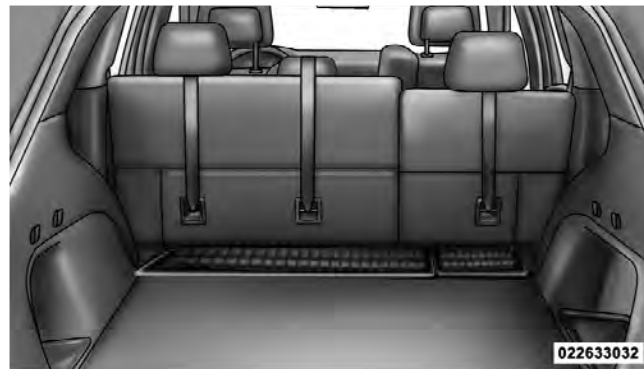

Top Tether Strap Mounting

WARNING!

- An incorrectly anchored tether strap could lead to increased head motion and possible injury to the child. Use only the anchor positions directly behind the child seat to secure a child restraint top tether strap.
- Do not use the cargo tie downs located on the load floor. Improper usage of the tether can lead to a failure of an infant or child restraint. The child could be badly injured or killed.

Top Tether Strap Attachment

For the center seating position route the tether strap over the seatback and headrest then attach the hook to the **top tether anchorage** located on the back of the seat **behind the gap panel**. For the outboard seating positions, route the tether strap under the headrests and attach the hook to the **top tether anchorage** located on the back of the seat

behind the gap panel. Please note the top tether anchorages are not visible until you fold the gap panel down. Do not use the cargo tie down hooks located on the floor behind the seats.

Transporting Pets

Airbags deploying in the front seat could harm your pet. An unrestrained pet will be thrown about and possibly injured, or injure a passenger during panic braking or in an accident. Pets should be restrained in the rear seat in pet harnesses or pet carriers that are secured by seat belts.

ENGINE BREAK-IN RECOMMENDATIONS

A long break-in period is not required for the engine and drivetrain (transmission and axle) in your vehicle.

Drive moderately during the first 300 miles (500 km). After the initial 60 miles (100 km), speeds up to 50 or 55 mph (80 or 90 km/h) are desirable.

While cruising, brief full-throttle acceleration within the limits of local traffic laws, contributes to a good break-in. Wide-open throttle acceleration in low gear can be detrimental and should be avoided.

The engine oil installed in the engine at the factory is a high-quality energy conserving type lubricant. Oil changes should be consistent with anticipated climate conditions under which vehicle operations will occur. For the recommended viscosity and quality grades refer to "Maintenance Procedures" in "Maintaining Your Vehicle". NON-DETERGENT OR STRAIGHT MINERAL OILS MUST NEVER BE USED.

A new engine may consume some oil during its first few thousand miles (kilometers) of operation. This should be considered a normal part of the break-in and not interpreted as an indication of difficulty.

SAFETY TIPS

Transporting Passengers

NEVER TRANSPORT PASSENGERS IN THE CARGO AREA.

WARNING!

- Do not leave children or animals inside parked vehicles in hot weather. Interior heat build-up may cause serious injury or death.
- It is extremely dangerous to ride in a cargo area, inside or outside of a vehicle. In a collision, people riding in these areas are more likely to be seriously injured or killed.
- Do not allow people to ride in any area of your vehicle that is not equipped with seats and seat belts.
- Be sure everyone in your vehicle is in a seat and using a seat belt properly.

Exhaust Gas

WARNING!

Exhaust gases can injure or kill. They contain carbon monoxide (CO), which is colorless and odorless. Breathing it can make you unconscious and can eventually poison you. To avoid breathing (CO) follow these safety tips:

Do not run the engine in a closed garage or in confined areas any longer than needed to move your vehicle in or out of the area.

If it is necessary to sit in a parked vehicle with the engine running, adjust your heating or cooling controls to force outside air into the vehicle. Set the blower at high speed.

If you are required to drive with the trunk/liftgate open, make sure that all windows are closed and the climate control BLOWER switch is set at high speed. DO NOT use the recirculation mode.

The best protection against carbon monoxide entry into the vehicle body is a properly maintained engine exhaust system.

Whenever a change is noticed in the sound of the exhaust system, when exhaust fumes can be detected inside the vehicle, or when the underside or rear of the vehicle is damaged, have a competent mechanic inspect the complete exhaust system and adjacent body areas for broken, damaged, deteriorated, or mispositioned parts. Open seams or loose connections could permit exhaust fumes to seep into the passenger compartment. In addition, inspect the exhaust system each time the vehicle is raised for lubrication or oil change. Replace as required.

Safety Checks You Should Make Inside The Vehicle

Seat Belts

Inspect the belt system periodically, checking for cuts, frays, and loose parts. Damaged parts must be replaced immediately. Do not disassemble or modify the system.

Front seat belt assemblies must be replaced after a collision. Rear seat belt assemblies must be replaced after a collision if they have been damaged (i.e., bent retractor, torn webbing, etc.). If there is any question regarding belt or retractor condition, replace the belt.

Airbag Warning Light

The light should come on and remain on for four to eight seconds as a bulb check when the ignition switch is first turned ON. If the light is not lit during starting, see your authorized dealer. If the light stays on, flickers, or comes on while driving, have the system checked by an authorized dealer.

Defroster

Check operation by selecting the defrost mode and place the blower control on high speed. You should be able to feel the air directed against the windshield. See your authorized dealer for service if your defroster is inoperable.

Floor Mat Safety Information

Always use floor mats designed to fit the foot well of your vehicle. Use only floor mats that leave the pedal area unobstructed and that are firmly secured so that they cannot slip out of position and interfere with the pedals or impair safe operation of your vehicle in other ways.

WARNING!

Pedals that cannot move freely can cause loss of vehicle control and increase the risk of serious personal injury.

- Always make sure that floor mats are properly attached to the floor mat fasteners.
- Never place or install floor mats or other floor coverings in the vehicle that cannot be properly secured to prevent them from moving and interfering with the pedals or the ability to control the vehicle.
- Never put floor mats or other floor coverings on top of already installed floor mats. Additional floor mats and other coverings will reduce the size of the pedal area and interfere with the pedals.

(Continued)

WARNING! (Continued)

- Check mounting of mats on a regular basis. Always properly reinstall and secure floor mats that have been removed for cleaning.
- Always make sure that objects cannot fall into the driver foot well while the vehicle is moving. Objects can become trapped under the brake pedal and accelerator pedal causing a loss of vehicle control.
- If required, mounting posts must be properly installed, if not equipped from the factory. Failure to properly follow floor mat installation or mounting can cause interference with the brake pedal and accelerator pedal operation causing loss of control of the vehicle.

Periodic Safety Checks You Should Make Outside The Vehicle

Tires

Examine tires for excessive tread wear and uneven wear patterns. Check for stones, nails, glass, or other objects lodged in the tread. Inspect the tread and sidewall for cuts and cracks. Check the wheel nuts for tightness. Check the tires (including spare) for proper pressure.

Lights

Have someone observe the operation of exterior lights while you work the controls. Check turn signal and high beam indicator lights on the instrument panel.

Door Latches

Check for positive closing, latching, and locking.

Fluid Leaks

Check area under vehicle after overnight parking for fuel, engine coolant, oil, or other fluid leaks. Also, if gasoline fumes are detected or if fuel, power steering fluid, or brake fluid leaks are suspected, the cause should be located and corrected immediately.

UNDERSTANDING THE FEATURES OF YOUR VEHICLE

CONTENTS

■ Mirrors	108	□ Illuminated Vanity Mirrors	111
□ Inside Day/Night Mirror	108	□ Sun Visor Extension — If Equipped	112
□ Automatic Dimming Mirror — If Equipped . .	109	■ Blind Spot Monitoring — If Equipped	112
□ Outside Mirrors	110	□ Rear Cross Path	118
□ Outside Mirrors Folding Feature	110	□ Modes Of Operation	120
□ Outside Automatic Dimming Mirrors — If Equipped	110	■ Uconnect™ Phone — If Equipped	121
□ Outside Power Mirrors	110	■ Voice Command — If Equipped	121
□ Heated Mirrors — If Equipped	111	■ Seats	121
		□ Power Seats — If Equipped	122

102 UNDERSTANDING THE FEATURES OF YOUR VEHICLE

- Passenger's Power Seat 124
- Power Lumbar — If Equipped 125
- Manual Front Seats Forward/Rearward Adjustment 126
- Manual Front Passenger Seatback Adjustment — Recline 127
- Front Passenger Seat Fold-Flat Feature — If Equipped 128
- Heated Seats — If Equipped 129
- Ventilated Seats — If Equipped 131
- Head Restraints 132
- 60/40 Split Rear Seat 137
- Reclining Rear Seat 139
- Driver Memory Seat — If Equipped 140
 - Setting Memory Positions And Linking Remote Keyless Entry Transmitter To Memory 141
 - Memory Position Recall 142
 - To Disable A RKE Transmitter Linked To Memory 142
 - Easy Entry/Exit Seat 143
- To Open And Close The Hood 144
- Lights 146
 - Headlight Switch 146
 - Automatic Headlights — If Equipped 147
 - Headlights On Automatically With Wipers 147
 - Smartbeam™ — If Equipped 148

□ Daytime Running Lights — If Equipped	149
□ Automatic Headlight Leveling — HID Headlights Only	149
□ Headlight Delay	149
□ Parking Lights And Panel Lights	150
□ Fog Lights — If Equipped	150
□ Interior Lights	151
□ Lights-On Reminder	152
□ Battery Saver	152
□ Front Map/Reading Lights	152
□ Ambient Light	153
□ Multifunction Lever	154
□ Turn Signals	154

UNDERSTANDING THE FEATURES OF YOUR VEHICLE 103

□ Lane Change Assist	154
□ Flash-To-Pass	154
□ High/Low Beam Switch	155
■ Windshield Wipers And Washers	155
□ Windshield Wiper Operation	156
□ Intermittent Wiper System	156
□ Windshield Washer Operation	157
□ Mist	158
□ Rain Sensing Wipers — If Equipped	159
■ Tilt/Telescoping Steering Column	160
■ Power Tilt/Telescoping Steering Column — If Equipped	161
■ Heated Steering Wheel — If Equipped	162

- Electronic Speed Control 163
 - To Activate 165
 - To Set A Desired Speed 165
 - To Deactivate 165
 - To Resume Speed 165
 - To Vary The Speed Setting 166
 - To Accelerate For Passing 166
- Adaptive Cruise Control (ACC) —
If Equipped 167
 - Adaptive Cruise Control (ACC) Operation . . 170
 - Activating Adaptive Cruise Control (ACC) . . 170
 - To Activate 171
 - To Set A Desired ACC Speed 172
 - To Cancel 173
 - To Turn Off 174
 - To Resume Speed 174
 - To Vary The Speed Setting 175
 - Setting The Following Distance In ACC 176
 - Adaptive Cruise Control (ACC) Menu 178
 - Display Warnings And Maintenance 180
 - Precautions While Driving With ACC 184
 - General Information 188
 - Normal (Fixed Speed)
Cruise Control Mode 188
 - Forward Collision Warning — If Equipped . . 190

■ Parksense® Rear Park Assist — If Equipped . . . 195		UNDERSTANDING THE FEATURES OF YOUR VEHICLE 105
□ Parksense® Sensors	195	□ Turning Parkview® On Or Off — Without Navigation/Multimedia Radio
□ Parksense® Warning Display	195	206
□ Parksense® Display	196	■ Overhead Console 206
□ Enabling And Disabling Parksense®	200	□ Front Map/Reading Lights
□ Service The Parksense® Rear Park Assist System	200	□ Sunglass Bin Door
□ Cleaning The Parksense® System	201	207
□ Parksense® System Usage Precautions	201	■ Garage Door Opener — If Equipped 208
■ Parkview® Rear Back Up Camera — If Equipped 204		□ Programming HomeLink®
□ Turning Parkview® On Or Off — With Navigation/Multimedia Radio	205	□ Gate Operator/Canadian Programming
		□ Using HomeLink®
		□ Reprogramming A Single HomeLink® Button
		□ Security
		□ Troubleshooting Tips
		□ General Information
		214

- Power Sunroof — If Equipped 214
 - Opening Sunroof — Express 215
 - Closing Sunroof — Express 215
 - Pinch Protect Feature 215
 - Pinch Protect Override 216
 - Venting Sunroof — Express 216
 - Sunshade Operation 216
 - Wind Buffeting 216
 - Sunroof Maintenance 217
 - Ignition Off Operation 217
- Command View Sunroof With Power Shade —
If Equipped 217
 - Opening Sunroof — Express 218
 - Venting Sunroof — Express 218
 - Closing Sunroof — Express 219
 - Opening Power Shade — Express 219
 - Closing Power Shade — Express 219
 - Sunroof And Power Shade Movement —
Manual 220
 - Pinch Protect Feature 220
 - Pinch Protect Override 220
 - Pinch Protect Override Cancellation 220
 - Wind Buffeting 221
 - Sunroof Maintenance 221
 - Ignition Off Operation 221
 - Sunroof Fully Closed 221

■ Electrical Power Outlets	221
■ Power Inverter — If Equipped	226
■ Cupholders	228
■ Storage	229
□ Glove Compartment	229
□ Door Storage	230
□ Center Console	230
■ Cargo Area Features	231
□ Rechargeable Flashlight	231

UNDERSTANDING THE FEATURES OF YOUR VEHICLE	107
□ Cargo Storage Bins	233
□ Retractable Cargo Area Cover — If Equipped	234
□ Cargo Tie-Down Hooks	236
■ Rear Window Features	237
□ Rear Window Wiper/Washer	237
□ Rear Window Defroster	238
■ Roof Luggage Rack — If Equipped	239

MIRRORS

Inside Day/Night Mirror

A single ball joint mirror is provided in the vehicle. It is a twist on mirror that has a fixed position. The mirror head can be adjusted up, down, left, and right for various drivers. The mirror should be adjusted to center on the view through the rear window.

Headlight glare from vehicles behind you can be reduced by moving the small control under the mirror to the night position (toward the rear of the vehicle). The mirror should be adjusted while set in the day position (toward the windshield).

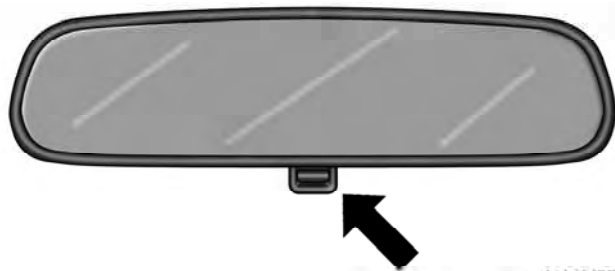

030434773

Adjusting Rearview Mirror

Automatic Dimming Mirror — If Equipped

This mirror automatically adjusts for headlight glare from vehicles behind you. You can turn the feature on or off by pressing the button at the base of the mirror. A light in the button will illuminate to indicate when the dimming feature is activated. The mirror is twisted on the windshield button counterclockwise and requires no tools for mounting.



030434774

Automatic Dimming Mirror

CAUTION!

To avoid damage to the mirror during cleaning, never spray any cleaning solution directly onto the mirror. Apply the solution onto a clean cloth and wipe the mirror clean.

Outside Mirrors

To receive maximum benefit, adjust the outside mirrors to center on the adjacent lane of traffic with a slight overlap of the view obtained on the inside mirror.

WARNING!

Vehicles and other objects seen in the passenger side convex mirror will look smaller and farther away than they really are. Relying too much on your passenger side convex mirror could cause you to collide with another vehicle or other object. Use your inside mirror when judging the size or distance of a vehicle seen in the passenger side convex mirror. Some vehicles will not have a convex passenger side mirror.

Outside Mirrors Folding Feature

All outside mirrors are hinged and may be moved either forward or rearward to resist damage. The hinges have three detent positions: full forward, full rearward and normal.

Outside Automatic Dimming Mirrors — If Equipped

The driver's outside mirror will automatically adjust for glare from vehicles behind you. This feature is controlled by the inside automatic dimming mirror and can be turned on or off by pressing the button at the base of the inside mirror. The mirrors will automatically adjust for headlight glare when the inside mirror adjusts.

Outside Power Mirrors

The power mirror switch is located on the driver's side door trim panel.

The power mirror controls consist of mirror select buttons and a four-way mirror control switch. To adjust a

mirror, press the mirror select button for the mirror that you want to adjust. Using the mirror control switch, press on any of the four arrows for the direction that you want the mirror to move.

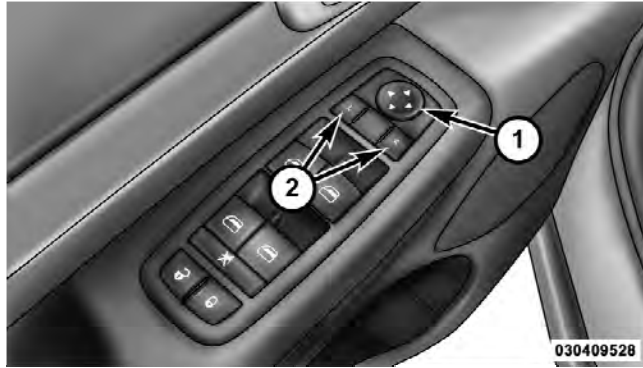

Power Mirror Switch

- 1 — Mirror Direction Control
- 2 — Mirror Selection

Power mirror preselected positions can be controlled by the optional Memory Seat Feature. Refer to “Driver Memory Seat” in “Understanding The Features Of Your Vehicle” for further information.

Heated Mirrors — If Equipped



These mirrors are heated to melt frost or ice. This feature is activated whenever you turn on the rear window defroster. Refer to “Rear Window Features” in “Understanding the Features of Your Vehicle” for further information.

Illuminated Vanity Mirrors

To access an illuminated vanity mirror, flip down one of the visors.

Lift the cover to reveal the mirror. The light will turn on automatically.

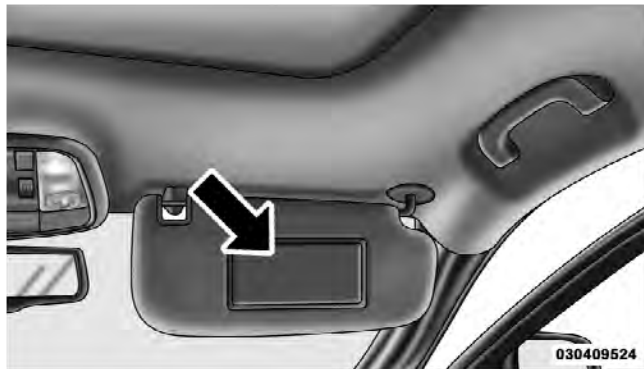

Illuminated Vanity Mirror

Sun Visor Extension — If Equipped

This feature has a pull out extension on the sun visor for increased coverage.

BLIND SPOT MONITORING — IF EQUIPPED

The Blind Spot Monitoring (BSM) system uses two radar-based sensors, located inside the rear bumper fascia, to detect highway licensable vehicles (automobiles, trucks, motorcycles, etc.) that enter the blind spot zones from the rear/front/side of the vehicle.

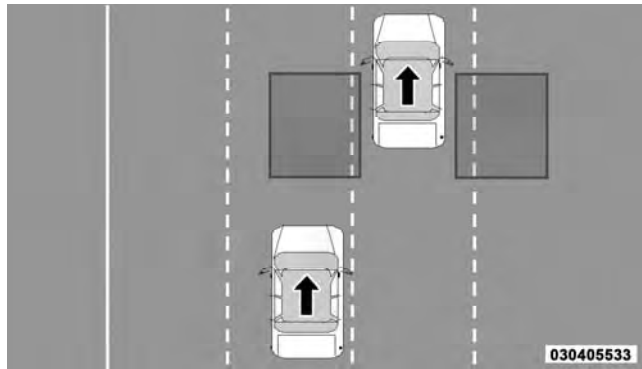

Rear Detection Zones

When the vehicle is started, the BSM warning light will momentarily illuminate in both outside rear view mirrors to let the driver know that the system is operational. The BSM system sensors operate when the vehicle is in any forward gear or REVERSE and enters stand by mode when the vehicle is in PARK.

The BSM detection zone covers approximately one lane on both sides of the vehicle (11 ft or 3.35 m). The zone starts at the outside rear view mirror and extends approximately 20 ft (6 m) to the rear of the vehicle. The BSM system monitors the detection zones on both sides of the vehicle when the vehicle speed has reached approximately 6 mph (10 km/h) or higher and will alert the driver of vehicles in these areas.

NOTE:

- The BSM system does NOT alert the driver about rapidly approaching vehicles that are outside the detection zones.
- The BSM system detection zone DOES NOT change if your vehicle is towing a trailer. Therefore, visually verify the adjacent lane is clear for both your vehicle and trailer before making a lane change. If the trailer or other object (i.e., bicycle, sports equipment) extends beyond the side of your vehicle, this may result in the BSM warning light remaining illuminated the entire time the vehicle is in a forward gear.

114 UNDERSTANDING THE FEATURES OF YOUR VEHICLE

The area on the rear fascia where the radar sensors are located must remain free of snow, ice, and dirt/road contamination so that the BSM system can function properly. Do not block the area of the rear fascia where the radar sensors are located with foreign objects (bumper stickers, bicycle racks, etc.).



Sensor Location (Driver Side Shown)

The BSM system notifies the driver of objects in the detection zones by illuminating the BSM warning light located in the outside mirrors.



Warning Light Location

The BSM system can also be configured to sound an audible (chime) alert and reduces the radio volume to notify the driver of objects that have entered the detection zones. Refer to “Modes Of Operation” for further information.

The BSM system monitors the detection zone from three different entry points (side, rear, front) while driving to see if an alert is necessary. The BSM system will issue an alert during these types of zone entries.

Entering From The Side

Vehicles that move into your adjacent lanes from either side of the vehicle.

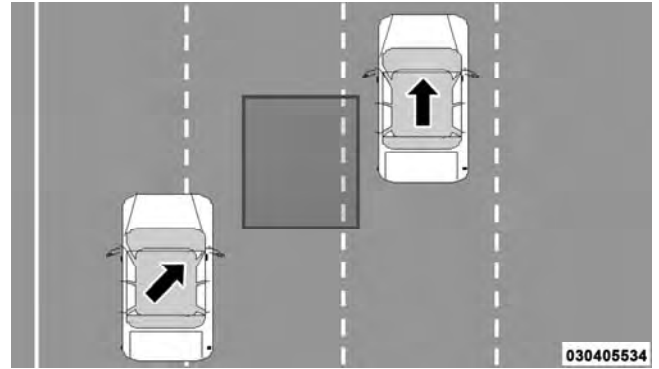

Side Monitoring

Entering From The Rear

Vehicles that come up from behind your vehicle on either side and enter the rear detection zone with a relative speed of less than 30 mph (48 km/h).

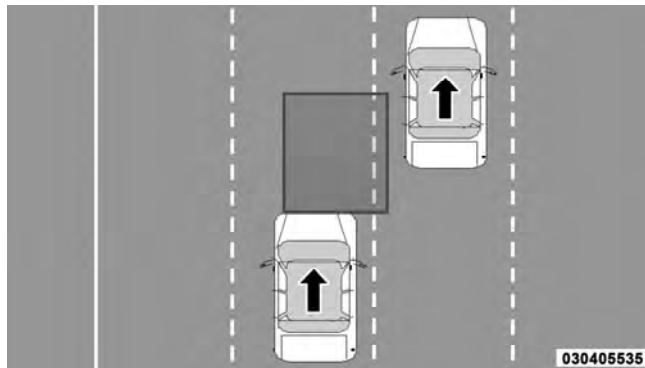

Rear Monitoring

Overtaking Traffic

If you pass another vehicle slowly (with a relative speed less than 10 mph (16 km/h) and the vehicle remains in the blind spot for approximately 1.5 seconds, the warning light will be illuminated. If the difference in speed between the two vehicles is greater than 10 mph (16 km/h), the warning light will not illuminate.

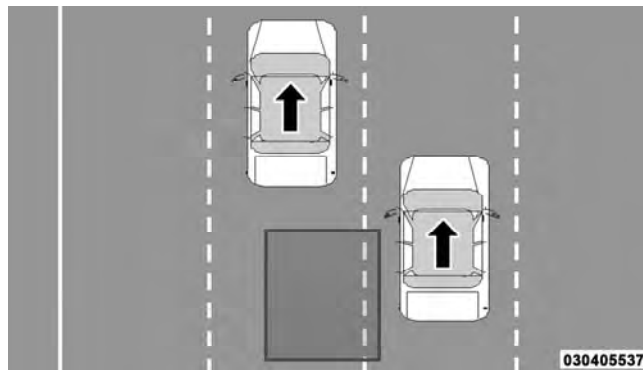

Overtaking/Approaching

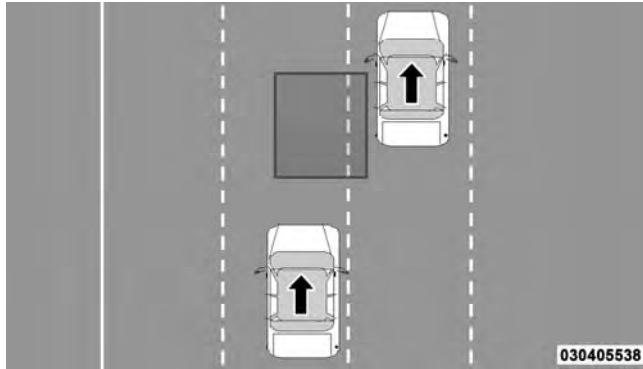

Overtaking/Passing

The BSM system is designed not to issue an alert on stationary objects such as guardrails, posts, walls, foliage, berms, etc. However, occasionally the system may alert on such objects. This is normal operation and your vehicle does not require service.

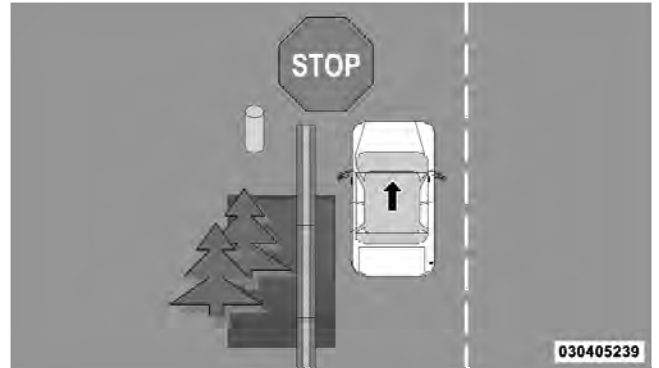

Stationary Objects

The BSM system will not alert you of objects that are traveling in the opposite direction of the vehicle in adjacent lanes.

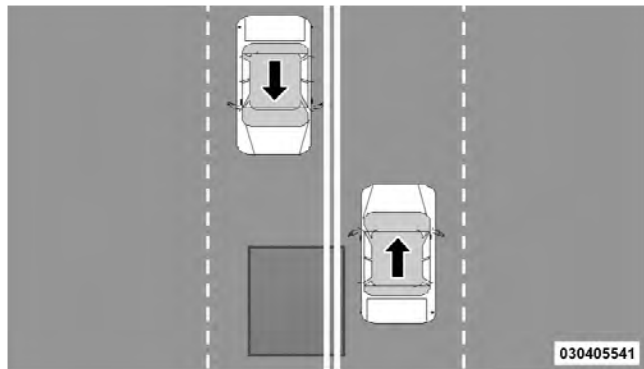

Opposing Traffic

WARNING!

The Blind Spot Monitoring system is only an aid to help detect objects in the blind spot zones. The BSM system is not designed to detect pedestrians, bicyclists, or animals. Even if your vehicle is equipped with the BSM system, always check your vehicles mirrors, glance over your shoulder, and use your turn signal before changing lanes. Failure to do so can result in serious injury or death.

Rear Cross Path

The Rear Cross Path (RCP) feature is intended to aid the driver when backing out of parking spaces where their vision of oncoming vehicles may be blocked. Proceed slowly and cautiously out of the parking space until the rear end of the vehicle is exposed. The RCP system will then have a clear view of the cross traffic and if an oncoming vehicle is detected, alert the driver.

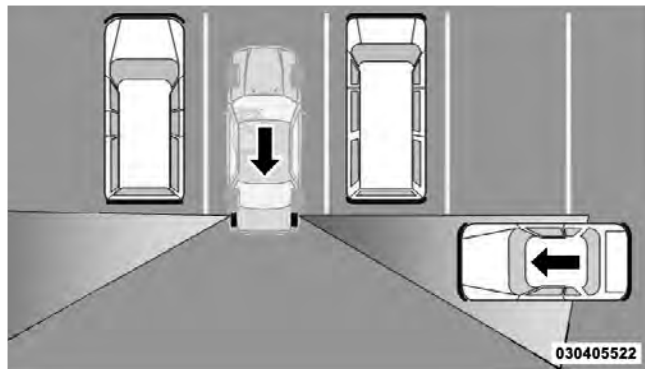

RCP Detection Zones

RCP monitors the rear detection zones on both sides of the vehicle, for objects that are moving toward the side of the vehicle with a minimum speed of approximately 1 to 2 mph (1 km/h to 3 km/h), to objects moving a maximum of approximately 10 mph (16 km/h), such as in parking lot situations.

NOTE: In a parking lot situation, oncoming vehicles can be obscured by vehicles parked on either side. If the sensors are blocked by other structures or vehicles, the system will not be able to alert the driver.

When RCP is on and the vehicle is in REVERSE, the driver is alerted using both the visual and audible alarms, including reducing the radio volume.

3

WARNING!

RCP is not a Back Up Aid system. It is intended to be used to help a driver detect an oncoming vehicle in a parking lot situation. Drivers must be careful when backing up, even when using RCP. Always check carefully behind your vehicle, look behind you, and be sure to check for pedestrians, animals, other vehicles, obstructions, and blind spots before backing up. Failure to do so can result in serious injury or death.

Modes Of Operation

Three selectable modes of operation are available in the Electronic Vehicle Information Center (EVIC). Refer to “Electronic Vehicle Information Center (EVIC)/Personal Settings (Customer-Programmable Features)” in “Understanding Your Instrument Panel” for further information.

Blind Spot Alert

When operating in Blind Spot Alert mode, the BSM system will provide a visual alert in the appropriate side view mirror based on a detected object. However, when the system is operating in RCP, the system will respond with both visual and audible alerts when a detected object is present. Whenever an audible alert is requested, the radio volume is reduced.

Blind Spot Alert Lights/Chime

When operating in Blind Spot Alert Lights/Chime, the BSM system will provide a visual alert in the appropriate side view mirror based on a detected object. If the turn

signal is then activated, and it corresponds to an alert present on that side of the vehicle, an audible chime will also be sounded. Whenever a turn signal and detected object are present on the same side at the same time, both the visual and audio alerts will be issued. In addition to the audible alert the radio volume (if on) will also be reduced.

NOTE:

- Whenever an audible alert is requested by the BSM system, the radio volume is reduced.
- If the hazard flashers are on, the system will request the appropriate visual alert only.

When the system is in RCP, the system shall respond with both visual and audible alerts when a detected object is present. Whenever an audible alert is requested, the radio volume is also reduced. Turn/hazard signal status is ignored; the RCP state always requests the chime.

Blind Spot Alert Off

When the BSM system is turned off there will be no visual or audible alerts from either the BSM or RCP systems.

NOTE: The BSM system will store the current operating mode when the vehicle is shut off. Each time the vehicle is started the previously stored mode will be recalled and used.

Uconnect™ Phone — IF EQUIPPED

Uconnect™ Phone is a hands-free system that allows you to use voice commands to dial a phone number stored in your mobile phone. Press the Uconnect™ Phone button  on the radio or steering wheel controls (if equipped) and follow the instructions to pair the mobile phone.

Refer to “Uconnect™ Phone” in the Uconnect™ User Manual located on the DVD for further details.

VOICE COMMAND — IF EQUIPPED

Voice Commands can be initiated by pressing the VR button  located on the radio or steering wheel controls (if equipped).

Refer to “Voice Command” in the Uconnect™ User Manual located on the DVD for further details.

SEATS

Seats are part of the Occupant Restraint System of the vehicle.

WARNING!

- **It is dangerous to ride in a cargo area, inside or outside of a vehicle. In a collision, people riding in these areas are more likely to be seriously injured or killed.**

(Continued)

WARNING! (Continued)

- Do not allow people to ride in any area of your vehicle that is not equipped with seats and seat belts. In a collision, people riding in these areas are more likely to be seriously injured or killed.
- Be sure everyone in your vehicle is in a seat and using a seat belt properly.

Power Seats — If Equipped

Some models may be equipped with eight-way power driver and front passenger seats. The power seat switches are located on the outboard side of the seat. There are two switches that control the movement of the seat cushion and the seatback.

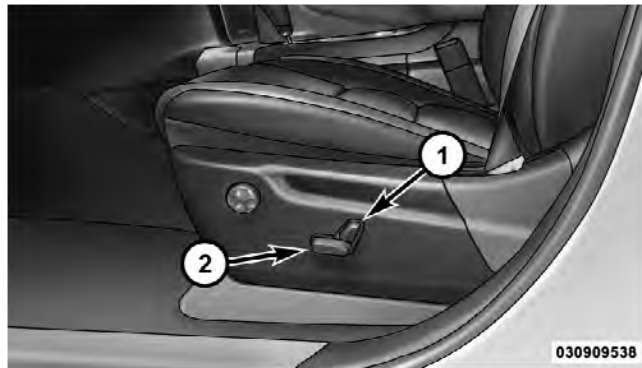
**Power Seat Switches**

- 1 — Seatback Switch
2 — Seat Switch

Adjusting The Seat Forward Or Rearward

The seat can be adjusted both forward and rearward. Push the seat switch forward or rearward, the seat will move in the direction of the switch. Release the switch when you have reached the desired position.

Adjusting The Seat Up Or Down

The height of the seats can be adjusted up or down. Pull upward or push downward on the rear of the seat switch, the seat will move in the direction of the switch. Release the switch when you have reached the desired position.

Tilting The Seat Up Or Down

The angle of the seat cushion can be adjusted up or down. Pull upward or push downward on the front of the seat switch, the front of the seat cushion will move in the direction of the switch. Release the switch when you have reached the desired position.

Reclining The Seatback

The angle of the seatback can be adjusted forward or backward. Push the seatback switch forward or rearward, the seat will move in the direction of the switch. Release the switch when you have reached the desired position.

WARNING!

- **Adjusting a seat while driving may be dangerous. Moving a seat while driving could result in loss of control which could cause a collision and serious injury or death.**
- **Seats should be adjusted before fastening the seatbelts and while the vehicle is parked. Serious injury or death could result from a poorly adjusted seatbelt.**

(Continued)

WARNING! (Continued)

- **Do not ride with the seatback reclined so that the shoulder belt is no longer resting against your chest. In a collision you could slide under the seat belt, which could result in serious injury or death.**

CAUTION!

Do not place any article under a power seat or impede its ability to move as it may cause damage to the seat controls. Seat travel may become limited if movement is stopped by an obstruction in the seat's path.

Passenger's Power Seat

Some models are equipped with a six-way power passenger seat. The power seat switch is located on the outboard side of the seat. The switch is used to control the movement of the seat and seat cushion.

Adjusting The Seat Forward Or Rearward

The seat can be adjusted both forward and rearward. Push the seat switch forward or rearward, the seat will move in the direction of the switch. Release the switch when you have reached the desired position.

Adjusting The Seat Up Or Down

The height of the seats can be adjusted up or down. Pull upward or push downward on the seat switch, the seat will move in the direction of the switch. Release the switch when you have reached the desired position.

Tilting The Seat Up Or Down

The angle of the seat cushion can be adjusted up or down. Pull upward or push downward on the front of the seat switch, the front of the seat cushion will move in the direction of the switch. Release the switch when you have reached the desired position.

WARNING!

- Adjusting a seat while driving may be dangerous. Moving a seat while driving could result in loss of control which could cause a collision and serious injury or death.
- Seats should be adjusted before fastening the seatbelts and while the vehicle is parked. Serious injury or death could result from a poorly adjusted seatbelt.

(Continued)

WARNING! (Continued)

- Do not ride with the seatback reclined so that the shoulder belt is no longer resting against your chest. In a collision you could slide under the seat belt, which could result in serious injury or death.

CAUTION!

Do not place any article under a power seat or impede its ability to move as it may cause damage to the seat controls. Seat travel may become limited if movement is stopped by an obstruction in the seat's path.

Power Lumbar — If Equipped

Vehicles equipped with power driver or passenger seats are also equipped with power lumbar. The power lumbar switch is located on the outboard side of the power seat. Push the switch forward to increase the lumbar support.

Push the switch rearward to decrease the lumbar support. Pushing upward or downward on the switch will raise and lower the position of the support.



Power Lumbar Switch

Manual Front Seats Forward/Rearward Adjustment

Some models may be equipped with manual front driver or passenger seats. The seats can be adjusted forward or rearward by using a bar located by the front of the seat cushion, near the floor.

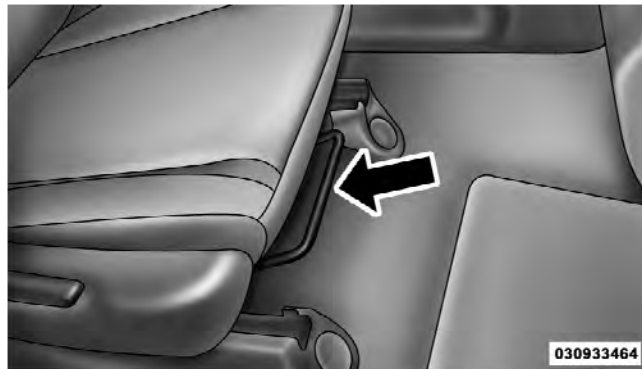

Adjustment Bar

While sitting in the seat, lift up on the bar located under the seat cushion and move the seat forward or rearward. Release the bar once you have reached the desired position. Then, using body pressure, move forward and rearward on the seat to be sure that the seat adjusters have latched.

WARNING!

- Adjusting a seat while driving may be dangerous. Moving a seat while driving could result in loss of control which could cause a collision and serious injury or death.
- Seats should be adjusted before fastening the seatbelts and while the vehicle is parked. Serious injury or death could result from a poorly adjusted seatbelt.

Manual Front Passenger Seatback Adjustment — Recline

To adjust the seatback, lift the lever located on the outboard side of the seat, lean back to the desired position and release the lever. To return the seatback, lift the lever, lean forward and release the lever.

3

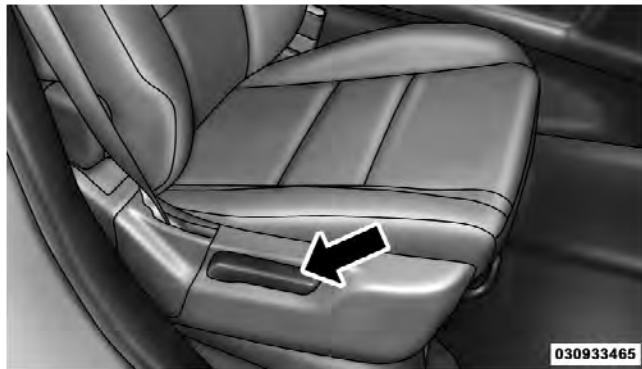

Recline Lever

WARNING!

Do not ride with the seatback reclined so that the shoulder belt is no longer resting against your chest. In a collision you could slide under the seat belt, which could result in serious injury or death.

**Front Passenger Seat Fold-Flat Feature —
If Equipped**

To fold the seatback to the flat load-floor position, lift the recline lever and push the seatback forward. To return to the seating position, raise the seatback and lock it into place.



Fold-Flat Passenger Seat

Heated Seats — If Equipped

On some models, the front and rear seats may be equipped with heaters in both the seat cushions and seatbacks.

WARNING!

- Persons who are unable to feel pain to the skin because of advanced age, chronic illness, diabetes, spinal cord injury, medication, alcohol use, exhaustion or other physical condition must exercise care when using the seat heater. It may cause burns even at low temperatures, especially if used for long periods of time.
- Do not place anything on the seat that insulates against heat, such as a blanket or cushion. This may cause the seat heater to overheat. Sitting in a seat that has been overheated could cause serious burns due to the increased surface temperature of the seat.

CAUTION!

Repeated overheating of the seat could damage the heating element and/or degrade the material of the seat.

Vehicles Equipped with Remote Start

On models that are equipped with remote start, the driver's heated seat can be programmed to come on during a remote start. Refer to "Remote Starting System — If Equipped" in "Things To Know Before Starting Your Vehicle" for further information.

Front Heated Seats

There are two heated seat switches that allow the driver and passenger to operate the seats independently. The controls for each heater are located near the bottom center of the instrument panel (below the climate controls).

You can choose from HIGH, LOW or OFF heat settings. Amber indicator lights in each switch indicate the level of heat in use. Two indicator lights will illuminate for HIGH, one for LOW and none for OFF.



Press the switch once to select HIGH-level heating. Press the switch a second time to select LOW-level heating. Press the switch a third time to shut the heating elements OFF.

NOTE: Once a heat setting is selected, heat will be felt within two to five minutes.

When the HIGH-level setting is selected, the heater will provide a boosted heat level during the first four minutes of operation. Then, the heat output will drop to the normal HIGH-level. If the HIGH-level setting is selected, the system will automatically switch to LOW-level after a maximum of 55 minutes of continuous operation. At that time, the number of illuminated LEDs changes from two to one, indicating the change. The LOW-level setting will turn OFF automatically after a maximum of 45 minutes.

Rear Heated Seats

On some models, the two outboard seats are equipped with heated seats. There are two heated seat switches that allow the rear passengers to operate the seats independently. The heated seat switches for each heater are located on the rear of the center console.

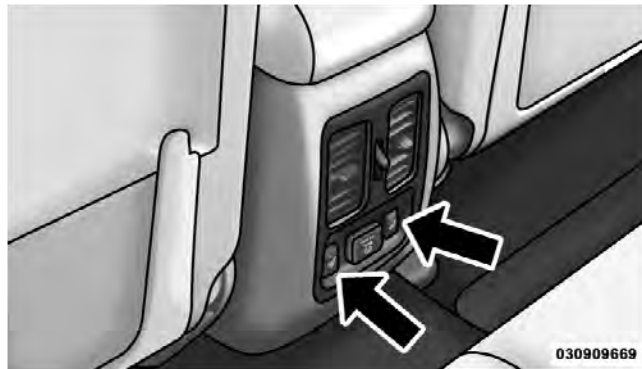

Rear Heated Seat Switches

You can choose from HIGH, LOW or OFF heat settings. Amber indicator lights in each switch indicate the level of heat in use. Two indicator lights will illuminate for HIGH, one for LOW and none for OFF.



Press the switch once to select HIGH-level heating. Press the switch a second time to select LOW-level heating. Press the switch a third time to shut the heating elements OFF.

NOTE: Once a heat setting is selected, heat will be felt within two to five minutes.

When the HIGH-level setting is selected, the heater will provide a boosted heat level during the first four minutes of operation. Then, the heat output will drop to the normal HIGH-level. If the HIGH-level setting is selected, the system will automatically switch to LOW-level after a maximum of 55 minutes of continuous operation. At that time, the number of illuminated LEDs changes from two

to one, indicating the change. The LOW-level setting will turn OFF automatically after a maximum of 45 minutes.

Ventilated Seats — If Equipped

On some models, both the driver and passenger seats are ventilated. Located in the seat cushion and seatback are small fans that draw the air from the passenger compartment and blow air through fine perforations in the seat cover to help keep the driver and front passenger cooler in higher ambient temperatures.

There are two ventilated seat switches that allow the driver and passenger to operate the seats independently. The ventilated seat switches are located on the switch bank in the center stack of the instrument panel, just below the climate controls.

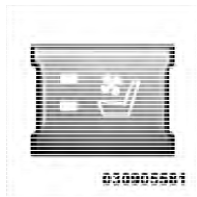

The ventilated seat switches are used to control the speed of the fans located in the seat. Press the switch once to choose HIGH, press it a second time to choose LOW. Pressing the switch a third time will turn the ventilated seat OFF. When HIGH speed is selected

both lights on the switch will be illuminated. When LOW speed is selected one light will be illuminated.

NOTE: The engine must be running for the ventilated seats to operate.

Vehicles Equipped With Remote Start

On models that are equipped with remote start, the driver's ventilated seat can be programmed to come on during a remote start. Refer to "Remote Starting System — If Equipped" in "Things To Know Before Starting Your Vehicle" for further information.

Head Restraints

Head restraints are designed to reduce the risk of injury by restricting head movement in the event of a rear-impact. Head restraints should be adjusted so that the top of the head restraint is located above the top of your ear.

WARNING!

The head restraints for all occupants must be properly adjusted prior to operating the vehicle or occupying a seat. Head restraints should never be adjusted while the vehicle is in motion. Driving a vehicle with the head restraints improperly adjusted or removed could cause serious injury or death in the event of a collision.

Active Head Restraints — Front Seats

Active Head Restraints are passive, deployable components, and vehicles with this equipment cannot be readily identified by any markings, only through visual inspection of the head restraint. The head restraint will be split in two halves, with the front half being soft foam and trim, the back half being decorative plastic.

When AHRs deploy during a rear impact, the front half of the head restraint extends forward to minimize the gap between the back of the occupant's head and the AHR. This system is designed to help prevent or reduce the extent of injuries to the driver and front passenger in certain types of rear impacts. Refer to "Occupant Restraints" in "Things To Know Before Starting Your Vehicle" for further information.

To raise the head restraint, pull upward on the head restraint. To lower the head restraint, press the push button, located at the base of the head restraint, and push downward on the head restraint.

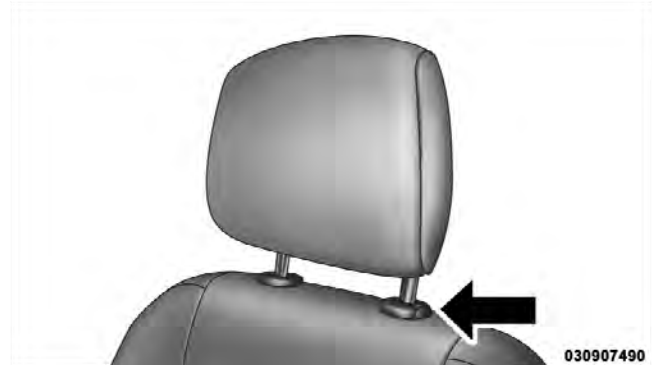

Push Button

134 UNDERSTANDING THE FEATURES OF YOUR VEHICLE

For comfort the Active Head Restraints can be tilted forward and rearward. To tilt the head restraint closer to the back of your head, pull forward on the bottom of the head restraint. Push rearward on the bottom of the head restraint to move the head restraint away from your head.

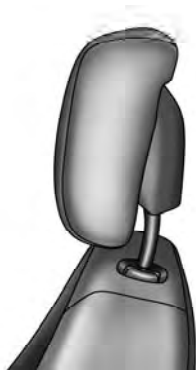

Active Head Restraint (Normal Position)

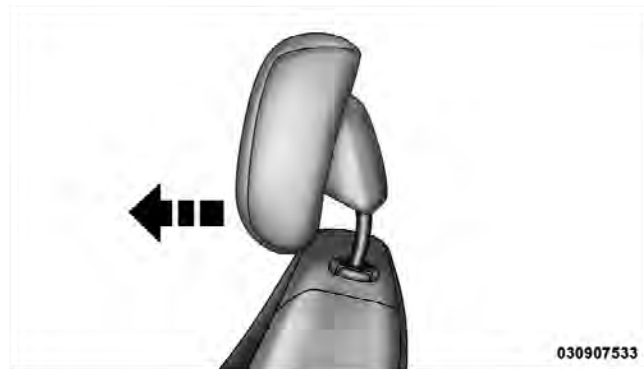

Active Head Restraint (Tilted)

NOTE:

- The head restraints should only be removed by qualified technicians, for service purposes only. If either of the head restraints require removal, see your authorized dealer.

- In the event of deployment of an Active Head Restraint, refer to “Occupant Restraints/Resetting Active Head Restraints (AHR)” in “Things To Know Before Starting Your Vehicle” for further information.

WARNING!

- Do not place items over the top of the Active Head Restraint, such as coats, seat covers or portable DVD players. These items may interfere with the operation of the Active Head Restraint in the event of a collision and could result in serious injury or death.

(Continued)

WARNING! (Continued)

- Active Head Restraints may be deployed if they are struck by an object such as a hand, foot or loose cargo. To avoid accidental deployment of the Active Head Restraint ensure that all cargo is secured, as loose cargo could contact the Active Head Restraint during sudden stops. Failure to follow this warning could cause personal injury if the Active Head Restraint is deployed.

Head Restraints — Rear Seats

The head restraints on the outboard seats are not adjustable. They automatically fold forward when the rear seat is folded to a load floor position but do not return to their normal position when the rear seat is raised. After returning either seat to its upright position, raise the head restraint until it locks in place. The outboard headrests are not removable.

136 UNDERSTANDING THE FEATURES OF YOUR VEHICLE

The center head restraint has limited adjustment. Lift upward on the head restraint to raise it, or push downward on the head restraint to lower it.



Rear Head Restraint

WARNING!

Sitting in a seat with the head restraint in its lowered position could result in serious injury or death in a collision. Always make sure the outboard head restraints are in their upright positions when the seat is to be occupied.

NOTE: For proper routing of a Child Seat Tether refer to “Occupant Restraints” in “Things to Know Before Starting Your Vehicle” for further information.

60/40 Split Rear Seat

To Lower Rear Seat

Either side of the rear seat can be lowered to allow for extended cargo space and still maintain some rear seating room.

NOTE: Be sure that the front seats are fully upright and positioned forward. This will allow the rear seatback to fold down easily.

1. Pull upward on the release lever to release the seat.

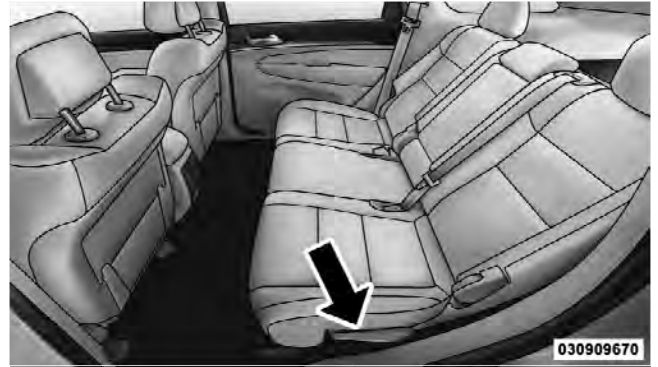

Rear Seat Release

NOTE:

- Do not fold the 60% rear seat down with the left outboard or rear center seat belt buckled.
- Do not fold the 40% rear seat down with the right outboard seat belt buckled.

2. Fold the rear seat completely forward.



Rear Seat Folded

To Raise Rear Seat

Raise the rear seatback and lock it into place. If interference from the cargo area prevents the seatback from fully locking, you will have difficulty returning the seat to its proper position.

WARNING!

- Be certain that the seatback is securely locked into position. If the seatback is not securely locked into position the seat will not provide the proper stability for child seats and/or passengers. An improperly latched seat could cause serious injury.
- The cargo area in the rear of the vehicle (with the rear seatbacks in the locked-up or folded down position) should not be used as a play area by children when the vehicle is in motion. They could be seriously injured in a collision. Children should be seated and using the proper restraint system.

Reclining Rear Seat

To recline the seatback, lift the lever located on the outboard side of the seat, lean back and release the lever at the desired position. To return the seatback, lift the lever, lean forward and release the lever.

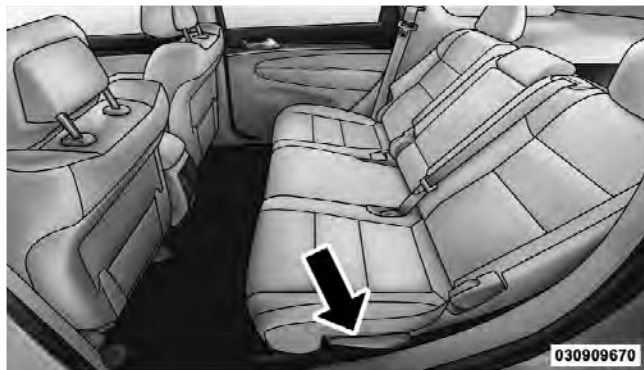

Rear Seat Release

WARNING!

Do not ride with the seatback reclined so that the shoulder belt is no longer resting against your chest. In a collision you could slide under the seat belt, which could result in serious injury or death.

DRIVER MEMORY SEAT — IF EQUIPPED

Once programmed, the memory buttons 1 and 2 on the driver's door panel can be used to recall the driver's seat, driver's outside mirror, adjustable steering wheel position (if equipped), and the radio station preset settings. Your Remote Keyless Entry (RKE) transmitters can also be programmed to recall the same positions when the UNLOCK button is pressed.

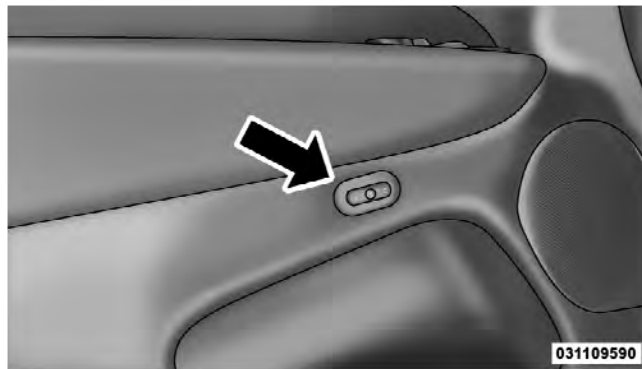

Driver Memory Buttons

Your vehicle is equipped with two RKE transmitters. One or both RKE transmitters can be linked to either memory position. The memory system can accommodate up to four RKE transmitters, each one linked to either of the two memory positions.

Setting Memory Positions And Linking Remote Keyless Entry Transmitter To Memory

NOTE: Each time the S (SET) button and a numbered button 1 or 2 are pressed, you erase the memory settings for that button and store a new one.

1. Insert the ignition key, and turn the ignition switch to the ON position.
2. Press the driver door MEMORY button number 1 if you are setting the memory for driver 1, or button number 2 if you are setting the memory for driver 2. The system will recall any stored settings. Wait for the system to complete the memory recall before continuing to Step 3.
3. Adjust the driver's seat, recliner, and driver's sideview mirror to the desired positions.
4. Adjust the power steering column tilt and telescoping position (if equipped) to the desired positions.

5. Turn on the radio and set the radio station presets (up to 12 AM and 12 FM stations can be set).
6. Turn the ignition switch to the LOCK position and remove the key.
7. Press and release the S (SET) button located on the driver's door.
8. Within five seconds, press and release MEMORY button 1 or 2 on the driver's door. The next step must be performed within five seconds if you desire to also use a RKE transmitter to recall memory positions.
9. Press and release the LOCK button on one of the RKE transmitters.
10. Insert the ignition key, and turn the ignition switch to the ON position.

11. Select "Remote Linked to Memory" in the Electronic Vehicle Information Center (EVIC) and enter "Yes". Refer to "Electronic Vehicle Information Center (EVIC)/Customer-Programmable Features" in "Understanding Your Instrument Panel" for further information.

12. Repeat the above steps to set the next memory position, using the other numbered memory button, or to link another RKE transmitter to memory.

Memory Position Recall

NOTE: The vehicle must be in PARK to recall memory positions. If a recall is attempted when the vehicle is not in PARK, a message will be displayed in the Electronic Vehicle Information Center (EVIC).

To recall the memory settings for driver one, press MEMORY button number 1 on the driver's door, or the UNLOCK button on the RKE transmitter linked to memory position 1.

To recall the memory setting for driver two, press MEMORY button number 2 on the driver's door, or the UNLOCK button on the RKE transmitter linked to memory position 2.

A recall can be cancelled by pressing any of the MEMORY buttons on the drivers door during a recall (S, 1, or 2). When a recall is cancelled, the driver's seat, driver's mirror and the pedals stop moving. A delay of one second will occur before another recall can be selected.

To Disable A RKE Transmitter Linked To Memory

1. Turn the ignition switch to the LOCK position, and remove the key.
2. Press and release MEMORY button number 1. The system will recall any memory settings stored in position 1. Wait for the system to complete the memory recall before continuing to Step 3.

3. Press and release the memory S (SET) button located on the driver's door.
4. Within five seconds, press and release MEMORY button 1 on the driver's door.
5. Within five seconds, press and release the UNLOCK button on the RKE transmitter.

To disable another RKE transmitter linked to either memory position, repeat steps 1 through 5 for each RKE transmitter.

NOTE: Once programmed, all RKE transmitters linked to memory can be easily enabled or disabled at one time. Refer to "Electronic Vehicle Information Center (EVIC)/Customer-Programmable Features" in "Understanding Your Instrument Panel" for further information.

Easy Entry/Exit Seat

This feature provides automatic driver's seat positioning which will enhance driver mobility out of and into the vehicle.

There are two possible Easy Entry/Exit adjustments available:

- The seat cushion will move rearward approximately 2.5 in (60 mm), if the starting position of the seat is greater than or equal to 2.67 in (68 mm) forward of the rear seat stop when the key is removed from the ignition switch. The seat will then move forward approximately 2.5 in (60 mm) when the key is placed into the ignition and turned out of the LOCK position.
- The seat will move to the position located 0.3 in (8 mm) forward of the rear stop if the starting position is between 0.9 to 2.67 in (23 to 68 mm) forward of the rear stop when the key is removed from the ignition switch. The seat will move forward to the memory/

driving position when the key is placed into the ignition, and turned out of the LOCK position toward the ACC/ON position.

The Easy Entry/Exit feature will be automatically disabled if the seat is already positioned closer than 0.9 in (23 mm) forward of the rear stop. At this position, there is no benefit to the driver by moving the seat for Easy Exit/Entry.

Each stored memory setting will have an associated Easy Entry/Exit position.

NOTE: The Easy Entry/Exit feature is not enabled when the vehicle is delivered from the factory. The Easy Entry/Exit feature is enabled (or later disabled) through the programmable features in the Electronic Vehicle Information Center (EVIC). Refer to “Electronic Vehicle Information Center (EVIC)/Customer-Programmable Features” in “Understanding Your Instrument Panel” for further information.

TO OPEN AND CLOSE THE HOOD

To open the hood, two latches must be released.

1. Pull the release lever located below the instrument panel and in front of the driver’s door.

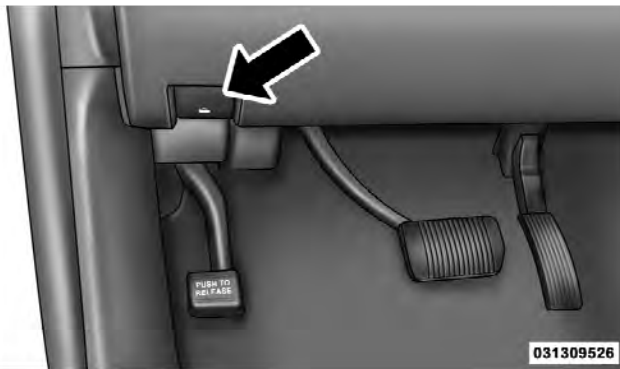

Hood Release

2. Reach under the hood, move safety latch to the left and lift the hood.



Safety Latch Location

CAUTION!

To prevent possible damage, do not slam the hood to close it. Use a firm downward push at the center of the hood to ensure that both latches engage.

WARNING!

Be sure the hood is fully latched before driving your vehicle. If the hood is not fully latched, it could open when the vehicle is in motion and block your vision. Failure to follow this warning could result in serious injury or death.

LIGHTS

Headlight Switch

The headlight switch is located on the left side of the instrument panel, next to the steering wheel. The headlight switch controls the operation of the headlights, parking lights, instrument panel lights, cargo lights and fog lights (if equipped).



Headlight Switch



To turn on the headlights, rotate the headlight switch clockwise. When the headlight switch is on the parking lights, taillights, license plate light and instrument panel lights are also turned on. To turn off the headlights, rotate the headlight switch back to the O (Off) position.

NOTE:

- Your vehicle is equipped with plastic headlight and fog light (if equipped) lenses that are lighter and less susceptible to stone breakage than glass lights. Plastic is not as scratch resistant as glass and therefore different lens cleaning procedures must be followed.
- To minimize the possibility of scratching the lenses and reducing light output, avoid wiping with a dry cloth. To remove road dirt, wash with a mild soap solution followed by rinsing.

CAUTION!

Do not use abrasive cleaning components, solvents, steel wool or other abrasive materials to clean the lenses.

Automatic Headlights — If Equipped

This system automatically turns the headlights on or off according to ambient light levels. To turn the system on, rotate the headlight switch to the A (AUTO) position.

When the system is on, the Headlight Delay feature is also on. This means the headlights will stay on for up to 90 seconds after you turn the ignition switch to the OFF position. To turn the automatic headlights off, turn the headlight switch out of the AUTO position.

NOTE: The engine must be running before the headlights will turn on in the Automatic Mode.

Headlights On Automatically With Wipers

If your vehicle is equipped with Automatic Headlights, it also has this customer-programmable feature. When your headlights are in the automatic mode and the engine is running, they will automatically turn on when the wiper system is on. Refer to “Electronic Vehicle Information Center (EVIC)/Customer-Programmable Features” in “Understanding Your Instrument Panel” for further information.

If your vehicle is equipped with a “Rain Sensitive Wiper System” and it is activated, the headlights will automatically turn on after the wipers complete five wipe cycles within approximately one minute, and they will turn off approximately four minutes after the wipers completely stop. Refer to “Windshield Wipers And Washers” in this section for further information.

NOTE: When your headlights come on during the daytime, the instrument panel lights will automatically dim to the lower nighttime intensity. Refer to “Lights” in this section for further information.

SmartBeam™ — If Equipped

The SmartBeam™ system provides increased forward lighting at night by automating high beam control through the use of a digital camera mounted on the inside rearview mirror. This camera detects vehicle specific light and automatically switches from high beams to low beams until the approaching vehicle is out of view.

NOTE: If the windshield or SmartBeam™ mirror is replaced, the SmartBeam™ mirror must be re-aimed to ensure proper performance. See your local authorized dealer.

To Activate

1. Enable the Automatic High Beams. Refer to “Electronic Vehicle Information Center (EVIC)/Customer-Programmable Features” in “Understanding Your Instrument Panel” for further information.
2. Turn the headlight switch to the AUTO headlight position.
3. Push the multifunction lever away from you (toward front of vehicle) to engage the high beam mode.

NOTE: This system will not activate until the vehicle is at or above 20 mph (32 km/h).

To Deactivate

1. Pull the multifunction lever toward you (or rearward in car) to manually deactivate the system (normal operation of low beams).

2. Push back on the multifunction lever once again to reactivate the system.

NOTE: Broken, muddy, or obstructed headlights and taillights of vehicles in the field of view will cause headlights to remain on longer (closer to the vehicle). Also, dirt, film, and other obstructions (sticker, toll box, etc.) on the windshield or camera lens will cause the system to function improperly.

Daytime Running Lights — If Equipped

The Daytime Running Lights (low intensity) come on whenever the engine is running, and the transmission is not in the PARK position. The lights will remain on until the ignition is switched to the OFF or ACC position or the parking brake is engaged. The headlight switch must be used for normal nighttime driving.

Automatic Headlight Leveling — HID Headlights Only

This feature prevents the headlights from interfering with the vision of oncoming drivers. Headlight leveling automatically adjusts the height of the headlight beam in reaction to changes in vehicle pitch.

Headlight Delay

To aid in your exit, your vehicle is equipped with a headlight delay that will leave the headlights on for approximately 90 seconds. This delay is initiated when the ignition is turned OFF while the headlight switch is on, and then the headlight switch is cycled off. Headlight delay can be cancelled by either turning the headlight switch on then off, or by turning the ignition ON.

The headlight delay time is programmable on vehicles equipped with an Electronic Vehicle Information Center (EVIC). Refer to “Electronic Vehicle Information Center (EVIC)/Customer-Programmable Features” in “Understanding Your Instrument Panel” for further information.

Parking Lights And Panel Lights

 To turn on the parking lights and instrument panel lights, rotate the headlight switch clockwise. To turn off the parking lights, rotate the headlight switch back to the O (Off) position.

Fog Lights — If Equipped

The fog lights are turned on by rotating the headlight switch to the parking light or headlight position and pushing in the headlight rotary control.



Fog Light Operation

The fog lights will operate only when the parking lights are on or when the vehicle headlights are on low beam. An indicator light located in the instrument cluster will illuminate when the fog lights are on. The fog lights will turn off when the switch is pushed a second time, when the headlight switch is rotated to the off position, or the high beam is selected.

Interior Lights

Courtesy and dome lights are turned on when the front doors are opened, when the dimmer control (rotating wheel on the right side of the headlight switch) is rotated to its farthest upward position, or if equipped, when the UNLOCK button is pressed on the Remote Keyless Entry (RKE) transmitter. When a door is open and the interior lights are on, rotating the dimmer control all the way down, to the OFF detent, will cause all the interior lights to go out. This is also known as the “Party” mode because it allows the doors to stay open for extended periods of time without discharging the vehicle’s battery.

The brightness of the instrument panel lighting can be regulated by rotating the dimmer control up (brighter) or down (dimmer). When the headlights are on you can supplement the brightness of the odometer, trip odometer, radio and overhead console by rotating the control

to its farthest position up until you hear a click. This feature is termed the “Parade” mode and is useful when headlights are required during the day.



Dimmer Control

Lights-On Reminder

If the headlights, parking lights, or cargo lights are left on after the ignition is turned OFF, a chime will sound when the driver's door is opened.

Battery Saver

To protect the life of your vehicle's battery, load shedding is provided for both the interior and exterior lights.

If the ignition is OFF and any door is left ajar for 10 minutes or the dimmer control is rotated all the way up to the dome ON position for 10 minutes, the interior lights will automatically turn off.

If the headlights remain on while the ignition is cycled OFF, the exterior lights will automatically turn off after eight minutes. If the headlights are turned on and left on for eight minutes while the ignition is OFF, the exterior lights will automatically turn off.

NOTE: Battery saver mode is cancelled if the ignition is ON.

Front Map/Reading Lights

The front map/reading lights are mounted in the overhead console.



Front Map/Reading Lights

Each light can be turned on by pressing a switch on either side of the console. These buttons are backlit for night time visibility. To turn the lights off, press the switch a second time. The lights will also turn on when the UNLOCK button on the Remote Keyless Entry (RKE) is pressed.



Front Map/Reading Light Switches

Ambient Light

The overhead console is equipped with an ambient light feature. This light casts illumination for improved visibility of the floor center console and PRNDL area.



Ambient Light

Multifunction Lever

The multifunction lever is located on the left side of the steering column.



031509530

Multifunction Lever

Turn Signals

Move the multifunction lever up or down and the arrows on each side of the instrument cluster flash to show proper operation of the front and rear turn signal lights.

NOTE: If either light remains on and does not flash, or there is a very fast flash rate, check for a defective outside light bulb. If an indicator fails to light when the lever is moved, it would suggest that the indicator bulb is defective.

Lane Change Assist

Tap the lever up or down once, without moving beyond the detent, and the turn signal (right or left) will flash three times then automatically turn off.

Flash-To-Pass

You can signal another vehicle with your headlights by partially pulling the multifunction lever toward the steering wheel. This will cause the high beam headlights to turn on until the lever is released.

High/Low Beam Switch

Push the multifunction lever toward the instrument panel to switch the headlights to high beam. Pulling the multifunction back toward the steering wheel will turn the low beams back on, or shut the high beams off.

WINDSHIELD WIPERS AND WASHERS

The windshield wiper/washer control lever is located on the left side of the steering column. The front wipers are operated by rotating a switch, located on the end of the lever. For information on the rear wiper/washer, refer to “Rear Window Features” in “Understanding the Features of Your Vehicle”.



Windshield Wiper/Washer Switch

Windshield Wiper Operation

Rotate the end of the lever to one of the first four detent positions for intermittent settings, the fifth detent for low wiper operation and the sixth detent for high wiper operation.



Windshield Wiper Operation

CAUTION!

Always remove any buildup of snow that prevents the windshield wiper blades from returning to the “park” position. If the windshield wiper switch is turned off, and the blades cannot return to the “park” position, damage to the wiper motor may occur.

Intermittent Wiper System

Use one of the four intermittent wiper settings when weather conditions make a single wiping cycle, with a variable delay between cycles, desirable. At driving speeds above 10 mph (16 km/h), the delay can be regulated from a maximum of approximately 18 seconds between cycles (first detent), to a cycle every one second (fourth detent).



Intermittent Wiper Operation

NOTE: If the vehicle is moving less than 10 mph (16 km/h), delay times will be doubled.

Windshield Washer Operation

To use the washer, push on the end of the lever (toward the steering wheel) and hold while spray is desired. If the lever is pushed while in the intermittent setting, the

wipers will turn on and operate for several wipe cycles after the end of the lever is released, and then resume the intermittent interval previously selected.



Windshield Washer Operation

If the end of the lever is pushed while the wipers are in the off position, the wipers will operate for several wipe cycles, then turn off.

WARNING!

Sudden loss of visibility through the windshield could lead to a collision. You might not see other vehicles or other obstacles. To avoid sudden icing of the windshield during freezing weather, warm the windshield with the defroster before and during windshield washer use.

Mist

Use the Mist feature when weather conditions make occasional usage of the wipers necessary. Rotate the end of the lever downward to the Mist position and release for a single wiping cycle.

**Mist Control**

Rain Sensing Wipers — If Equipped

This feature senses moisture on the windshield and automatically activates the wipers for the driver. The feature is especially useful for road splash or overspray from the windshield washers of the vehicle ahead. Rotate the end of the multifunction lever to one of four settings to activate this feature.

The sensitivity of the system can be adjusted with the multifunction lever. Wiper delay position 1 is the least sensitive, and wiper delay position 4 is the most sensitive. Setting 3 should be used for normal rain conditions. Settings 1 and 2 can be used if the driver desires less wiper sensitivity. Settings 4 can be used if the driver desires more sensitivity. Place the wiper switch in the OFF position when not using the system.

NOTE:

- The Rain Sensing feature will not operate when the wiper switch is in the low or high-speed position.

- The Rain Sensing feature may not function properly when ice, or dried salt water is present on the windshield.
- Use of Rain-X® or products containing wax or silicone may reduce Rain Sensing performance.
- A customer programmable feature in the Electronic Vehicle Information Center (EVIC) allows the Rain Sensing feature to be turned off. Refer to “Electronic Vehicle Information Center (EVIC)/Personal Settings (Customer-Programmable Features)” in “Understanding Your Instrument Panel” for further information.

The Rain Sensing system has protection features for the wiper blades and arms, and will not operate under the following conditions:

- **Low Ambient Temperature** — When the ignition is first turned ON, the Rain Sensing system will not

operate until the wiper switch is moved, vehicle speed is greater than 0 mph (0 km/h), or the outside temperature is greater than 32°F (0°C).

- **Transmission In NEUTRAL Position** — When the ignition is ON, and the transmission is in the NEUTRAL position, the Rain Sensing system will not operate until the wiper switch is moved, vehicle speed is greater than 5 mph (8 km/h), or the shift lever is moved out of the NEUTRAL position.

TILT/TELESCOPING STEERING COLUMN

This feature allows you to tilt the steering column upward or downward. It also allows you to lengthen or shorten the steering column. The tilt/telescoping lever is located below the steering wheel at the end of the steering column.

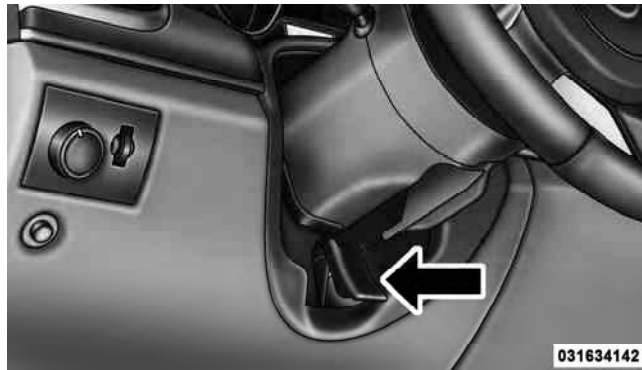

Tilt/Telescoping Lever

To unlock the steering column, push the lever downward (toward the floor). To tilt the steering column, move the steering wheel upward or downward as desired. To lengthen or shorten the steering column, pull the steering wheel outward or push it inward as desired. To lock the steering column in position, push the lever upward until fully engaged.

WARNING!

Do not adjust the steering column while driving. Adjusting the steering column while driving or driving with the steering column unlocked, could cause the driver to lose control of the vehicle. Be sure the steering column is locked before driving your vehicle. Failure to follow this warning may result in serious injury or death.

POWER TILT/TELESCOPING STEERING COLUMN — IF EQUIPPED

This feature allows you to tilt the steering column upward or downward. It also allows you to lengthen or shorten the steering column. The power tilt/telescoping steering column lever is located below the multifunction lever on the steering column.

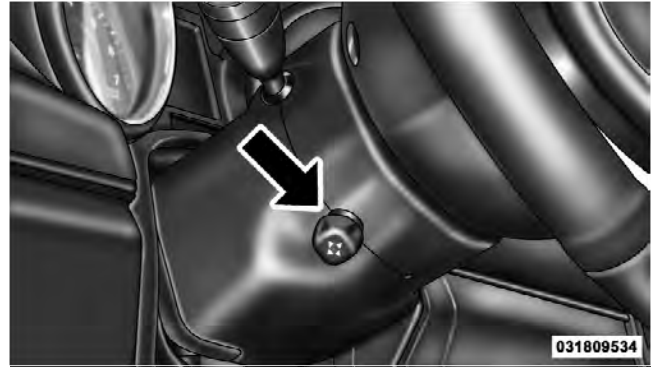
**Power Tilt/Telescoping Steering**

To tilt the steering column, move the lever up or down as desired. To lengthen or shorten the steering column, pull the lever toward you or push the lever away from you as desired.

NOTE: For vehicles equipped with Driver Memory Seat, you can use your Remote Keyless Entry (RKE) transmitter or the memory switch on the driver's door trim panel to return the tilt/telescopic steering column to pre-programmed positions. Refer to "Driver Memory Seat" in this section for further information.

WARNING!

Do not adjust the steering column while driving. Adjusting the steering column while driving or driving with the steering column unlocked, could cause the driver to lose control of the vehicle. Be sure the steering column is locked before driving your vehicle. Failure to follow this warning may result in serious injury or death.

HEATED STEERING WHEEL — IF EQUIPPED

The steering wheel contains a heating element that helps warm your hands in cold weather. The heated steering wheel has only one temperature setting. Once the heated steering wheel has been turned on it will operate for approximately 58 to 70 minutes before automatically shutting off. The heated steering wheel can shut off early or may not turn on when the steering wheel is already warm.

The heated steering wheel switch is located on the switch bank below the climate controls.



031705825

Press the switch to turn on the heated steering wheel. The light on the switch will illuminate to indicate the steering wheel heater is on. Pressing the switch a second time will turn off the heated steering wheel and light indicator.

NOTE: The engine must be running for the heated steering wheel to operate.

Vehicles Equipped With Remote Start

On models that are equipped with remote start, the heated steering wheel and seat can be programmed to come on during a remote start. Refer to “Remote Starting System — If Equipped” in “Things to Know Before Starting Your Vehicle” for further information.

WARNING!

- **Persons who are unable to feel pain to the skin because of advanced age, chronic illness, diabetes, spinal cord injury, medication, alcohol use, exhaustion, or other physical conditions must exercise care when using the steering wheel heater. It may cause burns even at low temperatures, especially if used for long periods.**

(Continued)

WARNING! (Continued)

- **Do not place anything on the steering wheel that insulates against heat, such as a blanket or cushion. This may cause the steering wheel heater to overheat.**

ELECTRONIC SPEED CONTROL

When engaged, the Electronic Speed Control takes over accelerator operations at speeds greater than 20 mph (32 km/h).

164 UNDERSTANDING THE FEATURES OF YOUR VEHICLE

The Electronic Speed Control buttons are located on the right side of the steering wheel.



Electronic Speed Control Buttons

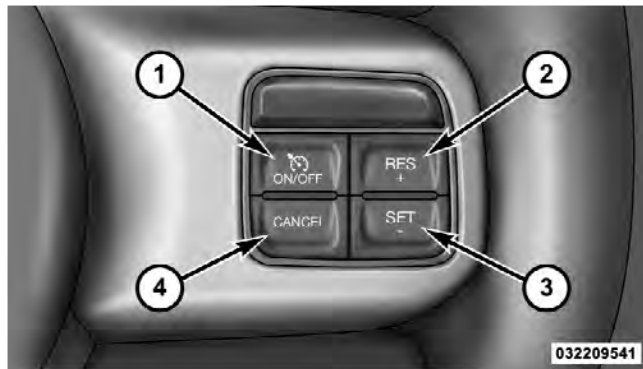

1 — ON/OFF
4 — CANCEL

2 — RES +
3 — SET -

NOTE: In order to ensure proper operation, the Electronic Speed Control System has been designed to shut down if multiple Speed Control functions are operated at the same time. If this occurs, the Electronic Speed Control

System can be reactivated by pushing the Electronic Speed Control ON/OFF button and resetting the desired vehicle set speed.

To Activate

Push the ON/OFF button. The Cruise Indicator Light in the instrument cluster will illuminate. To turn the system off, push the ON/OFF button a second time. The Cruise Indicator Light will turn off. The system should be turned off when not in use.

WARNING!

Leaving the Electronic Speed Control system on when not in use is dangerous. You could accidentally set the system or cause it to go faster than you want. You could lose control and have an accident. Always leave the system OFF when you are not using it.

To Set A Desired Speed

Turn the Electronic Speed Control ON. When the vehicle has reached the desired speed, press the SET (-) button and release. Release the accelerator and the vehicle will operate at the selected speed.

NOTE: The vehicle should be traveling at a steady speed and on level ground before pressing the SET button.

To Deactivate

A soft tap on the brake pedal, pushing the CANCEL button, or normal brake pressure while slowing the vehicle will deactivate Electronic Speed Control without erasing the set speed memory. Pressing the ON/OFF button or turning the ignition switch OFF erases the set speed memory.

To Resume Speed

To resume a previously set speed, push the RES (+) button and release. Resume can be used at any speed above 20 mph (32 km/h).

To Vary The Speed Setting

When the Electronic Speed Control is set, you can increase speed by pushing the RES (+) button. If the button is continually pressed, the set speed will continue to increase until the button is released, then the new set speed will be established.

Pressing the RES (+) button once will result in a 1 mph (1.6 km/h) increase in set speed. Each subsequent tap of the button results in an increase of 1 mph (1.6 km/h).

To decrease speed while the Electronic Speed Control is set, push the SET (-) button. If the button is continually held in the SET (-) position, the set speed will continue to decrease until the button is released. Release the button when the desired speed is reached, and the new set speed will be established.

Pressing the SET (-) button once will result in a 1 mph (1.6 km/h) decrease in set speed. Each subsequent tap of the button results in a decrease of 1 mph (1.6 km/h).

To Accelerate For Passing

Press the accelerator as you would normally. When the pedal is released, the vehicle will return to the set speed.

Using Electronic Speed Control On Hills

The transmission may downshift on hills to maintain the vehicle set speed.

NOTE: The Electronic Speed Control system maintains speed up and down hills. A slight speed change on moderate hills is normal.

On steep hills, a greater speed loss or gain may occur so it may be preferable to drive without Electronic Speed Control.

WARNING!

Electronic Speed Control can be dangerous where the system cannot maintain a constant speed. Your vehicle could go too fast for the conditions, and you could lose control and have an accident. Do not use Electronic Speed Control in heavy traffic or on roads that are winding, icy, snow-covered or slippery.

**ADAPTIVE CRUISE CONTROL (ACC) —
IF EQUIPPED**

Adaptive Cruise Control (ACC) increases the driving convenience provided by cruise control while traveling on highways and major roadways. However, it is not a safety system and not designed to prevent collisions.

ACC will allow you to keep cruise control engaged in light to moderate traffic conditions without the constant need to reset your cruise control. ACC utilizes a radar sensor designed to detect a vehicle directly ahead of you.

NOTE:

- If the sensor does not detect a vehicle ahead of you, ACC will maintain a fixed set speed.
- If the ACC sensor detects a vehicle ahead, ACC will apply limited braking or acceleration (not to exceed the original set speed) automatically to maintain a preset following distance, while matching the speed of the vehicle ahead.

WARNING!

- Adaptive Cruise Control (ACC) is a convenience system. It is not a substitute for active driving involvement. It is always the driver's responsibility to be attentive of road, traffic, and weather conditions, vehicle speed, distance to the vehicle ahead; and, most importantly, brake operation to ensure safe operation of the vehicle under all road conditions. Your complete attention is always required while driving to maintain safe control of your vehicle. Failure to follow these warnings can result in a collision or serious personal injury.
- The ACC system:
 - Does not react to pedestrians, oncoming vehicles, and stationary objects (e.g., a stopped vehicle in a traffic jam or a disabled vehicle).

(Continued)

WARNING! (Continued)

- Cannot take street, traffic, and weather conditions into account, and may be limited upon adverse sight distance conditions.
- Does not predict the lane curvature or the movement of preceding vehicles and will not compensate for such changes.
- Does not always fully recognize complex driving conditions, which can result in wrong or missing distance warnings.
- Can only apply a maximum of 25% of the vehicle's braking capability, and will not bring the vehicle to a complete stop.

WARNING!

You should switch off the ACC system:

- When driving in fog, heavy rain, heavy snow, sleet, heavy traffic, and complex driving situations (i.e., in highway construction zones).
- When entering a turn lane or highway off ramp; when driving on roads that are winding, icy, snow-covered, slippery, or have steep uphill or downhill slopes.
- When towing a trailer up or down steep slopes.
- When circumstances do not allow safe driving at a constant speed.

Failure to follow these warnings can result in a collision or serious personal injury.

The Cruise Control system has two control modes:

- Adaptive Cruise Control mode for maintaining an appropriate distance between vehicles.
- Normal (fixed speed) cruise control mode for cruising at a constant preset speed. For additional information, refer to “Normal (Fixed Speed) Cruise Control Mode” in this section.

NOTE: The system will not react to preceding vehicles. Always be aware of the mode selected.

You can change the mode by using the Cruise Control buttons. The two control modes function differently. Always confirm which mode is selected.

Adaptive Cruise Control (ACC) Operation

The speed control buttons (located on the right side of the steering wheel) operates the ACC system.

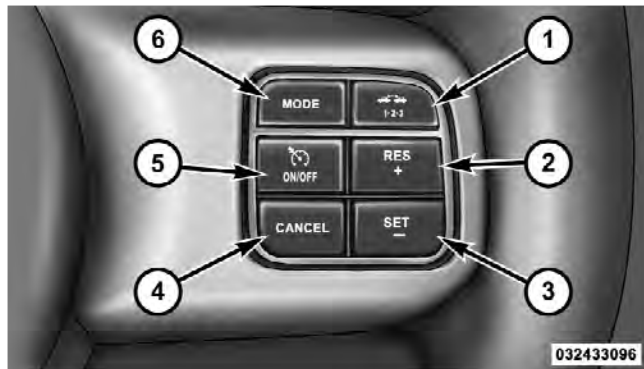

- 1 — DISTANCE SETTING
- 2 — RES +
- 3 — SET -
- 4 — CANCEL
- 5 — ON/OFF
- 6 — MODE

NOTE: Any chassis/suspension modifications to the vehicle will effect the performance of the Adaptive Cruise Control.

Activating Adaptive Cruise Control (ACC)

You can only activate ACC if the vehicle speed is above 20 mph (32 km/h).

When the system is turned on and in the READY state, the Electronic Vehicle Information Center (EVIC) displays “Adaptive Cruise Ready.”

When the system is OFF, the EVIC displays “Adaptive Cruise Control Off.”

NOTE: You cannot enable ACC under the following conditions:

- When in Four-Wheel Drive Low.
- When you apply the brakes.
- When the parking brake is set.
- When the automatic transmission is in PARK, REVERSE or NEUTRAL.
- When pushing the RES + button without a previously set speed in memory.

To Activate

Push and release the ON/OFF button. The ACC menu in the EVIC displays “Adaptive Cruise Ready.”



Adaptive Cruise Control Ready

To turn the system OFF, push and release the ON/OFF button again. At this time, the system will turn off and the EVIC will display “Adaptive Cruise Control Off.”

WARNING!

Leaving the Adaptive Cruise Control (ACC) system on when not in use is dangerous. You could accidentally set the system or cause it to go faster than you want. You could lose control and have a collision. Always leave the system off when you are not using it.

To Set A Desired ACC Speed

When the vehicle reaches the speed desired, push the SET - button and release. The EVIC will display the set speed.

**ACC Set**

Remove your foot from the accelerator pedal. If you do not, the vehicle may continue to accelerate beyond the set speed. If this occurs:

- The message “DRIVER OVERRIDE” will display in the EVIC.

- The system will not be controlling the distance between your vehicle and the vehicle ahead. The vehicle speed will only be determined by the position of the accelerator pedal.



Driver Override

To Cancel

The system will disable ACC without erasing the memory if:

- You softly tap the brake pedal.
- You depress the brake pedal.
- You press the CANCEL switch.
- An Anti-Lock Brake System (ABS) event occurs.
- A Trailer Sway Control (TSC) event occurs.
- If the transmission is shifted into NEUTRAL.
- The Electronic Stability Control/Traction Control System (ESC/TCS) activates.

NOTE: If ACC is resumed or set with the ESC/TCS off, ESC will automatically be re-engaged.



Adaptive Cruise Control Cancelled

To Turn Off

The system will turn off and erase the set speed in memory if:

- You push the ON/OFF button.

- You turn OFF the ignition.
- You switch to Four-Wheel Drive Low.

To Resume Speed

Press the RES + button and release. Then remove your foot from the accelerator pedal. The EVIC will display the last set speed.

NOTE: You can resume ACC from a minimum of 20 mph (32 km/h).

WARNING!

The Resume function should only be used if traffic and road conditions permit. Resuming a set speed that is too high or too low for prevailing traffic and road conditions could cause the vehicle to accelerate or decelerate too sharply for safe operation. This could cause a collision and/or serious injury.

To Vary The Speed Setting

While ACC is set, you can increase the set speed by pressing and holding the RES + button. If the button is continually pressed, the set speed will continue to increase in 5 mph (8 km/h) increments until the button is released. The increase in set speed is reflected in the EVIC display.

Pressing the RES + button once will result in a 1 mph (1.6 km/h) increase in set speed. Each subsequent tap of the button results in an increase of 1 mph (1.6 km/h).

While ACC is set, the set speed can be decreased by pressing and holding the SET - button. If the button is continually pressed, the set speed will continue to decrease in 5 mph (8 km/h) increments until the button is released. The decrease in set speed is reflected in the EVIC display.

Pressing the SET - button once will result in a 1 mph (1.6 km/h) decrease in set speed. Each subsequent tap of the button results in a decrease of 1 mph (1.6 km/h).

NOTE:

- When you use the SET - button to decelerate, if the engine's braking power does not slow the vehicle sufficiently to reach the set speed, the brake system will automatically slow the vehicle.
- The ACC system can only apply a maximum of 25% of the vehicle's braking capability and will not bring the vehicle to a complete stop.
- The ACC system maintains set speed when driving up hill and down hill. However, a slight speed change on moderate hills is normal. In addition, downshifting may occur while climbing uphill or descending downhill. This is normal operation and necessary to maintain set speed.

Setting The Following Distance In ACC

The specified following distance for ACC can be set by varying the distance setting between 3 (long), 2 (medium), and 1 (short). Using this distance setting and the vehicle speed, ACC calculates and sets the distance to the vehicle ahead. This distance setting displays in the EVIC.



Distance Setting 3



Distance Setting 2



Distance Setting 1

To change the distance setting, press the Distance button and release. Each time the button is pressed, the distance setting adjusts between long, medium, and short.

If there is no vehicle ahead, the vehicle will maintain the set speed. If a slower moving vehicle is detected in the same lane, the EVIC displays the “Sensed Vehicle Indicator” icon, and the system adjusts vehicle speed automatically to maintain the distance setting, regardless of the set speed.

The vehicle will then maintain the set distance until:

- The vehicle ahead accelerates to a speed above the set speed.
- The vehicle ahead moves out of your lane or view of the sensor.
- The vehicle ahead slows to a speed below 15 mph (24 km/h) and the system automatically disengages itself.
- The distance setting is changed.

178 UNDERSTANDING THE FEATURES OF YOUR VEHICLE

- The system disengages. (Refer to the information on ACC Activation).

The maximum braking applied by ACC is limited; however, the driver can always apply the brakes manually, if necessary.

NOTE: The brake lights will illuminate whenever the ACC system applies the brakes.

A Proximity Warning will alert the driver if ACC predicts that its maximum braking level is not sufficient to maintain the set distance. If this occurs, a visual alert "BRAKE" will flash in the EVIC and a chime will sound while ACC continues to apply its maximum braking capacity. When this occurs, you should immediately apply the brakes as needed to maintain a safe distance from the vehicle ahead.



Brake Alert

Adaptive Cruise Control (ACC) Menu

The EVIC displays the current ACC system settings. The EVIC is located in the upper part of the instrument cluster between the speedometer and the tachometer. The information it displays depends on ACC system status.



Press the MENU button (located on the steering wheel) repeatedly until one of the following displays in the EVIC:

Menu Button

Adaptive Cruise Control Off

- When ACC is deactivated, the display will read “Adaptive Cruise Control Off.”

Adaptive Cruise Control Ready

- When ACC is activated but the vehicle speed setting has not been selected, the display will read “Adaptive Cruise Control Ready.”

ACC SET

- When ACC is set, the set speed will display.

The set speed will continue to display in place of the odometer reading when changing the EVIC display while ACC is set.



Example Only

The ACC screen will display once again if any ACC activity occurs, which may include any of the following:

- Set Speed Change
- Distance Setting Change
- System Cancel
- Driver Override
- System Off
- ACC Proximity Warning
- ACC Unavailable Warning

The EVIC will return to the last display selected after five seconds of no ACC display activity.

Display Warnings And Maintenance

“Clean Radar Sensor In Front Of Vehicle” Warning

The ACC “Clean Radar Sensor In Front Of Vehicle” warning will display when conditions temporarily limit system performance. This most often occurs at times of poor visibility, such as in snow or heavy rain. The ACC system may also become temporarily blinded due to obstructions, such as mud, dirt or ice. In these cases, the EVIC will display “Clean Radar Sensor In Front Of Vehicle” and the system will deactivate.

The “Clean Radar Sensor In Front Of Vehicle” message can sometimes be displayed while driving in highly reflective areas (i.e. tunnels with reflective tiles, or ice and snow). The ACC system will recover after the vehicle has left these areas. Under rare conditions, when the radar is not tracking any vehicles or objects in its path this warning may temporarily occur.

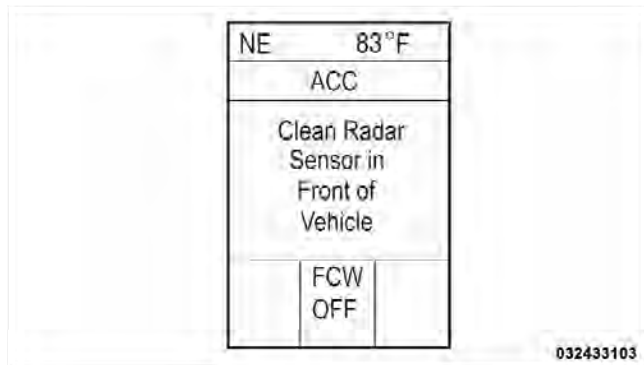

Clean Radar Sensor Warning

NOTE: If the ACC “Clean Radar Sensor In Front of Vehicle” warning is active Normal (Fixed Speed) Cruise Control is still available. For additional information refer to “Normal (Fixed Speed) Cruise Control Mode” in this section.

If weather conditions are not a factor, the driver should examine the sensor. It may require cleaning or removal of an obstruction. The sensor is located in the center of the vehicle behind the lower grille.

To keep the ACC System operating properly, it is important to note the following maintenance items:

- Always keep the sensor clean. Carefully wipe the sensor lens with a soft cloth. Be cautious not to damage the sensor lens.
- Do not remove any screws from the sensor. Doing so could cause an ACC system malfunction or failure and require a sensor realignment.
- If the sensor is damaged due to a collision, see your authorized dealer for service.

- Do not attach or install any accessories near the sensor, including transparent material or aftermarket grilles. Doing so could cause an ACC system failure or malfunction.

When the condition that deactivated the system is no longer present, the system will return to the “Adaptive Cruise Control Off” state and will resume function by simply reactivating it.

NOTE:

- If the “Clean Radar Sensor In Front Of Vehicle” message occurs frequently (e.g. more than once on every trip) without any snow, rain, mud, or other obstruction, have the radar sensor realigned at your authorized dealer.
- Installing a snow plow, front-end protector, an aftermarket grille or modifying the grille is not recommended. Doing so may block the sensor and inhibit ACC operation.

Removing ACC Sensor For Off-Roading

NOTE: When off-roading, it may be advisable to remove the ACC sensor. The sensor is located behind the front lower grille in the center of the vehicle. After removing the lower fascia, you may remove the lower sensor and bracket assembly.

To remove the sensor follow these instructions:

1. Unplug the connector by depressing the two tabs on the connector and pulling it out. Do not pull by the wiring or use any tools to remove the connector.
2. Remove the wiring christmas tree attachment from the back of the bracket.
3. Remove the two M6 fasteners that connect the bracket to the bumper.

NOTE: Do not change the adjustment fasteners or pull the sensor off of the bracket. Doing so may misalign the sensor.

Store the sensor and bracket assembly in a safe location. The wiring and connector must be stowed properly after the sensor and bracket assembly is removed.

A connector plug is stowed on top of the bumper beam. Insert the wiring connector into the connector plug.

NOTE: When the sensor is removed, Adaptive Cruise Control, Normal Cruise Control, and Forward Collision Warning will not be available. The cluster will display the warning “ACC/FCW Unavailable - Service Radar Sensor.”

To reinstall the sensor and bracket assembly reverse the process above. The fastener torque required to assembly the bracket back to the beam is 6.6 ft lbs (9 Nm).

ACC Unavailable Warning

If the system turns off, and the EVIC displays “ACC/FCW Unavailable, Vehicle System Error”, there may be a temporary malfunction that limits ACC functionality. Although the vehicle is still drivable under normal conditions, ACC will be temporarily unavailable. If this occurs, try activating ACC again later, following a key cycle. If the problem persists, see your authorized dealer.

Service ACC Warning

If the system turns off, and the EVIC displays “ACC/FCW Unavailable Service Radar Sensor”, it indicates there is an internal system fault. Although the vehicle is still drivable under normal conditions, have the system checked by an authorized dealer.

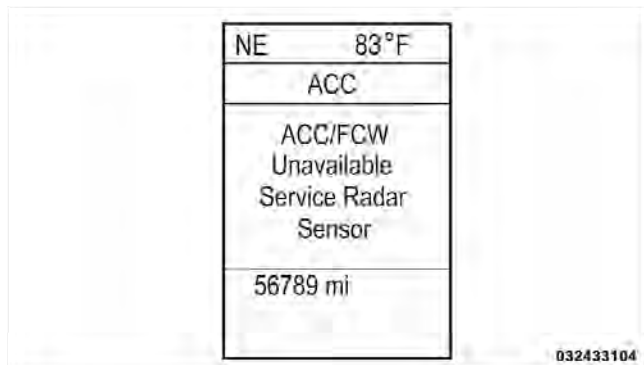

ACC/FCW Unavailable Warning

Precautions While Driving With ACC

In certain driving situations, ACC may have detection issues. In these cases, ACC may brake late or unexpectedly. The driver needs to stay alert and may need to intervene.

Adding A Trailer Hitch

The weight of a trailer/hitch may affect the performance of ACC. If there is a noticeable change in performance following the installation of a trailer/hitch, or if the ACC performance does not return to normal after removing the trailer/hitch see your authorized dealer.

Offset Driving

ACC may not detect a vehicle in the same lane that is offset from your direct line of travel. There will not be sufficient distance to the vehicle ahead. The offset vehicle may move in and out of the line of travel, which can cause your vehicle to brake or accelerate unexpectedly.

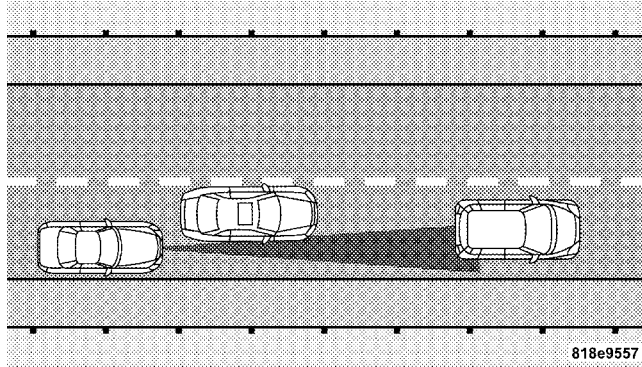

Turns And Bends

In turns or bends, ACC may detect a vehicle ahead too late or too early. This may cause your vehicle to brake late or unexpectedly. Give extra attention in curves and be ready to apply the brakes if necessary. Be sure to select an appropriate speed while driving in curves.

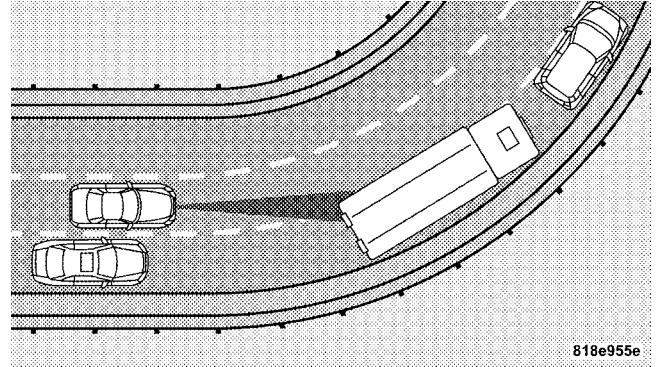

Using ACC On Hills

When driving on hills, ACC may not detect a vehicle in your lane. Depending on the speed, vehicle load, traffic conditions, and the steepness of the hills, ACC performance may be limited.

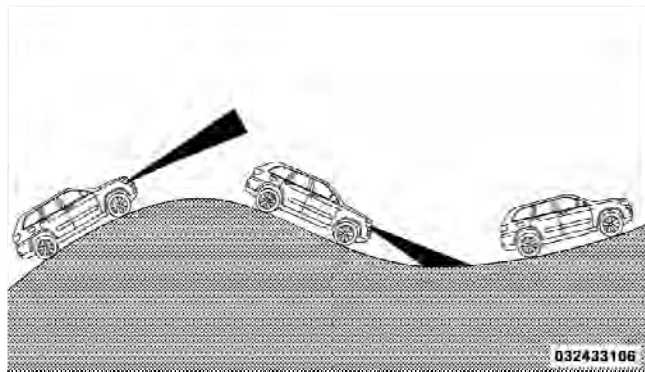

Lane Changing

ACC will not detect a vehicle until it is completely in the lane in which you are traveling. In the illustration shown, ACC has not yet detected the vehicle changing lanes and it may not detect the vehicle until it's too late for the ACC system to take action. ACC will not detect a vehicle until it is completely in the lane. There will not be sufficient distance to the lane-changing vehicle. Always be attentive and ready to apply the brakes if necessary.

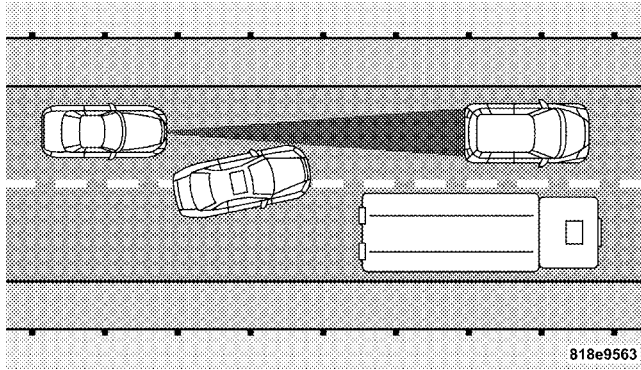

818e9563

Narrow Vehicles

Some narrow vehicles traveling near the outer edges of the lane or edging into the lane are not detected until they have moved fully into the lane. There will not be sufficient distance to the vehicle ahead.

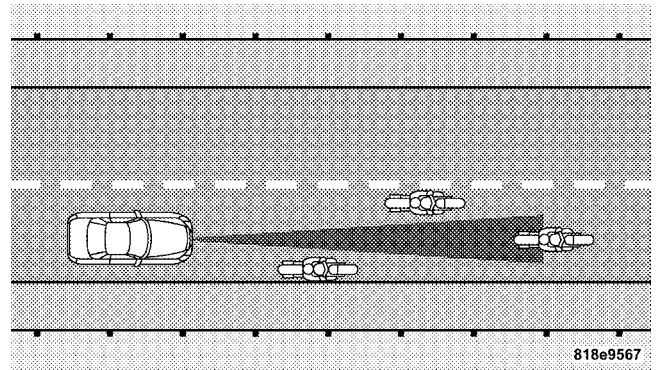

818e9567

Stationary Objects And Vehicles

ACC does not react to stationary objects and stationary vehicles. For example, ACC will not react in situations where the vehicle you are following exits your lane and the vehicle ahead is stopped in your lane. Always be attentive and ready to apply the brakes if necessary.

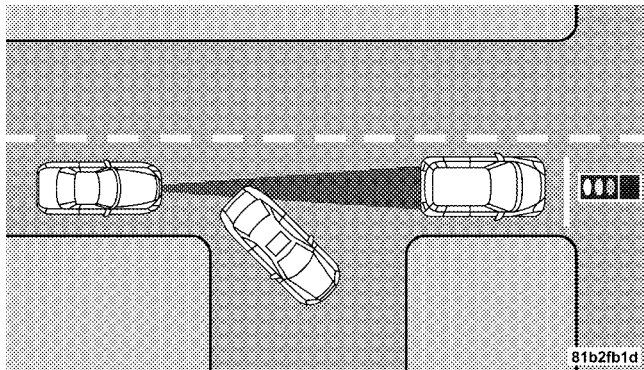

General Information

FCC Requirements For Vehicular Radar Systems

Classification Specifications:

47 C.F.R. Part 15

47 C.F.R Part 15.1515

Normal (Fixed Speed) Cruise Control Mode

In addition to Adaptive Cruise Control mode, a normal (fixed speed) Cruise Control mode is available for cruising at fixed speeds. The normal Cruise Control mode is designed to maintain a set cruising speed without requiring the driver to operate the accelerator. Cruise Control can only be operated if the vehicle speed is above 20 mph (32 km/h).

To change modes, press the MODE button when the system is in either the OFF, READY, or SET position. "Cruise Ready" will be displayed if the system was in ACC READY or ACC SET position. "Cruise Off" will be

displayed if the system was in the ACC OFF position. To switch back to Adaptive Cruise Control mode, press the MODE button a second time.

WARNING!

In the normal Cruise Control mode, the system will not react to vehicles ahead. In addition, the proximity warning does not activate and no alarm will sound even if you are too close to the vehicle ahead since the presence of the vehicle ahead nor the vehicle-to-vehicle distance is detected. Be sure to maintain a safe distance between your vehicle and the vehicle ahead. Always be aware which mode is selected.

To Set A Desired Speed

When the vehicle reaches the speed desired, press the SET - button and release. The EVIC will display the set speed.

NOTE: You must observe the display when setting or changing speed, not the speedometer.

To Vary The Speed Setting

There are two ways to change the set speed:

- Use the accelerator pedal to adjust the vehicle to the desired speed and press the SET - button.
- Tap the RES + or SET - button to increase or decrease the set speed in 1 mph (1.6 km/h) increments respectively. Hold the RES + or SET - button for 5 mph (8 km/h) increments.

To Cancel

The system will disable normal Cruise Control without erasing the memory if:

- You softly tap or depress the brake pedal.
- You press the CANCEL button.

- The Electronic Stability Control/Traction Control System (ESC/TCS) activates.

To Resume

Press the RES + button and then remove your foot from the accelerator pedal. The EVIC will display the last set speed.

To Turn Off

The system will turn off and erase the set speed in memory if:

- You push the ON/OFF button.
- You turn off the ignition.
- You engage Four-Wheel Drive Low.

If the Cruise Control system is turned off and reactivated, the system will return to the last driver setting (ACC or Normal Cruise Control).

Forward Collision Warning — If Equipped

Forward Collision Warning (FCW) warns the driver of a potential collision with the vehicle in front of you and prompts the driver to take action in order to avoid the collision.

FCW monitors the information from the forward looking sensor as well as the Electronic Brake Controller (EBC), wheel speed sensors, i.e., to calculate a probable rear-end collision. When the system determines that a rear-end collision is probable a warning message (both audible and visual) will be displayed on the EVIC. When the system determines a collision with the vehicle in front of you is no longer probable, the warning message will be deactivated.



FCW Message

NOTE: The minimum speed for FCW activation is 10 mph (16 km/h).

WARNING!

Forward Collision Warning (FCW) is not intended to avoid a collision on its own, nor can FCW detect every type of collision. The driver has the responsibility to avoid a collision by controlling the vehicle via braking and steering. Failure to follow this warning could lead to serious injury or death.

Changing FCW Status

The FCW feature can be set to far, set to near or turned off in the Electronic Vehicle Information Center (EVIC) refer to “Electronic Vehicle Information Center (EVIC)” in “Understanding Your Instrument Panel” for further information. The FCW Status Off, Near or Far will be displayed in the EVIC.

FCW settings can only be changed when the vehicle is in PARK.

192 UNDERSTANDING THE FEATURES OF YOUR VEHICLE

The default status of FCW is the “Far” setting, this allows the system to warn you of a possible collision with the vehicle in front of you when you are farther away. This gives you the most reaction time.

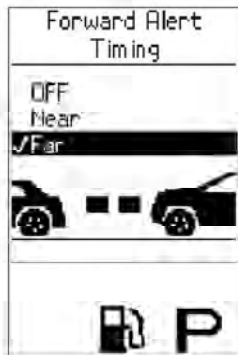

032435760

Example Only

Changing the FCW status to the “Near” setting, allows the system to warn you of a possible collision with the vehicle in front of you when you are much closer. This setting provides less reaction time than the “Far” setting, which allows for a more dynamic driving experience.



032435759

Example Only

Changing the FCW status to “Off” prevents the system from warning you of a possible collision with the vehicle in front of you.



Example Only

NOTE: In the “Off” setting FCW OFF will be displayed in the EVIC.



FCW Off Example

NOTE:

- The system will retain the last setting selected by the driver after ignition shut down.

- FCW will not react to irrelevant objects such as overhead objects, ground reflections, objects not in the path of the car, stationary objects that are far away, oncoming traffic, or leading vehicles with the same or higher rate of speed.
- FCW will be disabled like ACC below with the unavailable screens.

FCW Unavailable Warning

If the system turns off, and the EVIC displays “ACC/FCW Unavailable, Vehicle System Error”, there may be a temporary malfunction that limits FCW functionality. Although the vehicle is still drivable under normal conditions, FCW will be temporarily unavailable. If this occurs, try activating FCW again later, following a key cycle. If the problem persists, see your authorized dealer.

Service FCW Warning

If the system turns off, and the EVIC displays “ACC/FCW Unavailable Service Radar Sensor”, it indicates there is an internal system fault. Although the vehicle is still drivable under normal conditions, have the system checked by an authorized dealer.



ACC/FCW Unavailable Warning

PARKSENSE® REAR PARK ASSIST — IF EQUIPPED

The ParkSense® Rear Park Assist system provides visual and audible indications of the distance between the rear fascia and a detected obstacle when backing up, e.g. during a parking maneuver. Refer to ParkSense® System Usage Precautions for limitations of this system and recommendations.

ParkSense® will retain the last system state (enabled or disabled) from the last ignition cycle when the ignition is changed to the ON/RUN position.

ParkSense® can be active only when the shift lever is in REVERSE. If ParkSense® is enabled at this shift lever position, the system will remain active until the vehicle speed is increased to approximately 11 mph (18 km/h) or above. The system will become active again if the vehicle speed is decreased to speeds less than approximately 10 mph (16 km/h).

ParkSense® Sensors

The four ParkSense® sensors, located in the rear fascia/bumper, monitor the area behind the vehicle that is within the sensors' field of view. The sensors can detect obstacles from approximately 12 in (30 cm) up to 79 in (200 cm) from the rear fascia/bumper in the horizontal direction, depending on the location, type and orientation of the obstacle.

ParkSense® Warning Display

The ParkSense® Warning screen will only be displayed if Sound and Display is selected from the Customer-Programmable Features section of the Electronic Vehicle Information Center (EVIC). Refer to “Electronic Vehicle Information Center (EVIC)/Personal Settings (Customer-Programmable Features)” in “Understanding Your Instrument Panel” for further information.

The ParkSense® Warning Display is located in the Instrument cluster's EVIC display. It provides both visual and audible warnings to indicate the distance between the rear fascia/bumper and the detected obstacle.



Rear Park Assist Display

ParkSense® Display

When the vehicle is in REVERSE, the warning display will turn ON indicating the system status.



Park Assist ON



Park Assist OFF

The system will indicate a detected obstacle by showing three solid arcs and will produce a one-half second tone. As the vehicle moves closer to the object the EVIC display will show fewer arcs and the sound tone will change from slow, to fast, to continuous.



Slow Tone



Fast Tone



Continuous Tone

The vehicle is close to the obstacle when the EVIC display shows one flashing arc and sounds a continuous tone. The following chart shows the warning alert operation when the system is detecting an obstacle:

WARNING ALERTS					
Rear Distance (in/cm)	Greater than 79 in (200 cm)	79-39 in (200-100 cm)	39-25 in (100-65 cm)	25-12 in (65-30 cm)	Less than 12 in (30 cm)
Audible Alert Chime	None	Single 1/2 Second Tone	Slow	Fast	Continuous
Display Message	Park Assist ON	Warning Object Detected	Warning Object Detected	Warning Object Detected	Warning Object Detected
Arcs	None	3 Solid (Continuous)	3 Slow Flashing	2 Slow Flashing	1 Slow Flashing
Radio Mute	No	Yes	Yes	Yes	Yes

NOTE: ParkSense® will MUTE the radio, if on, when the system is sounding an audio tone.

Enabling And Disabling ParkSense®

ParkSense® can be enabled and disabled with a switch located in the switch bank of the instrument panel or through the Customer-Programmable Features section of the EVIC. The available choices are: OFF, Sound Only, or Sound and Display. Refer to “Electronic Vehicle Information Center (EVIC)/Personal Settings (Customer-Programmable Features)” in “Understanding Your Instrument Panel” for further information.



When the ParkSense® switch is pressed to disable the system, the instrument cluster will display the “PARK ASSIST OFF” message for approximately five seconds. Refer to “Electronic Vehicle Information Center (EVIC)” in “Understanding Your Instrument Panel” for further information. When the shift lever is moved to REVERSE and the system is disabled, the EVIC will display the “PARK ASSIST OFF” message for as long as the vehicle is in REVERSE.

The ParkSense® switch LED will be ON when ParkSense® is disabled or defective. The ParkSense® switch LED will be OFF when the system is enabled.

The ParkSense® system uses four sensors located in the rear bumper fascia to scan for obstacles up to 79 in (200 cm) away from the rear bumper fascia. The warning display located above in the Instrument Cluster’s EVIC provides both visual and audible warnings to indicate the range of the object.

Service The ParkSense® Rear Park Assist System

When the ParkSense® Rear Park Assist System is malfunctioning, the instrument cluster will actuate a single chime, once per ignition cycle, and it will display the “CLEAN PARK ASSIST SENSORS” or the “SERVICE PARK ASSIST SYSTEM” message. Refer to “Electronic Vehicle Information Center (EVIC)” in “Understanding Your Instrument Panel” for further information. When the shift lever is moved to REVERSE and the system has

detected a faulted condition, the EVIC will display the “CLEAN PARK ASSIST SENSORS” or the “SERVICE PARK ASSIST SYSTEM” message for as long as the vehicle is in REVERSE. Under this condition, ParkSense® will not operate.

If “CLEAN PARK ASSIST SENSORS” appears in the Electronic Vehicle Information Center (EVIC) and the rear fascia/bumper is clean and clear of snow, ice, mud, dirt or other obstruction, see your authorized dealer.

If “SERVICE PARK ASSIST SYSTEM” appears in the EVIC, see your authorized dealer.

Cleaning The ParkSense® System

Clean the ParkSense® sensors with water, car wash soap and a soft cloth. Do not use rough or hard cloths. Do not scratch or poke the sensors. Otherwise, you could damage the sensors.

ParkSense® System Usage Precautions

NOTE:

- Ensure that the rear bumper is free of snow, ice, mud, dirt and debris to keep the ParkSense® system operating properly.
- Jackhammers, large trucks, and other vibrations could affect the performance of ParkSense®.
- When you turn ParkSense® off, the instrument cluster will display “PARK ASSIST OFF.” Furthermore, once you turn ParkSense® off, it remains off until you turn it on again, even if you cycle the ignition key.
- When you move the shift lever to the REVERSE position and ParkSense® is turned off, the instrument cluster will display “PARK ASSIST OFF” message for as long as the vehicle is in REVERSE.
- ParkSense®, when on, will MUTE the radio when it is sounding a tone.

- Clean the ParkSense® sensors regularly, taking care not to scratch or damage them. The sensors must not be covered with ice, snow, slush, mud, dirt or debris. Failure to do so can result in the system not working properly. The ParkSense® system might not detect an obstacle behind the fascia/bumper, or it could provide a false indication that an obstacle is behind the fascia/bumper.
- Objects such as bicycle carriers, trailer hitches, etc., must not be placed within 12 in (30 cm) from the rear fascia/bumper while driving the vehicle. Failure to do so can result in the system misinterpreting a close object as a sensor problem, causing the “SERVICE PARK ASSIST SYSTEM” message to be displayed in the instrument cluster.
- On vehicles equipped with a tailgate, ParkSense® should be disabled when the tailgate is in the lowered

or open position and the vehicle is in REVERSE. A lowered tailgate could provide a false indication that an obstacle is behind the vehicle.

CAUTION!

- **ParkSense® is only a parking aid and it is unable to recognize every obstacle, including small obstacles. Parking curbs might be temporarily detected or not detected at all. Obstacles located above or below the sensors will not be detected when they are in close proximity.**
- **The vehicle must be driven slowly when using ParkSense® in order to be able to stop in time when an obstacle is detected. It is recommended that the driver looks over his/her shoulder when using ParkSense®.**

WARNING!

- Drivers must be careful when backing up even when using the ParkSense® Rear Park Assist System. Always check carefully behind your vehicle, look behind you, and be sure to check for pedestrians, animals, other vehicles, obstructions, and blind spots before backing up. You are responsible for safety and must continue to pay attention to your surroundings. Failure to do so can result in serious injury or death.

(Continued)

WARNING! (Continued)

- Before using the ParkSense® Rear Park Assist System, it is strongly recommended that the ball mount and hitch ball assembly is disconnected from the vehicle when the vehicle is not used for towing. Failure to do so can result in injury or damage to vehicles or obstacles because the hitch ball will be much closer to the obstacle than the rear fascia when the warning display turns on the single flashing arc and sounds the continuous tone. Also, the sensors could detect the ball mount and hitch ball assembly, depending on its size and shape, giving a false indication that an obstacle is behind the vehicle.

PARKVIEW® REAR BACK UP CAMERA — IF EQUIPPED

Your vehicle may be equipped with the ParkView® Rear Back Up Camera that allows you to see an on-screen image of the rear surroundings of your vehicle whenever the shift lever is put into REVERSE. The image will be displayed on the Navigation/Multimedia radio display screen along with a caution note to “check entire surroundings” across the top of the screen. After five seconds this note will disappear. The ParkView® camera is located on the rear of the vehicle above the rear License plate.

When the vehicle is shifted out of REVERSE, the rear camera mode is exited and the navigation or audio screen appears again.

When displayed, static grid lines will illustrate the width of the vehicle while a dashed center-line will indicate the center of the vehicle to assist with aligning to a hitch/receiver. The static grid lines will show separate zones that will help indicate the distance to the rear of the vehicle. The following table shows the approximate distances for each zone:

Zone	Distance to the rear of the vehicle
Red	0 - 1 ft (0 - 30 cm)
Yellow	1 ft - 3 ft (30 cm - 1 m)
Green	3 ft or greater (1 m or greater)

WARNING!

Drivers must be careful when backing up even when using the ParkView® Rear Back Up Camera. Always check carefully behind your vehicle, and be sure to check for pedestrians, animals, other vehicles, obstructions, or blind spots before backing up. You are responsible for the safety of your surroundings and must continue to pay attention while backing up. Failure to do so can result in serious injury or death.

CAUTION!

- To avoid vehicle damage, ParkView® should only be used as a parking aid. The ParkView® camera is unable to view every obstacle or object in your drive path.

(Continued)

CAUTION! (Continued)

- To avoid vehicle damage, the vehicle must be driven slowly when using ParkView® to be able to stop in time when an obstacle is seen. It is recommended that the driver look frequently over his/her shoulder when using ParkView®.

NOTE: If snow, ice, mud, or any foreign substance builds up on the camera lens, clean the lens, rinse with water, and dry with a soft cloth. Do not cover the lens.

**Turning ParkView® On Or Off —
With Navigation/Multimedia Radio**

1. Press the “menu” hard-key.
2. Select “system setup” soft-key.
3. Press the “camera setup” soft-key.

4. Enable or disable the rear camera feature by selecting the “enable rear camera in reverse” soft key and pressing the “save” soft-key.

Turning ParkView® On Or Off — Without Navigation/Multimedia Radio

1. Press the “menu” hard-key.
2. Select “system setup” soft-key.
3. Enable or disable the rear camera feature by selecting “enable rear camera in reverse” soft-key.

OVERHEAD CONSOLE

The overhead console contains courtesy/reading lights and storage for sunglasses. Universal Garage Door Opener (HomeLink®), power liftgate and power sunroof switches may also be included, if equipped.



Overhead Console

Front Map/Reading Lights

Lights are mounted in the overhead console. Each light can be turned on by pressing the switch on either side of the console. These buttons are backlit for night time visibility.



Front Map/Reading Lights

To turn the lights off, press the switch a second time. The lights also turn on when a door is opened. The lights will also turn on when the UNLOCK button on the RKE is pressed.

Sunglass Bin Door

At the front of the console a compartment is provided for the storage of a pair of sunglasses. The storage compartment access is a “push/push” design. Push the chrome pad on the door to open. Push the chrome pad on the door to close.



Sunglass Bin Door

GARAGE DOOR OPENER — IF EQUIPPED

HomeLink® replaces up to three remote controls (hand-held transmitters) that operate devices such as garage door openers, motorized gates, lighting or home security systems. The HomeLink® unit operates off your vehicle's battery.

The HomeLink® buttons that are located in the overhead console designate the three different HomeLink® channels.

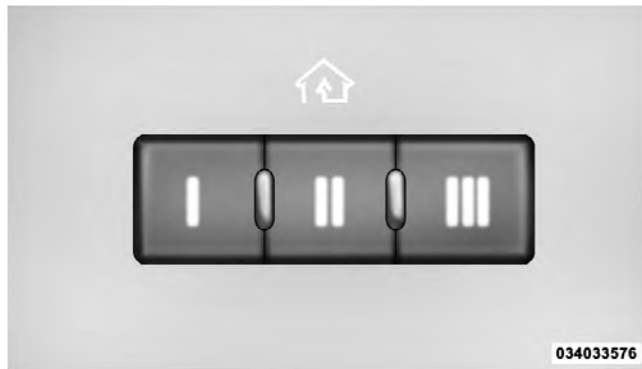

HomeLink® Buttons

NOTE: HomeLink® is disabled when the Vehicle Security Alarm is active.

WARNING!

- Your motorized door or gate will open and close while you are training the universal transceiver. Do not train the transceiver if people, pets or other objects are in the path of the door or gate. Only use this transceiver with a garage door opener that has a “stop and reverse” feature as required by Federal safety standards. This includes most garage door opener models manufactured after 1982. Do not use a garage door opener without these safety features. Call toll-free 1-800-355-3515 or, on the Internet at www.HomeLink.com for safety information or assistance.
- Vehicle exhaust contains carbon monoxide, a dangerous gas. Do not run your vehicle in the garage while training the transceiver. Exhaust gas can cause serious injury or death.

Programming HomeLink®**Before You Begin**

If you have not trained any of the HomeLink® buttons, erase all channels before you begin training.

To do this, press and hold the two outside buttons for up to 20 seconds until the red indicator flashes.

It is recommended that a new battery be placed in the handheld transmitter of the device that is being copied to HomeLink® for more efficient training and accurate transmission of the radio-frequency signal.

Your vehicle should be parked outside of the garage when programming.

1. Turn the ignition switch to the ON/RUN position.
2. Hold the battery side of the handheld transmitter away from the HomeLink® button you wish to program.

Place the handheld transmitter 1 to 3 in (3 to 8 cm) away from the HomeLink® button you wish to program while keeping the indicator light in view.

3. Simultaneously press and hold both the chosen HomeLink® button and the handheld transmitter button until the HomeLink® indicator changes from a slow to a rapidly blinking light, then release both the HomeLink® and handheld transmitter buttons.

Watch for the HomeLink® indicator to change flash rates. When it changes, it is programmed. It may take up to 30 seconds or longer in rare cases. The garage door may open and close while you train.

NOTE:

- Some gate operators and garage door openers may require you to replace Step 3 with procedures noted in the “Gate Operator/Canadian Programming” section.

- After training a HomeLink® channel, if the garage door does not operate with HomeLink® and the garage door opener was manufactured after 1995, the garage door opener may have a rolling code. If so, proceed to Step 5 “Programming A Rolling Code System.”

4. Press and hold the just-trained HomeLink® button and observe the indicator light.

If the indicator light stays on constantly, programming is complete and the garage door (or device) should activate when the HomeLink® button is pressed.

If the indicator light blinks rapidly for two seconds and then turns to a constant light, proceed to “Programming A Rolling Code System.”

Programming A Rolling Code System

At the garage door opener motor (in the garage), locate the “Learn” or “Training” button.

This can usually be found where the hanging antenna wire is attached to the garage door opener motor. It is NOT the button normally used to open and close the door.

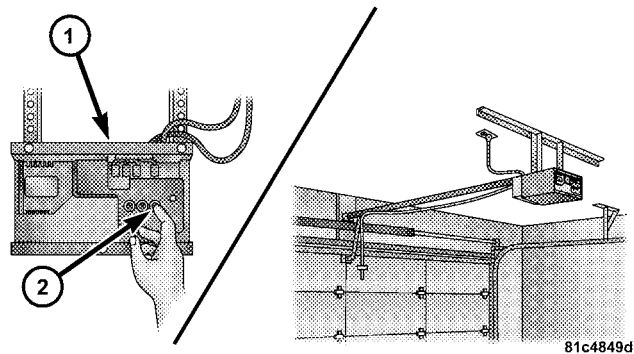

Training The Garage Door Opener

- 1 — Door Opener
2 — Training Button

1. Firmly press and release the LEARN or TRAINING button. The name and color of the button may vary by manufacturer.

NOTE: You have 30 seconds in which to initiate the next step after the LEARN button has been pressed.

2. Return to the vehicle and press the programmed HomeLink® button twice (holding the button for two seconds each time). If the device is plugged in and activates, programming is complete.

If the device does not activate, press the button a third time (for two seconds) to complete the training.

If you have any problems, or require assistance, please call toll-free 1-800-355-3515 or, on the Internet at www.HomeLink.com for information or assistance.

To program the remaining two HomeLink® buttons, repeat each step for each remaining button. DO NOT erase the channels.

Gate Operator/Canadian Programming

Canadian radio frequency laws require transmitter signals to time-out (or quit) after several seconds of transmission – which may not be long enough for HomeLink® to pick up the signal during programming. Similar to this Canadian law, some U.S. gate operators are designed to time-out in the same manner.

It may be helpful to unplug the device during the cycling process to prevent possible overheating of the garage door or gate motor.

If you are having difficulties programming a garage door opener or a gate operator, replace “Programming HomeLink®” Step 3, with the following:

3. Continue to press and hold the HomeLink® button, while you press and release (“cycle”), your handheld transmitter every two seconds until HomeLink® has successfully accepted the frequency signal. The indicator light will flash slowly and then rapidly when fully trained.

If you unplugged the device for training, plug it back in at this time.

Then proceed with Step 4 under “Programming HomeLink®,” earlier in this section.

Using HomeLink®

To operate, press and release the programmed HomeLink® button. Activation will now occur for the trained device (i.e., garage door opener, gate operator, security system, entry door lock, home/office lighting, etc.). The handheld transmitter of the device may also be used at any time.

Reprogramming A Single HomeLink® Button

To reprogram a channel that has been previously trained, follow these steps:

1. Turn the ignition switch to the ON/RUN position.
2. Press and hold the desired HomeLink® button until the indicator light begins to flash after 20 seconds. **Do not release the button.**
3. **Without releasing the button**, proceed with Programming HomeLink® Step 2 and follow all remaining steps.

Security

It is advised to erase all channels before you sell or turn in your vehicle.

To do this, press and hold the two outside buttons for 20 seconds until the red indicator flashes. Note that all channels will be erased. Individual channels cannot be erased.

The HomeLink® Universal Transceiver is disabled when the Vehicle Security Alarm is active.

Troubleshooting Tips

If you are having trouble programming HomeLink®, here are some of the most common solutions:

- Replace the battery in the original transmitter.
- Press the LEARN button on the Garage Door Opener to complete the training for a Rolling Code.
- Did you unplug the device for training, and remember to plug it back in?

If you have any problems, or require assistance, please call toll-free 1-800-355-3515 or, on the Internet at www.HomeLink.com for information or assistance.

General Information

This device complies with FCC rules Part 15 and Industry Canada RSS-210. Operation is subject to the following two conditions:

1. This device may not cause harmful interference.
2. This device must accept any interference that may be received including interference that may cause undesired operation.

NOTE:

- The transmitter has been tested and it complies with FCC and IC rules. Changes or modifications not expressly approved by the party responsible for compliance could void the user's authority to operate the device.
- The term IC before the certification/registration number only signifies that Industry Canada technical specifications were met.

POWER SUNROOF — IF EQUIPPED

The power sunroof switch is located between the sun visors on the overhead console.



034134074

Power Sunroof Switch

WARNING!

- Never leave children in a vehicle with the key in the ignition switch. Occupants, particularly unattended children, can become entrapped by the power sunroof while operating the power sunroof switch. Such entrapment may result in serious injury or death.
- In a collision, there is a greater risk of being thrown from a vehicle with an open sunroof. You could also be seriously injured or killed. Always fasten your seat belt properly and make sure all passengers are properly secured too.
- Do not allow small children to operate the sunroof. Never allow your fingers, other body parts, or any object to project through the sunroof opening. Injury may result.

Opening Sunroof — Express

Press the switch rearward and release, and the sunroof will open automatically from any position. The sunroof will open fully, then stop automatically. This is called “Express Open”. During Express Open operation, any movement of the sunroof switch will stop the sunroof.

Closing Sunroof — Express

Press the switch forward and release, and the sunroof will close automatically from any position. The sunroof will close fully and stop automatically. This is called “Express Close”. During Express Close operation, any movement of the switch will stop the sunroof.

Pinch Protect Feature

This feature will detect an obstruction in the opening of the sunroof during Express Close operation. If an obstruction is detected, the sunroof will automatically retract. Remove the obstruction if this occurs. Next, press the switch forward and release to Express Close.

NOTE: If three consecutive sunroof close attempts result in Pinch Protect reversals, the fourth close attempt will be a Manual Close movement with Pinch Protect disabled.

Pinch Protect Override

If a known obstruction (ice, debris, etc.) prevents closing the sunroof, press the switch forward and hold for two seconds after the reversal occurs. This allows the sunroof to move toward the closed position.

NOTE: Pinch protection is disabled while the switch is pressed.

Venting Sunroof — Express

Press and release the “Vent” button, and the sunroof will open to the vent position. This is called “Express Vent”, and will occur regardless of sunroof position. During Express Vent operation, any movement of the switch will stop the sunroof.

Sunshade Operation

The sunshade can be opened manually. However, the sunshade will open automatically as the sunroof opens.

NOTE: The sunshade cannot be closed if the sunroof is open.

Wind Buffeting

Wind buffeting can be described as the perception of pressure on the ears or a helicopter-type sound in the ears. Your vehicle may exhibit wind buffeting with the windows down, or the sunroof (if equipped) in certain open or partially open positions. This is a normal occurrence and can be minimized. If the buffeting occurs with the rear windows open, open the front and rear windows together to minimize the buffeting. If the buffeting occurs with the sunroof open, adjust the sunroof opening to minimize the buffeting or open any window.

Sunroof Maintenance

Use only a nonabrasive cleaner and a soft cloth to clean the glass panel.

Ignition OFF Operation

The power sunroof switches remain active for up approximately ten minutes after the ignition switch has been turned OFF. Opening either front door will cancel this feature.

COMMAND VIEW SUNROOF WITH POWER SHADE — IF EQUIPPED

The command view sunroof switch is located to the left between the sun visors on the overhead console.

The power shade switch is located to the right between the sun visors on the overhead console.



Command View Sunroof and Power Shade Switches

WARNING!

- Never leave children in a vehicle with the key in the ignition switch. Occupants, particularly unattended children, can become entrapped by the power sunroof while operating the power sunroof switch. Such entrapment may result in serious injury or death.
- In a collision, there is a greater risk of being thrown from a vehicle with an open sunroof. You could also be seriously injured or killed. Always fasten your seat belt properly and make sure all passengers are properly secured too.
- Do not allow small children to operate the sunroof. Never allow your fingers, other body parts, or any object to project through the sunroof opening. Injury may result.

Opening Sunroof – Express

Press the sunroof switch rearward for less than one second and release, and the sunroof glass will automatically slide fully open from any position, then stop. This is called “Express Open”. During Express Open operation, any sunroof switch press or shade switch press will stop the sunroof. If the shade is closed when the sunroof switch is pressed, the shade will automatically move to the middle position before the sunroof begins Express Open operation.

Venting Sunroof – Express

Press the center “Vent” button on the sunroof switch for less than one second and release, and the sunroof glass will automatically vent fully open from any position, then stop. This is called “Express Vent”. During Express Vent operation, any sunroof switch press or shade switch press will stop the sunroof. If the shade is closed when

the vent switch is pressed, the shade will automatically move to the middle position before the sunroof begins Express Vent operation.

Closing Sunroof – Express

Press the sunroof switch forward for less than one second and release, and the sunroof glass will automatically close from any position, then stop. This is called “Express Close”. During Express Close operation, any sunroof switch press or shade switch press will stop the sunroof.

Opening Power Shade – Express

Press the shade switch rearward for less than one second and release, and the shade will automatically open, then stop. This is called “Express Shade Open”. If the shade is forward of the middle position, it will move to the middle position then stop. If the shade is at or rearward of the middle position, it will move to the full open

position then stop. During Express Shade Open operation, any sunroof switch press or shade switch press will stop the shade.

Closing Power Shade – Express

Press the shade switch forward for less than one second and release, and the shade will automatically close, then stop. This is called “Express Shade Close”. If the sunroof is not at the closed position and the shade is rearward of the middle position, the shade will move to the middle position then stop. If the sunroof is not at the closed position and the shade is at the middle position, the sunroof will automatically move to the fully closed position before the shade begins Express Shade Close operation. During Express Shade Close operation, any sunroof switch press or shade switch press will stop the shade.

Sunroof And Power Shade Movement – Manual

If any sunroof or shade switch is pressed and held for more than one second, the sunroof or shade movement will continue only as long as the switch is continuously held. Whenever the switch is released, any sunroof or shade movement will stop. This allows the sunroof or shade to be stopped at any desired partially open position.

Pinch Protect Feature

This feature will detect an obstruction in the opening of the sunroof or the shade during any close operation. If an obstruction is detected, the sunroof or shade will automatically reverse direction to release the obstruction. If this occurs, remove the obstruction and then press the sunroof or shade switch forward to complete the desired close motion.

Pinch Protect Override

Method 1: If a known obstruction (ice, debris, etc) prevents closing of the sunroof or shade, press the corresponding switch forward and hold for two seconds after the reversal motion ends. After two seconds, all closing motions will be manual and will have Pinch Protect disabled. This will allow the sunroof or shade to move towards the closed position.

Method 2: If three consecutive sunroof or shade close attempts result in Pinch Protect reversals, the fourth close attempt will be a Manual Close movement with Pinch Protect disabled.

Pinch Protect Override Cancellation

Once the sunroof or shade reaches the closed position, Pinch Protect will reactivate. In addition, if any other switch is pressed which moves the sunroof or shade away from the closed position, Pinch Protect will reactivate.

Wind Buffeting

Wind buffeting can be described as the perception of pressure on the ears or a helicopter-type sound in the ears. Your vehicle may exhibit wind buffeting with the windows down, or the sunroof (if equipped) in certain open or partially open positions. This is a normal occurrence and can be minimized. If the buffeting occurs with the rear windows open, open the front and rear windows together to minimize the buffeting. If the buffeting occurs with the sunroof open, adjust the sunroof opening to minimize the buffeting or open any window.

Sunroof Maintenance

Use only a non-abrasive cleaner and a soft cloth to clean the glass panel.

Ignition OFF Operation

The power sunroof switches can be programmed to remain active for up to approximately ten minutes after the ignition switch has been turned OFF. Refer to “Electronic Vehicle Information Center (EVIC)/Customer-Programmable Features (System Setup)” under “Understanding Your Instrument Panel” for further information.

NOTE: Opening either front door will cancel this feature.

Sunroof Fully Closed

Press the switch forward and release to ensure that the sunroof is fully closed.

ELECTRICAL POWER OUTLETS

Your vehicle is equipped with 12 Volt (13 Amp) power outlets that can be used to power cellular phones, small electronics and other low powered electrical accessories. The power outlets are labeled with either a “key” or a “battery” symbol to indicate how the outlet is powered.

222 UNDERSTANDING THE FEATURES OF YOUR VEHICLE

Power outlets labeled with a “key” are powered when the ignition switch is in the ON or ACC position, while the outlets labeled with a “battery” are connected directly to the battery and powered at all times.

NOTE:

- All accessories connected to the “battery” powered outlets should be removed or turned off when the vehicle is not in use to protect the battery against discharge.
- To ensure proper operation a MOPAR® knob and element must be used.
- Do not exceed the maximum power of 160 Watts (13 Amps) at 12 Volts. If the 160 Watt (13 Amp) power rating is exceeded the fuse protecting the system will need to be replaced.

The front power outlet is located inside the storage area on the center stack of the instrument panel. Push inward on the storage lid to open the compartment and gain access to this power outlet.

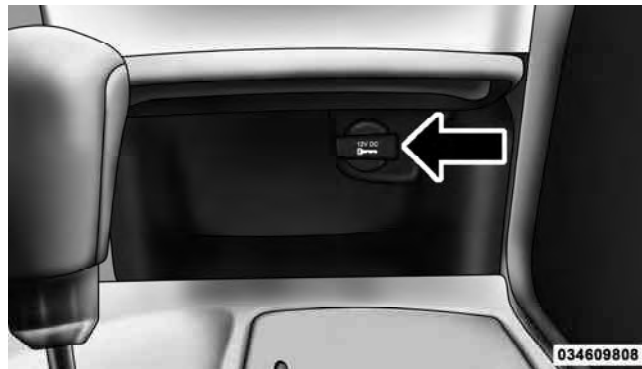

Front Power Outlet

In addition to the front power outlet, there is also a power outlet located in the storage area of the center console.

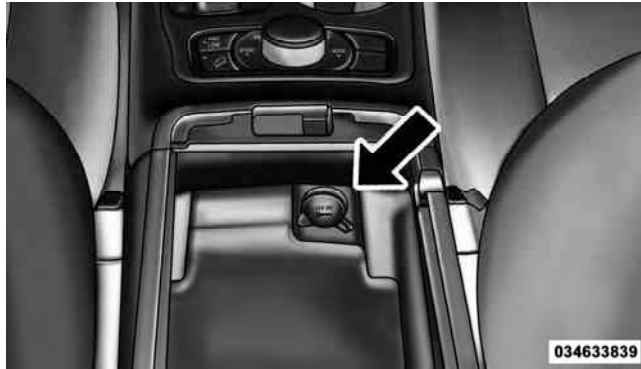

Center Console Outlet

The rear power outlet is located in the right rear cargo area.

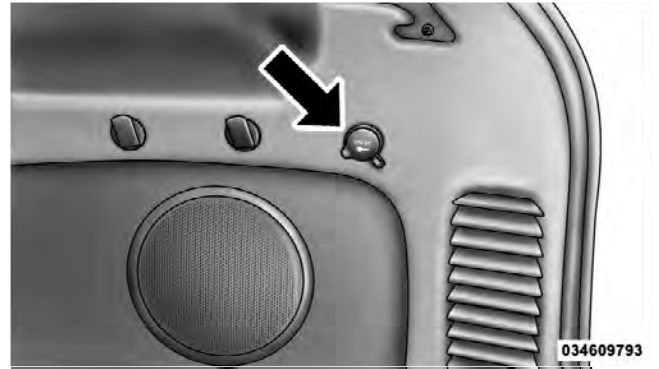

Rear Power Outlet

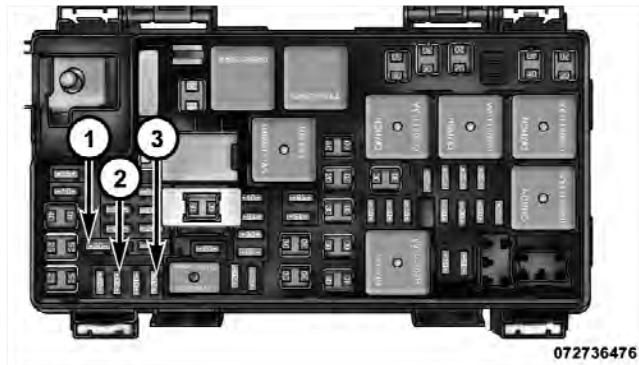

Power Outlet Fuse Locations

- 1 — M7 Fuse 20 A Yellow Power Outlet Right Rear Quarter Panel
- 2 — M6 Fuse 20 A Yellow Cigar Lighter Instrument Panel
- 3 — M36 Fuse 20 A Yellow Power Outlet Console Bin

WARNING!

To avoid serious injury or death:

- Only devices designed for use in this type of outlet should be inserted into any 12 Volt outlet.
- Do not touch with wet hands.
- Close the lid when not in use and while driving the vehicle.
- If this outlet is mishandled, it may cause an electric shock and failure.

CAUTION!

- Many accessories that can be plugged in draw power from the vehicle's battery, even when not in use (i.e., cellular phones, etc.). Eventually, if plugged in long enough, the vehicle's battery will discharge sufficiently to degrade battery life and/or prevent the engine from starting.
- Accessories that draw higher power (i.e., coolers, vacuum cleaners, lights, etc.) will degrade the battery even more quickly. Only use these intermittently and with greater caution.

(Continued)

CAUTION! (Continued)

- After the use of high power draw accessories, or long periods of the vehicle not being started (with accessories still plugged in), the vehicle must be driven a sufficient length of time to allow the generator to recharge the vehicle's battery.

POWER INVERTER — IF EQUIPPED

There is a 115 Volt, 150 Watt inverter outlet located on the back of the center console to convert DC current to AC current. This outlet can power cellular phones, electronics and other low power devices requiring power up to 150 Watts. Certain high-end video games, such as PlayStation3 and Xbox360 will exceed this power limit, as will most power tools.

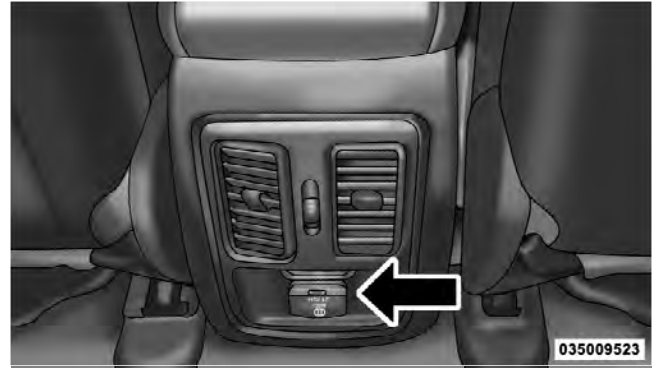

Power Inverter

The power inverter is designed with built-in overload protection. If the power rating of 150 Watts is exceeded, the power inverter will automatically shut down. Once the electrical device has been removed from the outlet the inverter should automatically reset. If the power rating exceeds approximately 170 Watts, the power inverter

may have to be reset manually. To reset the inverter manually press the power inverter button OFF and ON. To avoid overloading the circuit, check the power ratings on electrical devices prior to using the inverter.



035005840

The power inverter switch is located on the switch bank below the Climate Controls. To turn on the power outlet, press the switch once. Press the switch a second time to turn the power outlet off.

NOTE: When the power inverter switch is pressed, there will be a delay of approximately one second before the inverter status indicator turns ON. The status indicator of the AC power inverter indicates whether the inverter is producing AC power.

WARNING!

To avoid serious injury or death:

- Do not use a three-prong adaptor.
- Do not insert any objects into the receptacles.
- Do not touch with wet hands.
- Close the lid when not in use.
- If this outlet is mishandled it may cause an electric shock and failure.

CUPHOLDERS

There are two cupholders for the front seat passengers located in the center console.



Front Cupholder Location

There are two cupholders for the rear seat passengers located in the fold-down center armrest.

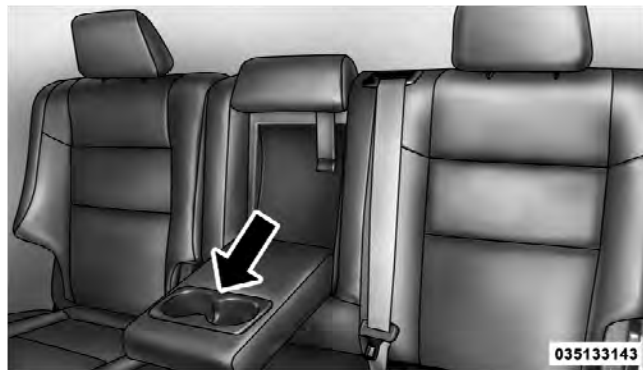

Rear Cupholders

STORAGE

Glove Compartment

The glove compartment is located on the right side of the instrument panel.



Glove Compartment

To open the glove compartment, pull outward on the latch and lower the glove box door.

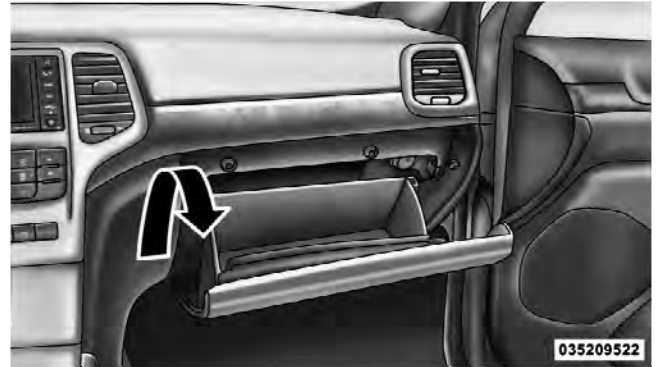

Opened Glove Compartment

Door Storage

Large storage areas are built into the door panels for easy access.



Door Panel Storage

Center Console

The center console contains both an upper and a lower storage area.



Storage Compartment

To open the upper storage compartment, pull upward on the small latch located on the lid.

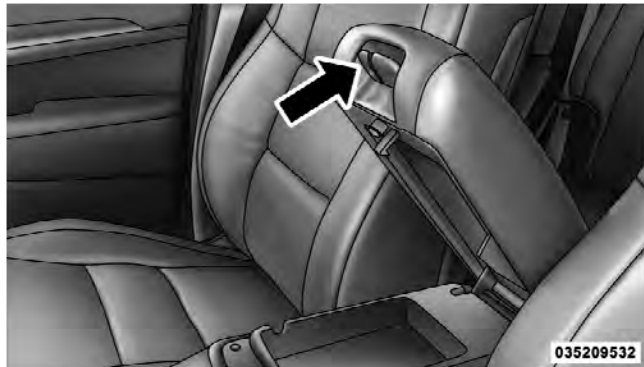

Storage Compartment Latches

Lift upward on the larger of the latches to access the lower storage compartment.

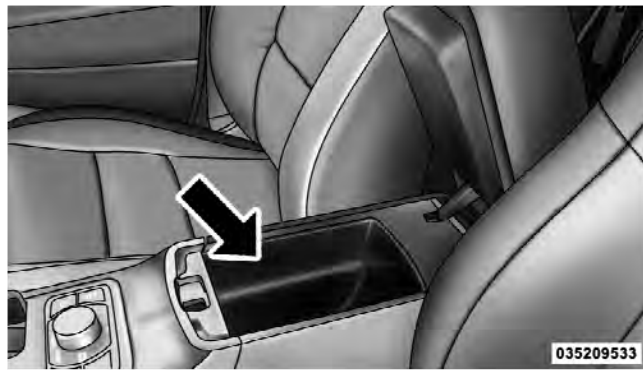

Lower Storage Compartment

CARGO AREA FEATURES

Rechargeable Flashlight

The rechargeable flashlight is mounted on the left side of the cargo area. The flashlight snaps out of the bezel when needed. The flashlight features two bright LED light

232 UNDERSTANDING THE FEATURES OF YOUR VEHICLE

bulbs and is powered by rechargeable lithium batteries that recharge when snapped back into place.

Press in on the flashlight to release it.



Press And Release

To operate the flashlight, press the switch once for high, twice for low, and a third time to return to off.

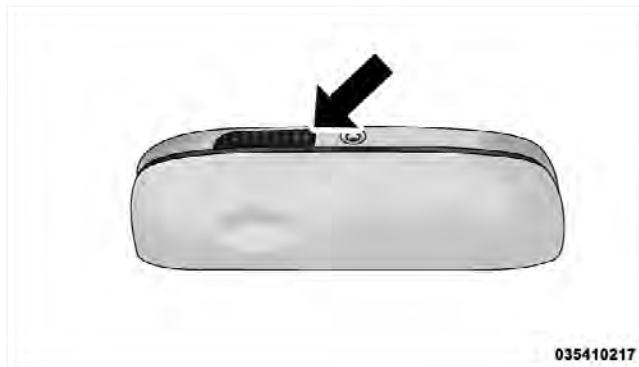

Three-Press Switch

Cargo Storage Bins

There are four removable storage bins located in the rear cargo area. There are two storage bins located on either side of the cargo area.



Rear Storage Bins

Two additional storage bins are located under the load floor. To access the lower storage bins, raise the load floor and attach the tether hook (attached to the bottom of the load floor) to the liftgate opening.

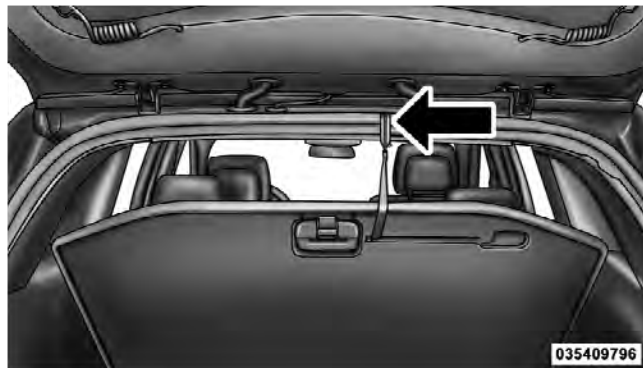

Tether Strap



Lower Storage Bins

Retractable Cargo Area Cover — If Equipped

NOTE: The purpose of this cover is for privacy, not to secure loads. It will not prevent cargo from shifting or protect passengers from loose cargo.

To cover the cargo area:

1. Grasp the cover at the center handle. Pull it over the cargo area.
2. Insert the pins on the ends of the cover into the slots in the pillar trim cover.
3. The liftgate may be opened with the cargo cover in place.

WARNING!

In a collision, a loose cargo cover in the vehicle could cause injury. It could fly around in a sudden stop and strike someone in the vehicle. Do not store the cargo cover on the cargo floor or in the passenger compartment. Remove the cover from the vehicle when taken from its mounting. Do not store it in the vehicle.

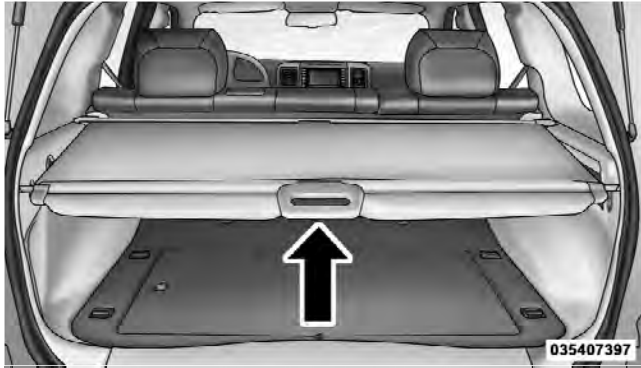
3

Rear Cargo Cover

Cargo Tie-Down Hooks

The cargo tie-downs, located on the cargo area floor, should be used to safely secure loads when the vehicle is moving.



Cargo Tie-Down Hooks

WARNING!

- To help protect against personal injury, passengers should not be seated in the rear cargo area. The rear cargo space is intended for load carrying purposes only, not for passengers, who should sit in seats and use seat belts.
- Cargo tie-down hooks are not safe anchors for a child seat tether strap. In a sudden stop or accident, a hook could pull loose and allow the child seat to come loose. A child could be badly injured. Use only the anchors provided for child seat tethers.

The weight and position of cargo and passengers can change the vehicle center of gravity and vehicle handling. To avoid loss of control resulting in personal injury, follow these guidelines for loading your vehicle:

(Continued)

WARNING! (Continued)

- Do not carry loads which exceed the load limits described on the label attached to the left door or left door center pillar.
- Always place cargo evenly on the cargo floor. Put heavier objects as low and as far forward as possible.
- Place as much cargo as possible in front of the rear axle. Too much weight or improperly placed weight over or behind the rear axle can cause the rear of the vehicle to sway.
- Do not pile luggage or cargo higher than the top of the seatback. This could impair visibility or become a dangerous projectile in a sudden stop or accident.

REAR WINDOW FEATURES**Rear Window Wiper/Washer**

The rear wiper/washer is controlled by a rotary switch located on the control lever. The control lever is located on the left side of the steering column.



Rear Wiper/Washer Control

 Rotate the center portion of the lever upward to the first detent for intermittent operation and to the second detent for continuous rear wiper operation.

 Rotating the center portion upward once more will activate the washer pump which will continue to operate as long as the switch is held. Upon release of the switch, the wipers will resume the continuous rear wiper operation. When this rotary control is in the OFF position, rotating it downward will activate the rear washer pump which will continue to operate as long as the switch is held. Once the switch is released it will return to the OFF position and the wipers will cycle two times before returning to the parked position.

NOTE: As a protective measure, the pump will stop if the switch is held for more than 20 seconds. Once the switch is released the pump will resume normal operation.

If the rear wiper is operating when the ignition is turned OFF, the wiper will automatically return to the “park” position.

If the liftgate flipper glass is open, the rear window wiper/washer functionality is interrupted and the wiper stops at that “park” position. When the liftgate flipper glass is closed, the rear wiper will resume wiper/washer functionality after five seconds.

Rear Window Defroster

 The rear window defroster button is located on the climate control panel. Press this button to turn on the rear window defroster and the heated outside mirrors (if equipped). An indicator in the button will illuminate when the rear window defroster is on. The rear window defroster automatically turns off after approximately 10 minutes. For an additional five minutes of operation, press the button a second time.

NOTE: To prevent excessive battery drain, use the rear window defroster only when the engine is operating.

CAUTION!

Failure to follow these cautions can cause damage to the heating elements:

- Use care when washing the inside of the rear window. Do not use abrasive window cleaners on the interior surface of the window. Use a soft cloth and a mild washing solution, wiping parallel to the heating elements. Labels can be peeled off after soaking with warm water.
- Do not use scrapers, sharp instruments, or abrasive window cleaners on the interior surface of the window.
- Keep all objects a safe distance from the window.

ROOF LUGGAGE RACK — IF EQUIPPED

The crossbars and siderails are designed to carry the weight on vehicles equipped with a luggage rack. The load must not exceed 150 lbs (68 kg), and should be uniformly distributed over the luggage rack crossbars.

NOTE: If not equipped with crossbars, your authorized dealer can order and install MOPAR® crossbars built specifically for this roof rack system.

Distribute cargo weight evenly on the roof rack crossbars. The roof rack does not increase the total load carrying capacity of the vehicle. Be sure the total load of cargo inside the vehicle plus that on the external rack does not exceed the maximum vehicle load capacity.

To move the crossbars, loosen the attachments, located at the upper edge of each crossbar, approximately eight turns using the anti-theft wrench provided with the MOPAR® crossbars. Then, move the crossbar to the desired position, keeping the crossbars parallel to the rack frame. Once the crossbar is in the desired position, retighten the with the wrench to lock the crossbar into position.

NOTE:

- To help control wind noise when the crossbars are not in use, place the front and rear crossbars approximately 24 in (61 cm) apart. Optimal noise reduction can then be achieved by adjusting the front crossbar forward or aft using increments of 1 in (2.5 cm).
- If the rear crossbar (or any metallic object) is placed over the satellite radio antenna (if equipped), you may experience interruption of satellite radio reception. For improved satellite radio reception, avoid placing the rear crossbar over the satellite radio antenna.
- The grab handles on the back of the vehicle (if equipped) are not to be used as a towing feature.

CAUTION!

- To prevent damage to the roof of your vehicle, do not carry any loads on the roof rack without the crossbars installed. The load should be secured and placed on top of the crossbars, not directly on the roof. If it is necessary to place the load on the roof, place a blanket or some other protection between the load and the roof surface.
- To avoid damage to the roof rack and vehicle, do not exceed the maximum roof rack load capacity of 150 lbs (68 kg). Always distribute heavy loads as evenly as possible and secure the load appropriately.
- Long loads which extend over the windshield, such as wood panels or surfboards, or loads with large frontal area should be secured to both the front and rear of the vehicle.

(Continued)

CAUTION! (Continued)

- Travel at reduced speeds and turn corners carefully when carrying large or heavy loads on the roof rack. Wind forces, due to natural causes or nearby truck traffic, can add sudden upward lift to a load. This is especially true on large flat loads and may result in damage to the cargo or your vehicle.

WARNING!

Cargo must be securely tied before driving your vehicle. Improperly secured loads can fly off the vehicle, particularly at high speeds, resulting in personal injury or property damage. Follow the roof rack cautions when carrying cargo on your roof rack.

UNDERSTANDING YOUR INSTRUMENT PANEL

CONTENTS

■ Instrument Panel Features	246	□ Engine Oil Change Indicator System	272
■ Instrument Cluster	247	□ Fuel Economy	272
■ Instrument Cluster Descriptions	248	□ Vehicle Speed	274
■ Electronic Vehicle Information Center (EVIC)	258	□ Trip Info	274
□ Electronic Vehicle Information Center (EVIC) Displays	260	□ Units	275
□ EVIC White Telltale Lights	266	□ Vehicle Info (Customer Information Features)	276
□ EVIC Amber Telltale Lights	267	□ Tire Psi	276
□ EVIC Red Telltale Lights	269	□ Keyless Enter-N-Go Display — If Equipped	277

244 UNDERSTANDING YOUR INSTRUMENT PANEL

- Compass / Temperature Display 277
- Customer-Programmable Features (System Setup) 280
- Media Center 730N/430/430N (RHR/RER/RBZ/RHB) CD/DVD/HDD/NAV — If Equipped 288
 - Operating Instructions (Voice Command System) — If Equipped 288
 - Operating Instructions (Uconnect™ Phone) — If Equipped 288
- Media Center 130 (Sales Code RES) 288
 - Operating Instructions — Radio Mode 289
 - Operation Instructions — CD Mode For CD And MP3 Audio Play 291
 - Notes On Playing MP3 Files 294
 - Operation Instructions - Auxiliary Mode 296
- Media Center 130 With Satellite Radio (Sales Code RES+RSC). 297
 - Operating Instructions — Radio Mode 297
 - Operation Instructions — CD Mode For CD And MP3 Audio Play 303
 - Notes On Playing MP3 Files 305
 - List Button (CD Mode For MP3 Play) 307
 - Info Button (CD Mode For MP3 Play) 307
 - Uconnect™ Multimedia (Satellite Radio) — If Equipped 308
 - Operating Instructions (Uconnect™ Phone) — If Equipped 312

<ul style="list-style-type: none"> ■ iPod®/USB/MP3 Control — If Equipped 313 <ul style="list-style-type: none"> □ Connecting The iPod® Or External USB Device 314 □ Using This Feature 314 □ Controlling The iPod® Or External USB Device Using Radio Buttons 315 □ Play Mode 315 □ List Or Browse Mode 317 □ Bluetooth Streaming Audio (BTSA) 319 ■ Uconnect™ Multimedia (Sirius Backseat TV™) — If Equipped 320 ■ Video Entertainment System™ (Sales Code XRV) — If Equipped 320 	<ul style="list-style-type: none"> ■ Steering Wheel Audio Controls 321 <ul style="list-style-type: none"> □ Radio Operation 322 □ CD Player 322 ■ CD/DVD Disc Maintenance 323 ■ Radio Operation And Mobile Phones 323 ■ Climate Controls 323 <ul style="list-style-type: none"> □ Dual-Zone Manual Heating And Air Conditioning 324 □ Dual-Zone Automatic Temperature Control (ATC) — If Equipped 328 □ Operating Tips 334 □ Operating Tips Chart 336
--	---

INSTRUMENT PANEL FEATURES



1 — Air Outlet

2 — Instrument Cluster

3 — Radio

4 — Glove Compartment

5 — Climate Controls

6 — Lower Switch Bank

7 — Hazard Switch

8 — Storage Bin

9 — ESC Button

10 — Ignition Switch

11 — Hood Release

12 — Fuel Door Release

13 — Headlight Switch

14 — Dimmer Control

INSTRUMENT CLUSTER

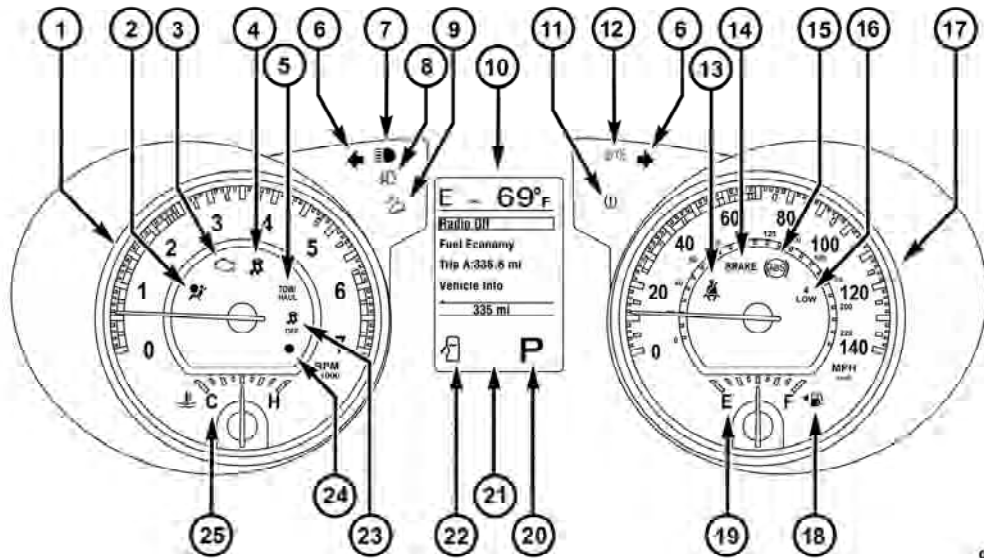

INSTRUMENT CLUSTER DESCRIPTIONS

1. *Tachometer*

Indicates the engine speed in revolutions per minute (RPM x 1000).

2. *Airbag Warning Light*



This light will turn on for four to eight seconds as a bulb check when the ignition switch is first turned to the ON/RUN position. If the light is either not on during starting, stays on, or turns on while driving, then have the system inspected at an authorized dealer as soon as possible. Refer to “Occupant Restraints” in “Things To Know Before Starting Your Vehicle” for further information.

3. *Malfunction Indicator Light (MIL)*



The Malfunction Indicator Light (MIL) is part of an onboard diagnostic system called OBD II that monitors engine and automatic transmission control systems. The light will illuminate when the key is in

the ON/RUN position before engine start. If the bulb does not come on when turning the key from OFF to ON/RUN, have the condition checked promptly.

Certain conditions such as a loose or missing gas cap, poor fuel quality, etc., may illuminate the light after engine start. The vehicle should be serviced if the light stays on through several of your typical driving cycles. In most situations, the vehicle will drive normally and will not require towing.

CAUTION!

Prolonged driving with the MIL on could cause damage to the engine control system. It also could affect fuel economy and drivability. If the MIL is flashing, severe catalytic converter damage and power loss will soon occur. Immediate service is required.

WARNING!

A malfunctioning catalytic converter, as referenced above, can reach higher temperatures than in normal operating conditions. This can cause a fire if you drive slowly or park over flammable substances such as dry plants or wood or cardboard, etc. This could result in death or serious injury to the driver, occupants or others.

4. *Electronic Stability Control (ESC) Activation/ Malfunction Indicator Light — If Equipped*



The “ESC Activation/Malfunction Indicator Light” in the instrument cluster will come on when the ignition switch is turned to the ON/RUN position. It should go out with the engine running. If the “ESC Activation/Malfunction Indicator Light” comes on continuously with the engine running, a malfunction has been detected in the ESC

system. If this light remains on after several ignition cycles, and the vehicle has been driven several miles (kilometers) at speeds greater than 30 mph (48 km/h), see your authorized dealer as soon as possible to have the problem diagnosed and corrected.

NOTE:

- The “ESC Off Indicator Light” and the “ESC Activation/Malfunction Indicator Light” come on momentarily each time the ignition switch is turned to ON/RUN.
- Each time the ignition is turned to ON/RUN, the ESC system will be ON even if it was turned off previously.
- The ESC system will make buzzing or clicking sounds when it is active. This is normal; the sounds will stop when ESC becomes inactive following the maneuver that caused the ESC activation.

5. TOW/HAUL Indicator Light — If Equipped**TOW/
HAUL**

This light will illuminate when the TOW/HAUL button has been selected. The TOW/HAUL button is located in the center of the instrument panel (below the climate controls).

6. Turn Signal Indicator

The arrows will flash with the exterior turn signals when the turn signal lever is operated. A tone will chime, and an EVIC message will appear if the turn signals are left on for more than 1 mile (1.6 km).

7. High Beam Indicator

Indicates that headlights are on high beam.

8. Front Fog Light Indicator — If Equipped

This indicator will illuminate when the front fog lights are on.

9. Hill Descent Control Indicator Light — If Equipped

The symbol indicates the status of the Hill Decent Control (HDC) feature. The lamp will be on solid when HDC is armed. HDC can only be armed when the transfer case is in the “4WD

Low” position and the vehicle speed is less than 30 mph (48 km/h). If these conditions are not met while attempting to use the HDC feature, the HDC indicator lamp will flash on/off.

10. Electronic Vehicle Information Center (EVIC) Display/Odometer Display

The odometer display shows the total distance the vehicle has been driven.

U.S. Federal regulations require that upon transfer of vehicle ownership, the seller certify to the purchaser the correct mileage that the vehicle has been driven. If your odometer needs to be repaired or serviced, the repair technician should leave the odometer reading the same

as it was before the repair or service. If s/he cannot do so, then the odometer must be set at zero, and a sticker must be placed in the door jamb stating what the mileage was before the repair or service. It is a good idea for you to make a record of the odometer reading before the repair/service, so that you can be sure that it is properly reset, or that the door jamb sticker is accurate if the odometer must be reset at zero.

When the appropriate conditions exist, this display shows the Electronic Vehicle Information Center (EVIC) messages. Refer to “Electronic Vehicle Information Center”.

11. *Tire Pressure Monitoring Telltale Light*



Each tire, including the spare (if provided), should be checked monthly, when cold and inflated to the inflation pressure recommended by the vehicle manufacturer on the vehicle

placard or tire inflation pressure label. (If your vehicle has tires of a different size than the size indicated on the vehicle placard or tire inflation pressure label, you should determine the proper tire inflation pressure for those tires.)

As an added safety feature, your vehicle has been equipped with a Tire Pressure Monitoring System (TPMS) that illuminates a low tire pressure telltale when one or more of your tires is significantly under-inflated. Accordingly, when the low tire pressure telltale illuminates, you should stop and check your tires as soon as possible, and inflate them to the proper pressure. Driving on a significantly under-inflated tire causes the tire to overheat and can lead to tire failure. Under-inflation also reduces fuel efficiency and tire tread life, and may affect the vehicle's handling and stopping ability.

Please note that the TPMS is not a substitute for proper tire maintenance, and it is the driver's responsibility to maintain correct tire pressure, even if under-inflation has not reached the level to trigger illumination of the TPMS low tire pressure telltale.

Your vehicle has also been equipped with a TPMS malfunction indicator to indicate when the system is not operating properly. The TPMS malfunction indicator is combined with the low tire pressure telltale. When the system detects a malfunction, the telltale will flash for approximately one minute and then remain continuously illuminated. This sequence will continue upon subsequent vehicle start-ups as long as the malfunction exists. When the malfunction indicator is illuminated, the system may not be able to detect or signal low tire pressure as intended. TPMS malfunctions may occur for a variety of reasons, including the installation of replacement or alternate tires or wheels on the vehicle that prevent the TPMS from functioning properly. Always check the

TPMS malfunction telltale after replacing one or more tires or wheels on your vehicle, to ensure that the replacement or alternate tires and wheels allow the TPMS to continue to function properly.

CAUTION!

The TPMS has been optimized for the original equipment tires and wheels. TPMS pressures and warning have been established for the tire size equipped on your vehicle. Undesirable system operation or sensor damage may result when using replacement equipment that is not of the same size, type, and/or style. Aftermarket wheels can cause sensor damage. Do not use tire sealant from a can, or balance beads if your vehicle is equipped with a TPMS, as damage to the sensors may result.

12. Position Light Indicator — If Equipped

 This indicator will illuminate when the park lights or headlights are turned on.

13. Seat Belt Reminder Light



When the ignition switch is first turned to the ON/RUN position, this light will turn on for four to eight seconds as a bulb check. During the bulb check, if the driver's seat belt is unbuckled, a chime will sound. After the bulb check or when driving, if the driver or front passenger seat belt remains unbuckled, the Seat Belt Indicator Light will flash or remain on continuously. Refer to "Occupant Restraints" in "Things To Know Before Starting Your Vehicle" for further information.

14. Brake Warning Light

BRAKE This light monitors various brake functions, including brake fluid level and parking brake application. If the brake light turns on, it may indicate that the parking brake is applied, that the brake fluid level is low, or that there is a problem with the anti-lock brake system reservoir.

If the light remains on when the parking brake has been disengaged, and the fluid level is at the full mark on the master cylinder reservoir, it indicates a possible brake hydraulic system malfunction or that a problem with the Brake Booster has been detected by the Anti-Lock Brake System (ABS) / Electronic Stability Control (ESC) system. In this case, the light will remain on until the condition has been corrected. If the problem is related to the brake booster, the ABS pump will run when applying the brake and a brake pedal pulsation may be felt during each stop.

The dual brake system provides a reserve braking capacity in the event of a failure to a portion of the hydraulic system. A leak in either half of the dual brake system is indicated by the Brake Warning Light, which will turn on when the brake fluid level in the master cylinder has dropped below a specified level.

The light will remain on until the cause is corrected.

NOTE: The light may flash momentarily during sharp cornering maneuvers, which change fluid level conditions. The vehicle should have service performed, and the brake fluid level checked.

If brake failure is indicated, immediate repair is necessary.

WARNING!

Driving a vehicle with the red brake light on is dangerous. Part of the brake system may have failed. It will take longer to stop the vehicle. You could have a collision. Have the vehicle checked immediately.

Vehicles equipped with the Anti-Lock Brake System (ABS), are also equipped with Electronic Brake Force Distribution (EBD). In the event of an EBD failure, the Brake Warning Light will turn on along with the ABS Light. Immediate repair to the ABS system is required.

Operation of the Brake Warning Light can be checked by turning the ignition switch from the OFF position to the ON/RUN position. The light should illuminate for approximately two seconds. The light should then turn off unless the parking brake is applied or a brake fault is detected. If the light does not illuminate, have the light inspected by an authorized dealer.

The light also will turn on when the parking brake is applied with the ignition switch in the ON/RUN position.

NOTE: This light shows only that the parking brake is applied. It does not show the degree of brake application.

15. *Anti-Lock Brake (ABS) Light*



This light monitors the Anti-Lock Brake System (ABS). The light will turn on when the ignition switch is turned to the ON/RUN position and may stay on for as long as four seconds.

If the ABS light remains on or turns on while driving, it indicates that the Anti-Lock portion of the brake system is not functioning and that service is required. However, the conventional brake system will continue to operate normally if the BRAKE warning light is not on.

If the ABS light is on, the brake system should be serviced as soon as possible to restore the benefits of Anti-Lock

brakes. If the ABS light does not turn on when the ignition switch is turned to the ON/RUN position, have the light inspected by an authorized dealer.

16. *4 LOW*



This light alerts the driver that the vehicle is in the four-wheel drive LOW mode. The front and rear driveshafts are mechanically locked together forcing the front and rear wheels to rotate at the same speed. Low range provides a greater gear reduction ratio to provide increased torque at the wheels.

For further information on four-wheel drive operation and proper use, refer to “Four-Wheel Drive Operation — If Equipped” in “Starting And Operating”.

17. *Speedometer*

Indicates vehicle speed.

18. Fuel Door Reminder

The fuel pump symbol points to the side of the vehicle where the fuel door is located.

19. Fuel Gauge

The pointer shows the level of fuel in the fuel tank when the ignition switch is in the ON/RUN position.

20. Electronic Vehicle Information Center (EVIC) White Telltale Area

This area will display the EVIC reconfigurable white telltales. For further information refer to “Electronic vehicle Information Center (EVIC)”.

21. Electronic Vehicle Information Center (EVIC) Amber Telltale Area

This area will display the EVIC reconfigurable amber caution telltales. For further information refer to “Electronic vehicle Information Center (EVIC)”.

22. Electronic Vehicle Information Center (EVIC) Red Telltale Area

This area will display the EVIC reconfigurable red telltales. For further information refer to “Electronic vehicle Information Center (EVIC)”.

23. Electronic Stability Control (ESC) OFF Indicator Light — If Equipped

This light indicates the Electronic Stability Control (ESC) is off.

24. Vehicle Security Light

This light will flash rapidly for approximately 15 seconds when the vehicle theft alarm is arming. The light will flash at a slower speed continuously after the alarm is set. The security light will also come on for about three seconds when the ignition is first turned on.

25. *Temperature Gauge*

The temperature gauge shows engine coolant temperature. Any reading within the normal range indicates that the engine cooling system is operating satisfactorily.

The gauge pointer will likely indicate a higher temperature when driving in hot weather, up mountain grades, or when towing a trailer. It should not be allowed to exceed the upper limits of the normal operating range.

CAUTION!

Driving with a hot engine cooling system could damage your vehicle. If the temperature gauge reads "H" pull over and stop the vehicle. Idle the vehicle with the air conditioner turned off until the pointer drops back into the normal range. If the pointer remains on the "H" and you hear continuous chimes, turn the engine off immediately, and call an authorized dealership for service.

WARNING!

A hot engine cooling system is dangerous. You or others could be badly burned by steam or boiling coolant. You may want to call an authorized dealership for service if your vehicle overheats. If you decide to look under the hood yourself, see "Maintaining Your Vehicle". Follow the warnings under the Cooling System Pressure Cap paragraph.

ELECTRONIC VEHICLE INFORMATION CENTER (EVIC)

The Electronic Vehicle Information Center (EVIC) features a driver-interactive display that is located in the instrument cluster.



Electronic Vehicle Information Center (EVIC) Display

The EVIC consists of the following:

- System Status
- Vehicle Information Warning Message Displays
- Personal Settings (Customer-Programmable Features)
- Compass Display
- Outside Temperature Display
- Trip Computer Functions

The system allows the driver to select information by pressing the following buttons mounted on the steering wheel:



EVIC Steering Wheel Buttons

UP Button



Press and release the UP button to scroll upward through the main menus (Fuel Economy, Vehicle Info, Tire PSI, Cruise, Messages, Units, System Setup) and sub menus.

DOWN Button



Press and release the DOWN button to scroll downward through the main menus and sub menus.

SELECT Button



Press and release the SELECT button for access to main menus, sub menus or to select a personal setting in the setup menu. Press and hold the SELECT button for two seconds to reset features.

BACK Button

Press the BACK button to scroll back to a **BACK** previous menu or sub menu.

Electronic Vehicle Information Center (EVIC) Displays

When the appropriate conditions exist, the EVIC displays the following messages:

- Service Tire Pressure System
- Service Park Assist System
- Park Assist System Blinded
- Park Assist Disabled
- Keyfob Battery Low
- Liftglass Open
- Left front turn signal lamp out
- Right front turn signal lamp out
- Left rear turn signal lamp out
- Right rear turn signal lamp out
- Check Tire Pressure
- ESC System Off
- Service blind spot system
- Blind spot detection unavailable
- Blind spot system off
- Blind spot system unavailable sensor blocked
- Normal Cruise Ready — When Adaptive Cruise Control (ACC) system is turned off and Normal (Fixed Speed) Cruise Control mode is available. Refer to “Adaptive Cruise Control (ACC)” in “Understanding The Features Of Your Vehicle” (if equipped).

- Adaptive Cruise Off — When the Adaptive Cruise Control (ACC) system is turned off. Refer to “Adaptive Cruise Control (ACC)” in “Understanding The Features Of Your Vehicle” (if equipped).
- ACC Ready — When the ACC system is activated. Refer to “Adaptive Cruise Control (ACC)” in “Understanding The Features Of Your Vehicle” (if equipped).
- ACC Set — After setting the desired speed in the ACC system. Refer to “Adaptive Cruise Control (ACC)” in “Understanding The Features Of Your Vehicle” (if equipped).
- ACC Cancelled — To disable the ACC system. Refer to “Adaptive Cruise Control (ACC)” in “Understanding The Features Of Your Vehicle” (if equipped).
- Sensed Vehicle Indicator — The system detects a slower moving vehicle in the same lane. Refer to “Adaptive Cruise Control (ACC)” in “Understanding The Features Of Your Vehicle” (if equipped).
- Driver Override — If you apply the accelerator after setting the desired speed in the ACC system. Refer to “Adaptive Cruise Control (ACC)” in “Understanding The Features Of Your Vehicle” (if equipped).
- Distance Set — After changing the desired following distance in the ACC system, this message will display momentarily. Refer to “Adaptive Cruise Control (ACC)” in “Understanding The Features Of Your Vehicle” (if equipped).
- Brake — If the ACC system predicts that its maximum braking level is not sufficient to maintain the set distance, this message will flash and a chime will sound while ACC continues to apply its maximum braking capacity. When this occurs, you should immediately apply the brakes as needed to maintain a safe distance from the vehicle ahead. Refer to “Adaptive Cruise Control (ACC)” in “Understanding The Features Of Your Vehicle” (if equipped).

- Clean Radar Sensor in the Front of Vehicle — If the ACC system deactivates due to performance limiting conditions. Refer to “Adaptive Cruise Control (ACC)” in “Understanding The Features Of Your Vehicle” (if equipped).
- ACC/FCW Unavailable Vehicle System Error — If the ACC system turns off due to a temporary malfunction that limits functionality. Refer to “Adaptive Cruise Control (ACC)” in “Understanding The Features Of Your Vehicle” (if equipped).
- ACC/FCW Unavailable Service Radar Sensor — If the ACC system turns off due to an internal system fault that requires service from an authorized dealer. Refer to “Adaptive Cruise Control (ACC)” in “Understanding The Features Of Your Vehicle” (if equipped).
- Coolant low
- Service air suspension system
- Oil change due
- Key in ignition
- Lights on
- Key in Ignition Lights On
- Ignition or Accessory On
- Ignition or Accessory On. Lights On
- Turn signal on
- Park assist on
- Warning object detected
- Remote start aborted — Door ajar
- Remote start aborted — Hood ajar
- Remote start aborted — L/Gate ajar
- Remote start aborted — Fuel low

- Remote start disabled — System fault
- Remote start disabled — Turn key
- Remote start active — Key to Run
- Memory 1 profile set
- Memory 2 profile set
- Memory system unavailable — Not in Park
- Memory system unavailable — Seatbelt buckled
- Memory 1 profile recall
- Memory 2 profile recall
- Press Brake Pedal and Push Button to Start
- Wrong Key
- Damaged Key
- Key not programmed
- Function currently unavailable — Power Liftgate
- Unlock to operate — Power Liftgate
- Put in Park to operate — Power Liftgate
- Automatic high beams on
- Automatic high beams off
- Service Four Wheel Drive System
- Four Wheel Drive System in neutral
- ECO — Fuel Saver Indicator
- TERRAIN SETTINGS — AUTOMATIC
- TERRAIN SETTINGS — ROCK
- TERRAIN SETTINGS — SAND/MUD
- TERRAIN SETTINGS — SNOW
- TERRAIN SETTINGS — SPORT

- Sport Not Available in 4 Low 4 High is Required
- Rock Not Available in 4 Low 4 High is Required
- To Tow Vehicle Safely, Read Neutral Shift Procedure in Owners Manual
- For 4x4 Low Slow Below 5 MPH or 8 KPH Put Trans in N Press 4 Low
- For 4x4 High Slow Below 5 MPH or 8 KPH Put Trans in N Press 4 Low
- Terrain System Settings Not Available
- Raising Vehicle Ride Height (with icon)
- Lowering Vehicle Ride Height (with icon)
- Normal Vehicle Ride Height — This message is displayed (for 5 seconds) when the vehicle has achieved the Normal Vehicle Ride Height.
- Off Road Ride Height Level 1 — This message is displayed (for 5 seconds) when the vehicle has achieved the Off Road Height Level 1.
- Off Road Ride Height Level 2 — This message is displayed (for 5 seconds) when the vehicle has achieved the Off Road Height Level 2.
- Vehicle Lowered To Entry/Exit (Park) Height — This message is displayed (for 5 seconds) when the vehicle has achieved the Park Height.
- Entry/Exit (Park) Height in Progress — This message is displayed (for 5 seconds) when the request is made to go into Entry/Exit Height while the vehicle speed is between 15 and 25 mph. This shows that the request has been recognized and will lower to Entry/Exit height when vehicle is below 15 mph.

- Service Air Suspension System — This is displayed when a fault has occurred in the system. The system will have limited operation at that point.
- Immediate Air Suspension Service/Repair Required — This is displayed when a fault has occurred in the system which results in a complete system shutdown. The system will be non operational at that point.
- Reduce Speed To Maintain Selected Ride Height — This message is displayed in advance warning to the driver that the vehicle will be moved to the next lower preset position unless the speed is reduced.
- Selected Ride Height Not Permitted — The vehicle speed is too high to enter one of the preset levels (Entry/Exit Level/Off Road Ride Height Level 1/Off Road Ride Height Level 2).
- Air Suspension System Cooling Down – Please Wait — This message is displayed if the compressor temperature level is too high. Level control is suspended until the compressor has cooled down.
- Vehicle Cannot Be Lowered – Door Open — This message is displayed if a door or the liftgate is ajar and level control is suspended.
- Air Suspension Temporarily Disabled For Jacking And Tire Change
- Aerodynamic Ride Height — This is displayed (for 5 seconds) when the vehicle has achieved the Aerodynamic Height.

EVIC White Telltale Lights

This area will show reconfigurable white caution telltales. These telltales include:

- *Shift Lever Status*

The shift lever status “P,R,N,D,L,5,4,3,2,1” are displayed indicating the shift lever position. Telltales “5,4,3,2,1” indicate the Electronic Range Select (ERS) feature has been engaged and the gear selected is displayed. For further information on ERS, refer to “Starting And Operating”

- *Electronic Speed Control ON*



This light will turn on when the electronic speed control is ON. For further information, refer to “Electronic Speed Control” in “Understanding The Features Of Your Vehicle”.

- *Electronic Speed Control SET*



This light will turn on when the electronic speed control is SET. For further information, refer to “Electronic Speed Control” in “Understanding The Features Of Your Vehicle”.

- *Adaptive Cruise Control (ACC) ON*



This light will turn on when the ACC is ON. For further information, refer to “Adaptive Cruise Control (ACC)” in “Understanding The Features Of Your Vehicle”.

- *Adaptive Cruise Control (ACC) SET*



This light will turn on when the ACC is SET. For further information, refer to “Adaptive Cruise Control (ACC)” in “Understanding The Features Of Your Vehicle”.

- *Power Steering System Over Temperature — If Equipped*



If the “POWER STEERING SYSTEM OVER TEMP” message and a icon are displayed on the EVIC screen, it indicates that extreme steering maneuvers may have occurred, which caused an over temperature condition in the power steering system. You will lose power steering assistance momentarily until the over temperature condition no longer exists. Once driving conditions are safe, then pull over and let vehicle idle. After five minutes, the system will cool and return to normal operation. Refer to “Power Steering” in “Starting and Operating” for further information.

NOTE:

- Even if power steering assistance is no longer operational, it is still possible to steer the vehicle. Under these conditions there will be a substantial increase in steering effort, especially at very low vehicle speeds and during parking maneuvers.
- If the condition persists, see your authorized dealer for service.

EVIC Amber Telltale Lights

This area will show reconfigurable amber caution telltales. These telltales include:

- *Forward Collision Warning (FCW) OFF*

FCW OFF This light warns the driver of a potential collision with the vehicle in front of you and prompts the driver to take action in order to avoid the collision. For further information, refer to “Adaptive Cruise Control (ACC)” in “Understanding The Features Of Your Vehicle”.

- *Air Suspension Up*



The air suspension up telltale will illuminate when the air suspension is in use. For further information, refer to “Starting And Operating”.

- *Air Suspension Down*



The air suspension down telltale will illuminate when the air suspension is in use. For further information, refer to “Starting And Operating”.

- *Low Fuel Light*



When the fuel level reaches approximately 3.0 gal (11.0 L) this light will turn on, and remain on until fuel is added.

- *Loose Gascap Indicator*



If the vehicle diagnostic system determines that the fuel filler cap is loose, improperly installed, or damaged, a loose gascap indicator

will display in the telltale display area. Tighten the fuel filler cap properly and press the SELECT button to turn off the message. If the problem continues, the message will appear the next time the vehicle is started.

A loose, improperly installed, or damaged fuel filler cap may also turn on the Malfunction Indicator Light (MIL).

- *Windshield Washer Fluid Low Indicator*



This light will turn on to indicate the windshield washer fluid is low.

- *SERV 4WD*



The SERV 4WD light monitors the electric shift 4WD system. If the SERV 4WD light stays on or comes on during driving, it means that the 4WD system is not functioning properly and that service is required.

EVIC Red Telltale Lights

This area will show reconfigurable red telltales. These telltales include:

- *Door Ajar*



This light will turn on to indicate that one or more door may be ajar.

- *Liftgate Ajar*



This light will turn on to indicate that liftgate may be ajar.

- *Liftgate Flipper Glass Ajar*



This light will turn on to indicate that liftgate flipper glass may be ajar.

- *Oil Pressure Warning Light*



This light indicates low engine oil pressure. The light should turn on momentarily when the engine is started. If the light turns on while driving, stop the vehicle and shut off the engine as soon as possible. A chime will sound for four minutes when this light turns on.

Do not operate the vehicle until the cause is corrected. This light does not show how much oil is in the engine. The engine oil level must be checked under the hood.

- *Charging System Light*



This light shows the status of the electrical charging system. The light should come on when the ignition switch is first turned ON and remain on briefly as a bulb check. If the light stays on or comes on while driving, turn off some of the vehicle's non-essential electrical devices or increase engine speed (if at idle). If the charging system light remains on, it means that the

vehicle is experiencing a problem with the charging system. Obtain SERVICE IMMEDIATELY. See an authorized dealer.

If jump starting is required, refer to “Jump Starting Procedures” in “What To Do In Emergencies”.

- **Electronic Throttle Control (ETC) Light**

 This light informs you of a problem with the Electronic Throttle Control (ETC) system. The light will come on when the ignition is first turned ON and remain on briefly as a bulb check. If the light does not come on during starting, have the system checked by an authorized dealer.

If a problem is detected, the light will come on while the engine is running. Cycle the ignition key when the vehicle has completely stopped and the shift lever is placed in the PARK position. The light should turn off.

If the light remains lit with the engine running, your vehicle will usually be drivable. However, see an authorized dealer for service as soon as possible. If the light is flashing when the engine is running, immediate service is required and you may experience reduced performance, an elevated/rough idle or engine stall and your vehicle may require towing.

- **Engine Temperature Warning Light**

 This light warns of an overheated engine condition. As temperatures rise and the gauge approaches **H**, this indicator will illuminate and a single chime will sound after reaching a set threshold. Further overheating will cause the temperature gauge to pass **H**, the indicator will continuously flash and a continuous chime will occur until the engine is allowed to cool.

If the light turns on while driving, safely pull over and stop the vehicle. If the A/C system is on, turn it off. Also, shift the transmission into NEUTRAL and idle the vehicle. If the temperature reading does not return to normal, turn the engine off immediately and call for service. Refer to “If Your Engine Overheats” in “What To Do In Emergencies” for more information.

- *Transmission Temperature Warning Light*



This light indicates that there is excessive transmission fluid temperature that might occur with severe usage such as trailer towing. It may also occur when operating the vehicle in a high torque converter slip condition, such as 4-wheel-drive operation (e.g., snow plowing, off- road operation). If this light comes on, stop the vehicle and run the engine at idle or faster, with the transmission in NEUTRAL until the light goes off.

CAUTION!

Continuous driving with the Transmission Temperature Warning Light illuminated will eventually cause severe transmission damage or transmission failure.

WARNING!

If the Transmission Temperature Warning Light is illuminated and you continue operating the vehicle, in some circumstances you could cause the fluid to boil over, come in contact with hot engine or exhaust components and cause a fire.

Engine Oil Change Indicator System

Oil Change Due

Your vehicle is equipped with an engine oil change indicator system. The “Oil Change Due” message will flash in the EVIC display for approximately 10 seconds after a single chime has sounded, to indicate the next scheduled oil change interval. The engine oil change indicator system is duty cycle based, which means the engine oil change interval may fluctuate, dependent upon your personal driving style.

Unless reset, this message will continue to display each time you turn the ignition switch to the ON/RUN position. To turn off the message temporarily, press and release the MENU button. To reset the oil change indicator system (after performing the scheduled maintenance) refer to the following procedure.

1. Turn the ignition switch to the ON position (Do not start the engine).

2. Fully depress the accelerator pedal, slowly, three times within 10 seconds.

3. Turn the ignition switch to the OFF/LOCK position.

NOTE: If the indicator message illuminates when you start the vehicle, the oil change indicator system did not reset. If necessary, repeat this procedure.

Fuel Economy

Press and release the UP or DOWN button until “Fuel Economy” displays highlighted in the EVIC and press the SELECT button. Press and release the UP/DOWN buttons until one of the following Fuel Economy functions displays in the EVIC:

- Average Fuel Economy/Fuel Saver Mode
- Distance To Empty (DTE)
- Miles Per Gallon (MPG)

Press the UP/DOWN buttons to cycle through all the Trip Computer functions.

The Trip Functions mode displays the following information:

Average Fuel Economy / Fuel Saver Mode — If Equipped

Shows the average fuel economy since the last reset. When the fuel economy is reset, the display will read “RESET” or show dashes for two seconds. Then, the history information will be erased, and the averaging will continue from the last fuel average reading before the reset.

The FUEL SAVER MODE message will display above the average fuel economy in the EVIC display. This message will appear whenever MDS (if equipped) allows the engine to operate on four cylinders, or if you are driving in a fuel efficient manner.

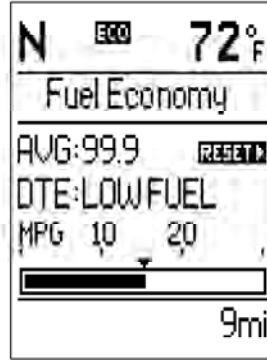

Fuel Saver Mode — On

This feature allows you to monitor when you are driving in a fuel efficient manner, and it can be used to modify driving habits in order to increase fuel economy.

Distance To Empty (DTE)

Shows the estimated distance that can be traveled with the fuel remaining in the tank. This estimated distance is

determined by a weighted average of the instantaneous and average fuel economy, according to the current fuel tank level. DTE cannot be reset through the SELECT button.

NOTE: Significant changes in driving style or vehicle loading will greatly affect the actual drivable distance of the vehicle, regardless of the DTE displayed value.

When the DTE value is less than 30 miles (48 km) estimated driving distance, the DTE display will change to a “LOW FUEL” message. This display will continue until the vehicle runs out of fuel. Adding a significant amount of fuel to the vehicle will turn off the “LOW FUEL” message and a new DTE value will display.

Vehicle Speed

Press and release the UP or DOWN button until “Vehicle Speed” displays highlighted in the EVIC and press the SELECT button. Press the SELECT button to display the

current speed in mph or km/h. Pressing the SELECT button a second time will toggle the unit of measure between mph or km/h

NOTE: Changing the unit of measure in the Vehicle Speed menu will not change the unit of measure in the EVIC.

Trip Info

Press and release the UP or DOWN button until “Trip Info” displays highlighted in the EVIC and press the SELECT button. Press and release the UP/DOWN buttons until one of the following Trip functions displays in the EVIC:

- Trip A
- Trip B
- Elapsed Time

Press the UP/DOWN buttons to cycle through all the Trip Computer functions.

The Trip Functions mode displays the following information:

Trip A

Shows the total distance traveled for Trip A since the last reset.

Trip B

Shows the total distance traveled for Trip B since the last reset.

Elapsed Time

Shows the total elapsed time of travel since the last reset when the ignition switch is in the ACC position. Elapsed time will increment when the ignition switch is in the ON or START position.

To Reset The Display

Reset will only occur while a resettable function is being displayed. Press and release the SELECT button once to clear the resettable function being displayed. To reset all resettable functions, press and hold the SELECT button for two seconds. Current display will reset along with other functions

Units

Press and release the UP or DOWN button until “Units” displays highlighted in the EVIC and press the SELECT button. The EVIC, odometer, and navigation system (if equipped) can be changed between English and Metric units of measure. To make your selection, scroll up or down until the preferred setting is highlighted, then press and release the SELECT button until a check-mark appears next to the setting, showing that setting has been selected.

Vehicle Info (Customer Information Features)

Press and release the UP or DOWN button until “Vehicle Info” displays in the EVIC and press the SELECT button. Press the UP and DOWN button to scroll through the available information displays, then press SELECT to display anyone of the following choices.

- **Coolant Temp**

Displays the actual coolant temperature.

- **Oil Temperature**

Displays the actual oil temperature.

- **Oil Pressure**

Displays the actual oil pressure.

- **Trans Temperature**

Displays the actual transmission temperature.

- **Engine Hours**

Displays the hours of engine operation.

Tire PSI

Press and release the UP or DOWN button until “Tire PSI” displays highlighted in the EVIC and press the SELECT button. Press and release the UP/DOWN buttons until one of the following System Status messages displays in the EVIC:

- System OK
- System Warnings Displayed (will display all currently active System Warnings)
- Tire Pressure Monitor System (shows the current pressure of all four road tires). For additional information, refer to “Tire Pressure Monitor System” in “Starting And Operating”.



Tire Pressure Display

041033426

NOTE:

- Tires heat up during normal driving conditions. Heat will cause the tire pressure to increase from 2 to 6 psi (14 to 41 kPa) during normal driving conditions. Refer to “Tires-General Information/Tire Inflation Pressures” in “Starting And Operating” for additional information.

- Your system can be set to display pressure units in PSI, kPa, or BAR.

Keyless Enter-N-Go Display — If Equipped

When the ENGINE START/STOP button is pressed to change ignition switch positions, the Keyless Enter-N-Go icon momentarily appears in the lower right corner of the EVIC display showing the new ignition switch position.

Refer to “Keyless Enter-N-Go” in “Starting And Operating” for more information.

NOTE: Under certain conditions, the display may be superseded by another display of higher priority. But when the ignition switch position is changed, the display always re-appears.

Compass / Temperature Display

The compass readings indicate the direction the vehicle is facing. The EVIC will display one of eight compass readings and the outside temperature.

NOTE: The system will display the last known outside temperature when starting the vehicle and may need to be driven several minutes before the updated temperature is displayed. Engine temperature can also affect the displayed temperature, therefore temperature readings are not updated when the vehicle is not moving.

Automatic Compass Calibration

This compass is self-calibrating, which eliminates the need to manually reset the compass. When the vehicle is new, the compass may appear erratic and the EVIC will display CAL until the compass is calibrated. You may also calibrate the compass by completing one or more 360-degree turns (in an area free from large metal or metallic objects) until the CAL indicator displayed in the EVIC turns off. The compass will now function normally.

NOTE: A good calibration requires a level surface and an environment free from large metallic objects such as buildings, bridges, underground cables, railroad tracks, etc.

Manual Compass Calibration

If the compass appears erratic and the CAL indicator does not appear in the EVIC display, you must put the compass into the Calibration Mode manually, as follows:

1. Turn ON the ignition switch.
2. Press the UP or DOWN button until the Setup (Customer-Programmable Features) menu is reached, then press the SELECT button.
3. Press the DOWN button until "Calibrate Compass" is displayed in the EVIC.
4. Press and release the SELECT button to start the calibration. The "CAL" indicator will be displayed in the EVIC.

5. Complete one or more 360-degree turns (in an area free from large metal or metallic objects) until the “CAL” indicator turns off. The compass will now function normally.

Compass Variance

Compass Variance is the difference between Magnetic North and Geographic North. To compensate for the differences the variance should be set for the zone where the vehicle is driven, per the zone map. Once properly set, the compass will automatically compensate for the differences, and provide the most accurate compass heading. For the most accurate compass performance, the compass must be set using the following steps.

NOTE: Keep magnetic materials away from the top of the instrument panel, such as iPod’s, Mobile Phones, Laptops and Radar Detectors. This is where the compass module is located, and it can cause interference with the compass sensor, and it may give false readings.

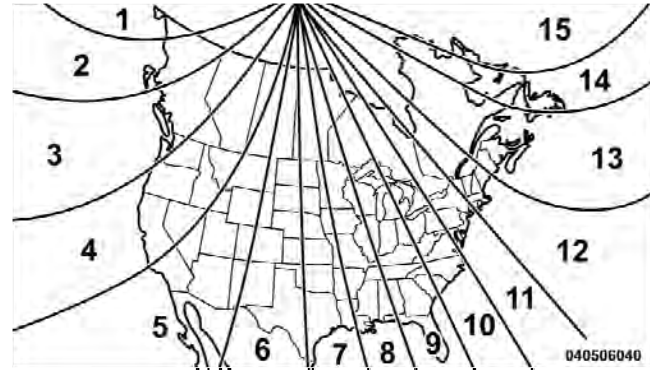

Compass Variance Map

1. Turn the ignition switch ON.
2. Press the UP or DOWN button until the Setup (Customer-Programmable Features) menu is reached, then press the SELECT button.

3. Press the DOWN button until the “Compass Variance” message is displayed in the EVIC, then press the SELECT button. The last variance zone number displays in the EVIC.
4. Press and release the SELECT button until the proper variance zone is selected, according to the map.
5. Press and release the RETURN button to exit.

Customer-Programmable Features (System Setup)

Personal Settings allows you to set and recall features when the transmission is in PARK. If the transmission is out of PARK or the vehicle begins moving, a warning message **SETUP NOT AVAILABLE**, is followed in three seconds by, **VEHICLE NOT IN PARK**.

Press and release the UP or DOWN button until Setup displays in the EVIC.

Use the UP or DOWN button to display one of the following choices.

Select Language

When in this display you may select one of five languages for all display nomenclature, including the trip functions and the navigation system (if equipped). Press the UP or DOWN button while in this display and scroll through the language choices. Press the SELECT button to select English, Spanish (Español), French (Français), Italian (Italiano), German (Deutsch), and Dutch (Nederlands). Then, as you continue, the information will display in the selected language.

Nav-Turn By Turn

When this feature is selected, the navigation system utilizes voice commands, guiding through the drive route, mile by mile, turn-by-turn until the final destination is reached. To make your selection, press and release the SELECT button until a check-mark appears next to the feature showing the system has been activated or the check-mark is removed, showing the system has been deactivated.

Auto Lock Doors

When this feature is selected, all doors will lock automatically when the vehicle reaches a speed of 15 mph (24 km/h). To make your selection, press and release the SELECT button until a check-mark appears next to the feature showing the system has been activated, or the check-mark is removed showing the system has been deactivated.

Auto Unlock Doors

When this feature is selected, all doors will unlock when the vehicle is stopped and the transmission is in the PARK or NEUTRAL position and the driver's door is opened. To make your selection, press and release the SELECT button until a check-mark appears next to the feature showing the system has been activated, or the check-mark is removed showing the system has been deactivated.

Remote Unlock Sequence

When **Unlock Driver Door Only On 1st Press** is selected, only the driver's door will unlock on the first press of the RKE transmitter UNLOCK button. When **Driver Door 1st Press** is selected, you must press the RKE transmitter UNLOCK button twice to unlock the passenger's doors. When **Unlock All Doors On 1st Press** is selected, all of the doors will unlock on the first press of the RKE transmitter UNLOCK button. To make your selection, scroll up or down until the preferred setting is highlighted, then press and release the SELECT button until a check-mark appears next to the setting, showing that setting has been selected.

NOTE: If the vehicle is equipped with Keyless Enter-N-Go (Passive Entry) and the EVIC is programmed to **Unlock All Doors 1st Press**, all doors will unlock no matter which Passive Entry equipped door handle is grasped. If **Driver Door 1st Press** is programmed, only the driver's door will unlock when the driver's door is

grasped. With Passive Entry, if Driver Door 1st Press is programmed touching the handle more than once will only result in the driver's door opening. If driver door first is selected, once the driver door is opened, the interior door lock/unlock switch can be used to unlock all doors (or use RKE transmitter).

RKE Linked To Memory

When this feature is selected, you can use your RKE transmitter to recall one of two pre-programmed memory profiles. Each memory profile contains desired position settings for the driver seat, side mirror, adjustable pedals (if equipped), power tilt and telescopic steering column (if equipped), and a set of desired radio station presets. When OFF is selected, only the MEMORY switch on the driver's door trim panel will recall memory profiles. To make your selection, press and release the SELECT button a check-mark appears next to the feature showing the system has been activated or the check-mark is

removed, showing the system has been deactivated. Refer to "Driver Memory Seat" in "Understanding The Features Of Your Vehicle".

Remote Start Comfort Sys.

When this feature is selected and the remote start is activated, the heated steering wheel and driver heated seat features will automatically turn on in cold weather. In warm weather, the driver vented seat feature will automatically turn on when the remote start is activated. These features will stay on through the duration of remote start or until the key is turned to RUN. To make your selection, press and release the SELECT button until a check-mark appears next to the feature showing the system has been activated or the check-mark is removed, showing the system has been deactivated.

Horn with Remote Lock

When this feature is selected, a short horn sound will occur when the RKE transmitter LOCK button is pressed.

This feature may be selected with or without the “Flash Lamps with Lock” feature. To make your selection, press and release the SELECT button until a check-mark appears next to the feature showing the system has been activated or the check-mark is removed, showing the system has been deactivated.

Horn With Remote Start

When this feature is selected, a short horn sound will occur when the RKE transmitter REMOTE START button is pressed. To make your selection, press and release the SELECT button until a check-mark appears next to the feature showing the system has been activated or the check-mark is removed, showing the system has been deactivated.

Flash Lamps With Lock

When this feature is selected, the front and rear turn signals will flash when the doors are locked or unlocked with the RKE transmitter. This feature may be selected

with or without the sound horn on lock feature selected. To make your selection, press and release the SELECT button until a check-mark appears next to the feature showing the system has been activated or the check-mark is removed, showing the system has been deactivated.

Headlamp Off Delay

When this feature is selected, the driver can choose to have the headlights remain on for 0, 30, 60, or 90 seconds when exiting the vehicle. To make your selection, scroll up or down until the preferred setting is highlighted, then press and release the SELECT button until a check-mark appears next to the setting, showing that setting has been selected.

Headlamps with Wipers

(Available with Automatic Headlamps Only)

When this feature is selected, and the headlight switch is in the AUTO position, the headlights will turn on approximately 10 seconds after the wipers are turned on.

The headlights will also turn off when the wipers are turned off if they were turned on by this feature. To make your selection, press and release the SELECT button until a check-mark appears next to the feature showing the system has been activated or the check-mark is removed, showing the system has been deactivated.

NOTE: Turning the headlights on during the daytime causes the instrument panel lights to dim. To increase the brightness, refer to “Lights” in “Understanding The Features Of Your Vehicle”.

Easy Entry/Exit Seat (Available with Memory Seat Only)

This feature provides automatic driver seat positioning to enhance driver mobility when entering and exiting the vehicle. To make your selection, press and release the SELECT button until a check-mark appears next to the feature showing the system has been activated or the check-mark is removed, showing the system has been deactivated.

NOTE: The seat will return to the memorized seat location (if Recall Memory with Remote Key Unlock is set to ON) when the RKE transmitter is used to unlock the door. Refer to “Driver Memory Seat” in “Understanding The Features Of Your Vehicle” for further information.

Tilt Mirror in Reverse

When this feature is selected, the outside rearview mirrors will tilt downward when the ignition switch is in the RUN position and the transmission shift lever is in the REVERSE position. The mirrors will move back to their previous position when the transmission is shifted out of REVERSE. To make your selection, press and release the SELECT button until a check-mark appears next to the feature showing the system has been activated or the check-mark is removed, showing the system has been deactivated.

Key-Off Power Delay

When this feature is selected, the power window switches, radio, hands-free system (if equipped), DVD video system (if equipped), power sunroof (if equipped), and power outlets will remain active for up to 10 minutes after the ignition switch is turned OFF. Opening either front vehicle door will cancel this feature. To make your selection, scroll up or down until the preferred setting is highlighted, then press and release the SELECT button until a check-mark appears next to the setting, showing that setting has been selected.

Illuminated Approach

When this feature is selected, the headlights will activate and remain on for 0, 30, 60, or 90 seconds when the doors are unlocked with the RKE transmitter. To make your selection, scroll up or down until the preferred setting is highlighted, then press and release the SELECT button until a check-mark appears next to the setting, showing that setting has been selected.

Display Fuel Saver — If Equipped

The “ECO” message is located in the Compass/Temperature display, this message can be turned on or off. To make your selection, press and release the FUNCTION SELECT button until “ON” or “OFF” appears.

Keyless Enter-N-Go (Passive Entry)

This feature allows you to lock and unlock the vehicle's door(s) without having to press the RKE transmitter lock or unlock buttons. To make your selection, press and release the SELECT button until a check-mark appears next to the feature showing the system has been activated or the check-mark is removed, showing the system has been deactivated. Refer to “Keyless Enter-N-Go” in “Things To Know Before Starting Your Vehicle”.

Auto High Beams

(Available with SmartBeam™ Only)

When this feature is selected, the high beam headlights will deactivate automatically under certain conditions. To

make your selection, press and release the SELECT button until a check-mark appears next to the feature showing the system has been activated or the check-mark is removed, showing the system has been deactivated. Refer to “Lights/SmartBeam™ — If Equipped” in “Understanding The Features Of Your Vehicle” for further information.

Wiper Mode — If Equipped

When this feature is selected, the system will automatically activate the windshield wipers if it senses moisture on the windshield. To make your selection, press and release the SELECT button until a check-mark appears next to the feature showing the system has been activated or the check-mark is removed, showing the system has been deactivated. When this feature is deactivated, the system reverts to the standard intermittent wiper operation.

Hill Start Assist (HSA)

When this feature is selected, the HSA system is active. Refer to “Electronic Brake Control System” in “Starting And Operating” for system function and operating information. To make your selection, press and release the SELECT button until a check-mark appears next to the feature showing the system has been activated or the check-mark is removed, showing the system has been deactivated.

Blind Spot Alert

There are three selections when operating Blind Spot Alert. By pressing and releasing the SELECT button once, the Blind Spot Alert feature can be activated in “Blind Spot: Lights Only” mode. When this mode is selected the Blind Spot Monitor (BSM) system is activated and will only show a visual alert in the outside mirrors. By pressing and releasing the SELECT button a second time “Blind Spot: Lights/CHM” mode is activated. In this mode the Blind Spot Monitor (BSM) will show a visual

alert in the outside mirrors as well as an audible alert when the turn signal is on. When “Blind Spot: Off” is selected the Blind Spot Monitor (BSM) system is deactivated.

NOTE: If your vehicle has experienced any damage in the area where the sensor is located, even if the fascia is not damaged, the sensor may have become misaligned. Take your vehicle to an authorized dealer to verify sensor alignment. Having a sensor that is misaligned will result in the BSM not operating to specification.

Forward Collision Warning

The Forward Collision Warning (FCW) feature can be set to Far, set to Near or turned Off. The default status of FCW is the Far setting. This means the system will warn you of a possible collision with the vehicle in front of you when you are farther away. This gives you the most reaction time. To change the setting for more dynamic driving select the Near setting. This warns you

of a possible collision with the vehicle in front of you when you are much closer. This allows for a more dynamic driving experience. To change FCW status press and release the SELECT button until a check-mark appears next to the feature showing the system has been activated or the check-mark is removed, showing the system has been deactivated.

For further information, refer to “Adaptive Cruise Control (ACC)” in “Understanding The Features Of Your Vehicle”.

Display Units of Measure In:

The EVIC, odometer, and Uconnect™ gps (if equipped) can be changed between English and Metric units of measure. To make your selection, press and release the SELECT button until “ENGLISH” or “METRIC” appears.

Calibrate Compass

Refer to “Compass Display” for more information.

Compass Variance

Refer to “Compass Display” for more information.

MEDIA CENTER 730N/430/430N (RHR/RER/RBZ/ RHB) CD/DVD/HDD/NAV — IF EQUIPPED

NOTE: The sales code is located on the lower right side of the unit’s faceplate.

Refer to your Uconnect™ Multimedia RHR, RER, RBZ or RHB user’s manual for detailed operating instructions.

Operating Instructions (Voice Command System) — If Equipped

Refer to “Voice Command” in the Uconnect™ User Manual located on the DVD for further details.

Operating Instructions (Uconnect™ Phone) — If Equipped

Refer to “Uconnect™ Phone” in the Uconnect™ User Manual located on the DVD for further details.

MEDIA CENTER 130 (SALES CODE RES)

NOTE: The radio sales code is located on the lower right side of the radio faceplate.

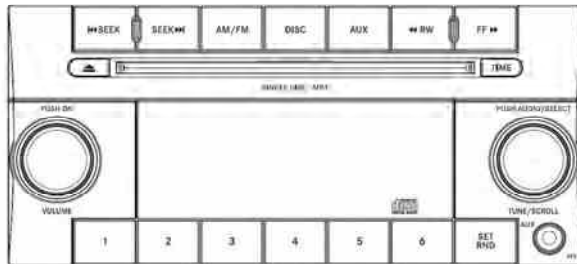

042305232

Media Center 130 (RES)

Operating Instructions — Radio Mode

NOTE: The ignition switch must be in the ON or ACC position to operate the radio.

Power Switch/Volume Control (Rotary)

Push the ON/VOLUME control knob to turn on the radio. Push the ON/VOLUME control knob a second time to turn off the radio.

Electronic Volume Control

The electronic volume control turns continuously (360 degrees) in either direction, without stopping. Turning the ON/VOLUME control knob to the right increases the volume, and to the left decreases it.

When the audio system is turned on, the sound will be set at the same volume level as last played.

SEEK Buttons

Press and release the SEEK buttons to search for the next listenable station in AM/FM mode. Press the right switch to seek up and the left switch to seek down. The radio will remain tuned to the new station until you make another selection. Holding either button will bypass stations without stopping, until you release it.

TIME Button

Press the TIME button to alternate display of the time and radio frequency.

Clock Setting Procedure

1. Press and hold the TIME button until the hours blink.
2. Adjust the hours by turning the right side TUNE/SCROLL control knob.
3. After adjusting the hours, press the right side TUNE/SCROLL control knob to set the minutes. The minutes will begin to blink.

4. Adjust the minutes using the right side TUNE/SCROLL control knob. Press the TUNE/SCROLL control knob to save time change.

5. To exit, press any button/knob, or wait five seconds.

RW/FF

Pressing the RW (Rewind) or FF (Fast Forward) buttons causes the tuner to search for the next frequency in the direction of the arrows. This feature operates in either AM or FM frequencies.

TUNE Control

Turn the rotary TUNE/SCROLL control knob clockwise to increase or counterclockwise to decrease the frequency.

Setting the Tone, Balance, and Fade

Push the rotary TUNE/SCROLL control knob and BASS will display. Turn the TUNE/SCROLL control knob to the right or left to increase or decrease the bass tones.

Push the rotary TUNE/SCROLL control knob a second time and MID will display. Turn the TUNE/SCROLL control knob to the right or left to increase or decrease the mid-range tones.

Push the rotary TUNE/SCROLL control knob a third time and TREBLE will display. Turn the TUNE/SCROLL control knob to the right or left to increase or decrease the treble tones.

Push the rotary TUNE/SCROLL control knob a fourth time and BALANCE will display. Turn the TUNE/SCROLL control knob to the right or left to adjust the sound level from the right or left side speakers.

Push the rotary TUNE/SCROLL control knob a fifth time and FADE will display. Turn the TUNE/SCROLL control knob to the left or right to adjust the sound level between the front and rear speakers.

Push the rotary TUNE/SCROLL control knob again to exit setting tone, balance, and fade.

AM/FM Button

Press the buttons to select either AM or FM mode.

SET/RND Button — To Set the Pushbutton Memory

When you are receiving a station that you wish to commit to pushbutton memory, press the SET/RND button. The symbol SET 1 will now show in the display window. Select the button (1 to 6) you wish to lock onto this station and press and release that button. If a button is not selected within five seconds after pressing the SET/RND button, the station will continue to play but will not be stored into pushbutton memory.

You may add a second station to each pushbutton by repeating the above procedure with this exception: Press the SET/RND button twice and SET 2 will show in the display window. Each button can be set for SET 1 and SET 2 in both AM and FM. This allows a total of 12 AM and 12 FM stations to be stored into pushbutton memory. The stations stored in SET 2 memory can be selected by pressing the pushbutton twice.

Every time a preset button is used, a corresponding button number will display.

Buttons 1 - 6

These buttons tune the radio to the stations that you commit to pushbutton memory (12 AM and 12 FM stations).

DISC Button

Pressing the DISC button will allow you to switch from AM/FM modes to Disc modes.

Operation Instructions — CD MODE For CD And MP3 Audio Play**NOTE:**

- The ignition switch must be in the ON or ACC position to operate the radio.

- This radio is capable of playing compact discs (CD), recordable compact discs (CD-R), rewritable compact discs (CD-RW), compact discs with MP3 tracks and multisession compact discs with CD and MP3 tracks.

Inserting Compact Disc(s)

Gently insert one CD into the CD player with the CD label facing up. The CD will automatically be pulled into the CD player and the CD icon will illuminate on the radio display. If a CD does not go into the slot more than 1.0 in (2.5 cm), a disc may already be loaded and must be ejected before a new disc can be loaded.

If you insert a disc with the ignition ON and the radio ON, the unit will switch from radio to CD mode and begin to play when you insert the disc. The display will show the track number, and index time in minutes and seconds. Play will begin at the start of track 1.

CAUTION!

- This CD player will accept 4-3/4 in (12 cm) discs only. The use of other sized discs may damage the CD player mechanism.
- Do not use adhesive labels. These labels can peel away and jam the player mechanism.
- RES is a single CD player. Do not attempt to insert a second CD if one is already loaded.
- Dual-media disc types (one side is a DVD, the other side is a CD) should not be used, and they can cause damage to the player.

EJECT Button - Ejecting a CD

Press the EJECT button to eject the CD.



If you have ejected a disc and have not removed it within 10 seconds, it will be reloaded. If the CD is not removed, the radio will reinsert the CD but will not play it.

A disc can be ejected with the radio and ignition OFF.

NOTE: Ejecting with the ignition OFF is not allowed on convertible or soft-top models (if equipped).

SEEK Button

Press the right SEEK button for the next selection on the CD. Press the left SEEK button to return to the beginning of the current selection, or return to the beginning of the previous selection if the CD is within the first second of the current selection. Pressing and holding the SEEK button will allow faster scrolling through the tracks in CD and MP3 modes.

TIME Button

Press this button to change the display from a large CD playing time display to a small CD playing time display.

RW/FF

Press and hold the FF (Fast Forward) button and the CD player will begin to fast forward until FF is released, or RW or another CD button is pressed. The RW (Reverse) button works in a similar manner.

AM/FM Button

Press the button to select either AM or FM mode.

SET/RND Button (Random Play Button)

Press this button while the CD is playing to activate Random Play. This feature plays the selections on the compact disc in random order to provide an interesting change of pace.

Press the right SEEK button to move to the next randomly selected track.

Press the RND button a second time to stop Random Play.

Notes on Playing MP3 Files

The radio can play MP3 files; however, acceptable MP3 file recording media and formats are limited. When writing MP3 files, pay attention to the following restrictions.

Supported Media (Disc Types)

The MP3 file recording media supported by the radio are CDDA, CD-R, CD-RW, MP3, and CDDA+MP3.

Supported Medium Formats (File Systems)

The medium formats supported by the radio are ISO 9660 Level 1 and Level 2 and includes the Joliet extension. When reading discs recorded using formats other than ISO 9660 Level 1 and Level 2, the radio may fail to read files properly and may be unable to play the file normally. UDF and Apple HFS formats are not supported.

The radio uses the following limits for file systems:

- Maximum number of folder levels: 8

- Maximum number of files: 255
- Maximum number of folders. (The radio display of file names and folder names is limited. For large numbers of files and/or folders, the radio may be unable to display the file name and folder name, and will assign a number instead. With a maximum number of files, exceeding 20 folders will result in this display. With 200 files, exceeding 50 folders will result in this display.)
- Maximum number of characters in file/folder names:
 - Level 1: 12 (including a separator "." and a three-character extension)
 - Level 2: 31 (including a separator "." and a three-character extension)

Multisession disc formats are supported by the radio. Multisession discs may contain combinations of normal CD audio tracks and computer files (including MP3 files).

Discs created with an option such as "keep disc open after writing" are most likely multisession discs. The use of multisession for CD audio or MP3 playback may result in longer disc loading times.

Supported MP3 File Formats

The radio will recognize only files with the *.MP3 extension as MP3 files. Non-MP3 files named with the *.MP3 extension may cause playback problems. The radio is designed to recognize the file as an invalid MP3 and will not play the file.

When using the MP3 encoder to compress audio data to an MP3 file, the bit rate and sampling frequencies in the following table are supported. In addition, variable bit rates (VBR) are also supported. The majority of MP3 files use a 44.1 kHz sampling rate and a 192, 160, 128, 96 or VBR bit rate.

MPEG Specification	Sampling Frequency (kHz)	Bit Rate (kbps)
MPEG-1 Audio Layer 3	48, 44.1, 32	320, 256, 224, 192, 160, 128, 112, 96, 80, 64, 56, 48, 40, 32
MPEG-2 Audio Layer 3	24, 22.05, 16	160, 128, 144, 112, 96, 80, 64, 56, 48, 40, 32, 24, 16, 8

ID3 Tag information for artist, song title, and album title are supported for version 1 ID3 tags. ID3 version 2 is not supported by the radios.

Playlist files are not supported. MP3 Pro files are not supported.

Playback of MP3 Files

When a medium containing MP3 data is loaded, the radio checks all files on the medium. If the medium contains a lot of folders or files, the radio will take more time to start playing the MP3 files.

Loading times for playback of MP3 files may be affected by the following:

- Media - CD-RW media may take longer to load than CD-R media
- Medium formats - Multisession discs may take longer to load than non-multisession discs
- Number of files and folders - Loading times will increase with more files and folders

To increase the speed of disc loading, it is recommended to use CD-R media and single-session discs. To create a single-session disc, enable the “Disc at Once” option before writing to the disc.

Operation Instructions - Auxiliary Mode

The auxiliary (AUX) jack is an audio input jack, which allows the user to plug in a portable device, such as an MP3 player, or cassette player, and utilize the vehicle’s audio system to amplify the source and play through the vehicle speakers.

Pressing the DISC/AUX button will change the mode to auxiliary device if the AUX jack is connected.

NOTE: The AUX device must be turned on and the device’s volume set to proper level. If the AUX audio is not loud enough, turn the device’s volume up. If the AUX audio sounds distorted, turn the device’s volume down.

TIME Button (Auxiliary Mode)

Press this button to change the display to time of day. The time of day will display for five seconds (when ignition is OFF).

MEDIA CENTER 130 WITH SATELLITE RADIO (SALES CODE RES+RSC)

NOTE: The radio sales code is located on the lower right side of the radio faceplate.

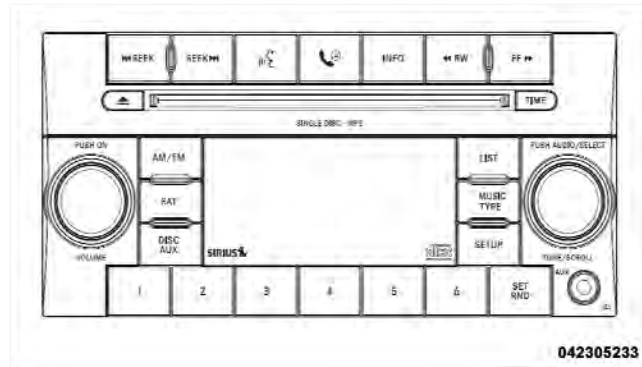

Media Center 130 (RES/RSC)

Operating Instructions — Radio Mode

NOTE: The ignition switch must be in the ON/RUN or ACC position to operate the radio.

Power Switch/Volume Control (Rotary)

Push the ON/VOLUME control knob to turn on the radio. Push the ON/VOLUME control knob a second time to turn off the radio.

Electronic Volume Control

The electronic volume control turns continuously (360 degrees) in either direction without stopping. Turning the ON/VOLUME control knob to the right increases the volume and to the left decreases it.

When the audio system is turned on, the sound will be set at the same volume level as last played.

SEEK Buttons

Press and release the SEEK buttons to search for the next listenable station in AM/FM mode. Press the right switch

to seek up and the left switch to seek down. The radio will remain tuned to the new station until you make another selection. Holding either button will bypass stations without stopping until you release it.

Voice Command System (Radio) — If Equipped

Refer to “Voice Command” in the Uconnect™ User Manual located on the DVD for further details.

Voice Command Button Uconnect™ Phone — If Equipped

Press this button to operate the Uconnect™ Phone feature (if equipped). Refer to “Voice Command” in the Uconnect™ User Manual located on the DVD for further details.

If your vehicle is not equipped with or this feature is not available on your vehicle, a “Not Equipped With Uconnect Phone” message will display on the radio screen.

Phone Button Uconnect™ Phone — If Equipped

Press this button to operate the Uconnect™ Phone feature (if equipped). Refer to “Uconnect™ Phone” in the Uconnect™ User Manual located on the DVD for further details.

If your vehicle is not equipped with or this feature is not available on your vehicle, a “Not Equipped With Uconnect Phone” message will display on the radio screen.

TIME Button

Press the TIME button to alternate display of the time and radio frequency.

Clock Setting Procedure

1. Press and hold the TIME button until the hours blink.
2. Adjust the hours by turning the right side TUNE/SCROLL control knob.

3. After adjusting the hours, press the right side TUNE/SCROLL control knob to set the minutes. The minutes will begin to blink.
4. Adjust the minutes using the right side TUNE/SCROLL control knob. Press the TUNE/SCROLL control knob to save time change.
5. To exit, press any button/knob or wait five seconds.

The clock can also be set by pressing the SETUP button. For vehicles equipped with satellite radio, press the SETUP button, use the TUNE/SCROLL control to select SET CLOCK, and then follow the above procedure, starting at Step 2. For vehicles not equipped with satellite radio, press the SETUP button and then follow the above procedure, starting at Step 2.

INFO Button

Press the INFO button for an RDS station (one with call letters displayed). The radio will return a Radio Text message broadcast from an FM station (FM mode only).

RW/FF

Pressing the RW (Rewind) or FF (Fast Forward) buttons causes the tuner to search for the next frequency in the direction of the arrows. This feature operates in either AM or FM frequencies.

TUNE Control

Turn the rotary TUNE/SCROLL control knob clockwise to increase or counterclockwise to decrease the frequency.

Setting the Tone, Balance, and Fade

Push the rotary TUNE/SCROLL control knob and BASS will display. Turn the TUNE/SCROLL control knob to the right or left to increase or decrease the bass tones.

Push the rotary TUNE/SCROLL control knob a second time and MID will display. Turn the TUNE/SCROLL control knob to the right or left to increase or decrease the mid-range tones.

Push the rotary TUNE/SCROLL control knob a third time and TREBLE will display. Turn the TUNE/SCROLL control knob to the right or left to increase or decrease the treble tones.

Push the rotary TUNE/SCROLL control knob a fourth time and BALANCE will display. Turn the TUNE/SCROLL control knob to the right or left to adjust the sound level from the right or left side speakers.

Push the rotary TUNE/SCROLL control knob a fifth time and FADE will display. Turn the TUNE/SCROLL control knob to the left or right to adjust the sound level between the front and rear speakers.

Push the rotary TUNE/SCROLL control knob again to exit setting tone, balance, and fade.

MUSIC TYPE Button

Pressing this button once will turn on the Music Type mode for five seconds. Pressing the MUSIC TYPE button or turning the TUNE/SCROLL control knob within five seconds will allow the program format type to be selected. Many radio stations do not currently broadcast Music Type information.

Toggle the MUSIC TYPE button to select the following format types:

Program Type	16-Digit Character Display
No program type or undefined	None
Adult Hits	Adlt Hit
Classical	Classicl
Classic Rock	Cls Rock
College	College
Country	Country
Foreign Language	Language

Program Type	16-Digit Character Display
Information	Inform
Jazz	Jazz
News	News
Nostalgia	Nostalgia
Oldies	Oldies
Personality	Persnlty
Public	Public
Rhythm and Blues	R & B
Religious Music	Rel Musc
Religious Talk	Rel Talk
Rock	Rock
Soft	Soft
Soft Rock	Soft Rck
Soft Rhythm and Blues	Soft R&B
Sports	Sports
Talk	Talk

Program Type	16-Digit Character Display
Top 40	Top 40
Weather	Weather

By pressing the SEEK button when the Music Type icon is displayed, the radio will be tuned to the next frequency station with the same selected Music Type name. The Music Type function only operates when in the FM mode.

If a preset button is activated while in the Music Type (Program Type) mode, the Music Type mode will be exited and the radio will tune to the preset station.

SETUP Button

Pressing the SETUP button allows you to select between the following items:

- **Set Clock** — Pressing the SELECT button will allow you to set the clock. Adjust the hours by turning the TUNE/SCROLL control knob. After adjusting the

hours, press the TUNE/SCROLL control knob to set the minutes. The minutes will begin to blink. Adjust the minutes using the right side TUNE/SCROLL control knob. Press the TUNE/SCROLL control knob to save time change.

AM/FM Button

Press the button to select either AM or FM mode.

SET/RND Button — To Set the Pushbutton Memory

When you are receiving a station that you wish to commit to pushbutton memory, press the SET/RND button. The symbol SET 1 will now show in the display window. Select the button (1–6) you wish to lock onto this station and press and release that button. If a button is not selected within five seconds after pressing the SET/RND button, the station will continue to play but will not be stored into pushbutton memory.

You may add a second station to each pushbutton by repeating the above procedure with this exception: Press the SET/RND button twice and SET 2 will show in the display window. Each button can be set for SET 1 and SET 2 in both AM and FM. This allows a total of 12 AM and 12 FM stations to be stored into pushbutton memory. The stations stored in SET 2 memory can be selected by pressing the pushbutton twice.

Every time a preset button is used, a corresponding button number will display.

Buttons 1 - 6

These buttons tune the radio to the stations that you commit to pushbutton memory (12 AM and 12 FM stations).

DISC/AUX Button

Pressing the DISC/AUX button will allow you to switch from AM/FM modes to DISC/AUX mode.

Operation Instructions — CD MODE for CD and MP3 Audio Play

NOTE:

- The ignition switch must be in the ON/RUN or ACC position to operate the radio.
- This radio is capable of playing compact discs (CD), recordable compact discs (CD-R), rewritable compact discs (CD-RW), compact discs with MP3 tracks and multisession compact discs with CD and MP3 tracks.

Inserting Compact Disc(s)

Gently insert one CD into the CD player with the CD label facing up. The CD will automatically be pulled into the CD player and the CD icon will illuminate on the radio display. If a CD does not go into the slot more than 1.0 in (2.5 cm), a disc may already be loaded and must be ejected before a new disc can be loaded.

If you insert a disc with the ignition ON/RUN and the radio ON, the unit will switch from radio to CD mode and begin to play when you insert the disc. The display will show the track number, and index time in minutes and seconds. Play will begin at the start of track 1.

CAUTION!

- **This CD player will accept 4-3/4 in (12 cm) discs only. The use of other sized discs may damage the CD player mechanism.**
- **Do not use adhesive labels. These labels can peel away and jam the player mechanism.**
- **RES is a single CD player. Do not attempt to insert a second CD if one is already loaded.**
- **Dual-media disc types (one side is a DVD, the other side is a CD) should not be used, and they can cause damage to the player.**

EJECT Button - Ejecting a CD

Press the EJECT button to eject the CD.



If you have ejected a disc and have not removed it within 10 seconds, it will be reloaded. If the CD is not removed, the radio will reinsert the CD but will not play it.

A disc can be ejected with the radio and ignition OFF.

NOTE: Ejecting with the ignition OFF is not allowed on convertible or soft-top models (if equipped).

SEEK Button

Press the right SEEK button for the next selection on the CD. Press the left SEEK button to return to the beginning of the current selection, or return to the beginning of the previous selection if the CD is within the first second of

the current selection. Pressing and holding the SEEK button will allow faster scrolling through the tracks in CD and MP3 modes.

TIME Button

Press this button to change the display from a large CD playing time display to a small CD playing time display.

RW/FF

Press and hold FF (Fast Forward) and the CD player will begin to fast forward until FF is released or RW or another CD button is pressed. The RW (Reverse) button works in a similar manner.

AM/FM Button

Press the button to select either AM or FM mode.

SET/RND Button (Random Play Button)

Press this button while the CD is playing to activate Random Play. This feature plays the selections on the compact disc in random order to provide an interesting change of pace.

Press the right SEEK button to move to the next randomly selected track.

Press the SET/RND button a second time to stop Random Play.

Notes On Playing MP3 Files

The radio can play MP3 files; however, acceptable MP3 file recording media and formats are limited. When writing MP3 files, pay attention to the following restrictions.

Supported Media (Disc Types)

The MP3 file recording media supported by the radio are CDDA, CD-R, CD-RW, MP3, and CDDA+MP3.

Supported Medium Formats (File Systems)

The medium formats supported by the radio are ISO 9660 Level 1 and Level 2 and includes the Joliet extension. When reading discs recorded using formats other than ISO 9660 Level 1 and Level 2, the radio may fail to read files properly and may be unable to play the file normally. UDF and Apple HFS formats are not supported.

The radio uses the following limits for file systems:

- Maximum number of folder levels: 8
- Maximum number of files: 255
- Maximum number of folders. (The radio display of file names and folder names is limited. For large numbers of files and/or folders, the radio may be unable to display the file name and folder name and will assign a number instead. With a maximum number of files, exceeding 20 folders will result in this display. With 200 files, exceeding 50 folders will result in this display.)

- Maximum number of characters in file/folder names:
 - Level 1: 12 (including a separator "." and a three-character extension)
 - Level 2: 31 (including a separator "." and a three-character extension)

Multisession disc formats are supported by the radio. Multisession discs may contain combinations of normal CD audio tracks and computer files (including MP3 files). Discs created with an option such as "keep disc open after writing" are most likely multisession discs. The use of multisession for CD audio or MP3 playback may result in longer disc loading times.

Supported MP3 File Formats

The radio will recognize only files with the *.MP3 extension as MP3 files. Non-MP3 files named with the *.MP3 extension may cause playback problems. The radio is designed to recognize the file as an invalid MP3 and will not play the file.

When using the MP3 encoder to compress audio data to an MP3 file, the bit rate and sampling frequencies in the following table are supported. In addition, variable bit rates (VBR) are also supported. The majority of MP3 files use a 44.1 kHz sampling rate and a 192, 160, 128, 96 or VBR bit rates.

MPEG Specification	Sampling Frequency (kHz)	Bit Rate (kbps)
MPEG-1 Audio Layer 3	48, 44.1, 32	320, 256, 224, 192, 160, 128, 112, 96, 80, 64, 56, 48, 40, 32
MPEG-2 Audio Layer 3	24, 22.05, 16	160, 128, 144, 112, 96, 80, 64, 56, 48, 40, 32, 24, 16, 8

ID3 Tag information for artist, song title, and album title are supported for version 1 ID3 tags. ID3 version 2 is not supported by the radios.

Playlist files are not supported. MP3 Pro files are not supported.

Playback of MP3 Files

When a medium containing MP3 data is loaded, the radio checks all files on the medium. If the medium contains a lot of folders or files, the radio will take more time to start playing the MP3 files.

Loading times for playback of MP3 files may be affected by the following:

- Media - CD-RW media may take longer to load than CD-R media
- Medium formats - Multisession discs may take longer to load than non-multisession discs
- Number of files and folders - Loading times will increase with more files and folders

To increase the speed of disc loading, it is recommended to use CD-R media and single-session discs. To create a single-session disc, enable the “Disc at Once” option before writing to the disc.

LIST Button (CD Mode for MP3 Play)

Pressing the LIST button will bring up a list of all folders on the disc. Scrolling up or down the list is done by turning the TUNE/SCROLL control knob. Selecting a folder by pressing the TUNE/SCROLL control knob will begin playing the files contained in that folder (or the next folder in sequence if the selection does not contain playable files).

The folder list will time out after five seconds.

INFO Button (CD Mode for MP3 Play)

Pressing the INFO button repeatedly will scroll through the following TAG information: Song Title, Artist, File Name, and Folder Name (if available).

Press the INFO button once more to return to "elapsed time" priority mode.

Press and hold the INFO button for three seconds or more and the radio will display song titles for each file.

Press and hold the INFO button again for three seconds to return to "elapsed time" display.

Operation Instructions - Auxiliary Mode

The auxiliary (AUX) jack is an audio input jack which allows the user to plug in a portable device such as an MP3 player or cassette player and utilize the vehicle's audio system to amplify the source and play through the vehicle speakers.

Pressing the AUX button will change the mode to auxiliary device if the AUX jack is connected.

NOTE: The AUX device must be turned on and the device's volume set to the proper level. If the AUX audio

is not loud enough, turn the device's volume up. If the AUX audio sounds distorted, turn the device's volume down.

TIME Button (Auxiliary Mode)

Press this button to change the display to time of day. The time of day will display for five seconds (when the ignition is OFF).

Uconnect™ Multimedia (Satellite Radio) — If Equipped

Satellite radio uses direct satellite-to-receiver broadcasting technology to provide clear digital sound, coast to coast. The subscription service provider is Sirius Satellite Radio. This service offers over 130 channels of music, sports, news, entertainment, and programming for children, directly from its satellites and broadcasting studios.

NOTE: Sirius service is not available in Hawaii and has limited coverage in Alaska.

System Activation

Sirius Satellite Radio service is pre-activated, and you may begin listening immediately to the one year of audio service that is included with the factory-installed satellite radio system in your vehicle. Sirius will supply a welcome kit that contains general information, including how to setup your on-line listening account. For further information, call the toll-free number 888-539-7474, or visit the Sirius web site at www.sirius.com, or at www.siriuscanada.ca for Canadian residents.

Electronic Serial Number/Sirius Identification Number (ESN/SID)

Please have the following information available when calling:

1. The Electronic Serial Number/Sirius Identification Number (ESN/SID).
2. Your Vehicle Identification Number.

To access the ESN/SID, refer to the following steps:

ESN/SID Access

With the ignition switch in the ON/RUN or ACC position and the radio on, press the SETUP button and scroll using the TUNE/SCROLL control knob until Sirius ID is selected. Press the TUNE/SCROLL control knob and the Sirius ID number will display. The Sirius ID number display will time out in two minutes. Press any button on the radio to exit this screen.

Selecting Uconnect™ Multimedia (Satellite) Mode

Press the SAT button until "SAT" appears in the display. A CD may remain in the radio while in the Satellite radio mode.

Satellite Antenna

To ensure optimum reception, do not place items on the roof around the rooftop antenna location. Metal objects placed within the line of sight of the antenna will cause decreased performance. Larger luggage items such as

bikes should be placed as far rearward as possible, within the loading design of the rack. Do not place items directly on or above the antenna.

Reception Quality

Satellite reception may be interrupted due to one of the following reasons:

- The vehicle is parked in an underground parking structure or under a physical obstacle.
- Dense tree coverage may interrupt reception in the form of short audio mutes.
- Driving under wide bridges or along tall buildings can cause intermittent reception.
- Placing objects over or too close to the antenna can cause signal blockage.

Operating Instructions - Uconnect™ Multimedia (Satellite) Mode

NOTE: The ignition switch must be in the ON/RUN or ACC position to operate the radio.

SEEK Buttons

Press and release the SEEK buttons to search for the next channel in Satellite mode. Press the right switch to seek up and the left switch to seek down. The radio will remain tuned to the new channel until you make another selection. Holding either button will bypass channels without stopping until you release it.

SCAN Button

Pressing the SCAN button causes the tuner to search for the next channel, pausing for eight seconds before continuing to the next. To stop the search, press the SCAN button a second time.

INFO Button

Pressing the INFO button will cycle the display information between Artist, Song Title, and Composer (if available). Also, pressing and holding the INFO button for an additional three seconds will make the radio display the Song Title all of the time (press and hold again to return to normal display).

RW/FF

Pressing the RW (Rewind) or FF (Fast Forward) buttons causes the tuner to search for the next channel in the direction of the arrows.

TUNE Control (Rotary)

Turn the rotary TUNE/SCROLL control knob clockwise to increase or counterclockwise to decrease the channel.

MUSIC TYPE Button

Pressing this button once will turn on the Music Type mode for five seconds. Pressing the MUSIC TYPE button or turning the TUNE/SCROLL control knob within five seconds will allow the program format type to be selected.

Toggle the MUSIC TYPE button again to select the music type.

By pressing the SEEK button when the Music Type function is active, the radio will be tuned to the next channel with the same selected Music Type name.

If a preset button is activated while in the Music Type (Program Type) mode, the Music Type mode will be exited and the radio will tune to the preset channel.

SETUP Button

Pressing the SETUP button allows you to select the following items:

- Display Sirius ID number — Press the AUDIO/SELECT button to display the Sirius ID number. This number is used to activate, deactivate, or change the Sirius subscription.

SET Button – To Set the Pushbutton Memory

When you are receiving a channel that you wish to commit to pushbutton memory, press the SET button. The symbol SET 1 will now show in the display window. Select the button (1-6) you wish to lock onto this channel and press and release that button. If a button is not selected within five seconds after pressing the SET button, the channel will continue to play but will not be stored into pushbutton memory.

You may add a second channel to each pushbutton by repeating the above procedure with this exception: Press the SET button twice and SET 2 will show in the display window. Each button can be set for SET 1 and SET 2. This allows a total of 12 Satellite channels to be stored into pushbutton memory. The channels stored in SET 2 memory can be selected by pressing the pushbutton twice.

Every time a preset button is used, a corresponding button number will display.

Buttons 1 - 6

These buttons tune the radio to the channels that you commit to pushbutton memory (12 Satellite stations).

Operating Instructions (Uconnect™ Phone) — If Equipped

Refer to “Uconnect™ Phone” in the Uconnect™ User Manual located on the DVD for further details.

iPod®/USB/MP3 CONTROL — IF EQUIPPED

NOTE: This section is for sales code RES and REQ/REL/RET radios only with Uconnect™. For sales code RBZ/RHB, RHR, RHP, RHW or RB2 touch-screen radio iPod®/USB/MP3 control feature, refer to the separate RBZ/RHB, RHR, RHP, RHW or RB2 User's Manual. iPod®/USB/MP3 control is available only if equipped as an option with these radios.

This feature allows an iPod® or external USB device to be plugged into the USB port, located in the center console or glove compartment.

iPod® control supports Mini, 4G, Photo, Nano, 5G iPod® and iPhone® devices. Some iPod® software versions may not fully support the iPod® control features. Please visit Apple's website for software updates.

NOTE:

- If the radio has a USB port, refer to the appropriate Uconnect™ Multimedia radio User's Manual for iPod® or external USB device support capability.
- Connecting an iPod® or consumer electronic audio device to the AUX port located in the radio faceplate, plays media, but does not use the iPod® /MP3 control feature to control the connected device.

Connecting The iPod® or External USB Device

Use the connection cable to connect an iPod® or external USB device to the vehicle's USB/AUX connector port which is located in the center console or glove compartment.

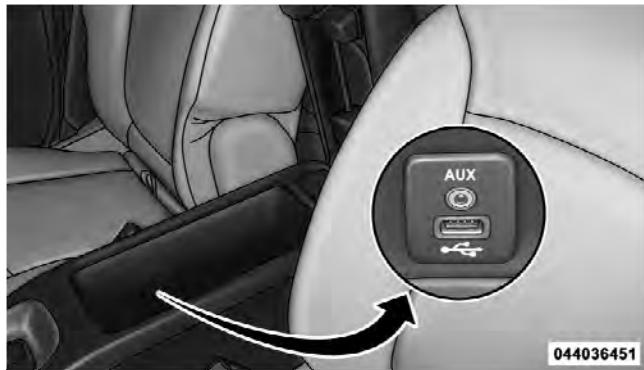

Center Console USB/AUX Connector Port

Once the audio device is connected and synchronized to the vehicle's iPod®/USB/MP3 control system (iPod® or external USB device may take a few minutes to connect), the audio device starts charging and is ready for use by pressing radio switches, as described below.

NOTE: If the audio device battery is completely discharged, it may not communicate with the iPod®/USB/MP3 control system until a minimum charge is attained. Leaving the audio device connected to the iPod®/USB/MP3 control system may charge it to the required level.

Using This Feature

By using iPod cable or external USB device to connect to USB port:

- The audio device can be played on the vehicle's sound system, providing metadata (artist, track title, album, etc.) information on the radio display.

- The audio device can be controlled using the radio buttons to Play, Browse, and List the iPod® contents.
- The audio device battery charges when plugged into the USB/AUX connector (if supported by the specific audio device)

Controlling The iPod® or External USB Device Using Radio Buttons

To get into the iPod®/USB/MP3 control mode and access a connected audio device, either press the “AUX” button on the radio faceplate or press VR button and say “USB” or “Switch to USB”. Once in the iPod®/USB/MP3 control mode, audio tracks (if available from audio device) start playing over the vehicle’s audio system.

Play Mode

When switched to iPod®/USB/MP3 control mode, the iPod® or external USB device automatically starts Play mode. In Play mode, the following buttons on the radio faceplate may be used to control the iPod® or external USB device and display data:

- Use the TUNE control knob to select the next or previous track.
 - Turning it clockwise (forward) by one click, while playing a track, skips to the next track or press VR button and say “Next Track”.
 - Turning it counterclockwise (backward) by one click, will jump to the previous track in the list or press VR button and say “Previous Track”
 - Jump backward in the current track by pressing and holding the << **RW** button. Holding the << **RW** button long enough will jump to the beginning of the current track.

- Jump forward in the current track by pressing and holding the **FF >>** button.
- A single press backward **<< RW** or forward **FF >>** will jump backward or forward respectively, for five seconds.
- Use the **<< SEEK** and **SEEK >>** buttons to jump to the previous or next track. Pressing the **SEEK >>** button during play mode will jump to the next track in the list, or can press VR button and say "Next or Previous Track".
- While a track is playing, press the **INFO** button to see the associated metadata (artist, track title, album, etc.) for that track. Pressing the **INFO** button again jumps to the next screen of data for that track. Once all screens have been viewed, the last **INFO** button press will go back to the play mode screen on the radio.
- Pressing the **REPEAT** button will change the audio device mode to repeat the current playing track or press the VR button and say "Repeat ON" or "Repeat Off".
- Press the **SCAN** button to use iPod®/USB/MP3 device scan mode, which will play the first 10 seconds of each track in the current list and then forward to the next song. To stop SCAN mode and start playing the desired track, when it is playing the track, press the **SCAN** button again. During Scan mode, pressing the **<< SEEK** and **SEEK >>** buttons will select the previous and next tracks.
- **RND** button (available on sales code RES radio only): Pressing this button toggles between Shuffle ON and Shuffle OFF modes for the iPod® or external USB device, or press VR button and say "Shuffle ON" or "Shuffle Off". If the **RND** icon is showing on the radio display, then the shuffle mode is ON.

List Or Browse Mode

During Play mode, pressing any of the buttons described below, will bring up List mode. List mode enables scrolling through the list of menus and tracks on the audio device.

- **TUNE** control knob: The **TUNE** control knob functions in a similar manner as the scroll wheel on the or external USB device.
 - Turning it clockwise (forward) and counterclockwise (backward) scrolls through the lists, displaying the track detail on the radio display. Once the track to be played is highlighted on the radio display, press the **TUNE** control knob to select and start playing the track. Turning the **TUNE** control knob fast will scroll through the list faster. During fast scroll, a slight delay in updating the information on the radio display may be noticeable.
- During all List modes, the iPod® displays all lists in “wrap-around” mode. So if the track is at the bottom of the list, just turn the wheel backwards (counter-clockwise) to get to the track faster.
 - In List mode, the radio **PRESET** buttons are used as shortcuts to the following lists on the iPod® or external USB device.
 - Preset 1 – Playlists
 - Preset 2 – Artists
 - Preset 3 – Albums
 - Preset 4 – Genres
 - Preset 5 – Audiobooks
 - Preset 6 – Podcasts

- Pressing a **PRESET** button will display the current list on the top line and the first item in that list on the second line.
- To Exit List mode without selecting a track, press the same **PRESET** button again to go back to **Play mode**.
- **LIST** button: The **LIST** button will display the top level menu of the iPod® or external USB device. Turn the **TUNE** control knob to list the top-menu item to be selected and press the **TUNE** control knob. This will display the next sub-menu list item on the audio device, then follow the same steps to go to the desired track in that list. Not all iPod® or external USB device sub-menu levels are available on this system.
- **MUSIC TYPE** button: The **MUSIC TYPE** button is another shortcut button to the genre listing on your audio device.

CAUTION!

- Leaving the iPod® or external USB device (or any supported device) anywhere in the vehicle in extreme heat or cold can alter the operation or damage the device. Follow the device manufacturer's guidelines.
- Placing items on the iPod® or external USB device, or connections to the iPod® or external USB device in the vehicle, can cause damage to the device and/or to the connectors.

WARNING!

Do not plug in or remove the iPod® or external USB device while driving. Failure to follow this warning could result in an accident.

Bluetooth Streaming Audio (BTSA)

Music can be streamed from your cellular phone to the Uconnect™ phone system.

Controlling BTSA using Radio Buttons

To get into the BTSA mode, press either “AUX” button on the radio or press VR button and say “Bluetooth Streaming Audio”.

Play Mode

When switched to BTSA mode, some audio devices can start playing music over the vehicle’s audio system, but some devices require the music to be initiated on the device first, then it will get streamed to Uconnect™ phone system. Seven devices can be paired to Uconnect™ phone system, but just one can be selected and played.

Selecting different Audio Device

1. Press PHONE button to begin.

2. After the “Ready” prompt and the following beep, say “Setup”, then “Select Audio Devices”.

3. Say name of the audio device or ask Uconnect™ phone system to list audio devices.

Next Track

Use the SEEK UP button, or press the VR button on the radio and say “Next Track” to jump to the next track music on your cellular phone.

Previous Track

Use the SEEK DOWN button, or press the VR button on the radio and say “Previous Track” to jump to the previous track music on your cellular phone.

Browse

Browsing is not available on a BTSA device. Only the current song that is playing will display info.

Uconnect™ Multimedia (SIRIUS BACKSEAT TV™) — IF EQUIPPED

Satellite video uses direct satellite receiver broadcasting technology to provide streaming video. The subscription service provider is SIRIUS Satellite Radio. Uconnect™ studio (SIRIUS Backseat TV™) offers three video channels for family entertainment, directly from its satellites and broadcasting studios.

NOTE: SIRIUS Backseat TV™ service is not available in Hawaii or Canada and has limited coverage in Alaska.

Refer to the Uconnect™ User Manual located on the DVD, RER Navigation, RHB Multimedia or RBZ Multimedia User Manuals for detailed operating instructions.

VIDEO ENTERTAINMENT SYSTEM™ (SALES CODE XRV) — IF EQUIPPED

The optional VES™ (Video Entertainment System) consists of a DVD player and LCD (liquid crystal display)

screen, a battery-powered remote control, and two headsets. Refer to the “Uconnect™ Multimedia” section of Uconnect™ User Manual located on the DVD for further details.

The LCD screen is located on the headliner behind the front seats.

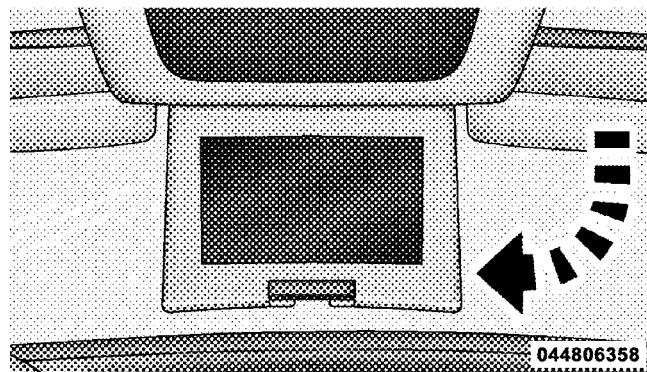

Lowering the Display Screen

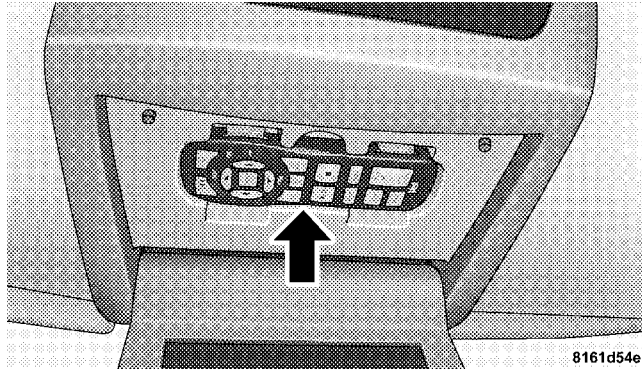

8161d54e

Remote Control Location

STEERING WHEEL AUDIO CONTROLS

The remote sound system controls are located on the rear surface of the steering wheel. Reach behind the wheel to access the switches.



045033001

Remote Sound System Controls
(Back View Of Steering Wheel)

The right-hand control is a rocker-type switch with a pushbutton in the center and controls the volume and mode of the sound system. Pressing the top of the rocker switch will increase the volume, and pressing the bottom of the rocker switch will decrease the volume.

Pressing the center button will make the radio switch between the various modes available (AM/FM/SAT/CD/HDD/AUX/VES, etc.).

The left-hand control is a rocker-type switch with a pushbutton in the center. The function of the left-hand control is different depending on which mode you are in.

The following describes the left-hand control operation in each mode.

Radio Operation

Pressing the top of the switch will “Seek” up for the next listenable station and pressing the bottom of the switch will “Seek” down for the next listenable station.

The button located in the center of the left-hand control will tune to the next preset station that you have programmed in the radio preset pushbutton.

CD Player

Pressing the top of the switch once will go to the next track on the CD. Pressing the bottom of the switch once will go to the beginning of the current track, or to the beginning of the previous track if it is within one second after the current track begins to play.

If you press the switch up or down twice, it plays the second track; three times, it will play the third, etc.

The center button on the left side rocker switch has no function for a single-disc CD player. However, when a multiple-disc CD player is equipped on the vehicle, the center button will select the next available CD in the player.

CD/DVD DISC MAINTENANCE

To keep a CD/DVD in good condition, take the following precautions:

1. Handle the disc by its edge; avoid touching the surface.
2. If the disc is stained, clean the surface with a soft cloth, wiping from center to edge.
3. Do not apply paper or tape to the disc; avoid scratching the disc.
4. Do not use solvents such as benzene, thinner, cleaners, or anti-static sprays.
5. Store the disc in its case after playing.
6. Do not expose the disc to direct sunlight.
7. Do not store the disc where temperatures may become too high.

NOTE: If you experience difficulty in playing a particular disc, it may be damaged (i.e., scratched, reflective coating removed, a hair, moisture or dew on the disc) oversized, or have protection encoding. Try a known good disc before considering disc player service.

RADIO OPERATION AND MOBILE PHONES

Under certain conditions, the mobile phone being on in your vehicle can cause erratic or noisy performance from your radio. This condition may be lessened or eliminated by relocating the mobile phone antenna. This condition is not harmful to the radio. If your radio performance does not satisfactorily “clear” by the repositioning of the antenna, it is recommended that the radio volume be turned down or off during mobile phone operation when not using Uconnect™ (if equipped).

CLIMATE CONTROLS

The Air Conditioning and Heating System is designed to make you comfortable in all types of weather.

Dual-Zone Manual Heating and Air Conditioning



045633437

The Dual-Zone Manual Climate Controls allow both driver and front passenger seat occupants to select individual comfort settings. The controls consist of a series of outer rotary dials and inner push knobs.

Blower Control



045633446

Rotate this control to regulate the amount of air forced through the ventilation system in any mode. The blower speed increases as you move the control to the right from the “0” (OFF) position. There are seven blower speeds.

Temperature Controls

- *Driver Temperature Control*



045633438

Rotate this control to regulate the temperature of the air inside the passenger compartment for the left front seat occupant. Rotating the dial left into the blue area of the scale indicates cooler temperatures while rotating right into the red area indicates warmer temperatures.

- *Passenger Temperature Control*



045633441

Rotate this control to regulate the temperature of the air inside the passenger compartment for the right front seat occupant. Rotating the dial left into the blue area of the scale indicates cooler temperatures while rotating right into the red area indicates warmer temperatures.

NOTE: If your air conditioning performance seems lower than expected, check the front of the A/C condenser located in front of the radiator for an accumulation of dirt or insects. Clean with a gentle water spray from behind the radiator and through the condenser. Fabric front fascia protectors may reduce airflow to the condenser, reducing air conditioning performance.

Mode Control (Air Direction)

Push the mode control buttons to choose from several patterns of air distribution.

Panel

 Air is directed through the outlets in the instrument panel. These outlets can be adjusted to direct airflow.

NOTE: The center instrument panel outlets can be aimed so that they are directed toward the rear seat passengers for maximum airflow to the rear.

Bi-Level

 Air is directed through the panel and floor outlets.

NOTE: For all settings except full cold or full hot, there is a difference in temperature between the upper and lower outlets. The warmer air flows to the floor outlets. This feature gives improved comfort during sunny but cool conditions.

Floor

 Air is directed through the floor outlets with a small amount flowing through the defrost and side window demist outlets.

Mix

 Air is directed through the floor, defrost, and side window demist outlets. This setting works best in cold or snowy conditions that require extra heat to the windshield. This setting is good for maintaining comfort while reducing moisture on the windshield.

Defrost

 Air is directed through the windshield and side window demist outlets. Use this mode with maximum blower and temperature settings for best windshield and side window defrosting.

NOTE:

- In Floor, Mix and Defrost modes a small amount of air will flow through the outboard panel outlets for occupant comfort.
- The air conditioning compressor operates in Mix, Defrost, or a blend of these modes, even if the Air Conditioning (A/C) button is not pressed. This dehumidifies the air to help dry the windshield. To improve fuel economy, use these modes only when necessary.

Recirculation Control

 Pressing the Recirculation Control button will put the system in recirculation mode. This can be used when outside conditions such as smoke, odors, dust, or high humidity are present. Activating recirculation will cause the LED in the control button to illuminate.

NOTE:

- Continuous use of the recirculation mode may make the inside air stuffy and window fogging may occur. Extended use of this mode is not recommended.
- The use of the recirculation mode in cold or damp weather could cause windows to fog on the inside, because of moisture buildup inside the vehicle. Select the Outside Air position for maximum defogging.
- The A/C will engage automatically to prevent fogging when the recirculation button is pressed and the mode control is set to panel or panel / floor.
- The A/C can be deselected manually without disturbing the mode control selection.
- When the ignition switch is turned to the LOCK position or the ignition switch START/STOP button is cycled to OFF, the recirculation feature will be cancelled.

Air Conditioning Control

Press this button to engage the Air Conditioning. A light will illuminate when the Air Conditioning System is engaged. Rotating the dial left into the blue area of the scale indicates cooler temperatures while rotating right into the red area indicates warmer temperatures.

NOTE: The air conditioning compressor will not engage until the engine has been running for about 10 seconds.

- **MAX A/C**

For maximum cooling use the A/C and recirculation buttons at the same time.

- **ECONOMY MODE**

If economy mode is desired, press the A/C button to turn OFF the indicator light and the A/C compressor. Then, move the temperature control to the desired temperature.

Dual-Zone Automatic Temperature Control (ATC) — If Equipped

- The Automatic Temperature Control (ATC) allows both driver and front passenger seat occupants to select individual comfort settings.
- When occupants in the vehicle select an Auto mode operation, Auto blower operation is set by using a push button on the control unit and a comfort temperature setting by using the temperature up and down buttons.
- The system provides set-and-forget operation for optimum comfort and convenience.
- The system can be controlled manually, if desired.

The ATC system automatically maintains the interior comfort level desired by the driver and passenger.



Automatic Temperature Control (ATC) Panel

1. A/C Button

Press and release to change the current Air Conditioning (A/C) setting, the indicator illuminates when A/C is ON. Performing this function will cause the ATC to switch into manual mode.

2. Recirculation Control Button

Press and release to change the current setting, the indicator illuminates when ON.

3. Left Front Seat Occupant Temperature Display

This display shows the temperature setting for the left front seat occupant.

4. Mode Display

This display shows the current Mode selection (Panel, Bi-Level, Floor, Mix).

5. Blower Control Display

This display shows the current Blower speed selection.

6. Right Front Seat Occupant Temperature Display

This display shows the temperature setting for the right front seat occupant.

7. Front Defrost Button

Press and release to change the current setting, the indicator illuminates when ON. Performing this function

will cause the ATC to switch into manual mode. The blower will engage immediately if the Defrost mode is selected.

8. Passenger Temperature Control Up Button

Provides the passenger with independent temperature control. Push the button for warmer temperature settings.

9. Passenger Temperature Control Down Button

Provides the passenger with independent temperature control. Push the button for cooler temperature settings.

10. Auto Temperature Control Button

Controls airflow temperature, distribution, volume, and the amount of air recirculation automatically. Press and release to select. Refer to “Automatic Operation” for more information. Performing this function will cause the ATC to switch between manual mode and automatic modes.

11. Blower Control

There are seven blower speeds, the blower speed increases as you move the control to the right from the lowest blower setting. Performing this function will cause the ATC to switch into manual mode.

12. Climate Control OFF Button

Press and release this button to turn the Climate Control OFF

13. Mode Control Button

Press and release to select between Modes (Panel, Bi-Level, Floor, Mix). Performing this function will cause the ATC to switch into manual mode.

14. SYNC Button

Press and release to control the temperature setting for both zones from the driver temperature control.

15. Driver Temperature Control Down Button

Provides the driver with independent temperature control. Push the button for cooler temperature settings.

16. Driver Temperature Control Up Button

Provides the driver with independent temperature control. Push the button for warmer temperature settings.

Automatic Operation

1. Press the AUTO button on the Automatic Temperature Control (ATC) Panel.
2. Next, adjust the temperature you would like the system to maintain by adjusting the driver and front passenger temperature control buttons. Once the desired temperature is displayed, the system will achieve and automatically maintain that comfort level.

3. When the system is set up for your comfort level, it is not necessary to change the settings. You will experience the greatest efficiency by simply allowing the system to function automatically.

NOTE:

- It is not necessary to move the temperature settings for cold or hot vehicles. The system automatically adjusts the temperature, mode and fan speed to provide comfort as quickly as possible.
- The temperature can be displayed in U.S. or Metric units by selecting the US/M customer-programmable feature. Refer to the “Electronic Vehicle Information Center (EVIC) — Customer-Programmable Features (SETUP)” in this section of the manual.

To provide you with maximum comfort in the Automatic mode, during cold start-ups the blower fan will remain on low until the engine warms up. The blower will increase in speed and transition into Auto mode.

Manual Operation

This system offers a full complement of manual override features.

NOTE: Each of these features operate independently from each other. If any one feature is controlled manually, temperature control will continue to operate automatically.



Blower Control

There are seven fixed blower speeds. Use the outer dial control to regulate the amount of air forced through the system in any mode you select. The blower speed increases as you move the control clockwise and decreases when you move the control counter-clockwise.

The blower fan speed can be set to any fixed speed by adjusting the blower control outer dial. The fan will now operate at a fixed speed until additional speeds are selected. This allows the front occupants to control the volume of air circulated in the vehicle and cancel the Auto mode.

The operator can also select the direction of the airflow by selecting one of the following positions.

Panel Mode

 Air comes from the outlets in the instrument panel. Each of these outlets can be individually adjusted to direct the flow of air. The air vanes of the center outlets and outboard outlets can be moved up and down or side to side to regulate airflow direction. There is a shut off wheel located below the air vanes to shut off or adjust the amount of airflow from these outlets.

Bi-Level Mode

 Air comes from the instrument panel outlets, floor outlets and defrost outlets.

NOTE: In many temperature positions, the BI-LEVEL mode is designed to provide cooler air out of the panel outlets and warmer air from the floor outlets.

Floor Mode

 Air comes from the floor outlets. A slight amount of air is directed through the defrost and side window demister outlets.

Mix Mode

 Air comes from the floor, defrost and side window demist outlets. This mode works best in cold or snowy conditions. It allows you to stay comfortable while keeping the windshield clear.

Defrost Mode



Air comes from the windshield and side window demist outlets. Use Defrost mode with maximum temperature settings for best windshield and side window defrosting. When the defrost mode is selected, the blower will automatically default to medium-high unless the blower is controlled manually.

NOTE: While operating in the other modes, the system will not automatically sense the presence of fog, mist or ice on the windshield. Defrost mode must be manually selected to clear the windshield and side glass.

Air Conditioning (A/C)

The Air Conditioning (A/C) button allows the operator to manually activate or deactivate the air conditioning system. When in A/C mode and the ATC is set to a cool temperature, dehumidified air flows through the air outlets. If Economy mode is desired, press the A/C button to turn off the A/C mode in the ATC display and deactivate the A/C system.

NOTE:

- If the system is in Mix, Floor or Defrost Mode, the A/C can be turned off, but the A/C system shall remain active to prevent fogging of the windows.
- If fog or mist appears on the windshield or side glass, select Defrost mode and increase blower speed.

Recirculation Control



When outside air contains smoke, odors, or high humidity, or if rapid cooling is desired, you may wish to recirculate interior air by pressing the RECIRCULATION control button.

Recirculation mode should only be used temporarily. The recirculation LED will illuminate when this button is selected. Push the button a second time to turn off the Recirculation mode LED and allow outside air into the vehicle.

NOTE: In cold weather, use of Recirculation mode may lead to excessive window fogging. The Recirculation mode is not allowed in the Floor/Defrost Mix and Defrost modes to improve window clearing operation. Recirculation will be disabled automatically if these modes are selected.

Operating Tips

Window Fogging

Windows will fog on the inside when the humidity inside the vehicle is high. This often occurs in mild or cool temperatures when it's rainy or humid. In most cases, turning the air conditioning (pressing the A/C button) on will clear the fog. Adjust the temperature control, air direction, and blower speed to maintain comfort.

As the temperature gets colder, it may be necessary to direct air onto the windshield. Adjust the temperature control and blower speed to maintain comfort. Higher blower speeds will reduce fogging. Interior fogging on the windshield can be quickly removed by selecting the DEFROST mode.

Regular cleaning of the inside of the windows with a non-filming cleaning solution (vinegar and water works very well) will help prevent contaminants (cigarette smoke, perfumes, etc.) from sticking to the windows. Contaminates increase the rate of window fogging.

Summer Operation

NOTE: In some cases during high temperature trailer tow operation the Air Conditioning system performance may be reduced. This is to help protect the engine from overheating during the high load condition.

Your air conditioning system is also equipped with an automatic recirculation system. When the system senses a heavy load or high heat conditions, it may use partial Recirculation A/C mode to provide additional comfort.











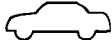





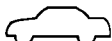

Winter Operation

When operating the system during the winter months, make sure the air intake, located directly in front of the windshield, is free of ice, slush, snow, or other obstructions.

Vacation Storage

Anytime you store your vehicle, or keep it out of service (i.e. vacation) for two weeks or more, run the air conditioning system at idle for about five minutes in the fresh air and high blower setting. This will ensure adequate system lubrication to minimize the possibility of compressor damage when the system is started again.

Operating Tips Chart

WEATHER	CONTROL SETTINGS
<p>HOT WEATHER AND VEHICLE INTERIOR IS VERY HOT</p>  	<p>Open the windows, start the vehicle, set the Mode control to Panel  or Bi-Level , and turn on A/C. Set the Fan control to the High position (full clockwise). Set the temperature control to full cool. After the hot air is flushed from the vehicle, set the Mode control to Recirculate  with A/C on and roll up the windows. Once you are comfortable, set the Mode control to Panel  or Bi-Level  with A/C on.</p>
<p>WARM WEATHER</p>  	<p>If it's sunny, set the Mode control to Panel  and turn on A/C. If it's cloudy or dark, set the Mode control to Bi-Level  with A/C on. Adjust Temperature control for comfort.</p>
<p>COOL OR COLD HUMID CONDITIONS</p>  	<p>Set the Mode control to Defrost/Floor  or Defrost . Set the Fan Control to the High position (full clockwise). Adjust Fan and Temperature control for comfort if windows are clear.</p>
<p>COLD DRY CONDITIONS</p>  	<p>Set the Mode control to Floor . If it's sunny, you may want more upper air. In this case, set the Mode control to Bi-Level . In very cold weather, if you need extra heat at the windshield, set the Mode control to Defrost/Floor  or Defrost  as needed. Adjust Fan and Temperature control for comfort.</p>

STARTING AND OPERATING

CONTENTS

■ Starting Procedures	343	■ Automatic Transmission	349
□ Automatic Transmission	343	□ Key Ignition Park Interlock	349
□ Keyless Enter-N-Go	344	□ Brake/Transmission Shift Interlock System	350
□ Normal Starting	345	□ Five-Speed Automatic Transmission	350
□ Extreme Cold Weather (Below -20°F Or -29°C)	346	□ Gear Ranges	350
□ If Engine Fails To Start	347	■ Four-Wheel Drive Operation	357
□ After Starting	348	□ Quadra-Trac I® Operating Instructions/ Precautions – If Equipped	357
■ Engine Block Heater — If Equipped	348	□ Quadra-Trac II® Operating Instructions/ Precautions – If Equipped	358

- Shift Positions 359
- Shifting Procedures 360
- Quadra-Drive® II System – If Equipped 362
- Selec-Terrain™ — If Equipped 363
 - Description 363
 - Electronic Vehicle Information Center (EVIC) Display Messages 365
- Quadra-Lift™ — If Equipped 365
 - Description 365
 - Electronic Vehicle Information Center (EVIC) Display Messages 368
 - Operation 368
- On-Road Driving Tips 370
- Off-Road Driving Tips 370
 - Quadra-Lift™ – If Equipped 371
 - When To Use 4WD Low Range – If Equipped 371
 - Driving Through Water 372
 - Driving In Snow, Mud And Sand 373
 - Hill Climbing 373
 - Traction Downhill 374
 - After Driving Off-Road 374
- Power Steering 375
 - 3.6L Engine 375
 - 5.7L Engine 377
 - Power Steering Fluid Check 378

■ Multi-Displacement System (MDS) (If Equipped) — 5.7L Engine Only	379	□ Hill Descent Control (HDC) — Four-Wheel Drive Models With MP3023 Two-Speed Transfer Case Only	390
■ Parking Brake	379	□ ESC Activation/Malfunction Indicator Light And ESC Off Indicator Light	392
■ Electronic Brake Control System	381	■ Tire Safety Information	394
□ Anti-Lock Brake System (ABS)	381	□ Tire Markings	394
□ Traction Control System (TCS)	382	□ Tire Identification Number (TIN)	397
□ Brake Assist System (BAS)	382	□ Tire Terminology And Definitions	398
□ Electronic Roll Mitigation (ERM)	383	□ Tire Loading And Tire Pressure	399
□ Electronic Stability Control (ESC)	384	■ Tires — General Information	403
□ Trailer Sway Control (TSC)	387	□ Tire Pressure	403
□ Hill Start Assist (HSA)	387	□ Tire Inflation Pressures	404
□ Ready Alert Braking – If Equipped	390	□ Tire Pressures For High Speed Operation	406
□ Rain Brake Support – If Equipped	390		

340 STARTING AND OPERATING

- Radial-Ply Tires 406
- Spare Tire Matching Original Equipped Tire
And Wheel – If Equipped 406
- Compact Spare Tire – If Equipped 407
- Full Size Spare – If Equipped 408
- Limited-Use Spare – If Equipped 408
- Tire Spinning 409
- Tread Wear Indicators 410
- Life Of Tire 410
- Replacement Tires 411
- Tire Chains (Traction Devices) 412
- Snow Tires 413
- Tire Rotation Recommendations 414
- Tire Pressure Monitor System (TPMS) 415
 - Base System 417
 - Premium System – If Equipped 420
 - General Information 424
- Fuel Requirements 424
 - 3.6L Engine 424
 - 5.7L Engine 424
 - Reformulated Gasoline 425
 - Gasoline/Oxygenate Blends 425
 - E-85 Usage In Non-Flex Fuel Vehicles 426
 - MMT In Gasoline 427
 - Materials Added To Fuel 427
 - Fuel System Cautions 427

□ Carbon Monoxide Warnings	428	■ Adding Fuel	433
■ Flexible Fuel (3.6L Engine Only) —		□ Fuel Filler Cap (Gas Cap)	433
If Equipped	429	□ Loose Fuel Filler Cap Message	436
□ E-85 General Information	429	■ Vehicle Loading	436
□ Ethanol Fuel (E-85)	430	□ Certification Label	436
□ Fuel Requirements	430	■ Trailer Towing	438
□ Selection Of Engine Oil For Flexible Fuel		□ Common Towing Definitions	439
Vehicles (E-85) And Gasoline Vehicles	431	□ Trailer Hitch Classification	443
□ Starting	432	□ Trailer Towing Weights	
□ Cruising Range	432	(Maximum Trailer Weight Ratings)	444
□ Replacement Parts	432	□ Trailer And Tongue Weight	445
□ Maintenance	432	□ Towing Requirements	446
		□ Towing Tips	451

- Snow Plow 452
- Recreational Towing
(Behind Motorhome, Etc.) 453
 - Towing This Vehicle Behind
Another Vehicle 453
 - Recreational Towing — Two-Wheel Drive
Models 454
 - Recreational Towing — Quadra-Trac I®
(Single-Speed Transfer Case) Four-Wheel
Drive Models 454
 - Recreational Towing — Quadra-
Trac II® /Quadra-Drive® II Four-Wheel
Drive Models 455

STARTING PROCEDURES

Before starting your vehicle, adjust your seat, adjust the inside and outside mirrors, fasten your seat belt, and if present, instruct all other occupants to buckle their seat belts.

WARNING!

Never leave children alone in a vehicle. Leaving unattended children in a vehicle is dangerous for a number of reasons. A child or others could be seriously or fatally injured. Do not leave the key fob in the ignition switch. A child could operate power windows, other controls, or move the vehicle.

Automatic Transmission

The shift lever must be in the NEUTRAL or PARK position before you can start the engine. Apply the brakes before shifting into any driving gear.

CAUTION!

Damage to the transmission may occur if the following precautions are not observed:

- Shift into PARK only after the vehicle has come to a complete stop.
- Shift into or out of REVERSE only after the vehicle has come to a complete stop and the engine is at idle speed.
- Do not shift from REVERSE, PARK, or NEUTRAL into any forward gear when the engine is above idle speed.
- Before shifting into any gear, make sure your foot is firmly on the brake pedal.

Using Fob With Integrated Key (Tip Start)

NOTE: Normal starting of either a cold or a warm engine is obtained without pumping or pressing the accelerator pedal.

Do not press the accelerator. Use the Fob with Integrated Key to briefly turn the ignition switch to the START position and release it as soon as the starter engages. The starter motor will continue to run, and it will disengage automatically when the engine is running. If the engine fails to start, the starter will disengage automatically in 10 seconds. If this occurs, turn the ignition switch to the LOCK position, wait 10 to 15 seconds, then repeat the “Normal Starting” procedure.

Keyless Enter-N-Go

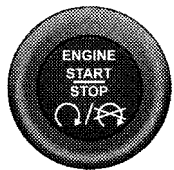

050105203

This feature allows the driver to operate the ignition switch with the push of a button, as long as the ENGINE START/STOP button is installed and the Remote Keyless Entry (RKE) transmitter is in the passenger compartment.

Installing and Removing the ENGINE START/STOP Button

Installing the Button

1. Remove the key fob from the ignition switch.
2. Insert the ENGINE START/STOP button into the ignition switch with the lettering facing up and readable.
3. Press firmly on the center of the button to secure it into position.

Removing the Button

1. The ENGINE START/STOP button can be removed from the ignition switch for key fob use.
2. Insert the metal part of the emergency key under the chrome bezel at the 6 o'clock position and gently pry the button loose.

NOTE: The ENGINE START/STOP button should only be removed or inserted with the ignition in the LOCK position (OFF position for Keyless Enter-N-Go).

Normal Starting

Using the ENGINE START/STOP Button

NOTE: Normal starting of either a cold or a warm engine is obtained without pumping or pressing the accelerator pedal.

To start the engine, the transmission must be in PARK or NEUTRAL. Press and hold the brake pedal while pressing the ENGINE START/STOP button once. The system takes over and attempts to start the vehicle. If the vehicle fails to start, the starter will disengage automatically after 10 seconds. If you wish to stop the cranking of the engine prior to the engine starting, press the button again.

To Turn Off the Engine Using ENGINE START/STOP Button

1. Place the shift lever in PARK, then press and release the ENGINE START/STOP button.
2. The ignition switch will return to the OFF position.
3. If the shift lever is not in PARK, the ENGINE START/STOP button must be held for two seconds and vehicle speed must be above 5 mph (8 km/h) before the engine will shut off. The ignition switch position will remain in the ACC position until the shift lever is in PARK and the button is pressed twice to the OFF position. If the shift lever is not in PARK and the ENGINE START/STOP button is pressed once, the EVIC (if equipped) will display a “Vehicle Not In Park” message and the engine will remain running. Never leave a vehicle out of the PARK position, or it could roll.

NOTE: If the ignition switch is left in the ACC or RUN (engine not running) position and the transmission is in PARK, the system will automatically time out after 30 minutes of inactivity and the ignition will switch to the OFF position.

Keyless Enter-N-Go Functions – With Driver’s Foot OFF the Brake Pedal (In PARK or NEUTRAL Position)

The Keyless Enter-N-Go feature operates similar to an ignition switch. It has four positions, OFF, ACC, RUN and START. To change the ignition switch positions without starting the vehicle and use the accessories follow these steps.

- Starting with the ignition switch in the OFF position:
- Press the ENGINE START/STOP button once to change the ignition switch to the ACC position (EVIC displays “IGNITION MODE ACCESSORY”),

- Press the ENGINE START/STOP button a second time to change the ignition switch to the RUN position (EVIC displays “IGNITION MODE RUN”),
- Press the ENGINE START/STOP button a third time to return the ignition switch to the OFF position (EVIC displays “IGNITION MODE OFF”).

Extreme Cold Weather (Below –20°F or –29°C)

To ensure reliable starting at these temperatures, use of an externally powered electric engine block heater (available from your authorized dealer) is recommended.

If Engine Fails To Start

WARNING!

- **Never pour fuel or other flammable liquids into the throttle body air inlet opening in an attempt to start the vehicle. This could result in a flash fire causing serious personal injury.**
- **Do not attempt to push or tow your vehicle to get it started. Vehicles equipped with an automatic transmission cannot be started this way. Unburned fuel could enter the catalytic converter and once the engine has started, ignite and damage the converter and vehicle. If the vehicle has a discharged battery, booster cables may be used to obtain a start from a booster battery or the battery in another vehicle. This type of start can be dangerous if done improperly. Refer to "Jump Starting" in "What To Do In Emergencies" for further information.**

Clearing a Flooded Engine (Using ENGINE START/STOP Button)

If the engine fails to start after you have followed the "Normal Starting" or "Extreme Cold Weather" procedures, it may be flooded. To clear any excess fuel, press and hold the brake pedal, push the accelerator pedal all the way to the floor and hold it, then press and release the ENGINE START/STOP button once. The starter motor will engage automatically, run for 10 seconds, and then disengage. Once this occurs, release the accelerator pedal and the brake pedal, wait 10 to 15 seconds, then repeat the "Normal Starting" procedure.

Clearing A Flooded Engine (Using Fob With Integrated Key)

If the engine fails to start after you have followed the "Normal Starting" or "Extreme Cold Weather" procedures, it may be flooded. To clear any excess fuel, push the accelerator pedal all the way to the floor and hold it. Then, turn the ignition switch to the START position and

release it as soon as the starter engages. The starter motor will disengage automatically in 10 seconds. Once this occurs, release the accelerator pedal, turn the ignition switch to the LOCK position, wait 10 to 15 seconds, then repeat the “Normal Starting” procedure.

CAUTION!

To prevent damage to the starter, wait 10 to 15 seconds before trying again.

After Starting

The idle speed is controlled automatically and it will decrease as the engine warms up.

ENGINE BLOCK HEATER — IF EQUIPPED

The engine block heater warms the engine, and permits quicker starts in cold weather. Connect the cord to a standard 110-115 Volt AC electrical outlet with a grounded, three-wire extension cord.

The engine block heater cord is located:

- 3.6L Engine – coiled and strapped to the engine oil dipstick tube.
- 5.7L Engine – bundled and fastened to the injector harness.

The engine block heater must be plugged in at least one hour to have an adequate warming effect on the engine.

WARNING!

Remember to disconnect the engine block heater cord before driving. Damage to the 110-115 Volt electrical cord could cause electrocution.

AUTOMATIC TRANSMISSION**CAUTION!**

Damage to the transmission may occur if the following precautions are not observed:

- Shift into PARK only after the vehicle has come to a complete stop.
- Shift into or out of REVERSE only after the vehicle has come to a complete stop and the engine is at idle speed.
- Do not shift from REVERSE, PARK, or NEUTRAL into any forward gear when the engine is above idle speed.
- Before shifting into any gear, make sure your foot is firmly on the brake pedal.

WARNING!

It is dangerous to move the shift lever out of PARK or NEUTRAL if the engine speed is higher than idle speed. If your foot is not firmly on the brake pedal, the vehicle could accelerate quickly forward or in reverse. You could lose control of the vehicle and hit someone or something. Only shift into gear when the engine is idling normally and when your foot is firmly on the brake pedal.

Key Ignition Park Interlock

This vehicle is equipped with a Key Ignition Park Interlock which requires the shift lever to be placed in PARK prior to turning the ignition switch to the LOCK position. The key fob can only be removed from the ignition switch when the ignition switch is in the LOCK position. Once the key fob is removed, the shift lever is locked in PARK.

Brake/Transmission Shift Interlock System

This vehicle is equipped with a Brake Transmission Shift Interlock System (BTSI) that holds the shift lever in the PARK position when the ignition switch is in the LOCK position. To move the shift lever out of the PARK position, the ignition switch must be turned to the ON or START position (engine running or not) and the brake pedal must be pressed.

Five-Speed Automatic Transmission

The electronically-controlled transmission provides a precise shift schedule. The transmission electronics are self-calibrating; therefore, the first few shifts on a new vehicle may be somewhat abrupt. This is a normal condition, and precision shifts will develop within a few hundred miles/kilometers.

Gear Ranges

NOTE: After selecting any gear range, wait a moment to allow the selected gear to engage before accelerating. This is especially important when the engine is cold. If there is a need to restart the engine, be sure to turn the ignition switch to the LOCK position before restarting. Transmission gear engagement may be delayed after restarting the engine if the ignition switch is not turned to the LOCK position first.

PARK

This range supplements the parking brake by locking the transmission. The engine can be started in this range. Never use PARK while the vehicle is in motion. Apply the parking brake when leaving the vehicle in this range. Always apply the parking brake first, then place the shift lever into the PARK position.

WARNING!

- Never use the PARK position as a substitute for the parking brake. Always apply the parking brake fully when parked to guard against vehicle movement and possible injury or damage.
- It is dangerous to move the shift lever out of PARK or NEUTRAL if the engine speed is higher than idle speed. If your foot is not firmly on the brake pedal, the vehicle could accelerate quickly forward or in reverse. You could lose control of the vehicle and hit someone or something. Only shift into gear when the engine is idling normally and when your right foot is firmly on the brake pedal.

REVERSE

This range is for moving the vehicle backward. Use only after the vehicle has come to a complete stop.

NEUTRAL

This range is used when vehicle is standing for prolonged periods with engine running. Engine may be started in this range. Set the parking brake and shift the transmission into PARK if you must leave the vehicle.

NOTE: Towing the vehicle, coasting, or driving for any other reason with the shift lever in NEUTRAL can result in severe transmission damage. Refer to "Recreational Towing" in "Starting and Operating" and "Towing a Disabled Vehicle" in "What To Do In Emergencies" for further information.

DRIVE

This range should be selected only when the vehicle is at a complete stop and the brakes are firmly applied. The transmission automatically upshifts through fifth gear. The DRIVE position provides optimum driving characteristics under all normal operating conditions.

Electronic Range Select (ERS) Operation

The Electronic Range Select (ERS) shift control allows you to move the shift lever left (-) or right (+) when the shift lever is in the DRIVE position, allowing you to limit the highest available gear. For example, if the driver shifts the transmission into ERS 3 (third gear), the transmission will never shift above third gear, but can shift down to 2 (second) or 1 (first), when needed.

NOTE:

- If you pull and hold (not tap) the shift lever to the left (-), the transmission will downshift to the lowest gear that can be attained without overrevving the engine. The display will show the gear the vehicle is in and will limit the top gear to the one displayed.
- If you push and hold (not tap) the shift lever to the right (+), the transmission will exit the gear limiting mode and shift to the appropriate gear. The display will read "D".

3.6L Engine

When in the DRIVE position, the first tap to the left (-) will shift down one gear and will display that gear. For example, if you are in DRIVE and are in fifth gear, when you tap the shift lever one time to the left (-), the transmission will downshift to fourth gear and the display will show 4. Another tap to the left (-) will shift the transmission into third gear.

5.7L Engine

On vehicles equipped with the 5.7L engine, use of ERS (or TOW/HAUL mode) also enables an additional underdrive gear which is not normally used during through-gear accelerations. This additional gear improves vehicle performance and cooling capability when towing a trailer on certain grades. ERS 1, 2, and 3 are underdrive gears; ERS 4 is direct drive. ERS 5 (Overdrive) is the same as the normal 4th gear. When in the DRIVE position in first through fourth gear, the first tap to the left (-) will display

the ERS designation for the current gear (the transmission will not downshift). For example, if you are in DRIVE and are in third (direct) gear, when you tap the shift lever one time to the left (-), the display will show 4 (ERS 4 is direct gear). Another tap to the left (-) will shift the transmission down to ERS 3 (the added underdrive gear). When in the DRIVE position in fifth gear, the first tap to the left (-) will downshift the transmission and display 5 (ERS 5 is the same as normal fourth gear). Another tap to the left (-) will shift the transmission down to ERS 4 (direct gear).

WARNING!

Do not downshift for additional engine braking on a slippery surface. The drive wheels could lose their grip and the vehicle could skid.

Screen Display	1	2	3	4	5*	D
Actual Gear(s) Allowed	1	1-2	1-3	1-4	1-5	1-5

* Applies to vehicles equipped with 5.7L engines only.

NOTE: To select the proper gear position for maximum deceleration (engine braking), move the shift lever to the left "D(-)" and hold it there. The transmission will shift to the range from which the vehicle can best be slowed down.

Overdrive Operation

The automatic transmission includes an electronically controlled Overdrive (fifth gear for 3.6L engine, fourth and fifth gears for 5.7L engine). The transmission will automatically shift to Overdrive, if the following conditions are present:

- the shift lever is in DRIVE;

- the engine coolant has reached normal operating temperature;
- vehicle speed is above approximately 30 mph (48 km/h);
- the TOW/HAUL switch has not been activated;
- transmission has reached normal operating temperature.

NOTE: If the vehicle is started in extremely cold temperatures, the transmission may not shift into Overdrive and will automatically select the most desirable gear for operation at this temperature. Normal operation will resume when the transmission fluid temperature has risen to a suitable level. Refer to the “Note” under “Torque Converter Clutch” in this section.

During cold temperature operation you may notice delayed upshifts, depending on engine and transmission temperature. This feature improves the warm-up time of the engine and transmission.

If the transmission temperature gets extremely hot, the transmission will automatically select the most desirable gear for operation at this temperature. If the transmission temperature becomes hot enough, the “TRANSMISSION OVER TEMP” message may display, and the transmission may downshift out of Overdrive until the transmission cools down. After cool down, the transmission will resume normal operation.

The transmission will downshift from Overdrive, to the most desirable gear, if the accelerator pedal is fully pressed at vehicle speeds above approximately 35 mph (56 km/h).

When to Use TOW/HAUL Mode – If Equipped

When driving in hilly areas, towing a trailer, carrying a heavy load, etc., and frequent transmission shifting occurs, press the TOW/HAUL switch. This will improve performance and reduce the potential for transmission overheating or failure due to excessive shifting. When

operating in TOW/HAUL mode, the transmission will shift into direct gear and Overdrive will be enabled under steady cruise conditions.



TOW/HAUL Switch

The “TOW/HAUL Indicator Light” will illuminate in the instrument cluster to indicate when the switch has been activated. Pressing the switch a second time restores

normal operation. If the TOW/HAUL mode is desired, the switch must be pressed each time the engine is started.

In high ambient temperatures with sustained high engine speed and load, an upshift, followed shortly thereafter by a downshift, may occur. The “TOW/HAUL Indicator Light” will turn off. This is a normal part of the overheat protection strategy when operating in the TOW/HAUL mode.

Transmission Limp Home Mode

Transmission function is monitored for abnormal conditions. If a condition is detected that could result in transmission damage, the Transmission Limp Home Mode will be engaged. In this mode, the transmission will remain in the current gear (3.6L engine) or in direct gear (5.7L engine) until the vehicle is brought to a stop.

To reset the transmission, use the following procedure:

1. Stop the vehicle.
2. Move the shift lever into the PARK position.
3. Turn the engine off, and be sure to turn the ignition switch to the LOCK position.
4. Wait approximately 10 seconds, then restart the engine.
5. Move the shift lever to the desired gear range.

If the problem is no longer detected, the transmission will return to normal operation. If the problem persists, PARK, REVERSE, and NEUTRAL will continue to operate. Only second gear (3.6L engine) or third gear (5.7L engine) will be available in the DRIVE position. Have the transmission checked at your authorized dealer as soon as possible.

Torque Converter Clutch

A feature, designed to improve fuel economy, has been included in the automatic transmission on your vehicle. A clutch within the torque converter engages automatically, at a calibrated speed, at light throttle. It engages at higher speeds under heavier acceleration. This may result in a slightly different feeling or response during normal operation in high gear. When the vehicle speed drops below a calibrated speed, or during acceleration, the clutch automatically and smoothly disengages.

NOTE:

- The torque converter clutch may not engage until the transmission fluid and engine coolant are warm [usually after 1 to 3 miles (1.6 to 4.8 km) of driving]. Because the engine speed is higher when the torque converter clutch is not engaged, it may seem as if the transmission is not shifting into Overdrive when cold. This is normal. Manually shifting (using the ERS shift control) between 4 (direct gear) and 5/D (Overdrive

gear) positions will demonstrate that the transmission is able to shift into and out of Overdrive. For vehicles with 5.7L engines (which have two Overdrive gears), the transmission may not shift into the top Overdrive gear (normal fifth gear) until the transmission fluid and engine coolant are warm.

- If the vehicle has not been driven in several days, the first few seconds of operation after shifting the transmission into gear may seem sluggish. This is due to the fluid partially draining from the torque converter into the transmission. This condition is normal and will not cause damage to the transmission. The torque converter will refill within five seconds after starting the engine.

FOUR-WHEEL DRIVE OPERATION

Quadra-Trac I® Operating Instructions/ Precautions – If Equipped

The Quadra-Trac I® is a single-speed (HI range only) transfer case, which provides convenient full-time four-wheel drive. No driver interaction is required. The Brake Traction Control (BTC) System, which combines standard ABS and Traction Control, provides resistance to any wheel that is slipping to allow additional torque transfer to wheels with traction.

NOTE: The Quadra-Trac I® system is not appropriate for conditions where 4WD LOW range is recommended. Refer to “Off-Road Driving Tips” in “Starting and Operating” for further information.

Quadra-Trac II® Operating Instructions/ Precautions – If Equipped

The Quadra-Trac II® transfer case is fully automatic in the normal driving 4WD AUTO mode. The Quadra-Trac II® transfer case provides three mode positions:



Transfer Case Switch

- 4WD HI
- NEUTRAL
- 4WD LOW

This transfer case is fully automatic in the 4WD HI mode.

When additional traction is required, the 4WD LOW position can be used to lock the front and rear driveshafts together and force the front and rear wheels to rotate at the same speed. The 4WD LOW position is intended for loose, slippery road surfaces only. Driving in the 4WD LOW position on dry, hard-surfaced roads may cause increased tire wear and damage to driveline components.

When operating your vehicle in 4WD LOW, the engine speed is approximately three times that of the 4WD HI position at a given road speed. Take care not to overspeed the engine and do not exceed 25 mph (40 km/h).

Proper operation of four-wheel drive vehicles depends on tires of equal size, type, and circumference on each wheel. Any difference will adversely affect shifting and cause damage to the transfer case.

Because four-wheel drive provides improved traction, there is a tendency to exceed safe turning and stopping speeds. Do not go faster than road conditions permit.

WARNING!

You or others could be injured if you leave the vehicle unattended with the transfer case in the N (Neutral) position without first fully engaging the parking brake. The transfer case N (Neutral) position disengages both the front and rear driveshafts from the powertrain and will allow the vehicle to move regardless of the transmission position. The parking brake should always be applied when the driver is not in the vehicle.

Shift Positions

For additional information on the appropriate use of each transfer case mode position, see the information below:

4WD AUTO

This range is used on surfaces such as ice, snow, gravel, sand, and dry hard pavement.

NOTE: Refer to “Selec-Terrain® – If Equipped” in “Starting and Operating” for further information on the various positions and their intended usages.

NEUTRAL

This range disengages both the front and rear driveshafts from the powertrain. It is to be used for flat towing behind another vehicle. Refer to “Recreational Towing” in “Starting and Operating” for further information.

4WD LOW

This range is for low speed four-wheel drive. It locks the front and rear driveshafts together and forces the front and rear wheels to rotate at the same speed. It provides additional traction and maximum pulling power for loose, slippery road surfaces only. Do not exceed 25 mph (40 km/h).

NOTE: Refer to “Selec-Terrain® – If Equipped” for further information on the various positions and their intended usages.

Shifting Procedures

4WD HI to 4WD LOW

With the vehicle at speeds of 0 to 3 mph (0 to 5 km/h), the ignition switch in the ON position or the engine running, shift the transmission into NEUTRAL, and press the “4WD LOW” button once on the transfer case switch. The “4WD LOW” indicator light in the instrument cluster will begin to flash and remain on solid when the shift is complete.



Transfer Case Switch

NOTE: If shift conditions/interlocks are not met, or a transfer case motor temperature protection condition exists, a “For 4x4 Low Slow Below 3 MPH or 5 KPH Put Trans in N Press 4 Low” message will flash from the Electronic Vehicle Information Center (EVIC). Refer to “Electronic Vehicle Information Center (EVIC)” in “Understanding Your Instrument Panel” for further information.

4WD LOW to 4WD HI

With the vehicle at speeds of 0 to 3 mph (0 to 5 km/h), the ignition switch in the ON position or the engine running, shift the transmission into NEUTRAL, and press the “4WD LOW” button once on the transfer case switch. The “4WD LOW” indicator light in the instrument cluster will flash and go out when the shift is complete.

NOTE:

- If shift conditions/interlocks are not met, or a transfer case motor temperature protection condition exists, a “For 4x4 High Slow Below 3 MPH or 5 KPH Put Trans in N Press 4 Low” message will flash from the Electronic Vehicle Information Center (EVIC). Refer to “Electronic Vehicle Information Center (EVIC)” in “Understanding Your Instrument Panel” for further information.
- Shifting into or out of 4WD LOW is possible with the vehicle completely stopped; however, difficulty may

occur due to the mating clutch teeth not being properly aligned. Several attempts may be required for clutch teeth alignment and shift completion to occur. The preferred method is with the vehicle rolling 0 to 3 mph (0 to 5 km/h). If the vehicle is moving faster than 3 mph (5 km/h), the transfer case will not allow the shift.

NEUTRAL Shift Procedure

1. Turn the ignition switch to the ON position, engine off.
2. Vehicle stopped, with foot on brake.
3. Place the transmission into NEUTRAL.
4. Hold down the NEUTRAL “pin” switch (with a pen, etc.) for four seconds until the LED light by the switch starts to blink indicating shift in progress. The light will stop blinking (stay on solid) when the NEUTRAL shift is complete. A “To Tow Vehicle Safely, Read Neutral Shift Procedure in Owners Manual” message will display on

the Electronic Vehicle Information Center (EVIC). Refer to “Electronic Vehicle Information Center (EVIC)” in “Understanding Your Instrument Panel” for further information.



Neutral Switch

5. Repeat Steps 1 to 4 to shift out of NEUTRAL.

NOTE: If shift conditions/interlocks are not met, a “To Tow Vehicle Safely, Read Neutral Shift Procedure in Owners Manual” message will flash from the Electronic Vehicle Information Center (EVIC). Refer to “Electronic Vehicle Information Center (EVIC)” in “Understanding Your Instrument Panel” for further information.

Quadra-Drive® II System – If Equipped

The optional Quadra-Drive® II System features two torque transfer couplings. The couplings include an Electronic Limited-Slip Differential (ELSD) rear axle and the Quadra-Trac II® transfer case. The optional ELSD axle is fully automatic and requires no driver input to operate. Under normal driving conditions, the unit functions as a standard axle, balancing torque evenly between left and right wheels. With a traction difference between left and right wheels, the coupling will sense a speed difference. As one wheel begins to spin faster than the other, torque will automatically transfer from the wheel that has less traction, to the wheel that has traction. While the transfer

case and axle coupling differ in design, their operation is similar. Follow the Quadra-Trac II® transfer case shifting information, preceding this section, for shifting this system.

SELEC-TERRAIN™ — IF EQUIPPED

Description

Selec-Terrain™ combines the capabilities of the vehicle control systems, along with driver input, to provide the best performance for all terrains.



Selec-Terrain™ Switch

Selec-Terrain™ consists of the following positions:

- **Sport** – Dry weather, on-road calibration. Only available in 4WD High range. Performance based tuning that provides a rear wheel drive feel but with improved handling and acceleration over a two-wheel drive vehicle. The Electronic Stability Control will set

to allow more driver control of vehicle while maintaining safe handling controls. The vehicle will lower (if equipped with Air Suspension) to Aero Mode in High Range. 4WD Low is not available in SPORT mode, if 4WD Low is selected the Selec-Terrain™ will automatically switch back to AUTO.

- **Snow** – Tuning set for additional stability in inclement weather. Use on and off road on loose traction surfaces such as snow. When in Snow mode (depending on certain operating conditions), the transmission may use second gear (rather than first gear) during launches, to minimize wheel slippage. If equipped with air suspension, the level will change to Normal Ride Height (NRH) if the transfer case is in high range. The level will change to Off-Road 1 if the transfer case is in Low range.
- **Auto** – Fully automatic full time four-wheel drive operation can be used on and off road. Balances

traction with seamless steering feel to provide improved handling and acceleration over two-wheel drive vehicles. If equipped with air suspension, the level will change to NRH.

- **Sand/Mud** – Off road calibration for use on low traction surfaces such as mud, sand, or wet grass. Driveline is maximized for traction. Some binding may be felt on less forgiving surfaces. The electronic brake controls are set to limit traction control management of throttle and wheel spin. If equipped with air suspension, the level will change to Off-Road 1.
- **Rock** – Off-road calibration only available in 4WD Low range. The vehicle is raised (if equipped with Air Suspension) for improved ground clearance. Traction based tuning with improved steer-ability for use on high traction off-road surfaces. Activates the Hill Descent Control for steep downhill control. Use for low speed obstacles such as large rocks, deep ruts, etc. If

equipped with air suspension, the vehicle level will change to Off-Road 2. If the Selec-Terrain™ switch is in ROCK mode, and the transfer case is switched from 4WD Low to 4WD High, the Selec-Terrain™ system will return to AUTO.

Electronic Vehicle Information Center (EVIC) Display Messages

When the appropriate conditions exist, a message will appear in the EVIC display. Refer to “Electronic Vehicle Information Center (EVIC)” in “Understanding Your Instrument Panel” for further information.

QUADRA-LIFT™ — IF EQUIPPED

Description

The Quadra-Lift™ air suspension system provides full time load leveling capability along with the benefit of being able to adjust vehicle height by the push of a button.



Selec-Terrain™ Switch

- 1 — Up Button
- 2 — Down Button
- 3 — Park Mode Indicator Lamp
- 4 — Normal Ride Height Indicator Lamp
- 5 — Off-Road 1 Indicator Lamp
- 6 — Off-Road 2 Indicator Lamp

- **Normal Ride Height (NRH)** – This is the standard position of the suspension and is meant for normal driving.

- **Off-Road 1 (OR1) (Raises the vehicle approximately 1.3 in (33 mm))** – This position should be the default position for all off-road driving until OR2 is needed. A smoother and more comfortable ride will result. Press the “Up” button once from the NRH position while the vehicle speed is below 48 mph (77 km/h). When in the OR1 position, if the vehicle speed remains between 40 mph (64 km/h) and 50 mph (80 km/h) for greater than 20 seconds or if the vehicle speed exceeds 50 mph (80 km/h), the vehicle will be automatically lowered to NRH. Refer to “Off-Road Driving Tips” in “Starting and Operating” for further information.
- **Off-Road 2 (OR2) (Raises the vehicle approximately 2.6 in (65 mm))** – This position is intended for off-roading use only where maximum ground clearance is required. To enter OR2, press the “Up” button twice from the NRH position or once from the OR1 position while vehicle speed is below 20 mph (32 km/h). While in OR2, if the vehicle speed exceeds 25 mph (40 km/h) the vehicle height will be automatically lowered to OR1. Refer to “Off-Road Driving Tips” in “Starting and Operating” for further information.
- **Aero Mode (Lowers the vehicle approximately 0.5 in (13 mm))** – This position provides improved aerodynamics by lowering the vehicle. The vehicle will automatically enter Aero Mode when the vehicle speed remains between 62 mph (99 km/h) and 66 mph (106 km/h) for greater than 20 seconds or if the vehicle speed exceeds 66 mph (106 km/h). The vehicle will return to NRH from Aero Mode if the vehicle speed remains between 30 mph (48 km/h) and 35 mph (56 km/h) for greater than 20 seconds or if the vehicle speed falls below 30 mph (48 km/h). The vehicle will enter Aero Mode, regardless of vehicle speed if the Selec-Terrain™ knob is turned to the “SPORT” position. Turning the Selec-Terrain™ knob to the “AUTO” position will return the system to normal operation.

- **Park Mode (Lowers the vehicle approximately 1.5 in (38 mm) –** This position lowers the vehicle for easier passenger entry and exit as well as lowering the rear of the vehicle for easier loading and unloading of cargo. To enter Park Mode, press the “Down” button once while the vehicle speed is below 25 mph (40 km/h). Once the vehicle speed goes below 15 mph (24 km/h) the vehicle height will begin to lower. If the vehicle speed remains between 15 mph (24 km/h) and 25 mph (40 km/h) for greater than 60 seconds, or the vehicle speed exceeds 25 mph (40 km/h) the Park Mode change will be cancelled. To exit Park Mode, press the “Up” button once while in Park Mode or drive the vehicle over 15 mph (24 km/h).

The Selec-Terrain™ switch will automatically change the vehicle to the proper height based on the position of the Selec-Terrain™ switch. The height can be changed from the default Selec-Terrain™ setting by normal use of the

air suspension buttons. Refer to “Selec-Terrain™” in “Starting and Operating” for further information.

The system requires that the engine be running for all changes. When lowering the vehicle all of the doors, including the liftgate, must be closed. If a door is opened at any time while the vehicle is lowering the change will not be completed until the open door(s) is closed.

The Quadra-Lift™ air suspension system uses a lifting and lowering pattern which keeps the headlights from incorrectly shining into oncoming traffic. When raising the vehicle, the rear of the vehicle will move up first and then the front. When lowering the vehicle, the front will move down first and then the rear.

After the engine is turned off, it may be noticed that the air suspension system operates briefly, this is normal. The system is correcting the position of the vehicle to ensure a proper appearance.

To assist with changing a spare tire, the Quadra-Lift™ air suspension system has a feature which allows the automatic leveling to be disabled. Press and hold both the “Up” and “Down” buttons simultaneously between 5 and 10 seconds, a message will appear in the EVIC stating leveling has been disabled immediately after both buttons have been released. Refer to “Electronic Vehicle Information Center (EVIC)” in “Understanding Your Instrument Panel” for further information. Driving the vehicle over 5 mph (8 km/h) will return the air suspension to normal operation. Refer to “Jacking and Tire Changing” in “What To Do In Emergencies” for further information.

WARNING!

The air suspension system uses a high pressure volume of air to operate the system. To avoid personal injury or damage to the system, see your authorized dealer for service.

Electronic Vehicle Information Center (EVIC) Display Messages

When the appropriate conditions exist, a message will appear in the EVIC display. Refer to “Electronic Vehicle Information Center (EVIC)” in “Understanding Your Instrument Panel” for further information.

An audible chime will be heard whenever a system error has been detected.

Operation

The indicator lamps 3 through 6 will illuminate to show the current position of the vehicle. Flashing indicator lamps will show a position which the system is working to achieve. When raising, if multiple indicator lamps are flashing on the “Up” button, the highest flashing indicator lamp is the position the system is working to achieve. When lowering, if multiple indicators are flashing on the “Up” button the lowest solid indicator lamp is the position the system is working to achieve.

Pressing the “UP” button once will move the suspension one position higher from the current position, assuming all conditions are met (i.e. engine running, speed below threshold, etc). The “UP” button can be pressed multiple times, each press will raise the requested level by one position up to a maximum position of OR2 or the highest position allowed based on current conditions (i.e. vehicle speed, etc).

Pressing the “DOWN” button once will move the suspension one position lower from the current level, assuming all conditions are met (i.e. engine running, doors closed, speed below threshold, etc). The “DOWN” button can be pressed multiple times. Each press will lower the requested level by one position down to a minimum of Park Mode or the lowest position allowed based on current conditions (i.e. vehicle speed, etc.)

Automatic height changes will occur based on vehicle speed and the current vehicle height. The indicator lamps and EVIC messages will operate the same for automatic changes and user requested changes.

- Off-Road 2 (OR2) – Indicator lamps 4, 5, and 6 will be illuminated when the vehicle is in OR2.
- Off-Road 1 (OR1) – Indicator lamps 4 and 5 will be illuminated when the vehicle is in OR1.
- Normal Ride Height (NRH) – Indicator lamp 4 will be illuminated when the vehicle is in this position.
- Park Mode – Indicator lamp 3 will be illuminated when the vehicle is in Park Mode. If Park Mode is requested while vehicle speed is between 15 mph (24 km/h) and 25 mph (40 km/h), indicator lamp 4 will remain on solid and indicator lamp 3 will flash as the system waits for the vehicle to reduce speed. If vehicle speed is reduced to, and kept below, 15 mph

(24 km/h) indicator lamp 4 will turn off and indicator lamp 3 will flash until Park Mode is achieved at which point indicator lamp 3 will go solid. If during the height change to Park Mode, the vehicle speed exceeds 15 mph (24 km/h), the height change will be paused until the vehicle speed either goes below 15 mph (24 km/h) and the height change continues to Park Mode, or exceeds 25 mph (40 km/h) and the vehicle height will return to NRH. Park Mode may be selected while the vehicle is not moving provided that the engine is still running and all doors remain closed.

ON-ROAD DRIVING TIPS

Utility vehicles have higher ground clearance and a narrower track to make them capable of performing in a wide variety of off-road applications. Specific design characteristics give them a higher center of gravity than ordinary cars.

An advantage of the higher ground clearance is a better view of the road, allowing you to anticipate problems. They are not designed for cornering at the same speeds as conventional two-wheel drive vehicles any more than low-slung sports cars are designed to perform satisfactorily in off-road conditions. If at all possible, avoid sharp turns or abrupt maneuvers. As with other vehicles of this type, failure to operate this vehicle correctly may result in loss of control or vehicle rollover.

OFF-ROAD DRIVING TIPS

NOTE: Prior to off-road driving, remove the front air dam to prevent damage. The front air dam is attached to the lower front fascia with seven quarter turn fasteners and can be removed by hand.

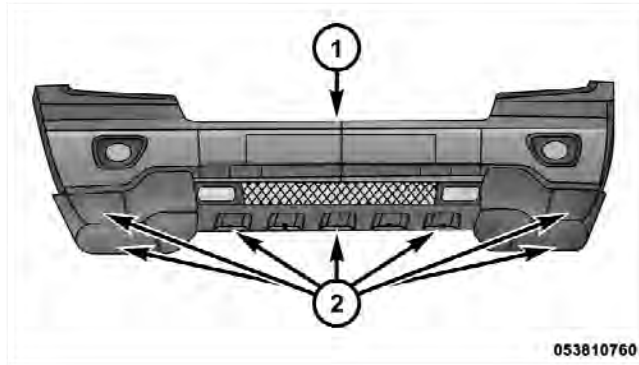

Front Air Dam

- 1 — Front Bumper
- 2 — Front Air Dam Fasteners

Quadra-Lift™ – If Equipped

When off-roading, it is recommended that the lowest useable vehicle height that will clear the current obstacle

or terrain be selected. The vehicle height should then be raised as required by the changes in terrain.

The Selec-Terrain™ switch will automatically change the vehicle to the optimized height based on the Selec-Terrain™ switch position. The vehicle height can be changed from the default height for each Selec-Terrain™ mode by normal use of the air suspension switches. Refer to “Quadra-Lift™ – If Equipped” in “Starting and Operating” for further information.

When To Use 4WD LOW Range – If Equipped

When off-road driving, shift to 4WD LOW for additional traction. This range should be limited to extreme situations such as deep snow, mud, or sand where additional low speed pulling power is needed. Vehicle speeds in excess of 25 mph (40 km/h) should be avoided when in 4WD LOW range.

Driving Through Water

Although your vehicle is capable of driving through water, there are a number of precautions that must be considered before entering the water.

NOTE: Your vehicle is capable of water fording in up to 20 inches (51 cm) of water, while crossing small rivers or streams. To maintain optimal performance of your vehicle's heating and ventilation system it is recommended to switch the system into recirculation mode during water fording.

CAUTION!

When driving through water, do not exceed 5 mph (8 km/h). Always check water depth before entering, as a precaution, and check all fluids afterward. Driving through water may cause damage that may not be covered by the new vehicle limited warranty.

Driving through water more than a few inches/centimeters deep will require extra caution to ensure safety and prevent damage to your vehicle. If you must drive through water, try to determine the depth and the bottom condition (and location of any obstacles) prior to entering. Proceed with caution and maintain a steady controlled speed less than 5 mph (8 km/h) in deep water to minimize wave effects.

Flowing Water

If the water is swift flowing and rising (as in storm run-off), avoid crossing until the water level recedes and/or the flow rate is reduced. If you must cross flowing water avoid depths in excess of 9 inches (23 cm). The flowing water can erode the streambed, causing your vehicle to sink into deeper water. Determine exit point(s) that are downstream of your entry point to allow for drifting.

Standing Water

Avoid driving in standing water deeper than 20 inches (51 cm), and reduce speed appropriately to minimize wave effects. Maximum speed in 20 inches (51 cm) of water is less than 5 mph (8 km/h).

Maintenance

After driving through deep water, inspect your vehicle fluids and lubricants (engine oil, transmission oil, axle, transfer case) to assure the fluids have not been contaminated. Contaminated fluid (milky, foamy in appearance) should be flushed/changed as soon as possible to prevent component damage.

Driving In Snow, Mud And Sand

In heavy snow, when pulling a load, or for additional control at slower speeds, shift the transmission to a low gear and shift the transfer case to 4WD LOW if necessary. Refer to “Four-Wheel Drive Operation” in “Starting and Operating” for further information. Do not shift to a

lower gear than necessary to maintain forward motion. Over-revving the engine can spin the wheels and traction will be lost.

Avoid abrupt downshifts on icy or slippery roads, because engine braking may cause skidding and loss of control.

Hill Climbing

NOTE: Before attempting to climb a hill, determine the conditions at the crest and/or on the other side.

Before climbing a steep hill, shift the transmission to a lower gear and shift the transfer case to 4WD LOW. Use first gear and 4WD LOW for very steep hills.

If you stall or begin to lose forward motion while climbing a steep hill, allow your vehicle to come to a stop and immediately apply the brakes. Restart the engine, and shift into REVERSE. Back slowly down the hill, allowing the compression braking of the engine to help

regulate your speed. If the brakes are required to control vehicle speed, apply them lightly and avoid locking or skidding the tires.

WARNING!

If the engine stalls, you lose forward motion, or cannot make it to the top of a steep hill or grade, never attempt to turn around. To do so may result in tipping and rolling the vehicle. Always back carefully straight down a hill in REVERSE gear. Never back down a hill in NEUTRAL using only the brake.

Remember, never drive diagonally across a hill always drive straight up or down.

If the wheels start to slip as you approach the crest of a hill, ease off the accelerator and maintain forward motion by turning the front wheels slowly. This may provide a fresh “bite” into the surface and will usually provide traction to complete the climb.

Traction Downhill

Shift the transmission into a low gear, and the transfer case into 4WD LOW range. Let the vehicle go slowly down the hill with all four wheels turning against engine compression drag. This will permit you to control the vehicle speed and direction.

When descending mountains or hills, repeated braking can cause brake fade with loss of braking control. Avoid repeated heavy braking by downshifting the transmission whenever possible.

After Driving Off-Road

Off-road operation puts more stress on your vehicle than does most on-road driving. After going off-road, it is always a good idea to check for damage. That way you can get any problems taken care of right away and have your vehicle ready when you need it.

- Completely inspect the underbody of your vehicle. Check tires, body structure, steering, suspension, and exhaust system for damage.
- Inspect the radiator for mud and debris and clean as required.
- Check threaded fasteners for looseness, particularly on the chassis, drivetrain components, steering, and suspension. Retighten them, if required, and torque to the values specified in the Service Manual.
- Check for accumulations of plants or brush. These things could be a fire hazard. They might hide damage to fuel lines, brake hoses, axle pinion seals, and propeller shafts.
- After extended operation in mud, sand, water, or similar dirty conditions, have the radiator, fan, brake rotors, wheels, brake linings, and axle yokes inspected and cleaned as soon as possible.

WARNING!

Abrasive material in any part of the brakes may cause excessive wear or unpredictable braking. You might not have full braking power when you need it to prevent a collision. If you have been operating your vehicle in dirty conditions, get your brakes checked and cleaned as necessary.

- If you experience unusual vibration after driving in mud, slush or similar conditions, check the wheels for impacted material. Impacted material can cause a wheel imbalance and freeing the wheels of it will correct the situation.

5

POWER STEERING

3.6L Engine

Your vehicle is equipped with an electro-hydraulic power steering system that will give you good vehicle response

and increased ease of maneuverability in tight spaces. The system will vary its assist to provide light efforts while parking and good feel while driving. If the electro-hydraulic power steering system experiences a fault that prevents it from providing power steering assist, then the system will provide mechanical steering capability.

CAUTION!

Extreme steering maneuvers may cause the electrically driven pump to reduce or stop power steering assistance in order to prevent damage to the system. Normal operation will resume once the system is allowed to cool.



If the “SERVICE POWER STEERING SYSTEM” message and a flashing icon are displayed on the EVIC screen, it indicates that the vehicle needs to be taken to the dealer for service. It is likely the vehicle has lost power steering assistance. Refer

to “Electronic Vehicle Information (EVIC)” in “Understanding Your Instrument Panel” for further information.

If the “POWER STEERING SYSTEM OVER TEMP” message and an icon are displayed on the EVIC screen, it indicates that extreme steering maneuvers may have occurred, which caused an over temperature condition in the power steering system. You will lose power steering assistance momentarily until the over temperature condition no longer exists. Once driving conditions are safe, then pull over and let vehicle idle for a few moments until the light turns off. Refer to “Electronic Vehicle Information (EVIC)” in “Understanding Your Instrument Panel” for further information.

NOTE:

- Even if power steering assistance is no longer operational, it is still possible to steer the vehicle. Under these conditions there will be a substantial increase in steering effort, especially at very low vehicle speeds and during parking maneuvers.

- If the condition persists, see your authorized dealer for service.

5.7L Engine

The standard power steering system will give you good vehicle response and increased ease of maneuverability in tight spaces. The system will provide mechanical steering capability if power assist is lost.

If for some reason the power assist is interrupted, it will still be possible to steer your vehicle. Under these conditions, you will observe a substantial increase in steering effort, especially at very low vehicle speeds and during parking maneuvers.

NOTE:

- Increased noise levels at the end of the steering wheel travel are considered normal and do not indicate that there is a problem with the power steering system.

- Upon initial start-up in cold weather, the power steering pump may make noise for a short amount of time. This is due to the cold, thick fluid in the steering system. This noise should be considered normal, and it does not in any way damage the steering system.

WARNING!

Continued operation with reduced power steering assist could pose a safety risk to yourself and others. Service should be obtained as soon as possible.

CAUTION!

Prolonged operation of the steering system at the end of the steering wheel travel will increase the steering fluid temperature and it should be avoided when possible. Damage to the power steering pump may occur.

Power Steering Fluid Check

Checking the power steering fluid level at a defined service interval is not required. The fluid should only be checked if a leak is suspected, abnormal noises are apparent, and/or the system is not functioning as anticipated. Coordinate inspection efforts through an authorized dealer.

CAUTION!

Do not use chemical flushes in your power steering system as the chemicals can damage your power steering components. Such damage is not covered by the New Vehicle Limited Warranty.

WARNING!

Fluid level should be checked on a level surface and with the engine off to prevent injury from moving parts and to ensure accurate fluid level reading. Do not overfill. Use only manufacturer's recommended power steering fluid.

If necessary, add fluid to restore to the proper indicated level. With a clean cloth, wipe any spilled fluid from all surfaces. Refer to "Fluids, Lubricants, and Genuine Parts" in "Maintaining Your Vehicle" for further information.

MULTI-DISPLACEMENT SYSTEM (MDS) (IF EQUIPPED) — 5.7L ENGINE ONLY

This feature offers improved fuel economy by shutting off four of the engine's eight cylinders during light load and cruise conditions. The system is automatic with no driver inputs or additional driving skills required.

NOTE: The MDS system may take some time to return to full functionality after a battery disconnect.

PARKING BRAKE

Before leaving the vehicle, make sure that the parking brake is fully applied and place the shift lever in the PARK position.

The foot operated parking brake is located below the lower left corner of the instrument panel. To apply the park brake, firmly push the park brake pedal fully. To release the parking brake, press the park brake pedal a second time and let your foot up as you feel the brake disengage.

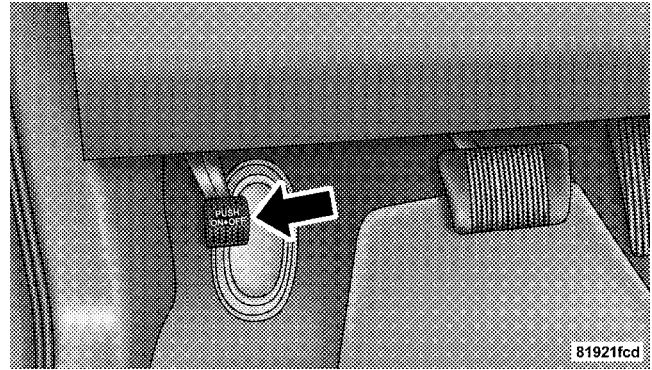

Parking Brake

When the parking brake is applied with the ignition switch in the ON position, the "Brake Warning Light" in the instrument cluster will illuminate.

NOTE:

- When the parking brake is applied and the transmission is placed in gear, the “Brake Warning Light” will flash. If vehicle speed is detected, a chime will sound to alert the driver. Fully release the parking brake before attempting to move the vehicle.
- This light only shows that the parking brake is applied. It does not show the degree of brake application.

When parking on a hill, it is important to turn the front wheels toward the curb on a downhill grade and away from the curb on an uphill grade. Apply the parking brake before placing the shift lever in PARK, otherwise the load on the transmission locking mechanism may make it difficult to move the shift lever out of PARK. The parking brake should always be applied whenever the driver is not in the vehicle.

WARNING!

- **Never use the PARK position as a substitute for the parking brake. Always apply the parking brake fully when parked to guard against vehicle movement and possible injury or damage.**
- **Never leave children alone in a vehicle. Leaving unattended children in a vehicle is dangerous for a number of reasons. A child or others could be seriously or fatally injured.**
- **Do not leave the key fob in the ignition switch. A child could operate power windows, other controls, or move the vehicle.**
- **Be sure the parking brake is fully disengaged before driving; failure to do so can lead to brake failure and a collision.**

(Continued)

WARNING! (Continued)

- Always fully apply the parking brake when leaving your vehicle, or it may roll and cause damage or injury. Also be certain to leave the transmission in PARK. Failure to do so may allow the vehicle to roll and cause damage or injury.

CAUTION!

If the “Brake Warning Light” remains on with the parking brake released, a brake system malfunction is indicated. Have the brake system serviced by an authorized dealer immediately.

ELECTRONIC BRAKE CONTROL SYSTEM

Your vehicle is equipped with an advanced electronic brake control system that includes the Anti-Lock Brake System (ABS), Traction Control System (TCS), Brake Assist System (BAS), Electronic Roll Mitigation (ERM), and Electronic Stability Control (ESC). All five of these systems work together to enhance vehicle stability and control in various driving conditions.

Also, your vehicle is equipped with Trailer Sway Control (TSC), Hill Start Assist (HSA), Brake Lock Differential (BLD), Ready Alert Braking, Rain Brake Support and, if it has four-wheel drive with the MP 3023 two-speed transfer case, Hill Descent Control (HDC).

Anti-Lock Brake System (ABS)

This system aids the driver in maintaining vehicle control under adverse braking conditions. The system controls hydraulic brake pressure to prevent wheel lock-up and help avoid skidding on slippery surfaces during braking.

WARNING!

The ABS cannot prevent the natural laws of physics from acting on the vehicle, nor can it increase the traction afforded by prevailing road conditions. The ABS cannot prevent collisions, including those resulting from excessive speed in turns, driving on very slippery surfaces, or hydroplaning. The capabilities of an ABS-equipped vehicle must never be exploited in a reckless or dangerous manner which could jeopardize the user's safety or the safety of others.

Traction Control System (TCS)

This system monitors the amount of wheel spin of each of the driven wheels. If wheel spin is detected, brake pressure is applied to the slipping wheel(s) and engine power is reduced to provide enhanced acceleration and stability. A feature of the TCS system, Brake Limited

Differential (BLD), functions similar to a limited-slip differential and controls the wheel spin across a driven axle. If one wheel on a driven axle is spinning faster than the other, the system will apply the brake of the spinning wheel. This will allow more engine torque to be applied to the wheel that is not spinning. This feature remains active even if ESC system is in the "Partial Off" mode. Refer to "Electronic Stability Control (ESC)" in this section for further information.

Brake Assist System (BAS)

The BAS is designed to optimize the vehicle's braking capability during emergency braking maneuvers. The system detects an emergency braking situation by sensing the rate and amount of brake application and then applies optimum pressure to the brakes. This can help reduce braking distances. The BAS complements the anti-lock brake system (ABS). Applying the brakes very quickly results in the best BAS assistance. To receive the

benefit of the system, you must apply **continuous** braking pressure during the stopping sequence (do not “pump” the brakes). Do not reduce brake pedal pressure unless braking is no longer desired. Once the brake pedal is released, the BAS is deactivated.

WARNING!

The BAS cannot prevent the natural laws of physics from acting on the vehicle, nor can it increase the traction afforded by prevailing road conditions. The BAS cannot prevent collisions, including those resulting from excessive speed in turns, driving on very slippery surfaces, or hydroplaning. The capabilities of a BAS-equipped vehicle must never be exploited in a reckless or dangerous manner which could jeopardize the user’s safety or the safety of others.

Electronic Roll Mitigation (ERM)

This system anticipates the potential for wheel lift by monitoring the driver’s steering wheel input and the speed of the vehicle. When ERM determines that the rate of change of the steering wheel angle and vehicle speed are sufficient to potentially cause wheel lift, it then applies the brake of the appropriate wheel and may also reduce engine power to lessen the chance that wheel lift will occur. ERM will only intervene during very severe or evasive driving maneuvers.

ERM can only reduce the chance of wheel lift occurring during severe or evasive driving maneuvers. It cannot prevent wheel lift due to other factors such as road conditions, leaving the roadway or striking objects or other vehicles.

WARNING!

Many factors, such as vehicle loading, road conditions and driving conditions, influence the chance that wheel lift or rollover may occur. ERM cannot prevent all wheel lift or rollovers, especially those that involve leaving the roadway or striking objects or other vehicles. The capabilities of an ERM-equipped vehicle must never be exploited in a reckless or dangerous manner which could jeopardize the user's safety or the safety of others.

Electronic Stability Control (ESC)

This system enhances directional control and stability of the vehicle under various driving conditions. ESC corrects for oversteering or understeering of the vehicle by applying the brake of the appropriate wheel to assist in counteracting the oversteer or understeer condition. Engine power may also be reduced to help the vehicle maintain the desired path.

ESC uses sensors in the vehicle to determine the vehicle path intended by the driver and compares it to the actual path of the vehicle. When the actual path does not match the intended path, ESC applies the brake of the appropriate wheel to assist in counteracting the oversteer or understeer condition.

- Oversteer - when the vehicle is turning more than appropriate for the steering wheel position.
- Understeer - when the vehicle is turning less than appropriate for the steering wheel position.

The "ESC Activation/Malfunction Indicator Light" located in the instrument cluster will start to flash as soon as the tires lose traction and the ESC system becomes active. The "ESC Activation/Malfunction Indicator Light" also flashes when the TCS is active. If the "ESC Activation/Malfunction Indicator Light" begins to flash during acceleration, ease up on the accelerator and apply

as little throttle as possible. Be sure to adapt your speed and driving to the prevailing road conditions.

WARNING!

The Electronic Stability Control (ESC) cannot prevent the natural laws of physics from acting on the vehicle, nor can it increase the traction afforded by prevailing road conditions. ESC cannot prevent collisions, including those resulting from excessive speed in turns, driving on very slippery surfaces, or hydroplaning. The capabilities of an ESC equipped vehicle must never be exploited in a reckless or dangerous manner which could jeopardize the user's safety or the safety of others.

The ESC system has two available operating modes in 4WD HIGH range and two-wheel drive vehicles, and one operating mode in 4WD LOW range.

High Range (Four-Wheel Drive Models) or Two-Wheel Drive Models

On

This is the normal operating mode for ESC in 4WD HIGH range and in two-wheel drive vehicles. Whenever the vehicle is started or the transfer case (if equipped) is shifted from 4WD LOW range or NEUTRAL back to 4WD HIGH range, the ESC system will be in this "On" mode. This mode should be used for most driving situations. ESC should only be turned to "Partial Off" mode for specific reasons as noted below.

Partial Off

This mode is entered by momentarily pressing the "ESC OFF" switch. When in "Partial Off" mode, the TCS portion of ESC, except for the BLD feature described in the TCS section, has been disabled and the "ESC Off Indicator Light" will be illuminated. All other stability features of ESC function normally. This mode is intended

to be used if the vehicle is in deep snow, sand, or gravel conditions and more wheel spin than ESC would normally allow is required to gain traction. To turn ESC on again, momentarily press the “ESC OFF” switch. This will restore the normal “ESC On” mode of operation.



ESC OFF Switch

NOTE: To improve the vehicle’s traction when driving with snow chains, or starting off in deep snow, sand, or gravel, it may be desirable to switch to the “Partial Off” mode by pressing the “ESC OFF” switch. Once the situation requiring ESC to be switched to the “Partial Off” mode is overcome, turn ESC back on by momentarily pressing the “ESC OFF” switch. This may be done while the vehicle is in motion.

4WD Low Range

Partial Off

This is the normal operating mode for ESC in 4WD LOW range. Whenever the vehicle is started in 4WD LOW range, or the transfer case (if equipped) is shifted from 4WD HIGH range or NEUTRAL to 4WD LOW range, the ESC system will be in the “Partial Off” mode.

Trailer Sway Control (TSC)

TSC uses sensors in the vehicle to recognize an excessively swaying trailer and will take the appropriate actions to attempt to stop the sway. The system may reduce engine power and apply the brake of the appropriate wheel(s) to counteract the sway of the trailer. TSC will become active automatically once an excessively swaying trailer is recognized. No driver action is required. Note that TSC cannot stop all trailers from swaying. Always use caution when towing a trailer and follow the trailer tongue weight recommendations. Refer to “Trailer Towing” in “Starting and Operating” for further information. When TSC is functioning, the “ESC Activation/Malfunction Indicator Light” will flash, the engine power may be reduced and you may feel the brakes being applied to individual wheels to attempt to stop the trailer from swaying. TSC is disabled when the ESC system is in the “Partial Off” mode.

WARNING!

If TSC activates while driving, slow the vehicle down, stop at the nearest safe location, and adjust the trailer load to eliminate trailer sway.

Hill Start Assist (HSA)

The HSA system is designed to assist the driver when starting a vehicle from a stop on a hill. HSA will maintain the level of brake pressure the driver applied for a short period of time after the driver takes their foot off of the brake pedal. If the driver does not apply the throttle during this short period of time, the system will release brake pressure and the vehicle will roll down the hill. The system will release brake pressure in proportion to the amount of throttle applied as the vehicle starts to move in the intended direction of travel.

HSA Activation Criteria

The following criteria must be met in order for HSA to activate:

- Vehicle must be stopped.
- Vehicle must be on a 6% (approximate) grade or greater hill.
- Gear selection matches vehicle uphill direction (i.e., vehicle facing uphill is in forward gear; vehicle backing uphill is in REVERSE gear).

HSA will work in REVERSE and all forward gears when the activation criteria have been met. The system will not activate if the vehicle is placed in NEUTRAL or PARK.

WARNING!

There may be situations on minor hills (i.e., less than 8%), with a loaded vehicle, or while pulling a trailer, when the system will not activate and slight rolling may occur. This could cause a collision with another vehicle or object. Always remember the driver is responsible for braking the vehicle.

Towing With HSA

HSA will provide assistance when starting on a grade when pulling a trailer.

WARNING!

- If you use a trailer brake controller with your trailer, your trailer brakes may be activated and deactivated with the brake switch. If so, when the brake pedal is released, there may not be enough brake pressure to hold the vehicle and trailer on a hill and this could cause a collision with another vehicle or object behind you. In order to avoid rolling down the hill while resuming acceleration, manually activate the trailer brake prior to releasing the brake pedal. Always remember the driver is responsible for braking the vehicle.

(Continued)

WARNING! (Continued)

- HSA is not a parking brake. If you stop the vehicle on a hill without putting the transmission in PARK and using the parking brake, it will roll down the hill and could cause a collision with another vehicle or object. Always remember to use the parking brake while parking on a hill, and that the driver is responsible for braking the vehicle.

HSA Off

If you wish to turn off the HSA system, it can be done using the Customer Programmable Features in the Electronic Vehicle Information Center (EVIC). Refer to “Electronic Vehicle Information Center (EVIC)” in “Understanding Your Instrument Panel” for further information.

Ready Alert Braking – If Equipped

Ready Alert Braking may reduce the time required to reach full braking during emergency braking situations. It anticipates when an emergency braking situation may occur by monitoring how fast the throttle is released by the driver. When the throttle is released very quickly, Ready Alert Braking applies a small amount of brake pressure. This brake pressure will not be noticed by the driver. The brake system uses this brake pressure to allow a fast brake response if the driver applies the brakes.

Rain Brake Support – If Equipped

Rain Brake Support may improve braking performance in wet conditions. It will periodically apply a small amount of brake pressure to remove any water buildup

on the front brake rotors. It only functions when the windshield wipers are in the LO or HI mode, it does not function in the intermittent mode. When Rain Brake Support is active, there is no notification to the driver and no driver interaction is required.

Hill Descent Control (HDC) — Four-Wheel Drive Models With MP3023 Two-Speed Transfer Case Only

HDC maintains vehicle speed while descending hills during off-road driving situations and is available in 4WD LOW range only. To enable HDC, press the HDC switch or put the Selec-Terrain™ system in “ROCK” mode (“ROCK” mode is only available in 4WD LOW range).



Hill Descent Switch

When HDC is enabled, the HDC icon will be illuminated in the instrument cluster. HDC will automatically apply the brakes to control downhill speed to the selected level when necessary on grades greater than approximately 8%. It will usually not activate on level ground.

The HDC speed may be adjusted by the driver to suit the driving conditions. The speed corresponds to the transmission gear selected.

HDC operation can be overridden with brake application to slow the vehicle down below the HDC control speed. Conversely, if more speed is desired during HDC control, the accelerator pedal will increase vehicle speed in the usual manner. When either the brake or the accelerator is released, HDC will control the vehicle back to the original set speed.

HDC Operation in 4WD Low Range

To enable HDC, press the HDC switch or put the Selec-Terrain™ system in the “ROCK” mode. The HDC icon will be illuminated in the instrument cluster and HDC will function. If the vehicle speed goes above 20 mph (32 km/h), the HDC icon will flash and HDC will not function. To disable HDC, press the HDC switch.

4WD Low Range Set Speeds

- 1st = 1 mph (1.6 km/h)
- 2nd = 2.5 mph (4 km/h)
- 3rd = 4 mph (6 km/h)
- 4th = 5.5 mph (9 km/h)
- 5th or D (Drive) = 7.5 mph (12 km/h)
- REVERSE = 1 mph (1.6 km/h)
- NEUTRAL = 2.5 mph (4 km/h)
- PARK = HDC will not function

HDC is intended for low speed off-road driving only. At vehicle speeds above 20 mph (32 km/h), HDC will no longer function. When the vehicle speed drops below 20 mph (32 km/h), HDC function will automatically resume and the vehicle speed will return to the chosen set speed.

WARNING!

HDC is only intended to assist the driver in controlling vehicle speed when descending hills. The driver must remain attentive to the driving conditions and is responsible for maintaining a safe vehicle speed.

ESC Activation/Malfunction Indicator Light and ESC OFF Indicator Light



The “ESC Activation/Malfunction Indicator Light” in the instrument cluster will come on when the ignition switch is turned to the ON position. It should turn off with the engine running. If the “ESC Activation/Malfunction Indicator Light” comes on continuously with the engine running, a malfunction has been detected in the ESC system. If this light remains on after several ignition cycles, and the vehicle has been driven several miles (kilometers) at

speeds greater than 30 mph (48 km/h), see your authorized dealer as soon as possible to have the problem diagnosed and corrected.

The “ESC Activation/Malfunction Indicator Light” (located in the instrument cluster) starts to flash as soon as the tires lose traction and the ESC system becomes active. The “ESC Activation/Malfunction Indicator Light” also flashes when TCS is active. If the “ESC Activation/Malfunction Indicator Light” begins to flash during acceleration, ease up on the accelerator and apply as little throttle as possible. Be sure to adapt your speed and driving to the prevailing road conditions.

NOTE:

- The “ESC Activation/Malfunction Indicator Light” and the “ESC OFF Indicator Light” come on momentarily each time the ignition switch is turned ON.
- Each time the ignition is turned ON, the ESC system will be ON even if it was turned off previously.
- The ESC system will make buzzing or clicking sounds when it is active. This is normal; the sounds will stop when ESC becomes inactive following the maneuver that caused the ESC activation.



The “ESC OFF Indicator Light” indicates the Electronic Stability Control (ESC) is off.

TIRE SAFETY INFORMATION

Tire Markings

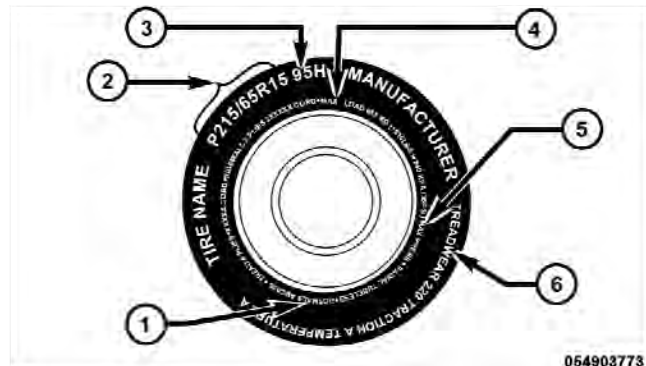

1 — U.S. DOT Safety Standards Code (TIN)

2 — Size Designation

3 — Service Description

4 — Maximum Load

5 — Maximum Pressure

6 — Treadwear, Traction and Temperature Grades

NOTE:

- P (Passenger) - Metric tire sizing is based on U.S. design standards. P-Metric tires have the letter "P" molded into the sidewall preceding the size designation. Example: P215/65R15 95H.
- European-Metric tire sizing is based on European design standards. Tires designed to this standard have the tire size molded into the sidewall beginning with the section width. The letter "P" is absent from this tire size designation. Example: 215/65R15 96H.
- LT (Light Truck) - Metric tire sizing is based on U.S. design standards. The size designation for LT-Metric tires is the same as for P-Metric tires except for the letters "LT" that are molded into the sidewall preceding the size designation. Example: LT235/85R16.
- Temporary spare tires are high-pressure compact spares designed for temporary emergency use only.

Tires designed to this standard have the letter "T" molded into the sidewall preceding the size designation. Example: T145/80D18 103M.

- High flotation tire sizing is based on U.S. design standards and it begins with the tire diameter molded into the sidewall. Example: 31x10.5 R15 LT.

Tire Sizing Chart

EXAMPLE:	
Size Designation:	
<p>P = Passenger car tire size based on U.S. design standards "...blank..." = Passenger car tire based on European design standards LT = Light truck tire based on U.S. design standards T = Temporary spare tire 31 = Overall diameter in inches (in) 215 = Section width in millimeters (mm) 65 = Aspect ratio in percent (%) — Ratio of section height to section width of tire 10.5 = Section width in inches (in) R = Construction code — "R" means radial construction — "D" means diagonal or bias construction 15 = Rim diameter in inches (in)</p>	

EXAMPLE:**Service Description:**

95 = Load Index

— A numerical code associated with the maximum load a tire can carry

H = Speed Symbol

— A symbol indicating the range of speeds at which a tire can carry a load corresponding to its load index under certain operating conditions

— The maximum speed corresponding to the speed symbol should only be achieved under specified operating conditions (i.e., tire pressure, vehicle loading, road conditions, and posted speed limits)

Load Identification:

"...**blank**..." = Absence of any text on the sidewall of the tire indicates a Standard Load (SL) tire

Extra Load (XL) = Extra load (or reinforced) tire

Light Load = Light load tire

C, D, E = Load range associated with the maximum load a tire can carry at a specified pressure

Maximum Load — Maximum load indicates the maximum load this tire is designed to carry

Maximum Pressure — Maximum pressure indicates the maximum permissible cold tire inflation pressure for this tire

Tire Identification Number (TIN)

The TIN may be found on one or both sides of the tire, however, the date code may only be on one side. Tires with white sidewalls will have the full TIN, including the date code, located on the white sidewall side of the tire.

Look for the TIN on the outboard side of black sidewall tires as mounted on the vehicle. If the TIN is not found on the outboard side, then you will find it on the inboard side of the tire.

EXAMPLE:**DOT MA L9 ABCD 0301**

DOT = Department of Transportation

— This symbol certifies that the tire is in compliance with the U.S. Department of Transportation tire safety standards and is approved for highway use

MA = Code representing the tire manufacturing location (two digits)

L9 = Code representing the tire size (two digits)

ABCD = Code used by the tire manufacturer (one to four digits)

03 = Number representing the week in which the tire was manufactured (two digits)

—03 means the 3rd week.

01 = Number representing the year in which the tire was manufactured (two digits)

—01 means the year 2001

— Prior to July 2000, tire manufacturers were only required to have one number to represent the year in which the tire was manufactured. Example: 031 could represent the 3rd week of 1981 or 1991

Tire Terminology and Definitions

Term	Definition
B-Pillar	The vehicle B-Pillar is a structural member of the body located between the front and rear door (of a four-door vehicle) running from the sill to the roof.
Cold Tire Pressure	Cold tire inflation pressure is defined as the tire pressure after the vehicle has not been driven for at least 3 hours, or driven less than 1 mile (1.6 km) after sitting for a three hour period. Inflation pressure is measured in units of PSI (pounds per square inch) or KPa (kilopascals).
Maximum Inflation Pressure	The maximum inflation pressure is the maximum permissible cold tire inflation pressure for this tire. The max inflation pressure is molded into the sidewall.
Recommended Inflation Pressure	Vehicle manufacturer's recommended tire inflation pressure as shown on the tire placard.
Tire Placard	A paper label permanently attached to the vehicle showing the vehicle's loading capacity, the original equipment tire size and the recommended inflation pressure.

Tire Loading And Tire Pressure

Tire Placard Location

NOTE: The proper cold tire inflation pressure is listed on the driver's side B-Pillar.

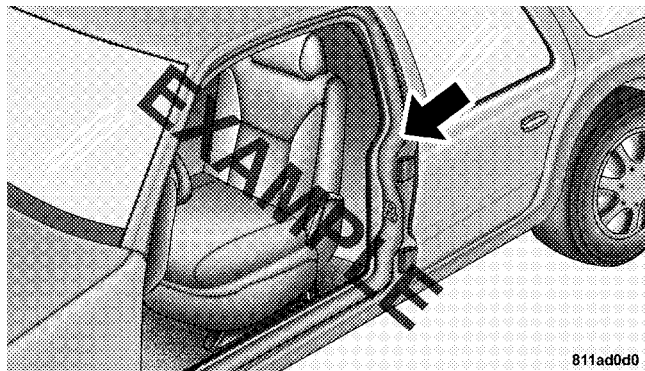

Tire Placard Location

Tire and Loading Information Placard

TIRE AND LOADING INFORMATION

SEATING CAPACITY - TOTAL 5 FRONT 2 REAR 3

THE COMBINED WEIGHT OF OCCUPANTS AND CARGO SHOULD NEVER EXCEED XXX KG OR XXX LBS.

TIRE	FRONT	REAR	SPARE
ORIGINAL TIRE SIZE	P195/70R14	P195/70R14	T125/70D15
COLD TIRE INFLATION PRESSURE	200kPa, 29PSI	200kPa, 29PSI	420kPa, 60PSI

SEE OWNER'S MANUAL FOR ADDITIONAL INFORMATION

4N109268

811b5a9a

Tire and Loading Information Placard

This placard tells you important information about the:

- 1) number of people that can be carried in the vehicle
- 2) total weight your vehicle can carry
- 3) tire size designed for your vehicle
- 4) cold tire inflation pressures for the front, rear, and spare tires.

Loading

The vehicle maximum load on the tire must not exceed the load carrying capacity of the tire on your vehicle. You will not exceed the tire's load carrying capacity if you adhere to the loading conditions, tire size, and cold tire inflation pressures specified on the Tire and Loading Information placard and in the "Vehicle Loading" section of this manual.

NOTE: Under a maximum loaded vehicle condition, gross axle weight ratings (GAWRs) for the front and rear axles must not be exceeded. For further information on GAWRs, vehicle loading, and trailer towing, refer to "Vehicle Loading" in this section.

To determine the maximum loading conditions of your vehicle, locate the statement "The combined weight of occupants and cargo should never exceed XXX lbs or XXX kg" on the Tire and Loading Information placard. The combined weight of occupants, cargo/luggage and trailer tongue weight (if applicable) should never exceed the weight referenced here.

Steps For Determining Correct Load Limit

1. Locate the statement “The combined weight of occupants and cargo should never exceed XXX lbs or XXX kg” on your vehicle’s placard.
2. Determine the combined weight of the driver and passengers that will be riding in your vehicle.
3. Subtract the combined weight of the driver and passengers from XXX lbs or XXX kg.
4. The resulting figure equals the available amount of cargo and luggage load capacity. For example, if “XXX” amount equals 1,400 lbs (635 kg) and there will be five 150 lb (68 kg) passengers in your vehicle, the amount of available cargo and luggage load capacity is 650 lbs (295 kg) (since $5 \times 150 = 750$, and $1400 - 750 = 650$ lbs [295 kg]).

5. Determine the combined weight of luggage and cargo being loaded on the vehicle. That weight may not safely exceed the available cargo and luggage load capacity calculated in Step 4.
6. If your vehicle will be towing a trailer, load from your trailer will be transferred to your vehicle. Consult this manual to determine how this reduces the available cargo and luggage load capacity of your vehicle.

NOTE:

- The following table shows examples on how to calculate total load, cargo/luggage, and towing capacities of your vehicle with varying seating configurations and number and size of occupants. This table is for illustration purposes only and may not be accurate for the seating and load carry capacity of your vehicle.
- For the following example, the combined weight of occupants and cargo should never exceed 865 lbs (392 kg).

Occupants			Combined weight of occupants and cargo from Tire Placard	MINUS	Combined Occupant's weight	=	AVAILABLE Cargo/Luggage and Trailer Tongue Weight
TOTAL	FRONT	REAR					
<u>EXAMPLE 1</u>							
5	2	3	865 lbs	minus	670 lbs	=	195 lbs
					Occupant 1: 200 lbs Occupant 2: 130 lbs Occupant 3: 160 lbs Occupant 4: 100 lbs Occupant 5: 80 lbs TOTAL WEIGHT: 670 lbs		
<u>EXAMPLE 2</u>							
3	2	1	865 lbs	minus	540 lbs	=	325 lbs
					Occupant 1: 210 lbs Occupant 2: 180 lbs Occupant 3: 150 lbs TOTAL WEIGHT: 540 lbs		
<u>EXAMPLE 3</u>							
2	2	0	865 lbs	minus	400 lbs	=	465 lbs
					Occupant 1: 200 lbs Occupant 2: 200 lbs TOTAL WEIGHT: 400 lbs		

WARNING!

Overloading of your tires is dangerous. Overloading can cause tire failure, affect vehicle handling, and increase your stopping distance. Use tires of the recommended load capacity for your vehicle. Never overload them.

TIRES — GENERAL INFORMATION**Tire Pressure**

Proper tire inflation pressure is essential to the safe and satisfactory operation of your vehicle. Three primary areas are affected by improper tire pressure:

Safety**WARNING!**

- Improperly inflated tires are dangerous and can cause collisions.
- Under-inflation increases tire flexing and can result in over-heating and tire failure.
- Over-inflation reduces a tire's ability to cushion shock. Objects on the road and chuckholes can cause damage that result in tire failure.
- Unequal tire pressures can cause steering problems. You could lose control of your vehicle.
- Over-inflated or under-inflated tires can affect vehicle handling and can fail suddenly, resulting in loss of vehicle control.

(Continued)

WARNING! (Continued)

- Unequal tire pressures from one side of the vehicle to the other can cause the vehicle to drift to the right or left.
- Always drive with each tire inflated to the recommended cold tire inflation pressure.

Economy

Improper inflation pressures can cause uneven wear patterns to develop across the tire tread. These abnormal wear patterns will reduce tread life resulting in a need for earlier tire replacement. Under-inflation also increases tire rolling resistance and results in higher fuel consumption.

Ride Comfort and Vehicle Stability

Proper tire inflation contributes to a comfortable ride. Over-inflation produces a jarring and uncomfortable ride. Both under-inflation and over-inflation affect the

stability of the vehicle and can produce a feeling of sluggish response or over responsiveness in the steering.

Unequal tire pressures can cause erratic and unpredictable steering response.

Unequal tire pressure from side to side may cause the vehicle to drift left or right.

Tire Inflation Pressures

The proper cold tire inflation pressure is listed on the driver's side "B" Pillar.

The pressure should be checked and adjusted, as well as inspected for signs of tire wear or visible damage, at least once a month. Use a good quality pocket-type gauge to check tire pressure. Do not make a visual judgement when determining proper inflation. Radial tires may look properly inflated even when they are under-inflated.

CAUTION!

After inspecting or adjusting the tire pressure, always reinstall the valve stem cap. This will prevent moisture and dirt from entering the valve stem, which could damage it.

Inflation pressures specified on the placard are always cold tire inflation pressure. Cold tire inflation pressure is defined as the tire pressure after the vehicle has not been driven for at least three hours, or driven less than 1 mile (1.6 km) after a three-hour period. The cold tire inflation pressure must not exceed the maximum inflation pressure molded into the tire sidewall.

Check tire pressures more often if subject to a wide range of outdoor temperatures, as tire pressures vary with temperature changes.

Tire pressures change by approximately 1 psi (7 kPa) per 12°F (7°C) of air temperature change. Keep this in mind when checking tire pressure inside a garage, especially in the winter.

Example: If garage temperature = 68°F (20°C) and the outside temperature = 32°F (0°C) then the cold tire inflation pressure should be increased by 3 psi (21 kPa), which equals 1 psi (7 kPa) for every 12°F (7°C) for this outside temperature condition.

Tire pressure may increase from 2 to 6 psi (13 to 40 kPa) during operation. DO NOT reduce this normal pressure build-up, or your tire pressure will be too low.

Tire Pressures For High Speed Operation

The manufacturer advocates driving at safe speeds within posted speed limits. Where speed limits or conditions are such that the vehicle can be driven at high speeds, maintaining correct tire inflation pressure is very important. Increased tire pressure and reduced vehicle loading may be required for high-speed vehicle operation. Refer to original equipment or an authorized tire dealer for recommended safe operating speeds, loading and cold tire inflation pressures.

WARNING!

High speed driving with your vehicle at or above maximum load is dangerous. The added strain on your tires could cause them to fail. You could have a serious collision. Do not drive a vehicle loaded to the maximum capacity at continuous speeds above 75 mph (120 km/h).

Radial-Ply Tires

WARNING!

Combining radial ply tires with other types of tires on your vehicle will cause your vehicle to handle poorly. The instability could cause a collision. Always use radial tires in sets of four. Never combine them with other types of tires.

Cuts and punctures in radial tires are repairable only in the tread area because of sidewall flexing. Consult your authorized dealer for radial tire repairs.

Spare Tire Matching Original Equipped Tire and Wheel – If Equipped

The spare tire of your vehicle is equivalent in look and function as the original equipment tire and wheel found on the front or rear axle of your vehicle. This spare tire may be used in the tire rotation for your vehicle. If your

vehicle has an option for a spare tire matching original equipment tire and wheel, refer to the recommended tire rotation pattern in “Tire Rotation Recommendations” in “Starting and Operating” for further information.

If your vehicle is not equipped with an original equipment tire and wheel as a spare, a non-matching temporary emergency use spare may be equipped with your vehicle. Temporary use spares are engineered to be used only with your vehicle. Your vehicle may be equipped with one of the following types of non-matching temporary use spares; compact, full size, or limited-use.

Do not install more than one non-matching temporary use spare tire/wheel on the vehicle at any given time.

CAUTION!

Because of the reduced ground clearance, do not take your vehicle through an automatic car wash with a compact, full size or limited-use temporary spare installed. Damage to the vehicle may result.

Compact Spare Tire – If Equipped

The compact spare is for temporary emergency use only. You can identify if your vehicle is equipped with a compact spare by looking at the spare tire description on the Tire and Loading Information Placard located on the driver’s side door opening or on the sidewall of the tire. Compact spare tire descriptions begin with the letter “T” or “S” preceding the size designation. Example: T145/80D18 103M.

T, S = Temporary Spare Tire

Since this tire has limited tread life the original equipment tire should be repaired (or replaced) and reinstalled on your vehicle at the first opportunity.

Do not install a wheel cover or attempt to mount a conventional tire on the compact spare wheel, since the wheel is designed specifically for the compact spare. Do not install more than one compact spare tire/wheel on the vehicle at any given time

WARNING!

Compact spares are for temporary emergency use only. With these spares, do not drive more than 50 mph (80 km/h). Temporary use spares have limited tread life. When the tread is worn to the tread wear indicators, the temporary use spare tire needs to be replaced. Be sure to follow the warnings, which apply to your spare. Failure to do so could result in spare tire failure and loss of vehicle control.

Full Size Spare – If Equipped

The full size spare is for temporary emergency use only. This tire may look like the original equipped tire on the front or rear axle of your vehicle, but it is not. This spare tire may have limited tread life. When the tread is worn to the tread wear indicators, the temporary use full size spare tire needs to be replaced. Since it is not the same as your original equipment tire, replace (or repair) the original equipment tire and reinstall on the vehicle at the first opportunity.

Limited-Use Spare – If Equipped

The limited-use spare tire is for temporary emergency use only. This tire is identified by a label located on the limited-use spare wheel. This label contains the driving limitations for this spare. This tire may look like the original equipped tire on the front or rear axle of your vehicle, but it is not. Installation of this limited-use spare tire affects vehicle handling. Since it is not the same as

your original equipment tire, replace (or repair) the original equipment tire and reinstall on the vehicle at the first opportunity.

WARNING!

Limited-use spares are for emergency use only. Installation of this limited-use spare tire affects vehicle handling. With this tire, do not drive more than the speed listed on the limit-use spare wheel. Keep inflated to the cold tire inflation pressure listed on your Tire and Loading Information Placard located on the driver's side door opening. Replace (or repair) the original equipment tire at the first opportunity and reinstall it on your vehicle. Failure to do so could result in loss of vehicle control.

Tire Spinning

When stuck in mud, sand, snow, or ice conditions, do not spin your vehicle's wheels above 30 mph (48 km/h).

WARNING!

Fast spinning tires can be dangerous. Forces generated by excessive wheel speeds may cause tire damage or failure. A tire could explode and injure someone. Do not spin your vehicle's wheels faster than 30 mph (48 km/h) when you are stuck, and do not let anyone near a spinning wheel no matter what the speed.

Tread Wear Indicators

Tread wear indicators are in the original equipment tires to help you in determining when your tires should be replaced.

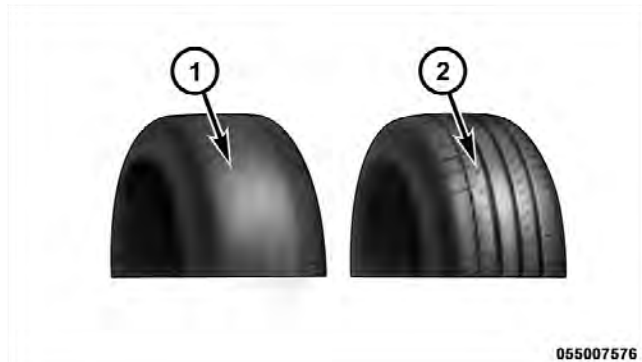

- 1 — Worn Tire
2 — New Tire

These indicators are molded into the bottom of the tread grooves. They will appear as bands when the tread depth becomes 1/16 in (2 mm). When the tread is worn to the tread wear indicators, the tire should be replaced.

Life Of Tire

The service life of a tire is dependent upon various factors including but not limited to:

- Driving style
- Tire pressure
- Distance driven

WARNING!

Tires and the spare tire should be replaced after six years, regardless of the remaining tread. Failure to follow this warning can result in sudden tire failure. You could lose control and have an collision resulting in serious injury or death.

Keep dismantled tires in a cool, dry place with as little exposure to light as possible. Protect tires from contact with oil, grease, and gasoline.

Replacement Tires

The tires on your new vehicle provide a balance of many characteristics. They should be inspected regularly for wear and correct cold tire inflation pressure. The manufacturer strongly recommends that you use tires equivalent to the originals in size, quality and performance when replacement is needed. (Refer to the paragraph on “Tread Wear Indicators”). Refer to the “Tire and Loading Information” placard for the size designation of your tires. The service description and load identification will be found on the original equipment tire. Failure to use equivalent replacement tires may adversely affect the safety, handling, and ride of your vehicle. We recommend that you contact your original equipment or an authorized tire dealer with any questions you may have on tire specifications or capability.

WARNING!

- Do not use a tire, wheel size or rating other than that specified for your vehicle. Some combinations of unapproved tires and wheels may change suspension dimensions and performance characteristics, resulting in changes to steering, handling, and braking of your vehicle. This can cause unpredictable handling and stress to steering and suspension components. You could lose control and have a collision resulting in serious injury or death. Use only the tire and wheel sizes with load ratings approved for your vehicle.
- Never use a tire with a smaller load index or capacity than what was originally equipped on your vehicle. Using a tire with a smaller load index could result in tire overloading and failure. You could lose control and have a collision.

(Continued)

WARNING! (Continued)

- Failure to equip your vehicle with tires having adequate speed capability can result in sudden tire failure and loss of vehicle control.

CAUTION!

Replacing original tires with tires of a different size may result in false speedometer and odometer readings.

TIRE CHAINS (TRACTION DEVICES)

Use of traction devices require sufficient tire-to-body clearance. Follow these recommendations to guard against damage.

- Install on Rear Tires Only

- Due to limited clearance, use SAE class "S" low profile cables or traction devices only. Security Chain Company (SCC) Super Z6 #SZ 441 cables or equivalent are recommended.

WARNING!

Using tires of different size and type (M+S, Snow) between front and rear axles can cause unpredictable handling. You could lose control and have a collision.

CAUTION!

To avoid damage to your vehicle or tires, observe the following precautions:

(Continued)

CAUTION! (Continued)

- Because of restricted traction device clearance between tires and other suspension components, it is important that only traction devices in good condition are used. Broken devices can cause serious damage. Stop the vehicle immediately if noise occurs that could indicate device breakage. Remove the damaged parts of the device before further use.
- Install device as tightly as possible and then retighten after driving about $\frac{1}{2}$ mile (0.8 km).
- Do not exceed 30 mph (48 km/h).
- Drive cautiously and avoid severe turns and large bumps, especially with a loaded vehicle.
- Do not drive for prolonged period on dry pavement.

(Continued)

CAUTION! (Continued)

- Observe the traction device manufacturer's instructions on the method of installation, operating speed, and conditions for use. Always use the suggested operating speed of the device manufacturer's if it is less than 30 mph (48 km/h).
- Do not use traction devices on a compact spare tire.

SNOW TIRES

Some areas of the country require the use of snow tires during the winter. All season tires satisfy this requirement and can be indicated by the M+S designation on the tire sidewall.

If you need snow tires, select tires equivalent in size and type to the original equipment tires. Use snow tires only in sets of four; failure to do so may adversely affect the safety and handling of your vehicle.

Snow tires generally have lower speed ratings than what was originally equipped with your vehicle and should not be operated at sustained speeds over 75 mph (120 km/h). For speeds above 75 mph (120 km/h) refer to original equipment or an authorized tire dealer for recommended safe operating speeds, loading and cold tire inflation pressures.

While studded tires improve performance on ice, skid and traction capability on wet or dry surfaces may be poorer than that of non-studded tires. Some states prohibit studded tires; therefore, local laws should be checked before using these tire types.

TIRE ROTATION RECOMMENDATIONS

The tires on the front and rear of your vehicle operate at different loads and perform different steering, handling, and braking functions. For these reasons, they wear at unequal rates.

These effects can be reduced by timely rotation of tires. The benefits of rotation are especially worthwhile with aggressive tread designs such as those on On/Off-Road type tires. Rotation will increase tread life, help to maintain mud, snow, and wet traction levels, and contribute to a smooth, quiet ride.

Refer to the “Maintenance Schedule” for the proper maintenance intervals. More frequent rotation is permissible if desired. The reasons for any rapid or unusual wear should be corrected prior to rotation being performed.

NOTE: The premium Tire Pressure Monitor System will automatically locate the pressure values displayed in the correct vehicle position following a tire rotation.

The suggested rotation method is the “forward-cross” shown in the following diagram.

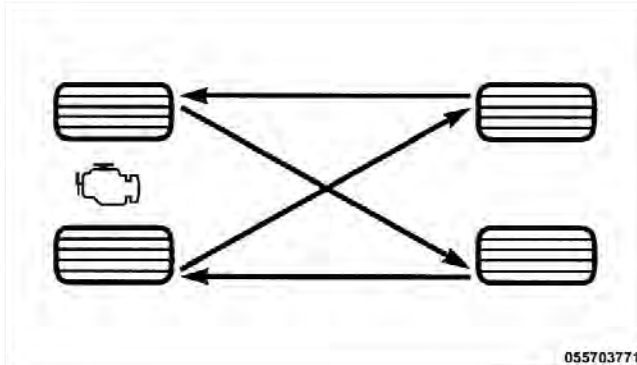

Tire Rotation

TIRE PRESSURE MONITOR SYSTEM (TPMS)

The Tire Pressure Monitoring System (TPMS) will warn the driver of a low tire pressure based on the vehicle recommended cold tire pressure.

The tire pressure will vary with temperature by about 1 psi (7 kPa) for every 12°F (6.5°C). This means that when

the outside temperature decreases, the tire pressure will decrease. Tire pressure should always be set based on cold inflation tire pressure. This is defined as the tire pressure after the vehicle has not been driven for at least three hours, or driven less than 1 mile (1.6 km) after a three-hour period. **Refer to “Tires – General Information” in “Starting and Operating” for information on how to properly inflate the vehicle’s tires.** The tire pressure will also increase as the vehicle is driven - this is normal and there should be no adjustment for this increased pressure.

The TPMS will warn the driver of a low tire pressure if the tire pressure falls below the low pressure warning threshold for any reason, including low temperature effects, or natural pressure loss through the tire.

The TPMS will continue to warn the driver of low tire pressure as long as the condition exists, and will not turn off until the tire pressure is at or above recommended

cold tire pressure. Once the low tire pressure warning has been illuminated, the tire pressure must be increased to the recommended cold tire pressure in order for the Tire Pressure Monitoring Telltale Light to be turned off. The system will automatically update and the Tire Pressure Monitoring Telltale Light will extinguish once the updated tire pressures have been received. The vehicle may need to be driven for up to 20 minutes above 15 mph (24 km/h) to receive this information.

For example, your vehicle has a recommended cold (parked for more than three hours) tire pressure of 33 psi (227 kPa). If the ambient temperature is 68°F (20°C) and the measured tire pressure is 28 psi (193 kPa), a temperature drop to 20°F (-7°C) will decrease the tire pressure to approximately 24 psi (165 kPa). This tire pressure is sufficiently low enough to turn ON the Tire Pressure Monitoring Telltale Light. Driving the vehicle may cause the tire pressure to rise to approximately 28 psi (193 kPa), but the Tire Pressure Monitoring Telltale Light will still

be ON. In this situation, the Tire Pressure Monitoring Telltale Light will turn OFF only after the tires have been inflated to the vehicle's recommended cold tire pressure value.

CAUTION!

- **The TPMS has been optimized for the original equipment tires and wheels. TPMS pressures have been established for the tire size equipped on your vehicle. Undesirable system operation or sensor damage may result when using replacement equipment that is not of the same size, type, and/or style. Aftermarket wheels can cause sensor damage. Do not use aftermarket tire sealants or balance beads if your vehicle is equipped with a TPMS, as damage to the sensors may result.**

(Continued)

CAUTION! (Continued)

- After inspecting or adjusting the tire pressure always reinstall the valve stem cap. This will prevent moisture and dirt from entering the valve stem, which could damage the Tire Pressure Monitoring Sensor.

NOTE:

- The TPMS is not intended to replace normal tire care and maintenance, or to provide warning of a tire failure or condition.
 - The TPMS should not be used as a tire pressure gauge while adjusting your tire pressure.
 - Driving on a significantly under-inflated tire causes the tire to overheat and can lead to tire failure. Under-inflation also reduces fuel efficiency and tire tread life, and may affect the vehicle's handling and stopping ability.
- The TPMS is not a substitute for proper tire maintenance, and it is the driver's responsibility to maintain correct tire pressure using an accurate tire gauge, even if under-inflation has not reached the level to trigger illumination of the Tire Pressure Monitoring Telltale Light.
 - Seasonal temperature changes will affect tire pressure, and the TPMS will monitor the actual tire pressure in the tire.

Base System

The Tire Pressure Monitor System (TPMS) uses wireless technology with wheel rim-mounted electronic sensors to monitor tire pressure levels. Sensors, mounted to each wheel as part of the valve stem, transmit tire pressure readings to the Receiver Module.

NOTE: It is particularly important, for you to regularly check the tire pressure in all of your tires, and to maintain the proper pressure.

The TPMS consists of the following components:

- Receiver Module
- Four Tire Pressure Monitoring Sensors
- Tire Pressure Monitoring Telltale Light

A low spare tire will not cause the Tire Pressure Monitoring Telltale Light to illuminate, a warning message to appear, or the chime to sound.

 The Tire Pressure Monitoring Telltale Light will illuminate in the instrument cluster, a “TIRE LOW PRESSURE” message will display in the instrument cluster for 5 seconds, and an audible chime will be activated, when one or more of the four active road tire pressures are low. Should this occur, you should stop as soon as possible, check the inflation pressure of each tire on your vehicle, and inflate each tire to the vehicle’s recommended cold placard pressure value. The system

will automatically update and the Tire Pressure Monitoring Telltale Light will extinguish, once the updated tire pressures have been received. The vehicle may need to be driven for up to 20 minutes above 15 mph (24 km/h) to receive this information.

The Tire Pressure Monitoring Telltale Light will flash on and off for 75 seconds, and remain on solid when a system fault is detected. In addition, a “SERVICE TPM SYSTEM” message may be displayed for approximately 5 seconds when a system fault is detected, and a chime will sound. If the ignition switch is cycled, this sequence will repeat, providing the system fault still exists. The Tire Pressure Monitoring Telltale Light will turn off when the fault condition no longer exists. A system fault can occur by any of the following:

1. Jamming due to electronic devices or driving next to facilities emitting the same Radio Frequencies as the TPM sensors.

2. Installing some form of aftermarket window tinting that affects radio wave signals.
3. Lots of snow or ice around the wheels or wheel housings.
4. Using tire chains on the vehicle.
5. Using wheels/tires not equipped with TPM sensors.

NOTE: There is no tire pressure monitoring sensor in the spare tire. The TPMS will not be able to monitor the tire pressure. If you install the spare tire, in place of a road tire, that has a pressure below the low-pressure warning limit, upon the next ignition switch cycle, a chime will sound, a “TIRE LOW PRESSURE” message will be displayed in the instrument cluster for 60 seconds, and the Tire Pressure Monitoring Telltale Light will turn ON. After driving the vehicle for up to 20 minutes above

15 mph (24 km/h), the Tire Pressure Monitoring Telltale Light will flash on and off for 75 seconds and then remain on solid. In addition, a “SERVICE TPM SYSTEM” message will be displayed for 75 seconds. For each subsequent ignition switch cycle, a chime will sound, a “SERVICE TPM SYSTEM” message will be displayed for 75 seconds, and the Tire Pressure Monitoring Telltale Light will flash on and off for 75 seconds and then remain on solid. Once you repair or replace the original road tire, and reinstall it on the vehicle in place of the spare tire, the TPMS will update automatically and the Tire Pressure Monitoring Telltale Light will turn OFF, as long as no tire pressure is below the low-pressure warning limit in any of the four active road tires. The vehicle may need to be driven for up to 20 minutes above 15 mph (24 km/h) in order for the TPMS to receive this information.

Premium System – If Equipped

The Tire Pressure Monitor System (TPMS) uses wireless technology with wheel rim-mounted electronic sensors to monitor tire pressure levels. Sensors, mounted to each wheel as part of the valve stem, transmit tire pressure readings to the Receiver Module.

NOTE: It is particularly important, for you to regularly check the tire pressure in all of your tires and to maintain the proper pressure.

The Tire Pressure Monitor System (TPMS) consists of the following components:

- Receiver Module
- Four Tire Pressure Monitoring Sensors
- Various Tire Pressure Monitoring System Messages, which display in the Electronic Vehicle Information Center (EVIC), and a graphic displaying tire pressures

- Tire Pressure Monitoring Telltale Light

Tire Pressure Monitoring Low Pressure Warnings



The Tire Pressure Monitoring Telltale Light will illuminate in the instrument cluster, and an audible chime will be activated, when one or more of the four active road tire pressures are low. In addition, the EVIC will display one or more Low Pressure messages (Left Front, Left Rear, Right Front, Right Rear) for a minimum of five seconds, and a graphic display of the pressure value(s) with the low tire(s) “flashing.” Refer to “Electronic Vehicle Information Center (EVIC)” in “Understanding Your Instrument Panel” for further information.

NOTE: Your system can be set to display pressure units in PSI, kPa, or BAR.

TIRE	35		34
PSI	24		34

8197133c



Should a low tire condition occur on any of the four active road tire(s), you should stop as soon as possible, and inflate the low tire(s) that is “flashing” on the graphic display to the vehicle’s recommended cold tire pressure.

The system will automatically update, the graphic display of the pressure value(s) will stop “flashing,” and the Tire Pressure Monitoring Telltale Light will extinguish once the updated tire pressure(s) have been received. The vehicle may need to be driven for up to 20 minutes above 15 mph (24 km/h) to receive this information.

SERVICE TPM SYSTEM Warning

The Tire Pressure Monitoring Telltale Light will flash on and off for 75 seconds, and remain on solid when a system fault is detected. The system fault will also sound a chime. The EVIC will display a “SERVICE TPM SYSTEM” message for a minimum of five seconds. This message is then followed by a graphic display, with “- -” in place of the pressure value(s), indicating which Tire Pressure Monitoring Sensor(s) is not being received.

NOTE: Your system can be set to display pressure units in PSI, kPa, or BAR.

TIRE 35  **34**
PSI --  **34**

81971362

If the ignition switch is cycled, this sequence will repeat, providing the system fault still exists. If the system fault no longer exists, the Tire Pressure Monitoring Telltale Light will no longer flash, the "SERVICE TPM SYSTEM"

message will not be present, and a pressure value will be displayed instead of dashes. A system fault can occur by any of the following:

1. Jamming due to electronic devices or driving next to facilities emitting the same Radio Frequencies as the TPM sensors.
2. Installing some form of aftermarket window tinting that affects radio wave signals.
3. Lots of snow or ice around the wheels or wheel housings.
4. Using tire chains on the vehicle.
5. Using wheels/tires not equipped with TPM sensors.

The EVIC will also display a "SERVICE TPM SYSTEM" message for a minimum of five seconds when a system fault is detected possibly related to the trigger component an incorrect sensor location fault. In this case, the

"SERVICE TPM SYSTEM" message is then followed by a graphic display, with pressure values still shown. This indicates the pressure values are still being received from the TPM Sensors but they may not be located in the correct vehicle position. However, the system still needs to be serviced as long as the "SERVICE TPM SYSTEM" message exists.

NOTE: There is no tire pressure monitoring sensor in the spare tire. The TPMS will not be able to monitor the tire pressure. If you install the spare tire in place of a road tire that has a pressure below the low-pressure warning limit, upon the next ignition switch cycle, the Tire Pressure Monitoring Telltale Light will remain ON, a chime will sound, and the EVIC will still display a "flashing" pressure value in the graphic display. After driving the vehicle for up to 20 minutes above 15 mph (24 km/h), the Tire Pressure Monitoring Telltale Light will flash on and off for 75 seconds and then remain on solid. In addition,

the EVIC will display a "SERVICE TPM SYSTEM" message for three seconds and then display dashes (- -) in place of the pressure value. For each subsequent ignition switch cycle, a chime will sound, the Tire Pressure Monitoring Telltale Light will flash on and off for 75 seconds and then remain on solid, and the EVIC will display a "SERVICE TPM SYSTEM" message for three seconds and then display dashes (- -) in place of the pressure value. Once you repair or replace the original road tire, and reinstall it on the vehicle in place of the spare tire, the TPMS will update automatically.

In addition, the Tire Pressure Monitoring Telltale Light will turn OFF and the graphic in the EVIC will display a new pressure value instead of dashes (- -), as long as no tire pressure is below the low-pressure warning limit in any of the four active road tires. The vehicle may need to be driven for up to 20 minutes above 15 mph (24 km/h) in order for the TPMS to receive this information.

General Information

This device complies with part 15 of the FCC rules and RSS 210 of Industry Canada. Operation is subject to the following conditions:

- This device may not cause harmful interference.
- This device must accept any interference received, including interference that may cause undesired operation.

The tire pressure sensors are covered under one of the following licenses:

United States MRXC4W4MA4
 Canada 2546A-C4W4MA4

FUEL REQUIREMENTS

3.6L Engine



This engine is designed to meet all emissions regulations and provide excellent fuel economy and performance when using high-quality unleaded “regular” gasoline having an octane rating of 87. The use of premium gasoline is not recommended, as it will not provide any benefit over regular gasoline in these engines.

5.7L Engine



This engine is designed to meet all emissions regulations and provide satisfactory fuel economy and performance when using high-quality unleaded gasoline having an octane range of 87 to 89. The manufacturer recommends the use of 89 octane for

optimum performance. The use of premium gasoline is not recommended, as it will not provide any benefit over regular gasoline in these engines.

Light spark knock at low engine speeds is not harmful to your engine. However, continued heavy spark knock at high speeds can cause damage and immediate service is required. Poor quality gasoline can cause problems such as hard starting, stalling, and hesitations. If you experience these symptoms, try another brand of gasoline before considering service for the vehicle.

Over 40 auto manufacturers worldwide have issued and endorsed consistent gasoline specifications (the Worldwide Fuel Charter, WWFC) which define fuel properties necessary to deliver enhanced emissions, performance, and durability for your vehicle. The manufacturer recommends the use of gasolines that meet the WWFC specifications if they are available.

Reformulated Gasoline

Many areas of the country require the use of cleaner burning gasoline referred to as "Reformulated Gasoline." Reformulated gasoline contains oxygenates and are specifically blended to reduce vehicle emissions and improve air quality.

The manufacturer supports the use of reformulated gasoline. Properly blended reformulated gasoline will provide excellent performance and durability of engine and fuel system components.

Gasoline/Oxygenate Blends

Some fuel suppliers blend unleaded gasoline with oxygenates such as Ethanol. Fuels blended with oxygenates may be used in your vehicle.

CAUTION!

DO NOT use gasoline containing Methanol or gasoline containing more than 10% Ethanol. Use of these blends may result in starting and driveability problems, damage critical fuel system components, cause emissions to exceed the applicable standard, and/or cause the "Malfunction Indicator Light" to illuminate. Pump labels should clearly communicate if a fuel contains greater than 10% Ethanol.

Problems that result from using gasoline containing Methanol or gasoline containing more than 10% Ethanol are not the responsibility of the manufacturer and may not be covered under warranty.

E-85 Usage In Non-Flex Fuel Vehicles

Non-FFV vehicles are compatible with gasoline containing 10% ethanol (E10). Gasoline with higher ethanol content may void the vehicle's warranty.

If a Non-FFV vehicle is inadvertently fueled with E-85 fuel, the engine will have some or all of these symptoms:

- operate in a lean mode
- OBD II "Malfunction Indicator Light" on
- poor engine performance
- poor cold start and cold driveability
- increased risk for fuel system component corrosion

To fix a Non-FFV vehicle inadvertently fueled once with E-85 perform the following:

- change the engine oil and oil filter
- disconnect and reconnect the battery
- drain the fuel tank (see your authorized dealer)

More extensive repairs will be required for prolonged exposure to E-85 fuel.

MMT In Gasoline

MMT is a manganese-containing metallic additive that is blended into some gasoline to increase octane. Gasoline blended with MMT provides no performance advantage beyond gasoline of the same octane number without MMT. Gasoline blended with MMT reduces spark plug life and reduces emissions system performance in some vehicles. The manufacturer recommends that gasoline without MMT be used in your vehicle. The MMT content of gasoline may not be indicated on the gasoline pump, therefore, you should ask your gasoline retailer whether the gasoline contains MMT. It is even more important to look for gasoline without MMT in Canada, because MMT can be used at levels higher than those allowed in the United States. MMT is prohibited in Federal and California reformulated gasoline.

Materials Added to Fuel

All gasoline sold in the United States is required to contain effective detergent additives. Use of additional detergents or other additives is not needed under normal conditions and they would result in additional cost. Therefore, you should not have to add anything to the fuel.

Fuel System Cautions

CAUTION!

Follow these guidelines to maintain your vehicle's performance:

- The use of leaded gas is prohibited by Federal law. Using leaded gasoline can impair engine performance and damage the emissions control system.

(Continued)

CAUTION! (Continued)

- An out-of-tune engine or certain fuel or ignition malfunctions can cause the catalytic converter to overheat. If you notice a pungent burning odor or some light smoke, your engine may be out of tune or malfunctioning and may require immediate service. Contact your authorized dealer for service assistance.
- The use of fuel additives, which are now being sold as octane enhancers, is not recommended. Most of these products contain high concentrations of methanol. Fuel system damage or vehicle performance problems resulting from the use of such fuels or additives is not the responsibility of the manufacturer.

NOTE: Intentional tampering with the emissions control system can result in civil penalties being assessed against you.

Carbon Monoxide Warnings**WARNING!**

Carbon monoxide (CO) in exhaust gases is deadly. Follow the precautions below to prevent carbon monoxide poisoning:

- Do not inhale exhaust gases. They contain carbon monoxide, a colorless and odorless gas, which can kill. Never run the engine in a closed area, such as a garage, and never sit in a parked vehicle with the engine running for an extended period. If the vehicle is stopped in an open area with the engine running for more than a short period, adjust the ventilation system to force fresh, outside air into the vehicle.

(Continued)

WARNING! (Continued)

- Guard against carbon monoxide with proper maintenance. Have the exhaust system inspected every time the vehicle is raised. Have any abnormal conditions repaired promptly. Until repaired, drive with all side windows fully open.
- Keep the liftgate closed when driving your vehicle to prevent carbon monoxide and other poisonous exhaust gases from entering the vehicle.

**FLEXIBLE FUEL (3.6L ENGINE ONLY) —
IF EQUIPPED****E-85 General Information**

The information in this section is for Flexible Fuel vehicles only. These vehicles can be identified by a unique fuel filler door label that states **Ethanol (E-85) or Unleaded Gasoline Only**. This section only covers those subjects that are unique to these vehicles. Please refer to

the other sections of this manual for information on features that are common between Flexible Fuel and gasoline-only powered vehicles.

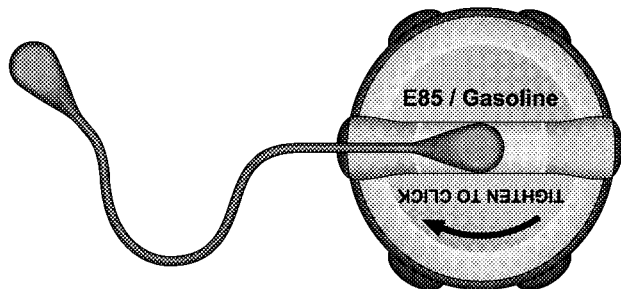

81ae46ab

E-85 Fuel Cap

CAUTION!

Only vehicles with the E-85 fuel filler door label can operate on E-85.



81ae46a9

E-85 Badge

Ethanol Fuel (E-85)

E-85 is a mixture of approximately 85% fuel ethanol and 15% unleaded gasoline.

WARNING!

Ethanol vapors are extremely flammable and could cause serious personal injury. Never have any smoking materials lit in or near the vehicle when removing the fuel filler tube cap (gas cap) or filling the tank. Do not use E-85 as a cleaning agent and never use it near an open flame.

Fuel Requirements

Your vehicle will operate on both unleaded gasoline with an octane rating of 87, or E-85 fuel, or any mixture of these two. For best results, a refueling pattern that alternates between E-85 and unleaded gasoline should be avoided.

When you do switch fuel types it is recommended that:

- you do not switch when the fuel gauge indicates less than 1/4 full
- you do not add less than 5 gallons (19 Liters) when refueling
- you operate the vehicle immediately after refueling for a period of at least 5 minutes

Observing these precautions will avoid possible hard starting and/or significant deterioration in driveability during warm up.

NOTE:

- When the ambient temperature is above 90° F (32° C), you may experience hard starting and rough idle following start up even if the above recommendations are followed.

- Some additives used in regular gasoline are not fully compatible with E-85 and may form deposits in your engine. To eliminate driveability issues that may be caused by these deposits, a supplemental gasoline additive, such as MOPAR® Injector Cleanup or Techron may be used.

Selection Of Engine Oil For Flexible Fuel Vehicles (E-85) and Gasoline Vehicles

FFV vehicles operated on E-85 require specially formulated engine oils. These special requirements are included in MOPAR® engine oils, and in equivalent oils meeting Chrysler Specification MS-6395. The manufacturer requires engine oils that are API Certified and meet the requirements of Material Standard MS-6395. MS-6395 contains additional requirements, developed during extensive fleet testing, to provide additional protection to Chrysler Group LLC engines. Use MOPAR® or an equivalent oil meeting the specification MS-6395.

Starting

The characteristics of E-85 fuel make it unsuitable for use when ambient temperatures fall below 0°F (-18°C). In the range of 0°F (-18°C) to 32°F (0°C), you may experience an increase in the time it takes for your engine to start, and a deterioration in driveability (sags and/or hesitations) until the engine is fully warmed up.

NOTE: Use of the engine block heater (if equipped) is beneficial for E-85 startability when the ambient temperature is less than 32°F (0°C).

Cruising Range

Because E-85 fuel contains less energy per gallon/liter than gasoline, you will experience an increase in fuel consumption. You can expect your miles per gallon (mpg)/miles per liter and your driving range to decrease by about 30%, compared to gasoline operation.

Replacement Parts

Many components in your Flexible Fuel Vehicle (FFV) are designed to be compatible with ethanol. Always be sure that your vehicle is serviced with correct ethanol compatible parts.

CAUTION!

Replacing fuel system components with non-ethanol compatible components can damage your vehicle.

Maintenance

CAUTION!

Do not use ethanol mixture greater than 85% in your vehicle. It will cause difficulty in cold starting and may affect driveability.

ADDING FUEL

Fuel Filler Cap (Gas Cap)

The gas cap is located behind the locking fuel filler door, on the driver's side of the vehicle. If the gas cap is lost or damaged, be sure the replacement cap is for use with this vehicle.

1. Press the fuel filler door release switch (located under the headlamp switch).



Fuel Filler Door Release Switch

2. Open the fuel filler door, and remove the fuel filler cap.

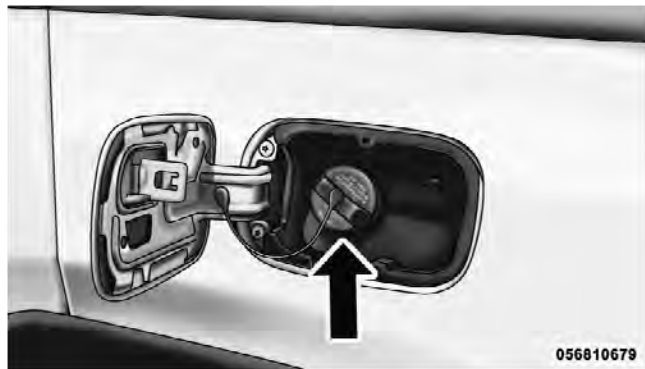

Fuel Filler Cap

CAUTION!

- Damage to the fuel system or emission control system could result from using an improper fuel cap (gas cap). A poorly fitting cap could let impurities into the fuel system. Also, a poorly fitting aftermarket cap can cause the "Malfunction Indicator Light (MIL)" to illuminate, due to fuel vapors escaping from the system.
- A poorly fitting gas cap may cause the MIL to turn on.
- To avoid fuel spillage and overfilling, do not "top off" the fuel tank after filling.

WARNING!

- Never have any smoking materials lit in or near the vehicle when the gas cap is removed or the tank is being filled.
- Never add fuel when the engine is running. This is in violation of most state and federal fire regulations and may cause the malfunction indicator light to turn on.
- A fire may result if gasoline is pumped into a portable container that is inside of a vehicle. You could be burned. Always place gas containers on the ground while filling.

NOTE:

- When the fuel nozzle “clicks” or shuts off, the fuel tank is full.

- Tighten the gas cap about one-quarter turn until you hear one click. This is an indication that the cap is properly tightened.
- If the gas cap is not tightened properly, the MIL will come on. Be sure the gas cap is tightened every time the vehicle is refueled.

Emergency Fuel Filler Door Release

If you are unable to open the fuel filler door, use the fuel filler door emergency release.

1. Open the liftgate.
2. Remove the left rear storage bin cover.
3. Pull the release cable.

Loose Fuel Filler Cap Message



If the vehicle diagnostic system determines that the fuel filler cap is loose, improperly installed, or damaged, a loose gascap indicator will display in the EVIC telltale display area.

Refer to “Electronic Vehicle Information Center (EVIC)” in “Understanding Your Instrument Panel” for further information. Tighten the fuel filler cap properly and press the SELECT button to turn off the message. If the problem continues, the message will appear the next time the vehicle is started.

VEHICLE LOADING

Certification Label

As required by National Highway Traffic Safety Administration regulations, your vehicle has a certification label affixed to the driver’s side door or B-Pillar.

This label contains the month and year of manufacture, Gross Vehicle Weight Rating (GVWR), Gross Axle Weight

Rating (GAWR) front and rear, and Vehicle Identification Number (VIN). A Month-Day-Hour (MDH) number is included on this label and indicates the month, day, and hour of manufacture. The bar code that appears on the bottom of the label is your VIN.

Gross Vehicle Weight Rating (GVWR)

The GVWR is the total permissible weight of your vehicle including driver, passengers, vehicle, options, trailer tongue weight, and cargo. The label also specifies maximum capacities of front and rear axle systems (GAWR). Total load must be limited, so GVWR, and front and rear GAWR are not exceeded.

Payload

The payload of a vehicle is defined as the allowable load weight a truck or any given vehicle can carry, including the weight of the driver, all passengers, options and cargo.

Gross Axle Weight Rating (GAWR)

The GAWR is the maximum permissible load on the front and rear axles. The load must be distributed in the cargo area so that the GAWR of each axle is not exceeded.

Each axle's GAWR is determined by the components in the system with the lowest load carrying capacity (axle, springs, tires, or wheels). Heavier axles or suspension components, sometimes specified by purchasers for increased durability, does not necessarily increase the vehicle's GVWR.

Tire Size

The tire size on the label represents the actual tire size on your vehicle. Replacement tires must be equal to the load capacity of this tire size.

Rim Size

This is the rim size that is appropriate for the tire size listed.

Inflation Pressure

This is the cold tire inflation pressure for your vehicle for all loading conditions up to full GAWR.

Curb Weight

The curb weight of a vehicle is defined as the total weight of the vehicle with all fluids, including vehicle fuel, at full capacity conditions, and with no occupants or cargo loaded into the vehicle. The front and rear curb weight values are determined by weighing your vehicle on a commercial scale before any occupants or cargo are added.

Loading

The actual total weight and the weight of the front and rear of your vehicle at the ground can best be determined by weighing it when it is loaded and ready for operation.

The entire vehicle should first be weighed on a commercial scale to ensure that the GVWR has not been exceeded. The weight on the front and rear of the vehicle should then be determined separately to be sure that the load is properly distributed over front and rear axle. Weighing the vehicle may show that the GAWR of either the front or rear axles has been exceeded, but the total load is within the specified GVWR. If so, weight must be shifted from front to rear, or rear to front, as appropriate until the specified weight limitations are met. Store the heavier items down low and be sure that the weight is distributed equally. Stow all loose items securely before driving.

Improper weight distributions can have an adverse affect on the way your vehicle steers and handles, and the way the brakes operate.

CAUTION!

Do not load your vehicle any heavier than the GVWR or the maximum front and rear GAWR. If you do, parts on your vehicle can break, or it can change the way your vehicle handles. This could cause you to lose control. Also, overloading can shorten the life of your vehicle.

TRAILER TOWING

In this section you will find safety tips and information on limits to the type of towing you can reasonably do with your vehicle. Before towing a trailer, carefully review this information to tow your load as efficiently and safely as possible.

To maintain warranty coverage, follow the requirements and recommendations in this manual concerning vehicles used for trailer towing.

Common Towing Definitions

The following trailer towing related definitions will assist you in understanding the following information.

Gross Vehicle Weight Rating (GVWR)

The GVWR is the total allowable weight of your vehicle. This includes driver, passengers, cargo and trailer tongue weight. The total load must be limited so that you do not exceed the GVWR. Refer to "Vehicle Loading/Vehicle Certification Label" in "Starting and Operating" for further information.

Gross Trailer Weight (GTW)

The GTW is the weight of the trailer plus the weight of all cargo, consumables and equipment (permanent or temporary) loaded in or on the trailer in its "loaded and ready for operation" condition.

The recommended way to measure GTW is to put your fully loaded trailer on a vehicle scale. The entire weight of the trailer must be supported by the scale.

WARNING!

If the gross trailer weight is 3,500 lbs (1 587 kg) or more, it is mandatory to use a weight-distributing hitch to ensure stable handling of your vehicle. If you use a standard weight-carrying hitch, you could lose control of your vehicle and cause a collision.

Gross Combination Weight Rating (GCWR)

The GCWR is the total permissible weight of your vehicle and trailer when weighed in combination.

NOTE: The GCWR rating includes a 150 lbs (68 kg) allowance for the presence of a driver.

Gross Axle Weight Rating (GAWR)

The GAWR is the maximum capacity of the front and rear axles. Distribute the load over the front and rear axles evenly. Make sure that you do not exceed either front or

rear GAWR. Refer to “Vehicle Loading/Vehicle Certification Label” in “Starting and Operating” for further information.

WARNING!

It is important that you do not exceed the maximum front or rear GAWR. A dangerous driving condition can result if either rating is exceeded. You could lose control of the vehicle and have a collision.

Trailer Tongue Weight (TW)

The TW is the downward force exerted on the hitch ball by the trailer. In most cases it should not be less than 10% or more than 15% of the trailer load. You must consider this as part of the load on your vehicle.

Frontal Area

The frontal area is the maximum height multiplied by the maximum width of the front of a trailer.

Weight-Carrying Hitch

A weight-carrying hitch supports the trailer tongue weight, just as if it were luggage located at a hitch ball or some other connecting point of the vehicle. These kind of hitches are the most popular on the market today and they are commonly used to tow small- and medium-sized trailers.

Weight-Distributing Hitch

A weight-distributing hitch system works by applying leverage through spring (load) bars. They are typically used for heavier loads, to distribute trailer tongue weight to the tow vehicle’s front axle and the trailer axle(s). When used in accordance with the manufacturers’ directions, it provides for a more level ride, offering more consistent steering and brake control, thereby enhancing towing safety. The addition of a friction/hydraulic sway control also dampens sway caused by traffic and crosswinds, and contributes positively to tow vehicle and

trailer stability. Trailer sway control and a weight-distributing (load equalizing) hitch are recommended for heavier trailer tongue weights (TW) and may be required depending on Vehicle and Trailer configuration/loading to comply with gross axle weight rating (GAWR) requirements.

WARNING!

- An improperly adjusted weight-distributing hitch system may reduce handling, stability, and braking performance, and could result in a collision.
- Weight-distributing hitch systems may not be compatible with Surge Brake Couplers. Consult with your hitch and trailer manufacturer or a reputable Recreational Vehicle dealer for additional information.

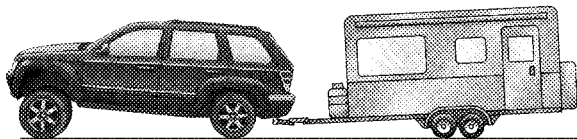

Without Weight-Distributing Hitch (Incorrect)

057007122

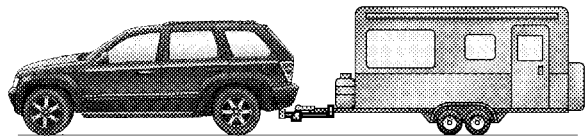

057007121

With Weight-Distributing Hitch (Correct)

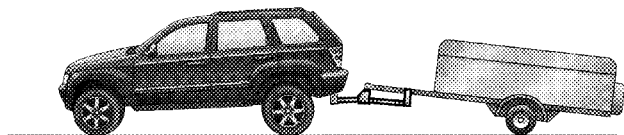

057007120

Improper Adjustment of Weight-Distributing Hitch
(Incorrect)

Trailer Hitch Classification

Your vehicle may be factory equipped for safe towing of trailers weighing over 3,500 lbs (1 587 kg) with the optional Trailer Tow Prep Package. See your authorized dealer for package content.

The following chart provides the industry standard for the maximum trailer weight a given trailer hitch class can tow and should be used to assist you in selecting the correct trailer hitch for your intended towing condition. Refer to the Trailer Towing Weights (Maximum Trailer Weight Ratings) chart for the Max. GTW towable for your given drivetrain.

Trailer Hitch Classification Definitions	
Class	Max. Trailer Hitch Industry Standards
Class I - Light Duty	2,000 lbs (907 kg)
Class II - Medium Duty	3,500 lbs (1 587 kg)
Class III - Heavy Duty	5,000 lbs (2 268 kg)
Class IV - Extra Heavy Duty	10,000 lbs (4 540 kg)
Refer to the "Trailer Towing Weights (Maximum Trailer Weight Ratings)" chart for the Maximum Gross Trailer Weight (GTW) towable for your given drivetrain.	

All trailer hitches should be professionally installed on your vehicle.

Trailer Towing Weights (Maximum Trailer Weight Ratings)

The following chart provides the maximum trailer weight ratings towable for your given drivetrain.

Engine/Model	Model	GCWR (Gross Combined Wt. Rating)	Frontal Area	Max. GTW (Gross Trailer Wt.)	Max. Trailer Tongue Wt. (See Note)
3.6L	4x2	8,900 lbs (4 037 kg)	40 sq ft (3.72 sq m)	5,000 lbs (2 268 kg)	500 lbs (227 kg)
3.6L	4x4	8,900 lbs (4 037 kg)	40 sq ft (3.72 sq m)	5,000 lbs (2 268 kg)	500 lbs (227 kg)
5.7L	4x2	13,100 lbs (5 942 kg)	60 sq ft (5.57 sq m)	7,400 lbs (3 357 kg)	740 lbs (336 kg)
5.7L	4x4	13,100 lbs (5 942 kg)	60 sq ft (5.57 sq m)	7,200 lbs (3 266 kg)	720 lbs (327 kg)

Refer to local laws for maximum trailer towing speeds.

NOTE: The trailer tongue weight must be considered as part of the combined weight of occupants and cargo, and should never exceed the weight referenced on the Tire and Loading Information placard. Refer to "Tire Safety Information" in "Starting and Operating" for further information. The addition of passengers and cargo may require reducing trailer tongue load and Gross Trailer Weight (GTW). Redistributing cargo (to the trailer) may be necessary to avoid exceeding Rear Gross Axle Weight Rating (GAWR) of 3,700 lbs (1 678 kg).

Trailer And Tongue Weight

Always load a trailer with 60% to 65% of the weight in the front of the trailer. This places 10% to 15% of the Gross Trailer Weight (GTW) on the tow hitch of your vehicle. Loads balanced over the wheels, or heavier in the rear, can cause the trailer to sway **severely** side-to-side which will cause loss of control of vehicle and trailer. Failure to load trailers heavier in front is the cause of many trailer collisions. Never exceed the maximum tongue weight stamped on your trailer hitch.

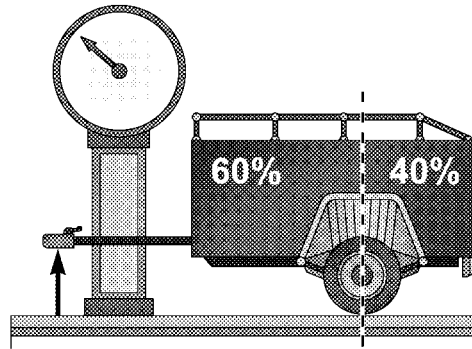

057003767

5

Consider the following items when computing the weight on the front/rear axles of the vehicle:

- The trailer tongue weight of the trailer.
- The weight of any other type of cargo or equipment put in or on your vehicle.
- The weight of the driver and all passengers.

NOTE: Remember that everything put into or on the trailer adds to the load on your vehicle. Also, additional factory-installed options, or authorized dealer-installed options, must be considered as part of the total load on your vehicle. Refer to “Tire Safety Information/Tire and Loading Information Placard” in “Starting and Operating” for further information.

Towing Requirements

To promote proper break-in of your new vehicle drivetrain components, the following guidelines are recommended.

CAUTION!

- Do not tow a trailer at all during the first 500 miles (805 km) the new vehicle is driven. The engine, axle or other parts could be damaged.

(Continued)

CAUTION! (Continued)

- Then, during the first 500 miles (805 km) that a trailer is towed, do not drive over 50 mph (80 km/h) and do not make starts at full throttle. This helps the engine and other parts of the vehicle wear in at the heavier loads.

Perform the maintenance listed in the “Maintenance Schedule.” Refer to “Maintenance Schedule” for the proper maintenance intervals. When towing a trailer, never exceed the GAWR or GCWR ratings.

WARNING!

Improper towing can lead to a collision. Follow these guidelines to make your trailer towing as safe as possible:

(Continued)

WARNING! (Continued)

- Make certain that the load is secured in the trailer and will not shift during travel. When trailering cargo that is not fully secured, dynamic load shifts can occur that may be difficult for the driver to control. You could lose control of your vehicle and have a collision.
- When hauling cargo or towing a trailer, do not overload your vehicle or trailer. Overloading can cause a loss of control, poor performance or damage to brakes, axle, engine, transmission, steering, suspension, chassis structure or tires.
- Safety chains must always be used between your vehicle and trailer. Always connect the chains to the hook retainers of the vehicle hitch. Cross the chains under the trailer tongue and allow enough slack for turning corners.

(Continued)

WARNING! (Continued)

- Vehicles with trailers should not be parked on a grade. When parking, apply the parking brake on the tow vehicle. Put the tow vehicle transmission in PARK. For four-wheel drive vehicles, make sure the transfer case is not in NEUTRAL. Always, block or "chock" the trailer wheels.
- GCWR must not be exceeded.
- Total weight must be distributed between the tow vehicle and the trailer such that the following four ratings are not exceeded:
 1. GVWR
 2. GTW
 3. GAWR
 4. Trailer tongue weight rating for the trailer hitch utilized (This requirement may limit the ability to always achieve the 10% to 15% range of tongue weight as a percentage of total trailer weight).

Towing Requirements – Tires

- Do not attempt to tow a trailer while using a compact spare tire.
- Proper tire inflation pressures are essential to the safe and satisfactory operation of your vehicle. Refer to “Tires – General Information” in “Starting and Operating” for proper tire inflation procedures.
- Check the trailer tires for proper tire inflation pressures before trailer usage.
- Check for signs of tire wear or visible tire damage before towing a trailer. Refer to “Tires – General Information” in “Starting and Operating” for proper inspection procedure.
- When replacing tires, refer to “Tires – General Information” in “Starting and Operating” for proper tire

replacement procedures. Replacing tires with a higher load carrying capacity will not increase the vehicle’s GVWR and GAWR limits.

Towing Requirements – Trailer Brakes

- Do **not** interconnect the hydraulic brake system or vacuum system of your vehicle with that of the trailer. This could cause inadequate braking and possible personal injury.
- An electronically-actuated trailer brake controller is required when towing a trailer with electronically-actuated brakes. When towing a trailer equipped with a hydraulic surge-actuated brake system, an electronic brake controller is not required.
- Trailer brakes are recommended for trailers over 1,000 lbs (454 kg), and required for trailers in excess of 2,000 lbs (907 kg).

CAUTION!

If the trailer weighs more than 1,000 lbs (454 kg) loaded, it should have its own brakes and they should be of adequate capacity. Failure to do this could lead to accelerated brake lining wear, higher brake pedal effort, and longer stopping distances.

WARNING!

- Do not connect trailer brakes to your vehicle's hydraulic brake lines. It can overload your brake system and cause it to fail. You might not have brakes when you need them and could have a collision.

(Continued)

WARNING! (Continued)

- Towing any trailer will increase your stopping distance. When towing, you should allow for additional space between your vehicle and the vehicle in front of you. Failure to do so could result in a collision.

Towing Requirements – Trailer Lights and Wiring

Whenever you pull a trailer, regardless of the trailer size, stop lights and turn signals on the trailer are required for motoring safety.

The Trailer Tow Package includes a seven-pin connector at the rear of the vehicle and a four-pin harness located under the rear bumper. The four-pin harness must be unclipped before use. Use a factory-approved trailer harness and connector.

The electrical connections are all complete to the vehicle but you must mate the harness to a trailer connector. Refer to the following illustrations.

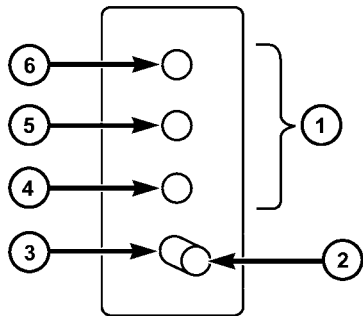

Four-Pin Connector

057003766

- | | |
|-----------------|---------------------|
| 1 — Female Pins | 4 — Park |
| 2 — Male Pin | 5 — Left Stop/Turn |
| 3 — Ground | 6 — Right Stop/Turn |

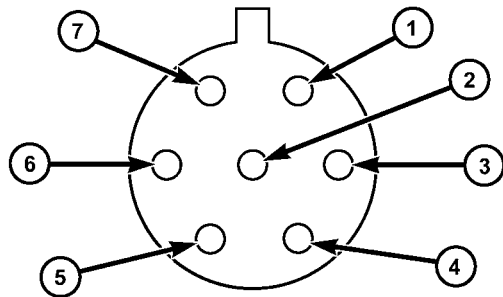

Seven-Pin Connector

057003765

- | | |
|---------------------|--------------------|
| 1 — Battery | 5 — Ground |
| 2 — Backup Lamps | 6 — Left Stop/Turn |
| 3 — Right Stop/Turn | 7 — Running Lamps |
| 4 — Electric Brakes | |

Towing Tips

Before setting out on a trip, practice turning, stopping and backing the trailer in an area away from heavy traffic.

Automatic Transmission

The DRIVE range can be selected when towing. However, if frequent shifting occurs while in this range, the TOW/HAUL mode (if equipped), or a lower gear range, should be selected.

NOTE: Using the TOW/HAUL mode (if equipped) or selecting a lower gear range (using the Electronic Range Select (ERS) feature) while operating the vehicle under heavy operating conditions, will improve performance and extend transmission life by reducing excessive shifting and heat buildup. This action will also provide better engine braking.

The transmission fluid and filter should be changed if you REGULARLY tow a trailer for more than 45 minutes of continuous operation. Refer to “Maintenance Schedule” for the proper maintenance intervals.

NOTE: Check the transmission fluid level before towing (5.7L engine).

Electronic Speed Control – If Equipped

- Do not use in hilly terrain or with heavy loads.
- When using the speed control, if you experience speed drops greater than 10 mph (16 km/h), disengage until you can get back to cruising speed.
- Use speed control in flat terrain and with light loads to maximize fuel efficiency.

Cooling System

To reduce potential for engine and transmission overheating, take the following actions:

– *City Driving*

When stopped for short periods of time, shift the transmission into NEUTRAL and increase engine idle speed.

– *Highway Driving*

Reduce speed.

– *Air Conditioning*

Turn off temporarily.

SNOW PLOW

Snow plows, winches, and other aftermarket equipment should **not** be added to the front end of your vehicle. The airbag crash sensors may be affected by the change in the front end structure. The airbags could deploy unexpectedly or could fail to deploy during a collision.

WARNING!

Do not add a snow plow, winches, or any other aftermarket equipment to the front of your vehicle. This could adversely affect the functioning of the airbag system and you could be injured.

RECREATIONAL TOWING (BEHIND MOTORHOME, ETC.)**Towing This Vehicle Behind Another Vehicle**

Towing Condition	Wheel OFF the Ground	Two-Wheel Drive Models	Four-Wheel Drive Models
Flat Tow	NONE	NOT ALLOWED	<i>See Instructions</i> <ul style="list-style-type: none"> • Transmission in PARK • Transfer case in NEUTRAL (N) • Tow in forward direction
Dolly Tow	Front	NOT ALLOWED	NOT ALLOWED
	Rear	OK	NOT ALLOWED
On Trailer	ALL	OK	OK

NOTE: Vehicles equipped with Quadra-Lift™ must be lowered to the “Park” (lowest) level, and have automatic leveling disabled, before tying them down (from the body) on a trailer or flatbed truck. Refer to “Quadra-Lift™ – If Equipped” in “Starting and Operating” for more information. If the vehicle cannot be lowered to the “Park” level (for example, engine will not run), tie-downs must be fastened to the axles (not to the body). Failure to follow these instructions may cause fault codes to be set and/or loss of proper tie-down tension.

Recreational Towing — Two-Wheel Drive Models

DO NOT flat tow this vehicle. Damage to the drivetrain will result.

Recreational towing (for two-wheel drive models) is allowed **ONLY** if the rear wheels are **OFF** the ground. This may be accomplished using a tow dolly or vehicle trailer. If using a tow dolly, follow this procedure:

1. Properly secure the dolly to the tow vehicle, following the dolly manufacturer's instructions.
2. Drive the rear wheels onto the tow dolly.
3. Firmly set the parking brake. Place the transmission in **PARK**.
4. Properly secure the rear wheels to the dolly, following the dolly manufacturer's instructions.
5. Turn the ignition switch to the unlocked **OFF** position.

6. Install a suitable clamping device, designed for towing, to secure the front wheels in the straight position.
7. Disconnect the negative battery cable and secure it away from the battery post.

CAUTION!

Towing with the rear wheels on the ground will cause severe transmission damage. Damage from improper towing is not covered under the New Vehicle Limited Warranty.

Recreational Towing — Quadra-Trac I® (Single-Speed Transfer Case) Four-Wheel Drive Models

Recreational towing is not allowed. These models do not have a **NEUTRAL (N)** position in the transfer case.

NOTE: This vehicle may be towed on a flatbed or vehicle trailer provided all four wheels are **OFF** the ground.

CAUTION!

Towing this vehicle in violation of the above requirements can cause severe transmission and/or transfer case damage. Damage from improper towing is not covered under the New Vehicle Limited Warranty.

Recreational Towing — Quadra- Trac II® /Quadra-Drive® II Four-Wheel Drive Models

The transfer case must be shifted into NEUTRAL (N) and the transmission must be placed in PARK for recreational towing. The NEUTRAL (N) selection button is adjacent to the transfer case selector switch. Shifts into and out of transfer case NEUTRAL (N) can take place with the selector switch in any mode position.

CAUTION!

- Front or rear wheel lifts should not be used. Internal damage to the transmission or transfer case will occur if a front or rear wheel lift is used when recreational towing.
- Tow only in a forward direction. Towing this vehicle backwards can cause severe damage to the transfer case.
- The transmission must be placed in PARK for recreational towing.
- Before recreational towing, perform the procedure outlined under “Shifting into NEUTRAL (N)” to be certain that the transfer case is fully in NEUTRAL (N). Otherwise, internal damage will result.
- Failure to follow these procedures can cause severe transmission and/or transfer case damage.

(Continued)

CAUTION! (Continued)

- Do not use a bumper-mounted clamp-on tow bar on your vehicle. The bumper face bar will be damaged.

Shifting Into NEUTRAL (N)

WARNING!

You or others could be injured if you leave the vehicle unattended with the transfer case in the NEUTRAL (N) position without first fully engaging the parking brake. The transfer case NEUTRAL (N) position disengages both the front and rear drive-shafts from the powertrain and will allow the vehicle to move, even if the transmission is in PARK. The parking brake should always be applied when the driver is not in the vehicle.

Use the following procedure to prepare your vehicle for recreational towing.

CAUTION!

It is necessary to follow these steps to be certain that the transfer case is fully in NEUTRAL (N) before recreational towing to prevent damage to internal parts.

1. Bring the vehicle to a complete stop and shift the transmission to PARK.
2. Turn OFF the ignition.
3. For vehicles with Keyless Enter-N-Go, remove the Keyless Enter-N-Go button and use the key fob to complete this procedure. Refer to "Starting Procedures/Keyless Enter-N-Go" in "Starting and Operating" for further information.

4. Turn the ignition switch to the ON/RUN position, but do not start the engine.
5. Press and hold the brake pedal.
6. Shift the transmission into NEUTRAL.
7. Using the point of a ballpoint pen or similar object, press and hold the recessed transfer case N (Neutral) button (located by the selector switch) for four seconds, until the light behind the N symbol starts to blink, indicating shift in progress. The light will stop blinking (stay on solid) when the shift to N (Neutral) is complete. A "FOUR WHEEL DRIVE SYSTEM IN NEUTRAL" message will display on the EVIC (Electronic Vehicle Information Center). Refer to "Electronic Vehicle Information Center (EVIC)" in "Understanding Your Instrument Panel" for further information.



Neutral Switch

8. Start the engine.
9. Shift the transmission into REVERSE.
10. Release the brake pedal for five seconds and ensure that there is no vehicle movement.
11. Turn OFF the engine.

12. Firmly apply the parking brake.
13. Shift the transmission into PARK and remove the key fob.

CAUTION!

Damage to the transmission may occur if the transmission is shifted into PARK with the transfer case in NEUTRAL (N) and the engine running. With the transfer case in NEUTRAL (N) ensure that the engine is off prior to shifting the transmission into PARK.

14. Attach the vehicle to the tow vehicle using a suitable tow bar.
15. Release the parking brake.

NOTE:

- Steps 1 through 6 are requirements that must be met prior to pressing the NEUTRAL (N) button, and must continue to be met until the four seconds elapse and the shift has been completed. If any of these requirements are not met prior to pressing the NEUTRAL (N) button or are no longer met during the four second timer, then the NEUTRAL (N) indicator light will flash continuously until all requirements are met or until the NEUTRAL (N) button is released.
- The ignition switch must be in the ON/RUN position for a shift to take place and for the position indicator lights to be operable. If the ignition switch is not in the ON/RUN position, the shift will not take place and no position indicator lights will be on or flashing.
- A flashing NEUTRAL (N) position indicator light indicates that shift requirements have not been met.

Shifting Out Of NEUTRAL (N)

Use the following procedure to prepare your vehicle for normal usage.

1. Bring the vehicle to a complete stop, leaving it connected to the tow vehicle.
2. Firmly apply the parking brake.
3. Turn the key fob to the ON/RUN position, but do not start the engine.
4. Press and hold the brake pedal.
5. Shift the transmission into NEUTRAL.
6. Using the point of a ballpoint pen or similar object, press and hold the recessed transfer case N (Neutral) button (located by the selector switch) for four seconds, until the light behind the N symbol starts to blink, indicating shift in progress. The light will stop blinking (go out) when shift is complete. The “FOUR WHEEL

DRIVE SYSTEM IN NEUTRAL” message will no longer be displayed on the EVIC (Electronic Vehicle Information Center). Refer to “Electronic Vehicle Information Center (EVIC)” in “Understanding Your Instrument Panel” for further information.



Neutral Switch

NOTE: When shifting out of transfer case NEUTRAL (N), turning the engine OFF may be required to avoid gear clash.

7. Shift the transmission into PARK.
8. Release the brake pedal.
9. Disconnect vehicle from the tow vehicle.
10. Start the engine.
11. Press and hold the brake pedal.
12. Release the parking brake.
13. Shift the transmission into DRIVE, release the brake pedal, and check that the vehicle operates normally.
14. The Keyless Enter-N-Go button (if equipped) may now be reinstalled if desired. Refer to “Starting Procedures/Keyless Enter-N-Go” in “Starting and Operating” for further information.

NOTE:

- Steps 1 through 5 are requirements that must be met prior to pressing the NEUTRAL (N) button, and must continue to be met until the shift has been completed. If any of these requirements are not met prior to pressing the NEUTRAL (N) button or are no longer met during the shift, the NEUTRAL (N) indicator light will flash continuously until all requirements are met or until the NEUTRAL (N) button is released.
- The ignition switch must be in the ON/RUN position for a shift to take place and for the position indicator lights to be operable. If the ignition switch is not in the ON/RUN position, the shift will not take place and no position indicator lights will be on or flashing.
- A flashing NEUTRAL (N) position indicator light indicates that shift requirements have not been met.

WHAT TO DO IN EMERGENCIES

CONTENTS

■ Hazard Warning Flashers	462	■ Jump-Starting	471
■ If Your Engine Overheats	462	□ Preparations For Jump-Start	472
■ Jacking And Tire Changing	463	□ Jump-Starting Procedure	473
□ Jack Location	464	■ Emergency Tow Hooks — If Equipped	475
□ Spare Tire Stowage	464	■ Shift Lever Override	476
□ Preparations For Jacking	465	■ Towing A Disabled Vehicle	477
□ Jacking Instructions	466	□ Towing Without The Ignition Key FOB	479
		□ Two-Wheel Drive Models	479
		□ Four-Wheel Drive Vehicles	480

HAZARD WARNING FLASHERS

The Hazard Warning flasher switch is located on the switch bank just above the climate controls.

 Press the switch to turn on the Hazard Warning flasher. When the switch is activated, all directional turn signals will flash on and off to warn oncoming traffic of an emergency. Press the switch a second time to turn off the Hazard Warning flashers.

This is an emergency warning system and it should not be used when the vehicle is in motion. Use it when your vehicle is disabled and it is creating a safety hazard for other motorists.

When you must leave the vehicle to seek assistance, the Hazard Warning flashers will continue to operate even though the ignition is placed in the OFF position.

NOTE: With extended use the Hazard Warning flashers may wear down your battery.

IF YOUR ENGINE OVERHEATS

In any of the following situations, you can reduce the potential for overheating by taking the appropriate action.

- On the highways — slow down.
- In city traffic — while stopped, place the transmission in NEUTRAL, but do not increase the engine idle speed.

NOTE: There are steps that you can take to slow down an impending overheat condition:

- If your air conditioner (A/C) is on, turn it off. The A/C system adds heat to the engine cooling system and turning the A/C off can help remove this heat.

- You can also turn the temperature control to maximum heat, the mode control to floor and the blower control to high. This allows the heater core to act as a supplement to the radiator and aids in removing heat from the engine cooling system.

CAUTION!

Driving with a hot cooling system could damage your vehicle. If the temperature gauge reads HOT (H), pull over and stop the vehicle. Idle the vehicle with the air conditioner turned off until the pointer drops back into the normal range. If the pointer remains on HOT (H), and you hear continuous chimes, turn the engine off immediately and call for service.

WARNING!

You or others can be badly burned by hot engine coolant (antifreeze) or steam from your radiator. If you see or hear steam coming from under the hood, do not open the hood until the radiator has had time to cool. Never try to open a cooling system pressure cap when the radiator or coolant bottle is hot.

JACKING AND TIRE CHANGING**WARNING!**

- Do not attempt to change a tire on the side of the vehicle close to moving traffic. Pull far enough off the road to avoid the danger of being hit when operating the jack or changing the wheel.

(Continued)

WARNING! (Continued)

- Being under a jacked-up vehicle is dangerous. The vehicle could slip off the jack and fall on you. You could be crushed. Never put any part of your body under a vehicle that is on a jack.
- Never start or run the engine while the vehicle is on a jack. If you need to get under a raised vehicle, take it to a service center where it can be raised on a lift.
- The jack is designed to be used as a tool for changing tires only. The jack should not be used to lift the vehicle for service purposes. The vehicle should be jacked on a firm level surface only. Avoid ice or slippery areas.

Jack Location

The scissor-type jack and tire changing tools are located in rear cargo area, below the load floor.

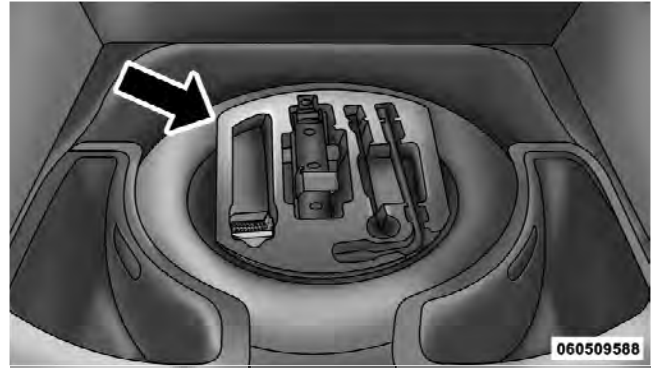

Jack Storage Location

Spare Tire Stowage

The spare tire is stowed under the load floor in the rear cargo area and is secured to the body with a special wing nut.

Preparations For Jacking

1. Park the vehicle on a firm, level surface. Avoid ice or slippery surfaces.

WARNING!

Do not attempt to change a tire on the side of the vehicle closest to moving traffic, pull far enough off the road to avoid being hit when operating the jack or changing the wheel.

2. Turn on the Hazard Warning flasher.
3. Set the parking brake.
4. Place the shift lever into PARK.
5. Turn the ignition OFF.



6. Block both the front and rear of the wheel diagonally opposite of the jacking position. For example, if changing the right front tire, block the left rear wheel.

NOTE: Passengers should not remain in the vehicle when the vehicle is being jacked.

7. For vehicle equipped with Quadra-Lift® refer to “Quadra-Lift — If Equipped” in “Starting and Operating” for further information on disabling automatic leveling.

Jacking Instructions

WARNING!

Carefully follow these tire changing warnings to help prevent personal injury or damage to your vehicle:

- Always park on a firm, level surface as far from the edge of the roadway as possible before raising the vehicle.
- Turn on the Hazard Warning flasher.
- Block the wheel diagonally opposite the wheel to be raised.
- Set the parking brake firmly and set an automatic transmission in PARK.
- Never start or run the engine with the vehicle on a jack.

(Continued)

WARNING! (Continued)

- Do not let anyone sit in the vehicle when it is on a jack.
- Do not get under the vehicle when it is on a jack.
- Only use the jack in the positions indicated and for lifting this vehicle during a tire change.
- If working on or near a roadway, be extremely careful of motor traffic.
- To assure that spare tires, flat or inflated, are securely stowed, spares must be stowed with the valve stem facing the ground.



Jack Warning Label

CAUTION!

Do not attempt to raise the vehicle by jacking on locations other than those indicated in the Jacking Instructions for this vehicle.

1. Remove the spare tire, jack, and tools from storage.
2. Loosen (but do not remove) the wheel lug nuts by turning them to the left, one turn, while the wheel is still on the ground.
3. Assemble the jack and jacking tools.



Jack and Tool Assembly

CAUTION!

Do not attempt to raise vehicle by jacking on locations other than those indicated in the Jacking Instructions for this vehicle.

4. For the front axle, place the jack and protective cap on the body flange just behind the front tire as indicated by the triangular lift point symbol on the sill molding. **Do not raise the vehicle until you are sure the jack is fully engaged.**

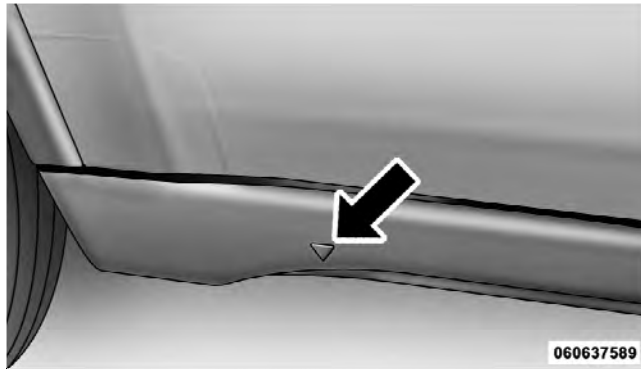

Lift Point Symbol On Sill Molding

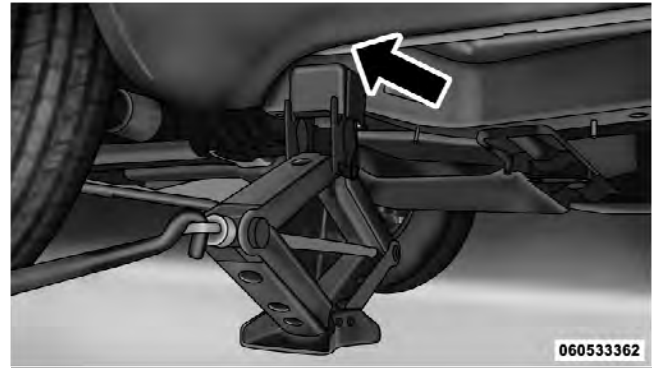

Front Jacking Location

5. For a rear tire, place the jack and protective cap in the slot on the rear tie-down bracket, just forward of the rear tire (as indicated by the triangular lift point symbol on the sill molding). **Do not raise the vehicle until you are sure the jack is fully engaged.**

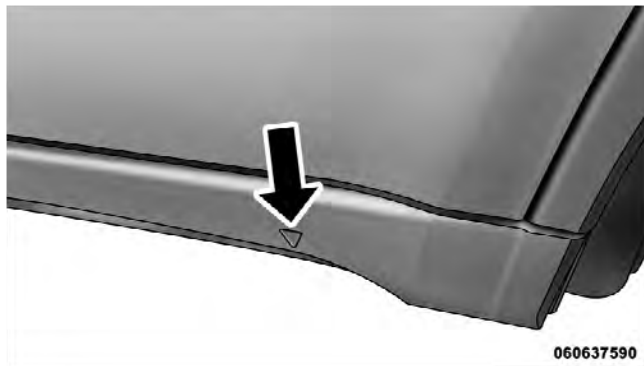

060637590

Lift Point Symbol On Sill Molding



060533363

Rear Jacking Location

6. Raise the vehicle by turning the jack screw clockwise. Raise the vehicle only until the tire just clears the surface and enough clearance is obtained to install the spare tire. Minimum tire lift provides maximum stability.

WARNING!

Raising the vehicle higher than necessary can make the vehicle less stable. It could slip off the jack and hurt someone near it. Raise the vehicle only enough to remove the tire.

7. Remove the lug nuts and wheel.
8. Position the spare wheel/tire on the vehicle and install the lug nuts with the cone-shaped end toward the wheel. Lightly tighten the nuts.

WARNING!

To avoid the risk of forcing the vehicle off the jack, do not tighten the wheel nuts fully until the vehicle has been lowered.

9. Lower the vehicle by turning the jack screw counter-clockwise, and remove the jack and wheel blocks.
10. Finish tightening the lug nuts. Push down on the wrench while tightening for increased leverage. Alternate nuts until each nut has been tightened twice. The correct wheel nut tightness is 110 ft lbs (150 N·m). If in doubt about the correct tightness, have them checked with a torque wrench by your authorized dealer or at a service station.
11. Lower the jack to the fully closed position and return it and the tools to the proper positions in the foam tray.

12. Securely store the road wheel and jack in the cargo area.



Stowed Spare

13. Have the aluminum road wheel and tire repaired as soon as possible, properly secure the spare tire with the

special wing nut torqued to 3.7 ft-lbs (5 N·m), reinstall the jack and tool kit foam tray, and latch the rear load floor cover.

WARNING!

A loose tire or jack, thrown forward in a collision or hard stop could endanger the occupants of the vehicle. Always stow the jack parts and the spare tire in the places provided. Have the deflated (flat) tire repaired or replaced immediately.

JUMP-STARTING

If your vehicle has a discharged battery it can be jump-started using a set of jumper cables and a battery in another vehicle or by using a portable battery booster pack. Jump-starting can be dangerous if done improperly so please follow the procedures in this section carefully.

NOTE: When using a portable battery booster pack follow the manufacturer's operating instructions and precautions.

CAUTION!

Do not use a portable battery booster pack or any other booster source with a system voltage greater than 12 Volts or damage to the battery, starter motor, alternator or electrical system may occur.

WARNING!

Do not attempt jump-starting if the battery is frozen. It could rupture or explode and cause personal injury.

Preparations For Jump-Start

The battery in your vehicle is located under the passenger's front seat. There are remote locations located under the hood to assist in jump-starting.

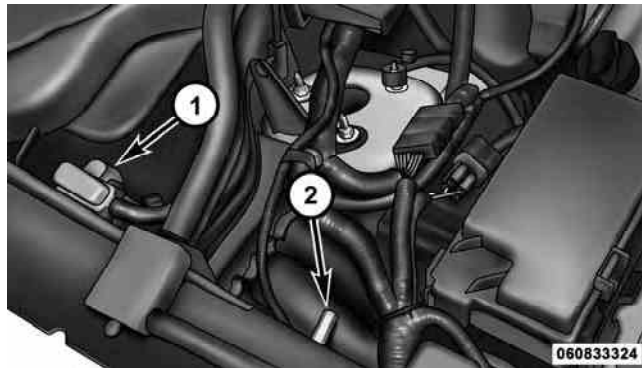
**Remote Battery Posts**

- 1 — Remote Positive (+) Post (covered with protective cap)
- 2 — Remote Negative (-) Post

WARNING!

- Take care to avoid the radiator cooling fan whenever the hood is raised. It can start anytime the ignition switch is on. You can be injured by moving fan blades.
- Remove any metal jewelry such as watch bands or bracelets that might make an inadvertent electrical contact. You could be seriously injured.
- Batteries contain sulfuric acid that can burn your skin or eyes and generate hydrogen gas which is flammable and explosive. Keep open flames or sparks away from the battery.

1. Set the parking brake, shift the automatic transmission into PARK and turn the ignition to LOCK.
2. Turn off the heater, radio, and all unnecessary electrical accessories.

3. Remove the protective cover over the remote positive (+) battery post. Pull upward on the cover to remove it.
4. If using another vehicle to jump-start the battery, park the vehicle within the jumper cables reach, set the parking brake and make sure the ignition is OFF.

WARNING!

Do not allow vehicles to touch each other as this could establish a ground connection and personal injury could result.

Jump-Starting Procedure**WARNING!**

Failure to follow this procedure could result in personal injury or property damage due to battery explosion.

CAUTION!

Failure to follow these procedures could result in damage to the charging system of the booster vehicle or the discharged vehicle.

1. Connect the positive (+) end of the jumper cable to the remote positive (+) post of the discharged vehicle.
2. Connect the opposite end of the positive (+) jumper cable to the positive (+) post of the booster battery.
3. Connect the negative end (-) of the jumper cable to the negative (-) post of the booster battery.
4. Connect the opposite end of the negative (-) jumper cable to the remote negative (-) post of the vehicle with the discharged battery.

WARNING!

Do not connect the cable to the negative post (-) of the discharged battery. The resulting electrical spark could cause the battery to explode and could result in personal injury.

5. Start the engine in the vehicle that has the booster battery, let the engine idle a few minutes, and then start the engine in the vehicle with the discharged battery.
- Once the engine is started, remove the jumper cables in the reverse sequence:
6. Disconnect the negative (-) jumper cable from the remote negative (-) post of the discharged vehicle.
 7. Disconnect the negative end (-) of the jumper cable from the negative (-) post of the booster battery.

8. Disconnect the opposite end of the positive (+) jumper cable from the positive (+) post of the booster battery.
9. Disconnect the positive (+) end of the jumper cable from the remote positive (+) post of the discharged vehicle.
10. Reinstall the protective cover over the remote positive (+) battery post of the discharged vehicle.

If frequent jump-starting is required to start your vehicle you should have the battery and charging system inspected at your authorized dealer.

CAUTION!

Accessories that can be plugged into the vehicle power outlets draw power from the vehicle's battery, even when not in use (i.e., cellular phones, etc.). Eventually, if plugged in long enough, the vehicle's battery will discharge sufficiently to degrade battery life and/or prevent the engine from starting.

EMERGENCY TOW HOOKS — IF EQUIPPED

If your vehicle is equipped with tow hooks, there will be one in the rear and two mounted on the front of the vehicle. The rear hook will be located on the driver's side of the vehicle.

NOTE: For off-road recovery, it is recommended to use both of the front tow hooks to minimize the risk of damage to the vehicle.

WARNING!

- Chains are not recommended for freeing a stuck vehicle. Chains may break, causing serious injury or death.
- Stand clear of vehicles when pulling with tow hooks. Tow straps and chains may break, causing serious injury.

CAUTION!

Tow hooks are for emergency use only, to rescue a vehicle stranded off road. Do not use tow hooks for tow truck hookup or highway towing. You could damage your vehicle.

SHIFT LEVER OVERRIDE

If a malfunction occurs and the shift lever cannot be moved out of the PARK position, you can use the following procedure to temporarily move the shift lever:

1. Firmly set the parking brake.
2. Turn the ignition switch to the ON/RUN position without starting the engine.
3. Remove the rubber liner from the cupholder (located next to the shifter on the center console).

4. Using a screwdriver or similar tool, carefully remove the shift lever override access cover, located on the bottom of the cupholder.

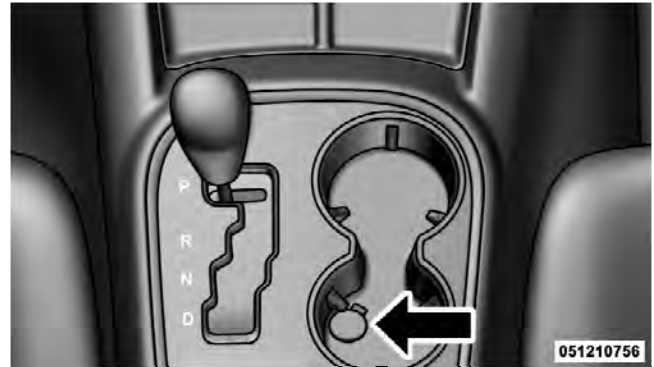

Shift Lever Override Access Cover

5. Press and maintain firm pressure on the brake pedal.
6. Using the screwdriver or similar tool, press and hold the shift lock lever down.

7. Move the shift lever into the NEUTRAL position.
8. The vehicle may then be started in NEUTRAL.
9. Reinstall the shift lever override access cover and install the rubber liner into the cupholder.

TOWING A DISABLED VEHICLE

This section describes procedures for towing a disabled vehicle using a commercial wrecker service. If the transmission and drivetrain are operable, disabled vehicles may also be towed as described under “Recreational Towing” in the “Starting and Operating” section.

NOTE: Vehicles equipped with Quadra-Lift™ must be lowered to the Park (lowest) level, and have automatic leveling disabled, before tying them down (from the body) on a trailer or flatbed truck. Refer to the section on Quadra-Lift™ for more information. If the vehicle cannot be lowered to the Park level (for example, engine will not run), tie-downs must be fastened to the axles (not to the body). Failure to follow these instructions may cause fault codes to be set and/or loss of proper tie-down tension.

Towing Condition	Wheels OFF the Ground	2WD Models	4WD Models
Flat Tow	NONE	<p><u>If transmission is operable:</u></p> <ul style="list-style-type: none"> • Trans in NEUTRAL • 30 mph max(48 km/h) • 15 miles (24 km) max distance 	<p>See instructions in “Recreational Towing” under “Starting and Operating”</p> <ul style="list-style-type: none"> • Trans in PARK • T/case in NEUTRAL • Tow in forward direction
Wheel Lift or Dolly Tow	Front		NOT ALLOWED
	Rear	OK	NOT ALLOWED
Flatbed	ALL	BEST METHOD	BEST METHOD

Proper towing or lifting equipment is required to prevent damage to your vehicle. Use only tow bars and other equipment designed for the purpose, following equipment manufacturer’s instructions. Use of safety chains is mandatory. Attach a tow bar or other towing device to

main structural members of the vehicle, not to bumpers or associated brackets. State and local laws applying to vehicles under tow must be observed.

If you must use the accessories (wipers, defrosters, etc.) while being towed, the ignition must be in the ON/RUN position, not the ACC position.

If the vehicle's battery is discharged, see Brake/Transmission Interlock Manual Override (under Starting and Operating, Automatic Transmission) for instructions on shifting the automatic transmission out of the PARK position for towing.

CAUTION!

- **Do not attempt to use sling type equipment when towing. When securing the vehicle to a flat bed truck, do not attach to front or rear suspension components. Damage to your vehicle may result from improper towing.**
- **If the vehicle being towed requires steering, the ignition must be in the ON/RUN or ACC position, not in the LOCK position.**

Towing Without the Ignition Key Fob

Special care must be taken when the vehicle is towed with the ignition in the LOCK position. The only approved method of towing without the ignition key is with a flatbed truck. Proper towing equipment is necessary to prevent damage to the vehicle.

Two-Wheel Drive Models

The manufacturer recommends towing your vehicle with all four wheels **OFF** the ground using a flatbed.

If flatbed equipment is not available, and the transmission is operable, the vehicle may be towed (with rear wheels on the ground) with the transmission in **NEUTRAL**. Speed must not exceed 30 mph (48 km/h) and the distance must not exceed 15 miles (24 km).

CAUTION!

Towing faster than 30 mph (48 km/h) or farther than 15 miles (24 km) with rear wheels on the ground can cause severe damage to the transmission. Such damage is not covered by the New Vehicle Limited Warranty.

If the transmission is not operable, or the vehicle must be towed faster than 30 mph (48 km/h) or farther than 15 miles (24 km), tow with the rear wheels **OFF** the ground. Acceptable methods are to tow the vehicle on a flatbed, or with the rear wheels raised using a wheel lift or towing dolly.

Four-Wheel Drive Vehicles

The manufacturer recommends towing with all wheels **OFF** the ground. Acceptable methods are to tow the vehicle on a flatbed or with one end of vehicle raised and the opposite end on a towing dolly.

If flatbed equipment is not available, and the transfer case is operable, the vehicle may be towed (in the forward direction, with **ALL** wheels on the ground), **IF** the transfer case is in **NEUTRAL** and the transmission is in **PARK**. Refer to "Recreational Towing" in "Starting and Operating" for further information.

CAUTION!

- **Front or rear wheel lifts should not be used. Internal damage to the transmission or transfer case will occur if a front or rear wheel lift is used when towing.**
- **Failure to follow these towing methods could result in damage to the transmission and/or transfer case. Such damage is not covered by the New Vehicle Limited Warranty.**

MAINTAINING YOUR VEHICLE

CONTENTS

■ Engine Compartment – 3.6L	483	□ Engine Oil Filter	492
■ Engine Compartment – 5.7L	484	□ Engine Air Cleaner Filter	492
■ Onboard Diagnostic System – OBD II	485	□ Maintenance-Free Battery	493
□ Loose Fuel Filler Cap Message	485	□ Air Conditioner Maintenance	495
■ Emissions Inspection And Maintenance Programs	486	□ Body Lubrication	496
■ Replacement Parts	487	□ Windshield Wiper Blades	496
■ Dealer Service	488	□ Adding Washer Fluid	498
■ Maintenance Procedures	488	□ Exhaust System	499
□ Engine Oil	489	□ Cooling System	502

- Brake System 507
- Front/Rear Axle Fluid 509
- Transfer Case 510
- Automatic Transmission 511
- Appearance Care And Protection From Corrosion 515
- Fuses 520
 - Totally Integrated Power Module 520
- Vehicle Storage 525
- Replacement Bulbs 526
- Bulb Replacement 527
 - High Intensity Discharge Headlamps (HID) – If Equipped 527
 - Halogen Headlamps – If Equipped 527
- Front Turn Signal 528
- Front Fog Lamps 528
- Rear Tail, Stop, Turn Signal, And Backup Lamps 530
- Rear Liftgate Mounted Tail Lamp 531
- Center High-Mounted Stop Lamp (CHMSL) 532
- Rear License Lamp 532
- Fluid Capacities 533
- Fluids, Lubricants, And Genuine Parts 534
 - Engine 534
 - Chassis 535

ENGINE COMPARTMENT – 3.6L

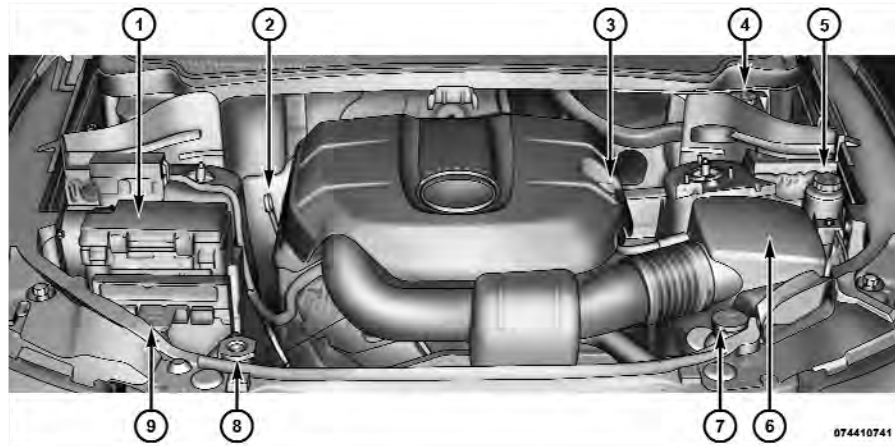

- 1 — Totally Integrated Power Module (Fuses)
- 2 — Engine Oil Dipstick
- 3 — Engine Oil Fill
- 4 — Brake Fluid Reservoir
- 5 — Power Steering Fluid Reservoir

- 6 — Air Cleaner Filter
- 7 — Washer Fluid Reservoir
- 8 — Coolant Pressure Cap (Radiator)
- 9 — Engine Coolant Reservoir

ENGINE COMPARTMENT – 5.7L

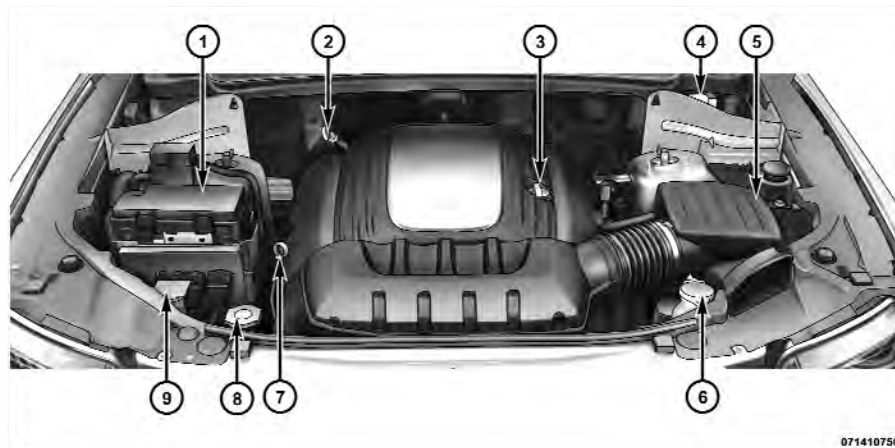

071410750

- 1 — Totally Integrated Power Module (Fuses)
- 2 — Automatic Transmission Dipstick
- 3 — Engine Oil Fill
- 4 — Brake Fluid Reservoir
- 5 — Air Cleaner Filter

- 6 — Washer Fluid Reservoir
- 7 — Engine Oil Dipstick
- 8 — Coolant Pressure Cap (Radiator)
- 9 — Engine Coolant Reservoir

ONBOARD DIAGNOSTIC SYSTEM – OBD II

Your vehicle is equipped with a sophisticated onboard diagnostic system called OBD II. This system monitors the performance of the emissions, engine, and automatic transmission control systems. When these systems are operating properly, your vehicle will provide excellent performance and fuel economy, as well as engine emissions well within current government regulations.

If any of these systems require service, the OBD II system will turn on the “Malfunction Indicator Light” (MIL). It will also store diagnostic codes and other information to assist your service technician in making repairs. Although your vehicle will usually be drivable and not need towing, see your authorized dealer for service as soon as possible.

CAUTION!

- **Prolonged driving with the MIL on could cause further damage to the emission control system. It could also affect fuel economy and drivability. The vehicle must be serviced before any emissions tests can be performed.**
- **If the MIL is flashing while the engine is running, severe catalytic converter damage and power loss will soon occur. Immediate service is required.**

Loose Fuel Filler Cap Message



If the vehicle diagnostic system determines that the fuel filler cap is loose, improperly installed, or damaged, a loose gascap indicator will display in the EVIC telltale display area. Refer to “Electronic Vehicle Information Center (EVIC)” in “Understanding Your Instrument Panel” for further information. Tighten the fuel filler cap properly and press

the SELECT button to turn off the message. If the problem continues, the message will appear the next time the vehicle is started.

A loose, improperly installed, or damaged fuel filler cap may also turn on the Malfunction Indicator Light (MIL).

EMISSIONS INSPECTION AND MAINTENANCE PROGRAMS

In some localities, it may be a legal requirement to pass an inspection of your vehicle's emissions control system. Failure to pass could prevent vehicle registration.



For states that require an Inspection and Maintenance (I/M), this check verifies the "Malfunction Indicator Light (MIL)" is functioning and is not on when the engine is running, and that the OBD II system is ready for testing.

Normally, the OBD II system will be ready. The OBD II system may **not** be ready if your vehicle was recently serviced, recently had a dead battery or a battery replacement. If the OBD II system should be determined not ready for the I/M test, your vehicle may fail the test.

Your vehicle has a simple ignition key-actuated test, which you can use prior to going to the test station. To check if your vehicle's OBD II system is ready, you must do the following:

1. Turn the ignition switch to the ON position, but do not crank or start the engine.
2. If you crank or start the engine, you will have to start this test over.
3. As soon as you turn the ignition switch to the ON position, you will see the MIL symbol come on as part of a normal bulb check.

4. Approximately 15 seconds later, one of two things will happen:

a. The MIL will flash for about 10 seconds and then return to being fully illuminated until you turn OFF the ignition or start the engine. This means that your vehicle's OBD II system is **not ready** and you should **not** proceed to the I/M station.

b. The MIL will not flash at all and will remain fully illuminated until you turn OFF the ignition or start the engine. This means that your vehicle's OBD II system is **ready** and you can proceed to the I/M station.

If your OBD II system is **not ready**, you should see your authorized dealer or repair facility. If your vehicle was recently serviced or had a battery failure or replacement, you may need to do nothing more than drive your vehicle as you normally would in order for your OBD II

system to update. A recheck with the above test routine may then indicate that the system is now ready.

Regardless of whether your vehicle's OBD II system is ready or not, if the MIL is illuminated during normal vehicle operation you should have your vehicle serviced before going to the I/M station. The I/M station can fail your vehicle because the MIL is on with the engine running.

REPLACEMENT PARTS

Use of genuine MOPAR® parts for normal/scheduled maintenance and repairs is highly recommended to ensure the designed performance. Damage or failures caused by the use of non-MOPAR® parts for maintenance and repairs will not be covered by the manufacturer's warranty.

DEALER SERVICE

Your authorized dealer has the qualified service personnel, special tools, and equipment to perform all service operations in an expert manner. Service Manuals are available which include detailed service information for your vehicle. Refer to these Service Manuals before attempting any procedure yourself.

NOTE: Intentional tampering with emissions control systems may void your warranty and could result in civil penalties being assessed against you.

WARNING!

You can be badly injured working on or around a motor vehicle. Only do service work for which you have the knowledge and the proper equipment. If you have any doubt about your ability to perform a service job, take your vehicle to a competent mechanic.

MAINTENANCE PROCEDURES

The pages that follow contain the **required** maintenance services determined by the engineers who designed your vehicle.

Besides those maintenance items specified in the fixed maintenance schedule, there are other components which may require servicing or replacement in the future.

CAUTION!

- Failure to properly maintain your vehicle or perform repairs and service when necessary could result in more costly repairs, damage to other components or negatively impact vehicle performance. Immediately have potential malfunctions examined by an authorized Chrysler Group LLC dealership or qualified repair center.

(Continued)

CAUTION! (Continued)

- **Your vehicle has been built with improved fluids that protect the performance and durability of your vehicle and also allow extended maintenance intervals. Do not use chemical flushes in these components as the chemicals can damage your engine, transmission, power steering or air conditioning. Such damage is not covered by the New Vehicle Limited Warranty. If a flush is needed because of component malfunction, use only the specified fluid for the flushing procedure.**

Engine Oil**Checking Oil Level**

To assure proper engine lubrication, the engine oil must be maintained at the correct level. Check the oil level at regular intervals, such as every fuel stop. The best time to

check the engine oil level is about five minutes after a fully warmed engine is shut off, or before starting the engine after it has sat overnight.

Checking the oil while the vehicle is on level ground will improve the accuracy of the oil level readings. Maintain the oil level in the SAFE level range. Adding 1 U.S. Quart (0.95L) of oil when the level is at the bottom of the SAFE range will result in the level being at the top of the SAFE range.

CAUTION!

Overfilling or underfilling the crankcase will cause aeration or loss of oil pressure. This could damage your engine.

Change Engine Oil

The oil change indicator system will remind you that it is time to take your vehicle in for scheduled maintenance. Refer to “Maintenance Schedule” for further information.

NOTE: Under no circumstances should oil change intervals exceed 8,000 miles (13 000 km) or six months, whichever occurs first.

Engine Oil Selection

For best performance and maximum protection for all engines under all types of operating conditions, the manufacturer recommends engine oils that are API Certified and meet the requirements of Chrysler Material Standard MS-6395.

American Petroleum Institute (API) Engine Oil Identification Symbol



This symbol means that the oil has been certified by the American Petroleum Institute (API). The manufacturer only recommends API Certified engine oils.

CAUTION!

Do not use chemical flushes in your engine oil as the chemicals can damage your engine. Such damage is not covered by the New Vehicle Limited Warranty.

Engine Oil Viscosity – 3.6L Engine

SAE 5W-30 engine oil is recommended for all operating temperatures. This engine oil improves low temperature starting and vehicle fuel economy.

The engine oil filler cap also shows the recommended engine oil viscosity for your vehicle. For information on engine oil filler cap location, refer to “Engine Compartment” in “Maintaining Your Vehicle” for further information.

Lubricants, which do not have both the engine oil certification mark and the correct SAE viscosity grade number, should not be used.

Engine Oil Viscosity – 5.7L Engine

SAE 5W-20 engine oil is recommended for all operating temperatures. This engine oil improves low temperature starting and vehicle fuel economy.

The engine oil filler cap also shows the recommended engine oil viscosity for your vehicle. For information on engine oil filler cap location, refer to “Engine Compartment” in “Maintaining Your Vehicle” for further information.

NOTE: Vehicles equipped with a 5.7L engine must use SAE 5W-20 oil. Failure to do so may result in improper operation of the Multiple Displacement System (MDS). Refer to “Multi-Displacement System” in “Starting and Operating” for further information.

Lubricants, which do not have both the engine oil certification mark and the correct SAE viscosity grade number, should not be used.

Synthetic Engine Oils

You may use synthetic engine oils if the recommended oil quality requirements are met, and the recommended maintenance intervals for oil and filter changes are followed.

Materials Added to Engine Oils

Do not add any supplemental materials, other than leak detection dyes, to your engine oil. Engine oil is an engineered product and its performance may be impaired by supplemental additives.

Disposing of Used Engine Oil and Oil Filters

Care should be taken in disposing of used engine oil and oil filters from your vehicle. Used oil and oil filters, indiscriminately discarded, can present a problem to the environment. Contact your local authorized dealer, service station, or governmental agency for advice on how and where used oil and oil filters can be safely discarded in your area.

Engine Oil Filter

The engine oil filter should be replaced with a new filter at every oil change.

Engine Oil Filter Selection

The manufacturer's engines have a full-flow type disposable oil filter. Use a filter of this type for replacement. The quality of replacement filters varies considerably. Only high-quality filters should be used to assure most efficient service. MOPAR® engine oil filters are high-quality oil filters and are recommended.

Engine Air Cleaner Filter

Refer to the "Maintenance Schedule" for the proper maintenance intervals.

WARNING!

The air induction system (air cleaner, hoses, etc) can provide a measure of protection in the case of engine backfire. Do not remove the air induction system (air cleaner, hoses, etc.) unless such removal is necessary for repair or maintenance. Make sure that no one is near the engine compartment before starting the vehicle with the air induction system (air cleaner, hoses, etc.) removed. Failure to do so can result in serious personal injury.

Engine Air Cleaner Filter Selection

The quality of replacement engine air cleaner filters varies considerably. Only high quality filters should be used to assure most efficient service. MOPAR® engine air cleaner filters are a high quality filter and are recommended.

Maintenance-Free Battery

Your vehicle is equipped with a maintenance-free battery. You will never have to add water, nor is periodic maintenance required.

WARNING!

- Battery fluid is a corrosive acid solution and can burn or even blind you. Do not allow battery fluid to contact your eyes, skin, or clothing. Do not lean over a battery when attaching clamps. If acid splashes in eyes or on skin, flush the area immediately with large amounts of water. Refer to "Jump-Starting Procedures" in "What To Do In Emergencies" for further information.

(Continued)

WARNING! (Continued)

- Battery gas is flammable and explosive. Keep flame or sparks away from the battery. Do not use a booster battery or any other booster source with an output greater than 12 Volts. Do not allow cable clamps to touch each other.
- Battery posts, terminals, and related accessories contain lead and lead compounds. Wash hands after handling.

CAUTION!

- It is essential when replacing the cables on the battery that the positive cable is attached to the positive post and the negative cable is attached to the negative post. Battery posts are marked positive (+) and negative (-) and are identified on the battery case. Cable clamps should be tight on the terminal posts and free of corrosion.
- If a "fast charger" is used while the battery is in the vehicle, disconnect both vehicle battery cables before connecting the charger to the battery. Do not use a "fast charger" to provide starting voltage.

Air Conditioner Maintenance

For best possible performance, your air conditioner should be checked and serviced by an authorized dealer at the start of each warm season. This service should include cleaning of the condenser fins and a performance test. Drive belt condition should also be checked at this time.

CAUTION!

Do not use chemical flushes in your air conditioning system as the chemicals can damage your air conditioning components. Such damage is not covered by the New Vehicle Limited Warranty.

WARNING!

- Use only refrigerants and compressor lubricants approved by the manufacturer for your air conditioning system. Some unapproved refrigerants are flammable and can explode, injuring you. Other unapproved refrigerants or lubricants can cause the system to fail, requiring costly repairs. Refer to Warranty Information Book, located on the DVD, for further warranty information.
- The air conditioning system contains refrigerant under high pressure. To avoid risk of personal injury or damage to the system, adding refrigerant or any repair requiring lines to be disconnected should be done by an experienced repairman.

NOTE: Use only manufacturer approved A/C System Sealers, Stop Leak Products, Seal Conditioners, Compressor Oil, and Refrigerants.

Refrigerant Recovery and Recycling

R-134a Air Conditioning Refrigerant is a hydrofluorocarbon (HFC) that is endorsed by the Environmental Protection Agency (EPA) and is an ozone-saving product. However, the manufacturer recommends that air conditioning service be performed by authorized dealers or other service facilities using recovery and recycling equipment.

Body Lubrication

Locks and all body pivot points, including such items as seat tracks, door hinge pivot points and rollers, liftgate, tailgate, sliding doors and hood hinges, should be lubricated periodically with a lithium based grease, such as MOPAR® Spray White Lube or equivalent to assure quiet, easy operation and to protect against rust and wear. Prior to the application of any lubricant, the parts concerned should be wiped clean to remove dust and grit; after lubricating excess oil and grease should be removed. Particular attention should also be given to

hood latching components to ensure proper function. When performing other underhood services, the hood latch, release mechanism and safety catch should be cleaned and lubricated.

The external lock cylinders should be lubricated twice a year, preferably in the Fall and Spring. Apply a small amount of a high quality lubricant, such as MOPAR® Lock Cylinder Lubricant or equivalent directly into the lock cylinder.

Windshield Wiper Blades

Clean the rubber edges of the wiper blades and the windshield periodically with a sponge or soft cloth and a mild nonabrasive cleaner to remove accumulations of salt or road film.

Operation of the wipers on dry glass for long periods may cause deterioration of the wiper blades. Always use washer fluid when using the wipers to remove salt or dirt from a dry windshield.

Avoid using the wiper blades to wipe frost or ice from the windshield. Keep the blade rubber out of contact with petroleum products such as engine oil, gasoline, etc.

NOTE: Life expectancy of wiper blades varies depending on geographical area and frequency of use. Poor performance of blades may be present with chattering, marks, water lines or wet spots. If any of these conditions are present, clean the wiper blades or replace as necessary.

Rear Wiper Blade Removal/Installation

1. Lift the pivot cap on the rear wiper arm upward, this will allow the rear wiper blade to be raised off of the liftgate glass.



- 1 — Wiper Arm
2 — Pivot Cap

NOTE: The rear wiper arm cannot be raised fully upward unless the pivot cap is raised first.

2. Lift the rear wiper arm upward to raise the wiper blade off of the liftgate glass.

3. Grab the bottom of the wiper blade and rotate it forward to unsnap the blade pivot pin from the wiper blade holder.

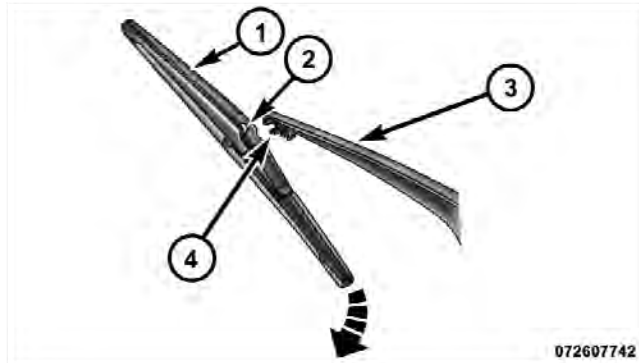

- 1 — Wiper Blade
- 2 — Blade Pivot Pin
- 3 — Wiper Arm
- 4 — Wiper Blade Holder

4. Install the wiper blade pivot pin into the wiper blade holder at the end of the wiper arm, and firmly press the wiper blade until it snaps into place.

5. Lower the wiper blade and snap the pivot cap into place.

Adding Washer Fluid

On vehicles equipped with a Electronic Vehicle Information Center (EVIC), the low washer fluid level will be indicated. When the sensor detects a low fluid level, the windshield will light on the vehicle graphic outline and the “WASHER FLUID LOW” message will be displayed.

The fluid reservoir for the windshield washers and the rear window washer is shared. The fluid reservoir is located in the engine compartment, be sure to check the fluid level at regular intervals. Fill the reservoir with windshield washer solvent only (not radiator antifreeze). When refilling the washer fluid reservoir, take some washer fluid and apply it to a cloth or towel and wipe

clean the wiper blades, this will help blade performance. To prevent freeze-up of your windshield washer system in cold weather, select a solution or mixture that meets or exceeds the temperature range of your climate. This rating information can be found on most washer fluid containers.

WARNING!

Commercially available windshield washer solvents are flammable. They could ignite and burn you. Care must be exercised when filling or working around the washer solution.

Exhaust System

The best protection against carbon monoxide entry into the vehicle body is a properly maintained engine exhaust system.

If you notice a change in the sound of the exhaust system; or if the exhaust fumes can be detected inside the vehicle; or when the underside or rear of the vehicle is damaged; have an authorized technician inspect the complete exhaust system and adjacent body areas for broken, damaged, deteriorated, or mispositioned parts. Open seams or loose connections could permit exhaust fumes to seep into the passenger compartment. In addition, inspect the exhaust system each time the vehicle is raised for lubrication or oil change. Replace as required.

WARNING!

- Exhaust gases can injure or kill. They contain carbon monoxide (CO), which is colorless and odorless. Breathing it can make you unconscious and can eventually poison you. To avoid breathing CO, refer to "Safety Tips/Exhaust Gas" in "Things To Know Before Starting Your Vehicle" for further information.
- A hot exhaust system can start a fire if you park over materials that can burn. Such materials might be grass or leaves coming into contact with your exhaust system. Do not park or operate your vehicle in areas where your exhaust system can contact anything that can burn.

CAUTION!

- The catalytic converter requires the use of unleaded fuel only. Leaded gasoline will destroy the effectiveness of the catalyst as an emissions control device and may seriously reduce engine performance and cause serious damage to the engine.
- Damage to the catalytic converter can result if your vehicle is not kept in proper operating condition. In the event of engine malfunction, particularly involving engine misfire or other apparent loss of performance, have your vehicle serviced promptly. Continued operation of your vehicle with a severe malfunction could cause the converter to overheat, resulting in possible damage to the converter and vehicle.

Under normal operating conditions, the catalytic converter will not require maintenance. However, it is important to keep the engine properly tuned to assure proper catalyst operation and prevent possible catalyst damage.

NOTE: Intentional tampering with emissions control systems can result in civil penalties being assessed against you.

In unusual situations involving grossly malfunctioning engine operation, a scorching odor may suggest severe and abnormal catalyst overheating. If this occurs, stop the vehicle, turn off the engine and allow it to cool. Service, including a tune-up to manufacturer's specifications, should be obtained immediately.

To minimize the possibility of catalytic converter damage:

- Do not shut off the engine or interrupt the ignition, when the transmission is in gear and the vehicle is in motion.
- Do not try to start the engine by pushing or towing the vehicle.
- Do not idle the engine with any spark plug wires disconnected or removed, such as when diagnostic testing, or for prolonged periods during very rough idle or malfunctioning operating conditions.

Cooling System

WARNING!

You or others can be badly burned by hot engine coolant (antifreeze) or steam from your radiator. If you see or hear steam coming from under the hood, do not open the hood until the radiator has had time to cool. Never try to open a cooling system pressure cap when the radiator or coolant bottle is hot.

Engine Coolant Checks

Check the engine coolant (antifreeze) protection every 12 months (before the onset of freezing weather, where applicable). If the engine coolant (antifreeze) is dirty or rusty in appearance, the system should be drained, flushed and refilled with fresh engine coolant (antifreeze). Check the front of the A/C condenser for any

accumulation of bugs, leaves, etc. If dirty, clean by gently spraying water from a garden hose vertically down the face of the condenser.

Check the engine cooling system hoses for brittle rubber, cracking, tears, cuts, and tightness of the connection at the coolant recovery bottle and radiator. Inspect the entire system for leaks.

With the engine at normal operating temperature (but not running), check the cooling system pressure cap for proper vacuum sealing by draining a small amount of engine coolant (antifreeze) from the radiator drain cock. If the cap is sealing properly, the engine coolant (antifreeze) will begin to drain from the coolant recovery bottle. **DO NOT REMOVE THE COOLANT PRESSURE CAP WHEN THE COOLING SYSTEM IS HOT.**

Cooling System – Drain, Flush, and Refill

If the engine coolant (antifreeze) is dirty and contains a considerable amount of sediment, clean and flush with reliable cooling system cleaner. Follow with a thorough rinsing to remove all deposits and chemicals. Properly dispose of the old engine coolant (antifreeze).

Refer to the “Maintenance Schedule” for the proper maintenance intervals.

Selection Of Coolant

Use only the manufacturer’s recommended engine coolant (antifreeze). Refer to “Fluids, Lubricants, and Genuine Parts” in “Maintaining Your Vehicle” for further information.

CAUTION!

- **Mixing of engine coolant (antifreeze), other than the specified HOAT engine coolant (antifreeze), may result in engine damage and may decrease corrosion protection. If a non-HOAT engine coolant (antifreeze) is introduced into the cooling system in an emergency, it should be replaced with the specified engine coolant (antifreeze) as soon as possible.**
- **Do not use water alone or alcohol based engine coolant (antifreeze) products. Do not use additional rust inhibitors or antirust products, as they may not be compatible with the engine coolant (antifreeze) and may plug the radiator.**

CAUTION! (Continued)

- **This vehicle has not been designed for use with Propylene Glycol-based engine coolant (antifreeze). Use of Propylene Glycol-based engine coolant (antifreeze) is not recommended.**

Adding Coolant

Your vehicle has been built with an improved engine coolant (antifreeze) that allows extended maintenance intervals. This engine coolant (antifreeze) can be used up to 5 Years or 104,000 miles (169 000 km) before replacement. To prevent reducing this extended maintenance period, it is important that you use the same engine coolant (antifreeze) throughout the life of your vehicle. Please review these recommendations for using Hybrid Organic Additive Technology (HOAT) engine coolant (antifreeze).

When adding engine coolant (antifreeze):

- The manufacturer recommends using MOPAR® Antifreeze/ Coolant 5-Year/100,000 Mile Formula HOAT (Hybrid Organic Additive Technology) or equivalent.
- Mix a minimum solution of 50% HOAT engine coolant (antifreeze) and distilled water. Use higher concentrations (not to exceed 70%) if temperatures below -34°F (-37°C) are anticipated.
- Use only high purity water such as distilled or deionized water when mixing the water/engine coolant (antifreeze) solution. The use of lower quality water will reduce the amount of corrosion protection in the engine cooling system.

Please note that it is the owner's responsibility to maintain the proper level of protection against freezing according to the temperatures occurring in the area where the vehicle is operated.

NOTE: Mixing engine coolant (antifreeze) types will decrease the life of the engine coolant (antifreeze) and will require more frequent engine coolant (antifreeze) changes.

Cooling System Pressure Cap

The cap must be fully tightened to prevent loss of engine coolant (antifreeze), and to ensure that engine coolant (antifreeze) will return to the radiator from the coolant recovery tank.

The cap should be inspected and cleaned if there is any accumulation of foreign material on the sealing surfaces.

WARNING!

- The warning words **DO NOT OPEN HOT** on the cooling system pressure cap are a safety precaution. Never add engine coolant (antifreeze) when the engine is overheated. Do not loosen or remove the cap to cool an overheated engine. Heat causes pressure to build up in the cooling system. To prevent scalding or injury, do not remove the pressure cap while the system is hot or under pressure.
- Do not use a pressure cap other than the one specified for your vehicle. Personal injury or engine damage may result.

Disposal of Used Engine Coolant

Used ethylene glycol-based engine coolant (antifreeze) is a regulated substance requiring proper disposal. Check with your local authorities to determine the disposal rules for your community. To prevent ingestion by animals and children, do not store ethylene glycol-based engine coolant (antifreeze) in open containers or allow it to remain in puddles on the ground. If ingested by a child or pet, seek emergency assistance immediately. Clean up any ground spills immediately.

Coolant Level

The coolant bottle provides a quick visual method for determining that the engine coolant (antifreeze) level is adequate. With the engine idling, and warm to normal operating temperature, the level of the engine coolant (antifreeze) in the bottle should be between the ranges indicated on the bottle.

The radiator normally remains completely full, so there is no need to remove the radiator cap, unless checking for engine coolant (antifreeze) freeze point or replacing engine coolant (antifreeze). Advise your service attendant of this. As long as the engine operating temperature is satisfactory, the coolant bottle need only be checked once a month.

When additional engine coolant (antifreeze) is needed to maintain the proper level, it should be added to the coolant bottle. Do not overfill.

Points To Remember

NOTE: When the vehicle is stopped after a few miles (kilometers) of operation, you may observe vapor coming from the front of the engine compartment. This is normally a result of moisture from rain, snow, or high humidity accumulating on the radiator and being vaporized when the thermostat opens, allowing hot engine coolant (antifreeze) to enter the radiator.

If an examination of your engine compartment shows no evidence of radiator or hose leaks, the vehicle may be safely driven. The vapor will soon dissipate.

- Do not overfill the coolant recovery bottle.
- Check engine coolant (antifreeze) freeze point in the radiator and in the coolant recovery bottle. If engine coolant (antifreeze) needs to be added, contents of coolant recovery bottle must also be protected against freezing.
- If frequent engine coolant (antifreeze) additions are required, or if the level in the coolant recovery bottle does not drop when the engine cools, the cooling system should be pressure tested for leaks.
- Maintain engine coolant (antifreeze) concentration at 50% HOAT engine coolant (antifreeze) (minimum) and distilled water for proper corrosion protection of your engine, which contains aluminum components.

- Make sure that the radiator and coolant recovery bottle hoses are not kinked or obstructed.
- Keep the front of the radiator clean. If your vehicle is equipped with air conditioning, keep the front of the condenser clean.
- Do not change the thermostat for Summer or Winter operation. If replacement is ever necessary, install **ONLY** the correct type thermostat. Other designs may result in unsatisfactory cooling performance, poor gas mileage, and increased emissions.

Brake System

In order to assure brake system performance, all brake system components should be periodically inspected. Refer to the "Maintenance Schedule" for the proper maintenance intervals.

WARNING!

Riding the brakes can lead to brake failure and possibly a collision. Driving with your foot resting or riding on the brake pedal can result in abnormally high brake temperatures, excessive lining wear, and possible brake damage. You would not have your full braking capacity in an emergency.

Fluid Level Check – Brake Master Cylinder

The fluid level of the master cylinder should be checked when performing under the hood service, or immediately if the brake system warning lamp indicates system failure.

The brake master cylinder has a plastic reservoir. On the outboard side of the reservoir, there is a “MAX” dot and a “MIN” dot. The fluid level must be kept within these two dots. Do not add fluid above the MAX mark, because leakage may occur at the cap.

With disc brakes, the fluid level can be expected to fall as the brake linings wear. However, an unexpected drop in fluid level may be caused by a leak and a system check should be conducted.

Refer to “Fluids, Lubricants, and Genuine Parts” in “Maintaining Your Vehicle” for further information.

WARNING!

- **Use only manufacturer’s recommended brake fluid. Refer to “Fluids, Lubricants, and Genuine Parts” in “Maintaining Your Vehicle” for further information. Using the wrong type of brake fluid can severely damage your brake system and/or impair its performance. The proper type of brake fluid for your vehicle is also identified on the original factory installed hydraulic master cylinder reservoir.**

(Continued)

WARNING! (Continued)

- To avoid contamination from foreign matter or moisture, use only new brake fluid or fluid that has been in a tightly closed container. Keep the master cylinder reservoir cap secured at all times. Brake fluid in an open container absorbs moisture from the air resulting in a lower boiling point. This may cause it to boil unexpectedly during hard or prolonged braking, resulting in sudden brake failure. This could result in a collision.
- Overfilling the brake fluid reservoir can result in spilling brake fluid on hot engine parts, causing the brake fluid to catch fire. Brake fluid can also damage painted and vinyl surfaces, care should be taken to avoid its contact with these surfaces.

(Continued)

WARNING! (Continued)

- Do not allow petroleum based fluid to contaminate the brake fluid. Brake seal components could be damaged, causing partial or complete brake failure. This could result in a collision.

Front/Rear Axle Fluid

For normal service, periodic fluid level checks are not required. When the vehicle is serviced for other reasons the exterior surfaces of the axle assembly should be inspected. If gear oil leakage is suspected inspect the fluid level. Refer to "Fluids, Lubricants, and Genuine Parts" in "Maintaining Your Vehicle" for further information.

Front Axle Fluid Level Check

The front axle oil level needs to be between 1/8 in (3 mm) below the bottom of the fill hole and the bottom of the fill hole.

The front axle fill and drain plugs should be tightened to 22 to 29 ft lbs (30 to 40 N·m).

CAUTION!

Do not over tighten the plugs as it could damage them and cause them to leak.

Rear Axle Fluid Level Check

The rear axle oil level needs to be between 1/8 in (3 mm) below the bottom of the fill hole and the bottom of the fill hole.

The rear axle fill and drain plugs should be tightened to 22 to 29 ft lbs (30 to 40 N·m) on axles with aluminum housings. The rear axle fill and drain plugs should be tightened to 22 to 52 ft lbs (30 to 70 N·m) on axles with cast iron housings.

CAUTION!

Do not over tighten the plugs as it could damage them and cause them to leak.

Selection of Lubricant

Use only the manufacturer's recommended fluid. Refer to "Fluids, Lubricants, and Genuine Parts" in "Maintaining Your Vehicle" for further information.

Transfer Case**Fluid Level Check**

Inspect the transfer case for fluid leaks. If a fluid leak is found, the transfer case fluid level can be checked by removing the filler plug located on the back side of the transfer case. The fluid level should be at the bottom edge of the filler plug hole when the vehicle is in a level position.

Adding Fluid

Add fluid at the filler hole, until it runs out of the hole, when the vehicle is in a level position.

Drain

First remove fill plug, then remove drain plug. Recommended tightening torque for drain and fill plugs is 15 to 25 ft lbs (20 to 34 N·m).

CAUTION!

When installing plugs, do not overtighten. You could damage them and cause them to leak.

Selection of Lubricant

Use only the manufacturer's recommended fluid. Refer to "Fluids, Lubricants, and Genuine Parts" in "Maintaining Your Vehicle" for further information.

Automatic Transmission

Selection of Lubricant

It is important that the proper lubricant is used in the transmission to assure optimum transmission performance. Use only the manufacturer's recommended transmission fluid. Refer to "Fluids, Lubricants, and Genuine Parts" in "Maintaining Your Vehicle" for further information. It is important that the transmission fluid be maintained at the prescribed level using the recommended fluid.

CAUTION!

Using a transmission fluid other than the manufacturer's recommended fluid may cause deterioration in transmission shift quality and/or torque converter shudder. Using a transmission fluid other than the manufacturer's recommended fluid will result in more frequent fluid and filter changes. Refer to "Fluids, Lubricants, and Genuine Parts" in "Maintaining Your Vehicle" for further information.

Special Additives

Automatic Transmission Fluid (ATF) is an engineered product and its performance may be impaired by supplemental additives. Therefore, do not add any fluid additives to the transmission. The only exception to this policy is the use of special dyes to aid in detecting fluid leaks. In addition, avoid using transmission sealers as they may adversely affect seals.

CAUTION!

Do not use chemical flushes in your transmission as the chemicals can damage your transmission components. Such damage is not covered by the New Vehicle Limited Warranty.

Fluid Level Check – 3.6L Engine

Regular fluid level checks are not required. For this reason, the dipstick is omitted.

If you notice fluid loss or transmission slippage or malfunction, have your authorized dealer check the transmission fluid level.

CAUTION!

- Using a transmission fluid other than the manufacturer's recommended fluid may cause deterioration in transmission shift quality and/or torque converter shudder. Using a transmission fluid other than that recommended by the manufacturer will result in more frequent fluid and filter changes. Refer to "Fluids, Lubricants, and Genuine Parts" in "Maintaining Your Vehicle" for further information.
- The fluid level is preset at the factory and it does not require adjustment under normal operating conditions. If a transmission fluid leak occurs, visit your authorized dealer immediately. Severe damage to the transmission may occur. Your authorized dealer has the proper tools to adjust the fluid level accurately.

Fluid Level Check – 5.7L Engine

Check the fluid level while the transmission is at normal operating temperature. This occurs after at least 15 miles (25 km) of driving. At normal operating temperature the fluid cannot be held comfortably between the fingertips.

To check the fluid level properly, the following procedure must be used:

1. Operate the engine at idle speed and normal operating temperature.
2. The vehicle must be on level ground.
3. Fully apply the parking brake, and press the brake pedal.
4. Place the shift lever momentarily in each gear position ending with the shift lever in PARK.
5. Remove the dipstick, wipe it clean and reinsert it until seated.

6. Remove the dipstick again, and note the fluid level on both sides. The fluid level should be between the "HOT" (upper) reference holes on the dipstick at normal operating temperature. The fluid level is only valid if there is a solid coating of oil on both sides of the dipstick. If the fluid is low, add as required into the dipstick tube. **Do not overfill.** After adding any quantity of oil through the oil fill tube, wait a minimum of two minutes for the oil to fully drain into the transmission before rechecking the fluid level.

NOTE: If it is necessary to check the transmission **below** the operating temperature, the fluid level should be between the two "COLD" (lower) holes on the dipstick with the fluid at approximately 70°F (21°C) (room temperature). If the fluid level is correctly established at room temperature, it should be between the "HOT" (upper) reference holes when the transmission reaches 180°F (82°C). Remember it is best to check the level at the normal operating temperature.

CAUTION!

Be aware that if the fluid temperature is below 50°F (10°C) it may not register on the dipstick. Do not add fluid until the temperature is elevated enough to produce an accurate reading.

7. Check for leaks. Release parking brake.

To prevent dirt and water from entering the transmission after checking or replenishing fluid, make certain that the dipstick cap is properly reseated. It is normal for the dipstick cap to spring back slightly from its fully seated position, as long as its seal remains engaged in the dipstick tube.

Appearance Care and Protection from Corrosion

Protection of Body and Paint from Corrosion

Vehicle body care requirements vary according to geographic locations and usage. Chemicals that make roads passable in snow and ice, and those that are sprayed on trees and road surfaces during other seasons, are highly corrosive to the metal in your vehicle.

The following maintenance recommendations will enable you to obtain maximum benefit from the corrosion resistance built into your vehicle.

What Causes Corrosion?

Corrosion is the result of deterioration or removal of paint and protective coatings from your vehicle.

The most common causes are:

- Road salt, dirt and moisture accumulation.
- Stone and gravel impact.

- Insects, tree sap and tar.
- Salt in the air near seacoast localities.
- Atmospheric fallout/industrial pollutants.

Washing

- Wash your vehicle regularly. Always wash your vehicle in the shade using MOPAR® Car Wash or a mild car wash soap, and rinse the panels completely with clear water.
- If insects, tar, or other similar deposits have accumulated on your vehicle, use MOPAR® Super Kleen Bug and Tar Remover or equivalent to remove.
- Use a high quality cleaner wax, such as MOPAR® Cleaner Wax to remove road film, stains, and to protect your paint finish. Take care never to scratch the paint.

- Avoid using abrasive compounds and power buffing that may diminish the gloss or thin out the paint finish.

CAUTION!

- **Do not use abrasive or strong cleaning materials such as steel wool or scouring powder, which will scratch metal and painted surfaces.**
- **Use of power washers exceeding 1,200 psi (8 274 kPa) can result in damage or removal of paint and decals.**

Special Care

- If you drive on salted or dusty roads or if you drive near the ocean, hose off the undercarriage at least once a month.

- It is important that the drain holes in the lower edges of the doors, rocker panels and tailgate must be kept clear and open.
- If you detect any stone chips or scratches in the paint, touch them up immediately. The cost of such repairs is considered the responsibility of the owner.
- If your vehicle is damaged due to a collision or similar cause which destroys the paint and protective coating, have your vehicle repaired as soon as possible. The cost of such repairs is considered the responsibility of the owner.
- If you carry special cargo such as chemicals, fertilizers, de-icer salt, etc., assure that such materials are well packaged and sealed.
- If a lot of driving is done on gravel roads, consider mud or stone shields behind each wheel.

- Use MOPAR® Touch Up Paint or equivalent on scratches or chips as soon as possible. Your authorized dealer has touch up paint to match the color of your vehicle.

Wheel and Wheel Trim Care

All wheels and wheel trim, especially aluminum and chrome-plated wheels should be cleaned regularly with a mild soap and water to prevent corrosion. To remove heavy soil, use MOPAR® Wheel Cleaner or select a nonabrasive, non-acidic cleaner. Do not use scouring pads, steel wool, a bristle brush or metal polishes. Only MOPAR® cleaners or equivalent are recommended. Do not use oven cleaner. Avoid automatic car washes that use acidic solutions or harsh brushes that may damage the wheels' protective finish.

Stain Repel Fabric Cleaning Procedure – If Equipped

Stain Repel seats may be cleaned in the following manner:

- Remove as much of the stain as possible by blotting with a clean, dry towel.
- Blot any remaining stain with a clean, damp towel.
- For tough stains, apply MOPAR® Total Clean or a mild soap solution to a clean, damp cloth and remove the stain. Use a fresh, damp towel to remove soap residue.
- For grease stains, apply MOPAR® Multi-Purpose Cleaner or equivalent to a clean, damp cloth and remove the stain. Use a fresh, damp towel to remove soap residue.
- Do not use any harsh solvents or any other form of protectants on Stain Repel products.

Interior Care

Use MOPAR® Total Clean or equivalent to clean fabric upholstery and carpeting.

Interior Trim should be cleaned starting with a damp cloth, a damp cloth with MOPAR® Total Clean or equivalent, then MOPAR® Spot & Stain Remover or equivalent, if absolutely necessary. Do not use harsh cleaners or Armor All®. Use MOPAR® Total Clean or equivalent to clean vinyl upholstery.

Leather Seat Care And Cleaning

MOPAR® Total Clean or equivalent is specifically recommended for leather upholstery.

Your leather upholstery can be best preserved by regular cleaning with a damp soft cloth. Small particles of dirt can act as an abrasive and damage the leather upholstery and should be removed promptly with a damp cloth. Stubborn soils can be removed easily with a soft cloth and MOPAR® Total Clean or equivalent. Care should be

taken to avoid soaking your leather upholstery with any liquid. Please do not use polishes, oils, cleaning fluids, solvents, detergents, or ammonia-based cleaners to clean your leather upholstery. Application of a leather conditioner is not required to maintain the original condition.

WARNING!

Do not use volatile solvents for cleaning purposes. Many are potentially flammable, and if used in closed areas, they may cause respiratory harm.

Cleaning Headlights

Your vehicle has plastic headlights that are lighter and less susceptible to stone breakage than glass headlights.

Plastic is not as scratch-resistant as glass and therefore different lens cleaning procedures must be followed.

To minimize the possibility of scratching the lenses and reducing light output, avoid wiping with a dry cloth. To remove road dirt, wash with a mild soap solution followed by rinsing.

Do not use abrasive cleaning components, solvents, steel wool or other aggressive material to clean the lenses.

Glass Surfaces

All glass surfaces should be cleaned on a regular basis with MOPAR® Glass Cleaner or any commercial household-type glass cleaner. Never use an abrasive type cleaner. Use caution when cleaning inside rear windows equipped with electric defrosters. Do not use scrapers or other sharp instruments which may scratch the elements.

When cleaning the rearview mirror, spray cleaner on the towel or rag that you are using. Do not spray cleaner directly on the mirror.

Cleaning Plastic Instrument Cluster Lenses

The lenses in front of the instruments in this vehicle are molded in clear plastic. When cleaning the lenses, care must be taken to avoid scratching the plastic.

1. Clean with a wet soft rag. A mild soap solution may be used, but do not use high alcohol content or abrasive cleaners. If soap is used, wipe clean with a clean damp rag.
2. Dry with a soft cloth.

Seat Belt Maintenance

Do not bleach, dye or clean the belts with chemical solvents or abrasive cleaners. This will weaken the fabric. Sun damage will also weaken the fabric.

If the belts need cleaning, use MOPAR® Total Clean, a mild soap solution, or lukewarm water. Do not remove the belts from the vehicle to wash them. Dry with a soft cloth.

Replace the belts if they appear frayed or worn or if the buckles do not work properly.

FUSES

Totally Integrated Power Module

The Totally Integrated Power Module is located in the engine compartment. This center contains cartridge fuses and mini fuses. A description of each fuse and component may be stamped on the inside cover, otherwise the cavity number of each fuse is stamped on the inside cover that corresponds to the following chart.



Totally Integrated Power Module

Cavity	Cartridge Fuse	Mini Fuse	Description
J01	40 Amp Green		Air Suspension
J02	30 Amp Pink		Power Liftgate Module

Cavity	Cartridge Fuse	Mini Fuse	Description
J03	30 Amp Pink		Trailer Tow
J04	25 Amp Natural		Driver Door Node
J05	25 Amp Natural		Passenger Door Node
J06	40 Amp Green		Antilock Brakes Pump/Stability Control System
J07	30 Amp Pink		Antilock Brakes Valve/Stability Control System
J08	40 Amp Green		Power Seat
J09	30 Amp Pink		E-Brake

Cavity	Cartridge Fuse	Mini Fuse	Description
J10	30 Amp Pink		Headlamp Wash Relay Contact
J11	30 Amp Pink		Drive Train Control Module
J12	30 Amp Pink		Rear Defroster
J13	60 Amp Yellow		Main Ignition Off Draw (IOD)
J14	20 Amp Blue		Trailer Tow Lamps/Park Lamps
J15	40 Amp Green		Front Cabin Fan/Blower
J17	40 Amp Green		Starter Motor Solenoid

Cavity	Cartridge Fuse	Mini Fuse	Description
J18	20 Amp Blue		Powertrain Control Module/Powertrain Control Module Transmission Range
J19	60 Amp Yellow		Radiator Fan Motor HI/Radiator Fan Motor Low
J20	30 Amp Pink		Front Wiper
J21	20 Amp Blue		Front/Rear Washer Control
J22	25 Amp Natural		Sunroof Module
M1		15 Amp Blue	Stop Lamps

Cavity	Cartridge Fuse	Mini Fuse	Description
M2		20 Amp Yellow	Electronic Limit Slip Differential/Air Suspension
M3		20 Amp Yellow	Liftgate/Headrest
M5		25 Amp Natural	115V AC Power Inverter
M6		20 Amp Yellow	Cigar Lighter
M7		20 Amp Yellow	Power Outlet #2 (Switchable)
M8		20 Amp Yellow	Front Heated Seat & Steering Wheel
M9		20 Amp Yellow	Rear Heated Seats
M10		15 Amp Blue	Video/Universal Garage Door Opener

Cavity	Cartridge Fuse	Mini Fuse	Description
M11		10 Amp Red	Heating, Ventilation & Air Conditioning (Climate Control System)
M12		30 Amp Green	Radio/Amplifier
M13		20 Amp Yellow	Instrument Cluster
M14		20 Amp Yellow	Back Up Camera
M15		20 Amp Yellow	Power Seat Module(s)/Adaptive Cruise Control/Audio Telematics/Daytime Running Lights Relay/Air Suspension Module/Instrument Cluster

Cavity	Cartridge Fuse	Mini Fuse	Description
M16		10 Amp Red	Occupant Restraint Controller
M19		25 Amp Natural	Automatic Shutdown 1 and 2
M20		15 Amp Blue	Instrument Cluster
M21		20 Amp Yellow	Automatic Shutdown 3
M22		10 Amp Red	Horns (Low/High) – Right
M23		10 Amp Red	Horns (Low/High) – Left
M24		25 Amp Natural	Rear Wiper
M25		20 Amp Yellow	Fuel Pump Motor Output/Diesel Lift Pump (Export Only)

Cavity	Cartridge Fuse	Mini Fuse	Description
M26		10 Amp Red	Driver Door Switch Bank
M27		10 Amp Red	Ignition Switch/ Wireless Control Module/Keyless Entry Module
M28		15 Amp Blue	Powertrain Controller/ Transmission Controller
M29		10 Amp Red	Tire Pressure Monitor
M30		15 Amp Blue	J1962 Diag Connector
M31		20 Amp Yellow	Backup Lamps
M32		10 Amp Red	Occupant Restraint Controller

Cavity	Cartridge Fuse	Mini Fuse	Description
M33		10 Amp Red	Powertrain Controller/ Transmission Controller
M34		10 Amp Red	Park Assist Module/ Climate Control System Module/Infra Red Sensor/Compass Module
M35		15 Amp Blue	Left Rear Parklamps
M36		20 Amp Yellow	Power Outlet
M37		10 Amp Red	Antilock Brakes/ Stability Control System Module
M38		25 Amp Natural	All Door Lock &Unlock

CAUTION!

- When installing the totally integrated power module cover, it is important to ensure the cover is properly positioned and fully latched. Failure to do so may allow water to get into the totally integrated power module and possibly result in an electrical system failure.
- When replacing a blown fuse, it is important to use only a fuse having the correct amperage rating. The use of a fuse with a rating other than indicated may result in a dangerous electrical system overload. If a properly rated fuse continues to blow, it indicates a problem in the circuit that must be corrected.

VEHICLE STORAGE

If you are leaving your vehicle dormant for more than 21 days you may want to take steps to protect your battery. You may:

- Remove fuse #27 in the Totally Integrated Power Module (TIPM) labeled Ignition-Off Draw (IOD#1).
- Or, disconnect the negative cable from the battery.
- Anytime you store your vehicle, or keep it out of service (i.e. vacation) for two weeks or more, run the air conditioning system at idle for about five minutes in the fresh air and high blower setting. This will ensure adequate system lubrication to minimize the possibility of compressor damage when the system is started again.

REPLACEMENT BULBS

Interior Lights

	Bulb Type
Glove Box Lamp	194
Grab Handle Lamp	L002825W5W
Overhead Console Reading Lamps	VT4976
Rear Cargo Lamp	214-2
Visor Vanity Lamp	V26377
Underpanel Courtesy Lamps	906
Instrument Cluster (General Illumination)	103
Telltale/Hazard Lamp	74

Exterior Lights

	Bulb Type
Aux Aperture Backup Lamps	7440 (W21W)
Auxiliary Liftgate Tail Lamps	W3W
Front Park/Turn Lamp	T20
Front Fog Lamps	PSX24W
Front Side Marker	W5W
Headlamps (Low Beam) – High Intensity Discharge (HID)	D1S (Serviced at Authorized Dealer)
Daytime Running Lamp (DRL)	3157K
Headlamps (Low Beam)	H11
Headlamps (High Beam)	9005
Liftgate Backup Lamps	921 (W16W)
Rear License Lamps	W5W
Rear Turn/Stop/Tail Lamps	3057

NOTE: Numbers refer to commercial bulb types that can be purchased from your authorized dealer.

If a bulb needs to be replaced, visit your authorized dealer or refer to the applicable Service Manual.

BULB REPLACEMENT

High Intensity Discharge Headlamps (HID) – If Equipped

The headlamps are a type of high voltage discharge tube. High voltage can remain in the circuit even with the headlamp switch off and the key removed. **Because of this, you should not attempt to service a headlamp bulb yourself. If a headlamp bulb fails, take your vehicle to an authorized dealer for service.**

WARNING!

A transient high tension occurs at the bulb sockets of High Intensity Discharge (HID) headlamps when the headlamp switch is turned ON. It may cause serious electrical shock or electrocution if not serviced properly. See your authorized dealer for service.

NOTE: On vehicles equipped with High Intensity Discharge (HID) headlamps, when the headlamps are turned on, there is a blue hue to the lamps. This diminishes and becomes more white after approximately 10 seconds, as the system charges.

Halogen Headlamps – If Equipped

1. Open the hood.
2. Turn the low or high beam bulb one-quarter turn counterclockwise to remove from housing.
3. Disconnect the electrical connector and replace the bulb.

CAUTION!

Do not touch the new bulb with your fingers. Oil contamination will severely shorten bulb life. If the bulb comes in contact with any oily surface, clean the bulb with rubbing alcohol.

Front Turn Signal

1. Open the hood.
2. Turn the turn signal bulb one-quarter turn counterclockwise to remove from housing.
3. Disconnect the electrical connector and replace the bulb.

CAUTION!

Do not touch the new bulb with your fingers. Oil contamination will severely shorten bulb life. If the bulb comes in contact with any oily surface, clean the bulb with rubbing alcohol.

Front Fog Lamps

1. Reach through the cutout in the splash shield and disconnect the wiring harness from the fog lamp connector.
2. Firmly grasp the bulb by the two latches and squeeze them together to unlock the bulb from the back of the front fog lamp housing.
3. Pull the bulb straight out from the keyed opening in the housing.

CAUTION!

- **Do not touch the new bulb with your fingers. Oil contamination will severely shorten bulb life. If the bulb comes in contact with any oily surface, clean the bulb with rubbing alcohol.**
- **Always use the correct bulb size and type for replacement. An incorrect bulb size or type may overheat and cause damage to the lamp, the socket or the lamp wiring.**

4. Align the index tabs of the front fog lamp bulb with the slots in the collar of the bulb opening on the back of the front fog lamp housing.

5. Insert the bulb into the housing until the index tabs are engaged in the slots of the collar.
6. Firmly and evenly push the bulb straight into the lamp housing until both tabs snap firmly into place and are fully engaged.
7. Connect the wiring harness to the front fog lamp connector.

Rear Tail, Stop, Turn Signal, And Backup Lamps

1. Raise the liftgate.
2. Remove the two push-pins from the tail lamp housing.



073310728

3. Grasp the tail lamp and pull firmly rearward to disengage the lamp from the aperture panel.
4. Twist socket counter clockwise and remove from lamp.
5. Pull the bulb to remove it from the socket.
6. Replace the bulb, reinstall the socket, and reattach the lamp assembly.

Rear Liftgate Mounted Tail Lamp

1. Raise the liftgate.
2. Use a fiber stick or flat blade screw driver to pry the lower trim from the liftgate.
3. Once lower trim is loose, close the liftgate.
4. Open the flipper glass.
5. Pull up glass seal at bottom of window opening.
6. Remove small trim panel around liftgate glass striker.
7. Close flipper glass and raise the liftgate.
8. Continue removing the trim.
9. Disconnect the two trim panel lights.



Rear Liftgate Tail Lamps

10. Tail lamps are now visible. Rotate socket(s) counter clockwise.
11. Remove/replace bulb(s).
12. Reinstall the socket(s)
13. Reverse process to reinstall the liftgate trim.

Center High-Mounted Stop Lamp (CHMSL)

The center high-mounted stop lamp is an LED assembly. See your authorized dealer for replacement.



073310730

Center High-Mounted Stop Lamp

Rear License Lamp

1. Use a screw driver to gently pry against the side of the snap tab to remove the license lamp lens.
2. Pull bulb from socket.
3. Replace bulb.
4. Reinstall lens.

FLUID CAPACITIES

	U.S.	Metric
Fuel (Approximate)		
3.6L and 5.7L Engines	24 Gallons	91 Liters
Engine Oil with Filter		
3.6L Engine (SAE 5W-30, API Certified)	6 Quarts	5.6 Liters
5.7L Engine (SAE 5W-20, API Certified)	7 Quarts	6.6 Liters
Cooling System *		
3.6L Engine (MOPAR® Engine Coolant/Antifreeze 5-Year/100,000 Mile Formula or equivalent)	10.4 Quarts	9.9 Liters
5.7 Liter Engine (MOPAR® Engine Coolant/Antifreeze 5-Year/100,000 Mile Formula or equivalent) – Without Trailer Tow Package	15.4 Quarts	14.6 Liters
5.7 Liter Engine (MOPAR® Engine Coolant/Antifreeze 5-Year/100,000 Mile Formula or equivalent) – With Trailer Tow Package	16 Quarts	15.2 Liters
* Includes heater and coolant recovery bottle filled to MAX level.		

FLUIDS, LUBRICANTS, AND GENUINE PARTS

Engine

Component	Fluid, Lubricant, or Genuine Part
Engine Coolant	MOPAR® Antifreeze/Coolant 5 Year/100,000 Mile Formula HOAT (Hybrid Organic Additive Technology) or equivalent.
Engine Oil – 3.6L Engine	Use API Certified SAE 5W-30 Engine Oil, meeting the requirements of Chrysler Material Standard MS-6395. Refer to your engine oil filler cap for correct SAE grade.
Engine Oil – 5.7L Engine	Use API Certified SAE 5W-20 Engine Oil, meeting the requirements of Chrysler Material Standard MS-6395. Refer to your engine oil filler cap for correct SAE grade.
Engine Oil Filter	MOPAR® Engine Oil Filter or equivalent.
Spark Plugs – 3.6L Engine	RER8ZWYCB4 (Gap 0.031 in [0.79 mm])
Spark Plugs – 5.7L Engine	LZFR5C-11G (Gap 0.043 in [1.09 mm])
Fuel Selection – 3.6L Engine	87 Octane
Fuel Selection – 5.7L Engine	87 Octane Acceptable - 89 Octane Recommended

Chassis

Component	Fluid, Lubricant, or Genuine Part
Automatic Transmission	MOPAR® ATF+4® Automatic Transmission Fluid or equivalent licensed ATF+4® product.
Transfer Case – 3.6L Engine	Shell Automatic Transmission Fluid 3353 or equivalent.
Transfer Case – 5.7L Engine	MOPAR® ATF+4® Automatic Transmission Fluid or equivalent licensed ATF+4® product.
Axle Differential (Front-Rear)	We recommend you use MOPAR® GL-5 Synthetic Axle Lubricant SAE 75W-85.
Axle Differential (Rear) – 5.7L Engine With Electronic Limited-Slip Differential (ELSD)	We recommend you use MOPAR® GL-5 Synthetic Axle Lubricant SAE 75W-85 with friction modifier additive.
Axle Differential (Rear) – 5.7L Engine Without Electronic Limited-Slip Differential (ELSD)	We recommend you use MOPAR® GL-5 Synthetic Axle Lubricant SAE 75W-85.
Brake Master Cylinder	MOPAR® DOT 3 Brake Fluid, SAE J1703 should be used. If DOT 3, SAE J1703 brake fluid is not available, then DOT 4 is acceptable. Use only recommended brake fluids or equivalent.

Component	Fluid, Lubricant, or Genuine Part
Power Steering Reservoir – 3.6L Engine	MOPAR® Hydraulic Fluid or equivalent meeting MS-1165, such as Fuchs EG ZH 3044 or Pentosin CHF 11s.
Power Steering Reservoir – 5.7L Engine	MOPAR® Power Steering Fluid +4, MOPAR® ATF+4® Automatic Transmission Fluid or equivalent licensed ATF+4® product.

MAINTENANCE SCHEDULES

CONTENTS

■	Maintenance Schedule	538
□	Required Maintenance Intervals	539

MAINTENANCE SCHEDULE

The Scheduled Maintenance services listed in this manual must be done at the times or mileages specified to protect your vehicle warranty and ensure the best vehicle performance and reliability. More frequent maintenance may be needed for vehicles in severe operating conditions, such as dusty areas and very short trip driving. Inspection and service should also be done anytime a malfunction is suspected.

The oil change indicator system will remind you that it is time to take your vehicle in for scheduled maintenance.

On Electronic Vehicle Information Center (EVIC) equipped vehicles "Oil Change Required" will be displayed in the EVIC and a single chime will sound, indicating that an oil change is necessary.

Based on engine operation conditions the oil change indicator message will illuminate, this means that service

is required for your vehicle. Have your vehicle serviced as soon as possible, within the next 500 miles (805 km).

NOTE:

- The oil change indicator message will not monitor the time since the last oil change. Change your vehicles oil if it has been 6 months since your last oil change even if the oil change indicator message is NOT illuminated.
- Change your engine oil more often if you drive your vehicle off-road for an extended period of time.
- Under no circumstances should oil change intervals exceed 8,000 miles (13,000 km) or 6 months, whichever comes first.

Your authorized dealer will reset the oil change indicator message after completing the scheduled oil change. If a scheduled oil change is performed by someone other than your authorized dealer, the message can be reset by

referring to the steps described under “Electronic Vehicle Information Center (EVIC)/Oil Change Required” in “Understanding Your Instrument Panel” for further information.

At Each Stop for Fuel

- Check the engine oil level about five minutes after a fully warmed engine is shut off. Checking the oil level while the vehicle is on level ground will improve the accuracy of the oil level reading. Add oil only when the level is at or below the ADD or MIN mark.
- Check the windshield washer solvent and add if required.

Once a Month

- Check tire pressure and look for unusual wear or damage.

- Check the fluid levels of the coolant reservoir, brake master cylinder, power steering and transmission (5.7L only) and add as needed.
- Check all lights and other electrical items for correct operation.

At Each Oil Change

- Change the engine oil filter.
- Inspect the brake hoses and lines.

CAUTION!

Failure to perform the required maintenance items may result in damage to the vehicle.

Required Maintenance Intervals

Refer to the Maintenance Schedules on the following pages for the required maintenance intervals.

**8,000 Miles (13,000 km) or
6 Months Maintenance Service
Schedule**

- Change the engine oil and engine oil filter.
- Rotate the tires, rotate at the first sign of irregular wear, even if it occurs before 8,000 miles (13 000 km).

_____ Date

_____ Dealer Code

Signature Authorized Chrysler Dealer

**16,000 Miles (26,000 km) or 12 Months Maintenance Service
Schedule**

- Change the engine oil and engine oil filter.
- Rotate the tires, rotate at the first sign of irregular wear, even if it occurs before 16,000 miles (26 000 km).
- If using your vehicle for any of the following: Dusty or off-road conditions. Inspect the engine air cleaner filter; replace if necessary.
- Replace the air conditioning filter.
- Inspect the brake linings, replace if necessary.
- Inspect exhaust system. Perform the first inspection at 16,000 miles (26 000 km) or 12 months.
- Inspect the front suspension, tie rod ends and boot seals for cracks or leaks and all parts for damage, wear, improper looseness or end play; replace if necessary.

_____ Date

_____ Dealer Code

Signature Authorized Chrysler Dealer

24,000 Miles (39,000 km) or 18 Months Maintenance Service Schedule

- Change the engine oil and engine oil filter.
- Rotate the tires, rotate at the first sign of irregular wear, even if it occurs before 24,000 miles (39 000 km).
- Inspect the CV joints.
- Inspect exhaust system.
- Inspect the front and rear axle fluid, change if using your vehicle for police, taxi, fleet, off-road or frequent trailer towing.

Odometer Reading Date

Repair Order # Dealer Code

Signature Authorized Chrysler Dealer

32,000 Miles (52,000 km) or 24 Months Maintenance Service Schedule

- Change the engine oil and engine oil filter.
- Rotate the tires, rotate at the first sign of irregular wear, even if it occurs before 32,000 miles (52 000 km).
- Replace the engine air cleaner filter.
- Replace the air conditioning filter.
- Replace the spark plugs (5.7L Engine).
- Adjust parking brake on vehicles equipped with four-wheel disc brakes.
- Inspect the transfer case fluid.
- Inspect the brake linings, replace if necessary.
- Inspect the front suspension, tie rod ends and boot seals for cracks or leaks and all parts for damage, wear, improper looseness or end play; replace if necessary.

Odometer Reading Date

Repair Order # Dealer Code

Signature Authorized Chrysler Dealer

40,000 Miles (65,000 km) or 30 Months Maintenance Service Schedule

- Change the engine oil and engine oil filter.
- Rotate the tires, rotate at the first sign of irregular wear, even if it occurs before 40,000 miles (65 000 km).

_____ Date

_____ Dealer Code

Signature Authorized Chrysler Dealer

48,000 Miles (78,000 km) or 36 Months Maintenance Service Schedule

- Change the engine oil and engine oil filter.
- Rotate the tires, rotate at the first sign of irregular wear, even if it occurs before 48,000 miles (78 000 km).
- If using your vehicle for any of the following: Dusty or off-road conditions. Inspect the engine air cleaner filter; replace if necessary.
- Replace the air conditioning filter.
- Inspect the brake linings, replace if necessary.
- Inspect the CV joints.
- Inspect exhaust system.
- Inspect the front suspension, tie rod ends and boot seals for cracks or leaks and all parts for damage, wear, improper looseness or end play; replace if necessary.
- Inspect the front and rear axle fluid, change if using your vehicle for police, taxi, fleet, off-road or frequent trailer towing.

_____ Date

_____ Dealer Code

Signature Authorized Chrysler Dealer

**56,000 Miles (91,000 km) or
42 Months Maintenance
Service Schedule**

- Change the engine oil and engine oil filter.
- Rotate the tires, rotate at the first sign of irregular wear, even if it occurs before 56,000 miles (91 000 km).

Odometer Reading

Date

Repair Order #

Dealer Code

Signature Authorized Chrysler Dealer

64,000 Miles (104,000 km) or 48 Months Maintenance Service Schedule

- Change the engine oil and engine oil filter.
- Rotate the tires, rotate at the first sign of irregular wear, even if it occurs before 64,000 miles (104 000 km).
- Replace the engine air cleaner filter.
- Replace the air conditioning filter.
- Inspect the brake linings; replace if necessary.
- Replace the spark plugs (5.7L Engine).
- Adjust parking brake on vehicles equipped with four-wheel disc brakes.
- Change the automatic transmission fluid and filter(s) if using your vehicle for any of the following: police, taxi, fleet, or frequent trailer towing.
- Change the transfer case fluid if using your vehicle for any of the following: police, taxi, fleet, or frequent trailer towing.
- Inspect the front suspension, tie rod ends and boot seals for cracks or leaks and all parts for damage, wear, improper looseness or end play; replace if necessary.

_____ Date

_____ Dealer Code

_____ Signature Authorized Chrysler Dealer

72,000 Miles (117,000 km) or 54 Months Maintenance Service Schedule

- Change the engine oil and engine oil filter.
- Rotate the tires, rotate at the first sign of irregular wear, even if it occurs before 72,000 miles (117 000 km).
- Inspect the CV joints.
- Inspect exhaust system.
- Inspect the front and rear axle fluid, change if using your vehicle for police, taxi, fleet, off-road or frequent trailer towing.

Odometer Reading Date

Repair Order # Dealer Code

Signature, Authorized Service Center

80,000 Miles (130,000 km) or 60 Months Maintenance Service Schedule

- Change the engine oil and engine oil filter.
- Rotate the tires, rotate at the first sign of irregular wear, even if it occurs before 80,000 miles (130 000 km).
- If using your vehicle for any of the following: Dusty or off-road conditions. Inspect the engine air cleaner filter; replace if necessary.
- Replace the air conditioning filter.
- Flush and replace the engine coolant at 60 months or 104,000 miles (169 000 km) whichever comes first.
- Inspect the brake linings, replace if necessary.
- Inspect the front suspension, tie rod ends and boot seals for cracks or leaks and all parts for damage, wear, improper looseness or end play; replace if necessary.

Odometer Reading Date

Repair Order # Dealer Code

Signature, Authorized Service Center

**88,000 Miles (143,000 km) or
66 Months Maintenance
Service Schedule**

- Change the engine oil and engine oil filter.
- Rotate the tires, rotate at the first sign of irregular wear, even if it occurs before 88,000 miles (143 000 km).

Odometer Reading Date

Repair Order # Dealer Code

Signature Authorized Chrysler Dealer

96,000 Miles (156,000 km) or 72 Months Maintenance Service Schedule

- Change the engine oil and engine oil filter.
- Rotate the tires, rotate at the first sign of irregular wear, even if it occurs before 96,000 miles (156 000 km).
- Replace the engine air cleaner filter.
- Replace the air conditioning filter.
- Replace the spark plugs (3.6L Engine).
- Replace the spark plugs (5.7L Engine).
- Inspect and replace PCV valve if necessary.†
- Adjust parking brake on vehicles equipped with four-wheel disc brakes.
- Inspect the transfer case fluid.
- Inspect the brake linings, replace if necessary.
- Inspect the CV joints.
- Inspect exhaust system.
- Inspect the front suspension, tie rod ends and boot seals for cracks or leaks and all parts for damage, wear, improper looseness or end play; replace if necessary.
- Inspect the front and rear axle fluid, change if using your vehicle for police, taxi, fleet, off-road or frequent trailer towing.

Odometer Reading _____ Date _____

Repair Order # _____ Dealer Code _____

Signature Authorized Chrysler Dealer _____

104,000 Miles (169,000 km) or 78 Months Maintenance Service Schedule

- Change the engine oil and engine oil filter.
- Rotate the tires, rotate at the first sign of irregular wear, even if it occurs before 104,000 miles (169 000 km).
- Flush and replace the engine coolant at 104,000 miles (169 000 km) or 60 months whichever comes first.

 Odometer Reading Date

 Repair Order # Dealer Code

 Signature, Authorized Service Center

112,000 Miles (182,000 km) or 84 Months Maintenance Service Schedule

- Change the engine oil and engine oil filter.
- Rotate the tires, rotate at the first sign of irregular wear, even if it occurs before 112,000 miles (182 000 km).
- If using your vehicle for any of the following: Dusty or off-road conditions. Inspect the engine air cleaner filter; replace if necessary.
- Replace the air conditioning filter.
- Inspect the brake linings, replace if necessary.
- Inspect the front suspension, tie rod ends and boot seals for cracks or leaks and all parts for damage, wear, improper looseness or end play; replace if necessary.

 Odometer Reading Date

 Repair Order # Dealer Code

 Signature, Authorized Service Center

120,000 Miles (195,000 km) or 90 Months Maintenance Service Schedule

- Change the engine oil and engine oil filter.
- Rotate the tires, rotate at the first sign of irregular wear, even if it occurs before 120,000 miles (195 000 km).
- Inspect the CV joints.
- Inspect exhaust system.
- Inspect the front and rear axle fluid, change if using your vehicle for police, taxi, fleet, off-road or frequent trailer towing.
- Change the automatic transmission fluid and filter(s).
- Replace the accessory drive belt(s).

_____ Date
Odometer Reading

_____ Dealer Code
Repair Order #

Signature Authorized Chrysler Dealer

128,000 Miles (208,000 km) or 96 Months Maintenance Service Schedule

- Change the engine oil and engine oil filter.
- Rotate the tires, rotate at the first sign of irregular wear, even if it occurs before 128,000 miles (208 000 km).
- Replace the engine air cleaner filter.
- Replace the air conditioning filter.
- Replace the spark plugs (5.7L Engine).
- Adjust parking brake on vehicles equipped with four-wheel disc brakes.
- Change the transfer case fluid.
- Inspect the brake linings, replace if necessary.
- Inspect the front suspension, tie rod ends and boot seals for cracks or leaks and all parts for damage, wear, improper looseness or end play; replace if necessary.

_____ Date

Odometer Reading

_____ Dealer Code

Repair Order #

Signature Authorized Chrysler Dealer

136,000 Miles (221,000 km) or 102 Months Maintenance Service Schedule

- Change the engine oil and engine oil filter.
- Rotate the tires, rotate at the first sign of irregular wear, even if it occurs before 136,000 miles (221 000 km).

_____ Date

Odometer Reading

_____ Dealer Code

Repair Order #

Signature Authorized Chrysler Dealer

144,000 Miles (234,000 km) or 108 Months Maintenance Service Schedule

- Change the engine oil and engine oil filter.
- Rotate the tires, rotate at the first sign of irregular wear, even if it occurs before 144,000 miles (234 000 km).
- If using your vehicle for any of the following: Dusty or off-road conditions. Inspect the engine air cleaner filter; replace if necessary.
- Replace the air conditioning filter.
- Inspect the brake linings, replace if necessary.
- Inspect the CV joints.
- Inspect exhaust system.
- Inspect the front suspension, tie rod ends and boot seals for cracks or leaks and all parts for damage, wear, improper looseness or end play; replace if necessary.
- Inspect the front and rear axle fluid, change if using your vehicle for police, taxi, fleet, off-road or frequent trailer towing.

_____ Date
Odometer Reading

_____ Dealer Code
Repair Order #

Signature Authorized Chrysler Dealer

152,000 Miles (247,000 km) or 114 Months Maintenance Service Schedule

- Change the engine oil and engine oil filter.
- Rotate the tires, rotate at the first sign of irregular wear, even if it occurs before 152,000 miles (247 000 km).

_____ Date
Odometer Reading

_____ Dealer Code
Repair Order #

Signature Authorized Chrysler Dealer

552 MAINTENANCE SCHEDULES

† This maintenance is recommended by the manufacturer to the owner, but is not required to maintain emissions warranty.

WARNING!

- You can be badly injured working on or around a motor vehicle. Do only service work for which you have the knowledge and the right equipment. If you have any doubt about your ability to perform a service job, take your vehicle to a competent mechanic.
- Failure to properly inspect and maintain your vehicle could result in a component malfunction and effect vehicle handling and performance. This could cause an accident.

IF YOU NEED CONSUMER ASSISTANCE

CONTENTS

■ Suggestions For Obtaining Service For Your Vehicle.	555	□ Customer Assistance For The Hearing Or Speech Impaired (TDD/TTY)	557
□ Prepare For The Appointment	555	□ Service Contract	557
□ Prepare A List	555	■ Warranty Information	558
□ Be Reasonable With Requests	555	■ MOPAR® Parts	558
■ If You Need Assistance	555	■ Reporting Safety Defects	558
□ Chrysler Group LLC Customer Center	556	□ In The 50 United States And Washington, D.C.	558
□ Chrysler Canada Inc. Customer Center	556	□ In Canada	559
□ In Mexico Contact	556	■ Publication Order Forms	559

554 IF YOU NEED CONSUMER ASSISTANCE

■ Department Of Transportation Uniform Tire Quality Grades	561	□ Traction Grades	561
□ Treadwear	561	□ Temperature Grades	562

SUGGESTIONS FOR OBTAINING SERVICE FOR YOUR VEHICLE

Prepare For The Appointment

If you're having warranty work done, be sure to have the right papers with you. Take your warranty folder. All work to be performed may not be covered by the warranty. Discuss additional charges with the service manager. Keep a maintenance log of your vehicle's service history. This can often provide a clue to the current problem.

Prepare A List

Make a written list of your vehicle's problems or the specific work you want done. If you've had an accident or work done that is not on your maintenance log, let the service advisor know.

Be Reasonable With Requests

If you list a number of items and you must have your vehicle by the end of the day, discuss the situation with

the service advisor and list the items in order of priority. At many authorized dealers, you may obtain a rental vehicle at a minimal daily charge. If you need a rental, it is advisable to make these arrangements when you call for an appointment.

IF YOU NEED ASSISTANCE

The manufacturer and its authorized dealers are vitally interested in your satisfaction. We want you to be happy with our products and services.

Warranty service must be done by an authorized dealer. We strongly recommend that you take the vehicle to an authorized dealer. They know your vehicle the best, and are most concerned that you get prompt and high quality service. The manufacturer's authorized dealers have the facilities, factory-trained technicians, special tools, and the latest information to ensure the vehicle is fixed correctly and in a timely manner.

This is why you should always talk to an authorized dealer's service manager first. Most matters can be resolved with this process.

- If for some reason you are still not satisfied, talk to the general manager or owner of the authorized dealership. They want to know if you need assistance.
- If an authorized dealership is unable to resolve the concern, you may contact the manufacturer's customer center.

Any communication to the manufacturer's customer center should include the following information:

- Owner's name and address
- Owner's telephone number (home and office)
- Authorized dealership name
- Vehicle Identification Number (VIN)
- Vehicle delivery date and mileage

Chrysler Group LLC Customer Center

P.O. Box 21-8004

Auburn Hills, MI 48321-8004

Phone: (877) 426-5337

Chrysler Canada Inc. Customer Center

P.O. Box 1621

Windsor, Ontario N9A 4H6

Phone: (800) 465-2001

In Mexico contact:

Av. Prolongacion Paseo de la Reforma, 1240

Sante Fe C.P. 05109

Mexico, D. F.

In Mexico City: 5081-7568

Outside Mexico City: 1-800-505-1300

Customer Assistance For The Hearing Or Speech Impaired (TDD/TTY)

To assist customers who have hearing difficulties, the manufacturer has installed special TDD (Telecommunication Devices for the Deaf) equipment at its customer center. Any hearing or speech impaired customer, who has access to a TDD or a conventional teletypewriter (TTY) in the United States, can communicate with the manufacturer by dialing 1-800-380-CHRY.

Canadian residents with hearing difficulties that require assistance can use the special needs relay service offered by Bell Canada. For TTY teletypewriter users, dial 711 and for Voice callers, dial 1 800 855-0511 to connect with a Bell Relay Service operator.

Service Contract

You may have purchased a service contract for a vehicle to help protect you from the high cost of unexpected repairs after the manufacturer's New Vehicle Limited Warranty expires. The manufacturer stands behind only

the manufacturer's service contracts. If you purchased a manufacturer's service contract, you will receive Plan Provisions and an Owner Identification Card in the mail within three weeks of the vehicle delivery date. If you have any questions about the service contract, call the manufacturer's Service Contract National Customer Hotline at 1-800-521-9922 (Canadian residents, call 1-800-485-2001).

The manufacturer will not stand behind any service contract that is not the manufacturer's service contract. It is not responsible for any service contract other than the manufacturer's service contract. If you purchased a service contract that is not a manufacturer's service contract, and you require service after the manufacturer's New Vehicle Limited Warranty expires, please refer to the contract documents, and contact the person listed in those documents.

We appreciate that you have made a major investment when you purchased the vehicle. An authorized dealer has also made a major investment in facilities, tools, and training to assure that you are absolutely delighted with the ownership experience. You'll be pleased with their sincere efforts to resolve any warranty issues or related concerns.

WARNING!

Engine exhaust, some of its constituents, and certain vehicle components contain, or emit, chemicals known to the State of California to cause cancer and birth defects, or other reproductive harm. In addition, certain fluids contained in vehicles and certain products of component wear contain, or emit, chemicals known to the State of California to cause cancer and birth defects, or other reproductive harm.

WARRANTY INFORMATION

See the Warranty Information Booklet, located on the DVD, for the terms and provisions of Chrysler Group LLC warranties applicable to this vehicle and market.

MOPAR® PARTS

MOPAR® fluids, lubricants, parts, and accessories are available from an authorized dealer. They are recommended for your vehicle in order to help keep the vehicle operating at its best.

REPORTING SAFETY DEFECTS

In the 50 United States and Washington, D.C.

If you believe that your vehicle has a defect that could cause a crash or cause injury or death, you should immediately inform the National Highway Traffic Safety Administration (NHTSA) in addition to notifying the manufacturer.

If NHTSA receives similar complaints, it may open an investigation, and if it finds that a safety defect exists in a group of vehicles, it may order a recall and remedy campaign. However, NHTSA cannot become involved in individual problems between you, your authorized dealer, and the manufacturer.

To contact NHTSA, you may either call the Auto Safety Hotline toll free at 1-888-327-4236 (TTY: 1-800-424-9153), or go to <http://www.safercar.gov>; or write to: Administrator, NHTSA, 1200 New Jersey Avenue, SE., West Building, Washington, D.C. 20590. You can also obtain other information about motor vehicle safety from <http://www.safercar.gov>.

In Canada

If you believe that your vehicle has a safety defect, you should contact the Customer Service Department immediately. Canadian customers who wish to report a safety defect to the Canadian government should contact Transport Canada, Motor Vehicle Defect Investigations and Recalls at 1-800-333-0510 or go to <http://www.tc.gc.ca/roadsafety/>

PUBLICATION ORDER FORMS

To order the following manuals, you may use either the website or the phone numbers listed below. Visa, Mastercard, American Express, and Discover orders are accepted. If you prefer mailing your payment, please call for an order form.

NOTE: A street address is required when ordering manuals (no P.O. Boxes).

- *Service Manuals*

These comprehensive Service Manuals provide the information that students and professional technicians need in diagnosing/troubleshooting, problem solving, maintaining, servicing, and repairing Chrysler Group LLC vehicles. A complete working knowledge of the vehicle, system, and/or components is written in straightforward language with illustrations, diagrams, and charts.

- *Diagnostic Procedure Manuals*

Diagnostic Procedure Manuals are filled with diagrams, charts and detailed illustrations. These practical manuals make it easy for students and technicians to find and fix problems on computer-controlled vehicle systems and features. They show exactly how to find and correct problems the first time, using step-by-step troubleshooting and drivability procedures, proven diagnostic tests and a complete list of all tools and equipment.

- *Owner's Manuals*

These Owner's Manuals have been prepared with the assistance of service and engineering specialists to acquaint you with specific Chrysler Group LLC vehicles. Included are starting, operating, emergency and maintenance procedures as well as specifications, capabilities and safety tips.

Call toll free at:

- 1-800-890-4038 (U.S.)
- 1-800-387-1143 (Canada)

Or

Visit us on the Worldwide Web at:

- www.techauthority.com

DEPARTMENT OF TRANSPORTATION UNIFORM TIRE QUALITY GRADES

The following tire grading categories were established by the National Highway Traffic Safety Administration. The specific grade rating assigned by the tire's manufacturer in each category is shown on the sidewall of the tires on your vehicle.

All passenger car tires must conform to Federal safety requirements in addition to these grades.

Treadwear

The Treadwear grade is a comparative rating, based on the wear rate of the tire when tested under controlled conditions on a specified government test course. For example, a tire graded 150 would wear one and one-half times as well on the government course as a tire graded 100. The relative performance of tires depends upon the actual conditions of their use, however, and may depart

significantly from the norm due to variations in driving habits, service practices, and differences in road characteristics and climate.

Traction Grades

The Traction grades, from highest to lowest, are AA, A, B, and C. These grades represent the tire's ability to stop on wet pavement, as measured under controlled conditions on specified government test surfaces of asphalt and concrete. A tire marked C may have poor traction performance.

WARNING!

The traction grade assigned to this tire is based on straight-ahead braking traction tests, and does not include acceleration, cornering, hydroplaning, or peak traction characteristics.

Temperature Grades

The temperature grades are A (the highest), B, and C, representing the tire's resistance to the generation of heat and its ability to dissipate heat, when tested under controlled conditions on a specified indoor laboratory test wheel. Sustained high temperature can cause the material of the tire to degenerate and reduce tire life, and excessive temperature can lead to sudden tire failure. The grade C corresponds to a level of performance, which all passenger car tires must meet under the Federal Motor Vehicle Safety Standard No. 109. Grades B and A represent higher levels of performance on the laboratory test wheel, than the minimum required by law.

WARNING!

The temperature grade for this tire is established for a tire that is properly inflated and not overloaded. Excessive speed, under-inflation, or excessive loading, either separately or in combination, can cause heat buildup and possible tire failure.

INDEX

- Adaptive Cruise Control (ACC) (Cruise Control) . . . 167
- Adding Fuel 433
- Additives, Fuel 427
- Air Cleaner, Engine (Engine Air Cleaner Filter) . . . 492
- Air Conditioner Maintenance 495
- Air Conditioning 324
- Air Conditioning Controls 324
- Air Conditioning Refrigerant 496
- Air Conditioning System 324,328
- Air Conditioning, Operating Tips 334
- Air Filter 492
- Air Pressure, Tires 404
- Air Suspension 365
- Airbag 68,77
- Airbag Deployment 78
- Airbag Light 75,76,81,98,248
- Airbag Maintenance 80
- Airbag, Side 71,74,77
- Airbag, Window (Side Curtain) 72,74,77
- Alarm (Security Alarm) 21,256
- Alarm, Panic 26
- Alterations/Modifications, Vehicle 9
- Antenna, Satellite Radio 309
- Anti-Lock Brake System (ABS) 381
- Anti-Lock Warning Light 255
- Anti-Theft System 256
- Antifreeze (Engine Coolant) 533
- Appearance Care 515
- Arming Theft System (Security Alarm) 21
- Assist, Hill Start 387
- Auto Down Power Windows 42
- Automatic Dimming Mirror 109
- Automatic Door Locks 34
- Automatic Headlights 147
- Automatic Temperature Control (ATC) 328
- Automatic Transmission 350,511
- Adding Fluid 514
- Fluid and Filter Changes 511

Fluid Level Check	512,513	Fluid Check	508
Fluid Type	511	Master Cylinder	508
Special Additives	512	Parking	379
Torque Converter	356	Warning Light	253
Autostick	352	Brake/Transmission Interlock	350
Auxiliary Electrical Outlet (Power Outlet)	221	Break-In Recommendations, New Vehicle	95
Auxiliary Power Outlet	221	Bulb Replacement	526,527
		Bulbs, Light	100
B-Pillar Location	399		
Battery	493	Calibration, Compass	278
Keyless Transmitter Replacement (RKE)	26	Camera, Rear	204
Belts, Seat	52,98	Capacities, Fluid	533
Blind Spot Monitoring	112	Caps, Filler	
Body Mechanism Lubrication	496	Fuel	433
Brake Assist System	382	Power Steering	378
Brake Control System, Electronic	381	Radiator (Coolant Pressure)	505
Brake Fluid	508	Car Washes	515
Brake System	507	Carbon Monoxide Warning	97,428
Anti-Lock (ABS)	381	Cargo (Vehicle Loading)	436

Cargo Area Cover	234	Clean Air Gasoline	425
Cargo Area Features	231	Climate Control	323
Cargo Compartment	231	Clock	289,298
Light	233	Cold Weather Operation	346
Cargo Light	233	Compact Disc (CD) Maintenance	323
Cargo Tie-Downs	236	Compact Spare Tire	407
Cellular Phone	121,323	Compass	277
Center High Mounted Stop Light	532	Compass Calibration	278
Certification Label	436	Compass Variance	279
Chains, Tire	412	Computer, Trip/Travel	274
Changing A Flat Tire	463	Connector	
Chart, Tire Sizing	395	UCI	313
Check Engine Light		Universal Consumer Interface (UCI)	313
(Malfunction Indicator Light)	486	Conserving Fuel	273
Checking Your Vehicle For Safety	96	Console, Overhead	206
Checks, Safety	96	Contract, Service	557
Child Restraint	82,83,88,91	Cooling System	502
Child Restraint Tether Anchors	86,88	Adding Coolant (Antifreeze)	504
Child Safety Locks	35	Coolant Capacity	533

- Coolant Level 506
- Disposal of Used Coolant 506
- Drain, Flush, and Refill 503
- Inspection 502
- Points to Remember 506
- Pressure Cap 505
- Radiator Cap 505
- Selection of Coolant (Antifreeze) 503,533
- Cruise Control (Speed Control) 167
- Cupholders 228
- Customer Assistance 555

- Data Recorder, Event 81
- Daytime Running Lights 149
- Dealer Service 488
- Defroster, Rear Window 238
- Defroster, Windshield 98,326,333
- Diagnostic System, Onboard 485

- Dipsticks
 - Automatic Transmission 513
 - Oil (Engine) 489
 - Power Steering 378
- Disabled Vehicle Towing 477
- Disarming, Theft System 22
- Disposal
 - Engine Oil 492
 - Used Engine Fluids 492
- Door Locks 33
- Door Locks, Automatic 34
- Door Opener, Garage 208
- Driving 370
 - Off-Pavement 370
 - Off-Road 370
- Driving to Achieve Maximum Fuel Economy 273
- DVD Player (Video Entertainment System™) 320

- E-85 Fuel 429
- Electric Remote Mirrors 110
- Electrical Outlet, Auxiliary (Power Outlet) 221
- Electronic Brake Control System 381
 - Anti-Lock Brake System 381
 - Brake Assist System 382
 - Electronic Roll Mitigation 383
 - Traction Control System 382
- Electronic Roll Mitigation (ERM) 383
- Electronic Speed Control (Cruise Control) 163,167
- Electronic Stability Control (ESC) 384
- Electronic Vehicle Information Center (EVIC) 250,258
- Emergency, In Case of
 - Hazard Warning Flasher 462
 - Jacking 463
 - Jump Starting 471
 - Tow Hooks 475
- Emission Control System Maintenance 486
- Engine
 - Air Cleaner 492
 - Block Heater 348
 - Break-In Recommendations 95
 - Compartment 483,484
 - Compartment Identification 483,484
 - Cooling 502
 - Exhaust Gas Caution 48,97,428
 - Fails to Start 347
 - Flooded, Starting 347
 - Fuel Requirements 424,533
 - Jump Starting 471
 - Multi-Displacement 379
 - Oil 489,533
 - Oil Change Interval 490
 - Oil Disposal 492
 - Oil Filter 492
 - Oil Filter Disposal 492
 - Oil Selection 490,533

Oil Synthetic	491	Finish Care	515
Overheating	462	Flashers	462
Starting	343	Hazard Warning	462
Temperature Gauge	257	Turn Signal	100,250,528,530
Engine Oil Viscosity	491	Flexible Fuel Vehicles	
Engine Oil Viscosity Chart	491	Cruising Range	432
Enhanced Accident Response Feature	78	Engine Oil	431
Entry System, Illuminated	23	Fuel Requirements	429,430
Ethanol	425	Maintenance	432
Event Data Recorder	81	Replacement Parts	432
Exhaust Gas Caution	48,97,428	Starting	432
Exhaust System	97,499	Flipper Glass, Liftgate	45
Exterior Finish Care	515	Flooded Engine Starting	347
Exterior Lights	100	Fluid Capacities	533
Filters		Fluid Leaks	100
Air Cleaner	492	Fluid Level Checks	
Engine Oil	492	Automatic Transmission	511,512,513
Engine Oil Disposal	492	Brake	508
		Engine Oil	489

Power Steering	378	Light	268
Fluids, Lubricants and Genuine Parts	534	Materials Added	427
Fog Light Service	528	Methanol	425
Fog Lights	250,528	Requirements	533
Folding Rear Seat	137	Saver Mode	273
Four Wheel Drive	357,363	Tank Capacity	533
Operation	357	Fuel Optimizer	273
Systems	357	Fuel Saver	273
Four Wheel Drive Operation	357	Fuel System Caution	434
Four-Way Hazard Flasher	462	Fuel, Flexible	429
Front Axle (Differential)	509	Fuses	520
Fuel	424	Garage Door Opener (HomeLink®)	208
Additives	427	Gas Cap (Fuel Filler Cap)	433,436,485
Clean Air	425	Gasoline (Fuel)	424
Conserving	273	Conserving	273
Ethanol	425	Gasoline, Clean Air	425
Filler Cap (Gas Cap)	433,436	Gasoline, Reformulated	425
Gasoline	424		
Gauge	256		

Gauges		Replacing	527
Coolant Temperature	257	Heated Mirrors	111
Fuel	256	Heater	324
Speedometer	255	Heater, Engine Block	348
Tachometer	248	High Beam Indicator	250
Gear Ranges	350	Hill Descent Control	390
Gear Select Lever Override	476	Hill Descent Control Indicator	250
General Information	20,28,188,424	Hill Start Assist	387
Glass Cleaning	519	Hitches	
Gross Axle Weight Rating	437,439	Trailer Towing	443
Gross Vehicle Weight Rating	436,439	Holder, Cup	228
GVWR	436	HomeLink® (Garage Door Opener) Transmitter	208
		Hood Release	144
Hands-Free Phone (uconnect™)	121	Ignition	16
Hazard Warning Flasher	462	Key	14,16
Headlights	527	Ignition Key Removal	16
Bulb Replacement	527	Illuminated Entry	23
Cleaning	518	Immobilizer (Sentry Key)	19
On With Wipers	147		

Infant Restraint	82,83	Key-In Reminder	18
Inflation Pressure Tires	404	Key, Programming	20
Information Center, Vehicle	258	Key, Replacement	20
Inside Rearview Mirror	108	Key, Sentry (Immobilizer)	19
Instrument Cluster	247,248	Keyless Enter-N-Go	36,277,344
Instrument Panel and Controls	246	Keyless Entry System	23
Instrument Panel Lens Cleaning	519	Keyless Go	14,277
Integrated Power Module (Fuses)	520	Keys	14
Interior Appearance Care	518	Lap/Shoulder Belts	52
Intermittent Wipers (Delay Wipers)	156	LATCH	
Introduction	4	(Lower Anchors and Tether for CHildren)	86,88
Inverter, Power	226	Latches	100
Jack Location	464	Lead Free Gasoline	424
Jack Operation	463,466	Leaks, Fluid	100
Jacking Instructions	466	Life of Tires	410
Jump Starting	471	Liftgate	44
		Liftgate Flipper Glass	45
		Liftgate Window Wiper/Washer	237

Light Bulbs	100	Headlights On With Wipers	147
Lights	100,146	High Beam Indicator	250
Airbag	75,76,81,98,248	Hill Descent Control Indicator	250
Anti-Lock	255	Illuminated Entry	23
Automatic Headlights	147	Low Fuel	268
Back-Up	530	Malfunction Indicator (Check Engine)	248
Brake Assist Warning	392	Map Reading	152
Brake Warning	253	Reading	152,206
Bulb Replacement	527	Rear Servicing	530
Cargo	233	Rear Tail	530
Center Mounted Stop	532	Seat Belt Reminder	253
Daytime Running	149	Security Alarm (Theft Alarm)	256
Dimmer Switch, Headlight	146	Service	527
Electronic Stability Program (ESP) Indicator	392	Service Engine Soon (Malfunction Indicator)	248
Exterior	100	Side Marker	530
Fog	250,528	SmartBeams	148
Fuses	520	Tire Pressure Monitoring (TPMS)	251
Hazard Warning Flasher	462	Tow/Haul Indicator	250
Headlights	527	Traction Control	392

Turn Signal	100,146,528,530	Memory Seats and Radio	140
Vanity Mirror	111	Methanol	425
Loading Vehicle	436	Mini-Trip Computer	274
Tires	399	Mirrors	108
Locks	33	Compass/Temperature	109
Child Protection	35	Electric Powered	110
Door	33	Electric Remote	110
Power Door	34	Exterior Folding	110
Lower Anchors and Tether for Children (LATCH)	86,88	Heated	111
Lubrication, Body	496	Outside	110
Maintenance Free Battery	493	Rearview	108
Maintenance Procedures	488	Vanity	111
Maintenance Schedule	538	Mode	
Malfunction Indicator Light (Check Engine)	248,486	Fuel Saver	273
Manual, Service	559	Modifications/Alterations, Vehicle	9
Memory Feature (Memory Seat)	140	Monitor, Tire Pressure System	415
Memory Seat	140	MOPAR Accessories	487,558
		MTBE/ETBE	425
		Multi-Displacement Engine System	379

Multi-Function Control Lever	146	Identification Logo	490
New Vehicle Break-In Period	95	Materials Added to	492
Occupant Restraints	48,74,78	Recommendation	490,533
Occupant Restraints (Sedan)	71,72,74,77	Synthetic	491
Odometer	250	Viscosity	491,533
Trip	250	Onboard Diagnostic System	485,486
Off-Pavement Driving (Off-Road)	370	Opener, Garage Door (HomeLink®)	208
Off-Road Driving (Off-Pavement)	370	Operator Manual (Owner's Manual)	6
Oil Change Indicator	272	Outside Rearview Mirrors	110
Oil Change Indicator, Reset	272	Overdrive	353
Oil, Engine	489	Overdrive OFF Switch	353
Capacity	533	Overhead Console	206
Change Interval	490	Overheating, Engine	257,462
Dipstick	489	Owner's Manual (Operator Manual)	6,559
Disposal	492	Paint Care	515
Filter	492	Paint Damage	515
Filter Disposal	492	Panic Alarm	26
		Park Sense System, Rear	195

- Parking Brake 379
- Personal Settings 280
- Pets 95
- Pets, Transporting 95
- Phone, Cellular 121
- Phone, Hands-Free (uconnect™) 121
- Placard, Tire and Loading Information 399
- Polishing and Waxing 515
- Power
- Door Locks 34
- Inverter 226
- Lift Gate 46
- Mirrors 110
- Outlet (Auxiliary Electrical Outlet) 221
- Seats 122,124
- Steering 375,378
- Sunroof 214,217
- Tilt/Telescoping Steering Column 161
- Windows 41
- Pregnant Women and Seat Belts 67
- Preparation for Jacking 465
- Pretensioners
- Seat Belts 61
- Programmable Electronic Features 280
- Programming Transmitters
(Remote Keyless Entry) 23
- Quadra-Lift 365
- Quadra-Trac 357,358
- Radial Ply Tires 406
- Radio Operation 323
- Radio, Satellite (uconnect™ studios) 320
- Rain Sensitive Wiper System 159
- Rear Axle (Differential) 509
- Rear Camera 204
- Rear Cross Path 118
- Rear Cupholder 228

Rear Park Sense System	195	Replacement Bulbs	526
Rear Seat, Folding	137	Replacement Keys	20
Rear Window Defroster	238	Replacement Parts	487
Rear Window Features	237	Replacement Tires	411
Rear Wiper/Washer	237	Reporting Safety Defects	558
Rearview Mirrors	108	Restraints, Child	82
Reclining Front Seats	127	Restraints, Occupant	48
Recorder, Event Data	81	Retractable Cargo Area Cover	234
Recreational Towing	453	Roll Over Warning	5
Shifting into Transfer Case Neutral (N)	456	Rotation, Tires	414
Shifting out of Transfer Case Neutral (N)	459	Safety Checks Inside Vehicle	98
Reformulated Gasoline	425	Safety Checks Outside Vehicle	100
Refrigerant	496	Safety Defects, Reporting	558
Reminder, Seat Belt	65	Safety Information, Tire	394
Remote Control		Safety Tips	96
Starting System	29	Safety, Exhaust Gas	48,97
Remote Keyless Entry (RKE)	23	Satellite Radio (uconnect™ studios)	320
Remote Sound System (Radio) Controls	321	Satellite Radio Antenna	309
Remote Starting System	29		

Schedule, Maintenance	538	Power	122,124
Seat Belt Reminder	65	Rear Folding	137
Seat Belts	52,98	Reclining	127
Adjustable Upper Shoulder Anchorage	57	Security Against Theft	21
And Pregnant Women	67	Security Alarm (Theft Alarm)	21,256
Child Restraint	82,91	Selec-Terrain	363
Extender	67	Selection of Oil	490
Front Seat	52	Sentry Key (Immobilizer)	19
Inspection	98	Sentry Key Programming	20
Maintenance	519	Sentry Key Replacement	20
Pretensioners	61	Service Assistance	555
Reminder	253	Service Contract	557
Shoulder Belt Anchorage	57	Service Engine Soon Light (Malfunction Indicator)	248
Untwisting Procedure	57	Service Manuals	559
Seats	121	Setting the Clock	289,298
Adjustment	126	Settings, Personal	280
Cleaning	518	Shift Lever Override	476
Easy Entry	143		
Memory	140		

Shifting	349	Engine Block Heater	348
Automatic Transmission	349	Engine Fails to Start	347
Shoulder Belts	52	Remote	29
Side Airbag	77	Starting and Operating	343
Signals, Turn	100,250,528,530	Starting Procedures	343
Sirius Backseat TV™ (uconnect™ studios)	320	Steering	
SmartBeams	148	Power	375,378
Snow Chains (Tire Chains)	412	Tilt Column	160,161
Snow Plow	452	Wheel, Heated	162
Snow Tires	413	Wheel, Tilt	160,161
Spare Tire	407,408,464	Steering Wheel Audio Controls	321
Specifications		Steering Wheel Mounted Sound	
Fuel (Gasoline)	424	System Controls	321
Oil	490	Storage	525
Speed Control (Cruise Control)	163,167	Storage, Vehicle	335,525
Speedometer	255	Storing Your Vehicle	525
Starting	29,343	Sun Roof	214,217
Automatic Transmission	343	Sun Visor Extension	112
Cold Weather	346,348	Sunglasses Storage	207

Supplemental Restraint System - Airbag	68	Tires	100,403,561
Suspension, Air	365	Air Pressure	404
Sway Control, Trailer	387	Chains	412
Synthetic Engine Oil	491	Changing	463
System, Remote Starting	29	Compact Spare	407
Tachometer	248	General Information	403
Telescoping Steering Column	160,161	High Speed	406
Temperature Control, Automatic (ATC)	328	Inflation Pressures	404
Temperature Gauge, Engine Coolant	257	Jacking	463
Tether Anchor, Child Restraint	86	Life of Tires	410
Theft System Arming	21	Load Capacity	399,400
Theft System Disarming	22	Pressure Monitor System (TPMS)	415
Tie Down Hooks, Cargo	236	Pressure Warning Light	251
Tilt Steering Column	160,161	Quality Grading	561
Tire and Loading Information Placard	399	Radial	406
Tire Identification Number (TIN)	397	Replacement	411
Tire Markings	394	Rotation	414
Tire Safety Information	394	Safety	394
		Sizes	395

Snow Tires	413	Minimum Requirements	446
Spare Tire	464	Trailer and Tongue Weight	445
Spinning	409	Wiring	449
Tread Wear Indicators	410	Trailer Towing Guide	444
Wheel Mounting	470	Trailer Weight	444
Tongue Weight/Trailer Weight	445	Transfer Case	510
Torque Converter Clutch	356	Maintenance	510
Tow Hooks, Emergency	475	Transmission	
Tow/Haul Indicator Light	250	Automatic	350,511
Towing	438,477	Maintenance	511
Disabled Vehicle	477	Shifting	349
Guide	444	Transmitter Battery Service	
Recreational	453	(Remote Keyless Entry)	26
Weight	444	Transmitter Programming	
Traction Control	382	(Remote Keyless Entry)	23
Trailer Sway Control (TSC)	387	Transmitter, Garage Door Opener (HomeLink®)	208
Trailer Towing	438	Transmitter, Remote Keyless Entry (RKE)	23
Cooling System Tips	452	Tread Wear Indicators	410
Hitches	443	Turn Signals	250,528,530

- UCI Connector 313
- uconnect™ (Hands-Free Phone) 121
- Uniform Tire Quality Grades 561
- Universal Consumer Interface (UCI) Connector . . . 313
- Universal Transmitter 208
- Untwisting Procedure, Seat Belt 57
- Upholstery Care 518
-
- Vanity Mirrors 111
- Variance, Compass 279
- Vehicle Certification Label 436
- Vehicle Identification Number (VIN) 8
- Vehicle Loading 400,436
- Vehicle Modifications/Alterations 9
- Vehicle Storage 335,525
- Video Entertainment System™
(Rear Seat Video System) 320
-
- Viscosity, Engine Oil 491
- Voice Recognition System (VR) 121
-
- Warning Flasher, Hazard 462
- Warning, Roll Over 5
- Warnings and Cautions 8
- Warranty Information 558
- Washers, Windshield 155,498
- Washing Vehicle 515
- Waxing and Polishing 515
- Wheel and Wheel Trim 517
- Wheel and Wheel Trim Care 517
- Wheel Mounting 470
- Wind Buffeting 44,216,221

Window Fogging	334	Windshield Wiper Blades	496
Windows	41	Windshield Wipers	155
Power	41	Wipers, Intermittent	156
Windshield Defroster	98,326	Wipers, Rain Sensitive	159
Windshield Washers	155		
Fluid	498		

INSTALLATION OF RADIO TRANSMITTING EQUIPMENT

Special design considerations are incorporated into this vehicle's electronic system to provide immunity to radio frequency signals. Mobile two-way radios and telephone equipment must be installed properly by trained personnel. The following must be observed during installation.

The positive power connection should be made directly to the battery and fused as close to the battery as possible. The negative power connection should be made to body sheet metal adjacent to the negative battery connection. This connection should not be fused.

Antennas for two-way radios should be mounted on the roof or the rear area of the vehicle. Care should be used in mounting antennas with magnet bases. Magnets may affect the accuracy or operation of the compass on vehicles so equipped.

The antenna cable should be as short as practical and routed away from the vehicle wiring when possible. Use only fully shielded coaxial cable.

Carefully match the antenna and cable to the radio to ensure a low Standing Wave Ratio (SWR).

Mobile radio equipment with output power greater than normal may require special precautions.

All installations should be checked for possible interference between the communications equipment and the vehicle's electronic systems.



STICK WITH THE SPECIALISTS®

Chrysler Group LLC

11WK741-126-AE



Fifth Edition

Printing in U.S.A.