

# 2013 Pilot

## Online Reference Owner's Manual

This owner's manual should be considered a permanent part of the vehicle and should remain with the vehicle when it is sold.

This owner's manual covers all models of your vehicle. You may find descriptions of equipment and features that are not on your particular model.

Images throughout this owner's manual (including the front cover) represent features and equipment that are available on some, but not all, models. Your particular model may not have some of these features.

This owner's manual is for vehicles sold in the United States and Canada.

The information and specifications included in this publication were in effect at the time of approval for printing. Honda Motor Co., Ltd. reserves the right, however, to discontinue or change specifications or design at any time without notice and without incurring any obligation.

Navigation Key	
<b>QRG</b>	Quick Reference Guide
<b>TOC</b>	Chapter Table of Contents
<b>Index</b>	Index
<b>Home</b>	Book Table of Contents

### ➤ Safe Driving P. 23

For Safe Driving P. 24      Seat Belts P. 29      Airbags P. 37

### ➤ Instrument Panel P. 67

Indicators P. 68      Gauges and Displays P. 80

### ➤ Controls P. 97

Setting the Clock P. 98      Locking and Unlocking the Doors P. 99  
Opening and Closing the Moonroof\* P. 123  
Adjusting the Seats P. 137

### ➤ Features P. 171

Audio System P. 172      Audio System Basic Operation P. 216  
General Information on the Audio System P. 272  
Compass\* P. 320

### ➤ Driving P. 323

Before Driving P. 324      Towing a Trailer P. 329  
Parking Your Vehicle P. 364      Rearview Camera\* P. 369  
Accessories and Modifications P. 375

### ➤ Maintenance P. 377

Before Performing Maintenance P. 378      Maintenance Minder™ P. 381  
Checking and Maintaining Wiper Blades P. 410  
Remote Control and Wireless Headphone Care\* P. 425

### ➤ Handling the Unexpected P. 433

Tools P. 434      If a Tire Goes Flat P. 435  
Overheating P. 448      Indicator, Coming On/Blinking P. 450

### ➤ Information P. 463

Specifications P. 464      Identification Numbers P. 466  
Emissions Testing P. 470      Warranty Coverages P. 472  
Gracenote® End User License Agreement P. 476

# Contents

2013 Pilot

Child Safety P. 52

Exhaust Gas Hazard P. 65

Safety Labels P. 66

Opening and Closing the Tailgate P. 110  
Operating the Switches Around the Steering Wheel P. 124  
Interior Lights/Interior Convenience Items P. 150

Security System P. 118

Opening and Closing the Windows P. 120  
Adjusting the Mirrors P. 135  
Climate Control System P. 165

Rear Entertainment System\* P. 251  
HomeLink® Universal Transceiver\* P. 276

Audio Error Messages P. 266

Bluetooth® HandsFreeLink® P. 278

Off-Highway Driving Guidelines P. 340  
Multi-View Rear Camera\* P. 370

When Driving P. 342  
Refueling P. 371

Braking P. 360  
Fuel Economy P. 374

Maintenance Under the Hood P. 389  
Checking and Maintaining Tires P. 414  
Climate Control System Maintenance P. 427

Replacing Light Bulbs P. 402  
Battery P. 423

Remote Transmitter Care P. 424  
Cleaning P. 428

Engine Does Not Start P. 444  
Fuses P. 454

Jump Starting P. 445  
Emergency Towing P. 459

Shift Lever Does Not Move P. 447  
When You Cannot Open the Tailgate P. 461

Devices that Emit Radio Waves P. 467  
Authorized Manuals P. 474

Reporting Safety Defects P. 469  
Customer Service Information P. 475

Quick Reference Guide P. 2

Safe Driving P. 23

Instrument Panel P. 67

Controls P. 97

Features P. 171

Driving P. 323

Maintenance P. 377

Handling the Unexpected P. 433

Information P. 463

Index P. 478

\* Not available on all models

# Visual Index

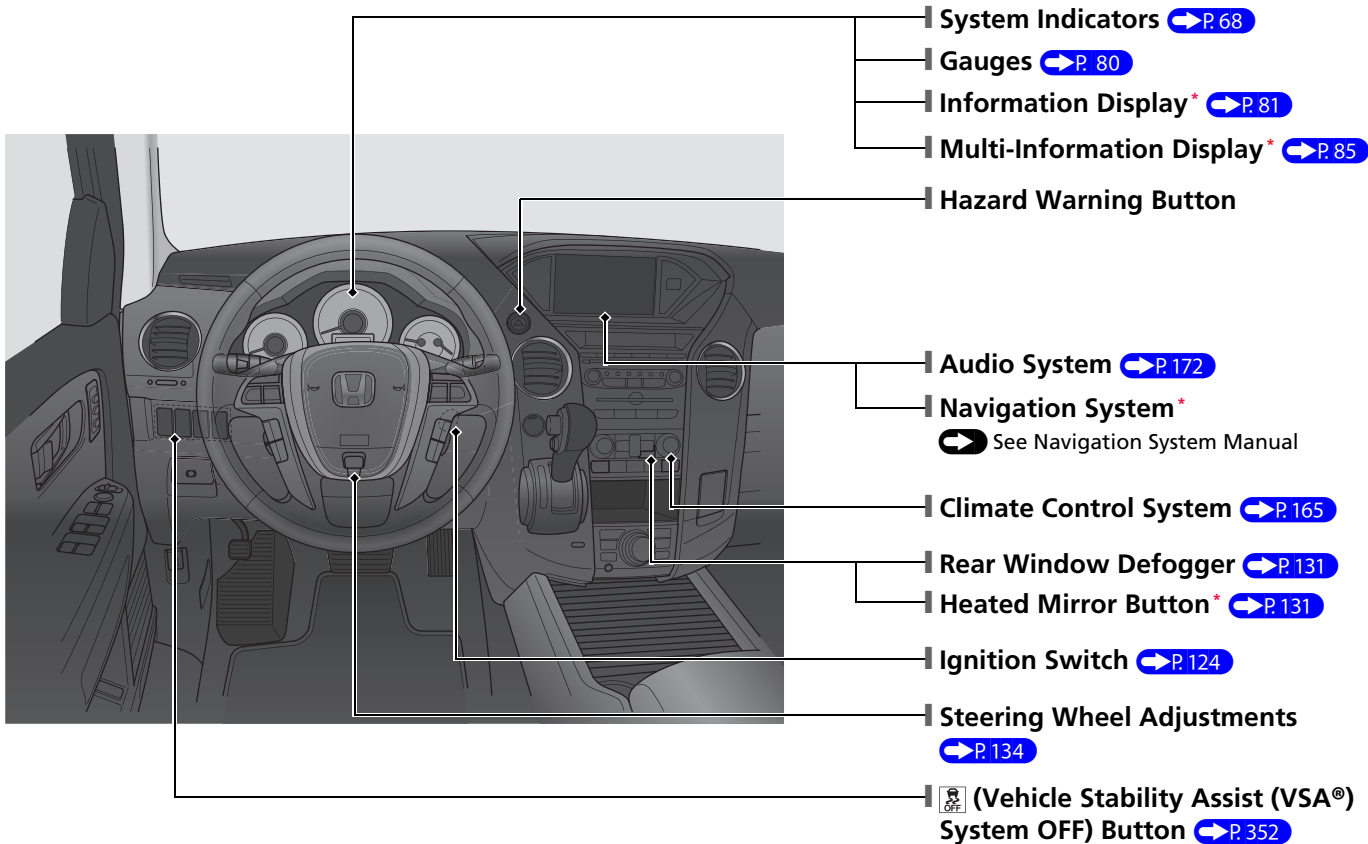

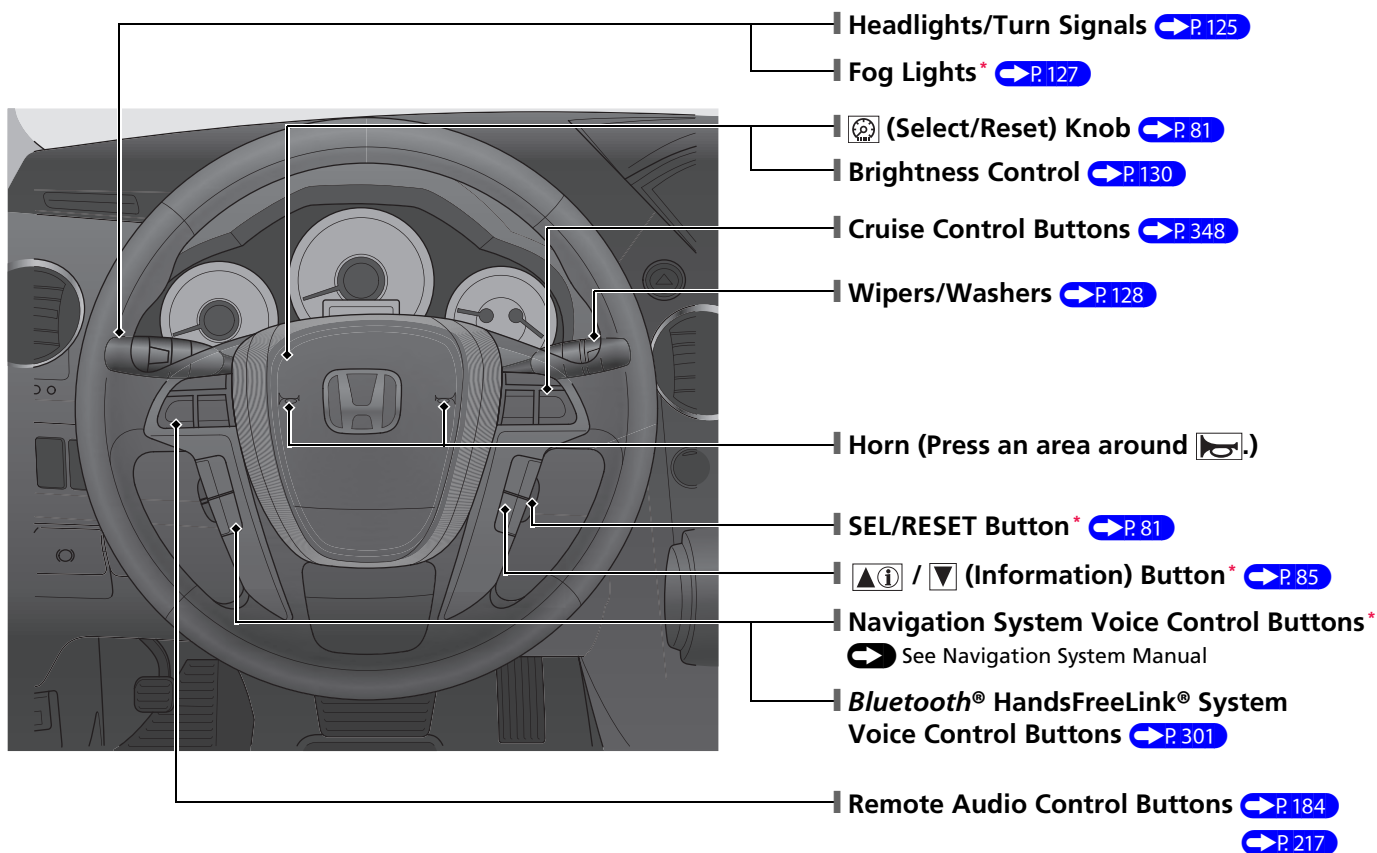

# Visual Index

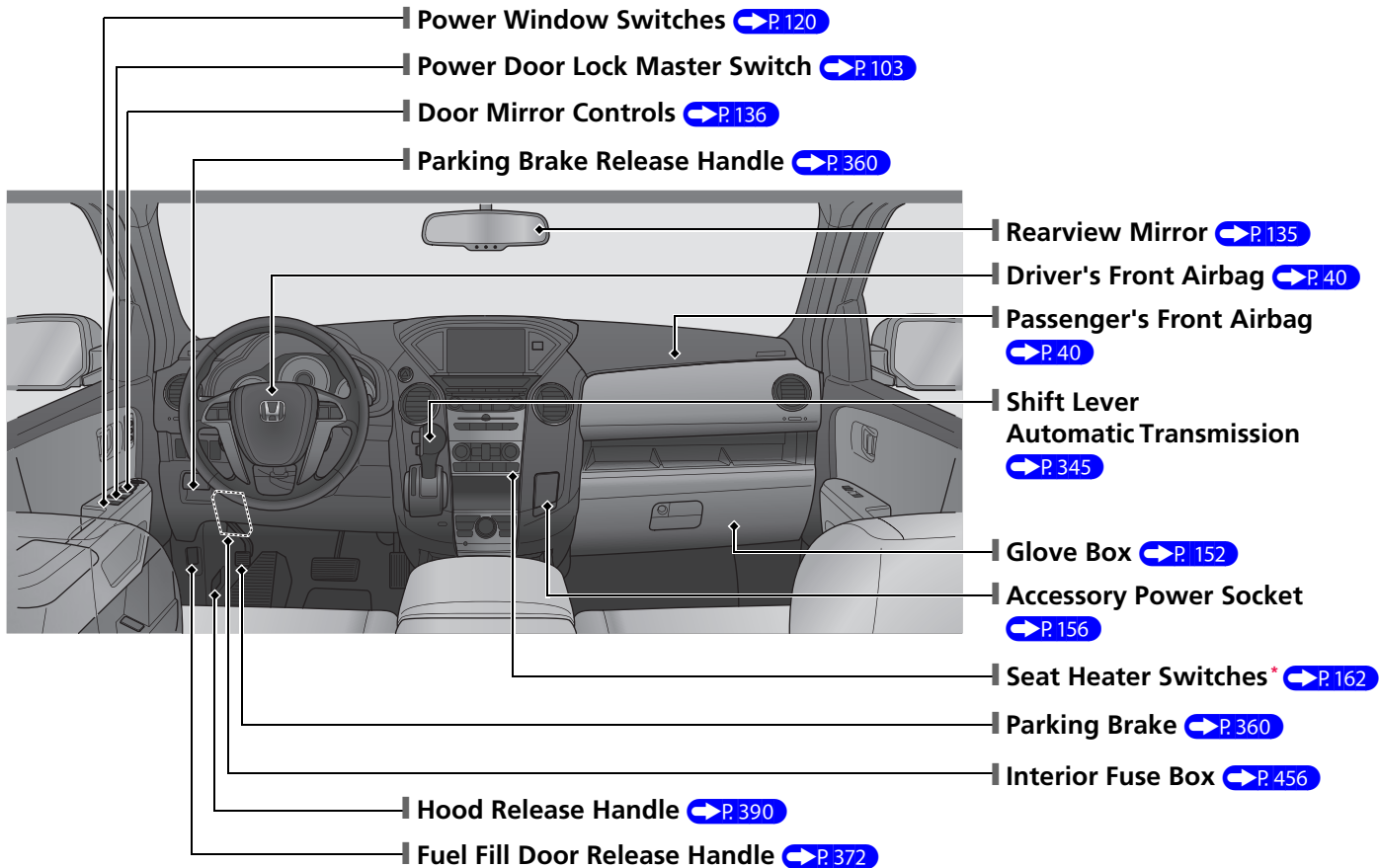

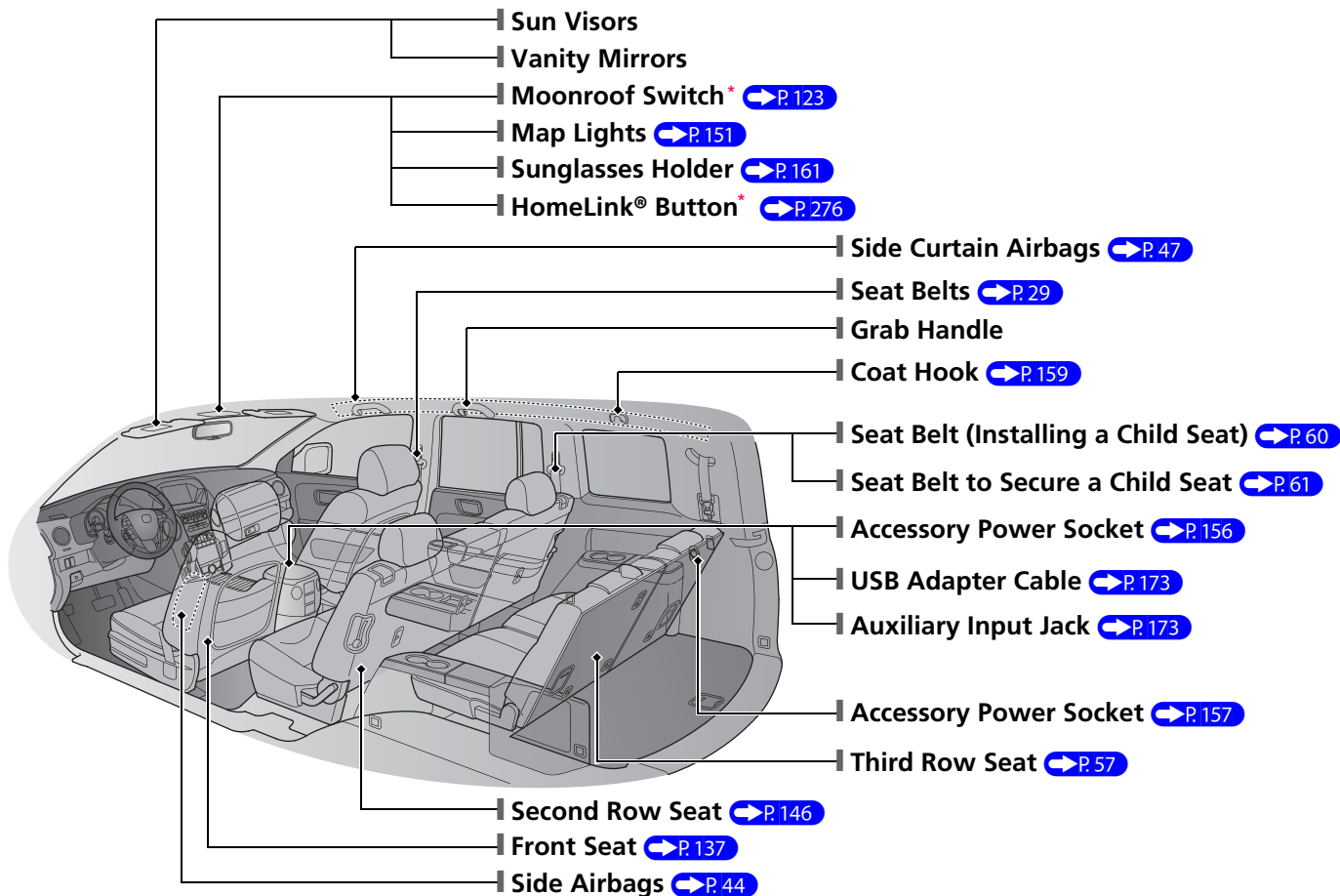

\* Not available on all models

# Visual Index

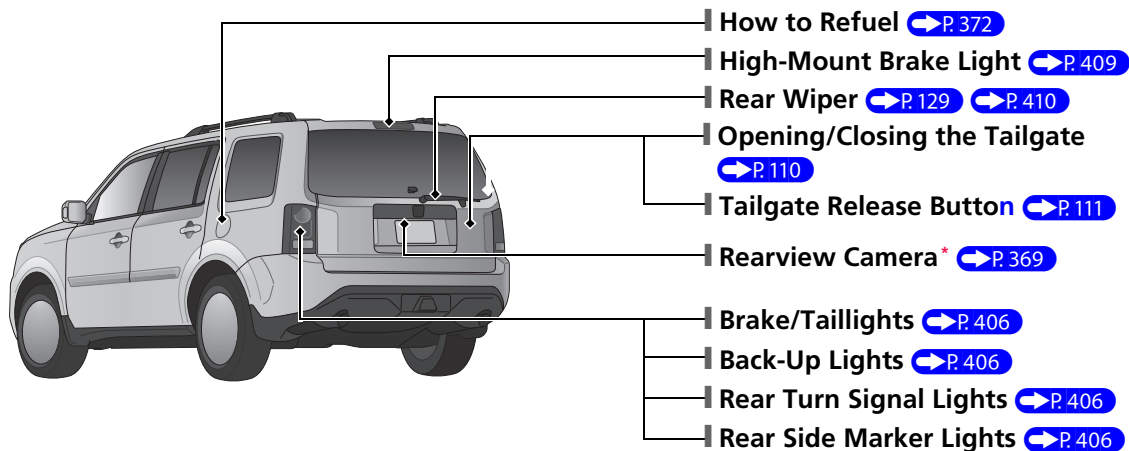
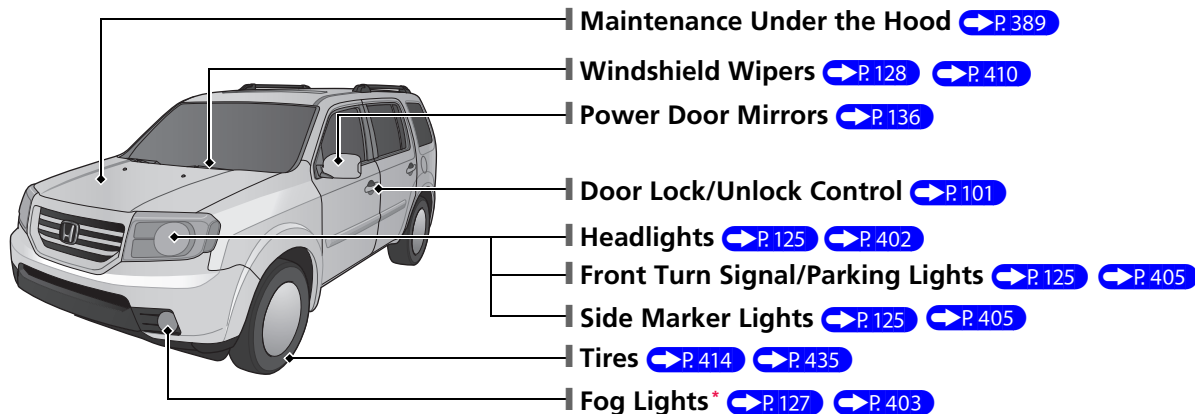

# Safe Driving [P. 23](#)

## Airbags [P. 37](#)

- Your vehicle is fitted with airbags to help protect you and your passengers during a moderate-to-severe collision.

## Child Safety [P. 52](#)

- All children 12 and younger should be seated in the rear seat.
- Smaller children should be properly restrained in a forward-facing child seat.
- Infants must be properly restrained in a rear-facing child seat.

## Exhaust Gas Hazard [P. 65](#)

- Your vehicle emits dangerous exhaust gases that contain carbon monoxide. Do not run the engine in confined spaces where carbon monoxide gas can accumulate.

## Seat Belts [P. 29](#)

- Fasten your seat belt and sit upright well back in the seat.
- Check that your passengers are wearing their seat belts correctly.

## Before Driving Checklist [P. 28](#)

- Before driving, check that the front seats, head restraints, steering wheel, and mirrors have been properly adjusted.

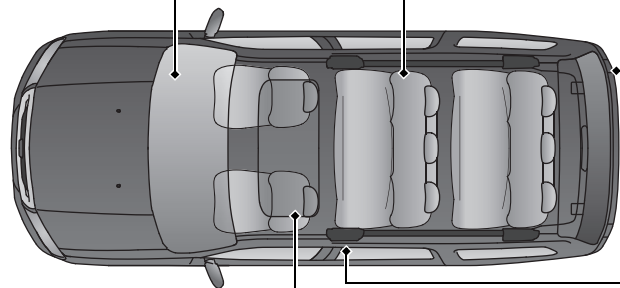

Fasten your lap belt as low as possible.













# Instrument Panel ↔ P. 67

Gauges ↔ P. 80 / Information Display\* ↔ P. 81 /



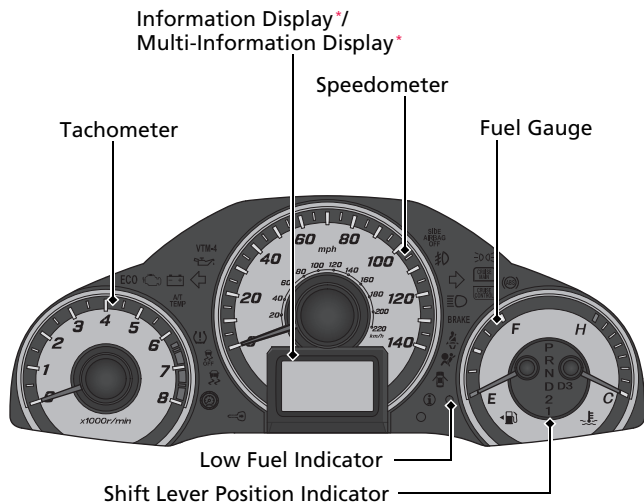

Multi-Information Display\* ↔ P. 85 / System Indicators ↔ P. 68

## System Indicators



-  Malfunction Indicator Lamp
-  Low Oil Pressure Indicator
-  Charging System Indicator
- DRL** Daytime Running Lights Indicator\*
-  Vehicle Stability Assist (VSA®) System Indicator
-  VSA® OFF Indicator
-  **TAIL GATE** U.S. Power Tailgate Indicator\*
-  **ECO** Fuel Economy Indicator
-  **VTM-4** VTM-4® system Indicator\*
-  Immobilizer System Indicator
- BRAKE** U.S. Parking Brake and Brake System Indicator
-  Canada









## System Indicators

- TPMS**  TPMS Indicator\*
-  Low Tire Pressure Indicator\*/Low Tire Pressure/TPMS Indicator\*
-  Maintenance Minder Indicator\*
-  Washer Level Indicator\*

## Lights Reminders

-  Lights On Indicator
-  High Beam Indicator
-  Fog Light Indicator\*

## System Indicators





-  Turn Signal and Hazard Warning Indicators
-  Security System Alarm Indicator\*
-  Seat Belt Reminder Indicator
-  Supplemental Restraint System Indicator
-  **SIDE AIRBAG OFF** U.S. Side Airbag Off Indicator
-  **CRUISE MAIN** CRUISE MAIN Indicator
-  **CRUISE CONTROL** CRUISE CONTROL Indicator
-  **STARTER SYSTEM** U.S. Starter System Indicator\*
-  Canada
-  Door Open Indicator
-  **A/T TEMP** A/T Temperature Indicator\*
-  System Message Indicator\*
-  **(ABS)** Anti-lock Brake System (ABS) Indicator

\* Not available on all models

# Controls [P. 97](#)

## Clock [P. 98](#)

### Models without navigation system

- 1 Press the **CLOCK** button to access the clock adjustment mode screen.
- 2 Press  to select the item you want to adjust (12/24 hour mode, hour, minutes).
- 3 Rotate  to make the adjustment.
- 4 Press  to enter your selection. Repeat steps 2 to 4 to adjust other items.
- 5 To enter the selection, press  and select **EXIT**, then press .

### Models with navigation system

The navigation system receives signals from GPS satellites, updating the clock automatically.

## Turn Signals [P. 125](#)

### Turn Signal Control Lever

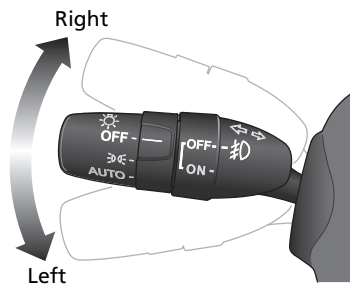

## Lights [P. 125](#)

### Light Control Switches

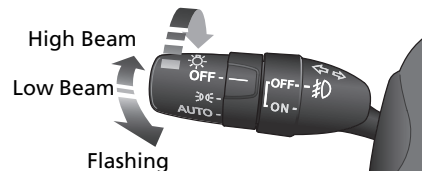

## Wipers and Washers

➔ P.128

Wiper/Washer Control Lever

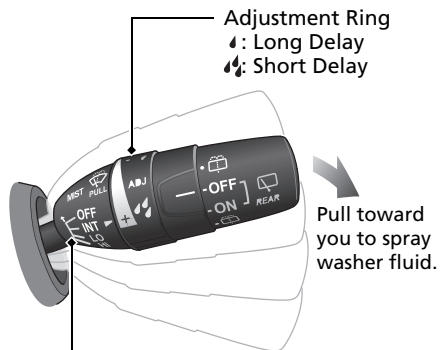

Adjustment Ring  
⬇: Long Delay  
⬇: Short Delay

Pull toward you to spray washer fluid.

MIST  
OFF

INT: Low speed with intermittent  
LO: Low speed wipe  
HI: High speed wipe

## Steering Wheel ➔ P.134

- To adjust, pull the adjustment lever towards you, adjust to the desired position, then lock the lever back in place.

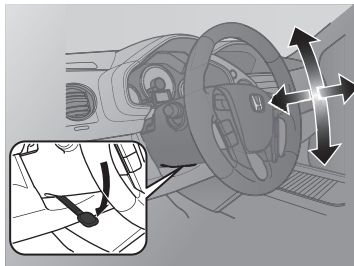

## Tailgate ➔ P.110

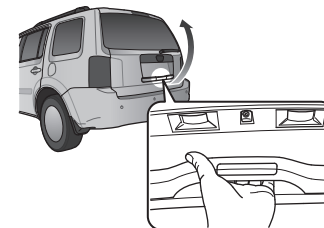

- With all the doors unlocked, press the tailgate release button and lift open the tailgate.

### Models with the power tailgate

- Press the power tailgate button on the driver's door or the remote transmitter to open and close the power tailgate.

## Glass Hatch ➔ P.116

- To open the glass hatch, press the glass hatch release button on the tailgate.

### Models without the power tailgate

- Press the glass hatch release button on the driver's door or the remote transmitter to open the glass hatch.

## Power Door Mirrors

➔ P.136

- With the ignition switch in ON **II**, move the selector switch to **L** or **R**.
- Push the appropriate edge of the adjustment switch to adjust the mirror.
- Place the selector switch in the **L** or **R** position to use the reverse tilt door mirror feature.

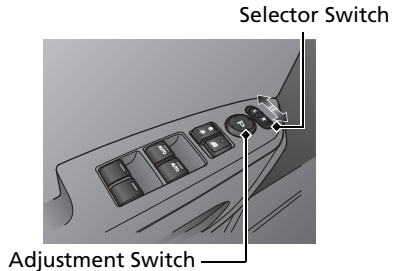

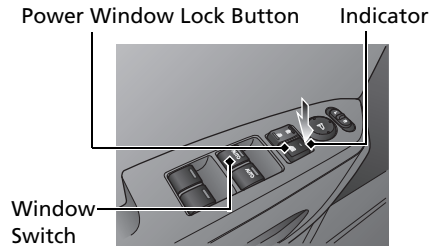

## Power Windows ➔ P.120

- With the ignition switch in ON **II**, open and close the power windows.
- If the power window lock button is in the off position, each passenger's window can be opened and closed with its own switch.
- If the power window lock button is in the on position (indicator is on), each passenger's window switch is disabled.



# Climate Control System ▶ P.165



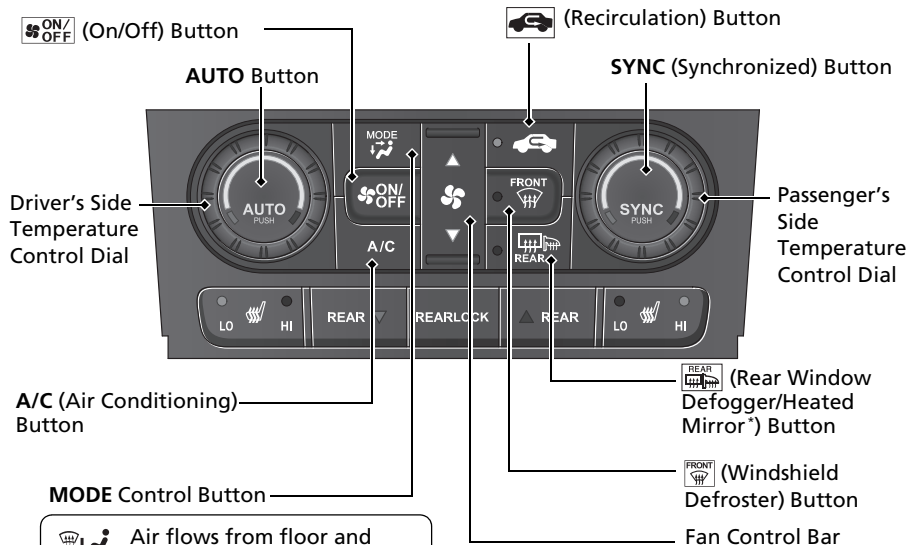

- Press the **AUTO** button to activate the climate control system.
- Press the  button to turn the system on or off.
- Press the  button to defrost the windshield.

## Models with navigation system

The climate control system is voice operable. See the navigation system manual for complete details.



**MODE Control Button**



-  Air flows from floor and windshield defroster vents.
-  Air flows from floor vents.
-  Air flows from floor and dashboard vents.
-  Air flows from dashboard vents.

## Rear Climate Control

- Press the **AUTO** button to activate the rear climate control system.
- Press the **OFF** button repeatedly to turn the system off.

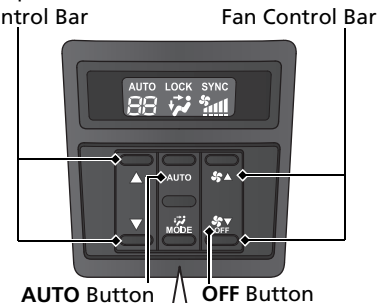
Rear Passenger Compartment Temperature Control Bar



-  Airflows from the rear floor vents
-  Airflow is divided between the rear floor vents and rear ceiling vents.
-  Airflows from the rear ceiling vents

# Features [↔ P.171](#)

## Audio System [↔ P.172](#)

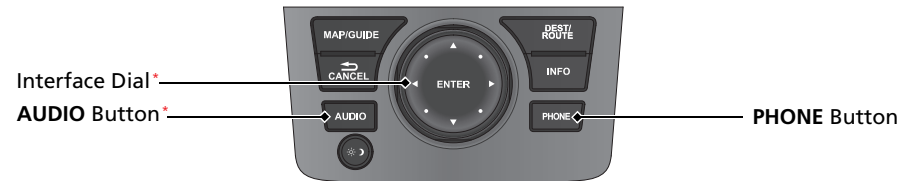

### ● Audio Remote Controls [↔ P.184](#)

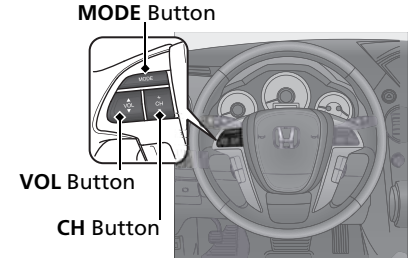

- **VOL (Volume) Button**  
Press and release to adjust the volume up/down.
- **MODE Button**  
Press and release to change the audio mode: FM1/FM2/AM/XM1\*/XM2\*/CD/CD-L\*/HDD\*/AUX.
- **CH (Channel) Button**  
Radio: Press and release to change the preset station.  
Press and hold to select the next or previous strong station.  
CD/CD Library\*/HDD\*/USB device:  
Press and release to skip to the beginning of the next song or return to the beginning of the current song.  
Press and hold to change a folder.

# Driving [P. 323](#)

## Automatic Transmission [P. 346](#)

- Shift to **P** and depress the brake pedal when starting the engine.

### ● Shifting

**P** **Park**  
Turn off or start the engine.  
Transmission is locked.

**R** **Reverse**

**N** **Neutral**  
Transmission is not locked.

**D** **Drive**  
Normal driving.

**2** **Second**  
Used to increase engine braking (the transmission is locked in 2nd gear)

**1** **First**  
Used to further increase engine braking (the transmission is locked in 1st gear)

**D3** **Drive (D3)**  
Press the **D3** button while the shift lever is in **D**.

Used when:

- Going up or down hills
- Towing a trailer in hilly terrain

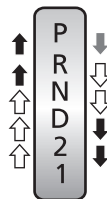
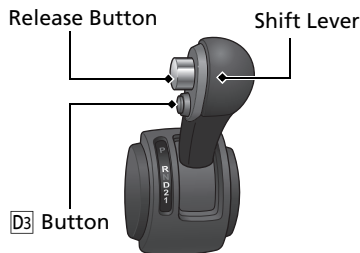

↓  
Depress the brake pedal and press the release button to move out of **P**.

↓ ↑  
Press the release button to move the shift lever.

↓ ↑  
Move the shift lever without pressing the release button.

## VSA® OFF Button [↔ P.353](#)

- The vehicle stability assist (VSA®) system helps stabilize the vehicle during cornering, and helps maintain traction while accelerating on loose or slippery road surfaces.
- VSA® comes on automatically every time you start the engine.
- To turn VSA® on or off, press and hold the button until you hear a beep.

## Cruise Control [↔ P.348](#)

- Cruise control allows you to maintain a set speed without keeping your foot on the accelerator pedal.
- To use cruise control, press the **CRUISE** button, then press **DECEL/SET** button once you have achieved the desired speed (above 25 mph or 40 km/h).

## Tire Pressure Monitoring System (TPMS) [↔ P.355](#)

- **TPMS** monitors tire pressure.
- **TPMS** is turned on automatically every time you start the engine.

## Refueling [↔ P.371](#)

**Fuel recommendation:** Unleaded gasoline with a pump octane number 87 or higher required

**Fuel tank capacity:** 21 US gal (79.5 L)

- 1** Pull the fuel fill door release handle.

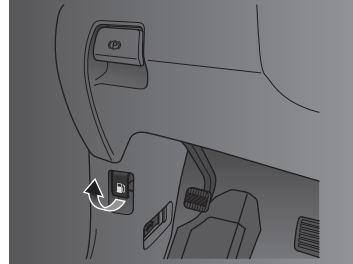

- 2** Turn the fuel fill cap slowly to remove the cap.

- 3** Place the cap in the holder on the fuel fill door.

- 4** After refueling, screw the cap back on until it clicks at least once.

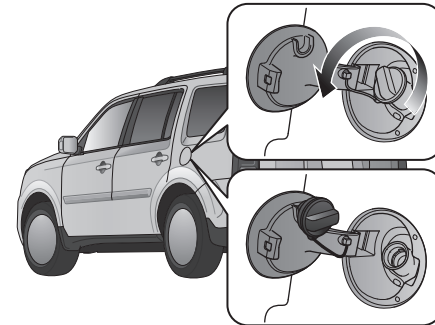



# Maintenance [↔ P.377](#)

## Under the Hood [↔ P.389](#)

- Check engine oil, engine coolant, and windshield washer fluid. Add when necessary.
- Check brake fluid.
- Check the battery condition monthly.

- 1 Pull the hood release handle under the corner of the dashboard.



- 2 Locate the hood latch lever, pull the lever up, and lift up the hood.



- 3 When finished, close the hood and make sure it is firmly locked in place.

## Wiper Blades [↔ P.410](#)

- Replace blades if they leave streaks across the windshield.

## Lights [↔ P.402](#)

- Inspect all lights regularly.

## Tires [↔ P.414](#)

- Inspect tires and wheels regularly.
- Check tire pressures regularly.
- Install snow tires for winter driving

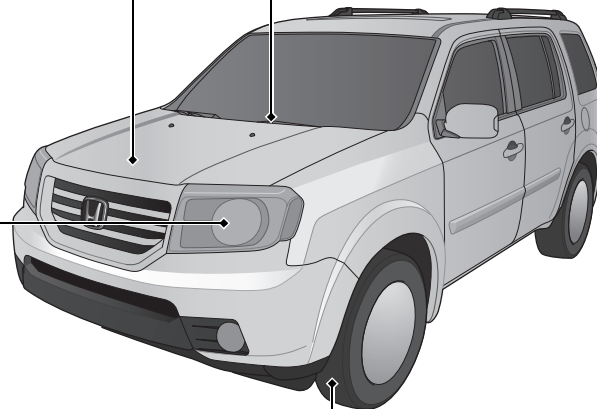

# Handling the Unexpected [➔ P. 433](#)

## Flat Tire [➔ P. 435](#)

- Park in a safe location and replace the flat tire with the compact spare tire in the cargo area.



## Engine Won't Start [➔ P. 444](#)

- If the battery is dead, jump start using a booster battery.

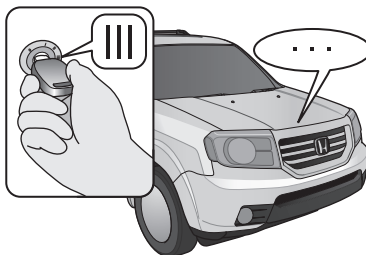

## Overheating [➔ P. 448](#)

- Park in a safe location. If you do not see steam under the hood, open the hood, and let the engine cool down.



## Indicators Come On

[➔ P. 450](#)

- Identify the indicator and consult the owner's manual.

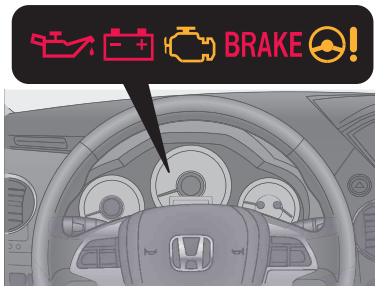

## Blown Fuse [➔ P. 454](#)

- Check for a blown fuse if an electrical device does not operate.

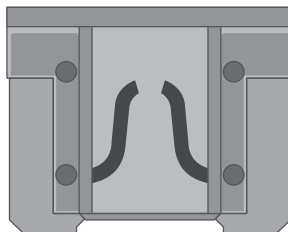

## Emergency Towing [➔ P. 459](#)

- Call a professional towing service if you need to tow your vehicle.

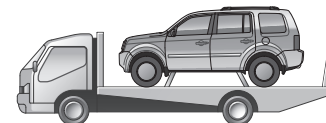

# What to Do If

**Q** The ignition switch does not turn from **0** to **1**. Why?

**A**

- The steering wheel may be locked.
- Try to turn the steering wheel left and right while turning the ignition key.



**Q** The ignition switch does not turn from **1** to **0** and I cannot remove the key. Why?

**A** The shift lever should be moved to **P**.



**Q** Why does the brake pedal pulsate slightly when applying the brakes?

**A** This can occur when the ABS activates, and does not indicate a problem. Apply firm, steady pressure on the brake pedal. Never pump the brake pedal.

**Q** The rear door cannot be opened from inside the vehicle. Why?

**A** Check if the childproof lock is in the lock position. If so, open the rear door with the outside door handle. To cancel this function, push the lever to the unlock position.

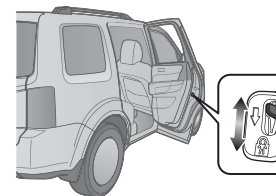



**Why do the doors lock after I unlocked the doors using a remote transmitter?**



If you do not open the doors within 30 seconds, the doors are relocked automatically for security.



**Why does the beeper sound when I open the driver's door?**



The beeper sounds when:

- The key is left in the ignition switch.
- The exterior lights are left on.



**Why does the beeper sound when I start driving?**



The beeper sounds when:

- Driver and/or front passenger are not wearing their seat belts.
- The parking brake lever is not fully released.



**Why do I hear a screeching sound when I apply the brake pedal?**



The brake pads may need to be replaced. Have your vehicle inspected by a dealer.

## California Proposition 65 Warning

**WARNING:** This product contains or emits chemicals known to the state of California to cause cancer and birth defects or other reproductive harm.

### Event Data Recorders

**This vehicle is equipped with an event data recorder (EDR).**

The main purpose of an EDR is to record, in certain crash or near crash-like situations, such as an air bag deployment or hitting a road obstacle, data that will assist in understanding how a vehicle's systems performed. **The EDR is designed to record data related to vehicle dynamics and safety systems for a short period of time, typically 30 seconds or less. The EDR in this vehicle is designed to record such data as:**

- **How various systems in your vehicle were operating;**
- **Whether or not the driver and passenger safety belts were buckled/fastened;**
- **How far (if at all) the driver was depressing the accelerator and/or brake pedal; and,**
- **How fast the vehicle was traveling.**

These data can help provide a better understanding of the circumstances in which crashes and injuries occur. NOTE: EDR data are recorded by your vehicle only if a non-trivial crash situation occurs; no data are recorded by the EDR under normal driving conditions and no personal data (e.g., name, gender, age, and crash location) are recorded. However, other parties, such as law enforcement, could combine the EDR data with the type of personally identifying data routinely acquired during a crash investigation.

To read data recorded by an EDR, special equipment is required, and access to the vehicle or the EDR is needed. In addition to the vehicle manufacturer, other parties, such as law enforcement, that have the special equipment, can read the information if they have access to the vehicle or the EDR.

The data belongs to the vehicle owner and may not be accessed by anyone else except as legally required or with the permission of the vehicle owner.

### Service Diagnostic Recorders

This vehicle is equipped with service-related devices that record information about powertrain performance. The data can be used to verify emissions law requirements and/or help technicians diagnose and solve service problems. It may also be combined with data from other sources for research purposes, but it remains confidential.

### California Perchlorate Contamination Prevention Act

The airbags, seat belt tensioners, and CR type batteries in this vehicle may contain perchlorate materials - special handling may apply. See [www.dtsca.gov/hazardouswaste/perchlorate/](http://www.dtsca.gov/hazardouswaste/perchlorate/)

As you read this manual, you will find information that is preceded by a **NOTICE** symbol. This information is intended to help you avoid damage to your vehicle, other property, or the environment.

## A Few Words About Safety

---

Your safety, and the safety of others, is very important. And operating this vehicle safely is an important responsibility.

To help you make informed decisions about safety, we have provided operating procedures and other information on labels and in this manual. This information alerts you to potential hazards that could hurt you or others.

Of course, it is not practical or possible to warn you about all the hazards associated with operating or maintaining your vehicle. You must use your own good judgement.

You will find this important safety information in a variety of forms, including:

- **Safety Labels** - on the vehicle.
- **Safety Messages** - preceded by a safety alert symbol  and one of three signal words: **DANGER**, **WARNING**, or **CAUTION**. These signal words mean:

### **DANGER**

You **WILL** be **KILLED** or **SERIOUSLY HURT** if you don't follow instructions.

### **WARNING**

You **CAN** be **KILLED** or **SERIOUSLY HURT** if you don't follow instructions.

### **CAUTION**

You **CAN** be **HURT** if you don't follow instructions.

- **Safety Headings** - such as Important Safety Precautions.
- **Safety Section** - such as Safe Driving.
- **Instructions** - how to use this vehicle correctly and safely.

This entire book is filled with important safety information - please read it carefully.



# Safe Driving

You can find many safety recommendations throughout this chapter, and throughout this manual.

## For Safe Driving

- Important Safety Precautions ..... 24
- Important Handling Information..... 26
- Your Vehicle's Safety Features..... 27

## Seat Belts

- About Your Seat Belts..... 29
- Fastening a Seat Belt..... 32
- Seat Belt Inspection..... 36

## Airbags

- Airbag System Components..... 37
- Types of Airbags ..... 40
- Front Airbags (SRS) ..... 40

- Side Airbags ..... 44
- Side Curtain Airbags..... 47
- Airbag System Indicators..... 48
- Airbag Care..... 51

## Child Safety

- Protecting Child Passengers ..... 52
- Safety of Infants and Small Children ..... 54
- Safety of Larger Children ..... 63

## Exhaust Gas Hazard

- Carbon Monoxide Gas..... 65

## Safety Labels

- Label Locations ..... 66



The following pages explain your vehicle's safety features and how to use them properly. The safety precautions below are ones that we consider to be among the most important.

## Important Safety Precautions

### ■ Always wear your seat belt

A seat belt is your best protection in all types of collisions. Airbags are designed to supplement seat belts, not replace them. So even though your vehicle is equipped with airbags, make sure you and your passengers always wear your seat belts, and wear them properly.

### ■ Restrain all children

Children age 12 and under should ride properly restrained in a back seat, not the front seat. Infants and small children should be restrained in a child seat. Larger children should use a booster seat and a lap/shoulder seat belt until they can use the belt properly without a booster seat.

### ■ Be aware of airbag hazards

While airbags can save lives, they can cause serious or fatal injuries to occupants who sit too close to them, or are not properly restrained. Infants, young children, and short adults are at the greatest risk. Be sure to follow all instructions and warnings in this manual.

### ■ Don't drink and drive

Alcohol and driving don't mix. Even one drink can reduce your ability to respond to changing conditions, and your reaction time gets worse with every additional drink. So don't drink and drive, and don't let your friends drink and drive, either.

### ▣ Important Safety Precautions

Some states, provinces and territories prohibit the use of cell phones other than hands-free devices by the driver while driving.

### ■ Pay appropriate attention to the task of driving safely

Engaging in cell phone conversation or other activities that keep you from paying close attention to the road, other vehicles, and pedestrians could lead to a crash. Remember, situations can change quickly, and only you can decide when it is safe to divert some attention away from driving.

### ■ Control your speed

Excessive speed is a major factor in crash injuries and deaths. Generally, the higher the speed, the greater the risk, but serious injuries can also occur at lower speeds. Never drive faster than is safe for current conditions, regardless of the maximum speed posted.

### ■ Keep your vehicle in safe condition

Having a tire blowout or a mechanical failure can be extremely hazardous. To reduce the possibility of such problems, check your tire pressures and condition frequently, and perform all regularly scheduled maintenance.

## Important Handling Information

Your vehicle has higher ground clearance than a passenger vehicle designed for use only on pavement. Higher ground clearance has many advantages for off-highway driving. It allows you to travel over bumps, obstacles, and rough terrain. It also provides good visibility so you can anticipate problems earlier.

These advantages come at some cost. Because your vehicle is taller and rides higher off the ground, it has a higher center gravity making it more susceptible to tripping or roll over if you make abrupt turns. Utility vehicles have a significantly higher rollover rate than other types of vehicles. In a rollover crash, an unbelted person is significantly more likely to die than a person wearing a seat belt. As a reminder, make sure you and your passengers always wear seat belts.

### ► Important Handling Information

For information on how to reduce the risk of rollover, read:

► [Driving Guidelines for Your Utility Vehicle](#)

P. 344

► [Off-Highway Driving Guidelines P. 340](#)

Failure to operate your vehicle correctly might result in a crash or a rollover.

## Your Vehicle's Safety Features

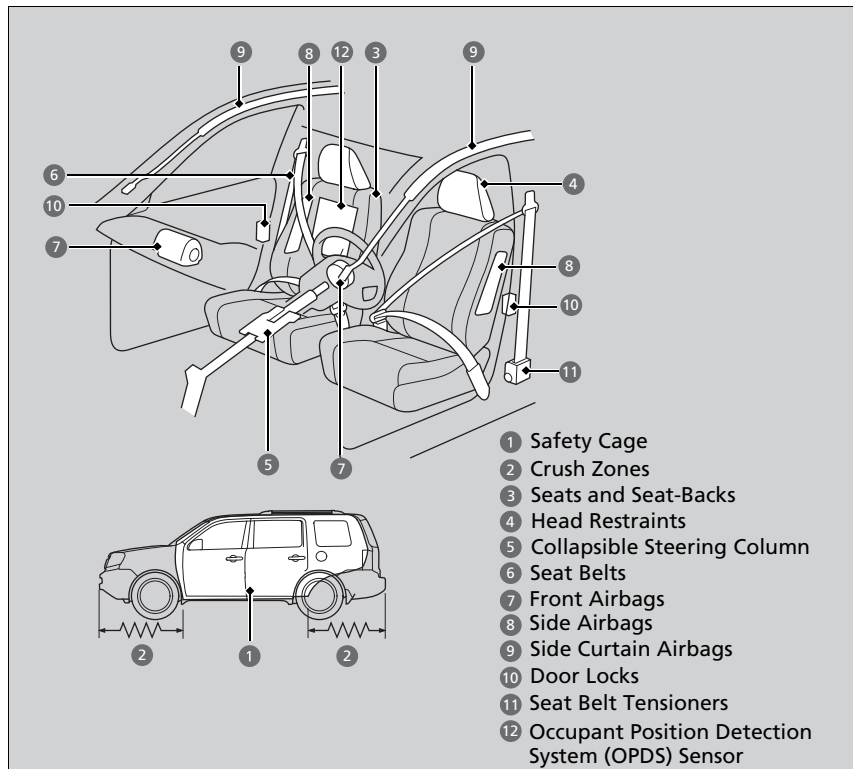

The following checklist will help you take an active role in protecting yourself and your passengers.

### Your Vehicle's Safety Features

Your vehicle is equipped with many features that work together to help protect you and your passengers during a crash.

Some features do not require any action on your part. These include a strong steel framework that forms a safety cage around the passenger compartment, front and rear crush zones, a collapsible steering column, and tensioners that tighten the front seat belts in a sufficient crash.

However, you and your passengers cannot take full advantage of these features unless you remain seated in the correct position and always wear your seat belts. In fact, some safety features can contribute to injuries if they are not used properly.

## Safety Checklist

For the safety of you and your passengers, make a habit of checking these items each time before you drive.

- After everyone has entered the vehicle, be sure all doors and the tailgate are closed and locked. Locking the doors and the tailgate helps prevent an occupant from being ejected and an outsider from unexpectedly opening a door or the tailgate.
  - [Locking/Unlocking the Doors from the Inside](#) P. 103
- Adjust your seat to a position suitable for driving. Be sure the front seats are adjusted as far to the rear as possible while allowing the driver to control the vehicle. Sitting too close to a front airbag can result in serious or fatal injury in a crash.
  - [Adjusting the Seats](#) P. 137
- Adjust head restraints to the proper position. Head restraints are most effective when the center of the head restraint aligns with the center of your head. Taller persons should adjust their head restraint to the highest position.
  - [Adjusting the Head Restraints](#) P. 141
- Always wear your seat belt, and make sure you wear it properly. Confirm that any passengers are properly belted as well.
  - [Fastening a Seat Belt](#) P. 32
- Protect children by using seat belts or child seats according to a child's age, height and weight.
  - [Child Safety](#) P. 52

## Safety Checklist

If the door and/or the tailgate open indicator is on, a door and/or the tailgate is not completely closed. Close all doors and the tailgate tightly until the indicator goes off.

► [Door Open Indicator](#) P. 72

► [Door, Glass Hatch, and Tailgate Open Indicator\\*](#) P. 72

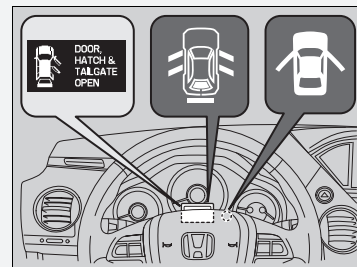

## About Your Seat Belts

Seat belts are the single most effective safety device because they keep you connected to the vehicle so that you can take advantage of many built-in safety features. They also help keep you from being thrown against the inside of the vehicle, against other passengers, or out of the vehicle. When worn properly, seat belts also keep your body properly positioned in a crash so that you can take full advantage of the additional protection provided by the airbags.

In addition, seat belts help protect you in almost every type of crash, including:

- frontal impacts
- side impacts
- rear impacts
- rollovers

### ■ Lap/shoulder seat belts

All eight seating positions are equipped with lap/shoulder seat belts with emergency locking retractors. In normal driving the retractor lets you move freely while keeping some tension on the belt. During a collision or sudden stop the retractor locks to restrain your body. The second and third row passenger's seat belts also have a lockable retractor for use with child seats.

[▶ Installing a Child Seat with a Lap/Shoulder Seat Belt P. 60](#)

▶ About Your Seat Belts

### ⚠ WARNING

**Not wearing a seat belt properly increases the chance of serious injury or death in a crash, even though your vehicle has airbags.**

**Be sure you and your passengers always wear seat belts and wear them properly.**

Seat belts cannot completely protect you in every crash. But in most cases, seat belts can reduce your risk of serious injury.

Most states and all Canadian provinces and territories require you to wear seat belts.

## ■ Proper use of seat belts

Follow these guidelines for proper use:

- All occupants should sit upright, well back in the seat, and remain in that position for the duration of the trip. Slouching and leaning reduces the effectiveness of the belt and can increase the chance of serious injury in a crash.
- Never place the shoulder part of a lap/shoulder seat belt under your arm or behind your back. This could cause very serious injuries in a crash.
- Two people should never use the same seat belt. If they do, they could be very seriously injured in a crash.
- Do not put any accessories on the seat belts. Devices intended to improve comfort or reposition the shoulder part of a seat belt can reduce the protective capability and increase the chance of serious injury in a crash.

## ■ Seat Belt Reminder

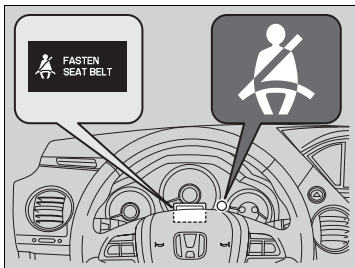

Your vehicle monitors front seat belt use. If the ignition switch is turned to ON **II** before the driver's seat belt is fastened, a beeper will sound and the indicator will blink. If the driver does not fasten the belt before the beeper stops, the indicator will remain on.

The beeper will also periodically sound and the indicator will blink while driving until the driver's and front passenger's seat belts are fastened.

## ▶▶ About Your Seat Belts

If a rear seat passenger moves around and extends the seat belt, the lockable retractor may activate. If this happens, release the retractor by unfastening the seat belt and allow the belt to retract completely. Then refasten the belt.

## ▶▶ Seat Belt Reminder

The indicator will also come on if a front passenger does not fasten their seat belt within 6 seconds after the ignition switch is turned to ON **II**. When no one is sitting in the front passenger's seat, or a child or small adult is riding there, the indicator will not come on. This is because the weight sensors in the seat cannot detect their presence.

## Automatic Seat Belt Tensioners

The front seats are equipped with automatic seat belt tensioners to enhance safety.

The tensioners automatically tighten the front seat belts during a moderate-to-severe frontal collision, sometimes even if the collision is not severe enough to inflate the front airbags.

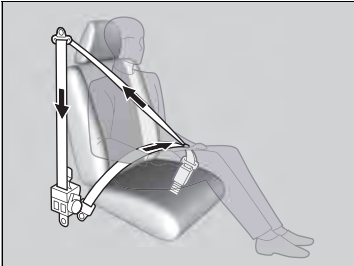

### Automatic Seat Belt Tensioners

The seat belt tensioners can only operate once. If a tensioner is activated, the SRS indicator will come on. Have a dealer replace the tensioner and thoroughly inspect the seat belt system as it may not offer protection in a subsequent crash.

During a moderate-to-severe side impact, the tensioner on that side of the vehicle also activates.



## Fastening a Seat Belt

After adjusting a front seat to the proper position, and while sitting upright and well back in the seat:

▶ [Adjusting the Seats](#) P. 137

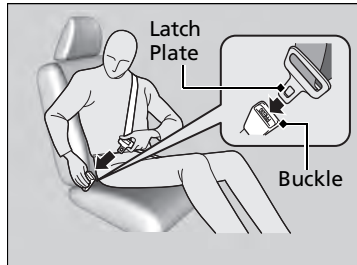
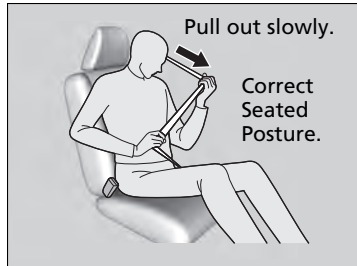

1. Pull the seat belt out slowly.

2. Insert the latch plate into the buckle, then tug on the belt to make sure the buckle is secure.

▶ Make sure that the belt is not twisted or caught on anything.

### Fastening a Seat Belt

No one should sit in a seat with an inoperative seat belt or one that does not appear to be working correctly. Using a seat belt that is not working properly may not protect the occupant in a crash. Have a dealer check the belt as soon as possible.

Never insert any foreign objects into the buckle or retractor mechanism.



3. Position the lap part of the belt as low as possible across your hips, then pull up on the shoulder part of the belt so the lap part fits snugly. This lets your strong pelvic bones take the force of a crash and reduces the chance of internal injuries.
4. If necessary, pull up on the belt again to remove any slack, then check that the belt rests across the center of your chest and over your shoulder. This spreads the forces of a crash over the strongest bones in your upper body.

## ■ Adjusting the Shoulder Anchor

The front seats have adjustable shoulder anchors to accommodate taller and shorter occupants.

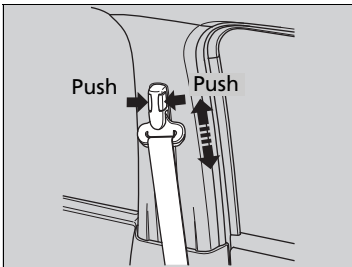

1. Move the anchor up and down while holding the release button.
2. Position the anchor so that the belt rests across the center of your chest and over your shoulder.

### ⊞ Fastening a Seat Belt

## ⚠ WARNING

Improperly positioning the seat belts can cause serious injury or death in a crash.

Make sure all seat belts are properly positioned before driving.

To release the belt, push the red **PRESS** button then guide the belt by hand until it has retracted completely.

When exiting the vehicle, be sure the belt is out of the way and will not get caught by closing the door.

### ⊞ Adjusting the Shoulder Anchor

The shoulder anchor height can be adjusted to four levels. If the belt contacts your neck, lower the height one level at a time.

After an adjustment, make sure that the shoulder anchor position is secure.

## Seat Belt with Detachable Anchor

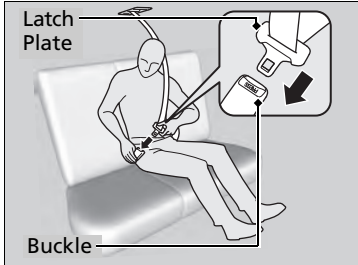
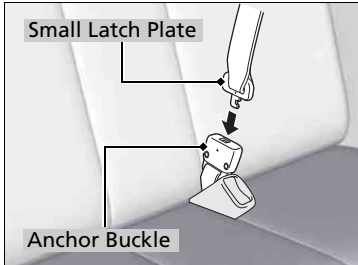
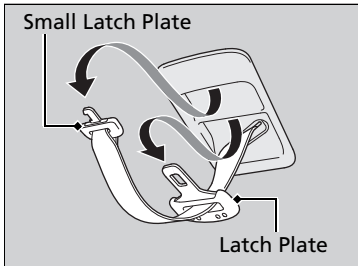

1. Pull out the seat belt's small latch plate and the latch plate from each holding slot in the ceiling.

2. Line up the triangle marks on the small latch plate and anchor buckle. Make sure the seat belt is not twisted. Attach the belt to the anchor buckle.

3. Insert the latch plate into the buckle. Properly fasten the seat belt the same way you fasten the lap/shoulder seat belt.

## Seat Belt with Detachable Anchor

### **WARNING**

Using the seat belt with the detachable anchor unlatched increases the chance of serious injury or death in a crash.

Before using the seat belt, make sure the detachable anchor is correctly latched.

To unlatch the detachable anchor, insert the latch plate into the slot on the side of the anchor buckle.

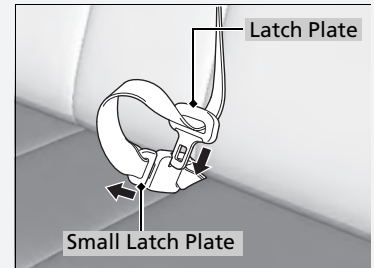

## Advice for Pregnant Women

If you are pregnant, the best way to protect yourself and your unborn child when driving or riding in a vehicle is to always wear a seat belt and keep the lap part of the belt as low as possible across the hips.

Wear the shoulder belt across the chest avoiding the abdomen.



Wear the lap part of the belt as low as possible across the hips.

### Advice for Pregnant Women

Each time you have a checkup, ask your doctor if it is okay for you to drive.

To reduce the risk of injuries to both you and your unborn child that can be caused by an inflating front airbag:

- When driving, sit upright and adjust the seat as far back as possible while allowing full control of the vehicle.
- When sitting in the front passenger's seat, adjust the seat as far back as possible.

## Seat Belt Inspection

Regularly check the condition of your seat belts as follows:

- Pull each belt out fully, and look for frays, cuts, burns, and wear.
- Check that the latches work smoothly and the belts retract easily.
  - ▶ If a belt does not retract easily, cleaning the belt may correct the problem. Only use a mild soap and warm water. Do not use bleach or cleaning solvents. Make sure the belt is completely dry before allowing it to retract.

Any belt that is not in good condition or working properly will not provide proper protection and should be replaced as soon as possible.

A belt that has been worn during a crash may not provide the same level of protection in a subsequent crash. Have your seat belts inspected by a dealer after any collision.

### **WARNING**

**Not checking or maintaining seat belts can result in serious injury or death if the seat belts do not work properly when needed.**

**Check your seat belts regularly and have any problem corrected as soon as possible.**

## Airbag System Components

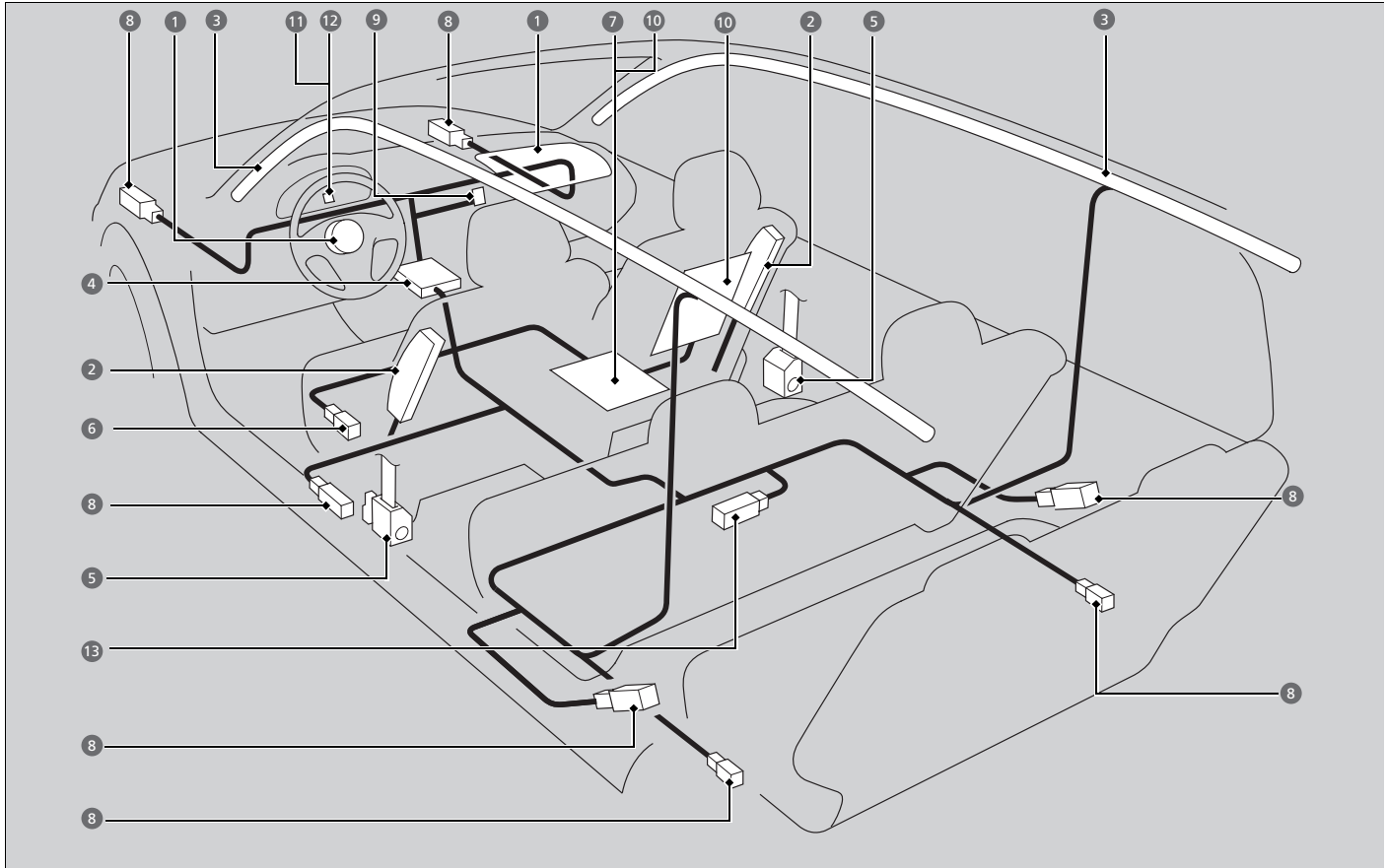

The front, front side, and side curtain airbags are deployed according to the direction and severity of impact. The airbag system includes:

- ① Two SRS (Supplemental Restraint System) front airbags. The driver's airbag is stored in the center of the steering wheel; the front passenger's airbag is stored in the dashboard. Both are marked **SRS AIRBAG**.
- ② Two side airbags, one for the driver and one for a front passenger. The airbags are stored in the outer edges of the seat-backs. Both are marked **SIDE AIRBAG**.
- ③ Two side curtain airbags, one for each side of the vehicle. The airbags are stored in the ceiling, above the side windows. The front and rear pillars are marked **SIDE CURTAIN AIRBAG**.
- ④ An electronic control unit that continually monitors and records information about the sensors, the airbag activators, the seat belt tensioners, and driver and front passenger seat belt use when the ignition switch is in ON **II**.
- ⑤ Automatic front seat belt tensioners. The driver's and front passenger's seat belts incorporate sensors that detect whether or not they are fastened.
- ⑥ A driver's seat position sensor. If the seat is too far forward, the airbag will inflate with less force.
- ⑦ Weight sensors in the front passenger's seat. The front passenger's airbag will be turned off if the weight on the seat is 65 lbs (29 kg) or less (the weight of an infant or small child).
- ⑧ Impact sensors that can detect a moderate to severe front impact, side impact, or if your vehicle is about to rollover.
- ⑨ An indicator on the dashboard that alerts you that the front passenger's front airbag has been turned off.
- ⑩ Sensors that can detect if a child or small statured adult is in the deployment path of the front passenger's side airbag.
- ⑪ An indicator on the instrument panel that alerts you to a possible problem with your airbag system or seat belt tensioners.
- ⑫ An indicator on the instrument panel that alerts you that the front passenger's side airbag has been turned off.
- ⑬ Safing Sensor

## Important Facts About Your Airbags

Airbags can pose serious hazards. To do their job, airbags must inflate with tremendous force. So, while airbags help save lives, they can cause burns, bruises, and other minor injuries, and sometimes even fatal ones if occupants are not wearing their seat belts properly and sitting correctly.

**What you should do:** Always wear your seat belt properly, and sit upright and as far back from the steering wheel as possible while allowing full control of the vehicle. A front passenger should move their seat as far back from the dashboard as possible.

Remember, however, that no safety system can prevent all injuries or deaths that can occur in a severe crash, even when seat belts are properly worn and the airbags deploy.

**Do not place hard or sharp objects between yourself and a front airbag.**

Carrying hard or sharp objects on your lap, or driving with a pipe or other sharp object in your mouth, can result in injuries if your front airbag inflates.

**Do not attach or place objects on the front airbag covers.** Objects on the covers marked **SRS AIRBAG** could interfere with the proper operation of the airbags or be propelled inside the vehicle and hurt someone if the airbags inflate.

### Important Facts About Your Airbags

Do not attempt to deactivate your airbags. Together, airbags and seat belts provide the best protection.

When driving, keep hands and arms out of the deployment path of the front airbag by holding each side of the steering wheel. Do not cross an arm over the airbag cover.



## Types of Airbags

Your vehicle is equipped with three types of airbags:

- **Front airbags:** Airbags in front of the driver's and front passenger's seats.
- **Side airbags:** Airbags in the driver's and front passenger's seat-backs.
- **Side curtain airbags:** Airbags above the side windows.

Each is discussed in the following pages.

### Front Airbags (SRS)

The front SRS airbags inflate in a moderate-to-severe frontal collision to help protect the head and chest of the driver and/or front passenger.

**SRS** (Supplemental Restraint System) indicates that the airbags are designed to supplement seat belts, not replace them. Seat belts are the occupant's primary restraint system.

#### Housing Locations

The front airbags are housed in the center of the steering wheel for the driver, and in the dashboard for the front passenger. Both airbags are marked **SRS AIRBAG**.

#### Types of Airbags

The airbags can inflate whenever the ignition switch is in ON **II**.

#### Front Airbags (SRS)

##### Dual-Stage, Multiple-Threshold Front Airbags (SRS)

Your vehicle is equipped with dual-stage, multiple-threshold front airbags (SRS). During a frontal crash severe enough to cause one or both front airbags to deploy, the airbags can inflate at different rates, depending on the severity of the crash, whether or not the seat belts are latched, and/or other factors. Frontal airbags are designed to supplement the seat belts to help reduce the likelihood of head and chest injuries in frontal crashes.

## Operation

Front airbags are designed to inflate during moderate-to-severe frontal collisions. When the vehicle decelerates suddenly, the sensors send information to the control unit which signals one or both front airbags to inflate.

A frontal collision can be either head-on or angled between two vehicles, or when a vehicle crashes into a stationary object, such as a concrete wall.

## How the Front Airbags Work

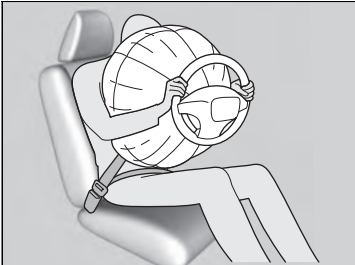

While your seat belt restrains your torso, the front airbag provides supplemental protection for your head and chest.

The front airbags deflate immediately so that they won't interfere with the driver's visibility or the ability to steer or operate other controls.

The total time for inflation and deflation is so fast that most occupants are not aware that the airbags deployed until they see them lying in front of them.

### How the Front Airbags Work

After a front airbag inflates in a crash, you may see what looks like smoke. This is actually powder from the airbag's surface. Although the powder is not harmful, people with respiratory problems may experience some temporary discomfort. If this occurs, get out of the vehicle as soon as it is safe to do so.

Although the driver's and front passenger's airbags normally inflate within a split second of each other, it is possible for only one airbag to deploy. This can happen if the severity of a collision is at the margin, or threshold, that determines whether or not the airbags will deploy. In such cases, the seat belt will provide sufficient protection, and the supplemental protection offered by the airbag would be minimal.

## ■ When front airbags should not deploy

**Minor frontal crashes:** Front airbags were designed to supplement seat belts and help save lives, not to prevent minor scrapes, or even broken bones that might occur during a less than moderate-to-severe frontal crash.

**Side impacts:** Front airbags can provide protection when a sudden deceleration causes a driver or front passenger to move towards the front of the vehicle. Side airbags and side curtain airbags have been specifically designed to help reduce the severity of injuries that can occur during a moderate-to-severe side impact which can cause the driver or passenger to move towards the side of the vehicle.

**Rear impacts:** Head restraints and seat belts are your best protection during a rear impact. Front airbags cannot provide any significant protection and are not designed to deploy in such collisions.

**Rollovers:** Seat belts and, in vehicles equipped with a rollover sensor, side airbags and side curtain airbags offer the best protection in a rollover. Because front airbags could provide little if any protection, they are not designed to deploy during a rollover.

## ■ When front airbags deploy with little or no visible damage

Because the airbag system senses sudden deceleration, a strong impact to the vehicle framework or suspension might cause one or more of the airbags to deploy. Examples include running into a curb, the edge of a hole, or other low fixed object that causes a sudden deceleration in the vehicle chassis. Since the impact is underneath the vehicle, damage may not be readily apparent.

## ■ When front airbags may not deploy, even though exterior damage appears severe

Since crushable body parts absorb crash energy during an impact, the amount of visible damage does not always indicate proper airbag operation. In fact, some collisions can result in severe damage but no airbag deployment because the airbags would not have been needed or would not have provided protection even if they had deployed.

## Advanced Airbags

Your front airbags have advanced features to help reduce the likelihood of airbag related injuries to smaller occupants.

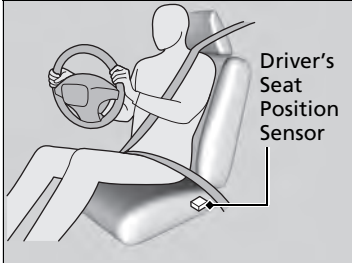

The driver's advanced front airbag system includes a seat position sensor.

If the seat is too far forward, the airbag inflates with less force, regardless of the severity of the impact.

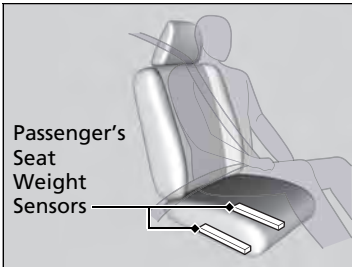

The passenger's advanced front airbag system has weight sensors.

Although Honda recommends against carrying an infant or small child in front, if the sensors detect the weight of a child (up to about 65 lbs or 29 kg), the system will automatically turn off the passenger's front airbag.

### Advanced Airbags

If there is a problem with the driver's seat position sensor, the SRS indicator will come on and the airbag will inflate with full (normal) force, regardless of the driver's seating position.

For both advanced front airbags to work properly:

- Do not spill any liquid on or under the seats.
- Do not put any object under the passenger's seat.
- Make sure any objects are positioned properly on the floor. Improperly positioned objects can interfere with the advanced airbag sensors.
- All occupants should sit upright and wear their seat belts properly.
- Do not place any cover over the passenger side dashboard.

Make sure the floor mat behind the front passenger's seat is hooked to the floor mat anchor. An improperly placed mat can interfere with the advanced airbag sensors.

[▶ Floor Mats P. 429](#)

## Side Airbags

The side airbags help protect the upper torso of the driver or a front passenger during a moderate-to-severe side impact.

### Housing Locations

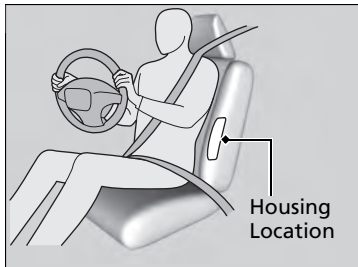

The side airbags are housed in the outside edge of the driver's and passenger's seat-backs.

Both are marked **SIDE AIRBAG**.

### Operation

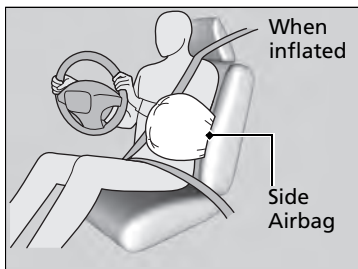

When the sensors detect a moderate-to-severe side impact, the control unit signals the side airbag on the impact side to immediately inflate.

### Side Airbags

Do not attach accessories on or near the side airbags. They can interfere with the proper operation of the airbags, or hurt someone if an airbag inflates.

If the impact is on the passenger's side, the airbag may not deploy when there is no passenger in the front passenger seat.

Do not cover or replace the front seat-back covers without consulting a dealer.

Improperly replacing or covering front seat-back covers can prevent your side airbags from properly deploying during a side impact.

■ **When a side airbag deploys with little or no visible damage**

Because the airbag system senses sudden acceleration, a strong impact to the side of the vehicle's framework can cause a side airbag to deploy. In such cases, there may be little or no damage, but the side impact sensors detected a severe enough impact to deploy the airbag.

■ **When a side airbag may not deploy, even though visible damage appears severe**

It is possible for a side airbag to not deploy during an impact that results in apparently severe damage. This can occur when the point of impact was towards the far front or rear of the vehicle, or when the vehicle's crushable body parts absorbed most of the crash energy. In either case, the side airbag would not have been needed nor provided protection even if it had deployed.

## Side Airbag Cutoff System

To reduce the likelihood that a front passenger may be injured by an inflating side airbag, the passenger side airbag is automatically turned off when:

- The height sensors detect a child or short-statured adult is seated in the front passenger seat.
- The position sensor detects that the front passenger is leaning into the deployment path of the side airbag.

When the side airbag cutoff system is activated, the side airbag off indicator comes on.

➤ [Side Airbag Off Indicator P. 50](#)

## Side Airbag Off Indicator

If the side airbag off indicator comes on, have the passenger sit upright. A few seconds after the passenger is sitting properly, the side airbag will automatically be turned on, and the indicator will go off.

If the front passenger is a child, stop when it is safe to do so, and have the child sit properly restrained in a rear seat.

### Side Airbag Cutoff System

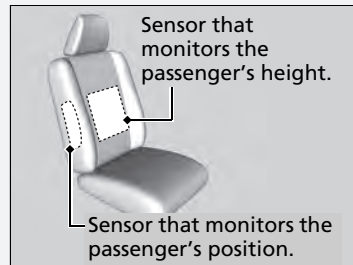

The sensors that monitor the front passenger's height and body position may not work if:

- The seat-back is wet
- The passenger is touching a metal or other electrical conductive object
- A seat cushion is on the seat
- The passenger is wearing excessively thick clothing

## Side Curtain Airbags

The side curtain airbags help protect the heads of the driver and passengers in outer seating positions during a moderate-to-severe side impact.

### Housing Locations

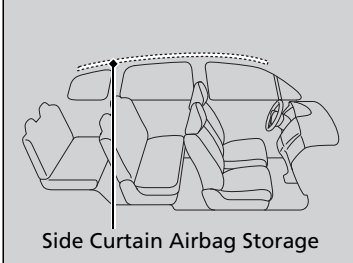

The side curtain airbags are located in the ceiling above the side windows on both sides of the vehicle.

### Operation

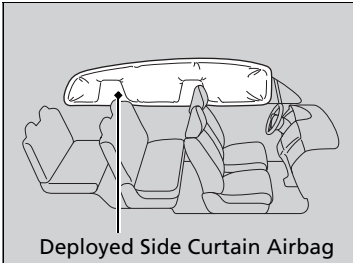

The side curtain airbag is designed to deploy in a moderate-to-severe side impact.

### When side curtain airbags deploy in a frontal collision

One or both side curtain airbags may inflate in a moderate to severe angled frontal collision.

In this case, the side curtain airbags will deploy slightly after the front airbags.

#### Side Curtain Airbags

The side curtain airbags are most effective when an occupant is wearing their seat belt properly and sitting upright, well back in their seat.

Do not attach any objects to the side windows or roof pillars as they can interfere with the proper operation of the side curtain airbags.



## Airbag System Indicators

If a problem occurs in the airbag system, the SRS indicator will come on and a message appears on the multi-information display\*.

### ■ SRS (Supplemental Restraint System) Indicator

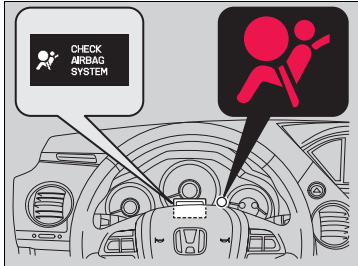

#### ■ When the ignition switch is turned to ON II

The indicator comes on for a few seconds, then goes off. This tells you the system is working properly.

If the indicator comes on at any other time, or does not come on at all, have the system checked by a dealer as soon as possible. If you don't, your airbags and seat belt tensioners may not work properly when they are needed.

### ▶▶ SRS (Supplemental Restraint System) Indicator

## ⚠ WARNING

Ignoring the SRS indicator can result in serious injury or death if the airbag systems or tensioners do not work properly.

Have your vehicle checked by a dealer as soon as possible if the SRS indicator alerts you to a possible problem.

## Passenger Airbag Off Indicator

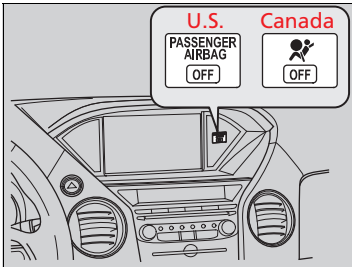

### When the passenger airbag off indicator comes on

The indicator comes on to alert you that the passenger's front airbag has been turned off. This occurs when the front passenger's weight sensors detect 65 lbs (29 kg) or less, the weight of an infant or small child, on the seat.

Infants and small children should always ride properly restrained in a back seat.

➤ [Child Safety P. 52](#)

Objects placed on the seat can also cause the indicator to come on.

If the front passenger seat is empty, the passenger's front airbag will not deploy and the indicator will not come on.

### Passenger Airbag Off Indicator

If the indicator comes on with no front passenger and no objects on the passenger's seat, or with an adult riding there, something may be interfering with the weight sensors. Such as:

- An object hanging on the seat or in the seat-back pocket.
- A child seat or other object pressing against the rear of the seat-back.
- A rear passenger pushing or pulling on the back of the front passenger's seat.
- The front seat or seat-back is forced back against an object on the seat or floor behind it.
- An object placed under the front passenger's seat.

If none of these conditions exist, have your vehicle checked by a dealer as soon as possible.

The passenger airbag off indicator may come on and goes off repeatedly if the total weight on the seat is near the airbag cutoff threshold.

## ■ Side Airbag Off Indicator

### ■ When the side airbag off indicator comes on

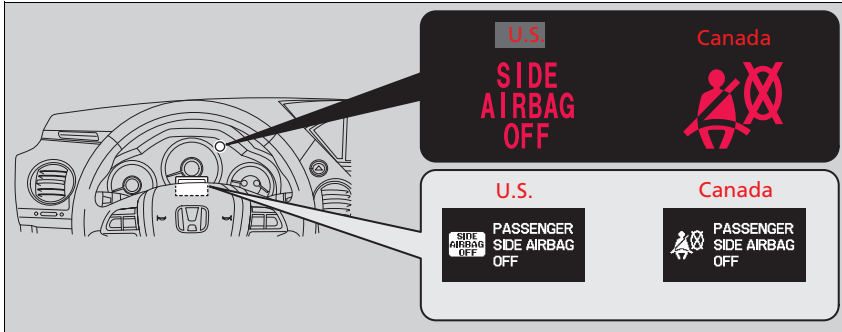

This indicator comes on if the passenger's side airbag has been turned off because the passenger is too small to be sitting in the front seat, is slouching or not sitting upright, or has leaned into the airbag's deployment path.

Unless the passenger is a smaller statured adult or a child, the indicator should go off when the passenger returns to a proper upright sitting position.

### ▶▶ Side Airbag Off Indicator

When you turn the ignition switch to ON (II), the indicator should come on for a few seconds and then go out. If it doesn't come on, stays on, or comes on while driving without a passenger in the front seat, have the system checked by a dealer as soon as possible.

## Airbag Care

You do not need to, and should not, perform any maintenance on or replace any airbag system components yourself. However, you should have your vehicle inspected by a dealer in the following situations:

### ■ When the airbags have deployed

If an airbag has inflated, the control unit and other related parts must be replaced. Similarly, once an automatic seat belt tensioner has been activated, it must be replaced.

### ■ When the vehicle has been in a moderate-to-severe collision

Even if the airbags did not inflate, have your dealer inspect the following: the driver's seat position sensor, weight sensors in the passenger's seat, front seat belt tensioners, and each seat belt that was worn during the crash.

### ■ Do not remove or modify a front seat without consulting a dealer

This would likely disable the driver's seat position sensor or the passenger's weight sensors. If it is necessary to remove or modify a front seat to accommodate a person with disabilities, contact a Honda dealer, or for U.S. vehicles, American Honda Automobile Customer Service at 800-999-1009 and for Canadian vehicles, Honda Canada Customer Relations at 888-9-HONDA-9.

#### ✘ Airbag Care

We recommend against the use of salvaged airbag system components, including the airbag, tensioners, sensors, and control unit.

## Protecting Child Passengers

Each year, many children are injured or killed in vehicle crashes because they are either unrestrained or not properly restrained. In fact, vehicle accidents are the number one cause of death of children age 12 and under.

To reduce the number of child deaths and injuries, every state, Canadian province and territory requires that infants and children be properly restrained when they ride in a vehicle.

**Children should sit properly restrained in a rear seat.** This is because:

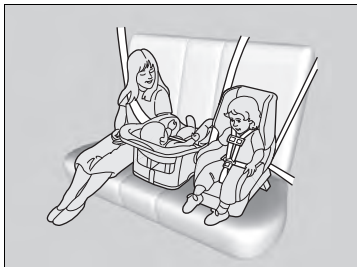

- An inflating front or side airbag can injure or kill a child sitting in the front seat.
- A child in the front seat is more likely to interfere with the driver's ability to safely control the vehicle.
- Statistics show that children of all sizes and ages are safer when they are properly restrained in a rear seat.

### Protecting Child Passengers

#### **WARNING**

**Children who are unrestrained or improperly restrained can be seriously injured or killed in a crash.**

**Any child too small for a seat belt should be properly restrained in a child seat. A larger child should be properly restrained with a seat belt, using a booster seat if necessary.**

The National Highway Traffic Safety Administration and Transport Canada recommend that all children age 12 and under be properly restrained in a rear seat. Some states or provinces/territories have laws restricting where children may ride.

- Any child who is too small to wear a seat belt correctly must be restrained in an approved child seat that is properly secured to the vehicle using either the lap belt portion of the lap/shoulder belt or the lower anchors of the LATCH system.
- Never hold a child on your lap because it is impossible to protect them in the event of a collision.
- Never put a seat belt over yourself and a child. During a crash, the belt would likely press deep into the child and cause serious or fatal injuries.
- Never let two children use the same seat belt. Both children could be very seriously injured in a crash.
- Do not allow children to operate the doors, windows or seat adjustments.
- Do not leave children in the vehicle unattended, especially in hot weather when the inside of the vehicle can get hot enough to kill them. They could also activate vehicle controls causing it to move unexpectedly.

## ▶▶ Protecting Child Passengers

**⚠ WARNING**

Allowing a child to play with a seat belt or wrap one around their neck can result in serious injury or death.

**Instruct children not to play with any seat belt and make sure any unused seat belt a child can reach is buckled, fully retracted, and locked.**

To deactivate a lockable retractor, release the buckle and allow the seat belt to wind up all the way.

To remind you of the passenger's front airbag hazards and child safety, your vehicle warning came with a label on the dashboard (U.S. models) and has labels on the front visors. Please read and follow the instructions on these labels.

▶ [Safety Labels P. 66](#)

## Safety of Infants and Small Children

### Protecting Infants

An infant must be properly restrained in a rear-facing, reclining child seat until the infant reaches the seat maker's weight or height limit for the seat, and the infant is at least one year old.



#### Positioning a rear-facing child seat

Child seats must be placed and secured in a rear seating position.

When properly installed, a rear-facing child seat may prevent the driver or a front passenger from moving their seat all the way back, or from locking their seat-back in the desired position.

It can also interfere with proper operation of the passenger's advanced front airbag system.

➤ [Airbags P. 37](#)

If this occurs, we recommend that you install the child seat directly behind the front passenger's seat, move the seat as far forward as needed, and leave it unoccupied. Or, you may wish to get a smaller rear-facing child seat.

### Protecting Infants

#### **WARNING**

Placing a rear-facing child seat in the front seat can result in serious injury or death during a crash.

Always place a rear-facing child seat in the rear seat, not the front.

Rear-facing child seats should never be installed in a forward facing position.

Always refer to the child seat manufacturer's instructions before installation.

## Protecting Smaller Children

If a child is at least one year old and within the weight range indicated by the child seat manufacturer, the child should be properly restrained in a firmly secured forward-facing child seat.



### Forward-facing child seat placement

We strongly recommend placing a forward-facing child seat in a rear seating position.

Placing a forward-facing child seat in the front seat can be hazardous, even with advanced front airbags that automatically turn the passenger's front airbag off. A rear seat is the safest place for a child.

### Protecting Smaller Children

## WARNING

Placing a forward-facing child seat in the front seat can result in serious injury or death if the front airbag inflates.

If you must place a forward-facing child seat in front, move the vehicle seat as far back as possible, and properly restrain the child.

Educate yourself about the laws and regulations regarding child seat use where you are driving, and follow the child seat manufacturer's instructions.

Many experts recommend use of a rear-facing seat up to age two, if the child's height and weight are appropriate for a rear-facing seat.



## ■ Selecting a Child Seat

Most child seats are LATCH-compatible (Lower Anchors and Tethers for Children). Some have a rigid-type connector, while others have a flexible-type connector. Both are equally easy to use. Some existing and previously owned child seats can only be installed using the seat belt. Whichever type you choose, follow the child seat manufacturer's use and care instructions as well as the instructions in this manual. Proper installation is key to maximizing your child's safety.

In seating positions and vehicles not equipped with LATCH, a LATCH compatible child seat can be installed using the seat belt and a top tether for added security. This is because all child seats are required to be designed so that they can be secured with a lap belt or the lap part of a lap/shoulder belt. In addition, the child seat manufacturer may advise that a seat belt be used to attach a LATCH-compatible seat once a child reaches a specified weight. Please read the child seat owner's manual for proper installation instructions.

### ■ Important consideration when selecting a child seat

Make sure the child seat meets the following three requirements:

- The child seat is the correct type and size for the child.
- The child seat is the correct type for the seating position.
- The child seat is compliant with Federal Motor Vehicle Safety Standard 213 or Canadian Motor Vehicle Safety Standard 213.

### ► Selecting a Child Seat

Installation of a LATCH-compatible child seat is simple.

LATCH-compatible child seats have been developed to simplify the installation process and reduce the likelihood of injuries caused by incorrect installation.

## Installing a LATCH-Compatible Child Seat

A LATCH-compatible child seat can be installed in each of the second row seats, and the passenger's side third row seat. A child seat is attached to the lower anchors with either the rigid or flexible type of connectors.

Second row seat

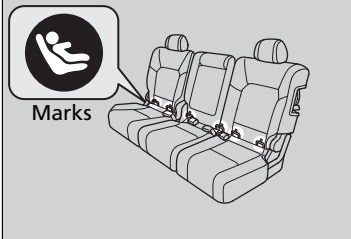

1. Locate the lower anchors under the marks.

Third row seat

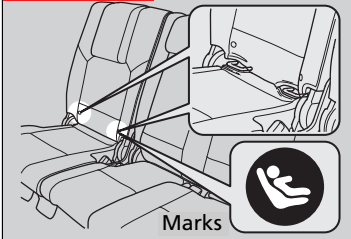

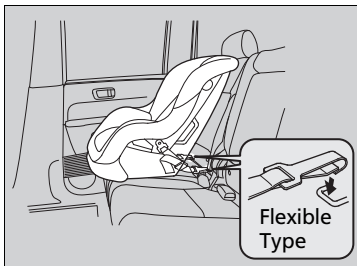
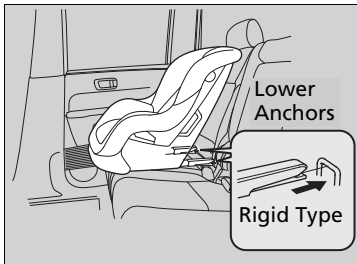

2. Place the child seat on the vehicle seat then attach the child seat to the lower anchors according to the instructions that came with the child seat.

- ▶ When installing the child seat, make sure that the lower anchors are not obstructed by the seat belt or any other object.

#### ▶▶ Installing a LATCH-Compatible Child Seat

For your child's safety, when using a child seat installed using the LATCH system, make sure that the seat is properly secured to the vehicle. A child seat that is not properly secured will not adequately protect a child in a crash and may cause injury to the child or other vehicle occupants.

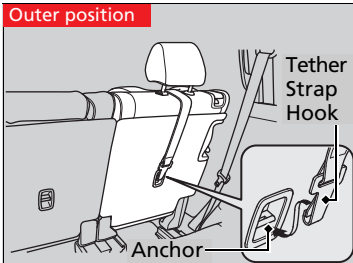

**Outer position**

3. Put the head restraint to its upper-most position, then route the tether strap between the head restraint legs, and secure the tether strap hook onto the anchor.
4. Go to step 6.

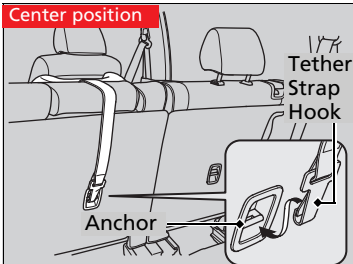

**Center position**

3. Lower the head restraint to its lowest position.
4. Route the tether strap over the head restraint. Make sure the strap is not twisted.
5. Secure the tether strap hook onto the anchor.

**All models**

6. Tighten the tether strap as instructed by the child seat maker.
7. Make sure the child seat is firmly secured by rocking it forward and back and side to side; little movement should be felt.
8. Make sure any unused seat belt that a child can reach is buckled, the lockable retractor is activated, and the belt is fully retracted and locked.

## ■ Installing a Child Seat with a Lap/Shoulder Seat Belt

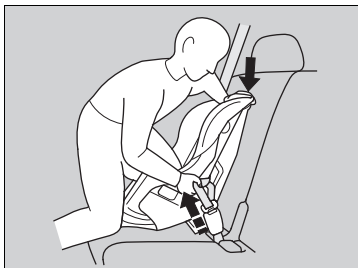
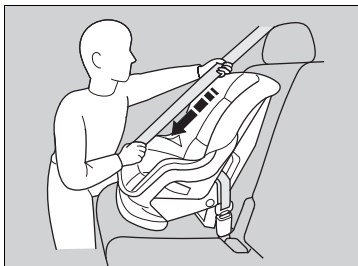
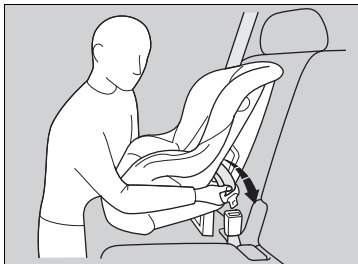

1. Place the child seat on the vehicle seat.
2. Route the seat belt through the child seat according to the seat maker's instructions, and insert the latch plate into the buckle.
  - ▶ Insert the latch plate fully until it clicks.
3. Slowly pull the shoulder part of the belt all the way out until it stops. This activates the lockable retractor.
4. Let the seat belt completely wind up into the retractor, then try to pull it out to make sure the retractor is locked.
  - ▶ If you are able to pull the shoulder belt out, the lockable retractor is not activated. Pull the seat belt all the way out, and repeat steps 3 – 4.
5. Grab the shoulder part of the seat belt near the buckle, and pull up to remove any slack from the lap part of the belt.
  - ▶ When doing this, place your weight on the child seat and push it into the vehicle seat.

### ▣ Installing a Child Seat with a Lap/Shoulder Seat Belt

A child seat that is not properly secured will not adequately protect a child in a crash and may cause injury to the child or other vehicle occupants.



6. Make sure the child seat is firmly secured by rocking it forward and back and side to side; little movement should be felt.
7. Make sure any unused seat belt that a child can reach is buckled, the lockable retractor is activated, and the belt is fully retracted and locked.

### ■ Adding Security with a Tether

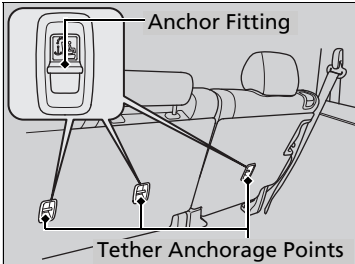

A tether anchorage point is provided behind each second and third row seating position. A child seat that is installed with a seat belt and comes with a tether can use the tether for additional security.

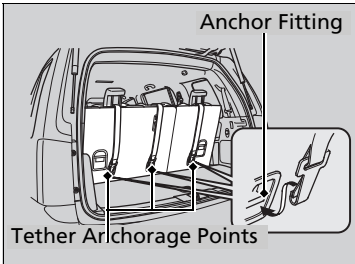

#### ☒ Installing a Child Seat with a Lap/Shoulder Seat Belt

To deactivate a lockable retractor, release the buckle and allow the seat belt to wind up all the way.

#### ☒ Adding Security with a Tether

Since a tether can provide additional security to the lap/shoulder seat belt installation, we recommend using a tether whenever one is available.

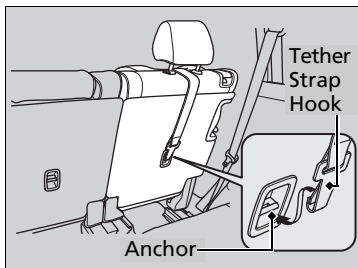

### ■ Using an outer anchor

1. Put the head restraint to its upper-most position, then route the tether strap through the head restraint legs. Make sure the strap is not twisted.
2. Secure the tether strap hook onto the anchor.
3. Tighten the tether strap as instructed by the child seat manufacturer.

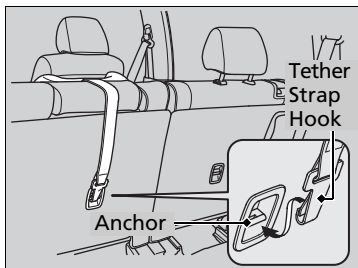

### ■ Using the center anchor

1. Lower the head restraint to its lowest position.
2. Route the tether strap over the head restraint. Make sure the strap is not twisted.
3. Secure the tether strap hook onto the anchor.
4. Tighten the tether strap as instructed by the child seat manufacturer.

## Safety of Larger Children

### Protecting Larger Children

The following pages give instructions on how to check proper seat belt fit, what kind of booster seat to use if one is needed, and important precautions for a child who must sit in front.

### Checking Seat Belt Fit

When a child is too big for a child seat, secure the child in a rear seat using the lap/shoulder seat belt. Have the child sit upright and all the way back, then answer the following questions.



#### Checklist

- Do the child's knees bend comfortably over the edge of the seat?
- Does the shoulder belt cross between the child's neck and arm?
- Is the lap part of the seat belt as low as possible, touching the child's thighs?
- Will the child be able to stay seated like this for the whole trip?

If you answer yes to all these questions, the child is ready to wear the lap/shoulder seat belt correctly. If you answer no to any question, the child needs to ride on a booster seat until the seat belt fits properly without a booster seat.

*Continued*

#### ▶ Safety of Larger Children

### ⚠ WARNING

Allowing a child age 12 or under to sit in front can result in injury or death if the passenger's front airbag inflates.

If a larger child must ride in front, move the vehicle seat as far to the rear as possible, have the child sit up properly and wear the seat belt properly, using a booster seat if needed.



## Booster Seats



If a lap/shoulder seat belt cannot be used properly, position the child in a booster seat in a rear seating position. For the child's safety, check that the child meets the booster seat manufacturer's recommendations.

## Protecting Larger Children-Final Checks

Your vehicle has a rear seat where children can be properly restrained. If you ever have to carry a group of children, and a child must ride in front:

- Make sure you read and fully understand the instructions and safety information in this manual.
- Move the front passenger seat as far back as possible.
- Have the child sit upright and well back in the seat.
- Check that the seat belt is properly positioned so that the child is secure in the seat.

## Monitoring child passengers

We strongly recommend that you keep an eye on child passengers. Even older, more mature children sometimes need to be reminded to fasten their seat belts and sit up properly.

## Booster Seats

When installing a booster seat, make sure to read the instructions that came with it, and install the seat accordingly.

There are high- and low-type booster seats. Choose a booster seat that allows the child to wear the seat belt correctly.

Some U.S. states and Canadian provinces and territories require children to use a booster seat until they reach a given age or weight (e.g. 6 years or 60 lbs). Be sure to check current laws in the state or province, or territory where you intend to drive.

## Carbon Monoxide Gas

The engine exhaust from this vehicle contains carbon monoxide, a colorless, odorless, and highly toxic gas. As long as you properly maintain your vehicle, carbon monoxide gas will not get into the interior.

### ■ Have the exhaust system inspected for leaks whenever

- The exhaust system is making an unusual noise.
- The exhaust system may have been damaged.
- The vehicle is raised for an oil change.

When you operate a vehicle with the tailgate open, airflow can pull exhaust gas into the interior and create a hazardous condition. If you must drive with the tailgate open, open all the windows and set the climate control system as shown below.

1. Select the fresh air mode.
2. Select the  mode.
3. Set the fan speed to high.
4. Set the temperature control to a comfortable setting.

Adjust the climate control system in the same manner if you sit in your parked vehicle with the engine running.

### ☒ Carbon Monoxide Gas

## ⚠ WARNING

Carbon monoxide gas is toxic. Breathing it can cause unconsciousness and even kill you.

Avoid any enclosed areas or activities that expose you to carbon monoxide.

An enclosed area such as a garage can quickly fill up with carbon monoxide gas.

Do not run the engine with the garage door closed. Even when the garage door is open, drive out of the garage immediately after starting the engine.

## Label Locations

These labels are in the locations shown. They warn you of potential hazards that can cause serious injury or death. Read these labels carefully.

If a label comes off or becomes hard to read (except for the U.S. dashboard label which may be removed by the owner), contact a dealer for a replacement.

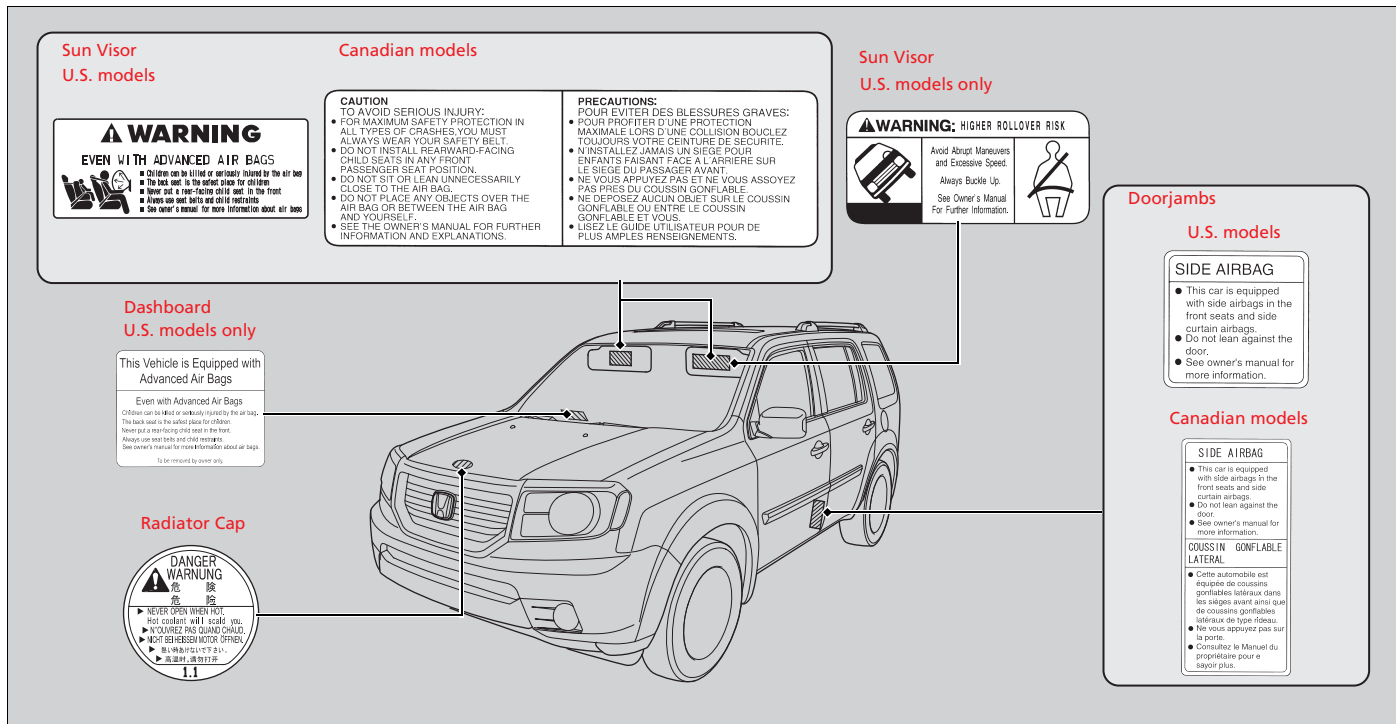





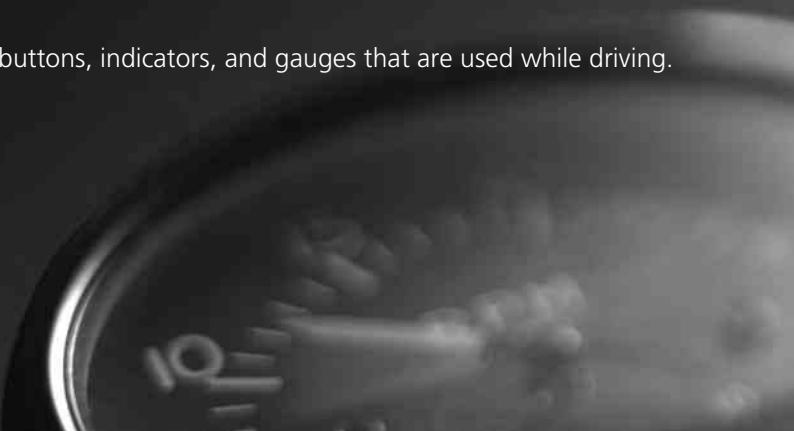



# Instrument Panel







This chapter describes the buttons, indicators, and gauges that are used while driving.







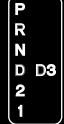

- Indicators** ..... 68
  - Multi-Information Display Warning and Information Messages\* ..... 78
- Gauges and Displays**
  - Gauges ..... 80
  - Information Display\* ..... 81
  - Multi-Information Display\* ..... 85



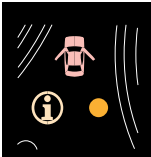

\* Not available on all models

Indicator	Name	On/Blinking	Explanation	Message*
	Parking Brake and Brake System Indicator (Red)	<ul style="list-style-type: none"> <li>Comes on for a few seconds when you turn the ignition switch to ON <b>(II)</b>, then goes off.</li> <li>Comes on when the parking brake is applied, and goes off when it is released.</li> <li>Comes on when the brake fluid level is low.</li> <li>Comes on if there is a problem with the brake system.</li> <li>The beeper sounds and the indicator comes on if you drive with the parking brake not fully released.</li> </ul>	<ul style="list-style-type: none"> <li><b>Comes on while driving</b> - Make sure the parking brake is released. Check the brake fluid level.                             <ul style="list-style-type: none"> <li>➤ <b>What to do when the indicator comes on while driving</b> P. 452</li> </ul> </li> <li><b>Comes on along with the ABS indicator</b> - Have the vehicle checked by a dealer.                             <ul style="list-style-type: none"> <li>➤ <b>If the Brake System Indicator (Red) Comes On</b> P. 452</li> </ul> </li> </ul>	<div style="display: flex; justify-content: space-around;"> <div style="text-align: center;"> <p>U.S.</p>  </div> <div style="text-align: center;"> <p>Canada</p>  </div> </div> <div style="display: flex; justify-content: space-around; margin-top: 10px;"> <div style="text-align: center;">  </div> <div style="text-align: center;">  </div> </div> <div style="display: flex; justify-content: space-around; margin-top: 10px;"> <div style="text-align: center;">  </div> <div style="text-align: center;">  </div> </div>
	Low Oil Pressure Indicator	<ul style="list-style-type: none"> <li>Comes on when you turn the ignition switch to ON <b>(II)</b>, and goes off when the engine starts.</li> <li>Comes on when the engine oil pressure is low.</li> </ul>	<ul style="list-style-type: none"> <li><b>Comes on while driving</b> - Immediately stop in a safe place.                             <ul style="list-style-type: none"> <li>➤ <b>If the Low Oil Pressure Indicator Comes On</b> P. 450</li> </ul> </li> </ul>	

Indicator	Name	On/Blinking	Explanation	Message*
	Malfunction Indicator Lamp	<ul style="list-style-type: none"> <li>• Comes on when you turn the ignition switch to ON <b>[II]</b>, and goes off either when the engine starts or after several seconds if the engine is not started. If “readiness codes” have not been set, it blinks five times before it goes off.</li> <li>• Comes on if there is a problem with the emissions control system.</li> <li>• Blinks when a misfire in the engine's cylinders is detected.</li> </ul>	<ul style="list-style-type: none"> <li>• Readiness codes are part of the on board diagnostics for the emissions control systems.                             <ul style="list-style-type: none"> <li>► <a href="#">Testing of Readiness Codes P. 470</a></li> </ul> </li> <li>• <b>Comes on while driving</b> - Have the vehicle checked by a dealer.</li> <li>• <b>Blinks while driving</b> - Stop in a safe place where there are no flammable objects. Stop the engine for 10 minutes or more, and wait for it to cool down. Then, take the vehicle to a dealer.                             <ul style="list-style-type: none"> <li>► <a href="#">If the Malfunction Indicator Lamp Comes On or Blinks P. 451</a></li> </ul> </li> </ul>	
	Charging System Indicator	<ul style="list-style-type: none"> <li>• Comes on when you turn the ignition switch to ON <b>[II]</b>, and goes off when the engine starts.</li> <li>• Comes on when the battery is not charging.</li> </ul>	<ul style="list-style-type: none"> <li>• <b>Comes on while driving</b> - Turn off the climate control system and rear defogger in order to reduce electricity consumption.                             <ul style="list-style-type: none"> <li>► <a href="#">If the Charging System Indicator Comes On P. 450</a></li> </ul> </li> </ul>	
	Shift Lever Position Indicator	<ul style="list-style-type: none"> <li>• Indicates current shift lever position. <b>[D3]</b> indicator:</li> <li>• Comes on for a few seconds when you turn the ignition switch to ON <b>[II]</b>, then goes off.</li> <li>• Comes on when you press the <b>[D3]</b> button while the shift lever is in <b>[D]</b>.</li> </ul>	<ul style="list-style-type: none"> <li>► <a href="#">Shifting P. 346</a></li> </ul>	







\* Not available on all models







Indicator	Name	On/Blinking	Explanation	Message*
	Transmission Indicator	<ul style="list-style-type: none"> <li>Comes on for a few seconds when you turn the ignition switch to ON <b>II</b>, then goes off.</li> <li>Blinks if the transmission system has a problem.</li> </ul>	<ul style="list-style-type: none"> <li><b>Blinks while driving</b> - Avoid sudden starts and acceleration and have the vehicle checked by a dealer immediately.</li> </ul>	
	Seat Belt Reminder Indicator	<ul style="list-style-type: none"> <li>Comes on and the beeper sounds if you are not wearing a seat belt when you turn the ignition switch to ON <b>II</b>. If the front passenger is not wearing a seat belt, the indicator comes on a few seconds later.</li> <li>Blinks while driving if either you or the front passenger has not fastened a seat belt. The beeper sounds and the indicator blinks at regular intervals.</li> </ul>	<ul style="list-style-type: none"> <li>The beeper stops and the indicator goes off when you and the front passenger fasten their seat belts.</li> <li><b>Stays on after you or the front passenger has fastened the seat belt</b> - A detection error may have occurred in the sensor. Have the vehicle checked by a dealer. ➤ <a href="#">Seat Belt Reminder P. 30</a></li> </ul>	 
	Low Fuel Indicator	<ul style="list-style-type: none"> <li>Comes on when the fuel reserve is running low (approximately 2.8 U.S. gal./10.8 Liter).</li> <li>Blinks if there is a problem with the fuel gauge.</li> </ul>	<ul style="list-style-type: none"> <li><b>Comes on</b> - Refuel your vehicle as soon as possible.</li> <li><b>Blinks</b> - Have the vehicle checked by a dealer.</li> </ul>	

Indicator	Name	On/Blinking	Explanation	Message*
	<b>ABS</b> (Anti-lock Brake System) Indicator	<ul style="list-style-type: none"> <li>Comes on for a few seconds when you turn the ignition switch to ON <b>II</b>, then goes off.</li> <li>If it comes on at any other time, there is a problem with the ABS.</li> </ul>	<ul style="list-style-type: none"> <li><b>Stays on constantly</b> - Have the vehicle checked by a dealer. With this indicator on, your vehicle still has normal braking ability but no anti-lock function.  <a href="#">▶ ABS (Anti-lock Brake System) P. 362</a></li> </ul>	
	Supplemental Restraint System Indicator	<ul style="list-style-type: none"> <li>Comes on for a few seconds when you turn the ignition switch to ON <b>II</b>, then goes off.</li> <li>Comes on if a problem with any of the following is detected:                             <ul style="list-style-type: none"> <li>Supplemental restraint system</li> <li>Side airbag system</li> <li>Side curtain airbag system</li> <li>Seat belt tensioner</li> </ul> </li> </ul>	<ul style="list-style-type: none"> <li><b>Stays on constantly or does not come on at all</b> - Have the vehicle checked by a dealer.</li> </ul>	
<b>VTM-4</b>	<b>VTM-4</b> ® System Indicator*	<ul style="list-style-type: none"> <li>Comes on for a few seconds when you turn the ignition switch to ON <b>II</b>, then goes off.</li> <li>Comes on if there is a problem with the VTM-4®.</li> <li>Blinks when the VTM-4® system is overheated. The system is inactive.</li> </ul>	<ul style="list-style-type: none"> <li><b>Stays on constantly</b> - Have the vehicle checked by a dealer.</li> <li><b>Blinks while driving</b> - The VTM-4® fluid temperature is too high. Stop in a safe place, shift to <b>P</b>, and idle the engine until the indicator goes off. If the indicator does not stop blinking, take your vehicle to a dealer.  <a href="#">▶ VTM (Variable Torque Management)-4® System* P. 354</a></li> </ul>	—







\* Not available on all models











Indicator	Name	On/Blinking	Explanation	Message*
	VSA® (Vehicle Stability Assist) System Indicator	<ul style="list-style-type: none"> <li>Comes on for a few seconds when you turn the ignition switch to ON <b>II</b>, then goes off.</li> <li>Blinks when VSA® is active.</li> <li>Comes on if there is a problem with the VSA® system.</li> <li>Comes on if there is a problem with the hill start assist system.</li> </ul>	<ul style="list-style-type: none"> <li><b>Stays on constantly</b> - Have the vehicle checked by a dealer.                             <ul style="list-style-type: none"> <li>➤ <b>VSA® (Vehicle Stability Assist), aka ESC (Electronic Stability Control), System P. 352</b></li> </ul> </li> </ul>	
	VSA® (Vehicle Stability Assist) OFF Indicator	<ul style="list-style-type: none"> <li>Comes on for a few seconds when you turn the ignition switch to ON <b>II</b>, then goes off.</li> <li>Comes on when you deactivate VSA®.</li> </ul>	<ul style="list-style-type: none"> <li>➤ <b>VSA® On and Off P. 353</b></li> </ul>	—
	Door Open Indicator	<ul style="list-style-type: none"> <li>Comes on for a few seconds if you turn the ignition switch to ON <b>II</b>, then goes off.</li> <li>Comes on if any door, glass hatch, or tailgate is not completely closed.</li> </ul>	<ul style="list-style-type: none"> <li>Goes off when all doors, glass hatch, and tailgate are closed.</li> </ul>	
	Door, Glass Hatch, and Tailgate Open Indicator*	<ul style="list-style-type: none"> <li>Comes on for a few seconds if you turn the ignition switch to ON <b>II</b>, then goes off.</li> <li>Comes on if any door, glass hatch, or tailgate is not completely closed.</li> </ul>	<ul style="list-style-type: none"> <li>Goes off when all doors, glass hatch, and tailgate are closed.</li> </ul>	—





Indicator	Name	On/Blinking	Explanation	Message*
<b>DRL</b>	Daytime Running Lights Indicator*	<ul style="list-style-type: none"> <li>Comes on for a few seconds when you turn the ignition switch to ON <b>[II]</b>, then goes off.</li> <li>Comes on if there is a problem with the DRL system.</li> </ul>	<ul style="list-style-type: none"> <li>Have your vehicle checked by a dealer. <a href="#">▶ Daytime Running Lights P. 127</a></li> </ul>	
	System Message Indicator*	<ul style="list-style-type: none"> <li>Comes on for a few seconds when you turn the ignition switch to ON <b>[II]</b>, then goes off.</li> <li>Comes on along with a beep when a problem is detected. A system message on the multi-information display appears at the same time.</li> </ul>	<ul style="list-style-type: none"> <li>While the indicator is on, press the  /  (information) button to see the message again.</li> <li>Refer to the Indicators information in this chapter when a system message appears on the multi-information display. Take the appropriate action for the message.</li> <li>The multi-information display does not return to the normal screen unless the warning is canceled, or the  /  (information) button is pressed.</li> </ul>	—
<b>A/T TEMP</b>	A/T Temperature Indicator*	<ul style="list-style-type: none"> <li>Comes on for a few seconds when you turn the ignition switch to ON <b>[II]</b>, then goes off.</li> <li>Comes on when the transmission fluid temperature is too high.</li> </ul>	<ul style="list-style-type: none"> <li>Comes on while driving - Stop in a safe place, shift to <b>[P]</b>, and idle the engine until the indicator goes off.</li> </ul>	





\* Not available on all models

Indicator	Name	On/Blinking	Explanation	Message*
	<p>Models with information display</p> <p><b>TPMS</b> Indicator</p>	<ul style="list-style-type: none"> <li>Comes on for a few seconds when you turn the ignition switch to ON .</li> <li>Comes on if there is a problem with the TPMS, or when a compact spare tire is temporarily installed.</li> </ul>	<ul style="list-style-type: none"> <li><b>Stays on constantly or does not come on at all</b> - Have the vehicle checked by a dealer. If the vehicle is fitted with a compact spare, get your regular tire repaired or replaced and put back on your vehicle as soon as you can.</li> </ul>	
	<p>Models with information display</p> <p>Low Tire Pressure Indicator</p> <p>Models with multi-information display</p> <p>Low Tire Pressure/TPMS Indicator</p>	<ul style="list-style-type: none"> <li>Comes on for a few seconds when you turn the ignition switch to ON .</li> <li>Comes on if the tire pressure of any of the tires becomes significantly low.</li> <li>Models with information display</li> <li>Comes on for a while and then goes off when a compact spare tire is temporarily installed.</li> <li>Models with multi-information display</li> <li>Blinks for about one minute, and then stays on if there is a problem with the TPMS, or when a compact spare tire is temporarily installed.</li> </ul>	<ul style="list-style-type: none"> <li><b>Comes on while driving</b> - Stop in a safe place, check tire pressures, and inflate the tire(s) if necessary.</li> <li>Models with multi-information display</li> <li><b>Blinks and remains on</b> - Have the vehicle checked by a dealer. If the vehicle is fitted with a compact spare, get your regular tire repaired or replaced and put back on your vehicle as soon as you can.</li> </ul>	 

Indicator	Name	On/Blinking	Explanation	Message*
	Turn Signal Indicators	<ul style="list-style-type: none"> <li>The turn signal indicators blink when you operate the turn signal lever.</li> <li>If you press the hazard warning button, both indicators and all turn signals blink at the same time.</li> </ul>	<ul style="list-style-type: none"> <li><b>Does not blink or blinks rapidly</b> - A turn signal light bulb has blown. Change the bulb immediately.  <a href="#">▶ Replacing Light Bulbs P. 404 P. 405 P. 406</a></li> </ul>	—
	High Beam Indicator	<ul style="list-style-type: none"> <li>Comes on when the high beam headlights are on.</li> </ul>	—	—
	Lights On Indicator	<ul style="list-style-type: none"> <li>Comes on whenever the light switch is on, or in <b>AUTO</b> when the exterior lights are on.</li> </ul>	<ul style="list-style-type: none"> <li>If you remove the key from the ignition switch while the lights are on, a chime sounds when the driver's door is opened.</li> </ul>	—
	Fog Light Indicator*	<ul style="list-style-type: none"> <li>Comes on when the fog lights are on.</li> </ul>	—	—
	Side Airbag Off Indicator	<ul style="list-style-type: none"> <li>Comes on for a few seconds when you turn the ignition switch to ON , then goes off.</li> <li>Comes on when the passenger side airbag system is automatically shut off.</li> </ul>	<ul style="list-style-type: none"> <li>It does not mean there is a problem with your side airbags.</li> <li><b>Comes on when nobody is sitting in the passenger seat</b> - Have the vehicle checked by a dealer.</li> <li><b>Comes on when someone is sitting in the seat</b> - Have the passenger sit properly.</li> </ul>	 

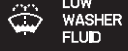

\* Not available on all models





Indicator	Name	On/Blinking	Explanation	Message*
	Immobilizer System Indicator	<ul style="list-style-type: none"> <li>Comes on briefly when you turn the ignition switch to ON <b>[II]</b>, then goes off.</li> <li>Comes on if the immobilizer system cannot recognize the key information.</li> </ul>	<ul style="list-style-type: none"> <li><b>Blinks</b> - You cannot start the engine. Turn the ignition switch to LOCK <b>[O]</b>, pull the key out, and then insert the key and turn it to ON <b>[II]</b> again.</li> <li><b>Repeatedly blinks</b> - The system may be malfunctioning. Have the vehicle checked by a dealer.</li> <li>Do not attempt to alter this system or add other devices to it. Electrical problems can occur.</li> </ul>	—
	Security System Alarm Indicator*	<ul style="list-style-type: none"> <li>Blinks when the security system alarm has been set.</li> </ul>	➤ <b>Security System Alarm* P. 118</b>	—
	Starter System Indicator*	<ul style="list-style-type: none"> <li>Comes on if there is a problem with the starter system.</li> </ul>	<ul style="list-style-type: none"> <li>As a temporary measure, hold the ignition switch to START <b>[III]</b> for up to 15 seconds and start the engine. Have the vehicle checked by a dealer.</li> </ul>	<div style="border: 1px solid black; padding: 5px; margin-bottom: 5px;"> <p style="text-align: center;">U.S.</p> <p style="text-align: center;">STARTER SYSTEM</p> <p style="text-align: center;">CHECK STARTER SYSTEM</p> </div> <div style="border: 1px solid black; padding: 5px;"> <p style="text-align: center;">Canada</p> <p style="text-align: center;">CHECK STARTER SYSTEM</p> </div>
	Fuel Economy Indicator	<ul style="list-style-type: none"> <li>Comes on and stays on while you are driving with good fuel economy.</li> </ul>	—	—

Indicator	Name	On/Blinking	Explanation	Message*
	<b>CRUISE MAIN</b> Indicator	<ul style="list-style-type: none"> <li>Comes on when you press the <b>CRUISE</b> button.</li> </ul>	<p>➤ <a href="#">Cruise Control P. 348</a></p>	—
	<b>CRUISE CONTROL</b> Indicator	<ul style="list-style-type: none"> <li>Comes on if you have set a speed for cruise control.</li> </ul>	<p>➤ <a href="#">Cruise Control P. 348</a></p>	—
	Washer Level Indicator*	<ul style="list-style-type: none"> <li>Comes on when washer fluid is low.</li> </ul>	<ul style="list-style-type: none"> <li>Refill washer fluid.</li> <li>➤ <a href="#">Refilling Window Washer Fluid P. 401</a></li> </ul>	
	Maintenance Minder Indicator*	<ul style="list-style-type: none"> <li>Comes on when you turn the ignition switch to ON <b>[II]</b>, then goes off.</li> <li>Comes on when the scheduled maintenance is due soon.</li> </ul>	<p>➤ <a href="#">Maintenance Minder™ P. 381</a></p>	—
	Power Tailgate Indicator*	<ul style="list-style-type: none"> <li>Comes on for a few seconds when you turn the ignition switch to ON <b>[II]</b>.</li> <li>Comes on if there is a problem with the power tailgate system.</li> </ul>	<ul style="list-style-type: none"> <li><b>Stays on constantly or does not come on at all</b> - You can still open or close the tailgate manually. Have the vehicle checked by a dealer.</li> </ul>	<div style="border: 1px solid black; padding: 5px; margin-bottom: 5px;"> <p style="text-align: center;">U.S.</p> <p style="text-align: center;">TAIL GATE CHECK POWER TAILGATE</p> </div> <div style="border: 1px solid black; padding: 5px;"> <p style="text-align: center;">Canada</p> <p style="text-align: center;">CHECK POWER TAILGATE</p> </div>

\* Not available on all models

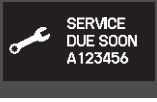
## Multi-Information Display Warning and Information Messages\*

The following messages appear only on the multi-information display. Press the  /  (information) button to see the message again with the system message indicator on.

Message	Condition	Explanation
	<ul style="list-style-type: none"> <li>Appears when the fuel fill cap is loose or is not installed.</li> </ul>	<a href="#">➤ Check/Tighten Fuel Cap Message P. 451</a>
	<ul style="list-style-type: none"> <li>Appears when the scheduled maintenance is due soon.</li> <li>Consequently, <b>SERVICE DUE NOW</b> and <b>SERVICE PAST DUE</b> follow.</li> </ul>	<a href="#">➤ Maintenance Minder Messages on the Multi-Information Display P. 386</a>
	<ul style="list-style-type: none"> <li>Appears when you open the driver's door while the ignition key is in LOCK .</li> </ul>	<ul style="list-style-type: none"> <li>Remove the key from the ignition switch.</li> </ul>
	<ul style="list-style-type: none"> <li>Appears when the engine coolant temperature gets abnormally high.</li> </ul>	<a href="#">➤ Overheating P. 448</a>
	<ul style="list-style-type: none"> <li>Appears when the daytime running lights are off.</li> </ul>	<a href="#">➤ Daytime Running Lights P. 127</a>

Message	Condition	Explanation
 <p>CHECK PARKING SENSOR SYSTEM</p>	<ul style="list-style-type: none"> <li>Appears if there is a problem with the parking sensor system. The beeper sounds.</li> </ul>	<ul style="list-style-type: none"> <li>Check if the area around the sensor(s) is covered with mud, ice, snow, etc. If the indicator(s) stays on even after you clean the area, have the system checked by a dealer.</li> </ul>

\* Not available on all models



## Gauges

Gauges include the speedometer, tachometer, fuel gauge, and related indicators. They are displayed when the ignition switch is in ON .

### Speedometer

Displays your driving speed in mph (U.S.) or km/h (Canada).

### Tachometer

Shows the number of engine revolutions per minute.

### Fuel Gauge

Displays the amount of fuel left in the fuel tank.

### Temperature Gauge

Displays the temperature of the engine coolant.

#### » Fuel Gauge

##### NOTICE

You should refuel when the reading approaches . Running out of fuel can cause the engine to misfire, damaging the catalytic converter.

The actual amount of remaining fuel may differ from the fuel gauge reading.

#### » Temperature Gauge

##### NOTICE

Driving with the temperature gauge pointer in the upper zone can cause serious engine damage. Pull safely to the side of the road and allow engine temperature to return to normal.

 [Overheating P. 448](#)

## Information Display\*

The information display shows the odometer, trip meter, engine oil life and maintenance service item codes, and other gauges.

### Switching the Display

Press the  (Select/Reset) knob to change the display.

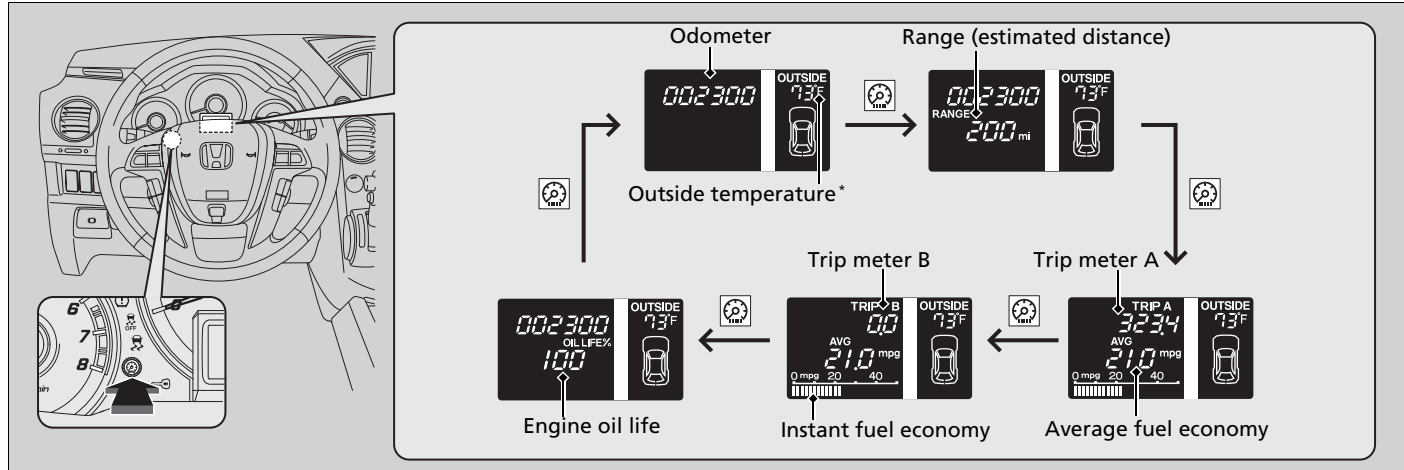

### Odometer

Shows the total number of miles or kilometers that your vehicle has accumulated.

\* Not available on all models

## ■ Trip Meter

Shows the total number of miles or kilometers driven since the last reset. Meters A and B can be used to measure two separate trips.

## ■ Resetting a trip meter

To reset a trip meter, display it, then press and hold the  knob. The trip meter is reset to **0.0**.

## ■ Instant Fuel Economy

Shows the instant fuel economy as a bar graph in mpg or l/100 km.

## ■ Average Fuel Economy

Shows the estimated average fuel economy of each trip meter in mpg (U.S.) or l/100 km (Canada). The display is updated at set intervals. When a trip meter is reset, the average fuel economy is also reset.

## ■ Engine Oil Life

Shows the remaining oil life and Maintenance Minder™.

 [Maintenance Minder™ P. 381](#)

## ■ Range

Shows the estimated distance you can travel on the remaining fuel. This distance is estimated from the fuel economy of your trips in the past.

## ►► Trip Meter

Switch between trip meter A and trip meter B by pressing the  knob.

## ■ Check Fuel Cap

Appears when the fuel fill cap is loose or is not installed.

➤ [Check/Tighten Fuel Cap Message](#) P. 451

## ■ Tire Pressure Monitor

Shows each tire's pressure.

➤ [TPMS \(Tire Pressure Monitoring System\)](#) P. 355





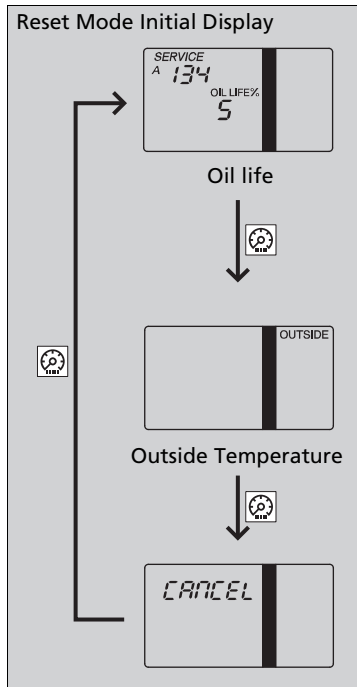

## ■ Outside Temperature \*

Shows the outside temperature in Fahrenheit (U.S.) or Celsius (Canada).

### ■ Adjusting the outside temperature indicator

Adjust the temperature reading up to  $\pm 5^{\circ}\text{F}$  or  $\pm 3^{\circ}\text{C}$  if the temperature reading seems incorrect.



1. Turn the ignition switch to ON .
2. Press and hold the  (Select/Reset) knob for 10 seconds or more.
  - ▶ The information display shows the reset mode initial display.
3. Select outside temperature with the  knob.
4. Press and hold the  knob for a few seconds to enter the outside temperature setting mode.
5. Turn the  knob to adjust the temperature.
6. Press and release the  knob.
  - ▶ The new outside temperature is now entered.

## ▶▶ Outside Temperature \*

The temperature sensor is in the front bumper. Road heat and exhaust from another vehicle can affect the temperature reading when your vehicle speed is less than 19 mph (30 km/h).

It may take several minutes for the display to be updated after the temperature reading has stabilized.



### ▶▶ Adjusting the outside temperature indicator

Adjust the temperature reading up to  $\pm 5^{\circ}\text{F}$  or  $\pm 3^{\circ}\text{C}$ .

## Multi-Information Display\*

Shows the odometer, trip meter, outside temperature indicator, and other gauges. It also displays important messages such as warnings and other helpful information.

### Switching the Display

Press the  /  (information) button or the **SEL/RESET** button to change the display.

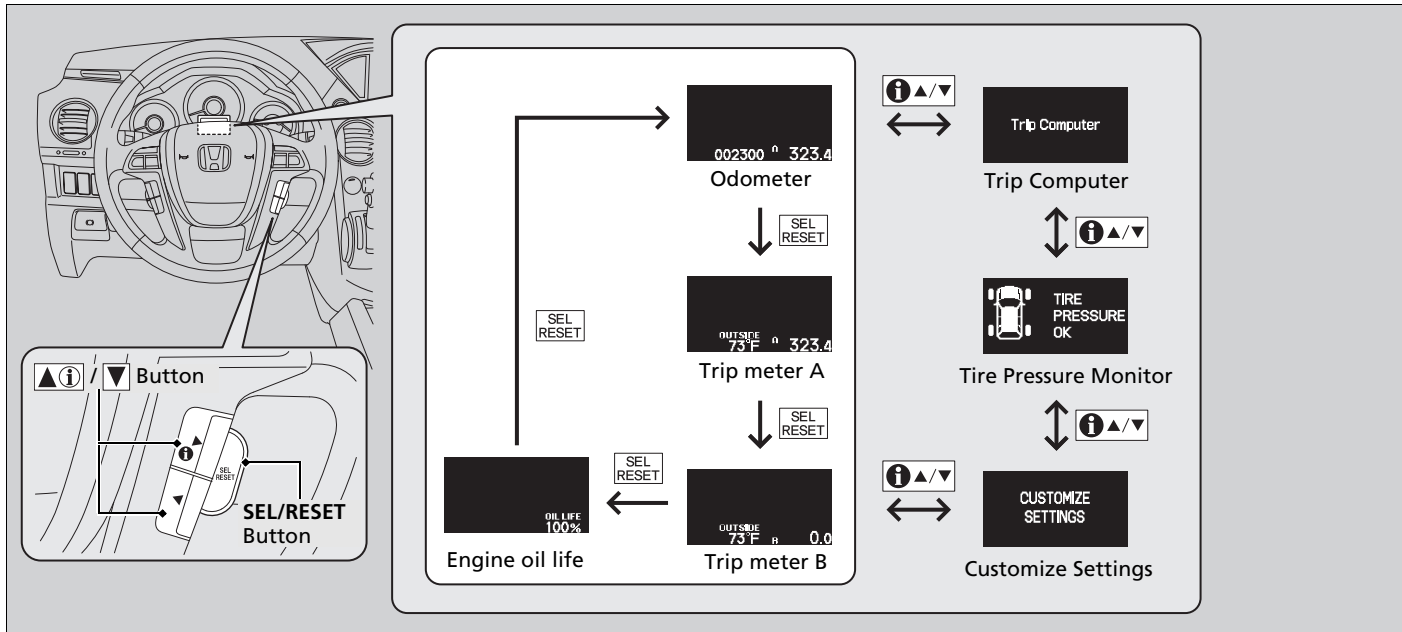

\* Not available on all models

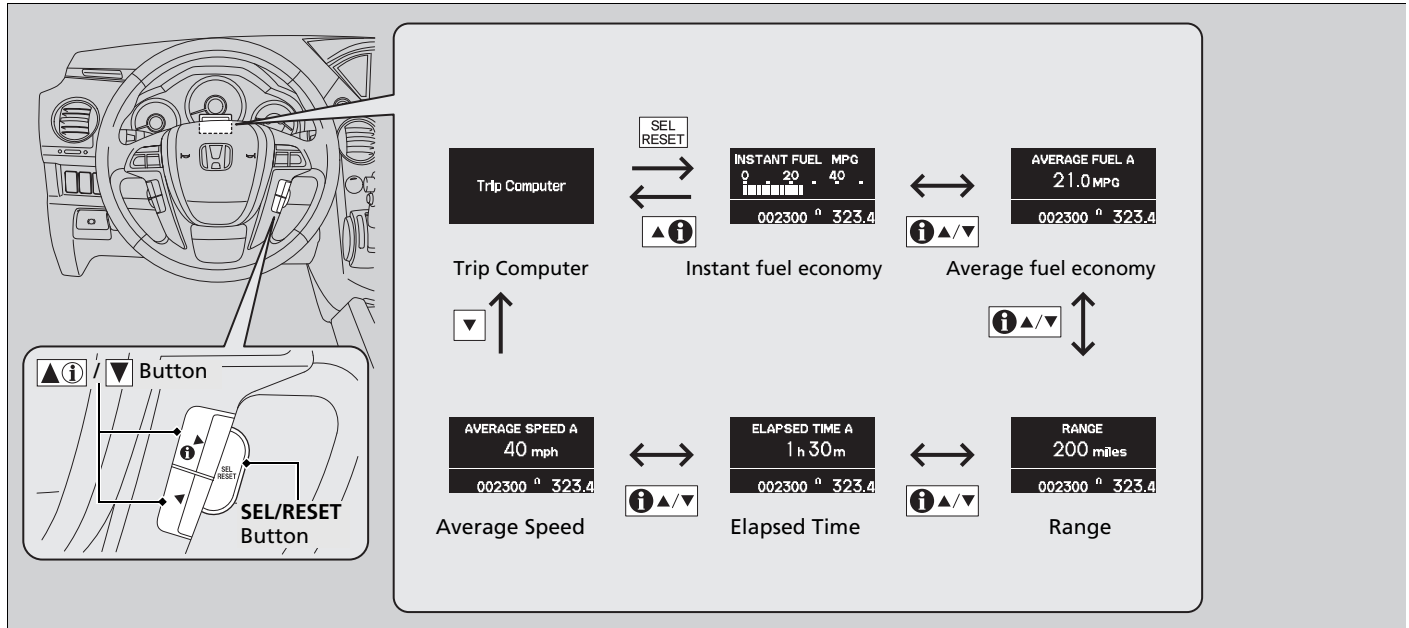

## ■ Odometer

Shows the total number of miles or kilometers that your vehicle has accumulated.

## ■ Trip Meter

Shows the total number of miles or kilometers driven since the last reset. Meters A and B can be used to measure two separate trips.

### ■ Resetting a trip meter

To reset a trip meter, display it, then press and hold the **SEL/RESET** button. The trip meter is reset to **0.0**.

## ■ Outside Temperature

Shows the outside temperature in Fahrenheit (U.S.) or Celsius (Canada).

### ■ Adjusting the outside temperature display

Adjust the temperature reading up to  $\pm 5^{\circ}\text{F}$  or  $\pm 3^{\circ}\text{C}$  if the temperature reading seems incorrect.

### ☒ Trip Meter

Switch between trip meter A and trip meter B by pressing the **SEL/RESET** button.

### ☒ Outside Temperature

The temperature sensor is in the front bumper. Road heat and exhaust from another vehicle can affect the temperature reading when your vehicle speed is less than 19 mph (30 km/h).

It may take several minutes for the display to be updated after the temperature reading has stabilized.

Use the multi-information display's customized features to correct the temperature.

[▶ Customized Features P. 90](#)

\* Not available on all models



## ■ Trip Computer

Shows the instant fuel economy, average fuel economy, range, elapsed time, and average speed.

## ■ Instant Fuel Economy

Shows the instant fuel economy as a bar graph in mpg (U.S.) or l/100 km (Canada).

## ■ Average Fuel Economy

Shows the estimated average fuel economy of each trip meter in mpg (U.S.) or l/100 km (Canada). The display is updated at set intervals. When a trip meter is reset, the average fuel economy is also reset.

## ■ Range

Shows the estimated distance you can travel on the remaining fuel. This distance is estimated from the fuel economy of your trips in the past.

## ■ Elapsed Time

Shows the time elapsed since the last time Trip A or Trip B was reset.

## ■ Average Speed

Shows the average speed in mph or km/h since the last time Trip A or Trip B was reset.

## ■ Tire Pressure Monitor

Shows each tire's pressure.

► [TPMS \(Tire Pressure Monitoring System\) P. 355](#)

### ►► Average Fuel Economy

You can change when to reset the average fuel economy.

► [Customized Features P. 90](#)

### ►► Elapsed Time

You can change when to reset the elapsed time.

► [Customized Features P. 90](#)

### ►► Average Speed

You can change when to reset the average speed.

► [Customized Features P. 90](#)

## ■ Engine Oil Life

Shows the remaining oil life and Maintenance Minder™.



➤ [Maintenance Minder™ P. 381](#)

\* Not available on all models

## ■ Customized Features



Use the multi-information display to customize certain features.

### ■ How to customize

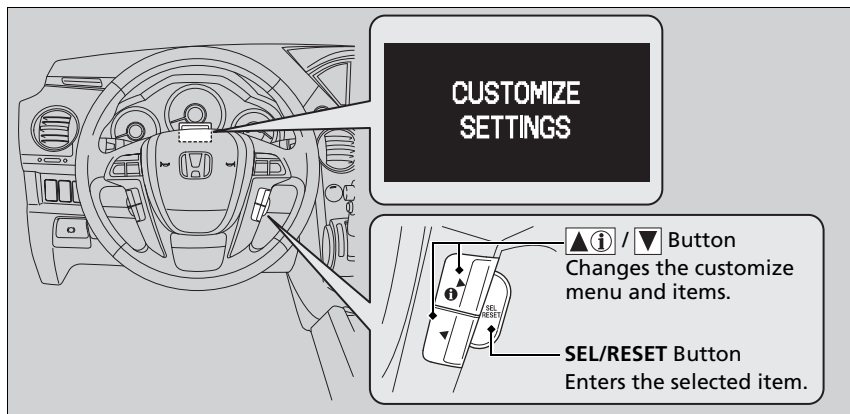
Select the **CUSTOMIZE SETTINGS** by pressing the  /  button while the ignition switch is in ON , and the vehicle is at a complete stop. Press the **SEL/RESET** button to change the display to the **CHG SETTING**.



## ► Customized Features

To customize other features, press the  /  button.

- [List of customizable options](#) P. 92
- [Example of customization settings](#) P. 94

Customization is possible when you see the driver's ID (**DRIVER 1** or **DRIVER 2**) on the **CHG SETTING** screen.

The driver's ID indicates which remote transmitter you have used to unlock the driver's door. The customized settings are recalled every time you unlock the driver's door with that remote.

When you customize settings:  
Shift to .

■ Customization flow

Press the ▲① / ▼ button.

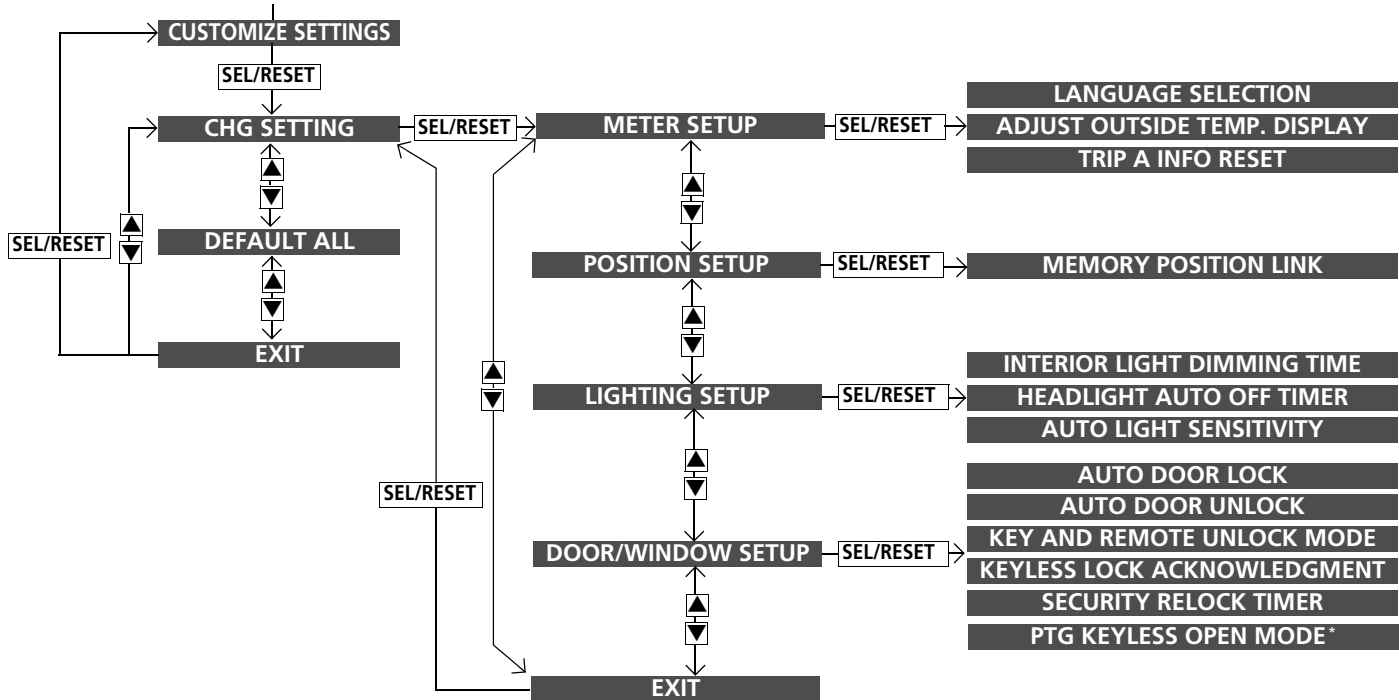

\* Not available on all models

■ List of customizable options

Setup Group	Customizable Features	Description	Selectable Settings
METER SETUP	<b>LANGUAGE SELECTION</b>	Changes the displayed language.	<b>ENGLISH*/FRENCH/SPANISH</b>
	<b>ADJUST OUTSIDE TEMP. DISPLAY</b>	Adjusts the temperature reading by a few degrees.	<b>-5°F ~ ±0°F* ~ +5°F (U.S.)</b>
			<b>-3°C ~ ±0°C* ~ +3°C (Canada)</b>
<b>TRIP A INFO RESET</b>	Changes the setting of how to reset trip meter A, average fuel economy A, average speed A, and elapsed time A.	<b>with REFUEL/ MANUAL ONLY*/IGN OFF</b>	
<b>POSITION SETUP</b>	<b>MEMORY POSITION LINK</b>	Changes the driver's seat and the outside mirror positions to a stored setting.	<b>ON*/OFF</b>
LIGHTING SETUP	<b>INTERIOR LIGHT DIMMING TIME</b>	Changes the length of time the interior lights stay on after you close the doors.	<b>60 sec/30 sec*/15 sec</b>
	<b>HEADLIGHT AUTO OFF TIMER</b>	Changes the length of time the exterior lights stay on after you close the driver's door.	<b>60 sec/30 sec/15 sec*/0 sec</b>
	<b>AUTO LIGHT SENSITIVITY</b>	Changes the timing for the headlights to come on.	<b>MAX/HIGH/MID*/LOW/MIN</b>

\*: Default Setting

Setup Group	Customizable Features	Description	Selectable Settings
<b>DOOR/ WINDOW SETUP</b>	<b>AUTO DOOR LOCK</b>	Changes the setting for the automatic locking feature.	<b>SHIFT FROM [P]/WITH VEH SPEED*<sup>2</sup>/OFF</b>
	<b>AUTO DOOR UNLOCK</b>	Changes the setting for when the doors unlock automatically.	<b>SHIFT TO [P] *<sup>2</sup>/IGN OFF/OFF DRIVER DOOR*<sup>2</sup>/ALL DOORS</b>
	<b>KEY AND REMOTE UNLOCK MODE</b>	Sets up either the driver's door or all doors to unlock on the first push of the remote transmitter.	<b>DRIVER DOOR*<sup>2</sup>/ALL DOOR</b>
	<b>KEYLESS LOCK ACKNOWLEDGMENT</b>	LOCK/UNLOCK- The exterior lights flash. LOCK (2nd push)- The beeper sounds.	<b>ON*<sup>2</sup>/OFF</b>
	<b>SECURITY RELOCK TIMER</b>	Changes the time it takes for the doors to relock and the security system to set after you unlock the vehicle without opening any door.	<b>90 sec/60 sec/30 sec*<sup>2</sup></b>
	<b>PTG KEYLESS OPEN MODE*<sup>1</sup></b>	Changes the keyless setting for when the power tailgate opens.	<b>ANYTIME*<sup>2</sup> / WHEN UNLOCKED</b>
<b>DEFAULT ALL</b>	Cancels/Resets all the customized settings as default.		<b>CANCEL*<sup>2</sup>/SET</b>



\*1: Not available on all models

\*2: Default Setting

### ■ Example of customization settings

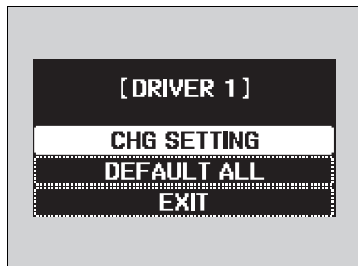
The steps for changing the **TRIP A INFO RESET** setting to **with REFUEL** are shown below. The default setting for **TRIP A INFO RESET** is **MANUAL ONLY**.



1. Press and release  /  button until **CUSTOMIZE SETTINGS** appears on the display.
2. Press the **SEL/RESET** button.
  - ▶ **CHG SETTING** appears on the display.
3. Press the **SEL/RESET** button to go into the **METER SETUP** group.
4. Press the **SEL/RESET** button again.
  - ▶ **LANGUAGE SELECTION** appears first on the display.

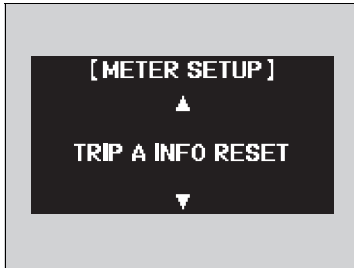

5. Press the / button until **TRIP A INFO RESET** appears on the display, then press the **SEL/RESET** button.

- ▶ The display switches to the setup screen, where you can select **with REFUEL**, **MANUAL ONLY**, **IGN OFF**, or **EXIT**.

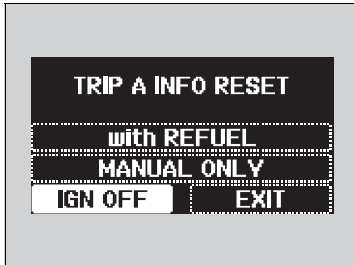

6. Press the / button and select **with REFUEL**, then press the **SEL/RESET** button.

- ▶ The **with REFUEL** setup screen appears, then the display returns to the customize item screen.



7. Press the / button until **EXIT** appears on the display, then press the **SEL/RESET** button.

8. Repeat Step 7 until you return to the normal screen.





# Controls

This chapter explains how to operate the various controls necessary for driving.



- Setting the Clock** ..... 98
- Locking and Unlocking the Doors**
  - Key Types and Functions ..... 99
  - Locking/Unlocking the Doors from the Outside ..... 101
  - Locking/Unlocking the Doors from the Inside ..... 103
  - Childproof Door Locks ..... 104
  - Auto Door Locking/Unlocking ..... 105
- Opening and Closing the Tailgate**... 110
- Security System** ..... 118
  - Immobilizer System ..... 118
  - Security System Alarm\* ..... 118
- Opening and Closing the Windows**..... 120

- Opening and Closing the Moonroof\***..... 123
- Operating the Switches Around the Steering Wheel**
  - Ignition Switch..... 124
  - Turn Signals ..... 125
  - Light Switches..... 125
  - Fog Lights\* ..... 127
  - Daytime Running Lights ..... 127
  - Wipers and Washers ..... 128
  - Brightness Control ..... 130
  - Rear Defogger/Heated Door Mirror\*
    - Button ..... 131
  - Driving Position Memory System\* .... 132
  - Adjusting the Steering Wheel..... 134

- Adjusting the Mirrors**..... 135
  - Interior Rearview Mirror ..... 135
  - Power Door Mirrors ..... 136
- Adjusting the Seats** ..... 137
  - Adjusting the Seat Positions ..... 137
- Interior Lights/Interior Convenience Items** ..... 150
  - Interior Lights ..... 150
  - Interior Convenience Items ..... 152
- Climate Control System** ..... 165
  - Using Automatic Climate Control .... 165
  - Automatic Climate Control Sensors ..... 170





\* Not available on all models

## Clock

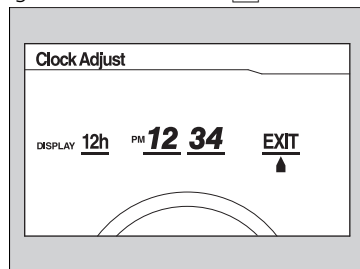
### Models with audio/information screen



You can adjust the time in the clock display, using the **CLOCK** button with the ignition switch in ON .





1. Press the **CLOCK** button to access the clock adjustment mode screen.
2. Press  to select the item you want to adjust (12/24 hour mode, hour, minute).
3. Rotate  to make the adjustment.
4. Press  to enter your selection. Repeat steps 2 to 4 to adjust other items.
5. To enter the selection, press  and select **EXIT**, then press .

### ⌘ Clock

These indications are used to show how to operate the selector knob.

Rotate  to select.  
Press  to enter.

You can also press the **SETUP** button to access the clock adjustment mode screen.

1. Press the **SETUP** button.
2. Rotate  to select **CLOCK ADJUST** on the screen.
3. Press , **CLOCK ADJUST** appears.

### Models with navigation system

The clock is automatically updated through the navigation system, so the time does not need to be adjusted.

## Key Types and Functions

This vehicle comes with the following keys:

### Master Keys



Use the keys to start and stop the engine, and to lock and unlock all the doors and tailgate. You can also use the remote transmitter to lock and unlock the doors and tailgate.

### Key Types and Functions

All the keys have an immobilizer system. The immobilizer system helps to protect against vehicle theft.

[Immobilizer System P. 118](#)

The keys contain precision electronics. Adhere to the following advice to prevent damage to the electronics:

- Do not leave the keys in direct sunlight, or in locations with high temperature or high humidity.
- Do not drop the keys or set heavy objects on them.
- Keep the keys away from liquids.
- Do not take the keys apart except for replacing the battery.

If the circuits in the keys are damaged, the engine may not start, and the remote transmitter may not work.

If the keys do not work properly, have them inspected by a dealer.

### ■ Valet Key

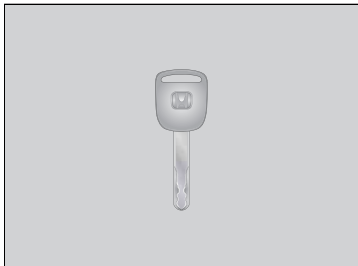

Can be used to start and stop the engine, and lock and unlock driver's door.

### ■ Key Number Tag

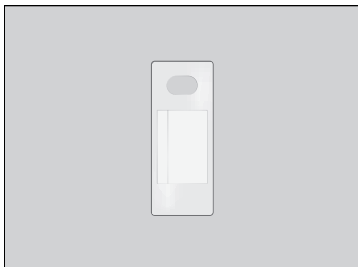

Contains a number that you will need if you purchase a replacement key.

#### ▶▶ Valet Key

When you need to leave a key with a third party, leave the valet key.

#### ▶▶ Key Number Tag

Keep the key number tag separate from the key in a safe place outside of your vehicle. If you wish to purchase an additional key, contact a dealer.

If you lose your key and you cannot start the engine, contact a dealer.

## Locking/Unlocking the Doors from the Outside

### ■ Using the Remote Transmitter

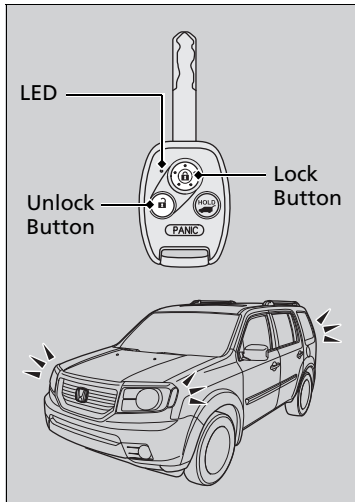

#### ■ Locking the doors

Press the lock button.

##### Once:

- ▶ Some exterior lights flash, all the doors and tailgate lock, and the security system sets.

##### Twice (within five seconds after the first push):

- ▶ A beeper sounds and verifies the security system is set.

#### ■ Unlocking the doors

Press the unlock button.

##### Once:

- ▶ Some exterior lights flash twice, and the driver's door unlocks.

##### Twice:

- ▶ The remaining doors and tailgate unlock.

### ✘ Using the Remote Transmitter

If you do not open a door within 30 seconds of unlocking the vehicle with the remote transmitter, the doors will automatically relock.

#### Models with multi-information display

You can change the relock timer setting.

➤ [Customized Features P. 90](#)

If the interior light switch is in the door activated position, the interior lights come on when you press the unlock button.

No doors opened: The lights fade out after 30 seconds.

Doors relocked with the remote: The lights go off immediately.

➤ [Interior Lights P. 150](#)

The remote transmitter uses low-power signals, so the operating range may vary depending on the surroundings.

The remote will not lock the vehicle when a door or the tailgate is open.

If the distance at which it works varies, the battery is probably low.

If the LED does not come on when you press a button, the battery is dead.

➤ [Replacing the Button Battery P. 424](#)

#### Models with multi-information display

You can customize the door unlock mode setting.

➤ [Customized Features P. 90](#)

### ■ Locking/Unlocking the Doors Using a Key

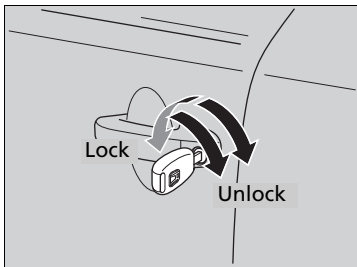

Fully insert the key and turn it.

### ■ Locking a Door Without Using a Key

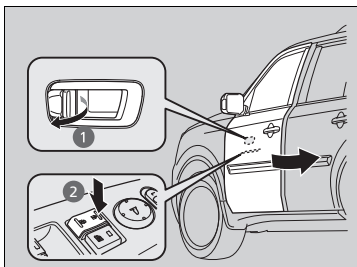

#### ■ Locking the driver's door

Push the lock tab rearward ① or push the master door lock switch in the lock direction ②, and close the door.

#### ■ Locking the passenger's doors

Push the lock tab rearward and close the door.

### ■ Lockout prevention system

The doors and the tailgate cannot be locked when the key is in the ignition switch, and any door or the tailgate is open.

### ▶▶ Locking/Unlocking the Doors Using a Key

When you lock the driver's door with a key, all of the other doors and tailgate lock at the same time. When unlocking, the driver's door unlocks first. Turn the key a second time within a few seconds to unlock the remaining doors and the tailgate.

#### Models with multi-information display

You can customize the door unlock mode setting.

▶ [Customized Features P. 90](#)

### ▶▶ Locking a Door Without Using a Key

When you lock the driver's door, all the other doors and tailgate lock at the same time.

Make sure you have the key in your hand before locking the door to prevent it from being locked in the vehicle.

## Locking/Unlocking the Doors from the Inside

### ■ Using the Lock Tab

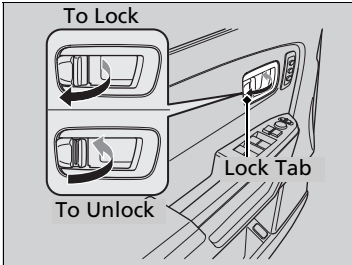

#### ■ Locking a door

Pull the lock tab.

#### ■ Unlocking a door

Push the lock tab in.

### ■ Using the Master Door Lock Switch

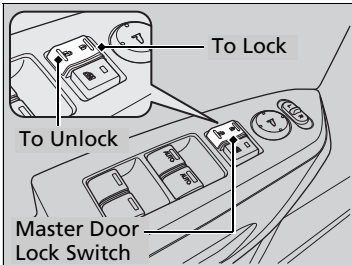

Press the master door lock switch in as shown to lock or unlock all doors and the tailgate.

### ☒ Using the Lock Tab

When you lock/unlock either front door using the master door lock switch, tailgate, glass hatch, and all the other doors lock/unlock at the same time.

### ☒ Using the Master Door Lock Switch

When you lock/unlock the driver's door using the master door lock switch, all the other doors and the tailgate lock/unlock at the same time.

The front passenger's door also has the master door lock switch.



## Childproof Door Locks

The childproof door locks prevent the rear doors from being opened from the inside regardless of the position of the lock tab.

### ■ Setting the Childproof Door Locks

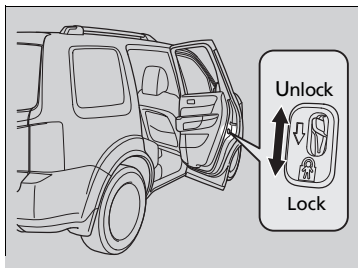

Slide the lever in the rear door to the lock position, and close the door.

### ■ When opening the door

Open the door using the outside door handle.

### ☒ Childproof Door Locks

To open the door from the inside when the childproof door lock is on, put the lock tab in the unlock position, lower the rear window, put your hand out of the window, and pull the outside door handle.

## Auto Door Locking/Unlocking

Your vehicle locks all doors and unlocks the driver's door automatically when a certain condition is met.

### Auto Door Locking

#### Drive lock mode

All doors and the tailgate lock when the vehicle's speed reaches about 10 mph (15 km/h).

### Auto Door Unlocking

#### Park unlock mode

The driver's door unlocks when the shift lever is moved into **P** with the brake pedal depressed.

\* Not available on all models

### Auto Door Locking/Unlocking

#### Models without multi-information display

You can turn off or change to another auto door locking/unlocking setting using the master door lock switch.

➤ [Customizing the Auto Door Locking/Unlocking Setting](#) \* P. 106

#### Models with multi-information display

You can turn off or change to another auto door locking/unlocking setting using the multi-information display.

➤ [Customized Features](#) P. 90

## Customizing the Auto Door Locking/Unlocking Setting\*

You can customize the auto door locking/unlocking setting to your liking using the master door lock switch.

### List of the Auto Door Locking/Unlocking Customizable Options

#### ■ Auto door locking

Mode	Description
<b>Drive Lock Mode</b> *1	All doors and the tailgate lock when the vehicle's speed reaches about 10 mph (15 km/h).
<b>Park Lock Mode</b>	All doors and the tailgate lock when the shift lever is moved out of <b>P</b> with the brake pedal depressed.
<b>Off</b>	The auto door locking is deactivated all the time.

#### ■ Auto door unlocking

Mode	Description
<b>Park Unlock Mode</b>	Driver's door unlocks.*1
	All doors and the tailgate unlock. When the shift lever is moved into <b>P</b> with the brake pedal depressed.
<b>Ignition Switch Unlock Mode</b>	Driver's door unlocks.
	All doors and the tailgate unlock. When the ignition switch is moved out of ON <b>II</b> .
<b>Off</b>	The auto door unlocking is deactivated all the time.

\*1: Default setting

## ■ Customizing Flow for Auto Door Locking Options

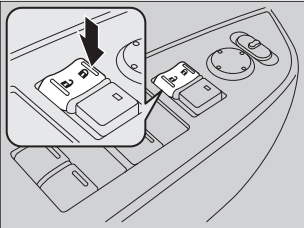
Steps	Drive Lock Mode*1	Park Lock Mode	Off
1	Apply the parking brake. Make sure the shift lever is in <b>P</b> .		
2	Turn the ignition switch to ON <b>II</b> .		
3	The driver's door must be closed at this stage.		Open the driver's door.
4	Move the shift lever out of <b>P</b> with the brake pedal depressed.		–
5	<p>Press and hold the front of the master door lock switch on the driver's door for more than five seconds. Release the switch after you hear a click twice.</p> 		Press and hold the front of the master door lock switch on the driver's door for more than five seconds. Release the switch after you hear one click.
6	Turn the ignition switch to ACCESSORY <b>I</b> within 20 seconds.		–
7	Move the shift lever to <b>P</b> .		–
8	<p>Turn the ignition switch to LOCK <b>0</b> within 20 seconds.</p> <p>▶ Customization is completed.</p>	<p>Turn the ignition switch to LOCK <b>0</b> within 20 seconds.</p> <p>▶ Customization is completed.</p>	<p>Turn the ignition switch to LOCK <b>0</b> within 20 seconds.</p> <p>▶ Customization is completed.</p>

\*1: Default setting

## ■ Customizing Flow for Auto Door Unlocking Options

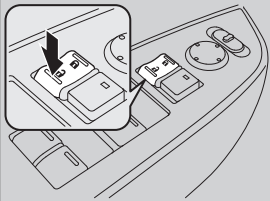
Steps	Ignition Switch Unlock Mode		Park Unlock Mode		Off
	To unlock driver's door	To unlock all doors and the tailgate	To unlock driver's door* <sup>1</sup>	To unlock all doors and the tailgate	
1	Apply the parking brake. Make sure the shift lever is in <b>P</b> .				
2	Turn the ignition switch to ON <b>II</b> .				
3	The driver's door must be closed at this stage.				Open the driver's door.
4	Move the shift lever out of <b>P</b> with the brake pedal depressed.		-		
5	Press and hold the rear of the master door lock switch on the driver's door for more than five seconds. You will hear a click twice. 				
6	Release the switch.	Keep pressing the switch for another five seconds to hear one more click.	Release the switch.	Keep pressing the switch for another five seconds to hear one more click.	Release the switch.

\*1: Default setting

Steps	Ignition Switch Unlock Mode		Park Unlock Mode		Off
	To unlock driver's door	To unlock all doors and the tailgate	To unlock driver's door <sup>*1</sup>	To unlock all doors and the tailgate	
7	Turn the ignition switch to ACCESSORY [I] within 20 seconds. ▶ Customization is completed.		-		
8	Move the shift lever to [P].		-		
9	Turn the ignition switch to LOCK [0] within 20 seconds. ▶ Customization is completed.		Turn the ignition switch to LOCK [0] within 20 seconds. ▶ Customization is completed.	Turn the ignition switch to LOCK [0] within 20 seconds. ▶ Customization is completed.	

\*1: Default setting

## Precautions for Opening/Closing the Tailgate

Always make sure individuals and objects are clear of the tailgate before opening or closing it.

### ■ Opening the tailgate

- Open the tailgate all the way.
  - ▶ If it is not fully opened, the tailgate may come down accidentally by its own weight.
- Be careful when it is windy. The wind may cause the tailgate to close.

### ■ Closing the tailgate

Keep the tailgate closed while driving to:

- ▶ Avoid possible damage.
- ▶ Prevent exhaust gas from leaking into the vehicle.

➤ [Carbon Monoxide Gas P. 65](#)

### » Precautions for Opening/Closing the Tailgate

Models with power tailgate

## WARNING

Closing a power tailgate while anyone is in the path of the tailgate can cause serious injury.

**Make sure everyone is clear before closing the tailgate.**

Be careful not to hit your head on the tailgate or to put your hands between the tailgate and the cargo area when closing the tailgate.

When operating the power tailgate, make sure there is enough space around your vehicle. People near the tailgate may be seriously hurt if the tailgate hits or closes on their heads. Be especially cautious if children are around.

When you are storing or picking up luggage from the cargo area while the engine is idling, do not stand in front of the exhaust pipe. You may get burned.

Do not allow any passenger in the cargo space. They may get hurt during hard braking, a sudden acceleration, or a crash.

## Opening/Closing the Tailgate Using the Tailgate Release Button

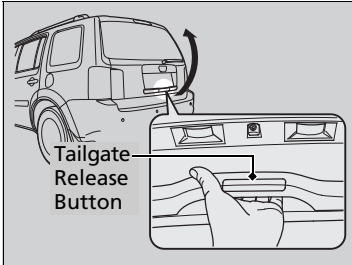

When all the doors are unlocked, the tailgate is unlocked. Press the tailgate release button and lift open the tailgate.

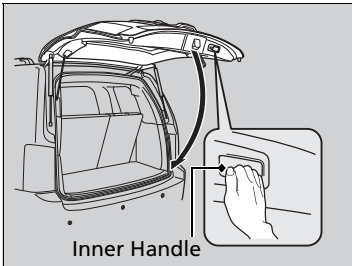

To manually close the tailgate, grab the inner handle, pull the tailgate down, and push it closed from outside.



## Opening/Closing the Power Tailgate\*

The power tailgate can be operated by pressing the power tailgate button on the remote transmitter, pressing the power tailgate button on the driver's door, or pressing the button on the tailgate.

### ■ The power tailgate can be opened when:

- The tailgate and glass hatch are fully closed.
- The shift lever is in **P**.
- The key is not in the ignition switch when using the remote transmitter.
- You have changed the **PTG KEYLESS OPEN MODE** setting to **WHEN UNLOCKED**, you need to unlock the tailgate before you press the tailgate button to open it.  
[📄 Customized Features P. 90](#)

### ■ The power tailgate can be closed when:

- The tailgate is fully open.
- The key is not in the ignition switch when using the remote transmitter.

### 🔑 Opening/Closing the Power Tailgate\*

The power tailgate may not open or close under the following conditions:

- The vehicle is parked on a steep hill.
- The vehicle is swayed in a strong wind.
- The tailgate or the roof is covered with snow or ice.

If you close the power tailgate when all the doors are locked, the power tailgate locks automatically.

If you replace the battery or the power tailgate fuse while the tailgate is open, the power tailgate may be disabled. The power tailgate resumes once you manually close the tailgate.

Installing aftermarket components other than genuine Honda accessories on the power tailgate may prevent it from fully opening or closing.

Make sure the power tailgate is fully open before you get your luggage in and out.

Make sure the power tailgate is fully closed before you start the vehicle.

## Remote Transmitter

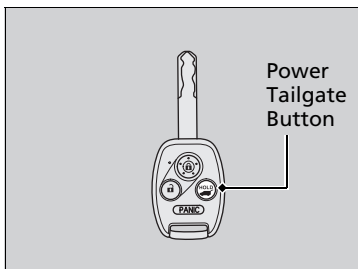

Press the power tailgate button for more than one second to operate.

To reverse direction while the power tailgate is in operation, press the button again. The beeper sounds three times and the tailgate reverses direction.

### Customizing when to open the tailgate

#### ANYTIME:

The power tailgate unlocks and opens at the same time. This is the default setting.

#### WHEN UNLOCKED:

The tailgate opens when all doors are unlocked.

Models with multi-information display

➔ [Customized Features P. 90](#)

Models without multi-information display

To change the setting, do the following:

1. Apply the parking brake.
2. Turn the ignition switch to ON **[II]**.
3. Press and hold the power tailgate button in the driver's door until you hear a beep.
4. Turn the ignition switch to OFF **[0]**.
  - ▶ When **ANYTIME** is set, you hear one long beep.
  - ▶ When **WHEN UNLOCKED** is set, you hear three short beeps.

## Opening/Closing the Power Tailgate\*

If the power tailgate meets resistance while opening or closing, the auto reverse feature reverses the direction. Three beeps sound.

The auto reverse function stops sensing when the tailgate is almost closed to make sure that it fully closes.

Do not touch the sensors located on both sides of the tailgate. The power tailgate does not close if you touch either sensor when you are trying to close the tailgate.

Be careful not to scratch the sensors with a sharp object. If scratched, they can be damaged, and the power tailgate closing feature malfunctions.

\* Not available on all models

## Power Tailgate Button

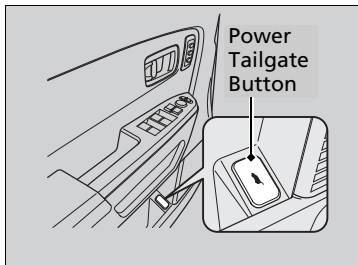

To open or close the power tailgate, press the tailgate button in the driver's door for about one second. The beeper sounds and some exterior lights flash.

To reverse direction while the power tailgate is in operation, press the button again. The beeper sounds three times and the tailgate reverses direction.

## Power Tailgate Close Button

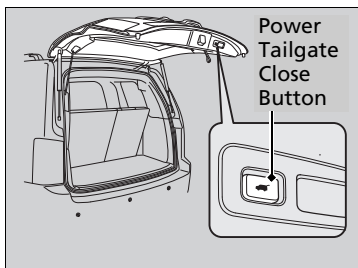

Press the button on the tailgate to close the power tailgate.  
If you press the button again while the power tailgate is closing, it stops and reverses direction.

### Power Tailgate Close Button

If you push the power tailgate close button while the tailgate is automatically opening or closing, the power tailgate operation stops. Use caution if the tailgate stops in the middle of either operation. It may suddenly swing up or down.

## Auto-Closer

If you manually close the power tailgate, it latches automatically.

### Auto-Closer

The auto-closer feature does not activate if you push the tailgate release button while the power tailgate is closing.

Do not put any force on the tailgate while the power tailgate is latching.

Keep your hands away from the tailgate when you manually close the tailgate and let it latch automatically. It is dangerous to put your hands around the tailgate as it starts to latch itself.

## Power Tailgate Fail-safe Mode

The power tailgate fail-safe mode detects if there is an extra load on the tailgate (for example, it is covered with snow). If an extra load is detected, the tailgate opens completely then lowers to the close position.

### Power Tailgate Fail-safe Mode

If you try to manually close the power tailgate immediately after it fully opens, the power tailgate fail-safe mode may activate.

Once the power tailgate fail-safe mode activates, wait until the power tailgate fully closes. Keep away from the power tailgate when it is in motion.

If the power tailgate fail-safe mode constantly activates, consult at a dealer.

## Opening/Closing the Glass Hatch

The glass hatch can be operated by pressing the glass hatch release button\* on the remote transmitter, pressing the glass hatch release button\* on the driver's door, or pressing the button on the tailgate.

### ■ Opening the glass hatch

- Open the glass hatch all the way.
  - If it is not fully opened, the glass hatch may come down accidentally by its own weight.
- Be careful when it is windy. The wind may cause the glass hatch to close.

### ■ Closing the glass hatch

- To close the glass hatch, lower it and press on the handle until it latches.
- Keep the glass hatch closed while driving to:
  - Avoid possible damage.
  - Prevent exhaust gas from leaking into the vehicle.
    - 📄 [Carbon Monoxide Gas P. 65](#)

### 📄 Opening/Closing the Glass Hatch

The rear wiper does not operate with the glass hatch open.

## Remote Transmitter\*



Press the glass hatch release button for more than one second to operate.

## Glass Hatch Release Button\*

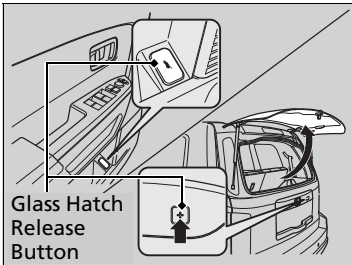

To open the glass hatch, press the glass hatch release button in the driver's door or press the button on the tailgate for about one second.

- ▶ The beeper sounds and some exterior lights flash.

\* Not available on all models

## Immobilizer System

The immobilizer system prevents a key that has not been pre-registered from starting the engine. Each key contains electronic transmitters that use electronic signals to verify the key.

Pay attention to the following when inserting the key into the ignition switch:

- Do not allow objects that emit strong radio waves near the ignition switch.
- Make sure the key is not covered by or touching a metal object.
- Do not bring a key from another vehicle's immobilizer system near the ignition switch.

## Security System Alarm \*

The security system alarm activates when the doors, tailgate, glass hatch, or hood is opened without the key, or remote transmitter.

### ■ When the security system alarm activates

The horn sounds intermittently, and all the exterior lights flash.

### ■ To deactivate the security system alarm

Unlock the vehicle using the key or remote transmitter. The system, along with the horn and flashing lights, is deactivated.

### » Immobilizer System

#### NOTICE

Leaving the ignition key in the vehicle can result in theft or accidental movement of the vehicle. Always take the ignition key with you whenever you leave the vehicle unattended.

Do not alter the system or add other devices to it. Doing so may damage the system and make your vehicle inoperable.

### » Security System Alarm

The security alarm continues for a maximum of two minutes until the security system alarm deactivates.

### ■ Setting the security system alarm

The security system alarm automatically sets when the following conditions have been met:

- The ignition switch is in LOCK [0], and the key has been removed from the ignition switch.
- The hood and tailgate are closed.
- All doors, the tailgate, and the glass hatch are locked with the key or the remote transmitter.

### ■ When the security system alarm sets

The security system alarm indicator in the instrument panel blinks. When the blinking interval changes after about 15 seconds, the security system alarm is set.

### ■ To cancel the security system alarm

The security system alarm is canceled when the vehicle is unlocked using the key or remote transmitter. The security system alarm indicator goes off at the same time.

### ☒ Security System Alarm\*

Do not set the security system alarm when someone is in the vehicle or a window is open. The system can accidentally activate when:

- Unlocking the door with the lock tab or the master door lock switch.

If the battery goes dead after you have set the security system alarm, the security alarm may go off once the battery is recharged or replaced.

If this occurs, deactivate the security system alarm by unlocking a door using the key or remote transmitter.

Do not attempt to alter this system or add another device to it.

## ■ Panic Mode

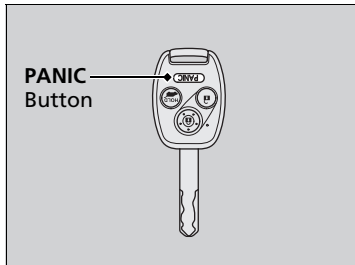

### ■ The PANIC button on the remote transmitter

If you press the **PANIC** button for approximately one second, the following will occur for about 30 seconds:

- The horn sounds.
- Some exterior lights flash.

### ■ Canceling panic mode

Press any button on the remote transmitter, or turn the ignition switch to ON [II].

\* Not available on all models



## Opening/Closing the Power Windows

The power windows can be opened and closed when the ignition switch is in ON , using the switches on the doors. The driver side switches can be used to open and close all of the windows.

The power window lock button on the driver side must be switched off (not pushed in, indicator off) to open and close the windows from anywhere other than the driver's seat.

When the power window lock button is pushed in, the indicator comes on and you can only operate the driver's window. Turn the power window lock button on when children are in the vehicle.

### Opening/Closing Windows with Auto-Open/Close Function

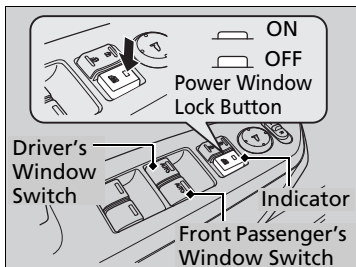

#### Automatic operation

**To open:** Push the switch down firmly.

**To close:** Pull the switch up firmly.

The window opens or closes completely. To stop the window at any time, push or pull the switch briefly.

#### Manual operation

**To open:** Push the switch down lightly.

**To close:** Pull the switch up lightly.

Release the switch when the window reaches the desired position.

### Opening/Closing the Power Windows

## WARNING

Closing a power window on someone's hands or fingers can cause serious injury.

Make sure your passengers are away from the windows before closing them.

The power windows can be operated for up to 10 minutes after you turn the ignition switch off. Opening either front door cancels this function.

#### Auto Reverse

If a power window senses resistance when closing automatically, it will stop closing and reverse direction.

The driver's window auto reverse function is disabled when you continuously pull up the switch.

The auto reverse function stops sensing when the window is almost closed to ensure that it fully closes.

## ■ Opening/Closing Windows without Auto-Open/Close Function

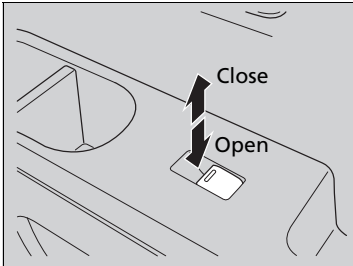

**To open:** Push the switch down.

**To close:** Pull the switch up.

Release the switch when the window reaches the desired position.

## ■ Opening the Windows and Moonroof\* with the Remote Transmitter

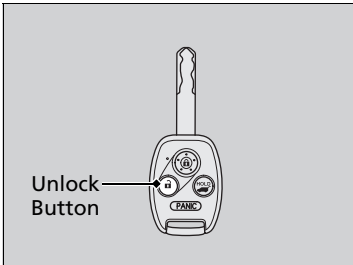

**To open:** Press the unlock button twice within 10 seconds and hold it down for the second time. If the windows stop midway, repeat the procedure.

\* Not available on all models

## ■ Opening/Closing the Windows and Moonroof\* with the Key

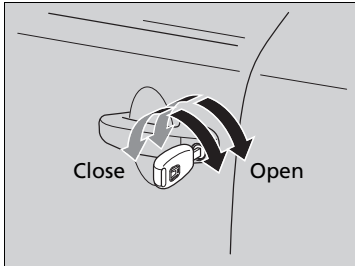

**To open:** Unlock the driver's door with the key. Within 10 seconds of returning the key to the central position, turn the key in the unlock direction and hold it there.

**To close:** Lock the driver's door with the key. Within 10 seconds of returning the key to the central position, turn the key in the lock direction and hold it there.

Release the key to stop the windows/moonroof at the desired position. If you want further adjustment, repeat the same operation.

## Opening/Closing the Moonroof

You can only operate the moonroof when the ignition switch is in ON **II**. Use the switch in the front of the ceiling to open and close the moonroof.

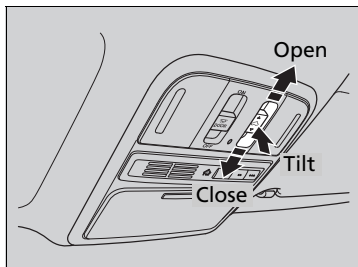

### Automatic operation

**To open:** Pull the switch back firmly, then release.

**To close:** Push the switch forward firmly, then release.

The moonroof will automatically open or close all the way. To stop the moonroof midway, touch the switch briefly.

### Manual operation

**To open:** Pull the switch back, and hold it until the desired position is reached.

**To close:** Push the switch forward, and hold it until the desired position is reached.

### Tilting the moonroof up

**To tilt:** Push on the center of the moonroof switch.

**To close:** Push the switch forward firmly, then release.

## Opening/Closing the Moonroof

### WARNING

Opening or closing the moonroof on someone's hands or fingers can cause serious injury.

Make sure all hands and fingers are clear of the moonroof before opening or closing it.

### NOTICE

Opening the moonroof in below freezing temperature or when it is covered with snow or ice can damage the moonroof panel or motor.

The power moonroof can be operated for up to 10 minutes after you turn the ignition switch off. Opening either front door cancels this function.

When resistance is detected, the auto reverse function causes the moonroof to change directions, then stop. Auto reverse stops sensing when the moonroof is almost closed to ensure that it fully closes. Make sure that all objects, including fingers, are clear of the moonroof.

You can use the remote transmitter or the key to operate the moonroof.

➤ [Opening the Windows and Moonroof\\* with the Remote Transmitter](#) P. 121

➤ [Opening/Closing the Windows and Moonroof\\* with the Key](#) P. 122

## Ignition Switch

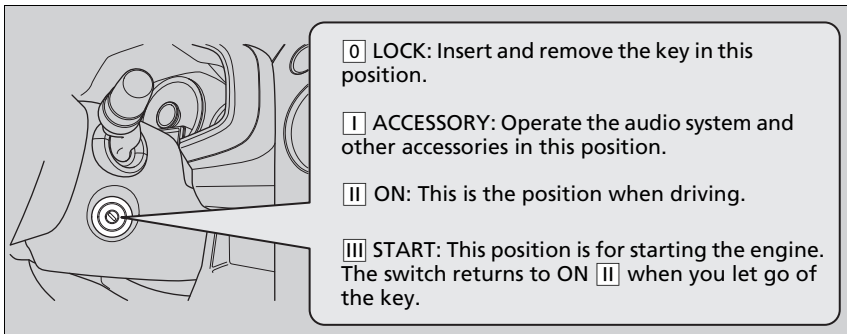

### Ignition Switch

You cannot take the key out unless the shift lever is in **P**.

If you open the driver's door when the key is in LOCK **0** or ACCESSORY **I**, a warning buzzer will sound to remind you to take the key out.

When this happens, the following messages appear on the multi-information display\*:

- In LOCK **0**: **REMOVE KEY**
- In ACCESSORY **I**: **REMOVE KEY** The buzzer will stop when you take the key out.

If the key won't turn from LOCK **0** to ACCESSORY **I**, turn the key while moving the steering wheel left and right. The steering wheel will unlock, allowing the key to turn.

## Turn Signals

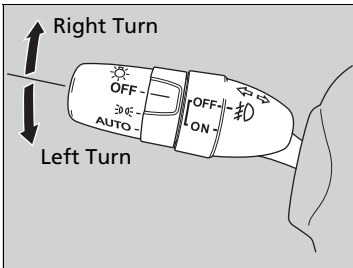

The turn signals can be used when the ignition switch is in ON **II**.

## Light Switches

### Manual Operation

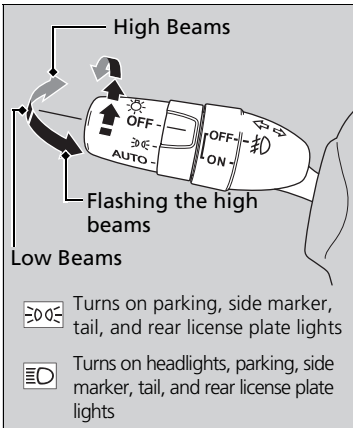

Rotating the light switch turns the lights on and off, regardless of the position of the ignition switch.

#### High beams

Push the lever forward until you hear a click.

#### Low beams

When in high beams, pull the lever back to return to low beams.

#### Flashing the high beams

Pull the lever back, and release it.

### Light Switches

If you remove the key from the ignition switch while the lights are on, a chime sounds when the driver's door is opened.

Do not leave the lights on when the engine is off because it will cause the battery to discharge.

## Automatic Lighting Control

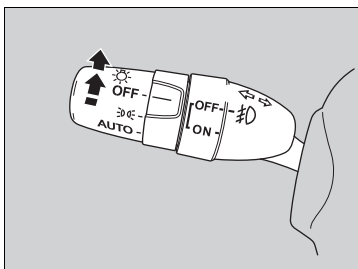

Automatic lighting control can be used when the ignition switch is in ON **II**.

When you turn the light switch to **AUTO**, the headlights and other exterior lights will switch on and off automatically depending on the ambient brightness.

- ▶ You can change the auto light sensitivity setting.

➤ [Customized Features P. 90](#)

## Automatic Lighting Off Feature

The headlights, all other exterior lights, and the instrument panel lights turn off within 15 seconds after you remove the key and close the driver's door.

- ▶ You can change the headlight auto off timer setting.

➤ [Customized Features P. 90](#)

If you turn the ignition switch to LOCK **0** with the headlight switch on, but do not open the door, the lights turn off after 10 minutes (three minutes, if the switch is in the **AUTO** position).

The lights turn on again when you unlock or open the driver's door. If you unlock the door, but do not open it within 15 seconds, the lights go off. If you open the driver's door, you will hear a lights on reminder chime.

## Automatic Lighting Control

We recommend that you turn on the lights manually when driving at night, in a dense fog, or in dark areas such as long tunnels or parking facilities.

The light sensor is in the location shown below. Do not cover this light sensor with anything; otherwise, the automatic lighting system may not work properly.

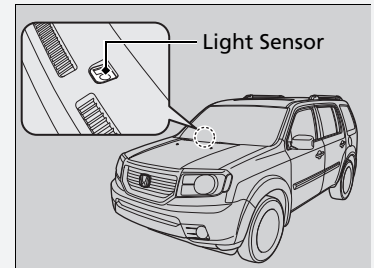

Adjust the auto light sensitivity as follows:

Setting	The exterior lights come on when the ambient light is at
MAX	<p>Bright</p>
HIGH	
MID	
LOW	
MIN	

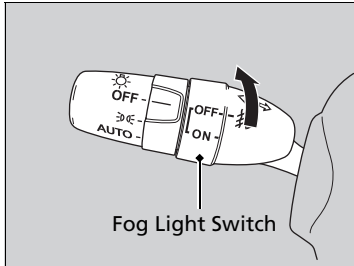

## Fog Lights\*



When the low beam headlights are on, turn the fog light switch on to use the fog lights.

## Daytime Running Lights

The high beam headlights come on slightly dimmer than normal when the following conditions have been met:

- The ignition switch is in ON .
- The headlight switch is off, or in .
- The parking brake is released.

The lights remain on even if you set the parking brake. Turning off the ignition switch will turn off the daytime running lights.

The high beam headlights return to the original brightness once the headlight switch is turned on.

\* Not available on all models

### Fog Lights\*

When the fog lights are on, the indicator in the instrument panel will be on.



# Wipers and Washers

## ■ Front Wiper/Washer

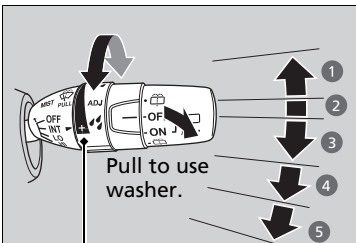

Intermittent Time Adjustment Ring

- 1 MIST
- 2 OFF
- 3 INT: Low speed with intermittent
- 4 LO: Low speed wipe
- 5 HI: High speed wipe

The windshield wipers and washers can be used when the ignition switch is in ON **(II)**.

### ■ MIST

The wipers run at high speed until you release the lever.

### ■ Wiper switch (OFF, INT, LO, HI)

Change the wiper switch setting according to the amount of rain.

### ■ Adjusting the delay

Turn the adjustment ring to adjust the wiper delay.



### ■ Washer

Sprays while you pull the lever toward you. When you release the lever, the wipers make two or three more sweeps before stopping.

## ▶▶ Wipers and Washers

### NOTICE

Do not use the wipers when the windshield is dry. The windshield will get scratched, or the rubber blades will get damaged.

### NOTICE

In cold weather, the blades may freeze to the windshield, becoming stuck. Operating the wipers in this condition may damage the wipers. Use the defroster to warm the windshield, then turn the wipers on.

Turn the washers off if no washer fluid comes out. The pump may get damaged.

If the vehicle speeds up while the wipers are operating intermittently, the length of the wipe interval shortens. When the vehicle starts moving, the wipers make a single sweep. When the vehicle speeds up, the wiper operation's shortest delay setting **(III)** and the **LO** setting become the same.

## ■ Rear Wiper/Washer

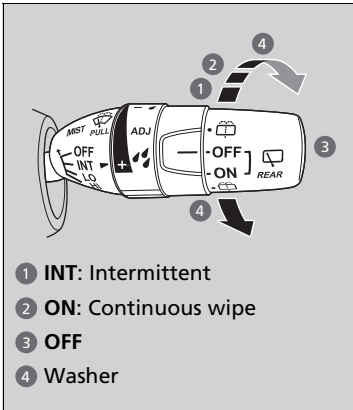

- 1 INT: Intermittent
- 2 ON: Continuous wipe
- 3 OFF
- 4 Washer

The rear wiper and washer can be used when the ignition switch is in ON **[II]**.

### ■ Wiper switch (OFF, INT, ON)

Change the wiper switch setting according to the amount of rain.

### ■ Washer

Sprays while you rotate the switch to this position.

Hold it to activate the wiper and to spray the washer. Once released, it stops operating after a few more sweeps.

### ■ Operating in reverse

When you shift the transmission to **[R]** with the front wiper activated, the rear wiper operates automatically as follows even if its switch is off.

Front Wiper Position	Rear Wiper Operation
<b>INT</b> (Intermittent)	Intermittent
<b>LO</b> (Low speed wipe) <b>HI</b> (High speed wipe)	Continuous

## ☒ Wipers and Washers

If the wiper stops operating due to any obstacle such as the build-up of snow, park the vehicle in a safe place.

Rotate the wiper switch to **OFF**, and turn the ignition switch to ACCESSORY **[I]** or LOCK **[0]**, then remove the obstacle.

The wiper motor is equipped with a breaker that may stop motor operation temporarily to prevent an overload. Wiper operation will return to normal within a few minutes, once the circuit has returned to normal.

## Brightness Control

ORG

TOC

Controls

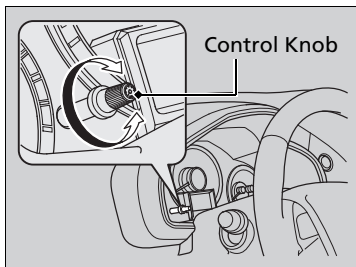

When the ignition switch is in ON **II**, you can use the brightness control knob to adjust instrument panel brightness.

**Brighten:** Turn the knob to the right.

**Dim:** Turn the knob to the left.

You will hear a beep when the brightness reaches minimum or maximum. The information display\*/multi-information display\* will return to its original state several seconds after you adjust the brightness.

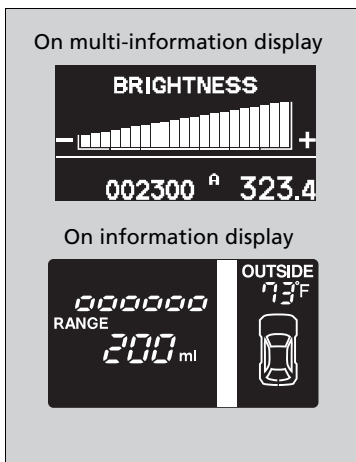

### ■ Brightness level indicator

The brightness level is shown on the information display\*/multi-information display\* while you are adjusting it.



### ▶▶ Brightness Control

Instrument panel brightness varies, depending on whether the exterior lights are on or off. The instrument panel dims to reduce glare when they are on.

Pressing the  (Select/Reset) knob or the  /  (information) button\* switches the display.

If you turn the knob to the right until the brightness display is up to max, the beeper sounds. This cancels the reduced instrument panel brightness when the exterior lights are on.

Index

Home

## Rear Defogger/Heated Door Mirror\* Button

Press the rear defogger and heated door mirror button to defog the rear window and mirrors when the ignition switch is in ON **II**.

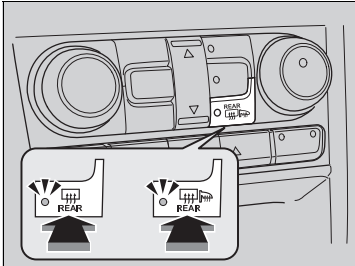

The rear defogger and heated door mirrors automatically switch off after 15 minutes.

### ⚠ Rear Defogger/Heated Door Mirror\* Button

#### NOTICE

When cleaning the inside of the rear window, be careful not to damage the heating wires. It is critical to wipe the window from side to side along the defogger heating wires.

This system consumes a lot of power, so turn it off when the window has been defogged. Also, do not use the system for a long period when the engine is idling. This may weaken the battery, making it difficult to start the engine.

\* Not available on all models

## Driving Position Memory System\*

You can store two driver's seat and door mirror positions with the driving position memory system.

When you unlock and open the driver's door with a remote transmitter, the seat and door mirrors adjust automatically to one of the two preset positions.

The multi-information display shows you which remote transmitter you used to unlock the vehicle when you enter.

- Driver 1 transmitter is linked to memory button 1.
- Driver 2 transmitter is linked to memory button 2.

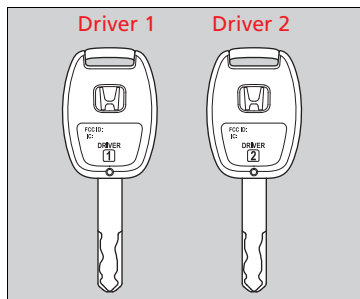

### ▶▶ Driving Position Memory System\*

Using the multi-information display, you can disable the automatic seat adjustment function.

[▶ Customized Features P. 90](#)

The customize setting is also stored by the Driver 1 and 2 transmitters. What setting is recalled next time depends on which transmitter you use to unlock and open the driver's door.

## Storing a Position in Memory

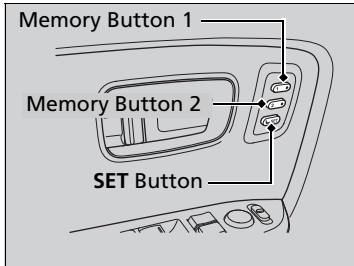

1. Turn the ignition switch to ON **[II]**. Adjust the driver's seat and the door mirrors to the desired position.
2. Press the **SET** button.
  - ▶ You will hear a beep, and the memory button indicator light will blink.
3. Press and hold memory button **[1]** or **[2]** within five seconds of pressing the **SET** button.
  - ▶ Once the seat and the door mirror positions have been memorized, the indicator light on the button you pressed stays on.

## Recalling the Stored Position

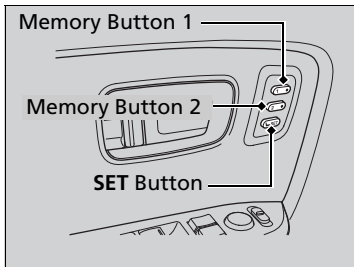

1. Move the shift lever to **[P]**.
2. Apply the parking brake.
3. Press a memory button (**[1]** or **[2]**).
  - ▶ You will hear a beep, and the indicator light will blink.

The seat and the door mirrors will automatically move to the memorized positions. When they have finished moving, you will hear a beep, and the indicator light stays on.

### Storing a Position in Memory

After you press the **SET** button, the storing operation will be canceled when:

- You do not press the memory button within five seconds.
- You readjust the seat position before the double-beep.
- You readjust the door mirrors.
- You turn the ignition switch to any position except ON **[II]**.

### Recalling the Stored Position

The seat and the door mirrors will stop moving if you:

- Press the **SET** button, or a memory button (**[1]** or **[2]**).
- Adjust the seat position.
- Adjust the door mirrors.
- Shift into any position except **[P]**.

## Adjusting the Steering Wheel

The steering wheel height and distance from your body can be adjusted so that you can comfortably grip the steering wheel in an appropriate driving posture.

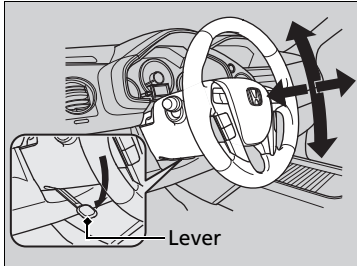

1. Push the steering wheel adjustment lever down.
  - ▶ The steering wheel adjustment lever is under the steering column.
2. Move the steering wheel up or down, and in or out.
  - ▶ Make sure you can see the instrument panel gauges and indicators.
3. Pull the steering wheel adjustment lever up to lock the steering wheel in position.
  - ▶ After adjusting the position, make sure you have securely locked the steering wheel in place by trying to move it up, down, in, and out.

### Adjusting the Steering Wheel

#### **⚠ WARNING**

Adjusting the steering wheel position while driving may cause you to lose control of the vehicle and be seriously injured in a crash.

Adjust the steering wheel only when the vehicle is stopped.

Make any steering wheel adjustments before you start driving.

## Interior Rearview Mirror

Adjust the angle of the rearview mirror when you are sitting in the correct driving position.

### Rearview Mirror with Day and Night Positions\*

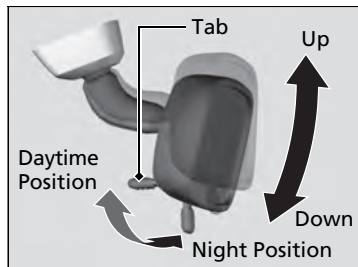

Flip the tab to switch the position. The night position will help to reduce the glare from headlights behind you when driving after dark.

### Automatic Dimming Rearview Mirror\*

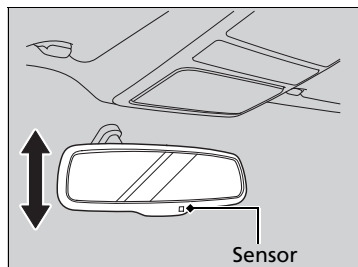

When driving after dark, the automatic dimming rearview mirror always reduces the glare from headlights behind you.

### Adjusting the Mirrors

Keep the inside and outside mirrors clean and adjusted for best visibility.

Adjust the mirrors before you start driving.

[Adjusting the Seat Positions P. 137](#)

### Automatic Dimming Rearview Mirror\*

The auto dimming function cancels when the shift position is in **R**.

\* Not available on all models



## Power Door Mirrors

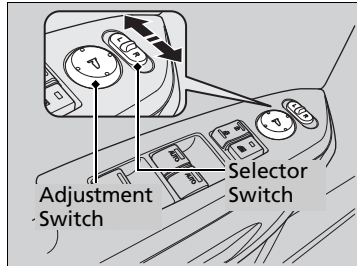

You can adjust the door mirrors when the ignition switch is in ON **II**.

### ■ Mirror position adjustment

**L/R selector switch:** Select the left or right mirror. After adjusting the mirror, return the switch to the center position.

**Mirror position adjustment switch:** Press the switch left, right, up, or down to move the mirror.

### ■ Reverse Tilt Door Mirror\*

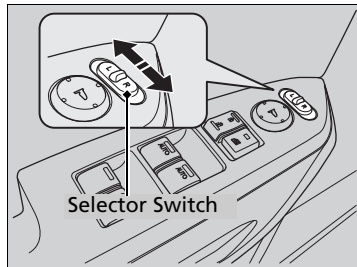

If activated, either side door mirror automatically tilts downward when you put the shift lever in **R**; this improves close-in visibility on the selected side of the vehicle when reversing. The mirror automatically returns to its original position when you shift out of **R**.

To activate this feature, turn the ignition switch to ON **II** and slide the selector switch to the left or right side.

## Adjusting the Seat Positions

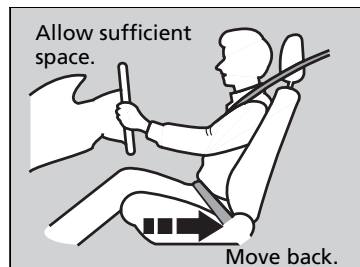

Adjust the driver's seat as far back as possible while allowing you to maintain full control of the vehicle. You should be able to sit upright, well back in the seat and be able to adequately press the pedals without leaning forward, and grip the steering wheel comfortably. The passenger's seat should be adjusted in a similar manner, so that it is as far back from the front airbag in the dashboard as possible.

### ■ Adjusting the front power seat(s)\*

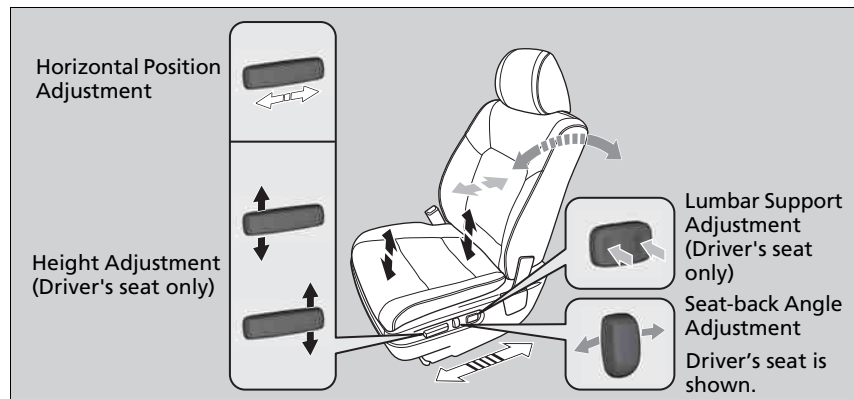

\* Not available on all models

Continued

### Adjusting the Seats

## ⚠ WARNING

Sitting too close to a front airbag can result in serious injury or death if the front airbags inflate.

Always sit as far back from the front airbags as possible while maintaining control of the vehicle.

The National Highway Traffic Safety Administration and Transport Canada recommend that drivers allow at least 10 inches (25 cm) between the center of the steering wheel and the chest.

Always make seat adjustments before driving.

## ■ Adjusting the front manual seat(s)\*

### Height Adjustment

(Driver side only)

Pull up or push down the lever to raise or lower the seat.

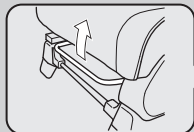
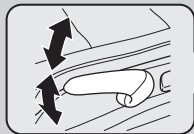

### Horizontal Position Adjustment

Pull up on the bar to move the seat, then release the bar.

Driver's seat is shown.

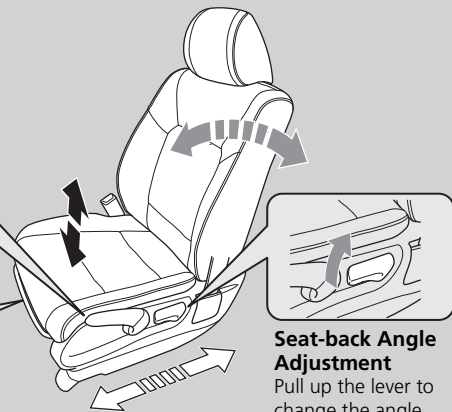

### Seat-back Angle Adjustment

Pull up the lever to change the angle.

## ▶▶ Adjusting the front manual seat(s)\*

Once a seat is adjusted correctly, rock it back and forth to make sure it is locked in position.

## ■ Adjusting the second row seats

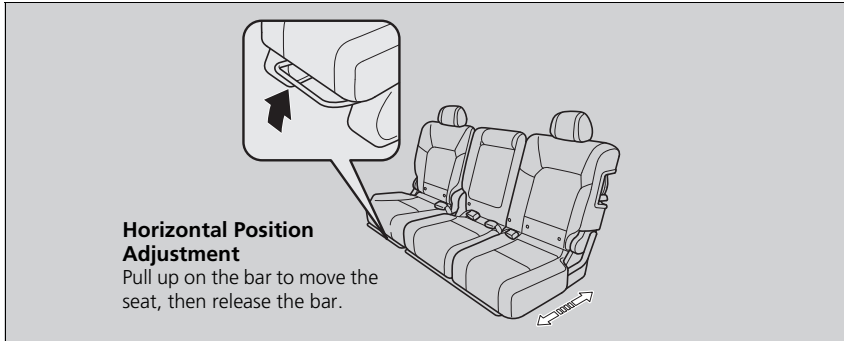

### ▶ Adjusting the second row seats

Once a seat is adjusted correctly, rock it back and forth to make sure it is locked in position.

## ■ Adjusting the Seat-Backs

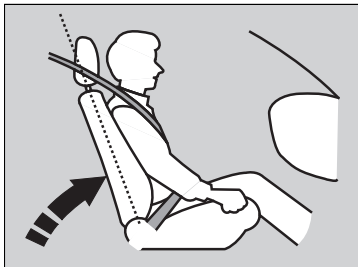

Adjust the driver's seat-back to a comfortable, upright position, leaving ample space between your chest and the airbag cover in the center of the steering wheel.

The front seat passenger should also adjust their seat-back to a comfortable, upright position.

Reclining a seat-back so that the shoulder part of the belt no longer rests against the occupant's chest reduces the protective capability of the belt. It also increases the chance of sliding under the belt in a crash and being seriously injured. The farther a seat-back is reclined, the greater the risk of injury.

## ►► Adjusting the Seat-Backs

### **⚠ WARNING**

**Reclining the seat-back too far can result in serious injury or death in a crash.**

**Adjust the seat-back to an upright position, and sit well back in the seat.**

Do not put a cushion, or other object, between the seat-back and your back.

Doing so may interfere with proper seat belt or airbag operation.

If you cannot get far enough away from the steering wheel and still reach the controls, we recommend that you investigate whether some type of adaptive equipment may help.

## Adjusting the Head Restraints

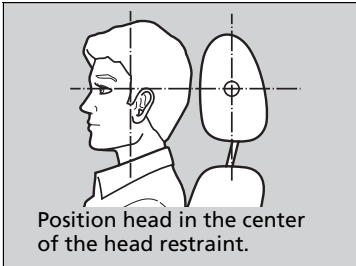

Your vehicle is equipped with head restraints in all seating positions.

Head restraints are most effective for protection against whiplash and other rear-impact crash injuries when the center of the back of the occupant's head rests against the center of the restraint. The tops of the occupant's ears should be level with the center height of the restraint.

### Adjusting the Head Restraints

#### **⚠ WARNING**

Improperly positioning head restraints reduces their effectiveness and increases the likelihood of serious injury in a crash.

Make sure head restraints are in place and positioned properly before driving.

■ **Adjusting the front, second row outer, and third row outer head restraint positions**

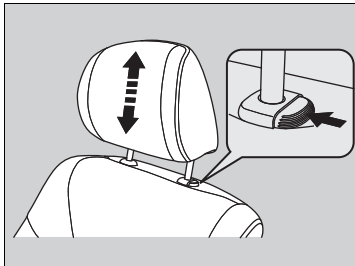

**To raise the head restraint:** Pull it upward.

**To lower the head restraint:** Push it down while pressing the release button.

## Changing the Second Row/Third Row Center Seat Head Restraint Positions

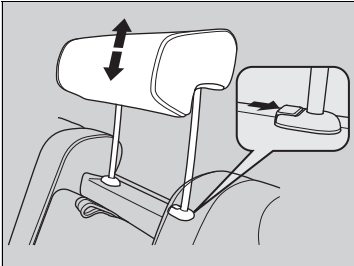

A passenger sitting in the second row/third row center seating position should adjust the height of their head restraint to an appropriate position before the vehicle begins moving.

### To raise the head restraint:

Pull it upward.

### To lower the head restraint:

Push it down while pressing the release button.

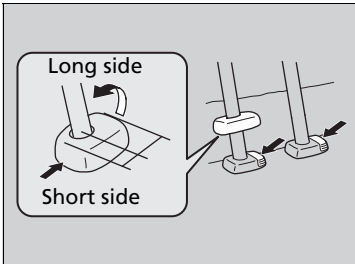

### Third row center seat

Push short side of the cap and pry up on long side of the cap. Push the release buttons sideways, and push the restraint down.



## ■ Removing and Reinstalling the Head Restraints

Head restraints can be removed for cleaning or repair.

### To remove a head restraint:

Pull the restraint up as far as it will go. Then push the release button, and pull the restraint up and out.

### To reinstall a head restraint:

Insert the legs back in place, then adjust the head restraint to an appropriate height while pressing the release button. Pull up on the restraint to make sure it is locked in position.

## ■ Maintain a Proper Sitting Position

After all occupants have adjusted their seats and head restraints, and put on their seat belts, it is very important that they continue to sit upright, well back in their seats, with their feet on the floor, until the vehicle is safely parked and the engine is off.

Sitting improperly can increase the chance of injury during a crash. For example, if an occupant slouches, lies down, turns sideways, sits forward, leans forward or sideways, or puts one or both feet up, the chance of injury during a crash is greatly increased.

In addition, an occupant who is out of position in the front seat can be seriously or fatally injured in a crash by striking interior parts of the vehicle or being struck by an inflating front airbag.

### ►► Removing and Reinstalling the Head Restraints

#### **WARNING**

Failure to reinstall, or correctly reinstall, the head restraints can result in severe injury during a crash.

Always replace the head restraints before driving.

### ►► Maintain a Proper Sitting Position

#### **WARNING**

Sitting improperly or out of position can result in serious injury or death in a crash.

Always sit upright, well back in the seat, with your feet on the floor.

## Active Head Restraints

The driver's and front passenger's seats have active head restraints. In a rear impact, an occupant properly secured by a seat belt will be pushed against the seat-back and the head restraint will move forward. This reduces the distance between the restraint and the occupant's head, which helps reduce the likelihood of whiplash and injuries to the neck and upper spine.

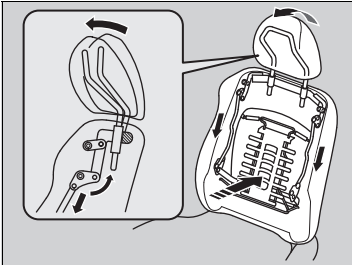

### Active Head Restraints

In order for the active head restraints to operate properly:

- Do not hang any items on the head restraints, or from the restraint legs.
- Do not place any objects between an occupant and the seat-back.
- Install each restraint in its proper location.

After a collision, the activated restraint should return to its normal position. If the restraint does not return to its normal position, or in the event of a severe collision, have the vehicle inspected by a dealer.

## Rear Seats

### Folding Down the Second Row Seats

The second row seats can fold down separately to allow for additional storage space.

#### To fold down the seat

1. Store the center seat belt first. Insert the latch plate into the slot on the side of the anchor buckle.
2. Retract the seat belt into the holder on the ceiling.
  - ▶ [Seat Belt with Detachable Anchor P. 34](#)
3. Lower the center head restraint to its lowest position. Put the armrest back into the seat-back.

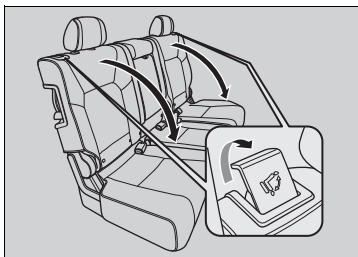

4. Pull the release lever.

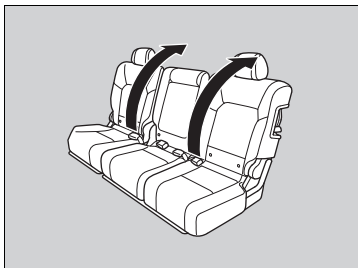

#### To return the seat to the original position

Pull the seat-back up in the upright position.

### Folding Down the Second Row Seats

**Make sure all items in the cargo area or items extending to the rear seats are properly secured. Loose items can fly forward if you have to brake hard.**

Remove any items from the rear seat cushion and floor before you fold down the rear seat.

The front seat(s) must be far enough forward so they do not interfere with the second seats as they fold down.

### To return the seat to the original position

Make sure the seat-back, head restraints and seat cushion are securely latched back into place before driving.

## Folding Down the Third Row Seats

The third row seats can fold down separately to allow for additional storage space.

### To fold down the seat

1. Store the center seat belt first. Insert the latch plate into the slot on the side of the anchor buckle.
2. Retract the seat belt into the holder on the ceiling and side panel.
  - ▶ [Seat Belt with Detachable Anchor](#) P. 34
3. Lower the center head restraint to its lowest position. Put the armrest back into the seat-back.
4. Pull the release lever.

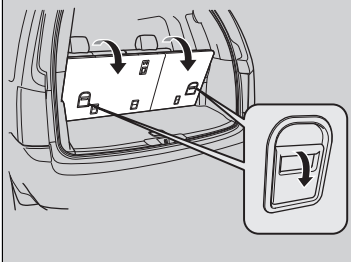
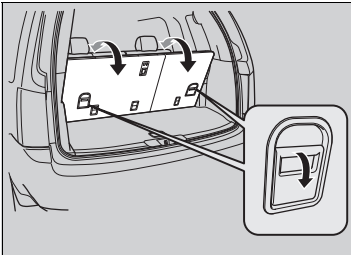

### To return the seat to the original position

Pull the seat-back up in the upright position.

### Folding Down the Third Row Seats

**Make sure all items in the cargo area or items extending to the rear seats are properly secured. Loose items can fly forward if you have to brake hard.**

Remove any items from the rear seat cushion and floor before you fold down the rear seat.

When you fold down one side of the rear seats and use the non-recessed part of the cargo area, make sure to secure the cargo. Loose items can fly forward and cause injury if you have to brake hard.

The second seat(s) must be far enough forward so they do not interfere with the third seats as they fold down.

### To return the seat to the original position

Make sure the seat-back, head restraints and seat cushion are securely latched back into place before driving.

## ■ Third Row Seat Access

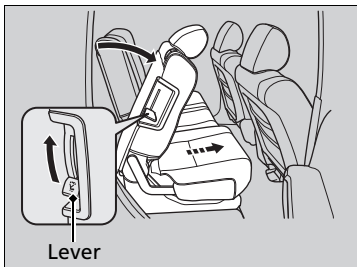

Pull up on the seat-back lever.

Slide the whole seat forward.

## ▶▶ Third Row Seat Access

When you enter the third row seat, be careful not to trip over the second row seat belt. If necessary, move the seat forward after tilting the seat-back forward.

## Armrest

### ■ Using the Front Seat Armrest

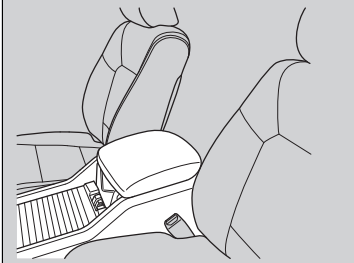

The console lid can be used as an armrest.

### ■ Using the Second Row Seat Armrest

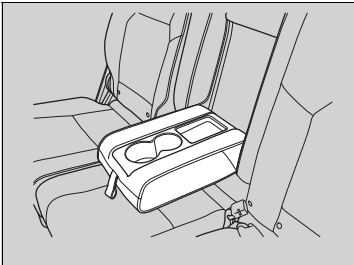

Pull down the armrest in the center seat-back.

## Interior Lights

### Interior Light Switches

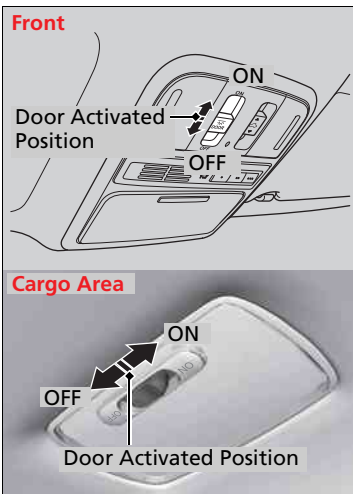

#### ■ ON

The interior lights come on regardless of whether the doors are open or closed.

#### ■ Door activated

The interior lights come on in the following situations:

- When any of the doors are opened.
- You unlock the driver's door.
- You remove the key from the ignition switch.

Only the cargo area light comes on when the tailgate is opened.

#### ■ OFF

The interior lights remain off regardless of whether the doors are open or closed.

### » Interior Light Switches

In the door activated position, the interior lights fade out and go off about 30 seconds after the doors are closed.

The lights go off after 30 seconds in the following situations:

- When you unlock the driver's door but do not open it.
- When you remove the key from the ignition switch but do not open a door.

The interior lights go off immediately in the following situations:

- When you lock the driver's door.
- When you close the driver's door with the key in the ignition switch.
- When you turn the ignition switch to ON **II**.

If you leave any of the doors open without the key in the ignition switch, the interior lights go off after about 15 minutes.

#### Models with multi-information display

You can change the interior lights dimming time.

➤ [Customized Features P. 90](#)

## Map Lights

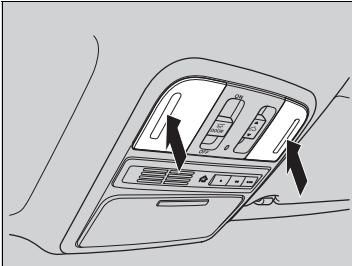

### ■ Front

The map lights can be turned on and off by pressing the lenses.

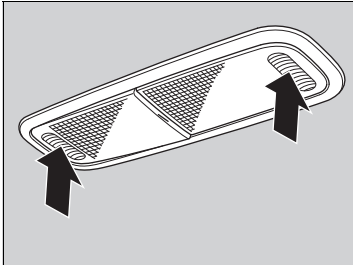

### ■ Second and third row

The map lights can be turned on and off by pressing the lenses when the front interior light switch is in the door activated position.

### ☒ Map Lights

When the front interior light switch is in the door activated position and any door is open, the map light will not go off when you press the lens.



## Interior Convenience Items

### ■ Glove Box

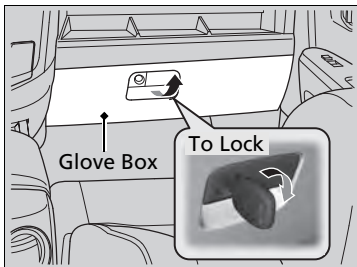

Pull the handle to open the glove box. You can lock the glove box with the master key.

### ■ Console Compartment

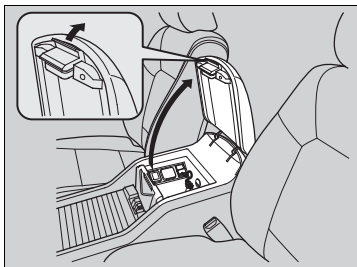

Pull the handle to open the console compartment.

### ☒ Glove Box

#### **⚠ WARNING**

An open glove box can cause serious injury to your passenger in a crash, even if the passenger is wearing the seat belt.

Always keep the glove box closed while driving.

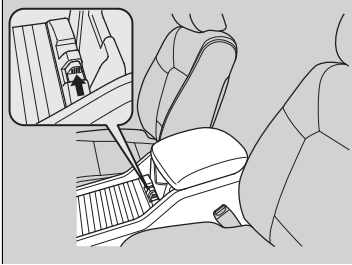

Slide the lid using the release knob to open or close the console compartment.

## ■ Under-floor Storage Area

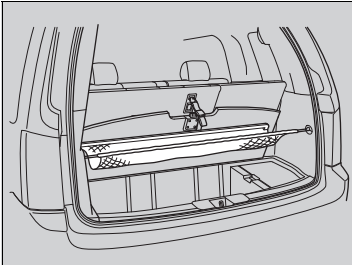

Hook the strap to the seat back to use it.

## ■ Storage Compartment

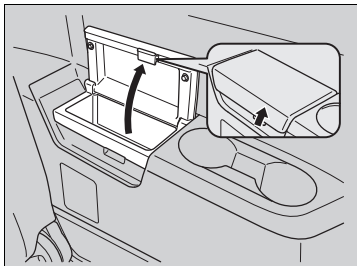

Pull the lever and lift the lid to open the compartment.

## ■ Beverage Holders

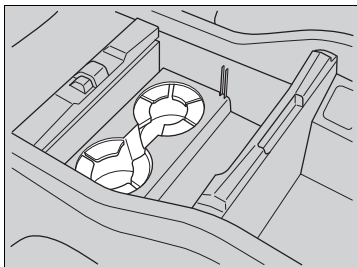

### ■ Front seat beverage holders

Are located in the console between the front seats.

## » Beverage Holders

### NOTICE

Spilled liquids can damage the upholstery, carpeting, and electrical components in the interior.

Be careful when you are using the beverage holders. Hot liquid can scald you.

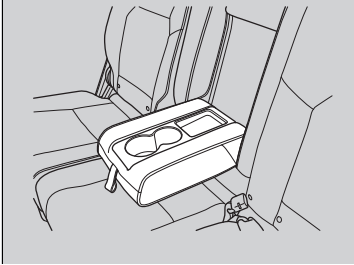

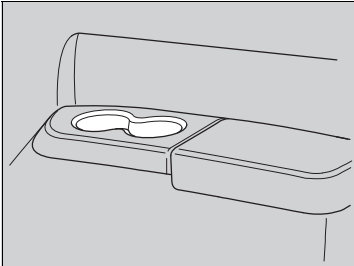

■ **Second row seat beverage holders**

Fold the armrest down to use the rear seat beverage holders.



■ **Third row seat beverage holders**

## ■ Accessory Power Sockets

The accessory power sockets can be used when the ignition switch is in ACCESSORY  or ON .

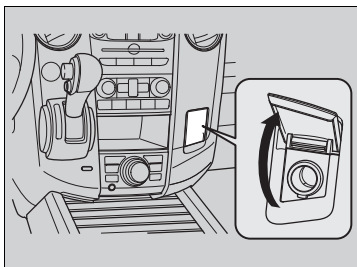

### ■ Accessory power socket (instrument panel)

Open the cover to use it.

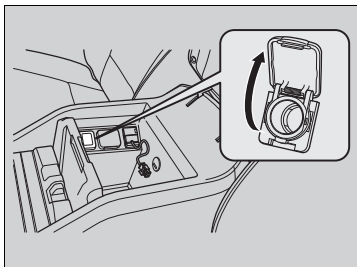

### ■ Accessory power socket (console compartment)

Open the console lid and the cover to use it.

## »» Accessory Power Sockets

### NOTICE

Do not insert an automotive type cigarette lighter element.

This can overheat the power socket.

The accessory power socket is designed to supply power for 12 volt DC accessories that are rated 120 watts or less (10 amps).

To prevent battery drain, only use the power socket with the engine running.

When each socket is being used simultaneously, the combined power rating of the accessories should not exceed 120 watts (10 amps).

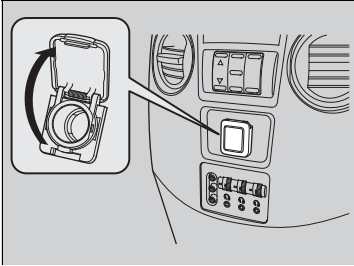

■ **Accessory power socket  
(back of the console compartment)**

Open the cover to use it.

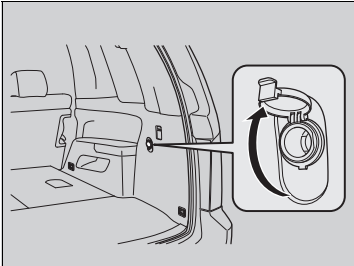

■ **Accessory power socket (cargo area)**

Open the cover to use it.

## AC Power Outlet\*

The AC power outlet can be used when the engine is running.

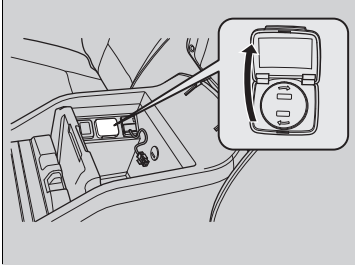

Open the cover to use it. Plug in the appliance slightly, turn it 90° clockwise, then push it all the way.

## AC Power Outlet\*

### NOTICE

Do not use the AC power outlet for electric appliances that require high initial peak wattage, such as cathode-ray tube type televisions, refrigerators, electric pumps, etc. It is not suitable for devices that process precise data, such as medical equipment, and that require an extremely stable power supply, such as microcomputer-controlled electric blankets, touch sensor lamps, etc.

The AC power outlet is designed to supply power for up to 115 volt appliances that are rated 150 watts or less.

## Coat Hooks

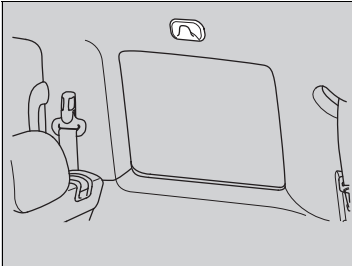

There are coat hooks near the third row seats.

### ☒ Coat Hooks

The coat hooks are not designed for large or heavy items.

## Cargo Net\*

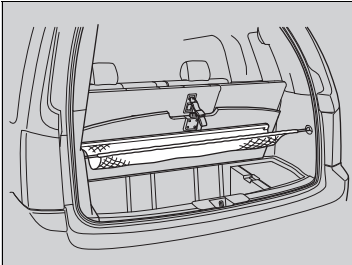

Use the cargo net to store small and light items.

### ☒ Cargo Net\*

## ⚠ WARNING

Do not use this cargo net if the third row seats are folded down.

Objects placed on the cargo net could be thrown forward during a crash or sudden stop and hurt someone.

### NOTICE

To prevent damage, do not place more than 22 lbs (10 kg) on this cargo net. Make sure to use the cargo net securely hooked.

\* Not available on all models



## ■ Cargo Hooks

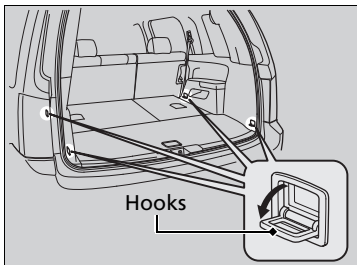

Use the floor cargo hooks to secure luggage in the cargo area.

## ■ Grocery Hook

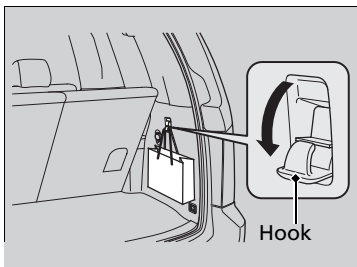

There is a hook on the side of the cargo area.

## » Cargo Hooks

### NOTICE

Do not hang a large object or an object. Hanging heavy or large objects may damage the hooks.

## ■ Sunglasses Holder

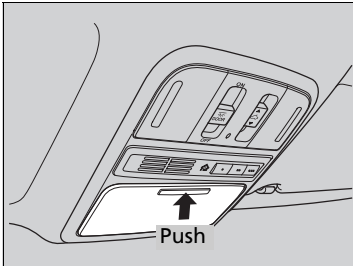

To open the sunglasses holder, push and release the indent. To close, push it again until it latches.

You can store eyeglasses and other small items in this holder.

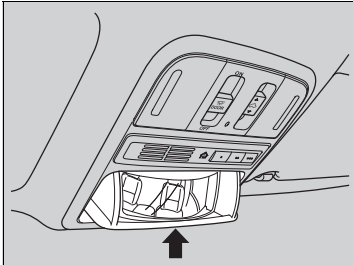

### ■ Conversation mirror\*

The sunglasses holder comes with a mirror. Open the sunglasses holder fully, then push it back to the first detent.

You can use the mirror to view the rear seats.

### ☒ Sunglasses Holder

Keep the holder closed while driving except when accessing stored items.

\* Not available on all models

## Seat Heaters\*

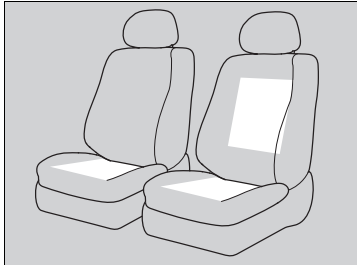

The ignition switch must be in ON (II) to use the seat heaters. The **HI** setting heats the seats faster than the **LO** setting.

There is no heater in the passenger's seat-back due to the side airbag cutoff system.

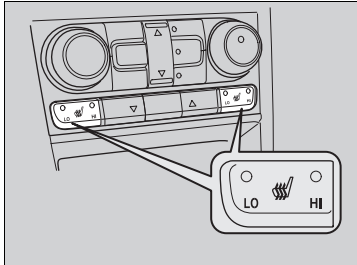

The appropriate indicator will be on while the seat heater is on. Each time you press the switch, the mode changes to **HI**, **LO** and OFF.

## Seat Heaters\*

### **WARNING**

Heat induced burns are possible when using seat heaters.

Persons with a diminished ability to sense temperature (e.g., persons with diabetes, lower-limb nerve damage, or paralysis) or with sensitive skin should not use seat heaters.

Do not use the seat heaters even in **LO** when the engine is off. Under such conditions, the battery may be weakened, making the engine difficult to start.

In the **LO** setting, the heater runs continuously and does not automatically turn off.

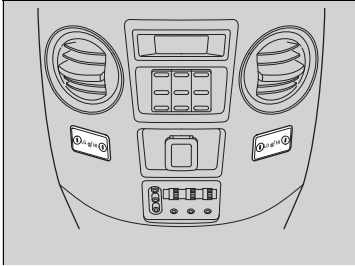

### ■ Second row seat heaters\*

The outer second row seat cushions and seat-backs are equipped with seat heaters. Turning the switch on the driver side warms the outer seat behind the driver's seat. The passenger side switch warms the outer seat behind the front passenger seat.

- Press the right side of the switch, **HI**, to rapidly heat up the seat.

When a comfortable temperature is reached, select **LO** to keep the seat warm.

\* Not available on all models

## ■ Integrated Sunshades\*

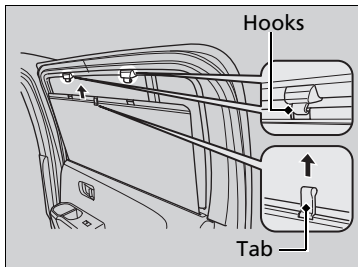

Pull the tab and roll up the sunshade all the way. Use the hooks to hang it.

## ▣ Integrated Sunshades\*

Use the sunshades only when the windows are fully closed. Using the shade while a window is open can unhook and blow off the shade, hitting and hurting anyone sitting near the window.

## Using Automatic Climate Control

The automatic climate control system maintains the interior temperature you select. The system also selects the proper mix of heated or cooled air that will raise or lower the interior temperature to your preference as quickly as possible.

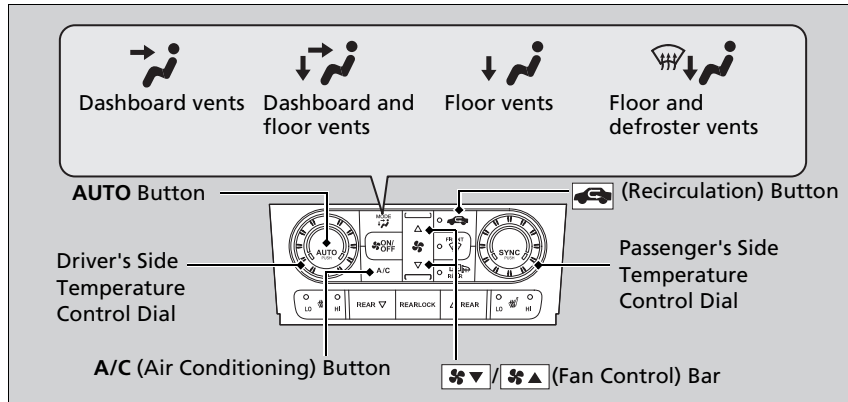

Use the system when the engine is running.

1. Press the **AUTO** button.
2. Adjust the interior temperature using the driver's side or passenger's side control dial.
3. Press the **NON OFF** button to cancel.

### Switching between the recirculation and fresh air modes

Press the **ON OFF** button and switch the mode depending on environmental conditions. Recirculation Mode (indicator on): Recirculates air from the vehicle's interior through the system.

Fresh Air Mode (indicator off): Maintains outside ventilation. Keep the system in fresh air mode in normal situations.

### Using Automatic Climate Control

If any buttons are pressed while using the climate control system in **AUTO**, the function of the button that was pressed will take priority. The **AUTO** indicator will go off, but functions unrelated to the button that was pressed will be controlled automatically.

To prevent cold air from blowing in from outside, the fan may not start immediately when the **AUTO** button is pressed.

If the interior is very warm, you can cool it down more rapidly by partially opening the windows, turning the system on **AUTO**, and setting the temperature to low. Change the fresh mode to recirculation mode until the temperature cools down.

When you set the temperature to the lower or upper limit, **Lo** or **Hi** is displayed.

Pressing the **ON OFF** button switches the climate control system between on and off. When turned on, the system returns to your last selection.

## ■ Defrosting the Windshield and Windows

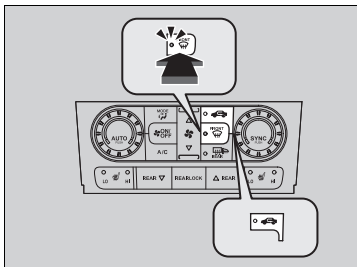

Pressing the  button turns the air conditioning system on and automatically switches the system to fresh air mode.

Pressing the  button again to turn off, the system returns to the previous settings.

## ■ To rapidly defrost the windows

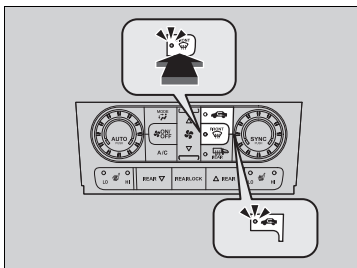

1. Press the  button.
2. Press the  button.

## ►► Defrosting the Windshield and Windows

**For your safety, make sure you have a clear view through all the windows before driving.**

Do not set the temperature near the upper or lower limit.

When cold air hits the windshield, the outside of the windshield may fog up.

If the side windows fog up, adjust the vents so that the air hits the side windows.

## ►► To rapidly defrost the windows

After defrosting the windows, switch over to fresh air mode.

If you keep the system in recirculation mode, the windows may fog up from humidity. This impedes visibility.

## Synchronized Mode

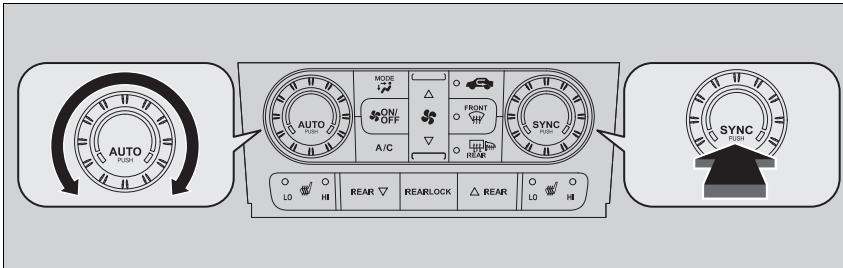

You can set the temperature synchronously for the driver side, the passenger side, and the rear passenger compartment in synchronized mode.

1. Press the **SYNC** button.  
► The system will switch to synchronized mode.
2. Adjust the temperature using driver's side temperature control dial.

Press the **SYNC** button to return to dual mode.

### ☒ Synchronized Mode

When you press the  button, the system changes to synchronized mode.

When the system is in tri-zone mode, the driver side temperature, the passenger side temperature, and the rear passenger compartment (if it is on) can be set separately.



## Rear Climate Control System

### ■ Using the Rear Climate Control System From the Front Panel

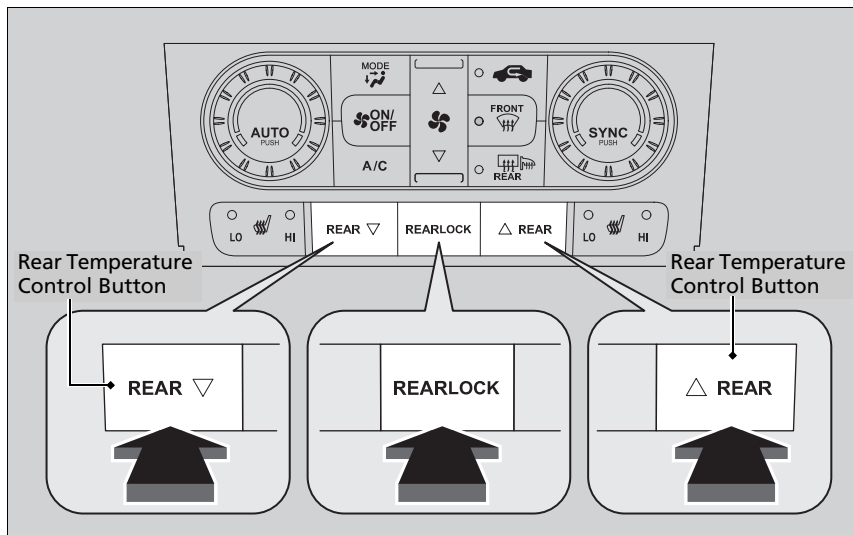

Use the system when the engine is running.

1. Press the **REARLOCK** button.
  - **LOCK** appears on the front control panel. The rear system changes to AUTO mode.
2. The system automatically adjusts the fan speed and airflow levels to maintain the set rear temperature.
  - Change the temperature if necessary.
3. To turn off the rear climate control system, press and hold the **REARLOCK** button for a few seconds.

### ▣ Rear Climate Control System

**AUTO LOCK** appears on the rear control panel while the rear lock is on.

If the rear lock is on while in SYNC mode, the rear control panel is disabled. **AUTO LOCK SYNC** appears on the rear control panel.

## ■ Using the Rear Climate Control System From the Rear Panel

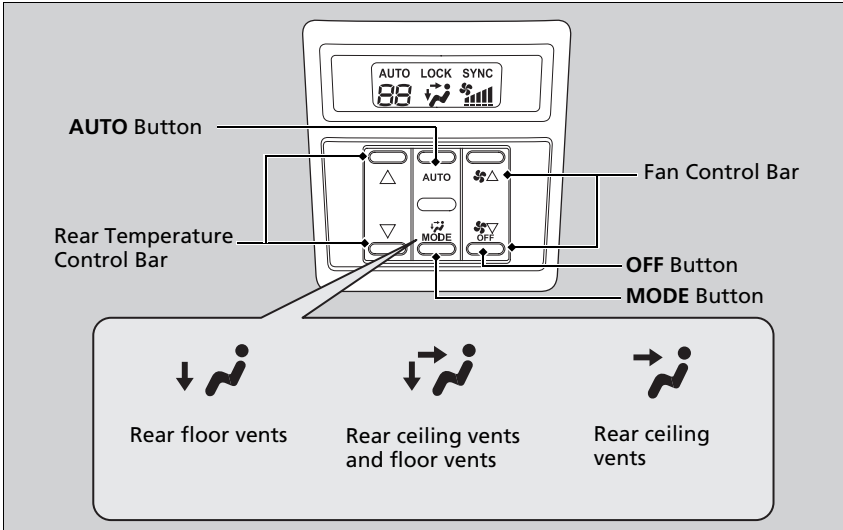

### ☒ Using the Rear Climate Control System From the Rear Panel

When the **REARLOCK** button on the front control panel is off, the temperature of the rear passenger compartment can be controlled independently.

Use the system when the engine is running.

1. Press the **AUTO** button.
2. Adjust the interior temperature using the rear temperature control bar.
3. To turn off the rear climate control system, press **OFF** button repeatedly until the system shuts off.

## Automatic Climate Control Sensors

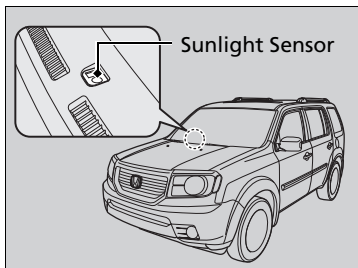

The automatic climate control system is equipped with a sunlight sensor, an interior temperature and humidity sensor. Do not cover or spill any liquid on them.

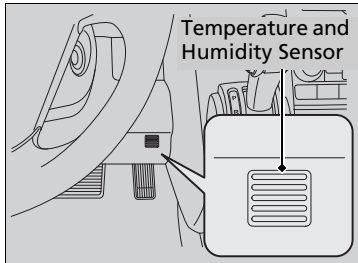

# Features

This chapter describes how to operate technology features.



## Audio System

- About Your Audio System ..... 172
- USB Adapter Cable ..... 173
- Auxiliary Input Jack ..... 173
- Audio System Theft Protection ..... 174

### Models without navigation system

- Audio System Basic Operation** ..... 175
  - Audio/Information Screen\* ..... 176
  - Audio Remote Controls ..... 184
  - Adjusting the Sound ..... 185
  - Playing the AM/FM Radio ..... 186
  - Playing the XM® Radio\* ..... 190
  - Playing a CD ..... 193

- Playing an iPod® ..... 203
- Playing a USB Flash Drive ..... 207
- Playing *Bluetooth*® Audio ..... 211

### Models with navigation system

- Audio System Basic Operation** ..... 216
  - Audio Remote Controls ..... 217
  - Adjusting the Sound ..... 218
  - Playing the AM/FM Radio ..... 219
  - Playing the XM® Radio ..... 223
  - Playing a CD ..... 226
  - Playing Hard Disc Drive (HDD) Audio ..... 230
  - Playing an iPod® ..... 240
- Rear Entertainment System\*** ..... 251

## Audio Error Messages ..... 266

### General Information on the Audio System ..... 272

### HomeLink® Universal Transceiver\* .. 276

#### Models without navigation system

- Bluetooth® HandsFreeLink®**
  - Using HFL ..... 278
  - HFL Menus ..... 280

#### Models with navigation system

- Bluetooth® HandsFreeLink®**
  - Using HFL ..... 301
  - HFL Menus ..... 303
- Compass\*** ..... 320

\* Not available on all models

## About Your Audio System

### Models with navigation system

See the Navigation System Manual for operation of the voice commands.

The audio system features AM/FM radio and the XM® Radio\* service. It can also play audio CDs, WMA/MP3/AAC files, iPod®, iPhone®, USB flash drives, and *Bluetooth*® devices.

You can operate the audio system from the buttons and switches on the panel, or the remote controls on the steering wheel.

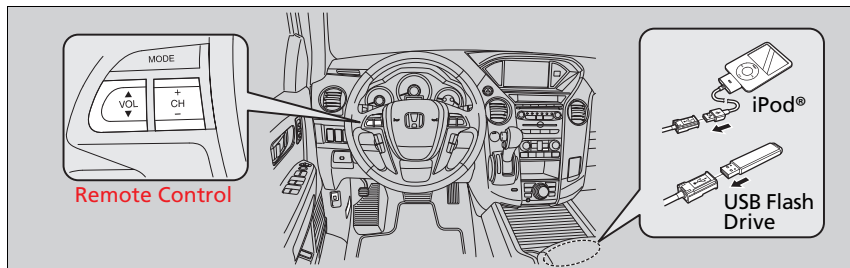

### About Your Audio System

XM® Radio is available on a subscription basis only. For more information on XM® Radio, contact a dealer.

[General Information on the Audio System](#)  
P. 272

XM® Radio is available in the United States and Canada, except Hawaii, Alaska, and Puerto Rico.

XM® is a registered trademark of Sirius XM Radio, Inc.

Video CDs, DVDs, and 3-inch (8-cm) mini CDs are not supported.

iPod® and iPhone® are registered trademarks owned by Apple Inc.

State or local laws may prohibit the operation of handheld electronic devices while operating a vehicle.

## USB Adapter Cable

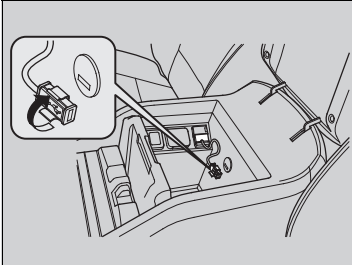

1. Unclip the USB connector and loosen the adapter cable.
2. Install the iPod® dock connector or the USB flash drive to the USB connector.

## Auxiliary Input Jack

Use the jack to connect standard audio devices.

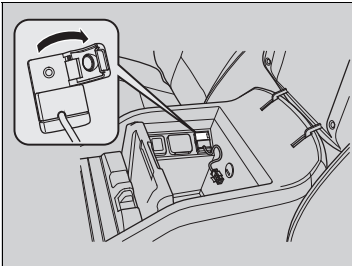

1. Open the AUX cover.
2. Connect a standard audio device to the input jack using a 1/8 inch (3.5 mm) stereo miniplug.
  - ▶ The audio system automatically switches to the AUX mode.

### ▣ USB Adapter Cable

- Do not leave the iPod® or USB flash drive in the vehicle. Direct sunlight and high temperatures may damage it.
- Do not use an extension cable with the USB adapter cable.
- Do not connect the iPod® or USB flash drive using a hub.
- Do not use a device such as a card reader or hard disk drive, as the device or your files may be damaged.
- We recommend backing up your data before using the device in your vehicle.
- Displayed messages may vary depending on the device model and software version.

If the audio system does not recognize the iPod®, try reconnecting it a few times or reboot the device. To reboot, follow the manufacturer's instructions provided with the iPod® or visit [www.apple.com/ipod](http://www.apple.com/ipod).

### ▣ Auxiliary Input Jack

To switch the mode, press any of the audio mode buttons. You can return to the AUX mode by pressing the **AUX** button.

You cannot use the auxiliary input jack if you replace the audio system.

State or local laws may limit the circumstances in which you can launch or control your attached audio device.

## Audio System Theft Protection

### Models without navigation system

The audio system is disabled when it is disconnected from the power source, such as when the battery is disconnected or goes dead.

### ■ Reactivating the audio system

1. Turn the ignition switch to ON **II**, and turn on the audio system.
  - ▶ If you turn the ignition switch to ACCESSORY **I**, you will be requested to enter the audio security code. See step 3.

### Except LX models

2. Press and hold the power button again for more than two seconds.
  - ▶ The audio system is reactivated when the system's control unit recognizes that the system is in your vehicle.  
If the control unit fails to recognize, **ENTER CODE** appears on the audio/information screen.
3. Enter the audio security code using the preset buttons. If you enter an incorrect digit, continue to the last digit, then try again. If you do not enter the code correctly after 10 tries, leave the system for one hour before trying again, or visit a dealer to have the system reset.

### ▶▶ Audio System Theft Protection

We recommend that you write down the serial number in this owner's manual.

You can find out about your serial number and security code from a dealer.



### U.S. models

You can register the security code at Owner Link ([owners.honda.com](http://owners.honda.com)), and find information on how to retrieve the serial number and obtain the code at [radio-navicode.honda.com](http://radio-navicode.honda.com).

### Models with navigation system

See the Navigation System Manual for details.

## Models without navigation system

To use the audio system function, the ignition switch must be in ACCESSORY  or ON .

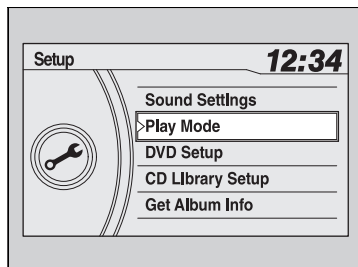
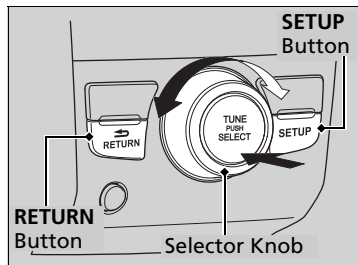

Use the selector knob or **SETUP** button to access some audio functions.

Press  to switch between the normal and extended display for some functions.

**Selector knob:** Rotate left or right to scroll through the available choices. Press  to set your selection.

**SETUP button:** Press to select any mode such as the Auto Select, Sound Settings, Play Mode, Resume/Pause, or compass.

**RETURN button:** Press to go back to the previous display.

 **button:** Press to change the audio/ information screen brightness. The brightness can be set differently for the day time and night time.

Press once for the daytime mode.

Press twice for the nighttime mode.

Adjust the brightness using .

## Audio System Basic Operation

These indications are used to show how to operate the selector knob.

Rotate  to select.



Press  to enter.



## Audio/Information Screen \*

Displays audio status, trip computer and wallpaper, and allows you to go to various setup options.

### Switching the Display

Press **DISPLAY** button. Rotate  and select the mode from the four display modes. Press .

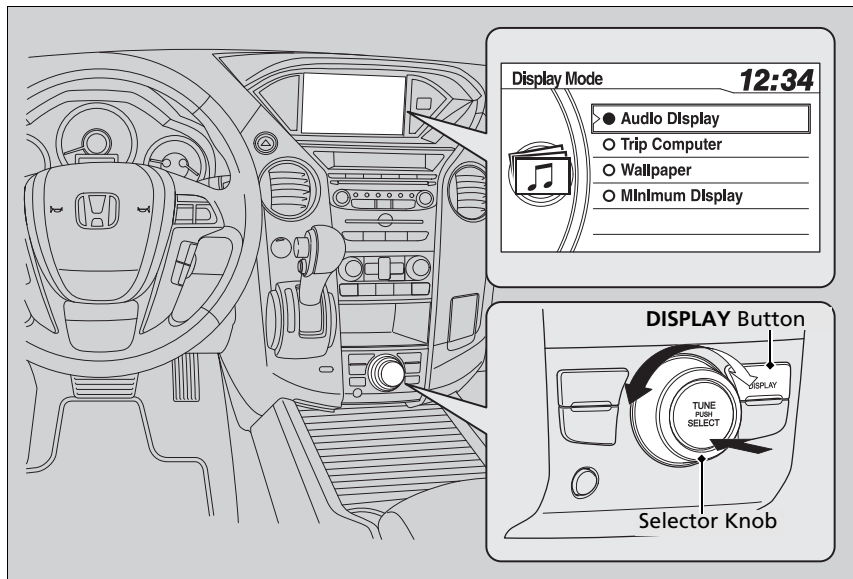

### Switching the Display

These indications are used to show how to operate the selector knob.

Rotate  to select.

Press  to enter.

## ■ Audio Display

Shows the current audio information.

▶ [Audio System Basic Operation](#) P. 175

## ■ Trip Computer

Shows the instant fuel economy, average fuel economy, distance (trip meter), average speed, elapsed time, and range.

▶ [Instant Fuel Economy](#) P. 82

▶ [Trip Meter](#) P. 82

▶ [Range](#) P. 82

## ■ Average speed

Shows the average speed in mph (U.S.) or km/h (Canada).

## ■ Elapsed time

Shows the time during one drive cycle.

## ■ Wallpaper

Shows a clock screen or an image you import.

▶ [Wallpaper Setup](#) P. 179

## ■ Minimum Display

Minimizes the display by only showing the compass, audio status, and clock on the upper part of the display.



## ▶ Trip Computer

You can reset the trip computer.

▶ [Trip Computer](#) P. 88

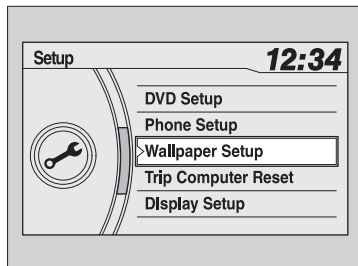
## ■ Setting Options









1. Press **SETUP** button.
2. Rotate  and select the setup option you want to change. Press .

## ■ DVD Setup \*

-  [DVD setup from the front panel](#) P. 254

## ■ Phone Setup

-  [Phone Setup](#) P. 283
-  [To Create Phone Name/PIN](#) P. 310
-  [Automatic Answering](#) P. 289
-  [Automatic Transferring](#) P. 289
-  [To Clear the System](#) P. 312
-  [Speed Dial](#) P. 313

## Wallpaper Setup

You can change, store, delete the wallpaper on the audio/information screen.





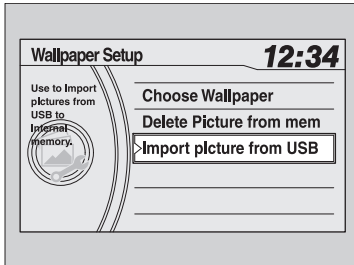

### Models with navigation system

See the navigation system manual for how to change the wallpaper.

### Importing pictures from USB

You can import up to five images, one at a time, for wallpaper from USB flash drive. Select **Import picture from USB** from setup menu and properly connect a USB flash drive to store an image.





1. Connect the USB flash drive to the adapter cable.  
▶ [USB Adapter Cable P. 173](#)
2. Press the **SETUP** button.
3. Rotate  to select **Wallpaper Setup**, then press .
4. Rotate  to select **Import picture from USB**, then press .
5. Rotate  to select a desired picture, then press .  
▶ **Loading Picture** will appear on the display.

### Wallpaper Setup



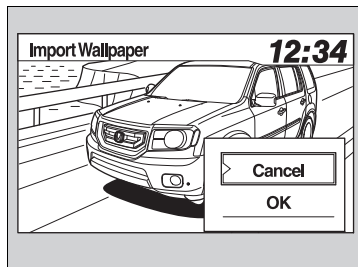

- When importing wallpaper files, the image must be in the USB flash drive's root directory. Images in a folder cannot be imported.
- The file format of the image that can be imported is BMP (bmp) or JPEG (jpg).
- The maximum image size is 1,024 x 768 pixels. Smaller images are displayed in the middle of the screen with the extra area appearing in black.

If the USB flash drive does not have any pictures, **No Files** will appear.









6. The preview of the imported data is displayed.
7. Rotate  to select **OK**, then press .
  - ▶ The imported list number and the confirmation message will appear. Then the display will return to the import wallpaper list.

## ■ Choose wallpaper

1. Rotate  to select **Choose Wallpaper** on the wallpaper setup menu, then press .
  - ▶ The screen will change to the wallpaper list.
2. Rotate  to select desired wallpaper and press .
3. Your selection will be indicated by the filled in circle.
  - ▶ You can also select **Default Wallpaper** (Honda logo) or **Clock** on the list.





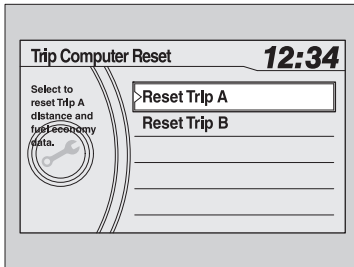

## ■ Delete wallpaper

1. Rotate  to select **Delete Picture from mem** on the wallpaper setup menu, then press .
  - ▶ The screen will change to the delete wallpaper list.
2. Rotate  to select wallpaper that you want to delete and press .
  - ▶ The confirmation message will appear.
3. Rotate  to select **Yes**, then press  to delete completely.

## Trip Computer Reset



You can reset all data on the trip computer.

1. Press the **SETUP** button.
2. Rotate  to select **Trip Computer Reset**, then press .
3. Rotate  to **Trip A** or **Trip B**, then press .
  - ▶ The confirmation message will appear.
4. Rotate  to select **Yes**, then press  to reset completely.

## ■ Display Setup

### ■ Brightness/Contrast

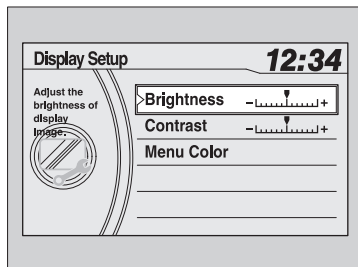

If you select **Brightness** or **Contrast**, adjust the setting by rotating  and pressing .



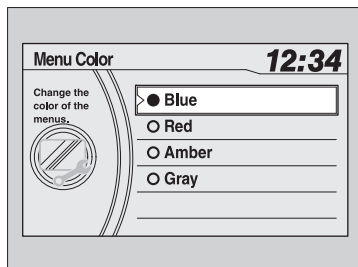

### ■ Menu Color

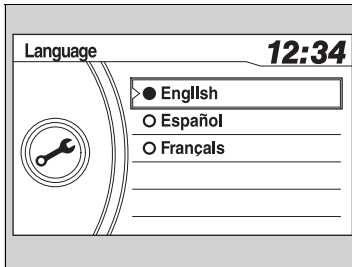

If you select **Menu Color**, rotate  to setting you want, then press .

## Language Selection



1. Rotate  to select **Language Selection**, then press .
2. Rotate  to select the language, then press .



## Audio Remote Controls

Allows you to operate the audio system while driving.

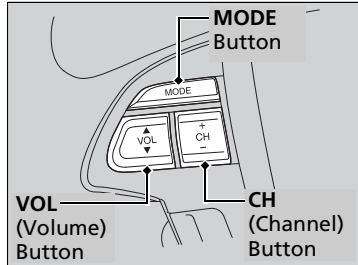

### MODE Button

Cycles through the audio modes as follows:  
 FM1→FM2→AM→XM1\*→XM2\*→CD→  
 CD-L→AUX

### VOL Button

Press ▲: Increases the volume.

Press ▼: Decreases the volume.

### CH Button

- When listening to the radio
  - Press +: Selects the next preset radio station.
  - Press -: Selects the previous preset radio station.
  - Press and hold +: Selects the next strong station.
  - Press and hold -: Selects the previous strong station.
- When listening to a CD, CD Library, iPod® or USB flash drive.
  - Press +: Skips to the next song.
  - Press -: Goes back to the beginning of the current or previous song.
- When listening to a CD or CD Library.
  - Press and hold +: Skips to the next folder/album.
  - Press and hold -: Goes back to the previous folder/album.

### ▶▶ Audio Remote Controls

The CD mode appears only when a CD is loaded.

When in AUX mode, the following are operable from the remote controls:

- iPod®/USB flash drive connected to the USB adapter cable
- Bluetooth® Audio (with some phones only)

## Adjusting the Sound

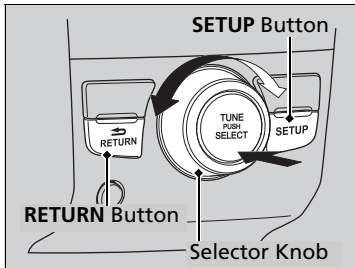

Press the **SETUP** button, and rotate to select **Sound Settings**, then press . Rotate to scroll through the following choices:

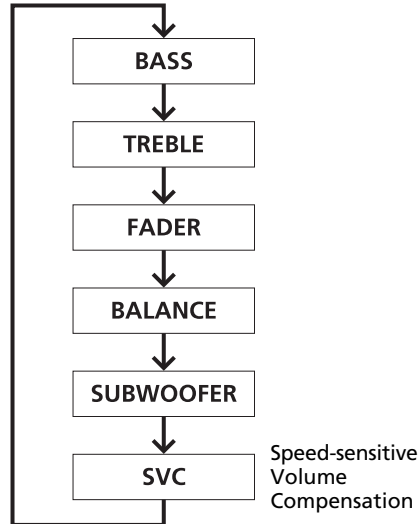
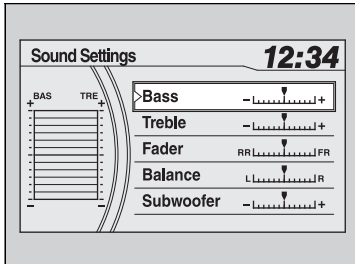

### Adjusting the Sound

The **SVC** has four modes: **OFF**, **LOW**, **MID**, and **HIGH**.

**SVC** adjusts the volume level based on the vehicle speed. As you go faster, audio volume increases. As you slow down, audio volume decreases.

## Playing the AM/FM Radio

Models without rear entertainment system

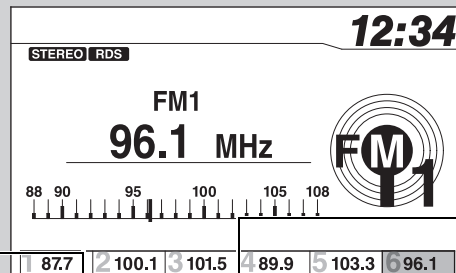

**AM/FM Button**  
Press to select a band.

**TITLE Button**  
Press to switch the RDS name on and off.

**SKIP Bar**  
Press and hold to search up and down the selected band for a station with a strong signal.

**SCAN Button**  
Press to sample each of the strongest stations on the selected band for 10 seconds. To turn off scan, press the button again.

**RETURN Button**  
Press to go back to the previous display.

**VOL/  (Volume/Power) Knob**  
Press to turn the audio system on and off.  
Turn to adjust the volume.

**Preset Buttons (1-6)**  
To store a station:  
1. Tune to the selected station.  
2. Pick a preset button and hold it until you hear a beep.  
To listen to a stored station, select a band, then press the preset button.

**CATEGORY Bar (FOLDER Bar)**  
Press either side to display and select an RDS category.

**SETUP Button**  
Press to display menu items.

**Selector Knob**  
Press and turn to tune the radio frequency.

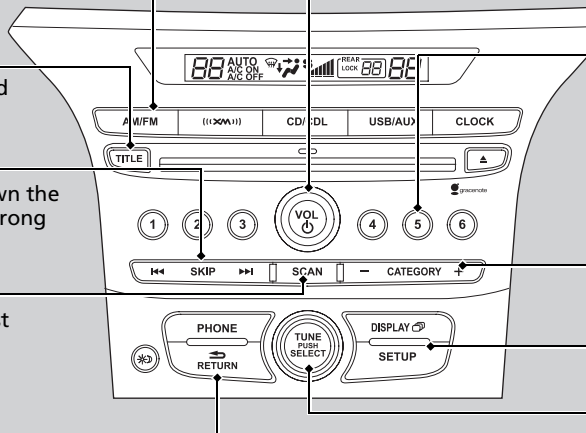

Models with rear entertainment system

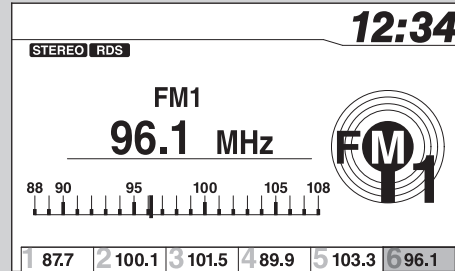

**AM/FM Button**  
Press to select a band.

**TITLE Button**  
Press to switch the RDS name on and off.

**SKIP Bar**  
Press and hold to search up and down the selected band for a station with a strong signal.

**SCAN Button**  
Press to sample each of the strongest stations on the selected band for 10 seconds. To turn off scan, press the button again.

**RETURN Button**  
Press to go back to the previous display.

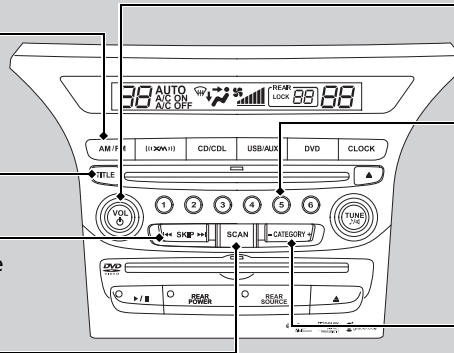

**VOL/ (Volume/Power) Knob**  
Press to turn the audio system on and off.  
Turn to adjust the volume.

**Preset Buttons (1-6)**  
To store a station:  
1. Tune to the selected station.  
2. Pick a preset button and hold it until you hear a beep.  
To listen to a stored station, select a band, then press the preset button.

**CATEGORY Bar**  
Press either side to display and select an RDS category.

**SETUP Button**  
Press to display menu items.

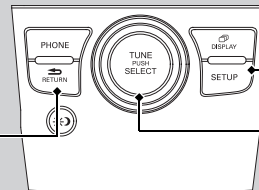

**Selector Knob**  
Press and turn to tune the radio frequency.

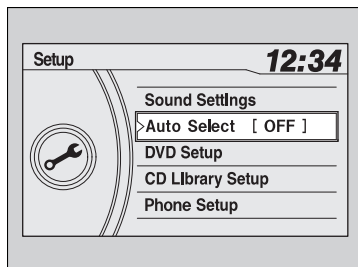

## ■ Auto Select

Use the auto select feature to scan both bands and store the strongest station in each preset.



1. Press the **SETUP** button.
2. Rotate  to select **Auto Select**, then press .
3. Select **ON**, then press .

To turn off auto select, select **OFF**, then press . This restores the presets you originally set.

## ▶▶ Playing the AM/FM Radio

The ST indicator appears on the display indicating stereo FM broadcasts. Stereo reproduction in AM is not available.

### Switching the Audio Mode

Press the **MODE** button on the steering wheel.

 [Audio Remote Controls P. 184](#)

You can store six AM stations and twelve FM stations into the preset button memory. FM1 and FM2 let you store six stations each.

Auto Select function scans and stores up to six AM stations and twelve FM stations with a strong signal into the preset button memory.

If you do not like the stations auto select has stored, you can manually store your preferred frequencies.

## Radio Data System (RDS)

Provides text data information related to your selected RDS capable FM station.

### ■ RDS INFO ON

Press the **TITLE** button while listening to an RDS capable station. **RDS INFO ON** appears, and the station name is displayed.

### ■ To find an RDS station from your selected program category

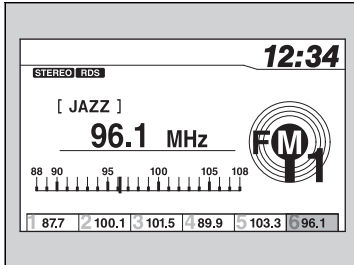

1. Press the **FOLDER** bar or the **CATEGORY** bar to display and select an RDS category.
2. Use **SKIP** or **SCAN** to select an RDS station.

## Playing the XM® Radio\*

Models without rear entertainment system

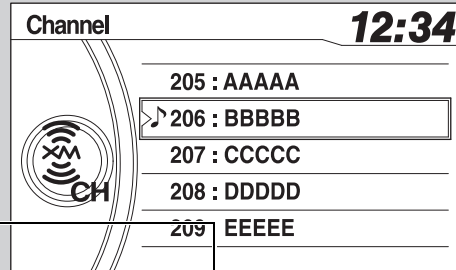

### SCAN Button

Press to sample all channels (in the channel mode), or channels within a category (in the category mode). Each sampling continues for a few seconds. Press **SCAN** again to cancel scanning and continue listening to the channel.

### ((XM)) (XM®) Button

Press to select XM® radio.

### TITLE Button

Press and release to cycle the display between the name, title, and category.

### SKIP Bar

Press to skip to the previous or next channel.

### RETURN Button

Press to go back to the previous display.

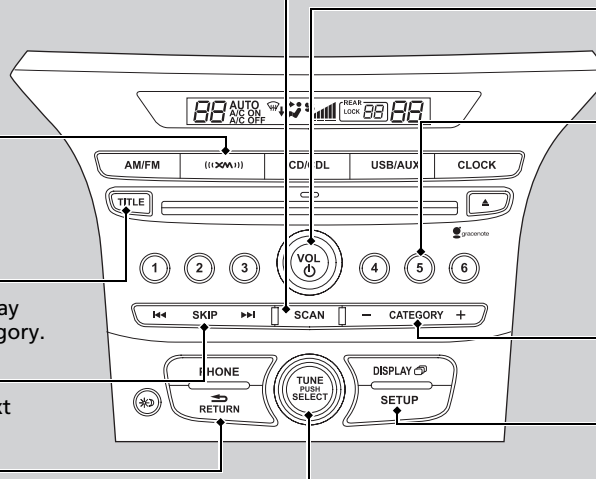

### VOL/ (Volume/Power) Knob

Press to turn the audio system on and off.  
Turn to adjust the volume.

### Preset Buttons (1-6)

To store a channel:  
1. Select the channel.  
2. Pick a preset button and hold it until you hear a beep.  
To listen to a stored channel, select XM, then press the preset button.

### CATEGORY Bar

Press either side to display and select an XM® Radio category.

### SETUP Button

Press to display menu items.

### Selector Knob

Turn to select channel.

Models with rear entertainment system

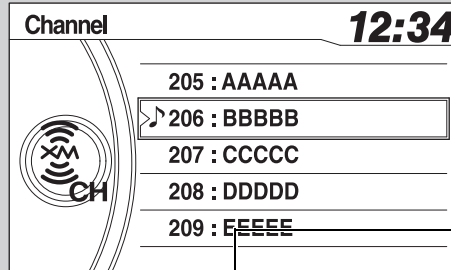

**(((XM))) (XM®) Button**  
Press to select XM® radio.

**TITLE Button**  
Press and release to cycle the display between the name, title, and category.

**VOL/ (Volume/Power) Knob**  
Press to turn the audio system on and off.  
Turn to adjust the volume.

**SKIP Bar**  
Press to skip to the previous or next channel.

**RETURN Button**  
Press to go back to the previous display.

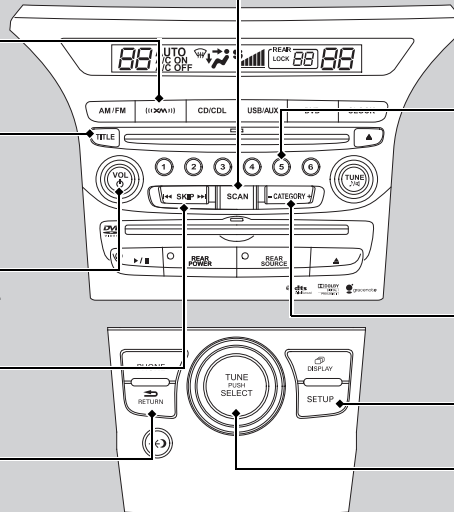

**SCAN Button**  
Press to sample all channels (in the channel mode), or channels within a category (in the category mode). Each sampling continues for a few seconds. Press **SCAN** again to cancel scanning and continue listening to the channel.

**Preset Buttons (1-6)**  
To store a channel:  
1. Select the channel.  
2. Pick a preset button and hold it until you hear a beep.  
To listen to a stored channel, select XM, then press the preset button.

**CATEGORY Bar**  
Press either side to display and select an XM® Radio category.



**SETUP Button**  
Press to display menu items.

**Selector Knob**  
Turn to select channel.



## ■ To Play the XM® Radio



1. Press the (Ⓜ) button to select the XM® radio band (XM1 or XM2).
2. Press and hold the **TITLE** button to switch between the channel mode and category mode.

If you press the **SETUP** button, rotate  to select **XM Mode**, and press . You can select channel mode or category mode by turning and pressing the selector knob.

3. Select a channel using the **TUNE** () , **SKIP**, **CATEGORY**, **SCAN**, or preset buttons.

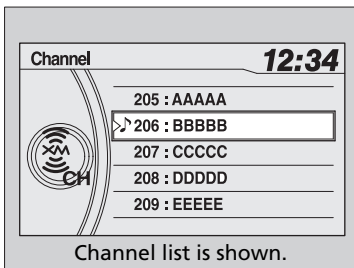
## ■ To Select a Channel from a List



1. Press  to display a channel list.
2. Rotate  to select a channel, then press .

## ▶▶ Playing the XM® Radio\*

In the channel mode, all available channels are selectable. In the category mode, you can select a channel within a category (Jazz, Rock, Classical, etc.).

You can store twelve XM® stations in the preset buttons. XM1 and XM2 let you store six stations each.

There may be instances when XM® Radio does not broadcast all the data fields (artist name, title). This does not indicate a problem with your audio system.

## Playing a CD

Your audio system supports audio CDs, CD-Rs and CD-RWs in either MP3, WMA, or AAC format. With the CD loaded, press the **CD** button.

### Models without rear entertainment system

**SCAN Button**  
You will get a 10-second sampling of each song.

- Press to sample all tracks on the CD (all files in the current folder in MP3, WMA, or AAC).
- Press two times to sample the first file in each of the main folders (MP3, WMA, or AAC).
- To turn off scan, press and hold the button.

**TITLE Button**  
Press to display the text data on a CD (if it was recorded with text data).

**SKIP Bar**  
Press **⏮** or **⏭** to change tracks (files in MP3, WMA or AAC).  
Press and hold to move rapidly within a track/file.

**RETURN Button**  
Press to go back to the previous display.

**VOL/ ⏻ (Volume/Power) Knob**  
Press to turn the audio system on and off.  
Turn to adjust the volume.

**CD Button**  
Press to play a CD

**CD Slot**  
Insert a CD about halfway into the CD slot.

**CATEGORY Bar (FOLDER Bar)**  
Press **+** to skip to the next folder, and **-** to skip to the beginning of the previous folder in MP3, WMA or AAC.

**▲ (CD Eject) Button**  
Press to eject a CD.

**Selector Knob**  
Turn to change tracks/files. Turn to select an item, then press to set your selection.

**SETUP Button**  
Press to display menu items.

Models with rear entertainment system

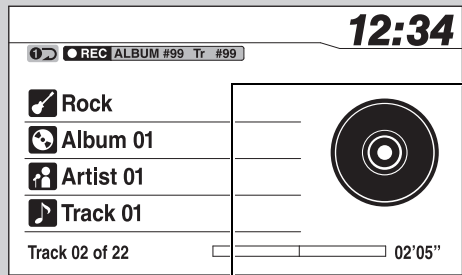

**CD Button**  
Press to play a CD

**VOL/ (Volume/Power) Knob**  
Press to turn the audio system on and off.  
Turn to adjust the volume.

**TITLE Button**  
Press to display the text data on a CD (if it was recorded with text data).

**SKIP Bar**  
Press ◀ or ▶ to change tracks (files in MP3, WMA or AAC).  
Press and hold to move rapidly within a track/file.

**RETURN Button**  
Press to go back to the previous display.

**SCAN Button**  
You will get a 10-second sampling of each song.

- Press to sample all tracks on the CD (all files in the current folder in MP3, WMA, or AAC).
- Press two times to sample the first file in each of the main folders (MP3, WMA, or AAC).
- To turn off scan, press and hold the button.

**CD Slot**  
Insert a CD about halfway into the CD slot.

**(CD Eject) Button**  
Press to eject a CD.

**CATEGORY Bar**  
Press + to skip to the next folder, and - to skip to the beginning of the previous folder in MP3, WMA or AAC.

**Selector Knob**  
Turn to change tracks/files. Turn to select an item, then press to set your selection.

**SETUP Button**  
Press to display menu items.

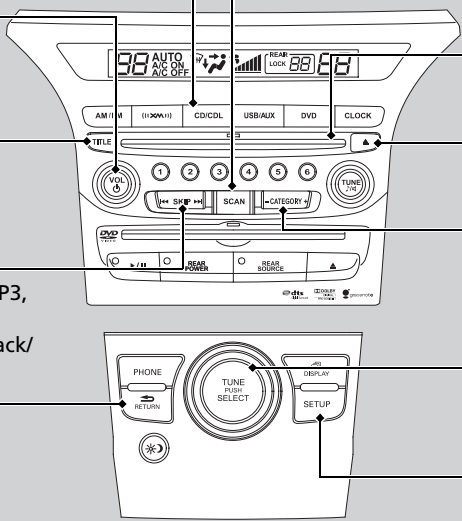

## How to Select a File from a Folder with the Selector Knob (MP3/WMA/AAC)

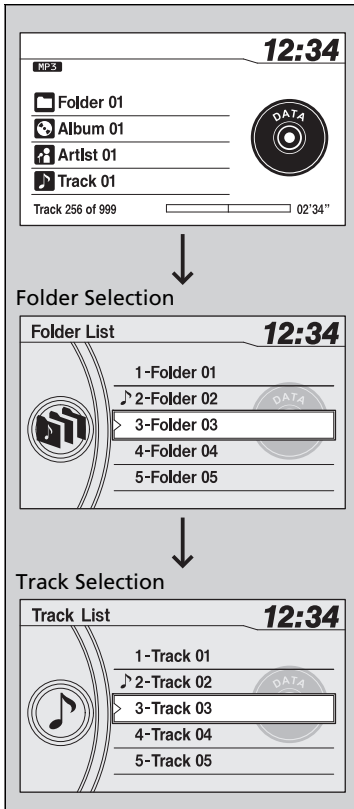

1. Press  to switch the display to a folder list.

2. Rotate  to select a folder.

3. Press  to change the display to a list of files in that folder.

4. Rotate  to select a file, then press .

### ▶▶ Playing a CD

#### NOTICE

Do not use CDs with adhesive labels. The label can cause the CD to jam in the unit.

WMA files protected by digital rights management (DRM) cannot be played.

The audio system displays **UNSUPPORTED**, then skips to the next file.

Text data appears on the display under the following circumstances:

- When you select a new folder, file, or track.
- When you change the audio mode to CD.
- When you insert a CD.



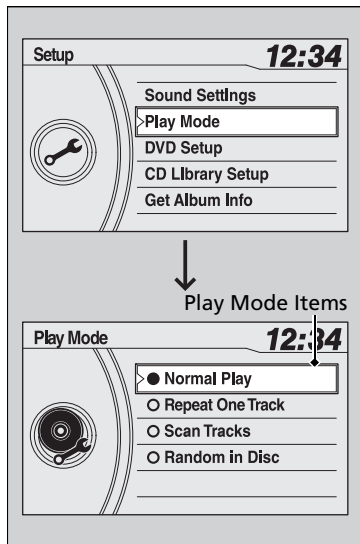

If you eject the CD but do not remove it from the slot, the system reloads the CD automatically after several seconds.

## ■ How to Select a Play Mode





You can select repeat, random, and scan modes when playing a track or file.



1. Press the **SETUP** button.

2. Rotate  to select **Play Mode**, then press .
3. Rotate  to select a mode, then press .

## ■ To turn off a play mode

1. Press the **SETUP** button.
2. Rotate  to select **Play Mode**, then press .
3. Rotate  to select **Normal Play**, then press .

## ▶▶ How to Select a Play Mode

Press the **RETURN** button to go back to the previous display, and press the **SETUP** button to cancel this setting mode.

### Play Mode Menu Items

#### Normal Play

**Repeat One Track:** Repeats the current track/file(s).

**Repeat One Folder (MP3/WMA/AAC):** Repeats all files in the current folder.

**Random in Folder (MP3/WMA/AAC):** Plays all files in the current folder in random order.

**Random in Disc:** Plays all tracks/files in random order.

**Scan Tracks:** Samples all tracks on the CD. (MP3/WMA/AAC): Samples all files in the current folder.

**Scan Folders (MP3/WMA/AAC):** Samples the first file in each folder.

# Playing CD Library

The songs on music CDs can be recorded to the flash memory. You can then play the songs directly from your vehicle's audio system.

Models without rear entertainment system

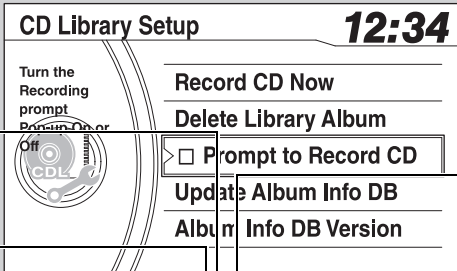

### VOL/ (Volume/Power) Knob

Press to turn the audio system on and off.  
Turn to adjust the volume.

### SCAN Button

You will get a 10-second sampling of each song.  
Press to sample all tracks on the album list.

- Press two times to sample the first track in each album list.
- To turn off scan, press and hold the button.

### TITLE Button

Press to display the text data on the album list (if it was recorded with text data or data was found from Gracenote®).

### SKIP Bar

Press ◀ or ▶ to change tracks.  
Press and hold to move rapidly within a track.

### RETURN Button

Press to go back to the previous display.

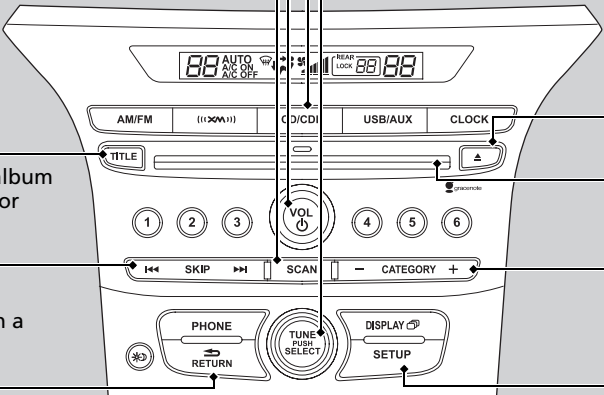

### CDL Button

Press to play tracks from CD Library. The previously selected track will be played.

### Selector Knob

Press to display the album list.  
Turn to change tracks/albums. Turn to select an item, then press to set your selection.

### (CD Eject) Button

Press to eject a CD.

### CD Slot

Insert a CD about halfway into the CD slot.

### CATEGORY Bar (FOLDER Bar)

Press + to skip to the next album, and - to skip to the beginning of the previous album.

### SETUP Button

Press to display menu items.

Models with rear entertainment system

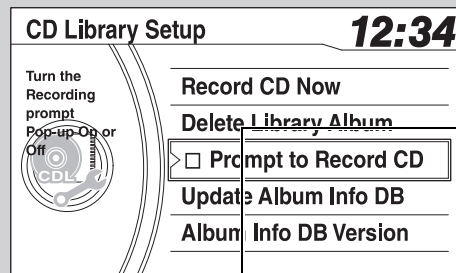

**SCAN Button**

You will get a 10-second sampling of each song. Press to sample all tracks on the album list.

- Press two times to sample the first track in each album list.
- To turn off scan, press and hold the button.

**CDL Button**

Press to play tracks from CD Library. The previously selected track will be played.

**TITLE Button**

Press to display the text data on the album list (if it was recorded with text data or data was found from Gracenote®).

**VOL/ (Volume/Power) Knob**

Press to turn the audio system on and off. Turn to adjust the volume.

**SKIP Bar**

Press ◀◀ or ▶▶ to change tracks. Press and hold to move rapidly within a track.

**RETURN Button**

Press to go back to the previous display.

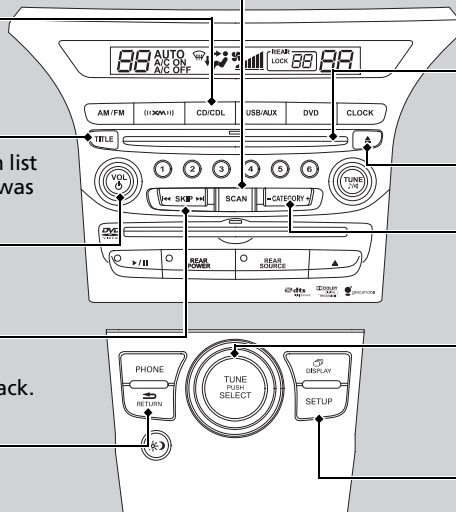

**CD Slot**

Insert a CD about halfway into the CD slot.

**(CD Eject) Button**

Press to eject a CD.

**CATEGORY Bar**

Press + to skip to the next album, and - to skip to the beginning of the previous album.

**Selector Knob**

Press to display the album list. Turn to change tracks/albums. Turn to select an item, then press to set your selection.

**SETUP Button**

Press to display menu items.

## Recording a Music CD to CD Library

### ■ If the CD is played in the audio unit for the first time

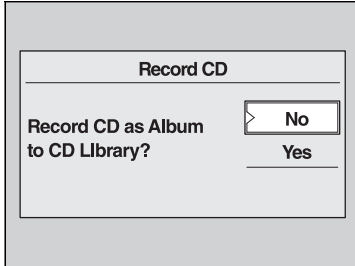

1. A prompt appears and asks if you want the currently playing CD to be recorded to the flash memory.

2. Rotate to select **YES**. Press to start recording.

▶ The display changes to the album list.

3. Rotate to select one of the album numbers you want the currently playing CD to be stored, then press .

4. The display indicates, with an icon, that the CD is being recorded.

▶ The icon disappears when the recording is finished.

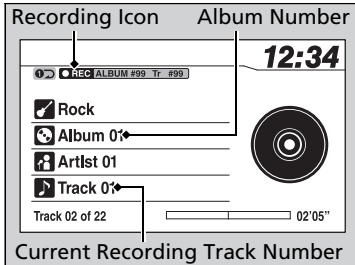

### ▶▶ Playing CD Library

You can store up to 18 albums.

The system supports the recording function from the standard CD-DA only.

▶ [Recommended CDs P. 273](#)

The system does not support the CD-DA with copy protection.

Gracenote® searches for the title information for the CD you have recorded to the flash memory. If the information is found, song titles are displayed.

#### While recording a CD:

- If you turn off the ignition switch, you need to record the CD from the beginning next time you turn on the ignition switch.
- If you eject the CD, and reload it again, you can start recording from where it was left off.

Forward/rewind, repeat, random and scan function are not available during recording. You can listen to tracks from other album lists while recording.





There is no compensation offered in the case of unsuccessful recording of audio data or the loss of audio data due to any cause whatsoever.

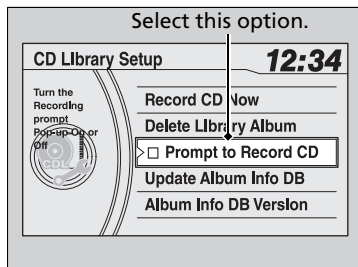

## ■ Deactivating the prompt display







If you do not want the prompt to appear on the display for the first time you play a CD:

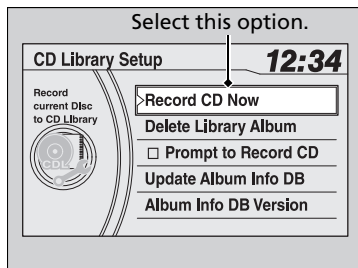

1. Press the **SETUP** button.
2. Rotate  to select **CD Library Setup**, then press .
3. Rotate  to select **Prompt to Record CD**, then press .
  - ▶ To activate the prompt display again, follow the same procedure.

## ■ Recording a CD Manually





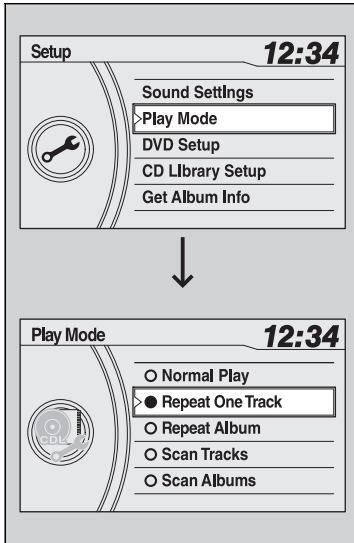

1. Insert a CD you want to record to the flash memory, and press the **SETUP** button.
2. Rotate  to select **CD Library Setup**, then press .
3. Rotate  to select **Record CD Now**, then press .
  - ▶ The display changes to the album list.
4. Rotate  to select one of the album numbers you want the currently playing CD to be stored, then press .
  - ▶ If you select an album number that has already had another CD, the system asks if you want to replace this album with the album currently in the slot. Select **Yes** to replace, and **No** to return.

## ■ Selecting a Play Mode for CD Library





You can select repeat, random, and scan modes when playing CD Library.



1. Press the **SETUP** button.
2. Rotate  to select **Play Mode**, then press .

3. Rotate  to select a mode, then press .

### ■ To turn off a play mode

1. Press the **SETUP** button.
2. Rotate  to select **Play Mode**, then press .
3. Rotate  to select **Normal Play**, then press .

### ▶▶ Selecting a Play Mode for CD Library

Press the **RETURN** button to go back to the previous display, and press the **SETUP** button to cancel this setting mode.

#### Play Mode Menu Items

##### Normal Play

**Repeat One Track:** Repeats the current track.

**Repeat Album:** Repeats all tracks in the current album.

**Scan Tracks:** Samples all tracks on the CD.

**Scan Albums:** Samples the first track in each album.

**Random in Albums:** Plays all tracks in the current album in random order.

**Random All:** Plays all tracks in the current album list in random order.

## Other CD Library Setup Menu

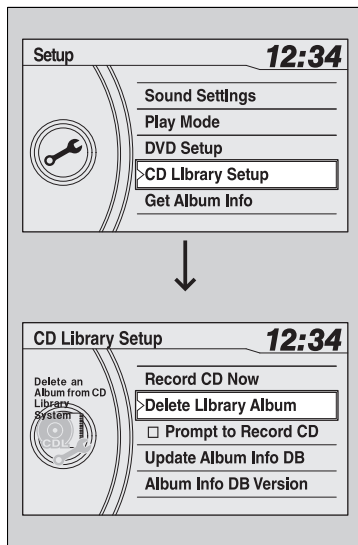

1. Press the **SETUP** button.
2. Rotate to select **CD Library Setup**, then press .

3. Rotate to select a menu item, then press .

### To update Gracenote® Album Info

1. Insert the update disc into the disc slot that includes the update.
2. Press the **SETUP** button.
3. Rotate to select **CD Library Setup**.
4. Rotate to select **Update Album Info DB**, then press .
5. Rotate to select **Yes**. Press to start updating.

### Other CD Library Setup Menu

#### CD Library setup menu items

**Delete Library Album:** Delete albums in CD Library. Rotate to select an album you want to delete and select **Yes**.

**Album Info DB Version:** Displays the current album's database version information.

#### Update Album Info DB:

[▶ To update Gracenote® Album Info P. 202](#)

### To update Gracenote® Album Info

To acquire updated files:

Consult a dealer

US: Visit [www.honda.com](http://www.honda.com).

Canada: Visit [www.honda.ca](http://www.honda.ca).

Once you perform an update, any information you edited before will be overwritten or erased.

[▶ Gracenote® End User License Agreement P. 476](#)

## Playing an iPod®

Connect the iPod® using your dock connector to the USB adapter cable, then press the **USB/AUX** button.

▶ [USB Adapter Cable](#) P. 173

Models without rear entertainment system

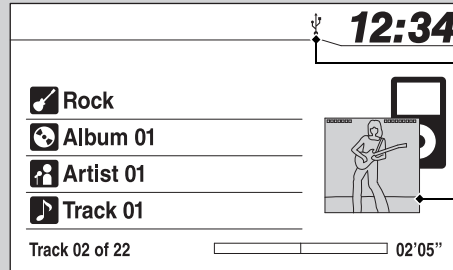

**USB Indicator**

Appears when an iPod® is connected.

**Album Art**

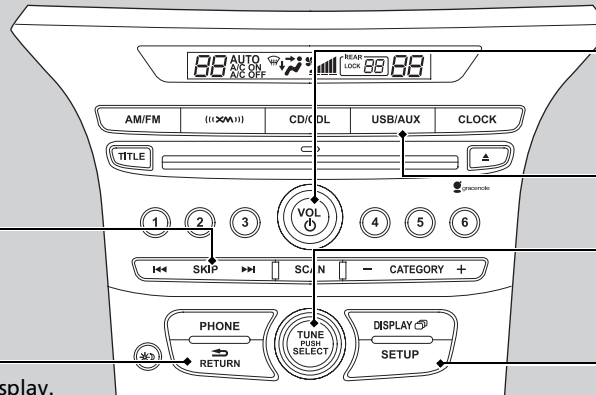

**SKIP Bar**

Press ◀◀ or ▶▶ to change songs.  
Press and hold to move rapidly  
within a song.

**RETURN Button**

Press to go back to the previous display.

**VOL/ (Volume/Power) Knob**

Press to turn the audio system on  
and off.

Turn to adjust the volume.

**USB/AUX Button**

Press to select iPod® (if connected).

**Selector Knob**

Turn to select a song, file, menu item,  
or play mode. Press to set your  
selection.

**SETUP Button**

Press to display menu items.

ORG

TOC

Features

Index

Home

Models with rear entertainment system

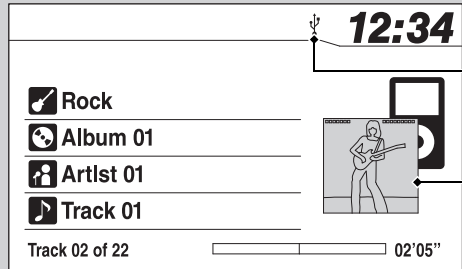

**USB Indicator**  
Appears when an iPod® is connected.

**Album Art**

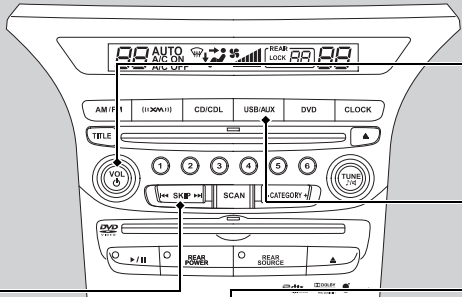

**VOL/ (Volume/Power) Knob**  
Press to turn the audio system on and off.  
Turn to adjust the volume.

**USB/AUX Button**  
Press to select iPod® (if connected).

**SKIP Bar**  
Press ◀ or ▶ to change songs.  
Press and hold to move rapidly within a song.

**Selector Knob**  
Turn to select a song, file, menu item, or play mode. Press to set your selection.

**RETURN Button**  
Press to go back to the previous display.

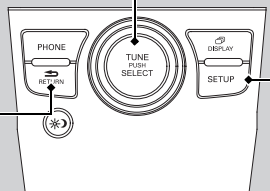

**SETUP Button**  
Press to display menu items.

## How to Select a File from the iPod® Menu

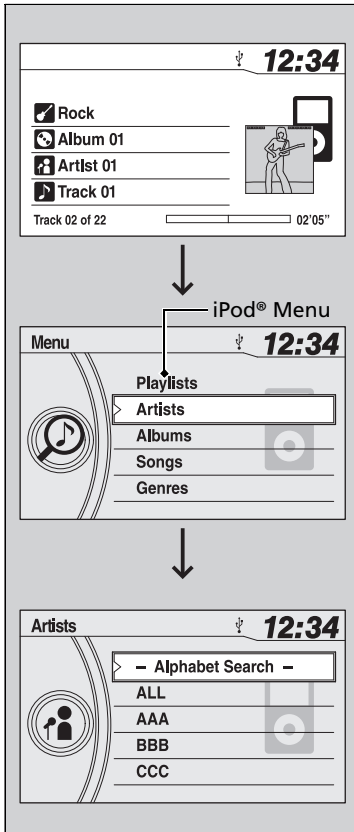

1. Press to display the iPod® menu.

2. Rotate to select a menu.

3. Press to display the items on that menu.

4. Rotate to select an item, then press .

### ▶▶ Playing an iPod®

Available operating functions vary on models or versions. Some functions may not be available on the vehicle's audio system.

If there is a problem, you may see an error message on the audio/information screen.



[▶ iPod®/USB Flash Drive P. 268](#)

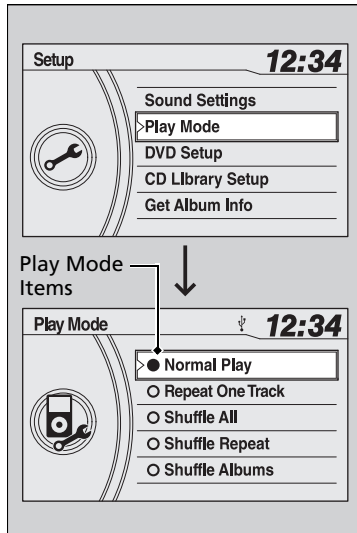

## ■ How to Select a Play Mode

You can select repeat and shuffle modes when playing a file.



1. Press the **SETUP** button.

2. Rotate  to select **Play Mode**, then press .

3. Rotate  to select a mode, then press .

## ■ To turn off a play mode

1. Press the **SETUP** button.

2. Rotate  to select **Play Mode**, then press .

3. Rotate  to select **Normal Play**, then press .

## ▶▶ How to Select a Play Mode

### Play Mode Menu Items

#### Normal Play

**Repeat One Track:** Repeats the current track.

**Shuffle All:** Plays all available files in a selected list (playlists, artists, albums, songs, genres, or composers) in random order.

**Shuffle Repeat:** Repeats the shuffle all feature.

**Shuffle Albums:** Plays all available albums in a selected list (playlists, artists, albums, songs, genres, or composers) in random order.

**Shuffle Album Repeat:** Repeats the shuffle album feature.

## Playing a USB Flash Drive

Your audio system reads and plays sound files on a USB flash drive in either MP3, WMA or AAC\*<sup>1</sup> format.

Connect your USB flash drive to the USB adapter cable, then press the **USB/AUX** button.

➤ **USB Adapter Cable** P. 173

Models without rear entertainment system

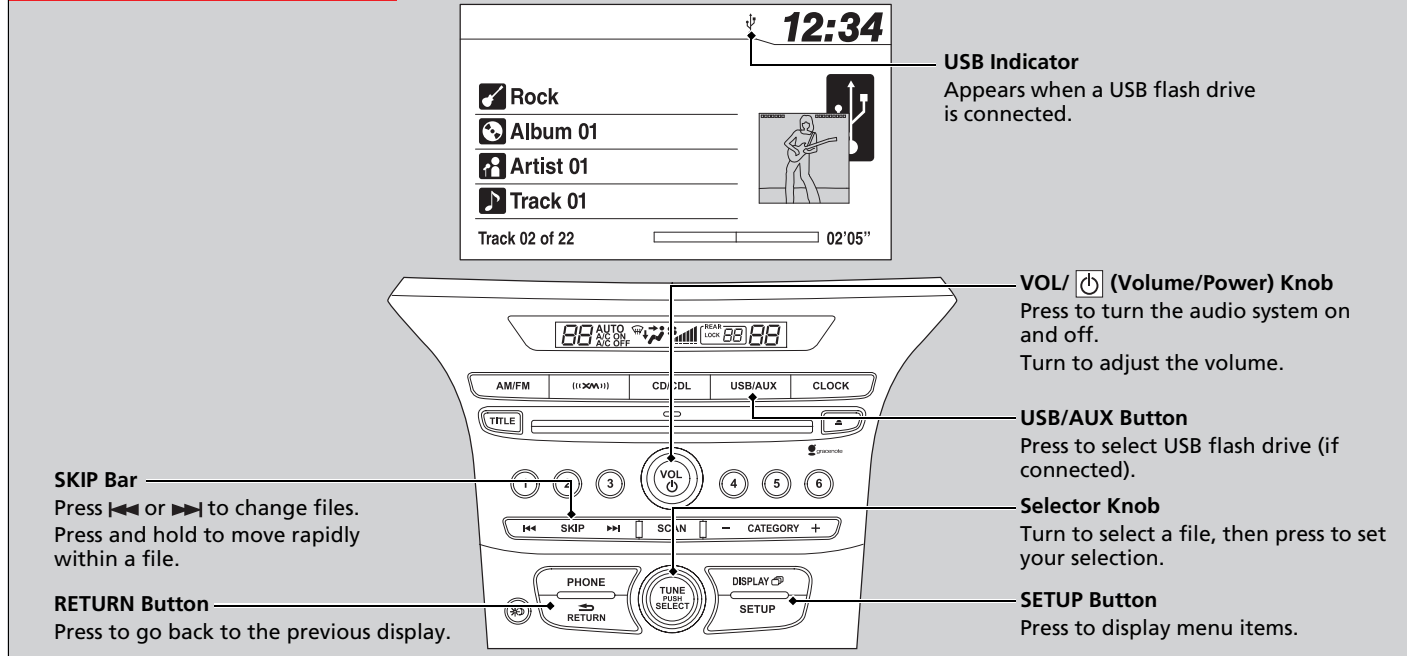

\*1: Only AAC format files recorded with iTunes ® are playable on this unit.

ORG

TOC

Features

Index

Home



Models with rear entertainment system

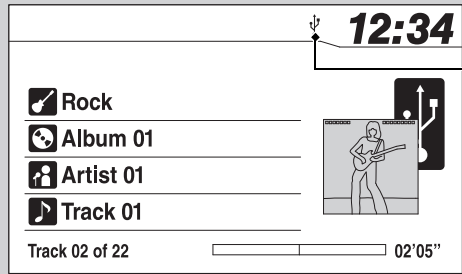

**USB Indicator**  
Appears when a USB flash drive is connected.

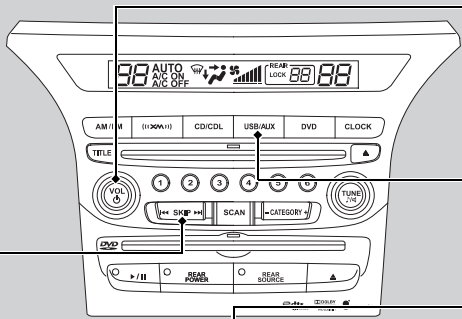

**VOL/ [Power] (Volume/Power) Knob**  
Press to turn the audio system on and off.  
Turn to adjust the volume.

**USB/AUX Button**  
Press to select USB flash drive (if connected).

**Selector Knob**  
Turn to select a file, then press to set your selection.

**SETUP Button**  
Press to display menu items.

**SKIP Bar**  
Press [Left Arrow] or [Right Arrow] to change files.  
Press and hold to move rapidly within a file.

**RETURN Button**  
Press to go back to the previous display.

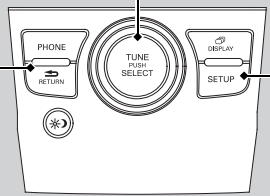

## How to Select a File from a Folder with the Selector Knob

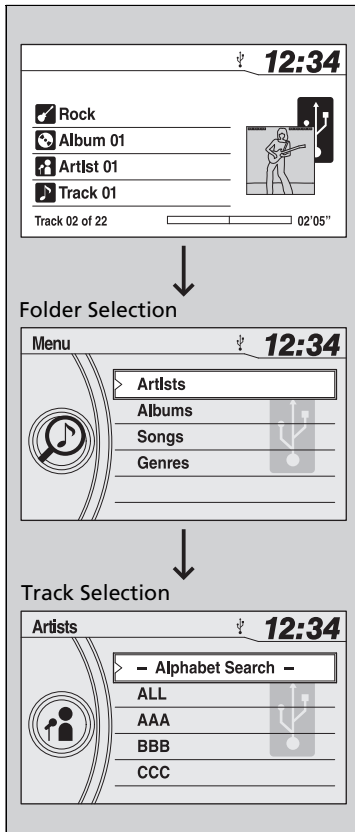

1. Press  to switch the display to a folder list.

2. Rotate  to select a folder.

3. Press  to change the display to a list of files in that folder.

4. Rotate  to select a file, then press .

### ▶▶ Playing a USB Flash Drive

Use the recommended USB flash drives.

▶ [General Information on the Audio System](#)  
P. 272

Files in WMA format protected by digital rights management (DRM) are not played.

The audio system displays **UNPLAYABLE FILE**, and then skips to the next file.

If there is a problem, you may see an error message on the audio/information screen.

▶ [iPod®/USB Flash Drive](#) P. 268

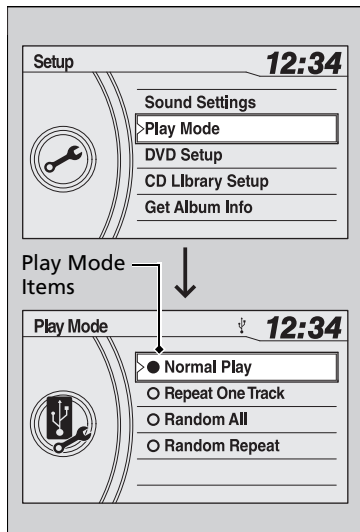

## ■ How to Select a Play Mode

You can select repeat and random modes when playing a file(s).



1. Press the **SETUP** button.

2. Rotate  to select **Play Mode**, then press .

3. Rotate  to select a mode, then press .

## ■ To turn off a play mode

1. Press the **SETUP** button.

2. Rotate  to select **Play Mode**, then press .

3. Rotate  to select **Normal Play**, then press .

## ▶▶ How to Select a Play Mode

### Play Mode Menu Items

#### Normal Play

**Repeat One Track:** Repeats the current file.

**Random All:** Plays all files in random order.

**Random Repeat:** Repeats the random all feature.

## Playing *Bluetooth*® Audio

Your audio system allows you to listen to music from your *Bluetooth*®-compatible phone.

This function is available when the phone is paired and linked to the vehicle's *Bluetooth*® HandsFreeLink® (HFL) system.

➤ **Phone Setup** P. 305

Models without rear entertainment system

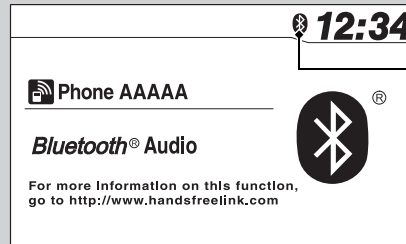

**Bluetooth Indicator**  
Appears when your phone is connected to HFL.

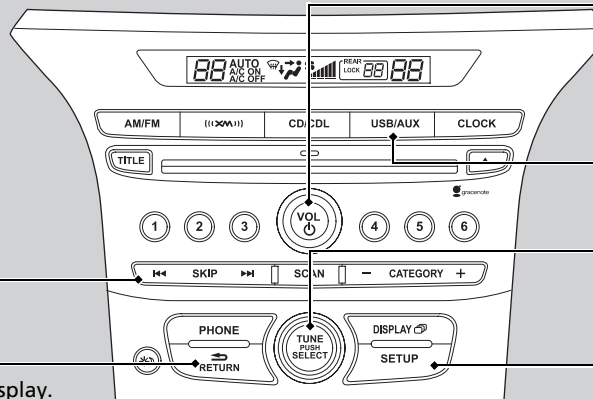

**VOL/ (Volume/Power) Knob**  
Press to turn the audio system on and off.  
Turn to adjust the volume.

**USB/AUX Button**  
Press to select *Bluetooth*® Audio.

**Selector Knob**  
Turn to change files. Turn to select an item, then press to set your selection.

**SETUP Button**  
Press to display menu items.

**SKIP Bar**  
Press ◀◀ or ▶▶ to change files.

**RETURN Button**  
Press to go back to the previous display.

Models with rear entertainment system

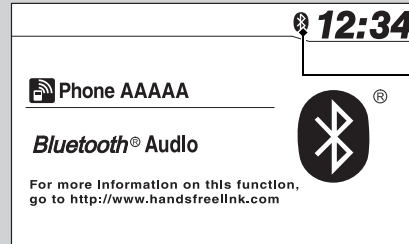

**Bluetooth Indicator**  
Appears when your phone is connected to HFL.

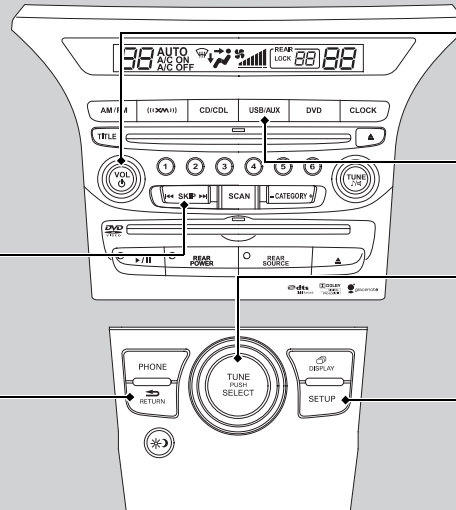

**VOL/ [Power] (Volume/Power) Knob**  
Press to turn the audio system on and off.  
Turn to adjust the volume.

**USB/AUX Button**  
Press to select *Bluetooth*® Audio.

**Selector Knob**  
Turn to change files. Turn to select an item, then press to set your selection.

**SETUP Button**  
Press to display menu items.

**SKIP Bar**  
Press [Left Arrow] or [Right Arrow] to change files.

**RETURN Button**  
Press to go back to the previous display.



## ■ To Play *Bluetooth*® Audio Files

1. Make sure that your phone is paired and linked to HFL.
2. Press the **USB/AUX** button.

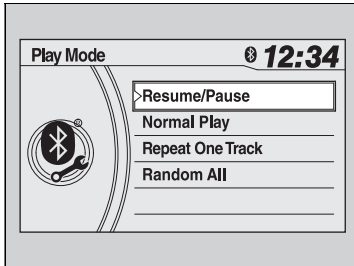
If the phone is not recognized, another HFL-compatible phone, which is not compatible for *Bluetooth*® Audio, **may be** already linked.



### ■ To pause or resume a file

1. Press the **SETUP** button.
2. Rotate  to select **Resume/Pause**, then press .

Each time you press , the setting switches between Pause and Resume.

### ▶▶ Playing *Bluetooth*® Audio

Not all *Bluetooth*-enabled phones with streaming audio capabilities are compatible with the system. For a list of compatible phones:

- **U.S.:** Visit [www.handsfreelink.honda.com](http://www.handsfreelink.honda.com), or call 1-888-528-7876.
- **Canada:** Visit [www.handsfreelink.ca](http://www.handsfreelink.ca), or call 1-888-528-7876.

In some states, it may be illegal to perform some data device functions while driving.

If more than one phone is paired to the HFL system, there will be a delay before the system begins to play.

### ▶▶ To Play *Bluetooth*® Audio Files

To play the audio files, you may need to operate your phone. If so, follow the phone maker's operating instructions.

The pause function may not be available on some phones.





If any audio device is connected to the auxiliary input jack, you may need to press the **USB/AUX** button repeatedly to select the *Bluetooth*® Audio system.

Switching to another mode pauses the music playing from your phone.

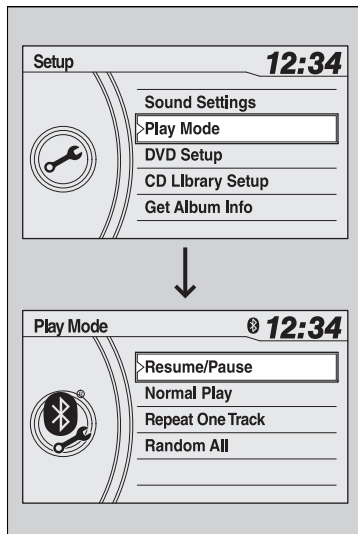



## ■ How to Select a Play Mode

You can select repeat and random modes when playing a file(s).



1. Press the **SETUP** button.
2. Rotate  to select **Play Mode**, then press .
3. Rotate  to select a mode, then press .

## ■ To turn off a play mode

1. Press the **SETUP** button.
2. Rotate  to select **Play Mode**, then press .
3. Rotate  to select **Normal Play**, then press .

## ▶▶ How to Select a Play Mode

### PlayMode Menu Items

#### Normal Play

**Repeat One Track:** Repeats the current file.

**Random All:** Plays all files in random order.

## Switching to HFL

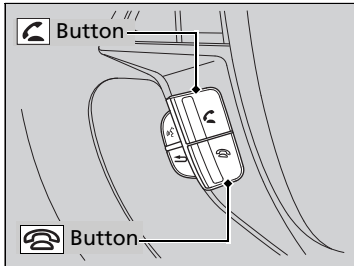

Press the  (pick-up) button on the steering wheel to receive a call when *Bluetooth*® Audio is playing.

[▶ Playing \*Bluetooth\*® Audio P. 211](#)

Press the  (hang-up) button to end the call and return to *Bluetooth*® Audio.

### Switching to HFL

If you receive a call while *Bluetooth*® Audio is in the pause mode, it will resume play after ending the call.



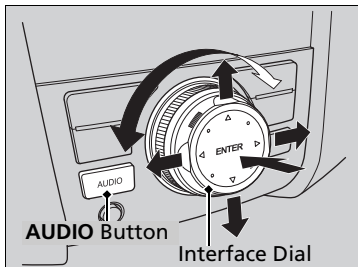

## Models with navigation system

To use the audio system function, the ignition switch must be in ACCESSORY **I** or ON **II**.



Use the interface dial or **AUDIO** button to access some audio functions.

Press  to switch between the normal and extended display for some functions.

**Interface dial:** Rotate left or right to scroll through the available choices. Move the interface dial and press  to set your selection.

**AUDIO button:** Press to display the audio system on the navigation screen.

## Audio System Basic Operation

These indications are used to show how to operate the interface dial.

Rotate  to select.





Press  to enter.

Move up  to select.

Move down  to select.

Move left  to select.

Move right  to select.

Press the **MODE**, , ,  or  button on the steering wheel to change any audio setting.

[Audio Remote Controls P. 217](#)

## Audio Remote Controls

Allows you to operate the audio system while driving.

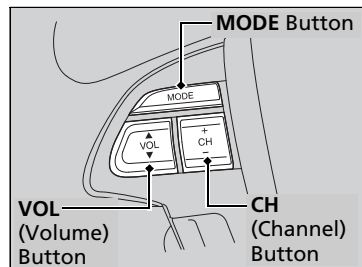

### MODE Button









Cycles through the audio modes as follows:  
FM1→FM2→AM→XM1→XM2→CD→  
HDD→AUX

### VOL Button

**Press** : Increases the volume.

**Press** : Decreases the volume.

### CH Button

- When listening to the radio
  - Press** : Selects the next preset radio station.
  - Press** : Selects the previous preset radio station.
  - Press and hold** : Selects the next strong station.
  - Press and hold** : Selects the previous strong station.
- When listening to a CD, HDD, iPod® or USB flash drive
  - Press** : Skips to the next song.
  - Press** : Goes back to the beginning of the current or previous song.
- When listening to a CD or HDD
  - Press and hold** : Skips to the next folder/album.
  - Press and hold** : Goes back to the previous folder/album.

### Audio Remote Controls

The CD mode appears only when a CD is loaded.

When in AUX mode, the following are operable from the remote controls:

- iPod®/USB flash drive connected to the USB adapter cable
- *Bluetooth*® Audio (with some phones only)

## Adjusting the Sound

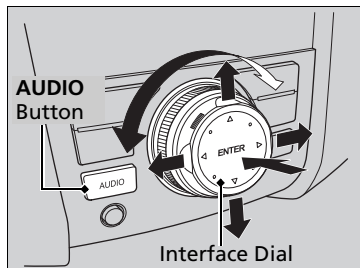

Press the **AUDIO** button, and move to select **AUDIO MENU**. Rotate to select **Sound Setup**, then press . Rotate to scroll through the following choices:

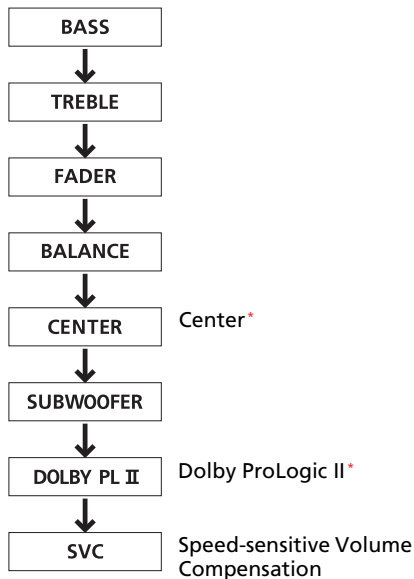
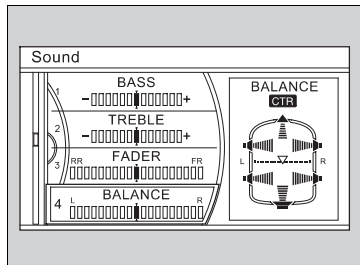

### ▶▶ Adjusting the Sound

The **SVC** has four modes: **OFF**, **LOW**, **MID**, and **HIGH**.

**SVC** adjusts the volume level based on the vehicle speed. As you go faster, audio volume increases. As you slow down, audio volume decreases.

Dolby PL II signal processing creates multi-channel surround sound from 2-channel stereo audio sources. Dolby ProLogic II is available only in DISC (CD-DA, MP3, WMA, AAC), XM® Radio, AUX (USB, iPod®, AUX, *Bluetooth*® Audio), and HDD modes.

Manufactured under license from Dolby Laboratories. Dolby, ProLogic, MLP Lossless, and the double-D symbol are trademarks of Dolby Laboratories.

# Playing the AM/FM Radio

ORG

Models without rear entertainment system



**FM Button**

**AM Button**

Press to select a band.

**TITLE Button**

Press to switch the RDS name on and off.

**VOL/⏻ (Volume/Power) Knob**

Press to turn the audio system on and off.  
Turn to adjust the volume.

**SKIP Bar**

Press to search up and down the selected band for a station with a strong signal.

**AUDIO Button**

Press to display the audio system on the navigation screen.

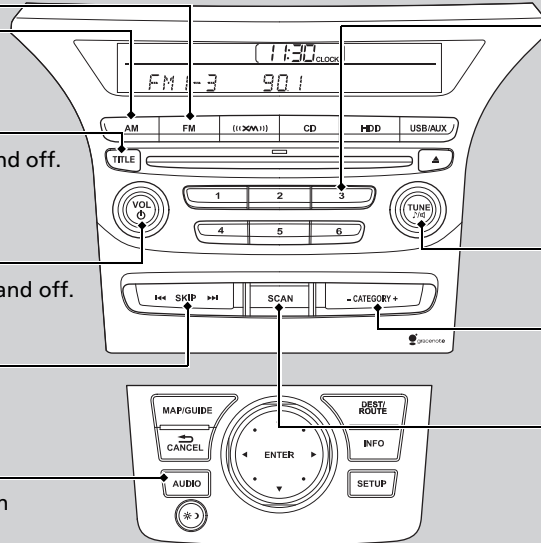

**Preset Buttons (1-6)**

To store a station:  
1. Tune to the selected station.  
2. Pick a preset button and hold it until you hear a beep.  
To listen to a stored station, select a band, then press the preset button.

**TUNE Knob**

Turn to tune the radio frequency.

**CATEGORY Bar**

Press either side to display and select an RDS category.

**SCAN Button**

Press to sample each of the strongest stations on the selected band for 10 seconds. To turn off scan, press the button again.

TOC

Features

Index

Home

Models with rear entertainment system



**VOL/  (Volume/Power) Knob**  
 Press to turn the audio system on and off.  
 Turn to adjust the volume.

**AM/FM Button**  
 Press to select a band.

**TITLE Button**  
 Press to switch the RDS name on and off.

**SKIP Bar**  
 Press and hold to search up and down the selected band for a station with a strong signal.

**SCAN Button**  
 Press to sample each of the strongest stations on the selected band for 10 seconds. To turn off scan, press the button again.

**AUDIO Button**  
 Press to display the audio system on the navigation screen.

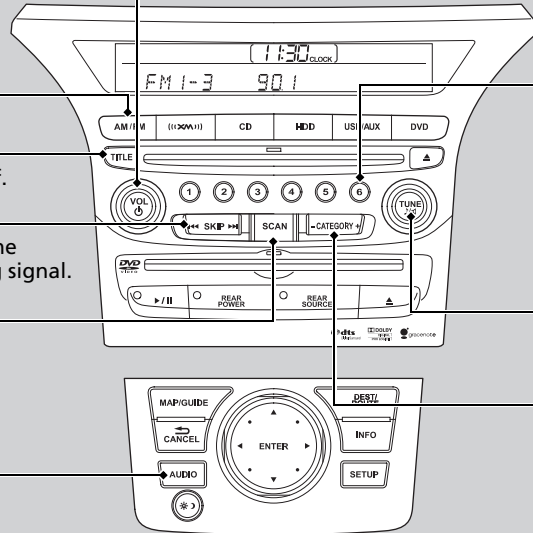

**Preset Buttons (1-6)**  
 To store a station:  
 1. Tune to the selected station.  
 2. Pick a preset button and hold it until you hear a beep.  
 To listen to a stored station, select a band, then press the preset button.





**TUNE Knob**  
 Turn to tune the radio frequency.



**CATEGORY Bar**  
 Press either side to display and select an RDS category.

## Auto Select

Use the auto select feature to scan both bands and store the strongest station in each preset.



1. Press the **AUDIO** button.
2. Move  to select **AUDIO MENU**.
3. Rotate  to select **A.SEL**, then press .
4. Rotate  to select **ON**, then press .

To turn off auto select, rotate  to select **OFF**, then press . This restores the presets you originally set.

## ▶▶ Playing the AM/FM Radio

The ST indicator appears on the display indicating stereo FM broadcasts. Stereo reproduction in AM is not available.

Switching the Audio Mode  
Press the **MODE** button on the steering wheel.

[▶ Audio Remote Controls P. 217](#)

You can store 6 AM stations and 12 FM stations into the preset button memory. FM1 and FM2 let you store 6 stations each.

Auto Select function scans and stores up to six AM stations and twelve FM stations with a strong signal into the preset button memory.

If you do not like the stations auto select has stored, you can manually store your preferred frequencies.

## Radio Data System (RDS)

Provides text data information related to your selected RDS-capable FM station.

### To find an RDS station from your selected program category

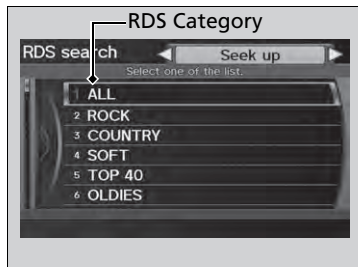

1. Press the **AUDIO** button.
2. Move to select **AUDIO MENU**.
3. Rotate to select **RDS Search**, then press .
4. Move or to select a search method (**Seek up, Seek down, Scan**).
5. Rotate to select a category. Press .

### Radio text display

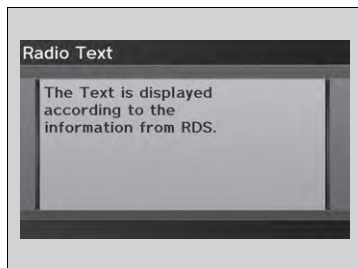

1. Press the **AUDIO** button.
2. Move to select **AUDIO MENU**.
3. Rotate to select **Read Radio Text**, then press .

# Playing the XM® Radio

Models without rear entertainment system



### TITLE Button

Press and release to cycle the display between the name, title, and category.

### ([[XM]]) (XM®) Button

Press to select XM® Radio, and to select the XM1 or XM2 band.

### VOL/⏻ (Volume/Power) Knob

Press to turn the audio system on and off. Turn to adjust the volume.

### SKIP Bar

Press ◀◀ or ▶▶ to the previous or next channel.

### AUDIO Button

Press to display the audio system on the navigation screen.

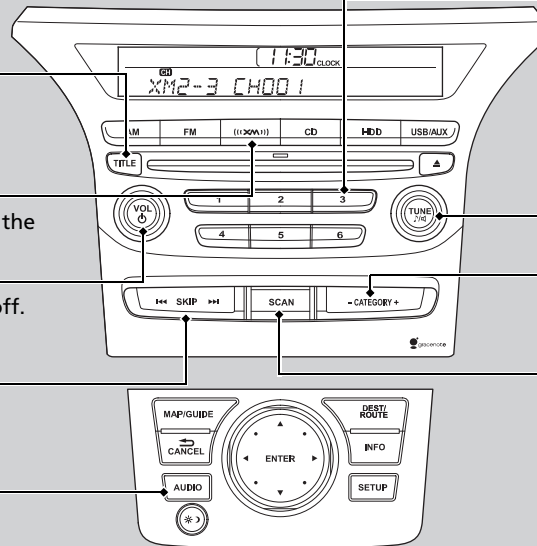

### Preset Buttons (1-6)

To store a channel:

1. Tune to the selected channel.
2. Pick a preset button and hold it until you hear a beep.

To listen to a stored channel, select XM, then press the preset button.

### TUNE Knob

Turn to tune a station.

### CATEGORY Bar

Press either side to display and select an XM® Radio category.

### SCAN Button

Press to sample all channels (in the channel mode), or channels within a category (in the category mode). Each sampling continues for a few seconds. Press SCAN again to cancel scanning and continue listening to the channel.



Models with rear entertainment system



**TITLE Button**

Press and release to cycle the display between the name, title, and category.

**(XM) (XM®) Button**

Press to select XM® radio, and to select the XM1 or XM2 band.

**VOL/ (Volume/Power) Knob**

Press to turn the audio system on and off. Turn to adjust the volume.

**SKIP Bar**

Press to skip to the previous or next channel.

**AUDIO Button**

Press to display the audio system on the navigation screen.

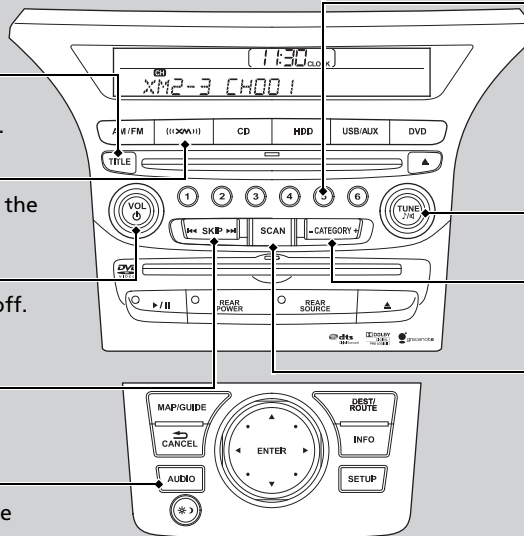

**Preset Buttons (1-6)**

To store a channel:  
 1. Select the channel.  
 2. Pick a preset button and hold it until you hear a beep.

To listen to a stored channel, select XM, then press the preset button.

**TUNE Knob**

Turn to tune a station.







**CATEGORY Bar**

Press either side to display and select an XM® Radio category.

**SCAN Button**





Press to sample all channels (in the channel mode), or channels within a category (in the category mode). Each sampling continues for a few seconds. Press SCAN again to cancel scanning and continue listening to the channel.

## To Play the XM® Radio

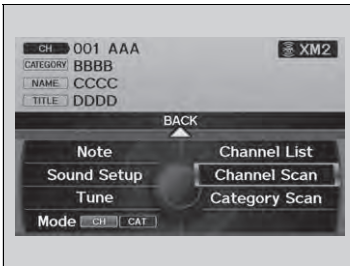
1. Press the ((XM)) button.
2. Press the **AUDIO** button, move  to select **AUDIO MENU**.
3. Rotate  to select **Mode**. Press .
4. Rotate  to select **CH** (channel mode) or **CAT** (category mode). Press .
5. Select a channel using the **TUNE** () , **SKIP**, **CATEGORY**, **SCAN**, or Preset buttons.

## To Select a Channel from a List



1. Press the **AUDIO** button, move  to select **AUDIO MENU**.
2. Rotate  to select **Channel List**. Then press .
3. Rotate  to select a channel, then press .

### ▶▶▶ Playing the XM® Radio

In the channel mode, all available channels are selectable. In the category mode, you can select a channel within a category (Jazz, Rock, Classical, etc.).

You can store 12 XM® stations in the preset buttons. XM1 and XM2 let you store 6 stations each.

There may be instances when XM® Radio does not broadcast all the data fields (artist name, title). This does not indicate a problem with your audio system.

## Playing a CD

Your audio system supports audio CDs, CD-Rs and CD-RWs in either MP3 or WMA format. With the CD loaded, press the **CD** button.

Models without rear entertainment system



### CD Button

Press to play a CD.

### TITLE Button

Press to display the text data on a CD (if it was recorded with text data).

### VOL/⏻ (Volume/Power) Knob

Press to turn the audio system on and off. Turn to adjust the volume.

### SKIP Bar

Press **⏮** or **⏭** to change tracks (files in MP3, WMA, or AAC). Press and hold to move rapidly within a track/file.

### AUDIO Button

Press to display the audio system on the navigation screen.

### CD Slot

Insert a CD about halfway into the CD slot.

### ⏮ (CD Eject) Button

Press to eject a CD.

### SCAN Button

You will get a 10-second sampling of each song.

- Press to sample all tracks on the CD (all files in the current folder in MP3, WMA, or AAC).
- Press two times to sample the first file in each of the main folders (MP3, WMA, or AAC).
- To turn off scan, press and hold the button.

### CATEGORY Bar

Press **+** to skip to the next folder, and **-** to skip to the beginning of the previous folder in MP3, WMA or AAC.

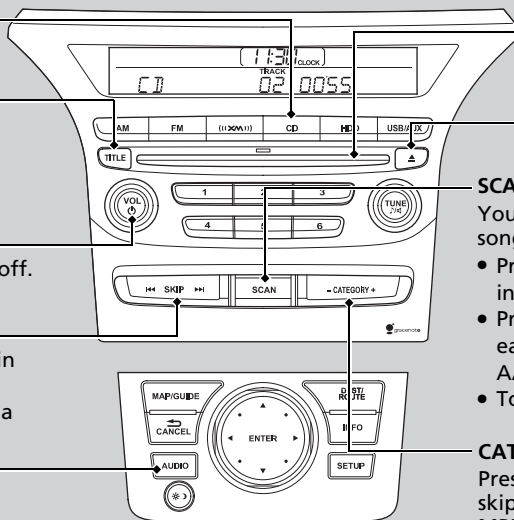

Models with rear entertainment system



**CD Button**

Press to play a CD

**TITLE Button**

Press to display the text data on a CD (if it was recorded with text data).

**VOL/ (Volume/Power) Knob**

Press to turn the audio system on and off. Turn to adjust the volume.

**SKIP Bar**

Press **◀** or **▶** to change tracks (files in MP3, WMA or AAC).

Press and hold to move rapidly within a track/file.

**AUDIO Button**

Press to display the audio system on the navigation screen.

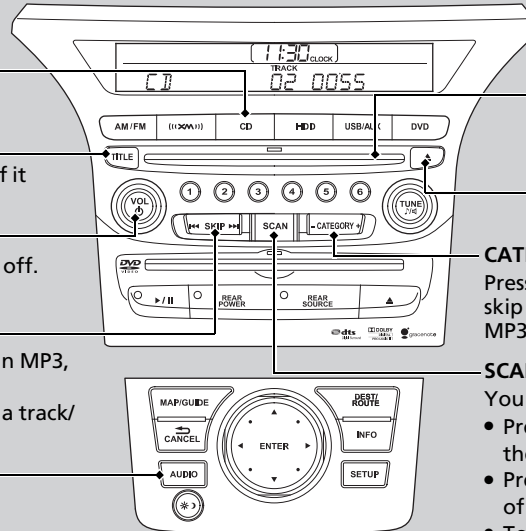

**CD Slot**

Insert a CD about halfway into the CD slot.

**(CD Eject) Button**

Press to eject a CD.

**CATEGORY Bar**

Press **+** to skip to the next folder, and **-** to skip to the beginning of the previous folder in MP3, WMA or AAC.

**SCAN Button**

You will get a 10-second sampling of each song.

- Press to sample all tracks on the CD (all files in the current folder in MP3, WMA, or AAC).
- Press two times to sample the first file in each of the main folders (MP3, WMA, or AAC).
- To turn off scan, press and hold the button.

## How to Select a File from a Folder with the Interface Dial (MP3/WMA/AAC)



1. Press the **AUDIO** button, move to select **FOLDER LIST**.
2. Rotate to select a folder.
3. Press to change the display to a list of files in that folder.
4. Rotate to select a file, then press .

### ▶▶ Playing a CD

#### NOTICE

Do not use CDs with adhesive labels. The label can cause the CD to jam in the unit.

WMA files protected by digital rights management (DRM) cannot be played.

The audio system displays **UNSUPPORTED**, then skips to the next file.

Text data appears on the display under the following circumstances:

- When you select a new folder, file, or track.
- When you change the audio mode to CD.
- When you insert a CD.

If you eject the CD but do not remove it from the slot, the system reloads the CD automatically after several seconds.

## How to Select a Play Mode

You can select repeat, random, and scan modes when playing a track or file.



1. Press the **AUDIO** button, move to select **AUDIO MENU**.
2. Rotate to select **Repeat, Random,** or **Scan**, then press .
3. Rotate to select a mode, then press .

### To turn off a play mode

1. Press the **AUDIO** button, move to select **AUDIO MENU**.
2. Rotate to select **Repeat, Random,** or **Scan**, then press .
3. Rotate to select **OFF**, then press .

### How to Select a Play Mode

#### Play Mode Menu Items

##### OFF

**TRACK REPEAT:** Repeats the current track/file.

**FOLDER REPEAT (MP3/WMA/AAC):** Repeats all files in the current folder.

**FOLDER RANDOM (MP3/WMA/AAC):** Plays all files in the current folder in random order.

**TRACK RANDOM:** Plays all tracks/files in random order.

**TRACK SCAN:** Samples all track/file(s).

**FOLDER SCAN (MP3/WMA/AAC):** Samples the first file in each folder.

## Playing Hard Disc Drive (HDD) Audio

The songs on music CDs can be recorded to the built-in HDD. You can then play the songs directly from your vehicle's audio system.

Models without rear entertainment system



**VOL/ (Volume/Power) Knob**  
Press to turn the audio system on and off.  
Turn to adjust the volume.

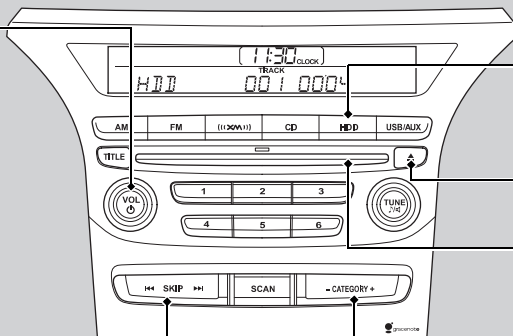

**HDD Button**  
Press to play tracks stored on the HDD.

**(CD Eject) Button**  
Press to eject a CD.

**CD Slot**  
Insert a CD about halfway into the CD slot.

**SKIP Bar**  
Press **⏮** or **⏭** to change tracks.  
Press and hold to move rapidly within a track.

**CATEGORY Bar**  
Press **+** to skip to the next track list, and **-** to skip to the beginning of the previous track list.

**AUDIO Button**  
Press to display the audio system on the navigation screen.

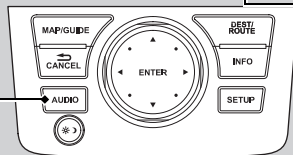

Models with rear entertainment system



**VOL/ (Volume/Power) Knob**  
 Press to turn the audio system on and off.  
 Turn to adjust the volume.

**SKIP Bar**  
 Press ◀◀ or ▶▶ to change tracks.  
 Press and hold to move rapidly within a track.

**AUDIO Button**  
 Press to display the audio system on the navigation screen.

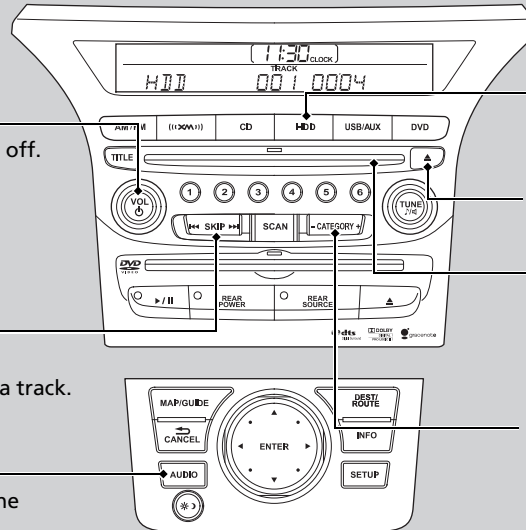

**HDD Button**  
 Press to play tracks stored on the HDD.

**(CD Eject) Button**  
 Press to eject a CD.

**CD Slot**  
 Insert a CD about halfway into the CD slot.

**CATEGORY Bar**  
 Press + to skip to the next track list, and - to skip to the beginning of the previous track list.



## Recording a Music CD to HDD

### ■ If the CD is played in the audio unit for the first time

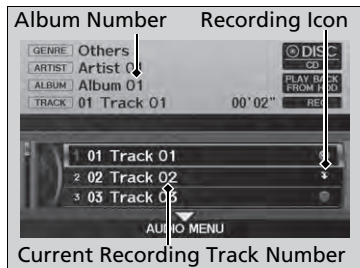

The songs on music CDs are automatically recorded to HDD by factory default.

- ▶ The recording icon appears while the CD is being recorded.

### ■ Stopping recording

1. Move to select **AUDIO MENU**.
2. Rotate to select **Cancel Rec to HDD**, then press .

### ▶▶ Recording a Music CD to HDD

You can store up to 9999 tracks.

The system supports the recording function from the standard CD-DA only.

▶ [Recommended CDs P. 273](#)

The system does not support the CD-DA with copy protection.

Gracenote® searches for the title information for the CD you have recorded to the HDD. If the information is found, song titles are displayed.

If you turn off the ignition switch while recording a CD, there may be pauses between songs when you playback from the HDD.





Forward/rewind, repeat, random and scan functions are not available during recording. You can listen to tracks from other album lists while recording.

There is no compensation offered in the case of unsuccessful recording of audio data or the loss of audio data due to any cause whatsoever.





## How to Select a Play Mode for HDD

You can select repeat, random, and scan modes when playing HDD.



1. Press the **AUDIO** button, move  to select **AUDIO MENU**.
2. Rotate  to select **Repeat, Random,** or **Scan**, then press .
3. Rotate  to select a mode, then press .

### ■ To turn off a play mode

1. Press the **AUDIO** button, move  to select **AUDIO MENU**.
2. Rotate  to select **Repeat, Random,** or **Scan**, then press .
3. Rotate  to select **OFF**, then press .

### ▶▶ How to Select a Play Mode for HDD

#### Play Mode Menu Items

##### OFF

**TRACK REPEAT:** Repeats the current track.

**TRACK SCAN:** Samples all tracks on the HDD.

**TRACK RANDOM:** Plays all tracks on the HDD in random order.

## HDD Setup

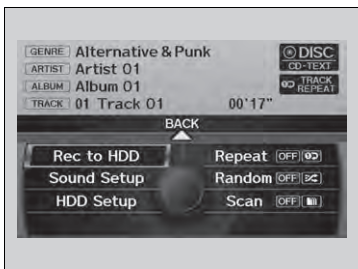
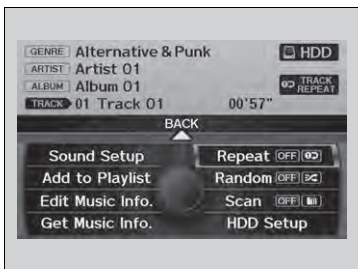











### ■ Recording a CD Manually

1. Press the **AUDIO** button, move to select **AUDIO MENU**.
2. Rotate to select **HDD Setup**, then press .
3. Rotate to select **CD Recording**, then press .
4. Rotate to select **MANUAL**, then press .
5. Move to select **RETURN**.
6. Rotate to select **Rec to HDD**. Press .
  - ▶ To cancel recording, rotate to select **Cancel Rec to HDD**. Press .

## ▶▶ HDD Setup

- HDD Setup** menu items
- CD Recording:**
- ▶ [Recording a CD Manually P. 200](#)
- Gracenote Info. Update:**
- ▶ [To update Gracenote® Album Info P. 202](#)

### ■ To update Gracenote® Album Info

1. Insert the update disc into the disc slot that includes the update.
2. Press the **AUDIO** button, move  to select **AUDIO MENU**.
3. Rotate  to select **HDD Setup**.
4. Rotate  to select **Gracenote Info. Update**, then press .
5. Rotate  to select USB or DISC update source media, then press .
6. Rotate  to select **Yes**. Press  to start updating.
7. Rotate  to select **OK**, on the confirmation screen. Press .

#### ▶▶ To update Gracenote® Album Info

To acquire updated files:

Consult a dealer

**US:** Visit [www.honda.com](http://www.honda.com).

**Canada:** Visit [www.honda.ca](http://www.honda.ca).

Once you perform an update, any information you edited before will be overwritten or erased.

 **Gracenote® End User License Agreement**  
P. 476

Continued



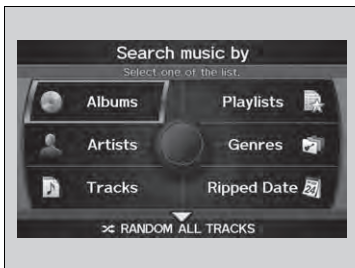

## ■ Searching for Music

Search for music recorded to HDD using six different methods.



1. Press the **AUDIO** button, move  to select **MUSIC SEARCH**.



2. Rotate  to select an item. Press .
  - ▶ Move  or  to select alphabetical tabs on some screens.
  - ▶ The first track begins playing.

## ▶▶ Searching for Music

**Albums**, **Artists**, and **Tracks** display lists in alphabetical order. **Ripped Date** displays albums in chronological order.

You can also search for music on the HDD through voice commands using SBV.

### RANDOM ALL TRACKS

Move  to select **RANDOM ALL TRACKS** to shuffle the playback of all tracks that have been recorded to HDD.

## Adding a Track to a User Playlist

Add a track from any playlist to one of the six user playlists.



1. Press the **AUDIO** button, move to select **AUDIO MENU**.
2. Rotate to select **Add to Playlist**, then press .
3. Rotate to select a playlist. Press .
  - ▶ The track is added to the end of the playlist.

### Adding a Track to a User Playlist

The maximum number of songs in each of the six user playlists is 999. Adding new songs overwrites the oldest songs.

Adding a track from a user playlist into the same user playlist will cause the track to appear twice in the playlist.

## Editing a Playlist

Change the playlist name, track title, artist name, genre, and track order of the current playlist. You can also delete tracks, playlists, and albums.

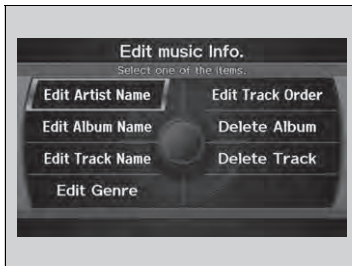









1. Press the **AUDIO** button, move to select **AUDIO MENU**.
2. Rotate to select **Edit Music Info.**, then press .
3. Rotate to select an item. Press .

### Editing a Playlist

Deleting an album (original playlist) also deletes the album tracks you have stored in any user playlists.

Deleting a user playlist or deleting all tracks from a user playlist does not remove the playlist folder. The folder retains the playlist name and artist information.

The following items are available, depending on the type of playlist:





- **Edit Artist Name:** Enter a new artist name. Move  to select **OK** when finished. Then, select whether to apply the new artist name to the album (playlist) and all tracks, the current track only, all tracks, or the album (playlist) only.
- **Edit Playlist Name** (user playlists): Enter a new playlist name. Move  to select **OK** when finished.
- **Edit Album Name** (original playlists): Enter a new album name. Move  to select **OK** when finished.
- **Edit Track Name:** Enter a new track name. Move  to select **OK** when finished.
- **Edit Genre:** Select a new genre. Then select the original playlist to apply the genre.
- **Edit Track Order** (user playlists): Select the track to move, and then select the new location. Repeat to move more than one track. Move  to select **OK** when finished.
- **Delete Playlist:** Deletes the user playlist. Rotate  to select **Yes** at the confirmation prompt to delete the playlist.
- **Delete Album:** Deletes the original playlist. Rotate  to select **Yes** at the confirmation prompt to delete the album.
- **Delete Track:** Deletes the current track. Rotate  to select **Yes** at the confirmation prompt to delete the current track.

## ■ Displaying Music Information

Display the music information (album name, artist name, genre) for an album (original playlist).



▶ Gracenote® searches for the information of the currently selected album (original playlist).

1. Press the **AUDIO** button, move  to select **AUDIO MENU**.
2. Rotate  to select **Add to Get Music Info.**, then press .
3. Rotate  to select an album. Press .
  - ▶ The information is displayed.



### ⌘ Displaying Music Information

The maximum number of original playlists is 999 with a maximum of 99 songs in each playlist. Each album CD counts as an original playlist.



## Playing an iPod®

Connect the iPod® using your dock connector to the USB adapter cable, then press the **USB/AUX** button.

➤ **USB Adapter Cable** P. 173

Models without rear entertainment system

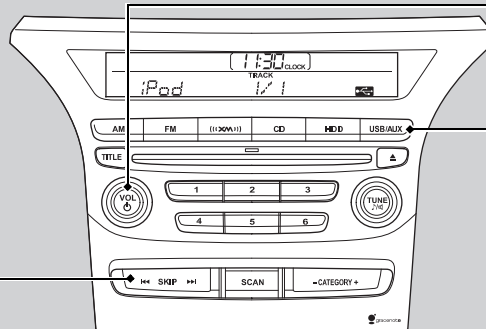

**VOL/⏻ (Volume/Power) Button**  
Press to turn the audio system on and off.  
Turn to adjust the volume.

**USB/AUX Button**  
Press to select iPod® (if connected).

**SKIP Bar**  
Press ◀◀ or ▶▶ to change songs.  
Press and hold to move rapidly  
within a song.

**AUDIO Button**  
Press to display the audio system  
on the navigation screen.

Models with rear entertainment system

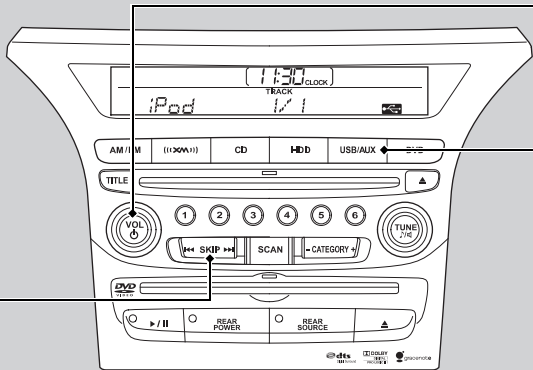
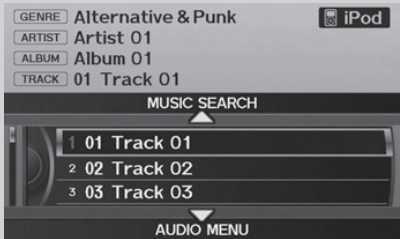

**VOL/PWR (Volume/Power) Button**  
 Press to turn the audio system on and off.  
 Turn to adjust the volume.

**USB/AUX Button**  
 Press to select iPod® (if connected).

**SKIP Bar**  
 Press ◀◀ or ▶▶ to change songs.  
 Press and hold to move rapidly within a song.

**AUDIO Button**  
 Press to display the audio system on the navigation screen.

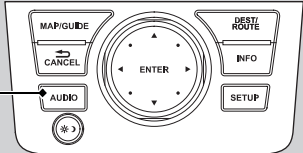

## How to Select a File from the iPod® Menu

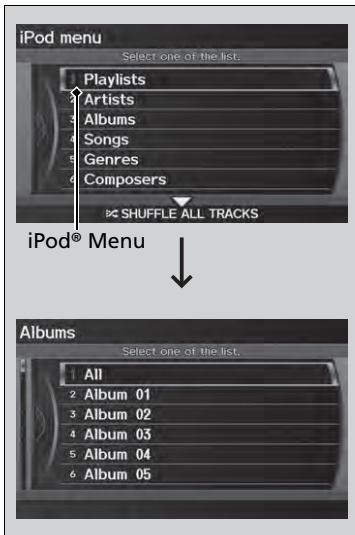

1. Press the **AUDIO** button, move to select **MUSIC SEARCH**.
2. Rotate to select a menu.
3. Press to display the items on that menu.
4. Rotate to select an item, then press .

### ▶▶ Playing an iPod®

Available operating functions vary on models or versions. Some functions may not be available on the vehicle's audio system.

If there is a problem, you may see an error message on the audio display.



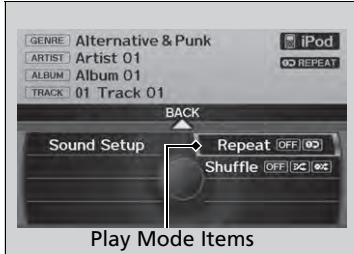

[▶▶ iPod®/USB Flash Drive P. 268](#)

## How to Select a Play Mode





You can select repeat and shuffle modes when playing a file.



Play Mode Items

1. Press the **AUDIO** button, move  to select **AUDIO MENU**.
2. Rotate  to select **Repeat or Shuffle**, then press .
3. Rotate  to select a mode, then press .

### ■ To turn off a play mode

1. Press the **AUDIO** button, move  to select **AUDIO MENU**.
2. Rotate  to select **Repeat or Shuffle**, then press .
3. Rotate  to select **OFF**, then press .

### ▶▶ How to Select a Play Mode

#### Play Mode Menu Items

##### OFF

**Shuffle:** Plays all available files in a selected list (playlists, artists, albums, songs, genres, or composers) in random order.

**Shuffle Albums:** Plays all available albums in a selected list (playlists, artists, albums, songs, genres, or composers) in random order.

**Repeat:** Repeats the current track.

## Playing a USB Flash Drive

Your audio system reads and plays sound files on a USB flash drive in either MP3, WMA or AAC\*1 format.

Connect your USB flash drive to the USB adapter cable, then press the **USB/AUX** button.

➤ **USB Adapter Cable** P. 173

Models without rear entertainment system



### VOL/⏻ (Volume/Power) Knob

Press to turn the audio system on and off.  
Turn to adjust the volume.

### SKIP Bar

Press ◀◀ or ▶▶ to change files.  
Press and hold to move rapidly within a song.

### AUDIO Button

Press to display the audio system on the navigation screen.

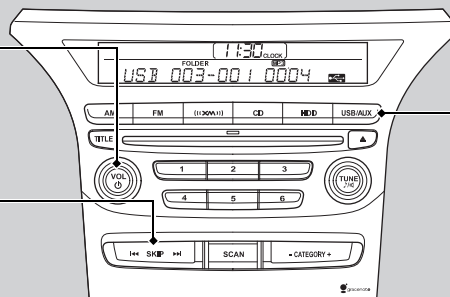

### USB/AUX Button

Press to select USB flash drive (if connected).

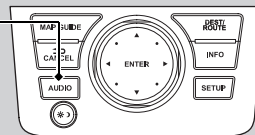

\*1: Only AAC format files recorded with iTunes® are playable on this unit.

Models with rear entertainment system



**VOL/⏻ (Volume/Power) Knob**

Press to turn the audio system on and off.  
Turn to adjust the volume.

**SKIP Bar**

Press ◀◀ or ▶▶ to change files.  
Press and hold to move rapidly within a song.

**AUDIO Button**

Press to display the audio system on the navigation screen.

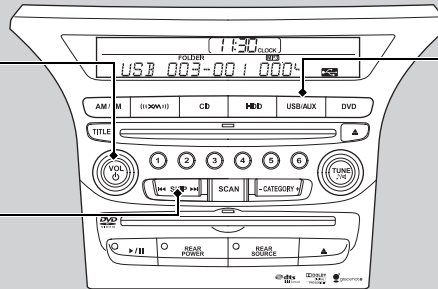

**USB/AUX Button**

Press to select USB flash drive (if connected).

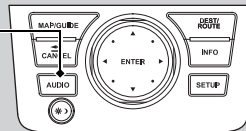

## How to Select a File from a Folder with the Selector Knob



1. Press the **AUDIO** button, move to select **FOLDER LIST**.
2. Rotate to select a folder.
3. Press to change the display to a list of files in that folder.
4. Rotate to select a file, then press .

### ▶▶ Playing a USB Flash Drive

Use the recommended USB flash drives.

[▶ General Information on the Audio System P. 272](#)

Files in WMA format protected by digital rights management (DRM) are not played.

The audio system displays **UNPLAYABLE FILE**, and then skips to the next file.

If there is a problem, you may see an error message on the audio display.

[▶ iPod®/USB Flash Drive P. 268](#)





### RANDOM ALL TRACKS

Move to select **RANDOM ALL TRACKS** to shuffle the playback of all tracks on the USB flash drive.

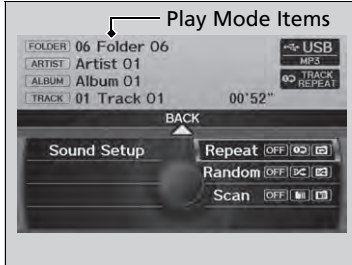



## How to Select a Play Mode

You can select repeat, random, and scan modes when playing a file.



1. Press the **AUDIO** button, move  to select **AUDIO MENU**.
2. Rotate  to select **Repeat, Random, or Scan**, then press .
3. Rotate  to select a mode, then press .

### ■ To turn off a play mode

1. Press the **AUDIO** button, move  to select **AUDIO MENU**.
2. Rotate  to select **Repeat, Random, or Scan**, then press .
3. Rotate  to select **OFF**, then press .

## ▶▶ How to Select a Play Mode

### Play Mode Menu Items

#### OFF

**TRACK REPEAT:** Repeats the current file.

**FOLDER REPEAT:** Repeats all files in the current folder.

**FOLDER RANDOM:** Plays all files in the current folder in random order.

**TRACK RANDOM:** Plays all files in random order.

**TRACK SCAN:** Samples all files in the current folder.

**FOLDER SCAN (MP3/WMA/AAC):** Samples the first file in each folder.



## Playing *Bluetooth*® Audio

Your audio system allows you to listen to music from your *Bluetooth*®-compatible phone.

This function is available when the phone is paired and linked to the vehicle's *Bluetooth*® HandsFreeLink® (HFL) system.

➤ **Phone Setup** P. 305

### ▶▶ Playing *Bluetooth*® Audio

Not all *Bluetooth*-enabled phones with streaming audio capabilities are compatible with the system. For a list of compatible phones:

- **U.S.:** Visit [www.handsfreelink.honda.com](http://www.handsfreelink.honda.com), or call 1-888-528-7876.
- **Canada:** Visit [www.handsfreelink.ca](http://www.handsfreelink.ca), or call 1-888-528-7876.

In some states, it may be illegal to perform some data device functions while driving.

If more than one phone is paired to the HFL system, there will be a delay before the system begins to play.

#### Models without rear entertainment system

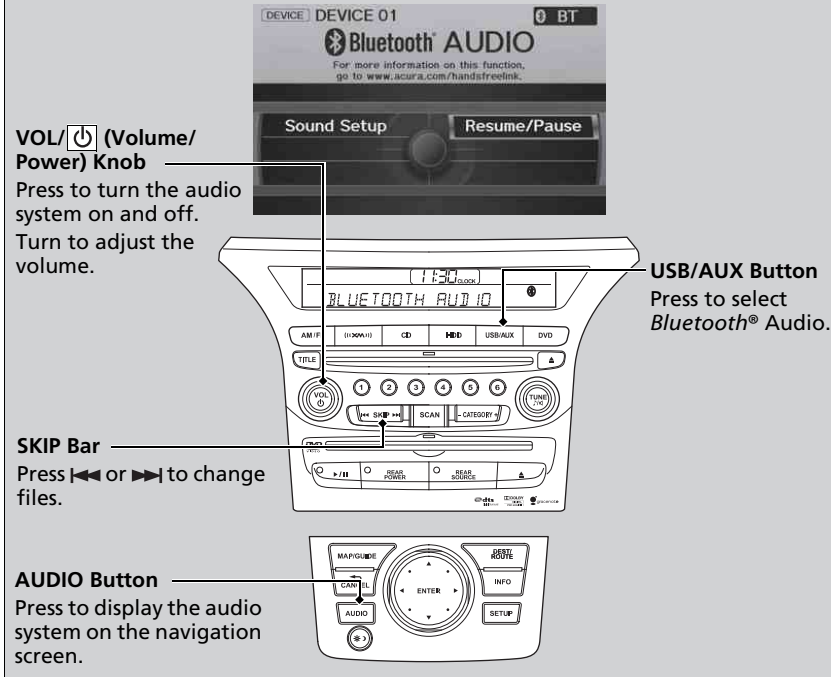

**Models with rear entertainment system**

**VOL/⏻ (Volume/Power) Knob**  
Press to turn the audio system on and off. Turn to adjust the volume.

**USB/AUX Button**  
Press to select *Bluetooth®* Audio.

**SKIP Bar**  
Press ◀◀ or ▶▶ to change files.

**AUDIO Button**  
Press to display the audio system on the navigation screen.



## ■ To Play *Bluetooth*® Audio Files



1. Make sure that your phone is paired and linked to HFL.
2. Press the **USB/AUX** button.

If the phone is not recognized, another HFL-compatible phone, which is not compatible for *Bluetooth*® Audio, **may be** already linked.

## ■ To pause or resume a file

1. Press the **AUDIO** button, move  to select **AUDIO MENU**.
2. Rotate  to select **Resume/Pause**, then press .

Each time you press , the setting switches between **Pause** and **Resume**.

## ■ Switching to HFL

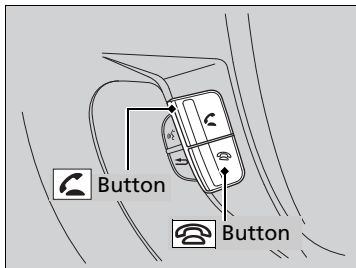

Press the  (pick-up) button on the steering wheel to receive a call when *Bluetooth*® Audio is playing.

➤ [Bluetooth® HandsFreeLink® P. 301](#)

Press the  (hang-up) button to end the call and return to *Bluetooth*® Audio.

## ▶▶ To Play *Bluetooth*® Audio Files

To play the audio files, you may need to operate your phone. If so, follow the phone maker's operating instructions.

The pause function may not be available on some phones.

If any audio device is connected to the auxiliary input jack, you may need to press the **USB/AUX** button repeatedly to select the *Bluetooth*® Audio system.

Switching to another mode pauses the music playing from your phone.

## ▶▶ Switching to HFL

If you receive a call while *Bluetooth*® Audio is in the pause mode, it will resume play after ending the call.

# Rear Entertainment System\*

Allows the rear passengers to enjoy a different entertainment source, such as DVD, CD, CD Library\*, HDD\*, and radio, than the front passengers.

## Wireless Headphones

The rear seat passengers can listen to audio from the rear entertainment system by a wireless headphone that comes with your vehicle.

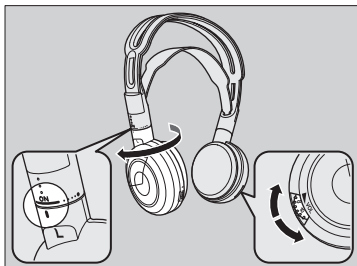

**To turn on the switch:** Pivot the left earpiece outward.

**To adjust the volume:** Turn the dial at the bottom of the right earpiece.

## Rear Entertainment System\*

### NOTICE

This vehicle's overhead mounted video display, if so equipped, includes mercury-containing components. Upon removal, please reuse, recycle, or dispose of as hazardous waste.

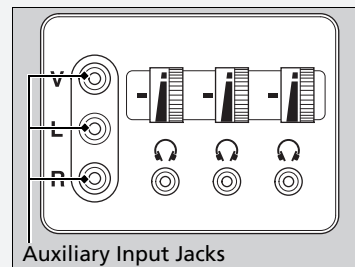

Auxiliary Input Jacks

The system also allows for auxiliary inputs from standard video games. The jacks are on the back of the center console compartment.

V = Video jack

L = Left audio jack

R = Right audio jack

## Wireless Headphones

Your vehicle comes with two wireless headphones.

Wear the headphone correctly with the earpiece marked with L goes to your left ear and R goes to your right ear.

Wearing the headphone backward may affect the audio reception.

\* Not available on all models

Continued

### ■ Overhead Screen

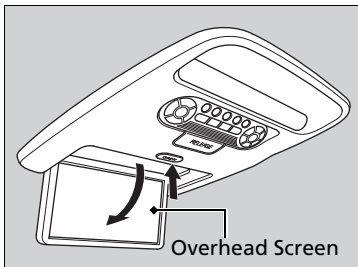

Press the **OPEN** button and pull down the screen to the first or second detent until it latches.

### ▶▶ Overhead Screen

#### NOTICE

This vehicle's overhead mounted video display, if so equipped, includes mercury-containing components. Upon removal, please reuse, recycle, or dispose of as hazardous waste.

You can use the rear control panel as a remote. Press the **RELEASE** button to detach it.

## Operating the System

To operate the system, turn the ignition switch to ON **II** or ACCESSORY **I**. Press the **REAR POWER** button to turn on the system (indicator on).

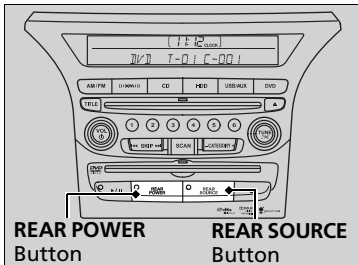

### ■ **REAR SOURCE** button on the front panel

When you press the **REAR SOURCE** button (indicator on), the beeper sounds twice, and the front display changes to what is displayed on the rear overhead screen.

The audio from the front speakers switches to the audio played in the rear.

### ▶▶ Operating the System

If you do not operate the system from the front panel for more than 20 seconds, the indicator in the **REAR SOURCE** button goes off, and the front display returns to what has previously been displayed.

## System Controls and Menus for DVD

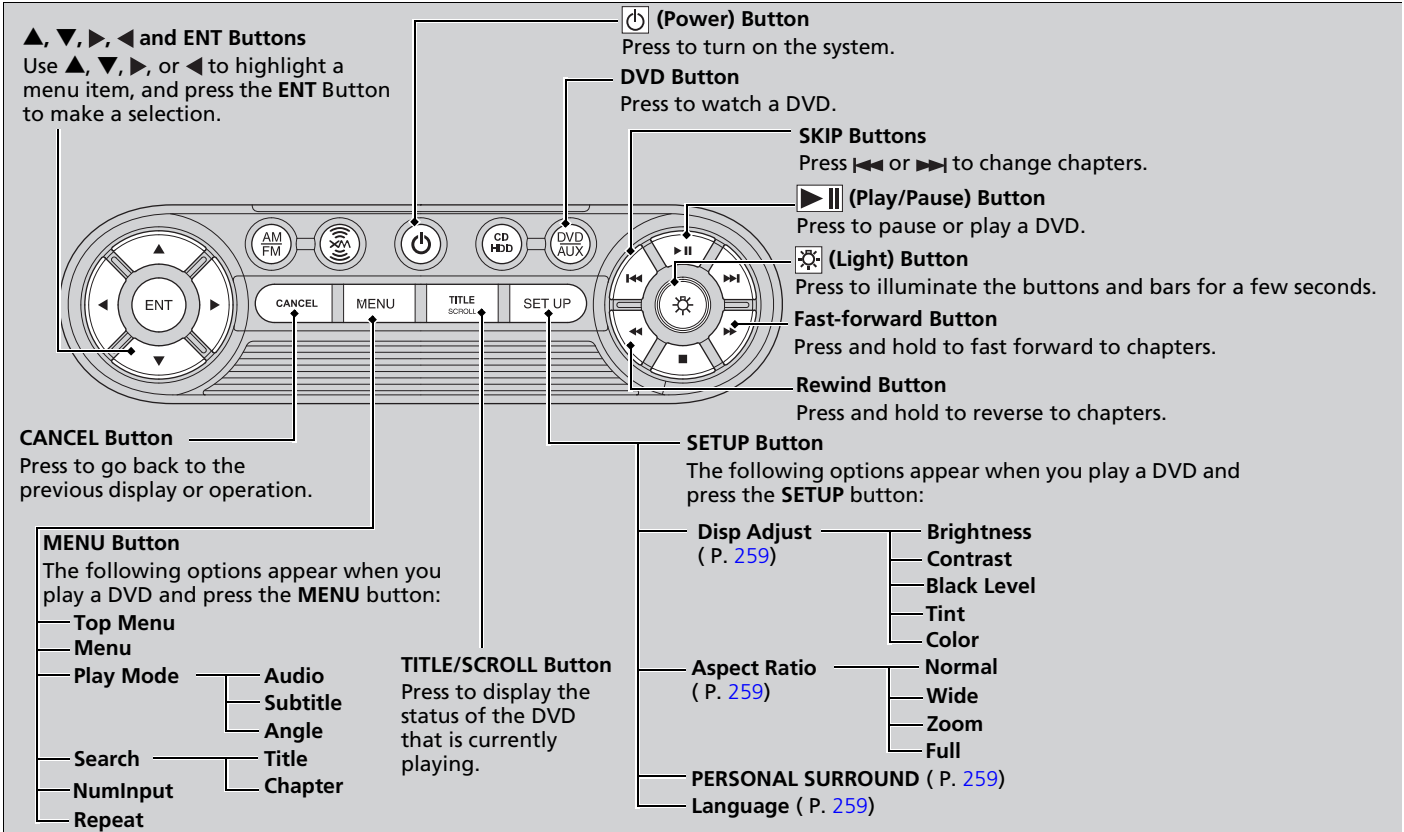

\* Not available on all models



## ■ Playing a DVD

- Insert a DVD into the lower slot of the front audio unit.
  - ▶ The system automatically starts the DVD.
- To fast forward, press and hold the ▶▶ (SKIP) bar, and to reverse, press and hold the ◀◀ bar on the front panel.
- To go to the next chapter, press the ▶▶ bar, and to go to the beginning of the current chapter, press the ◀◀ bar on the front panel. Quickly press the ◀◀ bar twice to go to the previous chapter.



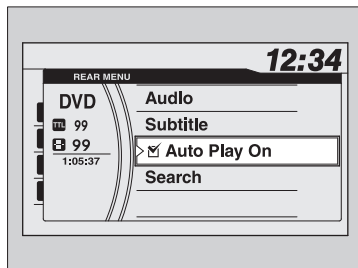

### Models without navigation system

## ■ DVD setup from the front panel





Press the **REAR SOURCE** button on the front panel while a DVD is playing and display **REAR MENU** in front. Rotate  to select **DVD Setup**, then press .

### Setting up Audio:

1. Rotate  to select **Audio**, then press .
2. Rotate  to select a language for audio that is available on the DVD, then press .

### Setting up Subtitle:



1. Rotate  to select **Subtitle**, then press .
2. Rotate  to select a subtitle language that is available on the DVD.

## ▶▶ Playing a DVD





DVD is available for the rear seat passenger only.

If you have turned off the Auto Play feature, press the  (play) button on the front panel or remote.

**Auto Play On:**

1. Rotate  to select **Auto Play On**, then press .
2. The check mark disappears, and the auto play feature turns off.
  - ▶ With this feature off, the DVD does not automatically start playing when the disc is inserted. Press  button to play.



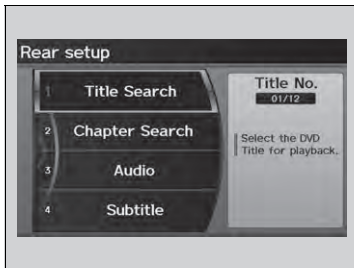

**Title/Chapter Search:**

1. Rotate  to select **Title Search** or **Chapter Search**, then press .
2. Rotate  to select a title or chapter number, then press .





**Models with navigation system**

Press the  button on the front panel while a DVD is playing. Rotate  to select **DVD Setup**, then press .

**Title/Chapter Search:**

1. Rotate  to select **Title Search** or **Chapter Search**, then press .
2. Rotate  to select a title or chapter number, then press .



**Setting up Audio:**

1. Rotate  to select **Audio**, then press .
2. Rotate  to select a language for audio that is available on the DVD, then press .



\* Not available on all models







### Setting up Subtitle:

1. Rotate  to select **Subtitle**, then press .
2. Rotate  to select a subtitle language that is available on the DVD.

### Setting up Repeat:

1. Rotate  to select **Repeat**, then press .
2. Rotate  to select the icon in the center to repeat the current chapter, the icon on the right to repeat the current title, or **OFF** to turn off repeat.

### Auto Play:

1. Rotate  to select **Auto Play**, then press .
2. Rotate  to select **OFF** or **ON**, then press 
  - ▶ With this feature off, the DVD does not automatically start playing when the disc is inserted. Press  button to play.

### ■ TITLE/SCROLL button on the remote

Press the **TITLE/SCROLL** button while the DVD is playing to see the current status of title, chapter, elapsed time, angle, subtitle, audio, and sound characteristics.

▶▶TITLE/SCROLL button on the remote

Press the **TITLE/SCROLL** button again to return.

## ■ MENU button on the remote

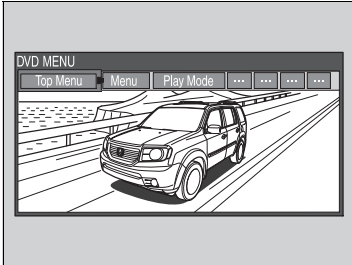

Press the **MENU** button while the DVD is playing to see the available options. Use the ◀ and ▶ buttons to highlight the option and then press the **ENT** button.

### Top Menu:

The top page of the DVD's title menu appears. The title menu also appears when you press the **MENU** button while the DVD is in the slot not playing. Press the **CANCEL** or **MENU** button to return.

### Menu:

The DVD's title menu appears.

### Play Mode:

You can change the following three settings:

**Audio** - Select a language for audio that is available on the DVD. The sound characteristics (Dolby Digital, LPCM, MPEG Audio, etc) of that audio is also displayed.

**Subtitle** - Select a subtitle that is available on the DVD.

**Angle** - Select a view angle that is available on the DVD. If the DVD currently playing does not carry multiple angles, only one option **Angle 1** comes on. Press the **CANCEL** or **MENU** button to return.

\* Not available on all models

### Search:

You can search for a DVD segment from the following methods.

Title Search - Select the title you want to play.

Chapter Search - Select the chapter you want to play.

### NumInput:

Enter a two digit number, if issued to the DVD, to find the segment you want to start to play.

1. Select **NumInput** to go to the number input screen.
2. Use the ▲, ▼, ▶, and ◀ buttons to input numbers.
  - ▶ If you want to delete a number, select **DEL**.
3. The cursor automatically goes to **ENT** after you input two digits. Press the **ENT** button to enter.

### Repeat:

Highlight this option and press the **ENT** button to change the repeat mode from chapter repeat and title repeat, to repeat off.

## ■ SETUP button on the remote

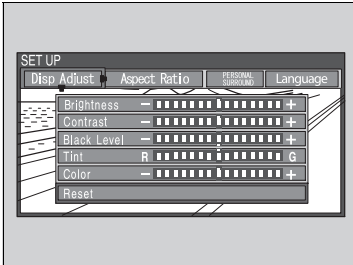

Press the **SETUP** button while the DVD is playing to see the available options. Use the ◀ and ▶ buttons to highlight the option and then press **ENT**.

### Disp Adjust:

You can adjust the overhead screen's **Brightness**, **Contrast**, **Black Level**, **Tint**, and **Color**. To return to the default display setting, select **Reset**.

After you make all the adjustments, the screen goes back to the top **SETUP** screen, or press the **CANCEL** button to return.

### Aspect Ratio:

You can select the screen mode with a different aspect ratio from **Normal**, **Wide**, **Zoom**, and **Full**. After you select the mode, it takes about one second to return to the play mode with the selected ratio.

### PERSONAL SURROUND:

You can select the sound effect mode that fits the DVD's audio source from **Music**, **Cinema**, and **Voice**. Select **Off** to turn this feature off.

### Language:

You can select the display language from **English**, **French**, and **Spanish**.

\* Not available on all models

*Continued*

## ▶▶ SETUP button on the remote

Some DVD formats do not allow for some of the setting adjustments.

When the DVD is not playing

**Initial Settings -**

Press the **SETUP** button to configure the initial Language, Dynamic Range, and Angle Mark settings before playing a DVD.

**Language Settings:**

Select the language for the DVD's displayed menus (**Menu Language**), the DVD's audio (**Audio Language**), and the DVD's subtitle (**Subtitle Language**).

1. Select the language setting.
2. Select the language from **English, French, Spanish, Arabic, German, Italian, Dutch, Chinese, Korean, Thai, Japanese,** and **other**.
3. If you select **other**, you need to enter the four digit language code to configure the language that is not listed. Select **Yes** to go to the number input screen.
  - ▶ To return to the Language Settings screen, select **No**.
4. Press the **ENT** button each time you input a digit.
  - ▶ If you want to delete a number, select **DEL**.
5. The cursor automatically goes to **ENT** after you input four digits. Press the **ENT** button to command.

**Dynamic Range:**

This feature reduces the difference between the loud and quiet sound levels. Select **ON** or **OFF**.

**Angle Mark:**

You can select whether to display the angle mark appearing in the upper right corner of the screen when you change the view angle while the DVD is playing. Select **ON** or **OFF**.

\* Not available on all models

▶▶ SETUP button on the remote

**Initial Settings:**

The prior language varies by disc. You may not be able to configure your selected language setting.

## System Controls and Menus for Audio

**▲, ▼, ►, ◀ and ENT Buttons**  
Use ▲, ▼, ►, or ◀ to highlight a menu item, and press the ENT Button to make a selection.

**AM/FM Button**  
Press to listen to AM or FM radio.

**XM Button**  
Press to listen to XM radio.

**(Power) Button**  
Press to turn on the system.

**CD/HDD Button\***  
Press to listen to a CD or hard disc drive.

**CD/CDL Button\***  
Press to listen to a CD or CD library.

**SKIP Buttons**  
[▶▶ Audio System Basic Operation P. 175 P. 216](#)

**(Play/Pause) Button**  
Press to pause a playing CD.

**Fast-forward Button**  
Press and hold to fast-forward the track.

**(Light) Button**  
Press to illuminate the buttons and bars for a few seconds.

**Rewind Button**  
Press and hold to reverse the track.

**AUX Button**  
Press to use a USB, iPod, auxiliary video (rear), or auxiliary audio (front).

**SETUP Button**  
[▶▶ SETUP button on the remote P. 259](#)

**SCROLL Button**  
Press to switch search mode on XM radio, and scroll titles on CD.

**MENU Button**  
Press to display audio menu for AM/FM radio, XM radio, or CD on the overhead screen.

**CANCEL Button**  
Press to go back to the previous display or operation.

**ENT Button**  
Press to make a selection.

**CANCEL, MENU, TITLE/SCROLL, SET UP Buttons**  
These are the four rectangular buttons located in the center of the control panel.

\* Not available on all models

### ■ Playing AM/FM radio in the rear

Press the **AM/FM** button.

When you press the **MENU** button while the radio is playing, the audio menu appears on the overhead screen. The available functions are the same as those of the front audio system. The **SKIP** button on the control panel works the same as the **SKIP** bar on the front panel for AM/FM radio operation.

➔ [Playing the AM/FM Radio P. 186](#)

### ■ Playing XM radio in the rear

Press the **XM** button.

When you press the **MENU** button while the radio is playing, the audio menu appears on the overhead screen. The available functions are the same as those of the front audio system. The **SKIP** button on the control panel works the same as the **SKIP** bar on the front panel for XM radio operation.

➔ [Playing the XM® Radio\\* P. 190](#)

To change the mode between category and channel, press and hold the **TITLE/SCROLL** button for five seconds.

### ▶▶ System Controls and Menus for Audio

If you press the  button on the front panel, you can operate the rear entertainment system from the front display.

➔  [button on the front panel P. 252](#)

## ■ Playing a CD, CD Library\*, and Hard disc drive\*

Press the **CD/CDL** or **CD/HDD** button.

The available options appear on the overhead screen are **Repeat**, **Random**, and **Scan**. These functions are the same as those of the front audio system.

- [Playing a CD](#) P. 193
- [Playing CD Library](#) P. 197
- [Playing Hard Disc Drive \(HDD\) Audio](#) P. 230

To scroll your audio data title, press the **TITLE/SCROLL** button.

## ■ Playing iPod® and a USB flash drive

Press the **AUX** button.

The available options appear on the overhead screen are **Repeat**, **Random**, and **Scan**. These functions are the same as those of the front audio system.

- [Playing an iPod®](#) P. 203
- [Playing a USB Flash Drive](#) P. 207

To scroll your audio data title, press the **TITLE/SCROLL** button.

### ☒ System Controls and Menus for Audio

You can also insert an audio CD compatible with the system, or recorded in MP3/WMA/AAC formats into the lower slot and play. The front passengers can listen to the same CD, or select another audio source.

- [Playable Discs](#) P. 265
- [Audio Sources for Front and Rear Seats](#) P. 264



## Audio Sources for Front and Rear Seats

The table shows the possible audio source combinations of the front audio system and rear entertainment system's simultaneous use.

Front Rear	AM/FM Radio	XM Radio	CD	CD Library	HDD	DVD*1	USB iPod®
AM/FM Radio	Yes	Yes	Yes	Yes	Yes	Yes	Yes
XM Radio	Yes	Yes	Yes	Yes	Yes	Yes	No
CD	Yes	Yes	Yes*2	No	Yes	Yes	Yes
CD Library	Yes	Yes	No	Yes	Yes	Yes	Yes
HDD	Yes	Yes	Yes	Yes	Yes	Yes	Yes
DVD	Yes	Yes	Yes	Yes	Yes	Yes	Yes
USB iPod®	Yes	No	Yes	Yes	Yes	Yes	Yes

\*1: The front seat passengers are only able to hear the DVD's sound from the front speakers.

\*2: There are two cases. Two different CDs can be played, one for the front seats, and the other for rear seats if the upper and lower slots are used. If only one slot is used, the front and rear seats can't share the same audio source.

### ▶▶ Audio Sources for Front and Rear Seats

**Yes:** These audio sources are simultaneously playable.

**No:** These audio sources are not simultaneously playable.

## Playable Discs



The discs that come with these labels can be played in your vehicle's rear entertainment system.

Also look for the region code of 1 or ALL on the package or jacket on the disc.

DVD-ROMs are not playable in this unit.

### ▶▶ Playable Discs

This product incorporates copyright protection technology that is protected by U.S. patents and other intellectual property rights.

Use of this copyright protection technology must be authorized by Macrovision, and is intended for home and other limited viewing uses only unless otherwise authorized by Macrovision.

Manufactured under license under U.S. Patent's: 5,451,942; 5,956,674; 5,974,380; 5,978,762; 6,487,535 & other U.S. and worldwide patents issued & pending. DTS and DTS Digital Surround are registered trademarks and the DTS logos and Symbol are trademarks of DTS, Inc. All Rights Reserved. Reverse engineering or disassembly is prohibited.

Manufactured under license from Dolby Laboratories. Dolby, Pro Logic, MLP Lossless and the double-D symbol are trademarks of Dolby Laboratories.



## CD Player

If a disc error occurs, you may see the following error messages.

### Models without navigation system

Error Message	Cause	Solution
UNSUPPORTED FILE	Track/file format not supported	<ul style="list-style-type: none"><li>• Current track/file will be skipped. The next supported track/file plays automatically.</li></ul>
CHECK DISC	Disc error	<ul style="list-style-type: none"><li>• Check that the disc is not damaged or deformed. ➔ <a href="#">Protecting CDs</a> P. 274</li></ul>

## Models with navigation system

Error Message	Cause	Solution
<b>BAD DISC PLEASE CHECK OWNERS MANUAL</b>	Servo error	<ul style="list-style-type: none"> <li>Press the  (eject) button and remove the disc, and check that the error message is cleared.</li> <li>Check that the disc is not damaged or deformed, and insert the disc again. <ul style="list-style-type: none"> <li> <a href="#">Recommended CDs P. 273</a></li> </ul> </li> </ul>
<b>BAD DISC PLEASE CHECK OWNERS MANUAL PUSH EJECT</b>	Mechanical error	
<b>MECH ERROR</b>	Mechanical error	<ul style="list-style-type: none"> <li>If the error message reappears, press the  button, and pull out the disc.</li> <li>Insert a different disc. If the new disc plays, there is a problem with the first disc.</li> <li>If the error message repeats, or the disc cannot be removed, contact a dealer. Do not try to force the disc out of the player.</li> </ul>
<b>CHECK DISC</b>	Focus error Disc violates copyright Disc not supported	
<b>CHECK DISC LOAD</b>	Load error	
<b>UNSUPPORTED</b>	Track format not supported	<ul style="list-style-type: none"> <li>Current track will be skipped. The next supported track plays automatically.</li> </ul>
<b>HEAT ERROR</b>	High temperature	<ul style="list-style-type: none"> <li>Turn the audio system off and allow the player to cool down until the error message is cleared.</li> </ul>

## iPod®/USB Flash Drive

If an error occurs while playing an iPod® or USB flash drive, you may see the following error messages. If you cannot clear the error message, contact a dealer.

### Models without navigation system

Error Message	Solution
<b>USB ERROR</b>	Appears when there is a problem with the USB adapter unit. Check if the device is compatible with the USB adapter unit.
<b>BAD USB DEVICE PLEASE CHECK OWNERS MANUAL</b>	Appears when an incompatible device is connected. Disconnect the device. Then turn the audio system off, and turn it on again. Do not reconnect the device that caused the error.
<b>NO SONG</b>	Appears when the iPod® is empty. Check that compatible files are stored on the device.
<b>UNSUPPORTED VER</b>	Appears when an unsupported iPod® is connected. If it appears when a supported iPod® is connected, update the iPod® software to the newer version.
<b>Retry Connection</b>	Appears when the system does not acknowledge the iPod®. Reconnect the iPod®.
<b>UNPLAYABLE FILE</b>	Appears when the files in the USB flash drive are DRM or an unsupported format. This error message appears for about 3 seconds, then plays the next song.
<b>No Song</b>	Appears when the USB flash drive is empty or there are no MP3, WMA, or AAC files in the USB flash drive. Check that compatible files are stored on the device.
<b>UNSUPPORTED</b>	Appears when an unsupported device is connected. If it appears when a supported device is connected, reconnect the device.

## iPod®

### Models with navigation system

Error Message	Cause	Solution
<b>UNSUPPORTED</b>	Appears when an unsupported iPod® is connected.	Update the iPod® software to the latest version.
<b>CONNECT RETRY</b>	Appears when the iPod® cannot be authenticated.	Reconnect the iPod®.
<b>NO SONG</b>	Appears when there are no tracks in the iPod®.	Store tracks in the iPod®.

## USB Flash Drive

### Models with navigation system

Error Message	Cause	Solution
<b>FILE ERROR</b>	The system cannot read the track(s).	Check the tracks in the USB flash drive. There is a possibility that the tracks have been damaged.
<b>UNSUPPORTED</b>	Appears when an unsupported device is connected.	If it appears when a supported device is connected, reconnect the device.
<b>UNPLAYABLE FILE</b>	Appears when the tracks in the USB flash drive are DRM or an unsupported format.	This error message appears for about 3 seconds, then plays the next song.
<b>NO SONG</b>	Appears when the USB flash drive is empty or there are no tracks in MP3, WMA, or AAC format in the drive.	Save tracks in MP3, WMA, or AAC format in the USB flash drive.
<b>BAD USB DEVICE PLEASE CHECK OWNER'S MANUAL</b>	Appears when the overcurrent protection feature of the system stops supplying power to USB because an incompatible device is connected.	Disconnect the device. Turn the audio system off, and turn it on again. Do not reconnect the device that caused the error.
<b>ERROR</b>	Appears when the Internal USB ROM error occurs.	Try a different USB flash drive.

Models with rear entertainment system

## DVD Player Error Messages

Error Message	Cause	Solution
<b>CHECK DISC</b>	FOCUS Error	Press the disc eject button, and remove the disc. Check for an error indication. Insert the disc again. If the code does not disappear or the disc cannot removed, consult a dealer.
<b>Mech Error</b>	Mechanical Error	
<b>CHECK REGION</b>	Invalid region code	The disc is not playable in this unit. Eject the disc, and insert a disc compatible with this system.
<b>UNSUPPORTED FILE</b>	DVD format not supported	

[QR](#)[TOC](#)[Features](#)[Index](#)[Home](#)



## XM® Radio Service \*

### Subscribing to XM® Radio

1. You need your radio ID ready before registering for subscription.  
To see the ID on the display: Turn the selector knob until **0** appears.
2. Have your radio ID and credit card number ready, and either call or visit the XM® website to subscribe.

### Receiving XM® Radio

Press the ((XM)) (XM®) button and stay in this mode for about 30 minutes until the service is activated. Make sure your vehicle is in an open area with good reception.

### XM® Radio Display Messages

**LOADING:** XM® is loading the audio or program information.

**Ch Off Air:** The channel is not currently broadcasting.

**Ch Unauthorized:** The encryption code is being updated. Channels 0 and 1 still work normally.

**NO SIGNAL:** The signal is too weak in the current location.

**Ch Unavailable:** No such channel exists, the channel is not part of your subscription, or the artist or title information is unavailable.

**CHECK ANTENNA:** There is a problem with the XM® antenna. Contact a dealer.

### Subscribing to XM® Radio

Contact Information for XM® Radio:

**US:** XM® Radio at [www.siriusxm.com](http://www.siriusxm.com) or

1-800-852-9696

**Canada:** XM® Canada at [www.xmradio.ca](http://www.xmradio.ca), or

1-877-209-0079

### Receiving XM® Radio

The XM® satellites are in orbit over the equator, therefore, objects south of the vehicle may cause satellite reception interruptions. Satellite signals are more likely to be blocked by tall buildings and mountains the farther north you travel from the equator.

You may experience reception problems under the following circumstances:

- In a location with an obstruction to the south of your vehicle.
- In tunnels
- On the lower level of a multi-tiered road
- Large items carried on the roof rack

## Recommended CDs

- Use only high-quality CD-R or CD-RW discs labeled for audio use.
- Use only CD-R or CD-RW discs on which the recordings are closed.
- Play only standard round-shaped CDs.



### CDs with MP3, WMA or AAC files

- Some software files may not allow for audio play or text data display.
- Some versions of MP3, WMA or AAC formats may be unsupported.

#### Recommended CDs

A Dual-disc cannot play on this audio unit. If recorded under certain conditions, a CD-R or CD-RW may not play either.

## ■ Protecting CDs

Follow these precautions when handling or storing CDs:

- Store a CD in its case when it is not being played.
- When wiping a CD, use a soft clean cloth from the center to the outside edge.
- Handle a CD by its edge. Never touch either surface.
- Never insert foreign objects into the CD player.
- Keep CDs out of direct sunlight and extreme heat.
- Do not place stabilizer rings or labels on the CD.
- Avoid fingerprints, liquids, and felt-tip pens on the CD.

## ▶▶ Protecting CDs

### NOTICE

Do not insert a damaged CD. It may be stuck inside and damage the audio unit.

#### Examples:

- Bubbled, wrinkled, labeled, and excessively thick CDs



Bubbled/  
Wrinkled



With Label/  
Sticker



Using  
Printer Label  
Kit



Sealed



With Plastic Ring

- Damaged CDs



Chipped/  
Cracked

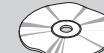

Warped



Burrs

- Poor quality CDs

- Small CDs



3-inch  
(8-cm)  
CD

## Compatible iPod® and USB Flash Drives

### ■ iPod® Model Compatibility

Model
iPod classic® 80GB/160GB
iPod classic® 120GB
iPod classic® 160GB (launch in 2009)
iPod® (5th generation)
iPod nano®
iPod touch®

### ■ USB Flash Drives

- Use a recommended USB flash drive of 256 MB or higher.
- Some digital audio players may not be compatible.
- Some USB flash drives (e.g., a device with security lockout) may not work.
- Some software files may not allow for audio play or text data display.
- Some versions of MP3, WMA, or AAC formats may be unsupported.

#### ⌘ iPod® Model Compatibility

This system may not work with all software versions of these devices.

#### ⌘ USB Flash Drives

Files on the USB flash drive are played in their stored order. This order may be different from the order displayed on your PC or device.

The HomeLink® Universal Transceiver can be programmed to operate up to three remote controlled devices around your home, such as garage doors, lighting, or home security systems.

## Important Safety Precautions

Refer to the safety information that comes with your garage door opener to test that the safety features are functioning properly. If you do not have the safety information, contact the manufacturer.

Before programming HomeLink, make sure that people and objects are out of the way of the garage or gate to prevent potential injury or damage.

When programming a garage door opener, park just outside the garage door's path.

## Training HomeLink

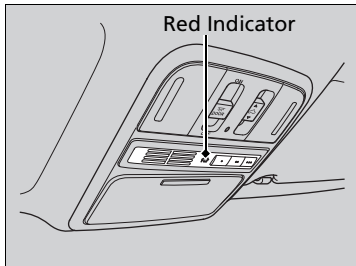

If you have not trained any of the buttons in HomeLink before, you should erase any previously learned codes. To do this:

- Press and hold the two outside buttons for about 20 seconds, until the red indicator blinks. Release the buttons, and proceed to step 1.
- If you are training the second or third button, go directly to step 1.

### HomeLink® Universal Transceiver\*

HomeLink® is a registered trademark of Johnson Controls., Inc.

Before programming HomeLink to operate a garage door opener, confirm that the opener has an external entrapment protection system, such as an "electronic eye," or other safety and reverse stop features. If it does not, HomeLink may not be able to operate it.

## Training a Button

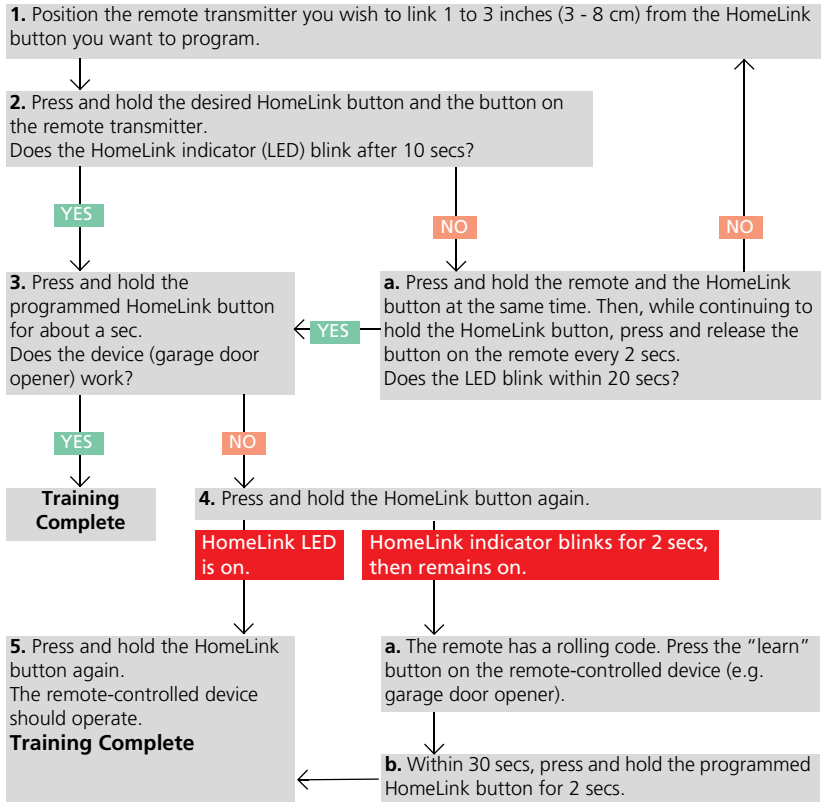

## Training a Button

### Retraining a Button

If you want to retrain a programmed button for a new device, you do not have to erase all button memory. You can replace the existing memory code using this procedure.

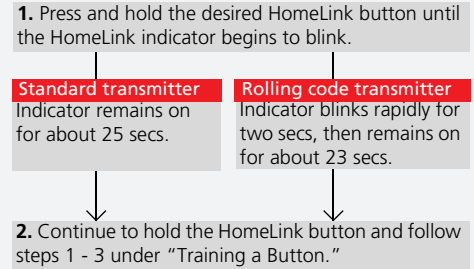

### Erasing Codes

To erase all the codes, press and hold the two outside buttons until the HomeLink indicator begins to blink (about 10 to 20 secs). You should erase all codes before selling the vehicle.

If you have any problems, see the device's instructions, visit [www.homelink.com](http://www.homelink.com), or call HomeLink at (800) 355-3515.

## Models without navigation system

Bluetooth® HandsFreeLink® (HFL) allows you to place and receive phone calls using your vehicle's audio system, without handling your cell phone.

## Using HFL

### HFL Buttons

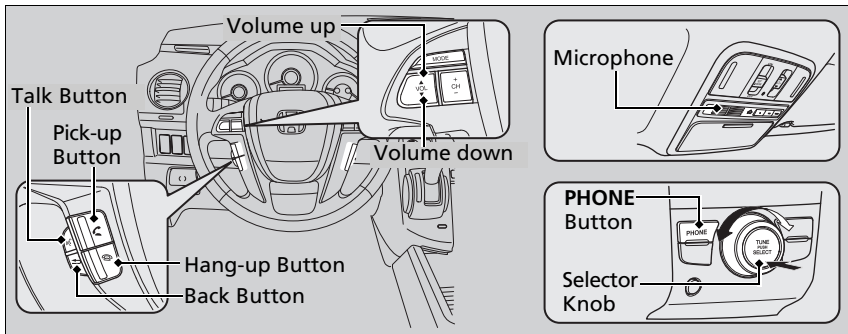

**(Pick-up) button:** Press to go directly to the **Phone** screen or to answer an incoming call.

**(Hang-up) button:** Press to end a call.

**(Talk) button:** Press to call a number with a stored voice tag.

**(Back) button:** Press to cancel a command.

**PHONE button:** Press to go directly to the **Phone** screen.

**Selector knob:** Rotate to select an item on the screen, then press.

### Bluetooth® HandsFreeLink®

To use HFL, you need a *Bluetooth*-compatible cell phone. For a list of compatible phones, pairing procedures, and special feature capabilities:

- **U.S.:** Visit [www.handsfreelink.honda.com](http://www.handsfreelink.honda.com), or call 1-888-528-7876.
- **Canada:** Visit [www.handsfreelink.ca](http://www.handsfreelink.ca), or call 1-888-528-7876.

### Voice control tips

- Aim the vents away from the ceiling and close the windows, as noise coming from them may interfere with the microphone.
- Press and release the  button when you want to call a number using a stored voice tag. Speak clearly and naturally after a beep.
- If the microphone picks up voices other than yours, the command may be misinterpreted.
- To change the volume level, use the audio system's volume knob or the remote audio controls on the steering wheel.

State or local laws may prohibit the operation of handheld electronic devices while operating a vehicle.

## HFL Status Display

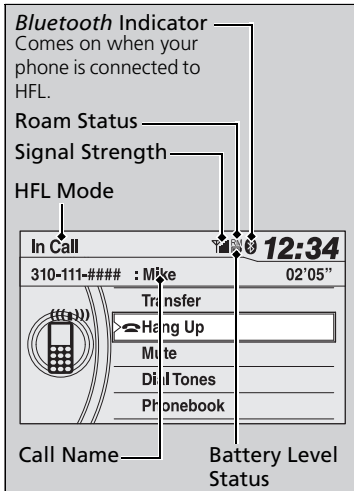

The display shows call status and phone information.

### Bluetooth® HandsFreeLink®

#### Bluetooth® Wireless Technology

The *Bluetooth*® word mark and logos are registered trademarks owned by *Bluetooth* SIG, Inc., and any use of such marks by Honda Motors Co., Ltd., is under license. Other trademarks and trade names are those of their respective owners.

#### HFL Limitations

An incoming call on HFL will interrupt the audio system when it is playing. It will resume when the call is ended.

### HFL Status Display

The information that appears on the display varies between phone models.

You can change the system language to English, French, or Spanish.

▶ [Customized Features P. 90](#)



# HFL Menu

The ignition switch must be in ACCESSORY **I** or ON **II** to use HFL.

PHONE or 

▶▶ HFL Menu  
To use HFL, you must first pair your *Bluetooth*-compatible cell phone to the system while the vehicle is parked.

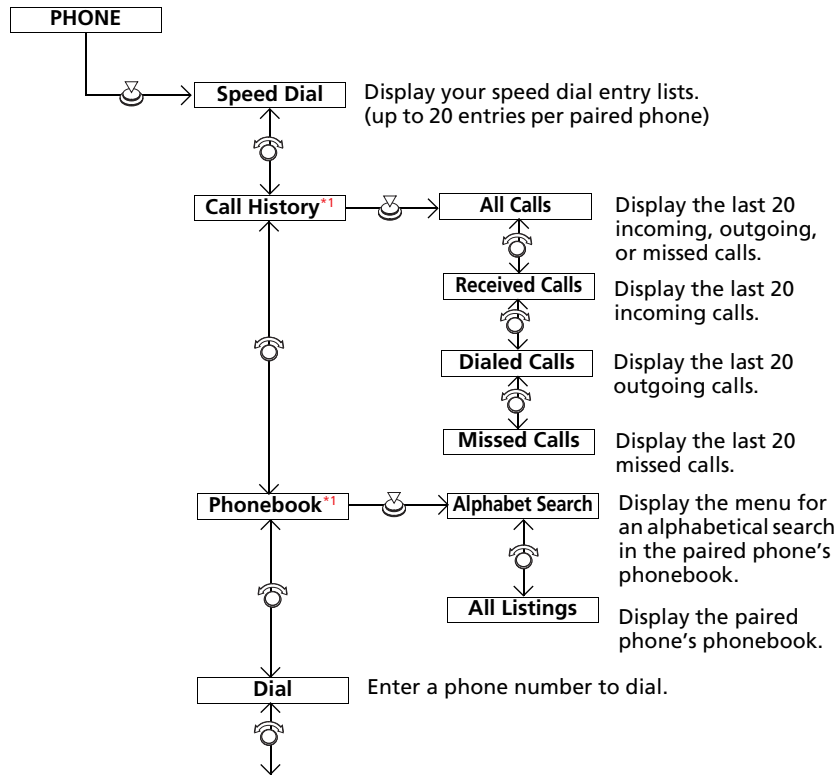

\*1: Appears only when a phone is connected to HFL.

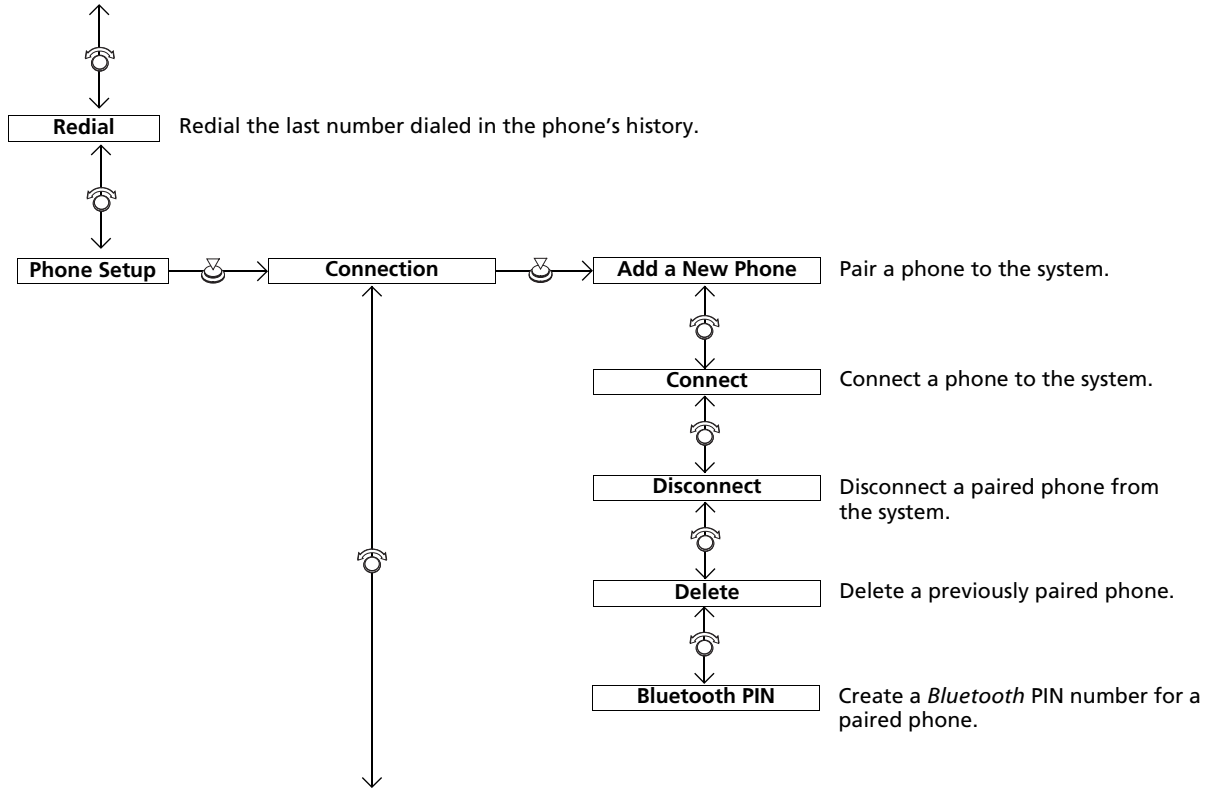

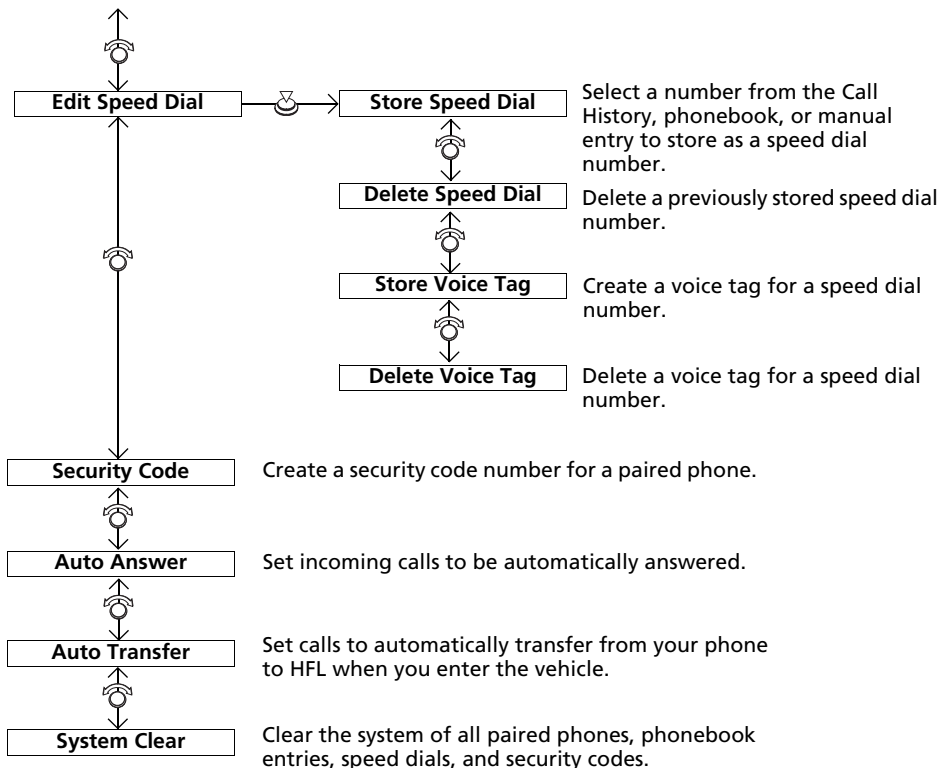

## Phone Setup

### To pair a cell phone (when there is no phone paired to the system)

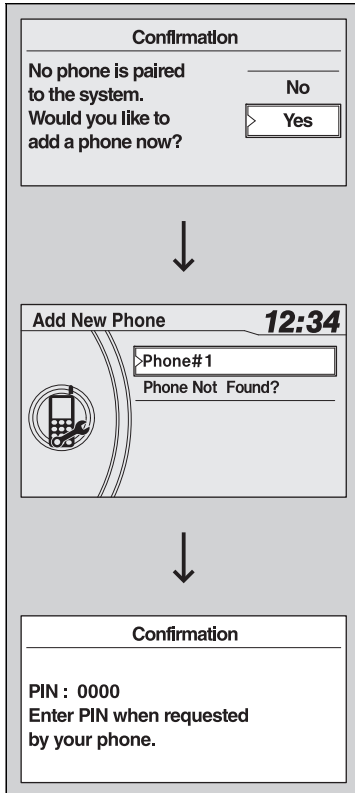

1. Press the **PHONE** button or the button.
2. Rotate to select **Yes**, then press .
3. Make sure your phone is in search or discoverable mode, then press .
  - ▶ HFL automatically searches for a *Bluetooth* device.
4. When your phone appears on the list, select it by pressing .
  - ▶ If your phone doesn't appear, select **Phone Not Found?** and search for *Bluetooth* devices using your phone. From your phone, select **HandsFreeLink**.
5. HFL gives you a four-digit pairing code to input on your phone. When your phone prompts you, input the four-digit pairing code.
6. You will receive a notification on the screen if pairing is successful.

### Phone Setup

Your *Bluetooth*-compatible phone must be paired to HFL before you can make and receive hands-free calls.







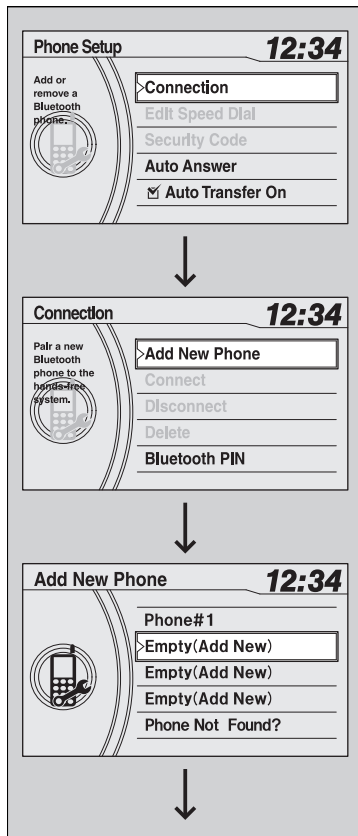

#### Phone Pairing Tips:

- You cannot pair your phone while the vehicle is moving.
- Up to six phones can be paired.
- Your phone's battery may drain faster when it is paired to HFL.
- If your phone is not ready for pairing or not found by the system within three minutes, the system will time out and returns to idle.

Continued

■ To pair a cell phone (when a phone has already been paired to the system)



1. Press the **PHONE** button or the  button.
2. Rotate  to select **Phone Setup**, then press .
3. Rotate  to select **Connection**, then press .
4. Rotate  to select **Add New Phone**, then press .
5. Rotate  to select **Empty (Add New)**, then press .

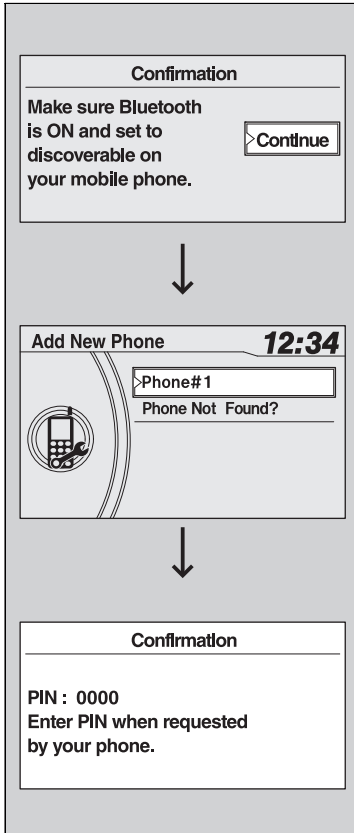

6. Make sure your phone is in search or discoverable mode, then press .
  - ▶ HFL automatically searches for a *Bluetooth* device.
  
7. When your phone appears on the list, select it by pressing .
  - ▶ If your phone doesn't appear, select **Phone Not Found?** and search for *Bluetooth* devices using your phone. From your phone, select **HandsFreeLink**.
  
8. HFL gives you a four-digit pairing code to input on your phone. When your phone prompts you, input the four-digit pairing code.
  
9. You will receive a notification on the screen if pairing is successful.

■ To change the *Bluetooth* PIN setting

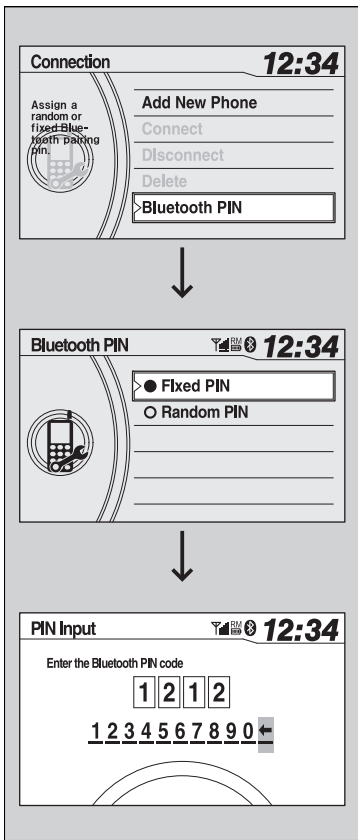

1. Press the **PHONE** button or the button.
  - ▶ Rotate to select **Phone Setup**, then press .
2. Rotate to select **Connection**, then press .
3. Rotate to select *Bluetooth* **PIN**, then press .
4. Rotate to select **Fixed PIN** or **Random PIN**, then press .
5. If you select **Fixed PIN**, enter a new *Bluetooth* PIN.
  - ▶ Rotate to select, then press .
  - Rotate to select , then press to delete.

▶▶ To change the *Bluetooth* PIN setting





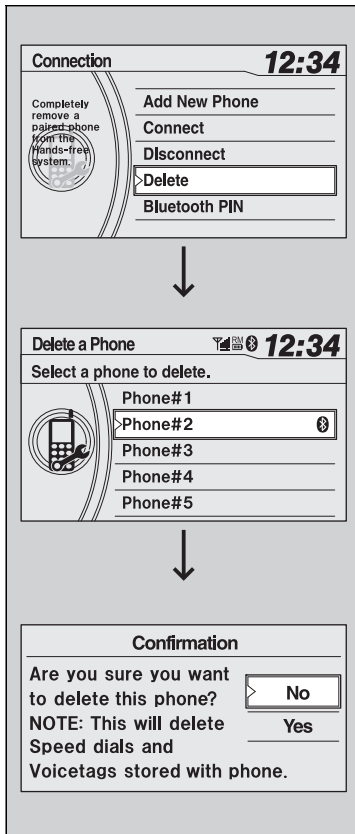

The default pairing code is **0000** until you change the setting.

To create your own, select **Fixed**, and delete the current code, then enter a new one.

For a randomly generated pairing code each time you pair a phone, select **Random**.

■ To delete a paired phone



1. Press the **PHONE** button or the  button.
2. Rotate  to select **Phone Setup**, then press .
  - ▶ Repeat the procedure to select **Connection**, then **Delete**.
3. Rotate  to select a phone you want to delete, then press .
  - ▶ The *Bluetooth* icon indicates the currently linked phone.
4. You will receive a confirmation message on the screen. Rotate  to select **Yes**, then press .
  - ▶ You will receive a notification on the screen if it is successful.



## ■ To Create a Security Code

You can protect each of the six cell phones with a security PIN.

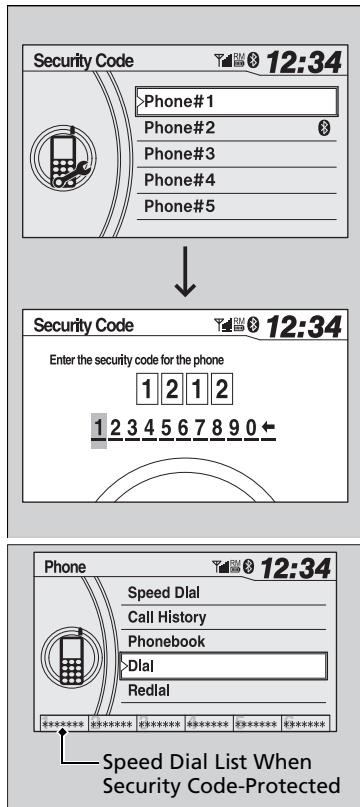

1. Press the **PHONE** button or the button.
2. Rotate to select **Phone Setup**, then press .
  - ▶ Repeat the procedure to select **Security Code**.
3. Select a phone you want to add a security code to.
  - ▶ Rotate to select a phone you want to add a security code to, then press .
4. Enter a new four-digit number.
  - ▶ Rotate to select, then press .
  - Rotate to select , then press to delete.

If the phone name you selected is security code protected the speed dial list becomes  
\*\*\*\*\*.





## ▶▶ To Create a Security Code

In the phone is already security code protected, you need to enter the current security code before clearing the code or creating a new one.

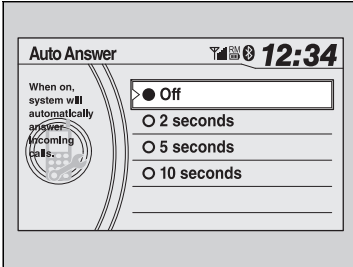
## Automatic Answering

You can choose when the HFL system automatically answers incoming calls.





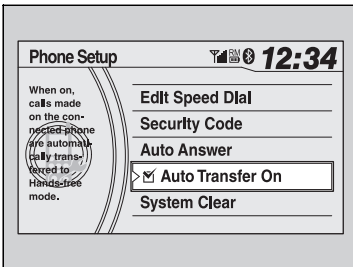

1. Press the **PHONE** button or the  button.
2. Rotate  to select **Phone Setup**, then press .
  - ▶ Repeat the procedure to select **Auto Answer**.
3. Rotate  to select a mode you want, then press .

## Automatic Transferring

If you get into the vehicle while you are on the phone, the call can be automatically transferred to **HFL**.





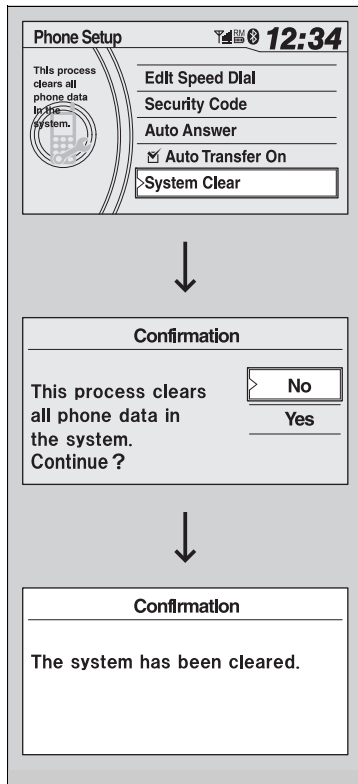

1. Press the **PHONE** button or the  button.
2. Rotate  to select **Phone Setup**, then press .
  - ▶ Repeat the procedure to select **Auto Transfer**.
3. Press  to select On or Off.
  - ▶ The check box is checked when **Auto Transfer On** is selected. Select **Auto Transfer On** again to turn it off.

## ■ To Clear the System

Security codes, paired phones, all stored voice tags, all speed dial entries, and all imported phonebook data are erased.



1. Press the **PHONE** button or the  button.
2. Rotate  to select **Phone Setup**, then press .
  - ▶ Repeat the procedure to select **System Clear**.
3. You will receive a notification message on the screen. Rotate  to select **Yes**, then press .
4. You will receive a confirmation message on the screen.

## Automatic Import of Cellular Phonebook and Call History

When your phone is paired, the contents of its phonebook and call history are automatically imported to HFL.

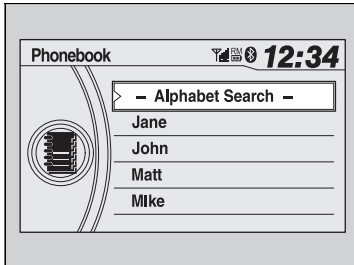

### Automatic Import of Cellular Phonebook and Call History

When you select a person from the list in the cellular phonebook, you can see up to three category icons. The icons indicate what types of numbers are stored for that name.

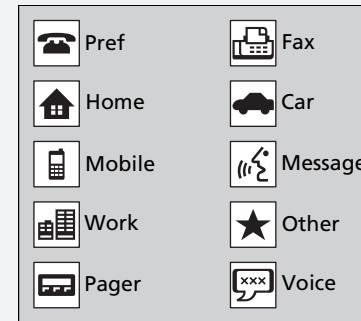

If a name has four or more numbers, ... appears instead of category icons.

On some phones, it may not be possible to import the category icons to HFL.

The phonebook is updated after every connection. Call history is updated after every connection or call.

## ■ Speed Dial

Up to 20 speed dial numbers can be stored per phone.

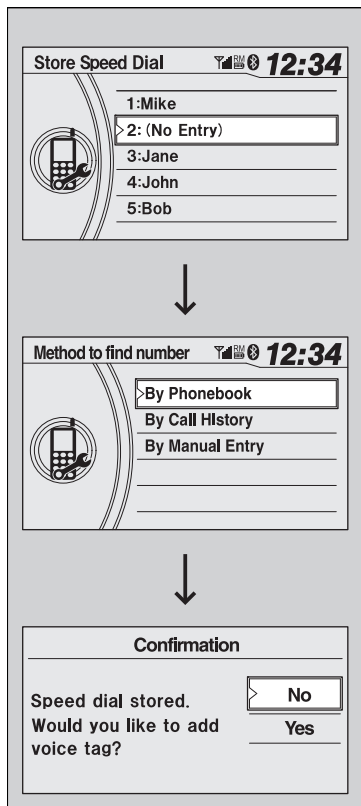

To store a speed dial number:

1. Press the **PHONE** button or the button.
2. Rotate to select **Phone Setup**, then press .
  - ▶ Repeat the procedure to select **Edit Speed Dial**, then **Store Speed Dial**.
3. Rotate to select **No Entry**, then press .
4. Rotate to select a place to choose a number from, then press .
  - By Phonebook:
    - ▶ Select a number from the linked cell phone's imported phonebook.
  - By Call History:
    - ▶ Select a number from the call history.
  - By Manual Entry:
    - ▶ Input the number manually.
5. When the speed dial is successfully stored, you are asked to create a voice tag for the number. Rotate to select **Yes** or **No**, then press .
6. Using the button, follow the prompts to say the name for the speed dial entry.

■ To add a voice tag to a stored speed dial number

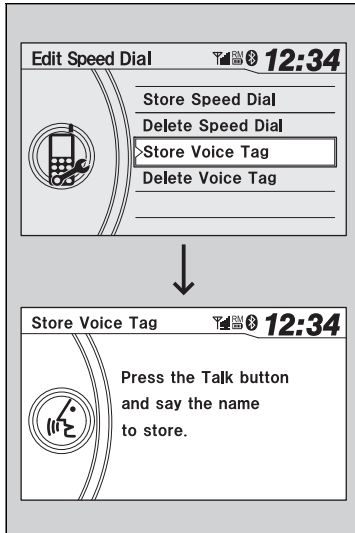





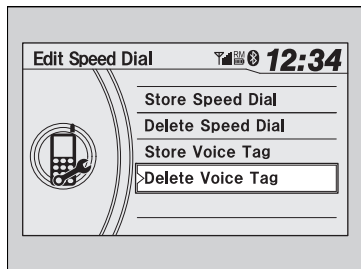

1. Press the **PHONE** button or the button.
2. Rotate to select **Phone Setup**, then press .
- ▶ Repeat the procedure to select **Edit Speed Dial**.
3. Select an existing speed dial entry.
4. Rotate to select **Store Voice Tag**, then press .
5. Using the button, follow the prompts to complete the voice tag.

☒ Speed Dial

Avoid using duplicate voice tags.  
 Avoid using "home" as a voice tag.  
 It is easier for HFL to recognize a longer name. For example, use "John Smith" instead of "John."





■ To delete a voice tag

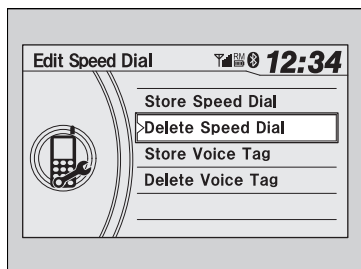

1. Press the **PHONE** button or the  button.
2. Rotate  to select **Phone Setup**, then press .
  - ▶ Repeat the procedure to select **Edit Speed Dial**.
3. Select an existing speed dial entry.
4. Rotate  to select **Delete Voice Tag**, then press .
5. You will receive a confirmation message on the screen.

■ To delete a speed dial number



1. Press the **PHONE** button or the  button.
2. Rotate  to select **Phone Setup**, then press .
  - ▶ Repeat the procedure to select **Edit Speed Dial**.
3. Select an existing speed dial entry.
4. Rotate  to select **Delete Speed Dial**, then press .
5. You will receive a confirmation message on the screen.

## ■ Making a Call

You can make calls by inputting any phone number, or by using the imported phonebook, call history, speed dial entries, or redial.

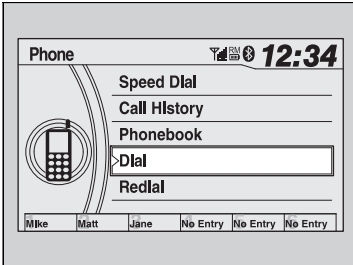

## ☒ Making a Call

Any voice-tagged speed dial entry can be dialed by voice from any screen.

Press the  button and follow the prompts.

The maximum range between your phone and vehicles is 30 feet (10 meters).







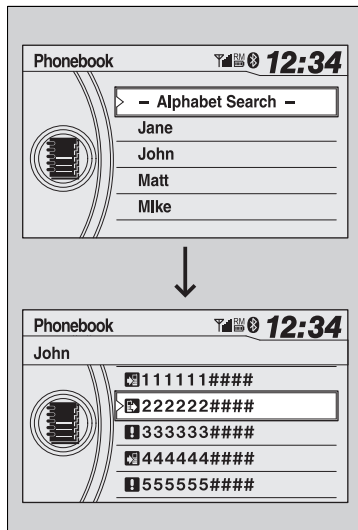

Once a call is connected, you can hear the voice of the person you are calling through the audio speakers.



## ■ To make a call using the imported phonebook







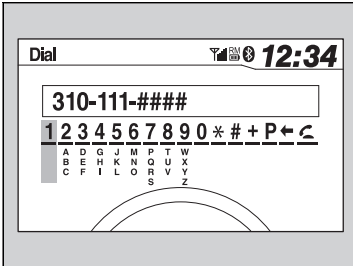

When your phone is paired, the contents of its phonebook are automatically imported to HFL.



1. Press the **PHONE** button or the  button.
2. Rotate  to select **Phonebook**, then press .
3. The phonebook is stored alphabetically. Rotate  to select the initial, then press .
4. Rotate  to select a name, then press .
5. Rotate  to select a number, then press .
  - ▶ Dialing starts automatically.



■ To make a call using a phone number

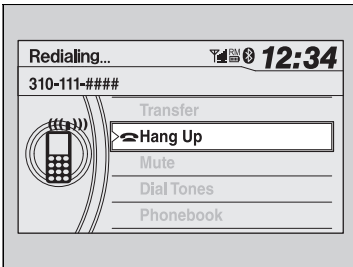

1. Press the **PHONE** button or the  button.
2. Rotate  to select **Dial**, then press .
3. Rotate  to select a number, then press .
4. Rotate  to select , then press .
  - ▶ Dialing starts automatically.

■ To make a call using redial



1. Press the **PHONE** button or the  button.
2. Rotate  to select **Redial**, then press .
  - ▶ Dialing starts automatically.

☒ To make a call using redial

Press and hold the  button to redial the last number dialed in your phone's history.

### ■ To make a call using the call history

Call history is stored by **All Calls**, **Dialed Calls**, **Received Calls**, and **Missed Calls**.

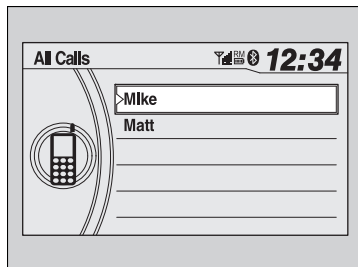

1. Press the **PHONE** button or the button.
2. Rotate to select **Call History**, then press .
3. Rotate to select **All Calls**, **Dialed Calls**, **Received Calls**, or **Missed Calls**, then press .
4. Rotate to select a number, then press .
  - ▶ Dialing starts automatically.

### ■ To make a call using a speed dial entry

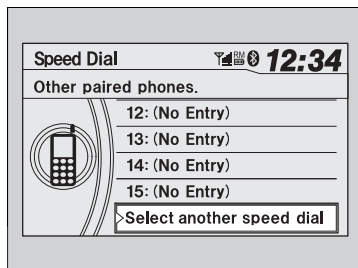

1. Press the **PHONE** button or the button.
2. Rotate to select **Speed Dial**, then press .
3. Rotate to select a number, then press .
  - ▶ Dialing starts automatically.

### ▶▶ To make a call using the call history

The call history displays the last 20 dialed, received, or missed calls.

(Appears only when a phone is connected to HFL.)

Some phones do not support **All Calls**.

### ▶▶ To make a call using a speed dial entry

On the **Phone** screen, the first six speed dials on the list can be directly selected by pressing the corresponding audio preset buttons (1-6).

Select **Select another speed dial** to view another paired phone's speed dial list. You can make a call from that list using the currently connected phone.

Any voice-tagged speed dial entry can be dialed by voice from any screen.

Press the button and follow the prompts.

## Receiving a Call

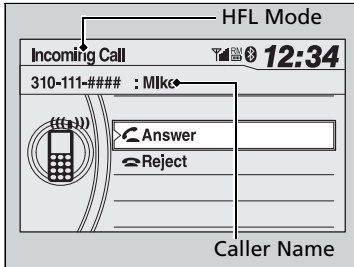

When there is an incoming call, an audible notification sounds (if activated) and the Incoming Call screen appears.

Press the  button to answer the call.

Press the  button to decline or end the call.

### Receiving a Call

#### Call Waiting.

Press the  button to put the current call on hold to answer the incoming call.

Press the  button again to return to the current call.

Ignore the incoming call if you do not want to answer it.

Press the  button if you want to hang up the current call.

## Options During a Call



The following options are available during a call.

**Mute:** Mute your voice.

**Transfer:** Transfer a call from HFL to your phone.

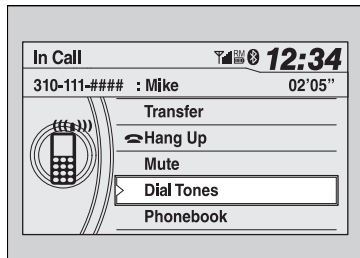
**Dial Tones:** Send numbers during a call. This is useful when you call an automated phone system.



1. To view the available options, press the **PHONE** button.
2. Rotate  to select the option, then press .

## Options During a Call

**Dial Tones:** Available on some phones.

## Models with navigation system

Bluetooth® HandsFreeLink® (HFL) allows you to place and receive phone calls using your vehicle's audio system, without handling your cell phone.

## Using HFL

### HFL Buttons

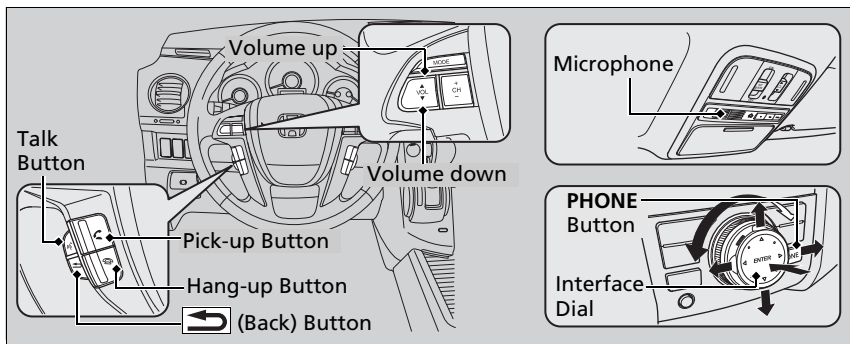

 **(Pick-up) button:** Press to go directly to the **Phone** screen or to answer an incoming call.

 **(Hang-up) button:** Press to end a call.

 **(Talk) button:** Press to call a number with a stored voice tag.

**PHONE button:** Press to go directly to the **Phone** screen.

 **(Back) button:** Press to cancel a command.

**Interface dial:** Rotate  or move to select an item on the screen, then press .

### Bluetooth® HandsFreeLink®

To use HFL, you need a *Bluetooth*-compatible cell phone. For a list of compatible phones, pairing procedures, and special feature capabilities:

- **U.S.:** Visit [www.handsfreelink.honda.com](http://www.handsfreelink.honda.com), or call 1-888-528-7876.
- **Canada:** Visit [www.handsfreelink.ca](http://www.handsfreelink.ca), or call 1-888-528-7876.

### Voice control tips

- Aim the vents away from the ceiling and close the windows, as noise coming from them may interfere with the microphone.
- Press and release the  button when you want to call a number using a stored voice tag. Speak clearly and naturally after a beep.
- If the microphone picks up voices other than yours, the command may be misinterpreted.
- To change the volume level, use the audio system's volume knob or the remote audio controls on the steering wheel.

State or local laws may prohibit the operation of handheld electronic devices while operating a vehicle.

## HFL Status Display

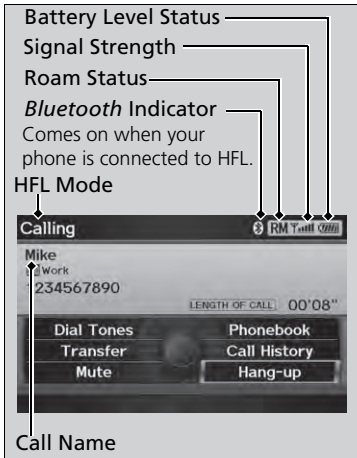

The display shows call status and phone information.

## Bluetooth® HandsFreeLink®

### Bluetooth® Wireless Technology

The *Bluetooth®* word mark and logos are registered trademarks owned by *Bluetooth* SIG, Inc., and any use of such marks by Honda Motors Co., Ltd., is under license. Other trademarks and trade names are those of their respective owners.

### HFL Limitations

An incoming call on HFL will interrupt the audio system when it is playing. It will resume when the call is ended.

### HFL Status Display

The information that appears on the display varies between phone models.

You can change the system language to English, French, or Spanish.

[▶ Customized Features P. 90](#)

# HFL Menus

The ignition switch must be in ACCESSORY **I** or ON **II** to use HFL.

You can operate HFL by voice when on the **PHONE** screen. Below is the flow chart showing available voice commands.

## HFL Menus

To use HFL, you must first pair your *Bluetooth*-compatible cell phone to the system while the vehicle is parked.

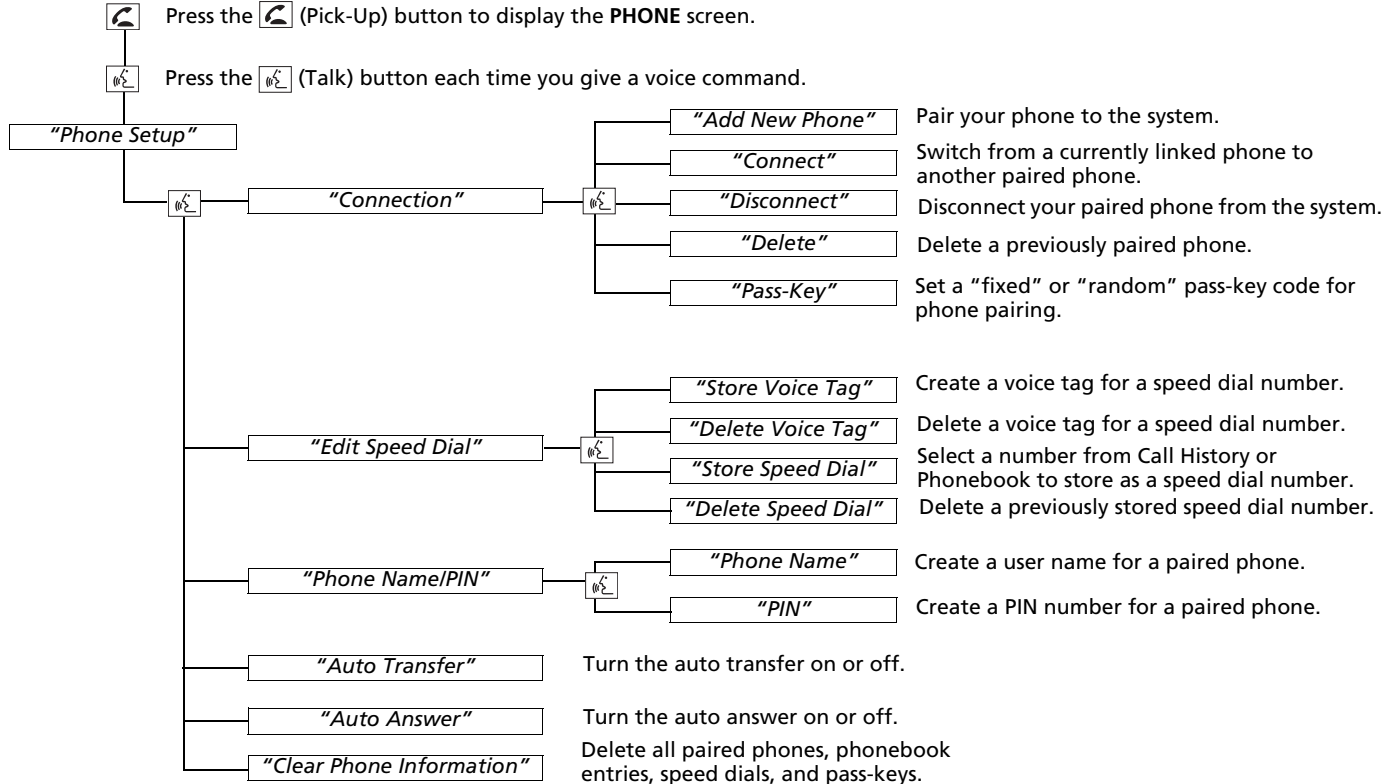

Continued



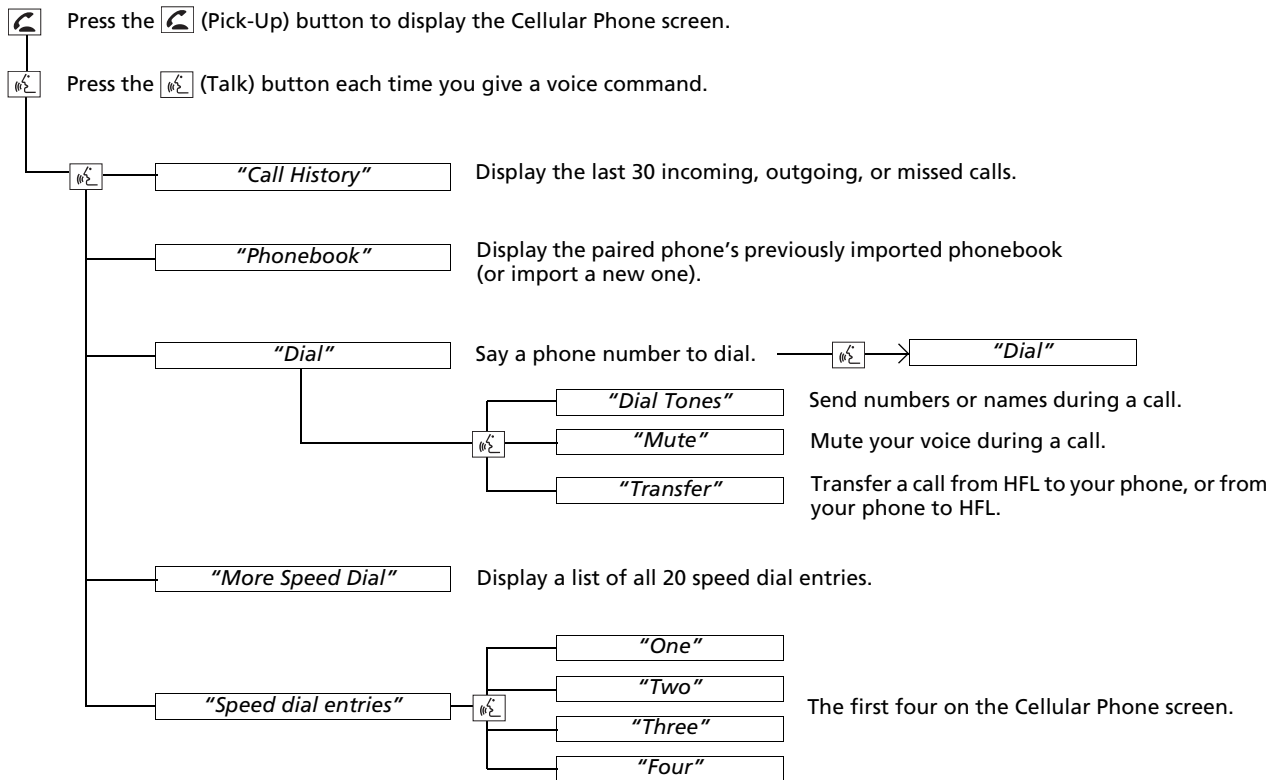

## Phone Setup

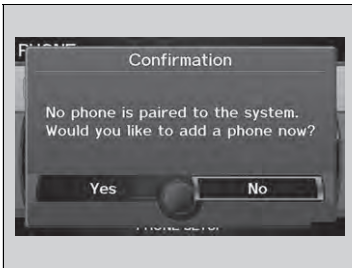

### ■ To pair a cell phone (when there is no phone paired to the system)

1. Press the **PHONE** button or the button.
2. Rotate to select **Yes**. Press .
3. Put your cell phone in **Discovery** or **Search** mode.
4. Select **OK**.
5. Select your phone in the list.
  - ▶ Select **Phone Not Found?** if your phone is not found.
  - ▶ Refer to your phone manual for instructions on searching for a *Bluetooth®* device.
6. Enter the 4-digit pairing code on your phone when prompted to complete the pairing process.

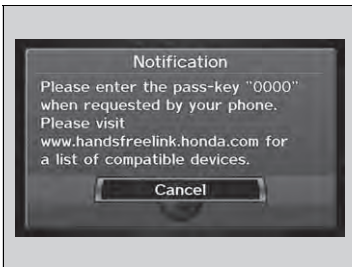

## ☒ Phone Setup

Your *Bluetooth*-compatible phone must be paired to HFL before you can make and receive hands-free calls.

You can control the HFL system using voice commands.

[▶ HFL Menus P. 303](#)

The maximum range between your phone and vehicle is about 30 feet (10 meters).

### Phone Pairing Tips

- You cannot pair your phone while the vehicle is moving.
- Your phone must be in discovery or search mode when pairing the phone. Refer to your phone's manual.
- Up to six phones can be paired.
- Your phone's battery may drain faster when it is paired to HFL.
- If your phone is not ready for pairing or not found by the system within three minutes, the system will time out and returns to idle.
- The default pass-key "0000" is used until you change the setting.

### Pass-Key





You can change the pass-key setting.

[▶ To change the Pass-key setting P. 307](#)



You can delete the paired phone.

[▶ To delete a paired phone P. 308](#)

**■ To pair a cell phone (when a phone has already been paired to the system)**

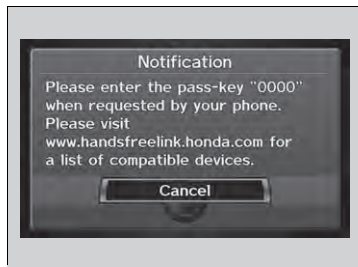
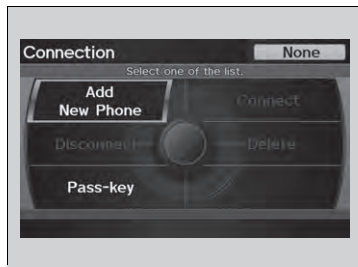
1. Press the **PHONE** button or the  button.
2. Move  to select **PHONE SETUP**.
3. Rotate  to select **Connection**, then press .











4. Rotate  to select **Add New Phone**, press .
5. Select the location (1-6) for the phone to be added.
6. Put your cell phone in **Discovery** or **Search** mode.
7. Select **OK**.
  - ▶ The system begins to search for your phone.
8. Select your phone in the list.
  - ▶ Select **Phone Not Found?** if your phone is not found.
  - ▶ Refer to your phone manual for instructions on searching for a *Bluetooth®* device.
9. Enter the 4-digit pairing code on your phone when prompted to complete the pairing process.

▶▶ To pair a cell phone (when a phone has already been paired to the system)

If a prompt appears asking to connect to a phone, select **No** and proceed with step 1.

## ■ To change the Pass-key setting

1. Press the **PHONE** button or the  button.
2. Move  to select **PHONE SETUP**.
3. Rotate  to select **Connection**, then press .
4. Rotate  to select **Pass-Key**. Press .
5. Rotate  to select an item. Press .

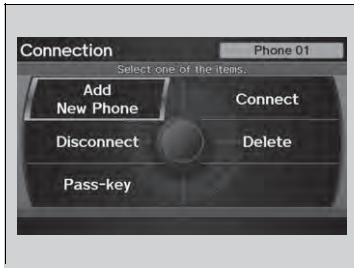

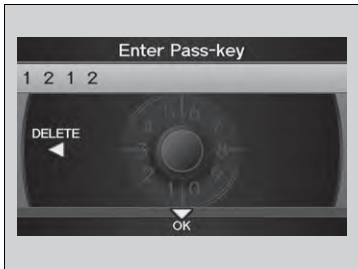

The following items are available:

- **Random:** Uses a randomly generated pass-key.
- **Fixed:** Create your own pass-key.



- 6. If you select **Fixed**, move ◀ to select **DELETE** to remove the current pass-key.
- 7. Enter a new pass-key. Move ⏴ to select **OK**

■ To delete a paired phone

- 1. Press the **PHONE** button or the  button.
- 2. Move ⏴ to select **PHONE SETUP**.
- 3. Rotate ⏴ to select a **Connection**, then press .

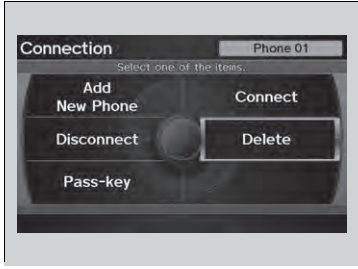

- 4. Rotate ⏴ to select **Delete**.

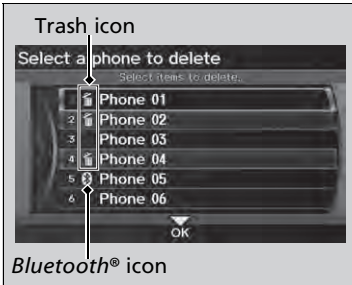

5. Rotate to select a phone to delete. press .
  - ▶ The *Bluetooth*® icon indicates the currently linked phone.
  - ▶ Items to be deleted are indicated with a trash icon.
6. Move to select **OK**.
7. Rotate to select **Yes**. Press to delete the device(s).

### ■ To change the currently paired phone

1. Press the **PHONE** button or the button.
2. Move to select **PHONE SETUP**.
3. Rotate to select **Connection**, then press .

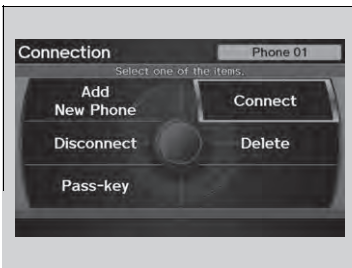







4. Rotate to select **Connect**. Press .
5. Rotate to select a phone. Press .
  - ▶ HFL disconnects the linked phone and starts searching for another paired phone. If no other paired phone is found, HFL automatically links the previous phone.
6. Press to select **OK**.

### ▶ To change the currently paired phone

If no other phones are found or paired when trying to switch to another phone, HFL will inform you that the original phone is linked again.

## ■ To Create Phone Name/PIN

1. Press the **PHONE** button or the  button.
2. Move  to select **PHONE SETUP**.
3. Rotate  to select **Phone Name/PIN**, then press .
4. Rotate  to select an item. Press .



The following items are available:

- **Phone Name:** Enter a name.
- **PIN:** Enter a 4-digit PIN. Re-enter to confirm. You can select **DO NOT USE PIN** to remove a PIN number.

## ▶▶ To Create Phone Name/PIN

You can control the HFL system using voice commands.

 [HFL Menus P. 303](#)







You can name up to six HFL users. Each can be PIN protected, and have their own phonebook, speed dial entries, and call history.



PIN-protected speed dial







## Automatic Transferring

If you get into the vehicle while you are on the phone, the call can be automatically transferred to HFL.

1. Press the **PHONE** button or the  button.
2. Move  to select **PHONE SETUP**.
3. Rotate  to select **Auto Transfer**, then press .
4. Rotate  to select **On**, then press .

## Automatic Answering











You can choose when the HFL system automatically answers incoming calls.

1. Press the **PHONE** button or the  button.
2. Move  to select **PHONE SETUP**.
3. Rotate  to select **Auto Answer**, then press .
4. Rotate  to select a mode you want press .



## ■ To Clear the System

All paired phones, phonebook entries, speed dials, and pass-keys are erased.

1. Press the **PHONE** button or the  button.
2. Move  to select **PHONE SETUP**.
3. Rotate  to select **Clear Phone Information**, then press .
  - ▶ If more than one phone is paired to the system, select the phone you want to clear. The *Bluetooth* icon indicates the currently linked phone. Move  to select **OK**.
4. Rotate  to select **Yes**, then press .
5. You will receive a notification message on the screen. Rotate  to select **Yes'** then press .
6. You will receive a notification message on the screen. Rotate  to finish.

## ■ Automatic Import of Cellular Phonebook and Call History

When your phone is paired, the contents of its phonebook and call history are automatically imported to HFL.

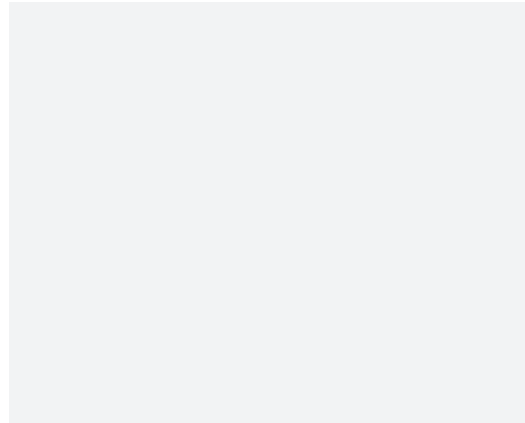

### ▶ Automatic Import of Cellular Phonebook and Call History



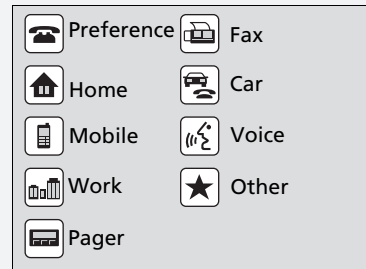







Up to 10,000 numbers for 1,000 names can be imported. Up to three icons are displayed for each phonebook entry. If there are more than three numbers for an entry, "... " is displayed.



This feature is not available on all phones.

## Speed Dial

To store a speed dial number:

1. Press the **PHONE** button or the  button.
2. Move  to select **PHONE SETUP**.
3. Rotate  to select **Edit Speed Dial**, then press .
4. Rotate  to select **Store Speed Dial**, then press .
5. Rotate  to select a location in the speed dial list. Press .
6. Rotate  to select a number entry method. Press .
7. Follow the prompt to enter a voice tag.

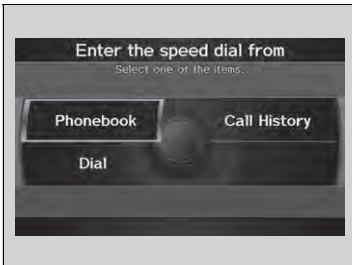
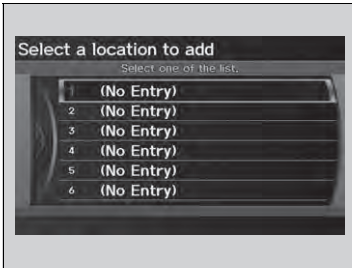

The following options are available:

- **Phonebook:** Adds a number from the imported phonebook.
- **Call History:** Adds a number from the last 30 numbers.
- **Dial:** Enters a number manually.

### Speed Dial

You can control the HFL system using voice commands.



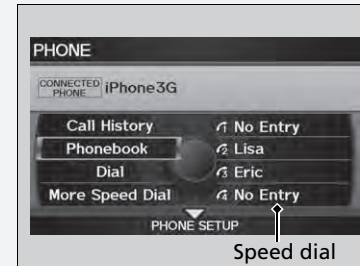

[▶ HFL Menus P. 303](#)

Up to 20 speed dial entries can be stored per user. The first four entries are displayed on the Cellular Phone screen.





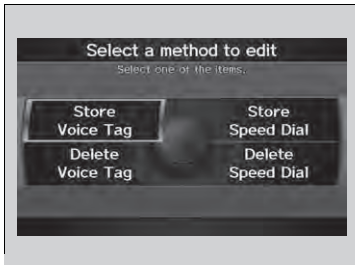

You can select a **No Entry** field directly from the Cellular Phone screen to store a speed dial number.

■ **To add a voice tag to a stored speed dial number**

1. Press the **PHONE** button or the  button.
2. Move  to select **PHONE SETUP**.
3. Rotate  to select **Edit Speed Dial**, then press .





4. Rotate  to select **Store Voice Tag**, press .
5. Rotate  to select a speed dial entry, press .











6. Follow the prompt to enter a voice tag.

▶▶ To add a voice tag to a stored speed dial number









Voice tags allow you to call speed dial entries from any screen by saying  "Dial by voice tag" and the voice tag followed by  "Dial".

- Avoid using duplicate voice tags.
- Avoid using "Home" as a voice tag.
- It is easier for HFL to recognize a longer name (e.g., "John Smith" instead of "John").

**■ To delete a voice tag**

1. Press the **PHONE** button or the  button.
2. Move  to select **PHONE SETUP**.
3. Rotate  to select **Edit Speed Dial**, then press .
4. Rotate  to select **Delete Voice Tag**. Press .
5. Rotate  to select the number you want to delete the voice tag for. Move  to select **OK**.

**■ To delete a speed dial number**

1. Press the **PHONE** button or the  button.
2. Move  to select **PHONE SETUP**.
3. Rotate  to select **Edit Speed Dial**, then press .
4. Rotate  to select **Delete Speed Dial**. Press .
5. Rotate  to select the entry you want to delete. Move  to select **OK**.



## ■ Making a Call

You can make calls by inputting any phone number, or by using the imported phonebook, call history, or speed dial entries.



### » Making a Call

You can control the HFL system using voice commands.

▶ [HFL Menus P. 303](#)

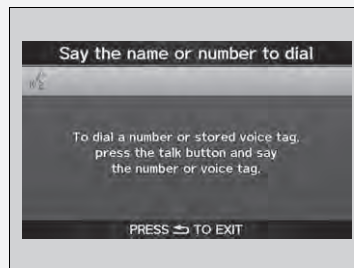
When you say  "Dial by number" or  "Dial by voice tag" on most screens, the following screen appears:





Say the phone number or the voice tag (e.g.,  "John Smith"), followed by  "Dial".

▶ [To add a voice tag to a stored speed dial number P. 314](#)







Only one phone can be used with HFL at a time. When there are more than two paired phones in the vehicle, a first paired phone the system finds will be automatically linked.

### ■ To make a call using the imported phonebook



When your phone is paired, the contents of its phonebook are automatically imported to HFL.

1. Press the **PHONE** button or the  button.
2. Rotate  to select **Phonebook**, then press .



3. Rotate  to select a name. Press .
  - ▶ Move  or  to select alphabetical tabs to display the entries in the group.
4. Rotate  to select a number. Press  to begin dialing.

### ■ To make a call using a phone number

1. Press the **PHONE** button or the  button.
2. Rotate  to select **Dial**, then press .



3. Enter a phone number.
4. Move  to select **DIAL** to begin dialing.

#### ☒ To make a call using the imported phonebook

You must first import a phonebook before using it to make calls.



[▶ Automatic Import of Cellular Phonebook and Call History P. 312](#)

#### ☒ To make a call using a phone number





A command that consists of several words can be spoken together. For example, say  “123-456-7890” at once.

### ■ To make a call using the call history

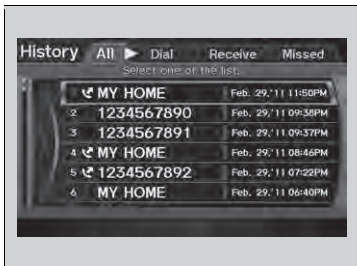

Call history is stored by **All**, **Dial**, **Receive**, and **Missed**.

1. Press the **PHONE** button or the  button.
2. Rotate  to select **Call History**, then press .



3. Rotate  to select a call. Press  to begin dialing.
  - ▶ Move  or  to select **All**, **Dial**, **Receive**, **Missed** to view the call history by category.

### ■ To make a call using a speed dial entry

1. Press the **PHONE** button or the  button.
2. Rotate  to select one of the four speed dial numbers. Press  to begin dialing.

### ▶▶ To make a call using the call history

The call history only shows the last 30 calls from your phone.

### ▶▶ To make a call using a speed dial entry

Select **More Speed Dial** to view another paired phone's speed dial list.

To make a call using speed dial, you need to create speed dial entries.



[▶ Speed Dial P. 313](#)

If the other phone is PIN-protected, enter the PIN when prompted. Select **OK**. PINs are optional.

[▶ To Create Phone Name/PIN P. 310](#)

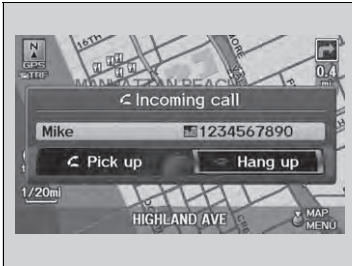
## Receiving a Call



1. Press the  (Pick-up) button to answer a call and display the Calling screen.  
▶ **HANDSFREELINK** is also displayed on the display.
2. Press the  (Hang-up) button to terminate the call.

## Options During a Call



The following options are available during a call.

**Mute:** Mute your voice.

**Transfer:** Transfer a call from HFL to your phone, or from your phone to HFL.



**Dial Tones:** Send numbers or names during a call. This is useful when you call an automated phone system.



1. To view the available options, press the **PHONE** button.
2. Rotate  to select the option, then press .

### Receiving a Call

An incoming call notification appears on the screen, and you hear an audible ring tone.

If your phone has Call Waiting, press the  button to put the original call on hold and answer the incoming call. To return to the original call, press the  button again. If you want to hang up the original call and answer the new call, press the  button.

To change the volume level of HFL, use the audio system volume knob or the steering wheel volume controls.

Some phones may send battery, signal strength, and roaming status information to the screen.

#### Phonebook

Displays the imported phonebook.

▶ [To make a call using the imported phonebook P. 317](#)

### Options During a Call

**Dial Tones:** Available on some phones.





When you turn the ignition switch to ON , the compass self-calibrates, and the compass display appears.

## Compass Calibration

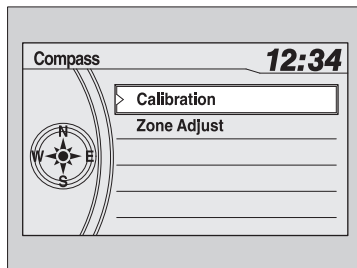
If the compass indicates the wrong direction, or the compass display blinks, you need to manually calibrate the system.



1. Turn the ignition switch to ON .
2. Press and hold the **SETUP** button until the display shows the compass setting menu list.
3. Rotate  to select **Calibration**, then press .

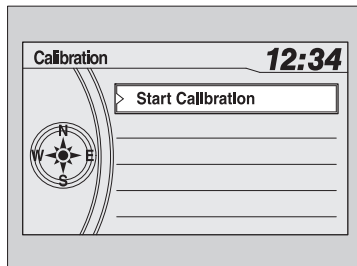

4. When the display changes to **Start Calibration**, press .
5. Drive the vehicle slowly in two circles.
  - ▶ The compass starts to show a direction after the calibration. The **CAL** indicator goes off.

### Compass\*

Compass calibration can be affected under the following conditions:

- Driving near power lines or stations
- Crossing a bridge
- Passing a large vehicle, or driving near a large object that can cause a magnetic disturbance
- When accessories such as antennas and roof racks are mounted by magnets

On some models, the Compass Calibration screen is displayed but **Calibration** and **Zone Adjust** will not respond if selected.

### Compass Calibration





Calibrate the compass in an open area.

While setting the compass:

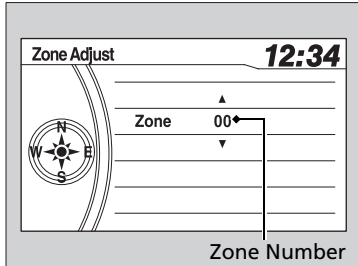
- The **RETURN** button returns to the previous screen.
- The **SETUP** button cancels the setting mode.

## Compass Zone Selection



1. Turn the ignition switch to ON .
2. Press and hold the **SETUP** button until the display shows the compass setting menu list.
3. Rotate  to select **Zone Adjust**, then press . The display shows the current zone number.
4. Rotate  to select the zone number of your area (See Zone Map), then press .

### ▶▶ Compass Zone Selection

The zone selection is done to compensate the variation between magnetic north and true north.

If the calibration starts while the audio system is in use, the display returns to normal after the calibration is completed.

### Zone Map

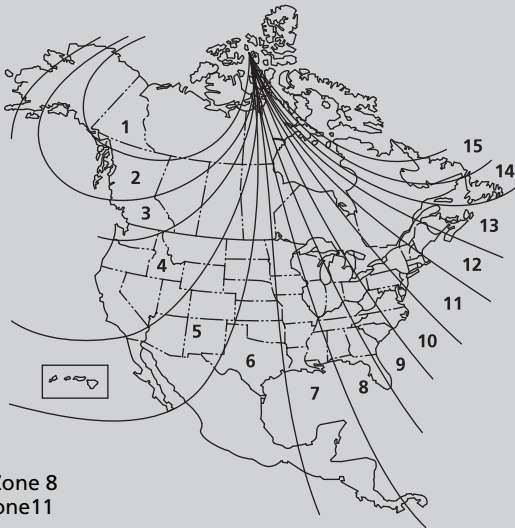

Guam Island: Zone 8  
Puerto Rico: Zone 11



# Driving

This chapter discusses driving, refueling, and information on items such as accessories.



- Before Driving**
- Driving Preparation ..... 324
- Maximum Load Limit..... 327
- Towing a Trailer**
- Towing Preparation..... 329
- Driving Safely with a Trailer..... 338
- Towing Your Vehicle..... 339
- Off-Highway Driving Guidelines**
- General Information..... 340
- Important Safety Precautions..... 340
- Avoiding Trouble ..... 341
- When Driving**
- Starting the Engine ..... 342
- Precautions While Driving..... 344

- Automatic Transmission..... 345
- Shifting..... 346
- Cruise Control ..... 348
- VSA® (Vehicle Stability Assist), aka ESC  
    (Electronic Stability Control), System ..... 352
- VTM (Variable Torque Management)-4®  
    System\* ..... 354
- TPMS (Tire Pressure Monitoring System)... 355
- Tire Pressure Monitoring System (TPMS) -  
    Required Federal Explanation ..... 357
- Braking**
- Brake System ..... 360
- ABS (Anti-lock Brake System) ..... 362

- Brake Assist System ..... 363
- Parking Your Vehicle**
- When Stopped ..... 364
- Parking Sensor System\* ..... 365
- Rearview Camera\*** ..... 369
- Multi-View Rear Camera\*** ..... 370
- Refueling**
- Fuel Information ..... 371
- How to Refuel ..... 372
- Fuel Economy**..... 374
- Accessories and Modifications**
- Accessories..... 375
- Modifications..... 375

\* Not available on all models

## Driving Preparation

Check the following items before you start driving.

### Exterior Checks

- Make sure there are no obstructions on the windows, door mirrors, exterior lights, or other parts of the vehicle.
  - ▶ Remove any frost, snow, or ice.
  - ▶ Remove any snow on the roof, as this can slip down and obstruct your field of vision while driving. If frozen solid, remove ice once it has softened.
  - ▶ When removing ice from around the wheels, be sure not to damage the wheel or wheel components.
- Make sure the hood is securely closed.
  - ▶ If the hood opens while driving, your front view will be blocked.
- Make sure the tires are in good condition.
  - ▶ Check air pressures, and check for damage and excessive wear.
    - ▶ [Checking and Maintaining Tires](#) P. 414
- Make sure there are no people or objects behind or around the vehicle.
  - ▶ There are blind spots from the inside.

### Exterior Checks

#### NOTICE

When doors are frozen shut, use warm water around the door edges to melt any ice. Do not try to force them open, as this can damage the rubber trim around the doors. When done, wipe dry to avoid further freezing.

Do not pour warm water into the key cylinder. You will be unable to insert key if the water freezes in the hole.

Heat from the engine and exhaust can ignite flammable materials left under the hood, causing a fire. If you've parked your vehicle for an extended period, inspect and remove any debris that may have collected, such as dried grass and leaves that have fallen or have been carried in for use as a nest by a small animal. Also check under the hood for leftover flammable materials after you or someone else has performed maintenance on your vehicle.

## Interior Checks

- Store or secure all items on board properly.
  - ▶ Carrying too much cargo, or improperly storing it, can affect your vehicle's handling, stability, stopping distance, and tires, and make it unsafe.
    - [Maximum Load Limit P. 327](#)
- Do not pile items higher than the seat height.
  - ▶ They can block your view and may be thrown forward in the event of sudden braking.
- Do not place anything in the front seat footwells. Make sure to secure the floor mat.
  - ▶ An object or unsecured floor mat can interfere with your brake and accelerator pedal operation while driving.
- If you have any animals on board, do not let them move around in the vehicle.
  - ▶ They may interfere with driving and a crash could occur.
- Securely close and lock all doors and the tailgate.
  - [Locking/Unlocking the Doors from the Inside P. 103](#)
- Adjust your seating position properly.
  - ▶ Adjust the head restraint, too.
    - [Adjusting the Seats P. 137](#)
    - [Adjusting the Head Restraints P. 141](#)
- Adjust the mirrors and steering wheel properly for your driving.
  - ▶ Adjust them while sitting in the proper driving position.
    - [Adjusting the Steering Wheel P. 134](#)
    - [Adjusting the Mirrors P. 135](#)

### Interior Checks

The headlight aim is set by the factory, and does not need to be adjusted. However, if you regularly carry heavy items in the cargo area or tow a trailer, have the aiming readjusted at a dealer or by a qualified technician.

- Be sure items placed on the floor behind the front seats cannot roll under the seats.
  - ▶ They can interfere with the driver's ability to operate the pedals, the operation of the seats, or the operation of the sensors under the seats.
- Everyone in the vehicle must fasten their seat belt.
  - ▶ [Fastening a Seat Belt P. 32](#)
- Make sure that the indicators in the instrument panel come on when you start the vehicle, and go off soon after.
  - ▶ Always have a dealer check the vehicle if a problem is indicated.
    - ▶ [Indicators P. 68](#)

## Maximum Load Limit

The maximum load for your vehicle is 1,340 lbs (608 kg).  
See Tire and Loading Information label attached to the driver's doorjamb.

Label Example

TIRE	SIZE	COLD TIRE PRESSURE	SEE OWNER'S MANUAL FOR ADDITIONAL INFORMATION
FRONT	XXXX/XXXXX XXX	XXXKPA, XXPSI	
REAR	XXXX/XXXXX XXX	XXXKPA, XXPSI	
SPARE	XXXX/XXXXX XXX	XXXKPA, XXPSI	

This figure includes the total weight of all occupants, cargo, and accessories, and the tongue load if you are towing a trailer.

Steps for Determining Correct Load Limit -

- (1)** Locate the statement “The combined weight of occupants and cargo should never exceed XXX kg or XXX lbs.” on your vehicle’s placard.
- (2)** Determine the combined weight of the driver and passengers that will be riding in your vehicle.
- (3)** Subtract the combined weight of the driver and passengers from XXX kg or XXX lbs.
- (4)** The resulting figure equals the available amount of cargo and luggage load capacity. For example, if the “XXX” amount equals 1,400 lbs. and there will be five 150 lb. passengers in your vehicle, the amount of available cargo and luggage load capacity is 650 lbs. (1,400 - 750 (5 x 150) = 650 lbs.)

Continued

### Maximum Load Limit

## ⚠ WARNING

Overloading or improper loading can affect handling and stability and cause a crash in which you can be hurt or killed.

Follow all load limits and other loading guidelines in this manual.

#### Gross Vehicle Weight Rating (GVWR):

The maximum allowable weight of the vehicle, all occupants, all accessories, all cargo, and the tongue load.

➤ [Specifications P. 464](#)

#### Gross Axle Weight Rating (GAWR):

The maximum allowable weight of the vehicle axle.







➤ [Specifications P. 464](#)



- (5) Determine the combined weight of luggage and cargo being loaded on the vehicle. That weight may not safely exceed the available cargo and luggage load capacity calculated in step 4.
- (6) If your vehicle will be towing a trailer, load from your trailer will be transferred to your vehicle. Consult this manual to determine how this reduces the available cargo and luggage load capacity of your vehicle.

In addition, the total weight of the vehicle, all occupants, accessories, cargo, and trailer tongue load must not exceed the Gross Vehicle Weight Rating (GVWR) or the Gross Axle Weight Rating (GAWR). Both are on a label on the driver's doorjamb.

### Load Limits Example

<p><b>Example1</b></p>  <p><b>Max Load</b> 1,340 lbs (608 kg)</p>	$\geq$		+	 <p><b>Cargo Weight</b> 1,040 lbs (472 kg)</p>
<p><b>Example2</b></p>  <p><b>Max Load</b> 1,340 lbs (608 kg)</p>	$\geq$		+	 <p><b>Cargo Weight</b> 590 lbs (268 kg)</p>
		<p><b>Passenger Weight</b> 150 lbs x 2 = 300 lbs (68 kg x 2 = 136 kg)</p>		
		<p><b>Passenger Weight</b> 150 lbs x 5 = 750 lbs (68 kg x 5 = 340 kg)</p>		

## Towing Preparation

### Towing Load Limits

Your vehicle can tow a trailer if you carefully observe the load limits, use the proper equipment, and follow the towing guidelines. Check the load limits before driving.

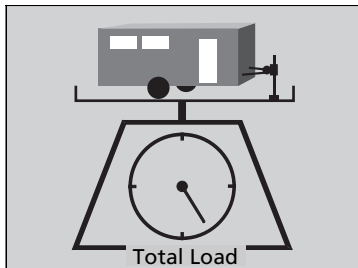

#### Total trailer weight

Do not exceed the maximum allowable weight of the trailer, cargo, and everything in or on it shown in the table.

Towing loads in excess of this can seriously affect vehicle handling and performance and can damage the engine and drivetrain.

Number of occupants	4WD models	2WD models with ATF cooler	2WD models without ATF cooler
2	4,500 lbs (2,041 kg)	3,500 lbs (1,588 kg)	2,000 lbs (905 kg)
3	4,300 lbs (1,950 kg)	3,300 lbs (1,497 kg)	
4	4,100 lbs (1,860 kg)	3,100 lbs (1,406 kg)	
5	4,000 lbs (1,814 kg)	3,000 lbs (1,361 kg)	
6	3,800 lbs (1,724 kg)	2,800 lbs (1,270 kg)	Towing not recommended
7	2,000 lbs (905 kg)	2,000 lbs (905 kg)	
8	Towing not recommended	Towing not recommended	

Each weight limit is calculated based on the following conditions:

- Occupants fill seats from the front of the vehicle to the back
- Each occupant weights 150 lbs (68 kg)
- Each occupant has 15 lbs (7 kg) of cargo in the cargo area

Any additional weight, cargo or accessories reduce the maximum trailer weight and maximum tongue load.

*Continued*

### Towing Load Limits

## ⚠ WARNING

Exceeding any load limit or improperly loading your vehicle and trailer can cause a crash in which you can be seriously hurt or killed.

Check the loading of your vehicle and trailer carefully before starting to drive.

Check if all loads are within limits at a public scale. If a public scale is not available, add the estimated weight of your cargo load to the weight of your trailer (as quoted by the manufacturer), and then measure the tongue load with an appropriate scale or tongue gauge or estimate it based on cargo distribution.

Refer to the trailer owner's manual for additional information.

**Break-in Period**  
Avoid towing a trailer during your vehicle's first 600 miles (1,000 km).

Never exceed the gross weight ratings.  
Gross weight information

[📄 Vehicle Specifications P. 464](#)

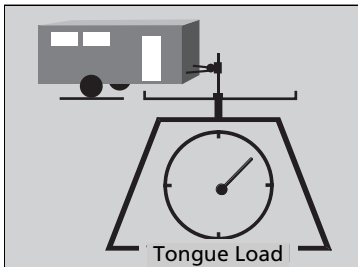

■ **Tongue load**

The weight of the tongue with a fully loaded trailer on the hitch should be approximately:

Boat trailers: 5 - 10% of the total trailer weight

Other trailers: 8 - 15% of total trailer weight

Number of occupants	4WD models	2WD models with ATF cooler	2WD models without ATF cooler
2	450 lbs (204 kg)	350 lbs (159 kg)	200 lbs (90 kg)
3	400 lbs (181 kg)	300 lbs (136 kg)	
4	330 lbs (150 kg)	230 lbs (104 kg)	
5	270 lbs (122 kg)	200 lbs (90 kg)	
6	190 lbs (86 kg)	150 lbs (68 kg)	Towing not recommended
7	100 lbs (45 kg)	100 lbs (45 kg)	
8	Towing not recommended	Towing not recommended	

**■ To estimate the tongue load**

Excessive tongue load reduces front tire traction and steering control. Too little tongue load can make the trailer unstable and cause it to sway.

You can estimate the tongue load by measuring the trailer hitch height from the ground in the following steps:

1. Park the vehicle on level ground.
2. Measure the distance between the ground and the bottom of the trailer hitch.
3. Connect the fully loaded trailer to the hitch.
4. Measure the distance between the ground and the bottom of the trailer hitch again.
5. Subtract the second measurement from the first measurement, then refer to the following table.

If the difference is	4WD models	2WD models
5/8"	150 lbs (68 kg)	
1 1/4"	250 lbs (114 kg)	
1 3/4"	350 lbs (159 kg)	
2 1/4"	450 lbs (205 kg)	-

If the difference becomes more than indicated in the table, distribute the load or remove cargo as needed.

### ■ How to weigh the trailer loads using the public scale

Check each weight in the order indicated as shown.

Refer to the table on the right for each weight's limit except for the tongue load.

➤ **Tongue load** P. 330

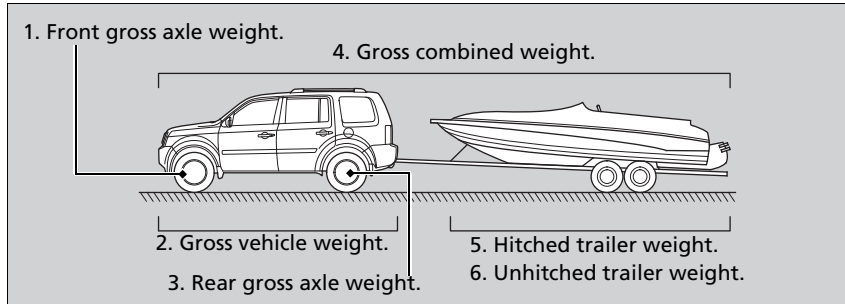

- If you cannot weigh the rear axle, subtract 1 from 2.
- The maximum gross combined weight (4) decreases by 2% for every 1,000 feet (305 meters) of elevation.
- To calculate the tongue load, subtract 5 from 6.
- Refer to the trailer owner's manual for additional information.

### ▶▶ How to weigh the trailer loads using the public scale

Fully load the vehicle and trailer. An attendant who watches the scale is needed as all occupants should stay in the vehicle.

Weight limit for	2WD models	4WD models
Front gross axle	2,921 lbs (1,325 kg)	
Gross vehicle	5,952 lbs (2,700 kg)	6,096 lbs (2,765 kg)
Rear gross axle	3,196 lbs (1,450 kg)	3,362 lbs (1,525 kg) 3,252 lbs (1,475 kg)*
Gross combined	8,466 lbs (3,840kg)	9,579 lbs (4,345kg)

\*: LX models

If a public scale is not available, add the estimated weight of your cargo load to the weight of your trailer (as quoted by the manufacturer), and then measure the tongue load with an appropriate scale or tongue gauge or estimate it based on cargo distribution.

## Towing Equipment and Accessories

Your vehicle has a class 3 trailer hitch as standard equipment. The jumper harness and trailer brake fuse are stored in the glove box.

▶ [Trailer brakes P. 334](#)

▶ [Trailer light P. 335](#)

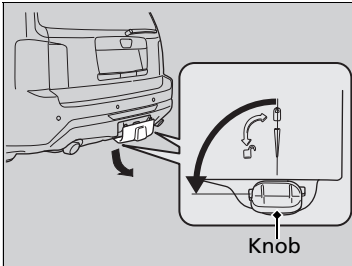

Turn the knob one-quarter left to open the cover.

▶ The 7-Pin trailer connector and trailer hitch are located.

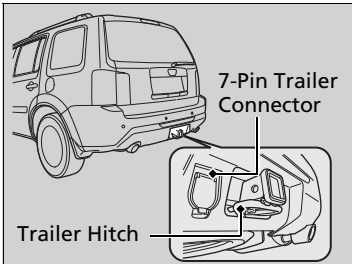

## Towing Equipment and Accessories

Make sure that all equipment is properly installed and maintained, and that it meets federal, state, province/territory, and local regulations.

Consult your trailer sales or rental agency if any other items are recommended or required for your towing situation.

The lighting and wiring of trailers can vary by type and brand. If a connector is required, it should only be installed by a qualified technician.

Trailer packages and products:

- Ball mount, hitch plug, hitch pin etc.
- Wiring harness kit
- Trailer hitch kit (jumper harness included)

▶ [Trailer brakes P. 334](#)

### 2WD models

- Automatic transmission cooler kit
- ▶ [Automatic transmission cooler P. 337](#)

Are available at a dealer.

## ■ Trailer brakes

Recommended for any trailer with a total weight of 1,000 lbs (450 kg) or more: There are two common types of trailer brakes: surge and electric. Surge brakes are common for boat trailers, since the brakes will get wet.

If you choose electric brakes, be sure they are electronically actuated. Do not attempt to attach trailer brakes to your vehicle's hydraulic system, as it will lower braking effectiveness and create a potential hazard.

The 4-pin gray connector installed in your vehicle has all of the circuits required to install most electric trailer brake controllers.

### ▶▶ Trailer brakes

The 4-pin gray connector is located under the instrument panel near the top of the parking brake pedal.

#### Trailer brake controller connector's terminals:

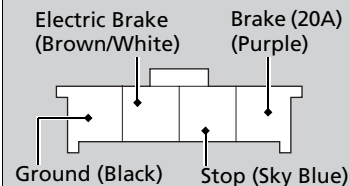

Have a qualified mechanic install your trailer brake controller following the trailer brake controller manufacturer's instructions. Failure to properly install the trailer brake controller may increase the distance it takes for you to stop your vehicle when towing a trailer.

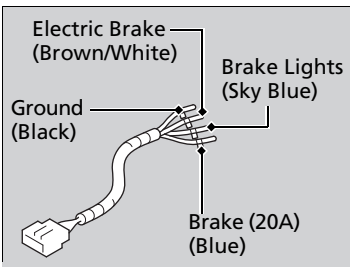

#### Touring models

The trailer jumper harness is used to install the controller for the electric trailer brakes. Insert the trailer brake fuse into the engine compartment sub fuse box.

▶ [Engine Compartment Sub Fuse Box P. 455](#)

## ■ Trailer light

Trailer lights and equipment must comply with federal, state, province/territory, and local regulations. Check with your local trailer sales or rental agency for the requirements in the area where you plan to tow.

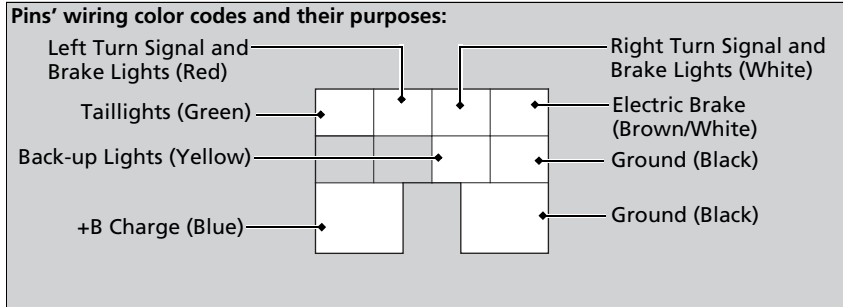

We recommend that you have a dealer install a Honda wiring harness and converter. They are designed for your vehicle.

### ▶▶ Trailer light

The trailer lighting connector is located behind the left side panel in the cargo area. Even if you are planning to use the non-Honda trailer lighting harness and converter, ask a dealer for the correct connector and pins.



**Touring models**

The 7-pin trailer connector is needed for your trailer lights.

When inserting the connector to the socket, check if the connector and the socket are free of dirt, moisture, or other foreign material.

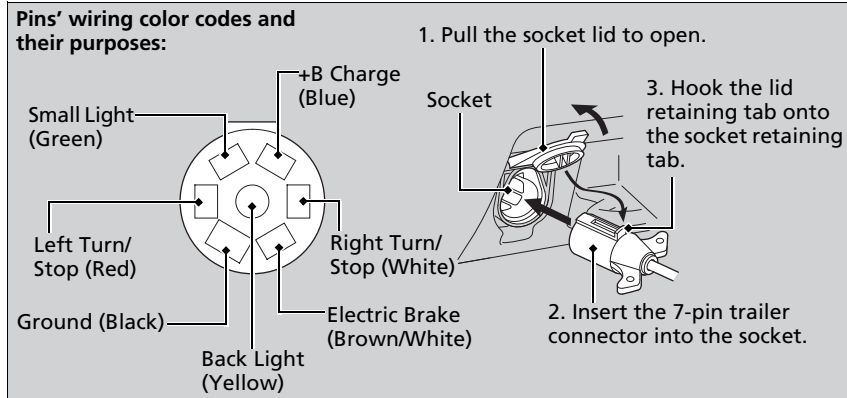

**■ Hitches**

Read the trailer manufacturer's instructions, and select the appropriate draw bar for the height of the trailer you will be towing.

**■ Weight distribution hitches**

A weight distributing hitch is not recommended for use with your vehicle.

An improperly adjusted weight distributing hitch may reduce handling, stability, and braking performance.

## ■ Safety chains

Always use safety chains when you tow a trailer. Leave enough slack to allow the trailer to turn corners easily, but do not allow the chains to drag on the ground.

## ■ Sway control

Recommended to use if your trailer tends to sway. Consult the trailer maker for what kind of sway control you need and how to install it.

### 2WD models

## ■ Automatic transmission cooler

Install an additional ATF (automatic transmission fluid) cooler to help prevent the transmission from overheating, and damaging. You can get the additional ATF cooler at a dealer.

## ■ Trailer mirrors

Many states, provinces and territories require special exterior mirrors when towing a trailer. Install special mirrors whenever you cannot clearly see behind you, or if the trailer creates a blind spot.

## Driving Safely with a Trailer

### ■ Things You Need To Know Before Towing a Trailer

- Have the trailer properly serviced and keep it in good condition.
- Make sure that all the weights and load in the vehicle and trailer are within limits.
  - ▶ [Towing Load Limits](#) P. 329
- When towing more than 3,500lbs (1,590 kg), use of gasoline with a pump octane number of 91 or higher is recommended.
  - ▶ Towing performance can be affected by high altitude, high temperature, or steep uphill.
- Securely attach the hitch, safety chains, and other necessary parts to the trailer.
- Securely store all the items in and on the trailer so that they do not shift while driving.
- Check if the lights and brakes on the trailer are working properly.
- Check the pressures of the trailer tires, including the spare.

### ■ Towing Speeds and Gears

- Drive slower than normal.
- Obey posted speed limits for vehicles with trailers.
- Use the **[D]** position when towing a trailer on level roads.

### ■ Turning and Braking

- Turn more slowly and with a wider turning arc than normal.
- Allow more time and distance for braking.
- Do not brake or turn suddenly.

#### ▶▶ Driving Safely with a Trailer

##### Parking

In addition to the normal precautions, place wheel chocks at each of the trailer's tires.

## Driving in Hilly Terrain

- Monitor your temperature gauge. If it nears the red (Hot) mark, turn off the climate control system and reduce speed. Pull to the side of the road safely to cool down the engine if necessary.
- Shift to the **D3** position if the transmission shifts frequently.

## Retrieving a Boat

If the tires slip when retrieving a boat from the water, shift to **1**, and turn on VTM-4® lock. Disengage VTM-4® lock as soon as the boat is out of the water to prevent damage to the VTM-4® system.

## Towing Your Vehicle

Your vehicle is not designed to be towed behind a motor home. If your vehicle needs to be towed in an emergency, refer to the emergency towing information.

 [Emergency Towing](#) P. 459

## General Information

Your vehicle has been designed primarily for use on pavement, however, its higher ground clearance allows you to occasionally travel on unpaved roads. It is not designed for trail-blazing, or other challenging off-road activities.

If you decide to drive on unpaved roads, you will find that it requires somewhat different driving skills and that your vehicle will handle somewhat differently than it does on pavement. Pay attention to the precautions and tips in this section, and get acquainted with your vehicle before leaving the pavement.

## Important Safety Precautions

To avoid loss of control or rollover, be sure to follow all precautions and recommendations:

- Be sure to store cargo properly and do not exceed your cargo load limits.  
[▶ Maximum Load Limit P. 327](#)
- Whenever you drive, make sure you and your passengers always wear seat belts.
- Keep your speed low, and never go faster than the conditions allow.
- It's up to you to continually assess the situation and drive within the limits.

### ▶ Off-Highway Driving Guidelines

#### **WARNING**

Improperly operating this vehicle on or off pavement can cause a crash or rollover in which you and your passengers can be seriously injured or killed.

- Follow all instructions and guidelines in this owner's manual.
- Keep your speed low, and don't drive faster than conditions permit.

Failure to operate your vehicle correctly might result in a crash or a rollover.

- ▶ [Important Handling Information P. 26](#)
- ▶ [Precautions While Driving P. 344](#)

## Avoiding Trouble

---

- **Check Out Your Vehicle** before you leave the pavement and make sure that all scheduled maintenance has been completed. Pay special attention to the condition of the tires, and check the tire pressures.
- **Remember** the route you choose presents limits (too steep or bumpy), you have limits (driving skill and comfort), and your vehicle has limits (traction, stability, and power). Failing to recognize these limits will likely put you and your passengers in a hazardous situation.
- **Accelerating and Braking** should be done slowly and gradually. Trying to start or stop too fast can cause a loss of traction and you could lose control.
- **Avoiding Obstacles and Debris** in the road reduces the likelihood of a rollover or damage to your suspension or other components.
- **Driving on Slopes** increasing your risk of a rollover, particularly if you attempt to drive across a slope that is too steep. Going straight or down a slope is usually the safest. If you can't clearly see all conditions or obstacles on a slope, walk it before you drive it. If there is any doubt whether you can safely pass, don't try it. Find another route. If you get stuck when climbing, do not try to turn around. Back down slowly following the same route you took up the hill.
- **Crossing a Stream** - Avoid driving through deep water. If you encounter water in your route (a small stream or large puddle, for example), evaluate it carefully before going ahead. Make sure it is shallow, flowing slowly, and has firm ground underneath. If you are not sure of the depth or the ground, turn around and find another route. Driving through deep water can also damage your vehicle. The water can get into the transmission and differential, diluting the lubricant and causing an eventual failure. It can also wash the grease out of the wheel bearings.
- **If You Get Stuck**, carefully go in the direction that you think will get you unstuck. Do not spin the tires as this will only make things worse and could damage the transmission. If you are unable to free yourself, your vehicle will need to be towed. Front and rear tow hooks are provided for this purpose.

## Starting the Engine

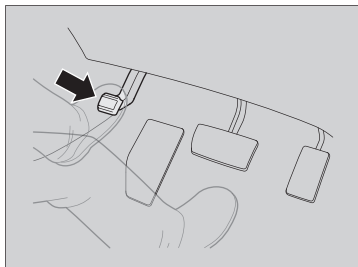

1. Make sure the parking brake is applied.

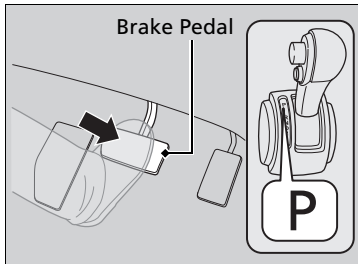

2. Check that the shift lever is in **P**, then depress the brake pedal.

▶ Although it is possible to start the vehicle in **N**, it is safer to start it in **P**.

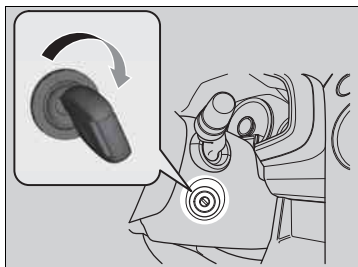

3. Turn the ignition switch to START **III** without depressing the accelerator pedal.

### Starting the Engine

Keep your foot firmly on the brake pedal when starting the engine.

The engine is harder to start in cold weather and in thinner air found at altitudes above 8,000 feet (2,400 meters).

When starting the engine in cold weather, turn off all electrical accessories such as the lights, climate control system, and rear defogger in order to reduce battery drain.

If you live in a region where winter is extremely cold, an engine block heater will improve starting and warming of the engine. If temperatures consistently below -22°F (-30°C) are expected, the coolant mixture should be changed to a higher concentration to prevent freezing. Consult a dealer for details.

If the exhaust system sounds abnormal or you can smell exhaust gas inside the vehicle, have your vehicle checked by a dealer. There may be a problem with the engine or exhaust system.

Do not hold the key in START **III** for more than 15 seconds.

- If the engine does not start right away, wait for at least 10 seconds before trying again.
- If the engine starts, but then immediately stops, wait at least 10 seconds before repeating step 3 while gently depressing the accelerator pedal. Release the accelerator pedal once the engine starts.

## Starting to Drive

1. Keeping your right foot on the brake pedal, release the parking brake. Check that the parking brake indicator has gone off.  
[▶ Parking Brake P. 360](#)
2. Put the shift lever in **[D]**. Select **[R]** when reversing.
3. Gradually release the brake pedal and gently depress the accelerator pedal to pull away.

### ■ Hill start assist system

Hill start assist keeps the brake engaged briefly to help prevent the vehicle from rolling on inclines as you move your foot from the brake pedal to the accelerator.

Move the shift lever to **[D]** or **[D3]** when facing uphill, or **[R]** when facing downhill, then release the brake pedal.

### ⌘ Starting the Engine

The immobilizer system protects your vehicle from theft. If an improperly coded key (or other device) is used, the engine's fuel system is disabled.

[▶ Immobilizer System P. 118](#)

### ⌘ Hill start assist system

Hill start assist may not prevent the vehicle from rolling downhill on a very steep or slippery slope, and does not operate on small inclines.

Hill start assist is not a replacement for the parking brake.

Hill start assist will operate even when VSA® is switched off.



## Precautions While Driving

### ■ Driving Guidelines for Your Utility Vehicle

Utility vehicles have a significantly higher rollover rate than other types of vehicles. To prevent rollovers or loss of control:

- Take corners at slower speeds than you would with a passenger vehicle.
- Avoid sharp turns and abrupt maneuvers whenever possible.
- Do not modify your vehicle in any way that you would raise the center of gravity.
- Do not carry heavy cargo on the roof.

### ■ In Rain

Avoid driving in deep water and on flooded roads. This can damage the engine, driveline, or cause electrical component failure.

### ■ Other Precautions

If there is a strong impact with something under the vehicle, stop in a safe location. Check the underside of the vehicle for damage or any fluid leaks.

### » Precautions While Driving

#### NOTICE

Do not operate the shift lever while pressing the accelerator pedal. You could damage the transmission.

If the ignition switch is turned to ACCESSORY [I] or LOCK [0] while driving, the engine will shut down and all steering and brake power assist functions will stop, making it difficult to control the vehicle.

Do not put the shift lever in [N], as you will lose engine braking (and acceleration) performance.

During the first 600 miles (1,000 km) of operation, avoid sudden acceleration or full throttle operation so as not to damage the engine or powertrain.

Avoid hard braking for the first 200 miles (300 km). You should also follow this when the brake pads are replaced.

### » Driving Guidelines for Your Utility Vehicle

Failure to operate your vehicle correctly might result in a crash or a rollover.

- ▶ [Important Handling Information P. 26](#)
- ▶ [Precautions While Driving P. 344](#)

## Automatic Transmission

### ■ Creeping

The following conditions cause the engine to run at high revolutions, and increase creeping:

- Immediately after the engine starts.
- When the climate control system is in use.

Keep the brake pedal firmly depressed when stopped.

### ■ Kickdown

Quickly depressing the accelerator pedal while driving uphill may cause the transmission to drop to a lower gear, unexpectedly increasing vehicle speed. Depress the accelerator pedal carefully, especially on slippery roads and curves.

# Shifting

Change the shift position in accordance with your driving needs.

## ■ Shift lever positions

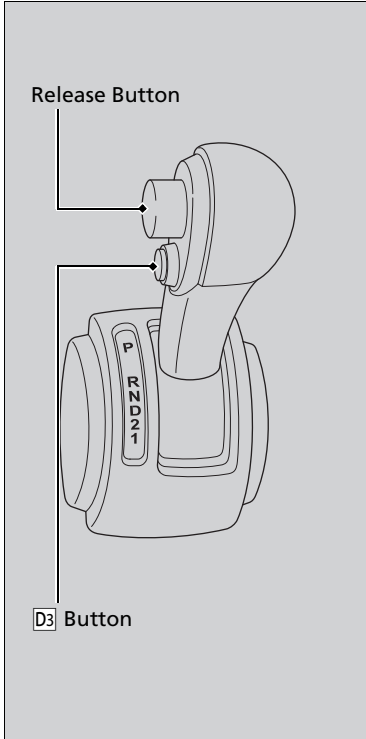

The diagram shows a shift lever assembly. A 'Release Button' is located at the top of the lever. Below it is a 'D3 Button'. The gear selector panel is labeled with 'P', 'R', 'N', 'D2', and '1' from top to bottom. The lever is shown in a vertical position.

<b>P</b>	<b>Park</b> Used when parking or starting the engine
<b>R</b>	<b>Reverse</b> Used when reversing
<b>N</b>	<b>Neutral</b> Used when idling
<b>D</b>	<b>Drive</b> Used for normal driving (gears change between 1st and 5th automatically)
<b>2</b>	<b>Second</b> Used to increase engine braking (the transmission is locked in 2nd gear)
<b>1</b>	<b>First</b> Used to further increase engine braking (the transmission is locked in 1st gear)
<b>D3</b>	<b>Drive (D3)</b> Press the <b>D3</b> button while the shift lever is in <b>D</b> . Used when: <ul style="list-style-type: none"> <li>• Going up or down hills</li> <li>• Towing a trailer in hilly terrain</li> </ul>

## ☒ Shifting

You cannot turn the ignition switch to LOCK **0** and remove the key unless the shift lever is in **P**.

The vehicle may move forward very slightly even in **N** while the engine is cold. Depress the brake pedal firmly and, when necessary, apply the parking brake.

## Shift Lever Operation

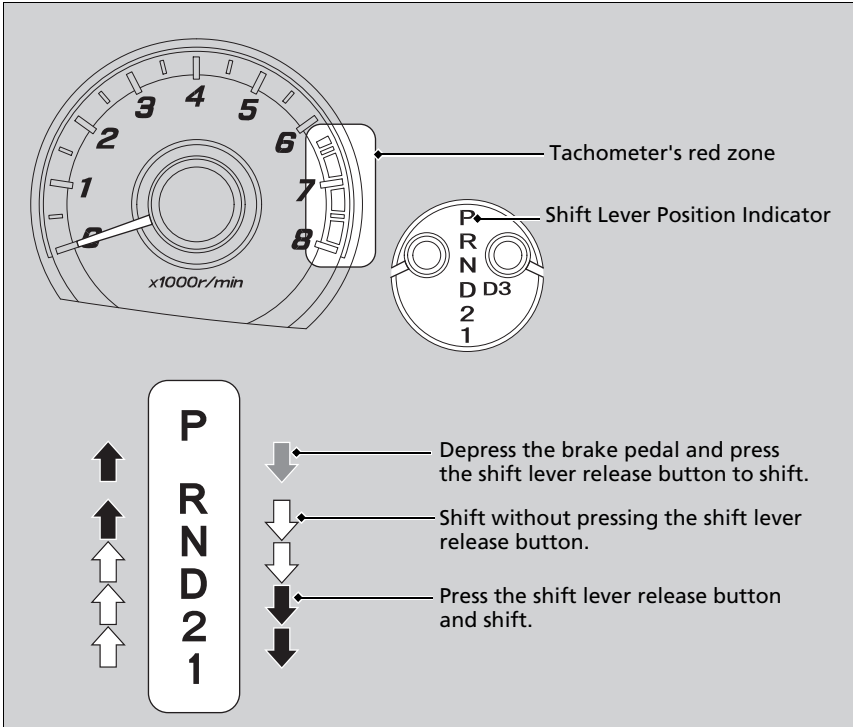

### Shift Lever Operation

#### NOTICE

When you change the shift lever from **D** to **R** and vice versa, come to a complete stop and keep the brake pedal depressed. Operating the shift lever before the vehicle has come to a complete standstill can damage the transmission.

Use the shift lever position indicator to check the lever position before pulling away.

Whichever position the shift lever is in when driving, a blinking **D** indicator indicates a transmission problem. Avoid sudden acceleration and have the transmission checked by a dealer as soon as possible.

The fuel supply may be cut off if you drive at engine speeds in or over the tachometer's red zone (engine speed limit). If this happens, you may experience a slight jolt.

It may not be possible to operate the shift lever if the brake pedal is applied while the shift lever release button is held down. Depress the brake pedal first.

## Cruise Control

Maintains a constant vehicle speed without having to keep your foot on the accelerator. Use cruise control on freeways or open roads where you can travel at a constant speed with little acceleration or deceleration.

### When to use

■ Vehicle speed for cruise control:  
Desired speed in a range above  
roughly 25 mph (40 km/h) ~

Always keep sufficient distance  
between you and the vehicle in  
front of you.

■ Shift positions for cruise control:  
In **D** or **D3**



### When to use

**CRUISE MAIN** is on in the  
instrument panel.  
Cruise control is ready to use.

■ Press the **CRUISE** button  
on the steering wheel.

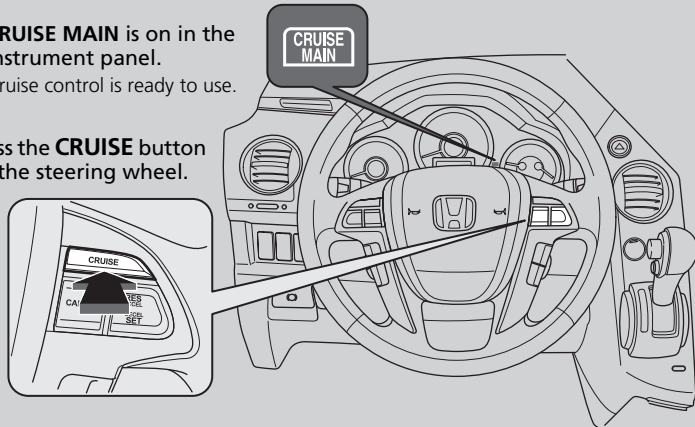

### ⌘ Cruise Control

## ⚠ WARNING

Improper use of the cruise control can lead to a crash.

Use the cruise control only when traveling on open highways in good weather.

It may not be possible to maintain a constant speed when driving uphill or downhill.

When not using cruise control:  
Turn off cruise control by pressing the **CRUISE** button.

## ■ To Set the Vehicle Speed

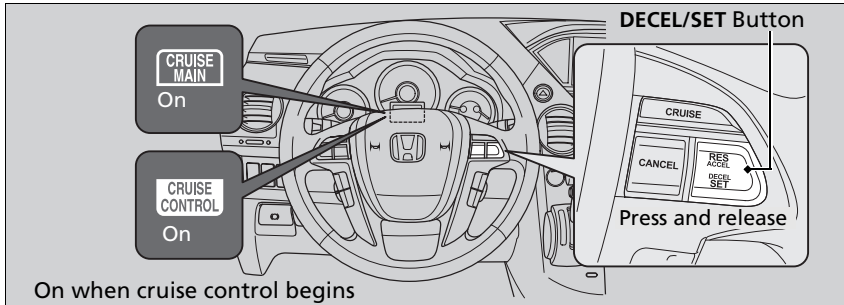

Take your foot off the pedal and press the **DECEL/SET** button when you reach the desired speed.

The moment you release the **DECEL/SET** button, the set speed is fixed, and cruise control begins. The **CRUISE CONTROL** indicator comes on.

## ■ To Adjust the Vehicle Speed

Increase or decrease the vehicle speed using the **RES/ACCEL** or **DECEL/SET** buttons on the steering wheel.

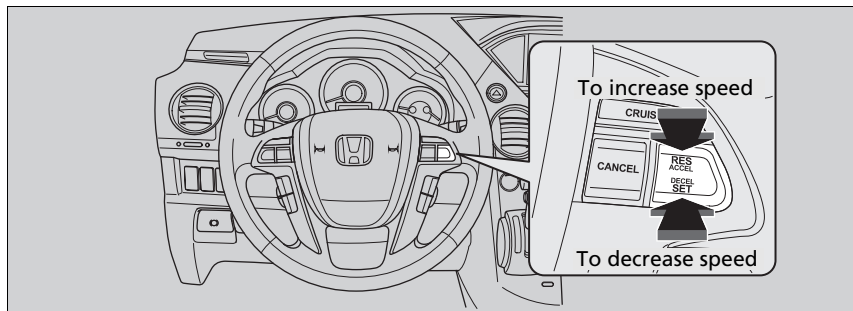

- Each time you press the button, the vehicle speed is increased or decreased by about 1 mph (1.6 km/h).
- If you keep the button pressed, the vehicle speed increases or decreases until you release it. This speed is then set.

## ▶▶ To Adjust the Vehicle Speed

You can set the vehicle speed using the **DECEL/SET** button on the steering wheel when adjusting the speed with the accelerator and brake pedals.

## ■ To Cancel

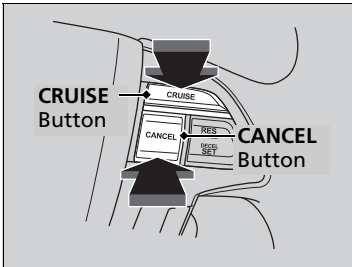

To cancel cruise control, do any of the following:

- Press the **CANCEL** button.
- Press the **CRUISE** button.
- Depress the brake pedal.

The **CRUISE CONTROL** indicator goes off.

## ☒ To Cancel

Resuming the prior set speed:

After cruise control has been canceled, you can still resume the prior set speed by pressing the **RES/ACCEL** button while driving at a speed of at least 25 mph (40 km/h) or more.

You cannot set or resume in the following situations:

- When vehicle speed is less than 25 mph (40 km/h)
- When the **CRUISE** button is turned off

At vehicle speeds of 22 mph (35 km/h) or less, cruise control is canceled automatically.



## VSA® (Vehicle Stability Assist), aka ESC (Electronic Stability Control), System

VSA® helps to stabilize the vehicle during cornering if the vehicle turns more or less than what was intended. It also assists in maintaining traction on slippery surfaces. It does so by regulating engine output and selectively applying the brakes.

### VSA® Operation

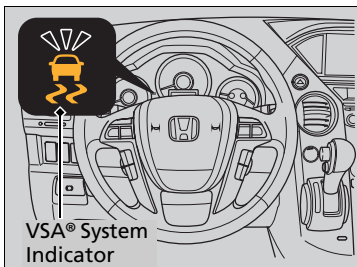

When VSA® activates, you may notice that the engine does not respond to the accelerator. You may also notice some noise from the hydraulic system. You will also see the indicator blink.

### VSA® (Vehicle Stability Assist), aka ESC (Electronic Stability Control), System

The VSA® may not function properly if tire type and size are mixed. Make sure to use the same size and type of tire, and the air pressures as specified.

When the VSA® indicator comes on and stays on while driving, there may be a problem with the system. While this may not interfere with normal driving, have your vehicle checked by a dealer immediately.

VSA® cannot enhance stability in all driving situations and does not control the entire braking system. You still need to drive and corner at speeds appropriate for the conditions and always leave a sufficient margin of safety.

The main function of the VSA® system is generally known as Electronic Stability Control (ESC). The system also includes a traction control function.

## VSA® On and Off

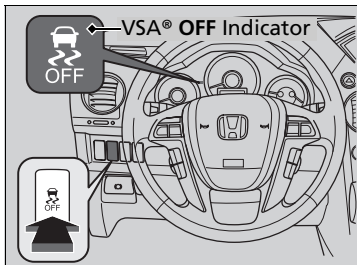

This button is on the driver side control panel. To turn the VSA® system on and off, press and hold it until you hear a beep.

VSA® will stop and the indicator will come on.

To turn it on again, press the  (VSA® OFF) button until you hear a beep.

VSA® is turned on every time you start the engine, even if you turned it off the last time you drove the vehicle.

## VSA® (Vehicle Stability Assist), aka ESC (Electronic Stability Control), System

Without VSA®, your vehicle will have normal braking and cornering ability, but it will not have VSA® traction and stability enhancement.

In certain unusual conditions when your vehicle gets stuck in shallow mud or fresh snow, it may be easier to free it with the VSA® temporarily switched off.

When the VSA® system is off, the traction control system is also off. You should only attempt to free your vehicle with the VSA® off if you are not able to free it when the VSA® is on.

Immediately after freeing your vehicle, be sure to switch VSA® on again. We do not recommend driving your vehicle with the VSA® and traction control systems switched off.

If the low tire pressure/TPMS, low tire pressure, or **TPMS** indicator comes on or blinks, the VSA® system comes on automatically. In this case, you cannot turn the system off by pressing the  button.

You may hear a motor sound coming from the engine compartment while system checks are being performed immediately after starting the engine or while driving. This is normal.

## VTM (Variable Torque Management)-4® System\*

Senses a traction loss caused by a road condition change, and automatically transfers some power to the rear wheels.

### ■ To Engage the VTM-4® LOCK

Use the VTM-4® LOCK to increase more torque to the rear wheels.

1. Stop your vehicle with the engine running.
2. Move the shift lever to **1**, **2**, or **R**.
3. Press the **VTM-4® LOCK** button.
  - ▶ The indicator in the button comes on.

### ■ To Disengage the VTM-4® LOCK

Any of the following disengages the VTM-4® LOCK:

- Pressing the **VTM-4® LOCK** button again.
- Moving the shift lever to **D** or **D3**.
- Turning the ignition switch to the LOCK **0** position.

### ▶▶ VTM (Variable Torque Management)-4® System\*

#### NOTICE

Do not continuously spin the front tires of your vehicle. Continuously spinning the front tires can cause transmission or rear differential damage.

### ▶▶ To Engage the VTM-4® LOCK

Do not use the **VTM-4® LOCK** button on dry, paved roads. Driving on dry, paved roads with VTM-4® LOCK on may damage the rear differential when making a turn. Strange noise and vibration can also result.

The VTM-4® LOCK can be used to help free your vehicle from being stuck in mud, sand, or gravel. When the lock is engaged, apply light pressure to the accelerator pedal.

When more torque is applied, the rear tires are not likely to spin. This is normal.

If you are not able to free the vehicle, stop and reverse direction.

As soon as this feature is no longer needed, disengage the VTM-4® LOCK.

### ▶▶ To Disengage the VTM-4® LOCK

The VTM-4® LOCK temporarily disengages when the vehicle speed exceeds 18 mph (30 km/h). The indicator in the button remains on.

## TPMS (Tire Pressure Monitoring System)

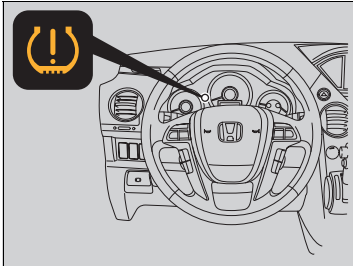

### Models with information display

Monitors the tire pressure while you are driving. If your vehicle's tire pressure becomes significantly low, the low tire pressure indicator comes on.

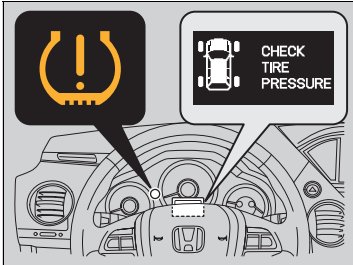

### Models with multi-information display

Monitors the tire pressure while you are driving. If your vehicle's tire pressure becomes significantly low, the low tire pressure/TPMS indicator comes on and a message appears on the multi-information display.

### ▶▶ TPMS (Tire Pressure Monitoring System)

#### Models with information display

Conditions such as low ambient temperature and altitude change directly affect tire pressure and can trigger the low tire pressure indicator to come on.

▶ [If the Low Tire Pressure Indicator Comes On P. 452](#)

Tire pressure checked and inflated in:

- Warm weather can become under-inflated in colder weather.
- Cold weather can become over-inflated in warmer weather.

The low tire pressure indicator will not come on as a result of over inflation.

#### Models with multi-information display

Conditions such as low ambient temperature and altitude change directly affect tire pressure and can trigger the low tire pressure/TPMS indicator to come on.

▶ [If the Low Tire Pressure/TPMS Indicator Comes On or Blinks P. 453](#)

Tire pressure checked and inflated in:

- Warm weather can become under-inflated in colder weather.
- Cold weather can become over-inflated in warmer weather.

The low tire pressure/TPMS indicator will not come on as a result of over inflation.



## ■ Tire Pressure Monitor

### Models with information display

If your vehicle's tire pressure becomes significantly low, the specific tire indicator comes on.



### Models with multi-information display

To select the tire pressure monitor, turn the ignition switch to ON , and press the  /  (information) button until you see the tire pressure screen.

The pressure for each tire is displayed in PSI (U.S.) or kPa (Canada).

**CHECK TIRE PRESSURE** is displayed when a tire has significantly low pressure. The specific tire is displayed on the screen.

## ▶▶ Tire Pressure Monitor

### Models with multi-information display

The pressure displayed on the multi-information display can be slightly different from the actual pressure as measured by a gauge. If there is a significant difference between the two values, or if the low tire pressure/TPMS indicator and the message on the multi-information display do not go off after you have inflated the tire to the specified pressure, have the system checked by a dealer.

**CHECK TPMS SYSTEM** may appear if you drive with the compact spare tire, or there is a problem with the TPMS.

## Tire Pressure Monitoring System (TPMS) - Required Federal Explanation

Each tire, including the spare (if provided), should be checked monthly when cold and inflated to the inflation pressure recommended by the vehicle manufacturer on the vehicle placard or tire inflation pressure label.

(If your vehicle has tires of a different size than the size indicated on the vehicle placard or tire inflation pressure label, you should determine the proper tire inflation pressure for those tires.)

As an added safety feature, your vehicle has been equipped with a tire pressure monitoring system (TPMS) that illuminates a low tire pressure telltale when one or more tires is significantly under-inflated.



Accordingly, when the low tire pressure tell tale illuminates, you should stop and check your tires as soon as possible, and inflate them to the proper pressure.

Driving on a significantly under-inflated tire causes the tire to overheat and can lead to tire failure. Under-inflation also reduces fuel efficiency and tire tread life, and may affect the vehicle's handling and stopping ability.

Please note that the TPMS is not a substitute for proper tire maintenance, and it is the driver's responsibility to maintain correct tire pressure, even if under-inflation has not reached the level to trigger illumination of the TPMS low tire pressure telltale.

**Models with information display**

Your vehicle has also been equipped with a TPMS malfunction indicator to indicate when the system is not operating properly. The TPMS malfunction indicator is provided by a separate telltale, which displays the symbol "TPMS" when illuminated.

When the malfunction indicator is illuminated, the system may not be able to detect or signal low tire pressure as intended.



TPMS malfunctions may occur for a variety of reasons, including the installation of replacement or alternate tires or wheels on the vehicle that prevent the TPMS from functioning properly.

Always check the TPMS malfunction telltale after replacing one or more tires or wheels on your vehicle to ensure that the replacement or alternate tires and wheels allow the TPMS to continue to function properly.

**Models with multi-information display**

Your vehicle has also been equipped with a TPMS malfunction indicator to indicate when the system is not operating properly. The TPMS malfunction indicator is combined with the low tire pressure telltale. When the system detects a malfunction, the telltale will flash for approximately one minute and then remain continuously illuminated. This sequence will continue upon subsequent vehicle start-ups as long as the malfunction exists.

When the malfunction indicator is illuminated, the system may not be able to detect or signal low tire pressure as intended.

TPMS malfunctions may occur for a variety of reasons, including the installation of replacement or alternate tires or wheels on the vehicle that prevent the TPMS from functioning properly.

Always check the TPMS malfunction telltale after replacing one or more tires or wheels on your vehicle to ensure that the replacement or alternate tires and wheels allow the TPMS to continue to function properly.



## Brake System

### Parking Brake

Use the parking brake to keep the vehicle stationary when parking.

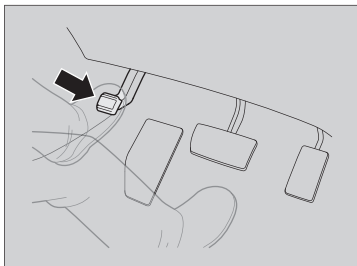

#### To apply:

Depress the parking brake pedal down with your foot.

#### To release:

1. Depress the brake pedal.
2. Pull the release handle fully.

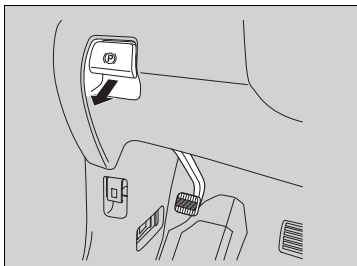

### » Parking Brake

#### NOTICE

Release the parking brake fully before driving. The rear brakes and axle can be damaged if you drive with the parking brake applied.

If you start driving without fully releasing the parking brake, a buzzer sounds as a warning, and **RELEASE PARKING BRAKE** appears on the multi-information display\*.

Always apply the parking brake when parking.

## Foot Brake

Your vehicle is equipped with disc brakes at all four wheels. A vacuum power assist helps reduce the effort needed on the brake pedal. The brake assist system increases the stopping force when you depress the brake pedal hard in an emergency situation. The anti-lock brake system (ABS) helps you retain steering control when braking very hard.

➤ [Brake Assist System](#) P. 363

➤ [ABS \(Anti-lock Brake System\)](#) P. 362

### Foot Brake

Check the brakes after driving through deep water, or if there is a buildup of road surface water. If necessary, dry the brakes by lightly depressing the pedal several times.

If you hear a continuous metallic friction sound when applying the brakes, the brake pads need to be replaced. Have the vehicle checked by a dealer.

Constantly using the brake pedal while going down a long hill builds up heat, which reduces the brake effectiveness. Apply engine braking by taking your foot off the accelerator pedal and downshifting to a lower gear.

Do not rest your foot on the brake pedal while driving, as it will lightly apply the brakes and cause them to lose effectiveness over time and reduce pad life. It will also confuse drivers behind you.

## ABS (Anti-lock Brake System)

### ABS

Helps prevent the wheels from locking up, and helps you retain steering control by pumping the brakes rapidly, much faster than you.

The electronic brake distribution (EBD) system, which is part of the ABS, also balances the front-to-rear braking distribution according to vehicle loading.

You should never pump the brake pedal. Let the ABS work for you by always keeping firm, steady pressure on the brake pedal. This is sometimes referred to as “stomp and steer.”

### ■ ABS operation

The brake pedal may pulsate slightly when the ABS is working. Keep holding the pedal firmly down. On dry pavement, you will need to press on the brake pedal very hard before the ABS activates. However, you may feel the ABS activate immediately if you are trying to stop on snow or ice.

When the vehicle speed goes under 6 mph (10 km/h), the ABS stops.

### ►► ABS (Anti-lock Brake System)

#### NOTICE

The ABS may not function correctly if you use an incorrect tire type and size.

When the **ABS** indicator comes on while driving, there may be a problem with the system. While normal braking is not affected, there is a possibility of the ABS not operating. Have the vehicle checked by a dealer immediately.

The ABS does not reduce the time or distance it takes to stop the vehicle. It only helps with steering control during hard braking.

In the following cases, your vehicle may need more stopping distance than a vehicle without the ABS:

- When driving on rough road surfaces, including when driving on uneven surfaces, such as gravel or snow.
- When tire chains are installed.

You may hear a motor sound coming from the engine compartment while system checks are being performed immediately after starting the engine or while driving. This is normal.

## Brake Assist System

---

Designed to assist the driver by generating greater braking force when you depress the brake pedal hard during emergency braking.

### ■ Brake assist system operation

Press the brake pedal firmly for more powerful braking.

When brake assist operates, the pedal may wiggle slightly and an operating noise may be heard. This is normal. Keep holding the brake pedal firmly down.

## When Stopped

1. Depress the brake pedal firmly with the shift lever in **[D]**.
2. Firmly apply the parking brake.
3. Move the shift lever from **[D]** to **[P]**.
4. Turn off the engine.

Always set the parking brake firmly, in particular if you are parked on an incline.

### » Parking Your Vehicle

Do not park your vehicle near flammable objects, such as dry grass, oil, or timber. Heat from the exhaust can cause a fire.

### » When Stopped

#### NOTICE

The following can damage the transmission:

- Depressing the accelerator and brake pedals simultaneously.
- Holding the vehicle in place when facing uphill by depressing the accelerator pedal.
- Moving the shift lever into **[P]** before the vehicle stops completely.

Raise the wiper arms when snow is expected.

## Parking Sensor System\*

The corner and rear center sensors monitor obstacles around your vehicle, and the beeper and display let you know the approximate distance between your vehicle and the obstacle.

### ■ The sensor location and range

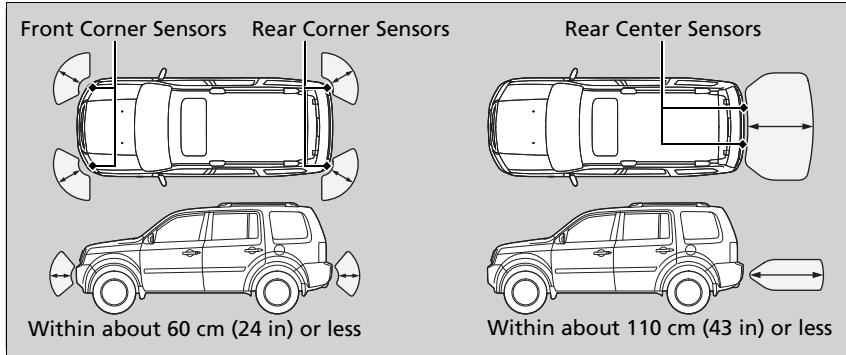

### ⊠ Parking Sensor System\*

Even when the system is on, always confirm if there is no obstacle near your vehicle before parking.

#### The system may not work properly when:

- The sensors are covered with snow, ice, mud, or dirt.
- The vehicle is on an uneven surface, such as grass, bumps, or a hill.
- The vehicle has been out in hot or cold weather.
- The system is affected by some electric devices that generate ultrasonic waves.
- Driving in bad weather.

#### The system may not sense:

- Thin or low objects.
- Sonic-absorptive materials, such as snow, cotton, or sponge.
- Objects directly under the bumper.

Do not put any accessories on or around the sensors.

\* Not available on all models

Continued

## ■ When you activate the system

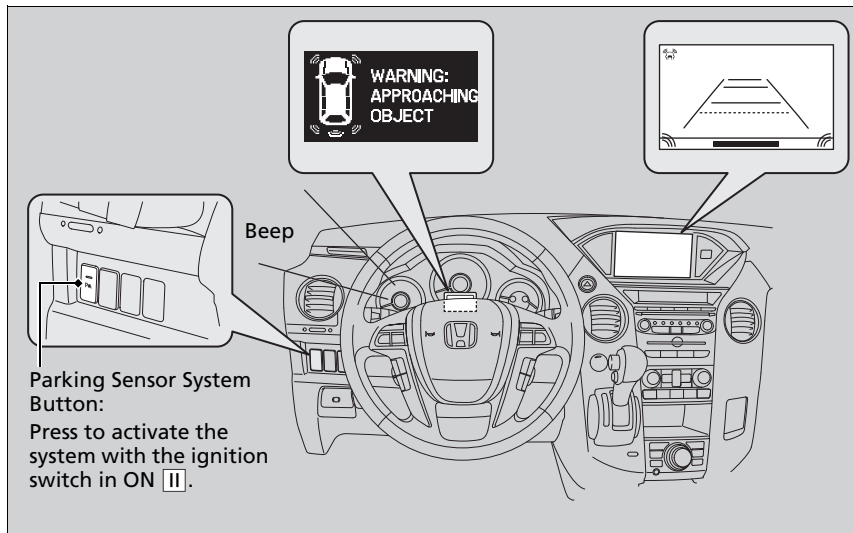

The indicator in the button comes on and the beeper sounds when the system is on.



The corner sensors start to detect an obstacle when the shift lever is in any position other than **P**, and the vehicle speed is less than 5 mph (8 km/h).

The rear center sensors start to detect an obstacle when the shift lever is in **R**, and the vehicle speed is less than 5 mph (8 km/h).

## ▶ Parking Sensor System \*

When you turn the ignition switch to ON **II**, the system will be in the previously selected condition.

■ When the distance between your vehicle and obstacles behind becomes shorter

Length of the intermittent beep	Distance between the Bumper and Obstacle		Appropriate Indicator		Navigation screen indicator color
	Corner Sensors	Center Sensors			
Long	—	About 43-24 in (110-60 cm)	Multi-information display  Stays on	Navigation screen  Blinks	Yellow
Short	About 24-18 in (60-45 cm)	About 24-18 in (60-45 cm)			Amber
Very short	About 18-14 in (45-35 cm)	About 18-14 in (45-35 cm)			Amber
Continuous	About 14 in (35 cm) or less	About 14 in (35 cm) or less			Red

\* Not available on all models



### ■ The parking sensor system on navigation screen

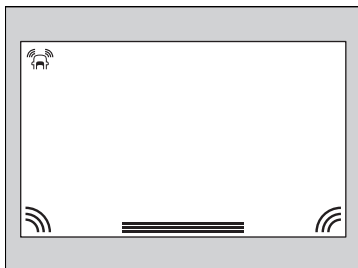

- An appropriate indicator blinks when there are any obstacles around the parking sensors. The color of the indicator changes in accordance with the distance between your vehicle and obstacles.
- An appropriate indicator stays on in red when there is a problem with the corresponding parking sensor.

▶ **Multi-Information Display Warning and Information Messages** \* P. 78

### ▶▶ Turning off All Rear Sensors

### ■ Turning off All Rear Sensors

1. Make sure that the parking sensor system is not activated. Turn the ignition switch to LOCK **0**.
2. Press and hold the parking sensor system button, and turn the ignition switch to ON **II**.
3. Keep pressing the button for ten seconds. Release the button when the indicator in the button flashes.
4. Press the button again. The indicator in the button goes off.
  - ▶ The beeper sounds twice. The rear sensors are now turned off.

When you shift to **R**, the indicator in the parking sensor system button blinks as a reminder that the rear sensors have been turned off.

To turn the rear sensors on again, follow the above procedure. The beeper sounds three times when the rear sensors come back on.

## About Your Rearview Camera

### Models without navigation system

The audio/information screen can display your vehicle's rear view.

The display automatically changes to a rear view when the shift lever is moved to **R**.

### Rearview Camera Display Area

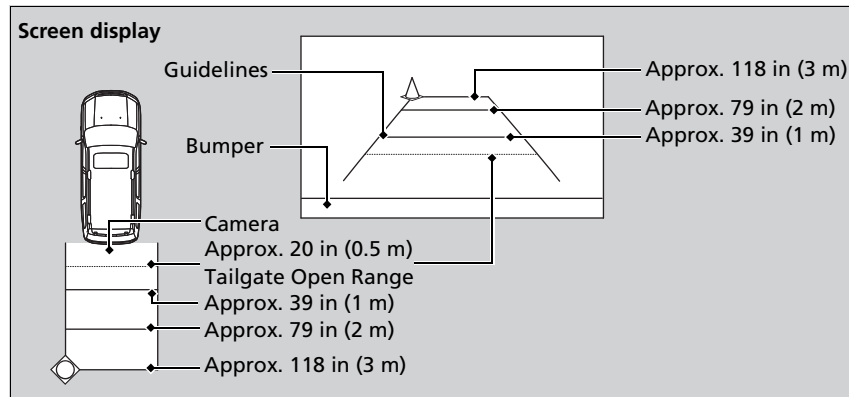

\* Not available on all models

### About Your Rearview Camera

The rear camera view is restricted. You cannot see the corner ends of the bumper or what is underneath the bumper. Its unique lens also makes objects appear closer or farther than they actually are.

Visually confirm that it is safe to drive before backing up. Certain conditions (such as weather, lighting, and high temperatures) may also restrict the rear view. Do not rely on the rearview display which does not give you all information about conditions at the back of your vehicle.

To turn the guide lines on or off, press and hold the **RETURN** button for about three seconds. If you turn the guide lines off, they remain off until you turn them back on.

Rotate  to adjust the brightness of the rearview camera.

If the camera lens is covered with dirt or moisture, use a soft, moist cloth to keep the lens clean and free of debris.

## About Your Multi-View Rear Camera

Models with navigation system

For models with the navigation system, see the Navigation System Manual.

## Fuel Information

### ■ Fuel recommendation

#### Unleaded gasoline, pump octane number 87 or higher

Use of lower octane gasoline can cause a persistent, heavy metallic knocking noise that can lead to engine damage.

### ■ Top tier detergent gasoline

Because the level of detergency and additives in gasoline vary in the market, Honda endorses the use of “TOP TIER Detergent Gasoline” where available to help maintain the performance and reliability of your vehicle. TOP TIER Detergent Gasoline meets a new gasoline standard jointly established by leading automotive manufacturers to meet the needs of today’s advanced engines.

Qualifying gasoline retailers will, in most cases, identify their gasoline as having met “TOP TIER Detergent Gasoline” standards at the retail location. This fuel is guaranteed to contain the proper level of detergent additives and be free of metallic additives. The proper level of detergent additives, and absence of harmful metallic additives in gasoline, help avoid build-up of deposits in your engine and emission control system.

For further important fuel-related information for your vehicle, or on information on gasoline that does not contain MMT, visit [www.hondacars.com](http://www.hondacars.com). In Canada, visit [www.honda.ca](http://www.honda.ca) for additional information on gasoline. For more information on top tier gasoline, visit [www.toptiergas.com](http://www.toptiergas.com).

*Continued*

### » Fuel Information

#### NOTICE

We recommend quality gasoline containing detergent additives that help prevent fuel system and engine deposits. In addition, in order to maintain good performance, fuel economy, and emissions control, we strongly recommend the use of gasoline that does NOT contain harmful manganese-based fuel additives such as MMT, if such gasoline is available.

Use of gasoline with these additives may adversely affect performance, and cause the malfunction indicator lamp on your instrument panel to come on. If this happens, contact a dealer for service.

### ■ Gasoline containing ethanol

Some gasoline today is blended with oxygenates such as ethanol. Your vehicle is designed to operate on oxygenated gasoline containing up to 10% ethanol by volume. Do not use gasoline containing methanol. If you notice any undesirable operating symptoms, try another service station or switch to another brand of gasoline.

### ■ Fuel tank capacity: 21.0 US gal (79.5 liters)

## How to Refuel

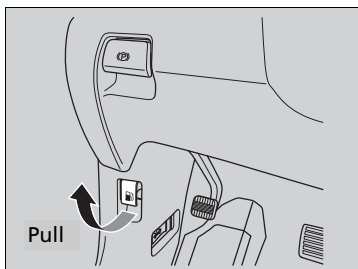

1. Stop your vehicle with the service station pump on the left side of the vehicle in the rear.
2. Turn off the engine.
3. Pull on the fuel fill door release handle under the lower left corner of the dashboard.
  - ▶ The fuel fill door opens.

### ▶▶ How to Refuel

## ⚠ WARNING

Gasoline is highly flammable and explosive. You can be burned or seriously injured when handling fuel.

- Stop the engine, and keep heat, sparks, and flame away.
- Handle fuel only outdoors.
- Wipe up spills immediately.

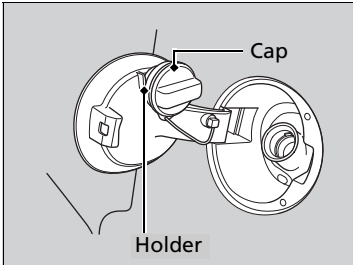
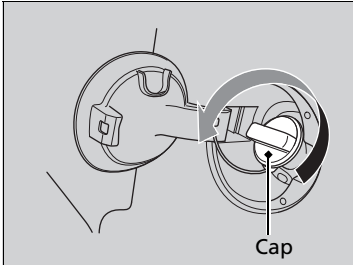

**4.** Remove the fuel fill cap slowly. If you hear a release of air, wait until this stops, then turn the knob slowly to open the fuel fill cap.

**5.** Place the fuel fill cap in the holder.

**6.** Insert the fuel filler nozzle fully.

▶ When the tank is full, the filler nozzle will click off automatically. This leaves space in the fuel tank in case the fuel expands with a change in the temperature.

**7.** After filling, replace the fuel fill cap, tightening it until you hear it click at least once.

▶ Shut the fuel fill door by hand.

#### How to Refuel

The filler nozzle automatically stops to leave space in the fuel tank so that fuel does not overflow as a result of changes in air temperature.

If the fuel filler nozzle keeps turning off when the tank is not full, there may be a problem with the pump's fuel vapor recovery system. Try filling at another pump. If this does not fix the problem, consult a dealer.

Do not continue to add fuel after the nozzle has automatically stopped. Additional fuel can exceed the full tank capacity.

## Improving Fuel Economy

Fuel economy depends on several conditions, including driving conditions, your driving habits, the condition of your vehicle, and loading. Depending on these and other conditions, you may or may not achieve the rated fuel economy of this vehicle.

### Maintenance and Fuel Economy

You can optimize your fuel economy with proper maintenance of your vehicle. Always maintain your vehicle in accordance with the messages displayed on the information display\*/multi-information display\*.

- Use the recommended viscosity engine oil, displaying the API Certification Seal.
- Maintain the specified tire pressure.
- Do not load the vehicle with excess cargo.
- Keep your vehicle clean. A buildup of snow or mud on your vehicle's underside adds weight and increases wind resistance.

### Improving Fuel Economy

Direct calculation is the recommended method to determine actual fuel consumed while driving.

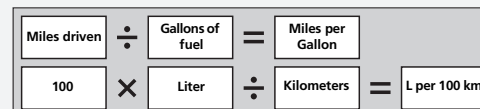

In Canada, posted fuel economy numbers are established following a simulated test. For more information on how this test is performed, please visit <http://oee.nrcan.gc.ca/>

## Accessories

When installing accessories, check the following:

- Do not install accessories on the windshield. They can obstruct your view and delay your reaction to driving conditions.
- Do not install accessories on the side pillars or across the side windows. Accessories installed in these areas may interfere with proper operation of the side curtain airbags.
- Be sure electronic accessories do not overload electrical circuits or interfere with proper operation of your vehicle.  
[▶ Fuses P. 454](#)
- Before installing any electronic accessory, have the installer contact a dealer for assistance. If possible, have a dealer inspect the final installation.

## Modifications

Do not modify your vehicle or use non-Honda components that can affect its handling, stability, and reliability.

Overall vehicle performance can be affected. Always make sure all equipment is properly installed and maintained, and that it meets federal, state, province, territory, and local regulations.

Accessories and Modifications

### **⚠ WARNING**

Improper accessories or modifications can affect your vehicle's handling, stability, and performance, and cause a crash in which you can be seriously hurt or killed.

Follow all instructions in this owner's manual regarding accessories and modifications.

Honda Genuine accessories are recommended to ensure proper operation on your vehicle.





# Maintenance

This chapter discusses basic maintenance.



## Before Performing Maintenance

- Inspection and Maintenance ..... 378
- Safety When Performing Maintenance..... 379
- Parts and Fluids Used in Maintenance Service ..... 380

## Maintenance Minder™ ..... 381

## Maintenance Under the Hood

- Maintenance Items Under the Hood..... 389
- Opening the Hood ..... 390
- Recommended Engine Oil ..... 392
- Oil Check ..... 393
- Adding Engine Oil ..... 394
- Changing the Engine Oil and Oil Filter ..... 395

- Engine Coolant ..... 397
- Transmission Fluid ..... 399
- Brake Fluid ..... 400
- Power Steering Fluid ..... 400
- Refilling Window Washer Fluid..... 401
- Replacing Light Bulbs** ..... 402
- Checking and Maintaining Wiper Blades** .... 410
- Checking and Maintaining Tires**
- Checking Tires ..... 414
- Tire and Loading Information Label..... 415
- Tire Labeling ..... 415
- DOT Tire Quality Grading (U.S. Vehicles)..... 417
- Wear Indicators..... 419

- Tire Service Life ..... 419
- Tire and Wheel Replacement ..... 420
- Tire Rotation ..... 421
- Winter Tires ..... 422
- Battery** ..... 423
- Remote Transmitter Care**
- Replacing the Button Battery ..... 424
- Remote Control and Wireless Headphone Care\*** ..... 425
- Climate Control System Maintenance** ..... 427
- Cleaning**
- Interior Care ..... 428
- Exterior Care..... 430

\* Not available on all models

## Inspection and Maintenance

For your safety, perform all listed inspections and maintenance to keep your vehicle in good condition. If you become aware of any abnormality (noise, smell, insufficient brake fluid, oil residue on the ground, etc.), have your vehicle inspected by a dealer. (Note, however, that service at a dealer is not mandatory to keep your warranties in effect.) Refer to the separate maintenance booklet for detailed maintenance and inspection information.

### Types of Inspection and Maintenance

#### ■ Daily inspections

Perform inspections before long distance trips, when washing the vehicle, or when refueling.

#### ■ Periodic inspections

- Check the automatic transmission fluid level monthly.  
[Automatic Transmission Fluid P. 399](#)
- Check the brake fluid level monthly.  
[Checking the Brake Fluid P. 400](#)
- Check the tire pressure monthly. Examine the tread for wear and foreign objects.  
[Checking and Maintaining Tires P. 414](#)
- Check the operation of the exterior lights monthly.  
[Replacing Light Bulbs P. 402](#)
- Check the condition of the wiper blades at least every six months.  
[Checking and Maintaining Wiper Blades P. 410](#)

### Inspection and Maintenance

#### U.S. models

**Maintenance, replacement, or repair of emissions control devices and systems may be done by any automotive repair establishment or individuals using parts that are "certified" to EPA standards.**

According to state and federal regulations, failure to perform maintenance on the maintenance main items marked with # will not void your emissions warranties. However, all maintenance services should be performed in accordance with the intervals indicated by the information display\*/multi-information display\*.

[Maintenance Service Items P. 383](#)

If you want to perform complex maintenance tasks that require more skills and tools, purchase the service manual.

[Authorized Manuals P. 474](#)

If you want to perform maintenance yourself, make sure that you have the necessary tools and skills first. After performing maintenance, update the records in the separate maintenance booklet.

## Safety When Performing Maintenance

Some of the most important safety precautions are given here. However, we cannot warn you of every conceivable hazard that can arise in performing maintenance. Only you can decide whether or not you should perform a given task.

### Maintenance Safety

- To reduce the possibility of fire or explosion, keep cigarettes, sparks, and flames away from the battery and all fuel related parts.
- Never leave rags, towels, or other flammable objects under the hood.
  - ▶ Heat from the engine and exhaust can ignite them causing a fire.
- To clean parts, use a commercially available degreaser or parts cleaner, not gasoline.
- Wear eye protection and protective clothing when working with the battery or compressed air.
- Engine exhaust contains carbon monoxide, which is poisonous and can kill you.
  - ▶ Only operate the engine if there is sufficient ventilation.

### Vehicle Safety

- The vehicle must be in a stationary condition.
  - ▶ Make sure your vehicle is parked on level ground, the parking brake is set, and the engine is off.
- Be aware that hot parts can burn you.
  - ▶ Make sure to let the engine and exhaust system cool thoroughly before touching vehicle parts.
- Be aware that moving parts can injure you.
  - ▶ Do not start the engine unless instructed, and keep your hands and limbs away from moving parts.

#### ⓘ Safety When Performing Maintenance

### WARNING

Improperly maintaining this vehicle or failing to correct a problem before driving can cause a crash in which you can be seriously hurt or killed.

Always follow the inspection and maintenance recommendations according to the schedules in this owner's manual.

### WARNING

Failure to properly follow maintenance instructions and precautions can cause you to be seriously hurt or killed.

Always follow the procedures and precautions in this owner's manual.

## Parts and Fluids Used in Maintenance Service

---

The use of Honda genuine parts and fluids is recommended when maintaining and servicing your vehicle. Honda genuine parts are manufactured according to the same high quality standards used in Honda vehicles.



If the engine oil life is less than 15%, you will see the Maintenance Minder messages appear on the information display\* or the multi-information display\* every time you turn the ignition switch to ON . The messages notify you when to change the engine oil, or when to bring your vehicle to a dealer for indicated maintenance services.

Models with information display

## To Use Maintenance Minder™

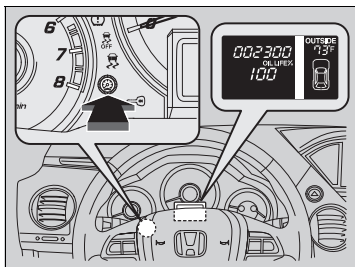
### ■ Displaying the Engine Oil Life



1. Turn the ignition switch to ON .
2. Press the  (Select/Reset) knob repeatedly until the engine oil life appears on the information display.

The Maintenance Minder indicator () stays on in the instrument panel after the engine oil life becomes 0%. Have the indicated maintenance done by a dealer immediately.

### ▣ Displaying the Engine Oil Life

Based on the engine operating conditions, the remaining engine oil life is calculated and displayed as a percentage.





Displayed Engine Oil Life (%)	Calculated Engine Oil Life (%)
100	100 to 91
90	90 to 81
80	80 to 71
70	70 to 61
60	60 to 51
50	50 to 41
40	40 to 31
30	30 to 21
20	20 to 16
15	15 to 11
10	10 to 6
5	5 to 1
0	0

\* Not available on all models

Continued

## ■ Maintenance Minder Messages on the Information Display

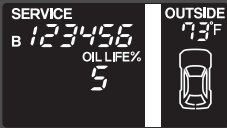
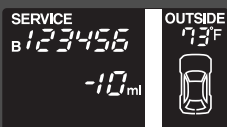
To switch the display, press the  (Select/Reset) knob.

Oil Life Display	Explanation	Information	Maintenance Minder Indicator
	<p>The engine oil life indicator starts to appear along with other due soon maintenance item codes when the remaining oil life becomes 15 percent.</p>	<p>The engine oil is approaching the end of its service life.</p>	 <p>Starts to come on when the remaining engine oil life becomes 15 percent.</p>
	<p>The <b>SERVICE</b> message also starts to appear along with the engine oil life indicator and the maintenance item codes.</p>	<p>The engine oil has almost reached the end of its service life, and the maintenance items should be inspected and serviced as soon as possible.</p>	<p>It goes off when the display is switched.</p>
	<p>The remaining engine oil life has passed its service life, and a negative distance appears after driving over 10 miles (U.S. models) or 10 km (Canadian models). The negative distance on the display blinks.</p>	<p>The engine oil life has passed. The maintenance items must be inspected and serviced immediately.</p>	 <p>Stays on as a reminder even when the display is switched.</p>

## Maintenance Service Items

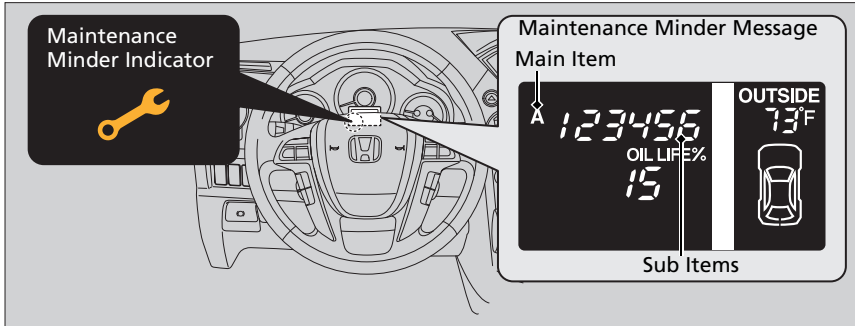

### Maintenance Service Items

- Independent of the Maintenance Minder information, replace the brake fluid every 3 years.
- Inspect idle speed every 160,000 miles (256,000 km).
- Adjust the valves during services A, B, 1, 2, or 3 if they are noisy.

CODE	Maintenance Main Items
A	<ul style="list-style-type: none"> <li>• Replace engine oil<sup>*1</sup></li> </ul>
B	<ul style="list-style-type: none"> <li>• Replace engine oil<sup>*1</sup> and oil filter</li> <li>• Inspect front and rear brakes/service as necessary</li> <li>• Check parking brake adjustment</li> <li>• Inspect tie rod ends, steering gearbox, and boots</li> <li>• Inspect suspension components</li> <li>• Inspect driveshaft boots</li> <li>• Inspect brake hoses and lines (Including ABS/VSA)</li> <li>• Inspect all fluid levels and condition of fluids</li> <li>• Inspect exhaust system<sup>#</sup></li> <li>• Inspect fuel lines and connections<sup>#</sup></li> </ul>

CODE	Maintenance Sub Items
1	<ul style="list-style-type: none"> <li>• Rotate tires</li> </ul>
2	<ul style="list-style-type: none"> <li>• Replace air cleaner element<sup>*2</sup></li> <li>• Replace dust and pollen filter<sup>*3</sup></li> <li>• Inspect drive belt</li> </ul>
3	<ul style="list-style-type: none"> <li>• Replace transmission and transfer<sup>*</sup> fluid</li> </ul>
4	<ul style="list-style-type: none"> <li>• Replace spark plugs</li> <li>• Replace timing belt and inspect water pump<sup>*4</sup></li> <li>• Inspect valve clearance</li> </ul>
5	<ul style="list-style-type: none"> <li>• Replace engine coolant</li> </ul>
6	<ul style="list-style-type: none"> <li>• Replace VTM-4<sup>®</sup> rear differential fluid<sup>*5</sup></li> </ul>

<sup>\*1</sup>: If a message **SERVICE** does not appear more than 12 months after the display is reset, change the engine oil every year.

<sup>\*2</sup>: If you drive in dusty conditions, replace the air cleaner element every 15,000 miles (24,000 km).

<sup>\*3</sup>: If you drive primarily in urban areas that have high concentrations of soot in the air from industry and from diesel-powered vehicles, replace the dust and pollen filter every 15,000 miles (24,000 km).

<sup>#</sup>: See information on maintenance and emissions warranty.

<sup>\*</sup> Not available on all models

<sup>\*4</sup>: If you drive regularly in very high temperatures (over 110°F, 43°C), in very low temperatures (under -20°F, -29°C), or tow a trailer, replace every 60,000 miles/100,000 km.

<sup>\*5</sup>: Driving in mountainous areas at very low vehicle speeds or trailer towing results in higher level of mechanical (shear) stress to fluid. This requires differential fluid changes more frequently than recommended by the Maintenance Minder. If you regularly drive your vehicle under these conditions, have the differential fluid changed at 7,500 miles (12,000 km), then every 15,000 miles (24,000 km).

Continued



## Resetting the Display

Reset the engine oil life display if you have performed the maintenance service.

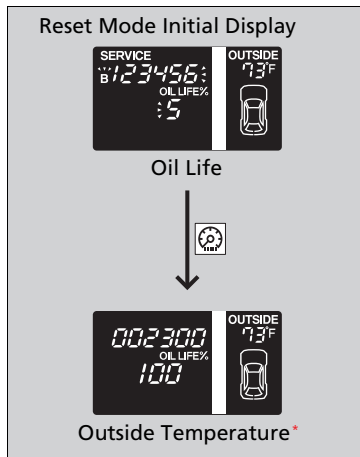

1. Turn the ignition switch to ON **II**.
2. Display the engine oil life by repeatedly pressing the (Select/Reset) knob.
3. Press and hold the knob for ten seconds or more.
  - The information display shows the reset mode initial display.
4. Press and hold the knob for five seconds or more.
  - The displayed maintenance items disappear and the engine oil life display will return to 100%.

## Resetting the Display

### NOTICE



Failure to reset the engine oil life after a maintenance service results in the system showing incorrect maintenance intervals, which can lead to serious mechanical problems.

The dealer will reset the engine oil life display after completing the required maintenance service. If someone other than a dealer performs maintenance service, reset the engine oil life display yourself.

Models with multi-information display

## To Use Maintenance Minder™

### ■ Displaying the Engine Oil Life

1. Turn the ignition switch to ON .
2. Press the  /  button repeatedly until the engine oil life appears on the multi-information display.

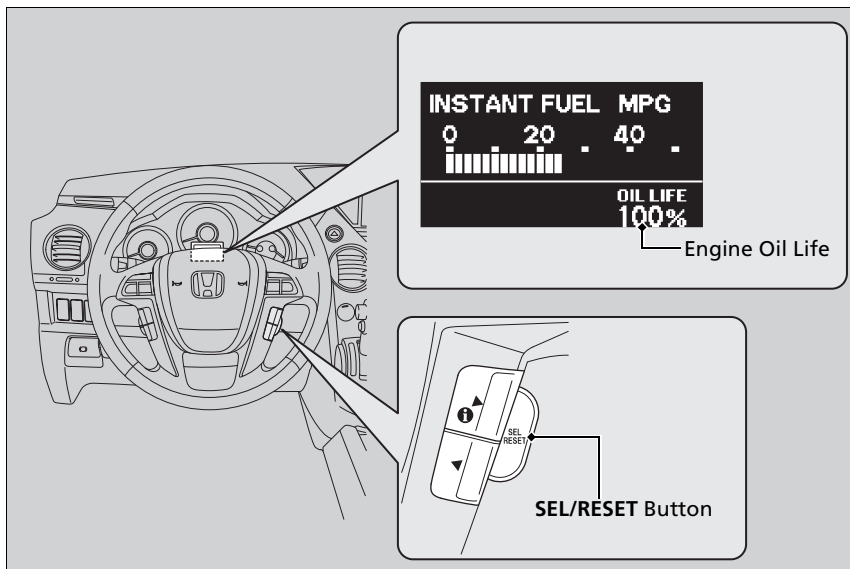

### ☒ Displaying the Engine Oil Life









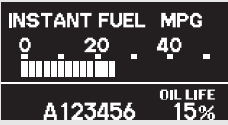

Based on the engine operating conditions, the remaining engine oil life is calculated and displayed as a percentage.

Displayed Engine Oil Life (%)	Calculated Engine Oil Life (%)
100	100 to 91
90	90 to 81
80	80 to 71
70	70 to 61
60	60 to 51
50	50 to 41
40	40 to 31
30	30 to 21
20	20 to 16
15	15 to 11
10	10 to 6
5	5 to 1
0	0

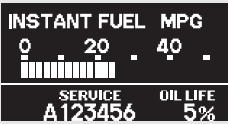
There is a list of maintenance main and sub items you can view on the multi-information display.

[▶ Maintenance Service Items P. 387](#)

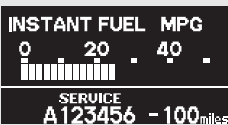
## Maintenance Minder Messages on the Multi-Information Display

Maintenance Message	Oil Life Display	Explanation	Information
<p><b>SERVICE DUE SOON</b></p> 	<p>15%</p> 	<p>The remaining engine oil life is 15 to 6 percent. Once you switch the display by pressing the  /  (information) button, this message will go off.</p>	<p>The engine oil is approaching the end of its service life, and the maintenance items should be inspected and serviced soon.</p>
<p><b>SERVICE DUE NOW</b></p> 	<p>5%</p> 	<p>The remaining engine oil life is 5 to 1 percent. Press the  /  button to switch to another display.</p>	<p>The engine oil has almost reached the end of its service life, and the maintenance items should be inspected and serviced as soon as possible.</p>
<p><b>SERVICE PAST DUE</b></p> 	<p>Negative Distance</p> 	<p>The remaining engine oil life has passed its service life, and a negative distance appears after driving over 10 miles (U.S. models) or 10 km (Canadian models). Press the  /  button to switch to another display.</p>	<p>The engine oil life has passed. The maintenance items must be inspected and serviced immediately.</p>

The system message indicator (i) comes on along with the Maintenance Minder message.

## Maintenance Service Items

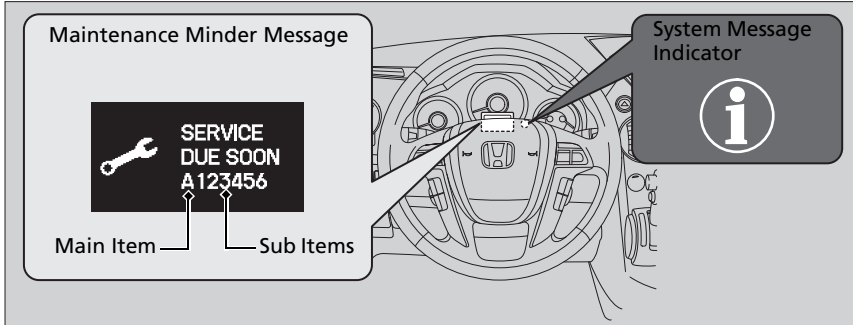

### ⊠ Maintenance Service Items

- Independent of the Maintenance Minder information, replace the brake fluid every 3 years.
- Inspect idle speed every 160,000 miles (256,000 km).
- Adjust the valves during services A, B, 1, 2, or 3 only if they are noisy.

CODE	Maintenance Main Items
A	<ul style="list-style-type: none"> <li>• Replace engine oil<sup>*1</sup></li> </ul>
B	<ul style="list-style-type: none"> <li>• Replace engine oil<sup>*1</sup> and oil filter</li> <li>• Inspect front and rear brakes/service as necessary</li> <li>• Check parking brake adjustment</li> <li>• Inspect tie rod ends, steering gearbox, and boots</li> <li>• Inspect suspension components</li> <li>• Inspect driveshaft boots</li> <li>• Inspect brake hoses and lines (Including ABS/VSA)</li> <li>• Inspect all fluid levels and condition of fluids</li> <li>• Inspect exhaust system<sup>#</sup></li> <li>• Inspect fuel lines and connections<sup>#</sup></li> </ul>

<sup>\*1</sup>: If a message **SERVICE** does not appear more than 12 months after the display is reset, change the engine oil every year.

<sup>\*2</sup>: If you drive in dusty conditions, replace the air cleaner element every 15,000 miles (24,000 km).

<sup>\*3</sup>: If you drive primarily in urban areas that have high concentrations of soot in the air from industry and from diesel-powered vehicles, replace the dust and pollen filter every 15,000 miles (24,000 km).

<sup>#</sup>: See information on maintenance and emissions warranty.

\* Not available on all models

CODE	Maintenance Sub Items
1	<ul style="list-style-type: none"> <li>• Rotate tires</li> </ul>
2	<ul style="list-style-type: none"> <li>• Replace air cleaner element<sup>*2</sup></li> <li>• Replace dust and pollen filter<sup>*3</sup></li> <li>• Inspect drive belt</li> </ul>
3	<ul style="list-style-type: none"> <li>• Replace transmission and transfer<sup>+</sup> fluid</li> </ul>
4	<ul style="list-style-type: none"> <li>• Replace spark plugs</li> <li>• Replace timing belt and inspect water pump<sup>*4</sup></li> <li>• Inspect valve clearance</li> </ul>
5	<ul style="list-style-type: none"> <li>• Replace engine coolant</li> </ul>
6	<ul style="list-style-type: none"> <li>• Replace VTM-4<sup>®</sup>* rear differential fluid<sup>*5</sup></li> </ul>

<sup>\*4</sup>: If you drive regularly in very high temperatures (over 110°F, 43°C), in very low temperatures (under -20°F, -29°C), or tow a trailer, replace every 60,000 miles/100,000 km.

<sup>\*5</sup>: Driving in mountainous areas at very low vehicle speeds or trailer towing results in higher level of mechanical (shear) stress to fluid. This requires differential fluid changes more frequently than recommended by the Maintenance Minder. If you regularly drive your vehicle under these conditions, have the differential fluid changed at 7,500 miles (12,000 km), then every 15,000 miles (24,000 km).

Continued

## ■ Resetting the Display

Reset the engine oil life display if you have performed the maintenance service.

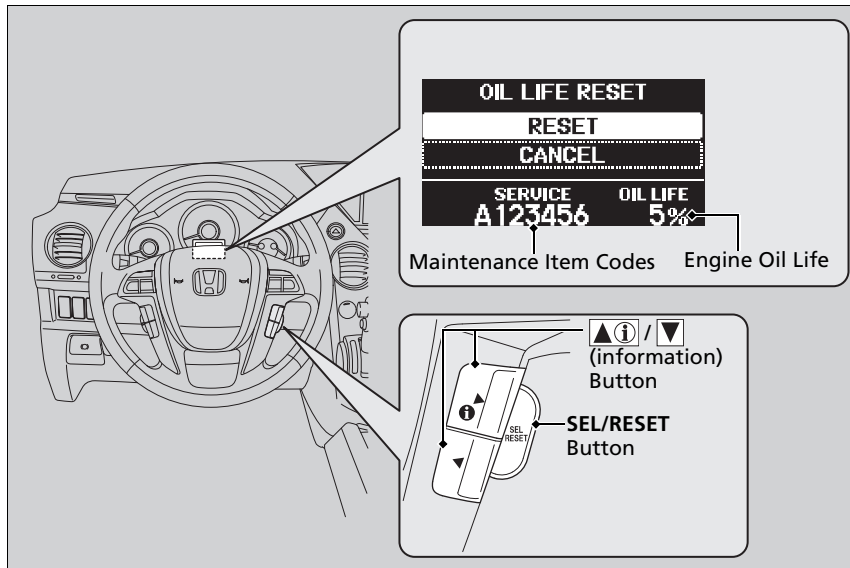

1. Turn the ignition switch to ON **II**.
  2. Display the engine oil life by repeatedly pressing the **SEL/RESET** button.
  3. Press and hold the **SEL/RESET** button for 10 seconds or more.
    - ▶ The oil life reset mode is displayed on the multi-information display.
  4. Select **RESET** with the ▲①/▼ button, then press the **SEL/RESET** button.
    - ▶ The service code will disappear and the engine oil life display will return to 100%.
- To cancel the oil life reset mode, select **CANCEL**, then press the **SEL/RESET** button.

## ▶▶ Resetting the Display

### NOTICE

Failure to reset the engine oil life after a maintenance service results in the system showing incorrect maintenance intervals, which can lead to serious mechanical problems.

The dealer will reset the engine oil life display after completing the required maintenance service. If someone other than a dealer performs maintenance service, reset the engine oil life display yourself.

## Maintenance Items Under the Hood

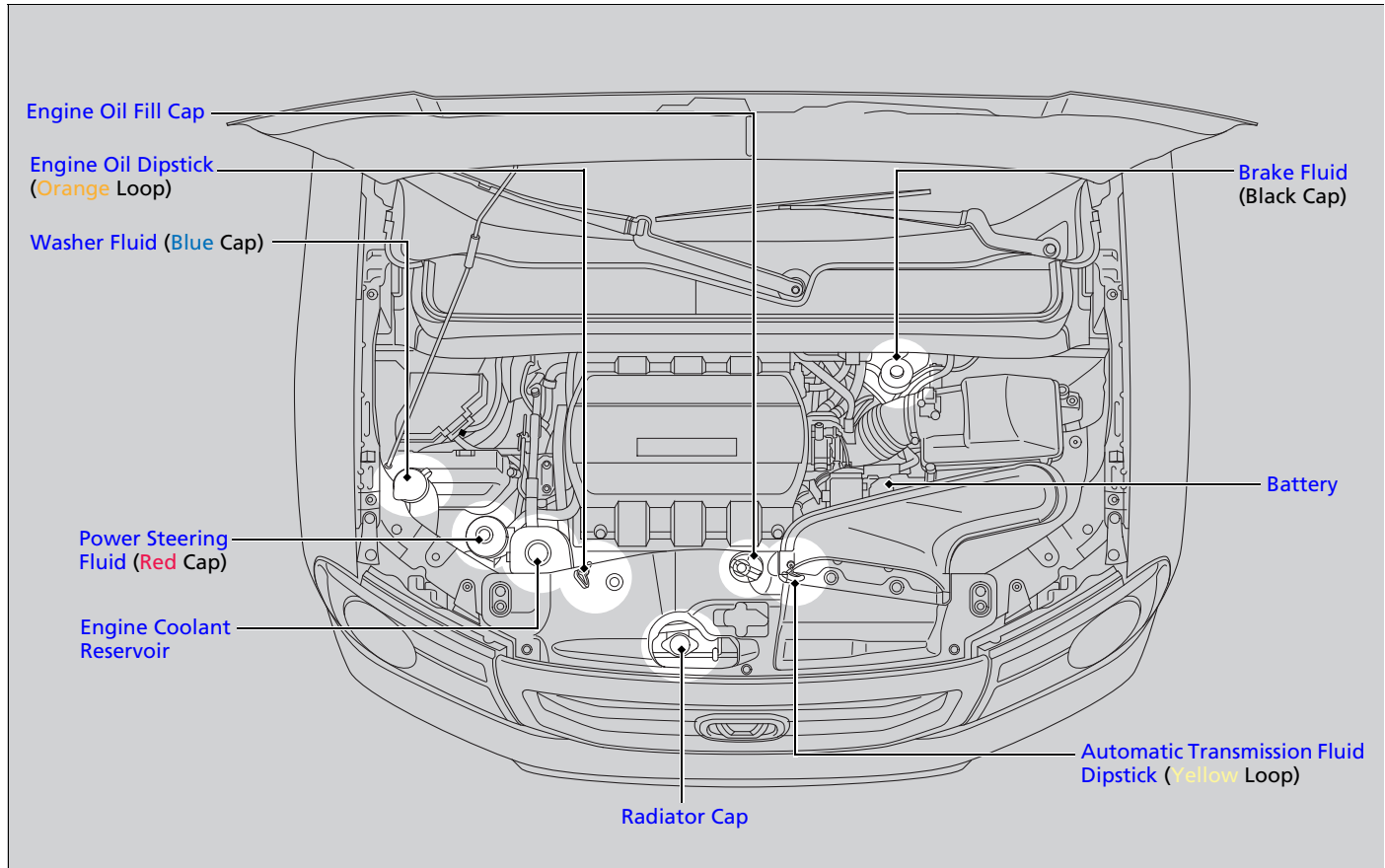

## Opening the Hood

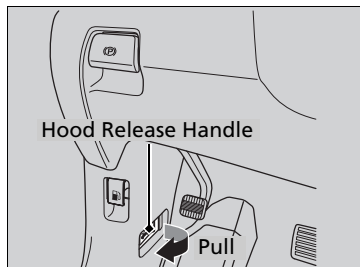

1. Park the vehicle on a level surface, and set the parking brake.
2. Pull the hood release handle under the lower left corner of the dashboard.
  - The hood will pop up slightly.

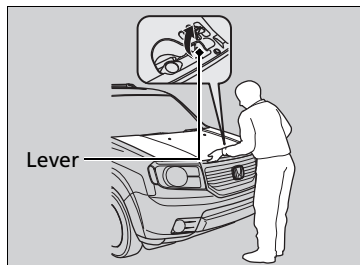

3. Push up the hood latch lever in the center of the hood to release the lock mechanism, and open the hood.

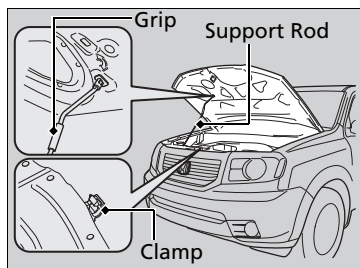

4. Remove the support rod from the clamp using the grip. Mount the support rod in the hood.

When closing, remove the support rod, and stow it in the clamp, then gently lower the hood. Remove your hand at a height of approximately 12 inches (30 cm) and let the hood close.

### ►► Opening the Hood

#### NOTICE

Do not open the hood when the wiper arms are raised.

The hood will strike the wipers, and may damage either the hood or the wipers.

When closing the hood, check that the hood is securely latched.

If the hood latch lever moves stiffly, or if you can open the hood without lifting the lever, the latch mechanism should be cleaned and lubricated.

## Engine Compartment Covers

The component parts in the engine compartment are protected by two covers. You may need to remove the covers when you perform certain maintenance work. To remove the covers:

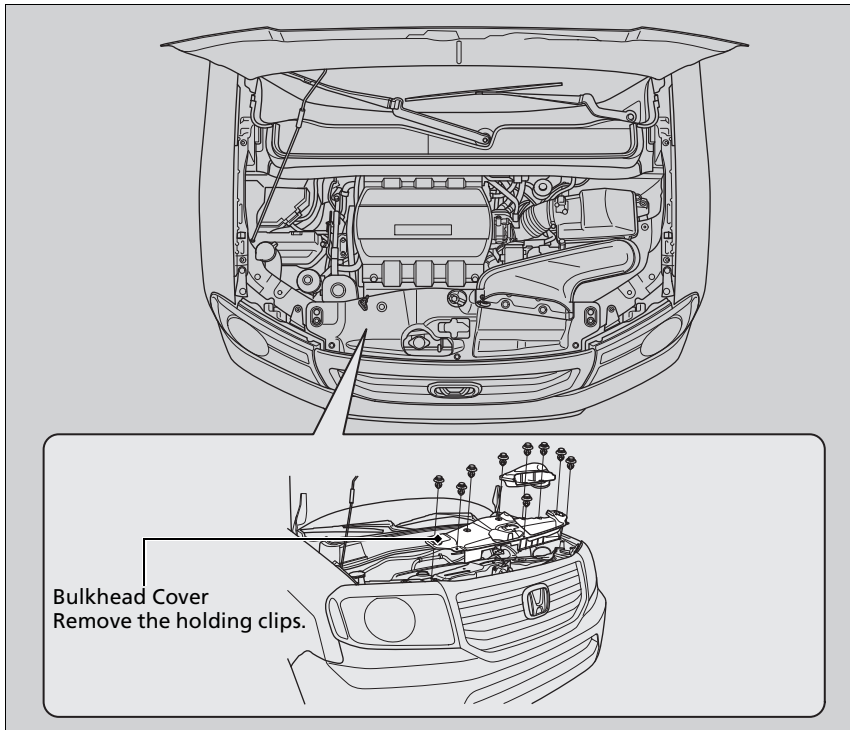

### ✕ Engine Compartment Covers

When removing the clip, insert a flat-tip screwdriver, then lift and remove the center pin.

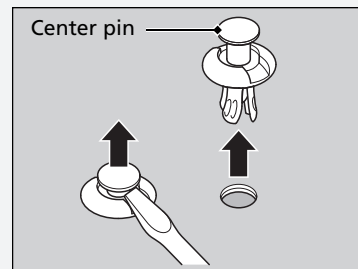

When mounting the clip, insert while keeping the center pin of the clip raised, then push until the pin is flat.

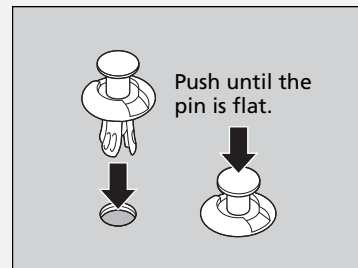



## Recommended Engine Oil

- **Genuine Honda Motor Oil**
- **Premium-grade 0W-20 detergent oil with an API Certification Seal on the container.**



Oil is a major contributor to your engine's performance and longevity. If you drive the vehicle with insufficient or deteriorated oil, the engine may fail or be damaged.

This seal indicates the oil is energy conserving and that it meets the American Petroleum Institute's latest requirements.

Use a Genuine Honda Motor Oil or another commercial engine oil of suitable viscosity for the ambient temperature as shown.

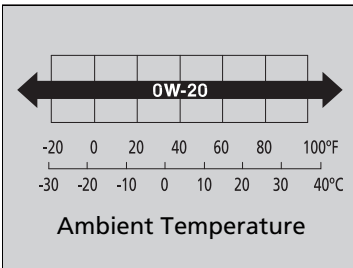

### ■ Synthetic oil

You may also use synthetic motor oil if it is labeled with the API Certification Seal and is the specified viscosity grade.

### ►► Recommended Engine Oil

#### Engine Oil Additives

Your vehicle does not require oil additives. In fact, they may adversely affect the engine performance and durability.

## Oil Check

We recommend that you check the engine oil level every time you refuel.

Park the vehicle on level ground.

Wait approximately three minutes after turning the engine off before you check the oil.

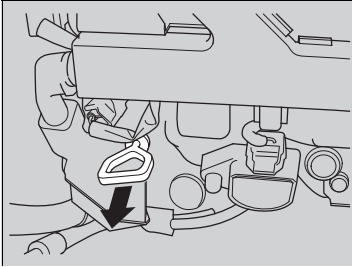

1. Remove the dipstick (orange loop).
2. Wipe the dipstick with a clean cloth or paper towel.
3. Insert the dipstick back all the way into its hole.

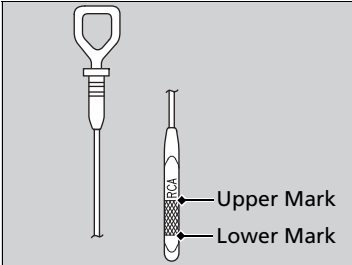

4. Remove the dipstick again, and check the level. It should be between the upper and lower marks. Add oil if necessary.

### Oil Check

If the oil level is near or below the lower mark, slowly add oil being careful not to overfill.

## Adding Engine Oil

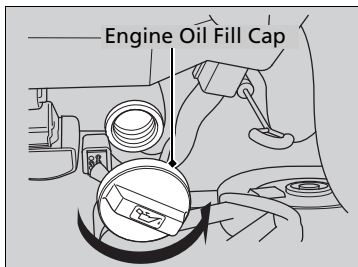

1. Unscrew and remove the engine oil fill cap.
2. Add oil slowly.
3. Reinstall the engine oil fill cap, and tighten it securely.
4. Wait for three minutes and recheck the engine oil dipstick.

### ►► Adding Engine Oil

If any oil spills, wipe it up immediately. Spilled oil may damage the engine compartment components.

#### NOTICE

Do not fill the engine oil above the upper mark. Overfilling the engine oil can result in leaks and engine damage.

## Changing the Engine Oil and Oil Filter

You must change the engine oil and oil filter regularly in order to maintain the engine's lubrication. The engine may be damaged if they are not changed regularly.

Change the oil and filter in accordance with the maintenance message on the information display\*/multi-information display\*.

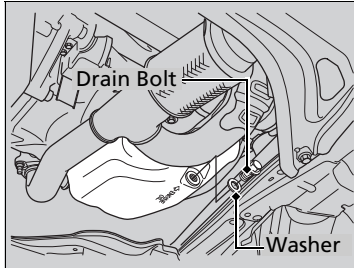

1. Run the engine until it reaches normal operating temperature, and then turn the engine off.
2. Open the hood and remove the engine oil fill cap.
3. Remove the drain bolt and washer from the bottom of the engine, and drain the oil into a suitable container.

### Changing the Engine Oil and Oil Filter

#### NOTICE

You may damage the environment if you do not dispose of the oil in a suitable way. If you are changing the oil by yourself, appropriately dispose of the used oil. Put the oil in a sealed container and take it to a recycling center. Do not throw the oil away into a garbage can or onto the ground.

\* Not available on all models

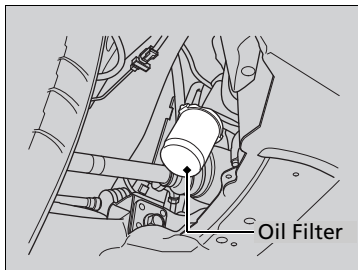

4. Remove the oil filter and dispose of the remaining oil.
5. Check that the filter gasket is not stuck to the engine contact surface.
  - If it is stuck, you must detach it.
6. Wipe away dirt and dust adhering to the contact surface of the engine block, and install a new oil filter.
  - Apply a light coat of new engine oil to the filter gasket.
7. Put a new washer on the drain bolt, then reinstall the drain bolt.
  - Tightening torque:  
29 lbf-ft (39 N·m, 4.0 kgf·m)
8. Pour the recommended engine oil into the engine.
  - Engine oil change capacity (including filter):  
4.5 US qt (4.3 L)
9. Reinstall the engine oil fill cap securely and start the engine.
10. Run the engine for a few minutes, and then check that there is no leak from the drain bolt or oil filter.
11. Stop the engine, wait for three minutes, and then check the oil level on the dipstick.
  - If necessary, add more engine oil.

#### ✎ Changing the Engine Oil and Oil Filter

You will need a special wrench to replace the oil filter. You can buy this wrench from a dealer.

When installing the new oil filter, follow the instructions supplied with the oil filter.

Reinstall the engine oil fill cap. Start the engine. The low oil pressure indicator should go off within five seconds. If it does not, turn off the engine, and check your work.

# Engine Coolant

## Specified coolant: Honda Long Life Antifreeze/Coolant Type 2

This coolant is premixed with 50% antifreeze and 50% water. Do not add any straight antifreeze or water.

We recommend you check the engine coolant level every time you refuel. Check the reserve tank first. If it is completely empty, also check the coolant level in the radiator. Add the engine coolant accordingly.

### Reserve Tank

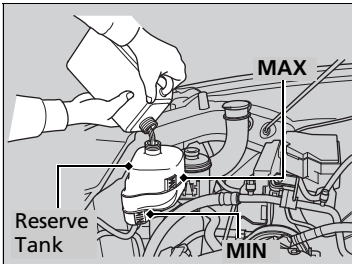

1. Check the amount of coolant in the reserve tank.
2. If the coolant level is below the **MIN** mark, add the specified coolant until it reaches the **MAX** mark.
3. Inspect the cooling system for leaks.

### Engine Coolant

#### NOTICE

If temperatures consistently below -22°F (-30°C) are expected, the coolant mixture should be changed to a higher concentration. Consult a dealer for more information.

If Honda antifreeze/coolant is not available, you may use another major brand non-silicate coolant as a temporary replacement. Check that it is a high quality coolant recommended for aluminum engines. Continued use of any non-Honda coolant can result in corrosion, causing the cooling system to malfunction or fail. Have the cooling system flushed and refilled with Honda antifreeze/coolant as soon as possible.

Do not add rust inhibitors or other additives to your vehicle's coolant system. They may not be compatible with the coolant or with the engine components.

Continued

QRG

TOC

Maintenance

Index

Home

## Radiator

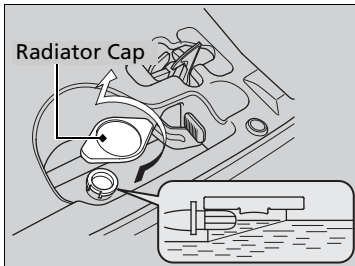

1. **Make sure the engine and radiator are cool.**
2. Turn the radiator cap counterclockwise and relieve any pressure in the coolant system. Do not push the cap down when turning.
3. Push down and turn the radiator cap counterclockwise to remove it.
4. The coolant level should be up to the base of the filler neck. Add coolant if it is low.
5. Put the radiator cap back on, and tighten it fully.
6. Pour coolant into the reserve tank until it reaches the **MAX** mark. Put the cap back on the reserve tank.

### Radiator

#### **⚠ WARNING**

Removing the radiator cap while the engine is hot can cause the coolant to spray out, seriously scalding you.

Always let the engine and radiator cool down before removing the radiator cap.

#### **NOTICE**

Pour the fluid slowly and carefully so you do not spill any. Clean up any spills immediately; they can damage components in the engine compartment.

## Transmission Fluid

### Automatic Transmission Fluid

#### Specified fluid: Honda ATF DW-1 (automatic transmission fluid)

Check the fluid level when the engine is at normal operating temperature.

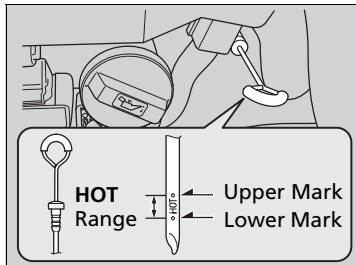

1. Park on level ground, and start the engine.
2. Wait until the radiator fan starts and then turn off the engine.
  - ▶ Perform step 3 after waiting for about 60 seconds (less than 90 seconds).
3. Remove the dipstick (yellow loop) from the transmission and wipe it with a clean cloth.
4. Insert the dipstick all the way back into the transmission securely, as shown in the image.
5. Remove the dipstick and check the fluid level.
  - ▶ It should be between the upper and lower marks in the **HOT** range.
6. If the level is below the lower mark, add fluid into the dipstick hole to bring it to the level between the upper and lower marks, and have your vehicle checked by a dealer immediately.

#### Automatic Transmission Fluid

##### NOTICE

**Do not mix Honda ATF DW-1 with other transmission fluids.**

Using a transmission fluid other than Honda ATF DW-1 may adversely affect the operation and durability of your vehicle's transmission, and damage the transmission.

Any damage caused by using a transmission fluid that is not equivalent to Honda ATF DW-1 is not covered by Honda's new vehicle warranty.

##### NOTICE

Pour the fluid slowly and carefully so you do not spill any. Clean up any spills immediately; they can damage components in the engine compartment.



## Brake Fluid

**Specified fluid: Honda Heavy Duty Brake Fluid DOT 3**

### ■ Checking the Brake Fluid

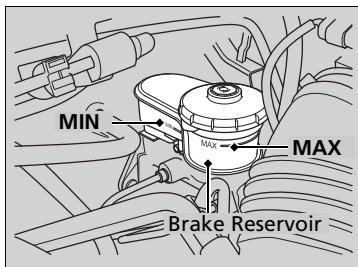

The fluid level should be between the **MIN** and **MAX** marks on the side of the reservoir.

## Power Steering Fluid

**Specified fluid: Honda Power Steering Fluid**

We recommend that you check the power steering fluid level every time you refuel. Check when the engine is not running.

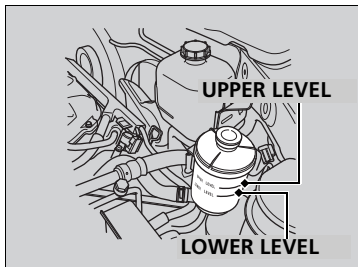

1. Look at the side of the reservoir. The fluid should be between the **UPPER LEVEL** and **LOWER LEVEL**.
2. Add power steering fluid if necessary to the **UPPER LEVEL** mark.
  - Inspect the system for a leak. If the fluid level goes below the **LOWER LEVEL** frequently, have the system inspected as soon as possible.

### ►► Brake Fluid

#### NOTICE

Brake fluid marked DOT 5 is not compatible with your vehicle's braking system and can cause extensive damage.

If the specified brake fluid is not available, you should use only DOT 3 or DOT 4 fluid from a sealed container as a temporary replacement.

Using any non-Honda brake fluid can cause corrosion and decrease the longevity of the system. Have the brake system flushed and refilled with Honda Heavy Duty Brake Fluid DOT 3 as soon as possible.

If the brake fluid level is at or below the **MIN** mark, have a dealer inspect for leaks or worn brake pads as soon as possible.

### ►► Power Steering Fluid

#### NOTICE

Turning the steering wheel to full left or right lock and holding it there can damage the power steering pump.

#### NOTICE

Pour the fluid slowly and carefully so you do not spill any. Clean up any spills immediately; it could damage components in the engine compartment.

## Refilling Window Washer Fluid

### Models without washer level sensor

Check the amount of window washer fluid.

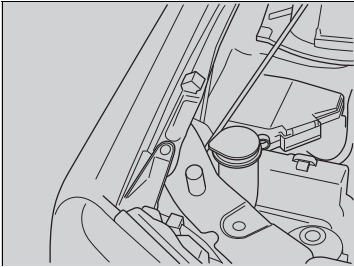

If the level is low, fill the washer reservoir.

### Models with washer level sensor

If the washer fluid is low, the washer level indicator\* appears on the instrument panel or a message appears on the multi-information display\*.

Pour the washer fluid carefully. Do not overflow the reservoir.

\* Not available on all models

### ▶▶ Refilling Window Washer Fluid

#### NOTICE

Do not use engine antifreeze or a vinegar/water solution in the windshield washer reservoir. Antifreeze can damage your vehicle's paint. A vinegar/water solution can damage the windshield washer pump.

## Headlight Bulbs

When replacing, use the following bulbs.

**High beam headlight:** 60W (HB3)

**Low beam headlight:** 55 W (H11)

### High Beam Headlight

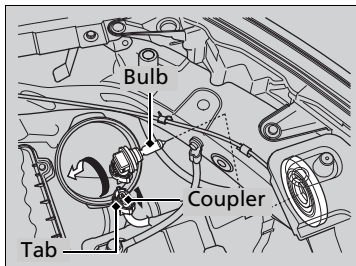

#### Driver's side

1. Remove the clips using a flat-tip screwdriver, then remove the upper part of the air intake duct.

[▶ Engine Compartment Covers P. 391](#)

#### Driver and passenger side

2. Push the tab to remove the coupler.
3. Rotate the old bulb to the left to remove.
4. Insert a new bulb into the headlight assembly and turn it to the right.
5. Insert the coupler into the connector of the bulb.

### Headlight Bulbs

#### NOTICE

Halogen bulbs get very hot when lit. Oil, perspiration, or a scratch on the glass can cause the bulb to overheat and shatter.

The headlight aim is set by the factory, and does not need to be adjusted. However, if you regularly carry heavy items in the cargo area or tow a trailer, have the aiming readjusted at a dealer or by a qualified technician.

The HB3 and H11 types are halogen bulbs. When replacing a bulb, handle it by its base, and protect the glass from contact with your skin or hard objects. If you touch the glass, clean it with denatured alcohol and a clean cloth.

The exterior lights' inside lenses (headlights, brake lights, etc.) may fog temporarily after a car wash or while driving in the rain. This does not impact the exterior light function.

However, if you see a large amount of water or ice accumulated inside the lenses, have your vehicle inspected by a dealer.

## Low Beam Headlights

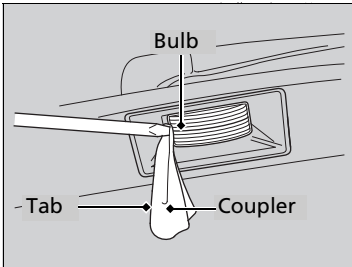

### Driver's side

1. Remove the clips using a flat-tip screwdriver, then remove the upper part of the air intake duct.

➔ [Engine Compartment Covers P. 391](#)

### Driver and passenger side

2. Push the tab to remove the coupler.
3. Rotate the old bulb to the left to remove.
4. Insert a new bulb into the headlight assembly and turn it to the right.
5. Insert the coupler into the connector of the bulb.

## Fog Light Bulbs\*

When replacing, use the following bulbs.

**Fog Light: 55 W (H11)**

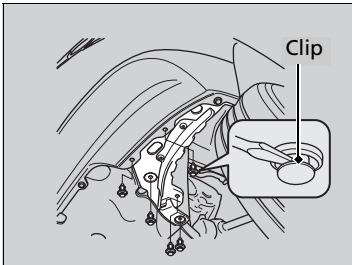

1. Remove the clips using a flat-tip screwdriver, and pull down the under cover.

### ☒ Fog Light Bulbs\*

#### NOTICE

Halogen bulbs get very hot when lit. Oil, perspiration, or a scratch on the glass can cause the bulb to overheat and shatter.

The fog lights are halogen bulbs.

When replacing a bulb, handle it by its plastic case, and protect the glass from contact with your skin or hard objects. If you touch the glass, clean it with denatured alcohol and a clean cloth.

\* Not available on all models

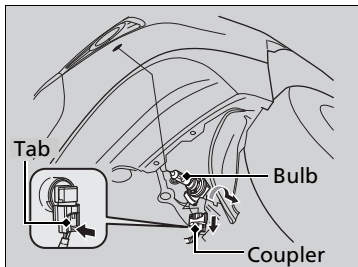

2. Push the tab to remove the coupler.
3. Rotate the old bulb to the left to remove.
4. Insert new bulb.

## Side Turn Signal/Emergency Indicator Light Bulbs\*

Door mirrors have the side turn lights. Have an authorized Honda dealer inspect and replace the light bulbs.

### ☒ Fog Light Bulbs\*

Insert a flat-tip screwdriver, lift and remove the center pin to remove the clip.

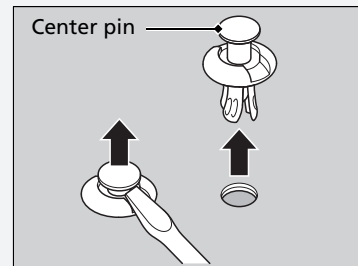

Insert the clip with the center pin raised, and push until it is flat.

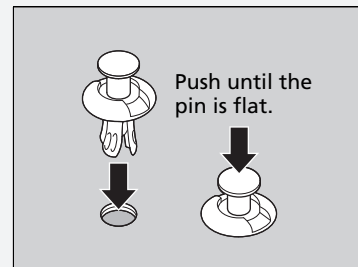

## Front Turn Signal/Parking Light and Front Side Marker Light Bulbs

When replacing, use the following bulbs.

**Front Turn Signal/Parking Light: 28/8 W (Amber)**  
**Front Side Marker Light: 3CP**

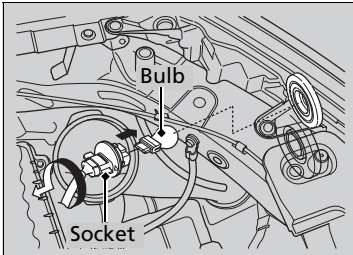

1. Turn the socket to the left and remove it.
2. Remove the old bulb and insert a new bulb.

## Brake Light, Taillight, Back-Up Light, Rear Turn Signal Light and Rear Side Marker Light Bulbs

When replacing, use the following bulbs.

**Brake/Taillight: 21/5 W**  
**Back-Up Light: 18 W**  
**Rear Turn Signal/Taillight: 21/5 W**  
**Rear Side Marker Light: 5 W**

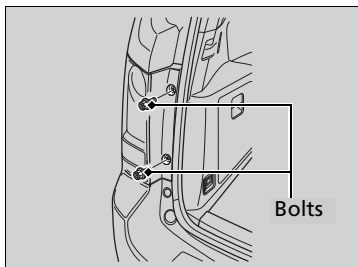

1. Use a Phillips-head screwdriver to remove the bolts.

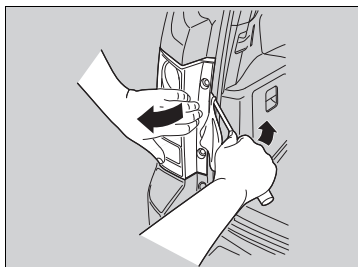

2. Loosen the assembly by carefully prying on the top and side edges.
  - Wrap the flat-tip screwdriver with a cloth to prevent scratches.

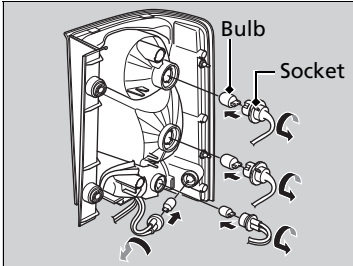

3. Turn the socket to the left and remove it.  
Remove the old bulb.
4. Insert a new bulb.
5. Reinstall the light assembly by sliding it into the hole on the body.



## Rear License Plate Light Bulb

When replacing, use the following bulb.

**Rear License Plate Light: 5 W**

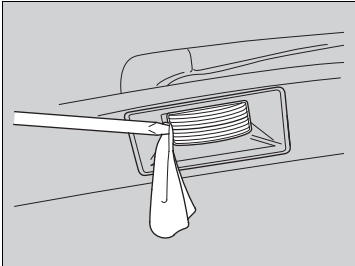

1. Remove the lens by prying on the edge of the lens using a flat-tip screwdriver.
  - ▶ Wrap the flat-tip screwdriver with a cloth to prevent scratches.

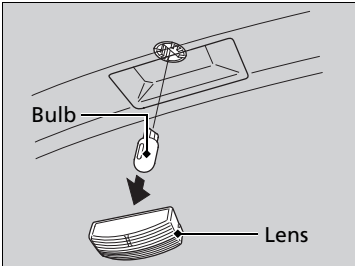

2. Remove the old bulb.
3. Insert a new bulb.

## High-Mount Brake Light Bulb

When replacing, use the following bulb.

### High-Mount Brake Light: 5 W

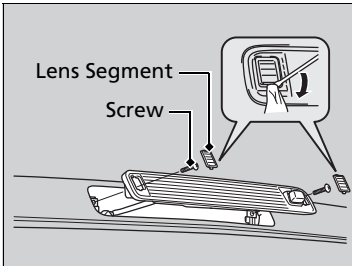

1. Remove the lens segment by prying on the edge using a flat-tip screwdriver.
  - ▶ Wrap the flat-tip screwdriver with a cloth to prevent scratches.

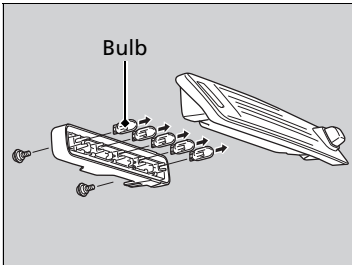

2. Remove the screw under each lens.
3. Pull the high-mount brake light assembly out of the vehicle.
4. Remove the two mounting screws from the light assembly.
5. Remove the lens from the light assembly.
6. Remove the old bulb and insert a new bulb.

## Checking Wiper Blades

If the wiper blade rubber has deteriorated, it will leave streaks and the metal wiper arm may scratch the window glass.

## Changing the Wiper Blade Rubber

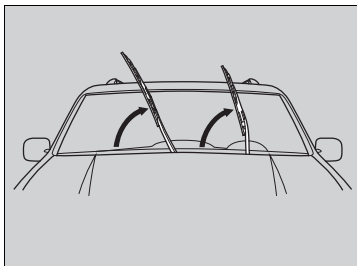

1. Lift the driver side wiper arm first, then the passenger side.

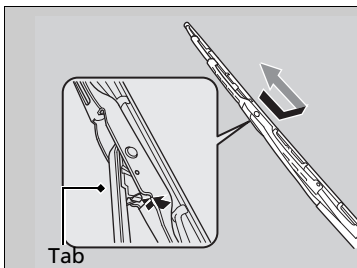

2. Press and hold the tab, then slide the blade from the wiper arm.

### Changing the Wiper Blade Rubber

**NOTICE**

Avoid dropping the wiper arm; it may damage the windshield.

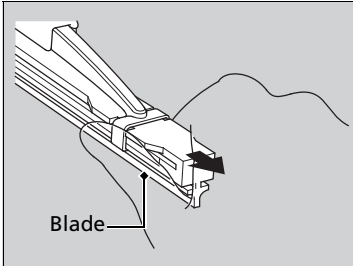

3. Slide the wiper blade out from its holder by pulling the tabbed end out.

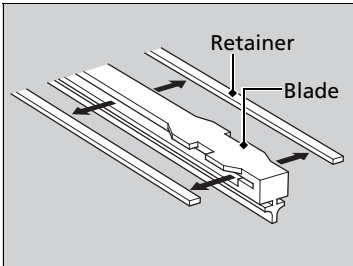

4. Remove the retainers from the rubber blade that has been removed, and mount to a new rubber blade.

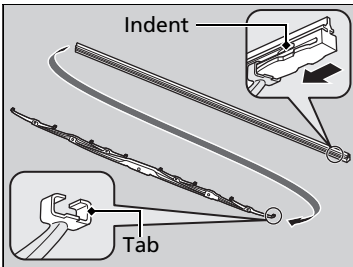

5. Slide the new wiper blade onto the holder from the bottom end.

▶ The tab on the holder should fit in the indent of the wiper blade.

6. Slide the wiper blade onto the wiper arm until it clicks.

7. Lower the passenger side wiper arm first, then the driver side.

## Changing the Rear Wiper Blade Rubber

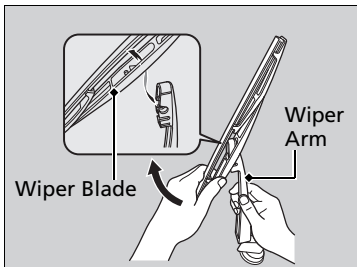

1. Raise the wiper arm off.
2. Pivot the bottom end of the wiper blade up until it comes off from the wiper arm.

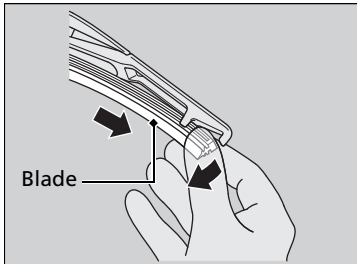

3. Slide the blade out of the wiper.

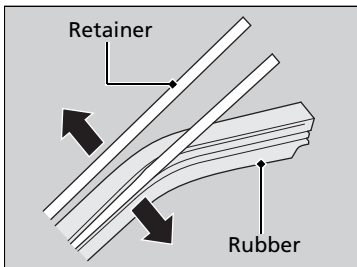

4. Remove the retainers from wiper blade and mount it to a new rubber blade.

### ▶▶ Changing the Wiper Blade Rubber

#### NOTICE

Avoid dropping the wiper blade, it may damage the rear window.

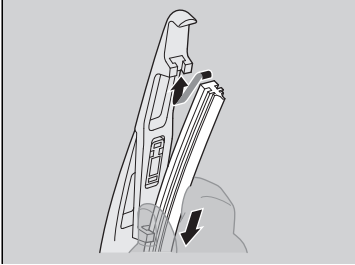

5. Slide the new wiper blade onto the holder.
  - ▶ Make sure it is engaged correctly, then install the wiper blade assembly onto the wiper arm.

## Checking Tires

To safely operate your vehicle, your tires must be of the proper type and size, in good condition with adequate tread, and properly inflated.

### ■ Inflation guidelines

Properly inflated tires provide the best combination of handling, tread life, and comfort. Refer to the driver's doorjamb label or specification's page for the specified pressure.

Underinflated tires wear unevenly, adversely affect handling and fuel economy, and are more likely to fail from overheating.

Overinflated tires make your vehicle ride harshly, are more prone to road hazards, and wear unevenly.

Every day before you drive, look at each of the tires. If one looks lower than the others, check the pressure with a tire gauge.

At least once a month or before long trips, use a gauge to measure the pressure in all tires, including the spare. Even tires in good condition can lose 1 to 2 psi (10 to 20 kPa, 0.1 to 0.2 kgf/cm<sup>2</sup>) per month.

### ■ Inspection guidelines

Every time you check inflation, also examine the tires and valve stems.

Look for:

- Bumps or bulges on the side or in the tread. Replace the tire if you find any cuts, splits, or cracks in the side of the tire. Replace it if you see fabric or cord.
- Remove any foreign objects and inspect for air leaks.
- Uneven tread wear. Have a dealer check the wheel alignment.
- Excessive tread wear.
  - ▶ [Wear Indicators P. 419](#)
- Cracks or other damage around valve stem.

### ▶ Checking Tires

## ⚠ WARNING

Using tires that are excessively worn or improperly inflated can cause a crash in which you can be seriously hurt or killed.

Follow all instructions in this owner's manual regarding tire inflation and maintenance.

Measure the air pressure when tires are cold. This means the vehicle has been parked for at least three hours, or driven less than 1 mile (1.6 km). If necessary, add or release air until the specified pressure is reached.

If checked when hot, tire pressure can be as much as 4–6 psi (30–40 kPa, 0.3–0.4 kgf/cm<sup>2</sup>) higher than if checked when cold.

Have a dealer check the tires if you feel a consistent vibration while driving. New tires and any that have been removed and reinstalled should be properly balanced.

## Tire and Loading Information Label

The label attached to the driver's doorjamb provides necessary tire and loading information.

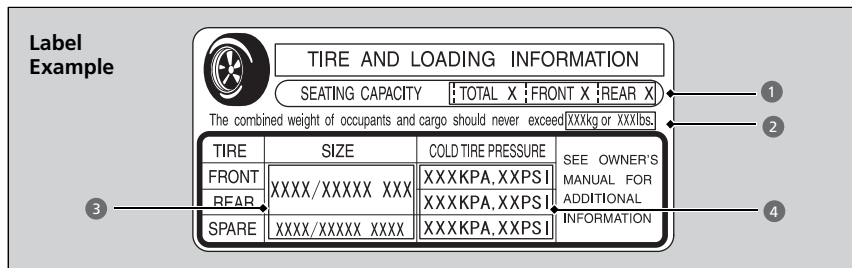

### Tire and Loading Information Label

The tire and loading information label attached to the driver's doorjamb contains:

- 1 The number of people your vehicle can carry.
- 2 The total weight your vehicle can carry. Do not exceed this weight.
- 3 The original tire sizes for front, rear, and spare.
- 4 The proper cold tire pressure for front, rear, and spare.

## Tire Labeling

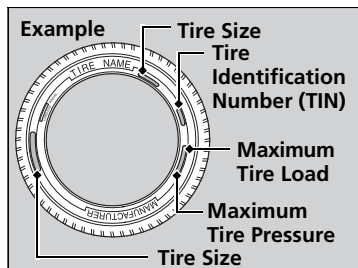

The tires that came on your vehicle have a number of markings. Those you should be aware of are described below.

### Tire Sizes

Following is an example of tire size with an explanation of what each component means.

#### **P235/60 R18 102T**

P: Vehicle type (P indicates passenger vehicle).

235: Tire width in millimeters.

60: Aspect ratio (the tire's section height as a percentage of its width).

R: Tire construction code (R indicates radial).

18: Rim diameter in inches.

102: Load index (a numerical code associated with the maximum load the tire can carry).

T: Speed symbol (an alphabetical code indicating the maximum speed rating).

### Tire Sizes

Whenever tires are replaced, they should be replaced with tires of the same size.

Continued



## ■ Tire Identification Number (TIN)

The tire identification number (TIN) is a group of numbers and letters that look like the example in the side column. TIN is located on the sidewall of the tire.

## ■ Glossary of Tire Terminology

**Cold Tire Pressure** – The tire air pressure when the vehicle has been parked for at least three hours or driven less than 1 mile (1.6 km).

**Load Rating** – Means the maximum load that a tire is rated to carry for a given inflation pressure.

**Maximum Inflation Pressure** – The maximum tire air pressure that the tire can hold.

**Maximum Load Rating** – Means the load rating for a tire at the maximum permissible inflation pressure for that tire.

**Recommended Inflation Pressure** – The cold tire inflation pressure recommended by the manufacturer.

**Treadwear Indicators (TWI)** – Means the projections within the principal grooves designed to give a visual indication of the degrees of wear of the tread.

## ▶▶ Tire Identification Number (TIN)

### **DOT B97R FW6X 2209**

**DOT:** This indicates that the tire meets all requirements of the U.S. Department of Transportation.

**B97R:** Manufacturer's identification mark.

**FW6X:** Tire type code.

**22 09:** Date of manufacture.

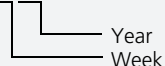

## DOT Tire Quality Grading (U.S. Vehicles)

The tires on your vehicle meet all U.S. Federal Safety Requirements. All tires are also graded for treadwear, traction, and temperature performance according to Department of Transportation (DOT) standards. The following explains these gradings.

### Uniform Tire Quality Grading

Quality grades can be found where applicable on the tire sidewall between shoulder and maximum section width.

### Treadwear

The treadwear grade is a comparative rating based on the wear rate of the tire tested under controlled conditions on a specified government test course. For example, a tire graded 150 would wear one and one-half (1 1/2) times as well on the government course as a tire graded 100. The relative performance of tires depends upon the actual conditions of their use, however, and may depart significantly from the norm due to variations in driving habits, service practices and differences in road characteristics and climate.

### Uniform Tire Quality Grading

For example:

**Treadwear 200**

**Traction AA**

**Temperature A**

All passenger car tires must conform to Federal Safety Requirements in addition to these grades.

## ■ Traction

The traction grades, from highest to lowest, are AA, A, B, and C. Those grades represent the tire's ability to stop on wet pavement as measured under controlled conditions on specified government test surfaces of asphalt and concrete. A tire marked C may have poor traction performance.

## ■ Temperature

The temperature grades are A (the highest), B, and C, representing the tire's resistance to the generation of heat and its ability to dissipate heat tested under controlled conditions on a specified indoor laboratory test wheel. Sustained high temperature can cause the material of the tire to degenerate and reduce tire life, and excessive temperature can lead to sudden tire failure. The grade C corresponds to a level of performance which all passenger car tires must meet under the Federal Motor Vehicle Safety Standard No. 109. Grades B and A represent higher levels of performance on the laboratory test wheel than the minimum required by law.

### ▶▶ Traction

**Warning:** The traction grade assigned to this tire is based on straight-ahead braking traction tests, and does not include acceleration, cornering, hydroplaning, or peak traction characteristics.

### ▶▶ Temperature

**Warning:** The temperature grade for this tire is established for a tire that is properly inflated and not overloaded. Excessive speed, underinflation, or excessive loading, either separately or in combination, can cause heat buildup and possible tire failure.

## Wear Indicators

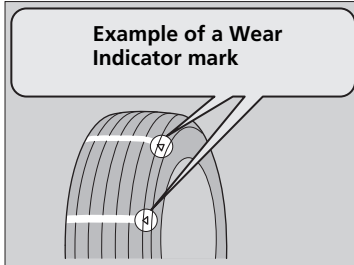

The groove where the wear indicator is located is 1/16 inch (1.6 mm) shallower than elsewhere on the tire. If the tread has worn so that the indicator is exposed, replace the tire.

**Worn out tires have poor traction on wet roads.**

## Tire Service Life

The life of your tires is dependent on many factors, including driving habits, road conditions, vehicle loading, inflation pressure, maintenance history, speed, and environmental conditions (even when the tires are not in use).

In addition to regular inspections and inflation pressure maintenance, it is recommended that you have annual inspections performed once the tires reach five years old. All tires, including the spare, should be removed from service after 10 years from the date of manufacture, regardless of their condition or state of wear.

## Tire and Wheel Replacement

Replace your tires with radials of the same size, load range, speed rating, and maximum cold tire pressure rating (as shown on the tire's sidewall). Using tires of a different size or construction can cause the ABS, VSA® (vehicle stability assist), hill start assist, and the VTM-4®\* system to work incorrectly.

It is best to replace all four tires at the same time. If that isn't possible, replace the front or rear tires in pairs.

Make sure that the wheel's specifications match those of the original wheels.

If you replace a wheel, only use TPMS specified wheels approved for your vehicle.

### ▶▶ Tire and Wheel Replacement

#### **WARNING**

Installing improper tires on your vehicle can affect handling and stability. This can cause a crash in which you can be seriously hurt or killed.

Always use the size and type of tires recommended in this owner's manual.

## Tire Rotation

Rotating tires according to the maintenance messages on the information display\*/ multi-information display\* helps to distribute wear more evenly and increase tire life.

### ■ Tires without rotation marks

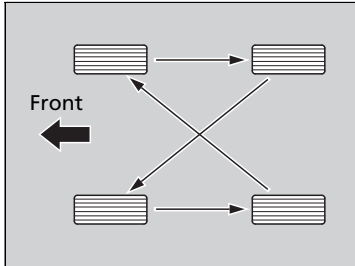

Rotate the tires as shown here.

### ■ Tires with rotation marks

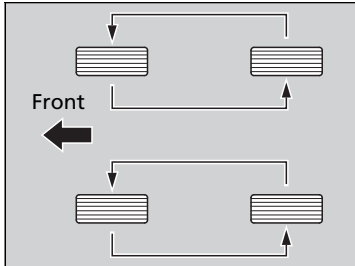

Rotate the tires as shown here.

### ☒ Tire Rotation

Tires with directional tread patterns should only be rotated front to back (not from one side to the other). Directional tires should be mounted with the rotation indication mark facing forward, as shown below.

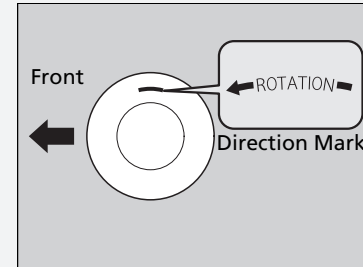

When the tires are rotated, make sure the air pressures are checked.

\* Not available on all models

## Winter Tires

If driving on snowy or frozen roads, mount all season marked “M+S” tires, snow tires, or tire chains; reduce speed; and maintain sufficient distance between vehicles when driving.

Be particularly careful when operating the steering wheel or brakes to prevent skidding.

Use tire chains, snow tires, or all season tires when necessary or according to the law.

When mounting, refer to the following points.

For winter tires:

- Select the size and load ranges that are the same as the original tires.
- Mount the tires to all four wheels.

For tire chains:

- Install them on the front tires only.
- Because your vehicle has limited tire clearance, we strongly recommend using the chains listed below:

**Cable-type: QCC Premium Cobra 1046P**

- Follow the chain manufacturer's instruction when installing. Mount them as tightly as you can.
- Check that the chains do not touch the brake lines or suspension.
- Drive slowly.

### ▶▶ Winter Tires

## ⚠ WARNING

Using the wrong chains, or not properly installing chains, can damage the brake lines and cause a crash in which you can be seriously injured or killed.

Follow all instructions in this owner's manual regarding the selection and use of tire chains.

### NOTICE

Traction devices that are the wrong size or improperly installed can damage your vehicle's brake lines, suspension, body, and wheels. Stop driving if they are hitting any part of the vehicle.

When tire chains are mounted, follow the chain manufacturer's instructions regarding vehicle operational limits.

If your vehicle is equipped with summer tires, be aware that these tires are not designed for winter driving conditions. For more information, contact a dealer.

## Checking the Battery

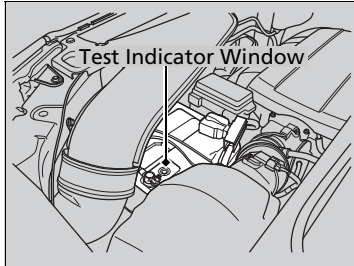

Check the battery condition monthly. Look at the test indicator window and check the terminals for corrosion.

If your vehicle's battery is disconnected or goes dead:

- The audio system is disabled.
  - [Reactivating the audio system P. 174](#)
- The clock resets.
  - [Setting the Clock P. 98](#)
- The navigation system\* is disabled.
  - [Refer to the navigation system manual](#)

## Charging the Battery

Disconnect both battery cables to prevent damaging your vehicle's electrical system. Always disconnect the negative (-) cable first, and reconnect it last.

\* Not available on all models

### ⓘ Battery

## ⚠ WARNING

The battery gives off explosive hydrogen gas during normal operation.

A spark or flame can cause the battery to explode with enough force to kill or seriously hurt you.

When conducting any battery maintenance, wear protective clothing and a face shield, or have a skilled technician do it.

**WARNING:** Battery post, terminals, and related accessories contain lead and lead compounds.

**Wash your hands after handling.**

The test indicator's color information is on the battery.

When you find corrosion, clean the battery terminals by applying a baking powder and water solution. Clean terminals with a damp towel. Cloth/towel dry the battery. Coat the terminals with grease to help prevent future corrosion.



## Replacing the Button Battery

If the indicator does not come on when the button is pressed, replace the battery.

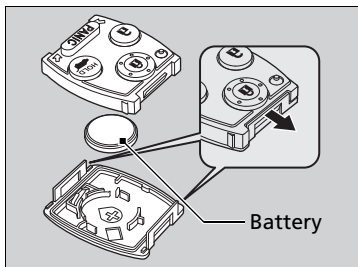
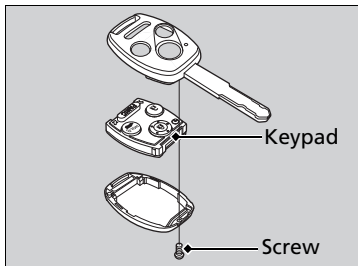

### Battery type: CR1616

1. Unscrew the cover with a small Phillips-head screwdriver. Press a button to pry open the transmitter.
2. Open the keypad.
  - ▶ Separate the inner cover from the keypad by releasing the two tabs on the cover.
3. Make sure to replace the battery with the correct polarity.

### ▶▶ Replacing the Button Battery

#### NOTICE

An improperly disposed of battery can damage the environment. Always confirm local regulations for battery disposal.

Replacement batteries are commercially available or at a dealer.

Models with rear entertainment system

## Replacing the Battery

### Remote Control

If it takes several pushes on the remote control buttons to operate the rear entertainment system\*.

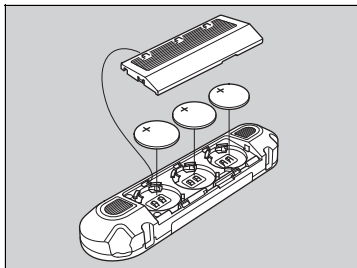

**Battery type: BR3032**

1. Remove the cover.
2. Make sure to replace the battery with the correct polarity.

### Replacing the Battery

#### NOTICE

An improperly disposed of battery can damage the environment. Always confirm local regulations for battery disposal.

Replacement batteries are commercially available or at a dealer.

\* Not available on all models

Continued

## ■ Wireless Headphone

If there is no sound coming from the wireless headphone, replace the battery.

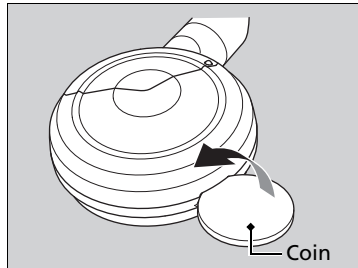

### **Battery type: AAA**

1. To open the cover, insert a coin in the slot and twist it slightly to pry the cover away from the earpiece.
2. Make sure to replace the battery with the correct polarity.

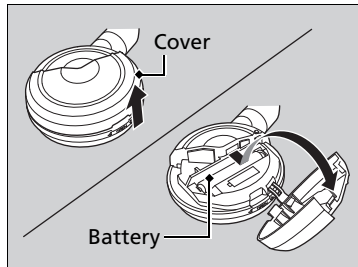

## Dust and Pollen Filter

The climate control system is equipped with a dust and pollen filter that collects pollen, dust, and other debris in the air. The Maintenance Minder™ messages will let you know when to replace the filter.

We recommend that you replace the dust and pollen filter sooner when using your vehicle in areas with high concentrations of dust.

### ☒ Dust and Pollen Filter

If the airflow from the climate control system deteriorates noticeably, and the windows fog up easily, the filter may need to be replaced. Please contact a dealer for replacement.

## Interior Care

Use a damp cloth with a mixture of mild detergent and warm water to remove dirt. Use a clean cloth to remove detergent residue.

### Cleaning Seat Belts

Use a soft brush with a mixture of mild soap and warm water to clean the seat belts. Let the belts air dry. Wipe the openings of the seat belt anchors using a clean cloth.

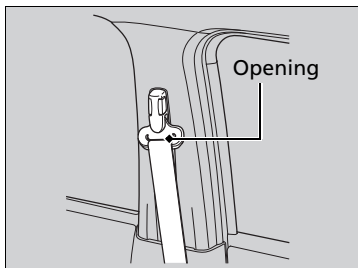

### Interior Care

Do not spill liquids inside the vehicle. Electrical devices and systems may malfunction if liquids are splashed on them.

Do not use silicone based sprays on electrical devices such as audio devices and switches.

Doing so may cause the items to malfunction or a fire inside the vehicle.

If a silicone based spray is inadvertently used on electrical devices, consult a dealer.

Depending on their composition, chemicals and liquid aromatics may cause discoloration, wrinkles, and cracking to resin-based parts and textiles. Do not use alkali solvents or organic solvents such as benzene or gasoline.

After using chemicals, make sure to gently wipe them off using a dry cloth.

Do not place used cloths on top of resin based parts or textiles for long periods of time without washing.

## Floor Mats

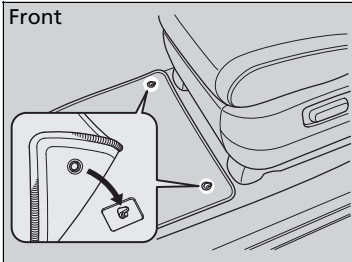

The floor mats hook over the floor anchors, which keep the mat from sliding forward.

**Do not put additional floor mats on top of the anchored mat.**

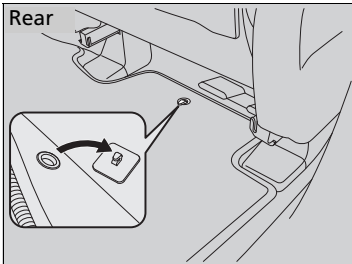

## Maintaining Genuine Leather\*

Vacuum dirt and dust from the leather frequently. Pay close attention to the pleats and seams. Clean the leather with a soft cloth dampened with a 90% water and 10% neutral soap solution. Then buff it with a clean, dry cloth. Remove any dust or dirt on leather surfaces immediately.

\* Not available on all models

### Floor Mats

If you use any floor mats that were not originally provided with your vehicle, make sure they are designed for your specific vehicle, fit correctly, and are securely anchored by the floor anchors. Position the rear seat floor mats properly. If they are not properly positioned, the floor mats can interfere with the front seat functions.

## Exterior Care

Dust off the vehicle body after you drive.

Regularly inspect your vehicle for scratches on painted surfaces. A scratch on a painted surface can result in body rust. If you find a scratch, promptly repair it.

### ■ Washing the Vehicle

Wash the vehicle regularly. Wash more frequently when driving in the following conditions:

- If driving on roads with road salt.
- If driving in coastal areas.
- If tar, soot, bird droppings, insects, or tree sap are stuck to painted surfaces.

### ■ Using an Automated Car Wash

- Fold in the door mirrors.

Make sure to follow the instructions indicated on the automated car wash.

### ■ Using High Pressure Cleaners

- Keep sufficient distance between the cleaning nozzle and the vehicle body.
- Take particular care around the windows. Standing too close may cause water to enter the vehicle interior. Do not spray water into the engine compartment.

### ► Washing the Vehicle

Do not spray water into the air intake vents or engine compartment. It can cause a malfunction.

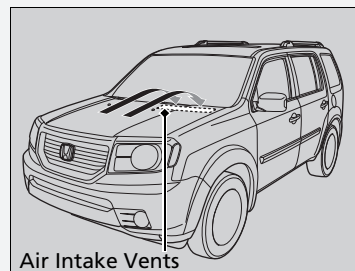

Air Intake Vents

## ■ Applying Wax

A good coat of automotive body wax helps protect your vehicle's paint from the elements. Wax will wear off over time and expose your vehicle's paint to the elements, so reapply as necessary.

## ■ Maintaining the Bumpers and Other Resin Coated Parts

If you get gasoline, oil, engine coolant, or battery fluid on resin coated parts, they may be stained or the coating may peel. Promptly wipe it away using a soft cloth and clean water.

## ■ Cleaning the Window

Wipe using a glass cleaner.

## ■ Maintaining Aluminum Wheels\*

Aluminum is susceptible to deterioration caused by salt and other road contaminants. Use a sponge and mild detergent to wipe away promptly. Be careful not to use harsh chemicals (including some commercial wheel cleaners) or a stiff brush. They can damage the clear coat of the aluminum alloy wheels that helps keep the aluminum from corroding and tarnishing.

### ▣ Applying Wax

#### NOTICE

Chemical solvents and strong cleaners can damage the paint, metal, and plastic on your vehicle. Wipe up spills immediately.

### ▣ Maintaining the Bumpers and Other Resin Coated Parts

Ask a dealer about the correct coating material when you want to repair the painted surface of the parts made of resin.

### ▣ Cleaning the Window

Wires are mounted to the inside of the rear window. Wipe along the same direction as the wires with a soft cloth so as not to damage them.

\* Not available on all models





# Handling the Unexpected

This chapter explains how to handle unexpected troubles.

## Tools

Types of Tools..... 434

## If a Tire Goes Flat

Changing a Flat Tire..... 435

## Engine Does Not Start

Checking the Engine..... 444

## Jump Starting..... 445

## Shift Lever Does Not Move..... 447

## Overheating

How to Handle Overheating..... 448

## Indicator, Coming On/Blinking

If the Low Oil Pressure Indicator Comes On ..... 450

If the Charging System Indicator Comes On ..... 450

If the Malfunction Indicator Lamp Comes On or Blinks ..... 451

If the Brake System Indicator (Red) Comes On ..... 452

If the Low Tire Pressure Indicator Comes On ..... 452

If the TPMS Indicator Comes On ..... 453

If the Low Tire Pressure/TPMS Indicator Comes On or Blinks ..... 453

## Fuses

Fuse Locations ..... 454

Inspecting and Changing Fuses..... 458

## Emergency Towing..... 459

## When You Cannot Open the Tailgate..... 461

## Types of Tools

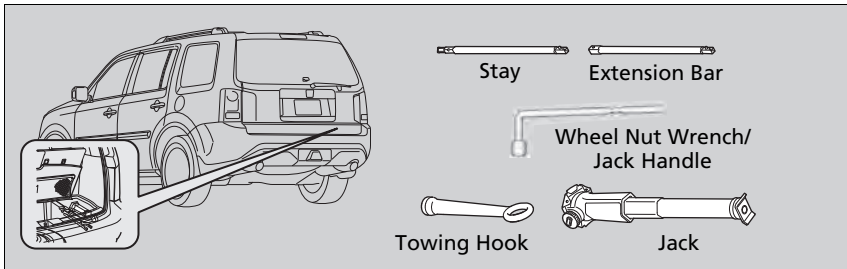

### Types of Tools

The tools and jack are under the cargo area on the passenger's side.

## Changing a Flat Tire

If a tire goes flat while driving, grasp the steering wheel firmly, and brake gradually to reduce speed. Then, stop in a safe place. Replace the flat tire with a compact spare tire. Go to a dealer as soon as possible to have the full-size tire repaired or replaced.

1. Park the vehicle on firm, level, and non-slippery surface and apply the parking brake.
2. Move the shift lever to **P**.
3. Turn on the hazard warning lights and turn the ignition switch to LOCK **0**.

### ✘ Changing a Flat Tire

Periodically check the tire pressure of the compact spare. It should be set to the specified pressure.  
Specified Pressure: 60 psi (420 kPa, 4.2 kgf/cm<sup>2</sup>)

When driving with the compact spare tire, keep the vehicle speed under 50 mph (80 km/h). Replace with a full-size tire as soon as possible.

The compact spare tire and wheel in your vehicle are specifically for this model.

Do not use them with another vehicle.

Do not use another type of compact spare tire or wheel with your vehicle.

Do not mount tire chains on a compact spare tire. If a chain-mounted front tire goes flat, remove one of the full-size rear tires and replace it with the compact spare tire. Remove the flat front tire and replace it with the full-size tire that was removed from the rear. Mount the tire chains on the front tire.

Do not use a puncture-repairing agent on a flat tire, as it can damage the tire pressure sensor.

## Getting Ready to Replace the Flat Tire

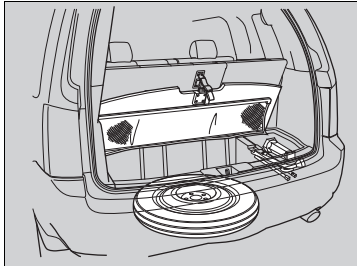

1. Remove the cargo area floor lid.

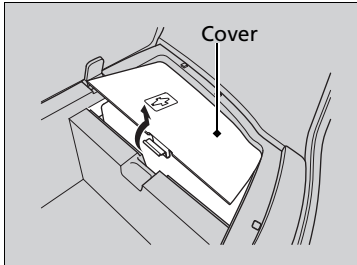

2. Remove the cover and take the jack, stay, wheel nut wrench, and extension bar out of the tool case.

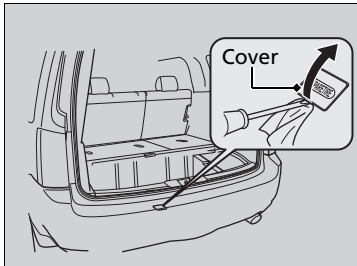

3. Remove the cover and the rubber cap on the cargo area to access the shaft for the spare tire hoist.

4. Fold down the third row seats.

[▶ Folding Down the Third Row Seats](#)

P. 147

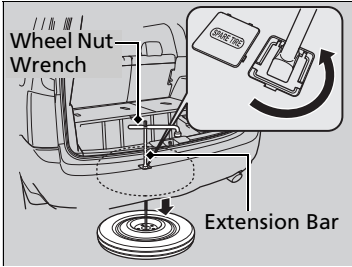

5. Put the extension bar with the wheel nut wrench on the hoist shaft. Turn the wrench to the left to lower the spare tire to the ground.

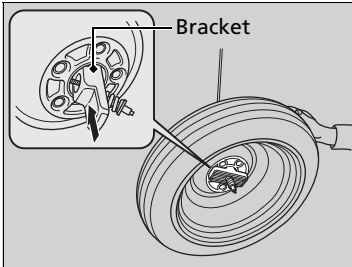

6. Keep turning the wheel nut wrench to create slack in the cable.
7. Remove the bracket from the spare tire.

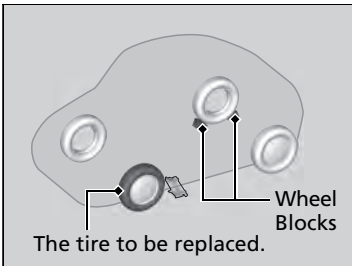

8. Place a wheel block or rock in front and rear of the wheel diagonal to the flat tire.

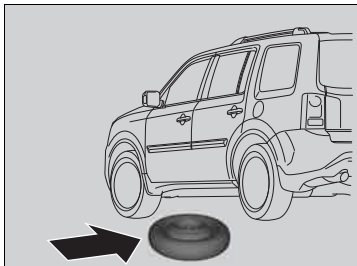

**9.** Place the compact spare tire (wheel side up) under the vehicle body, near the tire that needs to be replaced.

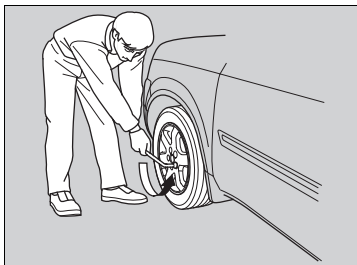

**10.** Loosen each wheel nut about one turn using the wheel nut wrench.

## How to Set Up the Jack

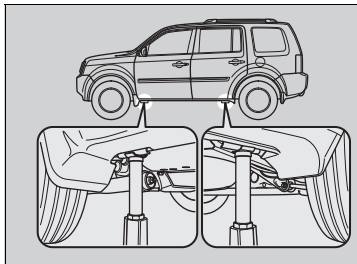

1. Place the jack under the jacking point closest to the tire to be changed.

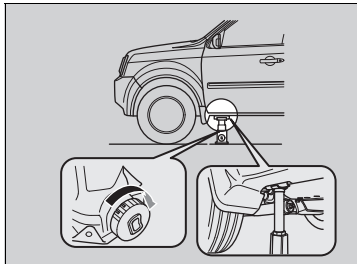

2. Turn the dial at the bottom of the jack to the right until the top of the jack contacts the jacking point.
  - ▶ Make sure that the jacking point tab is resting in the jack notch.

### How to Set Up the Jack

## ⚠ WARNING

The vehicle can easily roll off the jack, seriously injuring anyone underneath.

Follow the directions for changing a tire exactly, and never get under the vehicle when it is supported only by the jack.

Do not use the jack with people or luggage in the vehicle.

Use the jack provided in your vehicle. Other jacks may not support the weight ("load") or their shape may not match.

The following instructions must be followed to use the jack safely.

- Do not use while the engine is running.
- Use only where the ground is firm and level.
- Use only at the jacking points.
- Do not get in the vehicle while using the jack.
- Do not put anything on top of or underneath the jack.



3. Raise the vehicle, using the stay, extension bar, and the jack handle, until the tire is off the ground.

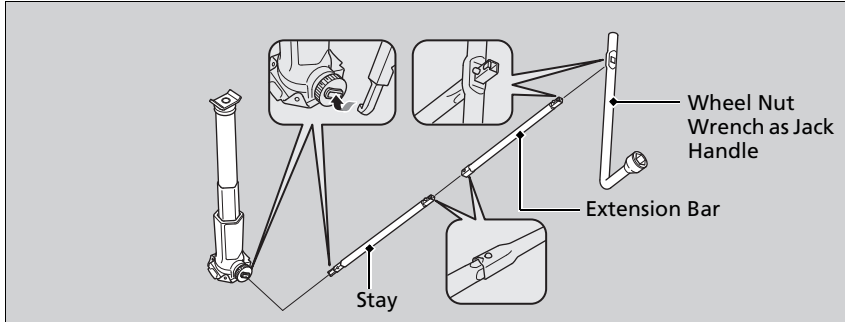

## Replacing the Flat Tire

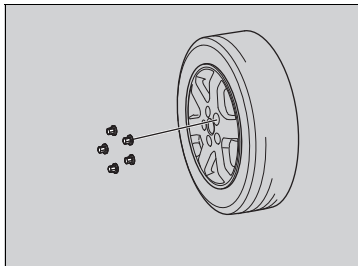

1. Remove the wheel nuts and flat tire.

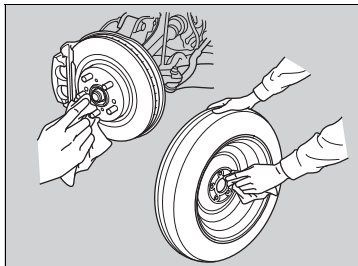

2. Wipe the mounting surfaces of the wheel with a clean cloth.

3. Mount the compact spare tire.

4. Screw the wheel nuts until they touch the lips around the mounting holes, and stop rotating.

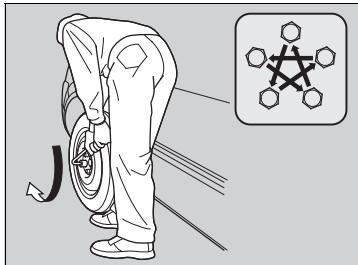

5. Lower the vehicle and remove the jack. Tighten the wheel nuts in the order indicated in the image. Go around, tightening the nuts, two to three times in this order.

### Wheel nut torque:

94 lbf-ft (127 N·m, 13 kgf·m)

### Replacing the Flat Tire

Do not over tighten the wheel nuts by applying extra torque using your foot or a pipe.

## Storing the Flat Tire

If you store a full size tire on the hoist, remove the spacer to loosen the two bolts.

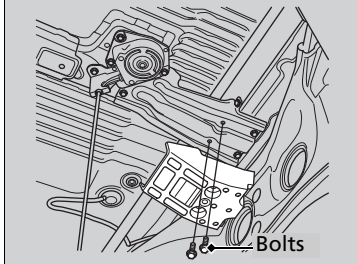

1. Remove the center cap.
2. Place the flat tire face up under the hoist.
3. Insert the hoist bracket into the center hole of the flat tire.

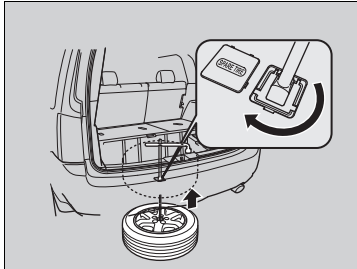

4. Turn the extension bar with the wheel nut wrench to the right until the flat tire rests against the underbody of the vehicle and you hear the hoist click.
5. Securely put the jack, stay, extension bar, and wheel nut wrench back in the tool case.

## Storing the Flat Tire

### **WARNING**

Loose items can fly around the interior in a crash and can seriously injure the occupants.  
Store the wheel, jack, and tools securely before driving.

Always raise the spare tire hoist, even if you are not stowing a tire. If the hoist is left down, it will be damaged during driving and need to be replaced.

## TPMS and the Spare Tire

### Models with information display

If you replace a flat tire with the spare tire, the low tire pressure indicator comes on while you are driving. After driving for a few miles (kilometers), the indicator will go off and the TPMS indicator comes on, but this is normal.

If you replace the tire with a specified regular tire, the low tire pressure or TPMS indicator will go off after a few miles (kilometers).

### Models with multi-information display

If you replace a flat tire with the spare tire, the low tire pressure/TPMS indicator comes on while you are driving. After driving for a few miles (kilometers), the indicator will start blinking for a short time and then stay on. **CHECK TPMS SYSTEM** appears on the multi-information display, but this is normal.

If you replace the tire with a specified regular tire, the warning message on the multi-information display and the low tire pressure/TPMS indicator will go off after a few miles (kilometers).

### TPMS and the Spare Tire

The system cannot monitor the pressure of the spare tire. Manually check the spare tire pressure to be sure that it is correct.

Use TPMS specific wheels. Each is equipped with a tire pressure sensor mounted inside the tire behind the valve stem.

## Checking the Engine

If the engine does not start, check the starter.

### ☒ Checking the Engine

If you must start the vehicle immediately, use an assisting vehicle to jump start it.

➤ [Jump Starting P. 445](#)

### Starter condition

### Checklist

#### **Starter doesn't turn or turns over slowly.**

The battery may be dead. Check each of the items on the right and respond accordingly.

#### **The starter turns over normally but the engine doesn't start.**

There may be a problem with the fuse. Check each of the items on the right and respond accordingly.

#### **Check brightness of the interior light.**

Turn on interior lights and check brightness.

- If the interior lights are dim or do not come on at all  
➤ [Battery P. 423](#)
- If the interior lights come on normally ➤ [Inspecting and Changing Fuses P. 458](#)

#### **Review the engine start procedure.**

Follow its instructions, and try to start the engine again. ➤ [Starting the Engine P. 342](#)

#### **Check the immobilizer system indicator.**

When the immobilizer system indicator is blinking, the engine cannot be started.

➤ [Immobilizer System P. 118](#)

#### **Check the fuel level.**

There should be enough fuel in the tank. ➤ [Fuel Gauge P. 80](#)

#### **Check the fuse.**

Check all fuses, or have the vehicle checked by a dealer.

➤ [Inspecting and Changing Fuses P. 458](#)

#### **If the problem continues:**

➤ [Emergency Towing P. 459](#)

## Jump Starting Procedure

Turn off the power to electric devices, such as audio and lights. Turn off the engine, then open the hood.

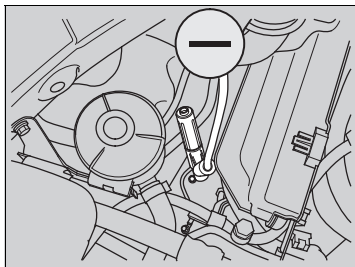
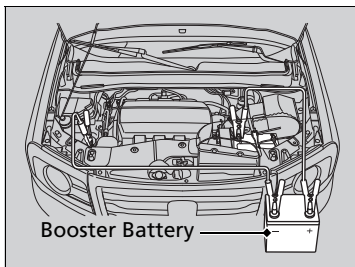

1. Connect the first jumper cable to your vehicle's  $\oplus$  terminal.
2. Connect the other end of the first jumper cable to the booster battery  $\oplus$  terminal.  
▶ Use a 12-volt booster battery only.
3. Connect the second jumper cable to the booster battery  $\ominus$  terminal.
4. Connect the other end of the second jumper cable to the grounding strap as shown.  
Do not connect this jumper cable to any other part.
5. If your vehicle is connected to another vehicle, start the assisting vehicle's engine and increase its rpm slightly.

6. Attempt to start your vehicle's engine. If it turns over slowly, check that the jumper cables have good metal-to-metal contact.

### Jump Starting

## ⚠ WARNING

A battery can explode if you do not follow the correct procedure, seriously injuring anyone nearby.

Keep all sparks, open flames, and smoking materials away from the battery.

Securely attach the jumper cables clips so that they do not come off when the engine vibrates. Also be careful not to tangle the jumper cables or allow the cable ends to touch each other while attaching or detaching the jumper cables.

Battery performance degrades in cold conditions and may prevent the engine from starting.

## What to Do After the Engine Starts

Once your vehicle's engine has started, remove the jumper cables in the following order.

1. Disconnect the jumper cable from your vehicle's ground.
2. Disconnect the other end of the jumper cable from the booster battery ⊖ terminal.
3. Disconnect the jumper cable from your vehicle's ⊕ terminal.
4. Disconnect the other end of the jumper cable from the booster battery ⊕ terminal.

Have your vehicle inspected by a nearby service station or a dealer.

# Shift Lever Does Not Move

Follow the procedure below if you cannot move the shift lever out of the **P** position.

## Releasing the Lock

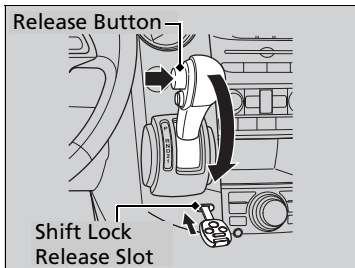
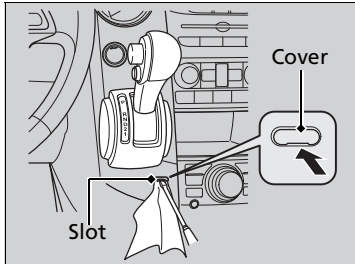

1. Set the parking brake.
2. Remove the key from the ignition switch.
3. Wrap a cloth around the tip of a small flat-tip screwdriver. Put it into the shift lock release slot as shown in the image, and remove the cover.
4. Insert the key into the shift lock release slot.
5. While pushing on the key, press the shift lever release button and place the shift lever into **N**.
  - ▶ The lock is now released. Have the shift lever checked by a dealer as soon as possible.



## How to Handle Overheating

Overheating symptoms are as follows:

- The temperature gauge needle is at the **H** mark or the engine suddenly loses power.
- Steam or spray comes out of the engine compartment.

### ■ First thing to do

1. Immediately park the vehicle in a safe place.
  - ▶ **No steam or spray present:** Keep the engine running and open the hood.
  - ▶ **Steam or spray is present:** Turn off the engine and wait until it subsides. Then, open the hood.

### » How to Handle Overheating

#### **WARNING**

Steam and spray from an overheated engine can seriously scald you.

Do not open the hood if steam is coming out.

#### **NOTICE**

Continuing to drive with the temperature gauge needle at the **H** mark may damage the engine.

## ■ Next thing to do

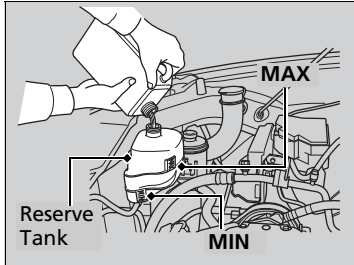

1. Check that the cooling fan is operating and stop the engine once the temperature gauge needle comes down.
  - ▶ If the cooling fan is not operating, immediately stop the engine.
2. Once the engine has cooled down, inspect the coolant level and check the cooling system components for leaks.
  - ▶ If the coolant level in the reserve tank is low, add coolant until it reaches the **MAX** mark.
  - ▶ If there is no coolant in the reserve tank, check that the radiator is cool. Cover the radiator cap with a heavy cloth and open the cap. If necessary, add coolant up to the base of the filler neck, and put the cap back on.

## ■ Last thing to do

Once the engine has cooled sufficiently, restart it and check the temperature gauge. If the temperature needle has gone down, resume driving. If it has not gone down, contact a dealer for repairs.

### How to Handle Overheating

## ⚠ WARNING

Removing the radiator cap while the engine is hot can cause the coolant to spray out, seriously scalding you.

Always let the engine and radiator cool down before removing the radiator cap.

If the coolant is leaking, contact a dealer for repairs.

Use water as an emergency/temporary measure only. Have a dealer flush the system with proper antifreeze as soon as possible.

## If the Low Oil Pressure Indicator Comes On



### ■ Reasons for the indicator to come on

Comes on when the engine oil pressure is low.

### ■ What to do as soon as the indicator comes on

1. Immediately park the vehicle on level ground in a safe place.
2. If necessary, turn the hazard warning lights on.

### ■ What to do after parking the vehicle

1. Stop the engine and let it sit for about three minutes.
  - ▶ [Oil Check P. 393](#)
2. Open the hood and check the oil level.
3. Start the engine and check the low oil pressure indicator.
  - ▶ The light goes out: Start driving again.
  - ▶ The light does not go out within 10 seconds: Stop the engine and contact a dealer for repairs immediately.

## If the Charging System Indicator Comes On



### ■ Reasons for the indicator to come on

Comes on when the battery is not being charged.

### ■ What to do when the indicator comes on

Turn off the climate control system, rear defogger, and other electrical systems, and immediately contact a dealer for repairs.

### » If the Low Oil Pressure Indicator Comes On

#### NOTICE

Running the engine with low oil pressure can cause serious mechanical damage almost immediately.

### » If the Charging System Indicator Comes On

If you need to stop temporarily, do not turn off the engine. Restarting the engine may rapidly discharge the battery.

## If the Malfunction Indicator Lamp Comes On or Blinks



### ■ Reasons for indicator lamp to come on or blink

- Comes on when there is a problem with the engine emissions control system, or the fuel fill cap is missing, or loose.
- Blinks when engine misfiring is detected.

### ■ What to do when the indicator lamp comes on

Avoid high speeds and immediately get your vehicle inspected at a dealer.

### ■ What to do when the indicator lamp blinks

Park the vehicle in a safe place with no flammable items and wait at least ten minutes or more with the engine stopped until it cools.

## ■ Check/Tighten Fuel Cap Message

### ■ The message appears on when:

An evaporative system leak is detected. This may be caused by the fuel fill cap being loose or not being installed.

### ■ What to do when the message appears:

1. Stop the engine.
2. Check that the fuel fill cap is fully installed.
  - ▶ If not, loosen the cap, and then retighten it until it clicks at least once.
3. Drive for several days of normal driving.
  - ▶ The message should go off.

### ■ When the malfunction indicator lamp comes on

Malfunction indicator lamp comes on if the system continues to detect a leak of gasoline vapor. If this happens, check the fuel fill cap using the procedures described above.

## ▶▶ If the Malfunction Indicator Lamp Comes On or Blinks

### NOTICE

If you drive with the malfunction indicator lamp on, the emissions control system and the engine could be damaged.

If the malfunction indicator lamp blinks again when restarting the engine, drive to the nearest dealer at 31 mph (50 km/h) or less. Have your vehicle inspected.

## If the Brake System Indicator (Red) Comes On

U.S.



### ■ Reasons for the indicator to come on

- The brake fluid is low.
- There is a malfunction in the brake system.

Canada



### ■ What to do when the indicator comes on while driving

Press the brake pedal lightly to check pedal pressure.

- If normal, check the brake fluid level the next time you stop.
- If abnormal, take immediate action. If necessary, downshift the transmission to slow the vehicle using engine braking.

Models with information display

## If the Low Tire Pressure Indicator Comes On



### ■ Reasons for the indicator to come on

A tire pressure is significantly low. If the compact spare tire is installed, the indicator stays on for a while, then goes off after driving a few miles (kilometers).

### ■ What to do when the indicator comes on

Stop your vehicle in a safe place. Check the tire pressure and adjust the pressure to the specified level. The specified tire pressure is on a label on the driver side doorjamb.

### ▶▶ If the Brake System Indicator (Red) Comes On

Have your vehicle repaired immediately. It is dangerous to drive with low brake fluid. If there is no resistance from the brake pedal, stop immediately in a safe place. If necessary downshift the gears.

If the brake system indicator and **ABS** indicator come on simultaneously, the electronic brake distribution system is not working. This can result in vehicle instability under sudden braking. Have your vehicle inspected by a dealer immediately.

### ▶▶ If the Low Tire Pressure Indicator Comes On

#### NOTICE

Driving on an extremely underinflated tire can cause it to overheat. An overheated tire can fail. Always inflate your tires to the prescribed level.

## Models with information display

## If the TPMS Indicator Comes On

**TPMS****■ Reasons for the indicator to come on**

- Comes on when there is a problem with the TPMS.
- If the compact spare is installed, the indicator comes on after driving for a few miles (kilometers).

**■ What to do when the indicator comes on**

Have the tire inspected by a dealer as soon as possible. If the compact spare tire causes the indicator to come on, change the tire to a full-size tire. The indicator goes off after driving for a few miles (kilometers).

## Models with multi-information display

## If the Low Tire Pressure/TPMS Indicator Comes On or Blinks

**■ Reasons for the indicator to come on or blink**

A tire pressure is significantly low. If there is a problem with the TPMS or the compact spare tire is installed, the indicator blinks for about one minute, and then stays on.

**■ What to do when the indicator comes on**

Stop your vehicle in a safe place. Check the tire pressure and adjust the pressure to the specified level. The specified tire pressure is on a label on the driver side doorjamb.

**■ What to do when the indicator blinks**

Have the tire inspected by a dealer as soon as possible. If the compact spare tire causes the indicator to blink, change the tire to a full-size tire. The indicator goes off after driving for a few miles (kilometers).

## ▶ If the Low Tire Pressure/TPMS Indicator Comes On or Blinks

**NOTICE**

Driving on an extremely underinflated tire can cause it to overheat. An overheated tire can fail. Always inflate your tires to the prescribed level.

## Fuse Locations

If any electrical devices are not working, turn the ignition switch to LOCK **0** and check to see if any applicable fuse is blown.

Fuse locations are shown on the fuse box cover. Locate the fuse in question by the fuse number and box cover number.

### Engine Compartment Fuse Box

Located on the passenger's side, near the windshield washer reservoir. Push the tabs to open the box.

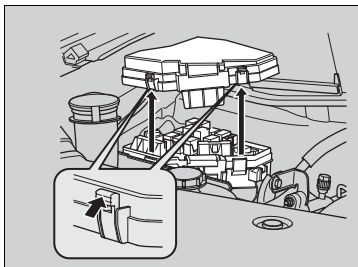

### ■ Circuit protected and fuse rating

	Circuit Protected	Amps
1	Main Fuse	120 A
	–	–
2	OP Main	80 A
	IG Main	50 A
3	Blower	40 A
	AC Inverter	30 A
4	Head Light Main	50 A
	Power Window Main	40 A
5	–	–
6	Condenser Fan	30 A
7	Cooling Fan	30 A
8	Rear Defogger	30 A
9	–	–
10	Fog Lights*	(20 A)
11	Sub	15 A
12	ACM	10 A
13	Front Passenger's Power Seat Reclining*	(20 A)
14	Front Passenger's Power Seat Slide*	(20 A)
15	Oil Level	7.5 A
16	FI ECU	(7.5 A)
17	Radio	20 A
18	IG Coil	15 A
19	Main	15 A
20	MG Clutch	7.5 A

	Circuit Protected	Amps
21	DBW	15 A
22	Interior Lights	7.5 A
23	Back Up	10 A

## ■ Engine Compartment Sub Fuse Box

Located near the battery. Push the tabs to open the box.

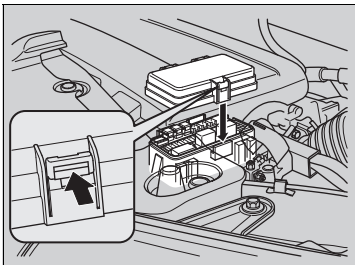

## ■ Circuit protected and fuse rating

	Circuit Protected	Amps
1	Power Tailgate Motor *	(40 A)
2	VTM-4 *	(20 A)
3	Trailer Main	(30 A)
4	VSA FSR	40 A
5	Rear Blower	30 A
6	VSA Motor	30 A
7	Hazard	15 A
8	Power Tailgate Closer *	(20 A)
9	Driver's Power Seat Reclining *	(20 A)
10	Driver's Power Seat Slide *	(20 A)
11	Stop & Horn	20 A
12	Rear Console Accessory Socket	15 A
13	Rear Wiper	10 A
14	Trailer E-Brake	(20 A)
15	Front Heated Seat *	(20 A)
16	Center Console Accessory Socket	15 A
17	Trailer Charge	(20 A)
18	Front Accessory Socket	15 A
19	Rear Accessory Socket	15 A
20	Glass Hatch Motor	20 A
21	Rear Heated Seat *	(15 A)
22	Head Light Washer Motor	(30 A)

\* Not available on all models



### Interior Fuse Box

Located under the dashboard.

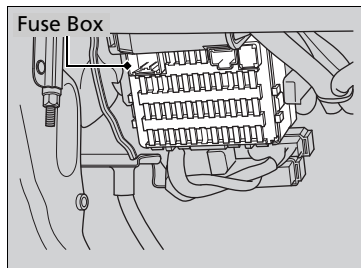

Fuse locations are shown on the label on the side panel.

Locate the fuse in question by the fuse number and label number.

#### ■ Circuit protected and fuse rating

	Circuit Protected	Amps
1	VTM-4*	(7.5 A)
2	Fuel Pump	20 A
3	ACG	10 A
4	VSA	7.5 A
5	–	–
6	–	–
7	Auto Light	10 A
8	Auto Light	7.5 A
9	ODS	7.5 A

	Circuit Protected	Amps
10	Meter	7.5 A
11	SRS	10 A
12	Right Daytime Running Light	10 A
13	Left Daytime Running Light	10 A
14	Small Lights (Interior)	7.5 A
15	Small Lights (Exterior)	10 A
16	Right Head Light Low	15 A
17	Left Head Light Low	15 A
18	Daytime Running Light Main	20 A
19	Small Lights Main	15 A
20	– TPMS	– 7.5 A
21	Head Light Low Main	20 A
22	VBSOL2	7.5 A
23	STRLD	7.5 A
24	–	–
25	–	–
26	Driver's Power Window	20 A
27	HAC OP	20 A
28	Moonroof	(20 A)
29	Door Lock	20 A
30	Front Passenger's Power Window	20 A
31	Audio Amp	(30 A)

	Circuit Protected	Amps
32	Passenger's Side Rear Power Window	20 A
33	Driver's Side Rear Power Window	20 A
34	–	–
35	ACC	10 A
36	HAC	10 A
37	Day Light	7.5 A
38	Wiper	30 A

\* Not available on all models

## ■ Cargo Area Fuse Box

Located on the left side of cargo area.  
Remove the cover by prying on the edge of the cover using a flat-tip screwdriver.

- Wrap the flat-tip screwdriver with a cloth to prevent scratches.

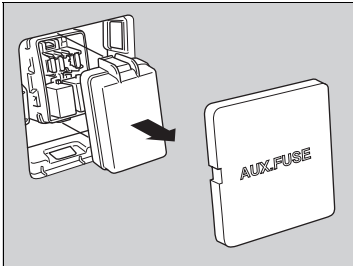

Fuse locations are shown on the fuse box cover.

Locate the fuse in question by the fuse number and box cover number.

## ■ Circuit protected and fuse rating

	Circuit Protected	Amps
1	Small Light	20 A
2	Stop Light	(7.5 A)
3	Back Light	(7.5 A)
4	Turn Light Hazard	(7.5 A)

## Inspecting and Changing Fuses

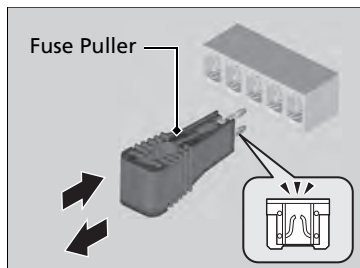
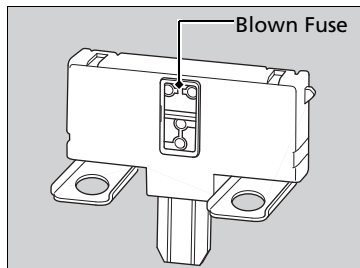

1. Turn the ignition switch to LOCK [0]. Turn headlights and all accessories off.
2. Remove the fuse box cover.
3. Check the large fuse in the engine compartment.
  - If the fuse is blown, use a Phillips-head screwdriver to remove the screw and replace it with a new one.
4. Inspect the small fuses in the engine compartment and the vehicle interior.
  - If there is a burned out fuse, remove it with the fuse puller and replace it with a new one.

### Inspecting and Changing Fuses

#### NOTICE

Replacing a fuse with one that has a higher rating greatly increases the chances of damaging the electrical system.

Replace fuse with a spare fuse of the same specified amperage. Confirm the specified amperage using the charts on P. 454 to 457.

There is a fuse puller on the back of the engine compartment fuse box cover.

Call a professional towing service if you need to tow your vehicle.

## All models

### ■ Flat bed equipment

The operator loads your vehicle on the back of a truck.

**This is the best way to transport your vehicle.**

## 2WD models

### ■ Wheel lift equipment

The tow truck uses two pivoting arms that go under the front tires and lift them off the ground. The rear tires remain on the ground. **This is an acceptable way to tow your vehicle.**

## » Emergency Towing

### NOTICE

Trying to lift or tow your vehicle by the bumpers will cause serious damage. The bumpers are not designed to support the vehicle's weight.

Never tow your vehicle with just a rope or chain. It is very dangerous, since ropes or chains may shift from side to side or break.

## If Your Vehicle Gets Stuck

For very short distances, such as freeing the vehicle, you can use the detachable towing hook that mounts on the anchors in the front and rear bumpers.

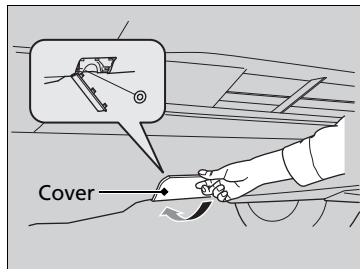

### Front

1. Put cloth on the edge of the cover. Carefully pry with a small flat-tip screwdriver or a metal fingernail file to remove the cover.
  - ▶ The cover is attached to the bumper by a tether.

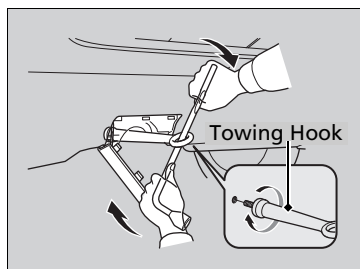

2. Remove the rubber cap by pulling it out.
3. Remove the towing hook and wheel wrench from the tool case in the cargo area.
4. Screw the towing hook into the hole, and tighten it with the wheel nut wrench.

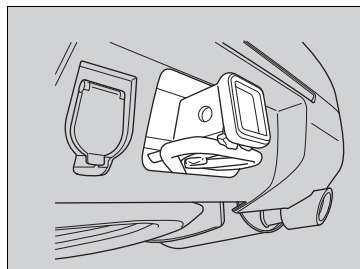

### Rear

Remove the rear bumper cover.

➤ [Towing Equipment and Accessories P. 333](#)

### ▶▶ If Your Vehicle Gets Stuck

#### NOTICE

To avoid damage to your vehicle, use the towing hook for straight, flat ground towing only. Do not tow at an angle. The hook should not be used to tow the vehicle onto a flat bed. Do not use it as a tie down.

# When You Cannot Open the Tailgate

## What to Do When Unable to Open the Tailgate

If you cannot open the tailgate, use the following procedure.

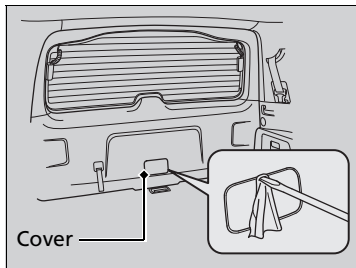

1. Use a flat-tip screwdriver and remove the cover on the inside of the tailgate.

### Models with power tailgate

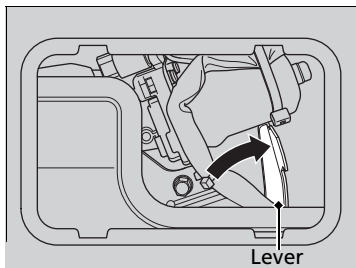

2. To open the tailgate, push the tailgate while sliding the lever to the right.

## What to Do When Unable to Open the Tailgate

### What to do-Following up

After taking these steps, contact a dealer to have the vehicle checked.

When you open the tailgate from inside, make sure there is enough space around the tailgate, and it does not hit anyone or any object.

Models without power tailgate

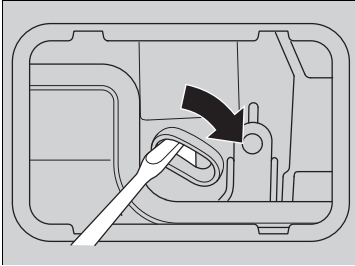

2. To open the tailgate, push the tailgate while pushing down the lever with the flat-tip screwdriver.

# Information

This chapter includes your vehicle's specifications, locations of identification numbers, and other information required by regulation.

<b>Specifications</b> .....	464	<b>Emissions Testing</b>	
<b>Identification Numbers</b>		Testing of Readiness Codes.....	470
Vehicle Identification Number (VIN).....	466	<b>Warranty Coverages</b> .....	472
Engine Number and Transmission		<b>Authorized Manuals</b> .....	474
Number.....	466	<b>Customer Service Information</b> .....	475
<b>Devices that Emit Radio Waves</b> .....	467	<b>Gracenote® End User License</b>	
<b>Reporting Safety Defects</b> .....	469	<b>Agreement</b> .....	476



## Vehicle Specifications

Model	Honda Pilot
No. of Passengers:	
Front	2
Second	3
Third	3
Total	8
Weights:	
Gross Vehicle Weight Rating	U.S.: 5,953 lbs (2,700 kg) <sup>*1</sup> 6,096 lbs (2,765 kg) <sup>*2</sup> Canada: 2,700 kg <sup>*1</sup> 2,765 kg <sup>*2</sup>
Gross Axle Weight Rating (Front)	U.S.: 2,921 lbs (1,325 kg) Canada: 1,325 kg
Gross Axle Weight Rating (Rear)	U.S.: 3,197 lbs (1,450 kg) <sup>*1</sup> 3,251 lbs (1,475 kg) <sup>*3</sup> 3,362 lbs (1,525 kg) <sup>*4</sup> Canada: 1,450 kg <sup>*1</sup> 1,525 kg <sup>*2</sup>
Air Conditioning:	
Refrigerant Type	HFC-134a (R-134a)
Charge Quantity	21.2 – 22.9 oz (600 – 650 g)
Lubricant Type	ND-OIL8

<sup>\*1</sup>: 2WD models

<sup>\*2</sup>: 4WD models

<sup>\*3</sup>: LX models with 4WD

<sup>\*4</sup>: Except LX models with 4WD

## Engine Specifications

Displacement	212 cu-in (3,471 cm <sup>3</sup> )
Spark Plugs	NGK DILZKR7A11G

## Fuel

Fuel:	Unleaded gasoline, Pump octane number of 87 or higher
Type	
Fuel Tank Capacity	21.0 US gal (79.5 ℓ)

## Battery

Capacity/Type	60AH(5)/72AH(20)
---------------	------------------

## Washer Fluid

Tank Capacity	U.S.: 4.2 US qt (4.0 ℓ) Canada: 6.9 US qt (6.5 ℓ)
---------------	--

## Light Bulbs

Headlights (Low Beam)	55W (H11)
Headlights (High Beam)	60 W (HB3)
Daytime Running Lights	60 W (HB3)
Fog Lights <sup>*5</sup>	55W (H11)
Front Turn Signal/Parking Lights	28/8W (Amber)
Side Turn Signal Lights (on Door Mirrors) <sup>*5</sup>	LED
Front Side Marker Lights	3CP
Rear Side Marker Lights	5W
Brake/Taillights	21/5W
Back-Up Lights	18W
Rear Turn Signal/Taillights	21/5W
High-Mount Brake Light	5W
Rear License Plate Light	5W
Interior Lights	
Map Lights (Front)	8W
Map Lights (Rear)	4CP
Door Courtesy Lights	2CP
Console Compartment Light	1.4W
Glove Box Light	1.4W
Foot Light	LED
Cargo Area Light	8W
Vanity Mirror Lights	1.4W

<sup>\*5</sup>: Not available on all models

■ Brake Fluid

Specified	Honda Heavy Duty Brake Fluid DOT 3
-----------	------------------------------------

■ Automatic Transmission Fluid

Specified	Honda ATF DW-1 (automatic transmission fluid)
-----------	--

Capacity	Change	3.2 US qt (3.1 ℓ) <sup>*1</sup> 3.6 US qt (3.4 ℓ) <sup>*2</sup>
----------	--------	--

\*1: 2WD models

\*2: 4WD models

■ Rear Differential Fluid \*

Specified	Honda VTM-4 Differential Fluid
Capacity	Change 2.79 US qt (2.64 ℓ)

■ Transfer Assembly Fluid \*

Specified	HYPOID GEAR OIL API GL4 or GL5 SAE75W-85 (SAE90 CAN BE USED)
Capacity	Change 0.45 US qt (0.43 ℓ)

■ Engine Oil

Recommended	-Genuine Honda Motor Oil 0W-20 -API Premium-grade 0W-20 detergent oil
Capacity	Change 4.2 US qt (4.0 ℓ)
	Change including filter 4.5 US qt (4.3 ℓ)

■ Engine Coolant

Specified	Honda Long-Life Antifreeze/Coolant Type2
Ratio	50/50 with distilled water 1.98 US gal (7.5 ℓ)
Capacity	(change including the remaining 0.198 US gal (0.75 ℓ) in the reserve tank)

■ Tire

Regular	Size	P235/65R/17 103T <sup>*3</sup> P235/60R/18 102T <sup>*4</sup>
	Pressure psi (kPa [kgf/cm <sup>2</sup> ])	Front 31 (210 [2.1]) <sup>*3</sup>
		Rear 33 (230 [2.3]) <sup>*3</sup>
Compact Spare	Size	T165/80D17 104M
Wheel Size	Regular	17 x 7.5J <sup>*3</sup> 18 x 7.5J <sup>*4</sup>
	Compact Spare	17 x 4T

\*3: U.S. LX

\*4: Except U.S. LX

\* Not available on all models

## Vehicle Identification Number (VIN)

Your vehicle has a 17-digit vehicle identification number (VIN) used to register your vehicle for warranty purposes, and for licensing and insuring your vehicle. See the image below for the VIN locations.

## Engine Number and Transmission Number

See the image below for the locations of your vehicle's engine number and transmission number.

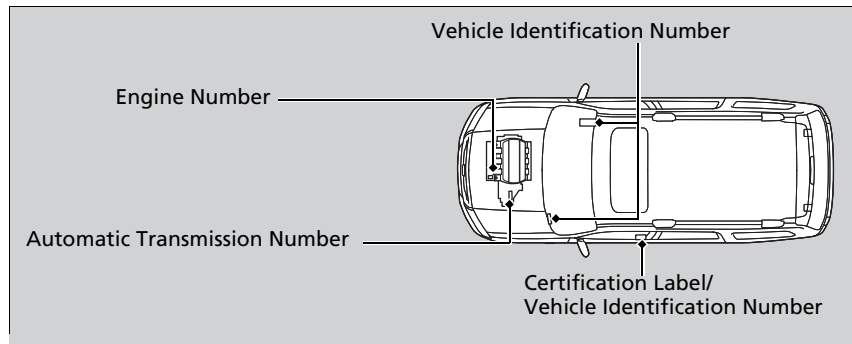

# Devices that Emit Radio Waves

The following products and systems on your vehicle emit radio waves when in operation.

## Audio System

*Bluetooth®* Audio

*Bluetooth®* HandsFreeLink®

Immobilizer System

## Models with Parking Sensor System

Parking Sensor System

Remote Transmitter

Tire Pressure Monitoring System (TPMS)

## Models with Rear Entertainment System

Rear Entertainment System Remote Control

Each of the above complies with the appropriate requirements or the required standards of FCC (Federal Communications Commission) and Industry Canada Standard, described below:

As required by the FCC:

This device complies with Part 15 of the FCC rules. Operation is subject to the following two conditions: (1) This device may not cause harmful interference, and (2) this device must accept any interference received, including interference that may cause undesired operation.

Changes or modifications not expressly approved by the party responsible for compliance could void the user's authority to operate the equipment.

*Continued*

This device complies with Industry Canada Standard RSS-Gen/210/310. Operation is subject to the following two conditions: (1) this device may not cause interference, and (2) this device must accept any interference, including interference that may cause undesired operation of the device.

## In the U.S.

If you believe that your vehicle has a defect which could cause a crash or could cause injury or death, you should immediately inform the National Highway Traffic Safety Administration (NHTSA) in addition to notifying American Honda Motor Co., Inc.

If NHTSA receives similar complaints, it may open an investigation, and if it finds that a safety defect exists in a group of vehicles, it may order a recall and remedy campaign. However, NHTSA cannot become involved in individual problems between you, your dealer, or American Honda Motor Co., Inc.

To contact NHTSA, you may:

call the Vehicle Safety Hotline toll-free at 1-888-327-4236 (TTY: 1-800-424-9153);

go to <http://www.safercar.gov>;

or write to: Administrator, NHTSA  
1200 New Jersey Avenue, SE.,  
Washington, DC 20590.

You can also obtain other information about motor vehicle safety from <http://www.safercar.gov>.

## In Canada

If you believe that your vehicle has a defect which could cause a crash or could cause injury or death, you should immediately inform Honda Canada Inc. and you may also inform Transport Canada.

If Transport Canada receives similar complaints, it may open an investigation, and if it finds that a safety defect exists in a group of vehicles, it may lead to a recall and remedy campaign. However, Transport Canada cannot become involved in individual problems between you, your dealer, or Honda Canada Inc.

To contact Transport Canada's Defect Investigations and Recalls Division, you may call 1-800-333-0510. For more information on reporting safety defects or about motor vehicle safety, go to <http://www.tc.gc.ca/roadsafety>

## Testing of Readiness Codes

Your vehicle uses “readiness codes,” as part of its onboard self diagnostic system. Some states refer to these codes during testing to see if your vehicle's emissions components are working properly. The codes may not be read if you go through the testing just after the battery has gone dead or been disconnected.

To check if they are set, turn the ignition switch to ON **[II]**, without starting the engine. The malfunction indicator lamp will come on for several seconds. If it then goes off, the readiness codes are set. If it blinks five times, the readiness codes are not set.

If you are required to have your vehicle tested before the readiness codes are ready, prepare the vehicle for retesting by doing the following:

1. Fill the gas tank to approximately 3/4 full.
2. Park the vehicle and leave the engine off for 6 hours or more.
3. Make sure the ambient temperature is between 40°F and 95°F (4°C and 35°C).
4. Start the engine without touching the accelerator pedal, and let it idle for 20 seconds.
5. Keep the vehicle in **[P]**. Increase the engine speed to 2,000 rpm, and hold it there for about 3 minutes.
6. Let the engine idle with your foot off the accelerator for 20 seconds.

### Testing of Readiness Codes

The readiness codes are erased when the battery is disconnected, and set again only after several days of driving under a variety of conditions.

If a testing facility determines that the readiness codes are not set, you may be requested to return at a later date to complete the test.

If the testing facility determines the readiness codes are still not set, see a dealer.

7. Select a nearby, lightly traveled major highway where you can maintain a speed of 50 to 60 mph (80 to 97 km/h) for at least 20 minutes. Drive on the highway in **D**. Do not use cruise control. When traffic allows, drive for 90 seconds without moving the accelerator pedal. (Vehicle speed may vary slightly; this is okay.) If you cannot do this for a continuous 90 seconds because of traffic conditions, drive for at least 30 seconds, then repeat it two more times (for a total of 90 seconds).
8. Drive in city/suburban traffic for at least 10 minutes. When traffic conditions allow, let the vehicle coast for several seconds without using the accelerator pedal or the brake pedal.
9. Park the vehicle and leave the engine off for 30 minutes.



## ■ U.S. Owners

Your new vehicle is covered by these warranties:

***New Vehicle Limited Warranty*** – covers your new vehicle, except for the emissions control systems and accessories, against defects in materials and workmanship.

***Emissions Control Systems Defects Warranty and Emissions Performance Warranty*** – these two warranties cover your vehicle's emissions control systems. Time, mileage, and coverage are conditional. Please read your warranty booklet for exact information.

***Seat Belt Limited Warranty*** – a seat belt that fails to function properly is covered by a limited warranty. Please read your warranty booklet for details.

***Rust Perforation Limited Warranty*** – all exterior body panels are covered for rust-through from the inside for the specified time period with no mileage limit.

***Accessory Limited Warranty*** – Honda accessories are covered under this warranty. Time and mileage limits depend on the type of accessory and other factors. Please read your warranty booklet for details.

***Replacement Parts Limited Warranty*** – covers all Honda replacement parts against defects in materials and workmanship.

**Replacement Battery Limited Warranty** – provides prorated coverage for a replacement battery purchased from a dealer.

**Replacement Muffler Lifetime Limited Warranty** – provides coverage for as long as the purchaser of the muffler owns the vehicle.

Restrictions and exclusions apply to all these warranties. Please read the 2013 Honda warranty information booklet that came with your vehicle for precise information on warranty coverages. Your vehicle's original tires are covered by their manufacturer. Tire warranty information is in a separate booklet.

■ **Canadian Owners**

Please refer to the 2013 warranty manual that came with your vehicle.

## ■ For U.S. Owners:

The publications listed below can be purchased from Helm Incorporated. You can order a manual by phone at (800) 782-4356 (credit card orders only), or online at [www.helminc.com](http://www.helminc.com).

Make an inquiry to Helm Inc. at (800) 782-4356 if you are interested in ordering other models' or other years' manuals.

Publication Form Number	Form Description
61SZA04	2013 Honda Pilot Service Manual
61SZA04EL	2013 Honda Pilot Electrical Troubleshooting Manual
61SZA40	2013 Honda Pilot Body Repair Manual
31SZA640	2013 Honda Pilot Owner's Manual
31SZA840	2013 Honda Pilot Navigation System Owner's Manual
31SZAM40	2013 Honda Pilot Service History
31SZAA40	2013 Honda Pilot Technology Reference Guide (LX/EX/EX-L/EX-L with RES)
31SZAB40	2013 Honda Pilot Technology Reference Guide (EX-L with Navigation)
31SZAC40	2013 Honda Pilot Technology Reference Guide (Touring)
HON-R	Order Form for Previous Years-Indicate Year and Model Desired

## » Authorized Manuals

### **Service Manual:**

Covers maintenance and recommended procedures for repair to engine and chassis components. It is written for the journeyman technician, but it is simple enough for most mechanically inclined owners to understand.

### **Electrical Troubleshooting Manual:**

Complements the Service Manual by providing in-depth troubleshooting information for each electrical circuit in your vehicle.

### **Body Repair Manual:**

Describes the procedures involved in the replacement of damaged body parts.

### **For Canadian Owners:**

Si vous avez besoin d'un Manuel du Conducteur en français, veuillez demander à votre concessionnaire de commander le numéro de pièce 33SZAC40

Honda dealership personnel are trained professionals.

They should be able to answer all your questions. If you encounter a problem that your dealership does not solve to your satisfaction, please discuss it with the dealership's service manager or general manager. If you are dissatisfied with the decision made by the dealership's management, contact Honda Customer Services.

## U.S. Owners:

American Honda Motor Co., Inc.  
Honda Automobile Customer Services  
Mail Stop 500-2N-7A  
1919 Torrance Blvd.  
Torrance, CA 90501-2746  
Tel: (800) 999-1009

## Canadian Owners:

Honda Canada Inc.  
Customer Relations  
180 Honda Boulevard  
Markham, ON  
L6C 0H9  
Tel: 1-888-9-HONDA-9  
Fax: 1-877-939-0909  
E-mail: [Honda\\_cr@ch.honda.com](mailto:Honda_cr@ch.honda.com)

## In Puerto Rico and the U.S. Virgin Islands:

Bella International  
P.O. Box 190816  
San Juan, PR 00919-0816  
Tel: (787) 620-7546

## Customer Service Information

When you call or write, please give us the following information:

- Vehicle Identification Number
  - **Vehicle Identification Number (VIN)**  
P. 466
- Date of purchase
- Odometer reading of your vehicle
- Your name, address, and telephone number
- A detailed description of the problem
- Name of the dealer who sold the vehicle to you

This application or device contains software from Gracenote, Inc. of Emeryville, California (“Gracenote”). The software from Gracenote (the “Gracenote Software”) enables this application to perform disc and/or file identification and obtain music-related information, including name, artist, track, and title information (“Gracenote Data”) from online servers or embedded databases (collectively, “Gracenote Servers”) and to perform other functions. You may use Gracenote Data only by means of the intended End-User functions of this application or device.

You agree that you will use Gracenote Data, the Gracenote Software, and Gracenote Servers for your own personal non-commercial use only.

You agree not to assign, copy, transfer or transmit the Gracenote Software or any Gracenote Data to any third party. YOU AGREE NOT TO USE OR EXPLOIT GRACENOTE DATA, THE GRACENOTE SOFTWARE, OR GRACENOTE SERVERS, EXCEPT AS EXPRESSLY PERMITTED HEREIN.

You agree that your non-exclusive license to use the Gracenote Data, the Gracenote Software, and Gracenote Servers will terminate if you violate these restrictions. If your license terminates, you agree to cease any and all use of the Gracenote Data, the Gracenote Software, and Gracenote Servers. Gracenote reserves all rights in Gracenote Data, the Gracenote Software, and the Gracenote Servers, including all ownership rights. Under no circumstances will Gracenote become liable for any payment to you for any information that you provide. You agree that Gracenote, Inc. may enforce its rights under this Agreement against you directly in its own name.

## Gracenote® End User License Agreement

### Gracenote Music Recognition Service (CDDB)



Music recognition technology and related data are provided by Gracenote®. Gracenote is the industry standard in music recognition technology and related content delivery. For more information, please visit [www.gracenote.com](http://www.gracenote.com).

When music is recorded to the HDD from a CD, information such as the recording artist and track name are retrieved from the Gracenote Database and displayed (when available). Gracenote may not contain information for all albums.

Gracenote is an internet-based music recognition service that allows artist, album, and track information from CDs to display on the HDD. More information about Gracenote is available at [www.honda.com/](http://www.honda.com/) (in U.S.) or [www.honda.ca](http://www.honda.ca) (in Canada).

CD and music-related data from Gracenote, Inc., copyright© 2000 to present Gracenote.

The Gracenote service uses a unique identifier to track queries for statistical purposes. The purpose of a randomly assigned numeric identifier is to allow the Gracenote service to count queries without knowing anything about who you are. For more information, see the web page for the Gracenote Privacy Policy for the Gracenote service.

The Gracenote Software and each item of Gracenote Data are licensed to you “AS IS.” Gracenote makes no representations or warranties, express or implied, regarding the accuracy of any Gracenote Data from in the Gracenote Servers. Gracenote reserves the right to delete data from the Gracenote Servers or to change data categories for any cause that Gracenote deems sufficient. No warranty is made that the Gracenote Software or Gracenote Servers are error-free or that functioning of Gracenote Software or Gracenote Servers will be uninterrupted. Gracenote is not obligated to provide you with new enhanced or additional data types or categories that Gracenote may provide in the future and is free to discontinue its services at any time.

GRACENOTE DISCLAIMS ALL WARRANTIES EXPRESS OR IMPLIED, INCLUDING, BUT NOT LIMITED TO, IMPLIED WARRANTIES OF MERCHANTABILITY, FITNESS FOR A PARTICULAR PURPOSE, TITLE, AND NON-INFRINGEMENT. GRACENOTE DOES NOT WARRANT THE RESULTS THAT WILL BE OBTAINED BY YOUR USE OF THE GRACENOTE SOFTWARE OR ANY GRACENOTE SERVER. IN NO CASE WILL GRACENOTE BE LIABLE FOR ANY CONSEQUENTIAL OR INCIDENTAL DAMAGES OR FOR ANY LOST PROFITS OR LOST REVENUES.

copyright © 2000 to present Gracenote

#### ☒ Gracenote® End User License Agreement

Gracenote Software, copyright© 2000 to present Gracenote. One or more patents owned by Gracenote apply to this product and service. See the Gracenote website for a non-exhaustive list of applicable Gracenote patents.

Gracenote, CDDDB, MusicID, MediaVOCS, the Gracenote logo and logotype, and the “Powered by Gracenote” logo are either registered trademarks or trademarks of Gracenote in the United States and/or other countries.

<b>A</b>		
ABS (Anti-lock Brake System).....	362	
AC Power Outlet.....	158	
Accessories and Modifications.....	375	
Accessory Power Sockets.....	156	
<b>Additives</b>		
Coolant.....	397	
Engine Oil.....	392	
Washer.....	401	
<b>Additives, Engine Oil.....</b>	<b>392</b>	
<b>Adjusting</b>		
Armrest.....	149	
Front Seats.....	137	
Head Restraints.....	141	
Mirrors.....	135	
Rear Seats.....	146	
Steering Wheel.....	134	
Temperature.....	87	
<b>Air Conditioning System</b>		
<b>(Climate Control System).....</b>	<b>165</b>	
Changing the Mode.....	165	
Defrosting the Windshield and Windows.....	166	
Dust and Pollen Filter.....	427	
Recirculation/Fresh Air Mode.....	165	
Sensors.....	170	
Synchronized Mode.....	167	
Using Automatic Climate Control.....	165	
<b>Air Pressure.....</b>	<b>415, 465</b>	
<b>Airbags.....</b>	<b>37</b>	
Advanced Airbags.....	43	
After a Collision.....	41	
Airbag Care.....	51	
Event Data Recorder.....	20	
Front Airbags (SRS).....	40	
Indicator.....	48, 71, 75	
Passenger Airbag Off Indicator.....	49	
Sensors.....	37	
Side Airbag Cutoff System.....	46	
Side Airbag Off Indicator.....	50	
Side Airbags.....	44	
Side Curtain Airbags.....	47	
<b>AM/FM Radio.....</b>	<b>186, 219</b>	
<b>Anti-lock Brake System (ABS).....</b>	<b>362</b>	
Indicator.....	71	
<b>Armrest.....</b>	<b>149</b>	
<b>Audio Remote Controls.....</b>	<b>184, 217</b>	
<b>Audio System.....</b>	<b>172</b>	
Adjusting the Sound.....	185, 218	
Auxiliary Input Jack.....	173	
Error Messages.....	266	
General Information.....	272	
iPod®.....	240	
MP3/WMA/AAC.....	207, 244	
Reactivating.....	174	
Recommended CDs.....	273	
Recommended Devices.....	275	
Remote Controls.....	184, 217	
Security Code.....	174	
Theft Protection.....	174	
USB Adapter Cable.....	173	
USB Flash Drives.....	275	
<b>Audio/Information Display.....</b>	<b>176</b>	
<b>Authorized Manuals.....</b>	<b>474</b>	
<b>Auto Door Locking/Unlocking.....</b>	<b>105</b>	
Customize.....	93, 106	
<b>Automatic Lighting.....</b>	<b>126</b>	
<b>Automatic Transmission.....</b>	<b>345</b>	
Creeping.....	345	
Fluid.....	399	
Kickdown.....	345	
Operating the Shift Lever.....	14, 347	
Shift Lever Does Not Move.....	447	
Shifting.....	346	
<b>Auxiliary Input Jack.....</b>	<b>173</b>	
<b>Average Fuel Economy.....</b>	<b>82, 88</b>	
<b>Average Speed.....</b>	<b>88, 177</b>	
<b>B</b>		
<b>Battery.....</b>	<b>423</b>	
Charging System Indicator.....	69, 450	
Jump Starting.....	445	
Maintenance (Checking the Battery).....	423	
Maintenance (Replacing).....	424	
<b>Belts (Seat).....</b>	<b>29</b>	
<b>Beverage Holders.....</b>	<b>154</b>	
<b>Bluetooth® Audio.....</b>	<b>211, 248</b>	
<b>Bluetooth® HandsFreeLink®.....</b>	<b>278, 301</b>	
<b>Booster Seats (For Children).....</b>	<b>64</b>	

<b>Brake System</b> .....	360	<b>Changing Bulbs</b> .....	402	<b>Coolant (Engine)</b> .....	397
Anti-lock Brake System (ABS) .....	362	<b>Charging System Indicator</b> .....	69, 450	Adding to the Radiator .....	398
Brake Assist System .....	363	<b>Child Safety</b> .....	52	Adding to the Reserve Tank .....	397
Fluid .....	400	Childproof Door Locks .....	104	Overheating .....	448
Foot Brake .....	361	<b>Child Seat</b> .....	52	<b>Creeping (Automatic Transmission)</b> .....	345
Indicator .....	68, 452	Booster Seats .....	64	<b>Cruise Control</b> .....	348
Parking Brake .....	360	Child Seat for Infants .....	54	Indicator .....	77
<b>Brightness Control (Instrument Panel)</b> ...	130	Child Seat for Small Children .....	55	<b>Cup Holders</b> .....	154
<b>Bulb Replacement</b> .....	402	Installing a Child Seat with a Lap/ Shoulder Seat Belt .....	60	<b>Customer Service Information</b> .....	475
Brake Light, Taillight, Back-Up Light, Rear Turn Signal Light and Rear Side Marker Light .....	406	Larger Children .....	63	<b>Customized Features</b> .....	90
Fog Lights .....	403	Rear-facing Child Seat .....	54		
Front Turn Signal/Parking Light and Front Side Marker Light .....	405	Selecting a Child Seat .....	56	<b>D</b>	
Headlights .....	402	<b>Childproof Door Locks</b> .....	104	<b>Daytime Running Lights</b> .....	127
High-Mount Brake Light .....	409	<b>Cleaning the Exterior</b> .....	430	<b>Dead Battery</b> .....	445
Rear License Plate Light .....	408	<b>Cleaning the Interior</b> .....	428	<b>Defrosting the Windshield and     Windows</b> .....	166
Side Turn Signal/ Emergency Indicator Light .....	404	<b>Climate Control System</b> .....	165	<b>Detachable Anchor</b> .....	34
<b>Bulb Specifications</b> .....	464	Changing the Mode .....	165	<b>Devices that Emit Radio Waves</b> .....	467
		Defrosting the Windshield and Windows .....	166	<b>Dimming</b>	
		Dust and Pollen Filter .....	427	Headlights .....	125
		Recirculation/Fresh Air Mode .....	165	Rearview Mirror .....	135
		Sensors .....	170	<b>Dipstick (Engine Oil)</b> .....	393
		Synchronized Mode .....	167	<b>Directional Signals (Turn Signal)</b> .....	125
		Using Automatic Climate Control .....	165	<b>Display/Information Button</b> .....	85
<b>C</b>		<b>Clock</b> .....	98	<b>Door Mirrors</b> .....	136
<b>Carbon Monoxide Gas</b> .....	65	<b>Coat Hook</b> .....	159	<b>Doors</b> .....	99
<b>Cargo Hook</b> .....	160	<b>Compact Spare Tire</b> .....	435, 465	Auto Door Locking .....	105
<b>Cargo Net</b> .....	159	<b>Console Compartment</b> .....	152	Auto Door Unlocking .....	105
<b>Carrying Cargo</b> .....	325, 327	<b>Controls</b> .....	97	Door Open Indicator .....	28, 72
<b>CD Library</b> .....	197			Keys .....	99
<b>CD Player</b> .....	193, 226				
<b>Certification Label</b> .....	466				



Locking/Unlocking the Doors  
 from the Inside ..... 103  
 Locking/Unlocking the Doors  
 from the Outside ..... 101  
 Lockout Prevention System ..... 102  
**DOT Tire Quality Grading** ..... 417  
**Driver's Seat Lumbar Support** ..... 137  
**Driving** ..... 323  
 Automatic Transmission ..... 345  
 Braking ..... 360  
 Cruise Control ..... 348  
 Off-Highway Driving Guidelines ..... 340  
 Shifting Gear ..... 346  
 Starting the Engine ..... 342  
**Driving Position Memory System** ..... 132  
**Dust and Pollen Filter** ..... 427

**E**

Elapsed Time ..... 88, 177  
 Electronic Stability Control (ESC) ..... 352  
 Emergency ..... 459  
 Emissions Testing (Readiness Codes) ..... 470  
**Engine** ..... 466  
 Coolant ..... 397  
 Jump Starting ..... 445  
 Oil ..... 392  
 Starting ..... 342  
 Switch Buzzer ..... 124  
 Engine Coolant ..... 397  
 Adding to the Radiator ..... 398

Adding to the Reserve Tank ..... 397  
 Overheating ..... 448  
 Temperature Gauge ..... 80  
**Engine Oil** ..... 392  
 Adding ..... 394  
 Checking ..... 393  
 Displaying Oil Life ..... 381, 385  
 Low Oil Pressure Indicator ..... 68, 450  
 Recommended Engine Oil ..... 392  
**Exhaust Gas Hazard  
 (Carbon Monoxide)** ..... 65  
**Exterior Care (Cleaning)** ..... 430  
**Exterior Mirrors** ..... 136

**F**

**Features** ..... 171  
**Filters**  
 Dust and Pollen ..... 427  
 Oil ..... 395  
**Flat Tire** ..... 435  
**Floor Mats** ..... 429  
**Fluids**  
 Automatic Transmission ..... 399  
 Brake ..... 400  
 Engine Coolant ..... 397  
 Power Steering ..... 400  
 Windshield Washer ..... 401  
**Fog Light Indicator** ..... 75  
**Folding Down the Rear Seats** .. 146, 147, 148  
**Foot Brake** ..... 361

**Front Airbags (SRS)** ..... 40  
**Front Seats** ..... 137  
 Adjusting ..... 137  
**Fuel** ..... 15, 371  
 Economy ..... 374  
 Gauge ..... 80  
 Instant Fuel Economy ..... 82, 88  
 Low Fuel Indicator ..... 70  
 Range ..... 82, 88  
 Recommendation ..... 371  
 Refueling ..... 371  
**Fuel Economy** ..... 374  
**Fuel Fill Cap** ..... 15, 373  
 Message ..... 451  
**Fuel Fill Door** ..... 15, 372  
**Fuses** ..... 454  
 Inspecting and Changing ..... 458  
 Locations ..... 454, 455, 456, 457

**G**

**Gasoline (Fuel)**  
 Economy ..... 374  
 Gauge ..... 80  
 Information ..... 371  
 Instant Fuel Economy ..... 82, 88  
 Low Fuel Indicator ..... 70  
 Refueling ..... 371  
**Gauges** ..... 80  
**Gear Shift Lever Positions**  
 Automatic Transmission ..... 346

Glass (care) ..... 431  
 Glove Box ..... 152

**H**

Halogen Bulbs ..... 402, 403  
 Handling the Unexpected ..... 433  
 HandsFreeLink® (HFL) ..... 278, 301  
     Automatic Answering ..... 289  
     Automatic Import of Cellular Phonebook and  
         Call History ..... 291, 312  
     Automatic Transferring ..... 289, 311  
     HFL Buttons ..... 278, 301  
     HFL Menus ..... 280, 303  
     HFL Status Display ..... 279, 302  
     Making a Call ..... 295, 316  
     Options During a Call ..... 300, 319  
     Phone Setup ..... 283, 305  
     Receiving a Call ..... 299, 319  
     Speed Dial ..... 292, 313  
     To Clear the System ..... 290, 312  
     To Create a Security PIN ..... 288, 310  
 Hazard Warning Button ..... 2  
 Head Restraints ..... 141  
 Headlights ..... 125  
     Aiming ..... 402  
     Automatic Operation ..... 126  
     Dimming ..... 125, 127  
     Operating ..... 125  
 Heaters (Seat) ..... 162  
 HFL (HandsFreeLink®) ..... 278, 301

High Beam Indicator ..... 75  
 Hill Start Assist System ..... 343

**I**

Identification Numbers ..... 466  
     Engine and Transmission ..... 466  
     Vehicle Identification ..... 466  
 Ignition Switch ..... 124  
 Illumination Control ..... 130  
     Knob ..... 130  
 Immobilizer System ..... 118  
     Indicator ..... 76  
 Indicators ..... 68  
     A/T Temperature ..... 73  
     ABS (Anti-lock Brake System) ..... 71  
     Charging System ..... 69, 450  
     CRUISE CONTROL ..... 77, 349  
     CRUISE MAIN ..... 77, 348  
     Door Open ..... 28, 72  
     Fog Light ..... 75  
     Fuel Economy ..... 76  
     High Beam ..... 75  
     Immobilizer System ..... 76  
     Lights On ..... 75  
     Low Fuel ..... 70  
     Low Oil Pressure ..... 68, 450  
     Low Tire Pressure ..... 74, 355, 357  
     Low Tire Pressure/TPMS ..... 74, 355  
     Maintenance Minder ..... 77, 381  
     Malfunction Indicator Lamp ..... 69, 451

Parking Brake and Brake System ..... 68, 452  
 Power Tailgate ..... 77  
 Seat Belt Reminder ..... 30, 70  
 Security System Alarm ..... 76  
 Shift Lever Position ..... 69  
 Side Airbag Off ..... 50, 75  
 Starter System ..... 76  
 Supplemental Restraint System ..... 48, 71  
 System Message ..... 73  
 Tailgate Open ..... 72  
 TPMS ..... 74, 358  
 Transmission ..... 70  
 Turn Signal ..... 75  
 VSA® (Vehicle Stability Assist)  
     System ..... 72, 352  
     VSA® OFF ..... 72, 353  
     VTM-4® System ..... 71, 354  
     Washer Level ..... 77  
 Information ..... 463  
 Information Display ..... 81  
 Instant Fuel Economy ..... 82, 88  
 Instrument Panel ..... 67  
     Brightness Control ..... 130  
 Integrated Sunshades ..... 164  
 Interior Lights ..... 150  
 Interior Rearview Mirror ..... 135  
 iPod® ..... 240

**J**

Jack (Wheel Nut Wrench)..... 439  
 Jump Starting..... 445

**K**

Key Number Tag..... 100  
 Keyless Lockout Prevention ..... 102  
 Keys ..... 99  
     Lockout Prevention..... 102  
     Master Keys..... 99  
     Number Tag..... 100  
     Rear Door Won't Open..... 104  
     Remote Transmitter..... 101  
     Types and Functions..... 99  
     Valet Key..... 100  
     Won't Turn..... 18  
 Kickdown (Automatic Transmission)..... 345

**L**

Language (HFL)..... 279, 302  
 LATCH (Child Seats)..... 57, 61  
 Lights..... 125, 402  
     Automatic..... 126  
     Bulb Replacement..... 402  
     Daytime Running Lights..... 127  
     Fog Lights..... 127  
     High Beam Indicator..... 75  
     Interior..... 150  
     Light Switches..... 125

Lights On Indicator..... 75  
 Turn Signals..... 125  
**Load Limits**..... 327  
**Locking/Unlocking**..... 99  
     Auto Door Locking/Unlocking..... 105  
     Childproof Door Locks..... 104  
     From Inside..... 103  
     From Outside..... 101  
     Keys..... 99  
     Using a Key..... 102  
**Lockout Prevention System**..... 102  
**Low Battery Charge**..... 450  
**Low Fuel Indicator**..... 70  
**Low Oil Pressure Indicator**..... 68, 450  
**Lower Anchors**..... 57, 61  
**Luggage (Maximum Load Limit)**..... 327

**M**

**Maintenance**..... 377  
     Battery..... 423  
     Brake Fluid..... 400  
     Cleaning..... 428  
     Climate Control System..... 427  
     Coolant..... 397  
     Maintenance Minder™..... 381  
     Oil..... 393  
     Power Steering Fluid..... 400  
     Precautions..... 378  
     Radiator..... 398  
     Remote Control..... 425

Remote Transmitter..... 424  
 Replacing Light Bulbs..... 402  
 Safety..... 379  
 Service Items..... 383, 387  
 Tires..... 414  
 Transmission Fluid..... 399  
 Under the Hood..... 389  
 Wireless Headphone..... 426  
**Malfunction Indicator Lamp**..... 69, 451  
**Map Lights**..... 151  
**Maximum Load Limit**..... 327  
**Meters, Gauges**..... 80  
**Mirrors**..... 135  
     Adjusting..... 135  
     Door..... 136  
     Exterior..... 136  
     Interior Rearview..... 135  
**Modifications (and Accessories)**..... 375  
**Moonroof**..... 123  
**MP3**..... 193, 207, 226, 244  
**Multi-Information Display**..... 85  
**Multi-View Rear Camera**..... 370

**N**

**Numbers (Identification)**..... 466

**O**

Odometer ..... 81, 86  
 Off-Highway Driving Guidelines ..... 340  
 Oil (Engine) ..... 392  
     Adding ..... 394  
     Checking ..... 393  
     Displaying Oil Life ..... 381, 385  
     Low Oil Pressure Indicator ..... 68, 450  
     Recommended Engine Oil ..... 392  
     Viscosity ..... 392  
 Opening/Closing  
     Hood ..... 390  
     Moonroof ..... 123  
     Power Windows ..... 120  
     Tailgate ..... 110  
 Outside Temperature Display ..... 84, 87  
 Overheating ..... 448

**P**

Panic Mode ..... 119  
 Parking ..... 364  
 Parking Brake ..... 360  
 Parking Brake and  
     Brake System Indicator ..... 68, 452  
 Parking Sensor System ..... 365  
 Passenger Airbag Off Indicator ..... 49  
 Passing Indicators ..... 125  
 Power Tailgate ..... 112  
 Power Windows ..... 120  
 Precautions While Driving ..... 344

Driving Guidelines  
     for Your Utility Vehicle ..... 344  
 Rain ..... 344  
 Pregnant Women ..... 35  
 Puncture (Tire) ..... 435

**R**

Radiator ..... 398  
 Radio (AM/FM) ..... 186, 219  
 Radio (XM®) ..... 223  
 Radio Data System (RDS) ..... 189, 222  
 Range ..... 82, 88  
 RDS (Radio Data System) ..... 189, 222  
 Readiness Codes (Emissions Testing) ..... 470  
 Rear Defogger/  
     Heated Door Mirror Button ..... 131  
 Rear Entertainment System ..... 251  
 Rear Seats (Folding Down) ..... 146, 147, 148  
 Rearview Camera ..... 369, 370  
 Rearview Mirror ..... 135  
 Refueling ..... 371  
     Fuel Gauge ..... 80  
     Gasoline ..... 371, 464  
     Low Fuel Indicator ..... 70  
 Regulations ..... 357, 417, 467  
 Remote Transmitter ..... 101  
 Replacement  
     Battery ..... 424  
     Bulbs ..... 402  
     Fuses ..... 454, 455, 456, 457

Tires ..... 420  
 Wiper Blade Rubber ..... 410  
 Reporting Safety Defects ..... 469  
 Resetting a Trip Meter ..... 82, 87

**S**

Safe Driving ..... 23  
 Safety Check ..... 28  
 Safety Labels ..... 66  
 Safety Message ..... 21  
 Seat Belts ..... 29  
     Adjusting the Shoulder Anchor ..... 33  
     Automatic Seat Belt Tensioners ..... 31  
     Checking ..... 36  
     Detachable Anchor ..... 34  
     Fastening ..... 32  
     Installing a Child Seat with a Lap/  
         Shoulder Seat Belt ..... 60  
     Pregnant Women ..... 35  
     Reminder ..... 30  
     Warning Indicator ..... 30, 70  
 Seat Heaters ..... 162  
 Seats ..... 137  
     Adjusting ..... 137  
     Driver's Seat Lumbar Support ..... 137  
     Front Seats ..... 137  
     Rear Seats ..... 146  
     Seat Heaters ..... 162  
 Security System ..... 118  
     Immobilizer System Indicator ..... 76

Security System Alarm Indicator ..... 76  
**SEL/RESET Knob** ..... 81, 85  
**Select Lever** ..... 14, 346  
     Operation ..... 14, 347  
     Releasing ..... 447  
     Won't Move ..... 447  
**Selecting a Child Seat** ..... 56  
**Selecting Knob (Audio)** ..... 175, 216  
**Setting the Clock** ..... 98  
**Shift Lever** ..... 14, 346  
**Shift Lever Position Indicator** ..... 69, 347  
**Shifting (Transmission)** ..... 346  
**Shoulder Anchor** ..... 33  
**Side Airbags** ..... 44  
     Cutoff System ..... 46  
     Off Indicator ..... 46  
**Side Curtain Airbags** ..... 47  
**Snow Tires** ..... 422  
**Spare Tire** ..... 435, 465  
**Spark Plugs** ..... 464  
**Specifications** ..... 464  
**Specified Fuel** ..... 371, 464  
**Speedometer** ..... 80  
**SRS Airbags (Airbags)** ..... 40  
**Starting the Engine** ..... 342  
     Does Not Start ..... 444  
     Engine Switch Buzzer ..... 124  
     Jump Starting ..... 445  
**Steering Wheel** ..... 134  
     Adjusting ..... 134  
**Stopping** ..... 364

**Storage Compartment** ..... 154  
**Summer Tires** ..... 422  
**Sunglasses Holder** ..... 161  
**Supplemental Restraint System (SRS)** ..... 40  
**Switches**  
     (Around the Steering Wheel) ..... 2, 3, 124  
**Synchronized Mode** ..... 167  
**System Message Indicator** ..... 73

**T**

**Tachometer** ..... 80  
**Tailgate** ..... 110  
     Unable to Open ..... 461  
**Temperature**  
     Outside Temperature Display ..... 84, 87  
**Temperature Gauge** ..... 80  
**Temperature Sensor** ..... 84, 87, 170  
**Time (Setting)** ..... 98  
**Tire Pressure Monitoring System (TPMS)** ..... 355  
     Indicator ..... 74, 453  
**Tires** ..... 414  
     Air Pressure ..... 415, 465  
     Checking and Maintaining ..... 414  
     Inspection ..... 414  
     Labeling ..... 415  
     Puncture (Flat Tire) ..... 435  
     Regulations ..... 417  
     Rotation ..... 421  
     Spare Tire ..... 435, 465

**Summer** ..... 422  
**Tire Chains** ..... 422  
**Wear Indicators** ..... 419  
**Winter** ..... 422

**Tools** ..... 434  
**Towing a Trailer** ..... 329  
     Equipment and Accessories ..... 333  
     Load Limits ..... 329  
**Towing Your Vehicle** ..... 339  
     Behind a Motorhome ..... 339  
     Emergency ..... 459

**TPMS**

**(Tire Pressure Monitoring System)** ..... 355  
     Indicator ..... 74, 453

**Transmission** ..... 346  
     Automatic ..... 346  
     Fluid ..... 399  
     Number ..... 466  
     Shift Lever Position Indicator ..... 69, 347

**Trip Meter** ..... 82, 87, 177

**Troubleshooting** ..... 433  
     Blown Fuse ..... 454, 455, 456, 457  
     Brake Pedal Vibrates ..... 18  
     Buzzer Sounds When Opening Door ..... 19  
     Emergency Towing ..... 459  
     Engine Won't Start ..... 444  
     Noise When Braking ..... 19  
     Overheating ..... 448  
     Puncture/Flat Tire ..... 435  
     Rear Door Won't Open ..... 18, 104  
     Select Lever Won't Move ..... 447

Warning Indicators..... 68  
 Turn Signals..... 125  
     Indicators (Instrument Panel)..... 75

**U**

Unlocking the Doors..... 101  
 USB Adapter Cable ..... 172, 173  
 USB Flash Drives..... 275

**V**

Valet Key..... 100  
 Vanity Mirrors..... 5  
 Vehicle Identification Number..... 466  
 Vehicle Stability Assist (VSA®)..... 352  
     Off..... 72  
     Off Button..... 353  
     System..... 72  
 Viscosity (Oil)..... 392, 465  
 VSA® (Vehicle Stability Assist)..... 352  
 VTM (Variable Torque Management)  
     System..... 354

**W**

Wallpaper..... 179  
 Warning and Information Messages..... 78  
 Warning Indicator On/Blinking..... 450  
 Warning Labels..... 66  
 Warranties (Warranty Manual provided  
     separately)..... 472

Watts..... 464  
 Wear Indicators (Tire)..... 419  
 Wheel Nut Wrench (Jack Handle)..... 439  
 Window Washers..... 128  
     Adding/Refilling Fluid..... 401  
     Switch..... 128  
 Windows (Opening and Closing)..... 120  
 Windshield..... 128  
     Cleaning..... 431  
     Defrosting/Defogging..... 166  
     Washer Fluid..... 401  
     Wiper Blades..... 410  
     Wipers and Washers..... 128  
 Winter Tires..... 422  
     Snow Tires..... 422  
     Tire Chains..... 422  
 Wipers and Washers..... 128  
     Checking and Replacing Wiper Blades..... 410  
     Front..... 128  
     Rear..... 129  
 WMA..... 193, 207, 226, 244  
 Worn Tires..... 414

**X**

XM® Radio..... 223