

# 2012 Pilot Owner's Manual (Unlinked)

This document does not contain hyperlinks and may be formatted for printing instead of web use. This is due to changes in content and specifications of the vehicle that happen throughout the model year. This manual will be replaced with a hyperlinked version at the end of the model year.

# Owner's Identification

---

OWNER \_\_\_\_\_  
\_\_\_\_\_

ADDRESS \_\_\_\_\_

STREET

\_\_\_\_\_

CITY

STATE/PROVINCE/TERRITORY

ZIP CODE/  
POSTAL CODE

V. I. N. \_\_\_\_\_

DELIVERY DATE \_\_\_\_\_

(Date sold to original retail purchaser)

DEALER NAME \_\_\_\_\_ DEALER NO. \_\_\_\_\_

ADDRESS \_\_\_\_\_

STREET

\_\_\_\_\_

CITY

STATE/PROVINCE/TERRITORY

ZIP CODE/  
POSTAL CODE

OWNER'S SIGNATURE \_\_\_\_\_

DEALER'S SIGNATURE \_\_\_\_\_

This owner's manual should be considered a permanent part of the vehicle and should remain with the vehicle when it is sold.

This owner's manual covers all models of the Pilot. You may find descriptions of equipment and features that are not on your particular model.

Images throughout this owner's manual (including the front cover) represent features and equipment that are available on some, but not all, models. Your particular model may not have some of these features.

The information and specifications included in this publication were in effect at the time of approval for printing. Honda Motor Co., Ltd. reserves the right, however, to discontinue or change specifications or design at any time without notice and without incurring any obligation whatsoever.

**POUR CLIENTS CANADIEN**  
**AVIS IMPORTANT: Si vous avez**  
**besoin d'un Manuel du Conducteur**  
**en français, veuillez demander à**  
**votre concessionnaire de**  
**commander le numéro de pièce**  
**33SZAC30**

Congratulations! Your selection of a 2012 Honda Pilot was a wise investment. It will give you years of driving pleasure.

One of the best ways to enhance the enjoyment of your new vehicle is to read this manual. In it, you will learn how to operate its driving controls and convenience items. Afterwards, keep this owner's manual in your vehicle so you can refer to it at any time.

Several warranties protect your new vehicle. Read the warranty booklet thoroughly so you understand the coverages and are aware of your rights and responsibilities.

Maintaining your vehicle according to the Maintenance Minder™ shown in the instrument panel helps to keep your driving trouble-free while it preserves your investment. When your vehicle needs maintenance, keep in mind that your dealer's staff is specially trained in servicing the many systems unique to your vehicle. Your dealer is dedicated to your satisfaction and will be pleased to answer any questions and concerns.

As you read this manual, you will find information that is preceded by a **NOTICE** symbol. This information is intended to help you avoid damage to your vehicle, other property, or the environment.

# Introduction

---

## California Proposition 65 Warning

**WARNING:** This product contains or emits chemicals known to the State of California to cause cancer and birth defects or other reproductive harm.

## Service Diagnostic Recorders

This vehicle is equipped with service-related devices that record information about powertrain performance. The data can be used to verify emissions law requirements and/or help technicians diagnose and solve service problems. It may also be combined with data from other sources for research purposes, but it remains confidential.

## California Perchlorate Contamination Prevention Act

The airbags, seat belt tensioners, and CR type batteries in this vehicle may contain perchlorate materials — special handling may apply. See [www.dtsc.ca.gov/hazardouswaste/perchlorate/](http://www.dtsc.ca.gov/hazardouswaste/perchlorate/)

## Event Data Recorders

This vehicle is equipped with an event data recorder (EDR).

The main purpose of an EDR is to record, in certain crash or near crash-like situations, such as an air bag deployment or hitting a road obstacle, data that will assist in understanding how a vehicle's systems performed. The EDR is designed to record data related to vehicle dynamics and safety systems for a short period of time, typically 30 seconds or less. The EDR in this vehicle is designed to record such data as:

- How various systems in your vehicle were operating;
- Whether or not the driver and passenger safety belts were buckled/fastened;
- How far (if at all) the driver was depressing the accelerator and/or brake pedal; and,
- How fast the vehicle was traveling.

These data can help provide a better understanding of the circumstances in which crashes and injuries occur. NOTE: EDR data are recorded by your vehicle only if a non-trivial crash situation occurs; no data are recorded by the EDR under normal driving conditions and no personal data (e.g., name, gender, age, and crash location) are recorded. However, other parties, such as law enforcement, could combine the EDR data with the type of personally identifying data routinely acquired during a crash investigation.

To read data recorded by an EDR, special equipment is required, and access to the vehicle or the EDR is needed. In addition to the vehicle manufacturer, other parties, such as law enforcement, that have the special equipment, can read the information if they have access to the vehicle or the EDR.

The data belongs to the vehicle owner and may not be accessed by anyone else except as legally required or with the permission of the vehicle owner.

## A Few Words About Safety

---

Your safety, and the safety of others, is very important. And operating this vehicle safely is an important responsibility.

To help you make informed decisions about safety, we have provided operating procedures and other information on labels and in this manual. This information alerts you to potential hazards that could hurt you or others.

Of course, it is not practical or possible to warn you about all the hazards associated with operating or maintaining your vehicle. You must use your own good judgement.

You will find this important safety information in a variety of forms, including:

- **Safety Labels** — on the vehicle.
- **Safety Messages** — preceded by a safety alert symbol  and one of three signal words: **DANGER**, **WARNING**, or **CAUTION**. These signal words mean:

 **DANGER**

You **WILL** be **KILLED** or **SERIOUSLY HURT** if you don't follow instructions.

 **WARNING**

You **CAN** be **KILLED** or **SERIOUSLY HURT** if you don't follow instructions.

 **CAUTION**

You **CAN** be **HURT** if you don't follow instructions.

- **Safety Headings** — such as Important Safety Reminders or Important Safety Precautions.
- **Safety Section** — such as Driver and Passenger Safety.
- **Instructions** — how to use this vehicle correctly and safely.

This entire book is filled with important safety information — please read it carefully.

Your Pilot has higher ground clearance than a passenger vehicle designed for use only on pavement. Higher ground clearance has many advantages for off-highway driving. It allows you to travel over bumps, obstacles, and rough terrain. It also provides good visibility so you can anticipate problems earlier.

These advantages come at some cost. Because your vehicle is taller and rides higher off the ground, it has a high center of gravity. This means your vehicle can tip or roll over if you make abrupt turns. Utility vehicles have a significantly higher rollover rate than other types of vehicles. In a rollover crash, an unbelted person is significantly more likely to die than a person wearing a seat belt. As a reminder, make sure you and your passengers always wear seat belts.

For information on how to reduce the risk of rollover, read “Driving Guidelines” on page 512 of this manual and the *Off-Highway Driving Guidelines* section on page 552. Failure to operate your vehicle correctly might result in loss of control, a crash, or rollover.





|   |           |
|---|-----------|
| <b>Your Vehicle at a Glance</b> (main controls) .....   | 3         |
| <b>Driver and Passenger Safety</b> (seat belts, SRS, and child protection) .....  | 5         |
| <b>Instruments and Controls</b> (indicators, gauges, multi-information display, dashboard, and steering column) .....     | 63        |
| <b>Features</b> (climate control, audio, steering wheel, rear entertainment, security, cruise control, and HomeLink®) ... | 191       |
| <b>Before Driving</b> (fuel, vehicle break-in, and cargo loading) .....   | 493       |
| <b>Driving</b> (engine and transmission operation).....   | 511       |
| <b>Maintenance</b> (minder, fluid checking, minor services, and vehicle storage).....                                     | 557       |
| <b>Taking Care of the Unexpected</b> (flat tire, jump starting, overheating, and fuses) .....                             | 611       |
| <b>Technical Information</b> (vehicle specifications, tires, and emissions controls).....                                 | 639       |
| <b>Warranty and Customer Relations (U.S. and Canada only)</b> (warranty and contact information).....                     | 657       |
| <b>Authorized Manuals (U.S. only)</b> (how to order) .....  | 661       |
| <b>Index</b> .....  | I         |
| <b>Service Information Summary</b> (fluid capacities and tire pressures) .....  | last page |

# Overview of Contents

---

## **Contents**

A convenient reference to the sections in this manual.

## **Your Vehicle at a Glance**

A quick reference to the main controls in your vehicle.

## **Driver and Passenger Safety**

Important information about the proper use and care of your vehicle's seat belts, an overview of the supplemental restraint system, and valuable information on how to protect children with child restraints.

## **Instruments and Controls**

Explains the purpose of each instrument panel indicator and gauge, and how to use the controls on the dashboard and steering column.

## **Features**

How to operate the climate control system, the audio system, rear entertainment system, and other convenience features.

## **Before Driving**

What gasoline to use, how to break-in your new vehicle, and how to load luggage and other cargo.

## **Driving**

The proper way to start the engine, shift the transmission, and park; plus what you need to know if you're planning to tow a trailer.

## **Maintenance**

The Maintenance Minder™ shows you when you need to take your vehicle to the dealer for maintenance service. There is also a list of things to check and instructions on how to check them.

## **Taking Care of the Unexpected**

This section covers several problems motorists sometimes experience, and details how to handle them.

## **Technical Information**

ID numbers, dimensions, capacities, and technical information.

## **Warranty and Customer Relations**

### **(U.S. and Canada only)**

A summary of the warranties covering your new vehicle, and how to contact us for any reason. Refer to your warranty manual for detailed information.

## **Authorized Manuals**

### **(U.S. only)**

How to order manuals and other technical literature.

## **Index**

## **Service Information Summary**

A summary of the information you need when you pull up to the fuel pump.

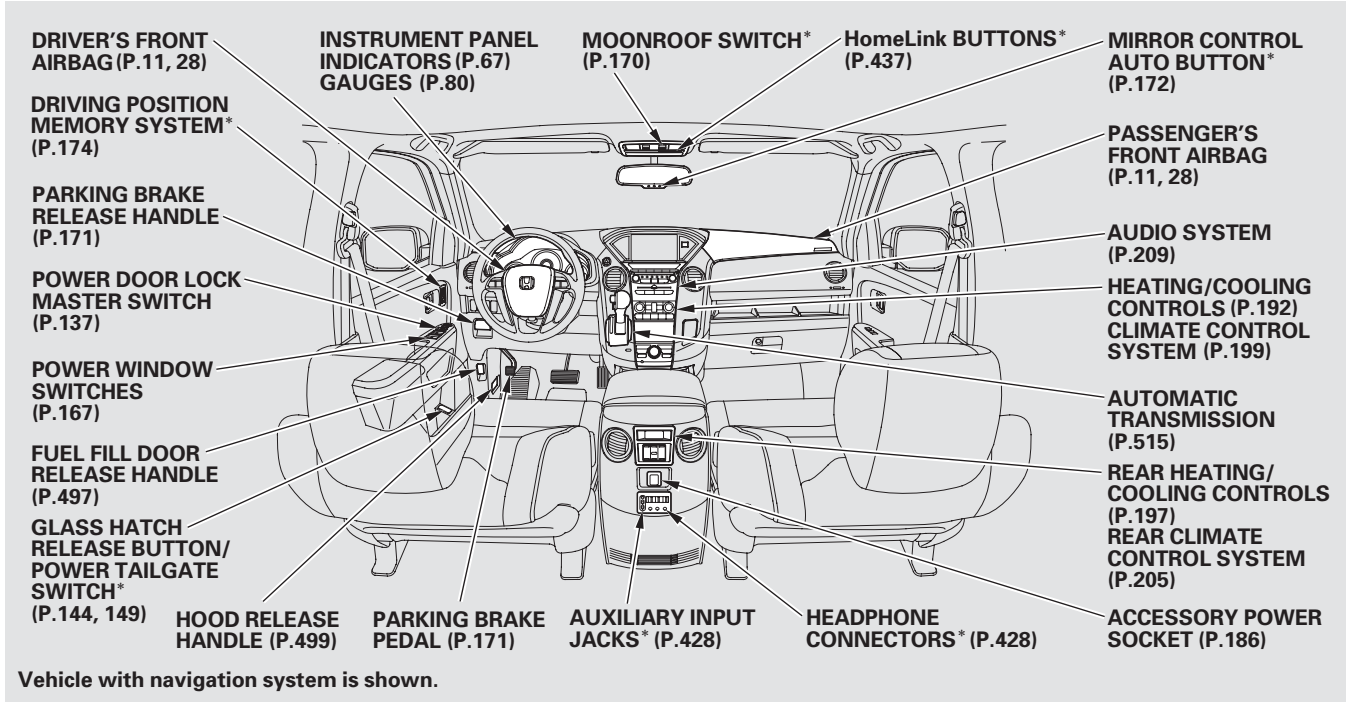

Vehicle with navigation system is shown.

\*: If equipped

CONTINUED

# Your Vehicle at a Glance

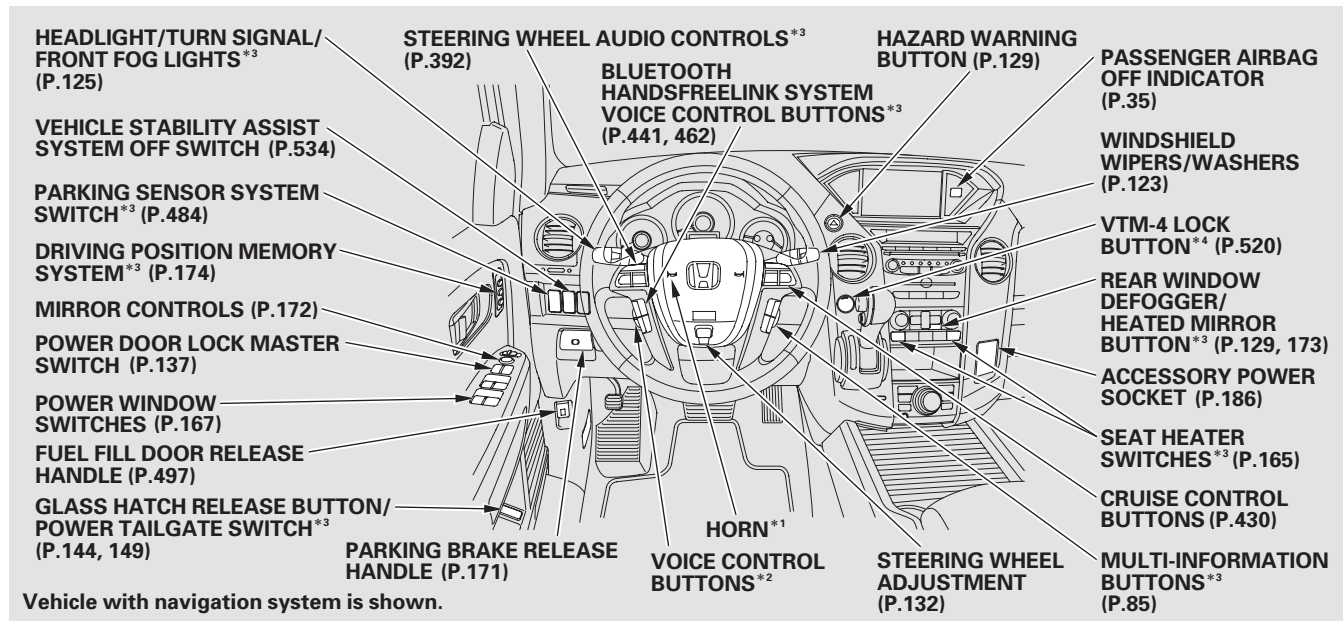

\* 1 : To use the horn, press the center pad of the steering wheel.

\* 2 : Only on vehicles equipped with navigation system. Refer to the navigation system manual.

\* 3 : If equipped

\* 4 : 4WD models only

This section gives you important information about how to protect yourself and your passengers. It shows you how to use seat belts. It explains how your airbags work. And it tells you how to properly restrain infants and children in your vehicle.

|  |    |
|--|----|
| Important Safety Precautions .....             | 6  |
| Your Vehicle's Safety Features.....            | 8  |
| Seat Belts .....                               | 9  |
| Airbags.....                                   | 11 |
| Protecting Adults and Teens.....               | 13 |
| 1. Close and Lock the Doors .....              | 13 |
| 2. Adjust the Front Seats .....                | 15 |
| 3. Adjust the Seat-Backs .....                 | 16 |
| 4. Adjust the Head Restraints ....             | 16 |
| 5. Fasten and Position the<br>Seat Belts.....  | 17 |
| 6. Maintain a Proper Sitting<br>Position ..... | 19 |
| Advice for Pregnant Women.....                 | 20 |
| Additional Safety Precautions....              | 21 |

|   |    |
|---|----|
| Additional Information About<br>Your Seat Belts ..... | 22 |
| Seat Belt System Components...                        | 22 |
| Lap/Shoulder Belt.....                                | 23 |
| Automatic Seat Belt<br>Tensioners.....                | 24 |
| Seat Belt Maintenance .....                           | 25 |
| Additional Information About<br>Your Airbags .....    | 26 |
| Airbag System Components.....                         | 26 |
| How Your Front Airbags<br>Work.....                   | 28 |
| How Your Side Airbags Work....                        | 31 |
| How Your Side Curtain Airbags<br>Work.....            | 33 |
| How the SRS Indicator Works... 34                     |    |
| How the Side Airbag Off<br>Indicator Works.....       | 34 |
| How the Passenger Airbag<br>Off Indicator Works.....  | 35 |
| Airbag Service.....                                   | 36 |
| Additional Safety Precautions....                     | 36 |
| Protecting Children – General<br>Guidelines.....      | 38 |
| All Children Must Be<br>Restrained .....              | 38 |

|  |    |
|--|----|
| All Children Should Sit in a<br>Back Seat .....              | 39 |
| The Passenger's Front Airbag<br>Can Pose Serious Risks ..... | 39 |
| If You Must Drive with Several<br>Children .....             | 41 |
| If a Child Requires Close<br>Attention .....                 | 41 |
| Additional Safety Precautions....                            | 42 |
| Protecting Infants and<br>Small Children.....                | 43 |
| Protecting Infants.....                                      | 43 |
| Protecting Small Children .....                              | 44 |
| Selecting a Child Seat.....                                  | 46 |
| Installing a Child Seat .....                                | 47 |
| With LATCH.....  | 48 |
| With a Lap/Shoulder Belt .....                               | 52 |
| With a Tether.....   | 53 |
| Protecting Larger Children .....                             | 56 |
| Checking Seat Belt Fit .....                                 | 56 |
| Using a Booster Seat.....                                    | 57 |
| When Can a Larger Child Sit in<br>Front.....                 | 58 |
| Additional Safety Precautions....                            | 59 |
| Carbon Monoxide Hazard .....                                 | 60 |
| Safety Labels.....   | 61 |

## Important Safety Precautions

---

You'll find many safety recommendations throughout this section, and throughout this manual. The recommendations on this page are the ones we consider to be the most important.

### **Always Wear Your Seat Belt**

A seat belt is your best protection in all types of collisions. Airbags are designed to supplement seat belts, not replace them. So even though your vehicle is equipped with airbags, make sure you and your passengers always wear your seat belts, and wear them properly (see page 17).

### **Restrain All Children**

Children age 12 and under should ride properly restrained in a back seat, not the front seat. Infants and small children should be restrained in a child seat. Larger children should use a booster seat and a lap/shoulder belt until they can use the belt properly without a booster seat (see pages 38 – 59).

### **Be Aware of Airbag Hazards**

While airbags can save lives, they can cause serious or fatal injuries to occupants who sit too close to them, or are not properly restrained. Infants, young children, and short adults are at the greatest risk. Be sure to follow all instructions and warnings in this manual.

### **Don't Drink and Drive**

Alcohol and driving don't mix. Even one drink can reduce your ability to respond to changing conditions, and your reaction time gets worse with every additional drink. So don't drink and drive, and don't let your friends drink and drive, either.

### **Pay Appropriate Attention to the Task of Driving Safely**

Engaging in mobile phone conversation or other activities that keep you from paying close attention to the road, other vehicles and pedestrians could lead to a crash. Remember, situations can change quickly, and only you can decide when it is safe to divert attention away from driving.

### **Control Your Speed**

Excessive speed is a major factor in crash injuries and deaths. Generally, the higher the speed, the greater the risk, but serious injuries can also occur at lower speeds. Never drive faster than is safe for current conditions, regardless of the maximum speed posted.

### **Keep Your Vehicle in Safe Condition**

Having a tire blowout or a mechanical failure can be extremely hazardous. To reduce the possibility of such problems, check your tire pressures and condition frequently, and perform all regularly scheduled maintenance (see page 599).

## Your Vehicle's Safety Features

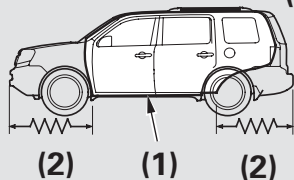
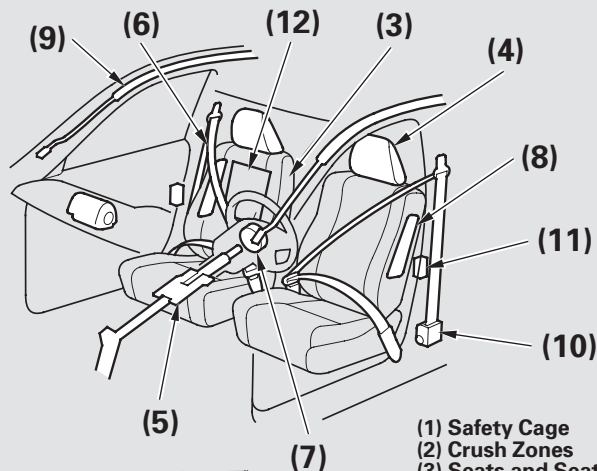

- (1) Safety Cage
- (2) Crush Zones
- (3) Seats and Seat-Backs
- (4) Head Restraints
- (5) Collapsible Steering Column
- (6) Seat Belts
- (7) Front Airbags
- (8) Side Airbags
- (9) Side Curtain Airbags
- (10) Front Seat Belt Tensioners
- (11) Door Locks
- (12) Occupant Position Detection System (OPDS) Sensors

Your vehicle is equipped with many features that work together to protect you and your passengers during a crash.

Some features do not require any action on your part. These include a strong steel framework that forms a safety cage around the passenger compartment, front and rear crush zones, a collapsible steering column, and tensioners that tighten the front seat belts in a crash.

However, you and your passengers can't take full advantage of these features unless you remain sitting in the correct position and ***always wear your seat belts***. In fact, some safety features can contribute to injuries if they are not used properly.

The following pages explain how you can take an active role in protecting yourself and your passengers.



## Seat Belts

Your vehicle is equipped with seat belts in all seating positions.

Your seat belt system also includes an indicator on the instrument panel and a beeper to remind you and your passengers to fasten your seat belts.

### *Why Wear Seat Belts*

Seat belts are the single most effective safety device for adults and larger children. (Infants and smaller children must be properly restrained in child seats.)

Not wearing a seat belt properly increases the chance of serious injury or death in a crash, even though your vehicle has airbags.

In addition, most states and all Canadian provinces and territories require you to wear seat belts.

### **⚠ WARNING**

Not wearing a seat belt properly increases the chance of serious injury or death in a crash, even though your vehicle has airbags.

Be sure you and your passengers always wear seat belts and wear them properly.

CONTINUED

## Your Vehicle's Safety Features

---

When properly worn, seat belts:

- Keep you connected to the vehicle so you can take advantage of the vehicle's built-in safety features.
- Help protect you in almost every type of crash, including:
  - frontal impacts
  - side impacts
  - rear impacts
  - rollovers

- Help keep you from being thrown against the inside of the vehicle and against other occupants.
- Keep you from being thrown out of the vehicle.
- Help keep you in a good position should the airbags ever deploy. A good position reduces the risk of injury from an inflating airbag and allows you to get the best advantage from the airbag.

Of course, seat belts cannot completely protect you in every crash. But in most cases, seat belts can reduce your risk of serious injury.

***What you should do:*** Always wear your seat belt, and make sure you wear it properly.

## Airbags

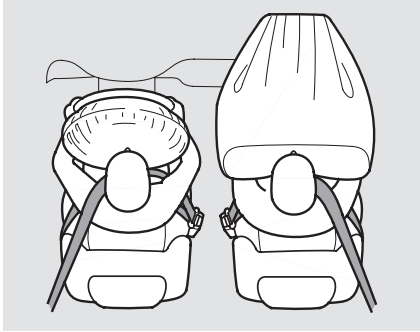

Your vehicle has a supplemental restraint system (SRS) with front airbags to help protect the heads and chests of the driver and a front seat passenger during a moderate to severe frontal collision (see page 28 for more information on how your front airbags work).

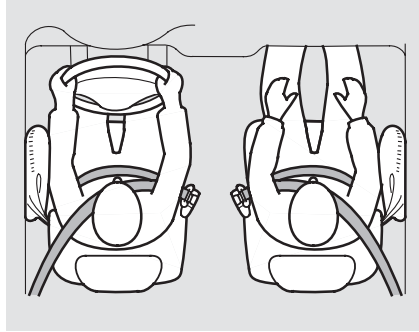

Your vehicle also has side airbags to help protect the torso and pelvis of the driver or a front seat passenger during a moderate to severe side impact (see page 31 for more information on how your side airbags work).

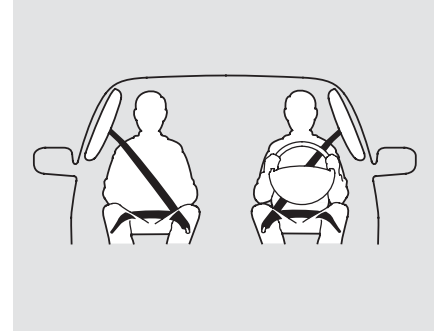

In addition, your vehicle has side curtain airbags to help protect the heads of the driver, front passenger, and passengers in the outer rear seating positions during a moderate to severe side impact or rollover (see page 33 for more information on how your side curtain airbags work).

*CONTINUED*

## Your Vehicle's Safety Features

---

The most important things you need to know about your airbags are:

- ***Airbags do not replace seat belts.*** They are designed to supplement the seat belts.
- ***Airbags offer no protection in rear collisions, or minor frontal or side collisions.***
- ***Airbags can pose serious hazards.*** To do their job, airbags must inflate with tremendous force. So while airbags help save lives, they can cause minor injuries or more serious or even fatal injuries if occupants are not properly restrained or sitting properly.

***What you should do:*** Always wear your seat belt properly, and sit upright and as far back from the steering wheel as possible while allowing full control of the vehicle. A front passenger should move their seat as far back from the dashboard as possible.

The rest of this section gives more detailed information about how you can maximize your safety.

Remember, however, that no safety system can prevent all injuries or deaths that can occur in a severe crash, even when seat belts are properly worn and the airbags deploy.

## Introduction

The following pages provide instructions on how to properly protect the driver, adult passengers, and teenage children who are large enough and mature enough to drive or ride in the front.

See pages 38 – 59 for important guidelines on how to properly protect infants, small children, and larger children who ride in your vehicle.

### 1. Close and Lock the Doors

After everyone has entered the vehicle, be sure the doors and the tailgate are closed and locked.



Your vehicle has a door-open indicator on the instrument panel to indicate when any door is open.

### *Except Touring models*



Your vehicle also has a tailgate, glass hatch, and door open indicator on the information display to indicate when the tailgate, the glass hatch, or a specific door is open. You will see the appropriate indicator(s) for each condition.

### *On Touring models*

Your vehicle also has a tailgate, glass hatch, and door open indicator on the multi-information display to indicate when the tailgate, the glass hatch, or a specific door is open. You will see the appropriate indicator(s) and message(s) for each condition.

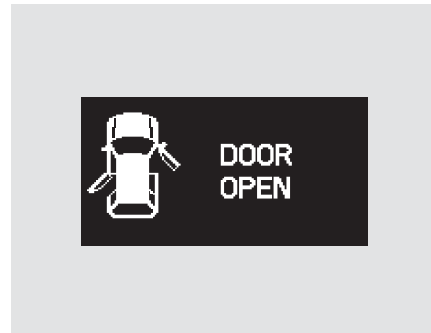

When one or more doors are open, the “DOOR OPEN” message will come on.

*CONTINUED*

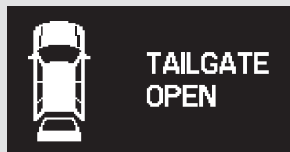

When the glass hatch, the tailgate, or both glass hatch and tailgate are open, the “HATCH OPEN,” “TAILGATE OPEN,” or “HATCH & TAILGATE OPEN” message will come on.



When the glass hatch, tailgate, and one or more doors are open, the “DOOR, HATCH & TAILGATE OPEN” message will come on.

Locking the doors, the glass hatch, and the tailgate reduces the chance of someone being thrown out of the vehicle during a crash, and it helps prevent passengers from accidentally opening a door, the glass hatch, or the tailgate and falling out.

Locking the doors, the glass hatch and the tailgate also helps prevent an outsider from unexpectedly opening a door, the glass hatch, or the tailgate when you come to a stop.

*Except Touring models*

This vehicle has auto door locking/unlocking features. See page 138 for how to set them.

*On Touring models*

This vehicle has auto door locking/unlocking features. See pages 114 and 115 for how to set them.

## 2. Adjust the Front Seats

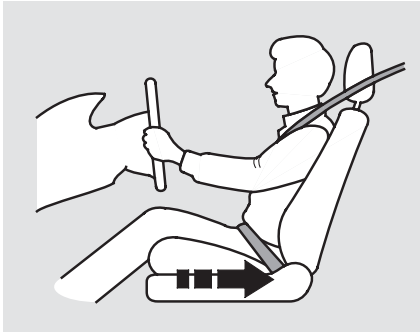

Adjust the driver's seat as far to the rear as possible while allowing you to maintain full control of the vehicle. Have a front passenger adjust their seat as far to the rear as possible.

If you sit too close to the steering wheel or dashboard, you can be seriously injured by an inflating front airbag, or by striking the steering wheel or dashboard.

The National Highway Traffic Safety Administration and Transport Canada recommend that drivers allow at least 10 inches (25 cm) between the center of the steering wheel and the chest. In addition to adjusting the seat, you can adjust the steering wheel up and down, and in and out (see page 132).

If you cannot get far enough away from the steering wheel and still reach the controls, we recommend that you investigate whether some type of adaptive equipment may help.

### **⚠ WARNING**

Sitting too close to a front airbag can result in serious injury or death if the front airbags inflate.

Always sit as far back from the front airbags as possible.

*On vehicles with manual adjustable seats*

Once your seat is adjusted correctly, rock it back and forth to make sure the seat is locked in position.

See page 154 for how to adjust a front seat (power adjustment) and page 155 for a manual adjustment.

## Protecting Adults and Teens

### 3. Adjust the Seat-Backs

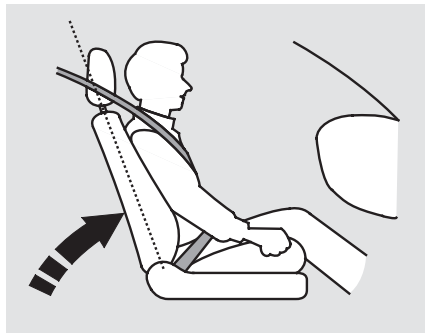

Adjust the driver's seat-back to a comfortable, upright position, leaving ample space between your chest and the airbag cover in the center of the steering wheel.

Passengers with adjustable seat-backs should also adjust their seat-back to a comfortable, upright position.

### **⚠ WARNING**

Reclining the seat-back too far can result in serious injury or death in a crash.

Adjust the seat-back to an upright position, and sit well back in the seat.

Reclining a seat-back so that the shoulder part of the belt no longer rests against the occupant's chest reduces the protective capability of the belt. It also increases the chance of sliding under the belt in a crash and being seriously injured. The farther a seat-back is reclined, the greater the risk of injury.

See page 155 for how to adjust the manual adjustable seat-back, and page 154 for the power adjustable seat-back.

### 4. Adjust the Head Restraints

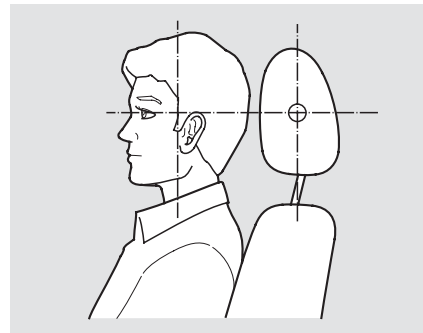

Adjust the driver's head restraint so the center of the back of your head rests against the center of the restraint.

Have passengers adjust their head restraints properly as well. Taller persons should adjust their restraint as high as possible.



### **⚠ WARNING**

Improperly positioning head restraints reduces their effectiveness and you can be seriously injured in a crash.

Make sure head restraints are in place and positioned properly before driving.

Properly adjusted head restraints will help protect occupants from whiplash and other crash injuries.

See page 157 for how to adjust the head restraints and how the driver's and front passenger's active head restraints work.

### **5. Fasten and Position the Seat Belts**

Insert the latch plate into the buckle, then tug on the belt to make sure the belt is securely latched. Check that the belt is not twisted, because a twisted belt can cause serious injuries in a crash.

The center seating position in the second row and all third row seats have a detachable seat belt that can be unlatched and retracted into the ceiling to allow the seats to be folded down. See page 163 for how to unlatch and relatch a belt.

Detachable seat belts should normally be latched whenever the seat-backs are in an upright position. See page 163 for how to unlatch a belt, and page 164 for how to relatch a belt.



Position the lap part of the belt as low as possible across your hips, then pull up on the shoulder part of the belt so the lap part fits snugly. This lets your strong pelvic bones take the force of a crash and reduces the chance of internal injuries.

*CONTINUED*

## Protecting Adults and Teens

---

If necessary, pull up on the belt again to remove any slack, then check that the belt rests across the center of your chest and over your shoulder.

This spreads the forces of a crash over the strongest bones in your upper body.

### **⚠ WARNING**

Improperly positioning the seat belts can cause serious injury or death in a crash.

Make sure all seat belts are properly positioned before driving.

If the seat belt touches or crosses your neck, or if it crosses your arm instead of your shoulder, you need to adjust the seat belt anchor height.

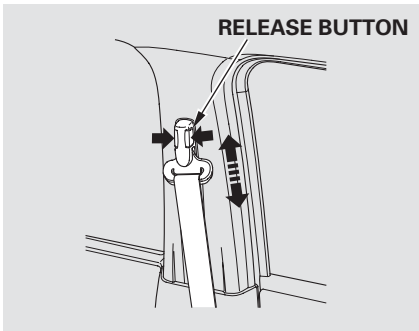

The front seats and second row seats have adjustable seat belt anchors. To adjust the height of an anchor, squeeze the two release buttons, and slide the anchor up or down as needed (it has four positions).

***Never place the shoulder portion of a lap/shoulder belt under your arm or behind your back.*** This could cause very serious injuries in a crash.

If a seat belt does not seem to work properly, it may not protect the occupant in a crash.

***No one should sit in a seat with an inoperative seat belt.*** Using a seat belt that is not working properly can result in serious injury or death. Have your dealer check the belt as soon as possible.

See page 22 for additional information about your seat belts and how to take care of them.

### **6. Maintain a Proper Sitting Position**

After all occupants have adjusted their seats and head restraints, and put on their seat belts, it is very important that they continue to sit upright, well back in their seats, with their feet on the floor, until the vehicle is safely parked and the engine is off.

Sitting improperly can increase the chance of injury during a crash. For example, if an occupant slouches, lies down, turns sideways, sits forward, leans forward or sideways, or puts one or both feet up, the chance of injury during a crash is greatly increased.

In addition, an occupant who is out of position in the front seat can be seriously or fatally injured in a crash by striking interior parts of the vehicle or being struck by an inflating front airbag.

#### **⚠ WARNING**

Sitting improperly or out of position can result in serious injury or death in a crash.

Always sit upright, well back in the seat, with your feet on the floor.

# Protecting Adults and Teens

---

## Advice for Pregnant Women



If you are pregnant, the best way to protect yourself and your unborn child when driving or riding in a vehicle is to always wear a seat belt, and keep the lap part of the belt as low as possible across the hips.

When driving, remember to sit upright and adjust the seat as far back as possible while allowing full control of the vehicle. When riding as a front passenger, adjust the seat as far back as possible.

This will reduce the risk of injuries to both you and your unborn child that can be caused by a crash or an inflating front airbag.

Each time you have a checkup, ask your doctor if it's okay for you to drive.

### Additional Safety Precautions

- **Never let passengers ride in the cargo area or on top of a folded-down back seat.** If they do, they could be very seriously injured in a crash.
- **Passengers should not stand up or change seats while the vehicle is moving.** A passenger who is not wearing a seat belt during a crash or emergency stop can be thrown against the inside of the vehicle, against other occupants, or out of the vehicle.
- **Two people should never use the same seat belt.** If they do, they could be very seriously injured in a crash.
- **Do not put any accessories on seat belts.** Devices intended to improve occupant comfort or reposition the shoulder part of a seat belt can reduce the protective capability of the belt and increase the chance of serious injury in a crash.
- **Do not place hard or sharp objects between yourself and a front airbag.** Carrying hard or sharp objects on your lap, or driving with a pipe or other sharp object in your mouth, can result in injuries if your front airbag inflates.
- **Keep your hands and arms away from the airbag covers.** If your hands or arms are close to an airbag cover, they could be injured if the airbag inflates.
- **Do not attach or place objects on the front airbag covers.** Objects on the covers marked “SRS AIRBAG” could interfere with the proper operation of the airbags or be propelled inside the vehicle and hurt someone if the airbags inflate.
- **Do not attach hard objects on or near a door.** If a side airbag or a side curtain airbag inflates, a cup holder or other hard object attached on or near the door could be propelled inside the vehicle and hurt someone.
- **Do not cover or replace front seat-back covers without consulting your dealer.** Improperly replacing or covering front seat-back covers can prevent your side airbags from inflating during a side impact.

## Additional Information About Your Seat Belts

---

### Seat Belt System Components

Your seat belt system includes lap/shoulder belts in all seating positions. The front seat belts are also equipped with automatic seat belt tensioners.



The seat belt system includes an indicator on the instrument panel and a beeper to remind you and your front passenger to fasten your seat belts.

This system monitors the front seat belts. If you turn the ignition switch to the ON (II) position before your seat belt is fastened, the beeper will sound and the indicator will flash. If your seat belt is not fastened before the beeper stops, the indicator will stop flashing but remain on.

If a front passenger does not fasten their seat belt, the indicator will come on about 6 seconds after the ignition switch is turned to the ON (II) position.

If either the driver or a front passenger does not fasten their seat belt while driving, the beeper will sound and the indicator will flash again at regular intervals.

### *On Touring models*

You will also see a “FASTEN SEAT BELT” or “FASTEN PASSENGER SEAT BELT” message on the multi-information display (see page 93).

When an infant or small child is riding there, the indicator may not come on and the beeper may not sound.

If the indicator comes on or the beeper sounds when the driver's seat belt is latched and there is no front seat passenger and no items on the front seat, something may be interfering with the monitoring system. Look for and remove:

- Any items under the front passenger's seat.
- Any object(s) hanging on the seat or in the seat-back pocket.
- Any object(s) touching the rear of the seat-back.

If no obstructions are found, have your vehicle checked by a dealer.

### Lap/Shoulder Belt

The lap/shoulder belt goes over your shoulder, across your chest, and across your hips.

To fasten the belt, insert the latch plate into the buckle, then tug on the belt to make sure the buckle is latched (see page 17 for how to properly position the belt).

To unlock the belt, press the red PRESS button on the buckle. Guide the belt across your body so that it retracts completely. After exiting the vehicle, be sure the belt is out of the way and will not get closed in the door.

All seat belts have an emergency locking retractor. In normal driving, the retractor lets you move freely in your seat while it keeps some tension on the belt. During a collision or sudden stop, the retractor automatically locks the belt to help restrain your body.

The seat belts in all positions except the driver's have a lockable retractor that must be activated to secure a child seat (see page 52).

If the shoulder part of the belt is pulled all the way out, the lockable retractor will activate. The belt will retract, but it will not allow the passenger to move freely.

To deactivate the lockable retractor, unlatch the buckle and let the seat belt fully retract. To refasten the seat belt, pull it out only as far as needed.

*CONTINUED*

## Additional Information About Your Seat Belts

### **⚠ WARNING**

Allowing a child to play with a seat belt or wrap one around their neck can result in serious injury or death.

Instruct children not to play with any seat belt and make sure any unused seat belt a child can reach is buckled, fully retracted, and locked.

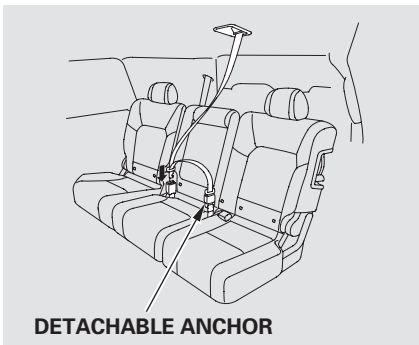

The lap/shoulder belts in the center seat of the second row and both of the third row seats are equipped with a detachable anchor that has two parts: a small latch plate and a buckle.

The detachable seat belt should normally be latched whenever the seat-backs are in an upright position. For more information about the detachable seat belt, see page 163 .

### Automatic Seat Belt Tensioners

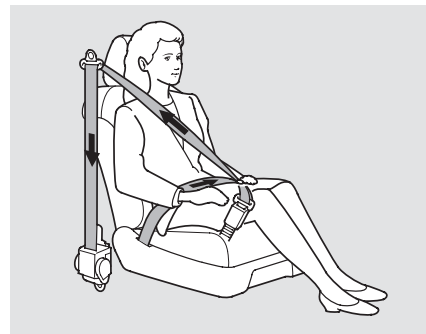

For added protection, the front seat belts are equipped with automatic seat belt tensioners. When activated, the tensioners immediately tighten the belts to help hold the driver and a front passenger in position.



The tensioners can also be activated during a collision in which the front airbags *do not deploy*. In this case, the airbags would not be needed, but the extra tension in the seat belt could be helpful.

If the tensioner is activated, the SRS indicator comes on and the tensioner must be replaced.

### Seat Belt Maintenance

For safety, you should check the condition of your seat belts regularly.

Pull each belt out fully, and look for frays, cuts, burns, and wear. Check that the latches work smoothly and the belts retract easily. If a belt does not retract easily, cleaning the belt may correct the problem (see page 593). Any belt that is not in good condition or working properly will not provide good protection and should be replaced as soon as possible.

Honda provides a limited warranty on seat belts. See your *Honda Warranty Information* booklet for details.

If a seat belt is worn during a crash, you should have your dealer inspect the belt, and replace it if necessary. A belt that has been worn during a crash may not provide the same level of protection in a subsequent crash.

The dealer should also inspect the anchors for damage and replace them if needed. If the automatic seat belt tensioners activate during a crash, they must be replaced.

### WARNING

Not checking or maintaining seat belts can result in serious injury or death if the seat belts do not work properly when needed.

Check your seat belts regularly and have any problem corrected as soon as possible.

# Additional Information About Your Airbags

## Airbag System Components

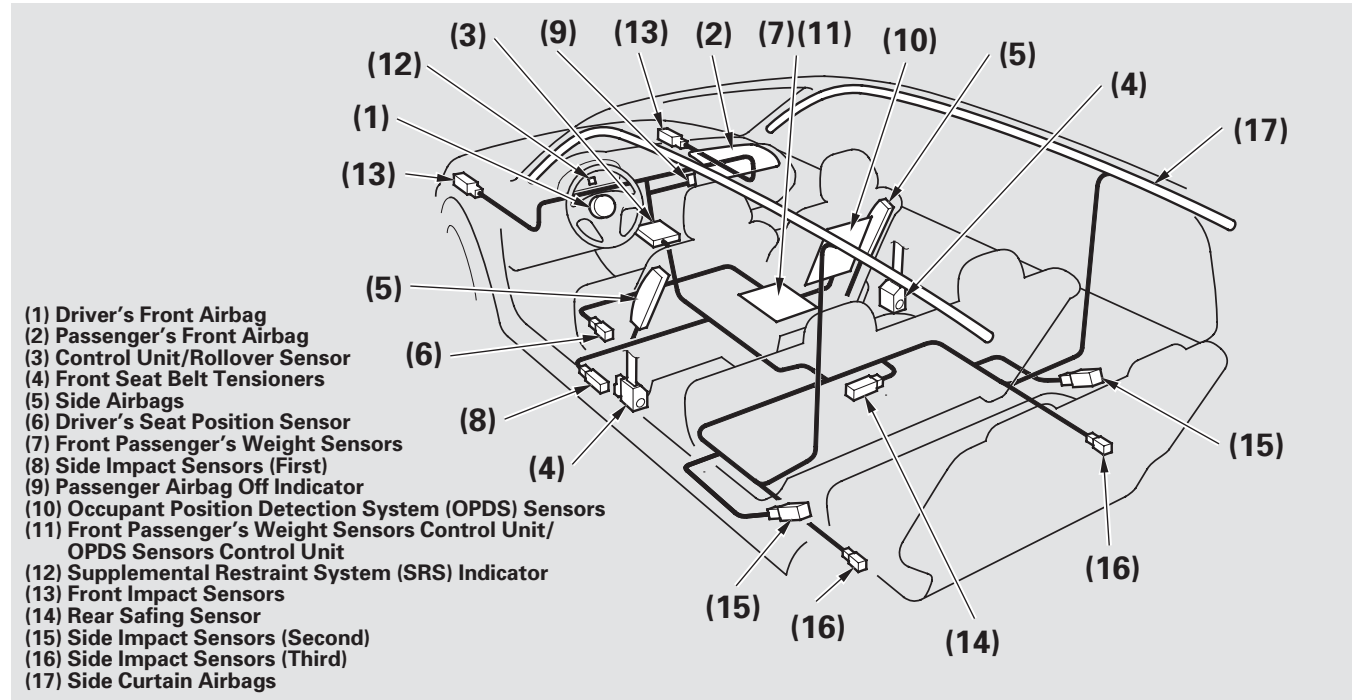

Your Airbag System includes:

- Two SRS (supplemental restraint system) front airbags. The driver's airbag is stored in the center of the steering wheel; the front passenger's airbag is stored in the dashboard. Both are marked "SRS AIRBAG" (see page 28 ).
- Two side airbags, one for the driver and one for a front passenger. The airbags are stored in the outer edges of the seat-backs. Both are marked "SIDE AIRBAG" (see page 31 ).
- Two side curtain airbags, one for each side of the vehicle. The airbags are stored in the ceiling above the side windows. The front and rear pillars are marked "SIDE CURTAIN AIRBAG" (see page 33 ).
- Automatic front seat belt tensioners (see page 24 ).
- Sensors that can detect a moderate to severe front impact, side impact, or if your vehicle is about to rollover.
- Sensors that can detect whether a child is in the passenger's side airbag path and signal the control unit to turn the airbag off (see page 32 ).
- Sensors that can detect whether the driver's seat belt and the front passenger's seat belt are latched or unlatched (see page 22 ).
- A driver's seat position sensor that monitors the distance of the seat from the front airbag. If the seat is too far forward, the airbag will inflate with less force (see page 30 ).
- Weight sensors that monitor the weight on the front passenger's seat. If the weight is about 65 lbs (29 kg) or less (the weight of an infant or small child), the passenger's front airbag will be turned off (see page 30 ).
- A rollover sensor that can detect if your vehicle is about to roll over and signal the control unit to deploy both side curtain airbags and front seat belt tensioners (see page 33 ).
- A sophisticated electronic system that continually monitors and records information about the sensors, the control unit, the airbag activators, the seat belt tensioners, and driver and front passenger seat belt use when the ignition switch is in the ON (II) position.

*CONTINUED*

## Additional Information About Your Airbags

---

- An indicator on the instrument panel that alerts you to a possible problem with your airbag system components (see page 34 ).
- An indicator on the instrument panel that alerts you that the passenger's side airbag has been turned off (see page 34 ).
- An indicator on the dashboard that alerts you that the passenger's front airbag has been turned off (see page 35 ).
- Emergency backup power in case your vehicle's electrical system is disconnected in a crash.

### How Your Front Airbags Work

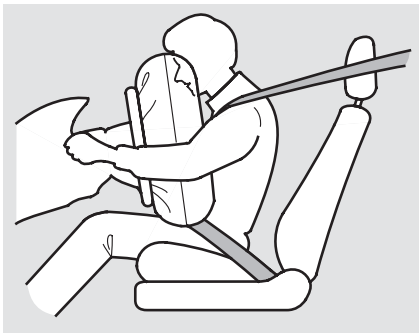

If you ever have a moderate to severe frontal collision, sensors will detect the vehicle's rapid deceleration.

If the rate of deceleration is high enough, the control unit will inflate the driver's and front passenger's airbags, at the time and with the force needed.

During a frontal crash, your seat belt restrains your lower body and torso, and the front airbag helps protect your head and chest.

Although both airbags normally inflate within a split second of each other, it is possible for only one airbag to deploy.

This can happen if the severity of a collision is at the margin, or threshold, that determines whether or not the airbags will deploy. In such cases, the seat belt will provide sufficient protection, and the supplemental protection offered by the airbag would be minimal.

Only the driver's airbag can deploy if there is no passenger in the front seat, or if the advanced airbag system has turned the passenger's airbag off (see page 35 ).

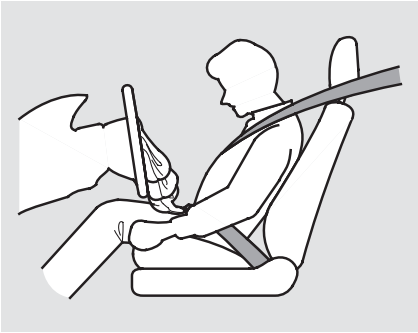

After inflating, the front airbags immediately deflate, so they won't interfere with the driver's visibility, or the ability to steer or operate other controls.

The total time for inflation and deflation is less than a second, so fast that most occupants are not aware that the airbags deployed until they see them lying in their laps.

After a crash, you may see what looks like smoke. This is actually powder from the airbag's surface. Although the powder is not harmful, people with respiratory problems may experience some temporary discomfort. If this occurs, get out of the vehicle as soon as it is safe to do so.

### ***Dual-Stage, Multiple-Threshold Front Airbags (SRS)***

Your vehicle is equipped with dual-stage, multiple-threshold front airbags (SRS). During a frontal crash severe enough to cause one or both front airbags to deploy, the airbags can inflate at different rates, depending on the severity of the crash, whether or not the seat belts are latched, and/or other factors. Front airbags are designed to supplement the seat belts to help reduce the likelihood of head and chest injuries in frontal crashes.

CONTINUED

## Additional Information About Your Airbags

### ***Advanced Airbags***

Your front airbags are also advanced airbags. The main purpose of this feature is to help prevent airbag-caused injuries to short drivers and children or small-statured adults who ride in front.

For both advanced airbags to work properly:

- Occupants must sit upright and wear their seat belts properly.
- Do not spill any liquids on or under the seats, cover the sensors, or put any objects or metal items under the front seats.
- Objects placed or pushed under the front passenger's seat may cause the sensor to malfunction, increasing the risk of injury in a crash.

Failure to follow these instructions could damage the sensors or prevent them from working properly.

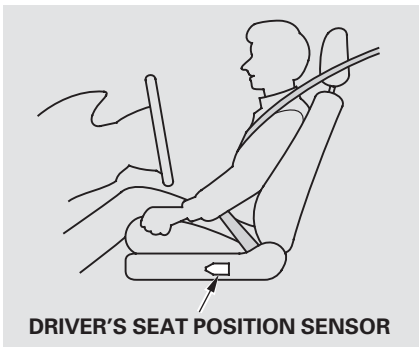

The driver's advanced front airbag system includes a seat position sensor under the seat. If the seat is too far forward, the airbag will inflate with less force, regardless of the severity of the impact.

If there is a problem with the sensor, the SRS indicator will come on, and the airbag will inflate in the normal manner regardless of the driver's seating position.



The passenger's advanced front airbag system has weight sensors under the seat. Although Honda does not encourage carrying an infant or small child in front, if the sensors detect the weight of an infant or small child (up to about 65 lbs or 29 kg), the system will automatically turn the passenger's front airbag off.

Be aware that objects placed on the passenger's seat can also cause the airbag to be turned off.

When the passenger airbag gets turned off by the weight sensors, a "passenger airbag off" indicator in the center of the dashboard comes on (see page 35 ).

If the weight sensors detect there is no passenger in the front seat, the airbag is automatically turned off. However, the passenger airbag off indicator in this situation will not come on.

To ensure that the passenger's advanced front airbag system will work properly, ***do not do anything that would increase or decrease the weight on the front passenger's seat.*** This includes:

- A second-row passenger pushing or pulling on the back of the front passenger's seat.

- Moving the front seat forcibly back against cargo on the seat or floor behind it.
- Hanging heavy items on the front passenger seat, or placing heavy items in the seat-back pocket.
- Moving the front passenger's seat or seat-back forcibly back against the folded right-side second-row seat.
- Second-row passengers should not wedge objects or intentionally force their feet under the front passenger seat.

Also, make sure the floor mat behind the front passenger's seat is hooked to the floor mat anchor (see page 594 ). If it is not, the mat may interfere with the proper operation of the sensors and operation of the seat.

### How Your Side Airbags Work

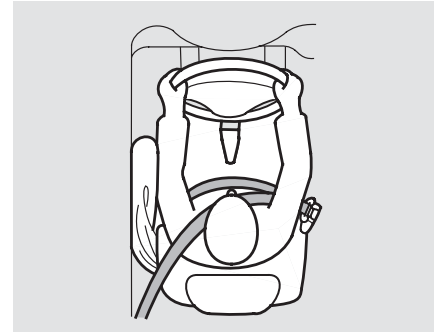

If you ever have a moderate to severe side impact, sensors will detect rapid acceleration and signal the control unit to instantly inflate either the driver's or the passenger's side airbag.

CONTINUED

## Additional Information About Your Airbags

---

Only one airbag will deploy during a side impact. If the impact is on the passenger's side, the passenger's side airbag may not deploy if there is no passenger.

To get the best protection from the side airbags, front seat occupants should wear their seat belts and sit upright and well back in their seats.

### *Side Airbag Cutoff System*

Your vehicle has a side airbag cutoff system designed primarily to protect a child riding in the front passenger's seat.

Although Honda does not encourage children to ride in front, if the position sensors detect a child has leaned into the side airbag's deployment path, the airbag will shut off.

The side airbag may also shut off if a short adult leans sideways, or a larger adult slouches and leans sideways into the airbag's deployment path.

Objects placed on the front passenger seat can also cause the side airbag to be shut off.

If the side airbag off indicator comes on (see page 34 ), have the passenger sit upright. Once the passenger is out of the airbag's deployment path, the system will turn the airbag back on, and the indicator will go out.

There will be some delay between the moment the passenger moves into or out of the airbag deployment path and when the indicator comes on or goes off.

A front seat passenger should not use a cushion or another object as a backrest. It may prevent the cutoff system from working properly.



### How Your Side Curtain Airbags Work

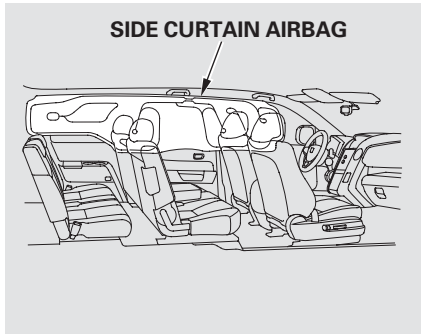

#### *In a Side Impact*

In a moderate to severe side impact, sensors will detect rapid acceleration and signal the control unit to instantly inflate the side curtain airbag and activate the seat belt tensioner on the impacted side of the vehicle.

If the impact is on the passenger's side, the passenger's side curtain airbag will inflate even if there are no occupants on that side of the vehicle.

#### *In a Rollover*

If the rollover sensor detects your vehicle is about to roll over, it signals the control unit, which immediately deploys both side curtain airbags and activates both front seat belt tensioners.

The airbag on the passenger's side will deploy, even if there are no passengers on that side of the vehicle.

To get the best protection from the side curtain airbags, occupants should wear their seat belts and sit upright and well back in their seats.

## Additional Information About Your Airbags

### How the SRS Indicator Works



The SRS indicator alerts you to a potential problem with your airbag system components.

When you turn the ignition switch to the ON (II) position, this indicator comes on briefly then goes off. This tells you the system is working properly.

If the indicator comes on at any other time, or does not come on at all, you should have the system checked by your dealer. For example:

- If the SRS indicator does not come on after you turn the ignition switch to the ON (II) position.
- If the indicator stays on after the engine starts.
- If the indicator comes on or flashes on and off while you drive.

### *On Touring models*

You will also see a “CHECK AIRBAG SYSTEM” message on the multi-information display (see page 93 ).

If you see any of these indications, the airbag system components may not work properly when you need them.

### **▲ WARNING**

Ignoring the SRS indicator can result in serious injury or death if the airbag systems or tensioners do not work properly.

Have your vehicle checked by a dealer as soon as possible if the SRS indicator alerts you to a possible problem.

### How the Side Airbag Off Indicator Works

**U.S.**



**Canada**



This indicator alerts you that the passenger’s side airbag has been automatically shut off. It does **not** mean there is a problem with your side airbags.

When you turn the ignition switch to the ON (II) position, the indicator should come on briefly and then go off (see page 70 ). If it doesn’t come on, stays on, or comes on while driving without a passenger in the front seat, have the system checked.

### *On Touring models*

You will also see a “PASSENGER SIDE AIRBAG OFF” message on the multi-information display (see page 93 ).

### How the Passenger Airbag Off Indicator Works

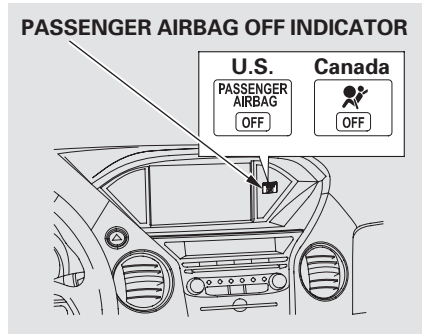

This indicator alerts you that the passenger's front airbag has been shut off because weight sensors detect about 65 lbs (29 kg) or less (the weight of an infant or small child) on the front passenger's seat. It does **not mean** there is a problem with the airbag.

Be aware that objects placed on the front seat can cause the indicator to come on.

If no weight is detected on the front seat, the airbag will be automatically shut off. However, the indicator will not come on.

The passenger airbag off indicator may come on and off repeatedly if the total weight on the seat is near the airbag cutoff threshold.

If an adult or teenage passenger is riding in front, move the seat as far to the rear as possible, and have the passenger sit upright and wear the seat belt properly.

If the indicator comes on with no front seat passenger and no objects on the seat, or with an adult riding there, something may be interfering with the weight sensors. Look for and remove:

- Any items under the front passenger's seat.
- Any object(s) hanging on the seat or in the seat-back pocket.
- Any object(s), such as a folded-down back seat, that are touching the rear of the seat-back.

If no obstructions are found, have your vehicle checked by a dealer as soon as possible.

## Additional Information About Your Airbags

---

### Airbag Service

Your airbag systems are virtually maintenance free, and there are no parts you can safely service.

However, you must have your vehicle serviced if:

- **An airbag ever inflates.** Any airbag that has deployed must be replaced along with the control unit and other related parts. Any seat belt tensioner that activates must also be replaced.

We recommend against the use of salvaged airbag system components, including the airbag, tensioners, sensors, and control unit.

Do not try to remove or replace any airbag by yourself. This must be done by an authorized dealer or a knowledgeable body shop.

- **The SRS indicator alerts you to a problem.** Take your vehicle to an authorized dealer as soon as possible. If you ignore this indication, your airbags may not operate properly.
- **If your vehicle has a moderate to severe impact.** Even if your airbags do not inflate, your dealer should inspect the driver's seat position sensor, the front passenger's weight sensors, the front seat belt tensioners, and all seat belts and their anchors worn during a crash to make sure they are operating properly.

### Additional Safety Precautions

- **Do not attempt to deactivate your airbags.** Together, airbags and seat belts provide the best protection.
- **Do not tamper with airbag components or wiring for any reason.** Tampering could cause the airbags to deploy, possibly causing very serious injury.
- **Do not expose the front passenger's seat-back to liquid.** If water or another liquid soaks into a seat-back, it can prevent the side airbag cutoff system from working properly.

- ***Do not remove or modify a front seat without consulting your dealer.*** This could make the driver's seat position sensor or the front passenger's weight sensors ineffective. If it is necessary to remove or modify a front seat to accommodate a person with disabilities, first contact Honda Automobile Customer Service at (800) 999-1009 in the US, or Honda Customer Relations at 1-888-9-HONDA-9 in Canada.

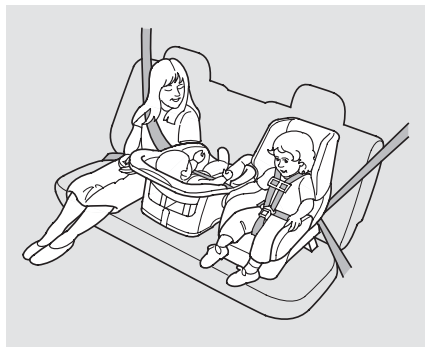

Children depend on adults to protect them. However, despite their best intentions, many adults do not know how to *properly* protect child passengers.

If you have children, or ever need to drive with a child in your vehicle, be sure to read this section. It begins with important general guidelines, then presents special information for infants, small children, and larger children.

**All Children Must Be Restrained**  
Each year, many children are injured or killed in vehicle crashes because they are either unrestrained or not properly restrained. In fact, traffic collisions are the number one cause of death of children age 12 and under.

To reduce the number of child deaths and injuries, every state, Canadian province and territory requires that infants and children be properly restrained when they ride in a vehicle.

***Infants and small children must be restrained in an approved child seat that is properly secured to the vehicle*** (see pages 43 – 55 ).

### **⚠ WARNING**

Children who are unrestrained or improperly restrained can be seriously injured or killed in a crash.

Any child too small for a seat belt should be properly restrained in a child seat. A larger child should be properly restrained with a seat belt and use a booster seat if necessary.

***Larger children must be restrained with a lap/shoulder belt and ride on a booster seat until the seat belt fits them properly*** (see pages 56 – 59 ).

### **All Children Should Sit in a Back Seat**

According to crash statistics, children of all ages and sizes are safer when they are restrained in a back seat.

The National Highway Traffic Safety Administration and Transport Canada recommend that all children aged 12 and under be properly restrained in a back seat. Some states have laws restricting where children may ride.

Children who ride in the back are less likely to be injured by striking interior vehicle parts during a collision or hard braking. Also, children cannot be injured by an inflating front airbag when they ride in the back.

### **The Passenger's Front Airbag Can Pose Serious Risks**

Front airbags have been designed to help protect adults in a moderate to severe frontal collision. To do this, the passenger's front airbag is quite large, and it can inflate with enough force to cause very serious injuries.

Even though your vehicle has an advanced front airbag system that automatically turns the passenger's front airbag off under certain circumstances (see page 35), please follow these guidelines:

#### ***Infants***

***Never put a rear-facing child seat in the front seat of a vehicle equipped with a passenger's front airbag.*** If the airbag inflates, it can hit the back of the child seat with enough force to kill or very seriously injure an infant.

#### ***Small Children***

***Placing a forward-facing child seat in the front seat of a vehicle equipped with a passenger's front airbag can be hazardous.*** If the vehicle seat is too far forward, or the child's head is thrown forward during a collision, an inflating front airbag can strike the child with enough force to kill or very seriously injure a small child.

#### ***Larger Children***

***Children who have outgrown child seats are also at risk of being injured or killed by an inflating passenger's front airbag.*** Whenever possible, larger children should sit in the back seat, on a booster seat if needed, and be properly restrained with a seat belt. (See page 56 for important information about protecting larger children.)

CONTINUED

# Protecting Children – General Guidelines

To remind you of the passenger's front airbag hazards, and that children must be properly restrained in a back seat, your vehicle has warning labels on the dashboard (U.S. models) and on the front visors. Please read and follow the instructions on these labels.

## U.S. Models

### SUN VISORS



## DASHBOARD

This Vehicle is Equipped with  
Advanced Air Bags

### Even with Advanced Air Bags

Children can be killed or seriously injured by the air bag.  
The back seat is the safest place for children.  
Never put a rear-facing child seat in the front.  
Always use seat belts and child restraints.  
See owner's manual for more information about air bags.

To be removed by owner only.

## Canadian Models

### SUN VISORS

#### CAUTION

TO AVOID SERIOUS INJURY:

- FOR MAXIMUM SAFETY PROTECTION IN ALL TYPES OF CRASHES, YOU MUST ALWAYS WEAR YOUR SAFETY BELT.
- DO NOT INSTALL REARWARD-FACING CHILD SEATS IN ANY FRONT PASSENGER SEAT POSITION.
- DO NOT SIT OR LEAN UNNECESSARILY CLOSE TO THE AIR BAG.
- DO NOT PLACE ANY OBJECTS OVER THE AIR BAG OR BETWEEN THE AIR BAG AND YOURSELF.
- SEE THE OWNER'S MANUAL FOR FURTHER INFORMATION AND EXPLANATIONS.

#### PRECAUTIONS:

POUR EVITER DES BLESSURES GRAVES:

- POUR PROFITER D'UNE PROTECTION MAXIMALE LORS D'UNE COLLISION BOUCLEZ TOUJOURS VOTRE CEINTURE DE SECURITE.
- N'INSTALLEZ JAMAIS UN SIEGE POUR ENFANTS FAISANT FACE A L'ARRIERE SUR LE SIEGE DU PASSAGER AVANT.
- NE VOUS APPUYEZ PAS ET NE VOUS ASSOYEZ PAS PRES DU COUSSIN GONFLABLE.
- NE DEPOSEZ AUCUN OBJET SUR LE COUSSIN GONFLABLE OU ENTRE LE COUSSIN GONFLABLE ET VOUS.
- LISEZ LE GUIDE UTILISATEUR POUR DE PLUS AMPLES RENSEIGNEMENTS.



### **If You Must Drive with Several Children**

Your vehicle has two rows of back seats where children can be properly restrained. If you ever have to carry a group of children, and a child must ride in front:

- Place the largest child in the front seat, provided the child is large enough to wear the lap/shoulder belt properly (see page 56).
- Move the vehicle seat as far to the rear as possible (see page 15).
- Have the child sit upright and well back in the seat (see page 19).
- Make sure the seat belt is properly positioned and secured (see page 17).

### **If a Child Requires Close Attention**

Many parents say they prefer to put an infant or a small child in the front passenger seat so they can watch the child, or because the child requires attention.

Placing a child in the front seat exposes the child to hazards in a frontal collision, and paying close attention to a child distracts the driver from the important tasks of driving, placing both of you at risk.

If a child requires close physical attention or frequent visual contact, we strongly recommend that another adult ride with the child in a back seat. The back seat is far safer for a child than the front.

## Protecting Children – General Guidelines

---

### Additional Safety Precautions

- **Never hold an infant or child on your lap.** If you are not wearing a seat belt in a crash, you could be thrown forward and crush the child against the dashboard or a seat-back. If you are wearing a seat belt, the child can be torn from your arms and be seriously hurt or killed.
- **Never put a seat belt over yourself and a child.** During a crash, the belt could press deep into the child and cause serious or fatal injuries.
- **Use the childproof door locks to prevent children from opening the rear doors.** This can prevent children from accidentally falling out (see page 143).
- **Make sure any unused seat belt that a child can reach is buckled, the lockable retractor is activated, and the belt is fully retracted and locked.** If a child wraps a loose seat belt around their neck, they can be seriously or fatally injured. (See pages 52 and 53 for how to activate and deactivate the lockable retractor.)
- **Never let two children use the same seat belt.** If they do, they could be very seriously injured in a crash.
- **Do not leave children alone in a vehicle.** Leaving children without adult supervision is illegal in most states, Canadian provinces and territories, and can be very hazardous.

For example, infants and small children left in a vehicle on a hot day can die from heatstroke. A child left alone with the key in the ignition switch can accidentally set the vehicle in motion, possibly injuring themselves or others.

- **Lock all doors, the tailgate and the glass hatch when your vehicle is not in use.** Children who play in vehicles can accidentally get trapped inside. Teach your children not to play in or around vehicles.
- **Keep vehicle keys/remote transmitters out of the reach of children.** Even very young children learn how to unlock vehicle doors, turn on the ignition switch, and open the tailgate or the glass hatch, which can lead to accidental injury or death.

## Protecting Infants

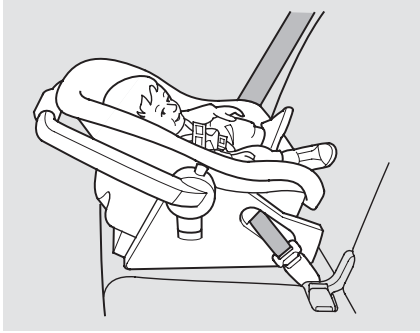

### ***Child Seat Type***

An infant must be properly restrained in a rear-facing, reclining child seat until the child reaches the seat maker's weight or height limit for the seat, and the child is at least one year old.

Only a rear-facing child seat provides proper support for a baby's head, neck, and back.

Two types of seats may be used: a seat designed exclusively for infants, or a convertible seat used in the rear-facing, reclining mode.

***Do not put a rear-facing child seat in a forward-facing position.*** If placed facing forward, an infant could be very seriously injured during a frontal collision.

### ***Rear-facing Child Seat Placement***

A rear-facing child seat can be placed in any seating position in the back seat, but not in the front. ***Never put a rear-facing child seat in the front seat.***

If the passenger's front airbag inflates, it can hit the back of the child seat with enough force to kill or seriously injure an infant.

When properly installed in the second row, a rear-facing child seat may prevent the driver or a front passenger from moving their seat as far back as recommended, or from locking their seat-back in the desired position.

It could also interfere with proper operation of the passenger's advanced front airbag system.

*CONTINUED*

## Protecting Infants and Small Children

---

In any of these situations, we strongly recommend that you install the child seat directly behind the front passenger's seat, move the seat as far forward as needed, and leave it unoccupied. Or, you may wish to get a smaller rear-facing child seat.

### **⚠ WARNING**

Placing a rear-facing child seat in the front seat can result in serious injury or death during a crash.

Always place a rear-facing child seat in the back seat, not the front.

### Protecting Small Children



#### *Child Seat Type*

Many states, Canadian provinces and territories allow a child one year of age or older who also meets the minimum size and weight requirements to transition from a rear-facing child seat to a forward facing seat. Know the requirements where you are driving and follow the child seat instructions. Many experts recommend use of a rear-facing seat up to age two, if the child's height

and weight are appropriate for a rear-facing seat.

Of the different seats available, we recommend those that have a five-point harness system as shown.

We also recommend that a small child use the child seat until the child reaches the weight or height limit for the seat.

### ***Child Seat Placement***

We strongly recommend placing a forward-facing child seat in a back seat, not the front.

***Placing a forward-facing child seat in the front seat of a vehicle equipped with a passenger's airbag can be hazardous.*** If the vehicle seat is too far forward, or the child's head is thrown forward during a collision, an inflating airbag can strike the child with enough force to cause very serious or fatal injuries.

Even with advanced front airbags that automatically turn the passenger's front airbag off (see page 35), a back seat is the safest place for a small child.

If it is necessary to put a forward-facing child seat in the front, move the vehicle seat as far to the rear as possible, be sure the child seat is firmly secured to the vehicle and the child is properly strapped in the seat.

### **⚠ WARNING**

Placing a forward-facing child seat in the front seat can result in serious injury or death if the front airbag inflates.

If you must place a forward-facing child seat in front, move the vehicle seat as far back as possible, and properly restrain the child.

## Selecting a Child Seat

---

Most child seats are LATCH-compatible (Lower Anchors and Tethers for CHildren). Some have a rigid-type connector, while others have a flexible-type connector. Both are equally easy to use. Some existing and previously owned child seats can only be installed using the seat belt. Whichever type you choose, follow the child seat manufacturer's use and care instructions as well as the instructions in this manual. Proper installation is key to maximizing your child's safety.

In seating positions and vehicles not equipped with LATCH, a LATCH-compatible child seat can be installed using the seat belt and a top tether for added security. This is because all child seats are required to be designed so that they can be secured with a lap belt or the lap part of a lap/shoulder belt.

In addition, the child seat manufacturer may advise that a seat belt be used to attach a LATCH-compatible seat once a child reaches a specified weight. Please read the child seat owner's manual for proper installation instructions.

### **Important considerations when selecting a child seat**

Make sure the child seat meets the following three requirements:

- The child seat is the correct type and size for the child.
- The child seat is the correct type for the seating position.
- The child seat is compliant with Federal Motor Vehicle Safety Standard 213 or Canadian Motor Vehicle Safety Standard 213.

After selecting a proper child seat and a good place to install the seat, there are three main steps in installing the seat:

- 1. Properly secure the child seat to the vehicle.** All child seats must be secured to the vehicle with the lap part of a lap/shoulder belt or with the LATCH (Lower Anchors and Tethers for CHildren) system. A child whose seat is not properly secured to the vehicle can be endangered in a crash.
- 2. Make sure the child seat is firmly secured.** After installing a child seat, push and pull the seat forward and from side-to-side to verify that it is secure.

A child seat secured with a seat belt should be installed as firmly as possible. However, it does not need to be “rock solid.” Some side-to-side movement can be expected and should not reduce the child seat’s effectiveness.

If the child seat is not secure, try installing it in a different seating position, or use a different style of child seat that can be firmly secured.

- 3. Secure the child in the child seat.** Make sure the child is properly strapped in the child seat according to the child seat maker’s instructions. A child who is not properly secured in a child seat can be seriously injured in a crash.

The following pages provide guidelines on how to properly install a child seat. A forward-facing child seat is used in all examples, but the instructions are the same for rear-facing child seats.

# Installing a Child Seat

## Installing a Child Seat with LATCH

Your vehicle is equipped with LATCH (Lower Anchors and Tethers for CHildren) at each of the second row seats and the passenger's side third row seat.

The lower anchors are located between the seat-back and seat bottom, and are to be used only with a child seat designed for use with LATCH.

The location of each lower anchor is indicated by a small button above the anchor point.

You can find lower anchors in the slits in the seat-backs.

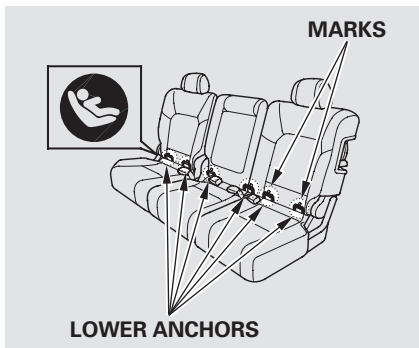

When you install a child seat in the second row seating position, use the lower anchors as shown in the illustration. You can install up to three child seats at a time with LATCH.

Do not attach two child seat connectors to a single lower anchor at a time.

## Using the Outer LATCH

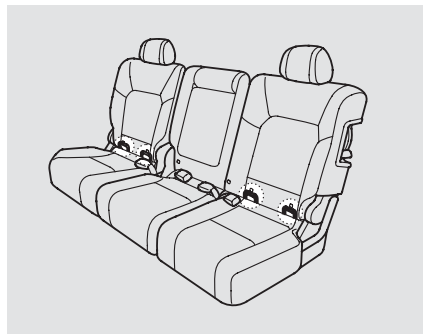

To install a LATCH-compatible child seat in either outer second row seat:

1. Move the seat belt buckle or tongue away from the lower anchors.
2. Make sure there are no objects near the anchors that could prevent a secure connection between the child seat and the anchors.



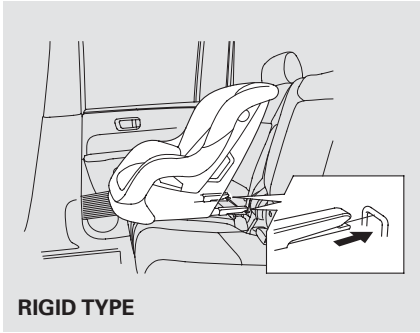

3. Place the child seat on the vehicle seat, then attach the seat to the lower anchors according to the child seat maker's instructions.

Some LATCH-compatible seats have a rigid-type connector as shown above.

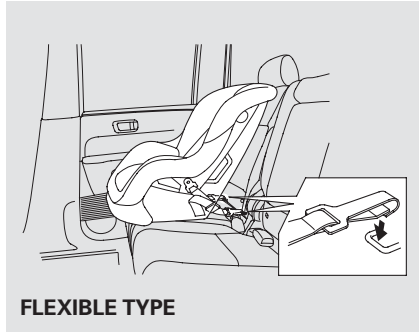

4. Whatever type you have, follow the child seat maker's instructions for adjusting or tightening the fit.

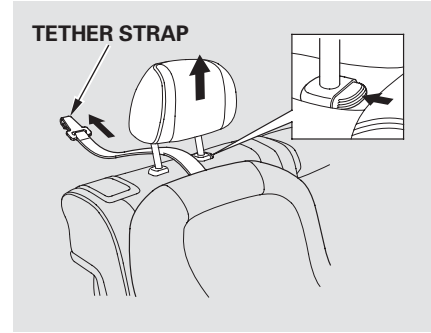

5. Lift the head restraint (see page 157), then route the tether strap through the legs of the head restraint and over the seat-back, making sure the strap is not twisted.

*CONTINUED*

## Installing a Child Seat

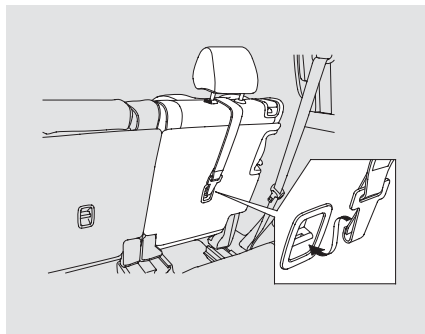

6. Attach the tether strap hook to the tether anchor, then tighten the strap as instructed by the child seat maker.
7. Push and pull the child seat forward and from side-to-side to verify that it is secure.

### *Using the Center LATCH*

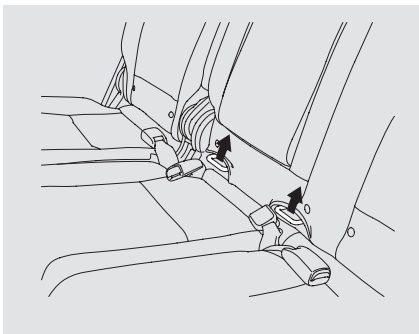

To install a LATCH-compatible child seat in the center seating position on the second row seat, use the center lower anchors as shown above.

1. Unlatch the detachable seat belt anchor latch and retract the seat belt all the way into the ceiling. Place the latch plate and anchor latch in their holding slots (see page 163 ).

2. Follow step 1 through 4 as described previously to secure the child seat.
3. Lower the head restraint first. Route the tether strap over the head restraint and seat-back, then attach the tether strap hook to the anchor, making sure the strap is not twisted.
4. Push and pull the child seat forward and from side-to-side to verify that it is secure.

To install a LATCH-compatible child seat in the passenger's side seating position of the third row:

1. Unlatch the detachable seat belt anchor latch and retract the seat belt all the way into the passenger's side panel. Place the latch plate and anchor latch in their holding slots (see page 163).

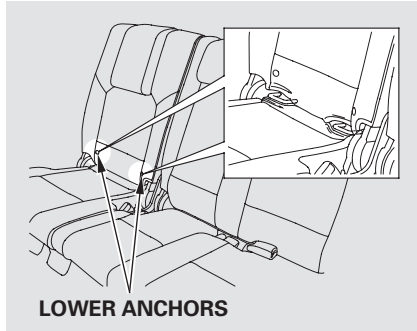

The location of each lower anchor is indicated by a small button above the anchor point.

You can find lower anchors in the slits in the seat-backs.

2. Follow steps 1 through 6 of the second row installation on pages 48 and 50.

3. If the child seat cannot be installed properly or interferes with the head restraint when in the highest position, remove the head restraint. Make sure the removed head restraint is secured in a safe place.
4. Push and pull the child seat forward and from side-to-side to verify that it is secure.

## Installing a Child Seat

### Installing a Child Seat with a Lap/Shoulder Belt

When not using the LATCH system, all child seats must be secured to the vehicle with the lap part of a lap/shoulder belt.

In addition, the lap/shoulder belts in all seating positions except the driver's have a lockable retractor that must be activated to secure a child seat.

If you intend to install a child seat in the center seating position of the second row or in the third row, make sure the detachable seat belt is securely latched (see page 163 ).



1. With the child seat in the desired seating position, route the belt through the child seat according to the seat maker's instructions, then insert the latch plate into the buckle and remove any slack from the lap portion of the belt.

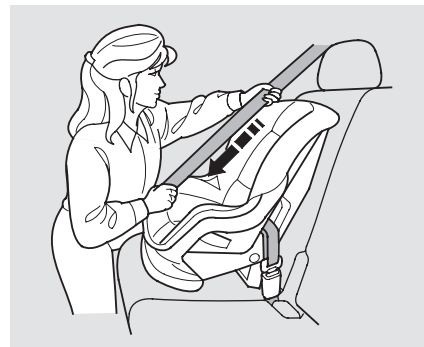

2. To activate the lockable retractor, slowly pull the shoulder part of the belt all the way out until it stops, then let the belt feed back into the retractor.
3. After the belt has retracted, tug on it. If the belt is locked, you will not be able to pull it out. If you can pull the belt out, it is not locked, and you will need to repeat these steps.

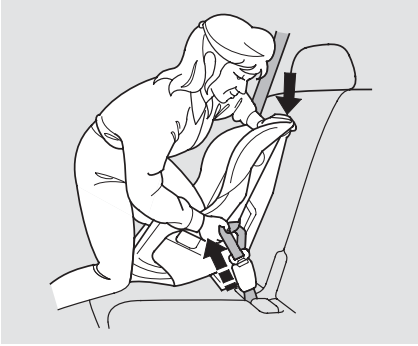

4. After confirming that the belt is locked, grab the shoulder part of the belt near the buckle, and pull up to remove any slack from the lap part of the belt. Remember, if the lap part of the belt is not tight, the child seat will not be secure.

To remove slack, it may help to put weight on the child seat, or push on the back of the seat while pulling up on the belt.



5. Push and pull the child seat forward and from side-to-side to verify that it is secure enough to stay upright during normal driving maneuvers. If the child seat is not secure, unlatch the belt, allow it to retract fully, then repeat these steps.

To deactivate the lockable retractor and remove a child seat, unlatch the buckle, unroute the seat belt, and let the belt fully retract.

## Installing a Child Seat with a Tether

A child seat with a tether can be installed in any seating position in the second or third row.

Since a tether can provide additional security to the lap/shoulder belt installation, we recommend using a tether whenever one is required or available.

*CONTINUED*

# Installing a Child Seat

## Second Row Installation

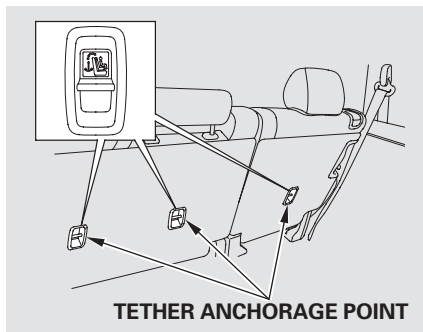

Each second row seat has a tether anchorage point behind the seat-back.

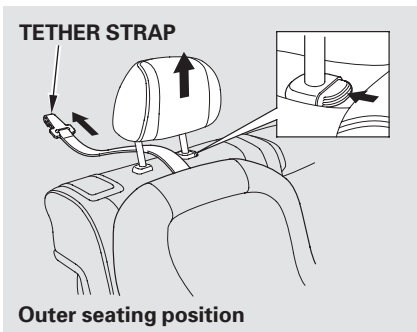

1. After properly securing the child seat (see page 52 ), lift the head restraint, then route the tether strap over the seat-back and through the head restraint legs.

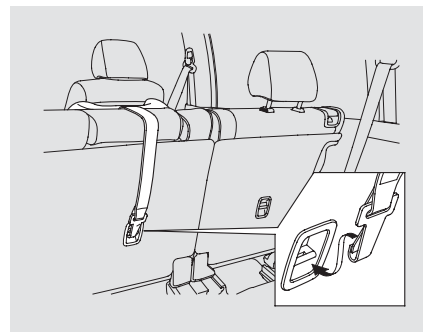

For the center seat, lower the head restraint, then route the tether strap over the head restraint and seat-back.

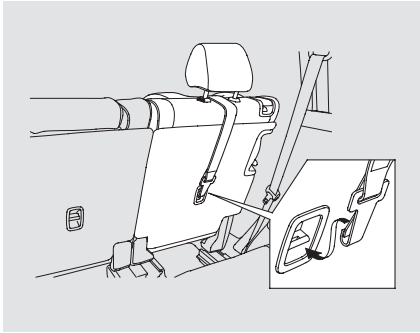

2. Attach the tether strap hook to the anchor, making sure the tether strap is not twisted.
3. Tighten the strap according to the seat maker's instructions.

## Third Row Installation

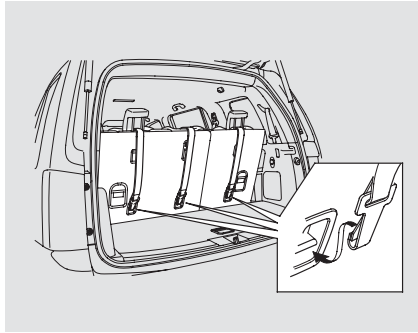

Each third row seat has a tether anchorage point behind the seat-back.

1. After properly securing the child seat (see pages 52 and 53 ), lift the left and right head restraint, then route the tether strap over the seat-back and through the head restraint legs.

2. If the child seat cannot be installed properly or interferes with the head restraint when in the highest position, remove the head restraint. Make sure the removed head restraint is secured in a safe place.
3. Attach the tether strap hook to the anchor, making sure the tether strap is not twisted.
4. For the center seating position, lower the head restraint first. Route the tether strap over the head restraint and seat-back, then attach the tether strap hook to the anchor, making sure the strap is not twisted.
5. Tighten the strap according to the seat maker's instructions.

CONTINUED

## Protecting Larger Children

---

When a child reaches the recommended weight or height limit for a forward-facing child seat, the child should sit in a back seat on a booster seat and wear the lap/shoulder belt.

The following pages give instructions on how to check proper seat belt fit, what kind of booster seat to use if one is needed, and important precautions for a child who must sit in front.

### **⚠ WARNING**

Allowing a child age 12 or under to sit in front can result in injury or death if the passenger's front airbag inflates.

If a child must ride in front, move the vehicle seat as far back as possible, use a booster seat if needed, have the child sit up properly and wear the seat belt properly.

### Checking Seat Belt Fit

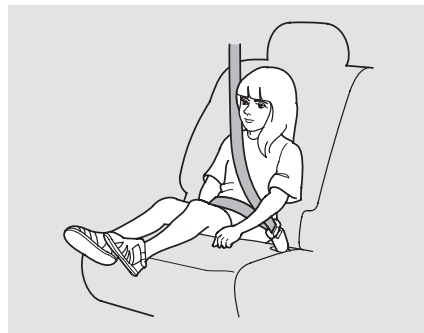

To determine if a lap/shoulder belt properly fits a child, have the child put on the seat belt, then ask yourself:

1. Does the child sit all the way back against the seat?
2. Do the child's knees bend comfortably over the edge of the seat?



3. Does the shoulder belt cross between the child's neck and arm?
4. Is the lap part of the belt as low as possible, touching the child's thighs?
5. Will the child be able to stay seated like this for the whole trip?

If you answer yes to all these questions, the child is ready to wear the lap/shoulder belt correctly. If you answer no to any question, the child needs to ride on a booster seat.

### Using a Booster Seat



A child who has outgrown a forward-facing child seat should ride in a back seat and use a booster seat until the lap/shoulder belt fits them properly without the booster.

Some states, Canadian provinces and territories also require children to use a booster seat until they reach a given age or weight (e.g., 6 years or 60 lbs). Be sure to check current laws in the states, provinces or territories where you intend to drive.

Booster seats can be high-back or low-back. Whichever style you select, make sure the booster seat meets federal safety standards (see page 46) and that you follow the booster seat maker's instructions.

*CONTINUED*

## Protecting Larger Children

---

If a child who uses a booster seat must ride in front, move the vehicle seat as far back as possible and be sure the child is wearing the seat belt properly.

A child may continue using a booster seat until the tops of their ears are even with the top of the vehicle's or booster's seat-back. A child of this height should be tall enough to use the lap/shoulder belt without a booster seat.

### **When Can a Larger Child Sit in Front**

The National Highway Traffic Safety Administration and Transport Canada recommend that all children age 12 and under be properly restrained in a back seat.

If the passenger's front airbag inflates in a moderate to severe frontal collision, the airbag can cause serious injuries to a child who is unrestrained, improperly restrained, sitting too close to the airbag, or out of position.

A side airbag also poses risks. If any part of a larger child's body is in the path of a deploying side airbag, the child could receive possibly serious injuries.

Of course, children vary widely. And while age may be one indicator of when a child can safely ride in front, there are other important factors you should consider.

### ***Physical Size***

Physically, a child must be large enough for the lap/shoulder belt to properly fit (see pages 17 and 56). If the seat belt does not fit properly, with or without the child sitting on a booster seat, the child should not sit in front.

### ***Maturity***

To safely ride in front, a child must be able to follow the rules, including sitting properly, and wearing the seat belt properly throughout a ride.

If you decide that a child can safely ride up front, be sure to:

- Carefully read the owner's manual, and make sure you understand all seat belt instructions and all safety information.
- Move the vehicle seat to the rear-most position.
- Have the child sit up straight, back against the seat, and feet on or near the floor.
- Check that the child's seat belt is properly and securely positioned.
- Supervise the child. Even mature children sometimes need to be reminded to fasten the seat belts or sit properly.

### Additional Safety Precautions

- ***Do not let a child wear a seat belt across the neck.*** This could result in serious neck injuries during a crash.
- ***Do not let a child put the shoulder part of a seat belt behind the back or under the arm.*** This could cause very serious injuries during a crash. It also increases the chance that the child will slide under the belt in a crash and be injured.
- ***Two children should never use the same seat belt.*** If they do, they could be very seriously injured in a crash.

- ***Do not put any accessories on a seat belt.*** Devices intended to improve a child's comfort or reposition the shoulder part of a seat belt can make the belt less effective and increase the chance of serious injury in a crash.

# Carbon Monoxide Hazard

---

Your vehicle's exhaust contains carbon monoxide gas. Carbon monoxide should not enter the vehicle in normal driving if you maintain your vehicle properly and follow the information on this page.

Have the exhaust system inspected for leaks whenever:

- The vehicle is raised for an oil change.
- You notice a change in the sound of the exhaust.
- The vehicle was in a crash that may have damaged the underside.

## **WARNING**

Carbon monoxide gas is toxic. Breathing it can cause unconsciousness and even kill you.

Avoid any enclosed areas or activities that expose you to carbon monoxide.

High levels of carbon monoxide can collect rapidly in enclosed areas, such as a garage. Do not run the engine with the garage door closed. Even with the door open, run the engine only long enough to move the vehicle out of the garage.

With the tailgate/glass hatch open, airflow can pull exhaust gas into your vehicle's interior and create a hazardous condition. If you must drive with the tailgate/glass hatch open, open all the windows and set the heating and cooling system/ climate control system as shown below.

If you must sit in your parked vehicle with the engine running, even in an unconfined area, adjust the heating and cooling system/ climate control system as follows:

1. Select the fresh air mode.
2. Select the  mode.
3. Turn the fan on high speed.
4. Set the temperature control to a comfortable setting.

These labels are in the locations shown. They warn you of potential hazards that could cause serious injury or death. Read these labels carefully.

If a label comes off or becomes hard to read (except for the U.S. dashboard label which may be removed by the owner), contact your dealer for a replacement.

## RADIATOR CAP



## DASHBOARD

*U.S. models only*

**This Vehicle is Equipped with Advanced Air Bags**

### Even with Advanced Air Bags

Children can be killed or seriously injured by the air bag.  
The back seat is the safest place for children.  
Never put a rear-facing child seat in the front.  
Always use seat belts and child restraints.  
See owner's manual for more information about air bags.

To be removed by owner only.

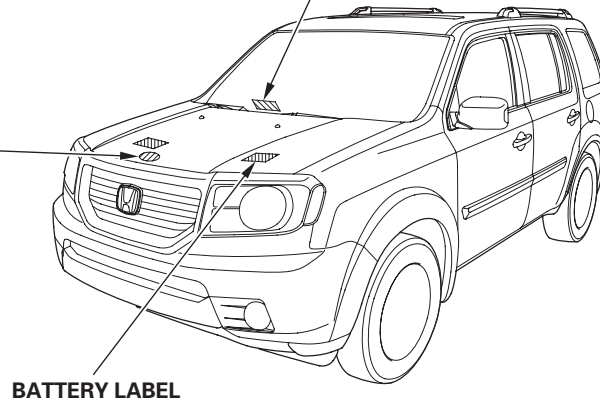

**BATTERY LABEL**

*CONTINUED*

# Safety Labels

## SUN VISOR

U.S. models

**▲ WARNING**

**EVEN WITH ADVANCED AIR BAGS**

- Children can be killed or seriously injured by the air bag.
- The back seat is the safest place for children.
- Never put a rear-facing child seat in the front.
- Always use seat belts and child restraints.
- See owner's manual for more information about air bags.



 **AIRBAG WARNING**  
FLIP VISOR OVER

Canadian models

|   |   |
|---|---|
| <p><b>CAUTION</b><br/>TO AVOID SERIOUS INJURY:<br/>• FOR MAXIMUM SAFETY PROTECTION IN ALL TYPES OF CRASHES, YOU MUST ALWAYS WEAR YOUR SAFETY BELT.<br/>• DO NOT INSTALL REARWARD FACING CHILD SEATS IN ANY FRONT PASSENGER SEAT POSITION.<br/>• DO NOT GET OUT OF THE CAR UNLESS NECESSARILY CLOSE TO THE AIR BAG.<br/>• DO NOT PLACE ANY OBJECT OVER THE AIR BAG OR BETWEEN THE AIR BAG AND YOURSELF.<br/>• SEE THE OWNER'S MANUAL FOR FURTHER INFORMATION AND EXPLANATIONS.</p> | <p><b>PRECAUTIONS:</b><br/><b>POUR ÉVITER DES BLESSURES GRAVES:</b><br/><b>POUR PROFITER D'UNE PROTECTION MAXIMALE, OBLIGÉ D'UNE POSITION DOUCÉE TOUJOURS VOTRE CEINTURE DE SÉCURITÉ, ET RÉGULER LA TAILLE D'UN SIÈGE POUR ENFANTS FAISANT FACE À L'ARRIÈRE SUR LE SIÈGE DU PASSAGER AVANT.</b><br/><b>NE VOUS APPROXIMÉZ PAS ET NE VOUS ASSOYÉZ PAS PRÈS DE LA COUSSIN GONFLABLE.</b><br/><b>NE D'OBJET AUCUN OBJET SUR LE COUSSIN GONFLABLE OU ENTRE LE COUSSIN GONFLABLE ET VOUS.</b><br/><b>NE PAS LE COUPE UTILISATEUR POUR DE PLUS AMPLES RENSEIGNEMENTS.</b></p> |
|---|---|

U.S. models

**▲ WARNING: HIGHER ROLLOVER RISK**

|  |  |   |
|--|--|---|
|  | <p>Avoid Abrupt Maneuvers and Excessive Speed.<br/>Always Buckle Up.<br/>See Owner's Manual For Further Information.</p> |  |
|--|--|---|

## DOORJAMBS

U.S. models

**SIDE AIRBAG**

- This car is equipped with side airbags in the front seats and side curtain airbags.
- Do not lean against the door.
- See owner's manual for more information.

Canadian models

**SIDE AIRBAG**

- This car is equipped with side airbags in the front seats and side curtain airbags.
- Do not lean against the door.
- See owner's manual for more information.

**COUSSIN GONFLABLE LATÉRAL**

- Cette automobile est équipée de coussins gonflables latéraux dans les sièges avant ainsi que de coussins gonflables latéraux de type rideau.
- Ne vous appuyez pas sur la porte.
- Consultez le Manuel du propriétaire pour en savoir plus.

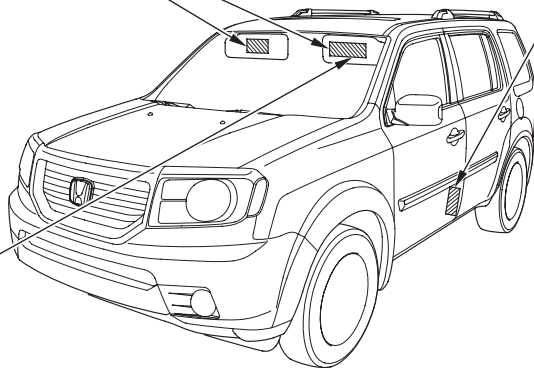

This section gives information about the controls and displays that contribute to the daily operation of your vehicle. All the essential controls are within easy reach.

|                                  |     |                                 |     |
|----------------------------------|-----|---------------------------------|-----|
| Control Locations .....          | 64  |                                 |     |
| Instrument Panel .....           | 65  | Seat Heaters .....              | 165 |
| Instrument Panel Indicators..... | 67  | Power Windows .....             | 167 |
| Gauges .....                     | 80  | Moonroof .....                  | 170 |
| Multi-Information Display .....  | 85  | Parking Brake .....             | 171 |
| Controls Near the Steering       |     | Mirrors.....                    | 172 |
| Wheel.....                       | 122 | Driving Position Memory         |     |
| Windshield Wipers and            |     | System.....                     | 174 |
| Washers.....                     | 123 | Interior Lights.....            | 176 |
| Rear Window Wiper and            |     | Interior Convenience Items..... | 179 |
| Washer.....                      | 124 | Center Console .....            | 180 |
| Turn Signals and Headlights..... | 125 | Console Compartments .....      | 180 |
| Hazard Warning Button.....       | 129 | Beverage Holders.....           | 181 |
| Rear Window Defogger .....       | 129 | Storage Compartment.....        | 182 |
| Instrument Panel Brightness..... | 130 | Glove Box .....                 | 183 |
| Steering Wheel Adjustment .....  | 132 | Integrated Sunshades .....      | 183 |
| Keys and Locks.....              | 133 | Sunglasses Holder .....         | 183 |
| Immobilizer System.....          | 134 | Conversation Mirror .....       | 184 |
| Ignition Switch .....            | 136 | Sun Visor .....                 | 184 |
| Door Locks.....                  | 137 | Vanity Mirror .....             | 185 |
| Childproof Door Locks .....      | 143 | Coat Hooks.....                 | 185 |
| Tailgate and Glass Hatch.....    | 143 | Accessory Power Sockets.....    | 186 |
| Power Tailgate .....             | 144 | AC Power Outlet.....            | 187 |
| Glass Hatch .....                | 148 | Cargo Floor Storage             |     |
| Remote Transmitter .....         | 150 | Compartment .....               | 188 |
| Seats .....                      | 154 | Cargo Net .....                 | 188 |
| Detachable Anchor.....           | 163 |                                 |     |

# Control Locations

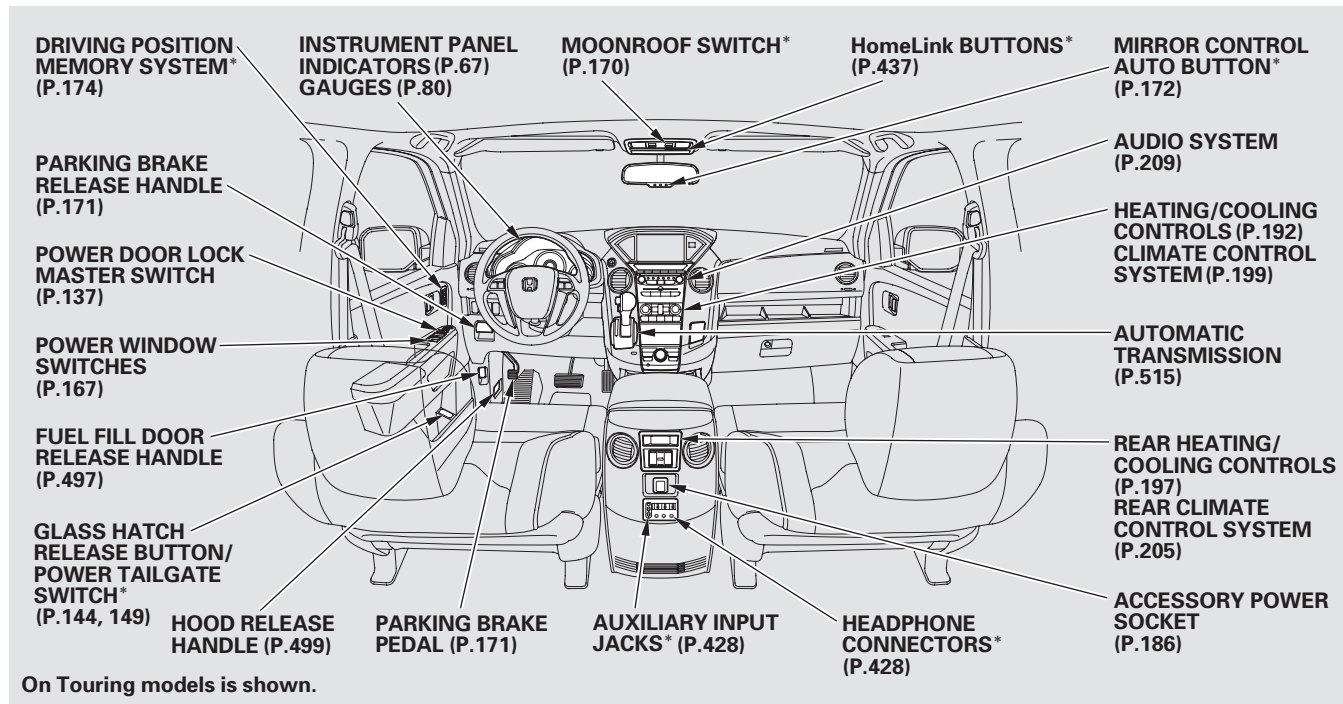

\*: If equipped



*Except Touring models*

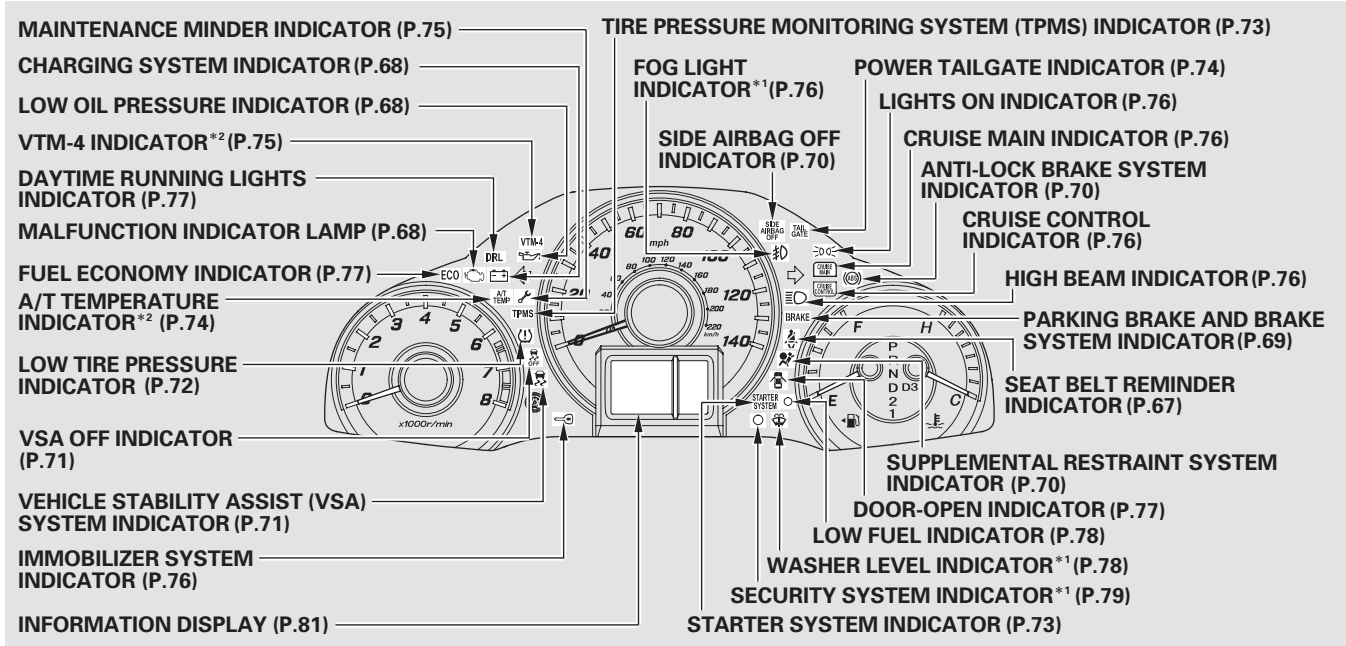

\* 1 : If equipped  
 \* 2 : 4WD models only

The U.S. instrument panel is shown. Differences for the Canadian models are noted in the text.

Instruments and Controls

# Instrument Panel

## On Touring models

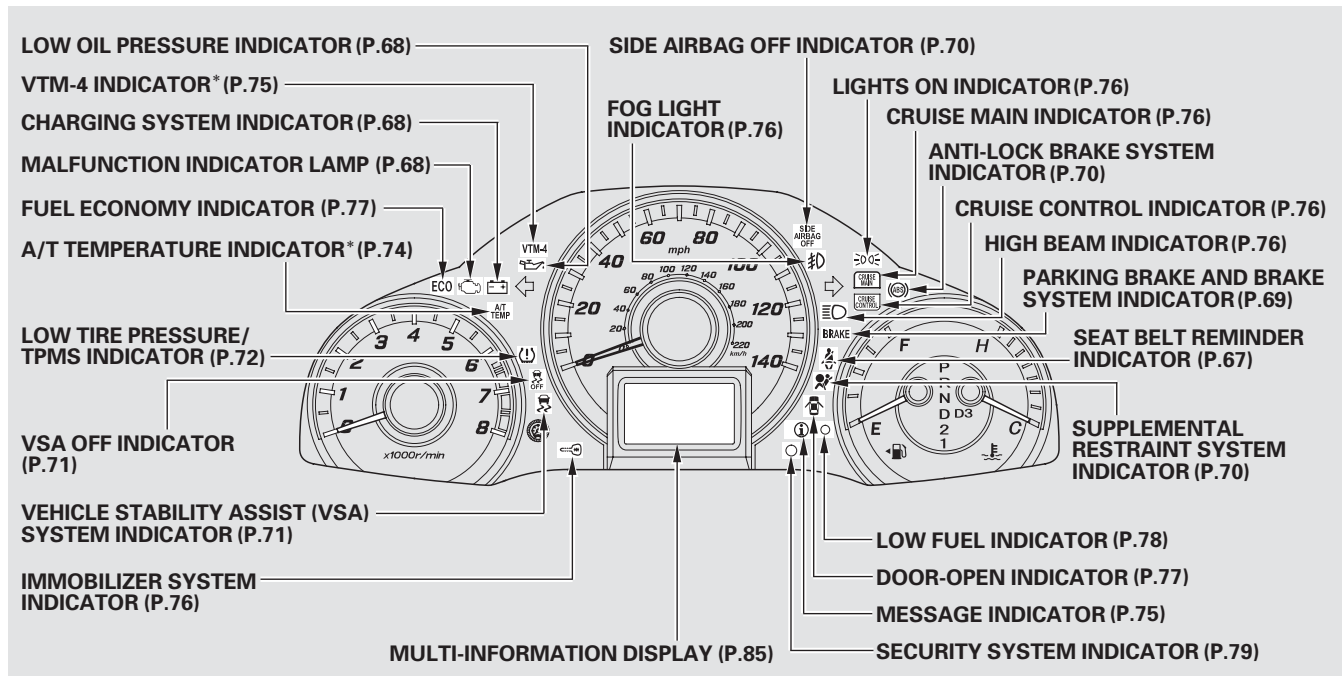

\* : 4WD models only

The U.S. instrument panel is shown. Differences for the Canadian models are noted in the text.

The instrument panel has many indicators to give you important information about your vehicle.



### Seat Belt Reminder Indicator

This indicator comes on when you turn the ignition switch to the ON (II) position. It reminds you and your passengers to fasten your seat belts. A beeper also sounds if you have not fastened your seat belt.

If you turn the ignition switch to the ON (II) position before fastening your seat belt, the beeper sounds, and the indicator flashes. If you do not fasten your seat belt before the beeper stops, the indicator stops flashing but remains on.

If your front passenger does not fasten their seat belt, the indicator comes on about 6 seconds after the ignition switch is turned to the ON (II) position.

If either of you do not fasten your seat belt while driving, the beeper will sound and the indicator will flash again at regular intervals. For more information, see page 22 .

#### *On Touring models*

You will also see a “FASTEN SEAT BELT” or “FASTEN PASSENGER SEAT BELT” message on the multi-information display (see page 93 ).

For more information, see page 22 .

## Instrument Panel Indicators

---



### Low Oil Pressure Indicator

The engine can be severely damaged if this indicator flashes or stays on when the engine is running. For more information, see page 625 .

#### *On Touring models*

You will also see a “CHECK ENGINE OIL LEVEL” message on the multi-information display (see page 93 ).



### Charging System Indicator

If this indicator comes on when the engine is running, the battery is not being charged. For more information, see page 626 .

#### *On Touring models*

You will also see a “CHECK CHARGING SYSTEM” message on the multi-information display (see page 93 ).



### Malfunction Indicator Lamp

For more information, see page 626 .

#### *On Touring models*

You will also see a “CHECK EMISSION SYSTEM” message on the multi-information display (see page 93 ). For more information, see page 626 .



This indicator has two functions:

1. It comes on when you turn the ignition switch to the ON (II) position. It is a reminder to check the parking brake. A beeper sounds if you drive with the parking brake not fully released. Driving with the parking brake not fully released can damage the brakes and tires.

*On Touring models*

You will also see a “RELEASE PARKING BRAKE” message on the multi-information display (see page 93 ).

2. If it remains on after you have fully released the parking brake while the engine is running, or if it comes on while driving, there could be a problem with the brake system. For more information, see page 627 .

*On Touring models*

You will also see a “LOW BRAKE FLUID” or “CHECK BRAKE SYSTEM” message on the multi-information display (see page 93 ).

## Instrument Panel Indicators

---



### Supplemental Restraint System Indicator

This indicator comes on briefly when you turn the ignition switch to the ON (II) position. If it comes on at any other time, it indicates a potential problem with your front airbags. This indicator will also alert you to a potential problem with your airbag system components. For more information, see page 34 .

#### *On Touring models*

You will also see a “CHECK AIRBAG SYSTEM” message on the multi-information display (see page 93 ).

U.S.



Canada



### Side Airbag Off Indicator

This indicator comes on for several seconds when you turn the ignition switch to the ON (II) position. If it comes on at any other time, it indicates that the passenger’s side airbag has automatically shut off. For more information, see page 34 .

#### *On Touring models*

You will also see a “PASSENGER SIDE AIRBAG OFF” message on the multi-information display (see page 93 ).



### Anti-lock Brake System (ABS) Indicator

This indicator normally comes on for a few seconds when you turn the ignition switch to the ON (II) position. If it comes on at any other time, there is a problem with the ABS. If this happens, have your vehicle checked at a dealer. With this indicator on, your vehicle still has normal braking ability but no anti-lock function. For more information, see page 531 .

#### *On Touring models*

You will also see a “CHECK ABS SYSTEM” message on the multi-information display (see page 93 ).



## Vehicle Stability Assist (VSA) System Indicator

This indicator normally comes on for a few seconds when you turn the ignition switch to the ON (II) position.

It flashes when VSA is active (see page 533 ).

If it comes on and stays on at any other time, there is a problem with the VSA or Hill Start Assist system. Take your vehicle to a dealer to have it checked. Without VSA, your vehicle still has normal driving ability, but will not have VSA traction and stability enhancement. See page 533 for more information on the VSA system.

### *On Touring models*

You will also see a “CHECK VSA SYSTEM” message on the multi-information display (see page 93 ).



## VSA OFF Indicator

This indicator normally comes on for a few seconds when you turn the ignition switch to the ON (II) position. For more information, see page 533 .

It comes on as a reminder that you have turned off the vehicle stability assist (VSA) system.

### *On Touring models*

You will also see a “CHECK VSA SYSTEM” message on the multi-information display (see page 93 ).



## Turn Signal and Hazard Warning Indicators

The left or right turn signal indicator blinks when you signal a lane change or turn. If an indicator does not blink or blinks rapidly, it usually means one of the turn signal bulbs is burned out (see page 587 ). Replace the bulb as soon as possible, since other drivers cannot see that you are signaling.

When you press the hazard warning button, both turn signal indicators and all turn signals on the outside of the vehicle flash.

## Instrument Panel Indicators

---



### Low Tire Pressure Indicator

*Except Touring models*

This indicator normally comes on for a few seconds when you turn the ignition switch to the ON (II) position. If it comes on while driving, it indicates that one or more of your vehicle's tires are significantly low on pressure.

If this happens, pull to the side of the road when it is safe, check which tire has lost pressure, and determine the cause. If it is because of a flat tire, replace the flat tire with the compact spare (see page 612 ), and have the flat tire repaired as soon as possible. If two or more tires are underinflated, call a professional towing service (see page 636). For more information, see page 522 .



### Low Tire Pressure/TPMS Indicator

*On Touring models*

This indicator normally comes on for a few seconds when you turn the ignition switch to the ON (II) position.

This indicator has two functions:

1. If it comes on while driving, it indicates that one or more of your vehicle's tires are significantly low on pressure.

You will also see a "CHECK TIRE PRESSURE" message on the multi-information display (see page 94 ).

Check the tire pressure monitor on the multi-information display and determine the cause (see page 526).

If this happens, pull to the side of the road when it is safe, check which tire has lost pressure on the multi-information display, and determine the cause. If it is because of a flat tire, have the flat tire repaired as soon as possible. If two or more tires are underinflated, call a professional towing service. For more information, see page 636 .



2. If this indicator begins to flash, there is a problem with the tire pressure monitoring system (TPMS). You will also see a “CHECK TPMS SYSTEM” message on the multi-information display. The indicator continues to flash for a while (approximately 1 minute), then stays on. If this happens, have your dealer check the system as soon as possible. For more information, see page 528 .

**U.S.**      **Canada**



## **Starter System Indicator**

*Except Touring models*

This indicator comes on when there is a problem with the starter system. For more information, see page 513 .

*On Touring models*

If you see a “CHECK STARTER SYSTEM” message on the multi-information display, there is a problem with the starter system (see page 94 ).

**TPMS**

## **Tire Pressure Monitoring System (TPMS) Indicator**

*Except Touring models*

This indicator normally comes on for a few seconds when you turn the ignition switch to the ON (II) position.

If this indicator comes on and stays on at any other time, or if it does not come on when you turn the ignition switch to the ON (II) position, there is a problem with the TPMS. With this indicator on, the low tire pressure indicator and the tire pressure monitor will not come on when a tire loses pressure. Take the vehicle to your dealer to have the system checked.

## Instrument Panel Indicators

---

A/T  
TEMP

### A/T Temperature Indicator

*4WD models only*

This indicator monitors the temperature of the automatic transmission fluid. It should come on for a few seconds when you turn the ignition switch to the ON (II) position. If it comes on while driving, it means the transmission fluid temperature is too high. Pull to the side of the road when it is safe, shift to Park, and let the engine idle until the indicator goes out.

*On Touring 4WD models*

You will also see an “A/T TEMP HIGH” message on the multi-information display (see page 94 ).

### NOTICE

*Continuing to drive with the A/T temperature indicator on may cause serious damage to the transmission.*

U.S.

TAIL  
GATE

Canada



### Power Tailgate Indicator

*On EX-L models*

This indicator comes on for a few seconds when you turn the ignition switch to the ON (II) position. If it comes on at any other time, there is a problem in the power tailgate system. Have the system checked by your dealer as soon as possible. You can still open or close the tailgate manually. For more information on the power tailgate, see page 144 .

*On Touring models*

You will also see a “CHECK POWER TAILGATE SYSTEM” message on the multi-information display.



## Maintenance Minder Indicator

*Except Touring models*

This indicator comes on for a few seconds when you turn the ignition switch to the ON (II) position. It reminds you that it is time to take your vehicle in for scheduled maintenance. The maintenance main items and sub items will be displayed in the information display. See page 559 for more information on the Maintenance Minder™.

This indicator goes off when your dealer resets it after completing the required maintenance service.



## Message Indicator

*On Touring models*

This indicator comes on when there is a system message on the multi-information display. Press the INFO button on the steering wheel (see page 85 ) to see the message (see page 92 ).

Most of the time, this indicator comes on along with other indicators in the instrument panel such as the seat belt reminder indicator, SRS indicator, VSA system indicator, etc.



## VTM-4 Indicator

*4WD models only*

This indicator normally comes on for a few seconds when you turn the ignition switch to the ON (II) position. If it comes on at any other time, there is a problem in the 4WD system. Take the vehicle to your dealer to have it checked.

If the indicator blinks while driving, the VTM-4 fluid temperature is too high. Pull to the side of the road when it is safe, shift to Park, and let the engine idle until the indicator goes out.

### NOTICE

*Continuing to drive with the VTM-4 indicator blinking may cause serious damage to the system.*

## Instrument Panel Indicators

---





### Immobilizer System Indicator

This indicator comes on briefly when you turn the ignition switch to the ON (II) position. It will then go off if you have inserted a properly coded ignition key. If it is not a properly coded key, the indicator will blink, and the engine's fuel system will be disabled (see page 134).



### Lights On Indicator

This indicator reminds you that the exterior lights are on. It comes on when the light switch is in either the  or  position. This indicator will also come on when the light switch is in AUTO and the lights turn on automatically. If you turn the ignition switch to the ACCESSORY (I) or the LOCK (0) position without turning off the light switch, this indicator will remain on. A reminder chime will also sound when you open the driver's door.



### Fog Light Indicator

*Except LX models*

This indicator comes on when you turn on the fog lights. For more information, see page 127.



### High Beam Indicator

This indicator comes on with the high beam headlights. For more information, see page 125.



### Cruise Main Indicator

This indicator comes on when you turn on the cruise control system by pressing the CRUISE button (see page 430).



### Cruise Control Indicator

This indicator comes on when you set the cruise control. See page 430 for information on operating the cruise control.

**DRL**

## Daytime Running Lights Indicator

*Except Touring models*

If this indicator comes on when the ignition switch is turned to the ON (II) position and the parking brake is released, it means there is a problem in the high beam headlight's circuit. Have your vehicle checked by your dealer.

*On Touring models*

If you see a "CHECK DRL SYSTEM" message on the multi-information display, there is a problem with the daytime running light system. Take your vehicle to a dealer to have it checked.

**ECO**

## Fuel Economy Indicator

While the engine is operating in its most economical range, this indicator may come on and stay on. It goes off when your vehicle uses extra fuel.



## Door-open Indicator

This indicator comes on if any door, tailgate, or glass hatch is not closed tightly.

# Instrument Panel Indicators



## Washer Level Indicator

*If equipped*

This indicator comes on when the washer fluid level is low. Add washer fluid when you see this indicator come on (see page 581).

*On Touring 4WD models*

You will see a “LOW WASHER FLUID” message on the multi-information display (see page 94 ).

## Low Fuel Indicator

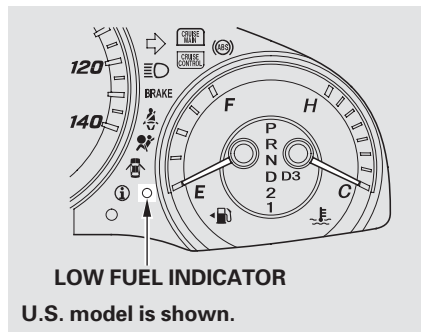

This indicator comes on as a reminder that you must refuel soon.

**United States:**

When the indicator comes on, there are about 3.1 US gal (11.9 ℓ) of fuel remaining in the tank.

**Canada:**

When the indicator comes on, there are about 9.3 ℓ (2.45 US gal) of fuel remaining in the tank.

When the needle reaches E, there is a very small amount of fuel in the tank.

*On Touring models*

You will also see a “LOW FUEL” message on the multi-information display.

## Security System Indicator

*Except LX models*

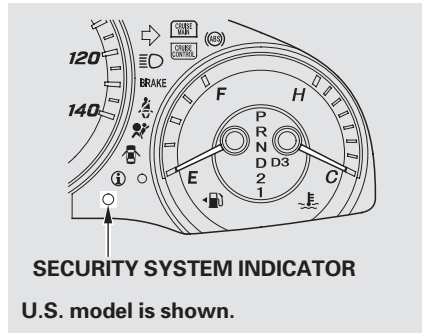

This indicator comes on when the security system is set. See page 429 for more information on the security system.

## Door, Glass Hatch, and Tailgate Open Indicator

*Except Touring models*



Your vehicle has a door, glass hatch, and tailgate open indicator on the information display. If any door(s), the glass hatch, or the tailgate is not closed tightly, the appropriate light/lights will come on to remind you to close the tailgate, the glass hatch or the door(s).

*On Touring models*

The door, glass hatch, and tailgate open indicator appears on the multi-information display (see page 13 ).



## Tire Pressure Monitor

*Except Touring models*

The appropriate tire indicator will come on in the information display along with the low tire pressure indicator if a tire is significantly underinflated or has suddenly lost pressure. See **Low Tire Pressure Indicator** for what to do if this indicator comes on.

*On Touring models*

This indicator is displayed as the system message on the multi-information display (see page 526 ).

## Except Touring models

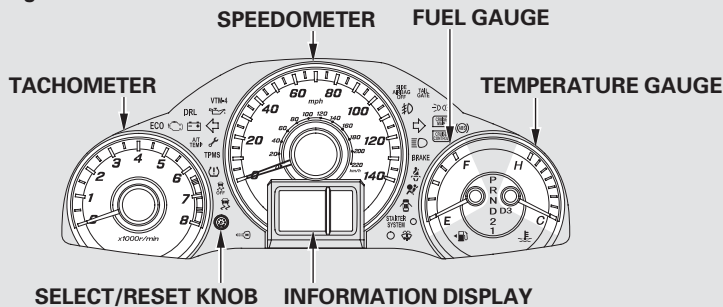

## On Touring models

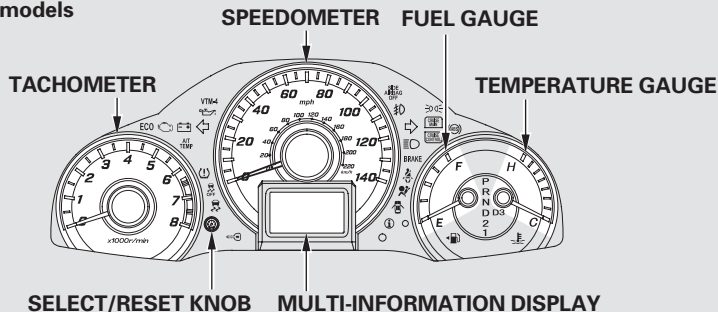

U.S. models are shown.

## Temperature Gauge

This shows the temperature of the engine's coolant. During normal operation, the pointer should rise to about the middle of the gauge. In severe driving conditions, the pointer may rise to the upper zone. If it reaches the red (hot) mark, pull safely to the side of the road. For instructions and precautions on checking the engine's cooling system, see page 623.

## Fuel Gauge

This shows how much fuel you have. It may show slightly more or less than the actual amount.

### NOTICE

*Avoid driving with an extremely low fuel level. Running out of fuel could cause the engine to misfire, damaging the catalytic converter.*



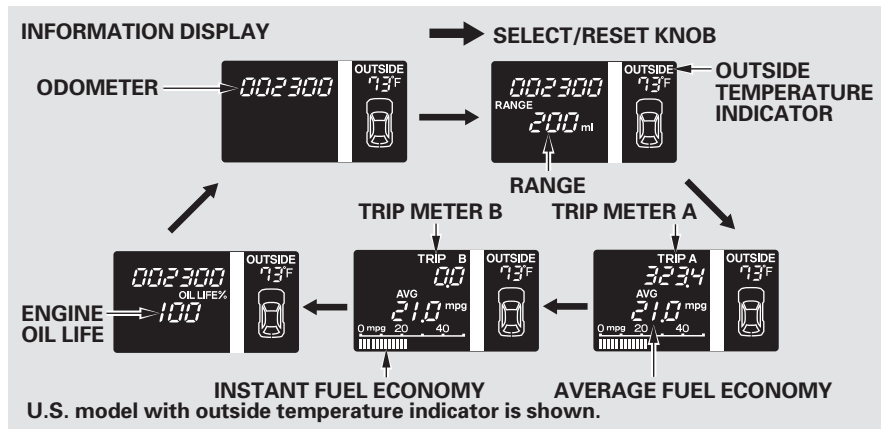

## Information Display

*Except Touring models*

The information display shows the odometer, trip meter, engine oil life, outside temperature (if equipped), instant fuel economy, average fuel economy, range (estimated distance), and maintenance item code(s).

To switch the display, press and release the select/reset knob repeatedly. When you turn the ignition switch to the ON (II) position, your last selection is displayed.

*On Touring models*

For information about the multi-information display, see page 85.

## Odometer

The odometer shows the total distance your vehicle has been driven. It measures miles in U.S. models and kilometers in Canadian models. It is illegal under U.S. federal law and Canadian provincial/territorial regulations to disconnect, reset, or alter the odometer with the intent to change the number of miles or kilometers indicated.

## Trip Meter

This meter shows the number of miles (U.S.) or kilometers (Canada) driven since you last reset it.

There are two trip meters: Trip A and Trip B. Switch between these displays by pressing the select/reset knob repeatedly.

Each trip meter works independently, so you can keep track of two different distances.

To reset a trip meter, display it, and then press and hold the select/reset knob until the number resets to "0.0".

# Gauges

---

## **Instant Fuel Economy**

This display shows the instant fuel economy you are getting.

It shows the number of mpg (U.S.) or l/100 km (Canada).

## **Average Fuel Economy**

When either of the trip meters (trip A or B) is displayed, your vehicle's average fuel economy since you last reset that trip meter can be shown on the information display (mpg on U.S. models and l/100 km on Canadian models). This number is updated once per 10 seconds. To see the average fuel economy, press and release the select/reset knob repeatedly.

When you reset a trip meter, the average fuel economy for that trip meter also resets.

## **Range (Estimated Distance)**

This display shows the estimated distance you can travel on the fuel remaining in the tank.

This distance is estimated from the fuel economy you have achieved over the last few miles (kilometers), so it will vary with changes in speed, traffic condition, etc.

### Outside Temperature Indicator

*Except LX models*

This indicator displays the outside temperature in Fahrenheit (U.S. models) or Celsius (Canadian models).

The temperature sensor is in the front bumper. The temperature reading can be affected by heat reflection from the road surface, engine heat, and the exhaust from surrounding traffic. This can cause an incorrect temperature reading when your vehicle speed is under 19 mph (30 km/h). When you start your trip, the sensor is not fully acclimatized, therefore it may take several minutes until the proper temperature is displayed.

In certain weather conditions, temperature readings near freezing (32°F, 0°C) could mean that ice is forming on the road surface.

If the outside temperature is incorrectly displayed, you can adjust it up to  $\pm 5^{\circ}\text{F}$  in U.S. models ( $\pm 3^{\circ}\text{C}$  in Canadian models) warmer or cooler.

**NOTE:** The temperature must be stabilized before doing this procedure.

To adjust outside temperature indicator,

1. Press and hold the select/reset knob until “Oil Life” appears (about 10 seconds).
2. Press and quickly release the select/reset knob again, and “Outside” appears.

3. Press and hold the select/reset knob until a numerical value appears (about 2 seconds).
4. Turn the select/reset knob to the desired temperature offset. The possible settings are 0, +1, +2, +3, +4, +5, -5, -4, -3, -2, -1 (U.S.) or 0, +1, +2, +3, -3, -2, -1 (Canada).
5. When the desired setting is reached, press and quickly release the select/reset knob to save the new offset.

*On Touring models*

To adjust outside temperature, see Customize Settings, page 103.

### **Maintenance Minder™**

The information display in the instrument panel shows you the engine oil life and maintenance service items when the ignition switch is in the ON (II) position. This information helps to keep you aware of the periodic maintenance your vehicle needs for continued trouble-free driving. Refer to page 559 for more information.

### **Check Fuel Cap Message**

Your vehicle's onboard diagnostic system will detect a loose or missing fuel fill cap as an evaporative system leak. The first time a leak is detected a "CHECK FUEL CAP" message appears on the information display.

Turn the engine off, and confirm the fuel fill cap is installed. If it is, loosen it, then retighten it until it clicks at least once. The message should go off after several days of normal driving once you tighten or replace the fuel fill cap. To scroll to another display, press the select/reset knob.

The "CHECK FUEL CAP" message will appear each time you restart the engine until the system turns the message off.

If the system still detects a leak in your vehicle's evaporative emissions system, the malfunction indicator lamp (MIL) comes on. If the fuel fill cap was not already tightened, turn the engine off, and check or retighten the fuel fill cap until it clicks at least once. The MIL should go off after several days of normal driving once the cap is tightened or replaced. If the MIL does not go off, have your vehicle inspected by a dealer. For more information, see page 626 .

### *On Touring models*

The multi-information display in the instrument panel displays various information and messages when the ignition switch is in the ON (II) position. Some of the messages help you operate your vehicle more comfortably. Others help to keep you aware of the periodic maintenance your vehicle needs for continued trouble-free driving.

When you open the driver's door, a "Welcome" message is shown on the multi-information display.

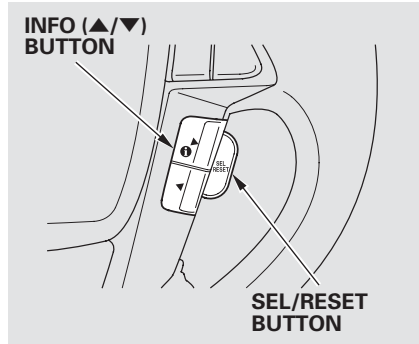

To change the display, press the INFO (▲/▼) button on the steering wheel repeatedly until the main menu appears (see page 86 ).

You can also change the display by pressing the select/reset knob in the instrument panel.

With the ignition switch in the ON (II) position, the multi-information display changes as shown on the next page each time you press the INFO (▲/▼) button or the SEL/RESET button.

When you turn the ignition switch to the ON (II) position, your last selection is displayed.

In the multi-information display, the system message is also displayed (see page 92 ) and you can customize your vehicle control settings (see page 95 ).

CONTINUED

# Multi-Information Display

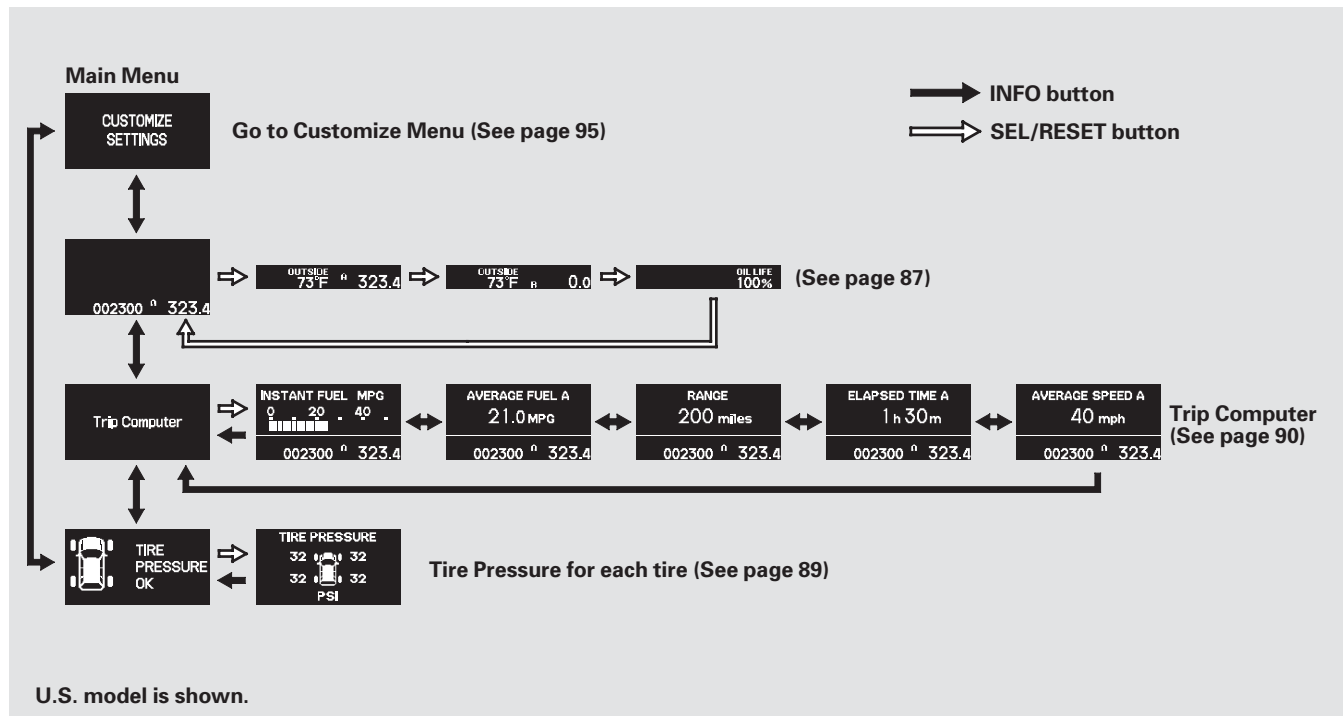

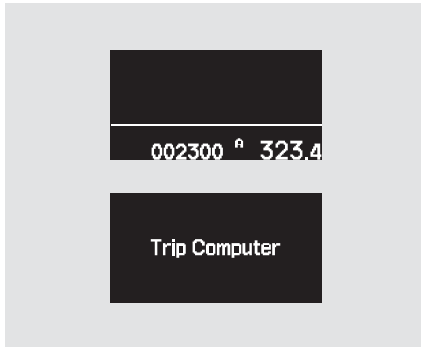

When the main menu is blank or Trip Computer is displayed, pressing the SEL/RESET button changes the display to “odometer/trip meter” “outside temperature/trip meter” and “engine oil life.”

## Odometer

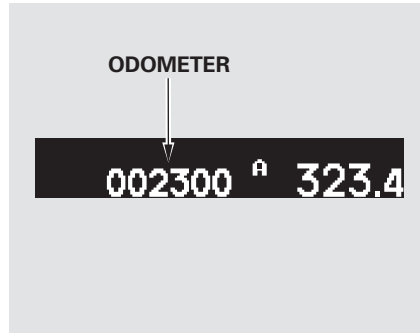

The odometer shows the total distance your vehicle has been driven. It measures miles in U.S. models and kilometers in Canadian models. It is illegal under U.S. federal law and Canadian provincial/territorial regulations to disconnect, reset, or alter the odometer with the intent to change the number of miles or kilometers indicated.

## Trip Meter

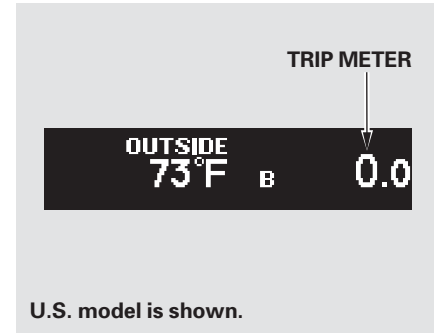

**U.S. model is shown.**

This meter shows the number of miles (U.S.) or kilometers (Canada) driven since you last reset it. There are two trip meters: Trip A and Trip B. Each trip meter works independently, so you can keep track of two different distances.

*CONTINUED*

## Multi-Information Display

---

To reset a trip meter, display it, and then press and hold the SEL/RESET button until the number resets to “0.0.”

When you reset Trip A, average fuel economy A is reset at the same time. When you reset Trip B, average fuel economy B is reset.

In the customizing mode, you can set Trip A and average fuel economy A to reset at the same time when you refuel your vehicle (see page 104).

### Outside Temperature

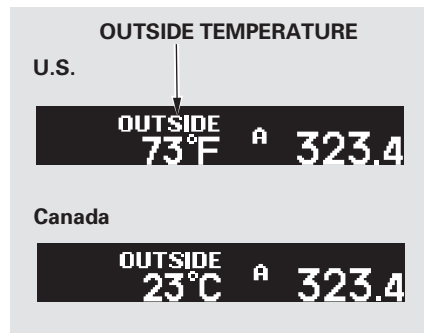

This shows the outside Fahrenheit temperature in U.S. models, and Celsius temperature in Canadian models.



The temperature sensor is in the front bumper. The temperature reading can be affected by heat reflection from the road surface, engine heat, and the exhaust from surrounding traffic. This can cause an incorrect temperature reading when your vehicle speed is under 19 mph (30 km/h). When you start your trip, the sensor is not fully acclimatized, therefore it may take several minutes until the proper temperature is displayed.

In certain weather conditions, temperature readings near freezing (32°F, 0°C) could mean that ice is forming on the road surface. You can adjust the outside temperature display (see page 103).

## Engine Oil Life

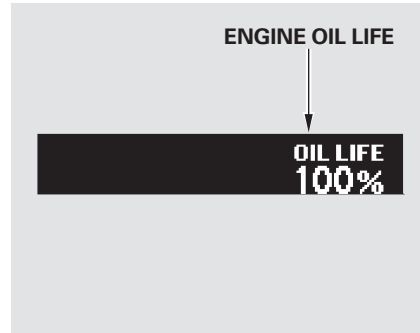

This shows the remaining life of the engine oil. It shows 100% after the engine oil is replaced and the display is reset. The engine oil life is calculated based on engine operating conditions and accumulated engine revolutions. For more information, see page 559.

## Tire Pressure Monitor

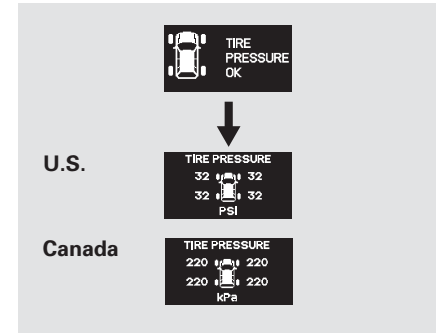

When the tire pressure monitor is shown on the multi-information display, press the SEL/RESET button. The display changes as shown.

You can see the pressure of each tire in this monitor. If one or more tires are low, inflate them to the correct pressure. For more information, see page 526.

## Multi-Information Display

---

### Trip Computer

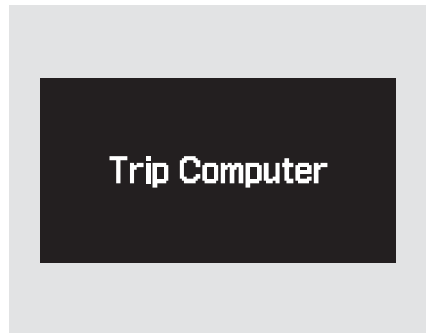

Along with the trip meter, the trip computer calculates these values:

- Instant Fuel Economy
- Average Fuel Economy
- Range
- Average Vehicle Speed
- Elapsed Time

***INSTANT FUEL MPG (U.S. models)/INSTANT FUEL L/100 km (Canadian models)***

This shows your instant fuel economy.

***AVERAGE FUEL A/B***

This shows your vehicle's average fuel economy in mpg (U.S. models) or liter/100 km (Canadian models) since you last reset Trip A or Trip B.

You can customize the Trip A and AVERAGE FUEL A reset condition on the multi-information display (see page 104).

***RANGE***

This shows the estimated distance you can travel on the fuel remaining in the fuel tank. This distance is estimated from the fuel economy you received over the last several miles (U.S.) or kilometers (Canada), so it will vary with changes in speed, traffic, etc.

### ***AVERAGE SPEED A/B***

This shows the average speed you are traveling in miles per hour (mph) for U.S. models or kilometers per hour (km/h) for Canadian models.

To reset the AVERAGE SPEED you have traveled, press and hold the SEL/RESET button until the number resets.

### ***ELAPSED TIME A/B***

This shows the accumulated traveling time since you last reset it.

If you want to reset the ELAPSED TIME manually, go to the trip computer's ELAPSED TIME display, and press and hold the SEL/RESET button until the number resets.

# Multi-Information Display

## System Messages

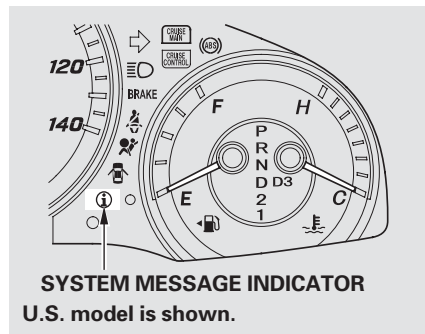







If there is a problem with your vehicle, for example the engine oil level is low or a door is not fully closed, the multi-information display will show you the problem. It does this by interrupting the current display with one or more messages.







The system message(s) triggers the appropriate indicator(s) on the instrument panel, including the system message indicator, to come on. The system message indicator does not go off until the problem(s) is corrected.







You will also hear a beep when the system message comes on for the first time.

When there are several messages to be shown, the system switches the messages every 5 seconds. The message is shown until you push the INFO (▲ or ▼) button. To see the message again, press the INFO (▲ or ▼) button, 5 seconds after the display disappears.

Here is a list of messages shown on the multi-information display:







|  |             |
|--|-------------|
|  DOOR, HATCH & TAILGATE OPEN                    | See page 13 |
|  FASTEN SEAT BELT                               | See page 22 |
|  FASTEN PASSENGER SEAT BELT                     | See page 22 |
|  CHECK AIRBAG SYSTEM                            | See page 34 |
| <p><b>U.S.</b></p>  PASSENGER SIDE AIRBAG OFF   | See page 34 |
| <p><b>Canada</b></p>  PASSENGER SIDE AIRBAG OFF |             |







|  |              |
|--|--------------|
| <p><b>U.S.</b></p>  RELEASE PARKING BRAKE   | See page 171 |
| <p><b>Canada</b></p>  RELEASE PARKING BRAKE |              |
| <p><b>U.S.</b></p>  LOW BRAKE FLUID         | See page 627 |
| <p><b>Canada</b></p>  LOW BRAKE FLUID       |              |
| <p><b>U.S.</b></p>  CHECK BRAKE SYSTEM      | See page 627 |
| <p><b>Canada</b></p>  CHECK BRAKE SYSTEM    |              |







|  |              |
|--|--------------|
|  CHECK CHARGING SYSTEM  | See page 626 |
|  CHECK EMISSION SYSTEM  | See page 626 |
|  CHECK ENGINE OIL LEVEL | See page 625 |
|  CHECK ABS SYSTEM       | See page 532 |
|  CHECK VSA SYSTEM       | See page 533 |
|  WATER TEMP HOT         | See page 623 |

CONTINUED

# Multi-Information Display

|  |                 |
|--|-----------------|
|  CHECK<br>TIRE<br>PRESSURE                              | See page<br>527 |
|  TPMS CHECK<br>TPMS<br>SYSTEM                           | See page<br>528 |
|  SYSTEM<br>FUNCTION<br>ERROR                            | See page<br>528 |
|  A/T<br>TEMP<br>HIGH                                    | See page<br>74  |
| <b>U.S.</b><br> TAIL<br>GATE CHECK<br>POWER<br>TAILGATE | See page<br>146 |
| <b>Canada</b><br> CHECK<br>POWER<br>TAILGATE            |                 |

|   |                 |
|---|-----------------|
| <b>U.S.</b><br> STARTER<br>SYSTEM CHECK<br>STARTER<br>SYSTEM | See page<br>514 |
| <b>Canada</b><br> CHECK<br>STARTER<br>SYSTEM                 |                 |
|  CHECK<br>TRANS-<br>MISSION                                  | See page<br>515 |
|  CHECK<br>PARKING<br>SENSOR<br>SYSTEM                        | See page<br>488 |
|  LOW<br>WASHER<br>FLUID                                      | See page<br>581 |
|  LOW FUEL  | See page<br>78  |

|   |                 |
|---|-----------------|
|  WARNING:<br>APPROACHING<br>OBJECT | See page<br>485 |
|  DRL CHECK<br>DRL<br>SYSTEM        | See page<br>127 |
|  DRL DRL OFF                       |                 |
|  SERVICE<br>DUE SOON<br>A123456    | See page<br>564 |
|  TIGHTEN<br>FUEL CAP               | See page<br>498 |
|  REMOVE KEY                        | See page<br>136 |

## Customize Settings



When the main menu displays “CUSTOMIZE SETTINGS” you can customize some vehicle control settings.

To enter the customizing mode, press the SEL/RESET button.

To change the settings, the ignition switch must be in the ON (II) position, and the vehicle must be stopped with the transmission in Park.

If you turn the ignition switch to the ACCESSORY (I) or the LOCK (0) position, or move the shift lever out of Park, the display will change to the normal screen.

### *On Touring models*

You can customize some vehicle control settings for “DRIVER 1” and “DRIVER 2” separately. If “DRIVER 1” or “DRIVER 2” is not displayed, customizing is not possible.

To have the driver’s ID detected, make sure your remote transmitter is linked to the system (see Recalling a Memorized Driving Position on page 153 ).

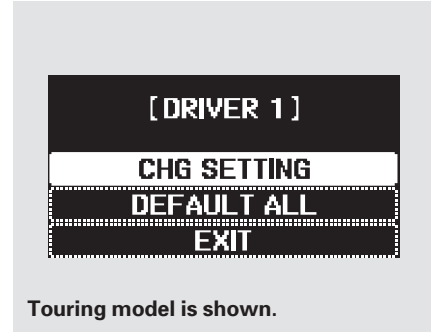

**Touring model is shown.**

If you want the settings as they were when the vehicle left the factory, select DEFAULT ALL, as described on page 98 .

If you want to change any vehicle control settings, select CHG SETTING, then press the SEL/RESET button.

Refer to the table on the following pages about the settings you want to customize. *CONTINUED*

# Multi-Information Display

| Group Setup                             | Menu Item                       | Description   | Setting Option                              |  | Page |
|---|---------------------------------|---|---|--|------|
| METER SETUP<br>(P.101)                  | LANGUAGE SELECTION              | Changes the language used in the display.   | ENGLISH* <sup>1</sup>                       |  | 102  |
|   |                                 |   | FRENCH                                      |  |      |
|   |                                 |   | SPANISH                                     |  |      |
|   | ADJUST OUTSIDE<br>TEMP. DISPLAY | Changes the outside temperature reading above or below its current reading.                               | -5°F ~ ±0°F* <sup>1</sup> ~ 5°F<br>(U.S.)   |  | 103  |
|   |                                 |   | -3°C ~ ±0°C* <sup>1</sup> ~ 3°C<br>(Canada) |  |      |
|   | TRIP A INFO RESET               | Changes the setting of how to reset trip meter A, average fuel A, elapsed time A, and average speed A.    | with REFUEL                                 |  | 104  |
| MANUAL ONLY* <sup>1</sup>               |                                 |   |   |  |      |
| IGN OFF                                 |                                 |   |   |  |      |
| POSITION SETUP* <sup>2</sup><br>(P.106) | MEMORY POSITION LINK            | Changes the driver's seat and the outside mirror positions to a stored setting.                           | ON* <sup>1</sup>                            |  | 107  |
|   |                                 |   | OFF   |  |      |
| LIGHTING SETUP<br>(P.108)               | INTERIOR LIGHT<br>DIMMING TIME  | Changes how long (in seconds) the interior lights stay on after you close the doors and the tailgate.     | 60 SEC      15 SEC                          |  | 109  |
|   |                                 |   | 30 SEC* <sup>1</sup>                        |  |      |
|   | HEADLIGHT<br>AUTO OFF TIMER     | Changes how long (in seconds) the exterior lights stay on after you close the driver's door.              | 60 SEC                                      |  | 110  |
|   |                                 |   | 30 SEC      0 SEC                           |  |      |
|   |                                 |   | 15 SEC* <sup>1</sup>                        |  |      |
|   | AUTO LIGHT<br>SENSITIVITY       | Changes the timing of when the headlights come on. The headlight switch needs to be in the AUTO position. | MAX      LOW                                |  | 111  |
| HIGH      MIN                           |                                 |   |   |  |      |
| MID* <sup>1</sup>                       |                                 |   |   |  |      |

\*1: Default setting

\*2: On Touring models



| Group Setup                     | Menu Item  | Description   | Setting Option  | Page                        |     |
|---------------------------------|--|---|-----------------|-----------------------------|-----|
| DOOR/WINDOW<br>SETUP<br>(P.113) | AUTO DOOR LOCK   | Changes the setting of when to automatically lock the doors.  | SHIFT FROM P    | 114                         |     |
|                                 |  |   | WITH VEH SPEED* |                             |     |
|                                 |  |   | OFF             |                             |     |
|                                 | AUTO DOOR UNLOCK   | Changes the setting of when to automatically unlock the driver's/all the doors.   | SHIFT TO P*     | DRIVER DOOR* /<br>ALL DOORS | 115 |
|                                 |  |   | IGN OFF         |                             |     |
|                                 |  |   | OFF             |                             |     |
|                                 | KEY AND REMOTE<br>UNLOCK MODE  | Changes which doors unlock with the remote transmitter on a first push.   | DRIVER DOOR*    | 117                         |     |
|                                 |  |   | ALL DOORS       |                             |     |
|                                 | KEYLESS LOCK<br>ACKNOWLEDGMENT   | The exterior lights flash each time you press the LOCK or UNLOCK button. A beeper will also sound when you press the LOCK button twice. | ON*             | 118                         |     |
|                                 |  |   | OFF             |                             |     |
| SECURITY RELOCK<br>TIMER        | Changes how long it takes (in seconds) for the doors to relock and the security system to set after you unlock but do not open the door. | 90 SEC  | 119             |                             |     |
|                                 |  | 60 SEC  |                 |                             |     |
|                                 |  | 30 SEC*   |                 |                             |     |
| PTG KEYLESS OPEN<br>MODE        | Changes the power tailgate opening setting.  | ANY TIME*   | 120             |                             |     |
|                                 |  | WHEN UNLOCKED   |                 |                             |     |
| DEFAULT ALL<br>(P.98)           |  | Set/Cancel all the customized settings as default.  | SET             | 98                          |     |
|                                 |  |   | CANCEL*         |                             |     |

\* : Default setting

# Multi-Information Display

## DEFAULT ALL

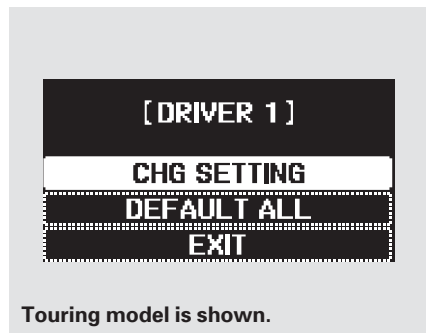

If you want to set the default settings, press the INFO (▲/▼) button to select DEFAULT ALL, then press the SEL/RESET button.

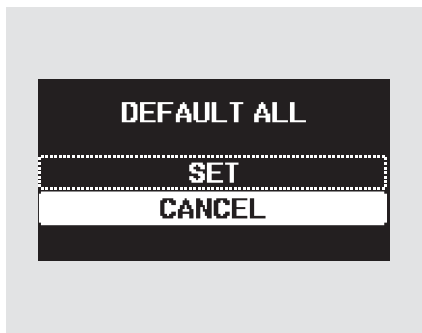

To set the default settings, press the INFO (▲/▼) button to select SET then press the SEL/RESET button.

If you want to cancel DEFAULT ALL, select CANCEL, then press the SEL/RESET button. The screen goes back to the previous display.

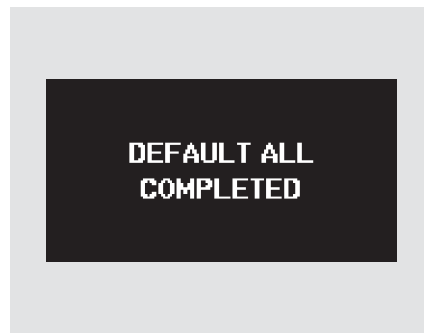

When DEFAULT ALL is set, you will see the above display for several seconds, then the screen returns to CUSTOMIZE ENTRY.

If the setting is not successfully completed, "FAILED" is shown for several seconds, and then the screen goes back to the normal message mode. Repeat the same procedure to select DEFAULT ALL.

## Customize Settings

You can customize some of the vehicle control settings to your preference. Here are the settings you can customize:

- METER SETUP
- POSITION SETUP
- LIGHTING SETUP
- DOOR/WINDOW SETUP

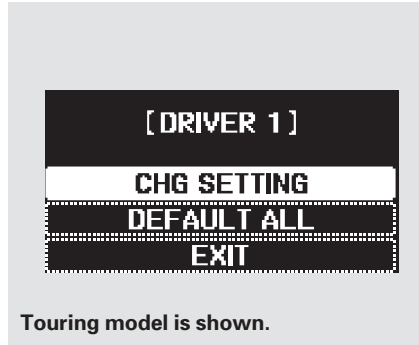

Touring model is shown.

When you want to change the vehicle control settings, press the INFO (▲/▼) button to select CHG SETTING, then press the SEL/RESET button.

Each time you press the INFO (▲/▼) button, the screen changes as shown on the next page. Press the INFO (▲/▼) button until you see the setup you want to customize, then press the SEL/RESET button to enter your selection.

CONTINUED

# Multi-Information Display

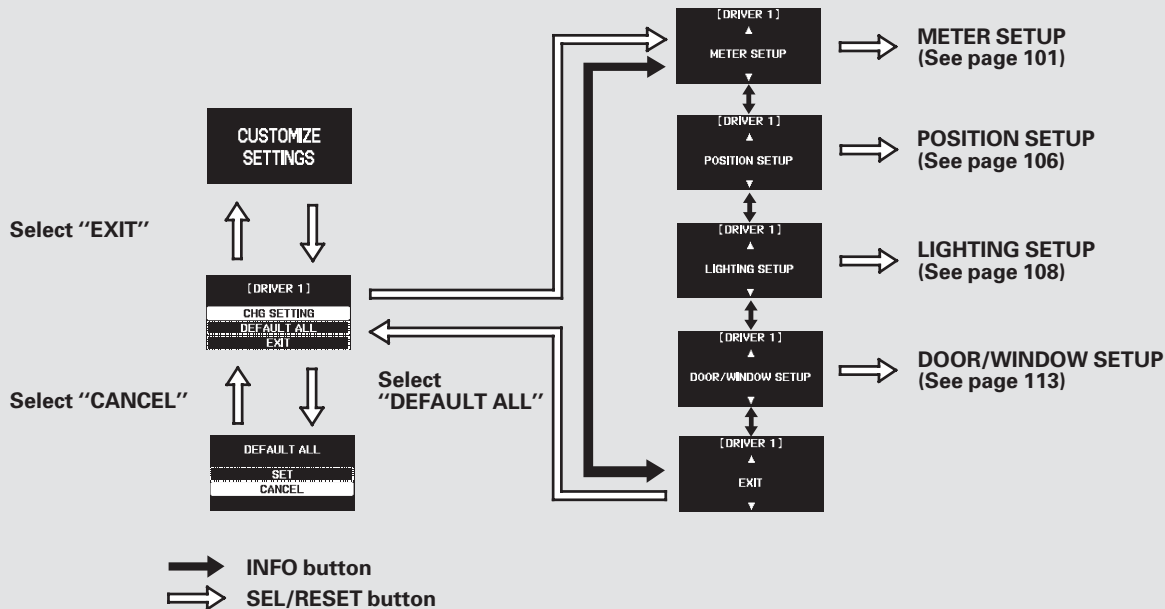

Touring model is shown.

## Meter Setup

Here are the three custom settings for the meter setup:

- LANGUAGE SELECTION
- ADJUST OUTSIDE TEMP. DISPLAY
- TRIP A INFO RESET

While “METER SETUP” is shown, press the SEL/RESET button to enter the customize mode.

Each time you press the INFO (▲/▼) button, the screen changes as shown in the illustration. Press the INFO (▲/▼) button until you see the setting you want to customize, then press the SEL/RESET button to enter your selection.

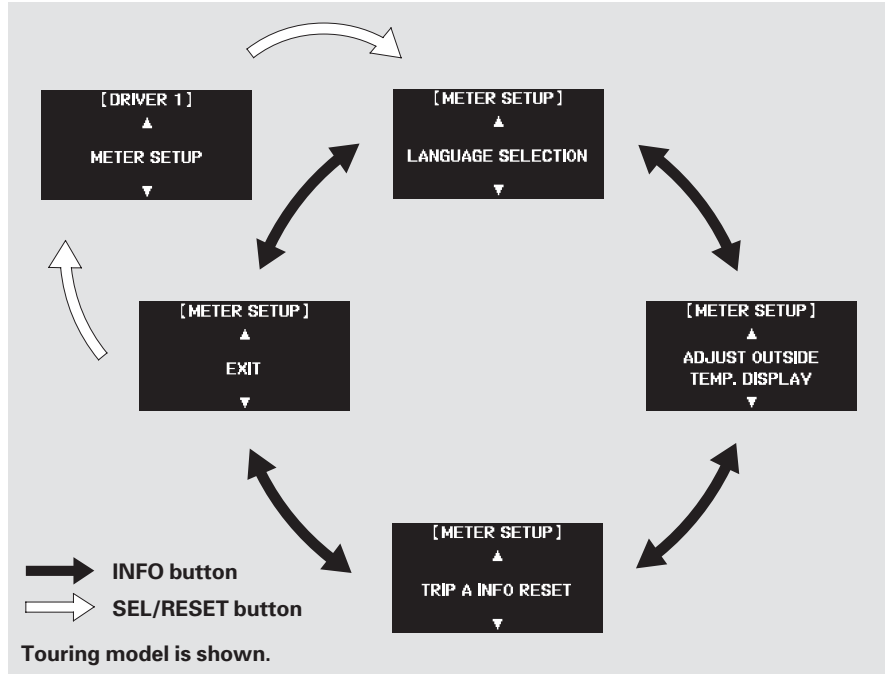

CONTINUED

## Multi-Information Display

### Language Selection

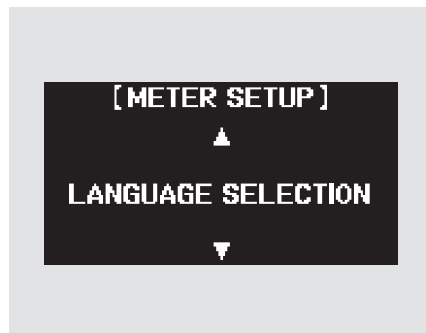

There are three language selections you can make: English, French, and Spanish. To choose the language you want, follow these instructions:

You can choose this item to customize from "METER SETUP" by pressing the INFO (▲/▼) button repeatedly.

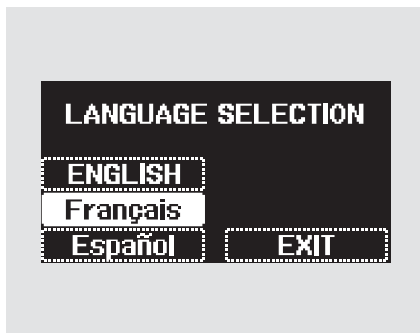

Press the SEL/RESET button to see the selections.

Select the desired language by pressing the INFO (▲/▼) button, then enter your selection by pressing the SEL/RESET button.



When your selection is successfully completed, the display changes as shown above, and then goes back to the customize item screen.

If the "SETTING INCOMPLETE" message appears, go back to "LANGUAGE SELECTION" and repeat the procedure again.

## Adjust Outside Temp. Display

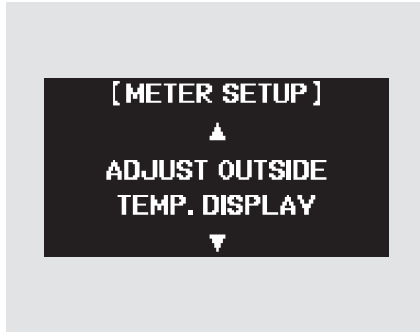

If you sometimes find that the temperature reading is a few degrees above or below the actual temperature, you can adjust it by following these instructions:

You can choose this item to customize from “METER SETUP” by pressing the INFO (▲/▼) button repeatedly.

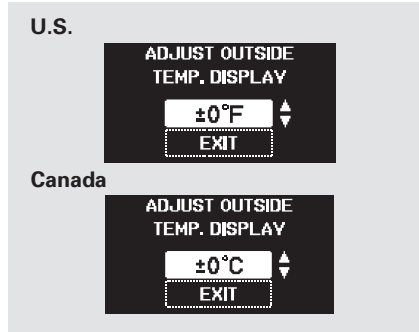

Adjust the outside temperature value by pressing the INFO (▲/▼) button repeatedly. Press the SEL/RESET button to set the desired value.

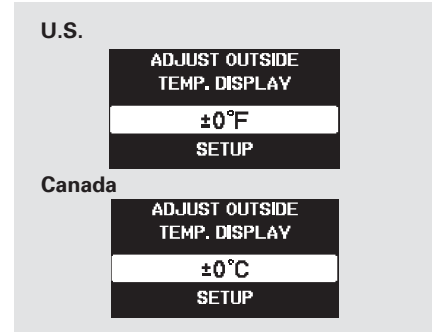

When your selection is successfully completed, the display changes as shown above, and then goes back to the customize item screen.

If the “SETTING INCOMPLETE” message appears, go back to “ADJUST OUTSIDE TEMP. DISPLAY” and repeat the procedure again.

CONTINUED

## Multi-Information Display

### *Trip A Info Reset*

There are three settings you can choose from:

with REFUEL – Trip A Info is reset every time you refuel your vehicle.

MANUAL ONLY – You can reset Trip A Info when you press and hold the SEL/RESET button until the number resets.

IGN OFF – Trip A Info is reset when you turn the ignition switch to the LOCK (0) position.

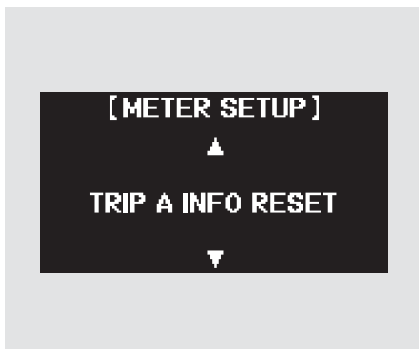

You can choose this item to customize from “METER SETUP” by pressing the INFO (▲/▼) button repeatedly.

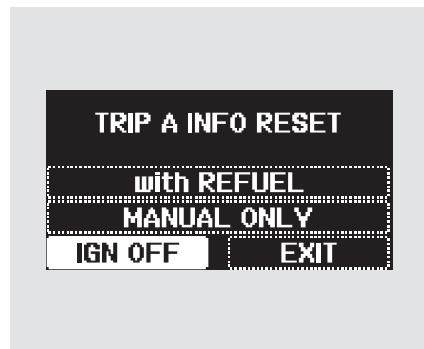

Press the SEL/RESET button to see the selections.

Select ON or OFF by pressing the INFO (▲/▼) button, then enter your selection by pressing the SEL/RESET button.



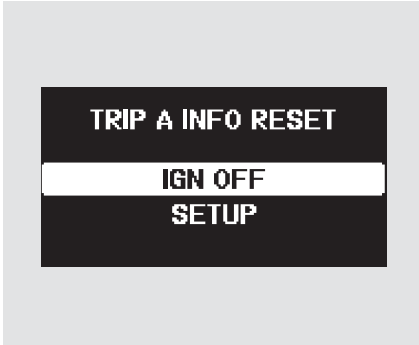

When your selection is successfully completed, the display changes as shown above, and then goes back to the customize item screen.

If the “SETTING INCOMPLETE” message appears, go back to “TRIP A INFO RESET” and repeat the procedure again.

# Multi-Information Display

## Position Setup

You can customize the MEMORY POSITION LINK setting in position setup.

While “POSITION SETUP” is shown, press the SEL/RESET button to enter the customize mode.

Each time you press the INFO (▲/▼) button, the screen changes as shown in the illustration. Press the INFO (▲/▼) button until you see the setting you want to customize, then press the SEL/RESET button to enter your selection.

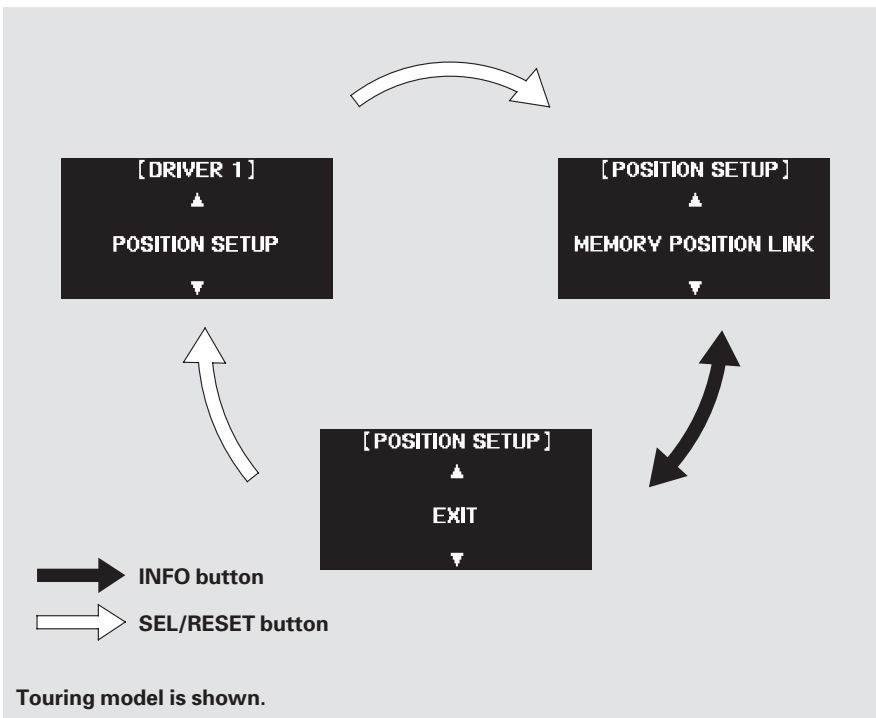

## Memory Position Link

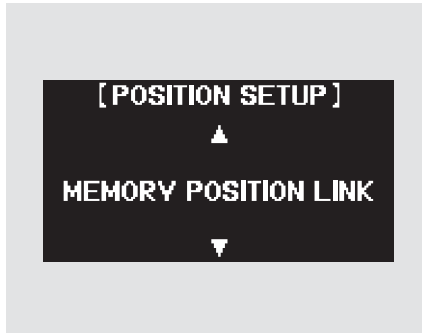

If “MEMORY POSITION LINK” is “ON,” the driver’s seat and outside mirrors move to the positions stored in the memory when you open the driver’s door, using the remote transmitter.

You can choose this item to customize from “POSITION SETUP” by pressing the INFO (▲/▼) button repeatedly.

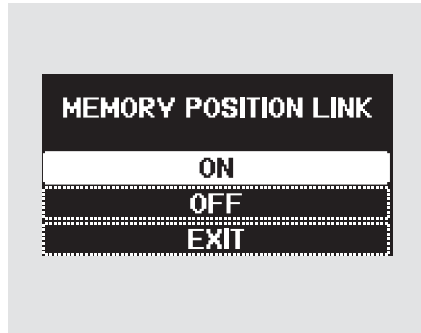

Press the SEL/RESET button to see the selections.

Select ON or OFF by pressing the INFO (▲/▼) button, then enter your selection by pressing the SEL/RESET button.

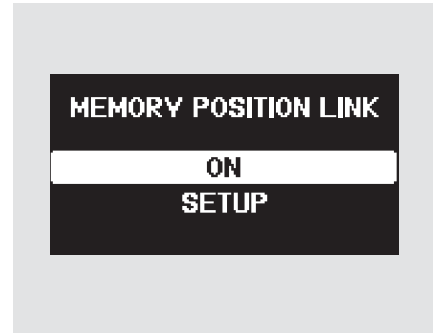

When your selection is successfully completed, the display changes as shown above, and then goes back to the customize item screen.

If the “SETTING INCOMPLETE” message appears, go back to “MEMORY POSITION LINK” and repeat the procedure again.

# Multi-Information Display

## Lighting Setup

Here are the three custom settings for the lighting setup:

- INTERIOR LIGHT DIMMING TIME
- HEADLIGHT AUTO OFF TIMER
- AUTO LIGHT SENSITIVITY

While “LIGHTING SETUP” is shown, press the SEL/RESET button to enter the customize mode.

Each time you press the INFO (▲/▼) button, the screen changes as shown in the illustration. Press the INFO (▲/▼) button until you see the setting you want to customize, then press the SEL/RESET button to enter your selection.

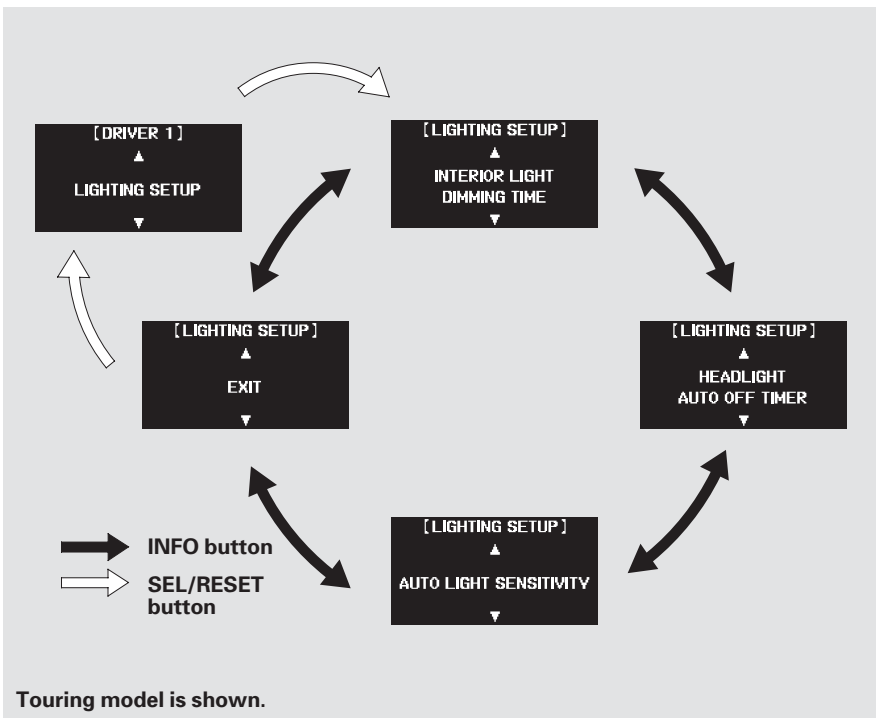

## Interior Light Dimming Time

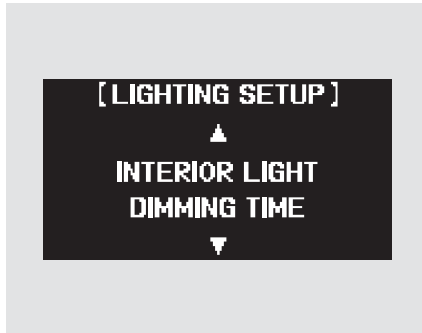

The interior lights fade out when you close all doors and tailgate. To change how long the lights stay on before they fade out, follow these instructions:

You can choose this item to customize from "LIGHTING SETUP" by pressing the INFO (▲/▼) button repeatedly.

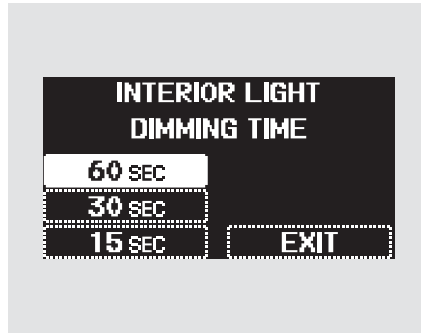

Press the SEL/RESET button to see the selections.

Select the desired setting by pressing the INFO (▲/▼) button, then enter your selection by pressing the SEL/RESET button.

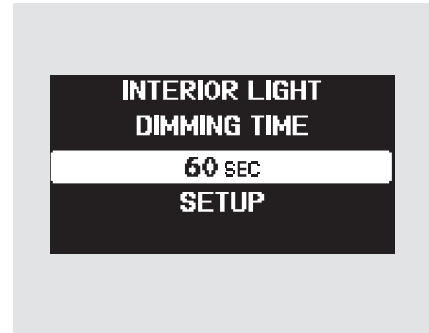

When your selection is successfully completed, the display changes as shown above, and then goes back to the customize item screen.

If the "SETTING INCOMPLETE" message appears, go back to "INTERIOR LIGHT DIMMING TIME" and repeat the procedure again.

*CONTINUED*

## Multi-Information Display

### *Headlight Auto Off Timer*

The headlights, parking lights, side marker lights, taillights, and license plate lights go off after the selected time when you remove the key from the ignition switch and close the driver's door. To change how long the lights stay on before they go off, follow these instructions:



You can choose this item to customize from "LIGHTING SETUP" by pressing the INFO (▲/▼) button repeatedly.

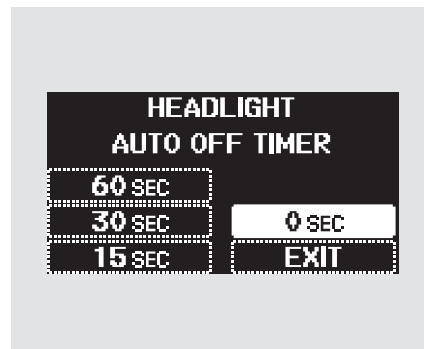

Press the SEL/RESET button to see the selections.

Select the desired setting by pressing the INFO (▲/▼) button, then enter your selection by pressing the SEL/RESET button.

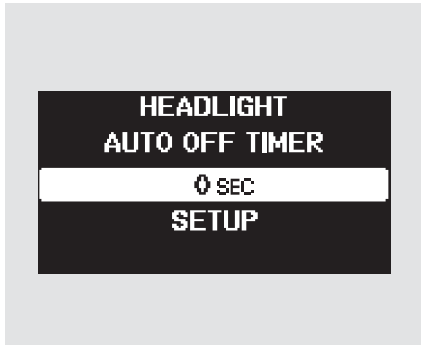

When your selection is successfully completed, the display changes as shown above, and then goes back to the customize item screen.

If the "SETTING INCOMPLETE" message appears, go back to "HEADLIGHT AUTO OFF TIMER" and repeat the procedure again.

### *Auto Light Sensitivity*

The headlights automatically come on when the headlight switch is in the AUTO position and the ambient light reaches a changeable level. You can select the auto light sensitivity from the following five levels:

MAX —

The headlights come on when it is bright.

HIGH —

The headlights come on when it is somewhat bright.

MID —

The headlights come on when it is as bright as sunset or sunrise.

LOW —

The headlights come on when it is somewhat dark.

MIN —

The headlights come on when it is dark.

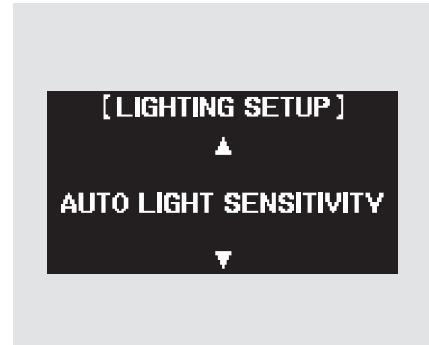

You can choose this item to customize from "LIGHTING SETUP" by pressing the INFO (▲/▼) button repeatedly.

CONTINUED

## Multi-Information Display

---

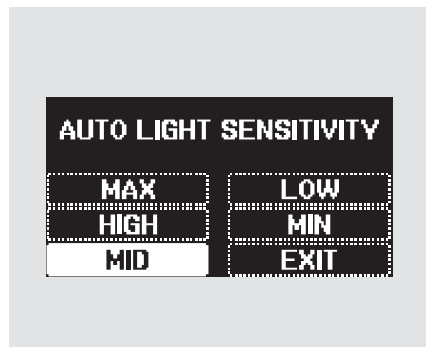

Press the SEL/RESET button to see the selections.

Select the desired setting by pressing the INFO (▲/▼) button, then enter your selection by pressing the SEL/RESET button.

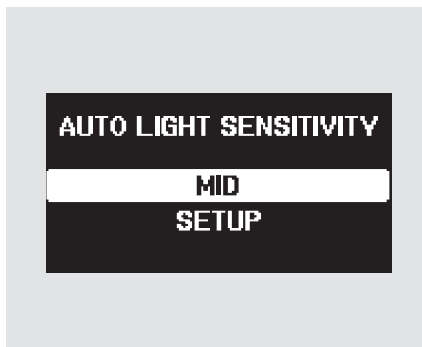

When your selection is successfully completed, the display changes as shown above, and then goes back to the customize item screen.

If the "SETTING INCOMPLETE" message appears, go back to "AUTO LIGHT SENSITIVITY" and repeat the procedure again.



## Door/Window Setup

Here are the six custom settings for the door/window setup:

- AUTO DOOR LOCK
- AUTO DOOR UNLOCK
- KEY AND REMOTE UNLOCK MODE
- KEYLESS LOCK ACKNOWLEDGMENT
- SECURITY RELOCK TIMER
- PTG (POWER TAILGATE) KEYLESS OPEN MODE

While “DOOR/WINDOW SETUP” is shown, press the SEL/RESET button to enter the customize mode.

Each time you press the INFO (▲/▼) button, the screen changes as shown in the illustration. Press the INFO (▲/▼) button until you see the setting you want to customize, then press the SEL/RESET button to enter your selection.

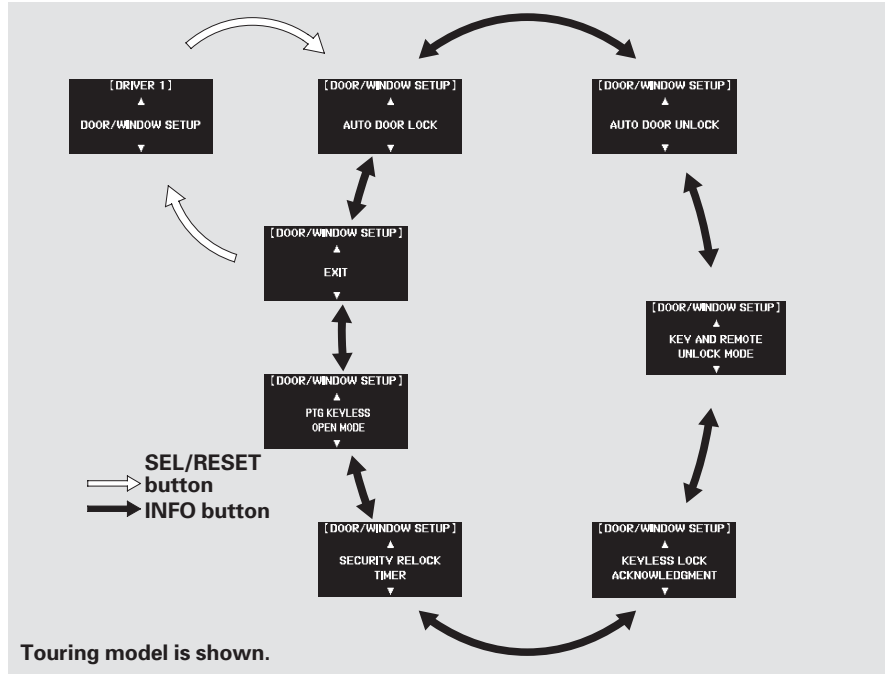

CONTINUED

## Multi-Information Display

### *Auto Door Lock*

There are three settings you can choose from:

#### SHIFT FROM P —

The doors lock whenever you move the shift lever out of Park.

#### WITH VEH SPEED —

The doors lock when the vehicle speed reaches about 10 mph (U.S.) and 15 km/h (Canada).

#### OFF —

The auto door lock mode is deactivated all the time.

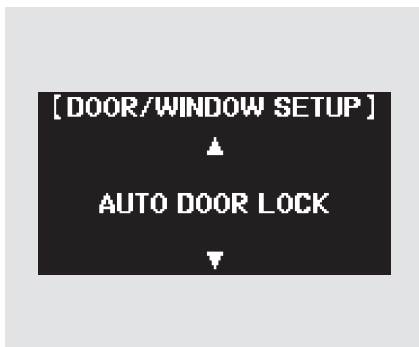

You can choose this item to customize from “DOOR/WINDOW SETUP” by pressing the INFO (▲/▼) button repeatedly.

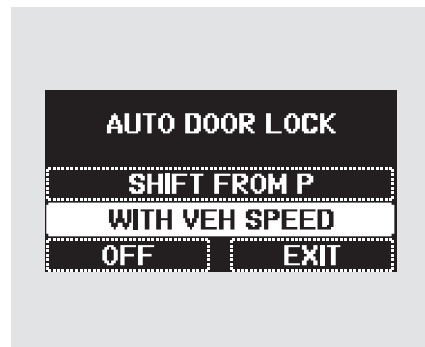

Press the SEL/RESET button to see the selections.

Select the desired setting by pressing the INFO (▲/▼) button, then enter your selection by pressing the SEL/RESET button.



When your selection is successfully completed, the display changes as shown above, and then goes back to the customize item screen.

If the “SETTING INCOMPLETE” message appears, go back to “AUTO DOOR LOCK” and repeat the procedure again.

### *Auto Door Unlock*

There are three settings you can choose from:

**SHIFT TO P** – The driver’s door or all the doors, depending on your selection in the next step, unlock when you move the shift lever to Park with the brake pedal depressed.

**IGN OFF** – The driver’s door or all the doors, depending on your selection in the next step, unlock when you turn the ignition switch to the LOCK (0) position.

**OFF** – The auto door unlock mode is deactivated all the time.



You can choose this item to customize from “DOOR/WINDOW SETUP” by pressing the INFO (▲/▼) button repeatedly.

CONTINUED

## Multi-Information Display

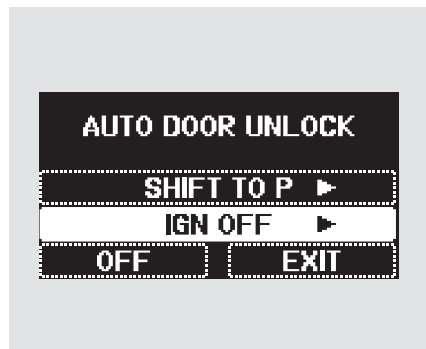

Press the SEL/RESET button to see the selections.

Select the desired setting by pressing the INFO (▲/▼) button, then enter your selection by pressing the SEL/RESET button.



If you choose "SHIFT TO P" or "IGN OFF", you will see the above display.

Press the INFO (▲/▼) button to switch the door lock mode setting between the driver's door and all doors. Then, press the SEL/RESET button to enter your selection.



When your selection is successfully completed, the display changes as shown above, and then goes back to the customize item screen.

If the "SETTING INCOMPLETE" message appears, go back to "AUTO DOOR UNLOCK" and repeat the procedure again.

## Key and Remote Unlock Mode

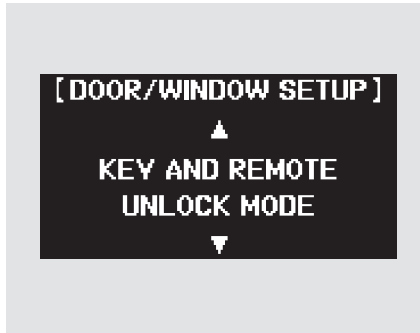

To select whether the driver's or all doors unlock when the remote transmitter or key is used, follow these instructions.

You can choose this item to customize from "DOOR/WINDOW SETUP" by pressing the INFO (▲/▼) button repeatedly.

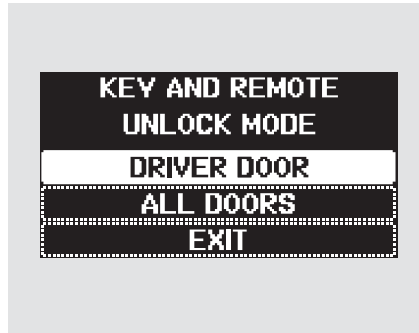

Press the SEL/RESET button to see the selections.

Select the desired setting by pressing the INFO (▲/▼) button, then enter your selection by pressing the SEL/RESET button.



When your selection is successfully completed, the display changes as shown above, and then goes back to the customize item screen.

If the "SETTING INCOMPLETE" message appears, go back to "KEY AND REMOTE UNLOCK MODE" and repeat the procedure again.

CONTINUED

## Multi-Information Display

### *Keyless Lock Acknowledgment*

When you push the LOCK button on the remote transmitter, some exterior lights flash, and a beeper sounds when you push the LOCK button again within 5 seconds to verify that the doors and the tailgate are locked and the security system has set (see page 429). You can customize the exterior lights not to flash and the beeper not to sound.

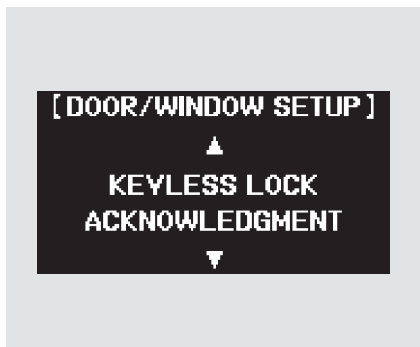

You can choose this item to customize from “DOOR/WINDOW SETUP” by pressing the INFO (▲/▼) button repeatedly.

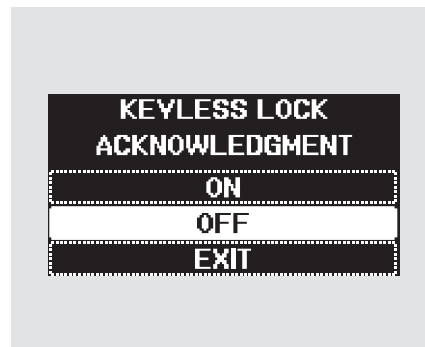

Press the SEL/RESET button to see the selections.

Select ON or OFF by pressing the INFO (▲/▼) button, then enter your selection by pressing the SEL/RESET button.



When your selection is successfully completed, the display changes as shown above, and then goes back to the customize item screen.

If the "SETTING INCOMPLETE" message appears, go back to "KEYLESS LOCK ACKNOWLEDGMENT" and repeat the procedure again.

### *Security Relock Timer*

If you unlock the doors and the tailgate with the remote transmitter, but do not open any of the doors or the tailgate within 30 seconds, the doors and the tailgate automatically relock and the security system sets.

You can change this relock time from 30 seconds to 60 or 90 seconds.



You can choose this item to customize from "DOOR/WINDOW SETUP" by pressing the INFO (▲/▼) button repeatedly.

*CONTINUED*

## Multi-Information Display

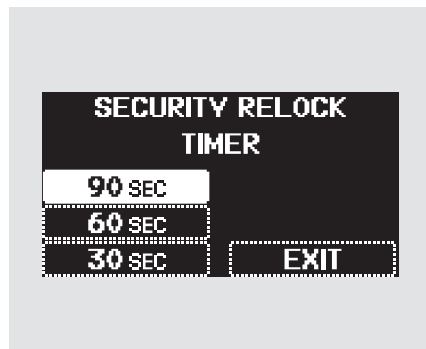

Press the SEL/RESET button to see the selections.

Select the desired setting by pressing the INFO (▲/▼) button, then enter your selection by pressing the SEL/RESET button.

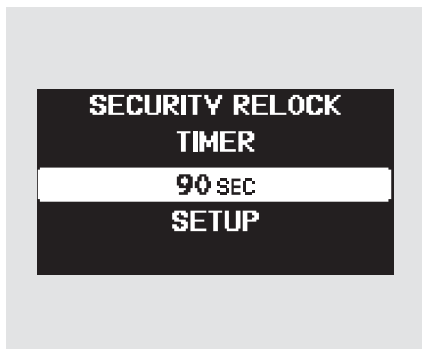

When your selection is successfully completed, the display changes as shown above, and then goes back to the customize item screen.

If the "SETTING INCOMPLETE" message appears, go back to "SECURITY RELOCK TIMER" and repeat the procedure again.

### *PTG (Power Tailgate) Keyless Open Mode*

You can customize the power tailgate setting not to open without unlocking the tailgate lock first by remote transmitter from the outside. There are two settings you can choose from:

**ANYTIME** – The tailgate unlocks and opens when you press and hold the tailgate button on the remote transmitter for 1 second. The tailgate will automatically relock when you close it when the doors are locked.

**WHEN UNLOCKED** – In this mode, you must unlock the tailgate before opening it. In addition, the tailgate will not automatically relock when you close it.

#### *On EX-L models*

See page 146 for how to customize the power tailgate keyless open mode.



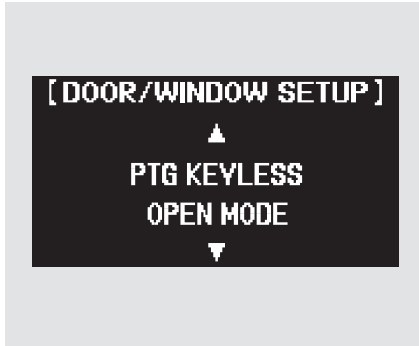

You can choose this item to customize from “DOOR/WINDOW SETUP” by pressing the INFO (▲/▼) button repeatedly.



Press the SEL/RESET button to see the selections.

Select the desired setting by pressing the INFO (▲/▼) button, then enter your selection by pressing the SEL/RESET button.

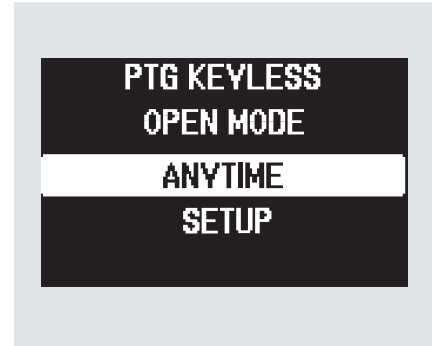

When your selection is successfully completed, the display changes as shown above, and then goes back to the customize item screen.

If the “SETTING INCOMPLETE” message appears, go back to “PTG KEYLESS OPEN MODE” and repeat the procedure again.

# Controls Near the Steering Wheel

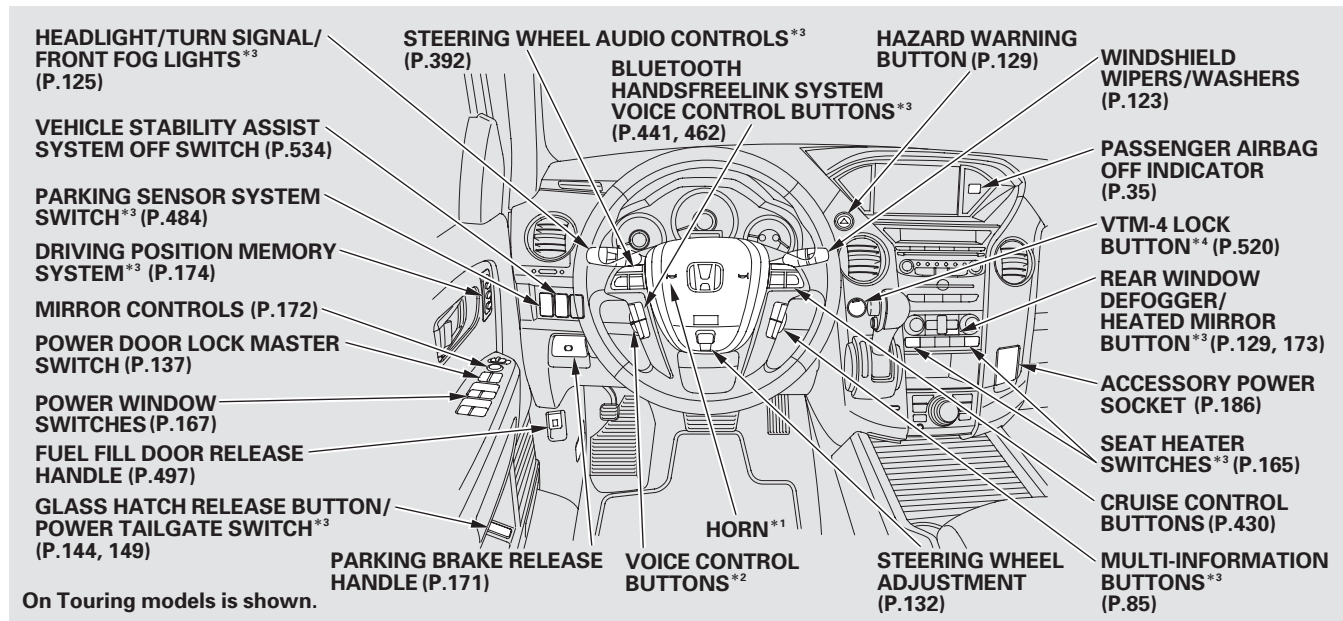

\* 1 : To use the horn, press the center pad of the steering wheel.

\* 2 : Only on vehicles equipped with navigation system. Refer to the navigation system manual.

\* 3 : If equipped

\* 4 : 4WD models only

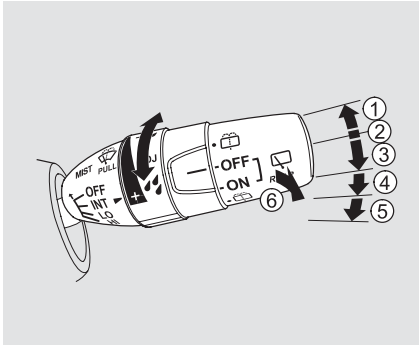

1. MIST
2. OFF
3. INT – Intermittent
4. LO – Low speed
5. HI – High speed
6. Windshield washers

Push the right lever up or down to select a position.

**MIST** – The wipers run at high speed until you release the lever.

**OFF** – The wipers are not activated.

**INT** – The length of the wipe interval is varied automatically according to vehicle speed.

If you turn it to the shortest delay, the wipers change to low speed operation when the vehicle speed exceeds 12 mph (20 km/h).

**LO** – The wipers run at low speed.

**HI** – The wipers run at high speed.

**Windshield Washer** – Pull the wiper control lever toward you, and hold it. The washers spray until you release the lever. The wipers run at low speed, then complete one more sweep after you release the lever.

# Windshield Wipers and Washers

## Rear Window Wiper and Washer

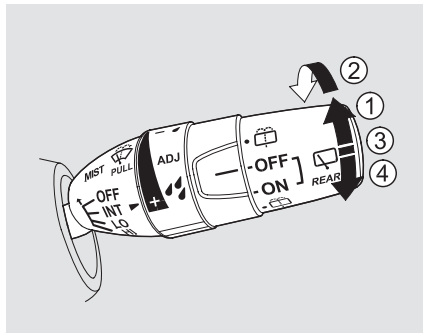

1. To turn on the rear window wiper, rotate the switch clockwise to ON. It operates intermittently.
2. Hold past ON to turn the rear window wiper on and to spray the rear window washer.

3. When you turn the wiper switch to the "OFF" position, the wiper will return to its parked position.

4. Rotate the switch counterclockwise to spray the window washer.

The rear wiper will not work if the glass hatch is not fully closed.

If you attempt to open the glass hatch while the rear wiper is operating, the wiper will return to the parked position, and then the glass hatch can be opened. After the glass hatch is closed, the rear wiper starts to operate again after a few seconds delay.

When you shift the transmission to the reverse position with the front windshield wipers activated, the rear window wiper operates automatically.

The rear window washer uses the same fluid reservoir as the windshield washer.

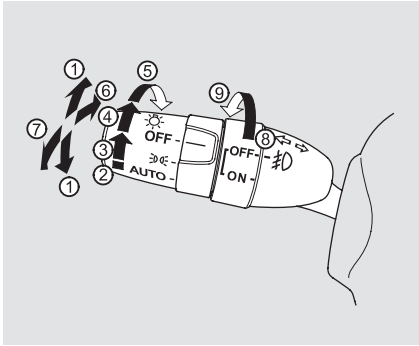

1. Turn signal
2. Off
3. Parking and indicator lights
4. AUTO
5. Headlights on
6. High beams
7. Flash high beams
8. Fog lights off\*
9. Fog lights on\*

\*: If equipped

**Turn Signal** — Push down on the left lever to signal a left turn and up to signal a right turn. To signal a lane change, push lightly on the lever and hold it. The lever will return to the center when you release it or complete a turn.

**Headlights On** — Turning the switch to the “ ” position turns on the parking lights, taillights, instrument panel lights, side-marker lights, and rear license plate lights.

Turning the switch to the “ ” position turns on the headlights. If you leave the lights on with the key removed from the ignition switch, you will hear a reminder chime when you open the driver’s door.

When the light switch is in either of these positions, the lights on indicator comes on as a reminder.

This indicator stays on if you leave the lights on and turn the ignition switch to the ACCESSORY (I) or LOCK (0) position.

**High Beams** — To switch from low beams to high beams, push the left lever forward until you hear a click. The blue high beam indicator will come on (see page 76). Pull it back to return to low beams. To flash the high beams, pull the lever back lightly, then release it. The high beams stay on as long as you hold the lever back.

# Headlights

*Except LX models*

**AUTO** – The automatic lighting feature turns on the headlights and all other exterior lights, when it senses low ambient light.

To turn on automatic lighting, turn the light switch to AUTO. The lights will come on automatically when the outside light level becomes low (at dusk, for example). The lights on indicator comes on as a reminder. The lights and indicator will turn off automatically when the system senses high ambient light.

The lights will remain on when you turn off the ignition switch. They will turn off automatically when you remove the key and open the driver's door. To turn them on again, either turn the ignition switch to the ON (II) position or turn the light switch to the  position.

Even with the automatic lighting feature turned on, we recommend that you turn on the lights manually when driving at night or in a dense fog, or when you enter dark areas such as long tunnels or parking facilities.

*On Touring models*

To change the “AUTO LIGHT SENSITIVITY” setting, see page 111.

Do not leave the light switch in AUTO if you will not be driving the vehicle for an extended period (a week or more). You should also turn off the lights if you plan to leave the engine idling or off for a long time.

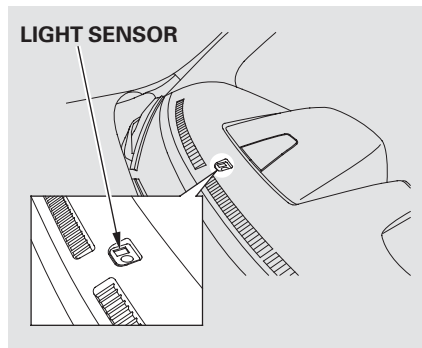

The automatic lighting feature is controlled by a sensor located on top of the dashboard. Do not cover this sensor or spill liquids on it.

## Fog Lights

*Except LX models*

Turn the fog lights on and off by turning the switch next to the headlight switch.

You can use the fog lights only when the headlights are on low beam.

With the light switch in the AUTO position, you can also use the fog lights when the headlights turn on automatically. They will go off when the headlights turn off.

## Daytime Running Lights

With the headlight switch off, the daytime running lights come on when you turn the ignition switch to the ON (II) position and release the parking brake. They remain on until you turn the ignition switch off, even if you set the parking brake.

When the headlights are on, the daytime running lights are off.

*On Touring models*

If you see a “CHECK DRL SYSTEM” message on the multi-information display, there is a problem with the daytime running light system. Take your vehicle to a dealer to have it checked.

When the multi-information display shows a “DRL OFF” message, the daytime running lights are off. Follow the procedure in the left column to turn them on.

# Headlights



---

## **Automatic Lighting Off Feature**

This feature turns off the headlights, all other exterior lights, and the instrument panel lights within 15 seconds after you remove the key and close the driver's door.

### *On Touring models*

To change the "HEADLIGHT AUTO OFF TIMER" setting, see page 110.

The automatic lighting off feature activates if you leave the headlight switch in the "  " or "  " position or if the lights are turned on by setting the switch in the "AUTO" position, and you remove the key, then open and close the driver's door.

If you turn the ignition switch to the LOCK (0) position with the headlight switch on, but do not open the door, the lights turn off after 10 minutes (3 minutes, if the switch is in the "AUTO" position).

The lights turn on again when you unlock or open the driver's door. If you unlock the door, but do not open it within 15 seconds, the lights go off. With the driver's door open, you will hear a lights-on reminder chime.



## Hazard Warning Button

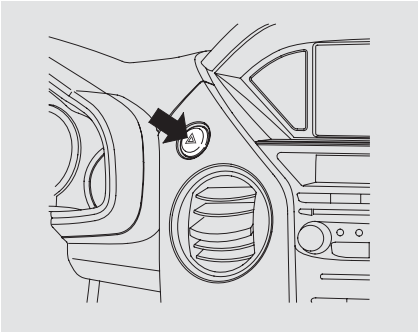

Push the button to turn on the hazard warning lights (four-way flashers). This causes all four outside turn signals and both turn indicators in the instrument panel to flash. Use the hazard warning lights if you need to park in a dangerous area near heavy traffic, or if your vehicle is disabled.

## Rear Window Defogger

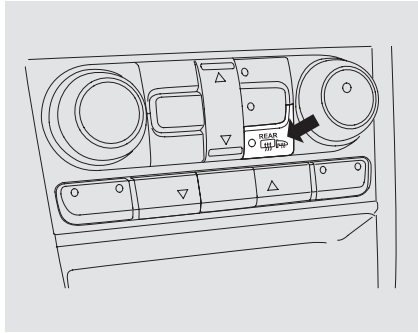

The rear window defogger will clear fog, frost, and thin ice from the window. Push the defogger button to turn it on and off. The indicator in the button lights to show the defogger is on. If you do not turn it off, the defogger will shut itself off after about 15 minutes. It also shuts off when you turn off the ignition. You have to turn it on again when you restart the vehicle.

Make sure the rear window is clear and you have good visibility before starting to drive.

The defogger wires on the inside of the rear window can be accidentally damaged. When cleaning the glass, always wipe side-to-side.

### *If equipped*

Pushing this button also turns the mirror heaters on or off. For more information, see page 173 .

## Instrument Panel Brightness

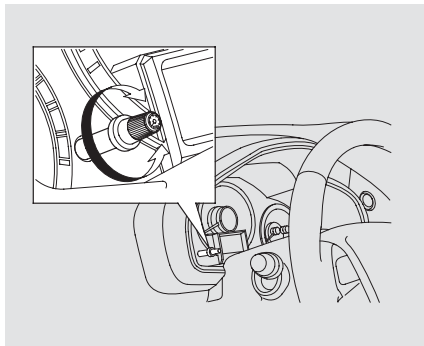

The select/reset knob on the instrument panel controls the brightness of the instrument panel lights. Turn the knob to adjust the brightness.

You will hear a beep when maximum or minimum brightness is reached. You will also hear a beep when the maximum level is canceled by turning the knob a click to the left.

To reduce glare at night, the instrument panel illumination dims when you turn the light switch to ☾☽ or ☾☽ . Turning the select/reset knob to the right until you hear a beep will cancel the reduced brightness.

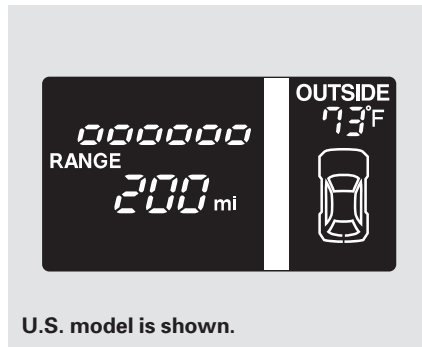

**U.S. model is shown.**

*Except Touring models*

The level of brightness is shown on the information display while you adjust it. It goes out about 5 seconds after you finish adjusting.

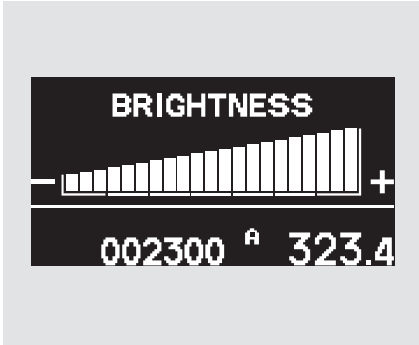

Brightness can only be adjusted when ambient light is low.

### *On Touring models*

The level of brightness is shown on the multi-information display while you adjust it. It goes out 5 seconds after you finish adjusting.

When the brightness reaches the maximum level, "BRIGHTNESS MAXIMUM LEVEL" appears on the display.

# Steering Wheel Adjustment

Make any steering wheel adjustment before you start driving.

## **⚠ WARNING**

Adjusting the steering wheel position while driving may cause you to lose control of the vehicle and be seriously injured in a crash.

Adjust the steering wheel only when the vehicle is stopped.

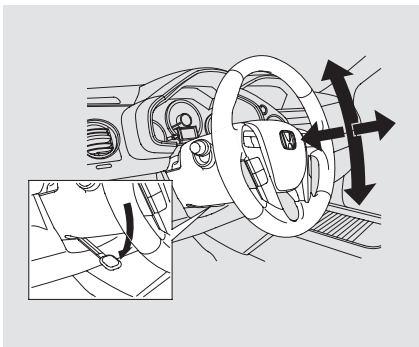

1. Push the lever under the steering column all the way down.
2. Move the steering wheel up or down, and in or out, so it points toward your chest, not toward your face. Make sure you can see the instrument panel gauges and indicators.

3. Push the lever up to lock the steering wheel in position.
4. Make sure you have securely locked the steering wheel in place by trying to move it up, down, in, and out.

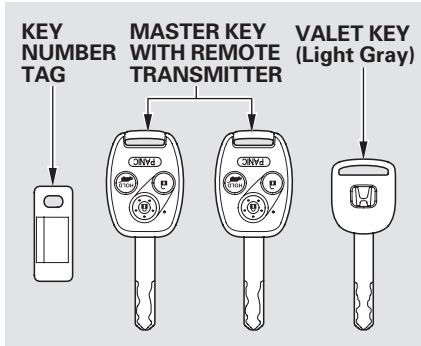

The master key fits all the locks on your vehicle. The valet key works only in the ignition and the driver's door lock. You can keep the glove box locked when you leave your vehicle and the valet key at a parking facility.

You should have received a key number tag with your keys. You will need this key number if you ever have to get a lost key replaced. Use only Honda-approved key blanks.

These keys contain electronic circuits that are activated by the immobilizer system. They will not work to start the engine if the circuits are damaged.

- Protect the keys from direct sunlight, high temperature, and high humidity.
- Do not drop the keys or set heavy objects on them.
- Keep the keys away from liquids. If they get wet, dry them immediately with a soft cloth.

The valet key does not contain a battery. Do not try to take it apart.

## Immobilizer System

---

The immobilizer system protects your vehicle from theft. If an improperly coded key (or other device) is used, the engine's fuel system is disabled.

When you turn the ignition switch to the ON (II) position, the immobilizer system indicator should come on briefly, then go off. If the indicator starts to blink, it means the system does not recognize the coding of the key. Turn the ignition switch to the LOCK (0) position, remove the key, reinsert it, and turn the ignition switch to the ON (II) position again.

The system may not recognize your key's coding if another immobilizer key or other metal object (i.e. key chain) is near the ignition switch when you insert the key.

If the system repeatedly does not recognize the coding of your key, contact your dealer.

Do not attempt to alter this system or add other devices to it. Electrical problems could result that may make your vehicle inoperable.

If you have lost your key and you cannot start the engine, contact your dealer.

## NOTICE

*Always take the ignition key with you whenever you leave the vehicle alone.*

*As required by the FCC:  
This device complies with Part 15 of the FCC rules. Operation is subject to the following two conditions: (1) This device may not cause harmful interference, and (2) this device must accept any interference received, including interference that may cause undesired operation.*

*Changes or modifications not expressly approved by the party responsible for compliance could void the user's authority to operate the equipment.*

*This device complies with Industry Canada Standard RSS-210.  
Operation is subject to the following two conditions: (1) this device may not cause interference, and (2) this device must accept any interference that may cause undesired operation of the device.*

## Ignition Switch

---

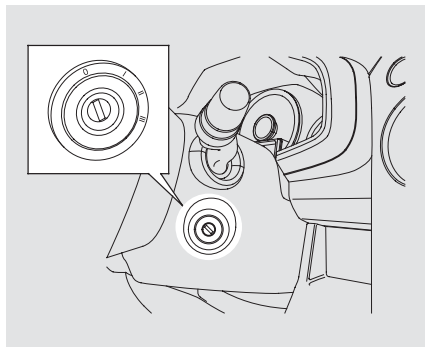

The ignition switch has four positions: LOCK (0), ACCESSORY (I), ON (II), and START (III).

**LOCK (0)** – You can insert or remove the key only in this position. To turn the key to the LOCK (0) position, the shift lever must be in Park, and you must push the key in slightly.

If the front wheels are turned, the anti-theft lock may make it difficult to turn the key. Firmly turn the steering wheel to the left or right as you turn the key.

**ACCESSORY (I)** – You can operate the audio system and the accessory power sockets in this position.

**ON (II)** – This is the normal key position when driving. Several of the indicators on the instrument panel come on as a test when you turn the ignition switch from the ACCESSORY (I) to the ON (II) position.

**START (III)** – Use this position only to start the engine. The switch returns to the ON (II) position when you let go of the key.

You will hear a reminder beeper if you leave the key in the ignition switch in the LOCK (0) or the ACCESSORY (I) position and open the driver's door. Remove the key to turn off the beeper.

*On Touring models*

You will also see a “REMOVE KEY” message on the multi-information display (see page 94 ).

The shift lever must be in Park before you can remove the key from the ignition switch.



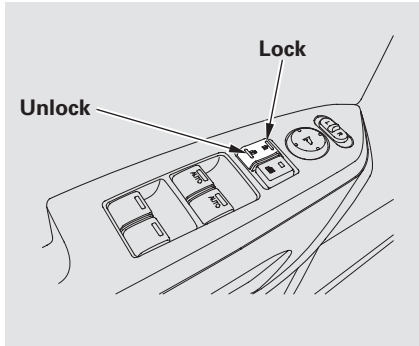

To lock all doors, the tailgate, and the glass hatch, push the top of the master door lock switch on either front door, pull the lock tab rearward on the driver's door, or use the key on the outside lock on the driver's door.

Pushing the rear of either master door lock switch will unlock all doors and the tailgate. Pushing forward the lock tab on the driver's door unlocks only that door.

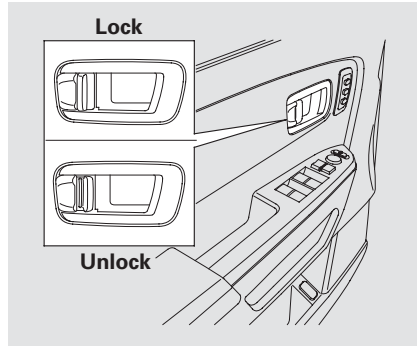

The lock tab on each passenger's door locks and unlocks that door.

All doors, the tailgate, and the glass hatch, can be locked from the outside by using the key in the driver's door lock. To unlock only the driver's door, insert the key, turn the key, and release it. The remaining doors and the tailgate unlock when you turn the key a second time within a few seconds.

### *On Touring models*

To change the "KEY AND REMOTE UNLOCK MODE" setting, see page 117.

When the vehicle speed reaches about 10 mph (U.S.) and 15 km/h (Canada) or more, all the doors lock automatically.

To change the "AUTO DOOR LOCK" setting, see page 114.

When you shift to P after driving, the driver's door unlocks.

To change the "AUTO DOOR UNLOCK" setting, see page 115.

## Door Locks

---

### Auto Door Locking/Unlocking

*Except Touring models*

Your vehicle has customizable settings for the doors and tailgate to automatically lock and unlock. There are default settings for each of these features. You can turn off or change the settings for these features as described on the following pages.

When you customize the setting, make sure your vehicle is parked safely, the engine is off, and the parking brake is applied. Make all settings before you start driving.

*On Touring models*

To change the “AUTO DOOR LOCK” setting, see page 114 .

To change the “AUTO DOOR UNLOCK” setting, see page 115 .

### Auto Door Locking

*Except Touring models*

The auto door locking feature has three possible settings:

- The auto door locking is deactivated all the time.
- The doors and tailgate lock whenever you move the shift lever out of the Park (P) position.
- The doors and tailgate lock when the vehicle speed reaches 10 mph (15 km/h). This is the default setting.

**To turn off the Auto Door Lock modes:**

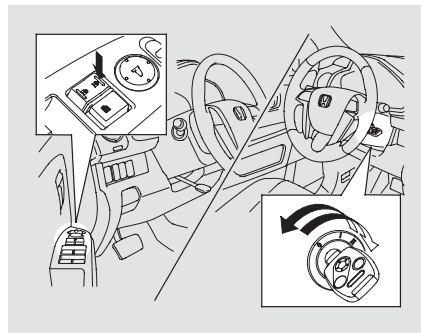

1. Make sure the shift lever is in the Park (P) position.
2. Turn the ignition switch to the ON (II) position, and open the driver's door.

3. Push and hold the front of the master door lock switch on the driver's door until you hear a click (after about 5 seconds).
4. Release the switch, and within 20 seconds, turn the ignition switch to the LOCK (0) position.

**To program the Park Lock mode:**  
*Locks all doors and tailgate when the shift lever is moved out of the Park (P) position.*

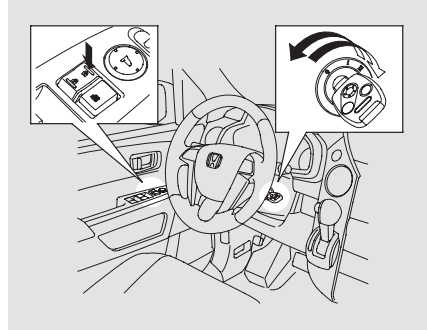

1. Make sure the shift lever is in the Park (P) position.
2. Turn the ignition switch to the ON (II) position, and make sure to close the driver's door.

3. Push and hold the front of the master door lock switch on the driver's door. You will hear a click. Keep holding the switch until you hear another click (after about 5 seconds).
4. Release the switch, and within 5 seconds, turn the ignition switch to the LOCK (0) position.

CONTINUED

## Door Locks

### **To program the Drive Lock mode:**

*Locks all doors and tailgate when the vehicle's speed reaches about 10 mph (15 km/h).*

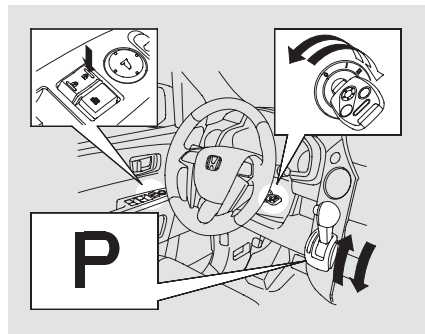

1. Make sure the shift lever is in the Park (P) position.
2. Turn the ignition switch to the ON (II) position, and make sure to close the driver's door.

3. Push and hold the brake pedal, and move the shift lever out of the Park (P) position.
4. Push and hold the front of the master door lock switch on the driver's door. You will hear a click. Keep holding the switch until you hear another click (after about 5 seconds).
5. Release the switch, and within 20 seconds, turn the ignition switch to the ACCESSORY (I) position. Move the shift lever to the Park (P) position.
6. Turn the ignition switch to the LOCK (0) position.

### **Auto Door Unlocking**

*Except Touring models*

The auto door unlocking feature has five possible settings:

- The auto door unlocking is deactivated all the time.
- The driver's door unlocks when you move the shift lever to the Park (P) position with the brake pedal depressed. This is the default setting.
- All doors and tailgate unlock when you move the shift lever to the Park (P) position with the brake pedal depressed.
- The driver's door unlocks whenever you turn the ignition switch to the ACCESSORY (I) position.
- All doors and tailgate unlock whenever you turn the ignition switch to the ACCESSORY (I) position.

## **To turn off the Auto Door Unlock modes:**

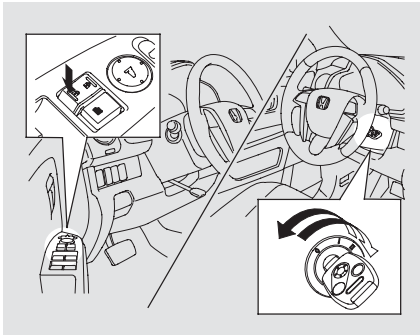

1. Make sure the shift lever is in the Park (P) position.
2. Turn the ignition switch to the ON (II) position, and open the driver's door.

3. Push and hold the rear of the master door lock switch on the driver's door. You will hear a click, and after about 5 seconds, you will hear another click.
4. Release the switch, and within 20 seconds, turn the ignition switch to the LOCK (0) position.

## **To program the Park Unlock mode:** *Unlocks the driver's door or all doors and tailgate when the shift lever is moved into the Park (P) position with the brake pedal depressed.*

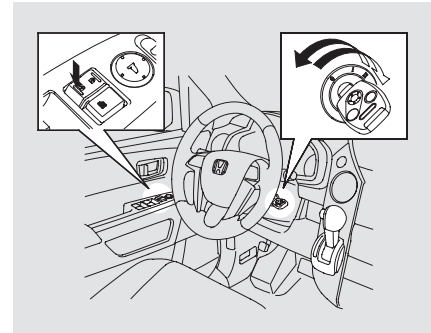

1. Make sure the shift lever is in the Park (P) position.
2. Turn the ignition switch to the ON (II) position, and make sure to close the driver's door.

CONTINUED

## Door Locks

3. Push and hold the rear of the master door lock switch on the driver's door. You will hear a click. Continue to hold down the switch:

- Until you hear another click (after about 5 seconds) to activate *driver's door unlock feature*.
- Or, until you hear two more clicks (after about 10 seconds) to activate *all doors and tailgate unlock feature*.

4. Release the switch, and within 20 seconds, turn the ignition switch to the LOCK (0) position.

### **To program the Ignition Switch**

#### **Unlock mode:**

*Unlocks the driver's door or all doors and tailgate when the ignition switch is moved out of the ON (II) position.*

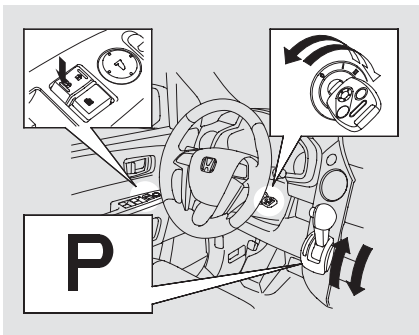

1. Make sure the shift lever is in the Park (P) position.
2. Turn the ignition switch to the ON (II) position, and make sure to close the driver's door.

3. Push and hold the brake pedal, and move the shift lever out of P.

4. Push and hold the rear of the master door lock switch on the driver's door. You will hear a click. Continue to hold the switch:

- Until you hear another click (after about 5 seconds) to activate the driver's door unlock feature.
- Or, until you hear two more clicks (after about 10 seconds) to activate all doors and tailgate unlock feature.

5. Release the switch, and within 20 seconds, turn the ignition switch to the ACCESSORY (I) position. Move the shift lever to the Park (P) position.

6. Turn the ignition switch to the LOCK (0) position.

### ***Lockout Prevention***

With any door or the tailgate open and the key in the ignition, both master door lock switches are disabled. They are not disabled if all the doors and the tailgate are closed. If you try to lock an open driver's door by pulling the lock tab rearward the lock tab on the driver's door pops out.

### **Childproof Door Locks**

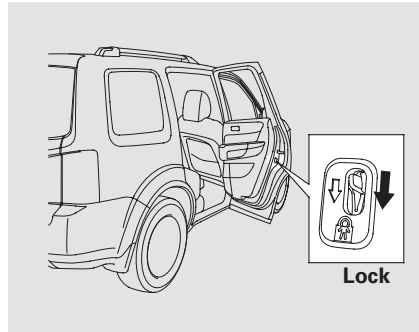

The childproof door locks are designed to prevent children seated in the rear from accidentally opening the rear doors. Each rear door has a lock lever near the edge. With the lever in the LOCK position (lever is down), the door cannot be opened from the inside regardless of the position of the lock tab. To open the door, push the lock tab forward and use the outside door handle.

### **Tailgate**

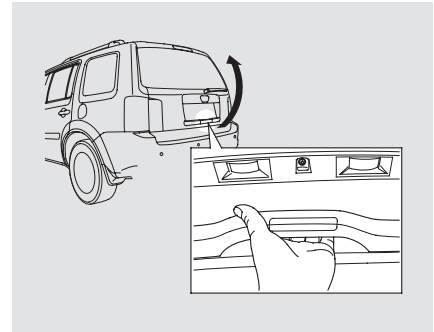

Make sure the shift lever is in the Park (P) position.

To open the tailgate, press and hold the switch, then lift up. To close the tailgate, use the inner handle to pull it down, then press down on the back edge.

*CONTINUED*

## Tailgate and Glass Hatch

---

Keep the tailgate closed at all times while driving to avoid damaging the tailgate and to prevent exhaust gas from getting into the interior. See **Carbon Monoxide Hazard** on page 60 .

### Power Tailgate *On EX-L and Touring models*

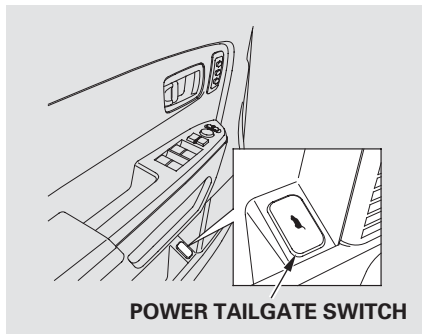

The tailgate can be opened and closed with the remote transmitter (see page 151 ) or the switch in the driver's door pocket when both front doors are unlocked.

If the glass hatch is opened, remote transmitter operation is canceled until it is closed.

Press and hold the tailgate button on the remote transmitter or the switch for about 1 second to open or close the tailgate. Each time you press the button on the remote transmitter or the switch, you will hear a beep, and some front and rear lights will flash.

If you push the same button or switch again while the tailgate is opening or closing, you will hear three beeps, and the tailgate will stop moving, reverse direction, and stop at the fully opened or closed position.



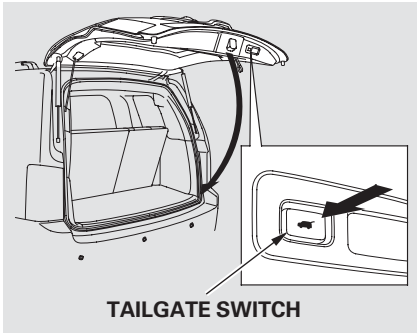

The tailgate can also be closed by pressing the button on the tailgate. If you press the button again while the tailgate is closing, you will hear three beeps, and the tailgate will stop moving, reverse direction, and stop at the fully opened position.

### **Auto-Reverse**

The power tailgate has an auto-reverse feature. If it meets resistance while opening or closing, it will beep three times and reverse direction. However, the tailgate may not reverse immediately. Always make sure passengers and objects are clear of the tailgate before opening or closing it.

### **⚠ WARNING**

Closing a power tailgate while anyone is in the path of the tailgate can cause serious injury.

Make sure everyone is clear before closing the power tailgate.

Also check that passengers, especially children, do not have their hands on the edge of the tailgate or on the tailgate sill. The auto reverse feature stops working when the tailgate is about to latch so the motor can pull the tailgate shut.

If your vehicle's battery is disconnected, goes dead, or the fuse is removed while the tailgate is fully open, the power tailgate needs to be reset. After connecting the battery or installing the fuse, close the tailgate fully by hand.

The power tailgate may not open or close under the these conditions:

- The vehicle is parked on a steep hill.
- When the vehicle is swayed in a strong wind.

*CONTINUED*

## Tailgate and Glass Hatch

---

- When the tailgate or the roof is covered with snow or ice.

Do not install any accessories on the tailgate. It may cause the tailgate to malfunction. If there is snow or ice on the tailgate, make sure to remove it before you operate the tailgate.

If you push the tailgate release button inside the handle while the tailgate is opening or closing, it will stop moving. You need to open or close it the rest of the way manually.

The tailgate has sensors on both sides. Be careful not to damage them. If the sensors are damaged, the power tailgate does not function properly.

### *On Touring models*

If you try to drive off with the tailgate open, a beeper sounds and a “TAILGATE OPEN” message is shown on the multi-information display.

Keep the tailgate closed at all times while driving to avoid damaging the tailgate and to prevent exhaust gas from getting into the interior. See **Carbon Monoxide Hazard** on page 60 .

If there is a problem in the power tailgate system, you will see a “CHECK POWER TAILGATE” message on the multi-information display, or the power tailgate indicator comes on. Have the system checked by your dealer.

With this message shown on the multi-information display, or the power tailgate indicator comes on, you can still open or close the tailgate manually.

### *On EX-L models*

#### ***To Customize the Power Tailgate Setting***

You can customize the power tailgate setting not to open without unlocking the tailgate lock first by remote transmitter from the outside.

When you customize the setting, make sure your vehicle is parked safely, the parking brake is applied, all doors and the tailgate are fully closed and locked, and the key is removed from the ignition switch.

There are two settings you can choose from:

**ANYTIME** – The tailgate unlocks and opens when you press and hold the tailgate button on the remote transmitter for 1 second. The tailgate will automatically relock when you close it when the doors are locked.

**WHEN UNLOCKED** – In this mode, you must unlock the tailgate before opening it. In addition, the tailgate will not automatically relock when you close it.

You can switch between these two modes as following:

1. Insert the key into the ignition and turn to the ON (II) position.

2. Press and hold the power tailgate switch until the PTG buzzer sounds. (Switch should be held on longer than 5 seconds).
3. Release the switch.
4. Turn off the ignition and remove the key.

To go back to the other setting, repeat the above procedure.

- When mode is set the “WHEN UNLOCKED,” you will hear three short beeps.
- When mode is set the “ANYTIME,” you will hear a long beep when the ignition is turned OFF (0).

### Unlocking the Tailgate

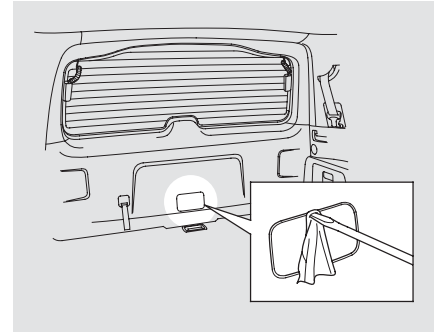

If the power door lock system cannot unlock the tailgate, unlock it manually.

Place a cloth on the top side of the cover to prevent scratches, then use a small flat-tip screwdriver to remove the cover on the back of the tailgate.

*CONTINUED*

## Tailgate and Glass Hatch

*On EX-L and Touring models*

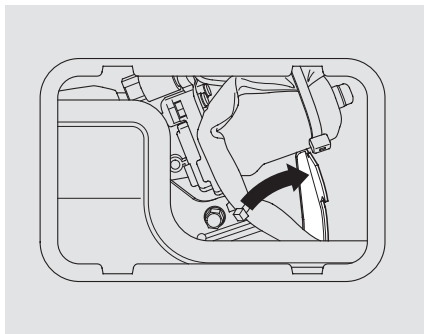

Make sure the shift lever is in the Park (P) position.

Push the release lever to the right as shown.

If you need to unlock the tailgate manually, it means there is a problem with the tailgate. Have the vehicle checked by your dealer.

*Except EX-L and Touring models*

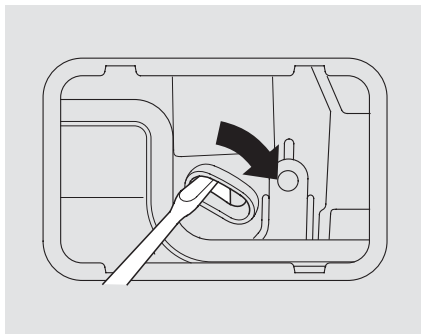

If you cannot open the tailgate, remove the cover on the back of the tailgate (see page 147). Make sure the shift lever is in the Park (P) position. Push the release lever to the right as shown, then pull the outer handle to open the tailgate.

### Glass Hatch

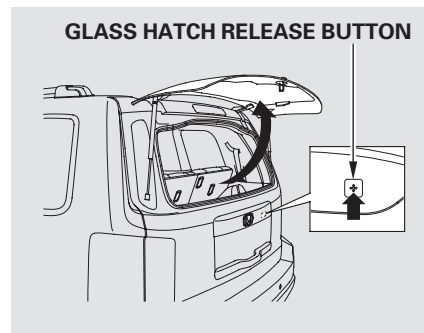

To open the glass hatch, press the glass hatch release button on the tailgate.

To close the glass hatch, lower it and press on the handle until it latches.

The rear wiper will not operate with the glass hatch open. If you open the glass hatch while the rear wiper is operating, the wiper will return to its parked position (see page 124 ). The wiper will resume operation after the glass hatch is closed.

*Except EX-L and Touring models*

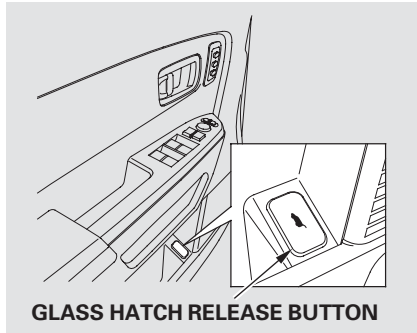

You can also open the glass hatch by pressing the glass hatch release button on the driver's door or on the remote transmitter.

Keep the tailgate and the glass hatch closed at all times while driving to avoid damaging the tailgate and the glass hatch, and to prevent exhaust gas from getting into the interior. See **Carbon Monoxide Hazard** on page 60 .

## Remote Transmitter

### Except EX-L and Touring models



**LOCK** — Press this button once to lock all doors and the tailgate. Some exterior lights will flash. When you push LOCK twice within 5 seconds, you will hear a beep to verify that the doors and tailgate are locked and the security system has set. This button does not work if any door or tailgate is not fully closed.

### On EX-L and Touring models

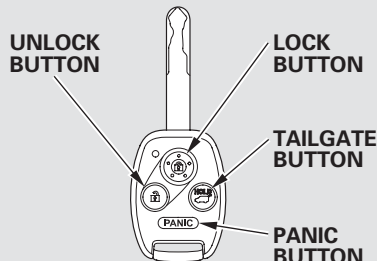

*On Touring models*  
To change the “KEYLESS LOCK ACKNOWLEDGEMENT” setting, see page 118 .

**UNLOCK** — Press this button once to unlock the driver’s door. Push it twice to unlock the other doors. Some exterior lights will flash twice when you push the button. If you do not open any door or the tailgate within 30 seconds, they will automatically relock.

*On Touring models*  
To change the “KEY AND REMOTE UNLOCK MODE” setting, see page 117 .

To change the “SECURITY RELOCK TIMER” setting, see page 119 .

When you press the UNLOCK button, the front and rear individual map lights and the cargo area light, depending on their switch positions, will come on (see page 176 ). If you do not open any door or the tailgate, the lights stay on for about 30 seconds, then go out. If you relock the doors and the tailgate with the remote transmitter before 30 seconds have elapsed, the lights will go off immediately.

*Except EX-L and Touring models*

**GLASS HATCH RELEASE** — Press this button for about 1 second to open the glass hatch. Even if the glass hatch is open, the tailgate can be locked with the remote transmitter.

*On EX-L and Touring models*

**TAILGATE** — Press and hold the TAILGATE button to open or close the power tailgate. When the tailgate begins to move, you will hear a beep, and some front and rear lights will flash.

If you push the same button again while the tailgate is opening or closing, three beeps sound, the tailgate stops moving, reverses direction and stops in the fully opened or fully closed position.

**PANIC** — Press and hold this button for about 1 second to attract attention; the horn will sound, and the exterior lights will flash for about 30 seconds. To cancel panic mode, press any other button on the remote transmitter, or turn the ignition switch to the ON (II) position. Panic mode does not work when the key is in the ignition switch.

**Remote Transmitter Care**

- Avoid dropping or throwing the transmitter.
- Protect the transmitter from extreme temperatures.
- Do not immerse the transmitter in any liquid.
- If you lose a transmitter, the replacement needs to be reprogrammed by your dealer.

# Remote Transmitter

## Replacing the Transmitter Battery

If it takes several pushes on the button to lock or unlock the doors and the tailgate, replace the battery as soon as possible.

Battery type: CR1616

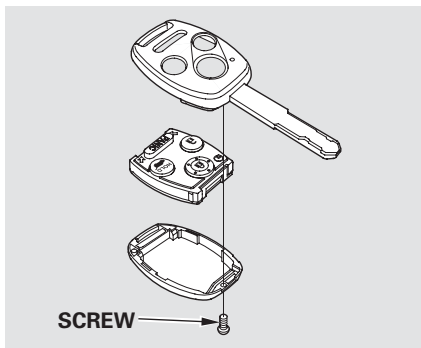

To replace the battery:

1. Remove the screw at the base of the transmitter with a small Phillips-head screwdriver.

**NOTE:** Be careful when removing this screw as the head of the screw can strip out.

2. Separate the transmitter by prying its middle seam with your fingernail.

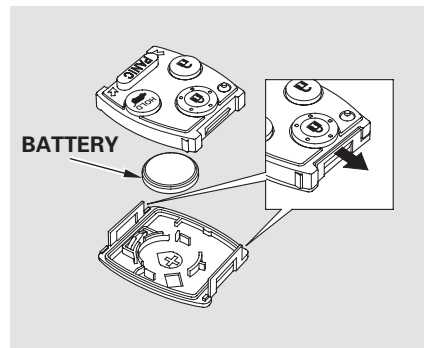

3. Inside the transmitter, separate the inner cover from the keypad by releasing the two tabs on the cover.



4. Remove the old battery, and insert a new battery into the back of the cover with the + side facing down.

An improperly disposed of battery can hurt the environment. Always confirm local regulations for battery disposal.

5. Install the parts in reverse order.

*As required by the FCC:*

*This device complies with Part 15 of the FCC rules. Operation is subject to the following two conditions: (1) This device may not cause harmful interference, and (2) this device must accept any interference received, including interference that may cause undesired operation.*

*Changes or modifications not expressly approved by the party responsible for compliance could void the user's authority to operate the equipment.*

*This device complies with Industry Canada Standard RSS-210.*

*Operation is subject to the following two conditions: (1) this device may not cause interference, and (2) this device must accept any interference that may cause undesired operation of the device.*

## Recalling a Memorized Driving Position

*On Touring models*

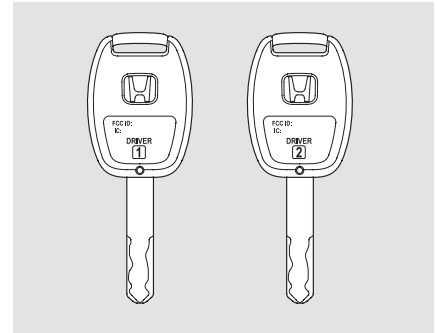

When you unlock the door with your remote, each remote activates the keyless memory settings related to that remote. The driver's ID (Driver 1 or Driver 2) is shown on the back of each remote.

CONTINUED

Here are the settings activated with the remote:

- Customized settings (see page 95 ).
- Driving position memory (see page 174).

When you unlock and open the driver's door with the remote transmitter, the driver's seat (except the power lumbar feature) and outside mirrors start to move to the positions stored in memory. The indicator in the related memory button to the remote comes on.

### **Front Seat Power Adjustments**

*Except LX models*

*See pages 15 – 16 for important safety information and warnings about how to properly position the seats and seat-backs.*

The controls for the power adjustable front seats are on the outside edge of each seat bottom. You can adjust the seats with the ignition switch in any position. Make all seat adjustments before you start driving.

*On EX-L and Touring models*

The passenger seat has the same adjustments as the driver's seat but without any height and lumbar adjustments.

*Except EX-L and Touring models*

The front passenger's seat adjusts manually.

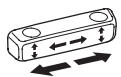
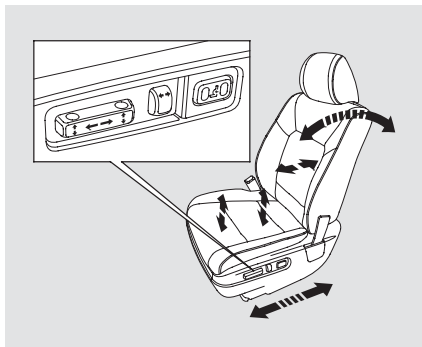

Moves the seat forward and backward.

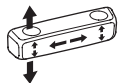

Moves the front of the seat up or down.

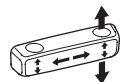

Raises or lowers the seat.

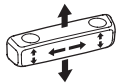

Moves the whole seat up and forward, or down and backward. The front of the seat also tilts up or down at the same time.



Adjusts the seat-back angle forward or backward.



Increases or decreases the lumbar support. (Driver's seat only)

## Front Seat Manual Adjustments

*Except EX-L and Touring models*  
See pages 15 – 16 for important safety information and warnings about how to properly position the seats and seat-backs.

Make all seat adjustments before you start driving.

CONTINUED

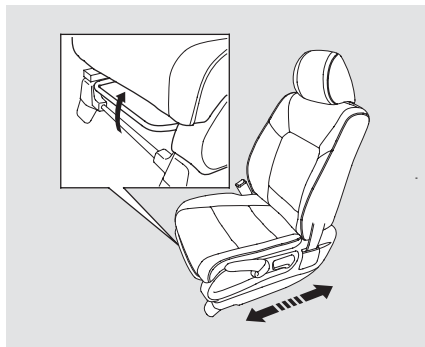

To adjust the seat forward or backward, pull up on the bar under the seat cushion's front edge. Move the seat to the desired position, and release the bar. Try to move the seat to make sure it is locked in position.

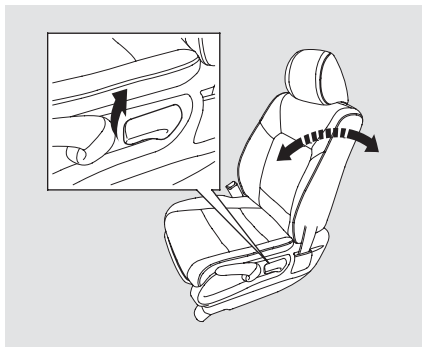

To change the seat-back angle, pull up on the lever on the outside of the seat bottom.

Once a seat is adjusted correctly, rock it back and forth to make sure it is locked in position.

### Driver's Seat Manual Height Adjustment

*On LX models*

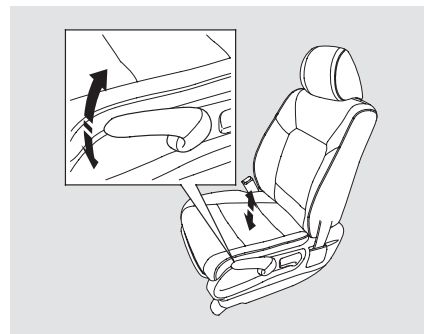

The height of your driver's seat is adjustable. To raise the seat, repeatedly pull up the lever on the outside of the seat cushion. To lower the seat, push the lever down repeatedly.

## Head Restraints

See page 16 for important safety information and a warning about improperly positioning head restraints.

Your vehicle is equipped with head restraints in all seating positions to help protect you and your passengers from the likelihood of whiplash and other injuries.

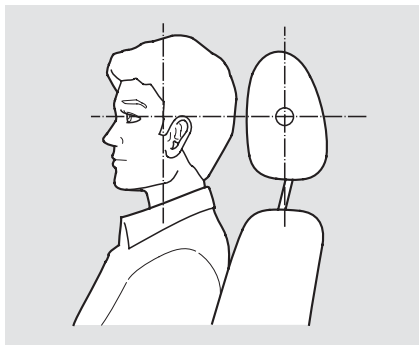

They are most effective when you adjust them so the center of the back of the occupant's head rests against the center of the restraint.

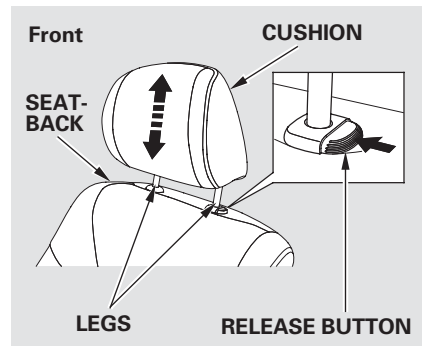

### *Adjusting the Head Restraint*

The head restraints adjust for height. You need both hands to adjust the restraint. Do not attempt to adjust it while driving. To raise it, pull upward. To lower the restraint, push the release button sideways, and push the restraint down.

CONTINUED

# Seats

## *Third Row Center Seat*

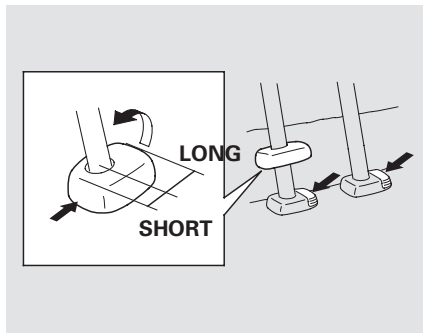

To lower the restraint, push short side of the cap and pry up on long side of the cap. Push the release buttons sideways, and push the restraint down.

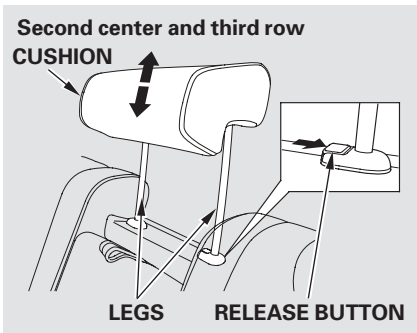

## ***Removing the Head Restraint***

To remove a head restraint for cleaning or repair, pull it up as far as it will go. Push the release button, then pull the restraint out of the seat-back.

## *Third Row Center Seat*

Push short side of the cap and pry up on long side of the cap. Push the release buttons, then pull the restraint out of the seat-back.

**⚠ WARNING**

Failure to reinstall, or correctly reinstall, the head restraints can result in severe injury during a crash.

Always replace the head restraints before driving.

When reinstalling a head restraint, put the legs back in place. Then adjust it to the appropriate height while pressing the release button.

*Third Row Center Seat*

When reinstalling a head restraint, install the cap with the long side toward the release button. Then adjust it to the appropriate height while pressing the release buttons.

Make sure the head restraint locks in position when you reinstall it.

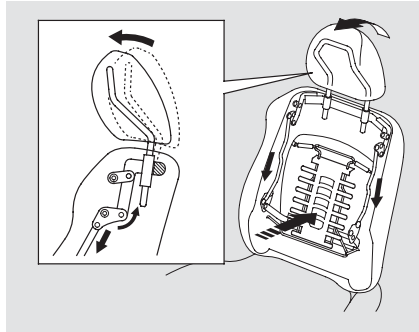
*Active Head Restraints*

The driver's and front passenger's seats have active head restraints. If the vehicle is struck severely from the rear, the occupant properly secured with the seat belt will be pushed against the seat-back and the head restraint will automatically move forward.

This reduces the distance between the restraint and the occupant's head. It also helps protect the occupants against the likelihood of whiplash and injuries to the neck and upper spine.

After a collision, the activated restraint should return to its normal position.

If the restraints do not return to their normal position, or in the event of a severe collision, have the vehicle inspected by a Honda dealer.

CONTINUED

## Seats

For a head restraint system to work properly:

- Do not hang any items on the head restraints, or from the restraint legs.
- Do not place any object between an occupant and the seat-back.
- Install each restraint in its proper location.
- Only use genuine Honda replacement head restraints.

### Adjusting the Second Row Seats

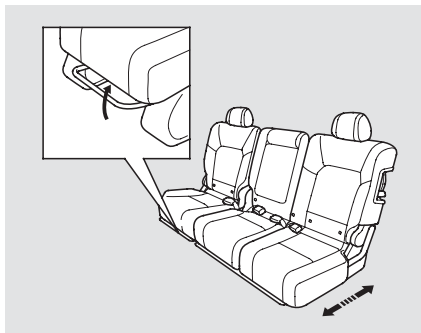

To adjust the second row seats forward and backward, pull up on the bar under the front edge of the seat cushion. Move the seat to the desired position and release the bar. Try to move the seat to make sure it is locked in position.

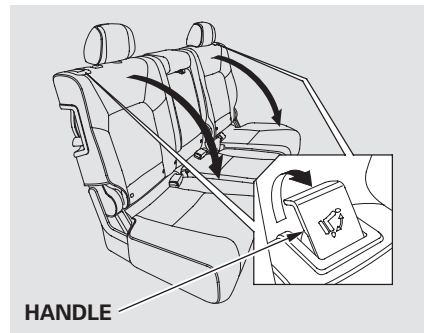

To change the seat-back angle of the seats in the second row, pull up on the handle on the outside of the seat-back, and push the seat-back.



### Folding the Second Row Seats

The left and right halves can be folded separately.

1. To unlatch the detachable anchor before folding the seat-back, insert the latch plate into the slot on the side of the anchor buckle (see page 163 ) and allow the seat belt to retract. Store the detachable anchor and seat belt latch plates in the retractor housing.
2. Lower the head restraints to their lowest positions.
3. Pull up the handle on the outside of the seat-back.
4. Fold the seat-back forward.

Reverse this procedure to return the seat to the upright position. Make sure the seat is locked securely before driving.

Make sure that the folded seat-back does not press against the front passenger's seat, as this could cause the weight sensors to work improperly.

### Third Row Access



To get into the third row seats, pull up the lever on the side of the passenger's side second row seat-back. The seat-back will tilt forward, and then can be slid forward.

After you return the seat-back to the upright position, push the whole seat backwards until it latches. Make sure the seat is fully latched before sitting in it.

## Seats

### Folding the Third Row Seat

1. Use the latch plate to release the seat belt from the detachable anchor (see page 163 ).
2. Lower the head restraints to their lowest positions.

**NOTE:** To fold the third row seat, the second row seat-back must be folded down or in the full upright position.

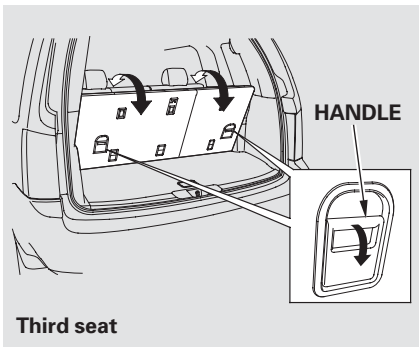

3. Unlock the seat-back by pulling the handle. Push the seat-back forward.

Make sure the outer shoulder belts are positioned in each holding slot on the side panel whenever the third seat is folded.

Reverse this procedure to return the seat to the upright position. Make sure the seat is locked securely before driving. Reconnect the seat belts to the detachable anchors.

Make sure all items in the cargo area are secured. Loose items can fly forward and cause injury if you have to brake hard (See **Carrying Cargo** on page 506 ).

## Detachable Anchor

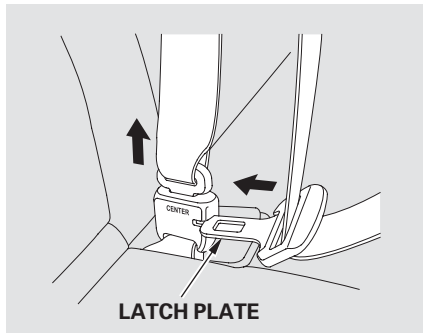

The seat belts in the second row center seat and the third row seats are equipped with detachable anchors.

To unlatch the detachable anchor, insert the latch plate into the slot on the side of the anchor buckle. Store the detachable anchor and seat belt latch plates in the retractor housing.

When the seats are returned to the upright position, these detachable anchors should be latched back properly.

### **⚠ WARNING**

Using the seat belt with the detachable anchor unlatched increases the chance of serious injury or death in a crash.

Before using the seat belt, make sure the detachable anchor is correctly latched.

If any children are riding in the rear seats, be sure that any unused seat belts are either buckled, the lockable retractor activated, and the belt fully retracted, or in the case of any unused detachable center belts, stored in the roof slots so they are out of reach. See page 24 for additional information.

*CONTINUED*

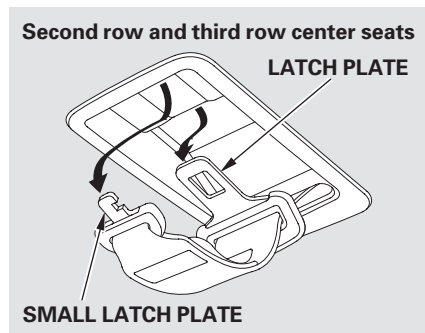

Pull out the small latch plate and the latch plate from each holding slot in the ceiling, and pull out the seat belt to extend it.

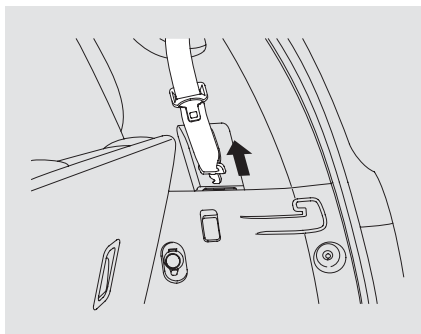

Pull out the outer shoulder belts from the holding slots. Both of the third-row holding slots should only be used when the seat belt is detached.

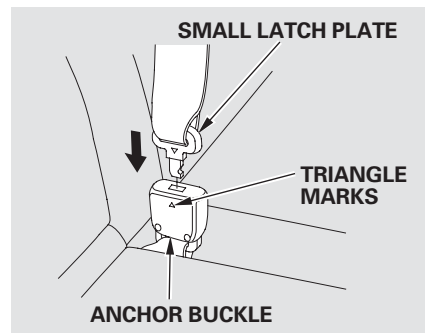

Line up the triangle marks on the small latch plate and anchor buckle when reattaching the belt and buckle.

Tug on the seat belt to verify that the detachable anchor is securely latched. Make sure the seat belt is not twisted.

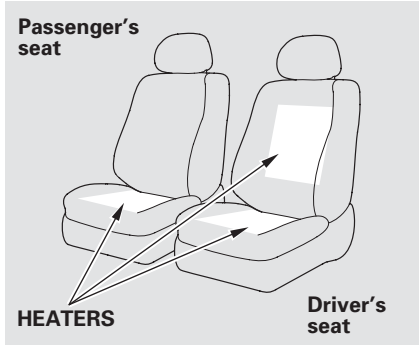

*If equipped*

Both front seats are equipped with seat heaters. Because of the sensors for the side airbag cutoff system, there is no heater in the passenger's seat-back. The ignition switch must be in the ON (II) position to use the heaters.

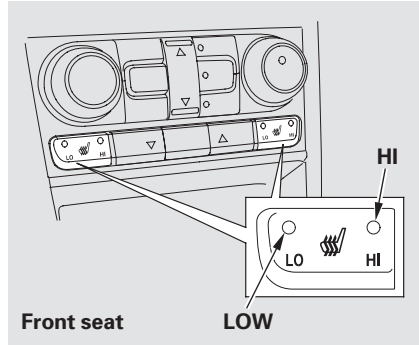

To use the heaters, press the seat heater switch. The indicator (amber) in the switch will come on. There are three settings in the heaters: HI, LO, and OFF.

When you press the seat heater switch once, the heater is set to HI. Select LO by pressing the seat heater switch again. To shut down the heater, press the seats heater switch until the indicators go off.

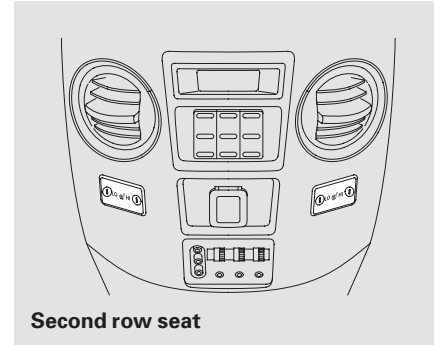

*On Canadian Touring models*

The outer second row seat cushions and seat-backs are equipped with seat heaters. Turning the switch on the driver side warms the outer seat behind the driver's seat only. The passenger side switch warms the outer seat behind the front passenger seat.

CONTINUED

## Seat Heaters

---

Push the right side of the switch, HI, to rapidly heat up the seat. After the seat reaches a comfortable temperature, select LO by pushing the left side of the switch. This will keep the seat warm.

Follow these precautions when using the seat heaters:

- Do not use the seat heater in the HI setting for an extended period, because it draws large amounts of current from the battery.
- If the engine is left idling for an extended period, do not use the seat heaters even on the LO setting. It can weaken the battery, causing hard starting.
- The heater runs continuously and does not automatically turn off after a period of time.

### **WARNING**

Heat induced burns are possible when using seat heaters.

Persons with a diminished ability to sense temperature (e.g., persons with diabetes, lower-limb nerve damage, or paralysis) or with sensitive skin should not use seat heaters.

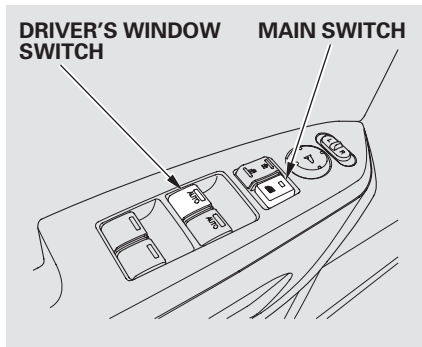

Turn the ignition switch to the ON (II) position to raise or lower any window. To open a window, push the switch down and hold it. Release the switch when you want the window to stop. Pull back on the switch and hold it to close the window.

The windows will operate for up to 10 minutes after you turn off the ignition switch. Opening either front door cancels this function.

### **⚠ WARNING**

Closing a power window on someone's hands or fingers can cause serious injury.

Make sure your passengers are away from the windows before closing them.

**AUTO** – To open either front window fully, push the window switch firmly down to the second detent, then release it. The window automatically goes down all the way. To stop the window from going all the way down, pull back on the window switch briefly.

To close either front window fully, pull back the window switch firmly to the second detent, then release it. The window automatically goes all the way up. To stop the window from going all the way up, push down on the window switch briefly.

When you push the MAIN switch in, the switch is off, and the passengers' windows cannot be raised or lowered. To cancel this feature, push on the switch again to get it to pop out. Keep the MAIN switch pushed in when you have children in the vehicle so they do not injure themselves by operating the windows unintentionally.

*CONTINUED*

**AUTO REVERSE** — If either front window senses any obstacle while it is closing automatically, it will reverse direction and then stop. To close the window, remove the obstacle, then use the window switch again.

Auto reverse stops sensing when the window is almost closed. You should always check that all passengers and objects are away from the window before closing it.

If your vehicle's battery is disconnected or goes dead, or the driver's window fuse is removed, the AUTO function may be disabled. If the AUTO function is disabled, the power window system will need to be reset after reconnecting the battery or installing the fuse.

1. Start the engine. Push down and hold the driver's window switch until the window is fully open.
2. Pull and hold the driver's window switch to close the window completely, then hold the switch for about 2 seconds.

If the power windows do not operate properly after resetting, have your vehicle checked by your dealer.

### **Opening the Windows and Moonroof with the Remote Transmitter**

You can open all of the windows and the moonroof (if equipped) from the outside with the remote transmitter.

1. Press the UNLOCK button once to unlock the driver's door.
2. Press the UNLOCK button a second time, and hold it. All the doors unlock, and all four windows and moonroof start to open. To stop the windows and moonroof, release the button.
3. To open the windows and moonroof further, press the button again (within 10 seconds of step 1) and hold it. If the windows and the moonroof stop before the desired position, repeat steps 1 and 2.

You cannot close the windows or the moonroof with the remote transmitter.



## Opening/Closing the Windows and Moonroof with the Key

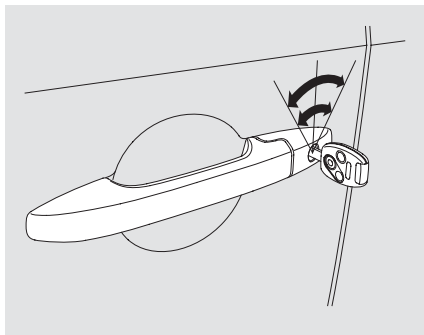

You can open and close the windows and the moonroof (if equipped) with the key in the driver's door lock.

To open:

1. Insert the key in the driver's door lock.
2. Turn the key clockwise, then release it.

3. Turn the key clockwise again, and hold it. All four windows and the moonroof start to open. To stop the windows and the moonroof, release the key.
4. To open the windows and the moonroof further, turn and hold the key again (within 10 seconds of step 2).

To close:

1. Insert the key in the driver's door lock.
2. Turn the key counterclockwise, then release it.
3. Turn the key counterclockwise again, and hold it. All four windows and the moonroof start to close. To stop the windows and the moonroof, release the key.

4. To close the windows and the moonroof further, turn and hold the key again (within 10 seconds of step 2).

Auto reverse does not work when closing the windows and moonroof with the key.

**NOTE:** If the windows and the moonroof stop before the desired position, repeat steps 2 and 3.

# Moonroof

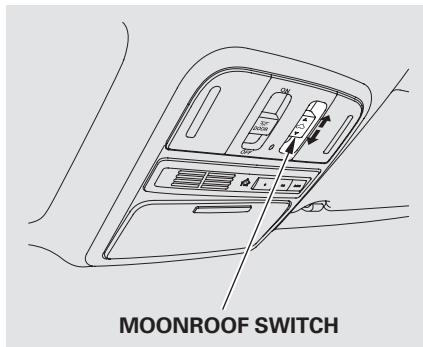

*On EX-L and Touring models*  
Turn the ignition switch to the ON (II) position before operating the moonroof switch on the ceiling console.

To open the moonroof fully, pull back the moonroof switch firmly. The moonroof opens all the way. To stop the moonroof from opening fully, push the switch briefly.

To tilt up the moonroof, push on the center of the moonroof switch. To stop the moonroof from tilting up fully, push the switch briefly.

To close the moonroof fully, firmly push the moonroof switch forward, then release it. The moonroof automatically closes all the way. To stop the moonroof from closing, push the switch briefly.

To open or close the moonroof partially, pull back or push forward the moonroof switch lightly and hold it. The moonroof will stop when you release the switch.

**AUTO REVERSE** — If the moonroof runs into any obstacle while it is closing automatically, it will reverse direction and then stop. To close the moonroof, remove the obstacle, then use the moonroof switch again.

Auto reverse stops sensing when the moonroof is almost closed. You should always check that all passengers and objects are away from the moonroof before closing it.

## **WARNING**

Opening or closing the moonroof on someone's hands or fingers can cause serious injury.

Make sure all hands and fingers are clear of the moonroof before opening or closing it.

You can open and close the moonroof for up to 10 minutes after you turn off the ignition switch. Opening either front door cancels this function.

## NOTICE

*If you try to open the moonroof in below-freezing temperatures, or when it is covered with snow or ice, you can damage the moonroof panel or its motor.*

**Operating the Moonroof with the Remote Transmitter or the Key**  
You can use the remote transmitter or the key to operate the moonroof from the outside. Refer to page 168 for details.

## Parking Brake

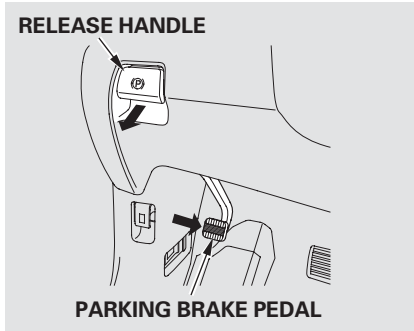

To apply the parking brake, push the pedal down with your foot. To release it, pull the release handle fully. The parking brake indicator on the instrument panel should go out when the parking brake is fully released (see page 69 ).

## NOTICE

*Driving the vehicle with the parking brake applied can damage the rear brakes and hubs. A beeper will sound if the vehicle is driven with the parking brake on.*

*On Touring models*  
You will also see a “RELEASE PARKING BRAKE” message on the multi-information display (see page 93 ).

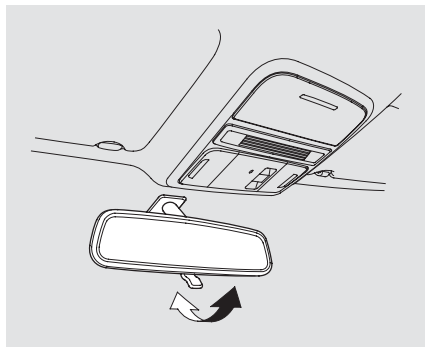

Keep the inside and outside mirrors clean and adjusted for best visibility. Be sure to adjust the mirrors before you start driving.

### *On LX and EX models*

The inside mirror has day and night positions. The night position reduces glare from headlights behind you. Flip the tab on the bottom edge of the mirror to select the day or night position.

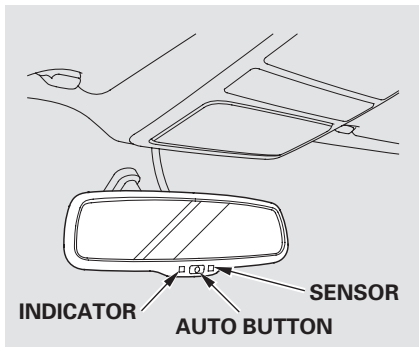

### *On EX-L and Touring models*

The inside mirror can automatically darken to reduce glare. To turn on this feature, press the button on the bottom of the mirror. The AUTO indicator comes on as a reminder. When it is on, the mirror darkens when it senses the headlights of a vehicle behind you, then returns to normal visibility when the lights are gone. Press the button again to turn off this feature.

## Adjusting the Power Mirrors

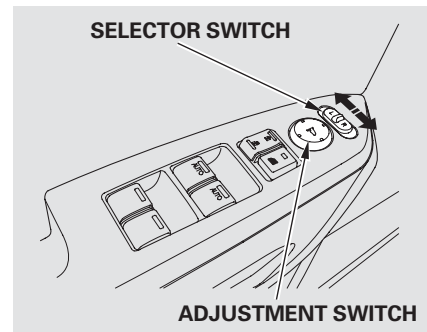

1. Turn the ignition switch to the ON (II) position.
2. Move the selector switch to L (driver's side) or R (passenger's side).

3. Push the appropriate edge of the adjustment switch to move the mirror right, left, up, or down.
4. When you finish, move the selector switch to the center (off) position. This turns the adjustment switch off to keep your settings.

## Reverse Tilt Door Mirror

*On Touring models*

Both outside door mirrors have a reverse tilt feature. When in reverse, the selected mirror will tilt down slightly to improve your view as you parallel park. Shifting out of reverse will return the mirror to its original position.

- To tilt the driver's mirror, place the selector switch in the left position.
- To tilt the passenger's mirror, place the switch in the right position.
- To turn the feature off, place the switch in the center position.

Outside mirror positions can be stored in the driving position memory system (see page 174 ).

## Heated Mirrors

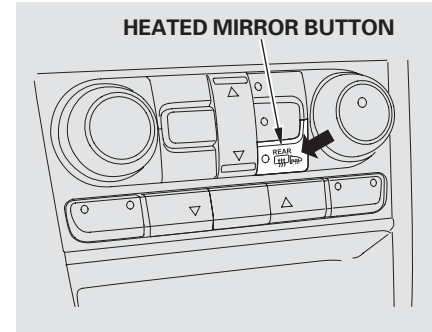

*If equipped*

The outside mirrors are heated to remove fog and frost. With the ignition switch in the ON (II) position, turn on the heaters by pressing the button. The indicator in the button comes on as a reminder. Press the button again to turn the heaters off. Pressing this button also turns the rear window defogger on and off.

# Driving Position Memory System

## *On Touring models*

Your vehicle has a memory feature for the driver's seat and outside mirror positions.

Two seat and outside mirror positions can be stored in separate memories. You select a memorized position by pushing the appropriate button or using the appropriate remote transmitter (Driver 1 or Driver 2).

You can change the "MEMORY POSITION LINK" setting on the multi-information display (see page 107).

## Storing a Driving Position in Memory

Store a driving position only when the vehicle is parked.

1. Turn the ignition switch to the ON (II) position. You cannot add a new driving position to the memory unless the ignition switch is in the ON (II) position. You can recall a memorized position with the ignition switch in any position.
2. Adjust the seat to a comfortable position (see page 154).
3. Adjust the outside mirrors for best visibility (see page 172).

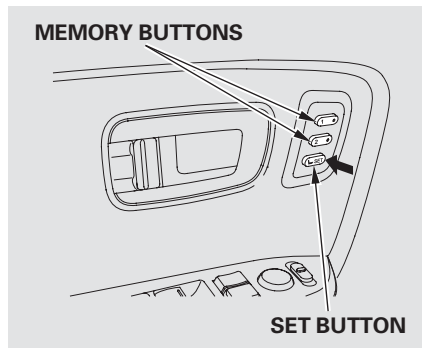

4. Press and release the SET button on the control panel. You will hear a beep. Immediately press and hold one of the memory buttons (1 or 2) until you hear two beeps. The indicator in the memory button will come on. The current positions of the driver's seat and outside mirrors are now stored.

To cancel the storing procedure after pressing the SET button, do any of the following:

- Fail to press a memory button within 5 seconds.
- Pressing the SET button again within 5 seconds.
- Readjust the seat position.
- Readjusting the outside mirror position.

Each memory button stores only one driving position. Storing a new position erases the previous setting stored in that button's memory. If you want to add a new position while retaining the current one, use the other memory button.

All stored driving positions will be lost if your vehicle's battery goes dead or is disconnected.

## Selecting a Memorized Position

To select a memorized position, do this:

1. Make sure the shift lever is in the Park (P) position.
2. Press the desired memory button (1 or 2) until you hear a beep, then release the button.

The system will move the seat and outside mirrors to the memorized positions. The indicator in the selected memory button will flash during movement. When the adjustments are complete, you will hear two beeps, and the indicator will remain on.

To stop the system's automatic adjustment, do any of these actions:

- Press any button on the control panel: SET, 1, or 2.
- Push any of the adjustment switches for the seat.
- Shift out of Park.
- Adjust the outside mirrors.

If desired, you can use the adjustment switches to change the positions of the seat or outside mirrors after they are in their memorized positions. If you change the memorized position, the indicator in the memory button will go out. To keep this driving position for later use, you must store it in the driving position memory.

# Interior Lights

## Light Control Switch

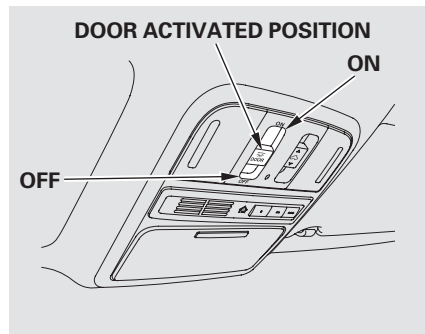

The light control switch has three positions: OFF, Door Activated, and ON.

*When the switch is in the OFF position:*

- The individual door lights will operate when a door is opened.
- The individual map lights in the front can be turned on and off by pressing the lenses.
- The individual map lights in the second and third rows cannot be turned on.

*When the switch is in the door activated position:*

- The individual map lights come on when any door or the tailgate is opened, or when the remote transmitter is used to unlock the doors. When the doors and the tailgate are closed, each light can be turned on and off by pushing the lens.
- The cargo area light comes on when the tailgate is opened if the light control switch is in the door activated (center) position. When the tailgate is closed, the cargo area light can be turned on with the switch in the light.



After all doors are closed tightly, the lights dim slightly, then fade out in about 30 seconds.

### *On Touring models*

To change the “INTERIOR LIGHT DIMMING TIME” setting, see page 109 .

With any door or the tailgate left open, the lights stay on about 15 minutes, then go out.

The lights also come on when the key is removed from the ignition switch.

*When the light control switch is in the ON position:*

All the individual map lights come on and stay on as long as the switch remains in the ON position.

### Individual Map Lights

Front

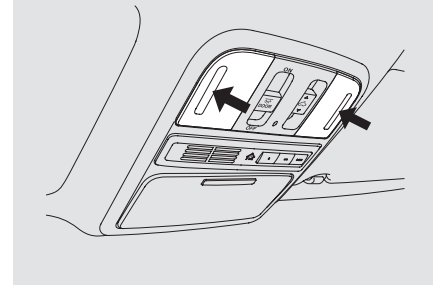

Turn on the front row individual map lights by pushing the lens. Push the lens again to turn it off. With the light control switch in the door activated position, the second row and third row map lights can be turned on by pushing the lens. Push the lens again to turn it off.

CONTINUED

## Interior Lights

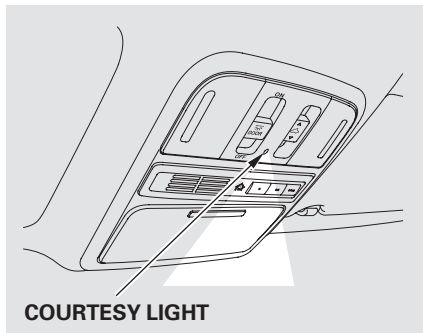

The courtesy light between the front map lights comes on when you turn the parking lights on. To adjust its brightness, turn the instrument panel brightness control dial on the dashboard (see page 130).

### Cargo Area Light

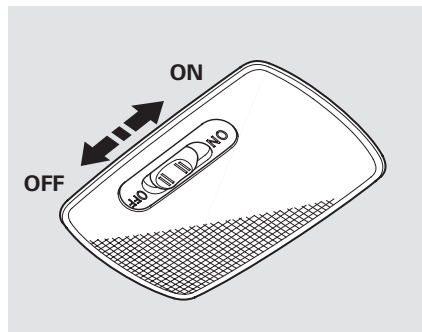

The cargo area light has a three-position switch. In the OFF position, the light does not come on. In the center position, the light comes on when you open the tailgate or the glass hatch. In the ON position, the light stays on continuously.

### Individual Interior Lights

The courtesy lights in all four doors come on when you open any door. The light around the ignition switch only comes on when you open the driver's door. After you close the door, the ignition switch light stays on for several seconds.

*On Touring models*

To change the "INTERIOR LIGHT DIMMING TIME" setting, see page 109.

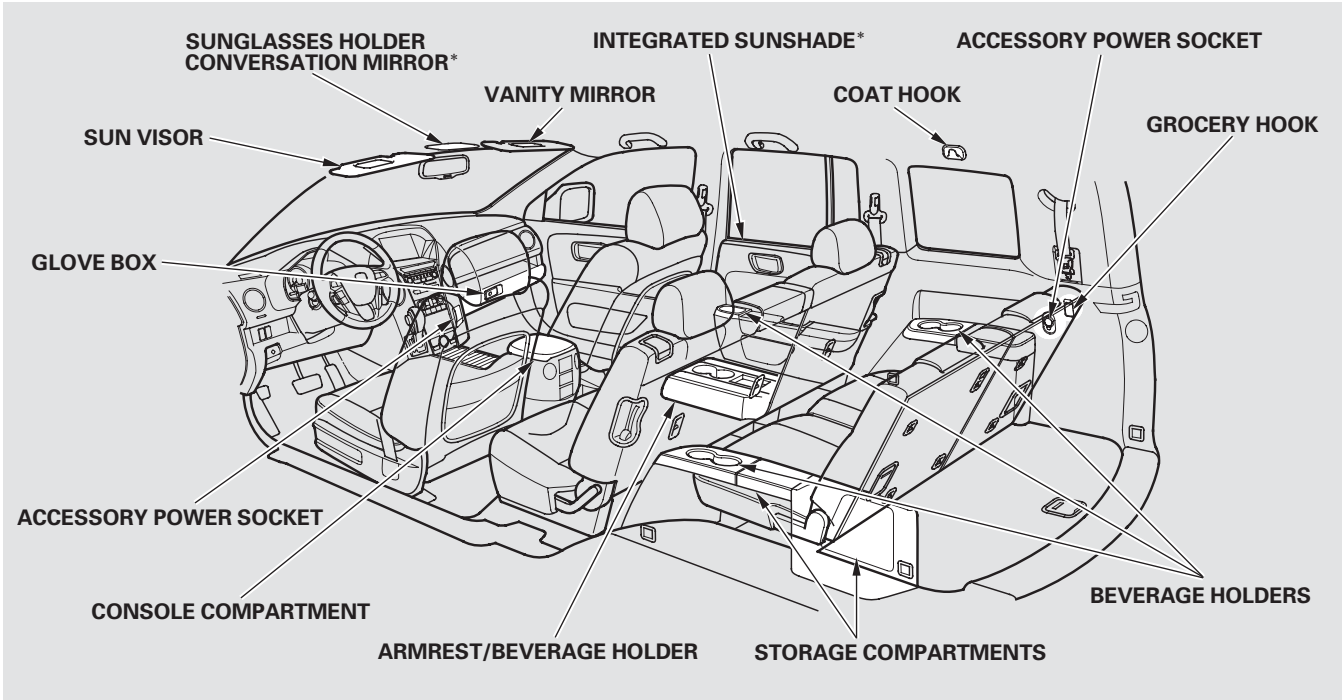

\* : If equipped

# Interior Convenience Items

## Center Console

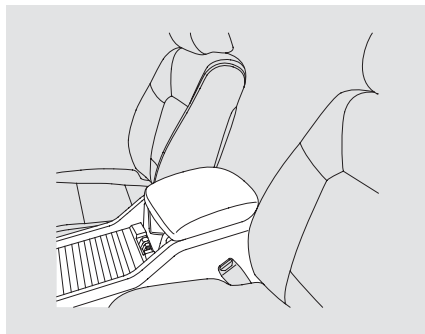

Your vehicle has a multi-function center console. It includes beverage holders, storage compartments, an armrest, and a storage tray.

## Console Compartments

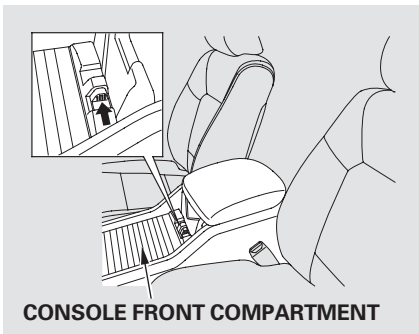

To open the front of the console compartment, squeeze the knob, and push it forward. To close, squeeze the knob and slide the cover backward.

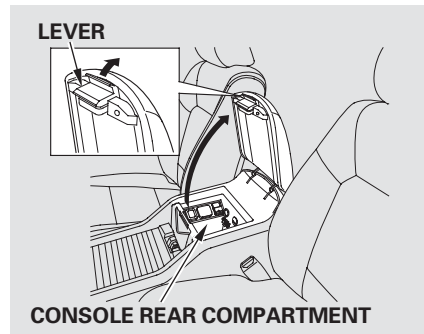

To open the rear of the console compartment, pull up on the lever and lift the armrest.

To close, lower the armrest, and push it down until it latches.

There is a removable partition in the main compartment area. The partition can be used to divide the forward compartment from the beverage holder area, or can be stored to the rear of the beverage area to create a deeper storage tray.

### **Beverage Holders**

Be careful when you are using the beverage holders. A spilled liquid that is very hot can scald you or your passengers. Liquid can also spill from the door pocket beverage holders when you open or close the doors. Use only resealable containers in the door pockets.

Spilled liquids can damage the upholstery, carpeting, and electrical components in the interior.

*CONTINUED*

## Interior Convenience Items

---

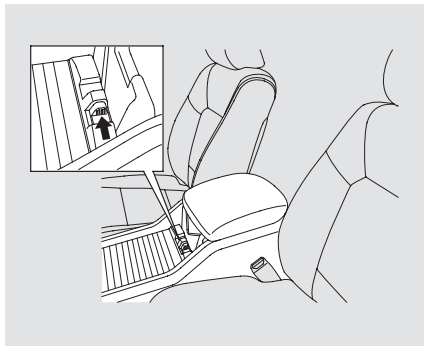

To open the beverage holder, squeeze the knob, and slide the cover forward.

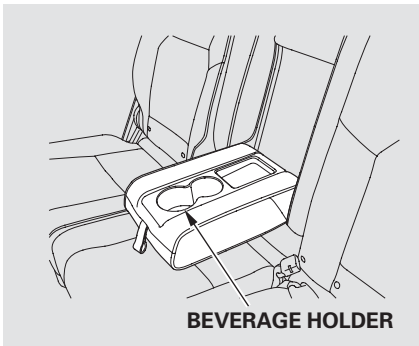

The center seat-back in the second row is equipped with an armrest that provides the beverage holder. Pivot down the seat-back to use them.

### Storage Compartment

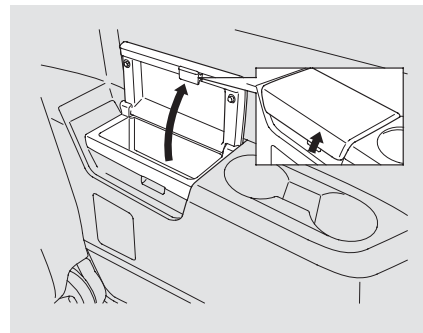

To open the compartment, pull the lever and lift the lid. To close, lower the lid and push it down until it latches.

### Glove Box

Open the glove box by pulling up on the handle. Close it with a firm push. Lock or unlock the glove box with the master key.

The glove box light comes on when the parking lights are on.

#### **⚠ WARNING**

An open glove box can cause serious injury to your passenger in a crash, even if the passenger is wearing the seat belt.

Always keep the glove box closed while driving.

### Integrated Sunshades

*On Touring models*

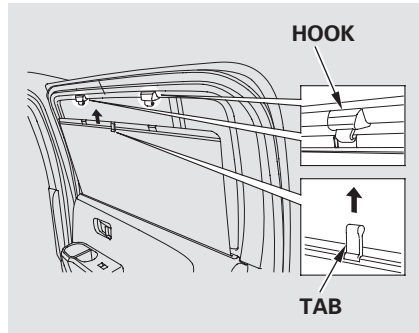

Each rear door has an integrated sunshade. To use a sunshade, hold the tab on the top, and pull the sunshade all the way up. Insert the holes on the sunshade into the hooks on the window frame.

### Sunglasses Holder

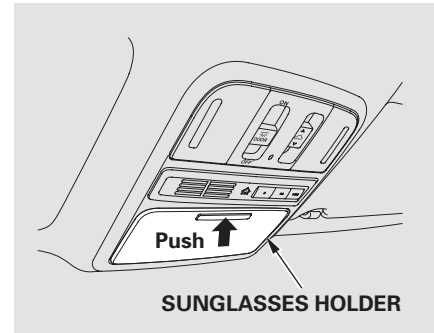

To open the sunglasses holder, push on the front edge. Make sure the holder is closed while you are driving.

Some larger styles of sunglasses may not fit in the holder.

*CONTINUED*

## Interior Convenience Items

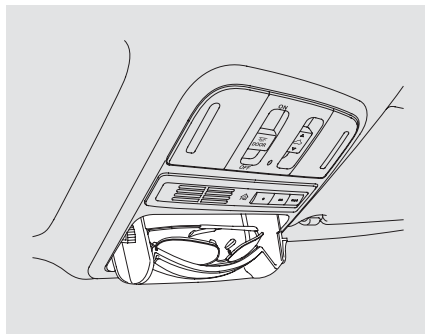

You may also store small items in this holder. Make sure they are small enough to let the holder close and latch, and that they are not heavy enough to cause the holder to pop open while driving.

### Conversation Mirror

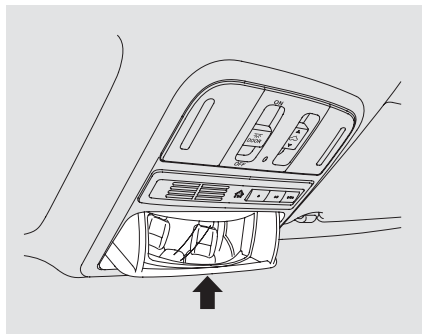

*On EX-L and Touring models*  
The sunglasses holder uses a convex mirror for its bottom panel. You can see all the vehicle passengers in this mirror. To use the mirror, open the sunglasses holder fully, push it to the first detent, and release it.

### Sun Visor

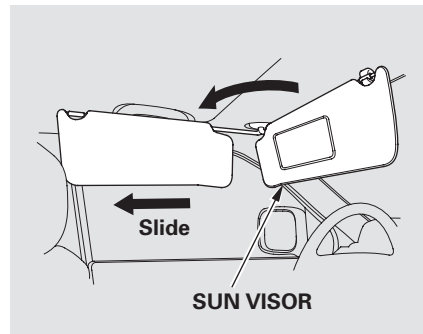

To use the sun visor, pull it down. When using the sun visor for the side window, remove the support rod from the clip, and swing it out.

In this position, the sun visor can be adjusted by moving it on its slider. Do not use the extended sun visor over the inside mirror. Make sure you put the sun visor back in place when you are getting into or out of the vehicle.



### Vanity Mirror

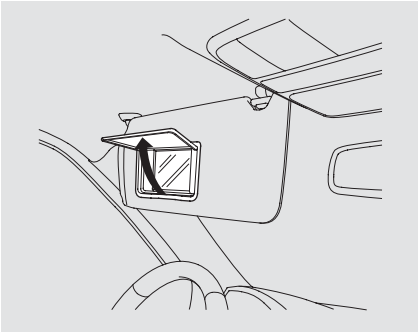

To use the vanity mirror on the back of the sun visor, pull up the cover.

### Coat Hooks

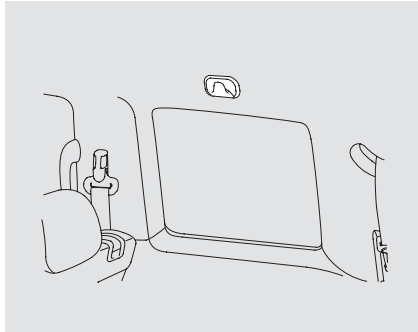

These hooks are not designed for large or heavy items.

## Interior Convenience Items

### Accessory Power Sockets

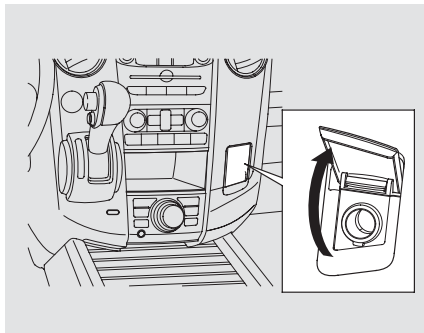

Your vehicle has four accessory power sockets. These are located on the instrument panel, in the console compartment, back of the center console box, or behind the third row seat on the passenger's side.

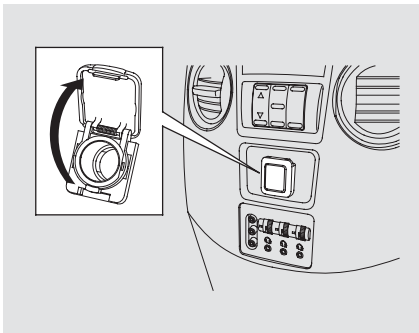

To use an accessory power socket, the ignition switch must be in the ACCESSORY (I) or ON (II) position.

Each socket is intended to supply power for 12 volt DC accessories that are rated 120 watts or less (10 amps).

When more than one socket is being used, the combined power rating of the accessories should be 120 watts or less (10 amps).

## Rear

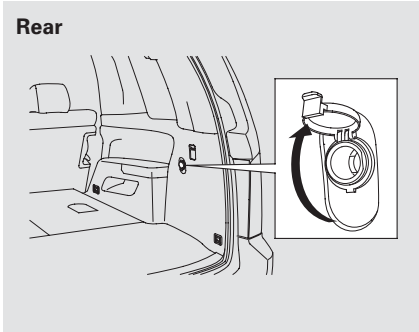

None of the sockets will power an automotive type cigarette lighter element.

Make sure to put the socket cover back in place to prevent any small foreign objects from getting into the socket.

## AC Power Outlet

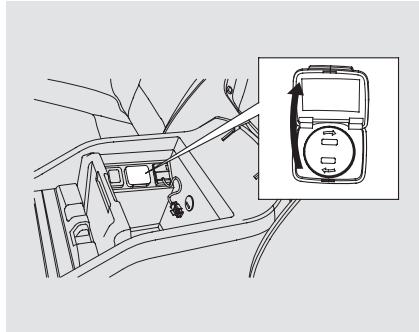

*On vehicles with rear entertainment system*

There is a 115 volt AC power outlet inside the front console compartment. To use the AC power outlet, open the lids and open the outlet cover. Insert the plug into the receptacle slightly, turn it 90° clockwise, then push in the plug all the way.

Always run the engine when you use the AC power outlet.

The maximum capacity for this power outlet is 115 volt AC at 150 watts or less. If you use an appliance which requires more than 150 watts, it automatically stops supplying the power. If this happens, turn the ignition switch off and turn it on again.

CONTINUED

## Interior Convenience Items

---

**NOTE:** The AC power outlet is not designed for electric appliances which require high initial peak wattage such as cathode-ray tube type televisions, refrigerators, electric pumps, etc. It is also not suitable for devices that process precise data such as medical equipment or measuring instruments. Any appliances that require an extremely stable power supply such as microcomputer-controlled electric blankets, touch sensor lamps, etc., should not be connected to this outlet.

### Cargo Floor Storage Compartment

Additional storage space for large items can be accessed by strapping the cargo floor to the seat back.

### Cargo Net

*On Touring models*

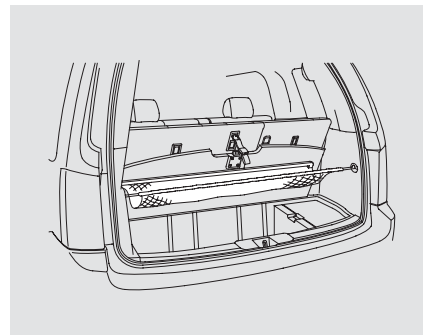

The cargo net will separate the storage area into two storage areas. On the upper area, you can store small and light items. You should place heavy items in the lower storage area. You can store the cargo net under the cargo floor to make a larger cargo area.

Make sure to use the cargo net securely hooked.

### **⚠ WARNING**

Do not use this cargo net if the third row seats are folded down.

Objects placed on the cargo net could be thrown forward during a crash or sudden stop and hurt someone.

When any of the third row seats are folded down, do not place any objects on the cargo net. Make sure to store the cargo net under the cargo area floor. It could be unlatched during a crash.

The maximum load on the cargo net is 22 lbs on U.S. models, and 10 kg on Canadian models. This is shown on a label back of the cargo area floor (see page 189 ). To prevent damage to the cargo net, do not exceed the maximum load.

Make sure all items in the cargo area are secured. Loose items can fly forward and cause injury if you have to brake hard (See **Carrying Cargo** on page 506 ).

### **NOTICE**



Do not use this net if the third row seats are folded down.

To prevent damage, do not place more than 22 lbs(10kg) on this net.

To prevent damage, do not place more than 22 lbs (10 kg) on this cargo net.



The heating and air conditioning system in your vehicle provides a comfortable driving environment in all weather conditions.

The standard audio system has many features. This section describes those features and how to use them.

Your vehicle has an anti-theft audio system that requires a code number to enable it.

The security system helps to discourage vandalism and theft of your vehicle.

### *On vehicles with navigation system*

The climate control system and the audio system have a voice control feature. Refer to the navigation system manual for more information.

|                               |     |
|-------------------------------|-----|
| Vents, Heating, and A/C ..... | 192 |
| Climate Control System.....   | 199 |
| Audio System .....            | 209 |
| <i>U.S. LX model</i>          |     |
| Playing the FM/AM Radio.....  | 212 |

|   |     |
|---|-----|
| Playing a Disc.....   | 219 |
| Disc Player Error Messages .....                                  | 226 |
| <i>EX, EX-L, and Canadian LX models without navigation system</i> |     |
| Audio System .....  | 227 |
| Playing the FM/AM Radio.....                                      | 228 |
| Playing the XM® Radio .....                                       | 237 |
| Playing a Disc.....   | 243 |
| Disc Player Error Messages .....                                  | 253 |
| Playing CD Library Audio .....                                    | 254 |
| Playing an iPod® .....  | 265 |
| iPod® Error Messages .....  | 273 |
| Playing a USB Flash Memory Device..                               | 274 |
| USB Flash Memory Device Error Messages .....                      | 281 |
| <i>Bluetooth® Audio System</i> .....                              | 282 |
| Wallpaper Setup.....  | 288 |
| Display Setup.....  | 291 |
| Setting the Clock .....   | 294 |
| Setting the Language .....  | 297 |
| <i>Models with navigation system</i>                              |     |
| Audio System .....  | 298 |
| Playing the FM/AM Radio.....                                      | 299 |
| Playing the XM® Radio .....                                       | 312 |
| Playing a Disc.....   | 319 |
| Disc Player Error Messages .....                                  | 331 |

|   |     |
|---|-----|
| Protecting Your Discs.....  | 332 |
| Playing Hard Disc Drive (HDD) Audio .....                                 | 335 |
| Playing an iPod®.....   | 363 |
| iPod® Error Messages .....  | 371 |
| Playing a USB Flash Memory Device..                                       | 372 |
| USB Flash Memory Device Error Messages.....                               | 383 |
| <i>Bluetooth® Audio System</i> .....                                      | 384 |
| FM/AM Radio Reception.....  | 389 |
| Auxiliary Input Jack.....   | 391 |
| Remote Audio Controls.....  | 392 |
| Radio Theft Protection.....   | 394 |
| Rear Entertainment System.....  | 396 |
| Security System .....   | 429 |
| Cruise Control.....   | 430 |
| Compass.....  | 433 |
| HomeLink® Universal Transceiver.....                                      | 437 |
| <i>Bluetooth® HandsFreeLink® (Models without navigation system)</i> ..... | 441 |
| <i>Bluetooth® HandsFreeLink® (Models with navigation system)</i> .....    | 462 |
| Parking Sensor System.....  | 484 |
| Review Camera and Monitor .....   | 491 |

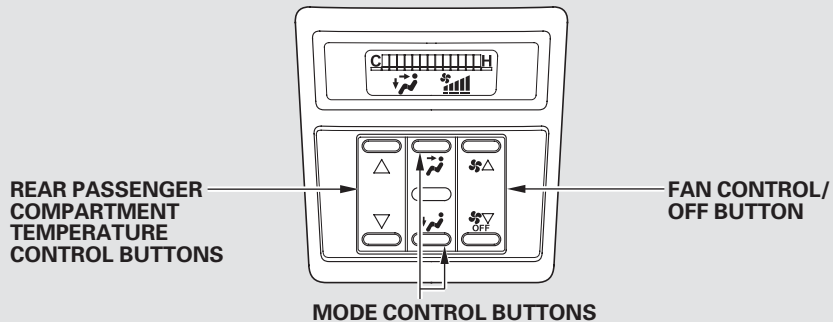
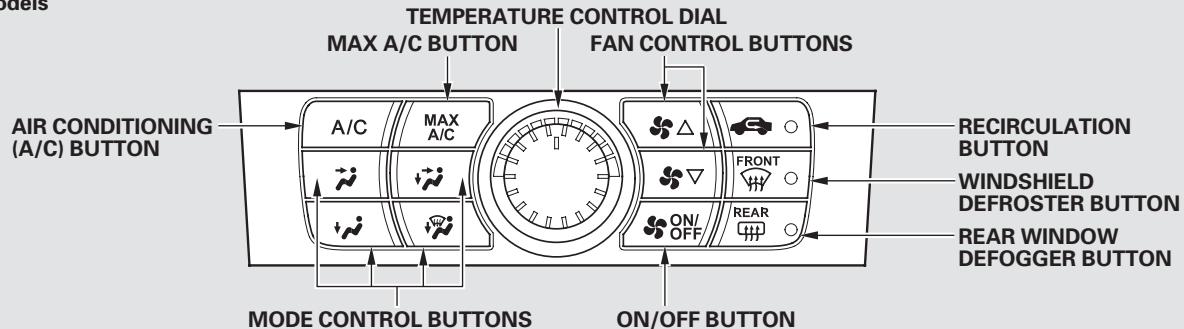

# Vents, Heating, and A/C

U.S. LX models





### Fan Control

Press the  ▲ button to increase the fan speed and airflow. Press the  ▼ button to decrease it.

### Temperature Control

Turning this dial clockwise increases the temperature of the airflow.

### Air Conditioning (A/C) Button

This button turns the air conditioning on and off. You will see A/C ON or A/C OFF in the display.

### Recirculation Button

When the indicator in the button is on, air from the vehicle's interior is sent throughout the system again. When the indicator is off, air is brought in from the outside of the vehicle (fresh air mode).

The outside air intakes for the heating and cooling system are at the base of the windshield. Keep this area clear of leaves and other debris.

The system should be left in fresh air mode under almost all conditions. Keeping the system in recirculation mode, particularly with the A/C off, can cause the windows to fog up.

Switch to recirculation mode when driving through dusty or smoky conditions, then return to fresh air mode.

## Vents, Heating, and A/C

---

### Rear Window Defogger

#### Button



This button turns the rear window defogger on and off (see page 129).

### Mode Control

Use the mode control buttons to select the vents air flows from. Some air will flow from the dashboard corner vents in all modes.

 Air flows from the center and corner vents in the dashboard.

 Airflow is divided between the vents in the dashboard and the floor vents.



 Air flows from the floor vents. When you select , the system automatically switches to fresh air mode.

 Airflow is divided between the floor vents and defroster vents at the base of the windshield.

 Air flows from the defroster vents at the base of the windshield.

When you select , the system automatically switches to fresh air mode and turns on the A/C.

 The system automatically turns on the A/C and switches to Recirculation mode. Air flows from the center and side vents in the dashboard.

When you switch to  from , the A/C stays on, and you can turn it on and off manually.

## Ventilation

The ventilation system draws in outside air, circulates it through the interior, then exhausts it through vents near the rear side panels.

1. Set the temperature to the lower limit.
2. Make sure the A/C is off.
3. Select  and fresh air mode.
4. Set the fan to the desired speed.

## Using the Heater

The heater uses engine coolant to warm the air. If the engine is cold, it will be several minutes before you feel warm air coming from the system.

1. Select  and fresh air mode.
2. Set the fan to the desired speed.
3. Adjust the warmth of the air with the temperature control dial.

## Using the A/C

Air conditioning places an extra load on the engine. Watch the engine coolant temperature gauge (see page 80 ). If it moves near the red mark, turn off the A/C until the gauge reads normally.

1. Turn on the A/C by pressing the button. You will see A/C ON in the display.
2. Make sure the temperature is set to the lower limit.
3. Select .
4. If the outside air is humid, select recirculation mode. If the outside air is dry, select fresh air mode.
5. Set the fan to the desired speed.

CONTINUED

## Vents, Heating, and A/C

---

If the interior is very warm, you can cool it down more rapidly by partially opening the windows, turning on the air conditioning, and setting the fan to maximum speed in fresh air mode.

### Dehumidify the Interior



Air conditioning, as it cools, removes moisture from the air. When used in combination with the heater, it makes the interior warm and dry.

1. Switch the fan on.
2. Turn on the air conditioning.
3. Select  and fresh air mode.
4. Adjust the temperature to your preference.

This setting is suitable for all driving conditions whenever the outside temperature is above 32°F (0°C).



### To Defog and Defrost

To remove fog from the inside of the windows:

1. Set the fan to the desired speed, or high for faster defrosting.
2. Select . The system automatically switches to fresh air mode and turns on the A/C. The A/C indicator will not come on if it was off to start with.
3. Adjust the temperature so the airflow feels warm.
4. Select  to help clear the rear window.
5. To increase airflow to the windshield, close the corner vents.

When you switch to another mode from , the A/C turns off. But if it was on to start with, it stays on.

### To Remove Exterior Frost or Ice From the Windows

1. Select . The system automatically switches to fresh air mode and turns on the A/C. The A/C indicator does not come on if it was off to start with.
2. Select .
3. Set the fan and temperature controls to maximum level.

To clear the windows faster, you can close the dashboard corner vents by rotating the wheel next to each vent. This sends more warm air to the windshield defroster vents. Once the windshield is clear, select fresh air mode to avoid fogging the windows.

For your safety, make sure you have a clear view through all the windows before driving.

## To Turn Everything Off

To turn the system completely off, press the ON/OFF button.

- Keep the system completely off for short periods only.
- To keep stale air and mustiness from collecting, you should have the fan running at all times.

## Using the Rear A/C Unit

The rear passengers can adjust the fan speed, temperature, and airflow of the rear A/C unit with the rear control panel.

## Rear Control Panel

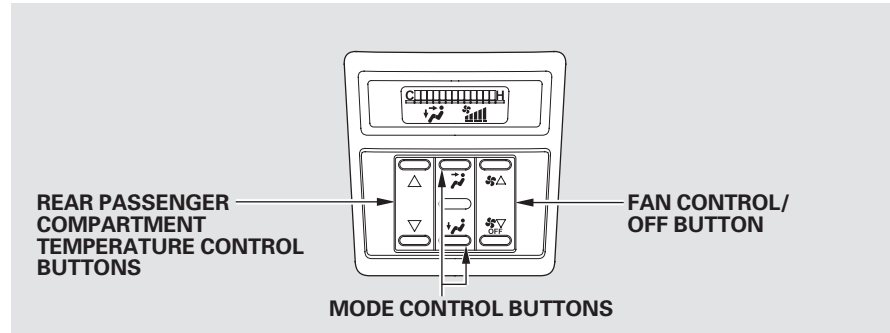

### *Temperature Control*

Press the ▲ temperature control button to increase the temperature of airflow, and the ▼ button to decrease it. The temperature you adjust is shown in the system display.

CONTINUED

## Vents, Heating, and A/C

---

### *Fan Control*

Press the  fan control button to increase the fan speed and airflow.

Press the  button to decrease it. The level of the fan speed is shown in the display.

### *Mode Control*

When  is selected, air flows from the upper vents on the back of the center console.

When  is selected, air flows from the lower vents.

To shut off the rear A/C unit, press the OFF button until the system shuts off.

To turn on the rear A/C unit, increase the fan speed and airflow.

Except U.S. LX models

## FRONT CONTROL PANEL

DRIVER'S SIDE TEMPERATURE CONTROL DIAL

AUTO BUTTON

AIR CONDITIONING (A/C) BUTTON

REAR PASSENGER COMPARTMENT TEMPERATURE CONTROL BUTTON

MODE BUTTON

ON/OFF BUTTON

FAN CONTROL BUTTONS

RECIRCULATION BUTTON

WINDSHIELD DEFROSTER BUTTON

FRONT PASSENGER'S SIDE TEMPERATURE CONTROL DIAL

SYNC BUTTON

REAR WINDOW DEFOGGER/ HEATED MIRROR BUTTON

REAR PASSENGER COMPARTMENT TEMPERATURE CONTROL BUTTON

REAR LOCK BUTTON

## REAR CONTROL PANEL

REAR PASSENGER COMPARTMENT TEMPERATURE

REAR PASSENGER COMPARTMENT TEMPERATURE CONTROL BUTTONS

MODE BUTTON

AUTO BUTTON

FAN CONTROL/ OFF BUTTON

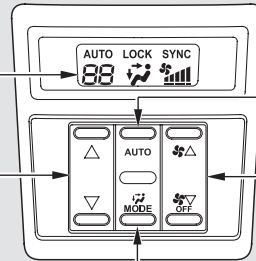
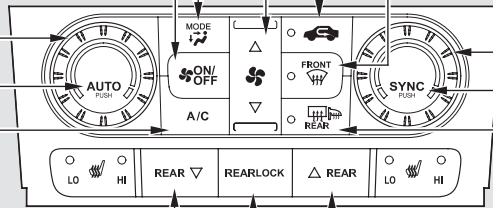

# Climate Control System

---

## Voice Control System

*On vehicles with navigation system*

The climate control system for your vehicle can also be operated using the voice control system. See the navigation system manual for complete details.

## Using Automatic Climate Control

The automatic climate control system in your vehicle maintains the interior temperature you select. The system also adjusts the fan speed and airflow levels.

1. Press the Auto button on the front control panel.
2. Set the desired temperature with the temperature control dial. You will see AUTO in the system's display.
3. You can set the driver's side temperature, the passenger's side temperature, and the temperature of the rear passenger compartment separately.

The system automatically selects the proper mix of conditioned and/or heated air that will, as quickly as possible, raise or lower the interior temperature to your preference.

## *Temperature Control*

The driver's side temperature, the passenger's side temperature and the rear passenger compartment temperature can be set separately. Turning each temperature control dial on the front control panel clockwise will increase the temperature of airflow. On the rear control panel, press the ▲ button to increase the temperature of airflow. Press the ▼ button to decrease it. Each set temperature is shown in the display. The rear temperature is shown in the display on the back of the center console.



When you set the temperature to its lower limit ( **L** ) or its upper limit ( **H** ), the system runs at full cooling or heating only. It does not regulate the interior temperature.

When you press a fan control button, the fan is taken out of AUTO mode.

### *On vehicles with navigation system*

In the Auto mode, the vehicle's interior temperature is independently regulated for the driver, front passenger, and rear passengers according to each adjusted temperature. The system also regulates each temperature based on the information of the sunlight sensor and the sun's position which is updated automatically by the navigation's global positioning system (GPS). For example, if the driver's side of the vehicle is getting too much sun, the system will adjust to a lower temperature.

### **Rear Lock Button**

When this button is on, you will see LOCK on the system display. The rear climate controls can only be controlled by the front control panel. The rear system automatically changes to AUTO mode and adjusts the fan speed and airflow levels to maintain the selected temperature of the rear passenger compartment. AUTO LOCK will be displayed on the rear control panel.

When this button is on while the system is in SYNC mode, the rear climate control system will be kept in SYNC mode and the rear control panel will be disabled. AUTO LOCK SYNC will be displayed on the rear control panel.

CONTINUED

# Climate Control System

---

## ***SYNC Button***

When you press this button, the indicator comes on, and the passenger's side temperature and the rear passenger compartment temperature are set to the same temperature as the driver's side temperature. When SYNC is on the entire vehicle interior temperature can be adjust via the driver's side temperature control dial on the front climate control. Changing the passenger's side temperature or pressing any control button for the rear passenger compartment makes the indicator go off, and takes the system out of SYNC mode.

## **To Turn Everything Off**

To turn the system completely off, press the ON/OFF button.

- Keep the system completely off for short periods only.
- To keep stale air and mustiness from collecting, you should have the fan running at all times.

## **Semi-automatic Operation**

You can manually select various functions of the climate control system when it is in fully automatic mode. All other features remain automatically controlled. Making any manual selection causes the word AUTO in the display to go out.

## Fan Control

Press the  ▲ button to increase the fan speed and airflow. Press the  ▼ button to decrease it.

## *Air Conditioning (A/C) Button*

This button turns the air conditioning on and off. You will see A/C ON or A/C OFF in the display.

When you turn the A/C off, the system cannot regulate the inside temperature if you set the temperature control below the outside temperature.

## *Recirculation Button*

When the indicator in the button is on, air from the vehicle's interior is sent through the system again. When the indicator is off, air is brought in from the outside of the vehicle (fresh air mode).

The outside air intakes for the climate control system are at the base of the windshield. Keep this area clear of leaves and other debris.

The system should be left in fresh air mode under almost all conditions. Keeping the system in recirculation mode, particularly with the A/C off, can cause the windows to fog up.

Switch to recirculation mode when driving through dusty or smoky conditions, then return to fresh air mode.

# Climate Control System

---

## **Rear Window Defogger**

**Button** 

This button turns the rear window defogger off and on (see page 129).

### *If equipped*

Pushing this button also turns the power mirror heaters on and off.

## **Mode Control**

Use the mode control button to select the vents the air flows from. Some air will flow from the dashboard vents in all modes.

 Air flows from the center and corner vents in the dashboard.

 Airflow is divided between the vents in the dashboard and the floor vents.

 Air flows from the floor vents.

 Airflow is divided between the floor and corner vents and the defroster vents at the base of the windshield.

## **Windshield Defroster Button**

This button directs the main airflow to the windshield for faster defrosting. It also overrides any mode selection you may have made.

When you select , the system automatically switches to fresh air mode and turns on the A/C. For faster defrosting, manually set the fan speed to high. You can also increase airflow to the windshield by closing the corner vents on the dashboard. To close the vents, rotate the wheel under each corner vent.

When you turn off  by pressing the button again, the system returns to its former settings.

For your safety, make sure you have a clear view through all the windows before driving.

When the indicator in the button is on, the front passenger's temperature cannot be set separately from the driver's.

## Rear Climate Controls

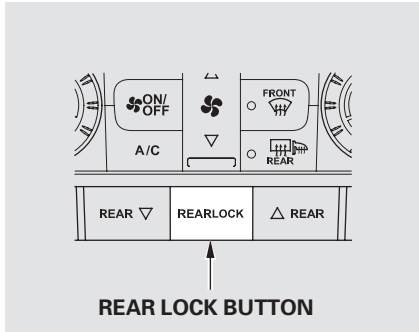

### *Rear Lock Button*

When this button is on, you will see LOCK on the system display. The rear climate controls can only be controlled by the front control panel. See page 201 for how to use the rear lock button.

## REAR CONTROL PANEL

REAR PASSENGER  
COMPARTMENT  
TEMPERATURE

REAR PASSENGER  
COMPARTMENT  
TEMPERATURE  
CONTROL BUTTONS

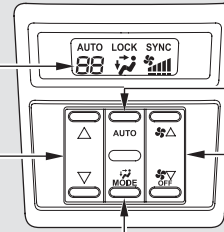

MODE BUTTON

AUTO BUTTON

FAN CONTROL/  
OFF BUTTON

### *Temperature Control*

Press the ▲ temperature control button to increase the temperature of airflow, and the ▼ button to decrease it. The temperature you adjust is shown in the system display.

CONTINUED

# Climate Control System



---

## *Fan Control*

Press the  fan control button to increase the fan speed and airflow.

Press the  button to decrease it. The level of the fan speed is shown in the display.

## *Mode Control*

Each time you press the mode button, the mode display changes from  to .

When  is selected, air flows from the upper vents on the back of the center console.

When  is selected, air flows from the lower vents.

## *Automatic Operation*

Pressing the AUTO button puts the system in automatic operation mode. The rear system automatically adjusts the fan speed and airflow levels to maintain the selected temperature of the rear passenger compartment. You will see AUTO in the display.

To shut off the rear climate control system, press the OFF button until the system shuts off, or push and hold rear lock button for 3 seconds. To turn on the system, press the rear lock button once, or press fan speed up button on rear control.

## Triple Zone Temperature Control

The temperatures of the driver's side and the front passenger's side can be controlled independently.

When the REAR LOCK button is off, the temperature of the rear passenger compartment can be controlled independently.

To adjust each temperature, press either of the temperature control buttons (▲ or ▼) on the climate control panel.

When you set each temperature to its lower limit or its upper limit, it will be displayed as "Lo" or "Hi."

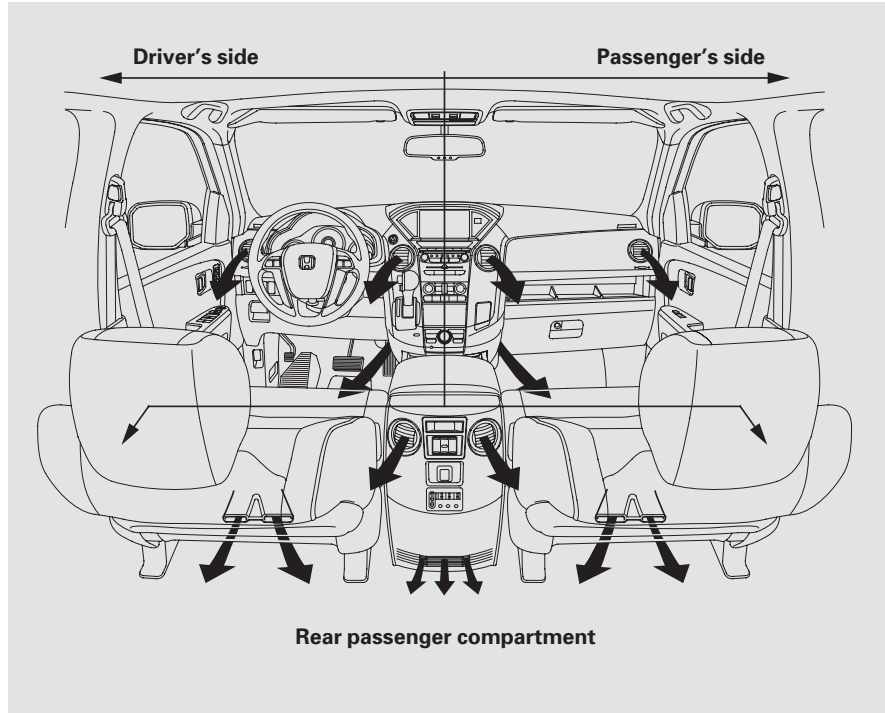

# Climate Control System

---

## Sunlight and Temperature Sensors

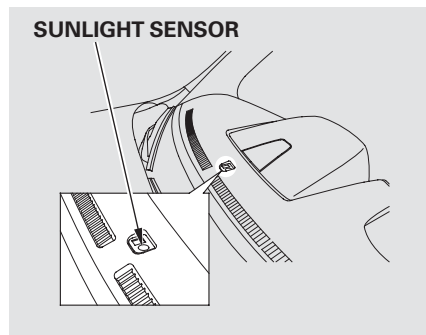

The climate control system has two sensors: a sunlight sensor on top of the dashboard, and a temperature and humidity sensor next to the steering column. Do not cover the sensors or spill any liquid on them.

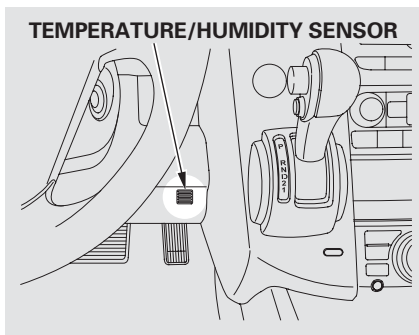



An audio system is standard on all models. Read the appropriate pages (as shown below) to use your vehicle's audio system.

For LX models, see pages 212 through 226 .

For vehicles without navigation system, see pages 227 through 297 .

For vehicles with navigation system, see pages 298 through 395 .

For vehicles with rear entertainment system, see pages 396 through 428 .

## *Without Navigation system*

### U.S. LX models

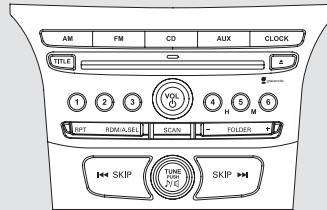

### U.S. EX and Canadian LX models

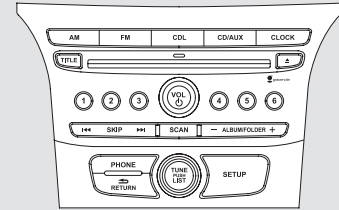

CONTINUED

## Without Navigation system

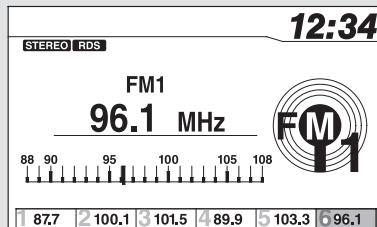

## Canadian EX models

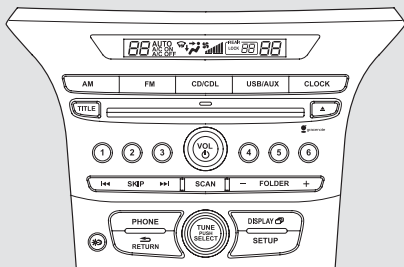

## EX-L models without Rear Entertainment System

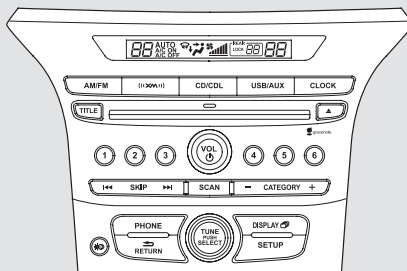

## EX-L models with Rear Entertainment System

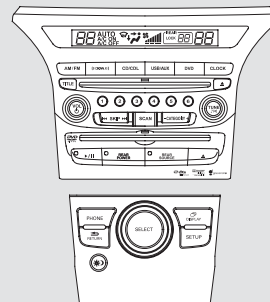

## With Navigation system

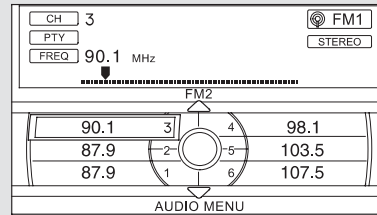

U.S. EX-L models

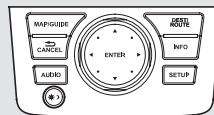
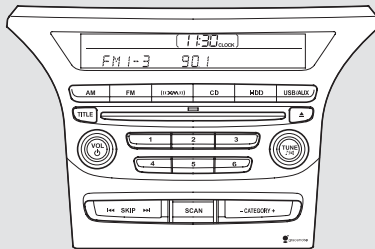

Touring models

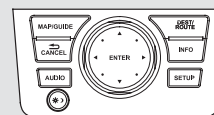
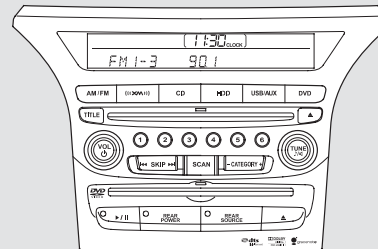

# Playing the FM/AM Radio (U.S. LX model)

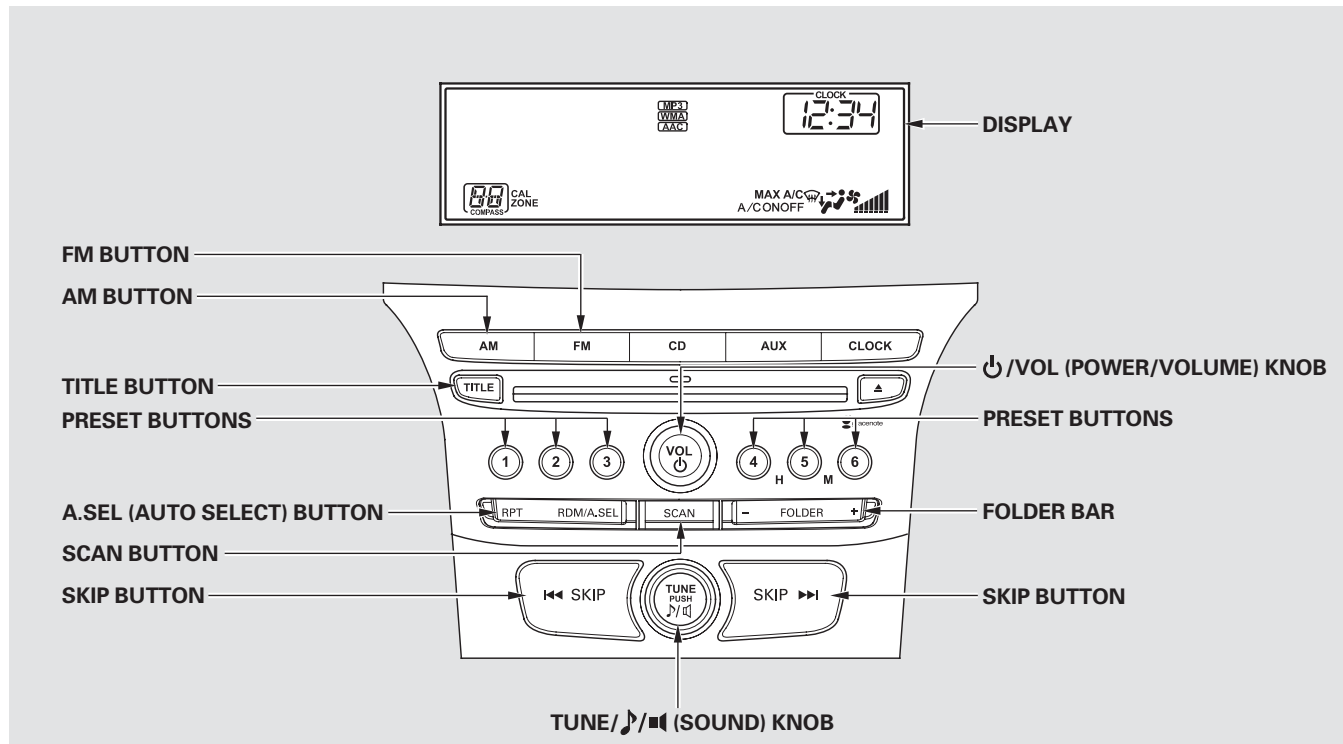

## To Play the Radio

The ignition switch must be in the ACCESSORY (I) or ON (II) position. Turn the system on by pushing the power/volume knob or the AM or FM button. Adjust the volume by turning the power/volume knob.

The band and frequency that the radio was last tuned to are displayed. To change bands, press the AM or FM button. On the FM band, ST will be displayed if the station is broadcasting in stereo. Stereo reproduction in AM is not available.

On the AM band, AM noise reduction turns on automatically.

## To Select a Station

You can use any of five methods to find radio stations on the selected band: tune, skip, scan, the preset buttons, and auto select.

On the FM band, you can also use the features provided by the radio data system (RDS). For more information on the RDS, see page 215 .

**TUNE** — Use the TUNE knob to tune the radio to a desired frequency. Turn the knob right to tune to a higher frequency, or left to tune to a lower frequency.

**SKIP** — The skip function searches up and down from the current frequency to find a station with a strong signal. To activate it, press either of the SKIP buttons ( ◀◀ or ▶▶ ), then release it.

Each time you press and release either of the SKIP buttons ( ◀◀ or ▶▶ ), the radio frequency changes in small increments.

**SCAN** — The scan function samples all stations with strong signals on the selected band. To activate it, press the SCAN button, then release it. You will see SCAN in the display. When the system finds a strong signal, it will stop and play that station for about 10 seconds.

If you do nothing, the system will scan for the next strong station and play it for 10 seconds. When it plays a station that you want to listen to, press the SCAN button again.

*CONTINUED*

## Playing the FM/AM Radio (U.S. LX model)

---

**Preset** — Each preset button can store one frequency on AM and two frequencies on FM.

1. Select the desired band, AM or FM. FM1 and FM2 let you store six stations each.
2. Use the tune, skip, scan, or RDS function to tune the radio to a desired station.
3. Pick a preset button, then press and hold it until you hear a beep.
4. Repeat steps 1 through 3 to store a total of six stations on AM and twelve stations on FM.

**AUTO SELECT** — If you are traveling and can no longer receive your preset stations, you can use the auto select feature to find stations in the local area.

Press the A. SEL button. “A-SEL” flashes in the display, and the system goes into scan mode for several seconds. It stores the frequencies of six AM and twelve FM stations in the preset buttons.

You will see a “0” displayed after pressing a preset button if auto select cannot find a strong station for that preset button.

If you do not like the stations auto select has stored, you can store other frequencies on the preset buttons as previously described.

*To turn off auto select*, press the A. SEL (auto select) button. This restores the presets you originally set.

For information on FM/AM radio frequencies and reception, see page 389.

### **Radio Data System (RDS)**

On the FM band, you can select a favorite station and display the program service name provided by the radio data system (RDS).

### ***Program Service (PS) Name Display***

The program service name display function shows the name of the station you are listening to. You can turn this function on or off.

To switch the function between on and off, press and release the TITLE button. With the system on, you will see the “RDS INFO ON” message on the display. If the station you are listening to is an RDS station, the displayed frequency switches to the station name and the RDS icon will appear.

If the station you are listening to is not an RDS station, the display continues to show the frequency with the PS name display function on.

When you turn off this function by pressing the TITLE button, the display shows “RDS INFO OFF.”

*CONTINUED*

## Playing the FM/AM Radio (U.S. LX model)

---

### **Radio Data System (RDS) Category**

On the FM band selected, you can select the program category provided by the RDS. Press either side of the FOLDER bar (+ or -) to display and select an RDS category. The principal RDS categories are shown as follows;

**ALL:** All RDS category stations

**ROCK:** Rock, classic rock and soft rock music

**COUNTRY:** Country music

**SOFT:** Adult hits and soft music

**TOP 40:** Top 40 hits

**OLDIES:** Nostalgia music and oldies

**R & B:** Rhythm and blues, and soft rhythm and blues

**RELIGION:** Programs concerned with religion

**CLASSIC:** Classical music

**JAZZ:** Jazz

**INFO:** News, information, sports, talk shows, foreign language, personality, public, college, and weather

**TRAFFIC:** Traffic information

Press either side of the FOLDER bar to select an RDS category. The display shows the selected RDS category name for about 10 seconds. You can use the search or scan function to find radio stations on the selected RDS category. If you do nothing while the RDS category name is displayed, the selected category is canceled.

### **RDS Program Search**

This function searches up and down a frequency for the strongest signal from the frequencies that carry the selected RDS category information. This can help you to find a station in your favorite category. To activate it, first press either side of the FOLDER bar to select an RDS category, then press and release either of the SKIP buttons ( ◀◀ or ▶▶ ). You will see the selected RDS category name blinking while searching it. When the system finds a station, the selected RDS category name will be displayed again for about 10 seconds.

If the system does not find a station, "NOTHING" blinks for about five seconds, then the system goes back to the last selected station.



### ***RDS Program SCAN***

The scan function samples all stations with strong signals on the selected RDS category. To activate it, first press either side of the FOLDER bar to select an RDS category, then press and release the SCAN button. You will see SCAN in the display. The system will scan for a station with a strong signal in the selected RDS category. You will also see the selected RDS category name blinking while searching it. When it finds a strong signal, it will stop and play that station for about 10 seconds.

If you do nothing, the system will scan for the next strong station and play it for 10 seconds. When it plays a station that you want to listen to, press the SCAN button again.

If the system does not find a station, “NOTHING” blinks for about five seconds, then the system goes back to the last selected station.

You can use the RDS program search or scan function even if the RDS information display function is off. In this case, the display shows a frequency in place of a RDS station name.

## Playing the FM/AM Radio (U.S. LX model)

---

### Adjusting the Sound

Press the TUNE/  (SOUND) knob repeatedly to display the BASS, TREBLE, FADER, BALANCE, SUBW (subwoofer), and SVC (speed-sensitive volume compensation) settings.

**BASS** – Adjusts the bass.

**TREBLE** – Adjusts the treble.

**FADER** – Adjusts the front-to-back strength of the sound.

**BALANCE** – Adjusts the side-to-side strength of the sound.

**SUBWOOFER** – Adjusts the strength of sound from the subwoofer speaker.

**SVC** – Adjusts the volume level based on the vehicle speed.

Each mode is shown in the display as it changes. Turn the TUNE/  (SOUND) knob to adjust the setting to your liking.

#### *Except SVC adjustment*

When the level reaches the center, you will see “C” in the display.

Wait 10 seconds and the display returns to normal.

#### *Speed-sensitive Volume Compensation (SVC)*

The SVC mode controls the volume based on vehicle speed. The faster you go, the louder the audio volume becomes. As you slow down, the audio volume decreases.

The SVC has four modes: SVC OFF, SVC LOW, SVC MID, and SVC HIGH. Turn the TUNE/

 (SOUND) knob to adjust the setting to your liking. If you feel the sound is too loud, choose low. If you feel the sound is too quiet, choose high.

### Audio System Lighting

You can use the instrument panel brightness control knob to adjust the illumination of the audio system (see page 130 ). The audio system illuminates when the parking lights are on, even if the radio is turned off.

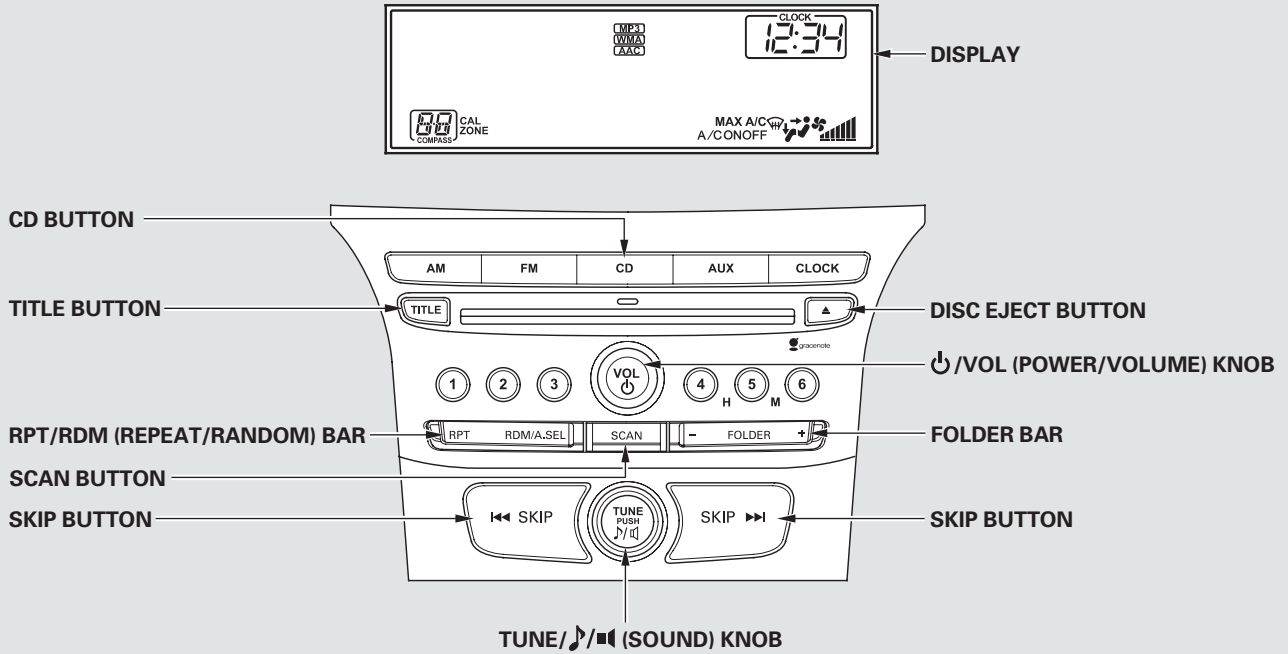

## Playing a Disc (U.S. LX model)

---

### To Play a Disc

To load or play a disc, the ignition switch must be in the ACCESSORY (I) or ON (II) position.

You operate the disc player with the same controls used for the radio. To select the disc player, press the CD button. You will see “CD” in the display.

#### **NOTICE**

*Do not use discs with adhesive labels. The label can curl up and cause the disc to jam in the unit.*

The CD player can play CD-Rs and CD-RWs compressed in MP3, WMA or AAC formats. When playing a disc in MP3, WMA or AAC, you will see “MP3,” “WMA” or “AAC” on the display. A disc can support more than 99 folders, and each folder can hold up to 255 playable files.

If you have a disc that is a combination of CD-DA tracks and MP3/WMA files, you can choose the format to listen by pressing and holding CD button until you hear a beep.

#### **NOTE:**

If a file on an MP3 or WMA disc is protected by digital rights management (DRM), the audio unit displays UNSUPPORTED, and then skips to the next file.

Video CDs and DVDs do not work in this unit.

Depending on the software the files were made with, it may not be possible to play some files, or display some text data.

### *To Load a Disc*

Insert a disc about halfway into the disc slot. The drive will pull the disc in the rest of the way to play it. You operate the disc player with the same controls used for the radio. The number of the current track is shown in the display. When playing a disc in MP3, WMA or AAC, the numbers of the current folder and file are shown. The system will continuously play a disc until you change modes.

You cannot load and play 3-inch (8-cm) discs in this system.

For information on how to handle and protect compact discs, see page 332.

### *Text Data Display Function*

Each time you press the TITLE button, the display shows you the text, if the disc was recorded with text data.

You can see the album, artist, and track name in the display. If a disc is recorded in MP3, WMA or AAC you can see the folder and file name, and the artist, album, and track tag.

When you press and release the TITLE button while a disc without text data is playing, you will see “NO INFO” on the display.

*CONTINUED*

## Playing a Disc (U.S. LX model)

---

The display shows up to about 14 characters of selected text data (the folder name, file name, etc.). If the text data has more than 14 characters, you will see the first 14 characters and the ► indicator in the display. Press and hold the TITLE button until the next 14 characters are shown.

If any letter is not available, it is replaced with “.” (dot) in the display. When the disc has no text data, you will see “NO INFO” on the display.

You will also see some text data under these conditions:

- When a new folder, file, or track is selected.
- When you change the audio mode to play a disc with text data or in MP3, WMA or AAC.
- When you insert a disc, and the system begins to play.

When playing a CD-DA with text data, the album and track name are shown in the display. With a disc in MP3, WMA or AAC the display shows the folder and file name.

### *To Change or Select Tracks/Files*

You can use the SKIP buttons while a disc is playing to select passages and change tracks (files in MP3, WMA or AAC mode).

**SKIP** — Each time you press and release the ►►| SKIP button, the player skips forward to the beginning of the next track (file in MP3, WMA or AAC mode). Press and release the |◄◄ to skip backward to the beginning of the current track. Press it again to skip to the beginning of the previous track.

To move rapidly within a track, press and hold the ►►| or |◄◄ SKIP button.

*In MP3 or WMA mode*

**FOLDER SELECTION** – To select a different folder, press either side of the FOLDER bar. Press the + side of the bar to skip to the next folder, and the – side of the bar to skip to the beginning of the previous folder.

### **REPEAT (TRACK/FILE**

**REPEAT)** – To continuously replay a track (files in MP3 or WMA mode), press and release the RPT side of the RPT/RDM bar. You will see RPT in the display. Press and hold the RPT side for 2 seconds to turn it off.

*In MP3 or WMA mode*

**FOLDER-REPEAT** – This feature, when activated, replays all files in the selected folder in the order they are compressed. To activate folder repeat, press the RPT side of the RPT/RDM bar twice. You will see F-RPT in the display. The system continuously replays the current folder. Press the RPT side of the bar again to turn it off. Pressing the RDM side of the bar, or selecting a different folder with the FOLDER bar also turns off the repeat feature.

Each time you press and release the RPT side of the bar, the mode changes from file repeat to folder repeat, then to normal play.

### **RANDOM (Random within a**

**disc)** – This feature plays the tracks within a disc (the files in MP3 or WMA mode) in random order. To activate random play, press and release the RDM side of the RPT/RDM bar. In MP3 or WMA mode, press the RDM side of the bar repeatedly to select RDM (within a disc random play). You will see RDM in the display. Press the RDM side of the bar for 2 seconds to return to normal play.

CONTINUED

## Playing a Disc (U.S. LX model)

---

*In MP3 or WMA mode*

**FOLDER-RANDOM** – This feature, when activated, plays all files in the selected folder in random order. To activate folder random, press the RDM side of the RPT/RDM bar. You will see F-RDM in the display. The system will then select and play files randomly. This continues until you deactivate folder random by pressing and holding the RDM side of the bar again, or by selecting a different folder with the FOLDER bar.

Each time you press and release the RDM side of the bar, the mode changes from folder random play to random play (within a disc random play), then to normal play.

**SCAN (TRACK/FILE SCAN)** –

The scan function samples all tracks (files in MP3 or WMA) on the disc in the order they are recorded on the disc. To activate scan, press and release the SCAN button. You will see SCAN in the display. You will get a 10 second sampling of each track/file on the disc. Press and hold the SCAN button until you hear a beep to get out of scan mode and play the last track/file sampled.

Pressing either of the SKIP buttons also turns off the scan feature.

*In MP3 or WMA mode*

**F-SCAN (FOLDER SCAN)** – This feature, when activated, samples the first file in each folder on the disc. To activate folder scan, press the SCAN button twice. You will see F-SCAN in the display.

The system plays the first file in the first folder for about 10 seconds. If you do nothing, the system will then play the first files in the next folders for 10 seconds. After playing the first file in the last folder, the system plays normally.

Pressing either of the SKIP buttons, selecting a different folder with the FOLDER bar, or pressing the SCAN button, also turns off the folder scan.

Each time you press and release the SCAN button, the mode changes from file scan to folder scan, then to normal play.



### **To Stop Playing a Disc**

Press the eject button ( ▲ ) to remove the disc. If you eject the disc, but do not remove it from the slot, the system will automatically reload the disc after 10 seconds and begin playing.

You can also eject the disc when the ignition switch is off.

To play the radio when a disc is playing, press the AM or FM button. Press the CD button again to switch back to the disc player.

If you turn the system off while a disc is playing, either with the power/volume knob or by turning off the ignition switch, the disc will stay in the drive. When you turn the system back on, the disc will begin playing where it left off.

### **Protecting Discs**

For information on how to handle and protect compact discs, see page 332 .

## Disc Player Error Messages (U.S. LX model)

---

The chart on the right explains the error messages you may see in the display while playing a disc.

If you see an error message in the display while playing a disc, press the eject button. After ejecting the disc, check it for damage or deformation. If there is no damage, insert the disc again.

For additional information on damaged discs, see page 333 .

The audio system will try to play the disc. If there is still a problem, the error message will reappear. Press the eject button, and pull out the disc. Insert a different disc. If the new disc plays, there is a problem with the first disc. If the error message cycle repeats and you cannot clear it, take your vehicle to a dealer.

| Error Message   | Cause                           | Solution   |
|---|---------------------------------|--|
| UNSUPPORTED   | Track/File format not supported | Current track will be skipped. The next supported track or file plays automatically.   |
| BAD DISC<br>PLEASE CHECK<br>OWNER'S<br>MANUAL PUSH<br>EJECT | Mechanical Error                | Press the eject button and pull out the disc. Check the disc for serious damage, signs of deformation, excessive scratches, and/or dirt (see page 333). Insert the disc again. If the code does not disappear, or the disc cannot be removed, consult your dealer. Do not try to force the disc out of the player. |
| BAD DISC<br>PLEASE CHECK<br>OWNER'S<br>MANUAL               | Servo Error                     |  |

The ejected disc will not be reloaded automatically.

# Audio System (EX, EX-L, and Canadian LX models without navigation system)

## Selector Knob

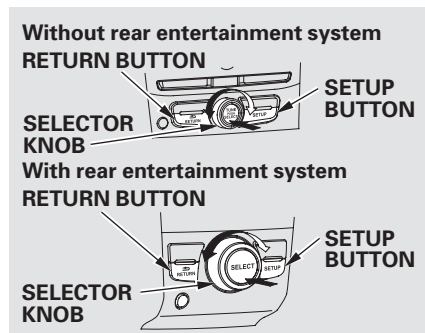

Most audio system functions can be controlled by standard buttons, bars, and knobs. In addition, you can access some functions by using the selector knob on the audio system.

The knob turns left and right. Use it to scroll through lists, or to make selections or adjustments to a list or menu item on the display. When you make a selection, push the center of the selector to go to that selection.

When the audio system is in XM<sup>®</sup> Radio mode or playing discs, pushing the selector knob switches the display between the normal display and the extended display.

## SETUP Display

To select any setting such as the clock or sound adjustment, press the SETUP button. To use any audio system function, the ignition switch must be in the ACCESSORY (I) or ON (II) position. You can select the item by turning the selector knob. To go back to the previous display, press the RETURN button.

Pressing the SETUP button again will also cancel the setup display mode.

# Playing the FM/AM Radio (EX, EX-L, and Canadian LX models without navigation system)

U.S. EX and Canadian LX models

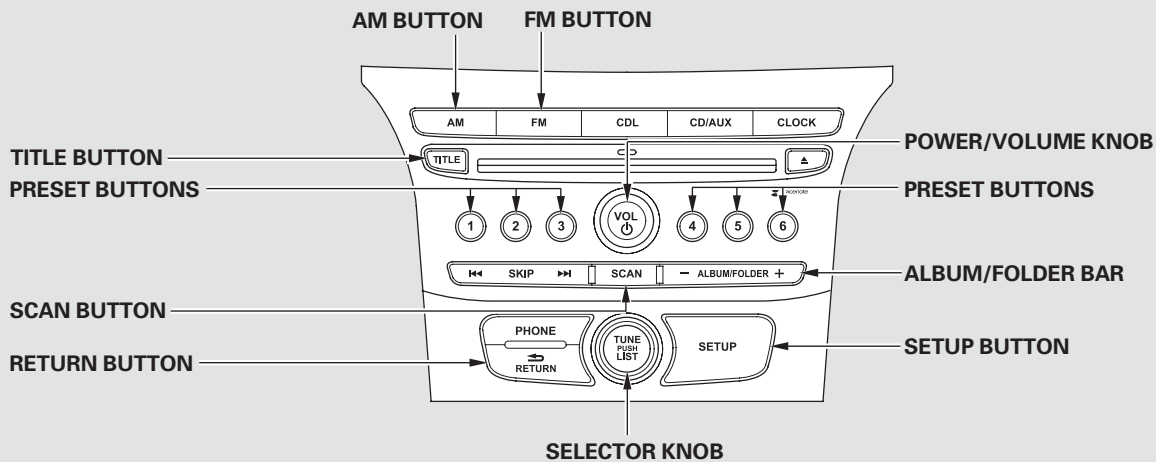
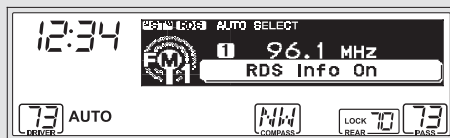

# Playing the FM/AM Radio (EX, EX-L, and Canadian LX models without navigation system)

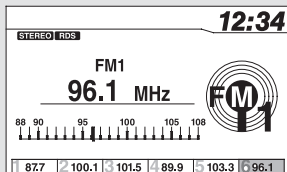

Canadian EX models

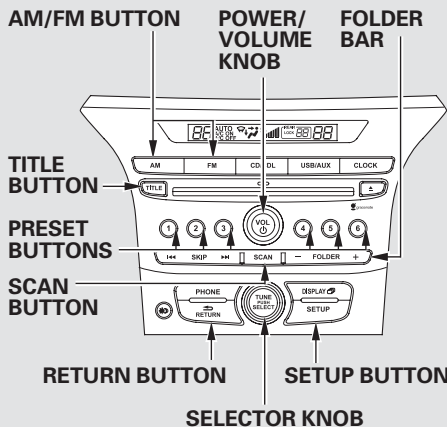

EX-L models

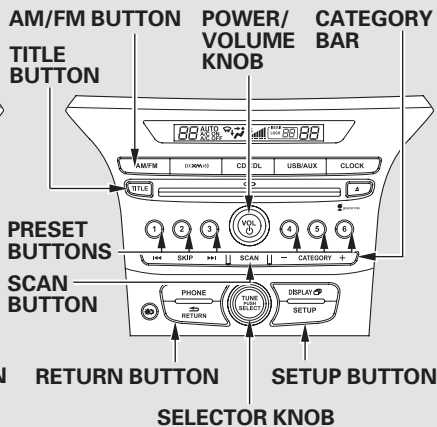

EX-L models with Rear Entertainment System

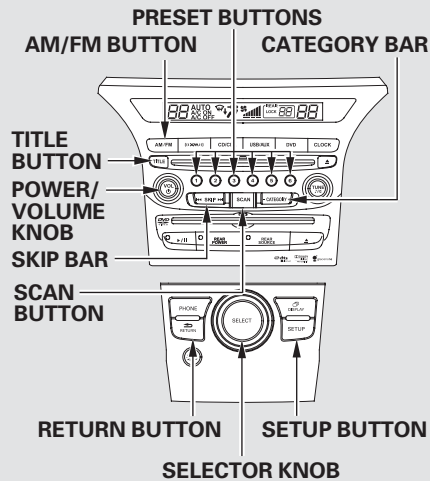

## Playing the FM/AM Radio (EX, EX-L, and Canadian LX models without navigation system)

---

### To Play the Radio

The ignition switch must be in the ACCESSORY (I) or ON (II) position. Turn the system on by pushing the power/volume knob. Adjust the volume by turning the same knob.

The band and frequency that the radio was last tuned to are displayed. To change bands, press the AM or FM button, or AM/FM button. On the FM band, ST will be displayed if the station is broadcasting in stereo. Stereo reproduction in AM is not available.

On the AM band, AM noise reduction turns on automatically.

### To Select a Station

You can use any of five methods to find radio stations on the selected band: tune, seek, scan, the preset buttons, and auto select.

On the FM band, you can also use the features provided by the radio data system (RDS). For more information on the RDS, see page 232 .

**TUNE** — Use the selector knob to tune the radio to a desired frequency. Turn the knob right to tune to a higher frequency, or left to tune to a lower frequency.

**SKIP** — The skip function searches up and down from the current frequency to find a station with a strong signal. To activate it, press and hold the ►► or ◄◄ side of the SKIP bar until you hear a beep, then release it.

## Playing the FM/AM Radio (EX, EX-L, and Canadian LX models without navigation system)

**SCAN** – The scan function samples all stations with strong signals on the selected band. To activate it, press the SCAN button, then release it. You will see SCAN in the display. When the system finds a strong signal, it will stop and play that station for about 10 seconds.

If you do nothing, the system will scan for the next strong station and play it for 10 seconds. When it plays a station that you want to listen to, press the SCAN button again.

**Preset** – Each preset button can store one frequency on AM and two frequencies on FM.

1. Select the desired band, AM or FM. You can store one frequency on FM1, and one frequency on FM2 with each preset button.
2. Use the tune, skip, scan, or RDS function to tune the radio to a desired station.
3. Pick a preset button, then press and hold it until you hear a beep.
4. Repeat steps 1 through 3 to store a total of six stations on AM and twelve stations on FM.

**AUTO SELECT** – If you are traveling and can no longer receive your preset stations, you can use the auto select feature to find stations in the local area.

Push the SETUP button to display the setup MENU. Turn the selector knob to select Auto Select, then press the selector knob. The display changes to the auto select mode. Select “ON,” then press the selector knob. You will see Auto Select on the display, and the system goes into the auto select mode for several seconds.

If you do not like the stations auto select has stored, you can store other frequencies on the preset buttons as previously described.

*CONTINUED*

## Playing the FM/AM Radio (EX, EX-L, and Canadian LX models without navigation system)

You will see “0” displayed if auto select cannot find a strong station for every preset button.

*To cancel auto select, select Auto Select on the setup menu again and turn the selector knob to select “OFF,” then press the selector knob. This restores the presets you originally set.*

For information on FM/AM radio frequencies and reception, see page 389.

### Radio Data System (RDS)

On the FM band, you can select a favorite station and display the program service name provided by the radio data system (RDS).

### RDS INFO Display

The RDS information display function shows the name of the RDS station you are listening to. With the audio system on and the FM band selected, you can turn this function on or off.

### U.S. EX and Canadian LX models

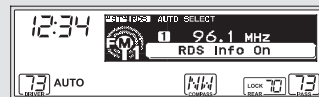

### EX-L and Canadian EX models

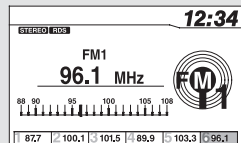

*On U.S. EX and Canadian LX models*  
To switch the function between on and off, press and release the TITLE button. With the system on, you will see the “RDS Info On” message briefly on the display. If the station you are listening to is an RDS station, the display shows the station name.



## Playing the FM/AM Radio (EX, EX-L, and Canadian LX models without navigation system)

If the station you are listening to is not an RDS station, the display continues to show the frequency with the PS name display function on.

When you turn off this function by pressing the TITLE button, the display briefly shows “RDS Info Off.”

### *On EX-L and Canadian EX models*

If the station you are listening to is an RDS station, the RDS icon appears in the display. To switch the function between on and off, press and release the TITLE button. With the system on, you will see the station name on the display.

You can turn off this function by pressing the TITLE button.

### **Radio Data System (RDS) Category**

On the FM band selected, you can select the program category provided by the RDS. Press either side (– or +) of the FOLDER bar or the CATEGORY bar to display and select an RDS category. The principal RDS categories are shown as follows:

ALL: All RDS category stations  
ROCK: Rock, classic rock and soft rock music  
COUNTRY: Country music  
SOFT: Adult hits and soft music  
TOP 40: Top 40 hits  
OLDIES: Nostalgia music and oldies  
R & B: Rhythm and blues, and soft rhythm and blues  
RELIGION: Programs concerned with religion

CLASSIC: Classical music

JAZZ: Jazz

INFO: News, information, sports, talk shows, foreign language, personality, public, college, and weather

TRAFFIC: Traffic information

Press either side of the FOLDER bar or the CATEGORY bar to select an RDS category. The display shows the selected RDS category name for about 10 seconds. You can use the search or scan function to find radio stations on the selected RDS category. If you do nothing while the RDS category name is displayed, the selected category is canceled.

CONTINUED

## Playing the FM/AM Radio (EX, EX-L, and Canadian LX models without navigation system)

---

### *RDS Program Search*

This function searches up and down a frequency for the strongest signal from the frequencies that carry the selected RDS category information. This can help you to find a station in your favorite category. To activate it, press either side of the FOLDER bar to select an RDS category, then press and release either side (◀◀ or ▶▶) of the SKIP bar. You will see the selected RDS category name blinking while searching it. When the system finds a station, the selected RDS category name will be displayed again for about 10 seconds.

If the system does not find a station, “No selected category found” or “NOTHING” blinks for about 5 seconds, then the system goes back to the last selected station.

### *RDS Program SCAN*

The scan function samples all stations with strong signals on the selected RDS category. To activate it, press either side of the FOLDER bar or the CATEGORY bar to select an RDS category, then press and release the SCAN button. You will see SCAN in the display. The system will scan for a station with a strong signal in the selected RDS category. You will also see the selected RDS category name blinking while searching it. When it finds a strong signal, it will stop and play that station for about 10 seconds.

If you do nothing, the system will scan for the next strong station and play it for 10 seconds. When it plays a station that you want to listen to, press the SCAN button again.

If the system does not find a station, “No selected category found” or “NOTHING” blinks for about 5 seconds, then the system goes back to the last selected station.

You can use the RDS program search or scan function even if the RDS information display function is off.

# Playing the FM/AM Radio (EX, EX-L, and Canadian LX models without navigation system)

## Adjusting the Sound

On U.S. EX and Canadian LX models

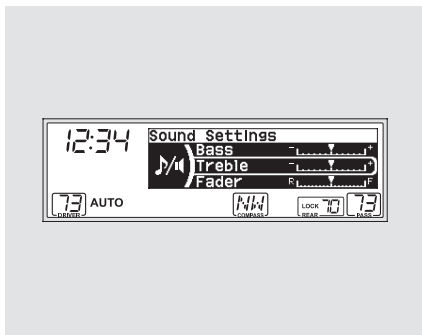

Press the SETUP button to display the sound settings. Turn the selector knob to select an appropriate setting: BASS, TREBLE, FADER, BALANCE, SUBW (subwoofer), and SVC (speed-sensitive volume compensation). Press the selector knob to enter the setting, then turn the selector knob to adjust the setting.

On EX-L and Canadian EX models

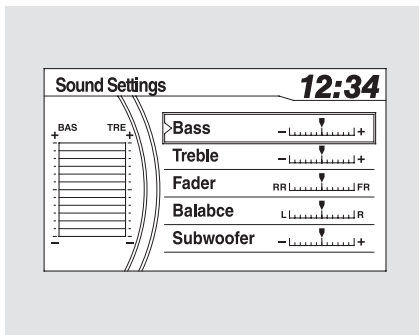

Press the SETUP button to display the Setup menu. Turn the selector knob to select Sound Settings, then press the selector knob. Turn the selector knob to select an appropriate setting: Bass, Treble, Fader, Balance, Subwoofer, and SVC (speed-sensitive volume compensation). Press the selector knob to enter the setting, then turn the selector knob to adjust the

setting. Press the selector knob again to set your setting.

**BASS** — Adjusts the bass.

**TREBLE** — Adjusts the treble.

**FADER** — Adjusts the front-to-back strength of the sound.

**BALANCE** — Adjusts the side-to-side strength of the sound.

**SUBW (SUBWOOFER)** — Adjusts the strength of sound from the subwoofer speaker.

**SVC** — Adjusts the volume level based on the vehicle speed.

CONTINUED

## Playing the FM/AM Radio (EX, EX-L, and Canadian LX models without navigation system)

---

Each mode is shown in the display as it changes. Turn the selector knob to adjust the setting to your liking.

Wait a few seconds and the display returns to normal or press the RETURN or MENU button.

### *Speed-sensitive Volume Compensation (SVC)*

The SVC mode controls the volume based on vehicle speed. The faster you go, the louder the audio volume becomes. As you slow down, the audio volume decreases.

The SVC has four modes: SVC OFF, SVC LOW, SVC MID, and SVC HIGH. Turn the selector knob to adjust the setting to your liking. If you feel the sound is too loud, choose low. If you feel the sound is too quiet, choose high.

### **Audio System Lighting**

You can use the instrument panel brightness control knob to adjust the illumination of the audio system (see page 130 ). The audio system illuminates when the parking lights are on, even if the radio is turned off.

# Playing the XM® Radio (EX-L model without navigation system)

|               |              |
|---------------|--------------|
| Channel       | <b>12:34</b> |
| 205 : AAAAA   |              |
| ➤ 206 : BBBBB |              |
| 207 : CCCCC   |              |
| 208 : DDDDD   |              |
| 209 : EEEEE   |              |

EX-L models

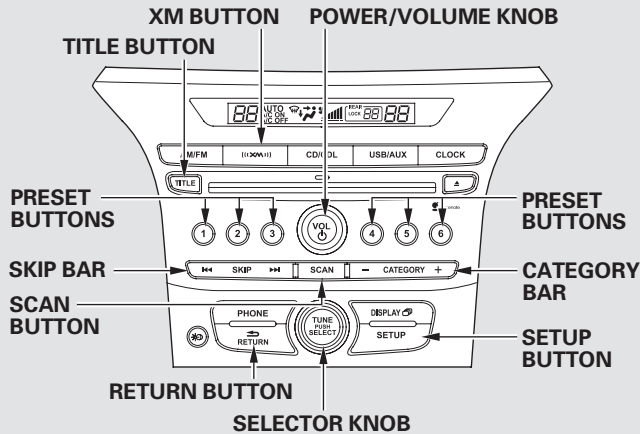

EX-L models with Rear Entertainment System

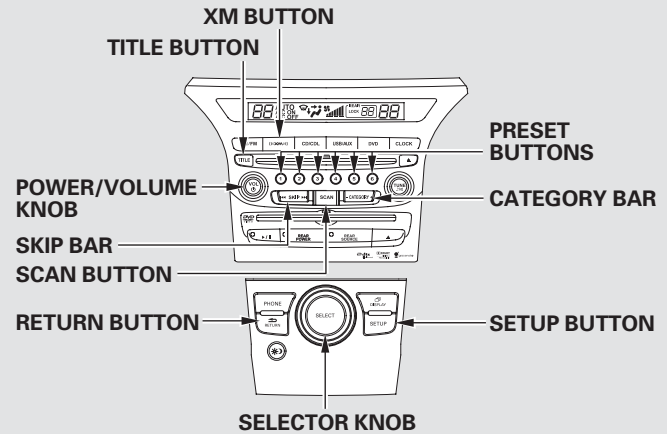

CONTINUED

## Playing the XM® Radio (EX-L model without navigation system)

---

Your vehicle is capable of receiving XM® Radio anywhere in the United States and Canada, except Hawaii, Alaska, and Puerto Rico. XM is a registered trademark of Sirius XM Radio®, Inc. and XM CANADA® is a registered business name of Canadian Satellite Radio Inc.

XM Radio receives signals from two satellites to produce clear, high-quality digital reception. It offers many channels in several categories. Along with a large selection of different types of music, XM Radio allows you to view channel and category selections in the display.

### Operating the XM Radio

To listen to XM Radio, turn the ignition switch to the ACCESSORY (I) or ON (II) position, and press the «» button. The last channel you listened to will show in the display. Adjust the volume by turning the power/volume knob.

**MODE** — To switch between channel mode and category mode, press and hold the TITLE button until the mode changes.

In the channel mode, you can select all of the available channels. In the category mode, such as Jazz, Rock, Classical, etc., you can select all of the channels within that category.

You can also change the mode from the setup menu. Press the SETUP button to display the setup menu. Turn the selector knob to select XM Mode and press the selector knob. You can select Channel mode or Category mode by turning and pressing the selector knob.

Each time you press and release the TITLE button, the display changes from artist name to song name.

You may experience periods when XM Radio does not transmit the artist's name and song title information. If this happens, there is nothing wrong with your system.

## Playing the XM® Radio (EX-L model without navigation system)

**TUNE** – Turn the selector knob to change channel selections. Turn the knob right for higher numbered channels and left for lower numbered channels. In the category mode, you can only select channels within that category.

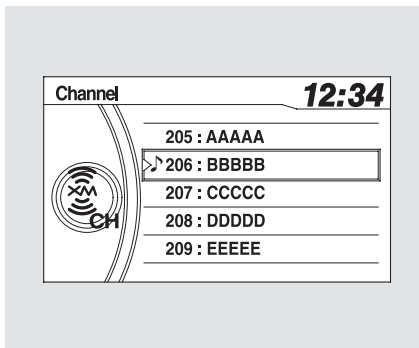

You can also select a channel from the list by using the selector knob. Push the selector knob to switch the display to the list, then turn the knob to select a channel. Press the selector knob to set your selection.

**CATEGORY** (– or +) – Press either side of the CATEGORY bar to select another category.

**SCAN** – The SCAN function gives you a sampling of all channels while in the channel mode. In the category mode, only the stations within that category are scanned. To activate scan, press the SCAN button. The system plays each channel in numerical order for a few seconds, then selects the next channel. When you hear a channel you want to continue listening to, press the button again.

CONTINUED

## Playing the XM<sup>®</sup> Radio (EX-L model without navigation system)

---

**Preset** — You can store up to 12 preset channels using the six preset buttons. Each button stores one channel from the XM1 band and one channel from the XM2 band.

To store a channel:

1. Press the «XM» button. Either XM1 or XM2 will show in the display.

2. Use the selector knob, SKIP bar, CATEGORY bar or SCAN button to tune to a desired channel.

In category mode, only channels within that category can be selected. In channel mode, all channels can be selected.

3. Pick the preset button you want for that channel. Press and hold the button until you hear a beep.

4. Repeat steps 2 and 3 to store the first six channels.

5. Press the «XM» button again. The other XM band will show. Store the next six channels using steps 2 and 3.

Once a channel is stored, simply press and release the proper preset button to tune to it.

### XM Radio Display Messages

**“LOADING”** — XM is loading the audio or program information.

**“OFF AIR”** — The channel currently selected is no longer broadcasting.

**“UNAUTHORIZED”** — The encryption code is being updated. Wait until the encryption code is fully updated. Channels 0 and 1 should still work normally.

**“NO SIGNAL”** — The signal is currently too weak. Move the vehicle to an area away from tall buildings, and with an unobstructed view of the southern horizon.

**“UNAVAILABLE”** — The selected channel number does not exist, is not part of your subscription, or this channel has no artist or title information at this time.

**“NO INFO”** — The selected channel has no artist or title information at this time.

**“CHECK ANTENNA”** — There is a problem with the XM antenna. Please consult your dealer.



## Playing the XM® Radio (EX-L model without navigation system)

The XM satellites are in orbit over the equator; therefore, objects south of the vehicle may cause satellite reception interruptions. To help compensate for this, ground-based repeaters are placed in major metropolitan areas.

Satellite signals are more likely to be blocked by tall buildings and mountains the farther north you travel from the equator. Carrying large items on a roof rack can also block the signal.

Depending on where you drive, you may experience reception problems. Interference can be caused by any of these conditions:

- Driving on the north side of an east/west mountain road.
- Driving on the north side of a large commercial truck on an east/west road.
- Driving in tunnels.

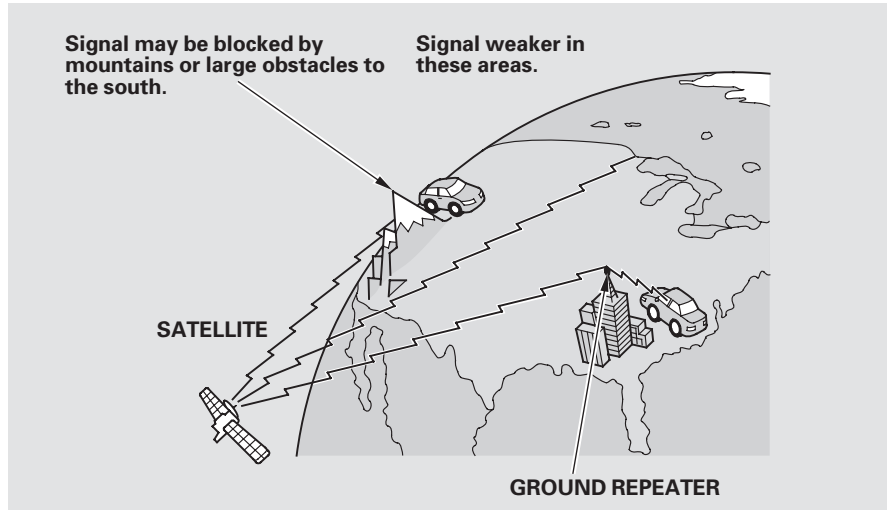

- Driving on a road beside a vertical wall, steep cliff, or hill to the south of you.
- Driving on the lower level of a multi-tiered road.

- Large items carried on a roof rack.

*CONTINUED*

## Playing the XM® Radio (EX-L model without navigation system)

---

- Driving on a single lane road alongside dense trees taller than 50 ft. (15 m) to the south of you.

*This Category II radiocommunication device complies with Industry Canada Standard RSS-310.*

*Operation is subject to the following two conditions: (1) this device may not cause interference, and (2) this device must accept any interference, including interference that may cause undesired operation of the device.*

There may be other geographic situations that could affect XM Radio reception.

*As required by the FCC:  
Changes or modifications not expressly approved by the party responsible for compliance could void the user's authority to operate the equipment.*

### **Receiving XM Radio Service**

If your XM Radio service has expired or you purchased your vehicle from a previous owner, you can listen to a sampling of the broadcasts available on XM Radio. With the ignition switch in the ACCESSORY (I) or the ON (II) position, press the «**XM**» button. A variety of music types and styles will play.

If you decide to purchase XM radio service, contact XM Radio at [www.siriusxm.com](http://www.siriusxm.com), or at 1-800-852-9696. In Canada, contact XM CANADA® at [www.xmradio.ca](http://www.xmradio.ca), or at 1-877-209-0079. You will need to give them your radio I.D. number and your credit card number. To get your radio I.D. number, press the «**XM**» button, then turn the selector knob until “CH 000” appears in the display. Your I.D. will appear in the display.

After you've registered with XM Radio, keep your audio system in the XM Radio mode while you wait for activation. This should take about 30 minutes.

While waiting for activation, make sure your vehicle remains in an open area with good reception. XM Radio will continue to send an activation signal to your vehicle for at least 12 hours from the activation request. If the service has not been activated after 36 hours, contact XM® Radio. In Canada, contact XM CANADA®.

# Playing a Disc (EX, EX-L, and Canadian LX models without navigation system)

U.S. EX and Canadian LX models

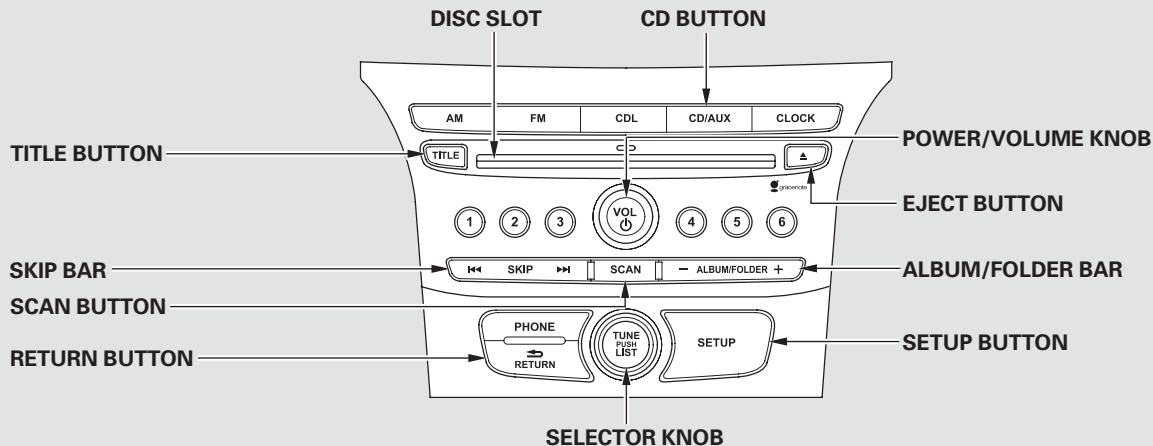
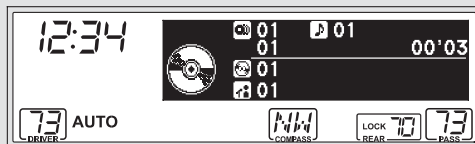

CONTINUED

# Playing a Disc (EX, EX-L, and Canadian LX models without navigation system)

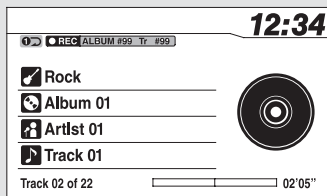

## Canadian EX models

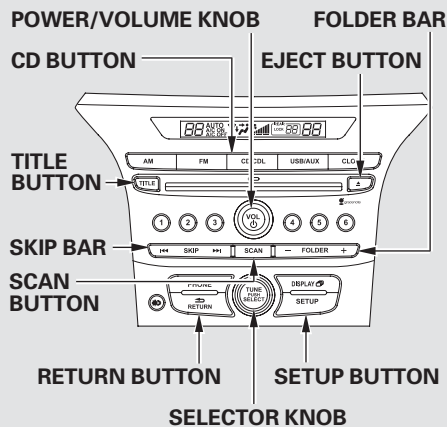

## EX-L models

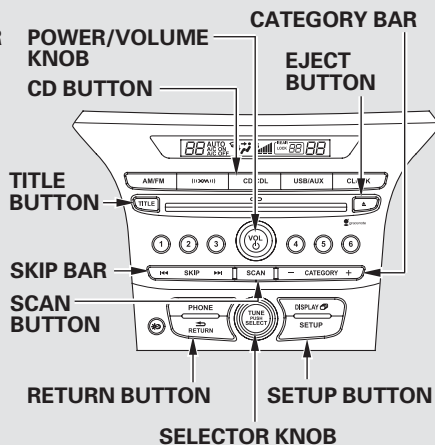

## EX-L models with Rear Entertainment System

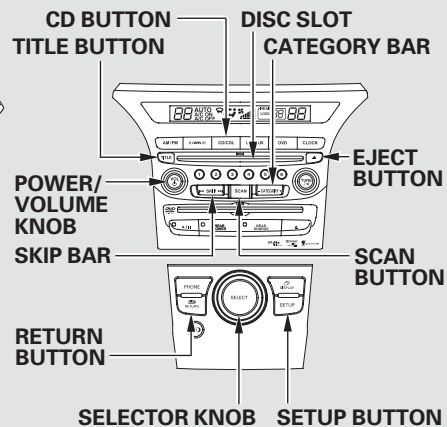

## Playing a Disc (EX, EX-L, and Canadian LX models without navigation system)

### To Play a Disc

To load or play a disc, the ignition switch must be in the ACCESSORY (I) or ON (II) position.

You operate the disc player with the same controls used for the radio. To select the disc player, press the CD button. You will see “CD” in the display. The number of the track playing is shown in the display. The system will continuously play a disc until you change modes.

Title information will be displayed by a list when the information is found in the Gracenote® Album Info (Gracenote® Media Database).

When you play a CD recorded with text data, you will see the genre, artist name, album and track name on the screen. When you play MP3/WMA/AAC discs, you will see the genre, artist name, album name and track name on the screen. If the disc was not recorded with this information, it will not be displayed.

You cannot load and play 3-inch (8-cm) discs in this system.

### NOTICE

*Do not use discs with adhesive labels. The label can curl up and cause the disc to jam in the unit.*

Video CDs and DVDs do not work in this unit.

The CD player can play CD-Rs and CD-RWs compressed in MP3, WMA or AAC formats. When playing a disc in MP3, WMA or AAC, you will see “MP3,” “WMA” or “AAC” on the display. A disc can support more than 99 folders, and each folder can hold up to 255 playable files.

CONTINUED

## Playing a Disc (EX, EX-L, and Canadian LX models without navigation system)

---

### **NOTE:**

If a file on a WMA disc is protected by digital rights management (DRM), the audio unit displays UNSUPPORTED, and then skips to the next file.

Depending on the software the files were made with, it may not be possible to play some files, or display some text data.

### ***Text Data Display Function***

*On U.S. EX and Canadian LX models*  
Each time you press the TITLE button, the display shows you the text, if the disc was recorded with text data.

If you select name off, the text display is turned off.

You can see the album, artist, and track name in the display. If a disc is recorded in MP3, WMA or AAC you can see the folder and file name, and the artist, album, and track tag.

With the folder name, you will see the FOLDER indicator in the display. The TRACK indicator is shown with the file or track name.

When you press and release the TITLE button while a disc without text data is playing, you will see “No album database information” on the display.

The display shows up to 16 characters of selected text data (the folder name, file name, etc.).

## Playing a Disc (EX, EX-L, and Canadian LX models without navigation system)

---

If the text data has more than 16 characters, you will see the first 16 characters and the ► indicator in the display. Press and hold the TITLE button until the next 16 characters are shown. You can see up to 32 characters of the text data.

If you press and hold the TITLE button again, the display shows the first 16 characters again.

If any letter is not available, it is replaced with “.” (dot) in the display. When the disc has no text data, you will see “No album database information” on the display.

You will also see some text data under these conditions:

- When a new folder, file, or track is selected.
- When you change the audio mode to play a disc with text data or in MP3, WMA or AAC.
- When you insert a disc, and the system begins to play.

When playing a CD-DA with text data, the album and track name are shown in the display. With a disc in MP3, WMA or AAC the display shows the folder and file name.

*On EX-L and Canadian EX models*  
In MP3 or WMA mode, each time you press and release the TITLE button, the display changes between track name and file name.

CONTINUED

## Playing a Disc (EX, EX-L, and Canadian LX models without navigation system)

---

### *Loading Discs*

Insert a disc about halfway into the disc slot. The drive will pull the disc in the rest of the way to play it. You operate the disc player with the same controls used for the radio. The number of the current track is shown in the display. When playing a disc in MP3, WMA or AAC, the numbers of the current folder and file are shown. The system will continuously play a disc until you change modes.

For information on how to handle and protect compact discs, see page 332 .

**SKIP** – Each time you press and release the ►► side of the SKIP bar, the player skips forward to the beginning of the next track (file in MP3, WMA or AAC mode). Press and release the ◀◀ side of the bar to skip backward to the beginning of the current track. Press it again to skip to the beginning of the previous track.

To move rapidly within a track or file, press and hold either side ( ◀◀ or ►► ) of the SKIP bar.

Turning the selector knob to the right or left also changes a file.

When you insert a CD for the first time, the recording CD prompt will appear on the display. If you select “Yes,” the system will start recording to the flash memory. For information on recording from music CDs, see page 257 .

When you insert a CD for the first time, a Gracenote notification appears. For more information, see page 360 .



## Playing a Disc (EX, EX-L, and Canadian LX models without navigation system)

*In MP3 or WMA mode*

**FOLDER SELECTION** – To select a different folder, press either side (+ or –) of the FOLDER bar or the CATEGORY bar to move to the beginning of the next folder. Press the + side to skip to the next folder, and press the – side to skip to the beginning of the previous folder.

You can also select a track from the list by using the selector knob. Push the selector knob while playing a CD. The display switches to the track list. Then turn the knob to select a track. Press the selector knob to start your selected track.

In MP3, WMA or AAC mode, push the selector knob to switch the display to the folder list then turn the knob to select a folder. Press the selector knob to change the display to the track/file list, then turn the selector knob to select a track/file.

**To Select Repeat, Random or Scan Mode:**

### U.S. EX and Canadian LX models



### EX-L and Canadian EX models

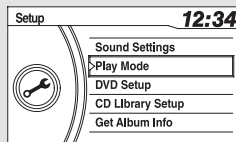

You can select any type of repeat, random and scan modes by using the SETUP button and the selector knob. Push the SETUP button to display the menu items, then turn the selector knob to select “PLAY MODE.” Press the selector knob to set the selection.

Turn the selector knob to select an appropriate repeat, random or scan mode, then press the selector knob to set your selection.

CONTINUED

## Playing a Disc (EX, EX-L, and Canadian LX models without navigation system)

### U.S. EX and Canadian LX models



### EX-L and Canadian EX models

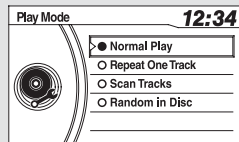

To cancel the selected mode, press the **SETUP** button to show “PLAY MODE,” then press the selector knob. When you see “NORMAL PLAY,” press **ENTER** again.

**REPEAT TRACK** – To continuously replay a track (file in MP3, WMA or AAC mode), select Repeat Track or Repeat One Track from the menu items. You will see the track repeat icon in the display. Select normal play to turn it off.

**REPEAT FOLDER** – This feature, when activated, replays all the files on the selected folder in the order they are compressed in MP3, WMA or AAC. To activate folder repeat mode, select Repeat Folder or Repeat One Folder from the menu items. You will see the folder repeat icon in the display. The system continuously replays the current list. Select normal play to turn it off.

**RANDOM IN FOLDER** – This feature, when activated, plays the files within the current folder in random order, rather than in the order they are compressed in MP3, WMA or AAC. To activate folder random play, select **RANDOM IN FLD** or **Random in FOLDER** from the menu items. You will see the folder random icon in the display. The system will then select and play files randomly. This continues until you deactivate folder random play by selecting it, or you select a different album list with the **FOLDER** bar or the **CATEGORY** bar.

## Playing a Disc (EX, EX-L, and Canadian LX models without navigation system)

---

**RANDOM (Random in Disc)** — This feature plays the tracks on disc (the files in MP3, WMA or AAC mode) in random order. To activate random play, select Random in Disc from the menu items. You will see disc random icon in the display. Select normal play to return to normal play.

**SCAN TRACK (Scan Tracks)** — The SCAN function samples all the tracks on the disc in the order they are recorded on the disc (all files in the selected folder in MP3, WMA or AAC mode). To activate the scan feature, press and release the SCAN button. You will see “SCAN” in the display. You will get a 10 second sampling of each track/file in the disc/folder. Press and hold the SCAN button to get out of scan mode and play the last track sampled.

You can also select the scan feature from the menu items with the selector knob (see page 249).

**SCAN FOLDER (Scan Folders)** — This function samples the first file in each folder on the disc in the order they are stored. To activate the folder scan feature, press and release the SCAN button repeatedly. You will see “F-SCAN” or “SCAN” in the display. You will get a 10 second sampling of the first file in each folder.

You can also select the folder scan feature from the menu items with the selector knob (see page 249).

*CONTINUED*

## Playing a Disc (EX, EX-L, and Canadian LX models without navigation system)

---

To turn this feature off, press and hold the SCAN button for more than 2 seconds, or press and release the selector knob while in scan mode.

Each time you press and release the SCAN button, the mode changes from file scan to folder scan, then to normal play.

### **To Stop Playing a Disc**

To take the system out of the disc mode, press one of the other source buttons than the CD button.

If you turn the system off while a disc is playing, either with the power/volume knob or the ignition switch, play will continue at the same point when you turn it back on.

### **Protecting Discs**

For information on how to handle and protect compact discs, see page 332 .

## Disc Player Error Messages (EX, EX-L, and Canadian LX models without navigation system)

The chart on the right explains the error messages you may see in the display while playing a disc.

If you see an error message in the display while playing a disc, press the eject button. After ejecting the disc, check it for damage or deformation. If there is no damage, insert the disc again.

For additional information on damaged discs, see page 333 .

The audio system will try to play the disc. If there is still a problem, the error message will reappear. Press the eject button, and pull out the disc. Insert a different disc. If the new disc plays, there is a problem with the first disc. If the error message cycle repeats and you cannot clear it, take your vehicle to a dealer.

| Error Message | Cause                           | Solution   |
|---------------|---------------------------------|--|
| UNSUPPORTED   | Track/File format not supported | Current track will be skipped. The next supported track or file plays automatically.   |
| PUSH EJECT    | Mechanical Error                | Press the EJECT button and pull out the disc. Check the disc for serious damage, signs of deformation, excessive scratches, and/or dirt (see page 333). Insert the disc again. If the code does not disappear, or the disc cannot be removed, consult your dealer. Do not try to force the disc out of the player. |
|               | Servo Error                     |  |
| CHECK DISC    | Disc Error                      | Check the disc for serious damage, signs of deformation, excessive scratches, and/or dirt (see page 333).  |

# Playing CD Library Audio (EX, EX-L, and Canadian LX models without navigation system)

U.S. EX and Canadian LX models

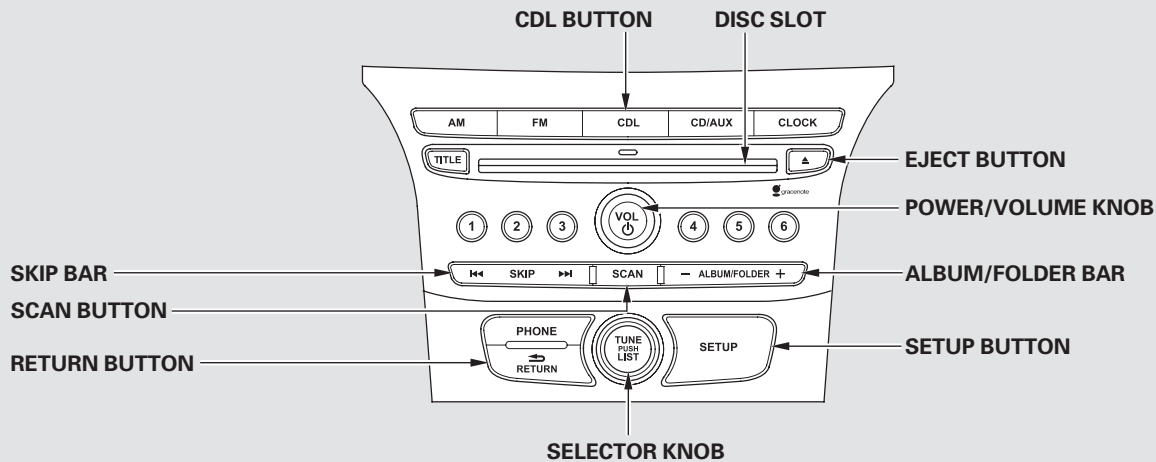

# Playing CD Library Audio (EX, EX-L, and Canadian LX models without navigation system)

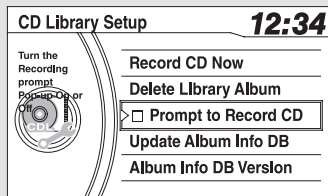

Canadian EX models

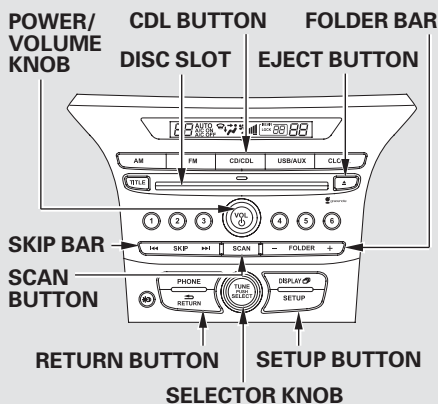

EX-L models

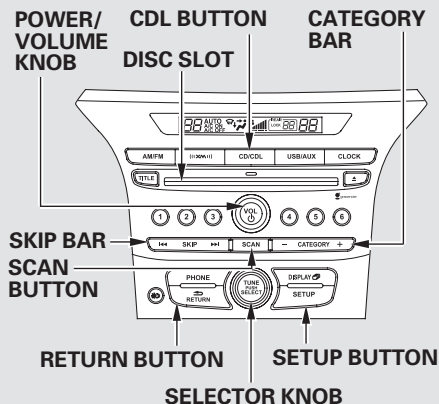

EX-L models with Rear Entertainment System

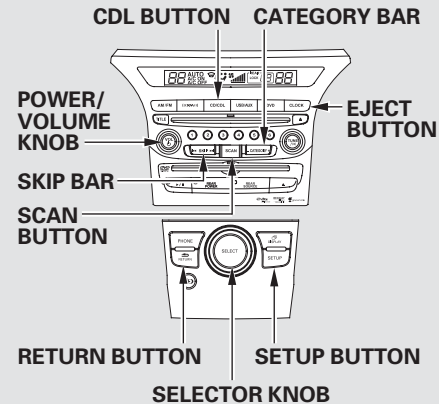

CONTINUED

## Playing CD Library Audio (EX, EX-L, and Canadian LX models without navigation system)

---

### *If equipped*

The CD Library Audio function can record tracks from music CDs to the flash memory. Each music CD is stored on an albumlist. This audio system can store up to 18 albums.

### **NOTE:**

- Only recordings from a standard CD-DA (44.1 kHz, 16 bit stereo PCM digital sound data) to CD Library are supported.
- Digital music files, such as MP3, WMA, AAC etc., from CD-R, DVD-R and USB flash memory devices cannot be copied to the CD Library. Likewise, digital music files recorded in the CD Library cannot be copied to CD-R, DVD-R and USB devices.

- Music data recorded in the CD Library can only be used for personal use.
- Although data is recorded using ultra-efficient compression technology, sound quality may vary slightly from the original.
- Title information will be displayed when the information is found in the Gracenote® Album Info (Gracenote® Media Database) in the built-in flash memory. See page 360.

- Recording function from following media is not supported.
  - CD-DA which prohibits the copying by SCMS
  - CD-DA with copy control
  - SACD (Super Audio CD)
  - DTS-CD
  - DVD-A
  - CD-R/RW
  - DVD-R/RW
  - Copy controlled CDs (Playback cannot be guaranteed)
  - DTS-CDs (Only enabled for playback)

If the CD Library is ever replaced, all data will be lost and stored music will not be recovered.



# Playing CD Library Audio (EX, EX-L, and Canadian LX models without navigation system)

## Recording a Music CD to CD Library

### U.S. EX and Canadian LX models



### EX-L and Canadian EX models

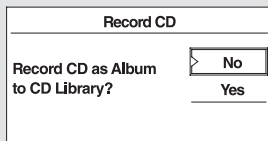

1. If you play a music CD that has not been recorded in the CD Library, the recording CD prompt will appear on the display. Select "YES" to start recording to the flash memory. To turn this display off, see page 258.

### U.S. EX and Canadian LX models

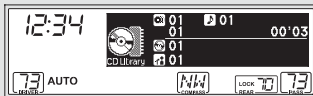

### EX-L and Canadian EX models

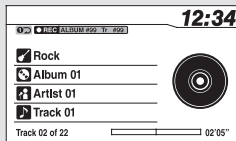

2. The display will change to the album list. Select the desired number of the list by turning the selector knob, then press the selector knob. The recording icon, recording album number, and current recording track number will appear while recording. When recording is finished, the recording icon will be turned off.

## NOTE:

- Please note that there will be no compensation offered in the case of unsuccessful recording of audio data or the loss of audio data due to any cause whatsoever.
- During recording, operation of this product may be slower.
- If you turn off the ignition switch while recording a CD, the CD will begin recording again when the power comes back.
- Tracks from music CDs are recorded at eight times the playback speed. You can listen to tracks as they are being recorded.
- Forward/rewind, repeat, random and scan functions are not available during recording.

CONTINUED

## Playing CD Library Audio (EX, EX-L, and Canadian LX models without navigation system)

- You can listen to tracks from other albumlists that have already been recorded while recording. Press the CD-L button and switch over to CD Library Audio.
- Recording settings cannot be changed during recording.

### Changing the Recording Settings *To Stop Displaying the Recording CD Prompt*

#### U.S. EX and Canadian LX models



#### EX-L and Canadian EX models

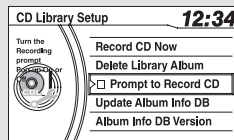

If you don't wish to display the recording CD prompt when you insert a CD for the first time, press and release the SETUP button and turn the selector knob to "CD Library Setup," then press the selector knob and select "Prompt to Record" or "Prompt to Record CD."

Each time you press and release the selector knob, this feature turns on and off.

# Playing CD Library Audio (EX, EX-L, and Canadian LX models without navigation system)

## To Record a CD Manually

### U.S. EX and Canadian LX models



### EX-L and Canadian EX models

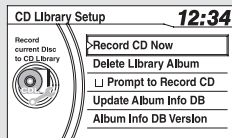

Insert a CD that has not been recorded in the CD Library, press the SETUP button and turn the selector knob to “CD Library Setup,” then press the selector knob. Select “RECORD CD NOW” and press the selector knob. The display will change to the albumlist. Select the desired slot and press the same knob to start recording.

### U.S. EX and Canadian LX models



### EX-L and Canadian EX models

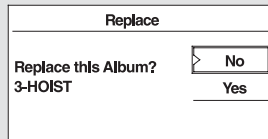

If you select a slot on the album list that has been recorded, a confirmation message will appear. Select “YES” to overwrite the old album. Select “NO” to return to the normal display.

### U.S. EX and Canadian LX models



### EX-L and Canadian EX models

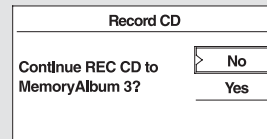

If you press the EJECT button while recording a CD, the recording is stopped. When you insert the same CD again, the “Continue REC” message will appear. Select “YES” to restart the recording feature from the point that the previous recording was disabled.

## Playing CD Library Audio (EX, EX-L, and Canadian LX models without navigation system)

### Playing Tracks in CD Library

To play tracks in the CD Library, push the CD-L button until the CD Library Audio display appears. Playback will start automatically with the track previously selected.

### Changing a Track/Albumlist

| Folder Bar or Category Bar |   |
|----------------------------|---|
| +                          | The next album in the list is selected. If you press + while the last album in the list is selected, the first album in the list is selected. |
| -                          | The previous album in the list is selected. If you press - while the first album is selected, the last album in the list is selected.         |

| Skip Bar |   |
|----------|---|
| ◀◀       | Returns to the beginning of the current track. Press again and hold to return to the beginning of the previous track. If you press this bar while the first track is playing, the last track is selected. |
| ▶▶       | Skips to the beginning of the next track. If you press this bar while the last track is playing, the first track is selected.   |

Turning the selector knob to the right or left also changes a file.

### Fast Forwarding and Rewinding

To fast forward, press and hold the ▶▶| side of the SKIP bar. To rewind, press and hold the |◀◀ side of the SKIP bar.

### Track Selection

You can also select an album or track from the list by using the selector knob. Push the selector knob while in the CD Library mode, the display will switch to the albumlist. Turn the selector knob to select an album. Press the selector knob to change the display to the track list, then turn the selector knob to select a track. Press the selector knob to start playing the track you wish to play.

# Playing CD Library Audio (EX, EX-L, and Canadian LX models without navigation system)

## To Select Repeat, Random or Scan Mode:

### U.S. EX and Canadian LX models



### EX-L and Canadian EX models

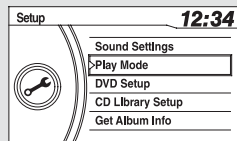

You can select any type of repeat, random and scan modes by using the SETUP button and the selector knob. Push the SETUP button to display the menu items, then turn the selector knob to select “PLAY MODE.” Press the selector knob to set the selection.

**REPEAT TRACK** – To continuously replay a track, select “Repeat Track” or “Repeat One Track” from the menu items and press the selector knob. You will see the repeat one track icon in the display. Select “NORMAL PLAY” to turn it off.

**REPEAT ALBUM** – This feature, when activated, replays all the tracks on the selected albumlist in the order they are recorded. To activate this feature, select “REPEAT ALBUM” and press the selector knob. You will see the repeat album icon in the display. The system continuously replays the current list. Select “NORMAL PLAY” to turn it off.

**RANDOM ALBUMS (Random in Albums)** – This feature, when activated, plays the tracks within the current albumlist in random order, rather than in the order they are recorded. You will see the random album icon in the display. The system will then select and play tracks randomly. This continues until you deactivate random album play by selecting “NORMAL PLAY,” or you select a different albumlist with the FOLDER bar or the CATEGORY bar.

**RANDOM (Random All)** – This feature plays all tracks within a CD Library in random order. You will see random all icon in the display. Select “NORMAL PLAY” to return to normal play.

CONTINUED

**SCAN TRK (Scan Tracks)** – The SCAN function samples all the tracks on the albumlist in the order they were recorded. To activate this feature, press and release the SCAN button. You will see “SCAN” in the display. You will get a 10 second sampling of each track in the list. Press and hold the SCAN button to get out of scan mode and play the last track sampled.

You can also select the scan feature from the menu items with the selector knob (see page 261 ).

**SCAN ALBUM** – This function samples the first track in each albumlist in the order they are stored. To activate the scan album feature, press and release the SCAN button repeatedly. You will see “SCAN” in the display. You will get a 10 second sampling of the first track in each list. Press and hold the SCAN button to get out of the scan album mode and play the last track sampled.

You can also select the scan album feature from the menu items with the selector knob (see page 261 ).

Pressing the selector knob turns off the scan or scan album feature.

Each time you press and release the SCAN button, the mode changes from scan track to scan album feature, then to normal play.

### **Deleting an Album**

1. Press the SETUP button and turn the selector knob to “CD Library Setup.” Then press the selector knob.
2. Select “Delete Album” or “Delete Library Album,” then press the selector knob.
3. The display will change to the albumlist. Select the album that you want to delete, press the selector knob.
4. The confirmation message is displayed. Select “YES” to delete album completely.

## Playing CD Library Audio (EX, EX-L, and Canadian LX models without navigation system)

### Acquiring Title Information

1. On the CD Library Audio display, press the SETUP button.

*On U.S. EX and Canadian LX models*  
Turn the selector knob to “CD Library Setup,” then press the selector knob.

2. Turn the selector knob to “GET ALBUM INFO.,” then press the selector knob. The display will change to the albumlist.
3. Select the title information for the albumlist, then press the selector knob. You will be returned to the normal display.

If more than one title is found for the CD inserted, a screen will appear to select the correct title.

### Updating Gracenote® Album Info (Gracenote® Media Database)

You can update the Gracenote® Album Info. (Gracenote® Media Database).

#### NOTE:

Consult your dealer, or visit [www.honda.com](http://www.honda.com) (in U.S.), or [www.honda.ca](http://www.honda.ca) (in Canada), to acquire updated files.

1. Insert the update disc into the disc slot.
2. Press the SETUP button and turn the selector knob to “CD Library Setup,” then press the selector knob.

3. Select “Update Album Info DB,” then press the selector knob.

4. *On U.S. EX and Canadian LX models*  
Press the selector knob to start updating.

*On EX-L and Canadian EX models*  
Select “Yes” on the confirmation screen, and press the selector knob to start updating.

After finishing the update, you will be returned to the normal display.

## Playing CD Library Audio (EX, EX-L, and Canadian LX models without navigation system)

---

### Checking Album Info DB Version

1. Press the SETUP button and turn the selector knob to “CD Library Setup,” then press the selector knob.
2. Select “ALBUM DB VER.” or “Album Info DB Version,” then press the selector knob.
3. The display will show you the current Album Info DB Version. Press the RETURN button to return to the CD Library Setup menu.

### Gracenote Music Recognition Service (CDDB)



Music recognition technology and related data are provided by Gracenote®. Gracenote is the industry standard in music recognition technology and related content delivery. For more information visit [www.gracenote.com](http://www.gracenote.com).

For more information, see page 360 .



# Playing an iPod® (EX-L and Canadian EX models without navigation system)

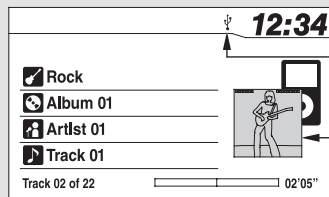

USB INDICATOR

ALBUM ART

## Canadian EX models

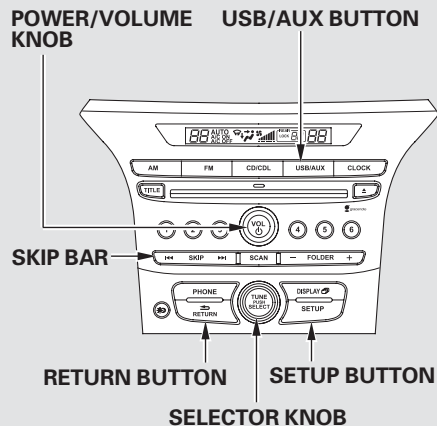

## EX-L models

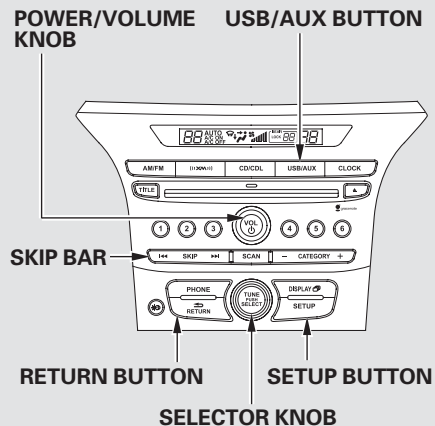

## EX-L models with Rear Entertainment System

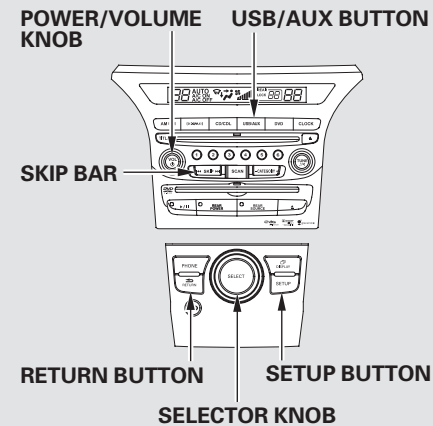

## Playing an iPod® (EX-L and Canadian EX models without navigation system)

---

### To Play an iPod®

This audio system can select and play the audio files on the iPod® with the same controls used for the in-dash disc player. To play an iPod, connect it to the USB adapter cable in the console compartment by using your dock connector, then press the USB/AUX button. The ignition switch must be in the ACCESSORY (I) or ON (II) position. The iPod will also be charged with the ignition switch in these settings.

The audio system reads and plays playable sound files on the iPod. The system cannot operate an iPod as a mass storage device. The system will only play songs stored on the iPod with iTunes.

iPod and iTunes are registered trademarks owned by Apple Inc.

iPods compatible with your audio system using the USB adapter cable are:

| Model                     | Software            |
|---------------------------|---------------------|
| iPod 5th generation       | Ver. 1.3 or more    |
| iPod classic              | Ver. 1.1.2 or more  |
| iPod nano 1st generation  | Ver. 1.3.1 or more  |
| iPod nano 2nd generation  | Ver. 1.1.3 or more  |
| iPod nano 3rd generation  | Ver. 1.1.3 or more  |
| iPod nano 4th generation  | Ver. 1.0.4 or more  |
| iPod nano 1st generation  | Ver. 1.1.1 or more  |
| iPod touch 2nd generation | Ver. 2.2.1 or more  |
| iPhone                    | Ver. 2.1.0 or more  |
| iPhone 3G                 | Ver. 2.1.0 or more  |
| iPhone 3GS                | Ver. 5.12.1 or more |

## Playing an iPod® (EX-L and Canadian EX models without navigation system)

Use only compatible iPods with the latest software. iPods that are not compatible will not work in this audio unit.

### NOTE:

- Do not connect your iPod using a hub.
- Do not keep the iPod and dock connector cable in the vehicle. Direct sunlight and high heat will damage it.
- Do not use an extension cable between the USB adapter cable equipped with your vehicle and your dock connector.
- We recommend backing up your data before playing it.
- Some devices cannot be powered or charged via the USB adapter. If this is the case, use the accessory adapter to supply power to your device.

### Connecting an iPod

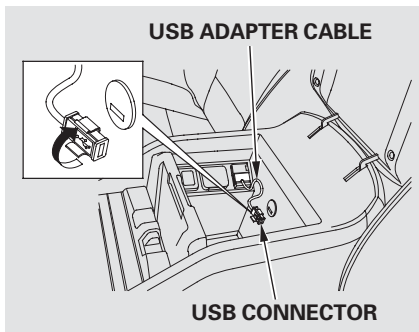

1. Unclip the USB connector by pivoting it, and pull out the USB adapter cable in the console compartment.

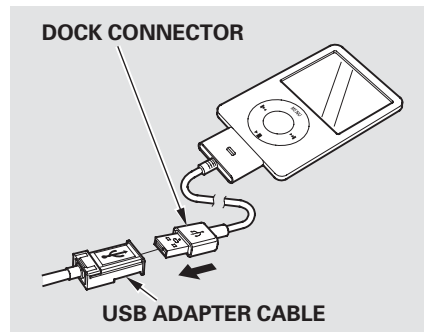

2. Connect your dock connector to the iPod correctly and securely.
3. Install the dock connector to the USB adapter cable securely.

CONTINUED

## Playing an iPod® (EX-L and Canadian EX models without navigation system)

If the iPod indicator does not appear in the audio display, check the connections, and try to reconnect the iPod a few times.

If the audio system still does not recognize the iPod, the iPod may need to be reset. Follow the instructions that came with your iPod, or you can find reset instructions online at [www.apple.com/](http://www.apple.com/)

The current file number and total of the selected playable files are on the display. It also shows the artist, album and track (file) names on the display.

If a file on your iPod has an album art, it will be shown in the display.

### *To Change or Select Files*

Use the SKIP bar while an iPod is playing to select passages and change files.

**SKIP** — Each time you press and release the ►| side of the SKIP bar, the system skips forward to the beginning of the next track. Press and release the |◄◄ side of the bar to skip backward to the beginning of the current track. Press it again to skip to the beginning of the previous track.

To move rapidly within playing track, press and hold either side ( ►| or |◄◄ ) of the SKIP bar.

Turning the selector knob to the right or left also changes a file.

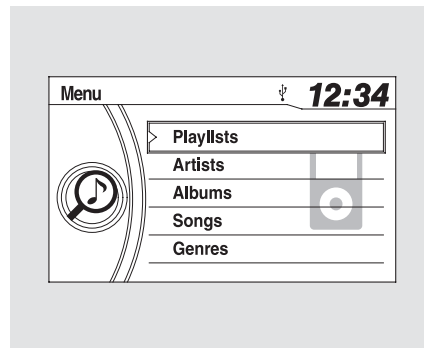

You can also select a file from any list on the iPod menu: playlists, artists, albums, songs, genres, composers and podcasts by using the selector knob. Push the selector knob to switch the display to an iPod menu, then turn the selector knob to select a desired list. Press the selector knob to set your selection.

## Playing an iPod® (EX-L and Canadian EX models without navigation system)

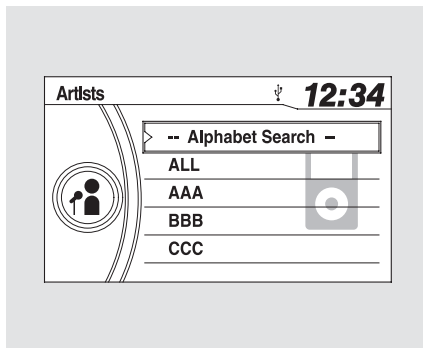

The display shows items on the selected list. Turn the selector knob to select an item, then press the selector knob to set your selection.

If you select “ALL” on the artists list, the albums list is displayed.

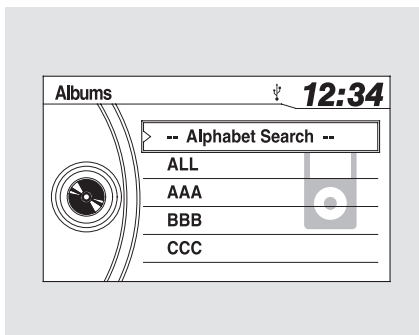

If you select “ALL” on the albums list, all the tracks become available for selection.

The track order that appears at this time varies depending on the iPod model and software.

CONTINUED

## Playing an iPod® (EX-L and Canadian EX models without navigation system)

### To Select Repeat or Shuffle Mode:

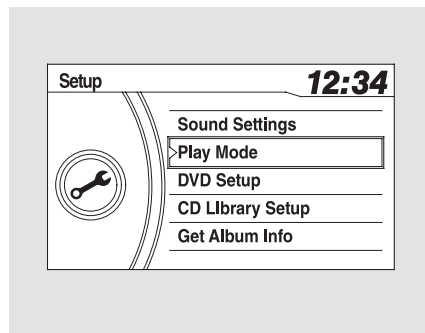

You can select any type of repeat and shuffle mode by using the SETUP button and the selector knob. Press the SETUP button to display the menu items, then turn the selector knob to select "Play Mode." Press the selector knob to set the selection.

Turn the selector knob to select a play mode: Normal Play, Repeat One Track, Shuffle All, Shuffle Repeat, Shuffle Albums, or Shuffle Album Repeat, then press the selector knob to set your selection.

To cancel the selected mode, press the selector knob and turn the selector knob to show "Play Mode," then press the selector knob. When you see "Normal Play," press the selector knob again.

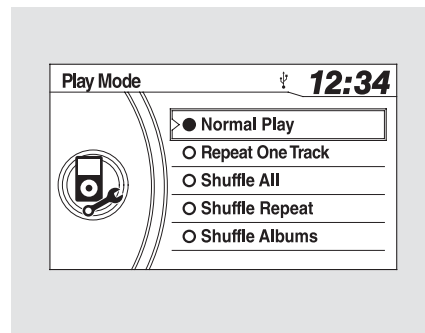

**Repeat One Track** — This feature continuously plays a file. You will see the repeat icon in the display. Select normal play to turn it off.

## Playing an iPod® (EX-L and Canadian EX models without navigation system)

---

**Shuffle All** — This feature plays all available files in a selected list (playlists, artists, albums, songs, genres, composers and podcasts) in random order. You will see the shuffle all icon in the display. Select normal play to turn off this feature.

**Shuffle Repeat** — This feature repeats the shuffle all feature. When the system finishes playing the shuffle all feature, it will repeat playing the songs in the same shuffled order. You will see the shuffle all and the repeat icon in the display. Select normal play to turn off this feature.

**Shuffle Albums** — This feature plays all available albums in a selected list (playlists, artists, albums, songs and genres) in random order. The files in each album are played in the recorded order. You will see the shuffle albums icon in the display. Select normal play to turn off this feature.

**Shuffle Albums Repeat** — This feature repeats the shuffle album feature. When the system finishes playing the shuffle album feature, it will repeat playing the albums in the same shuffled order. You will see the shuffle albums and the repeat icon in the display. Select normal play to turn off this feature.

**NOTE:**

Available operating functions vary on models or versions. Some functions may not be available on the vehicle's audio system.

## Playing an iPod® (EX-L and Canadian EX models without navigation system)

---

### To Stop Playing Your iPod

To take the system out of the iPod mode, press one of the other source buttons than the USB/AUX button. When a compatible audio unit is connected to the auxiliary input jack, press the USB/AUX button to select it.

You can also press the MODE button on the steering wheel to change modes.

### *Disconnecting an iPod*

You can disconnect the iPod at any time when you see the “OK to disconnect” message\* in the iPod display. Always make sure you see “OK to disconnect” message in the iPod display before you disconnect it. Make sure to follow the iPod’s instructions on how to disconnect the dock connector from the USB adapter cable.

\* : The displayed message may vary on models or versions. On some models, there is no message to disconnect.

When you disconnect the iPod while it is playing, the display shows No Data.

If you reconnect the same iPod, the system may begin playing where it left off, depending on what mode the iPod is in when it is reconnected.

### iPod® Error Messages

If you see an error message in the display, see page 273 .



## iPod® Error Messages (EX-L and Canadian EX models without navigation system)

If you see an error message on the audio display while playing an iPod, find the solution in the chart to the right. If you cannot clear the error message, take your vehicle to your dealer.

| Error Message                                      | Solution   |
|--|--|
| USB ERROR  | There is a problem with the USB adapter unit.  |
| BAD USB DEVICE<br>PLEASE CHECK<br>OWNERS<br>MANUAL | Appears when the overcurrent protection feature of the system stops supplying power to USB because an incompatible device is connected. Disconnect the device. Then, turn the audio system off, and turn it on again. Do not reconnect the device that caused the error. |
| NO SONG  | Appears when the iPod is empty. Store some files in the iPod.  |
| UNSUPPORTED  | Appears when an unsupported device is connected. Disconnect the device.  |
| UNSUPPORTED VER.                                   | Appears when an unsupported iPod is connected. See page 266 for specification information for iPods. If it appears when a supported iPod is connected, update the iPod software to the newer version.  |
| CONNECT RETRY                                      | Appears when the system does not acknowledge the iPod. Reconnect the iPod.   |

# Playing a USB Flash Memory Device (EX-L and Canadian EX models without navigation system)

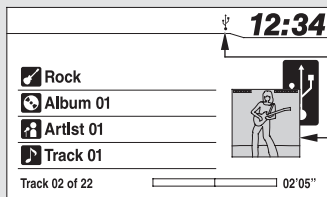

## Canadian EX models

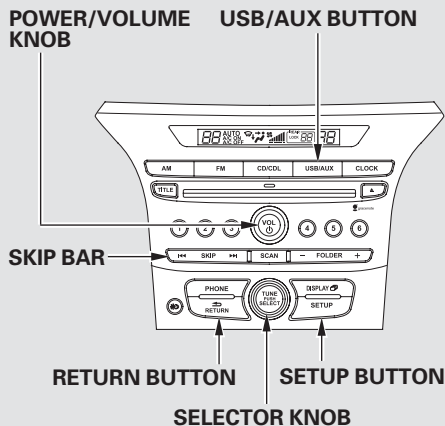

## EX-L models

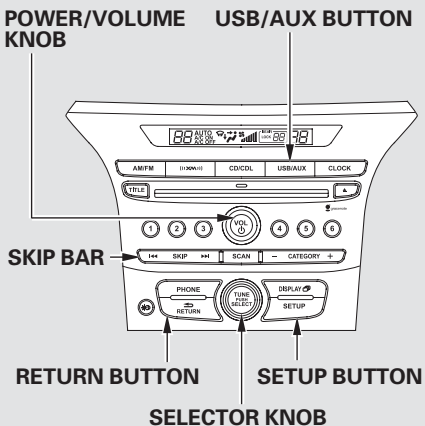

## EX-L models with Rear Entertainment System

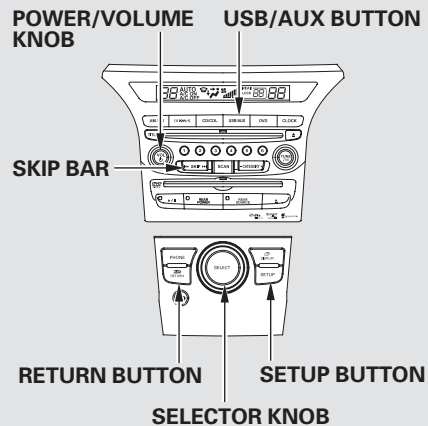

## Playing a USB Flash Memory Device (EX-L and Canadian EX models without navigation system)

---

### To Play a USB Flash Memory Device

This audio system can select and play the audio files from a USB flash memory device with the same controls used for the in-dash disc player. To play a USB flash memory device, connect it to the USB adapter cable in the console compartment, then press the USB/AUX button. The ignition switch must be in the ACCESSORY (I) or ON (II) position.

The recommended USB flash memory devices are 256 MB or higher, and formatted with the FAT file system. Some digital audio players may be compatible as well.

Some USB flash memory devices (such as devices with security lock-out features, etc.) will not work in this audio unit.

### NOTE:

- Do not use a device such as a card reader or hard drive as the device or your files may be damaged.
- Do not connect your USB flash memory device using a hub.
- Do not use an extension cable to the USB adapter cable equipped with your vehicle.
- Do not keep a USB flash memory device in the vehicle. Direct sunlight and high heat will damage it.

*CONTINUED*

## Playing a USB Flash Memory Device (EX-L and Canadian EX models without navigation system)

---

- We recommend backing up your data before playing a USB flash memory device.
- Depending on the type and number of files, it may take some time before they begin to play.
- Depending on the software the files were made with, it may not be possible to play some files, or display some text data.
- Depending on the type of encoding and writing software used, there may be cases where character information does not display properly.

- Some devices cannot be powered or charged via the USB adapter. If this is the case, use the accessory adapter to supply power to your device.
- The order of files in USB playback may be different from the order of files displayed in PC or other devices etc. Files are played in the order stored in USB flash memory device.

Some versions of MP3, WMA, or AAC format may not be supported. If an unsupported file is found, the audio unit displays UNSUPPORTED, then skips to the next file.

In WMA or AAC format, DRM (digital rights management) files cannot be played. If the system finds a DRM file, the audio unit displays UNPLAYABLE FILE, and then skips to the next file.

### **NOTICE**

*Combining a low sampling frequency with a low bitrate may result in extremely degraded sound quality.*

## Playing a USB Flash Memory Device (EX-L and Canadian EX models without navigation system)

### Connecting a USB Flash Memory Device

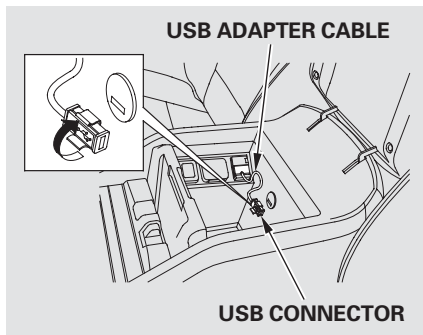

1. Unclip the USB connector by pivoting it, and pull out the USB adapter cable in the console compartment.

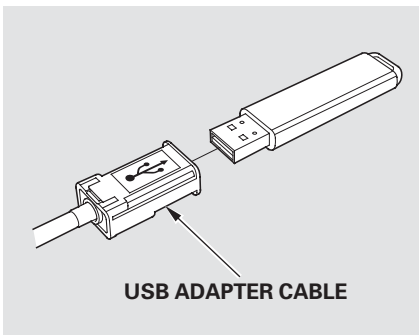

2. Connect the USB flash memory device to the USB adapter cable correctly and securely.

When the USB flash memory device is connected, the USB indicator is shown in the display.

If a file on your USB flash memory device has an album art, it will be shown in the display.

## Playing a USB Flash Memory Device (EX-L and Canadian EX models without navigation system)

### *To Change or Select Files*

Use the SKIP bar while a USB flash memory device is playing to select passages and change files.

**SKIP** — Each time you press and release the ►| side of the SKIP bar, the system skips forward to the beginning of the next file. Press and release the |◄◄ side of the bar, to skip backward to the beginning of the current file. Press it twice to skip to the beginning of the previous file.

To move rapidly within a file, press and hold either side (►| or |◄◄) of the SKIP bar.

Turning the selector knob to the right or left also changes a file.

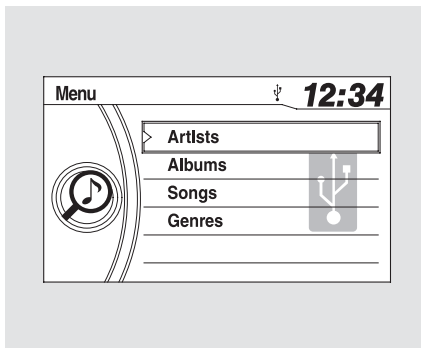

You can also select a file from any list on the USB top menu: artists, albums, songs, genres, by using the selector knob. Push the selector knob to switch the display to the USB top menu, then turn the selector knob to select a desired list. Press the selector knob to set your selection.

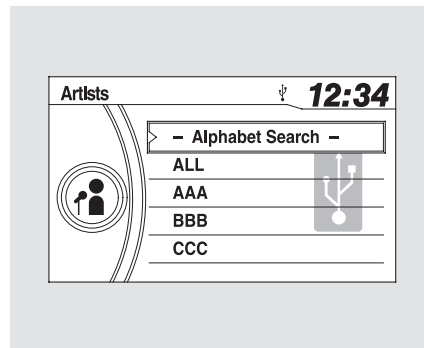

The display shows items on the selected list. Turn the selector knob to select an item, then press the selector knob to set your selection.

## Playing a USB Flash Memory Device (EX-L and Canadian EX models without navigation system)

If you select “ALL” on the artists list, the albums list is displayed.

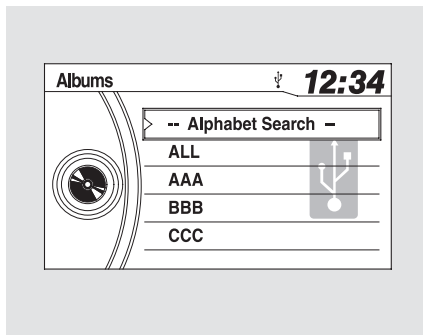

If you select “ALL” on the albums list, all the tracks become available for selection.

Pressing the RETURN button goes back to the previous display.

### To Select Repeat or Random Mode:

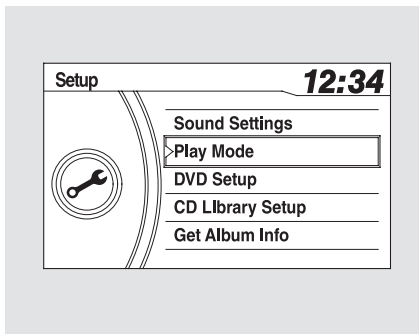

You can select any type of repeat and random mode by using the SETUP button and the selector knob. Press the SETUP button to display the menu items, then turn the selector knob to select “Play Mode.” Press the selector knob to set the selection.

Turn the selector knob to select a play mode: Normal Play, Repeat One Track, Random All or Random Repeat, then press the selector knob to set your selection.

To cancel the selected mode, press the selector knob and turn the selector knob to show “Play Mode,” then press the selector knob. When you see “Normal Play,” press the selector knob again.

CONTINUED

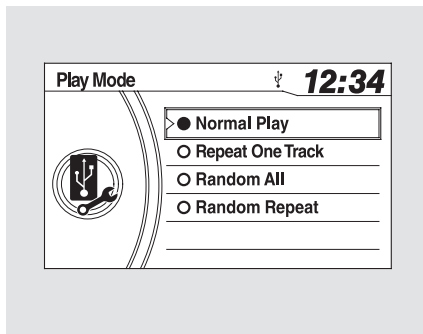

**Repeat One Track** — This feature continuously plays a file. You will see the repeat icon in the display. Select normal play to turn it off.

**Random All** — This feature plays all available files in a selected list (artists, albums, songs or genres) in random order. You will see the random all icon in the display. Select the normal play mode to turn off this feature.

**Random Repeat** — This feature repeats the random all feature. When the system finishes playing the random all feature, it will repeat playing the files in the same random order. You will see the random all and repeat icons in the display. Select the normal play to turn off this feature.

### **To Stop Playing a USB Flash Memory Device**

To take the system out of the USB mode, press one of the other source buttons than the USB/AUX button. When a compatible audio unit is connected to the auxiliary input jack, press the USB/AUX button to select it.

### ***Disconnecting a USB Flash Memory Device***

You can disconnect the USB flash memory device at any time even if the USB mode is selected on the audio system. Always follow the USB flash memory device's instructions when you remove it.

When you disconnect the USB flash memory device while it is playing, the display shows No Data.



## USB Flash Memory Device Error Messages (EX-L and Canadian EX models without navigation system)

If you see an error message on the audio display while playing a USB flash memory device, find the solution in the chart to the right. If you cannot clear the error message, take your vehicle to your dealer.

| Error Message                                      | Solution   |
|--|--|
| USB ERROR  | There is a problem with the USB adapter unit.  |
| BAD USB DEVICE<br>PLEASE CHECK<br>OWNERS<br>MANUAL | Appears when the overcurrent protection feature of the system stops supplying power to USB because an incompatible device is connected. Disconnect the device. Then, turn the audio system off, and turn it on again. Do not reconnect the device that caused the error. |
| UNPLAYABLE FILE                                    | Appears when the files in the USB flash memory device are DRM or an unsupported format. This error message appears for a few seconds, then plays the next song.  |
| NO SONG  | Appears when the USB flash memory device is empty or there are no MP3, WMA, or AAC files in the USB flash memory device. Save some MP3, WMA, or AAC files in the USB flash memory device.  |
| UNSUPPORTED  | Appears when an unsupported device is connected. See page 275 for specification information on USB flash memory devices. If it appears when the supported device is connected, reconnect the device.   |

# Bluetooth® Audio System (EX, EX-L, and Canadian LX models without navigation system)

U.S. EX and Canadian LX models

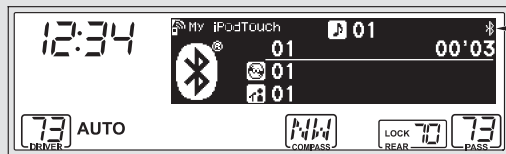

Bluetooth Indicator

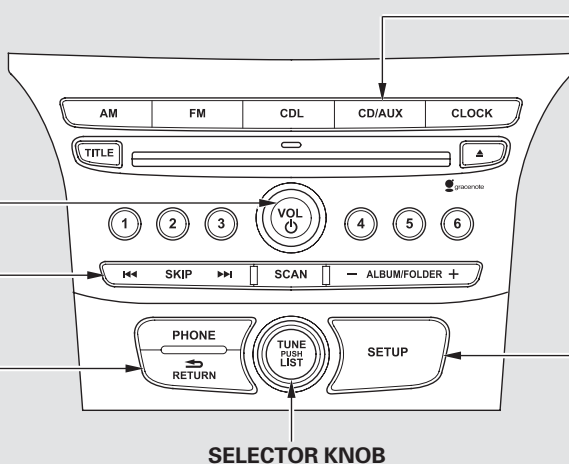

CD/AUX BUTTON

POWER/VOLUME KNOB

SKIP BAR

RETURN BUTTON

SETUP BUTTON

SELECTOR KNOB

# Bluetooth® Audio System (EX, EX-L, and Canadian LX models without navigation system)

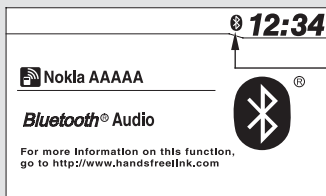

Bluetooth Indicator

## Canadian EX models

POWER/VOLUME KNOB

USB/AUX BUTTON

SKIP BAR

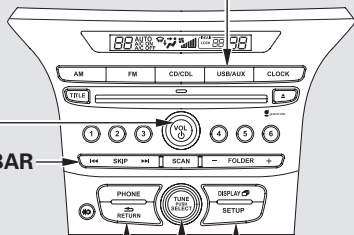

RETURN BUTTON

SETUP BUTTON

SELECTOR KNOB

## EX-L models

POWER/VOLUME KNOB

USB/AUX BUTTON

SKIP BAR

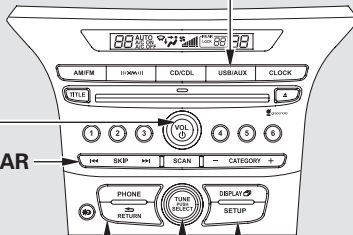

RETURN BUTTON

SETUP BUTTON

SELECTOR KNOB

## EX-L models with Rear Entertainment System

POWER/VOLUME KNOB

USB/AUX BUTTON

SKIP BAR

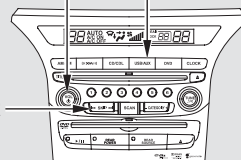

RETURN BUTTON

SETUP BUTTON

SELECTOR KNOB

CONTINUED

## Bluetooth® Audio System (EX, EX-L, and Canadian LX models without navigation system)

Your vehicle is equipped with a Bluetooth® Audio system, which allows you to listen to streaming audio from your Bluetooth® Audio compatible phone. This function is only available on phones that are paired and linked to the vehicle's Bluetooth® HandsFreeLink® (HFL) system (see page 447).

Not all Bluetooth-enabled phones with streaming audio capabilities are compatible with the system. You can find an approved phone by visiting [handsfreelink.honda.com](http://handsfreelink.honda.com) or call 888-528-7876. In Canada, visit [www.handsfreelink.ca](http://www.handsfreelink.ca), or call (888) 528-7876.

**NOTE:** In some states, provinces, and territories, it may be illegal to perform some data device functions while driving.

### To Play Bluetooth® Audio Files

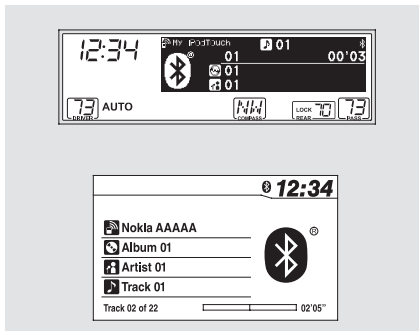

Make sure that your phone is paired and linked to HFL.

To begin to play the audio files, you may need to operate your phone. If so, follow the phone maker's operating instructions.

Press the USB/AUX or CD/AUX button\* with the ignition switch in the ACCESSORY (I) or ON (II) position. When the phone is recognized, you will see the Bluetooth® indicator and Bluetooth® Audio message or text data (album, artist, and song name) on a phone in the display.

Until the phone is recognized, you will see "No Connect" on the display. This message will go off when the phone is recognized, then the system begins to play.

\*: If an iPod or USB flash memory device or CD or audio unit connected to the auxiliary input jack was selected at the last mode, you will see iPod, USB, CD, or AUX in the display. Push the USB/AUX or CD/AUX button again to play audio files from your Bluetooth® Audio phone.

## Bluetooth® Audio System (EX, EX-L, and Canadian LX models without navigation system)

**NOTE:** The text display function may not be available on some phone devices.

If more than one phone is paired to the HFL system, there will be a delay before the system begins to play.

In the following conditions, the display shows “No Connect” message.

- The phone is not linked to HFL.
- The phone is not turned on.
- The phone is not in the vehicle.
- Another HFL compatible phone, which is not compatible for Bluetooth® Audio, is already connected.

### *To skip a file*

Press the ►► side of the SKIP bar to skip forward to the next file, and press the ◀◀ side to skip backward to the beginning of the current file. Push the ◀◀ side again to skip to the previous file.

Turning the selector knob to the right or the left also changes the file.

**NOTE:** The skip function may not be available on some phone devices.

CONTINUED

## Bluetooth® Audio System (EX, EX-L, and Canadian LX models without navigation system)

### *To pause or resume a file*

The resume/pause mode can stop playing a file temporarily. Press the SETUP button to display the setup menu, then turn the selector knob to select “Play Mode.” Press the selector knob to enter the play mode menu.

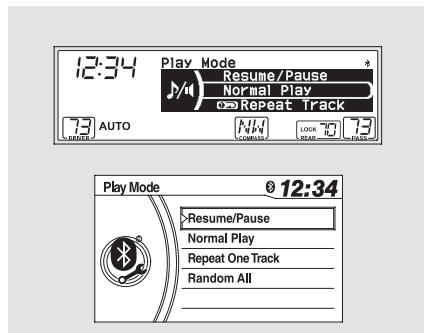

Turn the selector to select Resume/Pause mode, then press the selector knob to set your selection. Repeat to resume play.

**NOTE:** The pause function may not be available on some phone devices.

### *To Select Repeat or Random Mode:*

You can select repeat and random mode by using the SETUP button and the selector knob. Push the SETUP button to display the menu items, then turn the selector knob to select “Play Mode.” Press the selector knob to set the selection.

Turn the selector knob to select “Repeat One Track” or “Random All,” then press the selector knob to set your selection.

**Repeat One Track** — This feature continuously plays a file. Select normal play to turn it off.

**Random All** — This feature plays all available files in random order. Select the normal play to turn off this feature.

**NOTE:** The repeat or random play function may not be available on some phone devices.

### **To switch to HFL mode**

If you receive a call when the Bluetooth® Audio is playing, press the PICK-UP button on the steering wheel. The display switches to the HFL mode (see page 442).

After ending the call, press the HANG-UP button to go back to the Bluetooth® Audio mode.

### **To turn off the Bluetooth® Audio mode**

To take the system out of the Bluetooth® Audio mode, press one of the other source buttons than the USB/AUX or CD/AUX button. When a compatible audio unit is connected to the auxiliary input jack, press the USB/AUX or CD/AUX button to select it.

Switching to another mode pauses the music playing from your phone.

*As required by the FCC:*

*This device complies with Part 15 of the FCC rules. Operation is subject to the following two conditions: (1) This device may not cause harmful interference, and (2) this device must accept any interference received, including interference that may cause undesired operation.*

*Changes or modifications not expressly approved by the party responsible for compliance could void the user's authority to operate the equipment.*

*This device complies with Industry Canada Standard RSS-210.*

*Operation is subject to the following two conditions: (1) this device may not cause interference, and (2) this device must accept any interference that may cause undesired operation of the device.*

# Wallpaper Setup

## *EX-L and Canadian EX models*

The wallpaper setup function can change, store or delete the wallpaper on the display. You can store up to five pictures from USB flash memory devices. Two default wallpapers are already stored.

## *On vehicles with navigation system*

Refer to the navigation system manual for operation of the wallpaper setup.

## **Import Picture from USB**

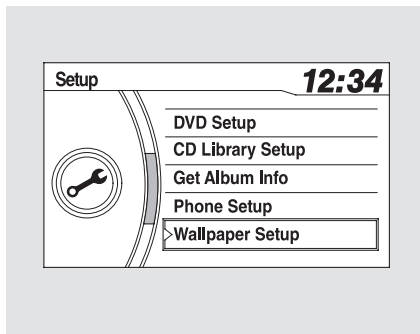

1. Connect the USB flash memory device that includes pictures you want to store. Press the SETUP button to display the setup menu. Turn the selector knob to “Wallpaper Setup” and press the selector knob.

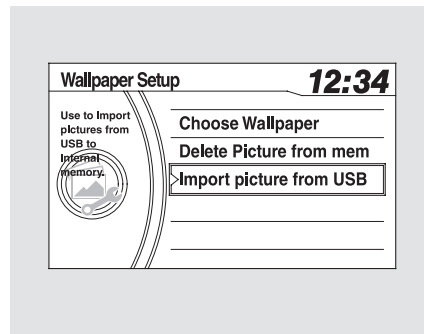

2. The display will change to the wallpaper setup menu. Turn the selector knob to “Import Picture from USB,” then press the selector knob.

If the USB flash memory device does not have any picture, “No Files” message will appear on the display.



- Turn the selector knob to select a desired picture, then press the knob to import the picture. “Loading Picture” message will appear on the display.

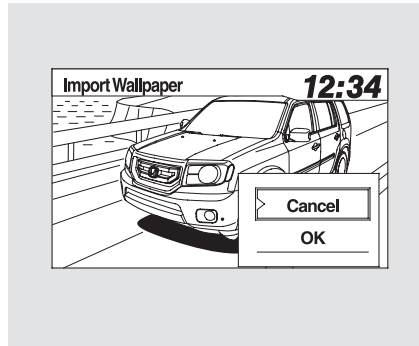

- The display will change to as shown above. Select OK to import the picture to the system. The imported list number and the confirmation message will appear. Then the display will return to the import wallpaper list.

## NOTE:

- If you choose an incompatible picture, such as one that is too large or in an unsupported format, a message will appear and the system will not be able to import the picture.
- You can only import images from the root directly. Images in the folders cannot be imported.
- The max file size is  $1024 \times 768$  pixels. Smaller images are displayed with the extra area appearing in black. Larger images are reduced to a displayable size without changing the aspect ratio.

CONTINUED

## Wallpaper Setup

---

- Five uploaded images (in BMP or JPEG format) can be saved.
- If you attempt to upload an image with the same name as an existing image, a pop-up screen will appear, asking if you want to overwrite the existing image file.
- You cannot import images while driving.

### *Choose Wallpaper*

On the wallpaper setup menu, select “Choose Wallpaper,” then press the selector knob. The screen will change to the wallpaper list. Select desired wallpaper and press the selector knob. Your selection will be indicated by the filled in circle.

You can also select “Default Wallpaper” (Honda logo) or “Clock” (analog) on the list.

You can confirm the wallpaper which you selected. Press the DISPLAY button, and select Wallpaper by turning and pressing the selector knob.

### *Delete Wallpaper*

On the wallpaper setup menu, select “Delete Picture from mem” and press the selector knob. The screen will change to the Delete Wallpaper list. Select the picture that you want to delete, then press the selector knob. The confirmation message will appear. Select “Yes” to delete completely.

*EX-L models without navigation system and Canadian EX models*

To adjust the display, highlight “Display Setup” from the setup menu with the selector knob. You can adjust these display settings:

- Brightness
- Contrast
- Menu Color

1. Press the SETUP button to display the setup menu. Turn the selector knob to “Display Setup” and press the selector knob.

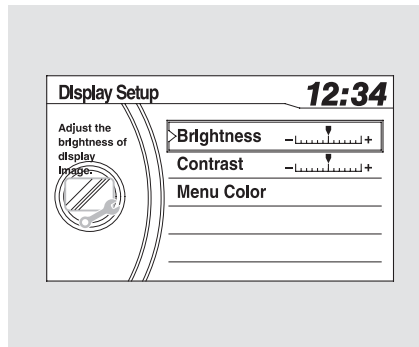

2. On the display setup menu, select adjustment menu and press the selector knob to enter the setting. Adjust the setting by turning the selector knob.

3. If you want to adjust the Menu Color, select it by turning the selector knob and press the selector knob.

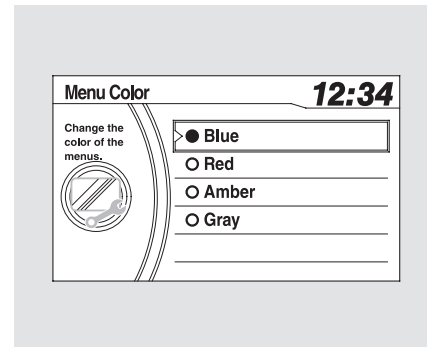

4. The display will change to as shown above. You can change the color of the screen to blue, red, amber, gray. Turn the selector knob to the setting you want, then press the selector knob.

Press and release the RETURN button to go back to the setup menu.

# Display Setup

## Display Button

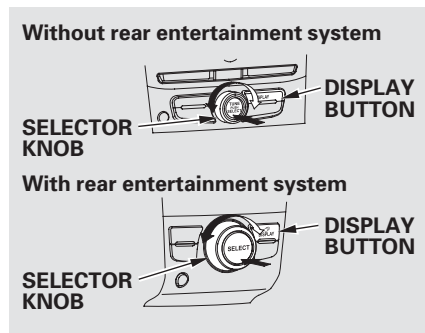

You can select one of the four types of screen by pressing the Display button, then turning and pressing the selector knob.

## Audio Display

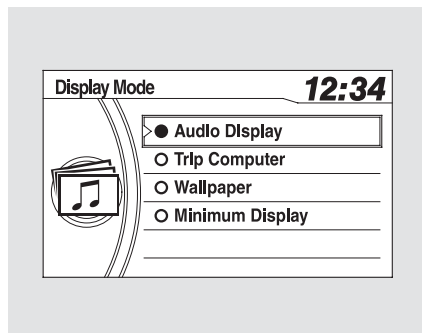

When you select “Audio Display,” the screen shows you the audio information currently selected.

## Trip Computer

When you select the trip computer, the display shows the instant fuel economy, average fuel economy, distance (trip meter), average speed, elapsed time, and range.

For information on instant fuel economy, average fuel economy, distance (trip meter) and range, see page 82 .

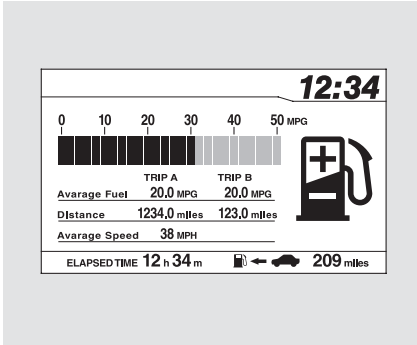

### *Average Speed*

This shows the average speed you are traveling in miles per hour (mph) for U.S. models or kilometers per hour (km/h) for Canadian models.

### *Elapsed Time*

This shows the accumulated traveling time since you last reset it.

You can reset the Trip Computer, see next column.

### *Trip Computer Reset*

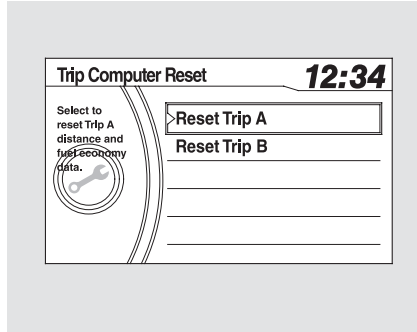

You can reset all data on the Trip Computer. To reset the trip computer, press the SETUP button to display the setup menu. Turn the selector knob to Trip Computer Reset, and press the selector knob. Select Trip A or Trip B by turning the selector knob, then press the selector knob. A confirmation message will appear. Select "Yes" and press the selector knob to completely reset.

### *Wallpaper*

When you select "Wallpaper," the display changes to your favorite screen. The minimum display information also appear on the upper part of the screen. See page 288 for how to set up the wallpaper.

CONTINUED

# Display Setup, Setting the Clock

## *Minimum Display*

When you select “Minimum Display,” you will see only the compass, audio status, and clock on the upper part of the display.

## *On Vehicles without Navigation System*

If your vehicle’s battery is disconnected or goes dead, you may need to set the clock.

## *On U.S. LX models*

To set the time, press the CLOCK button until you hear a beep. The displayed time begins to blink.

## Setting the Clock

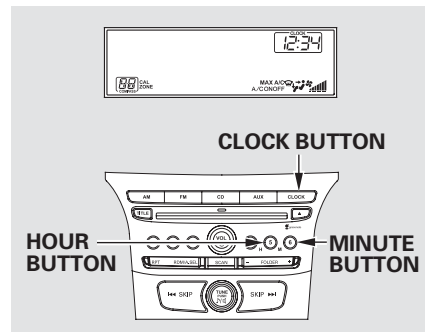

Change the hours by pressing the H (hour) button until the numbers advance to the desired time. Change the minutes by pressing the M (minute) button until the numbers advance to the desired time.

Press the CLOCK button again to enter the set time.

## EX, EX-L, and Canadian LX models

### U.S. EX and Canadian LX models

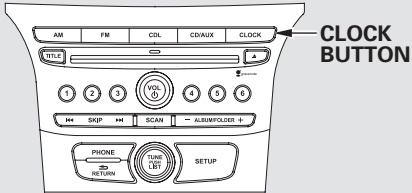

### Canadian EX models

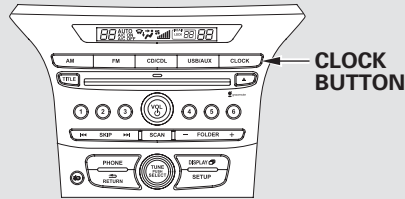

### EX-L models

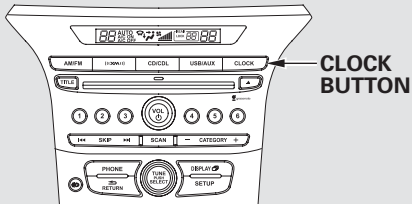

### EX-L models with Rear Entertainment System

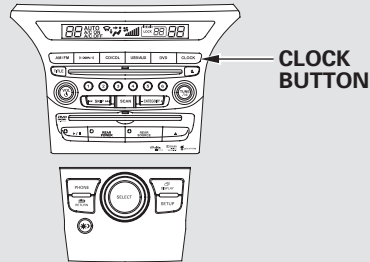

1. To set the time, press and release the **CLOCK** button. The display will change to the clock adjust screen.

You can also set the time from the setup menu. Press the **SETUP** button to display the setup menu. Turn the selector knob to “**CLOCK ADJUST**” and press the selector knob.

CONTINUED

## Setting the Clock

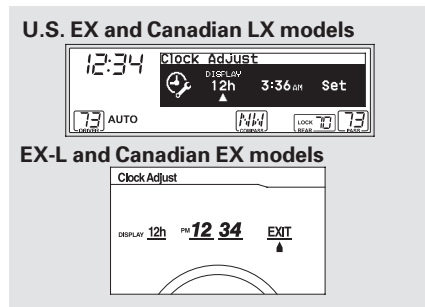

2. Press the selector knob to select the item which you want to adjust. Each time you press the selector knob, the selected item changes between hours, minutes, SET and EXIT. The selected item is indicated with  $\triangle$  in the display.

3. Turn the selector knob to change the setting between 12H and 24H, and count the numbers up or down.
4. To enter the clock setting, press the selector knob repeatedly to select "SET" or "EXIT," then press the knob. The display will return to the setup menu.

*On vehicles with navigation system*  
The navigation system receives signals from the global positioning system (GPS), and the displayed time is updated automatically by the GPS. Refer to the navigation system manual for how to adjust the time.



*EX-L models without navigation system and Canadian LX models*

### U.S. EX and Canadian LX models



### EX-L and Canadian EX models

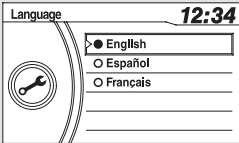

You can change the display language to English, Spanish, or French. Press the SETUP button to display the setup menu. Turn the selector knob to “Language” and press the selector knob.

Turn the selector knob to the language you want, then press the selector knob to change the display.

Press and release the RETURN button to go back to the setup menu.

## Audio System (Models with navigation system)

---

### Interface Dial

Most audio system functions can still be controlled by standard buttons, dials, and knobs, but some functions can only be accessed using the interface dial. The interface dial has two parts, a dial and a selector.

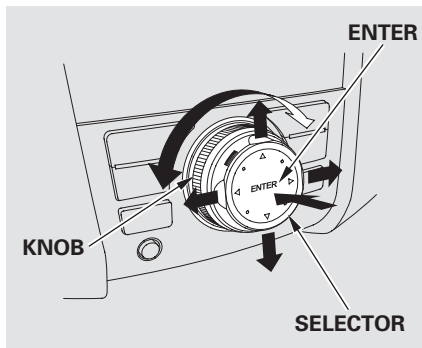

The dial turns left and right. Use it to make selections or adjustments to a list or menu on the screen.

The selector can be pushed left, right, up, down, and in. Use the selector to scroll through lists, to select menus, and to highlight menu items. When you make a selection, press ENTER to go to that selection.

### Voice Control System

The audio system, including the music search feature Song By Voice™, can be operated by voice control. See the navigation system manual for complete details.

# Playing the FM/AM Radio (Models with navigation system)

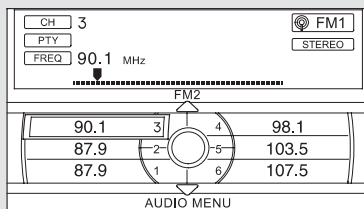

## Without rear entertainment system

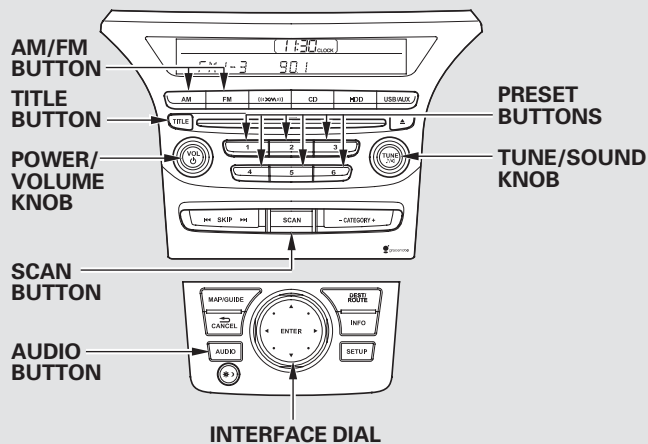

## With rear entertainment system

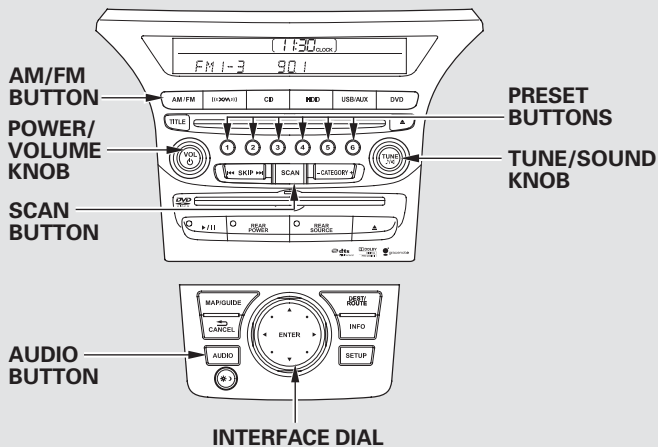

## Playing the FM/AM Radio (Models with navigation system)

### To Play the FM/AM Radio

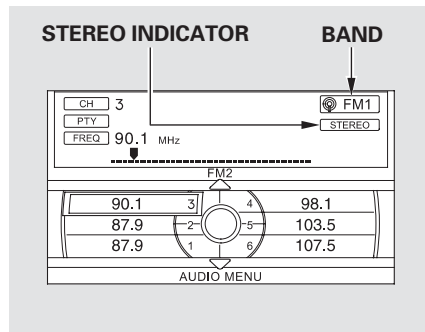

The ignition switch must be in the ACCESSORY (I) or the ON (II) position. Press the AUDIO button to view the audio control display. Turn the system on by pressing the power/volume knob, the AM, or FM button. Adjust the volume by turning the power/volume knob.

The band and frequency that the radio was last tuned to are shown on the display. To change bands, press the AM/FM button. You can also change bands by pushing the interface selector up. Each time you push it up, the band will change to FM1, FM2 or AM. On the FM bands, STEREO will be shown on the navigation screen and ST on the center display, if the station is broadcasting in stereo. Stereo reproduction on AM is not available.

On the AM band, AM noise reduction turns on automatically.

### To Select a Station

You can use any of five methods to find radio stations on the selected band: tune, skip (seek), scan, the preset buttons, and auto select.

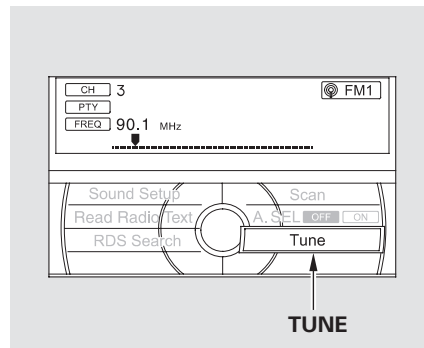

**TUNE** — Use the TUNE knob to tune the radio to a desired frequency. Turn the knob right to tune to a higher frequency, or left to tune to a lower frequency. To tune with the interface dial, push the selector down, and turn the knob to TUNE. Then press ENTER on the selector, and turn the knob to the desired frequency. To exit the TUNE mode, press ENTER on the selector.

## Playing the FM/AM Radio (Models with navigation system)

**SKIP (SEEK)** – The skip (seek) function searches up and down from the current frequency to find a station with a strong signal. To activate it, press either side ( ◀◀ or ▶▶ ) of the SKIP bar, then release it.

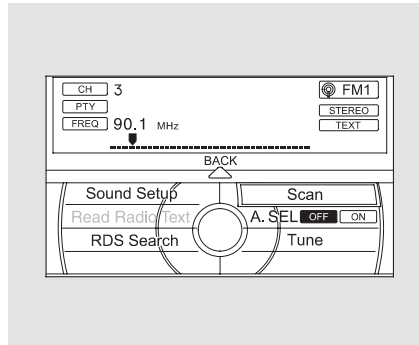

**SCAN** – The scan function samples all stations with strong signals on the selected band. To activate it, press the SCAN button, then release it.

To scan with the interface dial, push the interface selector down, and turn the interface dial to select Scan, then press ENTER on the interface selector.

The system will scan for a station with a strong signal. When it finds a strong signal, it will stop and play that station for about 10 seconds. If you do nothing, the system will then scan for the next strong station and play it for 10 seconds. When it plays a station that you want to listen to, press the SCAN button again.

CONTINUED

## Playing the FM/AM Radio (Models with navigation system)

**Preset** — Each preset button or preset icon can store one frequency on AM and two frequencies on FM.

*To store a preset memory location:*

1. Select the desired band, AM or FM. FM1 and FM2 let you store two sets of FM frequencies with the preset buttons (on-screen icons).
2. Use the tune, seek, or scan function to tune the radio to a desired station.
3. Press the preset button, and hold it until you hear a beep. You can also store frequencies with the interface dial. Select the preset icon you want to store the frequency on, then press ENTER on the interface selector, and hold it for more than 2 seconds.
4. Repeat steps 1 through 3 to store a total of six stations on AM and twelve stations on FM.

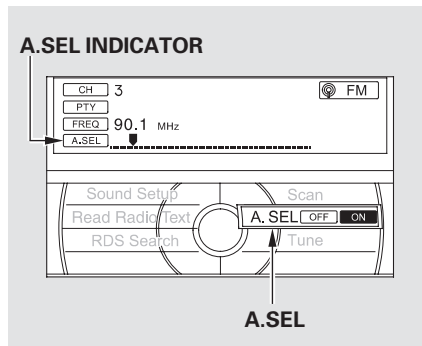

**AUTO SELECT** — If you are traveling and can no longer receive your preset stations, you can use the auto select feature to find stations in the local area.

Push the interface selector down to display the AUDIO MENU. Turn the interface dial to select A.SEL, then press ENTER on the interface selector. Turn the interface dial to select ON, then press ENTER on the interface selector. You will see

A.SEL on the screen and the system goes into auto select mode for several seconds.

The system stores the frequencies of six AM and twelve FM stations in the preset buttons (icons).

You will see "0" displayed if auto select cannot find a strong station for every preset button (icon).

If you do not like the stations auto select has stored, you can store other frequencies on the preset buttons (icons) as previously described.

*To cancel auto select*, select A.Sel on the audio menu again and turn the interface dial to select A.SEL OFF. This restores the presets you originally set.

## Playing the FM/AM Radio (Models with navigation system)

For information on FM/AM radio frequencies and reception, see page 389.

### **Radio Data System (RDS)**

On the FM band, you can select a favorite station and display the program service name provided by the radio data system (RDS).

#### ***RDS INFO Display***

The RDS INFO display function shows the name of the station you are listening to. With the audio system on and the FM band selected, you can turn this function on or off.

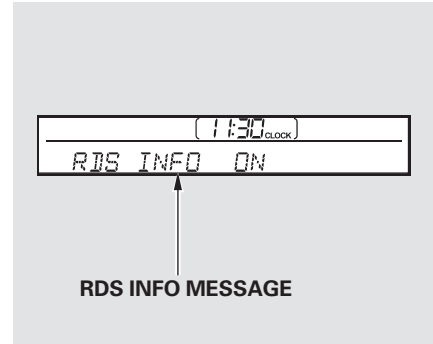

To switch the RDS INFO display function on and off, press and release the TITLE button. With the system on, you will see the “RDS INFO ON” message briefly on the center display. If the station you are listening to is an RDS station, the displayed frequency switches to the station name.

*CONTINUED*

## Playing the FM/AM Radio (Models with navigation system)

If the station you are listening to is not an RDS station, the audio screen and the center display continue to show the frequency.

When you turn off this function by pressing the TITLE button, the center display shows “RDS INFO OFF.”

### *Radio Data System (RDS) Category*

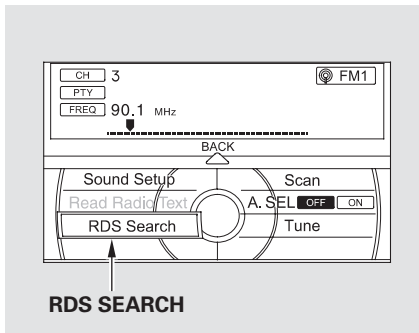

On the FM band selected, you can select the program type provided by the RDS. Press the AUDIO button to display the radio information on the screen. Push down the interface selector, then turn the interface dial to select RDS search. Press ENTER to set your selection. The principal RDS categories are shown as follows:

ALL: All RDS category stations  
ROCK: Rock, classic rock and soft rock music  
COUNTRY: Country music  
SOFT: Adult hits and soft music  
TOP 40: Top 40 hits  
OLDIES: Nostalgia music and oldies  
R & B: Rhythm and blues, and soft rhythm and blues  
RELIGION: Programs concerned with religion  
CLASSIC: Classical music  
JAZZ: Jazz  
INFO: News, information, sports, talk shows, foreign language, personality, public, college, and weather  
TRAFFIC: Traffic information



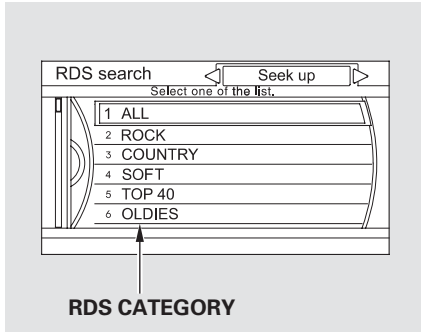

Turn the interface dial to select an RDS category. You can use the search or scan function to find radio stations on the selected RDS category by pressing the interface selector to the left or the right. Press ENTER to set your selection.

### ***RDS Category Search***

This function searches up and down for strong signal frequencies that carry the selected RDS category information. This can help you to find a station in your favorite category. To activate it, press and release either side ( ◀◀ or ▶▶ ) of the SKIP bar. You will also see the selected RDS category name blinking in the center display while searching it. When the system finds a station, the selected RDS category name will be displayed again for about 10 seconds, and the system stops searching.

If the system does not find a station, "NOTHING" blinks for about five seconds, then the system goes back to the last selected station.

CONTINUED

## Playing the FM/AM Radio (Models with navigation system)

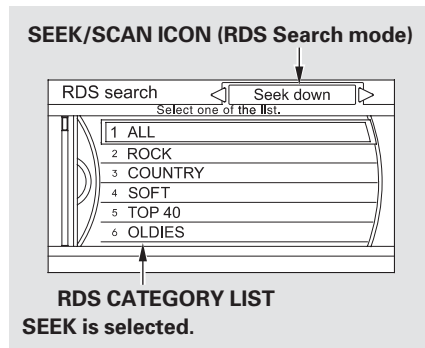

To activate RDS category search with the interface dial, push the AUDIO button to display the FM radio information on the screen. Push the interface selector down, and turn the interface dial to select RDS search. Press ENTER on the interface selector. The screen shows you the RDS category list.

Turn the interface dial to the desired RDS category.

While the RDS category is selected, move the interface selector to the left or right to select SEEK up or SEEK down in the upper right corner of the screen. Press ENTER to activate the RDS category search (SEEK up/down).

### ***RDS Category SCAN***

The scan function samples all stations with strong signals on the selected RDS category one by one. You will also see the selected RDS category name blinking in the display while scanning it. When the system finds one, it will stop and play that station for about 10 seconds.

If you do nothing, the system will scan for the next strong station and play it for 10 seconds. When it plays a station that you want to listen to, press the SCAN button again.

If the system does not find a station, "NOTHING" blinks for about 5 seconds on the navigation screen and the display, and the system will go back to the last selected station.

## Playing the FM/AM Radio (Models with navigation system)

### SEEK/SCAN ICON (RDS Search mode)

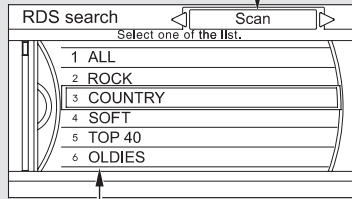

### RDS CATEGORY LIST SCAN is selected.

To activate RDS category scan with the interface dial, push the AUDIO button to display the FM radio information on the screen. Push the interface selector down, and turn the interface dial to select RDS search on the audio menu. Press ENTER on the interface selector. The screen shows you the RDS category list.

Turn the interface dial to the desired RDS category.

While the RDS category is selected, move the interface selector to the left or the right to select SCAN. Then press ENTER to activate the RDS SCAN.

### *Radio Text Display*

This function displays the radio text information of the selected RDS station.

If the selected RDS station has the radio text information, you will see the text indicator on the screen.

CONTINUED

## Playing the FM/AM Radio (Models with navigation system)

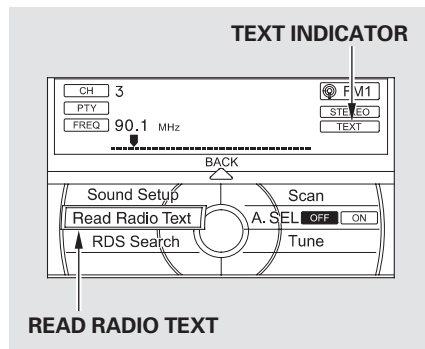

To activate radio text display, use the interface dial. Push the interface selector down, and turn the interface dial to select Read Radio Text. Press ENTER on the interface selector to enter the setting.

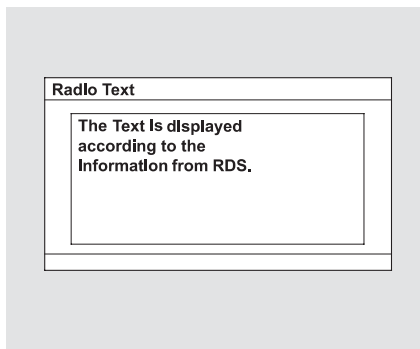

The display shows up to 64 characters on the selected RDS station.

# Playing the FM/AM Radio (Models with navigation system)

## Adjusting the Sound

BASS, TREBLE, BALANCE, and FADER are each adjustable. You can also adjust the strength of the sound coming from the center and subwoofer speakers. In addition, you can set the Dolby PL (ProLogic) II and Speed-sensitive volume compensation (SVC).

These adjustments can be made with the TUNE/SOUND knob or the interface dial.

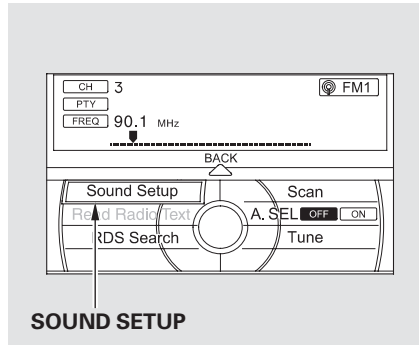

To adjust the sound, press the AUDIO button, push the interface selector down, and turn the interface dial to Sound Setup. Then press ENTER on the interface selector.

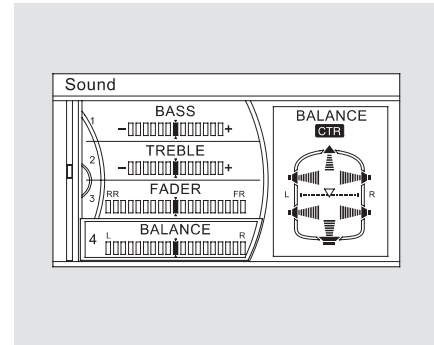

Select the mode you want to adjust by turning the interface dial then press ENTER.

You can also adjust the sound by turning the TUNE/SOUND knob. Each mode is shown in the audio display as it changes.

CONTINUED

## Playing the FM/AM Radio (Models with navigation system)

---

Turn the TUNE/SOUND knob or interface knob to adjust the setting to your liking. You can check the level on the navigation screen or on the center display. When the level reaches the center, you will see “C” in the center display.

The system will return to the audio playing mode in the center display about 5 seconds after you stop adjusting a mode.

If you do not make an adjustment within 5 seconds, you will need to select the mode again.

**BASS/TREBLE** – To adjust bass and treble, select BASS or TREBLE, and press ENTER on the interface selector. The current setting is shown on the display. Turn the interface knob to the desired level, and enter your selection by pressing ENTER on the interface selector.

**FADER/BALANCE** – These modes adjust the strength of the sound coming from each speaker. Fader adjusts the front-to-back strength, while balance adjusts the side-to-side strength. To adjust fader and balance, select FADER or BALANCE, then press ENTER on the interface selector. The current setting is shown on the screen. Turn the interface knob to the desired level, and enter your selection by pressing ENTER on the interface selector. To equalize the fader or balance, turn the interface knob until the marks on the sound grid come to the center of the adjustment bar.

**CENTER/SUBWOOFER** – To adjust the strength of the sound from the center or subwoofer speaker, select it and press ENTER on the interface selector. Turn the interface knob to the desired level, and enter your selection by pressing ENTER on the interface selector.

**Dolby PL (ProLogic) II** – Dolby PL (ProLogic) II signal processing creates multi-channel surround sound from 2 channel stereo audio sources. Dolby ProLogic II can only be activated when listening to DISC (CD-DA, MP3/WMA), XM Radio, and AUX. When ProLogic II is active, “PL II” is shown in the audio display.

To set this feature on or off, select Dolby PL II, and press ENTER on the interface selector. Rotate the interface dial to ON or OFF, and press ENTER.

Manufactured under license from Dolby Laboratories. Dolby, Pro Logic, and the double-D symbol are trademarks of Dolby Laboratories.

### *Speed-sensitive Volume Compensation (SVC)*

The SVC mode controls the volume based on vehicle speed. The faster you go, the louder the audio volume becomes. As you slow down, the audio volume decreases.

The SVC has four modes: SVC OFF, SVC LOW, SVC MID, and SVC HIGH. To change the SVC mode, select SVC, then press ENTER on the interface selector. The current setting is shown on the screen. Turn the interface knob to the desired level, and enter your selection by pressing ENTER on the interface selector. If you feel the sound is too loud, choose low. If you feel the sound is too quiet, choose high.

**NOTE:** In some audio playing modes (XM, AUX), when DPLII is on, the music coming from the rear speakers may sound distorted. This is due to compression of the music, and it does not indicate a problem with the setting.

# Playing the XM® Radio (Models with navigation system)

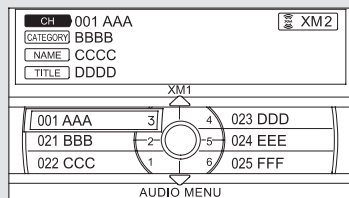

## Without rear entertainment system

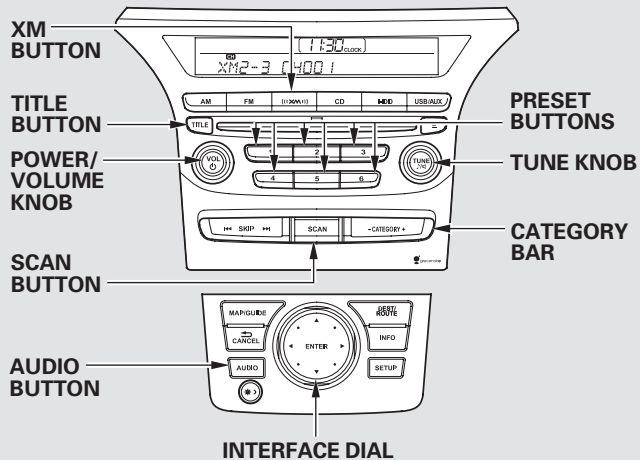

## With rear entertainment system

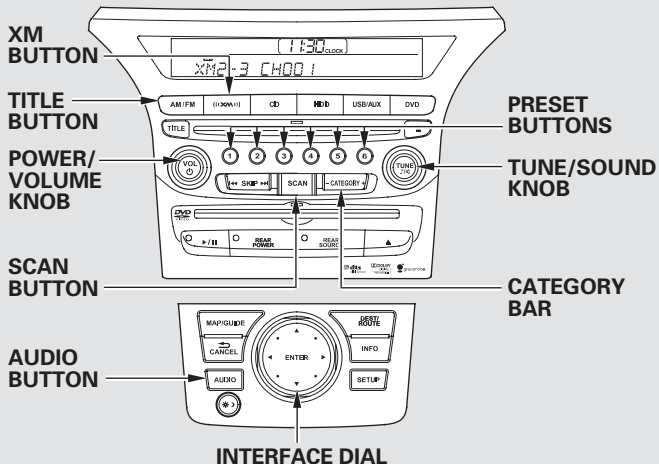



Your vehicle is capable of receiving XM® Radio anywhere in the United States and Canada, except Hawaii, Alaska, and Puerto Rico. XM is a registered trademark of Sirius XM Radio®, Inc. and XM CANADA® is a registered business name of Canadian Satellite Radio Inc.

XM Radio receives signals from two satellites to produce clear, high-quality digital reception. It offers many channels in several categories. Along with a large selection of different types of music, XM Radio also allows you to view channel and category selections in the audio display.

### Operating the XM Radio

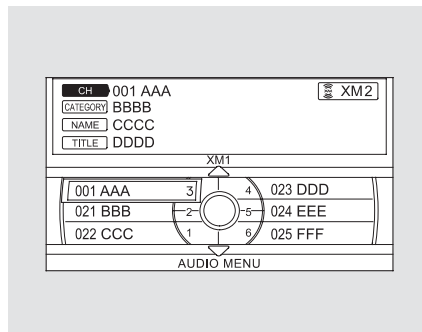

To listen to XM Radio, turn the ignition switch to the ACCESSORY (I) or ON (II) position. Push the power/volume knob to turn on the audio system, and press the « XM » button. The last channel you listened to will show in the display. Adjust the volume by turning the power/volume knob.

Each time you push the interface selector up, the band will change to XM1 or XM2. Push the AUDIO button to display XM information on the screen. You can operate the XM radio system with the interface dial.

CONTINUED

## Playing the XM® Radio (Models with navigation system)

---

**MODE** – To switch between the category mode and channel mode, push the interface selector down to display AUDIO MENU, then turn the interface dial to select Mode, and press ENTER on the interface selector.

Turn the interface dial to select CH or CAT, then press ENTER on the interface selector. Move the interface selector up to go back.

You can also switch the mode by pressing the TITLE button for 3 seconds.

In the category mode, such as Jazz, Rock, Classical, etc., you can navigate through all of the channels within that category. In the channel mode, you can select all of the available channels.

Each time you press and release the TITLE button, the center display changes in the following sequence: CATEGORY, NAME (artist name), TITLE (music title), and CHANNEL NAME (channel name).

You may experience periods when XM Radio does not transmit the artist's name and song title information. If this happens, there is nothing wrong with your system.

**TUNE** – Turn the TUNE knob to change channel selections. Turn the knob right for higher numbered channels and left for lower numbered channels. You can also change channels with the interface selector, push down the interface selector to choose TUNE and press ENTER on the selector. Turn the interface knob to the same directions. In the category mode, you can only select channels within that category.

**CHANNEL LIST** – Push down the interface selector to select AUDIO MENU, then turn the interface dial to select Channel List and press ENTER on the selector. Turn the interface dial to select a channel, then press ENTER to set your selection.

**CATEGORY (– or +)** – Press either side of the bar to select another category.

**SCAN** – The scan function gives you a sampling of all channels while in the channel mode. In the category mode, only the channels within that category are scanned. To activate scan, press the SCAN button. The system plays each channel in numerical order for a few seconds, then selects the next channel. When you hear a channel you want to continue listening to, press the button again.

**CHANNEL SCAN** – This function samples all channels. Push down the interface selector to select AUDIO MENU, then turn the interface dial to select Channel Scan and press ENTER on the interface selector.

**CATEGORY SCAN** – This function samples the stations in the selected category. Push down the interface selector to select AUDIO MENU, then turn the interface dial to select Category Scan and press ENTER on the interface selector.

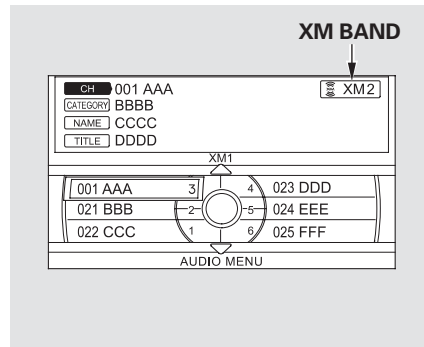
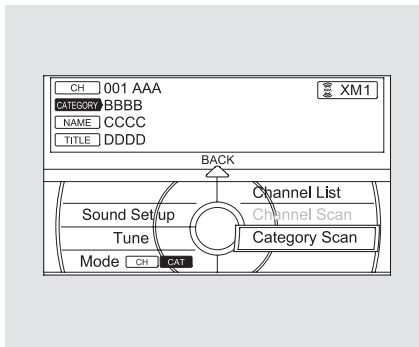

**Preset** – You can store up to 12 preset channels using the six preset buttons. Each button stores one channel from the XM1 band and one channel from the XM2 band.

To store a channel:

1. Press the «XM» button. Either XM1 or XM2 will be shown on the display.

CONTINUED

## Playing the XM® Radio (Models with navigation system)

---

2. Use the tune, list, or scan function to tune to a desired channel.

In category mode, only channels within that category can be selected. In channel mode, all channels can be selected.

3. Pick the preset button you want for that channel. Press and hold the preset button until you hear a beep. You can also pick the number with the interface dial. Select your desired number and press and hold ENTER on the interface selector.
4. Repeat steps 2 and 3 to store the first six channels.
5. Press the «XM» button or scroll up again. The other XM band will be shown. Store the next six channels using steps 2 and 3.

Once a channel is stored, press and release the proper preset button to tune to it.

### XM Radio Display Messages

**“OFF AIR”** – The channel currently selected is no longer broadcasting.

**“LOADING”** – XM is loading the audio or program information.

**“UNAUTHORIZED”** – The encryption code is being updated. Wait until the encryption code is fully updated. Channels 0 and 1 should still work normally.

**“NO SIGNAL”** – The signal is currently too weak. Move the vehicle to an area away from tall buildings, and with an unobstructed view of the southern horizon.

**“NO INFO”** – The selected channel has no artist or title information at this time.

**“CHECK ANTENNA”** – There is a problem with the XM antenna. Please consult your dealer.

**“UNAVAILABLE”** – The selected channel number does not exist, is not part of your subscription, or this channel has no artist or title information at this time.

## Playing the XM<sup>®</sup> Radio (Models with navigation system)

The XM satellites are in orbit over the equator; therefore, objects south of the vehicle may cause satellite reception interruptions. To help compensate for this, ground-based repeaters are placed in major metropolitan areas. Satellite signals are more likely to be blocked by tall buildings and mountains the farther north you travel from the equator.

Depending on where you drive, you may experience reception problems. Interference can be caused by any of these conditions:

- Driving on the north side of an east/west mountain road.
- Driving on the north side of a large commercial truck on an east/west road.
- Driving in tunnels.

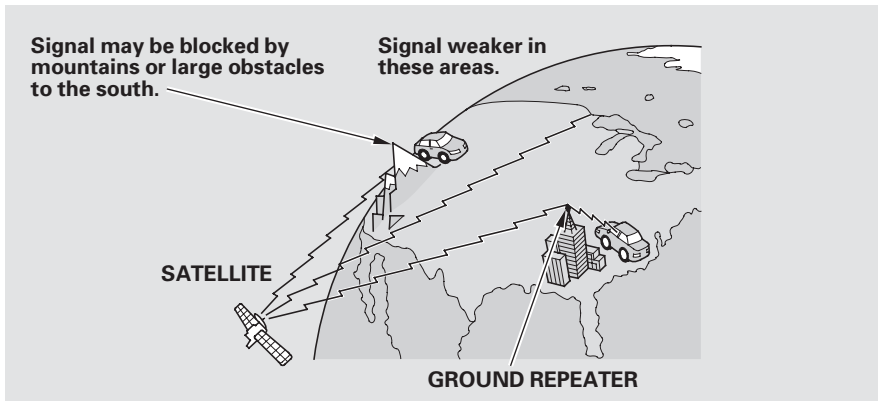

- Driving on a road beside a vertical wall, steep cliff, or hill to the south of you.
- Driving on the lower level of a multi-tiered road.
- Driving on a single lane road alongside dense trees taller than 50 ft. (15 m) to the south of you.

When DPLII is turned on (see page 311), sound coming from the rear speakers may be distorted due to the compression of the music being broadcast. Turn DPLII off if this happens.

*CONTINUED*

## Playing the XM® Radio (Models with navigation system)

---

*This Category II radiocommunication device complies with Industry Canada Standard RSS-310.*

*Operation is subject to the following two conditions: (1) this device may not cause interference, and (2) this device must accept any interference, including interference that may cause undesired operation of the device.*

There may be other geographic situations that could affect XM Radio reception.

*As required by the FCC:*

*Changes or modifications not expressly approved by the party responsible for compliance could void the user's authority to operate the equipment.*

### **Receiving XM Radio Service**

If your XM Radio service has expired or you purchased your vehicle from a previous owner, you can listen to a sampling of the broadcasts available on XM Radio. With the ignition switch in the ACCESSORY (I) or the ON (II) position, push the power/volume knob to turn on the audio system, and press the «XM» button. A variety of music types and styles will play.

If you decide to purchase XM Radio service, contact XM Radio at [www.siriusxm.com](http://www.siriusxm.com), or at 1-800-852-9696. In Canada, contact XM Canada at [www.xmradio.ca](http://www.xmradio.ca), or at 1-877-209-0079. You will need to give them your radio I.D. number and your credit card number. To get your radio I.D. number, turn the TUNE knob until "0" appears in the display. Your I.D. will appear in the displays.

After you have registered with XM Radio, keep your audio system in the XM Radio mode while you wait for activation. This should take about 30 minutes.

While waiting for activation, make sure your vehicle remains in an open area with good reception. XM Radio will continue to send an activation signal to your vehicle for at least 12 hours from the activation request. If the service has not been activated after 36 hours, contact XM® Radio. In Canada, contact XM CANADA®.

# Playing a Disc (Models with navigation system)

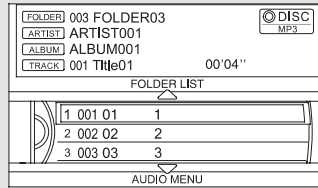

**AUDIO SCREEN**

## Without rear entertainment system

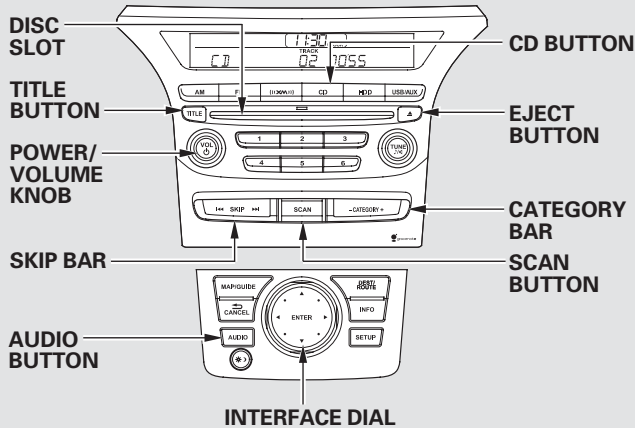

## With rear entertainment system

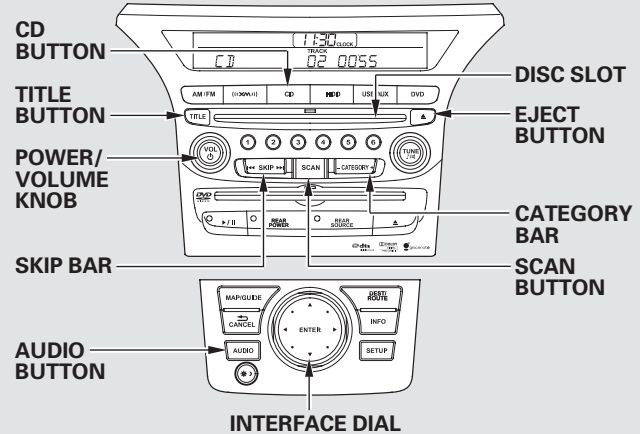

CONTINUED

## Playing a Disc (Models with navigation system)

---

To load or play a disc, the ignition switch must be in the ACCESSORY (I) or ON (II) position.

The disc player can play these disc formats:

- CD (CD-DA, CD-TEXT)
- CD-R/RW
- MP3/WMA

The disc packages or jackets should have one of these marks.

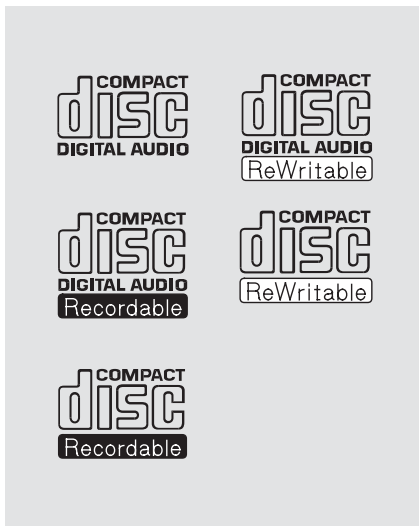

The disc player can also play CD-Rs and CD-RWs compressed in MP3, WMA or AAC formats.

### **NOTE:**

If a file on WMA or AAC disc is protected by digital rights management (DRM), the audio system skips to the next file.

Video CDs and DVD discs will not work in this unit.

Some CD-DA and CD-ROM mixed discs are not playable.



You cannot load and play 3-inch (8-cm) discs in this system.

**NOTICE**

*Do not use discs with adhesive labels. The label can curl up and cause the disc to jam in the unit.*

**To Load a Disc**

Insert a disc about halfway into the disc slot. The drive will pull the disc in the rest of the way to play it. You operate the disc player with the same controls used for the radio. The number of the current track is shown in the display. When playing a disc in MP3, WMA or AAC, the numbers of the current folder and file are shown. The system will continuously play a disc until you change modes.

For information on how to handle and protect compact discs, see page 332 .

## Playing a Disc (Models with navigation system)

---

### **To Play a Disc**

Select the disc player by pressing the CD button. The system will begin playing the last selected track in the disc. You will see the current track position highlighted.

Title information will be displayed in a list when the information is found in the Gracenote® Album Info (Gracenote® Media Database) on the built-in hard disk drive. When you play a CD recorded with text data, you will see the genre, artist name, album and track name on the screen. When you play MP3/WMA/AAC discs, you will see the folder name, artist name, album name and track name on the screen. If the disc was not recorded with this information, it will not be displayed.

Each time you press the TITLE button, the center display changes from artist name to album name, to track name and then to normal display that shows the track number and the elapsed time. When playing a disc in MP3/WMA/AAC, the display mode changes from folder name, to file name, to artist tag, to album tag, to track tag, and then to normal display.

## To Change Tracks

Each time you press and release the ►► side of the skip bar, the player skips forward to the beginning of the next track. Press and release the ◀◀ side of the skip bar to skip backward to the beginning of the current track. Press the ◀◀ side again to skip to the previous track. To move rapidly within a track, press and hold either side of the skip bar.

When you insert a CD for the first time, the system automatically starts recording to the hard disc. For information on recording from music CDs, see page 337.

When you insert a CD for the first time, a Gracenote notification appears. For more information, see page 360.

## To Choose a Track

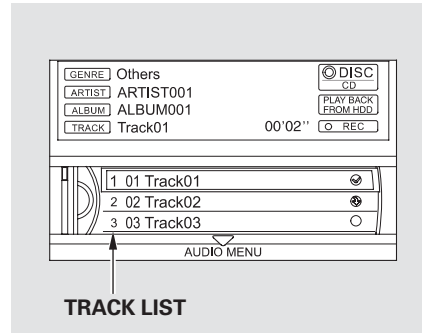

You can also choose a track directly from a track list. If there are no track names, you will see “No Title” displayed. Turn the interface dial to select the desired track, then press ENTER on the interface selector.

## Track Repeat

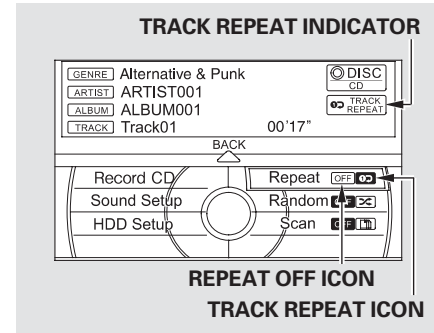

To replay the current track continuously, push the interface selector down while playing a disc. Turn the interface dial to select Repeat on the AUDIO MENU, and press ENTER on the interface selector. Turn the interface dial to select Repeat icon, and press ENTER on the interface selector.

CONTINUED

## Playing a Disc (Models with navigation system)

To turn this feature off, turn the interface dial to select the OFF icon, and press ENTER on the interface selector.

### Random Play

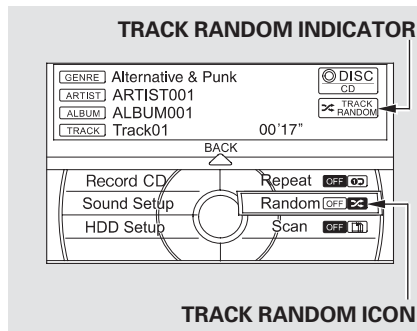

This feature plays the tracks within a disc in random order. When playing MP3, WMA or AAC format discs, all the tracks within the disc are played in random order, regardless of the configuration of the folder.

Push the interface selector down while playing a disc. Turn the interface dial to select Random on the AUDIO MENU, and press ENTER on the interface selector.

Turn the interface dial to select the track random icon, and press ENTER on the interface selector.

To turn this feature off, turn the interface dial to select the OFF icon, and press ENTER on the interface selector.

### Track Scan

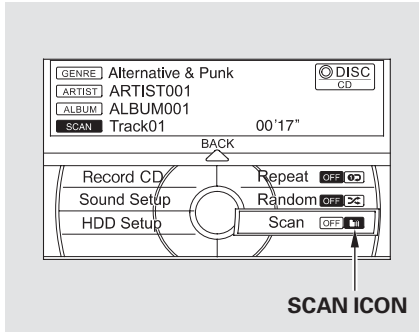

The scan function samples all tracks on the disc in the order they are recorded on the disc.

To activate scan, press the SCAN button, or push the interface selector down while playing a disc. Turn the interface dial to select Scan on the AUDIO MENU, and press ENTER on the interface selector.

Turn the interface dial to select the Scan icon, and press ENTER on the interface selector. You will hear a 10-second sampling of each track on the disc. When you return to disc mode, the disc will begin playing from where it left off.

To turn this feature off, press the SCAN button again, or turn the interface dial to select the OFF icon, and press ENTER on the interface selector. The system begins to play the last track sampled.

### To Stop Playing a Disc

To take the system out of the disc mode, press one of the other source buttons than the CD button.

You can also press the MODE button on the steering wheel to change modes.

If you turn the system off while a disc is playing, either with the power/volume knob or the ignition switch, play will continue at the same point when you turn it back on.

## Playing a Disc (Models with navigation system)

---

### Playing an MP3/WMA/AAC Disc

The CD player can play CD-Rs and CD-RWs compressed in MP3, WMA or AAC formats. When playing a disc in MP3, WMA or AAC, you will see “MP3,” “WMA” or “AAC” on the center display and screen (if selected). A disc can support more than 99 folders, and each folder can hold up to 255 playable files.

### NOTE:

Combining a low sampling frequency with a low bitrate may result in extremely degraded sound quality.

To play an MP3/WMA/AAC disc, use the disc controls previously described, along with the following information.

Depending on the software the files were made with, it may not be possible to play some files, or display some text data.

### Changing the Folders

Each time you press either side of the bar, the folder title and its first file's information appear on the center display. On the navigation display, each time you press either side of the bar, the system skips to the previous or next folder on the disc and displays a list of the selected folder's contents.

# Playing a Disc (Models with navigation system)

## Changing and Selecting the Folders/ Files

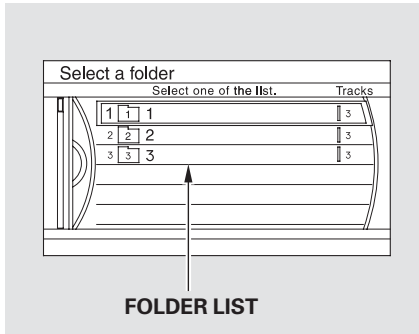

Using the interface selector, you can see the list of all the folders within a disc. While playing an MP3/WMA/AAC disc, push the interface selector up. The folder list in the currently playing disc will appear on the screen.

If the root folder has some additional folders in the lower layer, they will be listed on the screen.

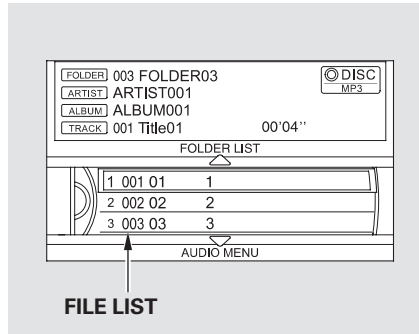

Select a desired folder by turning the interface dial, then press ENTER. The screen will change to the file list. Select a desired file and press ENTER. The selected file begins to play.

To change a file, turn the interface dial to select a desired file, then press ENTER.

## Folder Repeat

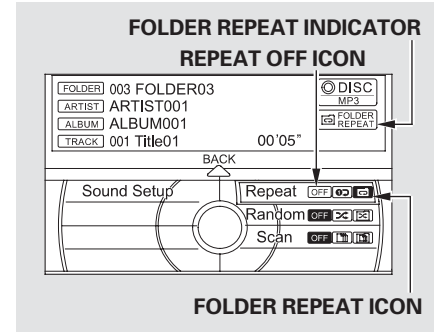

This feature, when activated, replays all files on the selected folder in the order they are compressed. To activate folder repeat play, push the interface selector down while playing a disc. Turn the interface dial to select Repeat on the AUDIO MENU, and press ENTER on the interface selector. Turn the interface dial to select the folder repeat icon, and press ENTER on the interface selector.

CONTINUED

## Playing a Disc (Models with navigation system)

To turn this feature off, turn the interface dial to select the OFF icon, and press ENTER on the interface selector.

### Folder Random

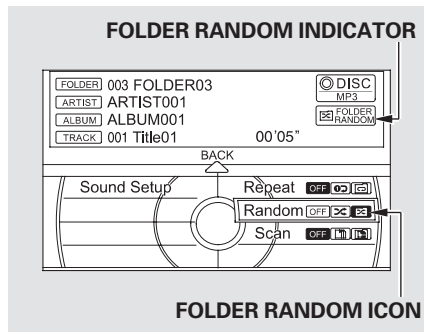

To turn this feature off, turn the interface dial to select OFF icon, and press ENTER on the interface selector.

This feature, when activated, plays all files in the current folder in random order. To activate folder random play, push the interface selector down while playing a disc. Turn the interface dial to select Random on the AUDIO MENU, and press ENTER on the interface selector. Turn the interface dial to select the folder random icon, and press ENTER on the interface selector.



## File Scan

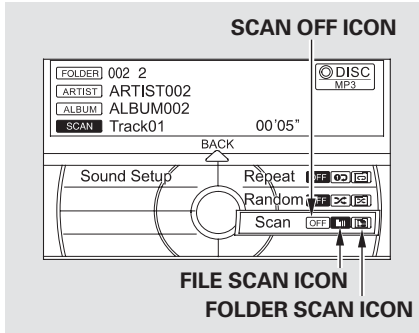

This feature samples all files in the selected folder in the order they are stored. To activate this feature, press the SCAN button. You can also select the SCAN icon with the interface dial. Push the selector down, turn the dial to select Scan on the AUDIO MENU, then press ENTER. Turn the dial to select the scan icon, then press ENTER. The system begins to play a file for about 10 seconds, and continues to sample

the remaining files.

To turn this feature off, press and hold the SCAN button for more than 2 seconds, or turn the interface dial to select the OFF icon, and press ENTER on the interface selector.

## Folder Scan

This feature, when activated, samples the first file of each folder for 10 seconds. To scan a folder, press the SCAN button repeatedly. Or, push the interface selector down while playing a disc. Turn the interface dial to select Scan on the AUDIO MENU, and press ENTER on the interface selector. Turn the interface dial to select the folder scan icon, and press ENTER on the interface selector.

CONTINUED

## Playing a Disc (Models with navigation system)

---

The system plays the first file in the first folder for about 10 seconds. If you do nothing, the system will then play the first files in the next folders for 10 seconds. After playing the first file in the last folder, the system plays normally.

To turn this feature off, press the SCAN button again, or turn the interface dial to select the OFF icon, and press ENTER on the interface selector. The system begins to play the last track sampled.

### **NOTE:**

Each time you press and release the SCAN button, the mode changes from file scan to folder scan, then to normal play.

### **Removing a Disc from the Player**

To remove the disc, press the eject ( ▲ ) button.

If you do not remove the disc from the slot, the system will reload the disc after 10 seconds. The disc starts playing automatically.

### **Protecting Discs**

For information on how to handle and protect discs, see page 332 .

## Disc Player Error Messages (Models with navigation system)

The chart on the right explains the error messages you may see in the center display while playing a disc.

If you see an error message in the center display while playing a disc, press the eject button. After ejecting the disc, check it for damage or deformation. If there is no damage, insert the disc again.

For additional information on damaged discs, see page 333 .

The audio system will try to play the disc. If there is still a problem, the error message will reappear. Press the eject button, and pull out the disc. Insert a different disc. If the new disc plays, there is a problem with the first disc. If the error message cycle repeats and you cannot clear it, take your vehicle to a dealer.

| Error Message   | Cause                           | Solution   |
|---|---------------------------------|--|
| HEAT ERROR  | High Temperature                | Will disappear when the temperature returns to normal.   |
| UNSUPPORTED   | Track/File format not supported | Current track will be skipped. The next supported track or file plays automatically.   |
| BAD DISC<br>PLEASE CHECK<br>OWNER'S<br>MANUAL PUSH<br>EJECT | Mechanical Error                | Press the EJECT button and pull out the disc. Check the disc for serious damage, signs of deformation, excessive scratches, and/or dirt (see page 333). Insert the disc again. If the code does not disappear, or the disc cannot be removed, consult your dealer. Do not try to force the disc out of the player. |
| BAD DISC<br>PLEASE CHECK<br>OWNER'S<br>MANUAL               | Servo Error                     |  |

## Protecting Your Discs

---

### General Information

- When using CD-R discs, use only high quality discs labeled for audio use.
- When recording a CD-R, the recording must be closed for it to be used.
- CD-RW discs will not work in this unit.
- Play only standard round discs. Odd-shaped CDs may jam in the drive or cause other problems.
- Handle your discs properly to prevent damage and skipping.

### Protecting Discs

When a disc is not being played, store it in its case to protect it from dust and other contamination. To prevent warpage, keep discs out of direct sunlight and extreme heat.

To clean a disc, use a clean soft cloth. Wipe across the disc from the center to the outside edge.

A new disc may be rough on the inner and outer edges. The small plastic pieces causing this roughness can flake off and fall on the recording surface of the disc, causing skipping or other problems. Remove these pieces by rubbing the inner and outer edges with the side of a pencil or pen.

Never try to insert foreign objects in the disc player.

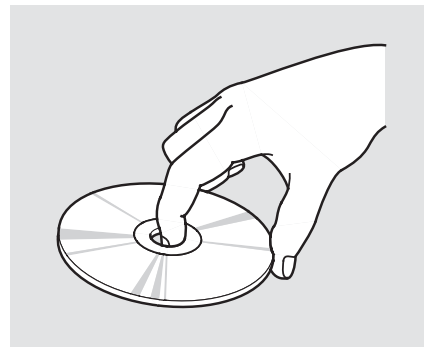

Handle a disc by its edges; never touch either surface. Do not place stabilizer rings or labels on the disc. These, along with contamination from fingerprints, liquids, and felt-tip pens, can cause the disc to not play properly, or possibly jam in the drive.

## Additional Information on Recommended Discs

The in-dash disc player has a sophisticated and delicate mechanism. If you insert a damaged disc as indicated in this section, it may become stuck inside and damage the audio unit.

Examples of these discs are shown to the right:

### 1. Bubbled, wrinkled, labeled, and excessively thick discs

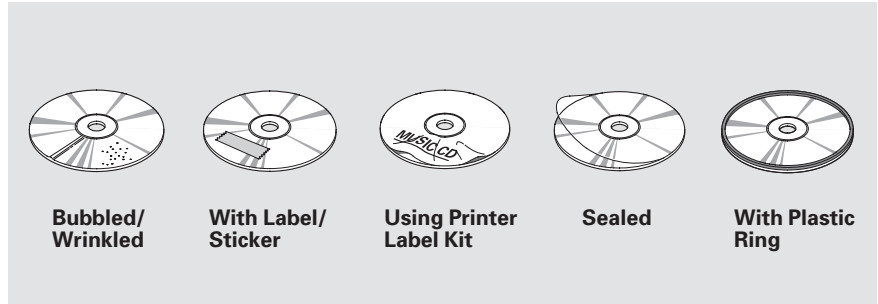

### 2. Damaged discs

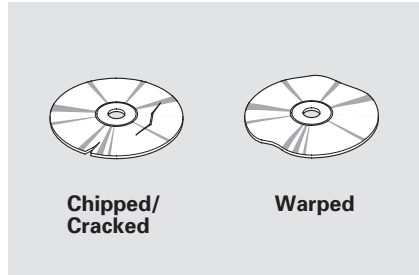

### 3. Poor quality discs

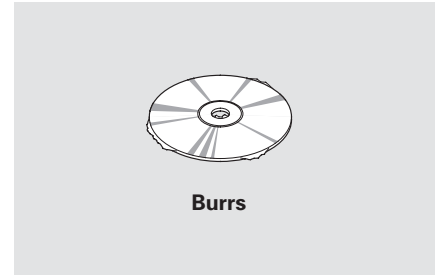

*CONTINUED*

# Protecting Your Discs

## 4. Small, irregular shaped discs

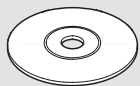

3-inch (8-cm) CD

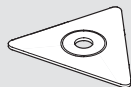

Triangle Shape

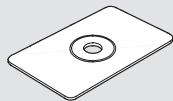

Can Shape

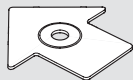

Arrow Shape

## 5. Discs with scratches, dirty discs

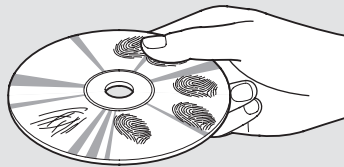

Fingerprints, scratches, etc.

- CD-R or CD-RW may not play due to the recording conditions.
- Scratches and fingerprints on the discs may cause the sound to skip.

- Recommended discs are printed with the following logo.



- Audio unit may not play the following formats.



- This audio unit cannot play a Dual-disc®.

# Playing Hard Disc Drive (HDD) Audio (Models with navigation system)

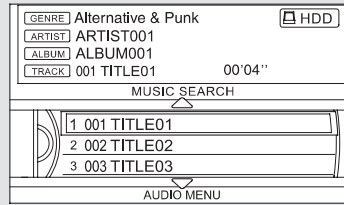

AUDIO SCREEN

## Without rear entertainment system

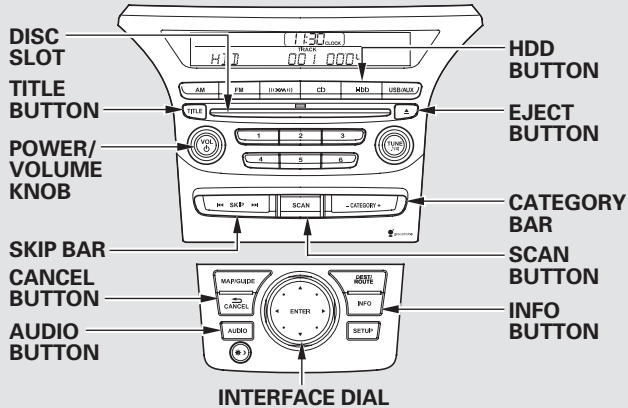

## With rear entertainment system

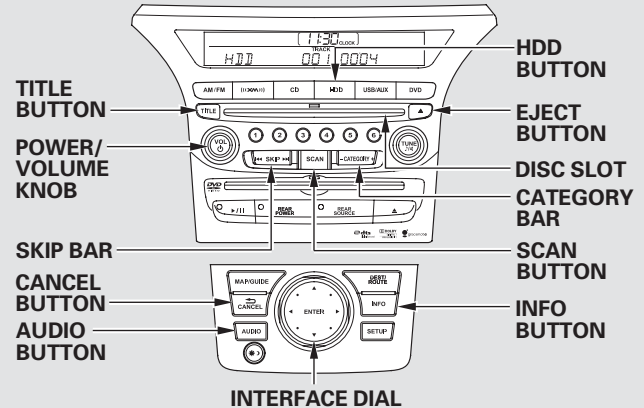

CONTINUED

## Playing Hard Disc Drive (HDD) Audio (Models with navigation system)

---

The Hard Disc Drive (HDD) Audio function can record tracks from music CDs to the navigation system's hard disc. This function also allows for various playing methods, such as playing recorded tracks on an artist-by-artist or genre-by-genre basis. For example, you can play the tracks that you want to listen to in any order that you like for each playlist.

### NOTE:

- Only recordings from a standard CD-DA (44.1 kHz, 16 bit stereo PCM digital sound data) to HDD are supported.
- Digital music files, such as MP3, WMA, AAC etc., in CD-R, DVD-R and USB flash memory devices cannot be copied to HDD. Likewise, digital music files recorded to HDD cannot be copied to CD-R, DVD-R and USB devices.

- Music data recorded on HDD can only be used for personal enjoyment.
- Data is recorded using ultra-efficient compression technology, therefore, sound quality may vary slightly from the original.
- Title information will be displayed when the information is found in the Gracenote® Album Info (Gracenote® Media Database) on the built-in hard disk drive. See page 360 .

- Recording function from following media is not supported.
  - CD-DA which prohibits the copying by SCMS
  - CD-DA with copy control
  - SACD (Super Audio CD)
  - DTS-CD
  - DVD-A
  - CD-R/RW
  - DVD-R/RW
  - Copy controlled CDs (Playback cannot be guaranteed)
  - DTS-CDs (Only enabled for playback)

If the HDD is ever replaced, all data will be lost and stored music will not be recovered.



### Playlists

Playlists are track lists in a certain playback group.

### Original Playlist

This playlist is automatically generated when the music CD is recorded. The maximum number of original playlists that can be stored to the HDD is 999, with 99 songs on each playlist. Each album name on the music CD is counted as a playlist.

### User Playlist

The HDD has six playlist folders for user customizing. Each playlist can be edited by the user, and will store up to 999 songs. For more information on how to edit the user playlist, see page 349.

### Track Search Methods

Songs that have been recorded on the HDD are categorized in groups for easy searching.

There are six categories:

Album record date: Album titles are arranged by date of recording.

Album: Album names are arranged in alphabetical order.

Artist: Artist names are arranged in alphabetical order.

Genre: Songs are arranged by genre.

Playlist: Any of six playlists that are arranged by the user.

Track: Track titles are arranged in alphabetical order.

For more information on how to search for music on the HDD, see page 344.

### Recording a Music CD to HDD Audio

If you play a music CD that has not yet been recorded on the HDD, the system will automatically begin recording to the HDD once the disc is loaded. To turn this feature off, see page 339.

*CONTINUED*

## Playing Hard Disc Drive (HDD) Audio (Models with navigation system)

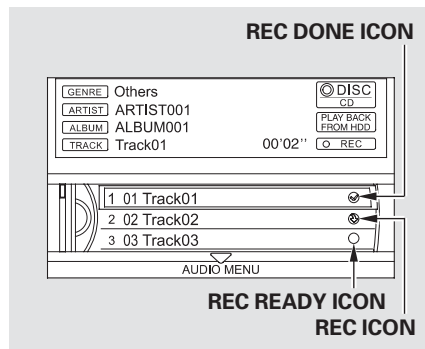

The icons show the recording

conditions for each track:

Rec icon: Now recording

Rec ready icon: Next to be recorded

Rec done icon: Recording finished

### NOTE:

- Please note that there will be no compensation offered in the case of unsuccessful recording of audio data or the loss of audio data due to any cause whatsoever.
  - During recording, operation of this product may be slower.
  - If you stop the engine or the power system is turned off while recording a CD, there may be pauses between songs when you play back from the HDD.
  - Tracks from music CDs are recorded at four times the playback speed. You can listen to tracks as they are being recorded.
  - Forward/rewind, repeat, random and scan functions are not available during recording.
- You can listen to tracks from other playlists that have already been recorded while recording. Press the HDD button and switch over to HDD Audio.
  - With the factory settings, all of the songs on a music CD are automatically recorded.
  - Recording settings cannot be changed during recording.
  - If the number of songs in the playlist exceeds 999, the oldest song will be overwritten each time you add a new song.

# Playing Hard Disc Drive (HDD) Audio (Models with navigation system)

## To Cancel Recording a Music CD to HDD

In order to suspend recording, push the interface selector down, select Cancel CD Recording, and press ENTER on the interface selector.

## Changing the Recording Settings Recording a Track on a Music CD Manually

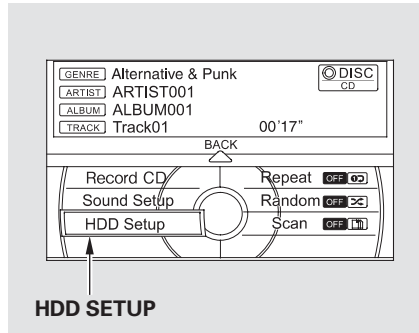

To change the setting to manual, push the interface selector down on the HDD screen. Turn the interface dial to select HDD Setup and press ENTER.

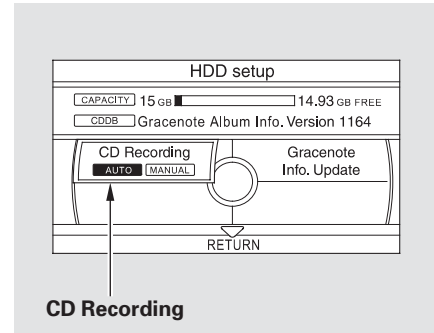

Turn the dial to select CD Recording and press ENTER on the interface selector.

Turn the interface dial to select MANUAL and press ENTER on the interface selector. Push down the interface selector to go back to the audio screen.

CONTINUED

## Playing Hard Disc Drive (HDD) Audio (Models with navigation system)

---

### *To Record a Track Manually*

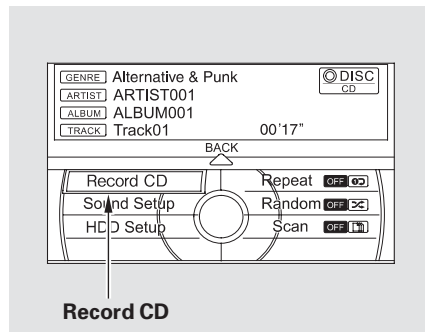

Select a track to record from the music CD, push the CD button, then push the interface selector down to display the audio menu. Turn the interface dial to select Record CD, and then press ENTER on the interface selector.

### *Recording All of the Tracks on a Music CD Automatically*

To change the setting to automatically record all of the tracks on a music CD, move the interface selector down on the HDD Audio screen. Turn the interface dial to select HDD Setup, and press ENTER on the interface selector.

Turn the dial to select CD Recording and press ENTER on the interface selector.

Turn the interface dial to select AUTO, and press ENTER on the interface selector.

### **Playing Tracks on HDD**

To play tracks on HDD, push the HDD button until the HDD Audio screen appears. Playback will start automatically with the track previously selected.

# Playing Hard Disc Drive (HDD) Audio (Models with navigation system)

## Changing a Track/Tracklist

To change a track or tracklist\*, press on the Category bar or the Skip bar.

| Category Bar |  |
|--------------|--|
| +            | The next tracklist is selected. If you press + during the last tracklist, the first tracklist is selected.     |
| -            | The previous tracklist is selected. If you press - during the first tracklist, the last tracklist is selected. |

\* : The tracklist has six search mode categories: album, artist, track, playlist, genre, and album record date. Within the selected category, the tracklist will be changed with the category bar.

| Skip Bar |   |
|----------|---|
| ◀◀       | Returns to the beginning of the song that is being played. Otherwise, the previous track is selected. If you press this bar during the first song, the last song is selected. |
| ▶▶       | The next song is selected. If you press this bar during the last song, the first song is selected.  |

## Fast Forwarding and Rewinding

To fast forward, press and hold the ▶▶ side of the SKIP bar. To rewind, press and hold the ◀◀ side of the SKIP bar.

## Repeat Playback

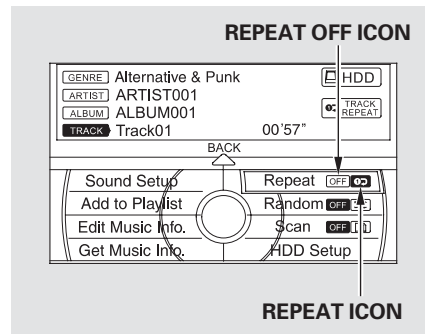

To replay the current track continuously, push the interface selector down during track playback.

Turn the interface dial to select Repeat on the HDD AUDIO MENU, and press ENTER on the interface selector. Turn the interface dial to select the repeat icon, then press ENTER on the interface selector.

CONTINUED

## Playing Hard Disc Drive (HDD) Audio (Models with navigation system)

To turn this feature off, turn the interface dial to select the OFF icon, then press ENTER on the interface selector.

### Random Playback

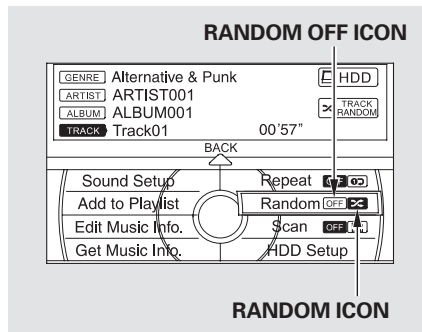

This function plays tracks in the current search mode in random order. To activate random play, push the interface selector down during track playback. Turn the interface dial to select Random on the HDD AUDIO MENU. Press ENTER on the interface selector.

Turn the interface dial to select the track random icon, and press ENTER on the interface selector.

To turn this feature off, turn the interface dial to select the OFF icon, then press ENTER on the interface selector.

# Playing Hard Disc Drive (HDD) Audio (Models with navigation system)

## Scan Playback

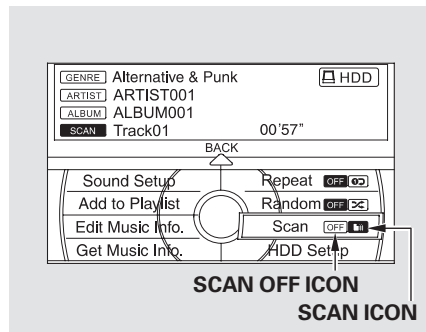

This function samples the tracks in the current search mode in the order that they were recorded.

To activate scan, push the interface selector down during track playback. Turn the interface dial to select Scan on the HDD AUDIO MENU, and press ENTER on the interface selector.

Turn the interface dial to select the scan icon. Press ENTER on the interface selector. You will hear a 10-second sampling of each track in the current search mode.

You can also select the scan feature with the SCAN button on the control panel. Press and release the SCAN button.

To turn this feature off, press the SCAN button again, or turn the interface dial to select the OFF icon, and press ENTER on the interface selector. The system begins to play the last track sampled.

## Making a User Playlist

The HDD has two types of the playlists: original playlist and user playlist. On the original playlist, the music CD is recorded automatically when it is played. In addition, you can create up to six user playlists on the HDD. In each playlist, you can store a desired music data from the original playlists or music CDs.

CONTINUED

## Playing Hard Disc Drive (HDD) Audio (Models with navigation system)

### *Adding a Track to an Original/User Playlist*

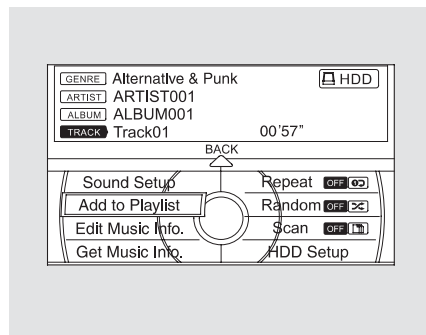

While a track is playing on an Original Playlist or User Playlist Playback screen, push the interface selector down. Turn the interface dial and select Add to Playlist, then press ENTER on the interface selector.

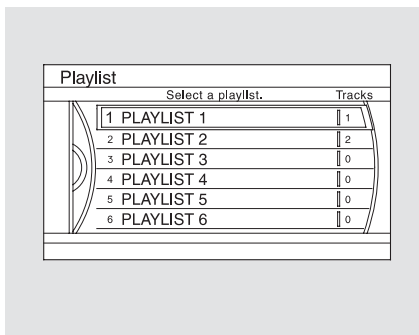

On the Playlist screen, turn the interface dial and select the Playlist to which the song is to be added, then press ENTER on the interface selector. You will be returned to the Playback screen.

After storing music data, you can customize the original and user playlists (see page 349).

### **Searching the Music**

While playing music in the HDD playback screen, push the interface selector up to select MUSIC SEARCH. You can search a track by album, artist, track, playlist, genre, or album record date, or you can shuffle all tracks.

The audio system, including the music search feature Song By Voice™, can be operated by voice control. See the navigation system manual for complete details.



# Playing Hard Disc Drive (HDD) Audio (Models with navigation system)

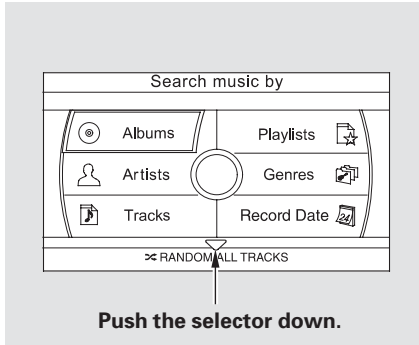

## RANDOM ALL TRACKS

Shuffles the playback of all tracks that have been recorded on HDD.

To shuffle all tracks, push the interface selector up to display the “Search music by” screen, and then push the interface selector down. Shuffled playback begins.

## Searching Music by Album

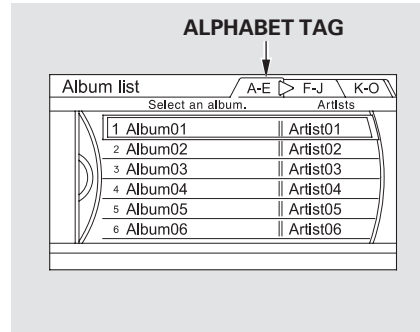

Push the interface selector up to display the “Search music by” screen, and turn the interface dial to select “Albums.” Press ENTER on the selector, and the album list will be displayed in alphabetical order.

If you push the interface selector right or left, you can change the alphabet tag.

Turn the interface dial to select the album you want to listen to, then press ENTER on the selector.

The first track on the selected album begins to play.

# Playing Hard Disc Drive (HDD) Audio (Models with navigation system)

## Searching Music by Artist

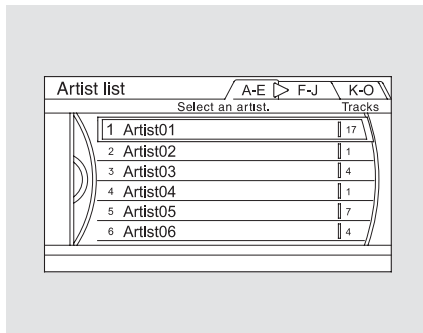

Push the interface selector up to display the Search music by screen, and turn the interface dial to select "Artists." Press ENTER on the interface selector, and the artist list will be displayed in alphabetical order.

If you push the interface selector right or left, you can change the alphabet tag.

Turn the interface dial to select the artist you want to listen to, and press ENTER on the interface selector.

The first track on the selected artist begins to play.

## Searching Music by Track

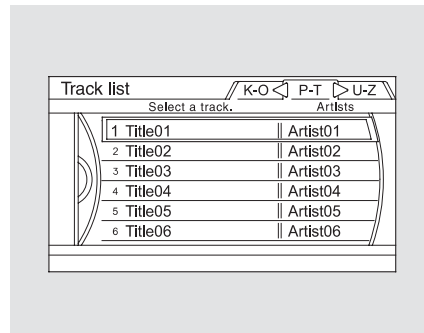

Push the interface selector up to display the Search music by screen, and turn the interface dial to select "Tracks." Press ENTER on the interface selector, and the track list will be displayed in alphabetical order.

## Playing Hard Disc Drive (HDD) Audio (Models with navigation system)

If you push the interface selector right or left, you can change the alphabet tag.

Turn the interface dial to select a track you want to listen to, then press ENTER on the interface selector.

The selected track begins to play.

### Searching Music by Playlists

| Playlist           |        |
|--------------------|--------|
| Select a playlist. | Tracks |
| 1 PLAYLIST 1       | 1      |
| 2 PLAYLIST 2       | 2      |
| 3 PLAYLIST 3       | 0      |
| 4 PLAYLIST 4       | 0      |
| 5 PLAYLIST 5       | 0      |
| 6 PLAYLIST 6       | 0      |

Push the interface selector up to display the Search music by screen, and turn the interface dial to select "Playlists." Press ENTER on the interface selector then the playlist will be displayed.

Turn the interface dial to select the playlist you want to listen to, then press ENTER on the interface selector.

The first track on the selected playlist begins to play.

# Playing Hard Disc Drive (HDD) Audio (Models with navigation system)

## Searching Music by Genre

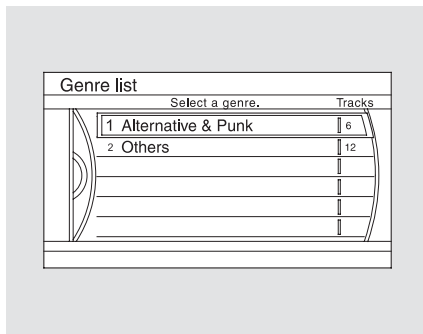

Push the interface selector up to display the Search music by screen, and turn the interface dial to select “Genres.” Press ENTER on the interface selector, and the genre list will be displayed.

Turn the interface dial to select the genre you want to listen to, and then press ENTER on the interface selector.

The first track on the selected genre begins to play.

## Searching Music by Album Record Date

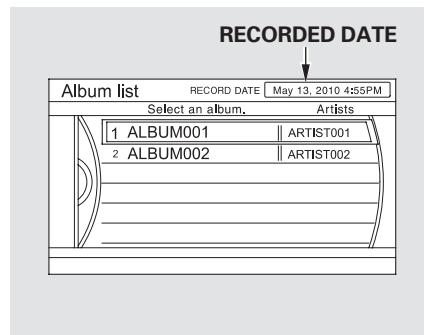

Push the interface selector up to display the Search music by screen, and turn the interface dial to select Album Record Date. Press ENTER on the interface selector. The album list will be displayed.

Turn the interface dial to select the album you want to listen to, then press ENTER on the selector.

The first track on the selected album begins to play.

### **Customizing Original/User Playlist**

After storing the data, you can change some items: name of an artist, play list name, track title, music genre, order of the tracks on the original/user playlist. You can also delete the track or the album from the playlist.

You cannot change the artist name, original play list name (album name), track name, and music genre unless you change them on the original play list.

### ***Changing the Order of Tracks of the Original Playlist or User Playlist***

1. On the HDD audio screen, push up the interface selector to select MUSIC SEARCH. Select Albums or Playlists by turning the interface dial, then press ENTER.
2. Turn the interface dial to select the album list or the playlist, then press ENTER.
3. Push the interface selector down to display the AUDIO MENU for the playlist.

CONTINUED

## Playing Hard Disc Drive (HDD) Audio (Models with navigation system)

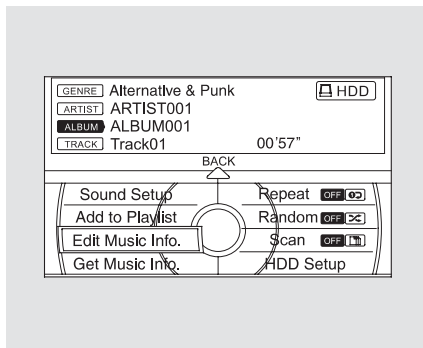

4. Turn the interface dial and select "Edit Music Info.," then press ENTER.

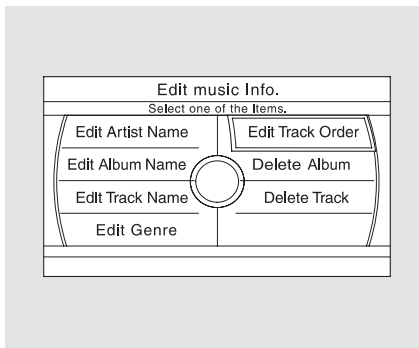

5. Turn the interface dial to select Edit Track Order, then press ENTER on the interface selector.
6. Turn the interface dial to select the track to be moved, then press ENTER on the interface selector.

7. Turn the interface dial to select where the track is to be moved, then press ENTER on the interface selector.
8. Push the interface selector down to return to the Edit Music Info. screen.
9. Push the CANCEL button or the AUDIO button. The screen returns to the playlist.

# Playing Hard Disc Drive (HDD) Audio (Models with navigation system)

## *Changing the Artist Name of the Original Playlist*

1. While a track is playing on an “Original Playlist Playback” screen, push the interface selector down.
2. Turn the interface dial and select “Edit Music Info.,” then press ENTER.

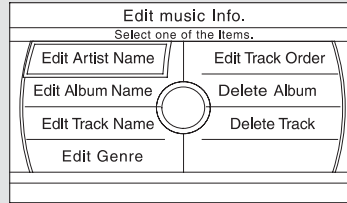

3. Turn the interface dial to select Edit Artist Name, then press ENTER on the interface selector.

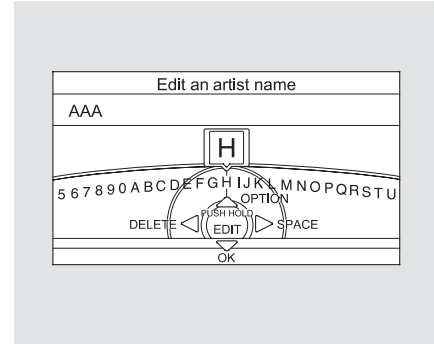

4. On the “Edit an artist name” screen, input the new artist name.  
  
Select a letter by turning the interface dial, then press ENTER.
5. After inputting the name, push the interface selector down to select OK.

CONTINUED

## Playing Hard Disc Drive (HDD) Audio (Models with navigation system)

---

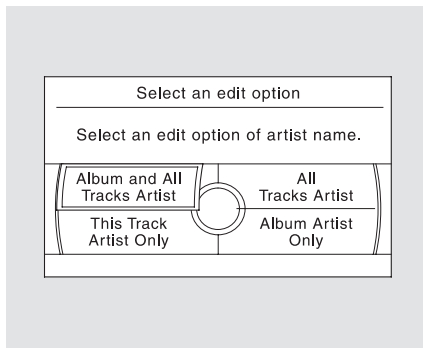

6. The “Select an edit option” screen is displayed. Choose if you would like to apply the new name to both the album artist and/or the track artist. Select your edit option by turning the dial, then press ENTER.

7. You will be returned to the “Edit music Info.” screen.
8. Push the CANCEL button or the AUDIO button. The screen returns to the playlist.

### *Changing the Name of the Original Playlist or User Playlist*

1. Select a desired playlist to change the user playlist name, or a desired album to change the original playlist name (album name). Refer to the Music Search function on page 344 for how to select a playlist or an album. Push the interface selector down to display the AUDIO MENU for a selected playlist or album.
2. Turn the interface dial and select “Edit Music Info.,” then press ENTER.



# Playing Hard Disc Drive (HDD) Audio (Models with navigation system)

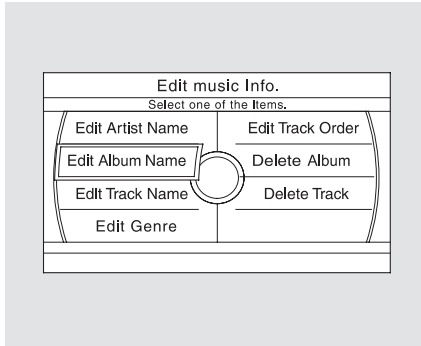

3. On the “Edit music Info.” screen, turn the interface dial to select Edit Album Name (or Edit Playlist Name to edit user playlist), then press ENTER on the interface selector.

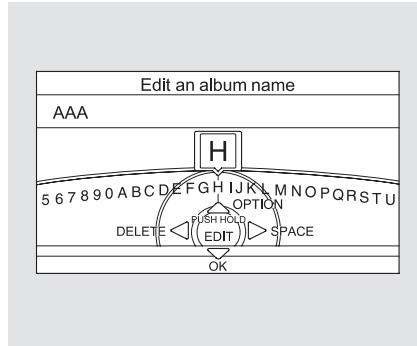

4. On the “Edit an album name” screen, input the new Original Playlist name or User Playlist name.
5. After inputting the name, push the interface selector down to select OK.
6. You will be returned to the “Edit music Info.” screen.
7. Push the CANCEL button or the AUDIO button. The screen returns to the playlist.

## *Changing the Track Name of the Original Playlist*

1. While a track is playing on an “Original Playlist Playback” screen, push the interface selector down.
2. Turn the interface dial and select “Edit Music Info.,” then press ENTER.

CONTINUED

## Playing Hard Disc Drive (HDD) Audio (Models with navigation system)

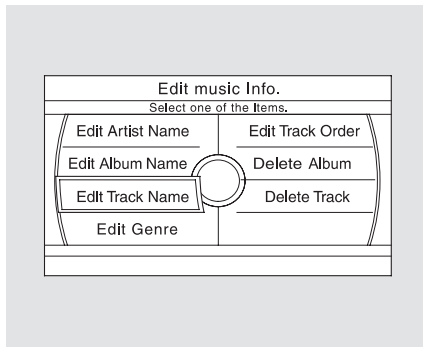

3. On the “Edit music Info.” screen, turn the interface dial to select Edit Track Name, then press ENTER on the interface selector.

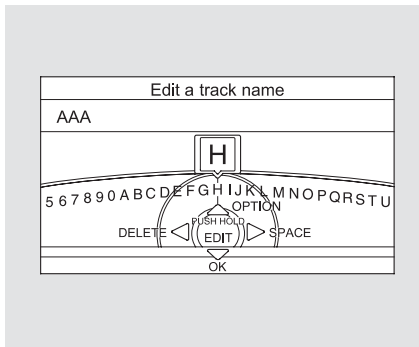

4. On the “Edit a track name” screen, input the new track name.
5. After inputting the name, push the interface selector down to select OK.
6. You will be returned to the “Edit music Info.” screen.
7. Push the CANCEL button or the AUDIO button. The screen returns to the playlist.

### *Changing the Musical Genre*

1. While a track is playing on an “Original Playlist Playback” screen, push the interface selector down.
2. Turn the interface dial and select “Edit Music Info.,” then press ENTER.

# Playing Hard Disc Drive (HDD) Audio (Models with navigation system)

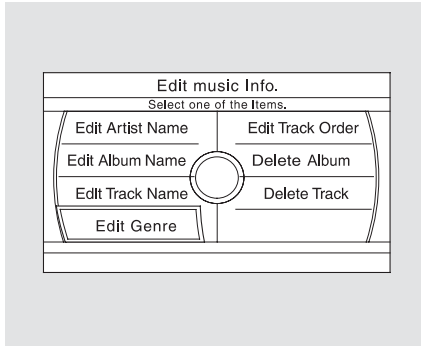

3. Turn the interface dial to select Edit Genre, then press ENTER on the interface selector in “Select a genre” screen.

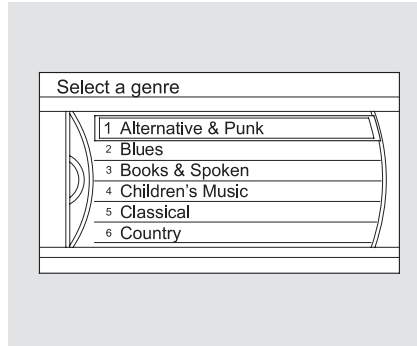

4. On the “Select a genre” screen, turn the interface dial and select genre, and then press ENTER on the interface selector.

5. Turn the interface dial on the “Select a genre” screen to select the Original Playlist that you want to change the genre and then press ENTER on the interface selector. You will be returned to the “Edit music Info.” screen.
6. Push the CANCEL button or the AUDIO button. The screen returns to the playlist.

## Playing Hard Disc Drive (HDD) Audio (Models with navigation system)

---

### Deleting an Album or Playlist

1. On the HDD playback screen of the album in which you want to delete, push the interface selector down to display the AUDIO MENU.
2. Turn the interface dial and select “Edit Music Info.,” then press ENTER.

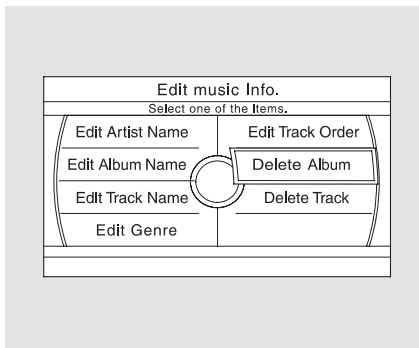

3. On the “Edit music Info.” screen, turn the interface dial and select Delete Album (or Delete Playlist), then press ENTER.
4. The Confirmation is displayed. Select OK and then press ENTER. You will be returned to the playback screen for the Original Playlist or User Playlist.

### NOTE:

- When you delete the Original Playlist, any tracks stored in a User Playlist are also deleted.
- Even if all the tracks are deleted from the User Playlist, the data folder for that playlist cannot be deleted, and their names (playlist and artist) are left. You can store tracks again on that playlist.

# Playing Hard Disc Drive (HDD) Audio (Models with navigation system)

## Deleting a Track

1. Select the track with the interface dial from the playback screen while it is playing. Push the interface selector down to display the AUDIO MENU.
2. Turn the interface dial and select “Edit Music Info.,” then press ENTER.

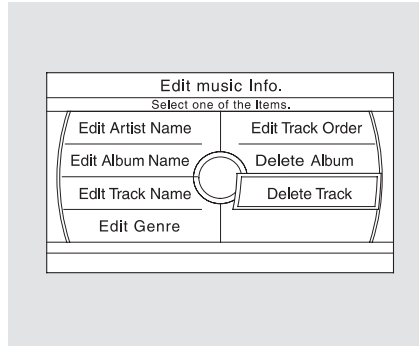

3. The “Edit music Info.” screen is displayed. Select Delete Track and press ENTER.
4. Select OK to confirm you want to delete the track. You will be returned to the Playback screen for the Original Playlist or User Playlist.

## NOTE:

- When you delete a track from the Original Playlist, the track is also deleted from the User Playlist in which the deleted track was stored.
- Even if all the tracks are deleted from the User Playlist, the data folder for that playlist cannot be deleted, and their names (playlist and artist) are left. You can store tracks again on that playlist.

## Playing Hard Disc Drive (HDD) Audio (Models with navigation system)

### Acquiring Title Information

1. Push the interface selector down to display the AUDIO MENU.
2. Turn the interface dial and select Get Music Info., then press ENTER.
3. On the “Select an Album” screen, turn the interface dial and select the title information for the Original Playlist, then press ENTER. You will be returned to the “Audio Menu” screen.

### Checking HDD Audio Capacity

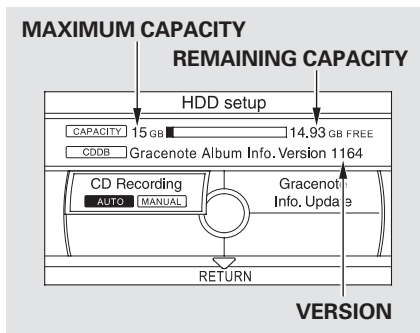

You can check the HDD Audio capacity and remaining space as well as the Gracenote Music Recognition Service (CDDDB) version included with the navigation system on the HDD Setup screen.

To check the HDD audio capacity, push the interface selector down to display the AUDIO MENU. Turn the interface dial to select HDD Setup, then press ENTER.

### Updating Gracenote® Album Info (Gracenote® Media Database)

You can update the Gracenote® Album Info (Gracenote® Media Database) that is included with the navigation system.

#### NOTE:

Consult your dealer, or visit [www.honda.com](http://www.honda.com) (in U.S.), or [www.honda.ca](http://www.honda.ca) (in Canada), to acquire updated files.

1. Insert the update disc into the disc slot, or connect the USB flash memory device that includes the update.

## Playing Hard Disc Drive (HDD) Audio (Models with navigation system)

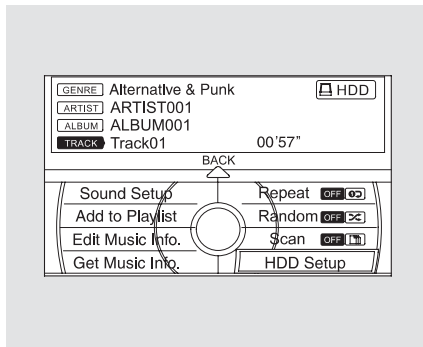

2. Push the interface selector down to select AUDIO MENU in the HDD playback screen or CD playback screen.
3. Turn the interface dial to select HDD Setup, then press ENTER on the interface selector.

4. Turn the interface dial and select Gracenote Info. Update, then press ENTER on the interface selector.
5. Turn the dial to select USB or DISC on the Update Gracenote by screen, then press ENTER on the selector.
6. Turn the dial to select Yes on the confirmation screen, and the update will start.
7. Turn the interface dial to select OK on the confirmation screen.
8. After updating is complete, press ENTER on the confirmation screen.

### NOTE:

Once you perform an update, any information you edited before will be overwritten.

### *Clearing the HDD*

Any music, data, calendar entries, etc. that have been stored on the HDD can be deleted.

1. Press the INFO button, rotate the interface dial to select “Set up,” and press ENTER.
2. Move the interface selector to the right to navigate to the “Set up (Other)” screen.
3. On the “Set up (Other)” screen, rotate the interface dial to select “Clear Personal Data,” and press ENTER.
4. Select the item you wish to delete.

CONTINUED

## Playing Hard Disc Drive (HDD) Audio (Models with navigation system)

---

5. A pop-up screen verifying whether the deletion is to be continued or not will be displayed. Select Yes to delete, or No to cancel.
6. A second confirmation will appear. Select Yes to delete, or No to cancel.
7. When you are finished deleting the data, press the interface selector down to select “Done.”

**NOTE:** If you select “Music on HDD,” the system will automatically restart after deletion.

### Gracenote Music Recognition Service (CDDB)



Music recognition technology and related data are provided by Gracenote®. Gracenote is the industry standard in music recognition technology and related content delivery. For more information visit [www.gracenote.com](http://www.gracenote.com).

When music is recorded to the HDD from a CD, information such as the recording artist and track name are retrieved from the Gracenote Database and displayed (when available). Gracenote may not contain information for all albums.

Gracenote is an internet-based music recognition service that allows artist, album, and track information from CDs to display on the HDD. More information about Gracenote is available at [www.honda.com](http://www.honda.com) (in U.S.) or [www.honda.ca](http://www.honda.ca) (in Canada).



## Playing Hard Disc Drive (HDD) Audio (Models with navigation system)

CD and music-related data from Gracenote, Inc., copyright © 2000 to present Gracenote. Gracenote Software, copyright © 2000 to present Gracenote. One or more patents owned by Gracenote apply to this product and service. See the Gracenote website for a non-exhaustive list of applicable Gracenote patents. Gracenote, CDDB, MusicID, MediaVOCS, the Gracenote logo and logotype, and the “Powered by Gracenote” logo are either registered trademarks or trademarks of Gracenote in the United States and/or other countries.

### **Gracenote® End User License Agreement**

This application or device contains software from Gracenote, Inc. of Emeryville, California (“Gracenote”). The software from Gracenote (the “Gracenote Software”) enables this application to perform disc and/or file identification and obtain music-related information, including name, artist, track, and title information (“Gracenote Data”) from online servers or embedded databases (collectively, “Gracenote Servers”) and to perform other functions. You may use Gracenote Data only by means of the intended End-User functions of this application or device. You agree that you will use Gracenote Data, the Gracenote Software, and Gracenote Servers for your own personal non-commercial use only.

You agree not to assign, copy, transfer or transmit the Gracenote Software or any Gracenote Data to any third party.

**YOU AGREE NOT TO USE OR EXPLOIT GRACENOTE DATA, THE GRACENOTE SOFTWARE, OR GRACENOTE SERVERS, EXCEPT AS EXPRESSLY PERMITTED HEREIN.**

You agree that your non-exclusive license to use the Gracenote Data, the Gracenote Software, and Gracenote Servers will terminate if you violate these restrictions. If your license terminates, you agree to cease any and all use of the Gracenote Data, the Gracenote Software, and Gracenote Servers.

*CONTINUED*

## Playing Hard Disc Drive (HDD) Audio (Models with navigation system)

---

Gracenote reserves all rights in Gracenote Data, the Gracenote Software, and the Gracenote Servers, including all ownership rights. Under no circumstances will Gracenote become liable for any payment to you for any information that you provide. You agree that Gracenote, Inc. may enforce its rights under this Agreement against you directly in its own name.

The Gracenote service uses a unique identifier to track queries for statistical purposes. The purpose of a randomly assigned numeric identifier is to allow the Gracenote service to count queries without knowing anything about who you are. For more information, see the web page for the Gracenote Privacy Policy for the Gracenote service.

The Gracenote Software and each item of Gracenote Data are licensed to you "AS IS."

Gracenote makes no representations or warranties, express or implied, regarding the accuracy of any Gracenote Data from in the Gracenote Servers. Gracenote reserves the right to delete data from the Gracenote Servers or to change data categories for any cause that Gracenote deems sufficient. No warranty is made that the Gracenote Software or Gracenote Servers are error-free or that functioning of Gracenote Software or Gracenote Servers will be uninterrupted.

Gracenote is not obligated to provide you with new enhanced or additional data types or categories that Gracenote may provide in the future and is free to discontinue its services at any time.

GRACENOTE DISCLAIMS ALL WARRANTIES EXPRESS OR IMPLIED, INCLUDING, BUT NOT LIMITED TO, IMPLIED WARRANTIES OF MERCHANTABILITY, FITNESS FOR A PARTICULAR PURPOSE, TITLE, AND NON-INFRINGEMENT. GRACENOTE DOES NOT WARRANT THE RESULTS THAT WILL BE OBTAINED BY YOUR USE OF THE GRACENOTE SOFTWARE OR ANY GRACENOTE SERVER. IN NO CASE WILL GRACENOTE BE LIABLE FOR ANY CONSEQUENTIAL OR INCIDENTAL DAMAGES OR FOR ANY LOST PROFITS OR LOST REVENUES.

Copyright© 2000 to present  
Gracenote

# Playing an iPod® (Models with navigation system)

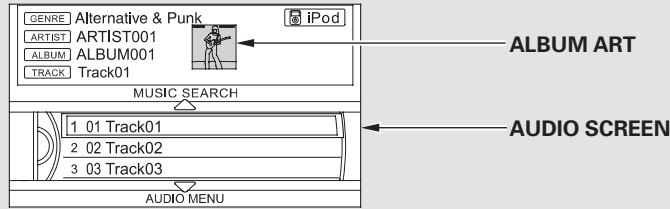

## Without rear entertainment system

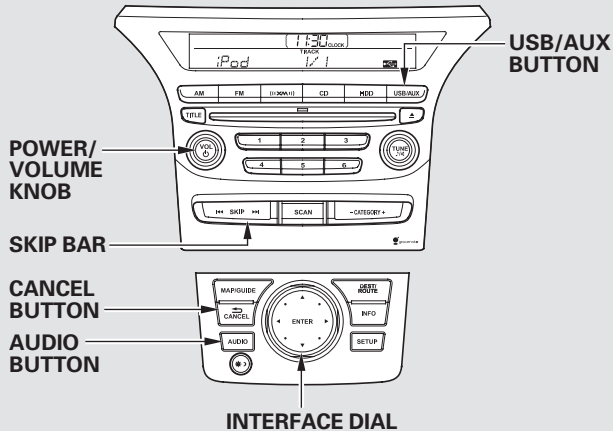

## With rear entertainment system

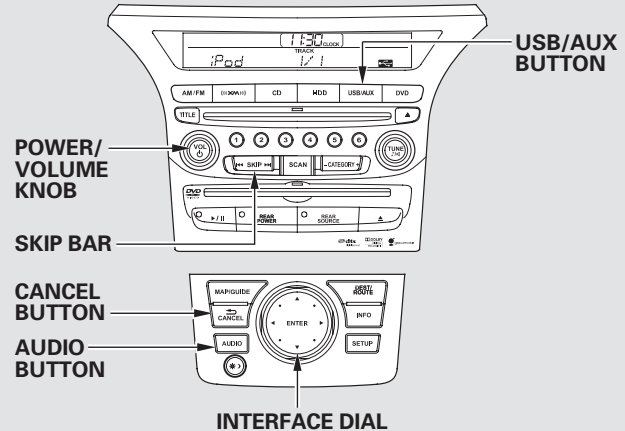

## Playing an iPod® (Models with navigation system)

---

### To Play an iPod®

This audio system can select and play the audio files on the iPod® with the same controls used for the in-dash disc player. To play an iPod, connect it to the USB adapter cable in the console compartment by using your dock connector, then press the USB/AUX button. The ignition switch must be in the ACCESSORY (I) or ON (II) position. The iPod will also be charged with the ignition switch in these settings.

The audio system reads and plays playable sound files on the iPod. The system cannot operate an iPod as a mass storage device. The system will only play songs stored on the iPod with iTunes.

iPod and iTunes are registered trademarks owned by Apple Inc.

### *Voice Control System*

You can select the AUX mode by using the voice control buttons.

The audio system, including the music search feature Song By Voice™, can be operated by voice control. See the navigation system manual for complete details.

iPods compatible with your audio system using the USB adapter cable are:

| Model                     | Software            |
|---------------------------|---------------------|
| iPod 5th generation       | Ver. 1.3 or more    |
| iPod classic              | Ver. 1.1.2 or more  |
| iPod nano 1st generation  | Ver. 1.3.1 or more  |
| iPod nano 2nd generation  | Ver. 1.1.3 or more  |
| iPod nano 3rd generation  | Ver. 1.1.3 or more  |
| iPod nano 4th generation  | Ver. 1.0.4 or more  |
| iPod touch 1st generation | Ver. 1.1.1 or more  |
| iPod touch 2nd generation | Ver. 2.2.1 or more  |
| iPhone                    | Ver. 2.1.0 or more  |
| iPhone 3G                 | Ver. 2.1.0 or more  |
| iPhone 3GS                | Ver. 5.12.1 or more |

## Playing an iPod® (Models with navigation system)

Use only compatible iPods with the latest software. iPods that are not compatible will not work in this audio unit.

### NOTE:

- Do not connect your iPod using a hub.
- Do not keep the iPod and dock connector cable in the vehicle. Direct sunlight and high heat will damage it.
- Do not use an extension cable between the USB adapter cable equipped with your vehicle and your dock connector.
- We recommend backing up your data before playing it.
- Some devices cannot be powered or charged via the USB adapter. If this is the case, use the accessory adapter to supply power to your device.

### Connecting an iPod

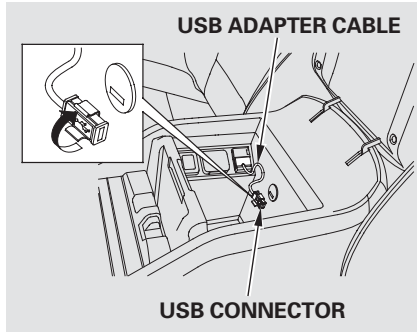

1. Unclip the USB connector by pivoting it, and pull out the USB adapter cable in the console compartment.

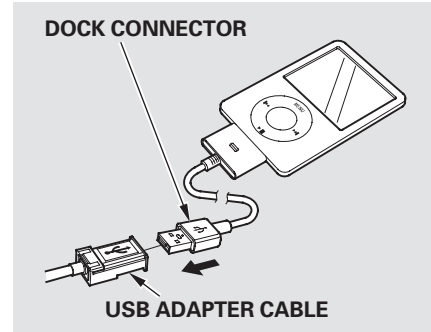

2. Connect your dock connector to the iPod correctly and securely.
3. Install the dock connector to the USB adapter cable securely.

CONTINUED

## Playing an iPod® (Models with navigation system)

If the iPod indicator does not appear in the audio display, check the connections, and try to reconnect the iPod a few times.

If the audio system still does not recognize the iPod, the iPod may need to be reset. Follow the instructions that came with your iPod, or you can find reset instructions online at [www.apple.com/](http://www.apple.com/)

The current file number and total of the selected playable files are displayed in the center display. Pressing the AUDIO button displays the artist, album and track (file) names on the navigation screen.

If a file on your iPod has an album art, it will be shown in the display.

### *To Change or Select Files*

Use the SKIP bar while an iPod is playing to select passages and change files.

**SKIP** — Each time you press and release the ►| side of the SKIP bar, the system skips forward to the beginning of the next track. Press and release the |◀ side of the bar to skip backward to the beginning of the current track. Press it again to skip to the beginning of the previous track.

To move rapidly within playing track, press and hold either side ( ►| or |◀ ) of the SKIP bar.

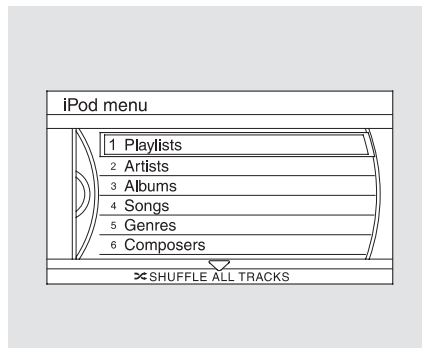

You can also select a track from any category on the list: Playlists, Artists, Albums, Songs, Genres, Composers and Podcasts by using the interface dial.

Push the interface selector up to display the Music Search screen. Turn the interface dial to select a desired search method.

## Playing an iPod® (Models with navigation system)

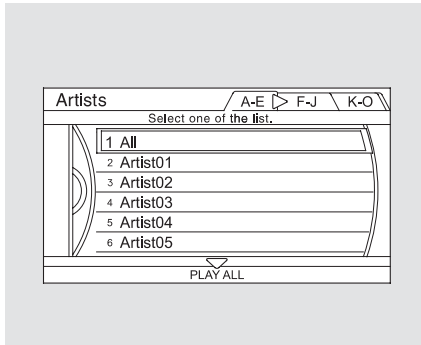

Press ENTER on the interface selector to display the items on that list, then turn the interface dial to make a selection. Press ENTER to set your selection.

If you select “ALL” on the artists list, the albums list is displayed.

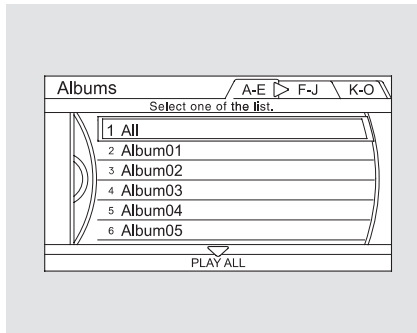

If you select “ALL” on the albums list, all the tracks become available for selection.

The track order that appears at this time varies depending on the iPod model and software.

Push the interface selector down to “PLAY ALL” on any list. All available files on the selected list are played.

Press the AUDIO button to go back to the normal audio playing display. Pressing the CANCEL button goes back to the previous screen, and pressing the MAP/GUIDE button cancels the audio control display on the screen.

CONTINUED

## Playing an iPod® (Models with navigation system)

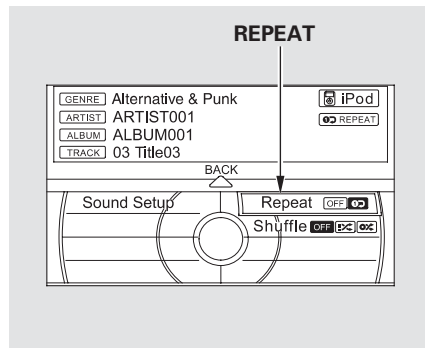

**REPEAT** — This feature continuously plays a file.

1. Press the AUDIO button to display the audio control screen, then push the interface selector down to display the AUDIO MENU.
2. Turn the interface dial, select Repeat, and press ENTER.

3. Turn the interface dial, select the Repeat icon and press ENTER. Playback of the track that is currently being played will be repeated.

To cancel this function, turn the interface dial and select the Repeat OFF icon, and then press ENTER.

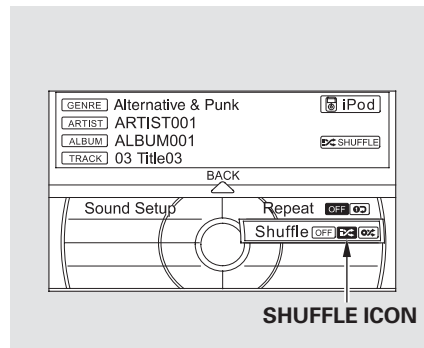

**SHUFFLE** — This feature shuffles playback of tracks contained within the iPod. This function can be established at the same time that Repeat Playback is set up.

1. On the iPod screen, push the interface selector down to display the AUDIO MENU.



## Playing an iPod® (Models with navigation system)

2. Turn the interface dial, select Shuffle and press ENTER on the interface selector.
3. Turn the interface dial, select the Shuffle icon and press ENTER on the interface selector.

Shuffle playback will begin. To cancel this function, turn the interface dial and select the Shuffle OFF icon, and then press ENTER on the interface selector.

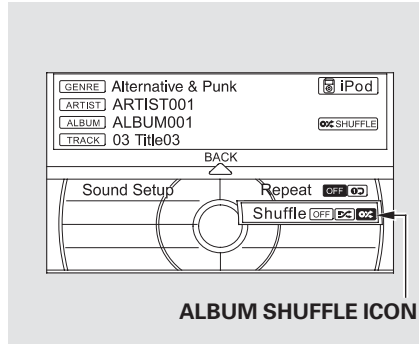

**ALBUM SHUFFLE** – Shuffles playback of all available albums, which are selected by the desired list: playlists, artists, albums or songs. This function can be selected at the same time that Repeat Playback is setup.

1. On the iPod screen, push the interface selector down to display the AUDIO MENU.

2. Turn the interface dial, select Shuffle and press ENTER on the interface selector.
3. Turn the interface dial, select the Album Shuffle icon and press ENTER on the interface selector. Shuffle playback of the album will begin.

To cancel this function, turn the interface dial and select the Shuffle OFF icon, and then press ENTER on the interface selector.

### NOTE:

Available operating functions vary on models or versions. Some functions may not be available on the vehicle's audio system.

## Playing an iPod® (Models with navigation system)

---

### To Stop Playing Your iPod

To take the system out of the iPod mode, press one of the other source buttons than the USB/AUX button. When a compatible audio unit is connected to the auxiliary input jack, press the USB/AUX button to select it.

You can also press the MODE button on the steering wheel to change modes.

### *Disconnecting an iPod*

You can disconnect the iPod at any time when you see the “OK to disconnect” message\* in the iPod display. Always make sure you see the “OK to disconnect” message in the iPod display before you disconnect it. Make sure to follow the iPod’s instructions on how to disconnect the dock connector from the USB adapter cable.

\* : The displayed message may vary on models or versions. On some models, there is no message to disconnect.

When you disconnect the iPod while it is playing, the audio screen (if selected) shows NO DATA.

If you reconnect the same iPod, the system may begin playing where it left off, depending on what mode the iPod is in when it is reconnected.

### NOTICE

*When you connect your iPod to the navigation system, the most recent settings (Shuffle, Repeat, etc.) will be carried over.*

## iPod® Error Messages (Models with navigation system)

---

If you see an error message in the center display while playing an iPod, find the solution in the chart to the right. If you cannot clear the error message, take your vehicle to your dealer.

| Error Message | Solution                                       |
|---------------|--|
| UNSUPPORTED   | Appears when an unsupported iPod is inserted.  |
| CONNECT RETRY | Appears when the iPod cannot be authenticated. |
| iPod NO SONG  | Appears when there are no files in the iPod.   |

# Playing a USB Flash Memory Device (Models with navigation system)

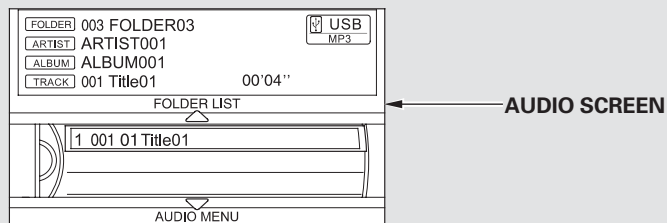

## Without rear entertainment system

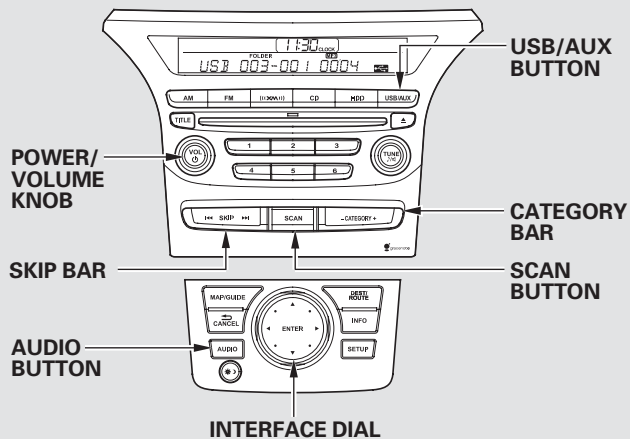

## With rear entertainment system

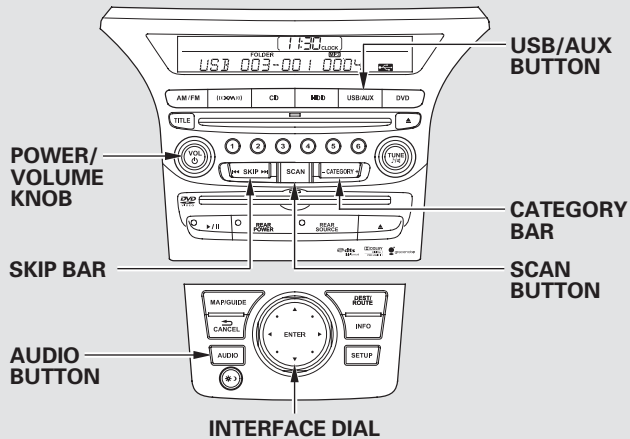

## Playing a USB Flash Memory Device (Models with navigation system)

### To Play a USB Flash Memory Device

This audio system can select and play the audio files from a USB flash memory device with the same controls used for the in-dash disc player. To play a USB flash memory device, connect it to the USB adapter cable in the console compartment, then press the USB/AUX button. The ignition switch must be in the ACCESSORY (I) or ON (II) position.

The audio system reads and plays the audio files on the USB flash memory device in MP3, WMA or AAC\* formats.

\* : Only AAC format files recorded with iTunes are playable on this audio unit.

The recommended USB flash memory devices are 256 MB or higher, and formatted with the FAT file system. Some digital audio players may be compatible as well.

Some USB flash memory devices (such as devices with security lock-out features, etc.) will not work in this audio unit.

### NOTE:

- Do not use a device such as a card reader or hard drive as it or your files may be damaged.
- Do not connect your USB flash memory device using a hub.
- Do not use an extension cable to the USB adapter cable equipped with your vehicle.

CONTINUED

## Playing a USB Flash Memory Device (Models with navigation system)

---

- Do not keep a USB flash memory device in the vehicle. Direct sunlight and high heat will damage it.
- We recommend backing up your data before playing a USB flash memory device.
- Depending on the type and number of files, it may take some time before they begin to play.
- Depending on the software the files were made with, it may not be possible to play some files, or display some text data.
- Depending on the type of encoding and writing software used, there may be cases where character information does not display properly.

- Some devices cannot be powered or charged via the USB adapter. If this is the case, use the accessory adapter to supply power to your device.
- The order of files in USB playback may be different from the order of files displayed in PC or other devices etc. Files are played in the order stored in USB flash memory device.

### ***Voice Control System***

You can select the AUX mode by using the voice control buttons, but cannot operate the play mode functions.

Some versions of MP3, WMA, or AAC format may not be supported. If an unsupported file is found, the audio unit displays UNSUPPORTED, then skips to the next file.

## Playing a USB Flash Memory Device (Models with navigation system)

In WMA or AAC format, DRM (digital rights management) files cannot be played. If the system finds a DRM file, the audio unit displays UNPLAYABLE FILE, and then skips to the next file.

### NOTICE

*Combining a low sampling frequency with a low bitrate may result in extremely degraded sound quality.*

### Connecting a USB Flash Memory Device

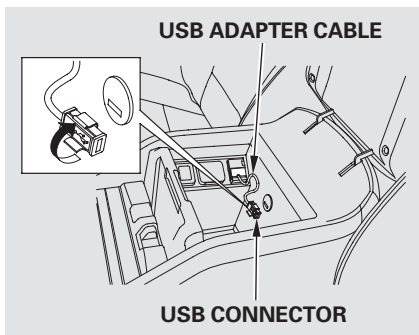

1. Unclip the USB connector by pivoting it, and pull out the USB adapter cable in the console compartment.

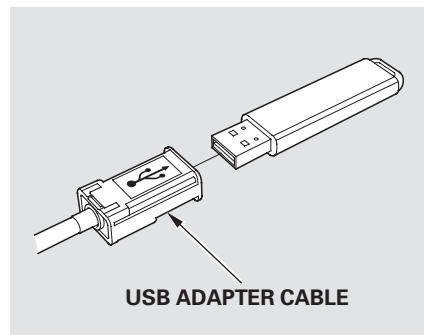

2. Connect the USB flash memory device to the USB adapter cable correctly and securely.

CONTINUED

## Playing a USB Flash Memory Device (Models with navigation system)

When the USB device is connected and the USB mode is selected on the audio system, the USB indicator is shown in the center display. It also shows the folder and file numbers. Pressing the AUDIO button displays the USB indicator, the folder and file names, and the elapsed time in the navigation screen.

### *To Change or Select Files*

Use the SKIP bar while a USB flash memory device is playing to select passages and change files.

**SKIP** — Each time you press and release the ►► side of the SKIP bar, the system skips forward to the beginning of the next file. Press and release the ◀◀ side of the bar, to skip backward to the beginning of the current file. Press it twice to skip to the beginning of the previous file.

To move rapidly within a file, press and hold either side ( ►► or ◀◀ ) of the SKIP bar.

**Folder Selection** — To select a different folder, press and release either side of the CATEGORY bar. Press the + side to skip to the next folder, and press the - side to skip to the beginning of the previous folder.

### *To Select a File from Folder and File Lists*

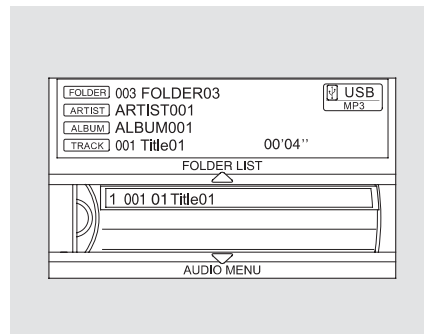

You can also select a folder or file from the list by using the interface dial. Press the AUDIO button to show the audio display on the navigation screen. Use the interface dial to highlight the file, then press ENTER to set your selection.



# Playing a USB Flash Memory Device (Models with navigation system)

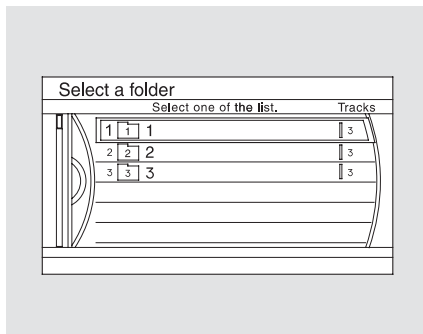

Push the selector up to display the “Select a folder” screen. Then turn the interface dial to select a folder, and press ENTER.

If you have more than one layer of folders (folders within folders), you can also see each folder on the screen.

To go back to the normal playing display, press the AUDIO button. Pressing the CANCEL button goes back to the previous screen and pressing the MAP button cancels the audio mode display.

### *To Select Repeat, Random or Scan Mode:*

Push the interface selector down to display the AUDIO MENU.

You can select any type of repeat, random or scan mode on the audio menu screen.

Move the interface selector up to select BACK to show the USB screen, or press the CANCEL button to return to the previous screen.

## TRACK REPEAT

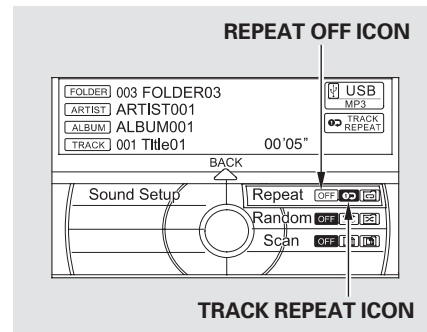

This function repeats playback of the track.

1. On the USB main screen, push the interface selector down to display the AUDIO MENU.
2. Turn the interface dial to select Repeat and press ENTER.

CONTINUED

## Playing a USB Flash Memory Device (Models with navigation system)

3. Turn the interface dial, select the Track Repeat icon and press ENTER on the interface selector. Playback of the track that is currently being played will be repeated.

To cancel this function, turn the interface dial and select the Repeat OFF icon, and then press ENTER.

Pressing either side of the SKIP bar also cancels this function.

### FOLDER REPEAT

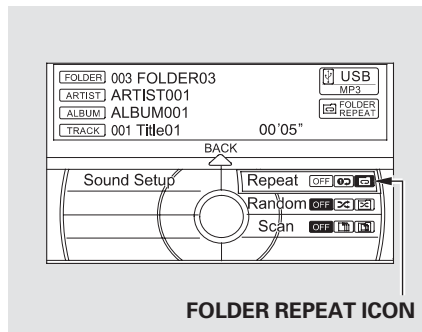

This function replays all the tracks in a folder in the order that they were stored.

1. On the USB main screen, push the interface selector down to display the AUDIO MENU.
2. Turn the interface dial to select Repeat and press ENTER.

3. Turn the interface dial, select the Folder Repeat icon and press ENTER on the interface selector. Playback of the folder that is currently being played will be repeated.

To cancel this function, turn the interface dial and select the Repeat OFF icon, and then press ENTER on the interface selector.

# Playing a USB Flash Memory Device (Models with navigation system)

## TRACK RANDOM

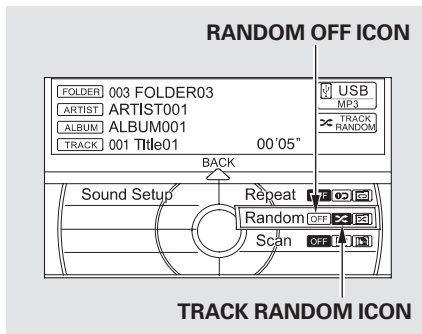

This function plays all the tracks on the USB flash memory device in random order.

1. On the USB main screen, push the interface selector down to display the AUDIO MENU.
2. Turn the interface dial, select Random and press ENTER on the interface selector.

3. Turn the interface dial, select the Track Random icon and press ENTER on the interface selector. The tracks are played in random order.

To cancel this function, turn the interface dial and select the Random OFF icon, and then press ENTER on the interface selector.

## FOLDER RANDOM

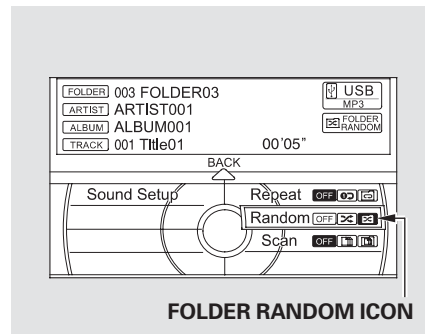

This function plays all of the tracks in the current folder in random order.

1. On the USB main screen, push the interface selector down to display the AUDIO MENU.
2. Turn the interface dial, select Random and press ENTER on the interface selector.

CONTINUED

## Playing a USB Flash Memory Device (Models with navigation system)

- Turn the interface dial, select the Folder Random icon and press ENTER on the interface selector. The files are played in random order.

To cancel this function, turn the interface dial and select the Random OFF icon, and then press ENTER on the interface selector.

When you want to use this function to another folder (not the folder that is currently played), you can select the folder to be played in random order as following:

- On the USB main screen, push the interface selector up to display the folder list screen.

Turn the interface dial and highlight the folder you want to change to.

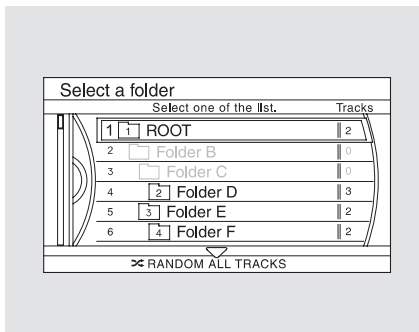

- Push the interface selector down to "RANDOM ALL TRACKS" on the folder list screen. All available files in the selected folder are played in random order.

### TRACK SCAN

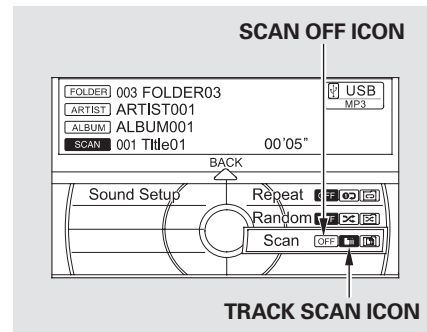

This function samples all the tracks in the current folder in the order that they were recorded.

- On the USB main screen, push the interface selector down to display the AUDIO MENU.
- Turn the interface dial, select the Scan icon and press ENTER on the interface selector.

## Playing a USB Flash Memory Device (Models with navigation system)

3. Turn the interface dial, select Track Scan icon and press ENTER on the interface selector. Each track or file is sampled for 10 seconds. When all the tracks in the folder have been scanned, regular playback is resumed.

To cancel this function, turn the interface dial and select the Scan OFF icon, and then press ENTER on the interface selector to play the last track sampled.

### FOLDER SCAN

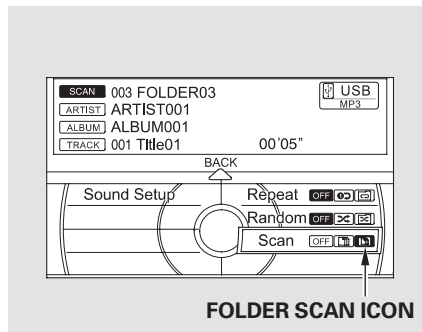

This function samples the first file in each folder within the USB flash memory device.

1. On the USB main screen, push the interface selector down to display the AUDIO MENU.
2. Turn the interface dial, select the Scan icon and press ENTER on the interface selector.

3. Turn the interface dial, select Folder Scan icon and press ENTER on the interface selector.

The first file of the first folder is sampled for 10 seconds. If no other operations are carried out, the first files of the remaining folders are played for 10 seconds. After the first file of the last folder is played back, regular playback is resumed.

To cancel this function, turn the interface dial and select the Scan OFF icon, and then press ENTER on the interface selector.

You can also select the scan feature with the SCAN button on the control panel. Press and release the SCAN button.

## Playing a USB Flash Memory Device (Models with navigation system)

---

### **To Stop Playing a USB Flash Memory Device**

To take the system out of the USB mode, press one of the other source buttons than the USB/AUX button. When a compatible audio unit is connected to the auxiliary input jack, press the USB/AUX button to select it.

You can also press the MODE button on the steering wheel to change modes.

If you reconnect the same USB flash memory device, the system will begin playing where it left off.

### ***Disconnecting a USB Flash Memory Device***

You can disconnect the USB flash memory device at any time even if the USB mode is selected on the audio system. Always follow the USB flash memory device's instructions when you remove it.

When you disconnect the USB flash memory device while it is playing, the center display and the audio screen (if selected) show NO DATA.

## USB Flash Memory Device Error Messages (Models with navigation system)

If you see an error message in the center display while playing a USB flash memory device, find the solution in the chart to the right. If you cannot clear the error message, take your vehicle to your dealer.

| Error Message                                    | Solution   |
|--|--|
| UNSUPPORTED                                      | Appears when an unsupported USB flash memory device is inserted.   |
| UNPLAYABLE FILE                                  | Appears when the file is copyright protected, such as DRM.   |
| USB NO SONG                                      | Appears when there are no playable files in the USB flash memory device.   |
| BAD USB DEVICE<br>PLEASE CHECK<br>OWNER'S MANUAL | Appears when the overcurrent protection feature of the system stops supplying power to USB because an incompatible device is connected. Disconnect the device. Then, turn the audio system off, and turn it on again. Do not reconnect the device that caused the error. |

# Bluetooth® Audio System (Models with navigation system)

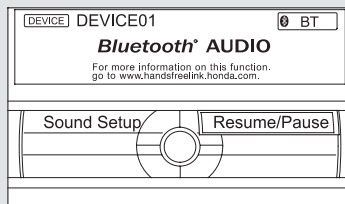

AUDIO SCREEN

*Without rear entertainment system*

*With rear entertainment system*

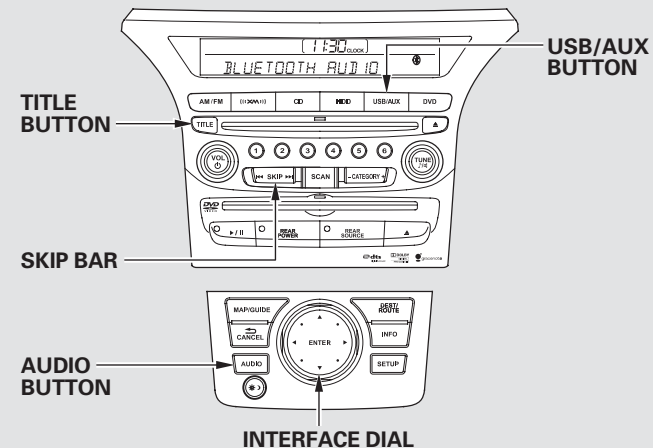
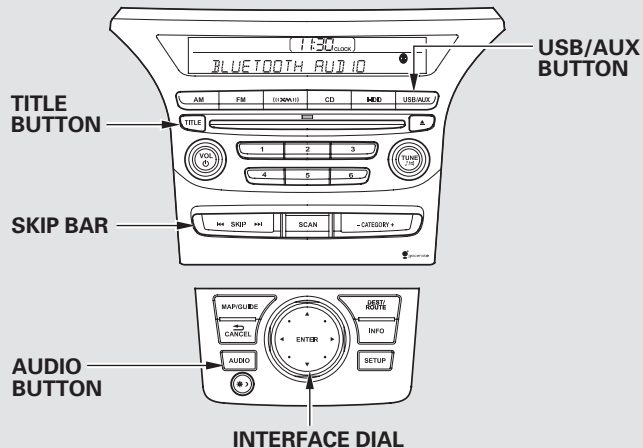



Your vehicle is equipped with a Bluetooth® Audio system, which allows you to listen to streaming audio from your Bluetooth® Audio compatible phone. This function is only available on phones that are paired and linked to the vehicle's Bluetooth® HandsFreeLink® (HFL) system (see page 468).

Not all Bluetooth-enabled phones with streaming audio capabilities are compatible with the system. You can find an approved phone by visiting [handsfreelink.honda.com](http://handsfreelink.honda.com) or call 888-528-7876. In Canada, visit [www.handsfreelink.ca](http://www.handsfreelink.ca), or call (888) 528-7876.

**NOTE:** In some states, provinces, and territories, it may be illegal to perform some data device functions while driving.

### To Play Bluetooth® Audio Files

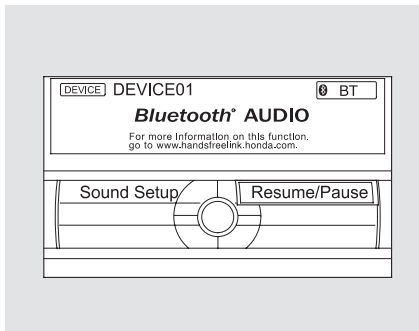

Make sure that your phone is paired and linked to HFL.

To begin to play the audio files, you may need to operate your phone. If so, follow the phone maker's operating instructions.

Press the USB/AUX button\*. When the phone is recognized, you will see the Bluetooth® Audio message on the center display and the screen (if selected), and the system begins to play.

- \*: If an iPod or USB flash memory device or audio unit connected to the auxiliary input jack was selected at the last mode, you will see iPod, USB or AUX in the center display and the audio control display on the navigation screen (if selected). Push the USB/AUX button again to play audio files from your Bluetooth® Audio phone.

CONTINUED

## Bluetooth® Audio System (Models with navigation system)

---

Once a device is linked, the name of the device will appear on the screen. Pressing the TITLE button switches the center display between the Bluetooth® Audio and the device name.

If more than one phone is paired to the HFL system, there will be a delay before the system begins to play.

**NOTE:** The text display function may not be available on some phone devices.

In the following conditions, the display shows “NO CONNECT” message after pressing the TITLE button.

- The phone is not linked to HFL.
- The phone is not turned on.
- The phone is not in the vehicle.
- Another HFL compatible phone, which is not compatible for Bluetooth® Audio, is already connected.

If your Bluetooth® Audio compatible phone does not operate as described, make sure it is a Honda approved phone. To find out if your phone is approved, go to *handsfreelink.honda.com* (in Canada, *www.handsfreelink.ca*), or call the HandsFreeLink® consumer support at 888-528-7876.

### ***Voice Control System***

You can select the AUX mode by using the voice control buttons, but cannot operate the play mode functions.

### ***To skip a file***

Press the ►► side of the SKIP bar to skip forward to the next file, and press the ◀◀ side to skip backward to the beginning of the current file. Push the ◀◀ side again to skip to the previous file.

**NOTE:** The skip function may not be available on some phone devices.

## To pause or resume a file

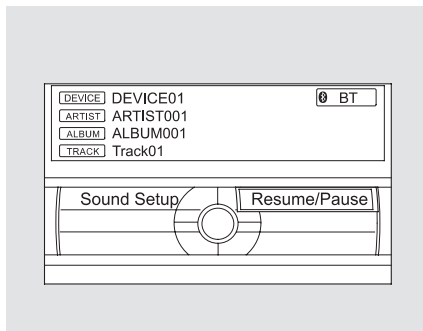

The resume/pause mode can stop playing a file temporarily.

Turn the interface dial to switch the setting between the resume/pause mode and the sound setup mode. Select Resume/Pause, then press ENTER to set your selection. Each time you press ENTER, the system switches between the resume mode and pause mode.

**NOTE:** The pause function may not be available on some phone devices.

## To change sound settings

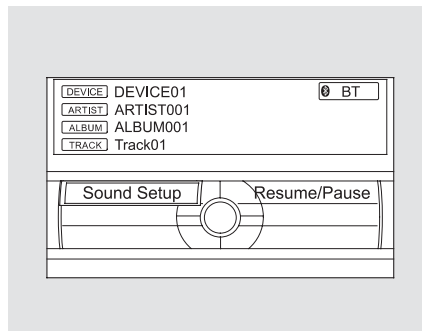

Press the AUDIO button to display the audio control display. Turn the dial to switch the setting between the resume/pause mode and the sound setup mode. Select Sound Setup, then press ENTER to set your selection.

CONTINUED

## **Bluetooth® Audio System (Models with navigation system)**

---

Turn the dial to select a sound setup mode, then press ENTER to set your selection. See page 309 for more sound setting information.

### ***To switch to HFL mode***

If you receive a call when the Bluetooth® Audio is playing, press the PICK-UP button on the steering wheel. The screen and the center display switch to the HFL mode (see page 463).

After ending the call, press the HANG-UP button to go back to the Bluetooth® Audio mode.

### ***To turn off the Bluetooth® Audio mode***

To take the system out of the Bluetooth® Audio mode, press one of the other source buttons than the USB/AUX button. When a compatible audio unit is connected to the auxiliary input jack, press the USB/AUX button to select it.

Switching to another mode pauses the music playing from your phone.

*As required by the FCC:*

*This device complies with Part 15 of the FCC rules. Operation is subject to the following two conditions: (1) This device may not cause harmful interference, and (2) this device must accept any interference received, including interference that may cause undesired operation.*

*Changes or modifications not expressly approved by the party responsible for compliance could void the user's authority to operate the equipment.*

*This device complies with Industry Canada Standard RSS-210.*

*Operation is subject to the following two conditions: (1) this device may not cause interference, and (2) this device must accept any interference that may cause undesired operation of the device.*

## Radio Frequencies

The radio can receive the complete AM and FM bands.

Those bands cover these frequencies:

AM band: 530 to 1,710 kHz  
FM band: 87.7 to 107.9 MHz

Radio stations on the AM band are assigned frequencies at least 10 kHz apart (530, 540, 550). Stations on the FM band are assigned frequencies at least 0.2 MHz apart (87.9, 88.1, 88.3).

Stations must use these exact frequencies. It is fairly common for stations to round-off the frequency in their advertising, so your radio could display a frequency of 100.9 even though the announcer may identify the station as "FM101."

## Radio Reception

How well the radio receives stations is dependent on many factors, such as the distance from the station's transmitter, nearby large objects, and atmospheric conditions.

A radio station's signal gets weaker as you get farther away from its transmitter. If you are listening to an AM station, you will notice the sound volume becoming weaker, and the station drifting in and out. If you are listening to an FM station, you will see the stereo indicator flickering off and on as the signal weakens. Eventually, the stereo indicator will go off and the sound will fade completely as you get out of range of the station's signal.

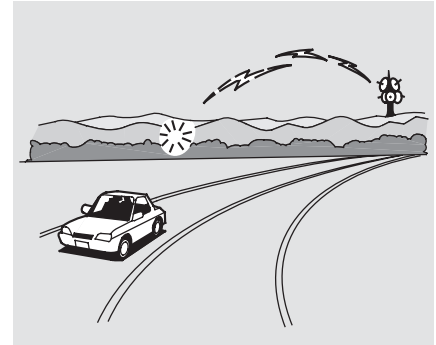

Driving very near the transmitter of a station that is broadcasting on a frequency close to the frequency of the station you are listening to can also affect your radio's reception. You may temporarily hear both stations, or hear only the station you are close to.

*CONTINUED*

## FM/AM Radio Reception

---

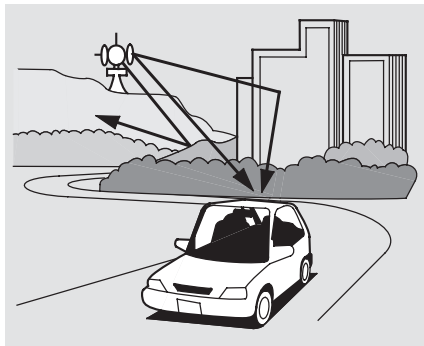

Radio signals, especially on the FM band, are deflected by large objects such as buildings and hills. Your radio then receives both the direct signal from the station's transmitter, and the deflected signal. This causes the sound to distort or flutter. This is a main cause of poor radio reception in city driving.



Radio reception can be affected by atmospheric conditions such as thunderstorms, high humidity, and even sunspots. You may be able to receive a distant radio station one day and not receive it the next day because of a change in conditions.

Electrical interference from passing vehicles and stationary sources can cause temporary reception problems.

*As required by the FCC:  
Changes or modifications not expressly  
approved by the party responsible for  
compliance could void the user's  
authority to operate the equipment.*

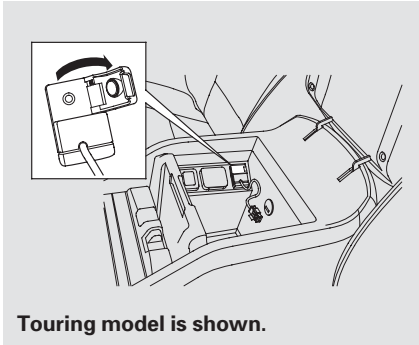

The auxiliary input jack is inside the front console compartment. The system will accept auxiliary input from standard audio accessories.

When a compatible audio unit is connected to the jack, press the AUX or CD/AUX button to select it.

*On vehicles with rear entertainment system*

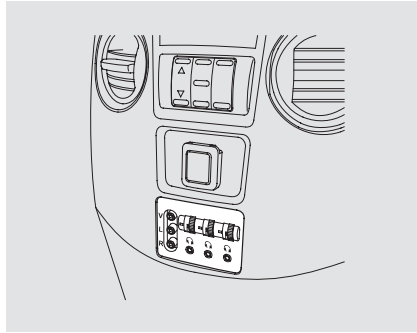

Auxiliary input jacks and headphone connectors for the rear entertainment system are on the back of the center console compartment.

For more information, see page 428.

## Remote Audio Controls

*Except U.S. LX models*

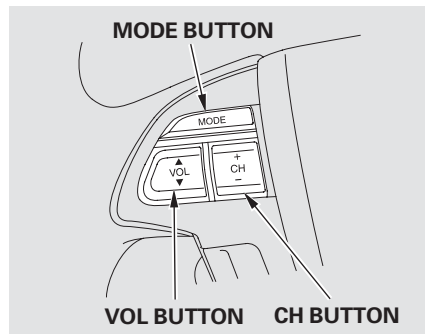

Three controls for the audio system are mounted in the steering wheel hub. These let you control basic functions without removing your hand from the wheel.

The VOL button adjusts the volume up (▲) or down (▼). Press the top or bottom of the button, hold it until the desired volume is reached, then release it.

The MODE button changes the mode.

*On vehicles with navigation system*  
Pressing the MODE button repeatedly cycles through all possible media sources whether they are present or not.

*On vehicles without navigation system*  
Pressing the MODE button repeatedly cycles through all present, connected media sources. Media sources that are not present or connected will not appear when cycling with the MODE button.

If you are listening to the radio, use the CH button to change stations. Each time you press the top (+) of the button, the system goes to the next preset station on the band you are listening to. Press the bottom (-) to go back to the previous station.

To search up and down from the current frequency and find a station with a strong signal, press the top (+) or bottom (-) of the button for 1 second.

If you are playing a disc, the system skips to the beginning of the next track each time you press the top (+) of the CH button. Press the bottom (-) to return to the beginning of the current track. Press it again to return to the previous track. You will see the disc and track numbers in the upper display.



If you are listening to XM Radio, use the CH button to change channels. Each time you press the top (+) of the button, the system goes to the next preset channel. Press the bottom (–) to go back to the previous preset channel.

To go to the next channel of the category you are listening to, press the top (+) of the button for 1 second. Press the bottom (–) for 1 second to go back to the previous channel.

*On vehicles with rear entertainment system*

If you are playing a DVD video, use the channel button to change chapters. Each time you press the top (+) of the button, the system goes to the next chapter. Press the bottom (–) to return to the beginning of the current chapter. Press it again to return to the previous chapter.

*Except LX and U.S. EX models*

If you are playing a USB flash memory device or iPod with the USB adapter cable, press and release the top (+) of the CH button to skip forward to the beginning of the next file. Press the bottom (–) to skip backward to the beginning of the current file. Press it twice to return to the previous file.

## Radio Theft Protection

---

*On all models except LX*

If your vehicle's battery is disconnected or goes dead, or the radio fuse is removed, the audio system will disabled itself. If this happens, there are two methods to make it work again. Turn the ignition switch to the ON (II) position, press the power/volume knob once. The enter code screen will appear.

**Vehicle Specific Method** — Press and hold the power/volume knob for a few seconds, the audio unit will check the VIN information stored in the vehicle. The audio system will start activating if the VIN information stored in the audio system and the vehicle match.

**Security Code Method** — The enter code screen will appear. Use the preset buttons to enter the five-digit code. The code is on the radio code card included in your owner's manual kit. When it is entered correctly, the radio will start playing.

You should have received a card that lists your audio system code number and serial number. It is best to store this card in a safe place at home. In addition, you should write the audio system's serial number in this owner's manual.

If you make a mistake entering the code, do not start over; complete the five-digit sequence, then enter the correct code. You have ten tries to enter the correct code. If you are unsuccessful in ten attempts, you must then leave the system on for one hour before trying again.

If you cannot activate the audio system, and lose the card, take the vehicle to your dealer.

The system will retain your AM and FM presets even if power is disconnected.

### *U.S. owners*

We recommend that you register the security code at Owner Link (owners.honda.com.) If you lose the Anti-theft Identification Card before registering the code at Owner Link, you must obtain the code from your dealer or <https://radio-navicode.honda.com/>. To do this, you will need the audio system's serial number. If you do not have the serial number with you, ask your dealer or go to <https://radio-navicode.honda.com/> for information on how to retrieve it.

### *Canadian owners*

If you lose the Anti-theft Identification Card, you must obtain the code from your dealer. To do this, you will need the audio system's serial number. If you do not have the serial number with you, ask your dealer how to retrieve it.

### *Models with navigation system*

You need to enter the same code for the navigation system to reactivate. Read the navigation system manual for details.

## Rear Entertainment System

---

Your vehicle is equipped with a rear entertainment system that includes a DVD player for the enjoyment of the rear passengers.

With this system, the rear passengers can enjoy a different entertainment source (radio, disc, CD Library, HDD, USB, iPod®, DVD player or XM Radio) than the front seat occupants. The audio is broadcast through the supplied wireless headphones.

The ignition switch must be in the ACCESSORY (I) or the ON (II) position to operate the rear entertainment system.

### NOTICE

*This vehicle's overhead mounted video display, if so equipped, includes mercury-containing components. Upon removal, please reuse, recycle, or dispose of as hazardous waste.*

### To Turn On the System

Press the REAR POWER button. The indicator on the REAR POWER button will come on. The rear seat passengers can then operate the rear system from the control panel in the ceiling. The rear control panel can also be detached and used as a remote control, by pushing the release button, and pulling the remote toward you.

### To turn off the rear control

You can disable the rear control panel from the front control panel.

*On vehicles without navigation system*  
Press the SETUP button and turn the selector knob to "Rear Setup," then press the selector knob. Select the "Rear Remote On." Each time you press and release the selector knob, this feature turn on and off.

### *On vehicles with navigation system*

Press and release the REAR SOURCE button. The indicator on the REAR SOURCE button will come on. The front screen shows the same screen as the rear screen does. Push the interface selector down. The screen changes to the rear menu. Turn the interface dial to the “Rear Setup,” then press ENTER on the interface dial. Turn the interface dial to select the “Rear Control,” and press ENTER.

To turn this feature off, turn the interface dial to select the OFF icon, and press ENTER on the interface selector.

### **Rear Speakers**

When you turn on the system, the rear speakers are automatically turned off if the rear system selects a different entertainment source than the front system. You will see the Rear Speakers Off icon in the audio display. The sound for the rear system is sent to the headphones.

If you want to turn the rear speakers on again, press and hold the REAR POWER button until the Rear Speakers Off icon goes off.

**NOTE:** The rear speakers are connected to the front system, so they will always play the source that the front system is set to.

# Rear Entertainment System

On vehicles without navigation system

On vehicles with navigation system

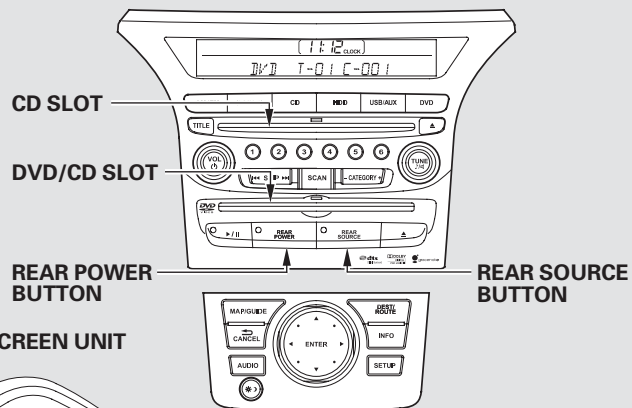
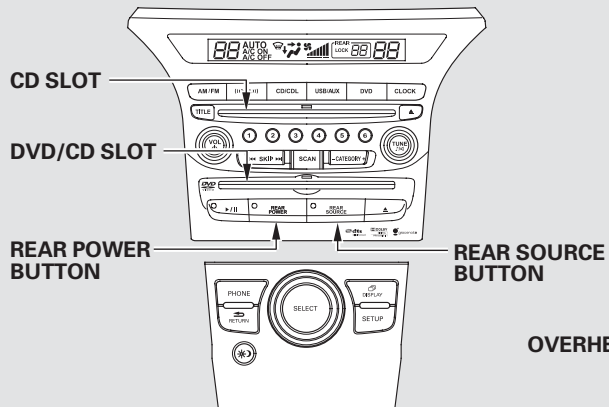

OVERHEAD SCREEN UNIT

### To Select Rear Entertainment from the Front Control Panel

To operate the rear entertainment system from the front panel, press the REAR SOURCE button. You will hear two beeps and the indicator in the button comes on to show that the control panel is enabled.

When REAR SOURCE is selected, the front entertainment system audio controls can also be used to operate the rear entertainment system in all modes.

The media that the rear passengers are listening to will then be heard from the front speakers.

If you do not operate the rear entertainment system from the front panel within 20 seconds, the indicator in the REAR SOURCE button will go off and the display will return to the front entertainment system automatically.

To play the radio, the buttons for the front entertainment system have the same functions.

If an audio CD is loaded into the upper slot, select the CD/CDL or CD button. If a DVD or CD is loaded into the lower slot, select the DVD button.

### Operating the DVD Player from the Front Control Panel

The DVD player in your rear entertainment system can play DVD video discs, audio CDs, MP3/WMA discs and DTS CDs.

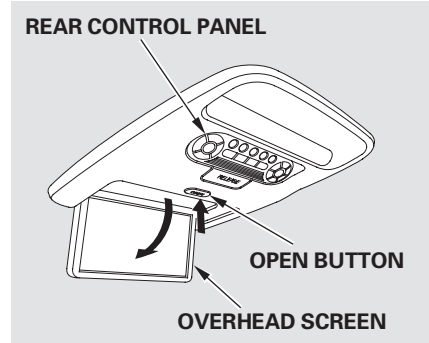

Open the overhead screen by pushing the OPEN button. The screen will swing down part-way. Pivot the screen the rest of the way. If you pivot the screen too far forward, past the second detent, the display will turn off. Pivot the screen back to the second or first detent to turn the display back on. To close the screen, pivot it up until it latches.

*CONTINUED*

# Rear Entertainment System

## On vehicles without navigation system

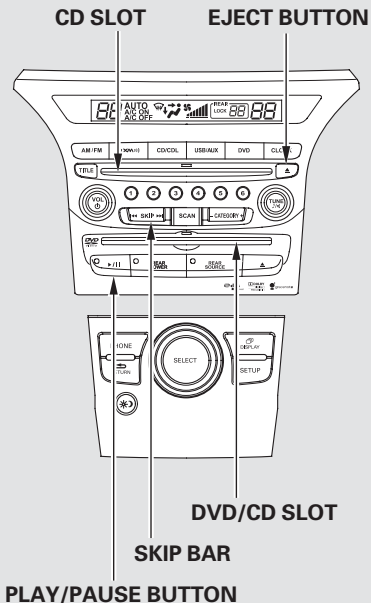

## On vehicles with navigation system

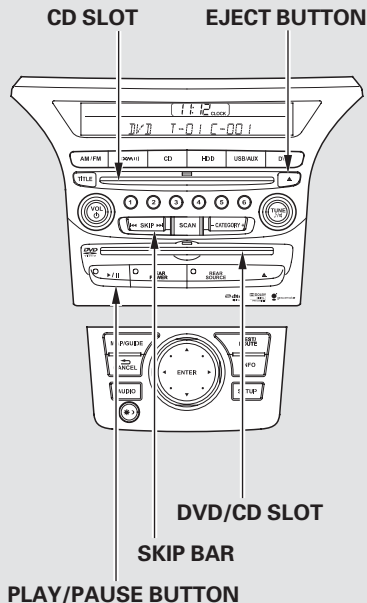

Insert a DVD into the lower DVD/CD slot in the audio unit.

Push the DVD in halfway, the drive will pull it in the rest of the way.

When you insert a DVD, the system automatically starts to play. To turn this feature off, see pages 402 and 405.

**PLAY** – Press the ►/|| button if the DVD does not start playing automatically.

**PAUSE** – Press the ►/|| button to pause the DVD. Press the button again or press PLAY to resume. Pause works only with the DVD player.



**SEEK/SKIP** — Press and hold the **▶▶** side of the SKIP bar to move forward. Press and hold the **◀◀** side of the SKIP bar to move backward. Release the bar when the system reaches the point you want.

Each time you press the **▶▶** side of the SKIP bar and release it, the system skips forward to the beginning of the next track or chapter. Press and release the **◀◀** side of the SKIP bar to skip backward to the beginning of the current track. Press and release it again to skip to the beginning of the previous track or chapter.

**EJECT** — Press the eject button to remove the DVD from the drive.

## DVD Setup

*On vehicles without navigation system*

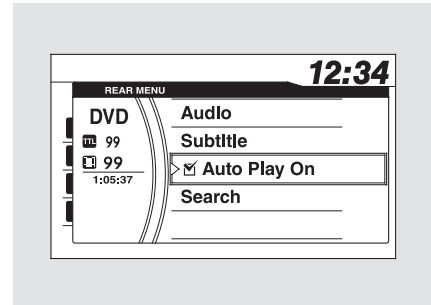

Press the REAR SOURCE button of the front panel while the DVD is playing on the overhead screen. The front screen shows “REAR MENU.” Turn the selector knob to “DVD Setup,” then press the selector knob. You can choose DVD setup from these selections:

- Audio
- Subtitle
- Auto Play On
- Search

*CONTINUED*

# Rear Entertainment System

## Audio

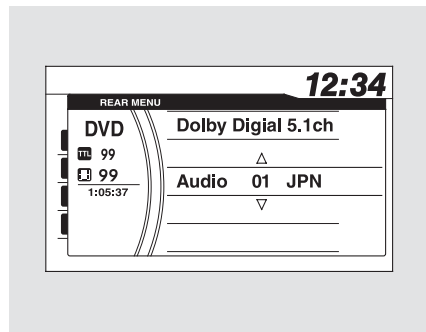

Turn the selector knob to “Audio,” then press the selector knob. Turn the selector knob to select the language you want for DVD audio, then press the selector knob. The languages that appear on the screen are limited to the language choices available on the DVD.

## Subtitle

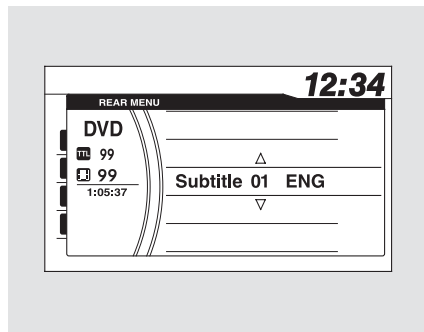

Turn the selector knob to “Subtitle,” then press the selector knob. Turn the selector knob to select the language you want for subtitles, then press the selector knob. The languages that appear on the screen are limited to the language choices available on the DVD.

## Auto Play ON

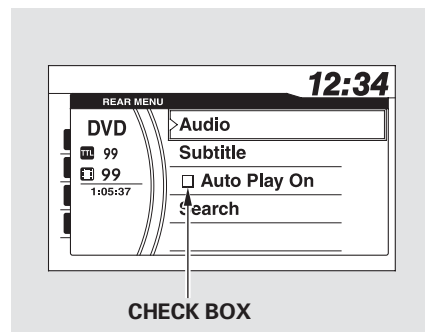

Turn the selector knob to “Auto Play ON,” then press the selector knob. When the check mark disappears from the check box, the auto play function also turns off.

Each time you press and release the selector knob, this feature turns ON and OFF.

## Title or Chapter Search

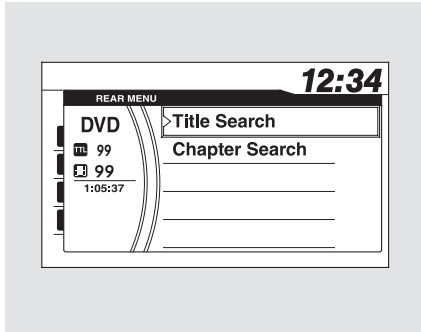

Turn the selector knob to “Title Search,” or “Chapter Search,” then press the selector knob. Turn the selector knob to a title or chapter number, then press the selector knob. The DVD skips to the selected title or chapter.

## On vehicles with navigation system

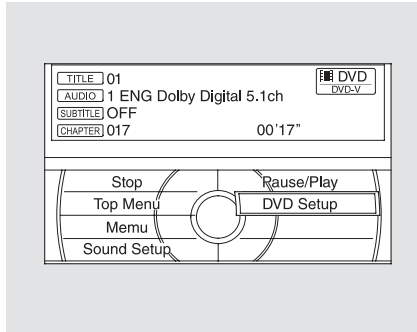

Press the REAR SOURCE button while a DVD is playing. Turn the interface dial to “DVD Setup,” then press ENTER on the interface selector. You can choose DVD setup from these selections:

- Title Search
- Chapter Search
- Audio
- Subtitle
- Repeat
- Auto Play

## Title or Chapter Search

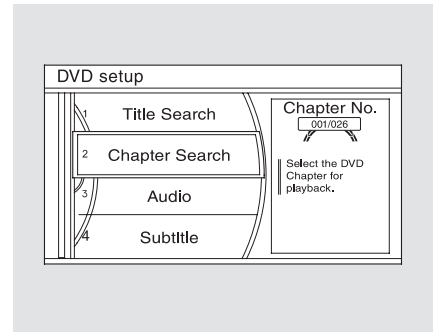

Turn the interface dial to “Title Search” or “Chapter Search,” then press ENTER on the interface selector. Turn the dial again to select a title or chapter number, then press ENTER on the interface selector. The DVD skips to the selected title or chapter.

CONTINUED

# Rear Entertainment System

## Audio

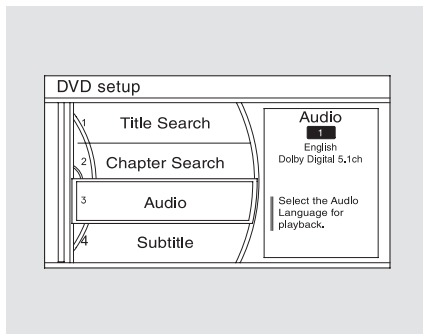

Turn the interface dial to “Audio,” then press ENTER on the interface selector. Turn the dial to select the language you want for DVD audio, then press ENTER on the interface selector. The languages that appear on the screen are limited to the language choices available on the DVD.

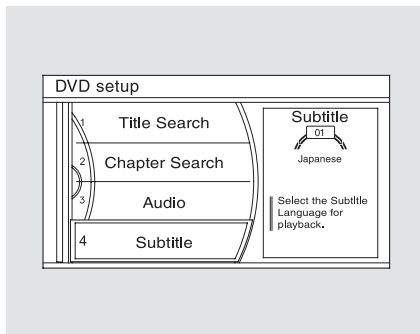

## Subtitle

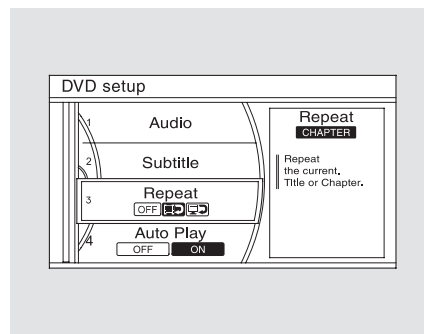

Turn the interface dial to “Subtitle,” then press ENTER on the interface selector. Turn the dial to select the language you want for subtitles, then press ENTER on the interface selector. The languages that appear on the screen are limited to the language choices available on the DVD.

## Repeat



Turn the interface dial to “Repeat,” then press ENTER on the interface selector. Select the icon in the center (  ) to repeat the current chapter, the icon on the right (  ) to repeat the current title, or select OFF to turn off repeat. If your DVD does not support titles or chapters, you cannot use this feature.

## Auto Play

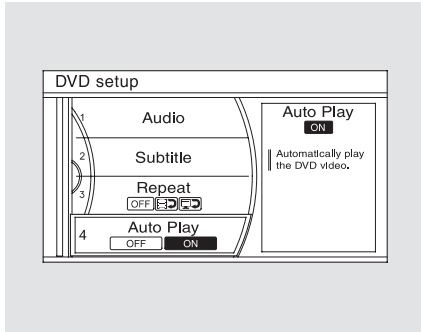

Turn the interface dial to “Auto Play,” then press ENTER on the interface selector. Select ON to play the DVD automatically, or select OFF to play the DVD manually.

## To Return to Front Audio Controls

To return front panel control to the front audio system, press the REAR SOURCE button. You will hear a beep and the indicator in the button goes off. The indicator also goes off automatically when you do not operate the rear entertainment system for 20 seconds.

## Using the Rear Control Panel

To turn on the rear entertainment system from the rear control panel, press the  (power) button. Use the FM/AM button, XM button, CD/CDL or CD/HDD button, or DVD/AUX button to select the entertainment source. The selected source will be shown in the display. Make sure the rear control operation has not been disabled. When the front audio system is off or the front panel’s Rear Power is off, the rear control panel cannot be turned on.

## Rear Entertainment System

### To Play the Radio from the Rear Control Panel

Press the FM/AM button to listen to the radio.

Use the ▲, ▼, ◀, or ▶ button to highlight SEEK, TUNE, AUTO SELECT, SCAN, or one of the preset radio stations on the overhead screen. You can enter the highlighted function by pressing the ENT button. These functions have the same features as those of the front audio system. You can also use the ◀◀ or ▶▶ buttons to seek up/down and ▶▶ or ◀◀ to tune up/down.

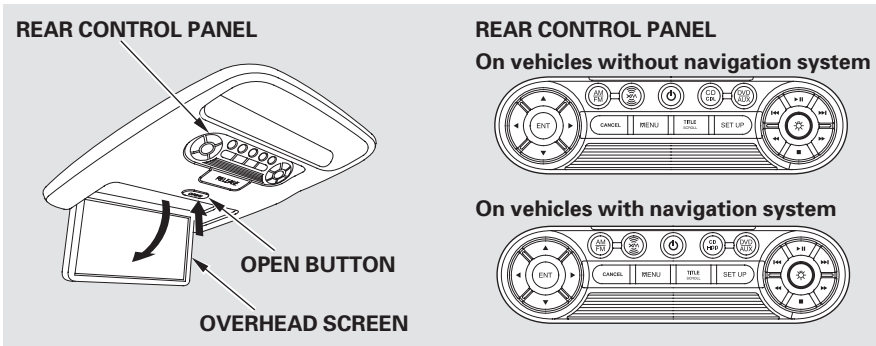

### To Play the XM Radio from the Rear Control Panel

Press the XM button to listen to the XM Radio. You can press either side (◀◀ or ▶▶) of the TUNE/SKIP bar to scroll up/down and select channels within a category (in CATEGORY mode), or to scroll up/down and select from among all available channels (in CH mode).

Press the MENU button to display the audio menu on the overhead screen. You can enter the highlighted function by pressing the ENTER button. These functions have the same features as those of the front audio system.

Pressing and holding the TITLE/SCROLL button for 5 seconds enables you to switch between search modes.

### To Play a Disc, CD Library, HDD, USB, or iPod® from the Rear Control Panel

Use the ▲, ▼, ►, or ◀ button to highlight Repeat, Random, or Scan on the screen. You can enter the highlighted function by pressing the ENT button. These functions have the same features as those of the front audio system.

When the TITLE/SCROLL button is pressed, the title scrolls. When it is pushed again, scrolling stops.

### To Play a DVD from the Rear Control Panel

The video screen is for use by rear seat passengers only. The driver and front seat passenger should not try to view the screen while driving.

Open the overhead screen by pushing the OPEN button. The screen will swing down part-way. Pivot the screen the rest of the way. If you pivot the screen too far forward, past the detent, the display will turn off. Pivot the screen back to the second or first detent to turn the display back on. To close the screen, pivot it up until it latches.

Press the ►|| button when you want to pause the DVD. Press this button again to go back to PLAY.

Press the ►► button to skip to the beginning of the next chapter. Press the ◀◀ button to return to the beginning of the current chapter.

Press the ◀◀ button again quickly to go to the previous chapter.

To move rapidly within a chapter, press and hold the ►► or ◀◀ button. The system will continue to move through the chapter. Press the ►► button to move forward, or the ◀◀ button to move backward. Release the button when the system reaches the point you want.

To select the menu on the DVD, press the MENU button. Use the ▲, ▼, ►, and ◀ button to move to the desired menu selection, then press the ENT button to enter your selection.

# Rear Entertainment System

## TITLE/SCROLL Button

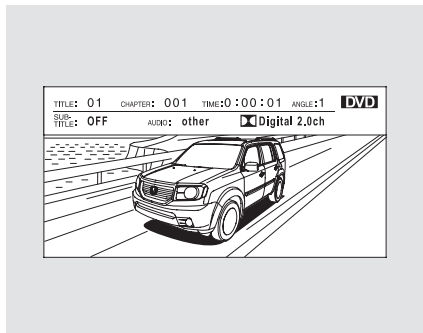

When you press the TITLE/SCROLL button while a DVD is playing, the current status of title, chapter, elapsed time, angle, subtitle, audio, and sound characteristics are displayed. To return to the DVD video screen, press the TITLE/SCROLL button again.

## MENU Button

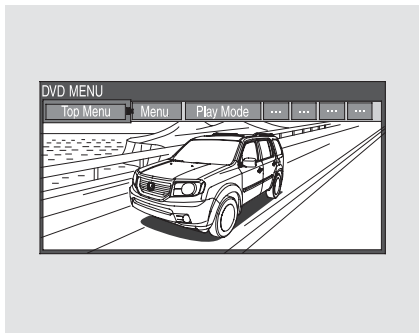

When you press the MENU button while a DVD is playing, the DVD Menu appears. The menu options are TOP MENU, MENU, PLAY MODE, SEARCH, NumInput and REPEAT.

To go to your selected menu, use the **▶** or **◀** button to highlight the icon and press the ENT button. To return to the DVD video screen, select RETURN.

## Top Menu

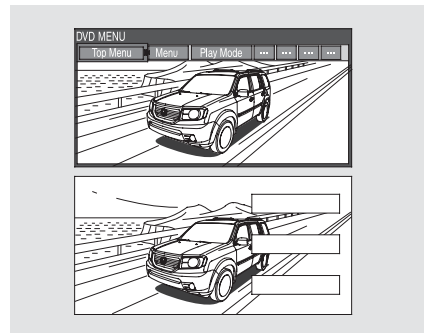

When you select "TOP MENU," the screen changes to the DVD's title menu. This menu also appears when you press the MENU button while a DVD is not playing. To go back to play, press the MENU or CANCEL button.



## Menu

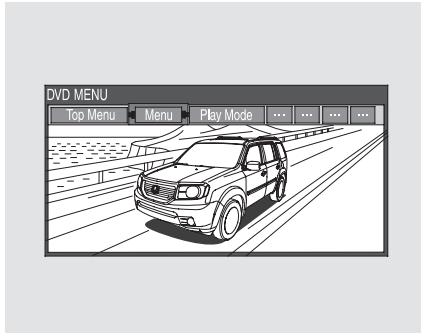

When you select “MENU” with the **▶** or **◀** button, the screen changes to the DVD’s title menu.

## Play Mode

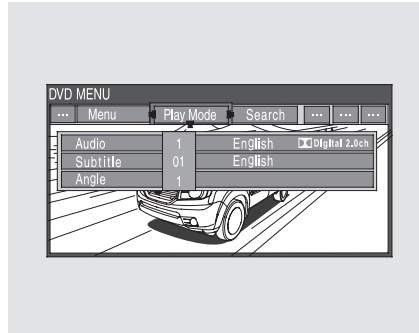

When you select “PLAY MODE” with the **▶** or **◀** button, you can change the DVD’s Audio, Subtitle or Angle setting.

## “Audio”

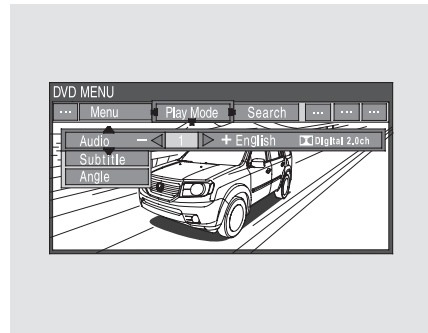

To change the Audio setting, highlight “Audio” from the play mode menu with the **▼** or **▲** button. A submenu of dubbed languages appears. You can select another language by pressing the **▶** or **◀** button. The sound characteristics (Dolby Digital, LPCM, MPEG Audio, dts) recorded with the selected language is also displayed next to the language.

*CONTINUED*

## Rear Entertainment System

---

The selectable languages vary from DVD to DVD, and this feature may not be available on some DVDs.

To go back to play, press the MENU or CANCEL button.

### *“Subtitle”*

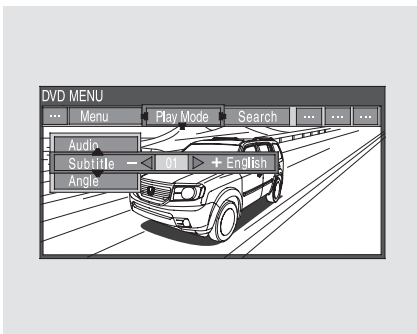

To change the DVD's subtitle, highlight "Subtitle" from the play mode menu with the ▼ or ▲ button. You can see the available subtitles with the ► or ◀ button.

To go back to play, press the MENU or CANCEL button.

## “Angle”

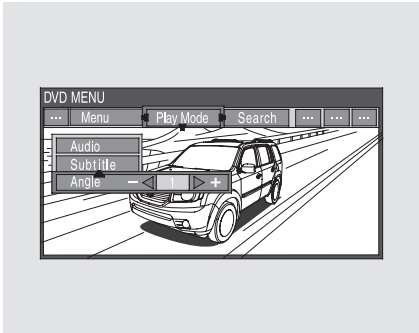

To change the view angle, highlight “Angle” from the play mode menu with the ▼ or ▲ button. You can see the available angle options with the ► or ◀ button.

If there are no multiple angles available on the DVD, you cannot change from “Angle 1.”

To go back to play, press the MENU or CANCEL button.

## Search

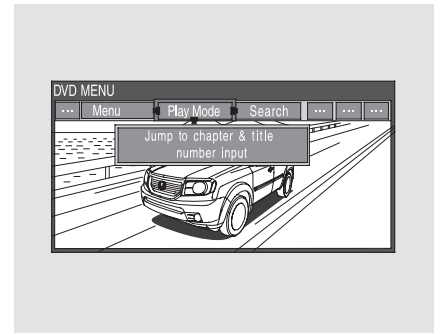

When you highlight “Search” with the ► or ◀ button, the “Jump to chapter and title number input” message appears. To select “Chapter” or “Title” search, press the ENT button.

CONTINUED

# Rear Entertainment System

## *“Title/Chapter Search”*

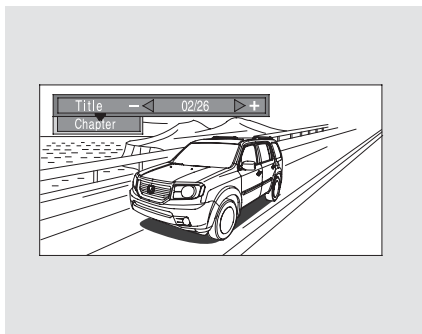

With “Title” highlighted, use the **▶** or **◀** button to jump to your desired title and press the ENT button. When “Chapter” is highlighted, follow the same procedure for the chapter search.

## Num Input

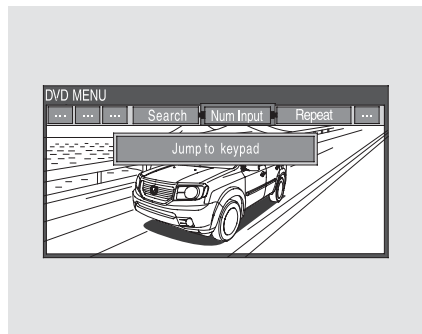

A numerical command can be issued to a DVD by inputting a two digit number, and a button number can be selected on the screen.

When you highlight, “NumInput” with the **▶** or **◀** button, the “Jump to keypad” message appears. Press the ENT button to go to the NumInput selection screen.

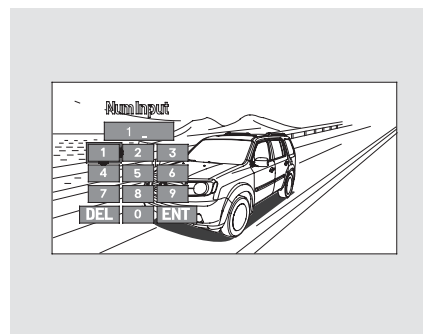

Select the first digit number using the **▼**, **▲**, **▶**, or **◀** button, and enter it by pressing the ENT button. If you want to change the number, select “DEL,” and press the ENT button, then select and enter the new number.

The cursor will automatically move to the “ENT” icon when you finish inputting the number. Press the ENT button to enter the number command. The display goes back to the DVD screen.

## Repeat

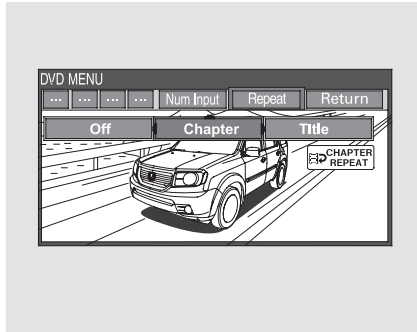

With “Repeat” highlighted, each time you press and release the ENT button, the repeat mode changes from chapter repeat to title repeat, and to repeat off.

## SETUP Button

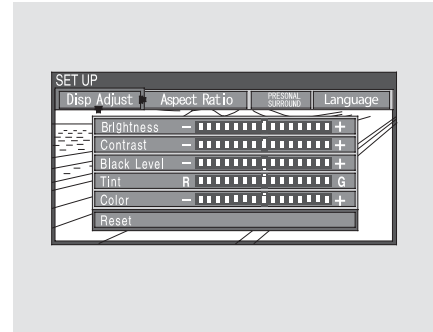

When you press the SETUP button while a DVD is playing, the setup menu appears. The menu options are Disp Adjust, Aspect Ratio, PERSONAL SURROUND, and Language.

To change a setup, use the ► or ◀ button to highlight your selection and press the ENT button. To return to the DVD video screen, press the SETUP or CANCEL button.

*CONTINUED*

## Rear Entertainment System

### *Disp Adjust*

To adjust the display, highlight “Disp Adjust” from the setup menu with the ▼ or ▲ button and press the ENT button. You can adjust these display settings:

- Brightness
- Contrast
- Black Level
- Tint
- Color

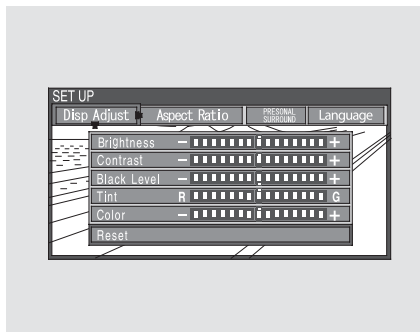

Select the quality you want to adjust by pressing the ▼ or ▲ button. Adjust the setting by pressing the ◀ or ▶ button. When you are finished with your adjustment, cursor back to the top of the setup menu, or press the CANCEL button to exit.

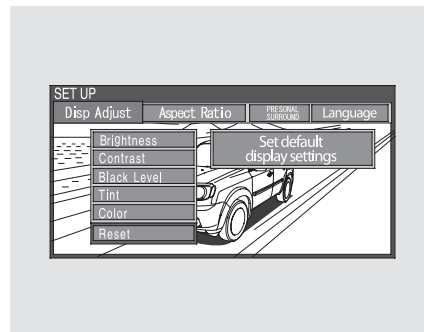

If you want to set the display to the default setting, select “Reset” by pressing the ▼ or ▲ button, then press the ENT button.

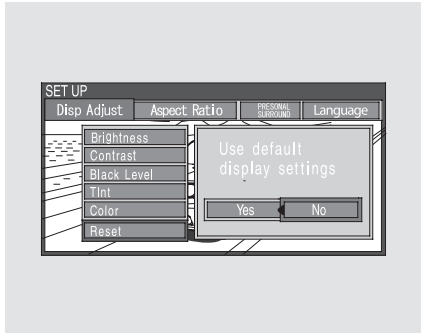

The display changes as shown above.

Select “Yes,” and press the ENT button. You will see the message “Default display settings applied” on the display for 5 seconds.

## *Aspect Ratio*

You can set the screen mode to these settings:

- Normal
- Wide
- Zoom
- Full

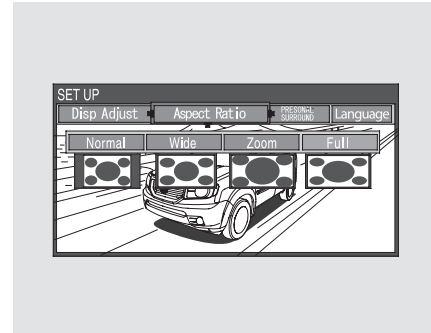

Select the “Aspect Ratio” by pressing the ► or ◀ button, then press the ENT button.

The selectable setting menu is displayed, and the current setting is highlighted in blue.

Select the desired setting by pressing the ► or ◀ button, then press the ENT button.

*CONTINUED*

# Rear Entertainment System

## Personal Surround

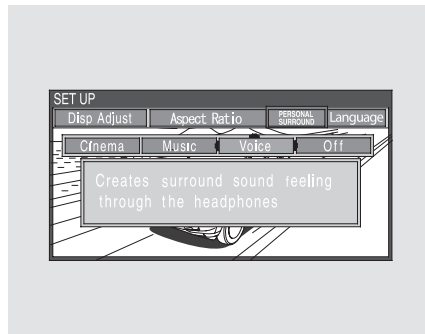

To change the Personal Surround setting, highlight "PERSONAL SURROUND" from the setup menu with the ▼ or ▲ button and press the ENT button. The effect selection appears.

Select "Cinema," "Music," or "Voice" by pressing the ► or ◀ button, and enter your selection by pressing the ENT button.

If you select "Off," the logo disappears, and there will be no special sound effect.

## Language

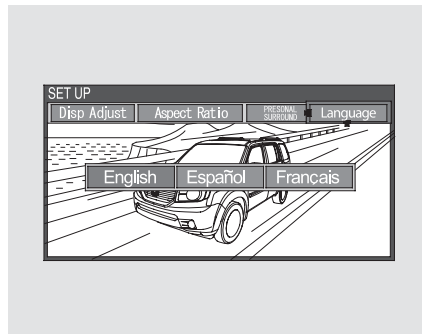

You can change the display language to English, French, or Spanish. Use the ◀ or ► button to select the setting you want, then press the ENT button.

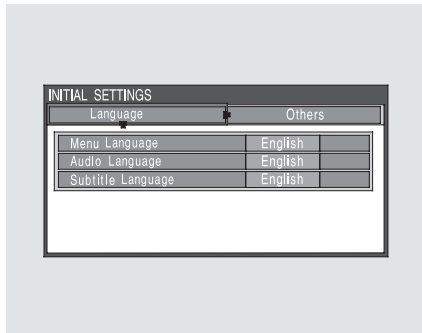

**INITIAL SETTINGS Menu**

When you press the SETUP button on the rear control panel when a DVD is not playing, the "INITIAL SETTINGS" menu is displayed.

There are two selectable menus: "Language" and "Others."

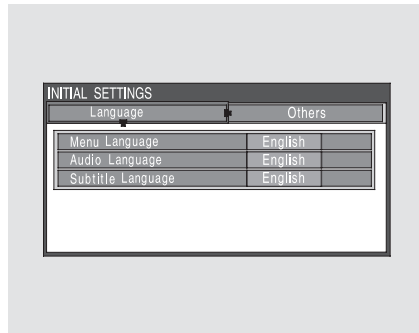
**INITIAL SETTINGS (Language)**

When you select "Language" with the ► or ◀ button, the menu shown above appears.

To return to the stop or previous screen, press the CANCEL button.

Because the priority language is determined by each disc you insert, you might not be able to set a selected item.

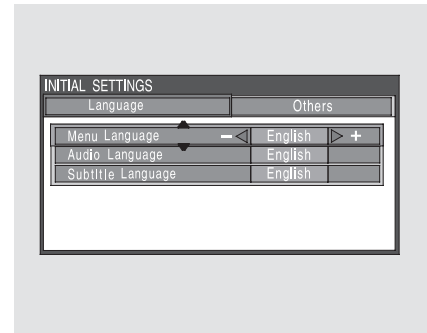
**Menu Language**

To select the language used in the DISC menus, select "Menu Language" by pressing the ▼ or ▲ button.

*CONTINUED*

# Rear Entertainment System

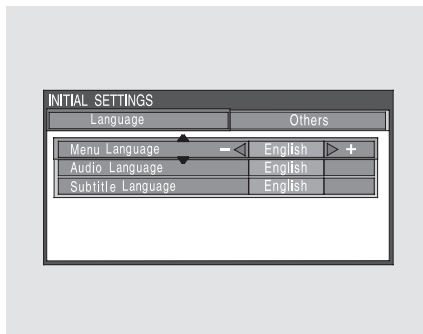

Select the desired language by pressing the ► or ◀ button.

The selectable languages are, English, French, Spanish, Arabic, German, Italian, Dutch, Chinese, Korean, Thai, Japanese or others.

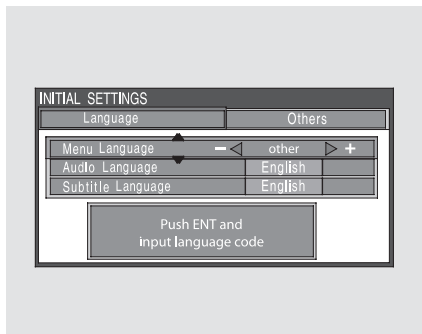

If you want another language than those listed, you need to enter the code number of the desired language. Select "other," and press the ENT button. The display changes as shown in the next column.

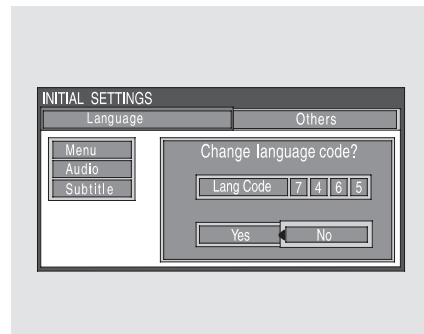

If you select "No," and press the ENT button, the display returns to the initial screen of the "Language" menu.

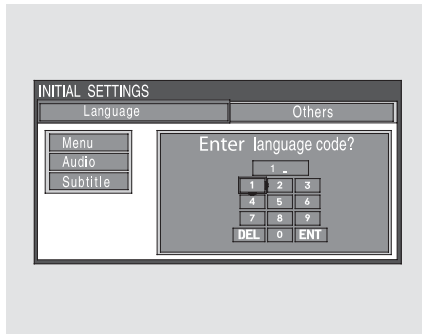

If you select “Yes,” the display changes to the language code input mode. Select the first number digit using the  $\blacktriangledown$ ,  $\blacktriangle$ ,  $\blacktriangleright$ , or  $\blacktriangleleft$  button, and press the ENT button to enter it. Repeat this until all four digits are filled. When the fourth digit is entered, the cursor automatically moves to “ENT” on the display. Press the ENT button on the control panel to enter the new language code.

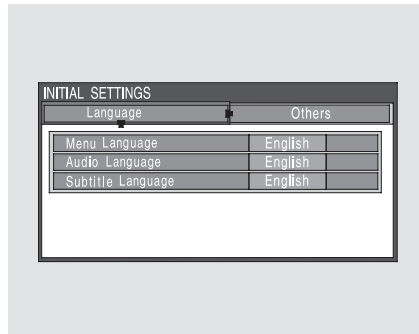

If you made a mistake entering a number digit, select “DEL” on the display with the  $\blacktriangledown$ ,  $\blacktriangle$ ,  $\blacktriangleright$ , or  $\blacktriangleleft$  button, and press the ENT button on the control panel. Then select and enter the correct number digit as described. The display returns to the initial “Language” menu screen.

## Audio Language

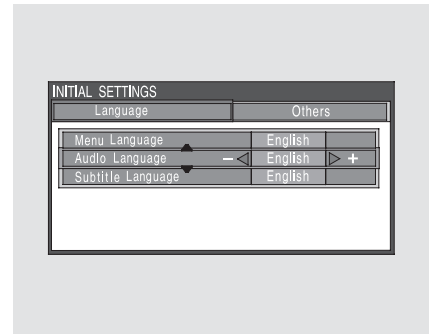

You can select the dubbed language before playing DVDs. Select “Audio Language” by pressing the  $\blacktriangledown$  or  $\blacktriangle$  button. You will see the submenu next to “Audio Language.”

Follow the same instructions you used to set the menu language.

*CONTINUED*

# Rear Entertainment System

## Subtitle Language

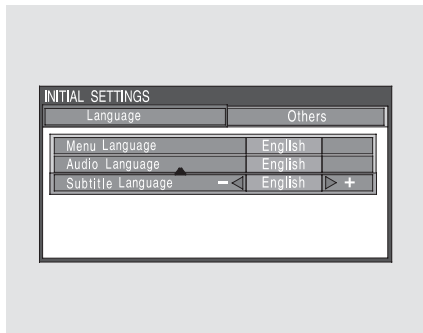

You can select the subtitle language before playing DVDs. Select "Subtitle Language" by pressing the ▼ or ▲ button. You will see the submenu next to the "Subtitle Language."

Follow the same instructions you used to set the menu language.

## INITIAL SETTINGS (Others)

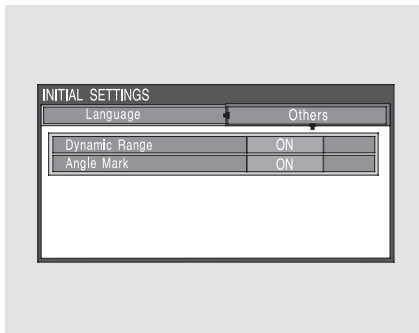

When you select "Others" at the top of the "INITIAL SETTINGS" screen, the above menu appears on the screen.

Dynamic Range  
"Dynamic Range" reduces the differences between the loud and quiet sound levels throughout the disc. When this is on, the louder sounds are lowered, and quieter sounds are increased.

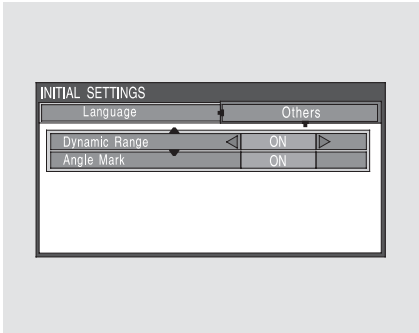

When you select the “Dynamic Range” by pressing the ▼ or ▲ button, you will see the submenu next to the “Dynamic Range” as shown above.

To turn “Dynamic Range” on or off, select “ON” or “OFF” by pressing the ► or ◀ button.

## Angle Mark

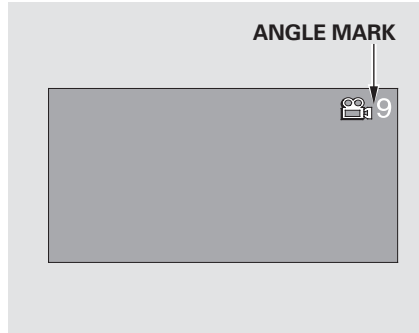

When you switch to another angle while playing a DVD, the angle mark is displayed in the upper right corner of the screen.

You can set the system to display or not display this angle mark.

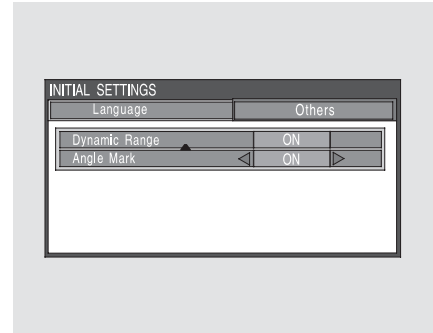

Select “Angle Mark” by pressing the ▼ or ▲ button. The above submenu appears. If you want the angle mark to be displayed, select “ON” with the ► or ◀ button.

## Rear Entertainment System

---

### Playable DVDs



There are various types of DVDs available. Some of them are not compatible with your system.

The DVD player in your rear entertainment system can play DVDs and CDs bearing the above marks on their packages or jackets.

The DVD player can also play discs recorded in MP3/WMA/AAC formats and DTS CDs.

Those packages or jackets should also bear the designation of “1” or “ALL” region. DVD-ROMs cannot be played in this system.

This product incorporates copyright protection technology that is protected by U.S. patents and other intellectual property rights.

This item incorporates copy protection technology that is protected by U.S. patents and other intellectual property rights of Rovi Corporation. Reverse engineering and disassembly are prohibited.

Manufactured under license under U.S. Patent #'s: 5,451,942; 5,956,674; 5,974,380; 5,978,762; 6,487,535 & other U.S. and worldwide patents issued & pending. DTS and the Symbol are registered trademarks & DTS Digital Surround and the DTS logos are trademarks of DTS, Inc. © DTS, Inc. All Rights Reserved.

Reverse engineering or disassembly is prohibited.

Manufactured under license from Dolby Laboratories. Dolby, Pro Logic, and the double-D symbol are trademarks of Dolby Laboratories.

### **Protecting DVDs**

The tips on how to handle and protect DVDs are basically the same as those for compact discs. Refer to "Protecting Your CDs" on page 332 .

## Rear Entertainment System

---

### DVD Player Error Messages

*On vehicles without navigation system*  
The chart on the right explains the error messages you may see in the display while playing a disc.

If you see an error message in the display while playing a disc, press the eject button. After ejecting the disc, check it for damage or deformation. If there is no damage, insert the disc again.

The audio system will try to play the disc. If there is still a problem, the error message will reappear. Press the eject button, and pull out the disc. Insert a different disc. If the new disc plays, there is a problem with the first disc. If the error message cycle repeats and you cannot clear it, take your vehicle to a dealer.

| Error Message    | Cause                    | Solution   |
|------------------|--------------------------|--|
| CHECK DISC       | FOCUS Error              | Press the disc eject button, and remove the disc. Check for an error indication. Insert the disc again. If the code does not disappear or the disc cannot be removed, consult your dealer. |
| PUSH EJECT       | Mechanical Error         |  |
| CHECK REGION     | Invalid region code      | The disc is not playable in this unit. Eject the disc, and insert a disc compatible with this system.  |
| UNSUPPORTED FILE | DVD format not supported |  |



## Remote Control



The rear control panel can be detached from the ceiling unit and used as a remote control. To remove it from the ceiling unit, press the release button. The control panel will swing down partway. Pivot it down further past the detent until it detaches from the hinge. To reinstall it, reverse the procedure.

## Replacing the Remote Control Batteries

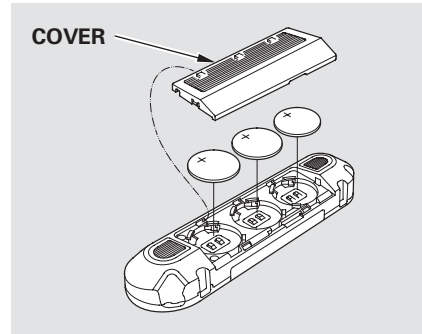

If it takes several pushes on the button to operate the rear entertainment system, have your dealer replace the batteries as soon as possible.

Battery type: BR3032

An improperly disposed of battery can hurt the environment. Always confirm local regulations for battery disposal.

CONTINUED

## Rear Entertainment System

*As required by the FCC:*

*This device complies with Part 15 of the FCC rules. Operation is subject to the following two conditions: (1) This device may not cause harmful interference, and (2) this device must accept any interference received, including interference that may cause undesired operation.*

*Changes or modifications not expressly approved by the party responsible for compliance could void the user's authority to operate the equipment.*

*This device complies with Industry Canada Standard RSS-210.*

*Operation is subject to the following two conditions: (1) this device may not cause interference, and (2) this device must accept any interference that may cause undesired operation of the device.*

### Wireless Headphones



Some state and local government agencies prohibit the use of headphones by the driver of a motor vehicle. Always obey applicable laws and regulations.

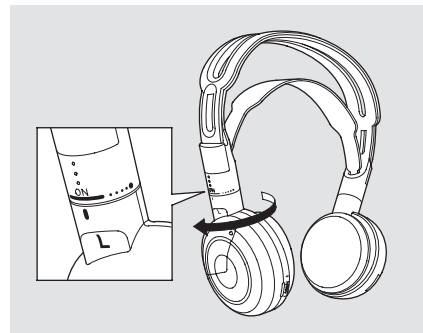

The audio for the rear entertainment system is sent to the wireless headphones that come with the system. When using the headphones, make sure you wear them correctly: L (left) and R (right) are marked on the sides of the frame. Wearing the headphones backwards may affect audio reception, limiting the sound quality and range.

To use the headphones, pivot the earpieces outward. This turns them on. To adjust the volume, turn the dial on the bottom of the right earpiece. When you remove the headphones, the earpieces automatically pivot inward, and the headphones turn off. When not in use, store the headphones in the pocket of either front seat, or the rear door lining pockets.

### *Replacing Batteries*

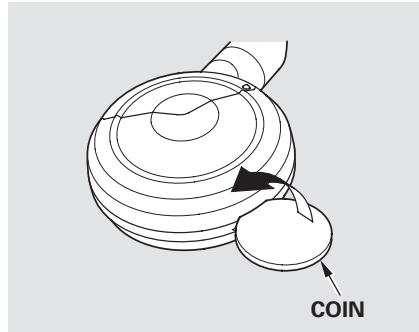

Each headphone uses one AAA battery. The battery is under the cover on the left earpiece. To remove the cover, insert a coin in the slot and twist it slightly to pry the cover away from the earpiece. Pull the cover outward, and pivot it out of the way.

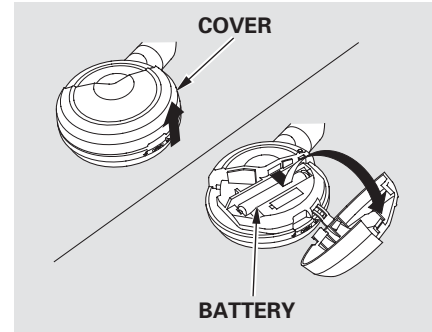

Remove the battery. Install the new battery in the earpiece as shown in the diagram next to the battery slot. Slide the cover back into place on the earpiece, then press down on the back edge to lock it in place.

An improperly disposed of battery can hurt the environment. Always confirm local regulations for battery disposal.

# Rear Entertainment System

## Auxiliary Input Jacks

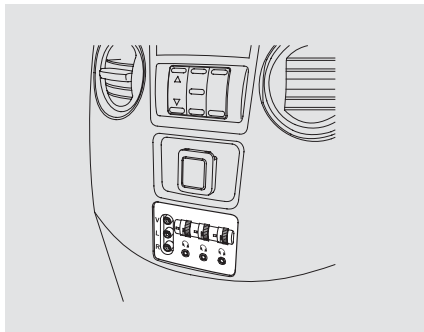

Auxiliary input jacks and headphone connectors for the rear entertainment system are on the back of the center console compartment.

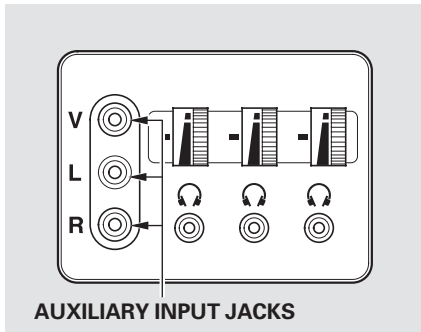

The system will accept auxiliary inputs from standard video games and video equipment. Some video game power supplies may cause poor picture quality.

V = Video jack  
L = Left audio jack  
R = Right audio jack

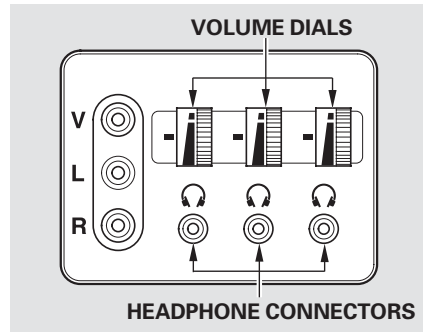

There are three headphone connectors for the third seat passengers. Each connector has its own volume control.

### *Except LX models*

The security system helps to protect your vehicle and valuables from theft. The horn sounds and a combination of headlights, parking lights, side marker lights and taillights flashes if someone attempts to break into your vehicle or remove the audio unit. This alarm continues for two minutes, then the system resets. To deactivate the system before the two minutes have elapsed, unlock the driver's door with the key or the remote transmitter.

The security system automatically sets 15 seconds after you lock the doors, the hood, the tailgate, and the glass hatch. For the system to activate, you must lock the doors, the tailgate and the glass hatch from the outside with the key, or use driver's lock tab, door lock master switch, or remote transmitter. The security system indicator on the instrument panel starts blinking immediately to show you the system

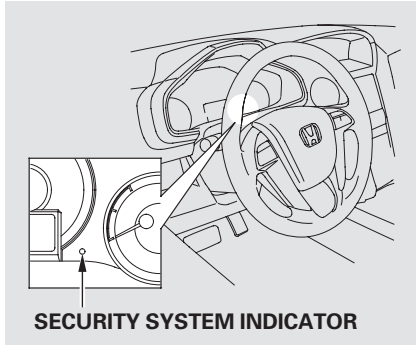

is setting itself.

Once the security system sets, opening any door, the tailgate, the glass hatch, or the hood without using the key or the remote transmitter will cause the alarm to activate. It also activates if the radio is removed from the dashboard or the wiring is cut.

The security system does not set if the hood, the tailgate, the glass hatch, or any door is not fully closed. If the system will not set, check that the doors, the tailgate and the hood are fully closed.

Do not attempt to alter this system or add other devices to it.

# Cruise Control

Cruise control allows you to maintain a set speed above 25 mph (40 km/h) without keeping your foot on the accelerator pedal. It should be used for cruising on straight, open highways. It is not recommended for city driving, winding roads, slippery roads, heavy rain, or bad weather.

## **⚠ WARNING**

Improper use of the cruise control can lead to a crash.

Use the cruise control only when traveling on open highways in good weather.

## Using Cruise Control

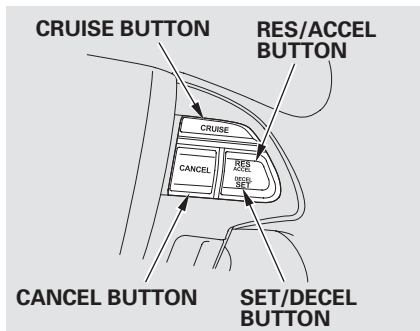

1. Push in the CRUISE button on the steering wheel. The CRUISE MAIN indicator on the instrument panel comes on.

The cruise control system can be left on, even when it is not in use.

2. Accelerate to the desired cruising speed above 25 mph (40 km/h).

3. Press and release the SET/DECEL button on the steering wheel. The CRUISE CONTROL indicator on the instrument panel comes on to show the system is now activated.

Cruise control may not hold the set speed when you are going up and down hills. If your vehicle speed increases going down a hill, use the brakes to slow down. This will cancel the cruise control. To resume the set speed, press the RES/ACCEL button. The CRUISE CONTROL indicator on the instrument panel will come back on.

## Changing the Set Speed

You can increase the set cruising speed in any of these ways:

- Press and hold the RES/ACCEL button. When you reach the desired cruising speed, release the button.
- Push on the accelerator pedal. Accelerate to the desired cruising speed, then press the SET/DECEL button.
- To increase the speed in very small amounts, tap the RES/ACCEL button. Each time you do this, your vehicle will speed up about 1 mph (1.6 km/h).

You can decrease the set cruising speed in any of these ways:

**NOTE:** If you need to decrease your speed quickly, use the brakes as you normally would.

- Press and hold the SET/DECEL button. Release the button when you reach the desired speed.
- To slow down in very small amounts, tap the SET/DECEL button. Each time you do this, your vehicle will slow down about 1 mph (1.6 km/h).
- Tap the brake pedal lightly with your foot. The CRUISE CONTROL indicator on the instrument panel will go out. When the vehicle slows to the desired speed, press the SET/DECEL button.

*CONTINUED*

## Cruise Control

---

Even with cruise control turned on, you can still use the accelerator pedal to speed up for passing. After completing the pass, take your foot off the accelerator pedal. The vehicle will return to the set cruising speed.

Resting your foot on the brake pedal causes cruise control to cancel.

### Canceling Cruise Control

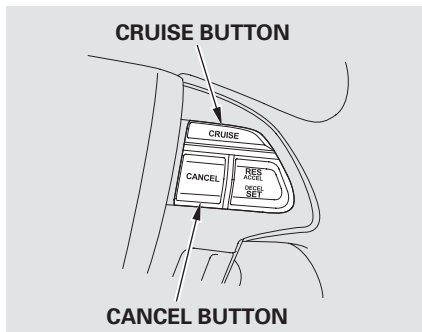

You can cancel cruise control in any of these ways:

- Tap the brake pedal.
- Push the CANCEL button on the steering wheel.
- Push the CRUISE button on the steering wheel.

### Resuming the Set Speed

When you push the CANCEL button or tap the brake pedal, the system remembers the previously set speed. To return to that speed, accelerate to above 25 mph (40 km/h), then press and release the RES/ACCEL button. The CRUISE CONTROL indicator comes on. The vehicle accelerates to the same speed as before.

Pressing the CRUISE button turns the system completely off and erases the previous cruising speed.



On EX, EX-L, and Canadian LX models without navigation system

### Compass Operation

Compass operation can be affected by driving near power lines or stations, across bridges, through tunnels, over railroad crossings, past large vehicles, or driving near large objects that can cause a magnetic disturbance. It can also be affected by accessories such as antennas and roof racks that are mounted by magnets.

When you turn the ignition switch to the ON (II) position, the compass is self-calibrating, then the compass display is shown in the display.

### Compass Calibration

#### U.S. EX and Canadian LX models

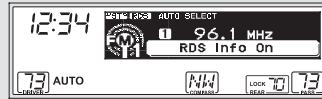

#### EX-L and Canadian EX models

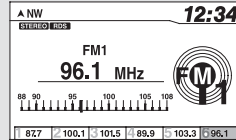

#### U.S. EX and Canadian LX models



#### EX-L and Canadian EX models

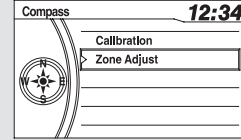

The compass may need to be manually calibrated after exposure to a strong magnetic field. If the compass seems to be continually showing the wrong direction and is not self-calibrating, or the compass display is blinking with the CAL indicator on, do the following procedure.

**NOTE:** Do this procedure in an open area, away from buildings, power lines, and other vehicles.

1. Turn the ignition switch to the ON (II) position.
2. Press and hold the SETUP button for about 5 seconds. The display shows you the compass setting menu items.

CONTINUED

## U.S. EX and Canadian LX models



## EX-L and Canadian EX models

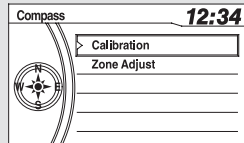

3. Turn the selector knob to select "Calibration."

## U.S. EX and Canadian LX models



## EX-L and Canadian EX models

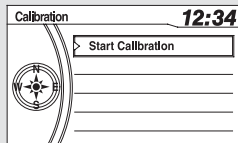

4. Press the selector knob to enter your selection. The display shows you "Start Calibration."

While setting the compass, press the RETURN button to go back to the previous display. Pressing the SETUP button will cancel the compass setting mode.

5. Press the selector knob. The compass display is blinking and the CAL indicator is shown.

6. Drive the vehicle slowly in two complete circles.

When the calibration is successfully completed, the CAL indicator goes off and the compass display will stop blinking and show an actual heading.

The audio system is not related to the compass system. Even if the compass system is calibrating, the display returns to the normal display which you last selected.

### Compass Zone Selection

In most areas, there is a variation between magnetic north and true north. Zone selection is required so the compass can compensate for this variation. To check and select the zone, do this:

1. Turn the ignition switch to the ON (II) position.
2. Press and hold the SETUP button for about 5 seconds. The display shows you the compass setting menu items.
3. Turn the selector knob to select "ZONE" or "Zone Adjust." Press the selector knob to enter your selection. The display shows you the currently selected zone number.

#### U.S. EX and Canadian LX models



#### EX-L and Canadian EX models

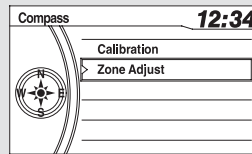

4. Find the zone for your area on the map (see page 436 ). If the correct zone is not shown, turn the selector knob to cycle the zone lists up or down.

If necessary, press the RETURN button to return to the previous display. Pressing the SETUP button will cancel the compass setting mode.

#### U.S. EX and Canadian LX models

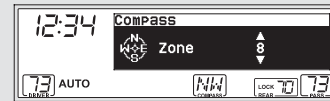

#### EX-L and Canadian EX models

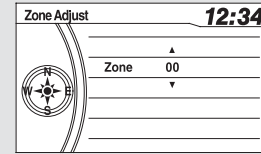

5. Once the correct zone is displayed, press the selector knob. The display then returns to normal.

CONTINUED

# Compass

The audio system is not related to the compass system. Even if the compass system is in the zone setting mode, the display returns to the normal display which you last selected.

Zone Map

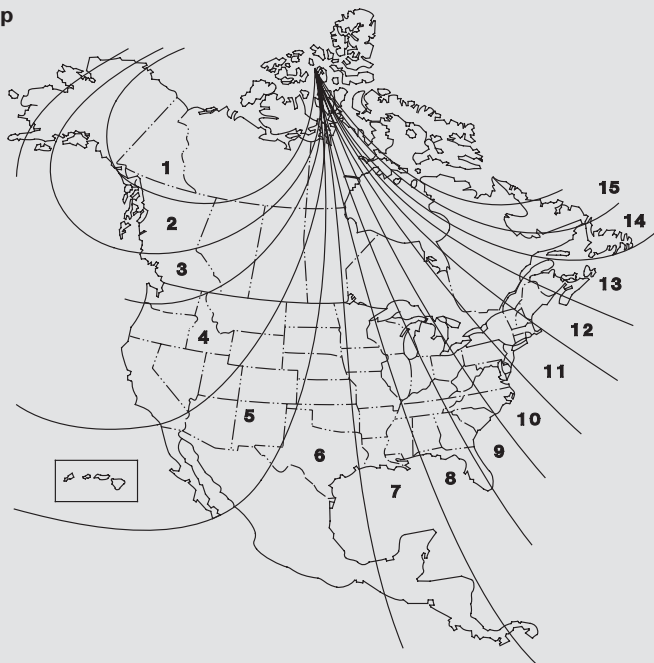

*Except LX models*

The HomeLink® Universal Transceiver built into your vehicle can be programmed to operate up to three remote controlled devices around your home, such as garage doors, lighting, or home security systems.

## **General Safety Information**

Before programming your HomeLink to operate a garage door opener, confirm that the opener has an external entrapment protection system, such as an “electronic eye,” or other safety and reverse stop features.

If your garage door was manufactured before April 1, 1982, you may not be able to program HomeLink to operate it. These units do not have safety features that cause the motor to stop and reverse it if an obstacle is detected during closing, increasing the risk of injury.

Do not use HomeLink with any garage door opener that lacks safety stop and reverse features.

*CONTINUED*

Units manufactured between April 1, 1982 and January 1, 1993 may be equipped with safety stop and reverse features. If your unit does not have an external entrapment protection system, an easy test to confirm the function and performance of the safety stop and reverse feature is to lay a 2 × 4 under the closing door. The door should stop and reverse upon contacting the piece of wood. As an additional safety feature, garage door openers manufactured after January 1, 1993 are required to have external entrapment protection systems, such as an electronic eye, which detect an object obstructing the door.

## **Important Safety Precautions**

Refer to the safety information that came with your garage door opener to test that the safety features are functioning properly. If you do not have this information, contact the manufacturer of the equipment. Before programming HomeLink to a garage door or gate opener, make sure that people and objects are out of the way of the device to prevent potential injury or damage. When programming a garage door opener, park just outside the garage.

## **Training HomeLink**

***Before you begin*** — If you just received your vehicle and have not trained any of the buttons in HomeLink before, you should erase any previously learned codes before training the first button. To do this, press and hold the two outside buttons on the HomeLink transceiver for about 20 seconds, until the red indicator flashes. Release the buttons, then proceed to step 1.

If you are training the second or third buttons, go directly to step 1.

## Training a Button

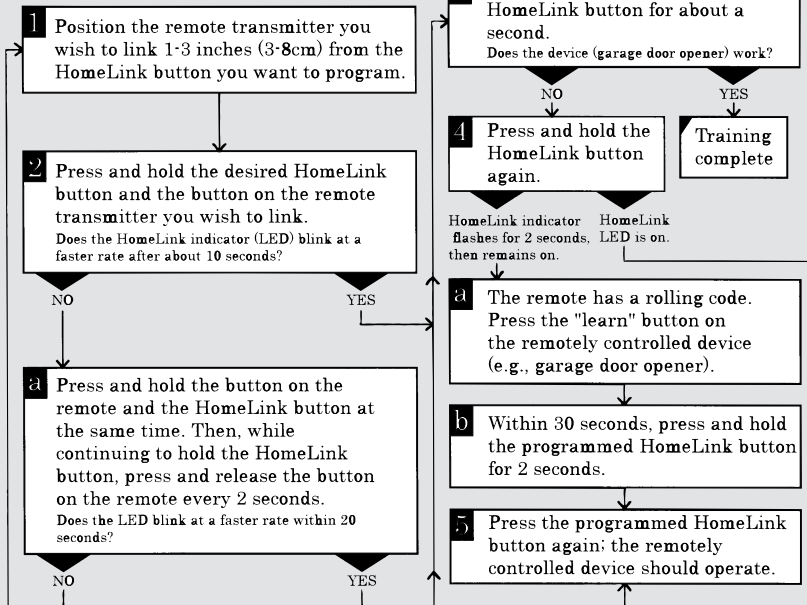

## Retraining a Button

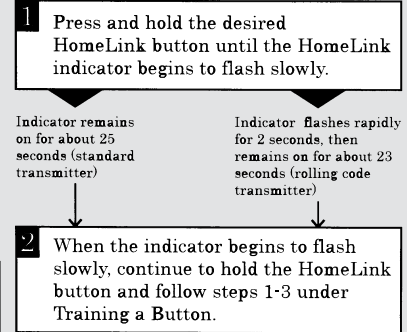

## Erasing Codes

To erase codes stored in all buttons, press and hold the two outer buttons until the HomeLink indicator begins to flash (about 10 to 20 seconds), then release the buttons. You should erase all three codes before selling the vehicle.

If you have any problems programming HomeLink, see the owner's manual included with the device you are trying to program, or call HomeLink at 1-800-355-3515 or go online to [www.homelink.com](http://www.homelink.com).

CONTINUED

# HomeLink® Universal Transceiver

---

HomeLink® is a registered trademark of Johnson Controls, Inc.

*As required by the FCC:*

*This device complies with Part 15 of the FCC rules. Operation is subject to the following two conditions: (1) This device may not cause harmful interference, and (2) this device must accept any interference received, including interference that may cause undesired operation.*

*Changes or modifications not expressly approved by the party responsible for compliance could void the user's authority to operate the equipment.*

*This device complies with Industry Canada Standard RSS-210.*

*Operation is subject to the following two conditions: (1) this device may not cause interference, and (2) this device must accept any interference that may cause undesired operation of the device.*



# Bluetooth® HandsFreeLink® (Models without navigation system)

Bluetooth® HandsFreeLink® (HFL) allows you to place and receive phone calls using voice commands, without handling your cell phone.

To use HFL, you need a Bluetooth-compatible cell phone. For a list of compatible phones, pairing procedures, and special feature capabilities:

In the U.S., visit [handsfreelink.honda.com](http://handsfreelink.honda.com) or call (888) 528-7876.

In Canada, visit [www.handsfreelink.ca](http://www.handsfreelink.ca), or call (888) 528-7876.

## Using HFL Selector Knob

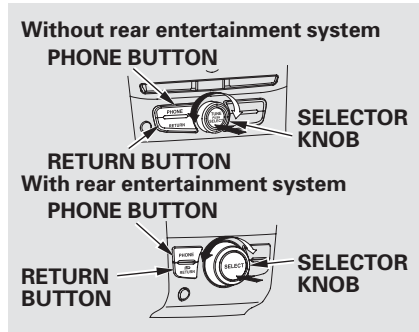

Use the selector knob to make menu or list selections.

To select an item on the screen, turn the selector knob left or right to highlight it, and then push the selector knob.

## U.S. EX and Canadian LX models



## EX-L and Canadian EX models

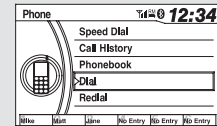

Press the PHONE button or PICK-UP button to go to the Phone screen.

Press the RETURN button to go back to the previous screen.

CONTINUED

## Bluetooth® HandsFreeLink® (Models without navigation system)

### HFL Buttons

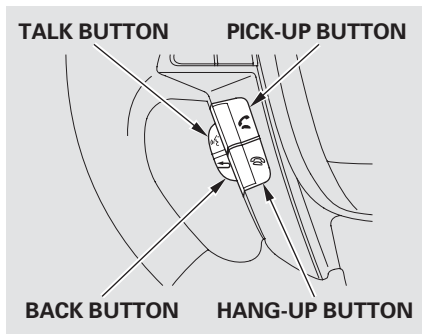

**PICK-UP Button** — Press and release to answer a call, or press to go directly to the Phone screen.

**HANG-UP Button** — Press and release to end or decline a call.

**TALK Button** — Press and release to call a number with a stored voice tag.

**BACK Button** — Press and release to cancel a command.

### Voice Control Tips

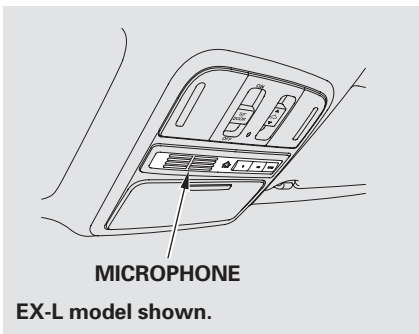

- Air or wind noise from the dashboard and side vents and all windows may interfere with the microphone. Adjust or close them as necessary.
- Press and release the Talk button when you want to call a number using a stored voice tag. After the beep, speak in a clear, natural tone.

- Try to reduce all background noise. If the microphone picks up voices other than yours, commands may be misinterpreted.

- To change the volume level of HFL, use the audio system volume knob or the steering wheel volume controls.

### Language Selection

You can change the system language to English, French, or Spanish (see page 297).

# Bluetooth® HandsFreeLink® (Models without navigation system)

## Display

When you receive an incoming call, you will see the following displays and notifications.

### U.S. EX and Canadian LX models



### EX-L and Canadian EX models

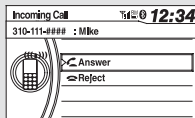

Some phones may send battery, signal strength, and roaming status information to the screen.

### U.S. EX and Canadian LX models

BATTERY LEVEL STATUS  
SIGNAL STRENGTH  
ROAM STATUS



CALL NAME  
PHONE DIALING

BLUETOOTH  
INDICATOR

### EX-L and Canadian EX models

BLUETOOTH INDICATOR

ROAM STATUS  
SIGNAL STRENGTH

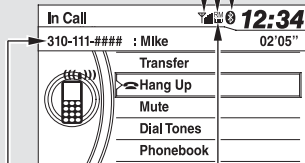

BATTERY LEVEL STATUS  
CALL NAME PHONE DIALING

## How to Use HFL

The ignition switch must be in the ACCESSORY (I) or ON (II) position.

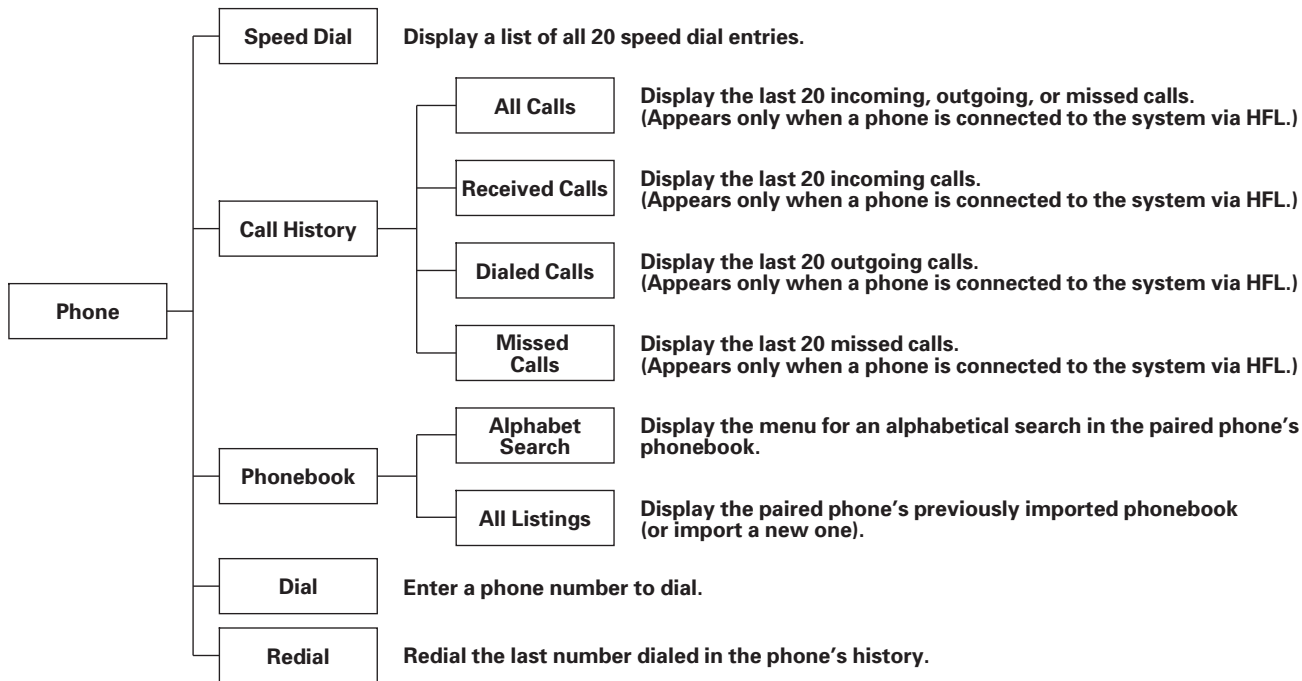

# Bluetooth® HandsFreeLink® (Models without navigation system)

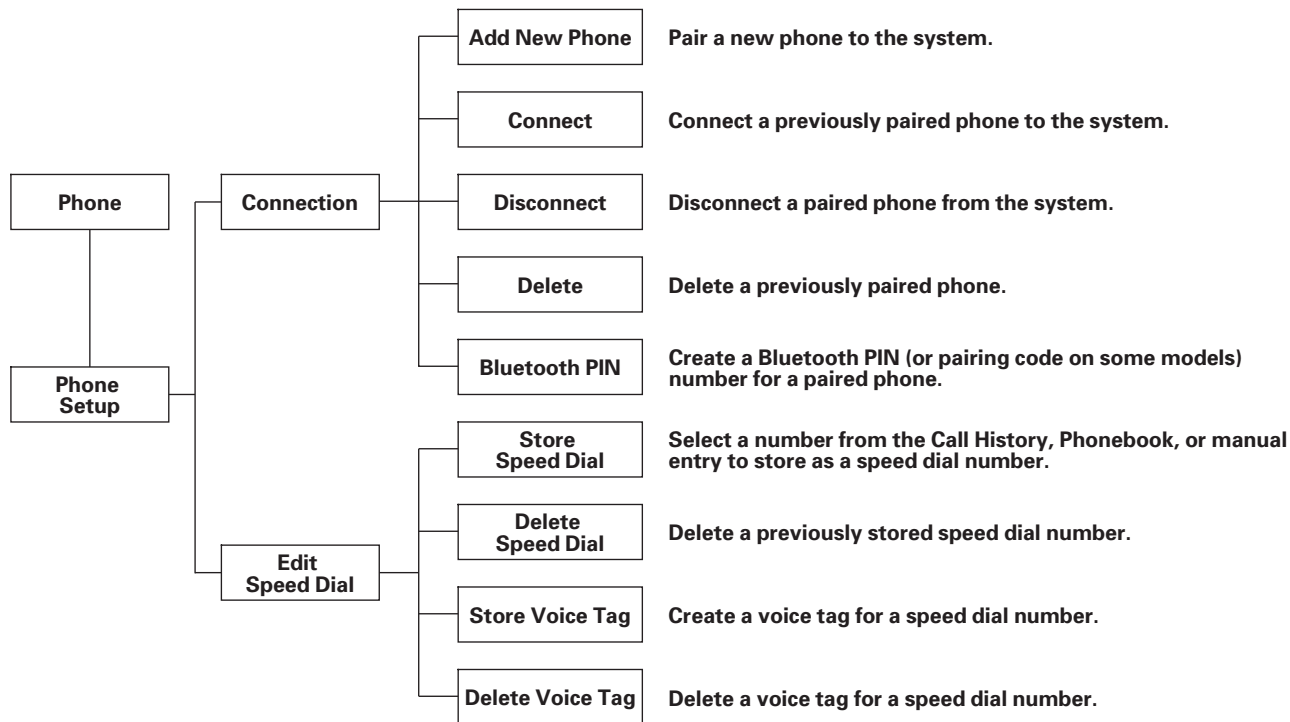

CONTINUED

## **Bluetooth® HandsFreeLink® (Models without navigation system)**

---

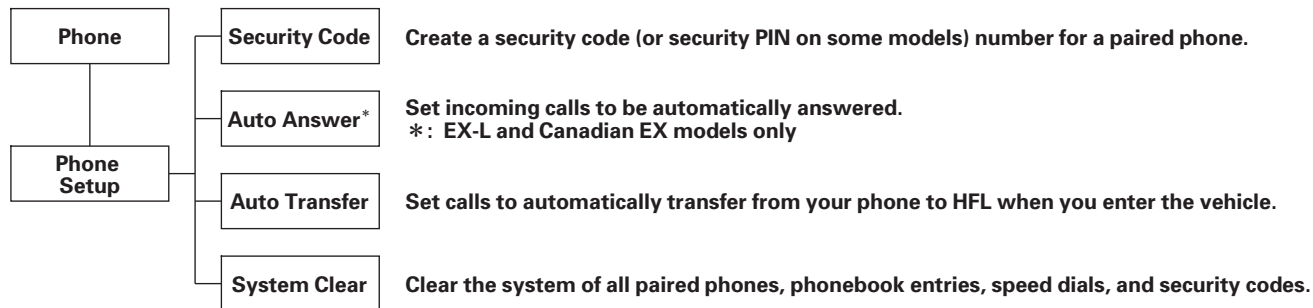

# Bluetooth® HandsFreeLink® (Models without navigation system)

To use HFL, you need to pair your Bluetooth-compatible cell phone to the system.

HFL uses a Class 2 Bluetooth, which means, the maximum range between your phone and vehicle is 30 feet (10 meters).

## Phone Screen

### U.S. EX and Canadian LX models



### EX-L and Canadian EX models

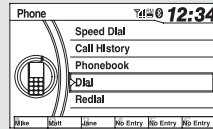

Press the PHONE button or PICK-UP button to go to the Phone screen.

## Phone Setup

You can set up your phone and other system options with this menu.

On EX-L and Canadian EX models A brief explanation of each option is displayed on the left side of the screen.

### U.S. EX and Canadian LX models



### EX-L and Canadian EX models

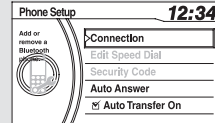

CONTINUED

Features

## Setup Bluetooth Phone

To pair a cell phone (when there is no phone paired to the system):

Press the PHONE button or PICK-UP button. The system starts pairing when there is no phone paired to the system.

### U.S. EX and Canadian LX models



### EX-L and Canadian EX models

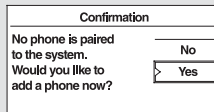

1. Press the PHONE button or PICK-UP button. The system prompts you to pair a phone. Select "Yes" on the confirmation screen.

### Example

### U.S. EX and Canadian LX models

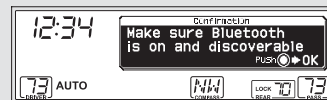

### EX-L and Canadian EX models

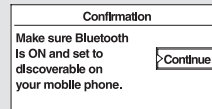

2. Make sure your phone is set to discoverable or visibility is on, and select "Continue." HFL begins to search for your phone.



# Bluetooth® HandsFreeLink® (Models without navigation system)

- If your phone is found, it is displayed on the screen. Select it and press ENTER.
- If your phone doesn't appear on the list, select "Phone not found?" and search for Bluetooth devices using your phone. From your phone, select "HandsFreeLink."

## U.S. EX and Canadian LX models



## EX-L and Canadian EX models

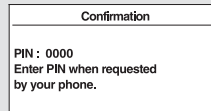

- HFL gives you a 4-digit pass-key that you will need to input on your phone.
- When your phone prompts you, input the 4-digit pass-key.
- You will receive a notification on the screen and your phone if pairing is successful.

*To pair a cell phone (when there are one or more phones paired to the system):*

## U.S. EX and Canadian LX models



## EX-L and Canadian EX models

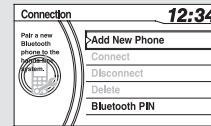

- Select "Phone Setup" from the Phone screen.
- Select "Connection" from the Phone Setup screen.
- Select "Add New Phone."
- Follow steps 2 through 7 from the previous page.

*CONTINUED*

## Phone pairing tips

- You cannot pair your phone while the vehicle is moving.
- Up to six phones can be paired.
- Your phone's battery may drain faster when it is paired to HFL.

To change the Pairing code or Bluetooth PIN setting:

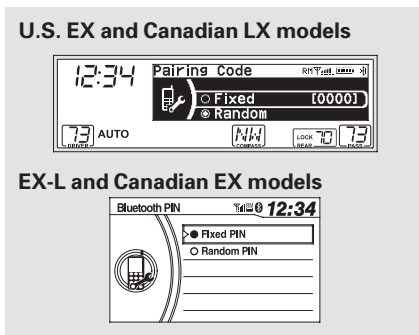

1. Select "Connection" from the Phone Setup screen.
2. Select "Pairing Code" or "Bluetooth PIN."

**NOTE:** The default Pairing code or Bluetooth PIN "0000" is used until you change the setting.

For a randomly generated Pairing code or Bluetooth PIN each time you pair a phone, select "Random" or "Random PIN."

## Example U.S. EX and Canadian LX models

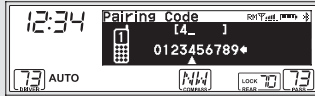

## EX-L and Canadian EX models

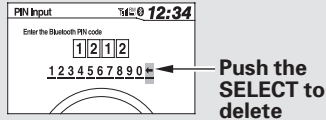

To create your own Pairing code or Bluetooth PIN, select “Fixed” or “Fixed PIN” and follow steps 3 and 4.

3. Delete the current Pairing code or Bluetooth PIN.
4. Enter a new Pairing code or Bluetooth PIN.

To delete a paired phone:

## U.S. EX and Canadian LX models



## EX-L and Canadian EX models

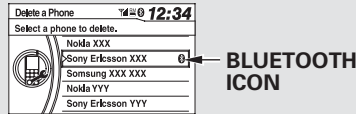

1. Select “Connection” from the Phone Setup screen.
2. Select “Delete.”
3. Select the phone you want to delete. The Bluetooth icon shows you the currently linked phone.
4. Select “Yes” from the confirmation screen.

## Edit Security Code

You can set each security code on all six cell phones. Each can be security code protected, and have its own phonebook, speed dial, and call history.

## U.S. EX and Canadian LX models



## EX-L and Canadian EX models

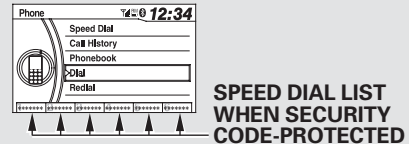

If the phone name you selected is security code protected the speed dial list becomes “\* \* \* \* \* .”

CONTINUED

Features

To create a security code for each phone:

When you set a security code for a phone, you will be asked to enter the security code every time you select the phone on the Phone screen.

## U.S. EX and Canadian LX models



## EX-L and Canadian EX models

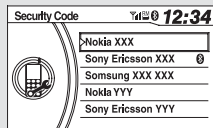

1. Select “Security PIN” or “Security Code” from the Phone Setup screen.
2. Select the phone you want to add a security code to.

## U.S. EX and Canadian LX models

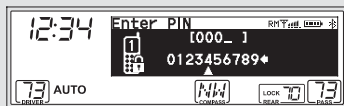

## EX-L and Canadian EX models



3. Enter a 4-digit security code, re-enter it.

If the phone is already security code protected, you need to enter the current security code before clearing the code or creating a new one.

## Automatic Transferring

If you get into the vehicle while you are on the phone, the call can be automatically transferred to HFL with the ignition switch in the ACCESSORY (I) or ON (II) position.

### U.S. EX and Canadian LX models

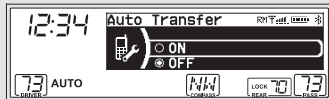

### EX-L and Canadian EX models

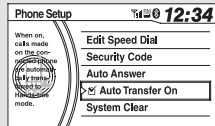

1. Select “Auto Transfer” from the Phone Setup screen.
2. Push the selector knob to turn it on or off. The default setting is On.

## Automatic Answering

*EX-L and Canadian EX models*

You can choose when the HFL system automatically answers incoming calls.

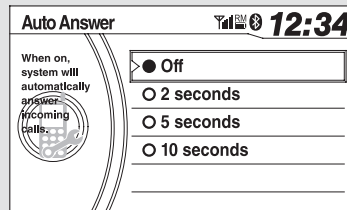

1. Select “Auto Answer” from the Phone Setup screen.
2. Select “Off,” “2 seconds,” “5 seconds,” or “10 seconds.” The default setting is Off.

## To clear the system

This operation clears the security codes, paired phones, all stored voice tags, all speed dial entries, and all imported phonebook data.

### U.S. EX and Canadian LX models

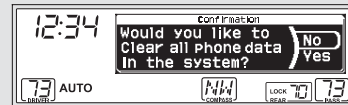

### EX-L and Canadian EX models

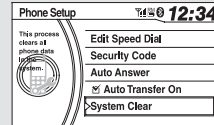

1. Select “System Clear” from the Phone Setup screen.
2. Select “Yes” from the confirmation screen.

CONTINUED

# Bluetooth® HandsFreeLink® (Models without navigation system)

## Automatic Import Cellular Phonebook and Call History

(available on some phones)

When your phone is paired, the contents of its phonebook and call history are automatically imported to HFL.

Up to three category icons appear next to the phonebook entries\*.



These indicate how many numbers are stored for the name. If a name has more than three category icons, “...” is displayed.

\* : Available on some phones

## Edit Speed Dial

### U.S. EX and Canadian LX models



### EX-L and Canadian EX models

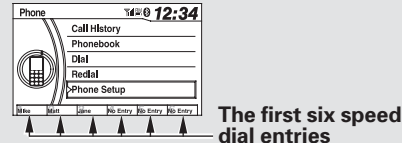

Up to 20 speed dial numbers can be stored per phone.

The first six speed dials are linked to the audio preset buttons while in the Phone screen.

To store a speed dial number:

1. Select “Edit Speed Dial” from the Phone Setup screen.
2. Select “Store Speed dial.”
3. Select a number on the speed dial list where you want to store the number.

You can also select speed dial directly from the Phone screen. Select a “No Entry” field, and continue following step 4.

**NOTE:** You can also store a speed dial number through the “Speed Dial” option on the Phone screen.

## U.S. EX and Canadian LX models



## EX-L and Canadian EX models

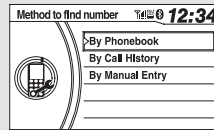

4. Choose a number:

By Phonebook — the linked cell phone’s imported phonebook

By Call History — the last 20 numbers

By Manual Entry — manual number input

5. When the speed dial number is successfully stored, you are asked

to store a voice tag for the number using the TALK button. Follow the prompts.

When a voice tag is stored for the entry, you can dial the entry by voice. Press the TALK button and say “Call” and the stored name.

To store a speed dial number during a call:

1. Press and hold the desired audio preset button during a call.
2. The contact information for the active call will be stored for the preset button.

CONTINUED

## Bluetooth® HandsFreeLink® (Models without navigation system)

---

To add a voice tag to a stored speed dial number:

1. Select “Edit Speed Dial” from the Phone Setup screen.
2. Select “Store Voice Tag.”
3. Select the number you want to store a voice tag for.

### U.S. EX and Canadian LX models

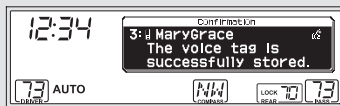

### EX-L and Canadian EX models

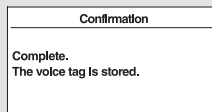

4. Follow the prompts to complete the voice tag.

### NOTE:

- Avoid using duplicate voice tags.
- Avoid using “home” as a voice tag.
- It is easier for HFL to recognize a longer name. For example, use “John Smith” instead of “John.”

To delete a voice tag:

1. Select “Edit Speed Dial” from the Phone Setup screen.
2. Select “Delete Voice Tag.”
3. Select the number you want to delete the voice tag for.



To delete a speed dial number:

1. Select “Edit Speed Dial” from the Phone Setup screen.
2. Select “Delete Speed Dial.”
3. Select the number you want to delete.

## Making a Call

You can make calls by inputting any phone number, using the imported phonebook, using the call history, or with speed dial entries, or by redial.

### U.S. EX and Canadian LX models



### EX-L and Canadian EX models

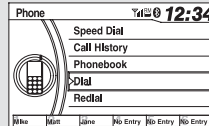

To make a call using a name in the Phonebook:

When your phone is paired, the contents of its phonebook are automatically imported to HFL.

### U.S. EX and Canadian LX models

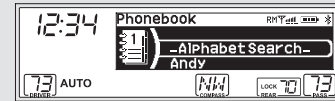

### EX-L and Canadian EX models

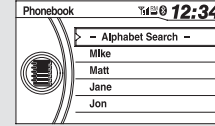

1. Select “Phonebook” from the Phone screen.
2. Select a name from the list.

CONTINUED

## Bluetooth® HandsFreeLink® (Models without navigation system)

3. Push the selector knob to list the number or numbers stored for the selected name.
4. Select a number and push the selector knob to begin automatic dialing.

*To make a call using a phone number:*

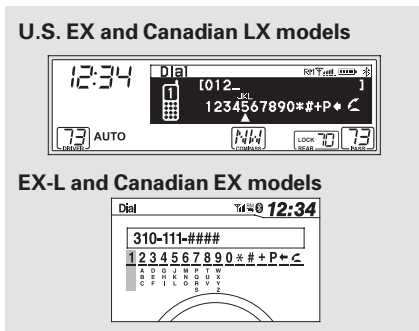

1. Select “Dial” from the Phone screen.
2. Enter the phone number, and select .

*To make a call using Call History:*

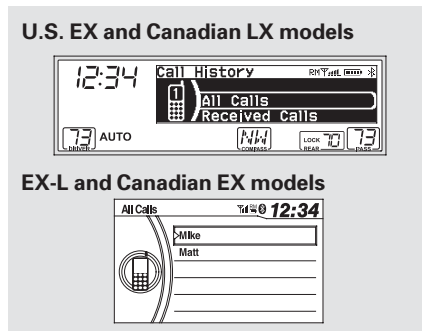

1. Select “Call History” from the Phone screen.
2. Call History is sorted by “All Calls,” “Received Calls,” “Dialed Calls,” and “Missed Calls.” Selecting a number begins automatic dialing.

**NOTE:** Some phones do not support “All Calls.”

To make a call using Speed Dial:

## U.S. EX and Canadian LX models



## EX-L and Canadian EX models

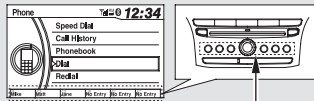

PRESET BUTTONS

The first six speed dial entries are linked to the audio preset buttons while in the Phone screen. Press the corresponding button to begin automatic dialing.

1. Select “Speed Dial” on the Phone screen.

2. A list of up to 20 stored speed dial entries is shown. Select the entry you want to call, and push SELECT to begin automatic dialing.

**NOTE:** Any voice-tagged speed dial entry can be dialed by voice from any screen.

To make a call using Redial:

Select “Redial” from the Phone screen or press and hold the PICK-UP button to redial the last number dialed in your phone’s history.

## Receiving a Call

When you receive a call, a notification appears on the screen (see page 443).

To answer the call, press the PICK-UP button on the steering wheel.

To end or decline the call, press the HANG-UP button.

## During a Call

### Example

#### U.S. EX and Canadian LX models



#### EX-L and Canadian EX models

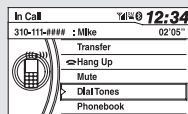

The following options are available during a call:

**Transfer** — Allows you to transfer a call from HFL to your phone, or from your phone to HFL.

**Mute** — Allows you to mute your voice.

**Dial Tones\*** — Allows you to send numbers or names during a call. This is useful when you call a menu-driven phone system.

\* : Available on some phones. Touch Tones on U.S. EX and Canadian LX models.

### ***Call Waiting***

If your phone has Call Waiting, a beep sounds for an incoming call. Press and release the PICK-UP button to put the original call on hold and answer the incoming call.

To return to the original call, press the PICK-UP button again. If you don't want to answer the incoming call, disregard it and continue with your original call. If you want to hang up the original call and answer the new call, press the HANG-UP button.

### **HFL Limitations**

An incoming call on HFL will interrupt Bluetooth® Audio when it is playing. Audio will resume when the call is ended.

### **Bluetooth® Wireless Technology**

The Bluetooth® name and logos are registered trademarks owned by Bluetooth SIG, Inc. and any use of such marks by Honda Motor Co., Ltd. is under license. Other trademarks and trade names are those of their respective owners.

*As required by the FCC:*

*This device complies with Part 15 of the FCC rules. Operation is subject to the following two conditions: (1) This device may not cause harmful interference, and (2) this device must accept any interference received, including interference that may cause undesired operation.*

*Changes or modifications not expressly approved by the party responsible for compliance could void the user's authority to operate the equipment.*

*This device complies with Industry Canada Standard RSS-210.*

*Operation is subject to the following two conditions: (1) this device may not cause interference, and (2) this device must accept any interference that may cause undesired operation of the device.*

## Bluetooth® HandsFreeLink® (Models with navigation system)

Bluetooth® HandsFreeLink® (HFL) allows you to place and receive phone calls using either the navigation system controls or voice commands without the distraction of handling your cell phone.

To use HFL, you need a Bluetooth-compatible cell phone. For a list of compatible phones, pairing procedures, and special feature capabilities:

In the U.S., visit [handsfreelink.honda.com](http://handsfreelink.honda.com) or call (888) 528-7876.

In Canada, visit [www.handsfreelink.ca](http://www.handsfreelink.ca), or call (888) 528-7876.

### Using HFL Interface Dial

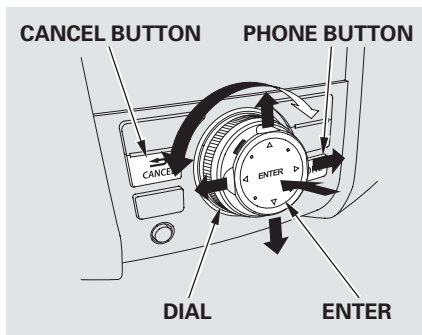

Use the Interface Dial to make menu or list selections.

To select an item on the screen, turn the interface dial left or right to highlight it, and then press ENTER.

To select an item that comes with ▲, ▼, ◀, or ▶ icons, push the interface selector up, down, left, or right.

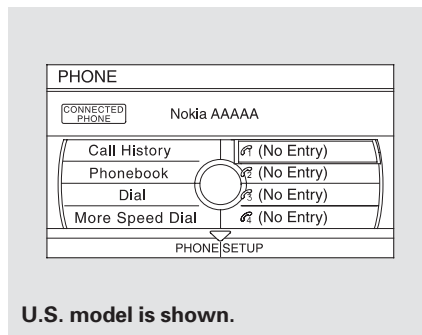

**U.S. model is shown.**

Press the PHONE button or PICK-UP button to go to the Phone screen.

Press the CANCEL button to go back to the previous screen.

## HFL Buttons

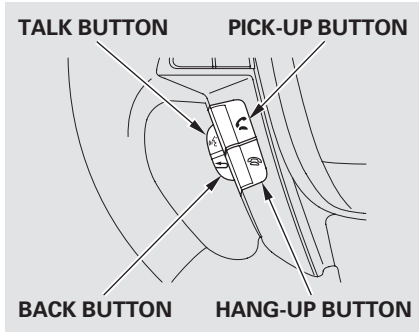

**PICK-UP Button** — Press and release to answer a call, or press to go directly to the Phone screen.

**HANG-UP Button** — Press and release to end or decline a call.

**TALK Button** — Press and release to give a command.

**BACK Button** — Press and release to go back to the previous command, or cancel the command.

## Voice Control Tips

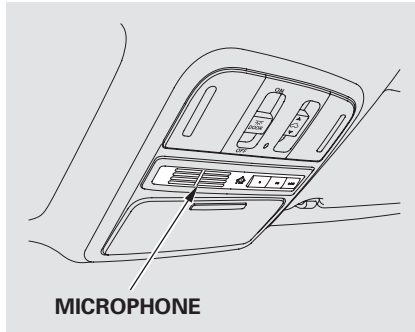

- Air or wind noise from the dashboard and side vents and all windows may interfere with the microphone. Adjust or close them as necessary.
- Press and release the Talk button each time you want to make a command. After the beep, speak in a clear, natural tone.

- Try to reduce all background noise. If the microphone picks up voices other than yours, commands may be misinterpreted.
- To change the volume level of HFL, use the audio system volume knob or the steering wheel volume controls.

## Help Feature

For help at any time, including a list of available options, say “Help.”

## Language Selection

Refer to the navigation system manual for how to change the system’s language between English, French, and Spanish.

CONTINUED

## Bluetooth® HandsFreeLink® (Models with navigation system)

### Display

When you receive an incoming call, you will see the following displays and notifications.

You will see “HANDSFREELINK” on the audio display while HFL is in use.

On the navigation screen:

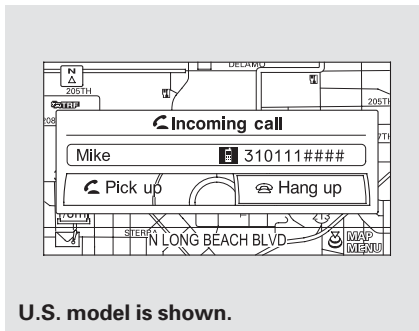

On the Phone screen:

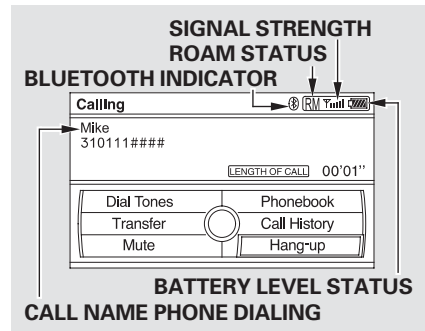

Some phones may send battery, signal strength, and roaming status information to the screen.



## How to Use HFL

The ignition switch must be in the ACCESSORY (I) or ON (II) position.

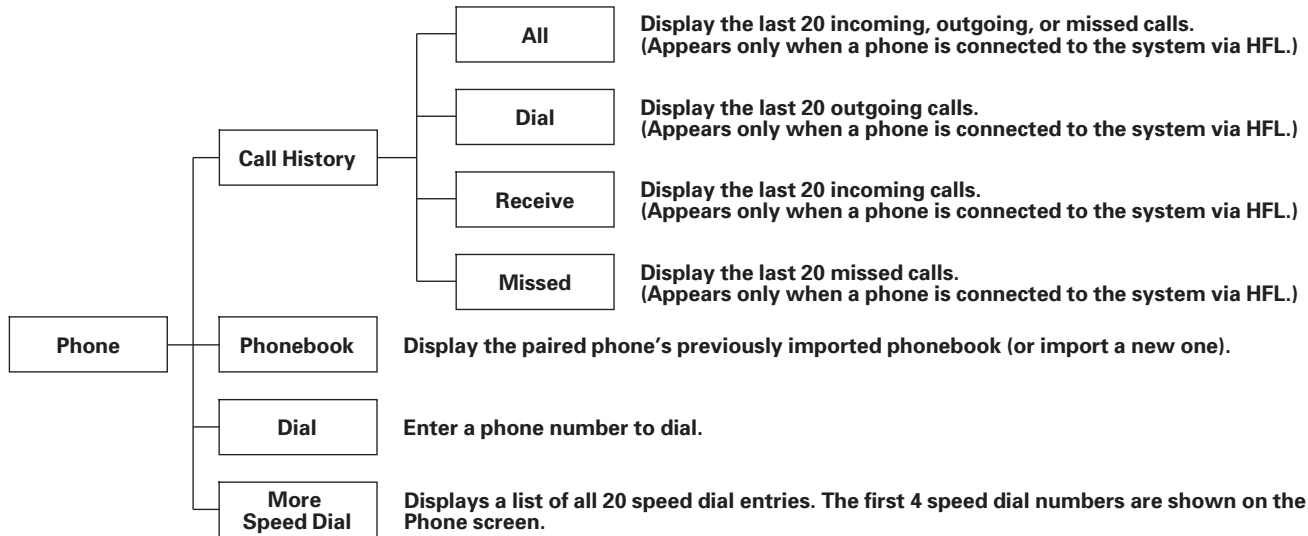

Voice commands can be used for all above options. Voice commands for the HFL system can only be used from the PHONE screen. To quickly access the PHONE screen, press the Pick-Up button on the steering wheel. Press and release the Talk button each time you give a command. From any other screen, you can press the Talk button and say "Dial by voice tag" or "Dial by number." The system will guide you through the process.

CONTINUED

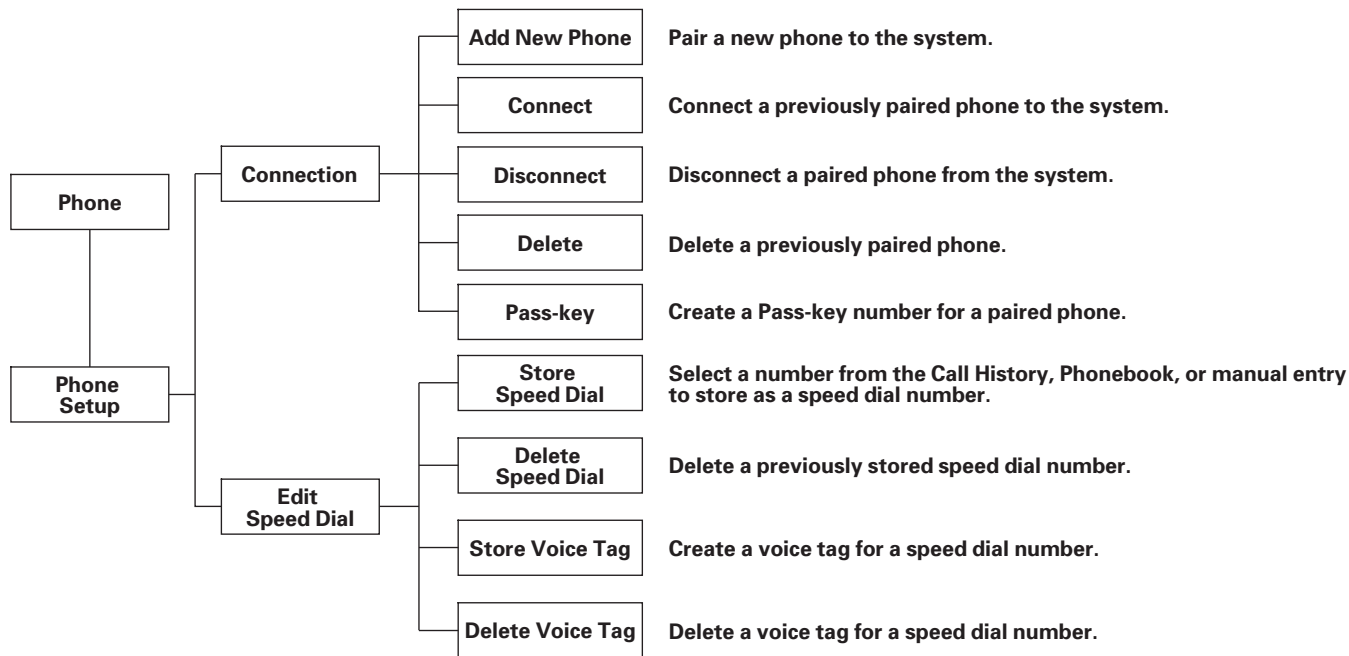

 Voice commands can be used for all above options. Voice commands for the HFL system can only be used from the PHONE screen. To quickly access the PHONE screen, press the Pick-Up button on the steering wheel. Press and release the Talk button each time you give a command. From any other screen, you can press the Talk button and say "Dial by voice tag" or "Dial by number." The system will guide you through the process.

# Bluetooth® HandsFreeLink® (Models with navigation system)

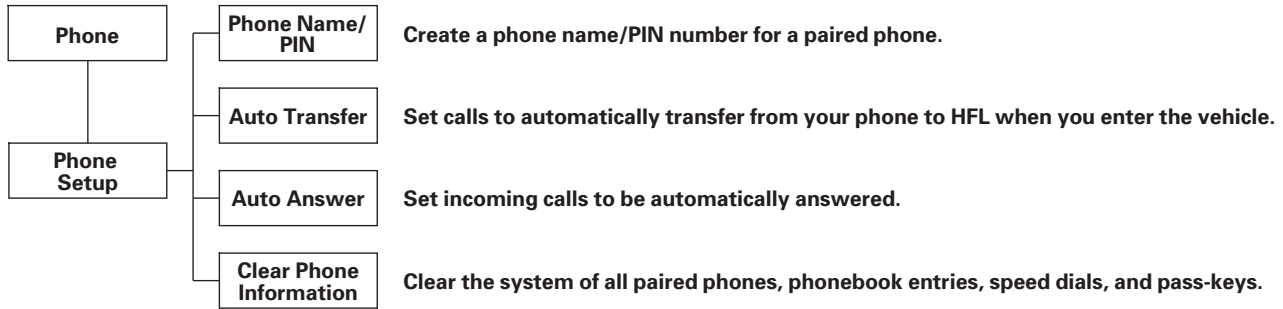

⌂  
{ }  
Voice commands can be used for all above options. Voice commands for the HFL system can only be used from the PHONE screen. To quickly access the PHONE screen, press the Pick-Up button on the steering wheel. Press and release the Talk button each time you give a command. From any other screen, you can press the Talk button and say "Dial by voice tag" or "Dial by number." The system will guide you through the process.

CONTINUED

## Bluetooth® HandsFreeLink® (Models with navigation system)

To use HFL, you need to pair your Bluetooth-compatible cell phone to the system.

HFL uses a Class 2 Bluetooth, which means, the maximum range between your phone and vehicle is 30 feet (10 meters).

### Phone Screen

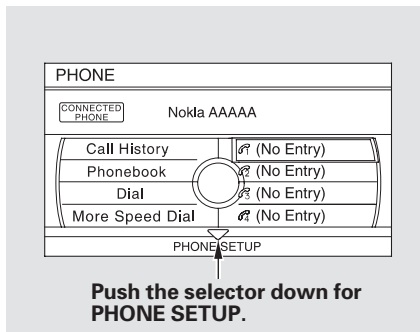

Press the PHONE button or PICK-UP button to go to the Phone screen.

### Phone Setup

You can set up your phone and other system options with this menu.

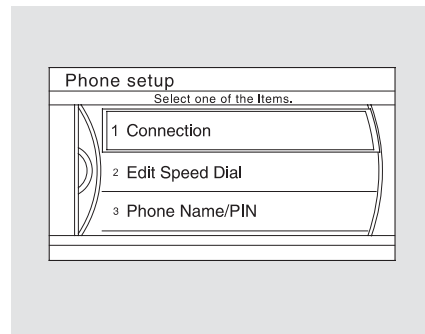

## Setup Bluetooth Phone

To pair a cell phone (when there is no phone paired to the system):

Press the PHONE button or PICK-UP button. The system starts pairing when there is no phone paired to the system.

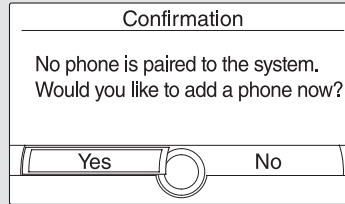

1. Press the PHONE button or PICK-UP button. The system prompts you to pair a phone. Select "Yes" on the confirmation screen.



2. Make sure your phone is set to discoverable or visibility is ON, and select "OK." HFL begins to search for your phone.

CONTINUED

## Bluetooth® HandsFreeLink® (Models with navigation system)

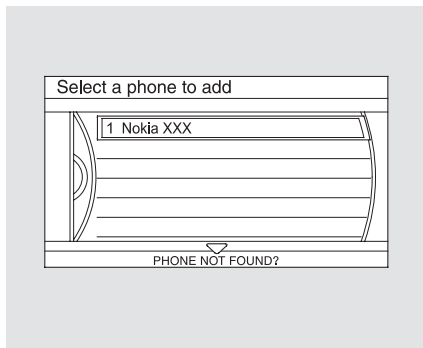

3. If your phone is found, it is displayed on the screen. Select it and press ENTER.
4. If your phone doesn't appear on the list, select "Phone not found?" and search for Bluetooth devices using your phone. From your phone, select "HandsFreeLink."

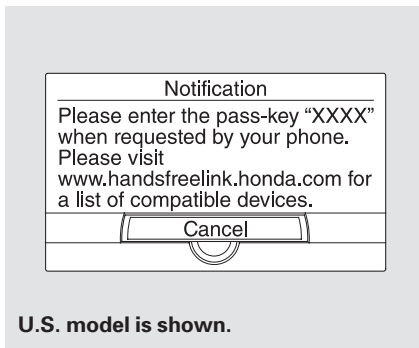

**U.S. model is shown.**

5. HFL gives you a 4-digit pass-key that you will need to input on your phone.
6. When your phone prompts you, input the 4-digit pass-key.
7. You will receive a notification on the screen and your phone if pairing is successful.

*To pair a cell phone (when there are one or more phones paired to the system):*

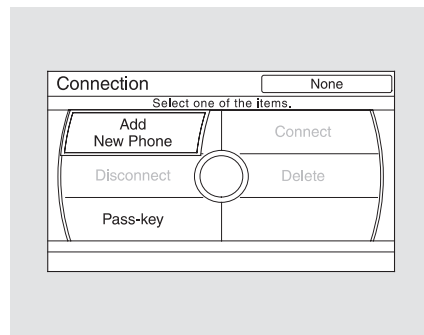

1. Select "Phone Setup" from the Phone screen.
2. Select "Connection" from the Phone Setup screen.
3. Select "Add New Phone."

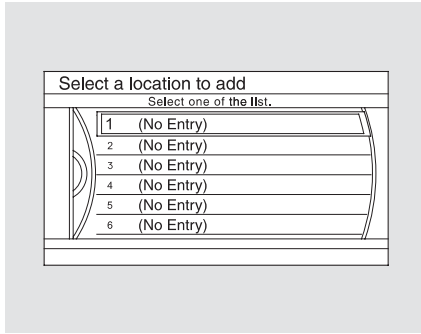

4. Select one of the six entries on the list. Make sure your phone is set to discoverable or visibility is ON.
5. Follow steps 2 through 7 from the previous page.

### *Phone pairing tips*

- You cannot pair your phone while the vehicle is moving.
- Up to six phones can be paired.
- Your phone's battery may drain faster when it is paired to HFL.

### *To change the pass-key setting:*

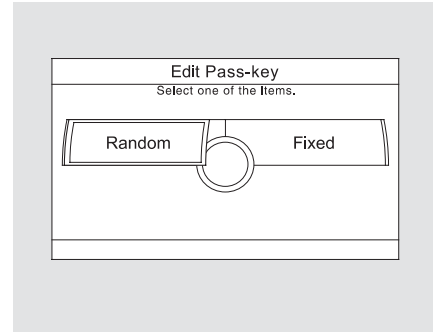

1. Select “Connection” from the Phone Setup screen.
2. Select “Pass-key.”

**NOTE:** The default pass-key “0000” is used until you change the setting.

For a randomly generated pass-key each time you pair a phone, select “Random.”

*CONTINUED*

## Example

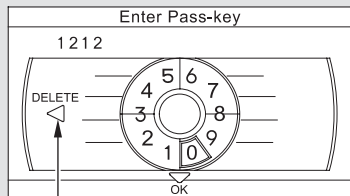

Push the selector to left to delete.

To create your own pass-key, select “Fixed” and follow steps 3 and 4.

3. Delete the current pass-key.

4. Enter a new pass-key, and select “OK.”

To delete a paired phone:

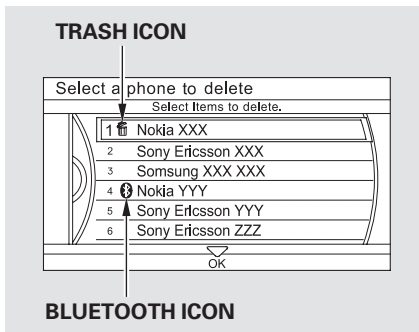

1. Select “Connection” from the Phone Setup screen.

2. Select “Delete.”

3. Select the phone you want to delete. The Bluetooth icon shows you the currently linked phone.

4. A trash icon appears next to the selected phone. Select “OK” to continue.

5. Select “Yes” from the confirmation screen.



## Phone Name/PIN

You can name up to six HFL phone names. Each can be PIN protected, and have its own phonebook, speed dial, and call history.

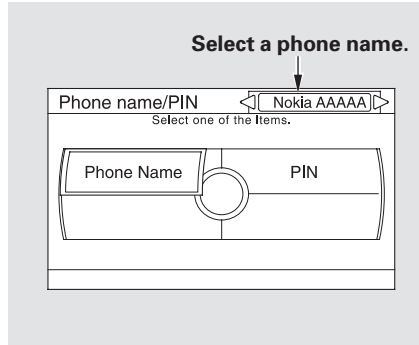

1. Select "Phone Name/PIN" from the Phone Setup screen.
2. Select the phone name you want to edit on the phone name/PIN screen.

If the phone name you selected is PIN-protected, the speed dial list becomes " \* \* \* \* ."

To name a phone:

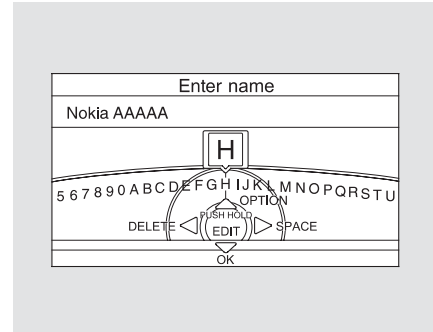

1. Select "Phone Name/PIN" from the Phone Setup screen.
2. Select "Phone Name."
3. Enter a phone name, and select "OK" when complete.

CONTINUED

### To create a PIN for each phone:

When you set a PIN for a phone, you will be asked to enter the PIN every time you select the phone on the Phone screen.

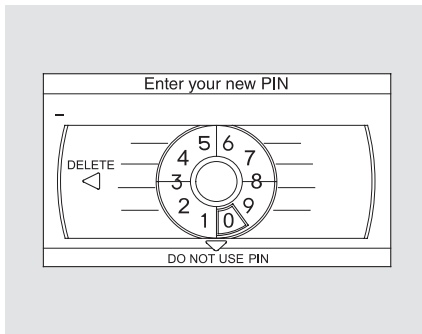

1. Select “Phone Name/PIN” from the Phone Setup screen.
2. Select “PIN.”
3. Enter a 4-digit PIN, re-enter it, and select “OK.”

If you select “DO NOT USE PIN,” before entering any number, the phone will not have a PIN.

If the phone is already PIN-protected, you need to enter the current PIN before creating a new one.

### Automatic Transferring

If you get into the vehicle while you are on the phone, the call can be automatically transferred to HFL with the ignition switch in the ACCESSORY (I) or ON (II) position.

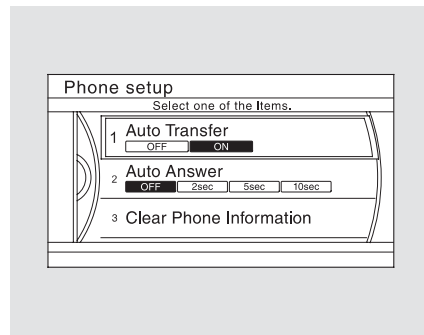

1. Select “Auto Transfer” from the Phone Setup screen.
2. Select “OFF” or “ON.”

## Automatic Answering

You can choose when the HFL system automatically answers incoming calls.

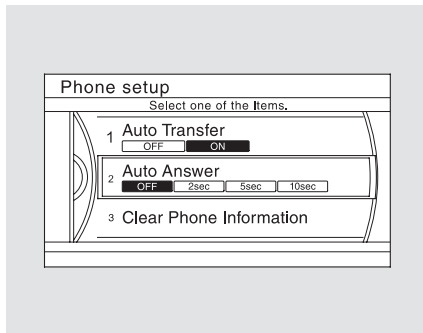

1. Select "Auto Answer" from the Phone Setup screen.
2. Select "Off," "2sec," "5sec," or "10sec."

## To clear the phone information

Clearing a phone name will clear all settings, such as call history and phonebook.

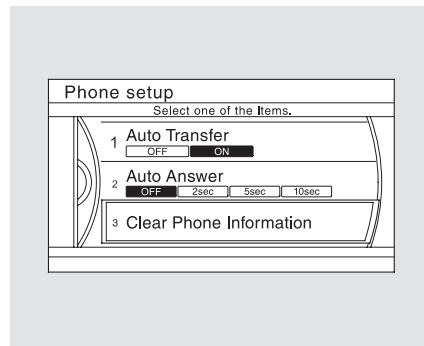

1. Select "Clear Phone Information" from the Phone Setup screen.
2. Select the phone you want to clear.
3. A trash icon appears next to the selected phone. Select "OK" to continue.
4. Select "Yes" from the confirmation screen.

CONTINUED

## Bluetooth® HandsFreeLink® (Models with navigation system)

### *Automatic Import Cellular Phonebook and Call History* (available on some phones)

When your phone is paired, the contents of its phonebook and call history are automatically imported to HFL.

Up to three category icons appear next to the phonebook entries\*.

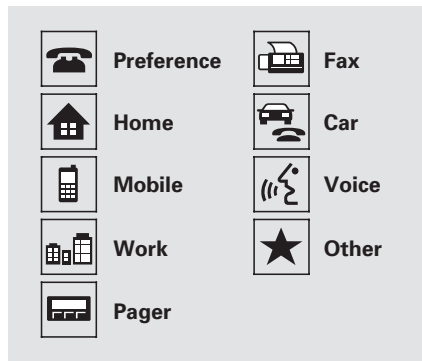

These indicate how many numbers are stored for the name. If a name has more than three category icons, “...” is displayed.

\* : Available on some phones

### *Edit Speed Dial*

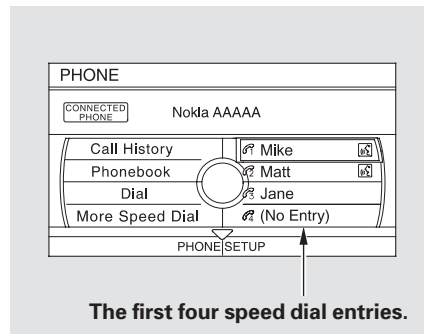

Up to 20 speed dial numbers can be stored per phone name, and the first four numbers are displayed on the Phone screen.

Select a “No Entry” field to store a speed dial entry, or use the following procedure.

*To store a speed dial number:*

1. Select “Edit Speed Dial” from the Phone Setup screen.
2. Select “Store Speed dial.”
3. Select a number on the speed dial list where you want to store the number.

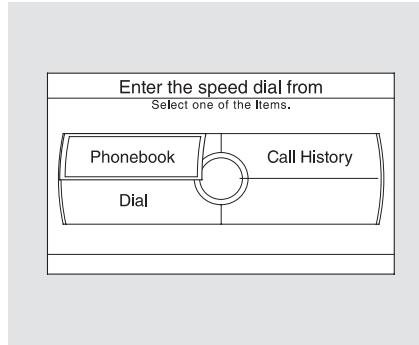

4. Choose a number from:

Phonebook — the linked cell phone’s imported phonebook

Call History — the last 20 numbers

Dial — manual number input

5. When the speed dial number is successfully stored, you are asked to store a voice tag for the number. Follow the prompts.

When a voice tag is stored for the entry, you can dial the number by saying “Call” and the voice tag name.

CONTINUED

*To add a voice tag to a stored speed dial number:*

1. Select “Edit Speed Dial” from the Phone Setup screen.
2. Select “Store Voice Tag.”
3. Select the number you want to store a voice tag for.



4. Follow the prompts to complete the voice tag.

**NOTE:**

- Avoid using duplicate voice tags.
- Avoid using “home” as a voice tag.
- It is easier for HFL to recognize a longer name. For example, use “John Smith” instead of “John.”

*To delete a voice tag:*

1. Select “Edit Speed Dial” from the Phone Setup screen.
2. Select “Delete Voice Tag.”
3. Select the number you want to delete the voice tag for.
4. A trash icon appears next to the selected numbers. Select “OK” to continue.

*To delete a speed dial number:*

1. Select “Edit Speed Dial” from the Phone Setup screen.
2. Select “Delete Speed Dial.”
3. Select the number you want to delete, and push ENTER.
4. A trash icon appears next to the selected numbers. Select “OK” to continue.

## Making a Call

You can make calls by inputting any phone number, using the imported phonebook, using the call history, or with speed dial entries.

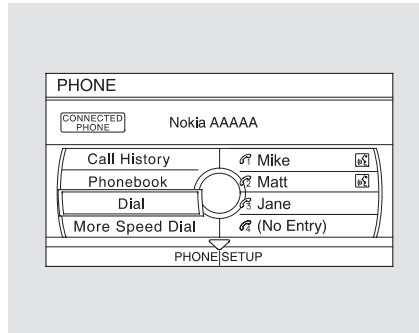

**NOTE:** If you are not on the PHONE screen, you can press the Talk button and say “Dial by voice tag” or “Dial by number.” The system will guide you through the process.

*To make a call using a name in the Phonebook:*

When your phone is paired, the contents of its phonebook are automatically imported to HFL.

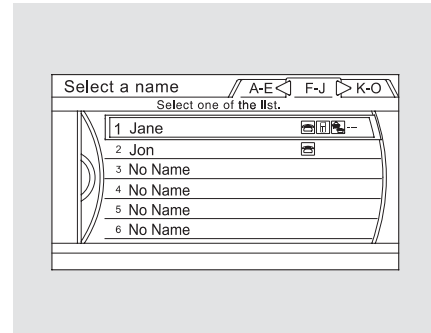

1. Select “Phonebook” from the Phone screen.
2. Select a name from the list.

CONTINUED

## Bluetooth® HandsFreeLink® (Models with navigation system)

3. Push ENTER to list the number or numbers stored for the selected name.
4. Select a number and push ENTER to begin automatic dialing.

*To make a call using a phone number:*

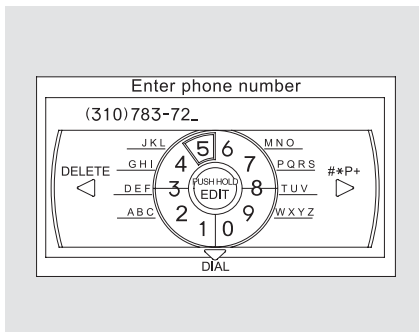

1. Select “Dial” from the Phone screen.
2. Enter the phone number, and select “Dial.”

To enter the phone number by voice, say it in a continuous string.

*To make a call using Call History:*

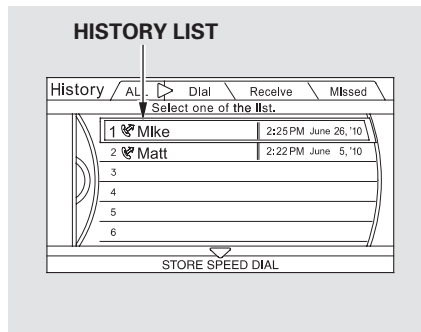

1. Select “Call History” from the Phone screen.
2. Call History is sorted by “All,” “Dial,” “Receive,” and “Missed.” Selecting a number begins automatic dialing.

**NOTE:** Some phones do not support “All” in the Call History.



To make a call using *Speed Dial*:

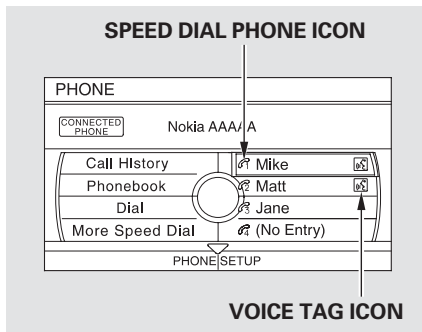

Select one of the four entries on the Phone screen, and push ENTER to begin automatic dialing.

To make a call using *More Speed Dial*:

1. Select "More Speed Dial" on the Phone screen.
2. A list of 20 stored speed dial entries is shown. Select the entry you want to call, and push ENTER to begin automatic dialing.

**NOTE:** Any voice-tagged speed dial entry can be dialed by voice from any screen.

To make a call using *Redial*:

Press and hold the PICK-UP button to redial the last number dialed in your phone's history. While the display is showing Phone screen, you can also redial by pressing and holding ENTER.

**Receiving a Call**

When you receive a call, a notification appears on the screen (see page 464 ).

To answer the call, press the PICK-UP button on the steering wheel.

To end or decline the call, press the HANG-UP button.

## During a Call

### Example

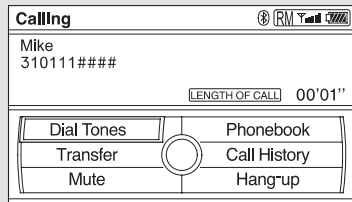

The following options are available during a call:

**Dial Tones\*** — Allows you to send numbers or names during a call. This is useful when you call a menu-driven phone system.

**Transfer** — Allows you to transfer a call from HFL to your phone, or from your phone to HFL.

**Mute** — Allows you to mute your voice.

\* : Available on some phones

### Call Waiting

If your phone has Call Waiting, press and release the PICK-UP button to put the original call on hold and answer the incoming call.

To return to the original call, press the PICK-UP button again. If you don't want to answer the incoming call, disregard it and continue with your original call. If you want to hang up the original call and answer the new call, press the HANG-UP button.

### **HFL Limitations**

An incoming call on HFL will interrupt *Bluetooth*<sup>®</sup> Audio when it is playing. Audio will resume when the call is ended.

### ***Bluetooth*<sup>®</sup> Wireless Technology**

The *Bluetooth*<sup>®</sup> name and logos are registered trademarks owned by Bluetooth SIG, Inc. and any use of such marks by Honda Motor Co., Ltd. is under license. Other trademarks and trade names are those of their respective owners.

*As required by the FCC:*

*This device complies with Part 15 of the FCC rules. Operation is subject to the following two conditions: (1) This device may not cause harmful interference, and (2) this device must accept any interference received, including interference that may cause undesired operation.*

*Changes or modifications not expressly approved by the party responsible for compliance could void the user's authority to operate the equipment.*

*This device complies with Industry Canada Standard RSS-210.*

*Operation is subject to the following two conditions: (1) this device may not cause interference, and (2) this device must accept any interference that may cause undesired operation of the device.*

## Parking Sensor System

---

### *On Touring models*

Your vehicle has a parking sensor system. The system lets you know the approximate distance between your vehicle and most obstacles while you are parking. When the system is on and your vehicle is nearing an obstacle, you will hear a beeper and see system messages on the multi-information display.

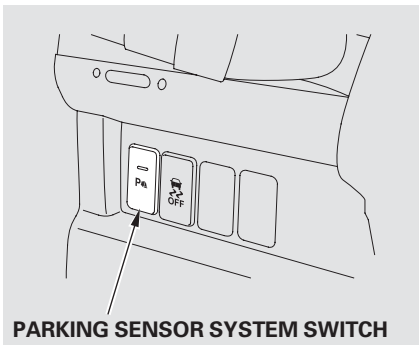

To activate the system, push the switch on the dashboard with the ignition in the ON (II) position. The indicator in the switch comes on when the system is on. To turn the system off, push the switch again.

All obstacles may not always be sensed. Even when the system is on, you should look for obstacles near your vehicle to make sure it is safe to park.

The system has two front corner sensors, two rear corner sensors, and two rear center sensors.

The rear center sensors work when the shift lever is in reverse (R), and the vehicle speed is less than 5 mph (8 km/h).

The corner sensors work only when the shift lever is in any position other than P and the vehicle speed is less than 5 mph (8 km/h).

## Indicators and Beeper Operation on the Multi-Information Display/Audio Screen



When you turn the system on, all indicators will appear on the multi-information display, and a beeper sounds once.

When the system senses an obstacle, the appropriate indicator comes on, and a beeper sounds as shown in the following tables.

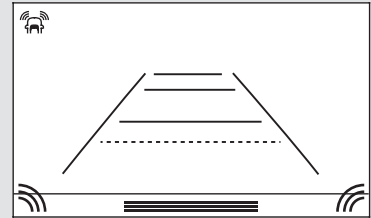

**Audio Screen**





The parking sensor indicators are automatically displayed on the audio screen when an obstacle is detected.

*CONTINUED*

# Parking Sensor System

## Corner Sensor Operation

Example shown: Obstacle is at the left front of the vehicle.

|                              |   |   |   |
|------------------------------|---|---|---|
| Distance                     | About 18-24 in<br>(45-60 cm)<br>   | About 14-18 in<br>(35-45 cm)<br> | About 14 in<br>(35 cm) or less<br>       |
| Indicator                    | Upper left indicator stays on.<br> |   | Indicator blinks.<br><b>INDICATOR</b><br> |
|                              | <b>MULTI-INFORMATION DISPLAY</b>  |   | <b>AUDIO SCREEN</b>   |
| Beeper                       | Short beeps   | Very short beeps  | Continuous beeps  |
| Audio Screen Indicator Color | Amber   |   | Red   |

## Rear Center Sensor Operation

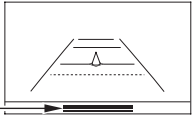
|                              |   |                              |   |                                |
|------------------------------|---|------------------------------|---|--------------------------------|
| Distance                     | About 28-43 in<br>(70-110 cm)   | About 22-28 in<br>(55-70 cm) | About 18-22 in<br>(45-55 cm)  | About 18 in<br>(45 cm) or less |
| Indicator                    | <p>Bottom indicator stays on.</p>  <p><b>MULTI-INFORMATION DISPLAY</b></p> |                              | <p>Indicator blinks.</p>  <p><b>AUDIO SCREEN</b></p> |                                |
| Beeper                       | Long beeps  | Short beeps                  | Very short beeps  | Continuous beeps               |
| Audio Screen Indicator Color | Yellow  | Amber                        |   | Red                            |

CONTINUED

## Parking Sensor System

---



If the system develops a problem, you will see a “CHECK PARKING SENSOR SYSTEM” message on the multi-information display.

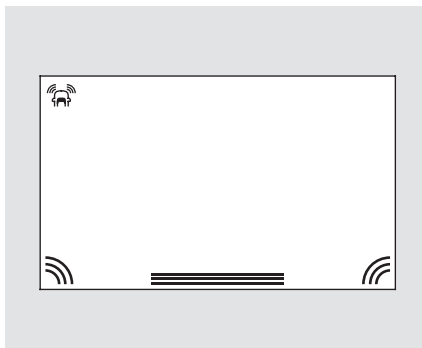

If there is a problem with any of the operational sensors, the indicators for these sensors will appear constantly in red.

Very often, a sensor covered with mud, ice, snow, etc. is the cause of this display. Check the sensors first. If the indicators stay on or the beeper does not stop, have the system checked by your dealer.



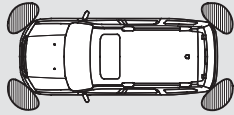

**Within about 24 in (60 cm)**

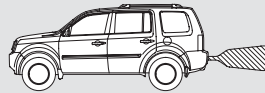
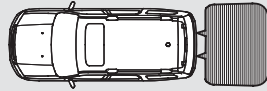

**Within about 43 in (1.1 m)**

The range of the corner sensors and the rear center sensor are limited. Each corner sensor is capable of sensing an obstacle only when your vehicle is 24 in (60 cm) or closer. The rear center sensor senses an obstacle that is behind your vehicle 43 in (1.1 m) or closer.

Do not put any accessories on or around the sensors.

The system may not function properly under these conditions:

- The sensors are covered with snow, ice, mud, etc.
- When the vehicle is on a rough road, on grass, or on a hill.
- After the vehicle has been sitting out in hot or cold weather.

- When the system is affected by some electrical equipment or devices generating an ultrasonic wave.
- When operating the vehicle in bad weather.

The system may not sense thin or low objects, or sonic-absorptive materials such as snow, cotton, or sponge.

The system cannot sense objects directly under the bumper.

*CONTINUED*

## Parking Sensor System

---

### ***To turn off all rear sensors***

The parking sensor system must be turned off before beginning this procedure.

1. Press and hold the parking sensor system switch and then turn the ignition switch to the ON (II) position.
2. Keep pressing the switch for 10 seconds. The LED indicator in the switch will flash.
3. Press the switch again and the LED indicator will turn off. A beeper will sound twice to confirm that the rear sensors are now disabled.

When you shift to reverse (R), the LED indicator in the switch will blink as a reminder that the rear sensors are disabled.

To return to the original setting, repeat the procedure. A beeper will sound 3 times to confirm that the rear sensors are now enabled.

### *Canadian Owners:*

*This device complies with Industry Canada Standard RSS-210.*

*Operation is subject to the following two conditions: (1) this device may not cause interference, and (2) this device must accept any interference that may cause undesired operation of the device.*

*This ISM device complies with Canadian ICES-001.*

On Canadian EX and EX-L without navigation system

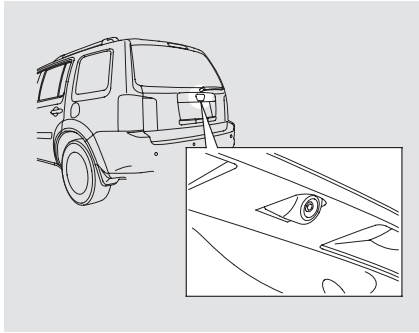

Whenever you shift to reverse (R) with the ignition switch in the ON (II) position, the rearview is shown on the display.

## SCREEN DISPLAY

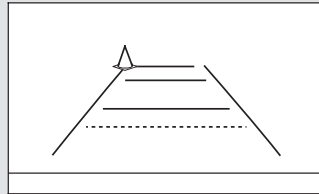

## ACTUAL DISTANCE

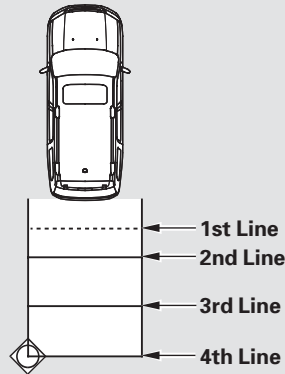

The camera display has parking guide lines that indicate distance from your vehicle.

|          |                     |
|----------|---------------------|
| 1st Line | 20 in (0.5 m)       |
|          | Tailgate Open Range |
| 2nd Line | 39 in (1 m)         |
| 3rd Line | 79 in (2 m)         |
| 4th Line | 118 in (3 m)        |

To turn off the guidelines, press and hold the RETURN button for about 3 seconds.

CONTINUED

## Rearview Camera and Monitor

---

### **NOTE:**

- For the best picture, always keep the rearview camera clean, and do not cover the camera lens. To avoid scratching the lens when you clean it, use a moist, soft cloth.
- The rearview camera has a unique lens that makes objects appear closer than they actually are.
- The rearview camera display has a limited coverage, and the size and position of objects may appear different than they actually are. Make sure to check the surrounding area carefully.

### *On models with Navigation System*

Refer to the navigation system manual for operation of the rearview camera.

Before you begin driving your vehicle, you should know what gasoline to use and how to check the levels of important fluids. You also need to know how to properly store luggage or packages. The information in this section will help you. If you plan to add any accessories to your vehicle, please read the information in this section first.

|                                      |     |
|--------------------------------------|-----|
| Break-in Period .....                | 494 |
| Fuel Recommendation .....            | 495 |
| Service Station Procedures .....     | 497 |
| Refueling.....                       | 497 |
| Tighten Fuel Cap Message .....       | 498 |
| Opening and Closing the<br>Hood..... | 499 |
| Oil Check .....                      | 500 |
| Engine Coolant Check .....           | 500 |
| Fuel Economy .....                   | 501 |
| Accessories and Modifications .....  | 504 |
| Carrying Cargo .....                 | 506 |

## Break-in Period

---

### **Break-in Period**

Help assure your vehicle's future reliability and performance by paying extra attention to how you drive during the first 600 miles (1,000 km). During this period:

- Avoid full-throttle starts and rapid acceleration.
- Avoid hard braking for the first 200 miles (300 km).
- Do not change the oil until the scheduled maintenance time.
- Do not tow a trailer.

You should also follow these recommendations after the brakes are replaced or if the vehicle receives an overhauled or new engine.

### Fuel Recommendation

Your vehicle is designed to operate on unleaded gasoline with a pump octane number of 87 or higher. Use of a lower octane gasoline can cause a persistent, heavy, metallic rapping noise that can lead to engine damage.

Premium fuel is recommended when towing in certain conditions (see page 549).

Some gasoline today is blended with oxygenates such as ethanol. Your vehicle is designed to operate on oxygenated gasoline containing up to 10% ethanol by volume. Do not use gasoline containing methanol. If you notice any undesirable operating symptoms, try another service station or switch to another brand of gasoline.

### NOTICE

*Do not use E85 fuel in a non-Flex Fuel Vehicle (FFV).*

*Non-FFV models are not designed to run on E85 fuel. Using E85 fuel can damage the fuel system components.*

- *If a non-FFV is inadvertently refueled once with E85 fuel, have the fuel tank drained at a dealer.*
- *If this occurs over a prolonged period, damage may occur.*

### NOTICE

*To help prevent harmful fuel system and engine deposits, use high quality fuel containing detergent and additives.*

In addition, in order to maintain good performance, fuel economy, and emissions control, we strongly recommend the use of gasoline that does NOT contain harmful manganese-based fuel additives such as MMT, if such gasoline is available.

Use of gasoline with these additives may adversely affect performance, and cause the Malfunction Indicator Lamp on your instrument panel to come on. If this happens, contact your dealer for service.

CONTINUED

## Fuel Recommendation

---

Because the level of detergency and additives in gasoline vary in the market, Honda endorses the use of “TOP TIER Detergent Gasoline” where available to help maintain the performance and reliability of your vehicle. TOP TIER Detergent Gasoline meets a new gasoline standard jointly established by leading automotive manufacturers to meet the needs of today’s advanced engines. Qualifying gasoline retailers will, in most cases, identify their gasoline as having met “TOP TIER Detergent Gasoline” standards at the retail location. This fuel is guaranteed to contain the proper level of detergent additives and be free of metallic additives. The proper level of detergent additives, and absence of harmful metallic additives in gasoline, help avoid build-up of deposits in your engine and emission control system.

For further important fuel-related information for your vehicle, or information on gasoline that does not contain MMT, visit Owner Link at [owners.honda.com](http://owners.honda.com). In Canada, visit [www.honda.ca](http://www.honda.ca) for additional information on gasoline. For more information on top tier gasoline, visit [www.toptiergas.com](http://www.toptiergas.com).



## Refueling

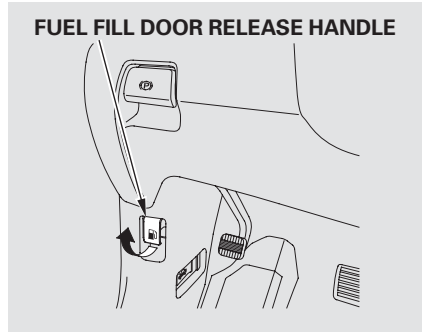

1. Park with the driver's side closest to the service station pump.
2. Open the fuel fill door by pulling on the handle located under the lower left corner of the dashboard.

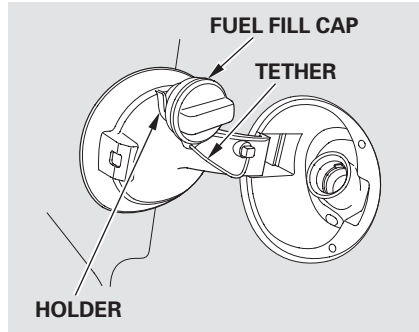

3. Remove the fuel fill cap slowly. You may hear a hissing sound as pressure inside the tank equalizes. Place the cap in the holder on the fuel fill door.
4. Stop filling the tank after the fuel nozzle automatically clicks off. Do not try to "top off" the tank. This leaves some room in the fuel tank for the fuel to expand with temperature changes.

If the fuel nozzle keeps clicking off even though the tank is not full, there may be a problem with your vehicle's fuel vapor recovery system. The system helps keep fuel vapor from going into the atmosphere. Try filling at another pump. If this does not fix the problem, consult your dealer.

### **⚠ WARNING**

Fuel is highly flammable and explosive. You can be burned or seriously injured when handling fuel.

- Stop the engine, and keep heat, sparks, and flame away.
- Handle fuel only outdoors.
- Wipe up spills immediately.

*CONTINUED*

- Screw the fuel fill cap back on until it clicks at least once.

*Except Touring models*

If you do not properly tighten the cap, you will see a “CHECK FUEL CAP” message on the information display (see page 84).

*On Touring models*

If you do not properly tighten the cap, you will see a “TIGHTEN FUEL CAP” message on the multi-information display.

- Push the fuel fill door closed until it latches.

### **Tighten Fuel Cap Message**

*On Touring models*



Your vehicle's on board diagnostic system will detect a loose or missing fuel fill cap as an evaporative system leak. The first time a leak is detected a “TIGHTEN FUEL CAP” message appears on the multi-information display. Turn the engine off, and confirm the fuel fill cap is installed. If it is, loosen it, then retighten it until it clicks at least once. The message should go off after several days of

normal driving once you tighten or replace the fuel fill cap. To scroll to another message, press the INFO button. The “TIGHTEN FUEL CAP” message will appear each time you restart the engine until the system turns the message off.

If the system still detects a leak in the vehicle's evaporative emissions system, the malfunction indicator lamp (MIL) comes on. If the fuel fill cap was not already tightened, turn the engine off, and check or retighten the fuel fill cap until it clicks at least once. The MIL should go off after several days of normal driving once the cap is tightened or replaced. If the MIL does not go off, have your vehicle inspected by a dealer. For more information, see page 626.

## Opening and Closing the Hood



1. Park the vehicle, and set the parking brake. Pull the hood release handle located under the lower left corner of the dashboard. The hood will pop up slightly.

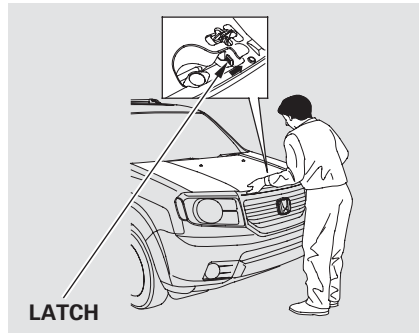

2. Put your fingers under the front edge of the hood near the center. Slide your hand to your left until you feel the hood latch handle. Push this handle up until it releases the hood. Lift up the hood.

If the hood latch handle moves stiffly, or if you can open the hood without lifting the handle, the mechanism should be cleaned and lubricated.

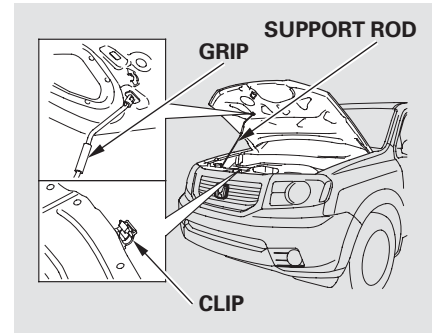

3. Holding the grip, pull the support rod out of its clip. Insert the end into the designated hole in the hood.

To close the hood, lift it up slightly to remove the support rod from the hole. Put the support rod back into its holding clip. Lower the hood to about a foot (30 cm) above the fender, then let it drop. Make sure it is securely latched.

# Service Station Procedures

## Oil Check

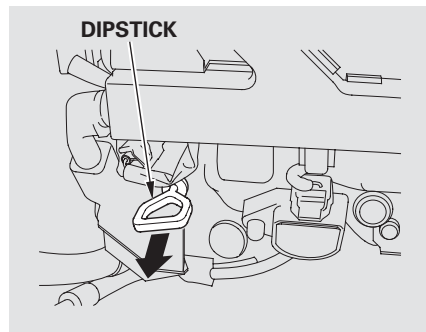

Wait a few minutes after turning the engine off before you check the oil.

1. Remove the dipstick (orange loop).
2. Wipe off the dipstick with a clean cloth or paper towel.
3. Insert the dipstick all the way back into its hole.

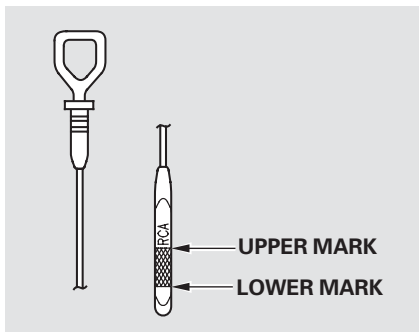

4. Remove the dipstick again, and check the level. It should be between the upper and lower marks.

If it is near or below the lower mark, see **Adding Engine Oil** on page 576.

## Engine Coolant Check

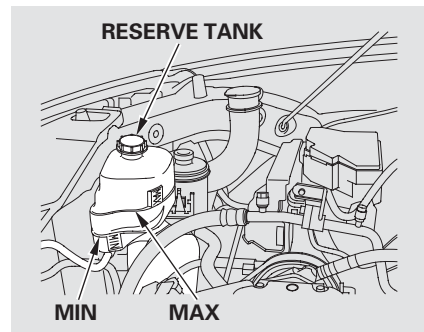

Look at the coolant level in the radiator reserve tank. Make sure it is between the MAX and MIN lines. If it is below the MIN line, see **Adding Engine Coolant** on page 579 for information on adding the proper coolant.

Refer to **Owner's Maintenance Checks** on page 571 for information about checking other items on your vehicle.

## Actual Mileage and EPA Fuel Economy Estimates Comparison.

Fuel economy is not a fixed number. It varies based on driving conditions, driving habits, and vehicle condition. Therefore, it is not possible for one set of estimates to predict fuel economy precisely for all drivers in all environments.

The EPA fuel economy estimates shown in the example to the right are a useful tool for comparison when buying a vehicle. EPA estimates include:

**City MPG** – Represents urban driving in light traffic. A range of miles per gallon achieved is also provided.

**Highway MPG** – Represents a mixture of rural and interstate driving, in a warmed-up vehicle, typical of longer trips in free-flowing traffic. A range of miles per gallon

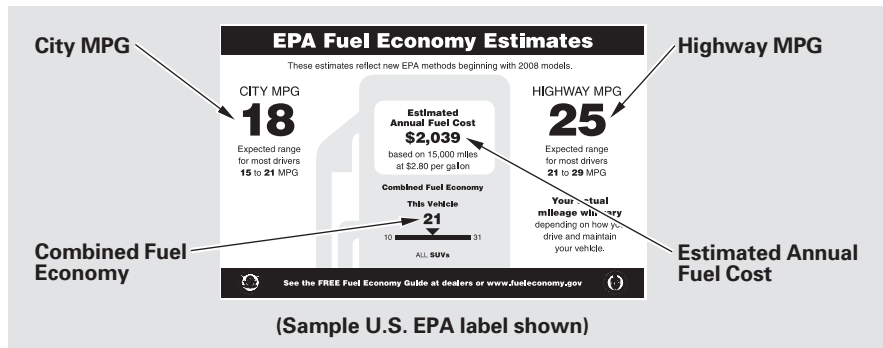

achieved is also provided.

**Combined Fuel Economy** — Represents a combination of city and highway driving. The scale represents the range of combined fuel economy for other vehicles in the class.

**Estimated Annual Fuel Cost** — Provides an estimated annual fuel cost, based on 15,000 miles (20,000 km) per year multiplied by the cost

per gallon (based on EPA fuel cost data) divided by the combined fuel economy.

For more information on fuel economy ratings and factors that affect fuel economy, visit [www.fueleconomy.gov](http://www.fueleconomy.gov) (Canada: Visit [www.vehicles.gc.ca](http://www.vehicles.gc.ca))

# Fuel Economy

---

## Fuel Economy Factors

The following factors can lower your vehicle's fuel economy:

- Aggressive driving (hard acceleration and braking)
- Excessive idling, accelerating and braking in stop-and-go traffic
- Cold engine operation (engines are more efficient when warmed up)
- Driving with a heavy load or the air conditioner running
- Improperly inflated tires

## Improving Fuel Economy

### *Vehicle Maintenance*

A properly maintained vehicle maximizes fuel economy. Poor maintenance can significantly reduce fuel economy. Always maintain your vehicle according to the maintenance messages displayed on the information display (see **Owner's Maintenance Checks** on page 571 ). For example:

- **Use the recommended viscosity motor oil, displaying the API Certification Seal (see page 576).**
- **Maintain proper tire inflation** — An underinflated tire increases “rolling resistance,” which reduces fuel economy.
- **Avoid carrying excess weight in your vehicle** — It puts a heavier load on the engine, increasing fuel consumption.
- **Keep your vehicle clean** — In particular, a build-up of snow or mud on your vehicle's underside adds weight and rolling resistance. Frequent cleaning helps your fuel economy.

### *Drive Efficiently*

- **Drive moderately** — Rapid acceleration, abrupt cornering, and hard braking increase fuel consumption.

- **Observe the speed limit** — Aerodynamic drag has a big effect on fuel economy at speeds above 45 mph (75 km/h). Reduce your speed and you reduce the drag. Trailers, car top carriers, roof racks and bike racks are also big contributors to increased drag.
- **Avoid excessive idling** — Idling results in 0 miles per gallon (0 kms per liter).

- **Minimize the use of the air conditioning system** – The A/C puts an extra load on the engine which makes it use more fuel. Use the fresh-air ventilation when possible.
- **Plan and combine trips** – Combine several short trips into one. A warmed-up engine is more fuel efficient than a cold one.

## Calculating Fuel Economy

### *Measuring Techniques*

Direct calculation is the recommended source of information about your actual fuel economy. Using frequency of fill-ups or taking fuel gauge readings are NOT accurate measures of fuel economy. Fuel economy may improve over the first several thousand miles (kilometers).

### *Checking Your Fuel Economy*

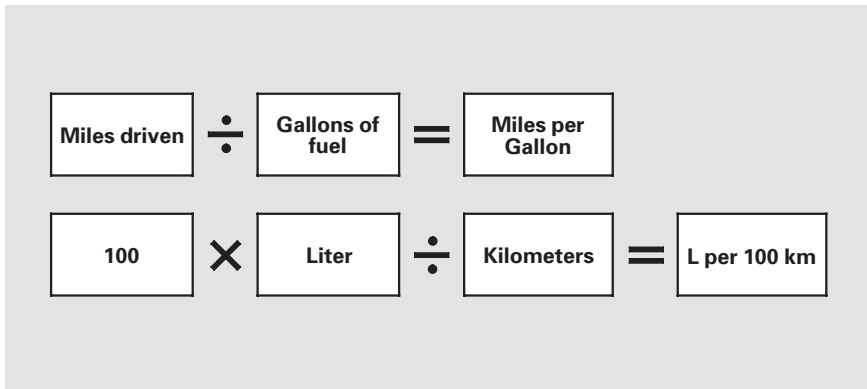

- 1) Fill the fuel tank until the nozzle automatically clicks off.
- 2) Reset trip counter to zero.
- 3) Record the total gallons (liters) needed to refill.
- 4) Follow one of the simple calculations above.

## Accessories and Modifications

---

Modifying your vehicle, or installing non-Honda accessories, may make it unsafe. Before you make any modifications or add any accessories, be sure to read the following information.

### Accessories

Your dealer has Honda accessories that allow you to personalize your vehicle. These accessories have been designed and approved for your vehicle, and are covered by warranty.

Although non-Honda accessories may fit on your vehicle, they may not meet factory specifications, and could adversely affect your vehicle's handling, stability, and reliability.

### **WARNING**

Improper accessories or modifications can affect your vehicle's handling, stability, and performance, and cause a crash in which you can be hurt or killed.

Follow all instructions in this owner's manual regarding accessories and modifications.

When properly installed, cellular phones, alarms, two-way radios, and low-powered audio systems should not interfere with your vehicle's computer controlled systems, such as your airbags, anti-lock brakes, and tire pressure monitoring system.

Before installing any accessory:

- Make sure the accessory does not obscure any lights, or interfere with proper vehicle operation or performance.
- Be sure electronic accessories do not overload electrical circuits (see page 629 ) or interfere with proper operation of your vehicle.
- Do not install accessories on the side pillars or across the rear windows. Accessories installed in these areas may interfere with proper operation of the side curtain airbags.
- Before installing any electronic accessory, have the installer contact your dealer for assistance. **If possible, have your dealer inspect the final installation.**



### Modifying Your Vehicle

Removing parts from your vehicle, or replacing components with non-Honda components could seriously affect your vehicle's handling, stability, and reliability.

Some examples are:

- Lowering your vehicle with a non-Honda suspension kit that significantly reduces ground clearance can allow the undercarriage to hit speed bumps or other raised objects, which could cause the airbags to deploy.
- Raising your vehicle with a non-Honda suspension kit can affect the handling, stability, and reliability.

- Non-Honda wheels, because they are a universal design, can cause excessive stress on suspension components and will not be compatible with the tire pressure monitoring system (TPMS).
- Larger or smaller wheels and tires can interfere with the operation of your vehicle's anti-lock brakes and other systems.

Modifying your steering wheel or any other part of your vehicle's safety features can make the systems ineffective.

If you plan to modify your vehicle, consult your dealer.

## Carrying Cargo

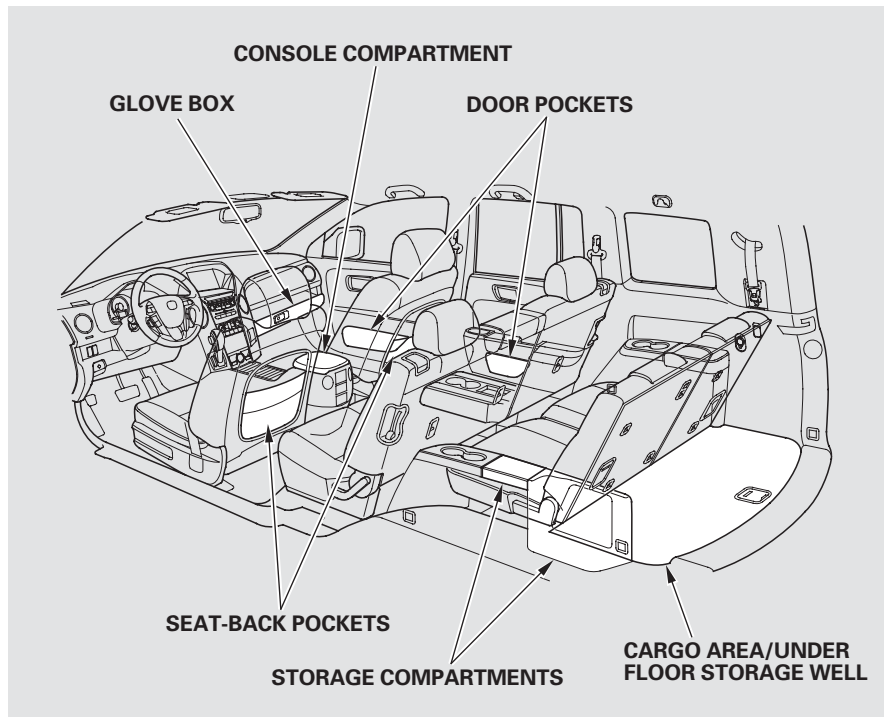

Your vehicle has several convenient storage areas:

- Glove box
- Door and seat-back pockets
- Rear cargo area, including the second and third row seats when folded flat
- Console compartment
- Storage compartment
- Roof-rack (if equipped)

However, carrying too much cargo, or improperly storing it, can affect your vehicle's handling, stability, stopping distance, and tires, and make it unsafe. Before carrying any type of cargo, be sure to read the following pages.

## Load Limits

The maximum load for your vehicle is 1,340 lbs (608 kg).

See Tire And Loading Information label attached to the driver's doorjamb.

### Label Example

| TIRE AND LOADING INFORMATION  |               |                    |   |
|---|---------------|--------------------|---|
| SEATING CAPACITY  |               | TOTAL 5            | FRONT 2 REAR 3                                |
| The combined weight of occupants and cargo should never exceed 385kg or 850lbs. |               |                    |   |
| TIRE  | SIZE          | COLD TIRE PRESSURE | SEE OWNER'S MANUAL FOR ADDITIONAL INFORMATION |
| FRONT   | XXXX/XXXX XXX | XXXKPA, XXPSI      |   |
| REAR  | XXXX/XXXX XXX | XXXKPA, XXPSI      |   |
| SPARE   | XXXX/XXXX XXX | XXXKPA, XXPSI      |   |

This figure includes the total weight of all occupants, cargo, and accessories, and the tongue load if you are towing a trailer.

## ⚠ WARNING

Overloading or improper loading can affect handling and stability and cause a crash in which you can be hurt or killed.









Follow all load limits and other loading guidelines in this manual.

### Steps for Determining Correct Load Limit –

- (1) Locate the statement “The combined weight of occupants and cargo should never exceed XXX kg or XXX lbs.” on your vehicle’s placard.
- (2) Determine the combined weight of the driver and passengers that will be riding in your vehicle.
- (3) Subtract the combined weight of the driver and passengers from XXX kg or XXX lbs.
- (4) The resulting figure equals the available amount of cargo and luggage load capacity. For example, if the “XXX” amount equals 1,400 lbs. and there will be five 150 lb. passengers in your vehicle, the amount of available cargo and luggage load capacity is 650 lbs.  
(1,400 – 750 (5 × 150) = 650 lbs.)
- (5) Determine the combined weight of luggage and cargo being loaded on the vehicle. That weight may not safely exceed the available cargo and luggage load capacity calculated in Step 4.
- (6) If your vehicle will be towing a trailer, load from your trailer will be transferred to your vehicle. Consult this manual to determine how this reduces the available cargo and luggage load capacity of your vehicle.

CONTINUED

## Carrying Cargo

|           |   |
|-----------|---|
| Example 1 | <br><b>Max Load (1,340 lbs)</b><br>(608 kg)<br><br>$\equiv$<br><br><b>Passenger Weight</b><br>(150 lbs x 2 = 300 lbs)<br>(68 kg x 2 = 136 kg)<br><br>+<br><br><b>Cargo Weight</b><br>(1,040 lbs)<br>(472 kg) |
| Example 2 | <br><b>Max Load (1,340 lbs)</b><br>(608 kg)<br><br>$\equiv$<br><br><b>Passenger Weight</b><br>(150 lbs x 4 = 600 lbs)<br>(68 kg x 4 = 272 kg)<br><br>+<br><br><b>Cargo Weight</b><br>(740 lbs)<br>(336 kg)   |
| Example 3 | <br><b>Max Load (1,340 lbs)</b><br>(608 kg)<br><br>$\equiv$<br><br><b>Passenger Weight</b><br>(150 lbs x 5 = 750 lbs)<br>(68 kg x 5 = 340 kg)<br><br>+<br><br><b>Cargo Weight</b><br>(590 lbs)<br>(268 kg)   |

In addition, the total weight of the vehicle, all occupants, accessories, cargo, and trailer tongue load must not exceed the Gross Vehicle Weight Rating (GVWR) or the Gross Axle Weight Rating (GAWR). Both are on a label on the driver's doorjamb.

### Carrying Cargo in the Passenger Compartment

- Store or secure all items that could be thrown around and hurt someone during a crash.
- Be sure items placed on the floor behind the front seats cannot roll underneath and interfere with the proper operation of the seats, the sensors under the seats, or the driver's ability to operate the pedals.

Keep all cargo below the bottom of the windows. If it is higher, it could interfere with the proper operation of the side curtain airbags.

- Keep the glove box closed while driving. If it is open, a passenger could injure their knees during a crash or sudden stop.

### Carrying Cargo in the Cargo Area or on a Roof Rack

- Distribute cargo evenly on the floor of the cargo area, placing the heaviest items on the bottom and as far forward as possible. Tie down items that could be thrown about the vehicle during a crash or sudden stop.
- If you fold down the second or third row seats, tie down items that could be thrown about the vehicle during a crash or sudden stop.

- If you carry large items that prevent you from closing the tailgate or the glass hatch, exhaust gas can enter the passenger area. To avoid the possibility of **carbon monoxide poisoning**, follow the instructions on page 60.
- If you carry any items on a roof rack, be sure the total weight of the rack and the items does not exceed 165 lbs (75 kg).

If you use an accessory roof rack, the roof rack weight limit may be lower. Refer to the information that came with your roof rack.

## Carrying Cargo

### Optional Separation Net

The separation net can be used to hold back soft, lightweight items stored in the cargo area. Heavy items should be tied down, as the net may not prevent them from being thrown about the vehicle in a crash or a sudden stop.

### Optional Cargo Cover

The cargo cover can be used to cover the cargo area behind the third row seats. When the third row seats are folded down, the cargo cover can be extended over the larger area. Do not install the cover over the larger area if the third row seats are not folded down.

### Cargo Hooks

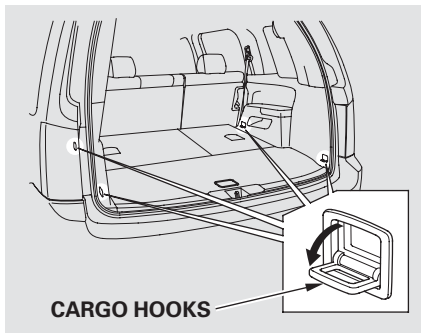

The four hooks on the side panels can be used to install a net for securing items. Each hook is designed to hold up to 56.2 lbs (25.5 kg) of weight.

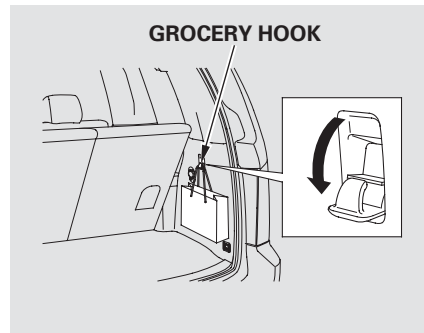

Your vehicle also has grocery hook(s) on the side panels and on the back of the third row seats in the cargo area.

They are designed to hold light items. Heavy objects may damage the hook.

This section gives you tips on starting the engine under various conditions, and how to operate the automatic transmission. It also includes important information on parking your vehicle, the braking system, the Variable Torque Management<sup>®</sup> 4-wheel drive (VTM-4<sup>®</sup>) system, the vehicle stability assist (VSA<sup>®</sup>), aka Electronic Stability Control (ESC), system, the tire pressure monitoring system (TPMS), and facts you need if you are planning to tow a trailer or drive off-highway.

|   |     |
|---|-----|
| Driving Guidelines.....                       | 512 |
| Preparing to Drive .....                      | 512 |
| Starting the Engine.....                      | 513 |
| Check Starter System                          |     |
| Message.....                                  | 514 |
| Automatic Transmission.....                   | 515 |
| VTM-4 <sup>®</sup> System .....               | 520 |
| Parking.....                                  | 521 |
| Tire Pressure Monitoring System               |     |
| (TPMS) .....                                  | 522 |
| Braking System.....                           | 530 |
| Anti-lock Brakes (ABS) .....                  | 531 |
| Vehicle Stability Assist (VSA <sup>®</sup> ), |     |
| aka Electronic Stability                      |     |
| Control (ESC), System .....                   | 533 |
| Towing a Trailer .....                        | 536 |
| Off-Highway Driving                           |     |
| Guidelines.....                               | 552 |

# Driving Guidelines, Preparing to Drive

---

## Driving Guidelines

Your vehicle has higher ground clearance that allows you to travel over bumps, obstacles, and rough terrain. It also provides good visibility so you can anticipate problems earlier.

Because your vehicle rides higher off the ground, it has a high center of gravity that can cause it to roll over if you make abrupt turns. Utility vehicles have a significantly higher roll over rate than other types of vehicles.

To prevent rollovers or loss of control:

- Take corners at slower speeds than you would with a passenger vehicle.
- Avoid sharp turns and abrupt maneuvers whenever possible.

- Do not modify your vehicle in any way that would raise the center of gravity.
- Do not carry heavy cargo on the roof.

### *4WD models only*

Your vehicle is equipped with a four-wheel drive (4WD) system. When the system senses a loss of front-wheel traction, it automatically transfers some power to the rear wheels. This gives you better traction and mobility.

You still need to exercise the same care when accelerating, steering, and braking that you would in a two-wheel drive vehicle.

*See page 552 for off-highway driving guidelines.*

## Preparing to Drive

You should do the following checks and adjustments before you drive your vehicle.

1. Make sure all windows, mirrors, and outside lights are clean and unobstructed. Remove frost, snow, or ice.
2. Check that the hood is fully closed.
3. Visually check the tires. If a tire looks low, use a gauge to check its pressure.
4. Check that any items you may be carrying are stored properly or fastened down securely.
5. Check the seat adjustment (see page 154 ).



6. Check the adjustment of the inside and outside mirrors (see page 172 ).
7. Check the steering wheel adjustment (see page 132 ).
8. Make sure the doors, the tailgate, and the glass hatch are securely closed and locked.
9. Fasten your seat belt. Check that your passengers have fastened their seat belts (see page 17 ).
10. When you start the engine, check the gauges and indicators in the instrument panel, and the messages on the information display or multi-information display (depending on the model) (see pages 65 , 66 , 80 , and 93 ).

### Starting the Engine

Your vehicle's starter system has an auto control mode. When you turn the ignition switch to the START (III) position, this feature keeps the engine's starter motor running until the engine starts. Follow these instructions to start the engine:

1. Apply the parking brake.
2. In cold weather, turn off all electrical accessories to reduce the drain on the battery.
3. Make sure the shift lever is in Park. Press on the brake pedal.
4. Without touching the accelerator pedal, turn the ignition switch to the START (III) position, then release the ignition switch. You do not need to hold the ignition switch in the START (III) position to start the engine. Depending on the outside temperature, the

starter motor runs for about 6 to 9 seconds until the engine starts.

If you hold the ignition switch in the START (III) position for more than 7 seconds, the starter motor, depending on the outside temperature, runs for about 10 to 25 seconds until the engine starts.

If the engine does not start, wait at least 10 seconds before trying again.

### NOTICE

*The immobilizer system protects your vehicle from theft. If an improperly coded key (or other device) is used, the engine's fuel system is disabled. For more information, see page 134 .*

CONTINUED

# Starting the Engine

## NOTICE

*The engine is harder to start in cold weather. Also, the thinner air found at altitudes above 8,000 feet (2,400 meters) adds to this problem.*

### Check Starter System Message On Touring models

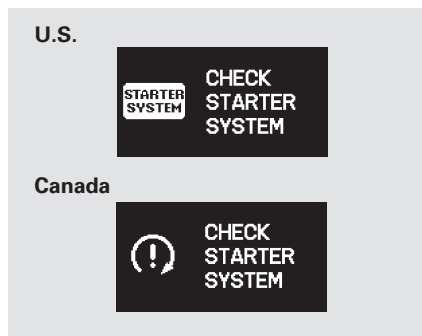

If there is a problem with the starter system, you will see a “CHECK STARTER SYSTEM” message on the multi-information display when the ignition switch is turned to the ON (II) position. You will also see this message when the auto control mode of the starter system has a problem.

If this message is on, the ignition switch has to be held in the START (III) position manually until the engine starts. The ignition switch can be held in that position up to 15 seconds.

Even though you may be able to start the engine manually without the auto control mode of the starter system, have your dealer inspect your vehicle.

## Shift Lever Position Indicators

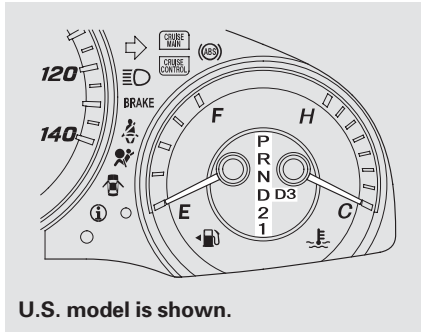

These indicators on the instrument panel show which position the shift lever is in.

The “D” indicator comes on for a few seconds when you turn the ignition switch to the ON (II) position. If it flashes while driving (in any shift position), it indicates a possible problem in the transmission.

If the malfunction indicator lamp comes on along with the “D” indicator, there is a problem with the automatic transmission control system. Avoid rapid acceleration, and have the transmission checked by your dealer as soon as possible.

### *On Touring models*

When the “D” indicator warns of a possible problem with the transmission, you will see a “CHECK TRANSMISSION” message on the multi-information display (see page 94 ).

## Shifting

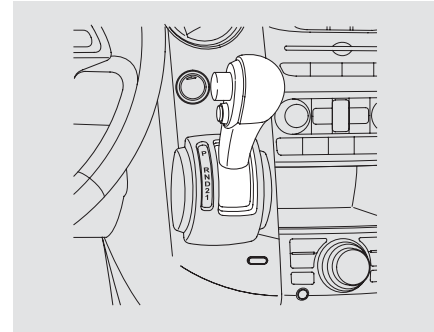

To shift from any position, press firmly on the brake pedal and the release button on the side of the shift lever. You cannot shift out of Park when the ignition switch is in the LOCK (0) or ACCESSORY (I) position.

CONTINUED

## Automatic Transmission

---

| To shift from:                                 | Do this:  |
|--|---|
| P to R   | Press the brake pedal and the shift lever release button. |
| R to P<br>N to R<br>D to 2<br>2 to 1           | Press the shift lever release button.                     |
| 1 to 2<br>2 to D<br>D to N<br>N to D<br>R to N | Move the shift lever.                                     |
| D <sub>3</sub> to D<br>D to D <sub>3</sub>     | Press the D <sub>3</sub> button.                          |

**Park (P)** – This position mechanically locks the transmission. Use Park whenever you are turning off or starting the engine. To shift out of Park, you must press on the brake pedal and the release button on the shift lever. Make sure your foot is off the accelerator pedal.

If you have done all of the above and still cannot move the lever out of Park, see **Shift Lock Release** on page 518.

To avoid transmission damage, come to a complete stop before shifting into Park. The shift lever must be in Park before you can remove the key from the ignition switch.

**Reverse (R)** – Press the brake pedal and the release button on the front of the shift lever to shift from Park to reverse. To shift from reverse to neutral, come to a complete stop, and then shift. Press the release button before shifting into reverse from neutral.

**Neutral (N)** – Use neutral if you need to restart a stalled engine, or if it is necessary to stop briefly with the engine idling. Shift to the Park position if you need to leave your vehicle for any reason. Press on the brake pedal when you are moving the shift lever from neutral to another gear.

**Drive (D)** — Use this position for your normal driving. The transmission automatically selects a suitable gear (1 through 5) for your speed and acceleration. You may notice the transmission shifting up at higher engine speeds when the engine is cold. This helps the engine warm up faster.

**Drive (D3)** — To use D3, press the D3 button when the shift lever is in the “D” position. This position is similar to D, except only the first three gears are selected instead of all five. Use D3 when towing a trailer in hilly terrain, or to provide engine braking when going down a steep hill. D3 can also keep the transmission from cycling between third and fourth gears in stop-and-go driving.

**Second (2)** — This position locks the transmission in second gear. It does not downshift to first gear when you come to a stop.

Use second gear:

- For more power when climbing.
- To increase engine braking when going down steep hills.
- For starting out on a slippery surface or in deep snow.
- When driving downhill with a trailer.

*CONTINUED*

# Automatic Transmission

---

**First (1)** – To shift from second to first, press the release button on the side of the shift lever. This position locks the transmission in first gear. By upshifting and downshifting through 1, 2, D3, and D, you can operate the transmission much like a manual transmission without a clutch pedal.

## Engine Speed Limiter

If you exceed the maximum speed for the gear you are in, the engine speed will enter into the tachometer's red zone. If this occurs, you may feel the engine cut in and out. This is caused by a limiter in the engine's computer controls. The engine will run normally when you reduce the rpm below the red zone.

Before downshifting, make sure the engine will not go into the tachometer's red zone.

## Shift Lock Release

This allows you to move the shift lever out of Park if the normal method of pushing on the brake pedal and pressing the release button does not work.

1. Set the parking brake.
2. Remove the key from the ignition switch.

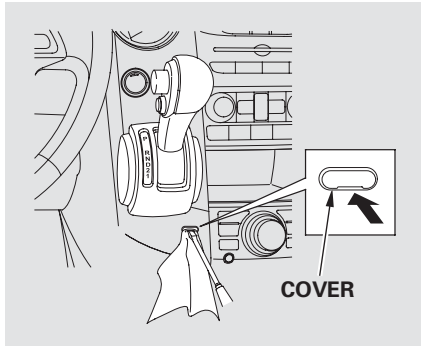

- Put a cloth on the edge of the shift lock release slot cover to prevent scratches. Use a small flat-tip screwdriver or metal fingernail file to carefully pry up the edge of the cover and remove it from the slot.

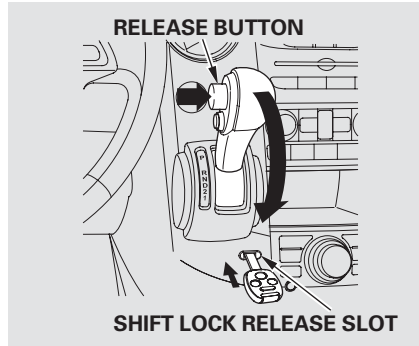

- Insert the key in the shift lock release slot.
- Push down on the key while you press the release button on the shift lever and move the shift lever out of Park to neutral.

- Remove the key from the shift lock release slot, then install the cover. Make sure the notch on the cover is on the underside. Insert the key back into the ignition switch, press the brake pedal, and restart the engine.

If you need to use the shift lock release, it means your vehicle is developing a problem. Have the vehicle checked by a dealer.

## VTM-4® System

### *4WD models only*

The variable torque management 4WD (VTM-4) system automatically transfers varying amounts of engine torque to the rear wheels under lower traction conditions.

If more traction is needed when your vehicle is stuck, or is likely to become stuck, you can use the VTM-4 LOCK button to increase torque to the rear wheels.

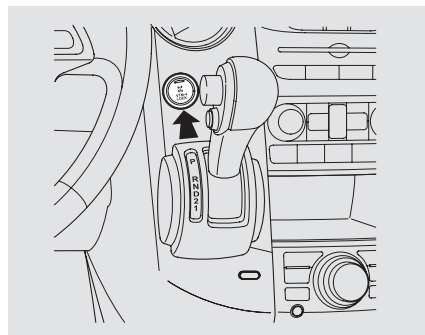

### **To Engage the VTM-4 Lock**

1. The vehicle must be stopped with the engine running.
2. Move the shift lever to first (1), second (2), or reverse (R) gear.
3. Press the VTM-4 LOCK button.  
The indicator in the button comes on.

To get unstuck, apply light pressure to the accelerator pedal. Do not spin the front tires for more than a few seconds. Because of the amount of torque applied to the rear tires, they should not spin. This is normal. If you are not able to move the vehicle, stop and reverse direction.

### **NOTICE**

*Do not use the VTM-4 LOCK button on dry, paved roads. Driving on dry, paved roads with VTM-4 Lock ON may damage the rear differential when making a turn. Strange noise and vibration can also result.*

### **To Disengage the VTM-4 Lock, do any of the following:**

- Press the VTM-4 LOCK button.
- Move the shift lever to D or D3.
- Turn the ignition switch to the LOCK (0) position.

The VTM-4 Lock will temporarily disengage when the vehicle speed exceeds 18 mph (30 km/h). The indicator in the button will remain on.

### **NOTICE**

*Do not continuously spin the front tires of your vehicle. Continuously spinning the front tires can cause transmission or rear differential damage.*



Always use the parking brake when you park your vehicle. Make sure the parking brake is set firmly, or your vehicle may roll if it is parked on an incline.

Set the parking brake before you put the transmission in Park. This keeps the vehicle from moving and putting pressure on the parking mechanism in the transmission.

## **Parking Tips**

- Make sure the moonroof (if equipped) and the windows are closed.
- Turn off the lights.
- Place any packages, valuables, etc. in the cargo area or take them with you.
- Lock the doors and the tailgate. Make sure the glass hatch is closed securely.

- Never park over dry leaves, tall grass, or other flammable materials. The hot three way catalytic converter could cause these materials to catch on fire.
- If the vehicle is facing uphill, turn the front wheels away from the curb.
- If the vehicle is facing downhill, turn the front wheels toward the curb.
- Make sure the parking brake is fully released before driving away. Driving with the parking brake partially set can overheat or damage the rear brakes.

### *Except LX models*

- Check the indicator on the instrument panel to verify that the security system is set.

## Tire Pressure Monitoring System (TPMS)

---

### *Except Touring models*

Your vehicle is equipped with a tire pressure monitoring system (TPMS) that turns on every time you start the engine and monitors the pressure in your tires while driving.

Each tire has its own pressure sensor (not including the spare tire). If the air pressure of a tire becomes significantly low while driving, the sensor in that tire immediately sends a signal that causes the low tire pressure indicator to come on.



### **Low Tire Pressure Indicator**

When the low tire pressure indicator is on, one or more of your tires is significantly underinflated. You should stop and check your tires as soon as possible, and inflate them to the proper pressure as indicated on the vehicle's tire information placard.

If you think you can safely drive a short distance to a service station, proceed slowly to the station, then inflate the tire to the recommended pressure.

If the tire is flat, or if the tire pressure is too low to continue driving, replace the tire with the compact spare tire (see page 612).

If you cannot make the low tire pressure indicator go out after inflating the tires to the specified values, have your dealer check the system as soon as possible.

Driving on a significantly underinflated tire causes the tire to overheat and can lead to tire failure. Underinflation also reduces fuel efficiency and tire tread life, and may affect the vehicle's handling and stopping ability.

Because tire pressure varies by temperature and other conditions, the low tire pressure indicator may come on unexpectedly.

For example, if you check and fill your tires in a warm area, then drive in extremely cold weather, the tire pressure will be lower than measured and could be underinflated and cause the low tire pressure indicator to come on. Or, if you check and adjust your tire pressure in cooler conditions, and drive into extremely hot conditions, the tire may become overinflated. However, the low tire pressure indicator will not come on if the tires are overinflated.

Refer to page 599 for tire inflation guidelines.

Although your tire pressure is monitored, you must manually check the tire pressures monthly.

Each tire, including the spare, should be checked monthly when cold, and set to the recommended inflation pressure as specified on the tire information label and in the owner's manual (see page 600 ).



## Tire Pressure Monitor

The appropriate tire indicator and low tire pressure indicator comes on if a tire becomes significantly underinflated. See **Low Tire Pressure Indicator** on page 72 .

## TPMS

### Tire Pressure Monitoring System (TPMS) Indicator

This indicator comes on and stays on if there is a problem with the tire pressure monitoring system.

If this happens, the system will shut off and no longer monitor tire pressures. Have the system checked by your dealer as soon as possible.

If the low tire pressure indicator or TPMS indicator comes on, the VSA system automatically turns on even if the VSA system is turned off by pressing the VSA OFF switch (see page 534 ). If this happens, you cannot turn the VSA system off by pressing the VSA OFF switch again.

When you restart the vehicle with the compact spare tire, the TPMS indicator may also come on and stay on after driving several miles (kilometers).

# Tire Pressure Monitoring System (TPMS)

---

## Changing a Tire with TPMS

If you have a flat tire, the low tire pressure indicator will come on. Replace the flat tire with the compact spare tire (see page 612).

Each wheel (except the compact spare tire wheel) is equipped with a tire pressure sensor. You must use TPMS specific wheels. It is recommended that you always have your tires serviced by your dealer or qualified technician.

After you replace the flat tire with the compact spare tire, the low tire pressure indicator stays on. This is normal; the system is not monitoring the spare tire pressure. Manually check the spare tire pressure to be sure it is correct. After several miles (kilometers) driving with the compact spare tire, the TPMS indicator comes on and the low tire pressure indicator goes off.

The low tire pressure indicator or the TPMS indicator will go off, after several miles (kilometers) driving, when you replace the spare tire with the specified regular tire equipped with the tire pressure monitor sensor.

Never use a puncture-repairing agent in a flat tire. If used, you will have to replace the tire pressure sensor. Have the flat tire repaired by your dealer as soon as possible.

*As required by the FCC:*

*This device complies with Part 15 of the FCC rules. Operation is subject to the following two conditions: (1) This device may not cause harmful interference, and (2) this device must accept any interference received, including interference that may cause undesired operation.*

*Changes or modifications not expressly approved by the party responsible for compliance could void the user's authority to operate the equipment.*

*This device complies with Industry Canada Standard RSS-210.*

*Operation is subject to the following two conditions: (1) this device may not cause interference, and (2) this device must accept any interference that may cause undesired operation of the device.*

### *On Touring models*

Your vehicle is equipped with a tire pressure monitoring system (TPMS) that turns on every time you start the engine and monitors the pressure in your tires while driving.

Each tire has its own pressure sensor. If the air pressure of a tire becomes significantly low, the sensor in that tire immediately sends a signal that causes the low tire pressure/TPMS indicator in the instrument panel to come on. If this happens, you will see which tire is losing pressure on the multi-information display along with a "CHECK TIRE PRESSURE" message.



### **Low Tire Pressure/ TPMS Indicator**

When the low tire pressure/TPMS indicator is on, one or more of your tires is significantly underinflated. You should stop and check your tires as soon as possible, and inflate them to the proper pressure as indicated on the vehicle's tire information placard.

It is possible that the pressures shown on the multi-information display and the pressures you manually measure are slightly different.

If the difference is significant or you cannot make the low tire pressure/TPMS indicator and message on the multi-information display go out after inflating the tires to the specified values, have your dealer check the system as soon as possible.

If you think you can safely drive a short distance to a service station, proceed slowly to the station, then inflate the tire to the recommended pressure.

If the tire is flat, or if the tire pressure is too low to continue driving, replace the tire with the compact spare tire (see page 613 ).

Driving on a significantly underinflated tire causes the tire to overheat and can lead to tire failure. Under-inflation also reduces fuel efficiency and tire tread life, and may affect the vehicle's handling and stopping ability.

Because tire pressure varies by temperature and other conditions, the low tire pressure/TPMS indicator may come on unexpectedly.

*CONTINUED*

## Tire Pressure Monitoring System (TPMS)

---

For example, if you check and fill your tires in a warm area, then drive in extremely cold weather, the tire pressure will be lower than measured and could be underinflated and cause the low tire pressure/TPMS indicator to come on. Or, if you check and adjust your tire pressure in cooler conditions, and drive into extremely hot conditions, the tire may become overinflated. However, the low tire pressure/TPMS indicator will not come on if the tires are overinflated.

Refer to page 599 for tire inflation guidelines.

If there is a problem with the TPMS, this indicator begins to flash. It stops flashing after approximately 1 minute, then stays on. You will also see a “CHECK TPMS SYSTEM” message on the multi-information display (see page 94 ).

Although your tire pressure is monitored, you must manually check the tire pressures monthly.

Each tire, including the spare, should be checked monthly when the vehicle is cold, and set to the recommended inflation pressure as specified on the vehicle placard and in the owner’s manual (see page 600 ).

### Tire Pressure Monitor



To select the tire pressure monitor, press the INFO button several times with the ignition switch in the ON (II) position.

You will see the above display on the multi-information display when all tire pressures are normal.

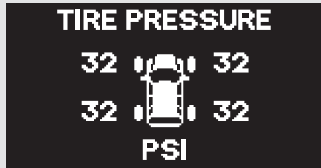

U.S. models

To see the inflation pressures of all four tires, press the SEL/RESET button. The display changes as shown above.

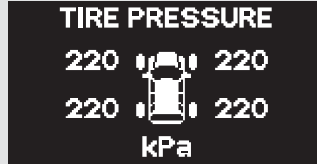

Canadian models

Each tire pressure is shown in PSI (U.S. models) or in kPa (Canadian models).



Each tire has its own pressure sensor. If the air pressure of a tire becomes significantly low, the sensor in that tire immediately sends a signal that causes the low tire pressure/TPMS indicator in the instrument panel to come on. If this happens, you will see which tire is losing pressure on the multi-information display along with a "CHECK TIRE PRESSURE" message.

*CONTINUED*

## Tire Pressure Monitoring System (TPMS)

---



If any of the tires has low pressure, the tire pressure monitor also shows the above message to warn you about the low tire pressure when you select the display by pressing the INFO button several times. Following this display, press the SEL/RESET button to see each tire pressure. When you continue driving after installing the spare tire, you will also see this message on the multi-information display.

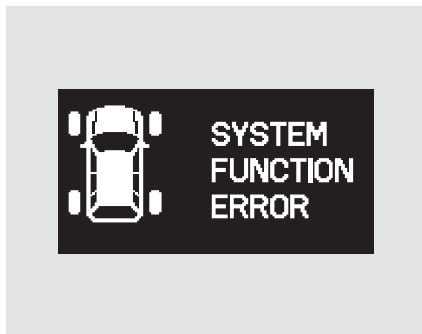

If there is a problem with the TPMS, the tire pressure monitor shows a "SYSTEM FUNCTION ERROR" message and the tire pressure readings are not displayed. If this happens, you will first see a system warning message "CHECK TPMS SYSTEM" on the multi-information display.

### TPMS System Failure

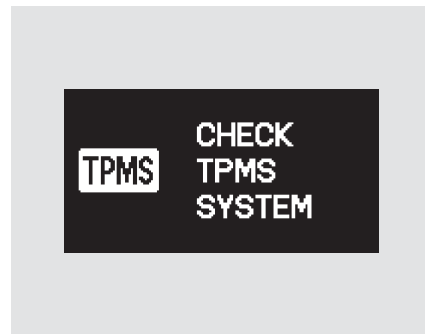

If there is a problem with the TPMS, you will see the above message on the multi-information display.

If you see this message, the system is off and is not monitoring the tire pressures. Have the system checked by your dealer as soon as possible.

Also, the low tire pressure/TPMS indicator begins to flash, then stays on (see page 525).



If the low tire pressure/TPMS indicator comes on, or the multi-information display shows a “CHECK TPMS SYSTEM” message, the VSA system automatically turns on even when the VSA system is turned off by pressing the VSA OFF switch (see page 534 ). If this happens, you cannot turn the VSA system off by pressing the VSA OFF switch again.

When you restart the vehicle with the compact spare tire, the TPMS system message will also be displayed on the multi-information display after several miles (kilometers) driving.

### **Changing a Tire with TPMS**

If you have a flat tire, the low tire pressure/TPMS and tire monitor indicators will come on. Replace the indicated flat tire with the compact spare tire (see page 612 ).

After the flat tire is replaced with the spare tire, the low tire pressure/TPMS indicator stays on while driving. After several miles (kilometers) driving, this indicator begins to flash, then stays on again. You will also see a “CHECK TPMS SYSTEM” message on the multi-information display. This is normal; the system cannot monitor the spare tire pressure. Manually check the spare tire pressure to be sure it is correct.

This indicator and the warning message on the multi-information display will go off, after several miles (kilometers) driving, when the spare tire is replaced with the specified regular tire equipped with the tire pressure monitor sensor. Each wheel is equipped with a tire pressure sensor. You must use TPMS specific wheels. It is recommended that you always have your tires serviced by your dealer or

a qualified technician.

Never use a puncture-repairing agent in a flat tire. If used, you will have to replace the tire pressure sensor. Have the flat tire repaired by your dealer as soon as possible.

*CONTINUED*

## Tire Pressure Monitoring System (TPMS), Braking System

---

*As required by the FCC:*

*This device complies with Part 15 of the FCC rules. Operation is subject to the following two conditions: (1) This device may not cause harmful interference, and (2) this device must accept any interference received, including interference that may cause undesired operation.*

*Changes or modifications not expressly approved by the party responsible for compliance could void the user's authority to operate the equipment.*

*This device complies with Industry Canada Standard RSS-210.*

*Operation is subject to the following two conditions: (1) this device may not cause interference, and (2) this device must accept any interference that may cause undesired operation of the device.*

### **Braking System**

Your vehicle is equipped with disc brakes at all four wheels. A power assist helps reduce the effort needed on the brake pedal. The emergency brake assist system increases the stopping force when you depress the brake pedal hard in an emergency situation. The anti-lock brake system (ABS) helps you retain steering control when braking very hard.

Resting your foot on the pedal keeps the brakes applied lightly, builds up heat, reduces their effectiveness and reduces brake pad life. In addition, fuel economy can be reduced. It also keeps your brake lights on all the time, confusing drivers behind you.

Constant application of the brakes when going down a long hill builds up heat and reduces their effectiveness. Use the engine to assist the brakes by taking your foot off the accelerator and downshifting to a lower gear.

Check the brakes after driving through deep water. Apply the brakes moderately to see if they feel normal. If not, apply them gently and frequently until they do. Be extra cautious in your driving.

### Braking System Design

The hydraulic system that operates the brakes has two separate circuits. Each circuit works diagonally across the vehicle (the left-front brake is connected with the right-rear brake, etc.). If one circuit should develop a problem, you will still have braking at two wheels.

### Brake Wear Indicators

All four brakes have audible brake wear indicators.

If the brake pads need replacing, you will hear a distinctive, metallic screeching sound when you apply the brake pedal. If you do not have the brake pads replaced, they will screech all the time. It is normal for the brakes to occasionally squeal or squeak when you apply them.

### Anti-lock Brakes (ABS)

The anti-lock brake system (ABS) helps prevent the wheels from locking up, and helps you retain steering control by pumping the brakes rapidly, much faster than a person can do it.

The electronic brake distribution (EBD) system, which is part of the ABS, also balances the front-to-rear braking distribution according to vehicle loading.

*You should never pump the brake pedal.* Let the ABS work for you by always keeping firm, steady pressure on the brake pedal. This is sometimes referred to as “stomp and steer.”

You will feel a pulsation in the brake pedal when the ABS activates, and may hear some noise. This is normal: it is the ABS rapidly pumping the brakes. On dry pavement, you will need to press on the brake pedal very hard before the ABS activates. However, you may feel the ABS activate immediately if you are trying to stop on snow or ice.

## Anti-lock Brakes (ABS)

---



### ABS Indicator

If this indicator comes on, the anti-lock function of the braking system has shut down. The brakes still work like a conventional system, but without anti-lock. You should have your dealer inspect your vehicle as soon as possible.

#### *On Touring models*

You will also see a “CHECK ABS SYSTEM” message on the multi-information display (see page 93 ).

If the indicator comes on while driving, test the brakes as instructed on page 627 .

If the ABS indicator and the brake system indicator come on together, and the parking brake is fully released, the EBD system may also be shut down.

#### *On Touring models*

If this happens, you will also see the “CHECK ABS SYSTEM” and “CHECK BRAKE SYSTEM” messages on the multi-information display.

Test your brakes as instructed on page 627 . If the brakes feel normal, drive slowly and have your vehicle repaired by your dealer as soon as possible. Avoid sudden hard braking which could cause the rear wheels to lock up and possibly lead to a loss of control.

**Important Safety Reminders**  
**ABS does not reduce the time or distance it takes to stop the vehicle.** It only helps with steering control during braking.

**ABS will not prevent a skid that results from changing direction abruptly,** such as trying to take a corner too fast or making a sudden lane change. Always drive at a safe speed for the road and weather conditions.

**ABS cannot prevent a loss of stability.** Always steer moderately when you are braking hard. Severe or sharp steering wheel movement can still cause your vehicle to veer into oncoming traffic or off the road.

**A vehicle with ABS may require a longer distance to stop** on loose or uneven surfaces, such as gravel or snow, than a vehicle without anti-lock.

# Vehicle Stability Assist (VSA®), aka Electronic Stability Control (ESC), System

The vehicle stability assist (VSA) system helps to stabilize the vehicle during cornering if the vehicle turns more or less than desired. It also assists you in maintaining traction while accelerating on loose or slippery road surfaces. It does this by regulating the engine's output and by selectively applying the brakes.

When VSA activates, you may notice that the engine does not respond to the accelerator in the same way it does at other times. There may also be some noise from the VSA hydraulic system. You will also see the VSA system indicator blink.

The VSA system cannot enhance the vehicle's driving stability in all situations and does not control your vehicle's entire braking system. It is still your responsibility to drive and corner at reasonable speeds and to leave a sufficient margin of safety.



## VSA OFF Indicator

When VSA is off, the VSA OFF indicator comes on as a reminder.



## Vehicle Stability Assist (VSA) System Indicator

When VSA activates, you will see the VSA activation indicator blink. If this indicator comes on while driving, pull to the side of the road when it is safe, and turn off the engine. Reset the system by restarting the engine. If the VSA system indicator stays on or comes back on while driving, have the VSA system inspected by your dealer.

**NOTE:** The main function of the VSA system is generally known as Electronic Stability Control (ESC). The system also includes a traction control function.

If the indicator does not come on when the ignition switch is turned to the ON (II) position, there may be a problem with the VSA system. Have your dealer inspect your vehicle as soon as possible.

### *On Touring models*

You will also see a "CHECK VSA SYSTEM" message on the multi-information display if there is a problem with the VSA system.

CONTINUED

## Vehicle Stability Assist (VSA®), aka Electronic Stability Control (ESC), System

---

### *Except Touring models*

- If the low tire pressure indicator or TPMS indicator comes on, see page 523 .

### *On Touring models*

- If the low tire pressure/TPMS indicator comes on, see page 525 . Or, if the multi-information display shows a “CHECK TPMS SYSTEM” message with the indicator flashing, see page 94 .

In this case, you cannot turn off the VSA using the OFF switch again.

Without VSA, your vehicle will have normal braking and cornering ability, but it will not have VSA traction and stability enhancement.

### VSA OFF Switch

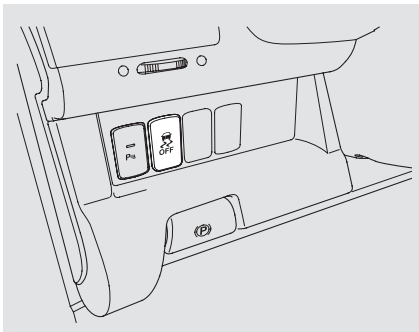

This switch is under the driver's side vent. To turn the VSA system on and off, press and hold it until you hear a beep.

When VSA is off, the VSA OFF indicator comes on as a reminder. Press and hold the switch again. It turns the system back on.

VSA is turned on every time you start the engine, even if you turned it off the last time you drove the vehicle.

In certain unusual conditions when your vehicle gets stuck in shallow mud or fresh snow, it may be easier to free it with the VSA temporarily switched off. When the VSA system is off, the traction control system is also off. You should only attempt to free your vehicle with the VSA off if you are not able to free it when the VSA is on.

Immediately after freeing your vehicle, be sure to switch the VSA on again. We do not recommend driving your vehicle with the VSA and traction control systems switched off.

# Vehicle Stability Assist (VSA®), aka Electronic Stability Control (ESC), System

---

## VSA and Tire Sizes

Driving with varying tire or wheel sizes may cause the VSA to malfunction. When replacing tires, make sure they are of the same size and type as your original tires (see page 605).

If you install winter tires, make sure they are the same size as those that were originally supplied with your vehicle. Exercise the same caution during winter driving as you would if your vehicle was not equipped with VSA.

## Hill Start Assist

Your vehicle is equipped with a hill start assist feature to help prevent the vehicle from rolling on inclines as you move your foot from the brake pedal to the accelerator.

This feature starts operating a few seconds after you are in any drive gear position (when faced uphill) or in reverse (when faced downhill).

This feature requires that the vehicle has come to a complete stop before it can work.

Hill start assist may not hold a heavily loaded vehicle, such as when your vehicle is connected to a trailer, or prevent your vehicle from rolling downhill on a very steep or slippery slope.

## Towing a Trailer

---

Your vehicle has been designed primarily to carry passengers and their cargo. You can also use it to tow a trailer if you carefully observe the load limits, use the proper equipment, and follow the guidelines in this section.

### ***Break-In Period***

Avoid towing a trailer during your vehicle's first 600 miles (1,000 km) (see page 494 ).

Be sure to read the **Off-Highway Driving Guidelines** section on page 552 if you plan to tow off paved surfaces.

### **⚠ WARNING**

Exceeding any load limit or improperly loading your vehicle and trailer can cause a crash in which you can be seriously hurt or killed.

Check the loading of your vehicle and trailer carefully before starting to drive.

### **Load Limit**

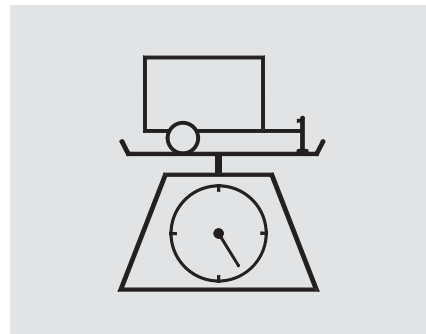

### ***Total Trailer Weight***

The maximum allowable weight of the trailer and everything in or on it depends on the number of occupants in your vehicle and the type of trailer being towed (see page 540 ).

Towing a trailer that is too heavy can seriously affect your vehicle's handling and performance. It can also damage the engine and drivetrain.



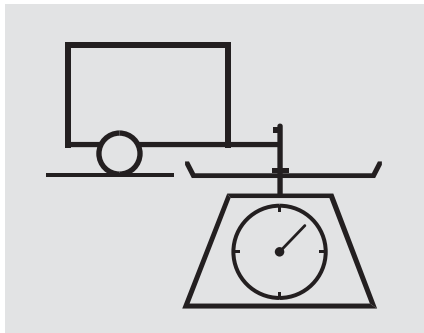

### ***Tongue Load***

The weight that the tongue of a fully loaded trailer puts on the hitch should be 5 to 10 percent of the total trailer weight for boat trailers, and 8 to 15 percent of total trailer weight for all other trailers. (See page 540 for limits for your towing situation). Too much tongue load reduces front-tire traction and steering control. Too little tongue load can make the trailer unstable

and cause it to sway.

### **Gross Vehicle Weight Rating (GVWR):**

The maximum allowable weight of the vehicle, all occupants, all accessories, all cargo, and the tongue load is:

*4WD models:*

6,096 lbs (2,765 kg)

*2WD models:*

5,952 lbs (2,700 kg)

### **Gross Axle Weight Rating (GAWR):**

The maximum allowable weight of the vehicle, all occupants, all accessories, all cargo, and the tongue load must not exceed:

*4WD models:*

2,921 lbs (1,325 kg)

on the front axle

3,362 lbs (1,525 kg) <sup>\*1</sup>

3,251 lbs (1,475 kg) <sup>\*2</sup>

on the rear axle

**\* 1 :** Except LX models

**\* 2 :** LX models

*2WD models:*

2,921 lbs (1,325 kg)

on the front axle

3,196 lbs (1,450 kg)

on the rear axle

## Towing a Trailer

---

### **Gross Combined Weight Rating (GCWR):**

The maximum allowable weight of the fully loaded vehicle and trailer with the proper hitch is:

*4WD models:*

9,579 lbs (4,345 kg)

*2WD models:*

8,466 lbs (3,840 kg)

The GCWR must be reduced 2 percent for every 1,000 feet (305 meters) of elevation.

### **Estimating Loads**

The best way to confirm that all loads are within limits is to check them at a public scale. For public scales in your area, check your local phone book, or contact your trailer dealer or rental agency for assistance.

To help ensure a safe drive to a scale, or if you cannot get to a public scale, we recommend that you estimate your total trailer weight and tongue load as described next.

### ***To Estimate the Total Trailer Weight***

Add the weight of your trailer (as quoted by the manufacturer) with everything in or on the trailer. Then check the tables on page 540 to make sure you do not exceed the limit for your conditions.

## To Estimate the Tongue Load

1. Park the vehicle on level ground.
2. Measure and record the distance from the ground to the bottom of the trailer hitch.
3. Connect the fully loaded trailer to the hitch.
4. Measure again from the ground to the same spot on the bottom of the hitch.
5. Subtract the second measurement from the first measurement, then refer to the following table.

### 2WD models

| If the difference is: | Estimated tongue load is: |
|-----------------------|---------------------------|
| 5/8"                  | 150 lbs (68 kg)           |
| 1 1/4"                | 250 lbs (114 kg)          |
| 1 3/4"                | 350 lbs (159 kg)          |

If the difference is more than 1 3/4 inch, you have too much load on the tongue. Redistribute the load or remove cargo as needed.

### 4WD models

| If the difference is: | Estimated tongue load is: |
|-----------------------|---------------------------|
| 5/8"                  | 150 lbs (68 kg)           |
| 1 1/4"                | 250 lbs (114 kg)          |
| 1 3/4"                | 350 lbs (159 kg)          |
| 2 1/4"                | 450 lbs (205 kg)          |

If the difference is more than 2 1/4 inch, you have too much load on the tongue. Redistribute the load or remove cargo as needed.

CONTINUED

# Towing a Trailer

---

## Total Trailer Weight and Tongue Load Limits:

### 2WD models

| Number of Occupants* | Maximum Total Trailer Weight | Maximum Tongue Load** |
|----------------------|------------------------------|-----------------------|
| 2                    | 2,000 lbs (905 kg)           | 200 lbs (90 kg)       |
| From 3 to 8          | Towing is Not Recommended    |                       |

### 2WD models with optional ATF Cooler installed

| Number of Occupants* | Maximum Total Trailer Weight | Maximum Tongue Load** |
|----------------------|------------------------------|-----------------------|
| 2                    | 3,500 lbs (1,588 kg)         | 350 lbs (159 kg)      |
| 3                    | 3,300 lbs (1,497 kg)         | 300 lbs (136 kg)      |
| 4                    | 3,100 lbs (1,406 kg)         | 230 lbs (104 kg)      |
| 5                    | 3,000 lbs (1,361 kg)         | 200 lbs (90 kg)       |
| 6                    | 2,800 lbs (1,270 kg)         | 150 lbs (68 kg)       |
| 7                    | 2,000 lbs (905 kg)           | 100 lbs (45 kg)       |
| 8                    | Towing is Not Recommended    |                       |

- \* The corresponding weight limits assume occupants fill seats from the front of the vehicle to the back, each occupant weighs 150 lbs (68 kg), and each has 15 lbs (7 kg) of cargo in the cargo area. Any additional weight, including cargo or accessories, reduces the maximum trailer weight and maximum tongue load. Never exceed the gross axle weight ratings (see page 537).
- \*\* Recommended tongue load should be 5 – 10% of the total trailer weight for boat trailers, and 8 – 15% of the total trailer weight for all other trailers.

## 4WD models

| Number of Occupants* | Maximum Total Trailer Weight | Maximum Tongue Load** |
|----------------------|------------------------------|-----------------------|
| 2                    | 4,500 lbs (2,041 kg)         | 450 lbs (204 kg)      |
| 3                    | 4,300 lbs (1,950 kg)         | 400 lbs (181 kg)      |
| 4                    | 4,100 lbs (1,860 kg)         | 330 lbs (150 kg)      |
| 5                    | 4,000 lbs (1,814 kg)         | 270 lbs (122 kg)      |
| 6                    | 3,800 lbs (1,724 kg)         | 190 lbs (86 kg)       |
| 7                    | 2,000 lbs (905 kg)           | 100 lbs (45 kg)       |
| 8                    | Towing is Not Recommended    |                       |

- \* The corresponding weight limits assume occupants fill seats from the front of the vehicle to the back, each occupant weighs 150 lbs (68 kg), and each has 15 lbs (7 kg) of cargo in the cargo area. Any additional weight, including cargo or accessories, reduces the maximum trailer weight and maximum tongue load. Never exceed the gross axle weight ratings (see page 537).
- \* \* Recommended tongue load should be 5 – 10% of the total trailer weight for boat trailers, and 8 – 15% of the total trailer weight for all other trailers.

# Towing a Trailer

---

## Checking Loads

To accurately check your loads at the public scale, the vehicle and trailer should be fully loaded, and all occupants should stay in the vehicle while the attendant watches the scale.

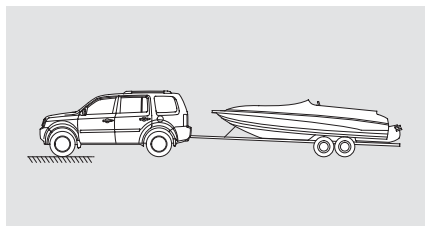

1. Check the front gross axle weight.  
Limit: 2,921 lbs (1,325 kg)

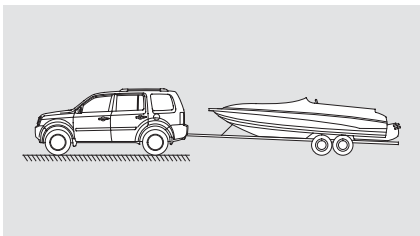

2. Check the gross vehicle weight.  
Limit (4WD models): 6,096 lbs (2,765 kg)  
Limit (2WD models): 5,952 lbs (2,700 kg)
3. Check the rear gross axle weight.  
Limit (4WD models except LX): 3,362 lbs (1,525 kg)  
Limit (4WD LX models): 3,252 lbs (1,475 kg)  
Limit (2WD models): 3,196 lbs (1,450 kg)
4. If you cannot weigh the rear axle directly, you can calculate the rear gross axle weight by subtracting the weight in step 1 from the weight in step 2.  
Limit (4WD models): 3,175 lbs (1,440 kg)  
Limit (2WD models): 3,031 lbs (1,375 kg)

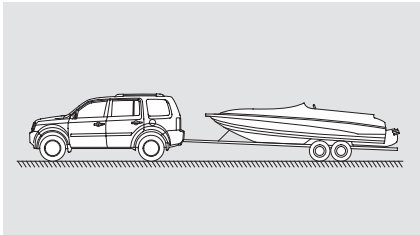

5. Check the gross combined weight.  
Limit (4WD models): 9,579 lbs  
(4,345 kg)  
Limit (2WD models): 8,466 lbs  
(3,840 kg)  
Remember, maximum gross  
combined weight should be  
decreased 2% for every 1,000 feet  
(305 meters) of elevation.

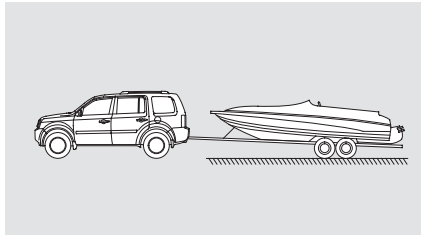

6. Check the weight of the hitched  
trailer. Write this number down.

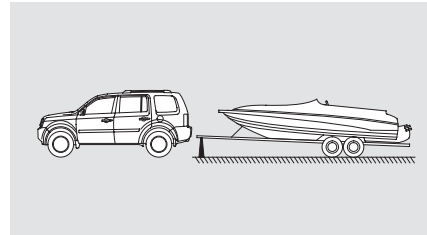

7. Check the weight of the unhitched  
trailer. Limit: See page 540 .
8. Calculate the tongue load.  
Subtract the weight in step 6 from  
the weight in step 7.  
Limit: See page 536 .  
Range: 5-10% for boat trailers  
8-15% for other trailers

# Towing a Trailer

---

## **Towing Equipment and Accessories**

Towing generally requires a variety of supplemental equipment. To ensure the best quality, we recommend that you purchase Honda equipment whenever possible.

Your dealer offers trailer packages that include a ball mount, hitch plug, and hitch pin. A wiring harness kit is also available from your dealer.

Discuss your needs with your trailer sales or rental agency, and follow the guidelines in this section. Also make sure that all equipment is properly installed and maintained, and that it meets federal, state, province, territory, and local regulations.

### ***Hitch***

Read the trailer manufacturer's instructions, and select the appropriate draw bar for the height of the trailer you will be towing.

### ***Weight Distributing Hitch***

A weight distributing hitch is not recommended for use with your vehicle, as an improperly adjusted weight distributing hitch may reduce handling, stability, and braking performance.

### ***Automatic Transmission Fluid Cooler (2WD models)***

2WD models are not equipped with a transmission fluid cooler, and have reduced towing capacities. See the Trailer Weight and Tongue Load Limits table on page 540 for maximum towing capacities. An optional automatic transmission fluid cooler kit is available if you plan to tow weight above the limits. Contact a dealer for additional information.

### ***Trailer Brakes***

Honda recommends that any trailer with a total trailer weight of 1,000 lbs (450 kg) or more has its own brakes.

There are two common types of trailer brakes: surge and electric. Surge brakes are common for boat trailers, since the brakes will get wet.

If you choose electric brakes, be sure they are electronically actuated. Do not attempt to tap into your vehicle's hydraulic system. No matter how successful it may seem, any attempt to attach trailer brakes to your vehicle's hydraulic system will lower braking effectiveness and create a potential hazard.

See your trailer dealer or rental agency for more information on installing electric brakes.



A factory installed, 4-pin gray connector is located under the instrument panel near the top of the parking brake pedal. This connector has all of the circuits required to install most electric trailer brake controllers. A jumper harness to adapt your electric trailer brake controller to the vehicle is included with the optional Genuine Honda trailer hitch kit. To obtain a trailer hitch kit, see your dealer.

Have a qualified mechanic install your trailer brake controller following the trailer brake controller manufacturer's instructions. Failure to properly install the trailer brake controller may increase the distance it takes for you to stop your vehicle when towing a trailer.

Use this illustration to identify each terminal in the trailer brake controller connector.

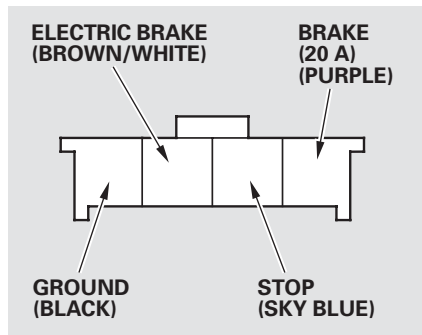

## ***Safety Chains***

Always use safety chains when you tow a trailer. Make sure the chains are secured to the trailer and hitch, and that they cross under the tongue and can catch the trailer if it becomes unhitched. Leave enough slack to allow the trailer to turn corners easily, but do not let the chains drag on the ground.

## ***Sway Control***

This device is recommended if your trailer tends to sway. Your trailer dealer or rental agency can tell you what kind of sway control you need and how to install it.

## ***Trailer Mirrors***

Many states and provinces require special exterior mirrors when towing a trailer. Even if they don't, you should install special mirrors if you cannot clearly see behind you, or if the trailer creates a blind spot.

*CONTINUED*

# Towing a Trailer

## *Spare Tires*

When towing a trailer, we recommend that you carry a full-size spare wheel and tire for your vehicle and trailer. When replacing the compact spare with a full size spare, remove the plastic spacer (see page 604 ). Store the plastic spacer and compact spare together. Reinstall the spacer before once again stowing the compact spare.

See page 605 for proper tire size, page 619 for how to store a full size wheel and tire, and page 613 for information on changing a flat tire.

Remember to unhitch the trailer before changing a flat. Ask your trailer sales or rental agency where and how to store the trailer's spare tire.

## Trailer Lights

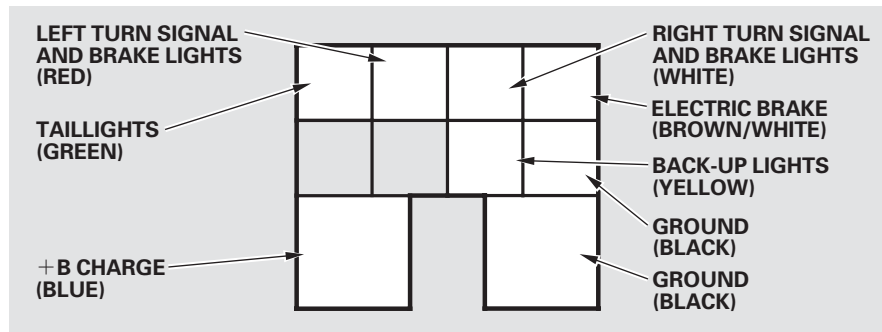

Trailer lights and equipment must comply with federal, state, province/territory, and local regulations. Check trailer light requirements for the areas where you plan to tow, and use only equipment designed for your vehicle.

Your vehicle is equipped with a connector to install an optional trailer lighting connector that mates with your vehicle. You can get this optional connector from your dealer.

Refer to the above illustration for wiring information.

We recommend that you have your dealer install a Honda wiring harness and converter. This harness has been designed for your vehicle.

If you use a non-Honda trailer lighting harness and converter, you can get the connector and pins that mate with the connector in your vehicle from your dealer.

Since lighting and wiring vary with trailer type and brand, you should also have a qualified mechanic install a suitable connector between the vehicle and the trailer.

## Towing Equipment

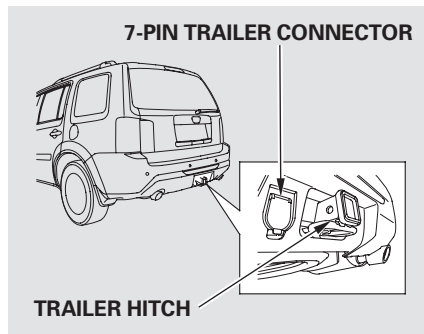

Your vehicle has a class 3 trailer hitch as standard equipment.

The jumper harness and trailer brake fuse are stored in the glove box.

Also see page 544 for trailer-related information.

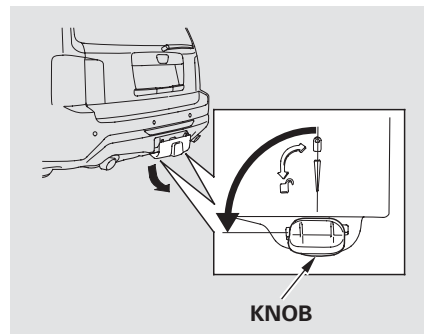

Remove the cover by turning the knobs about one-quarter turn counterclockwise.

CONTINUED

# Towing a Trailer

## Connecting the Trailer Connectors

*On Touring models*

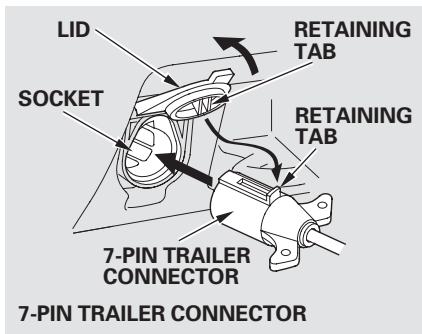

The 7-pin trailer connector is needed for the trailer lights. To connect the connector:

1. Make sure the connector and the socket are free of dirt, moisture, or other foreign material.
2. Open the socket lid by pulling it up.

3. Insert the connector securely into the socket.

Hook the retaining tab on the inner side of the lid against the retaining tab of the connector to prevent disconnection during operation.

## Trailer Connector Sockets

*On Touring models*

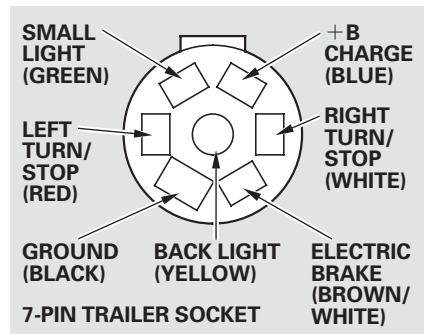

Refer to the above illustrations for wiring information.

## Trailer Jumper Harness

On Touring models

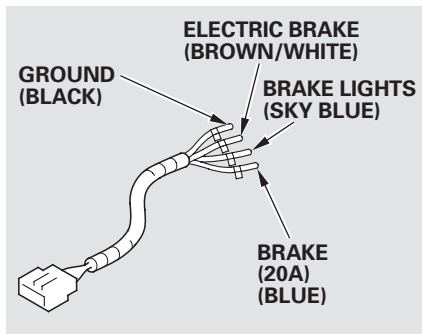

The trailer jumper harness is used to install the controller for the electric trailer brakes. For more information, see **Trailer Brakes** on page 544 .

## Trailer Brake Fuse

Insert the trailer brake fuse into the secondary under-hood fuse box (see page 634 ).

## Pre-Tow Checklist

When preparing to tow, and before driving away, be sure to check the following:

- The vehicle has been properly serviced, and the suspension and the cooling system are in good operating condition.
- The trailer has been properly serviced and is in good condition.
- All weights and loads are within limits.
- The hitch, safety chains, and any other attachments are secure.
- All items on and in the trailer are properly secured and cannot shift while you drive.
- The lights and brakes on your vehicle and the trailer are working properly.
- Your vehicle tires and spare are in good condition and properly inflated.
- Towing performance can be affected by high altitude, high temperature, or when climbing steep grades. Therefore, premium fuel (premium unleaded gasoline with pump octane number of 91 or higher) is recommended when towing more than 3,500 lbs (1,590 kg).
- The trailer tires and spare are in good condition and inflated as recommended by the trailer maker.

## Towing a Trailer

---

### **Driving Safely With a Trailer**

The added weight, length, and height of a trailer will affect your vehicle's handling and performance, so driving with a trailer requires some special driving skills and techniques.

For your safety and the safety of others, take time to practice driving maneuvers before heading for the open road, and follow the guidelines in this section.

### ***Towing Speeds and Gears***

Drive slower than normal in all driving situations, and obey posted speed limits for vehicles with trailers. Use D position when towing a trailer on level roads. D3 is the proper shift lever position to use when towing a trailer in hilly terrain. (See “***Driving on Hills***” on the next page for additional gear information.)

When towing a fixed-sided trailer (e.g., camper), do not exceed 55 mph (88 km/h). At higher speeds, the trailer may sway or affect vehicle handling.

### ***Making Turns and Braking***

Make turns more slowly and wider than normal. The trailer tracks a smaller arc than your vehicle, and it can hit or run over something the vehicle misses.

Allow more time and distance for braking. Do not brake or turn suddenly as this could cause the trailer to jackknife or turn over.

### *Driving on Hills*

When climbing hills, closely watch your temperature gauge. If it nears the red (Hot) mark, turn the air conditioning off, reduce speed and, if necessary, pull to the side of the road to let the engine cool.

If the automatic transmission shifts frequently while going up a hill, shift to D3.

If you must stop when facing uphill, use the foot brake or parking brake. Do not try to hold the vehicle in place by pressing on the accelerator, as this can cause the automatic transmission to overheat.

When driving down hills, reduce your speed and shift down to D3. Do not “ride” the brakes. **Remember, it takes longer to slow down and stop when towing a trailer.**

### *Handling Crosswinds and Buffeting*

Crosswinds and air turbulence caused by passing trucks can disrupt your steering and cause the trailer to sway. When being passed by a large vehicle, keep a constant speed, and steer straight ahead. Do not try to make quick steering or braking corrections.

### *Backing Up*

Always drive slowly and have someone guide you when backing up. Grip the *bottom* of the steering wheel, then turn the wheel to the left to get the trailer to move to the left. Turn the wheel to the right to move the trailer to the right.

### *Parking*

Follow all normal precautions when parking, including putting the transmission in Park and firmly setting the parking brake. Also, place wheel chocks at each of the trailer’s tires.

### *Retrieving a Boat*

If the vehicle’s tires slip when retrieving a boat from the water, shift to first gear, and turn on VTM-4 lock (see page 520 ). Disengage VTM-4 lock as soon as the boat is out of the water to prevent damage to the VTM-4 system.

### *Towing Your Vehicle*

Your vehicle is not designed to be towed behind a motor home. If your vehicle needs to be towed in an emergency, see page 636 .

# Off-Highway Driving Guidelines

---

## General Information

Your vehicle has been designed primarily for use on pavement. But its higher ground clearance allows you to occasionally travel on unpaved roads, such as campgrounds, picnic sites, and similar locations. It is not designed for trail-blazing, mountain climbing, or other challenging off-road activities.

If you decide to drive on unpaved roads, you will find that it requires somewhat different driving skills. Your vehicle will also handle somewhat differently than it does on pavement. Be sure to pay extra attention to the precautions and tips in this section, and get acquainted with your vehicle before leaving the pavement.

## **▲ WARNING**

Improperly operating this vehicle on or off-pavement can cause a crash or rollover in which you and your passengers could be seriously injured or killed.

- Follow all instructions and guidelines in this owner's manual.
- Keep your speed low, and don't drive faster than conditions permit.

## Important Safety Precautions

To avoid loss of control or rollover, be sure to follow all precautions and recommendations.

- Be sure to store cargo properly and do not exceed your cargo load limits (see page 507 and 536).
- Whenever you drive, make sure you and your passengers always wear seat belts.
- Keep your speed low, and never go faster than the conditions allow.
- It's up to you to continually assess the situation and drive within the limits.



### Check Out Your Vehicle

Before you leave the pavement, be sure to do all scheduled maintenance and service, and inspect your vehicle for any problems. Pay special attention to the condition of the tires, and check the tire pressures.

After you return to the pavement, carefully inspect your vehicle to make sure there is no damage that could make driving it unsafe. Recheck the condition of the tires and the tire pressures.

### Remember

The route presents limits (too steep or bumpy roads). You have limits (driving skill and comfort). And your vehicle has limits (traction, stability, and power).

Driving off-highway can be hazardous if you fail to recognize limits and take the proper precautions.

### Accelerating and Braking

For better traction on all surfaces, accelerate slowly and gradually build up speed. If you try to start too fast on wet soil, mud, snow, or ice, you might not have enough traction to get underway, and you may dig yourself a hole. Starting with the shift lever in D position will help you have a smoother start on snow or ice.

Keep in mind that you will usually need more time and distance to brake to a stop on unpaved surfaces. Avoid hard braking. Do not “pump” the brakes; let the anti-lock braking system pump them for you.

### Avoiding Obstacles

Debris in the road can damage your suspension or other components. Because your vehicle has a high center of gravity, driving over a large obstacle, or allowing a wheel to drop into a deep hole can cause your vehicle to tip or roll over.

### Driving on Slopes

If you can't clearly see all conditions or obstacles on a slope, walk the slope before you drive on it. If you have any doubt whether or not you can safely drive on the slope, don't do it. Find another route. If you are driving up a hill and find that you cannot continue, *do not try to turn around*. Your vehicle could roll over. Slowly back down the hill, following the same route you took up the hill.

## Off-Highway Driving Guidelines

---

### Crossing a Stream

Before driving through water, stop, get out if necessary, and make sure that:

- The water is not deep enough to cover your wheel hubs, axles, or exhaust pipe. You could stall and not be able to restart your engine. The water can also damage important vehicle components.
- The banks are sloped so you can drive out.
- The water is not flowing too fast. Deep rushing water can sweep you downstream. Even very shallow rushing water can wash the ground from under your tires and cause you to lose traction and possibly roll over.

- The banks and surface under the water provide good traction. The water may hide hazards such as rocks, holes, or mud.

If you decide it is safe to drive through water, choose a suitable speed and engage the VTM-4 Lock. Proceed without shifting or changing speeds, and do not stop the vehicle or shut off the engine.

After driving through water, test your brakes. If they got wet, gently “pump” them while driving slowly until they operate normally.

If the water is deeper than the wheel hubs, some additional service may be required. This service is not covered by your warranties.

### If You Get Stuck

If you get stuck, engage the VTM-4 Lock (see page 520 ). Carefully try to go in the direction (forward or reverse) that you think will get you unstuck. Do not spin the tires at high speeds. It will not help you get out and may cause damage to the transmission or VTM-4 system.

If you are still unable to free yourself, your vehicle is equipped with front and rear tow hooks designed for this purpose.

Use a nylon strap to attach your vehicle to the recovery vehicle, and carefully take out the slack in the strap. Once the strap is tight, the recovery vehicle should apply force. Remember that the recovery vehicle needs good traction to avoid becoming stuck, too.

You should never use a jack to try to get unstuck. Your vehicle could easily slip off the jack and hurt you or someone else.

### **Towing a Trailer Off-Road**

You may be able to safely tow a lightweight trailer (such as a motorcycle or small tent trailer) off-road if you follow these guidelines.

- Do not exceed 1,000 lbs (450 kg) or a tongue weight of 100 lbs (45 kg).
- Stay on smooth, level dirt roads, and avoid driving in hilly terrain.
- Allow extra room for starting, stopping, and turning.
- Slow down if you encounter bumps or other obstacles.



This section explains why it is important to keep your vehicle well maintained and how to follow basic maintenance safety precautions.

This section also includes instructions on how to read the Maintenance Minder messages on the information display or multi-information display (depending on the model), and instructions for simple maintenance tasks you may want to take care of yourself.

If you have the skills and tools to perform more complex maintenance tasks on your vehicle, you may want to purchase the service manual. See page 661 for information on how to obtain a copy, or see your dealer.

U.S. Vehicles:

**Maintenance, replacement, or repair of emissions control devices and systems may be done by any automotive repair establishment or individual using parts that are “certified” to EPA standards.**

|   |     |
|---|-----|
| Maintenance Safety .....                    | 558 |
| Maintenance Minder™ .....                   | 559 |
| Fluid Locations.....                        | 574 |
| Engine Compartment Covers.....              | 575 |
| Adding Engine Oil.....                      | 576 |
| Changing the Engine Oil and<br>Filter ..... | 577 |
| Engine Coolant.....                         | 579 |
| Windshield Washers .....                    | 581 |
| Automatic Transmission Fluid.....           | 582 |
| Brake Fluid .....                           | 584 |
| Power Steering Fluid.....                   | 585 |
| Timing Belt.....                            | 585 |
| Lights .....                                | 586 |
| Dust and Pollen Filter .....                | 593 |
| Cleaning the Seat Belts.....                | 593 |
| Floor Mats .....                            | 594 |
| Wiper Blades .....                          | 595 |
| Tires .....                                 | 599 |
| Checking the Battery.....                   | 607 |
| Vehicle Storage.....                        | 608 |
| Interior Care.....                          | 609 |

# Maintenance Safety

---

All service items not detailed in this section should be performed by a certified technician or other qualified mechanic.

## Important Safety Precautions

To eliminate potential hazards, read the instructions before you begin, and make sure you have the tools and skills required.

- Make sure your vehicle is parked on level ground, the parking brake is set, and the engine is off.
- To clean parts, use a commercially available degreaser or parts cleaner, not gasoline.
- To reduce the possibility of fire or explosion, keep cigarettes, sparks, and flames away from the battery and all fuel-related parts.

- Wear eye protection and protective clothing when working with the battery or compressed air.

### WARNING

Improperly maintaining this vehicle, or failing to correct a problem before driving can cause a crash in which you can be seriously hurt or killed.

Always follow the inspection and maintenance recommendations and schedules in this owner's manual.

## Potential Vehicle Hazards

- **Carbon Monoxide poison from engine exhaust.** Be sure there is adequate ventilation whenever you operate the engine.
- **Burns from hot parts.** Let the

engine and exhaust system cool down before touching any parts.

- **Injury from moving parts.** Do not run the engine unless instructed to do so.

### WARNING

Failure to properly follow maintenance instructions and precautions can cause you to be seriously hurt or killed.

Always follow the procedures and precautions in this owner's manual.

Some of the most important safety precautions are given here. However, we cannot warn you of every conceivable hazard that can arise in performing maintenance. Only you can decide whether or not you should perform a given task.

Your vehicle displays engine oil life and maintenance service items on the information display or multi-information display (depending on the model) to show you when you should have your dealer perform engine oil replacement and indicated maintenance services.

Based on the engine operating conditions and accumulated engine revolutions, the onboard computer in your vehicle calculates the remaining engine oil life and displays it as a percentage.

The remaining engine oil life is shown on the display according to this table:

| Calculated Engine Oil Life (%) | Displayed Engine Oil Life (%) |
|--------------------------------|-------------------------------|
| 100% – 91%                     | 100%                          |
| 90% – 81%                      | 90%                           |
| 80% – 71%                      | 80%                           |
| 70% – 61%                      | 70%                           |
| 60% – 51%                      | 60%                           |
| 50% – 41%                      | 50%                           |
| 40% – 31%                      | 40%                           |
| 30% – 21%                      | 30%                           |
| 20% – 16%                      | 20%                           |
| 15% – 11%                      | 15%                           |
| 10% – 6%                       | 10%                           |
| 5% – 1%                        | 5%                            |
| 0%                             | 0%                            |

### Engine Oil Life Display

*Except Touring models*

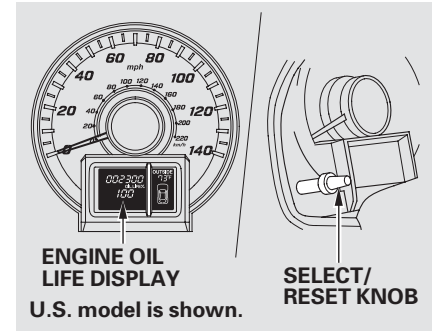

To see the current engine oil life, turn the ignition switch to the ON (II) position, and press the select/reset knob repeatedly until the engine oil life display appears (see page 81).

CONTINUED

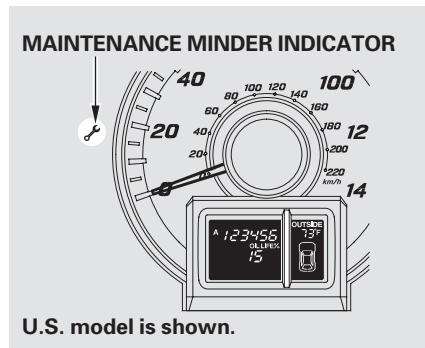

If the remaining engine oil life is 15 to 6 percent, you will see the engine oil life indicator every time you turn the ignition switch to the ON (II) position. The Maintenance Minder indicator will also come on, and the maintenance item code(s) for other scheduled maintenance items needing service will be displayed near the “OIL LIFE” message.

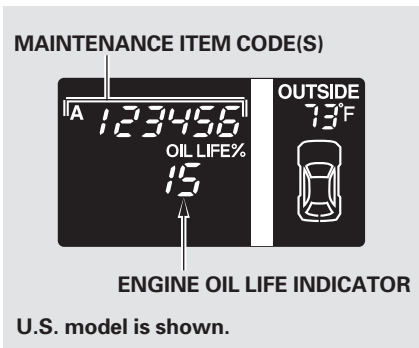

The 15 and 10 percent oil life indicators remind you that your vehicle will soon be due for scheduled maintenance.

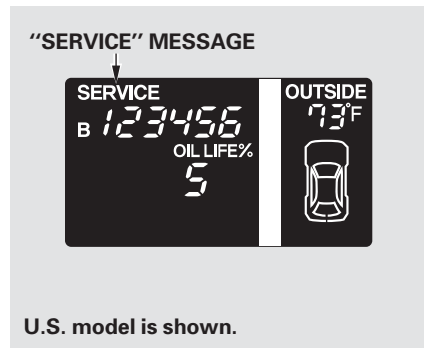

When the remaining engine oil life is 5 to 1 percent, you will see a “SERVICE” message along with the same maintenance item code(s), every time you turn the ignition switch to the ON (II) position.



The maintenance item code or codes indicate the main and sub items required at the time of the oil change (see page 562).

You can switch the information display from the engine oil life display to the odometer or the trip meter. Press and release the select/reset knob on the instrument panel.

When the engine oil life is 15 to 1 percent, the Maintenance Minder indicator (  ) comes on every time you turn the ignition switch to the ON (II) position, then it goes out if you switch the information display.

When you see this message, have the indicated maintenance performed by your dealer as soon as possible.

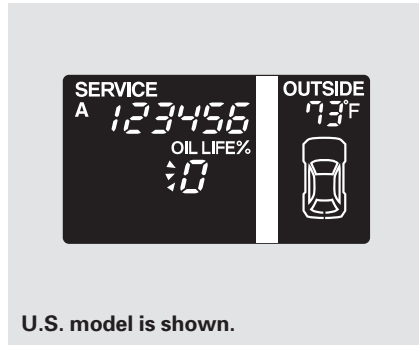

U.S. model is shown.

When the remaining engine oil life is 0 percent, the engine oil life indicator will blink. The display comes on every time you turn the ignition switch to the ON (II) position. The Maintenance Minder indicator (  ) also comes on and remains on in the instrument panel. When you see this message, immediately have the indicated maintenance done by your dealer.

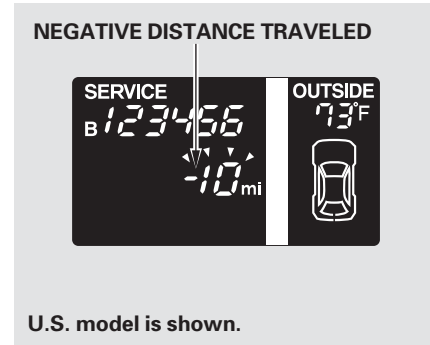

U.S. model is shown.

If you do not perform the indicated maintenance, negative distance traveled is displayed and begins to blink after the vehicle has been driven 10 miles (10 km) or more.

Negative distance traveled means your vehicle has passed the maintenance required point.

Immediately have the indicated maintenance done by your dealer.

*CONTINUED*

To change the information display from the engine oil life display to the odometer or the trip meter, press and release the select/reset knob.

When the engine oil life is 0 percent or negative distance traveled, the Maintenance Minder indicator (  ) remains on even if you change the information display.

Immediately have the service performed, and make sure to reset the display as described as follows.

## Maintenance Main Items and Sub Items

*Except Touring models*

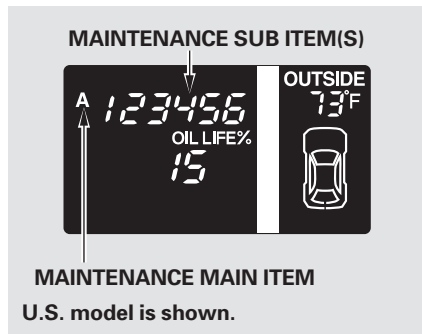

All maintenance items displayed on the information display are in code. For an explanation of these maintenance codes, see page 573 .

## Resetting the Engine Oil Life Display

*Except Touring models*

Your dealer will reset the display after completing the required maintenance service. You will see “OIL LIFE 100%” on the information display the next time you turn the ignition switch to the ON (II) position.

If maintenance service is done by someone other than your dealer, reset the Maintenance Minder as follows:

1. Turn the ignition switch to the ON (II) position.
2. Press the select/reset knob repeatedly until the engine oil life is displayed.

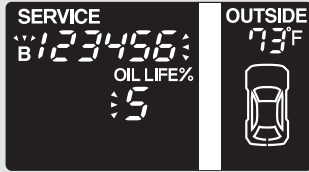

U.S. model is shown.

3. Press the select/reset knob for about 10 seconds. The engine oil life and the maintenance item code(s) will blink.

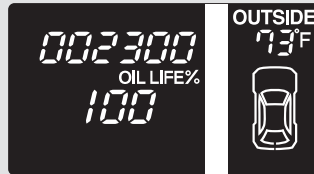

U.S. model is shown.

4. Press the select/reset knob for another 5 seconds. The maintenance item code(s) will disappear, and the engine oil life will reset to "100."

## On Touring models

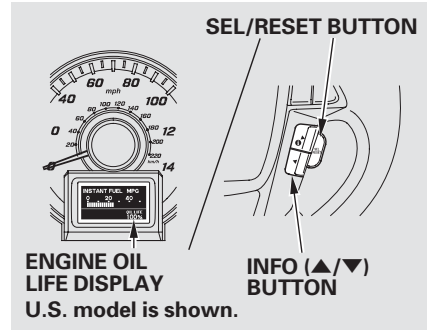

To see the current engine oil life, turn the ignition switch to the ON (II) position, and push and release the INFO (▲/▼) button on the steering wheel repeatedly, until the engine oil life is displayed (see page 86 ).

CONTINUED

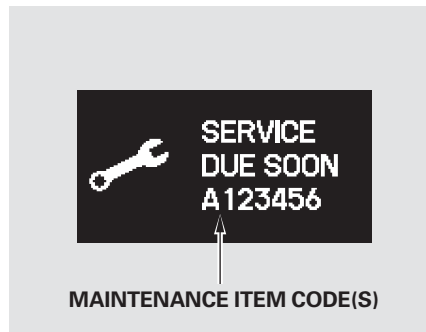

When the remaining engine oil life is 15 percent or less, the display shows a “SERVICE DUE SOON” message along with the maintenance item code(s) for other scheduled maintenance items needing service.

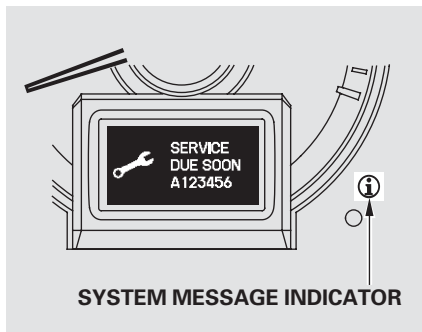

The system message indicator on the instrument panel will also come on, and a beeper will sound.

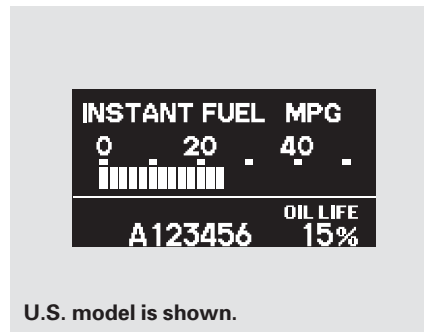

To cancel the system message, press and release the INFO (▲/▼) button on the steering wheel. At this time, the system message indicator will also be turned off. Then the display will change to the engine oil life display. You will see the maintenance item code(s) along with the engine oil life on the multi-information display.

You will also see the system message every time you turn the ignition switch to the ON (II) position until you have the indicated maintenance performed by your dealer.

The maintenance item code(s) indicate the main and sub items required at the time of the oil change (see page 569).



When the remaining engine oil life is less than 5 percent, you will see the above display. The display then changes to “SERVICE DUE NOW.” Have the indicated maintenance done as soon as possible.

The system message indicator on the instrument panel will also come on, and a beeper will sound.

*CONTINUED*

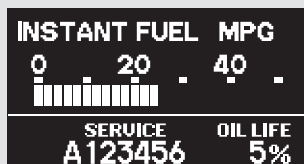

U.S. model is shown.

To cancel the system message, press and release the INFO (▲/▼) button on the steering wheel. At this time, the system message indicator will also be turned off. Then the display will change to the engine oil life display. You will see a “SERVICE” message and along with the maintenance item code(s) on the multi-information display.

You will also see the system message every time you turn the ignition switch to the ON (II) position until you have the indicated maintenance performed by your dealer.



U.S. model is shown.

If the indicated maintenance service is not done and the engine oil life reaches 0 percent, you will see a “SERVICE PAST DUE” message along with the maintenance item code(s) on the multi-information display.

The system message indicator on the instrument panel will also come on, and a beeper will sound.

When you see this message, have the indicated maintenance done by your dealer immediately.

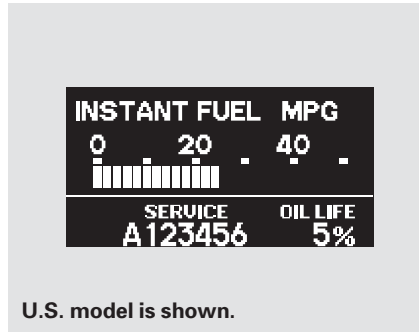

U.S. model is shown.

To cancel the system message, press and release the INFO (▲/▼) button on the steering wheel. At this time, the system message indicator will **not** be turned off. Then the display will change to the engine oil life display. You will see the engine oil life blinking and a “SERVICE” message along with the maintenance item code(s) on the multi-information display.

The system message will appear again by pressing the INFO (▲/▼) button after canceling it.

You will also see the system message every time you turn the ignition switch to the ON (II) position until you have the indicated maintenance performed by your dealer.

CONTINUED



If the indicated required service is not done and the remaining engine oil life becomes 0%, the multi-information display will show a “SERVICE PAST DUE” message, the total distance traveled after the remaining oil life became 0%, and the maintenance item code(s).

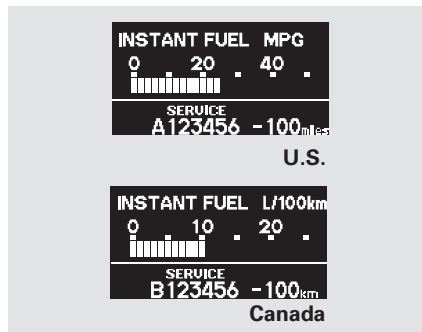

To cancel the system message, press and release the INFO (▲/▼) button on the steering wheel. At this time, the system message indicator will **not** be turned off. Then the display will change to the engine oil life display. You will see the negative distance traveled blinking and a “SERVICE” message along with the maintenance item code(s) on the multi-information display.

The system message will appear again by pressing the INFO (▲/▼) button after canceling it.

You will also see the system message every time you turn the ignition switch to the ON (II) position until you have the indicated maintenance performed by your dealer.

Negative distance traveled means your vehicle has passed the maintenance required point.

Immediately have the service performed, and make sure to reset the display as described on page 569.



## Maintenance Main Items and Sub Items

*On Touring models*

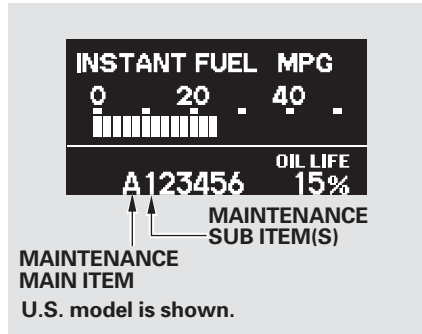

All maintenance items displayed on the information display are in code. For an explanation of these maintenance codes, see page 573.

## Resetting the Engine Oil Life Display

*On Touring models*

Your dealer will reset the display after completing the required maintenance service. You will see “OIL LIFE 100%” on the display the next time you turn the ignition switch to the ON (II) position.

If maintenance service is done by someone other than your dealer, reset the Maintenance Minder as follows:

1. Turn the ignition switch to the ON (II) position.
2. Press the SEL/RESET button on the steering wheel until you see the engine oil life display.

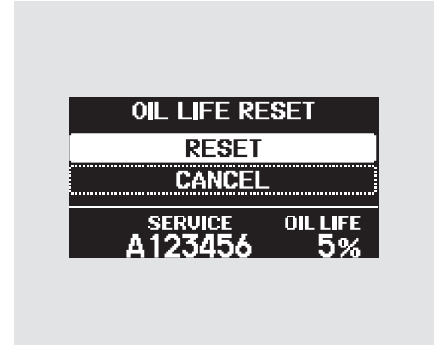

3. Press and hold the SEL/RESET button on the steering wheel for more than 10 seconds. The remaining engine oil life reset mode will be shown on the multi-information display.

CONTINUED

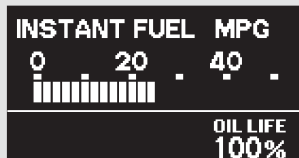

U.S. model is shown.

4. Select “RESET” by pressing the INFO (▲/▼) button, then press the SEL/RESET button to reset the engine oil life display. The maintenance item code(s) will disappear, and the engine oil life will reset to “100.” If you want to cancel the oil life reset mode, select “CANCEL.”

## Important Maintenance Precautions

If you have the required service done but do not reset the display, or reset the display without doing the service, the system will not show the correct maintenance intervals. This can lead to serious mechanical problems because you will no longer have an accurate record of when maintenance is needed.

Your authorized Honda dealer knows your vehicle best and can provide competent, efficient service.

However, service at a dealer is not mandatory to keep your warranties in effect. Maintenance may be done by any qualified service facility or person who is skilled in this type of automotive service. Make sure to have the service facility or person reset the display as previously described. Keep all receipts as proof of completion, and have the person who does the work fill out your Honda Service History or Canadian Maintenance Log. Check your warranty booklet for more information.

We recommend the use of Honda parts and fluids whenever you have maintenance done. These are manufactured to the same high-quality standards as the original components, so you can be confident of their performance and durability.

## U.S. Vehicles:

According to state and federal regulations, failure to perform maintenance on the items marked with # will not void your emissions warranties. However, all maintenance services should be performed in accordance with the intervals indicated by the odometer/trip meter display or the multi-information display.

## Owner's Maintenance Checks

You should check the following items at the specified intervals. If you are unsure of how to perform any check, turn to the appropriate page listed.

- Engine oil level — Check every time you fill the fuel tank. See page 500 .
- Engine coolant level — Check the radiator reserve tank every time you fill the fuel tank. See page 500 .
- Automatic transmission — Check the fluid level monthly. See page 582 .

*CONTINUED*

- Brakes — Check the fluid level monthly. See page 584 .
- Tires — Check the tire pressure monthly. Examine the tread for wear and foreign objects. See page 600 .
- Lights — Check the operation of all the lights monthly. See page 586 .

| Symbol   | Maintenance Main Items  |
|----------|---|
| <b>A</b> | <ul style="list-style-type: none"> <li>● Replace engine oil*<sup>1</sup></li> </ul>   |
| <b>B</b> | <ul style="list-style-type: none"> <li>● Replace engine oil*<sup>1</sup> and oil filter</li> <li>● Inspect front and rear brakes</li> <li>● Check parking brake adjustment</li> <li>● Inspect these items:               <ul style="list-style-type: none"> <li>● Tie rod ends, steering gear box, and boots</li> <li>● Suspension components</li> <li>● Driveshaft boots</li> <li>● Brake hoses and lines (including ABS/VSA)</li> <li>● All fluid levels and condition of fluids</li> <li>● Exhaust system<sup>#</sup></li> <li>● Fuel lines and connections<sup>#</sup></li> </ul> </li> </ul> |

\* 1 : If the message, "SERVICE" does not appear more than 12 months after the display is reset, change the engine oil every year.

# : See information on maintenance and emissions warranty on page 569.

NOTE : ● Independent of the Maintenance Minder information, replace the brake fluid every 3 years.  
 ● Inspect idle speed every 160,000 miles (256,000 km).  
 ● Adjust the valves during services A, B, 1, 2, or 3 if they are noisy.

| Symbol   | Maintenance Sub Items   |
|----------|---|
| <b>1</b> | <ul style="list-style-type: none"> <li>● Rotate tires</li> </ul>  |
| <b>2</b> | <ul style="list-style-type: none"> <li>● Replace air cleaner element<br/>If you drive in dusty conditions, replace every 15,000 miles (24,000 km).</li> <li>● Replace dust and pollen filter<br/>If you drive primarily in urban areas that have high concentrations of soot in the air from industry and from diesel-powered vehicles, replace every 15,000 miles (24,000 km).</li> <li>● Inspect drive belt</li> </ul>  |
| <b>3</b> | <ul style="list-style-type: none"> <li>● Replace transmission and transfer*<sup>2</sup> fluid</li> </ul>  |
| <b>4</b> | <ul style="list-style-type: none"> <li>● Replace spark plugs</li> <li>● Replace timing belt and inspect water pump<br/>If you drive regularly in very high temperatures (over 110°F, 43°C), in very low temperatures (under -20°F, -29°C), or towing a trailer, replace every 60,000 miles (U.S.)/100,000 km (Canada).</li> <li>● Inspect valve clearance</li> </ul>  |
| <b>5</b> | <ul style="list-style-type: none"> <li>● Replace engine coolant</li> </ul>  |
| <b>6</b> | <ul style="list-style-type: none"> <li>● Replace VTM-4 rear differential fluid*<sup>2</sup><br/>Driving in mountainous areas at very low vehicle speeds or trailer towing results in higher level of mechanical (shear) stress to fluid. This requires differential fluid changes more frequently than recommended by the Maintenance Minder. If you regularly drive your vehicle under these conditions, have the differential fluid changed at 7,500 miles (12,000 km), then every 15,000 miles (24,000 km).</li> </ul> |

\* 2 : 4WD models only

# Fluid Locations

---

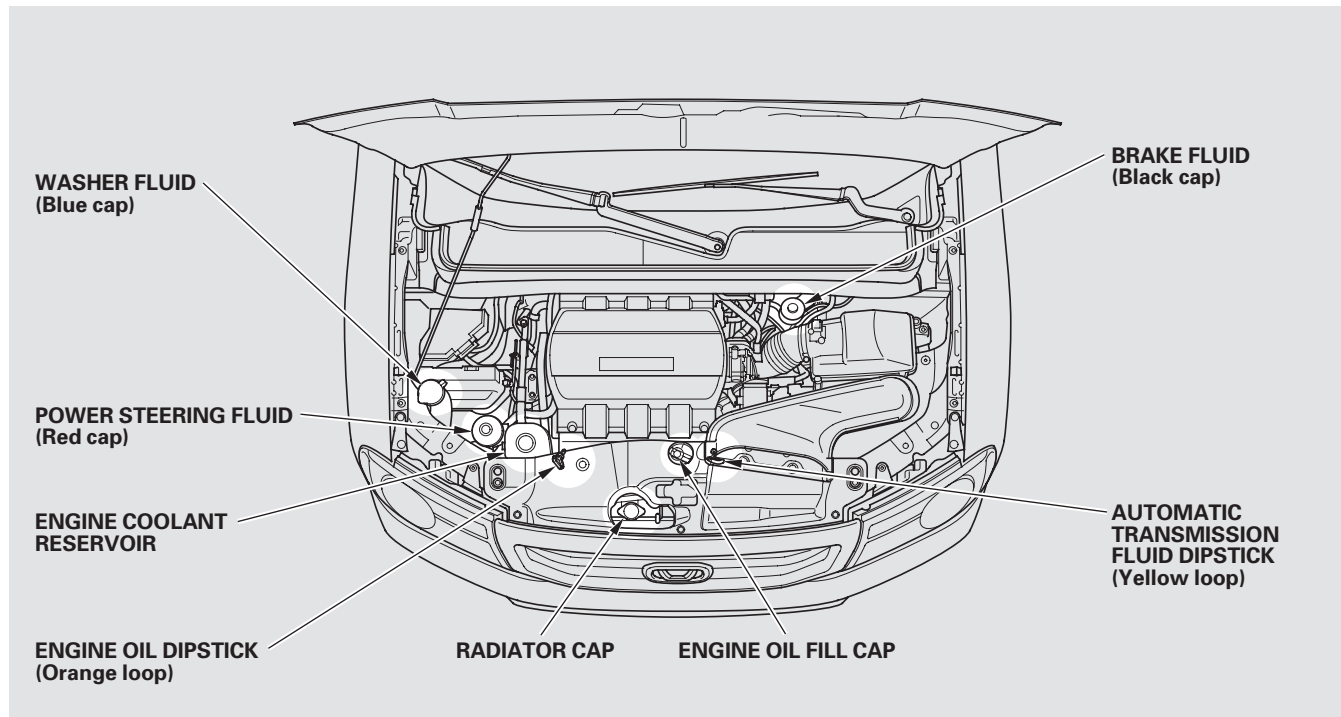

The component parts in the engine compartment are protected by the cover. You may need to remove the cover and the air intake cover when you perform some simple maintenance work.

Covers are secured by holding clips.

To remove the front bulkhead cover and the air intake cover, remove the holding clips with a flat-tip screwdriver.

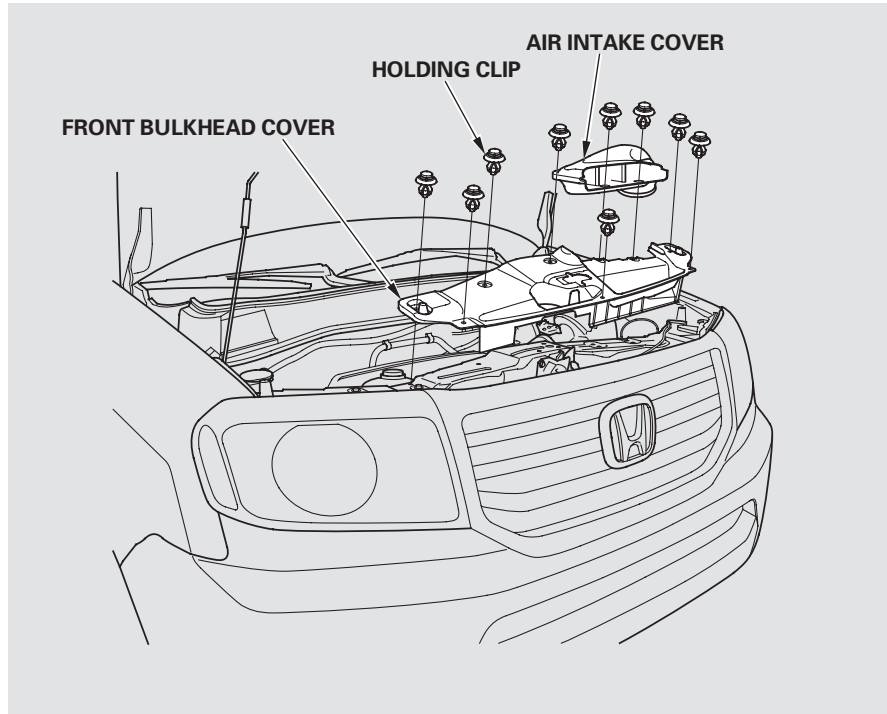

# Adding Engine Oil

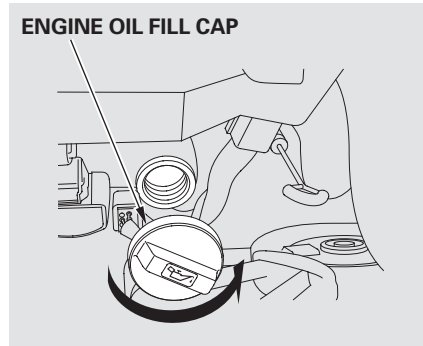

Unscrew and remove the engine oil fill cap on top of the valve cover. Pour in the oil slowly and carefully so you do not spill any. Clean up any spills immediately. Spilled oil could damage components in the engine compartment.

Reinstall the engine oil fill cap, and tighten it securely. Wait a few minutes, and recheck the oil level on the engine oil dipstick. Do not fill above the upper mark; you could damage the engine.

## Recommended Engine Oil

Oil is a major contributor to your engine's performance and longevity. Always use a premium-grade 0W-20 detergent oil displaying the API Certification Seal. This seal indicates the oil is energy conserving, and that it meets the American Petroleum Institute's latest requirements. It is highly recommended that you use Honda motor oil in your vehicle. Make sure the API Certification Seal says "For Gasoline Engines."



The oil viscosity or weight is provided on the container's label. 0W-20 oil is formulated for year-round protection of your vehicle to improve cold weather starting and fuel economy.

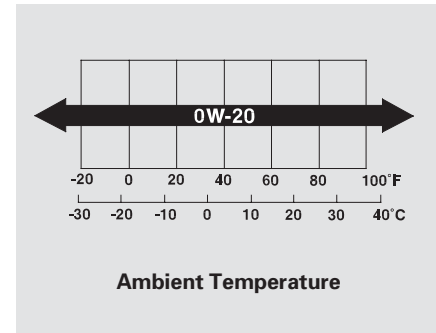



## Synthetic Oil

You may use a synthetic motor oil if it meets the same requirements given for a conventional motor oil: it displays the API Certification Seal, and it is the proper weight. You must follow the oil and filter change intervals shown on the odometer/trip meter display or on the multi-information display.

## Engine Oil Additives

Your vehicle does not require any oil additives. Additives may adversely affect the engine or transmission performance and durability.

## Changing the Engine Oil and Filter

Always change the oil and filter according to the maintenance messages shown on the information display or multi-information display (depending on the model). The oil and filter collect contaminants that can damage your engine if they are not removed regularly.

Changing the oil and filter requires special tools and access from underneath the vehicle. The vehicle should be raised on a service station-type hydraulic lift for this service. Unless you have the knowledge and proper equipment, you should have this maintenance done by a skilled mechanic.

1. Run the engine until it reaches normal operating temperature, then shut it off.

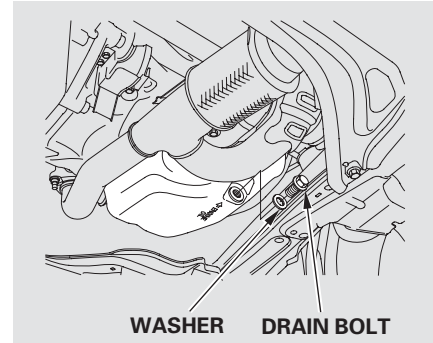

2. Open the hood, and remove the engine oil fill cap. Remove the oil drain bolt and washer from the bottom of the engine. Drain the oil into an appropriate container.

CONTINUED

## Changing the Engine Oil and Filter

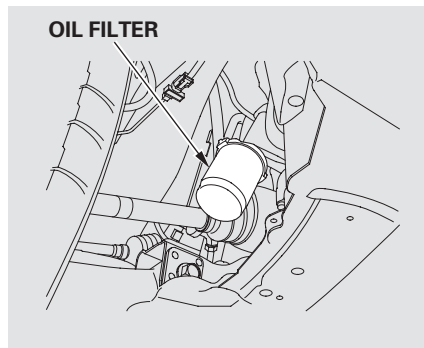

3. Remove the oil filter, and let the remaining oil drain. A special wrench (available from your dealer) is required.

Make sure the oil filter gasket is not stuck to the contacting surface of the engine. If it is, remove it before installing a new oil filter.

4. Install a new oil filter according to the instructions that come with it.

Make sure to clean off any dirt and dust on the contacting surface of a new oil filter.

5. Put a new washer on the drain bolt, then reinstall the drain bolt. Tighten the drain bolt to:  
29 lbf-ft (39 N·m , 4.0 kgf·m)

6. Refill the engine with the recommended oil.

Engine oil change capacity  
(including filter):  
4.5 US qt (4.3 ℓ)

7. Reinstall the engine oil fill cap. Start the engine. The oil pressure indicator should go out within 5 seconds. If it does not, turn off the engine, and check your work.

8. Let the engine run for several minutes, then check the drain bolt and oil filter for leaks.

9. Turn off the engine and let it sit for several minutes, then check the oil level on the dipstick. If necessary, add more oil.

### NOTICE

*Improper disposal of engine oil can be harmful to the environment. If you change your own oil, please dispose of the used oil properly. Put it in a sealed container, and take it to a recycling center. Do not discard it in a trash bin or dump it on the ground.*

## Adding Engine Coolant

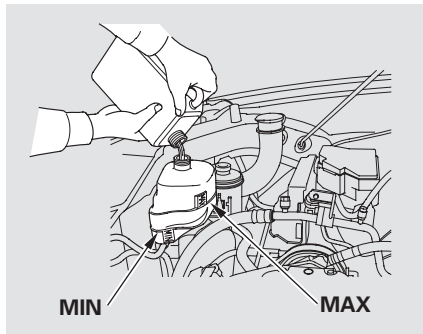

If the coolant level in the reserve tank is at or below the MIN line, add coolant to bring it up to the MAX line. Inspect the cooling system for leaks.

Always use Honda Long-life Antifreeze/Coolant Type 2. This coolant is pre-mixed with 50 percent antifreeze and 50 percent distilled water. Never add straight antifreeze or plain water.

If Honda antifreeze/coolant is not available, you may use another major-brand non-silicate coolant as a temporary replacement. Make sure it is a high-quality coolant recommended for aluminum engines. Continued use of any non-Honda coolant can result in corrosion, causing the cooling system to malfunction or fail. Have the cooling system flushed and refilled with Honda antifreeze/coolant as soon as possible.

If the reserve tank is completely empty, you should also check the coolant level in the radiator.

### **⚠ WARNING**

Removing the radiator cap while the engine is hot can cause the coolant to spray out, seriously scalding you.

Always let the engine and radiator cool down before removing the radiator cap.

*CONTINUED*

# Engine Coolant

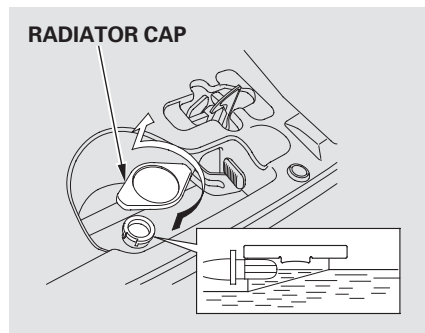

1. Make sure the engine and radiator are cool.
2. Relieve any pressure in the cooling system by turning the radiator cap counterclockwise, without pressing down.

3. Remove the radiator cap by pushing down and turning counterclockwise.

4. The coolant level should be up to the base of the filler neck. Add coolant if it is low.

Pour the coolant slowly and carefully so you do not spill any. Clean up any spill immediately; it could damage components in the engine compartment.

5. Put the radiator cap back on, and tighten it fully.

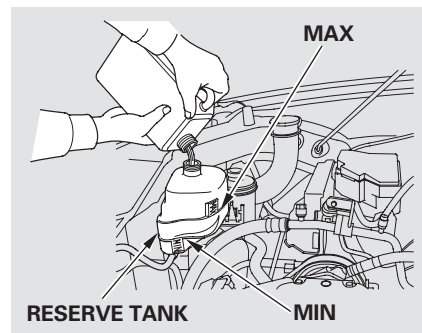

6. Pour coolant into the reserve tank. Fill it to halfway between the MAX and MIN marks. Put the cap back on the reserve tank.

Do not add any rust inhibitors or other additives to your vehicle's cooling system. They may not be compatible with the coolant or engine components.

Check the fluid level in the windshield washer reservoir at least monthly during normal use.

### *U.S. 2WD models*

Check the fluid level by removing the cap and looking at the level gauge.

### *If equipped*

The washer level indicator will come on when the level is low (see page 78 ).

### *On Touring 4WD models*

If the washer fluid is low, a “LOW WASHER FLUID” message appears on the multi-information display.

Fill the reservoir with a good-quality windshield washer fluid. This increases the cleaning capability and prevents freezing in cold weather.

When you refill the reservoir, clean the edges of the windshield wiper blades with windshield washer fluid on a clean cloth. This will help to condition the blade edges.

## NOTICE

*Do not use engine antifreeze or a vinegar/water solution in the windshield washer reservoir. Antifreeze can damage your vehicle's paint, while a vinegar/water solution can damage the windshield washer pump. Use only commercially-available windshield washer fluid.*

# Automatic Transmission Fluid

The transmission should be drained and refilled with new fluid when this service is shown on the information display or multi-information display (depending on the model).

Check the fluid level with the engine at normal operating temperature.

1. Park the vehicle on level ground. Start the engine, let it run until the radiator fan comes on, then shut off the engine. For accurate results, wait about 60 seconds (but no longer than 90 seconds) before doing step 2.

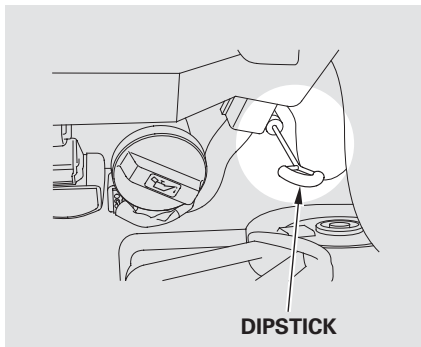

2. Remove the dipstick (yellow loop) from the transmission, and wipe it with a clean cloth.

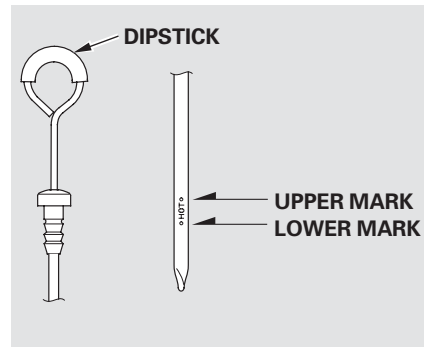

3. Insert the dipstick all the way into the transmission securely as shown in the illustration.
4. Remove the dipstick and check the fluid level. It should be between the upper and lower marks.

5. If the level is below the lower mark, add fluid into the dipstick hole to bring it to the level between the upper and lower marks.

Pour the fluid slowly and carefully so you do not spill any. Clean up any spill immediately; it could damage components in the engine compartment.

Always use Honda ATF DW-1 (automatic transmission fluid).

6. Insert the dipstick all the way back into the transmission securely as shown in the illustration.

Make sure the rubber cap on the dipstick fits in the dipstick guide and that you push the dipstick in all the way.

The transmission should be drained and refilled with new fluid when this service is indicated by a maintenance message on the multi-information display.

If you are not sure how to add fluid, contact your dealer.

### NOTICE

*Use only Honda ATF DW-1 (automatic transmission fluid). Do not mix with other transmission fluids.*

*Using transmission fluid other than Honda ATF DW-1 may cause deterioration in transmission operation and durability, and could result in damage to the transmission.*

*Damage resulting from the use of transmission fluid other than Honda ATF DW-1 is not covered by the Honda new vehicle warranty.*

## Brake Fluid

---

Replace the brake fluid when this service is indicated on a maintenance message on the information display or multi-information display (depending on the model).

Check the fluid level in the brake fluid reservoir monthly.

Independent of the Maintenance Minder information, replace the brake fluid every 3 years.

Always use Honda Heavy Duty Brake Fluid DOT 3. If it is not available, you should use only DOT 3 or DOT 4 fluid, from a sealed container, as a temporary replacement.

Using any non-Honda brake fluid can cause corrosion and decrease the life of the system. Have the brake system flushed and refilled with Honda Heavy Duty Brake Fluid DOT 3 as soon as possible.

Brake fluid marked DOT 5 is not compatible with your vehicle's braking system and can cause extensive damage.

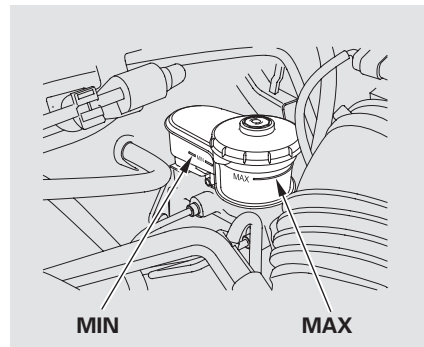

The fluid level should be between the MIN and MAX marks on the side of the reservoir. If the level is at or below the MIN mark, your brake system needs attention. Have the brake system inspected for leaks or worn brake pads.



## Power Steering Fluid

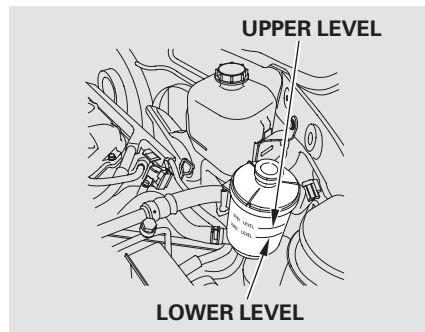

Check the level on the side of the reservoir when the engine is cold. The fluid should be between the **UPPER LEVEL** and **LOWER LEVEL**. If not add power steering fluid to the **UPPER LEVEL** mark.

Pour the fluid slowly and carefully so you do not spill any. Clean up any spills immediately; it could damage components in the engine compartment.

Always use Honda Power Steering Fluid. You may use another power steering fluid as an emergency replacement, but have the power steering system flushed and refilled with Honda PSF as soon as possible.

A low power steering fluid level can indicate a leak in the system. Check the fluid level frequently, and have the system inspected as soon as possible.

If you are not sure how to add fluid, contact your dealer.

### NOTICE

*Turning the steering wheel to full left or right lock and holding it there can damage the power steering pump.*

## Timing Belt

The timing belt should be replaced at the intervals shown in the Maintenance Minder™ schedule.

Replace the timing belt every 60,000 miles (100,000 km) if you regularly drive your vehicle in any of the following conditions:

- In very high temperatures (over 110°F, 43°C).
- In very low temperatures (under -20°F, -29°C).
- Frequently towing a trailer.

# Lights

## Headlight Aiming

The headlights were properly aimed when your vehicle was new. If you regularly carry heavy items in the cargo area or pull a trailer, readjustment may be required. Adjustments should be done by your dealer or another qualified technician.

## Replacing a Headlight/Daytime Running Light Bulb

Your vehicle has halogen headlight bulbs. When replacing a bulb, handle it by its base, and protect the glass from contact with your skin or hard objects. If you touch the glass, clean it with denatured alcohol and a clean cloth.

### NOTICE

*Halogen headlight bulbs get very hot when lit. Oil, perspiration, or a scratch on the glass can cause the bulb to overheat and shatter.*

## HIGH BEAM HEADLIGHT/ DAYTIME RUNNING LIGHT BULB

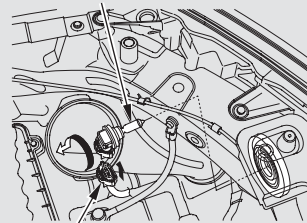

### CONNECTOR

The high beam headlight/daytime running light bulb and the low beam headlight bulb are replaced the same way.

1. Open the hood.

If you need to change the headlight bulb on the driver's side, remove the front end of the air intake duct by pulling it out.

## LOW BEAM HEADLIGHT BULB

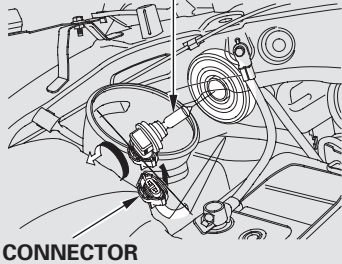

2. Remove the electrical connector from the bulb by pushing on the tab and pulling the connector down.
3. Remove the bulb by turning it about one-quarter turn counterclockwise.

4. Insert the new bulb into the hole, and turn it one-quarter turn clockwise to lock it in place.
5. Push the electrical connector onto the new bulb.
6. Turn on the headlights to test the new bulb.

## Replacing Front Turn Signal/ Parking and Side Marker Light Bulbs

### FRONT TURN SIGNAL/PARKING LIGHT

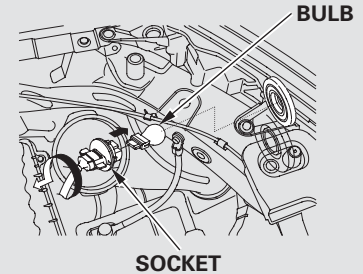

1. Open the hood.

If you need to change the bulbs on the driver's side, remove the front end of the air intake duct by pulling it out.

2. Remove the socket by turning it one-quarter turn counterclockwise.

*CONTINUED*

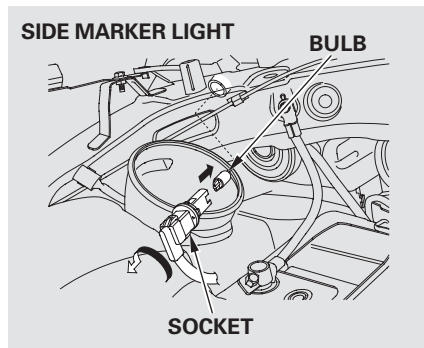

3. Pull the bulb straight out of its socket.
4. Push the new bulb straight into the socket until it bottoms.
5. Insert the socket back into the headlight assembly. Turn it clockwise to lock it in place.
6. Turn on the lights to make sure the new bulb is working.

## Replacing a Front Fog Light Bulb

*Except LX models*

Your vehicle uses halogen light bulbs. When replacing a bulb, handle it by its plastic case, and protect the glass from contact with your skin or hard objects. If you touch the glass, clean it with denatured alcohol and a clean cloth.

### NOTICE

*Halogen bulbs get very hot when lit. Oil, perspiration, or a scratch on the glass can cause the bulb to overheat and shatter.*

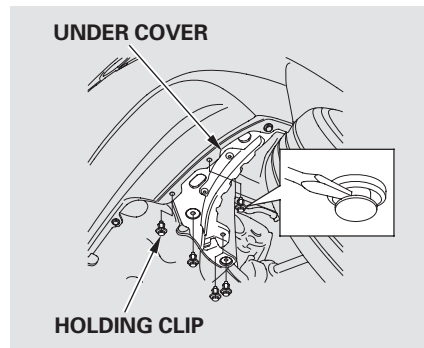

1. Remove the five holding clips with a flat-tip screwdriver.
2. Pull down the under cover from the bumper carefully.

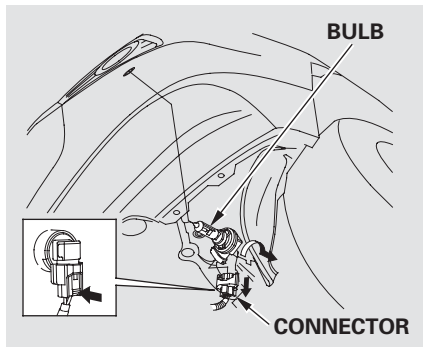

3. Remove the electrical connector from the bulb by pushing on the tab and pulling the connector down.
4. Remove the bulb from the fog light assembly by turning it one-quarter turn counterclockwise.
5. Install the new bulb into the hole and turn it one-quarter turn clockwise to lock it in place.

## Replacing Rear Bulbs (in Rear Pillar)

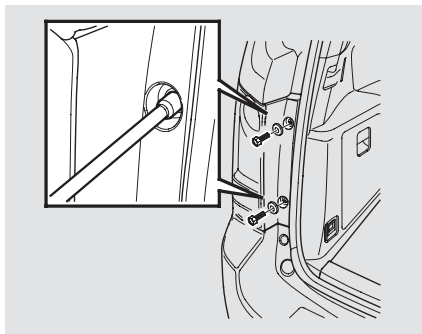

1. Open the tailgate.
2. Remove the two mounting bolts with an 8 mm wrench.

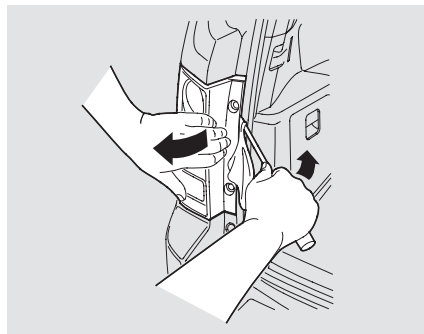

3. Place a cloth on the inner edge of the assembly to prevent scratches. Loosen the assembly by carefully prying on the top and side edges with a small flat-tip screwdriver. Use your fingers to further pull it loose.
4. Remove the assembly from the mounting holes by pulling it out.

*CONTINUED*

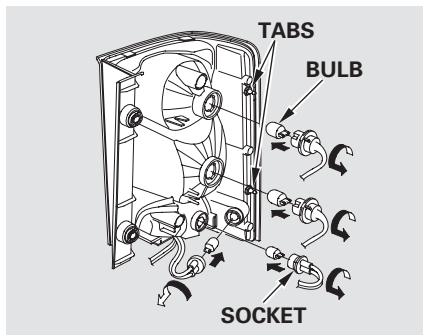

5. Determine which of the four bulbs is burned out: stop/taillight, back-up light, side marker light, or turn signal light.
6. Remove the socket by turning it one-quarter turn counterclockwise.
7. Pull the bulb straight out of its socket.

8. Push the new bulb straight into the socket until it bottoms.
9. Turn on the lights to make sure the new bulb is working.
10. Put the socket back into the light assembly, and turn it clockwise to lock it in place.
11. Align the two tabs on the light assembly with the mounting holes and install the rear light assembly in the rear pillar. Tighten the two bolts securely.

## Side Turn Signal Lights

### *On Touring models*

Each outside mirror has side turn signal lights. The lights should be replaced by your dealer.

## Replacing a High-mount Brake Light Bulb

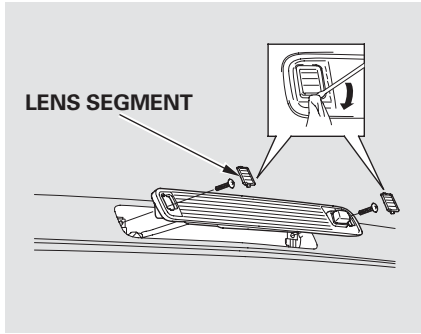

1. Place a cloth on the edge of the lens segment to prevent scratches. Remove each lens segment by carefully prying on its edge with a small flat-tip screwdriver.
2. Remove the screw under each lens.
3. Pull the high-mount brake light assembly out of the vehicle.

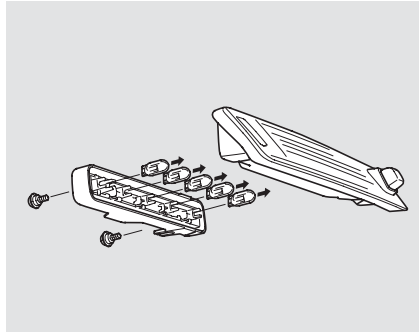

4. Remove the two mounting screws from the light assembly.
5. Remove the lens from the light assembly.
6. Pull the bulb straight out of its socket. Push the new bulb straight into the socket until it bottoms.

7. Put the lens back on the light assembly, and tighten the mounting bolts securely.
8. Turn on the lights to make sure the new bulb is working.
9. Put the light assembly back into the vehicle. Install the screws and tighten them securely. Reinstall the lens segments.

## Replacing a Rear License Plate Bulb

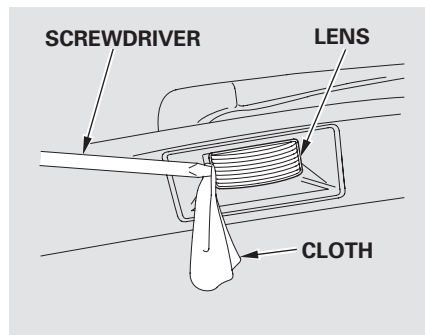

1. Place a cloth on the edge of the lens segment to prevent scratching. Insert a small flat-tip screwdriver between the left edge of the lens and the housing. The lens will come down.
2. Pull the bulb straight out of its socket. Push the new bulb in until it bottoms in the socket.

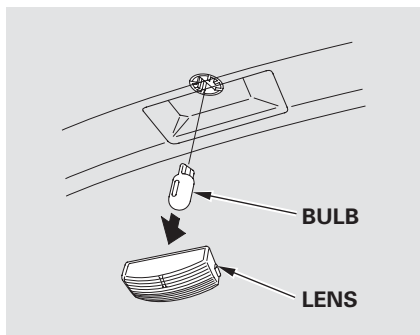

3. Turn on the parking lights and check that the new bulb is working.
4. Put the lens back into the light assembly, right side first. Push on the left edge until it snaps into place.



### Dust and Pollen Filter

This filter removes the dust and pollen that is brought in from the outside through the heating and cooling system/climate control system.

Have your dealer replace the filter when this service is indicated by a maintenance message on the information display or multi-information display (depending on the model). It should be replaced every 15,000 miles (24,000 km) if you drive primarily in urban areas that have high concentrations of soot in the air, or if the flow from the heating and cooling system/climate control system becomes less than usual.

### Cleaning the Seat Belts

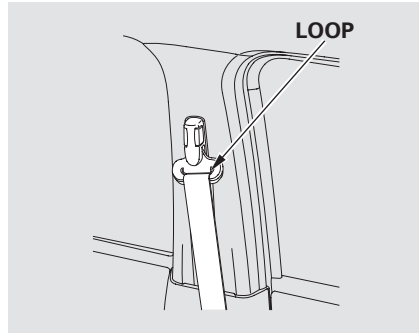

If your seat belts get dirty, use a soft brush with a mixture of mild soap and warm water to clean them. Do not use bleach, dye, or cleaning solvents. Let the belts air-dry before you use the vehicle.

Dirt build-up in the loops of the seat belt anchors can cause the belts to retract slowly. Wipe the insides of the loops with a clean cloth dampened in mild soap and warm water or isopropyl alcohol.

## Floor Mats

### Front

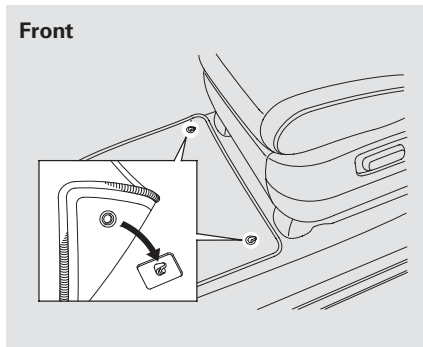

The floor mats that came with your vehicle hook over the floor mat anchors. This keeps the floor mats from sliding forward, possibly interfering with the pedals, or backwards, making the front passenger's weight sensors ineffective.

If you remove a floor mat, make sure to re-anchor it when you put it back in your vehicle.

### Rear

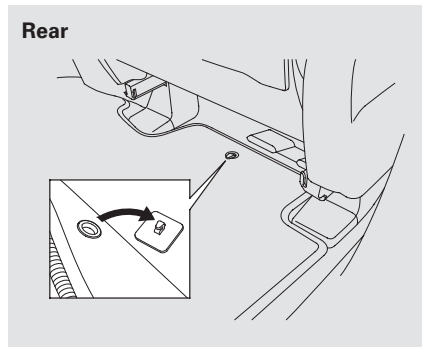

If you use a non-Honda floor mat, make sure it fits properly and that it can be used with the floor mat anchors. Do not put additional floor mats on top of the anchored mats.

Check the condition of the wiper blades at least every 6 months. Replace them if you find signs of cracking in the rubber, and areas that are getting hard or if they leave streaks and unwiped areas when used.

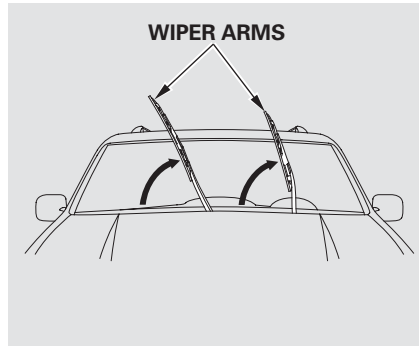

To replace the front wiper blades:

1. Raise each wiper arm off the windshield, lifting the driver's side first, then the passenger's side.

## NOTICE

*Do not open the hood when the wiper arms are raised, or you will damage the hood and the wiper arms.*

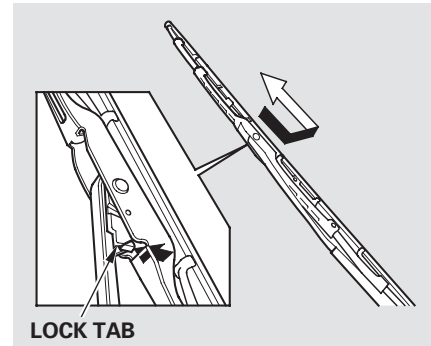

2. Disconnect the blade assembly from the wiper arm:
  - Press and hold the lock tab.
  - Slide the blade assembly toward the lock tab until it releases from the wiper arm.

When replacing a wiper blade, make sure not to drop the wiper blade or wiper arm down on the windshield.

CONTINUED

## Wiper Blades

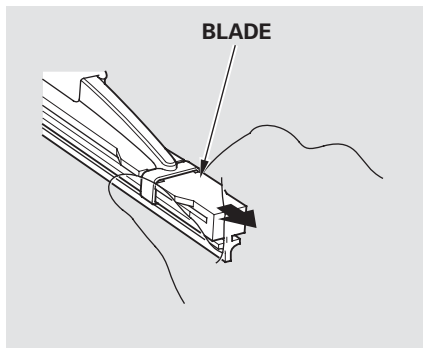

3. Remove the blade from its holder by grabbing the tabbed end of the blade. Pull firmly until the tabs come out of the holder.

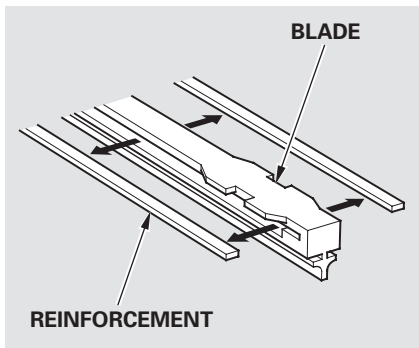

4. Examine the new wiper blades. If they have no plastic or metal reinforcement along the back edge, remove the metal reinforcement strips from the old wiper blade, and install them in the slots along the edge of the new blade.

5. Slide the new wiper blade into the holder until the tabs lock.
6. Slide the wiper blade assembly onto the wiper arm. Make sure it locks in place.
7. Lower the wiper arm against the window.  
Windshield: Lower the passenger's side first, then the driver's side.

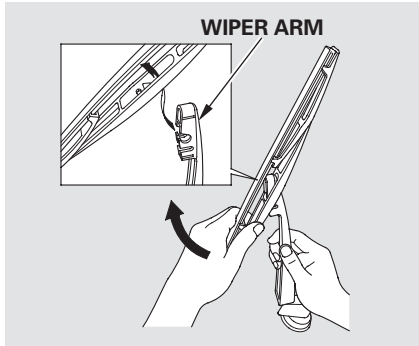

To replace the rear wiper blade:

1. Raise the wiper arm off the glass hatch and hold it.

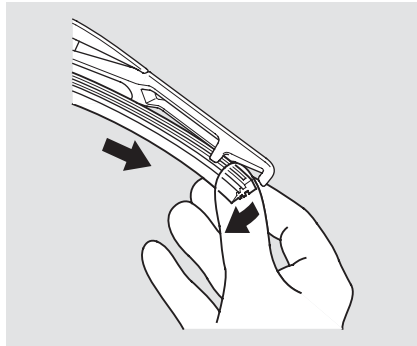

2. Slide the blade out of the wiper arm.

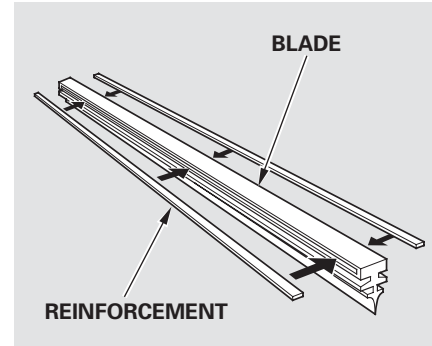

3. Examine the new wiper blades. If they have no plastic or metal reinforcement along the back edge, remove the metal reinforcement strips from the old wiper blade, and install them in the slots along the edge of the new blade.

CONTINUED

## Wiper Blades

---

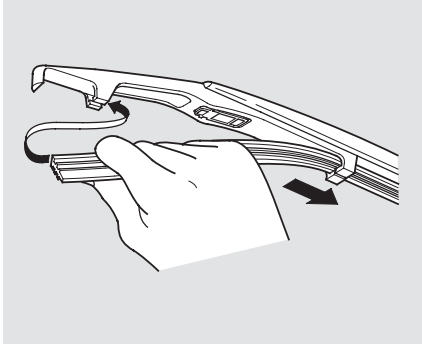

4. Slide the new blade into the wiper arm. Make sure it is engaged in the slot along its full length.
5. Lower the wiper arm down against the windshield or the hatch glass.

To safely operate your vehicle, your tires must be the proper type and size, in good condition with adequate tread, and correctly inflated.

The following pages give more detailed information on how to take care of your tires and what to do when they need to be replaced.

### **▲ WARNING**

Using tires that are excessively worn or improperly inflated can cause a crash in which you can be seriously hurt or killed.

Follow all instructions in this owner's manual regarding tire inflation and maintenance.

### **Inflation Guidelines**

Keeping the tires properly inflated provides the best combination of handling, tread life, and riding comfort.

- Underinflated tires wear unevenly, adversely affect handling and fuel economy, and are more likely to fail from being overheated.
- Overinflated tires can make your vehicle ride more harshly, are more prone to damage from road hazards, and wear unevenly.

The tire pressure monitoring system (TPMS) warns you when a tire pressure is low. See page 522 or 525 for more information.

Even though your vehicle is equipped with TPMS, we recommend that you visually check your tires every day. If you think a tire might be low, check it immediately with a tire gauge.

Use a gauge to measure the air pressure in each tire at least once a month. Even tires that are in good condition may lose 1 to 2 psi (10 to 20 kPa, 0.1 to 0.2 kgf/cm<sup>2</sup>) per month. Remember to check the spare tire at the same time.

*CONTINUED*

# Tires

---

Check the air pressures when the tires are cold. This means the vehicle has been parked for at least 3 hours, or driven less than 1 mile (1.6 km). Add or release air, if needed, to match the recommended cold tire pressures.

If you check air pressures when the tires are hot (driven for several miles/kilometers), you will see readings 4 to 6 psi (30 to 40 kPa, 0.3 to 0.4 kgf/cm<sup>2</sup>) higher than the cold readings. This is normal. Do not let air out to match the recommended cold air pressure. The tire will be underinflated.

While tubeless tires have some ability to self-seal if they are punctured, you should look closely for punctures if a tire starts losing pressure.

You should get your own tire pressure gauge and use it whenever you check your tire pressures. This will make it easier for you to tell if a pressure loss is due to a tire problem and not due to a variation between gauges.

## Recommended Tire Pressures

The following chart shows the recommended cold tire pressures for most normal and high-speed driving conditions.

| Tire Size       | Cold Tire Pressure for Normal Driving   |
|-----------------|---|
| P235/65R17 103T | Front:<br>31 psi (210 kPa ,<br>2.1 kgf/cm <sup>2</sup> )<br>Rear:<br>33 psi (230 kPa ,<br>2.3 kgf/cm <sup>2</sup> ) |
| P235/60R18 102T | Front/Rear:<br>35 psi (240 kPa ,<br>2.4 kgf/cm <sup>2</sup> )   |

The compact spare tire pressure is:  
60 psi (420 kPa , 4.2 kgf/cm<sup>2</sup>)

For convenience, the recommended tire sizes and cold tire pressures are on a label on the driver's doorjamb.

For additional information about your tires, see page 644 .



### Tire Inspection

Every time you check inflation, you should also examine the tires for damage, foreign objects, and wear.

You should look for:

- Bumps or bulges in the tread or side of the tire. Replace the tire if you find either of these conditions.
- Cuts, splits, or cracks in the side of the tire. Replace the tire if you can see fabric or cord.
- Excessive tread wear.

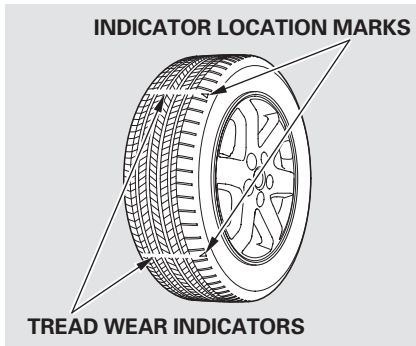

Your tires have wear indicators molded into the tread. When the tread wears down, you will see a 1/2 inch (12.7 mm) wide band across the tread. This shows there is less than 1/16 inch (1.6 mm) of tread left on the tire.

A tire this worn gives very little traction on wet roads. You should replace the tire if you can see three or more tread wear indicators.

### Tire Service Life

The service life of your tires is dependent on many factors, including, but not limited to, driving habits, road conditions, vehicle loading, inflation pressure, maintenance history, speed, and environmental conditions (even when the tires are not in use). In addition to your regular inspections and inflation pressure maintenance, it is recommended that you have annual inspections performed once the tires reach five years old. It is also recommended that all tires, including the spare, be removed from service after 10 years from the date of manufacture, regardless of their condition or state of wear.

The last four digits of the TIN (tire identification number) are found on the sidewall of the tire and indicate the date of manufacture (See **Tire Labeling** on page 646).

# Tires

## Tire Maintenance

In addition to proper inflation, correct wheel alignment helps to decrease tire wear. If you find a tire is worn unevenly, have your dealer check the wheel alignment.

Have your dealer check the tires if you feel a consistent vibration while driving. A tire should always be rebalanced if it is removed from the wheel. When you have new tires installed, make sure they are balanced. This increases riding comfort and tire life. For best results, have the installer perform a dynamic balance.

### NOTICE

*On vehicles with aluminum wheels, improper wheel weights can damage your vehicle's aluminum wheels. Use only Honda wheel weights for balancing.*

## Tire Rotation

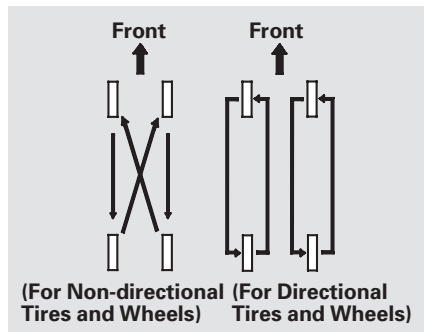

To help increase tire life and distribute wear more evenly, rotate the tires according to the maintenance messages displayed on the information display or multi-information display (depending on the model). Move the tires to the positions shown in the diagram each time they are rotated. If you purchase directional tires, rotate only front-to-back.

## Replacing Tires and Wheels

Replace your tires with radial tires of the same size, load range, speed rating, and maximum cold tire pressure rating (as shown on the tire's sidewall).

Mixing radial and bias-ply tires on your vehicle can reduce braking ability, traction, and steering accuracy. Using tires of a different size or construction can cause the ABS and vehicle stability assist system (VSA) to work inconsistently.

The ABS works by comparing the speed of the wheels. When replacing tires, use the same size originally supplied with the vehicle. Tire size and construction can affect wheel speed and may cause the system to activate.

When the tires are rotated, make sure the air pressures are checked.

It is best to replace all four tires at the same time. If that is not possible or necessary, replace the two front tires or two rear tires as a pair. Replacing just one tire can seriously affect your vehicle's handling.

If you ever replace a wheel, make sure that the wheel's specifications match those of the original wheels.

Also be sure you use only TPMS specific wheels. If you do not, the tire pressure monitoring system will not work.

*CONTINUED*

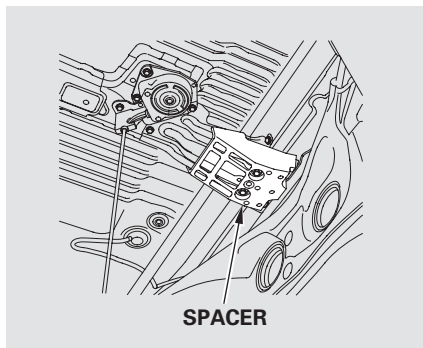

If you store a full size tire on the hoist, remove the spacer. Otherwise the hoist will not fully return to its original position.

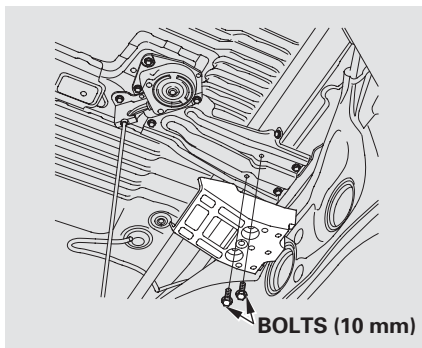

To remove the spacer, loosen the two bolts.

Replacement wheels are available at your dealer.

## **⚠ WARNING**

Installing improper tires on your vehicle can affect handling and stability. This can cause a crash in which you can be seriously hurt or killed.

Always use the size and type of tires recommended in this owner's manual.

## Wheel and Tire Specifications

### Wheels:

*U.S. LX models*

17 x 7 1/2J

*All models except U.S. LX models*

18 x 7 1/2J

### Tires:

*U.S. LX models*

P235/65R17 103T

*All models except U.S. LX models*

P235/60R18 102T

See page 644 for information about DOT Tire Quality Grading, and page 646 for tire size and labeling information.

## Winter Driving

Tires marked “M + S” or “All Season” on the sidewall have an all-weather tread design suitable for most winter driving conditions.

For the best performance in snowy or icy conditions, you should install snow tires or tire chains. They may be required by local laws under certain conditions.

## Snow Tires

If you mount snow tires on your vehicle, make sure they are radial tires of the same size and load range as the original tires. Mount snow tires on all four wheels. The traction provided by snow tires on dry roads may be lower than your original tires. Check with the tire dealer for maximum speed recommendations.

## Tire Chains

Mount tire chains on your tires when required by driving conditions or local laws. Install them only on the front tires.

Because your vehicle has limited tire clearance, Honda strongly recommends using the chains listed below.

SCC Super Z-6# SZ-429

When installing chains, follow the manufacturer's instructions and mount them as tightly as you can. Drive slowly with chains installed. If you hear them contacting the body or chassis, stop and investigate. Make sure the chains are installed tightly, and that they are not contacting the brake lines or suspension. Remove the chains as soon as you start driving on cleared roads.

## **⚠ WARNING**

Using the wrong chains, or not properly installing chains, can damage the brake lines and cause a crash in which you can be seriously injured or killed.

Follow all instructions in this owner's manual regarding the selection and use of tire chains.

## **NOTICE**

*Traction devices that are the wrong size or improperly installed can damage your vehicle's brake lines, suspension, body, and wheels. Stop driving if they are hitting any part of the vehicle.*

## Wheels

Clean the wheels as you would the rest of the exterior. Wash them with the same solution, and rinse them thoroughly.

Aluminum alloy wheels have a protective clear-coat that keeps the aluminum from corroding and tarnishing. Cleaning the wheels with harsh chemicals (including some commercial wheel cleaners) or a stiff brush can damage the clear-coat. To clean the wheels, use a mild detergent and a soft brush or sponge.

### TEST INDICATOR WINDOW

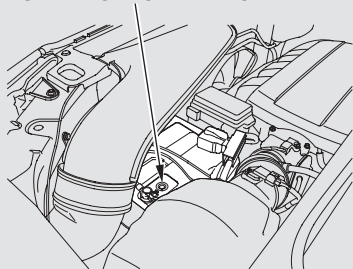

Check the condition of the battery monthly by looking at the test indicator window. The label on the battery explains the test indicator's colors.

Check the terminals for corrosion (a white or yellowish powder). To remove it, cover the terminals with a solution of baking soda and water. It will bubble up and turn brown. When this stops, wash it off with plain water. Dry off the battery with a cloth or paper towel. Coat the terminals with grease to help prevent further corrosion.

If additional battery maintenance is needed, see your dealer or a qualified technician.

**WARNING:** Battery posts, terminals, and related accessories contain lead and lead compounds. **Wash your hands after handling.**

If you need to connect the battery to a charger, disconnect both cables to prevent damaging your vehicle's electrical system. Always disconnect the negative (–) cable first, and reconnect it last.

### **⚠ WARNING**

The battery gives off explosive hydrogen gas during normal operation.

A spark or flame can cause the battery to explode with enough force to kill or seriously hurt you.

Wear protective clothing and a face shield, or have a skilled technician do the battery maintenance.

## Checking the Battery, Vehicle Storage

---

### *On vehicles without navigation system*

If your vehicle's battery is disconnected, or goes dead, the time is reset to 1:00. To set the time again, follow the setting procedure (see page 294).

### *On vehicles with navigation system*

The navigation system will also disable itself. The next time you turn on the ignition switch, the system will require you to enter a PIN before it can be used. Refer to the navigation system manual.

### **Vehicle Storage**

If you need to park your vehicle for an extended period (more than 1 month), there are several things you should do to prepare it for storage. Proper preparation helps prevent deterioration and makes it easier to get your vehicle back on the road. If possible, store your vehicle indoors.

- Fill the fuel tank.
- Wash and dry the exterior completely.
- Clean the interior. Make sure the carpeting, floor mats, etc., are completely dry.
- Leave the parking brake off. Put the transmission in Park.



- Block the rear wheels.
  - If the vehicle is to be stored for a longer period, it should be supported on jackstands so the tires are off the ground.
  - Leave one window open slightly (if the vehicle is being stored indoors).
  - Disconnect the battery.
  - Support the front and rear wiper blade arms with a folded towel or rag so they do not touch the windshield.
  - To minimize sticking, apply a silicone spray lubricant to all door and tailgate seals. Also, apply a vehicle body wax to the painted surfaces that mate with the door and tailgate seals.
- Cover the vehicle with a “breathable” cover, one made from a porous material such as cotton. Non-porous materials, such as plastic sheeting, trap moisture, which can damage the paint.
  - If possible, periodically run the engine until it reaches full operating temperature (the cooling fans cycle on and off twice). Preferably, do this once a month.

### **Leather**

*On EX-L and Touring models*

Vacuum dirt and dust from the leather frequently. Pay particular attention to the pleats and seams. Clean the leather with a soft cloth dampened with water solution of approximately 10% neutral wool detergent, then buff it with a clean, dry cloth. Remove any dust or dirt on leather surfaces immediately.



This section covers the more common problems that motorists experience with their vehicles. It gives you information about how to safely evaluate the problem and what to do to correct it. If the problem has stranded you on the side of the road, you may be able to get going again. If not, you will also find instructions on getting your vehicle towed.

- Compact Spare Tire..... 612
- Changing a Flat Tire ..... 613
- If the Engine Won't Start..... 620
- Jump Starting ..... 621
- If the Engine Overheats ..... 623
- Low Oil Pressure Indicator ..... 625
- Charging System Indicator..... 626
- Malfunction Indicator Lamp ..... 626
- Brake System Indicator ..... 627
- Fuses ..... 629
- Fuse Locations ..... 633
- Emergency Towing ..... 636
- If Your Vehicle Gets Stuck..... 637

## Compact Spare Tire

Use the compact spare tire as a temporary replacement only. Get your regular tire repaired or replaced, and put it back on your vehicle as soon as you can.

Check the air pressure of the compact spare tire every time you check the other tires. It should be inflated to:

60 psi (420 kPa , 4.2 kgf/cm<sup>2</sup>)

Follow these precautions:

- Never exceed 50 mph (80 km/h).
- This tire gives a harsher ride and less traction on some road surfaces. Use greater caution while driving.
- Do not mount snow chains on a compact spare.
- Do not use your compact spare tire on another vehicle unless it is the same make and model.

- If you store a full size tire on the hoist, remove the spacer. Otherwise the hoist will not fully return to its original position.

### *Except Touring models*

The low tire pressure indicator comes on and stays on after you replace the flat tire with the compact spare tire. After several miles (kilometers) driving with the compact spare tire, the TPMS indicator comes on and the low tire pressure indicator goes off.

### *On Touring models*

After the flat tire is replaced with the spare tire, the low tire pressure/TPMS indicator stays on. After several miles (kilometers) driving with the spare, this indicator begins to flash, then stays on again. You will also see a “CHECK TPMS SYSTEM” message on the multi-information display (see page 528 ).

### INDICATOR LOCATION MARK

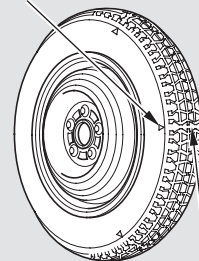

### TREAD WEAR INDICATOR BAR

Replace the tire when you can see the tread wear indicator bars. The replacement tire should be the same size and design, mounted on the same wheel. The spare tire is not designed to be mounted on a regular wheel, and the spare wheel is not designed for mounting a regular tire.

If you have a flat tire while driving, stop in a safe place to change it. Drive slowly along the shoulder until you get to an exit or an area to stop that is far away from the traffic lanes.

### **⚠ WARNING**

The vehicle can easily roll off the jack, seriously injuring anyone underneath.

Follow the directions for changing a tire exactly, and never get under the vehicle when it is supported only by the jack.

1. Park the vehicle on firm, level, and non-slippery ground. Put the transmission in Park. Apply the parking brake.

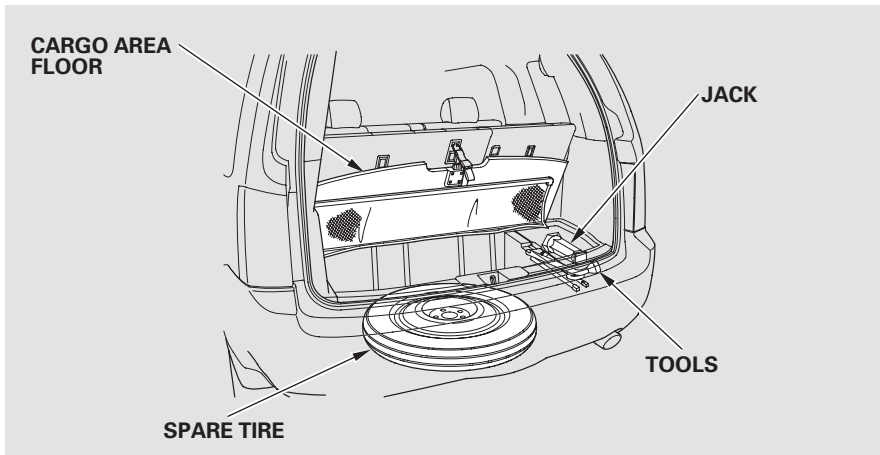

2. Turn on the hazard warning lights, and turn the ignition switch to the LOCK (0) position. Have all passengers get out of the vehicle while you change the tire.
3. Open the tailgate.
4. Push the rear edge of the handle to raise the handle loop and pull up the loop to raise the cargo area floor. Remove the cargo area floor.

*CONTINUED*

## Changing a Flat Tire

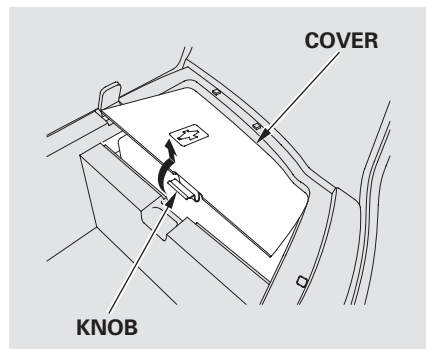

5. The tools and jack are under the cargo area behind a cover on the passenger's side. Remove the cover and take the jack out of the tool kit case.

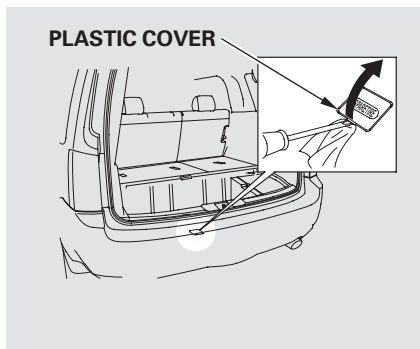

6. The spare tire is stored underneath the rear cargo area. Remove the plastic cover and the rubber cap on the cargo area lining to access the shaft for the spare tire hoist.

7. Fold down the third row seat (see page 162).

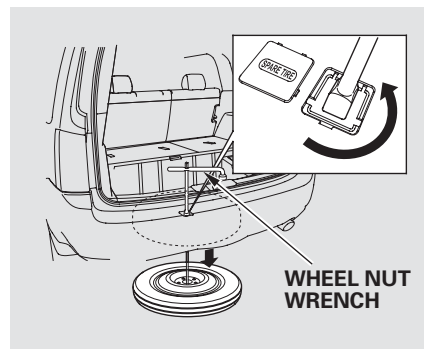

### NOTICE

*The wheel nut wrench supplied with your vehicle is specially adapted to fit the hoist shaft. Do not use any other tool.*

8. Put the extension with the wheel nut wrench on the hoist shaft. Turn the wrench counterclockwise to lower the spare tire to the ground.

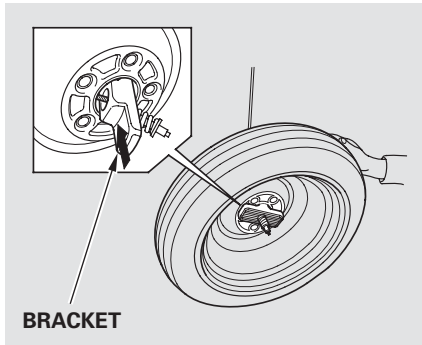

9. Keep turning the wheel nut wrench to create slack in the cable.
10. Remove the bracket from the spare tire.



11. Loosen each wheel nut 1/2 turn with the wheel nut wrench.

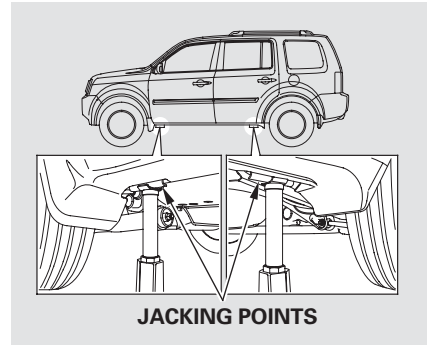

12. Place the jack under the jacking point nearest the tire you need to change.

CONTINUED

## Changing a Flat Tire

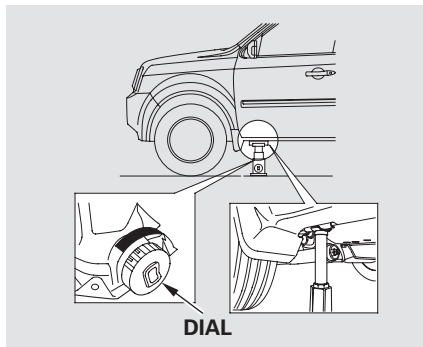

13. Turn the dial at the bottom of the jack clockwise until the top of the jack contacts the jacking point. Make sure the jacking point tab is resting in the jack notch.

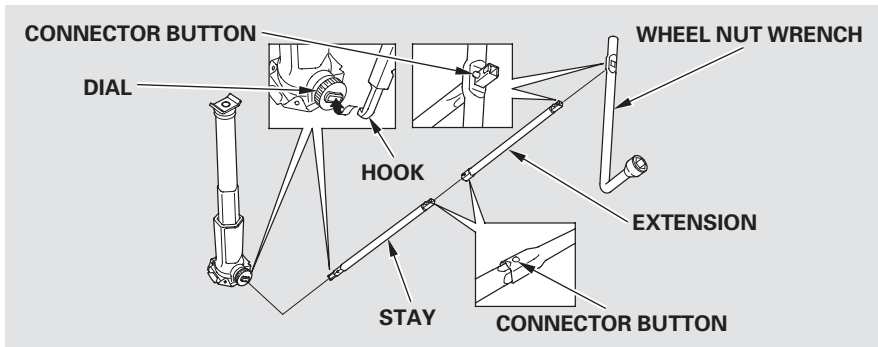

14. Attach the stay to the extension, then attach the wheel nut wrench to the end of the extension. Make sure the stay, the extension, and the wheel nut wrench are securely attached.
15. Insert the hook at the end of the stay into the opening on the dial at the bottom of the jack.



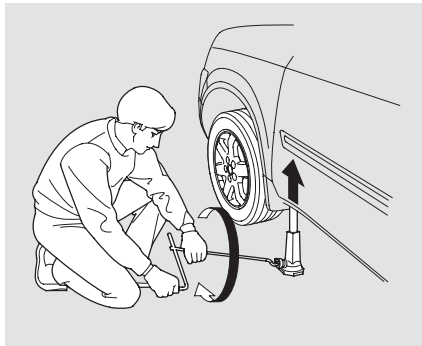

16. Turn the jack dial (wheel nut wrench) clockwise as shown to raise the vehicle until the flat tire is off the ground.

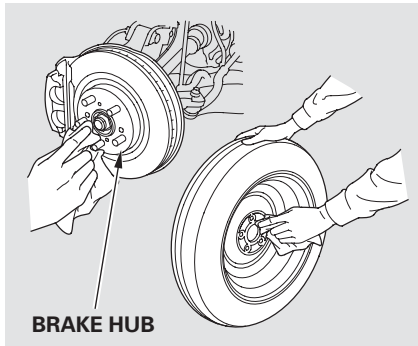

17. Before mounting the spare tire, wipe any dirt off the mounting surface of the wheel and hub with a clean cloth. Wipe the hub carefully; it may be hot from driving.

18. Put on the spare tire. Put the wheel nuts back on finger-tight, then tighten them in a crisscross pattern with the wheel nut wrench until the wheel is firmly against the hub. Do not try to tighten the wheel nuts fully.

19. Lower the vehicle to the ground, and remove the jack.

*CONTINUED*

## Changing a Flat Tire

---

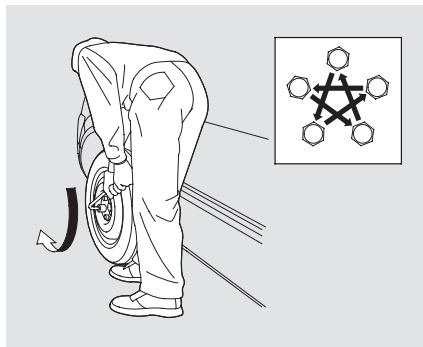

20. Tighten the wheel nuts securely in the same crisscross pattern. Have the wheel nut torque checked at the nearest automotive service facility.

Tighten the wheel nuts to:  
94 lbf·ft (127 N·m , 13 kgf·m)

21. Remove the center cap from the flat tire, and place the flat tire under the hoist, with the valve stem facing up.

22. Insert the hoist bracket into the center hole of the flat tire.

### WHEEL NUT WRENCH

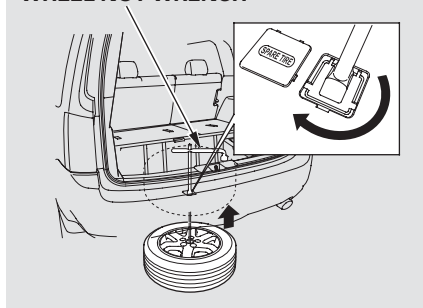

### NOTICE

*Always raise the spare tire hoist, even if you are not stowing a tire. If the hoist is left down, it will be damaged during driving and need to be replaced.*

25. Store the jack and the tools in the tool box.
26. Refer to **Changing a Tire with TPMS** (see page 524 or 529).

### ⚠ WARNING

Loose items can fly around the interior in a crash and could seriously injure the occupants.

Store the wheel, jack, and tools securely before driving.

23. Slowly turn the extension with the wheel nut wrench clockwise to take up the slack of the hoist cable. Make sure the bracket is seated in the center hole of the flat tire.
24. Turn the extension with the wheel nut wrench clockwise until the flat tire rests against the underbody of the vehicle and you hear the hoist click.

## If the Engine Won't Start

---

Diagnosing why the engine won't start falls into two areas, depending on what you hear when you turn the ignition switch to the START (III) position:

- You hear nothing, or almost nothing. The engine's starter motor does not operate at all, or operates very slowly.
- You can hear the starter motor operating normally, or the starter motor sounds like it is spinning faster than normal, but the engine does not start up and run.

### **Nothing Happens or the Starter Motor Operates Very Slowly**

When you turn the ignition switch to the START (III) position, you do not hear the normal noise of the engine trying to start. You may hear a clicking sound, a series of clicks, or nothing at all.

Check these things:

- Check the transmission interlock. The transmission must be in Park or neutral or the starter will not operate.
- Turn the ignition switch to the ON (II) position. Turn on the headlights, and check their brightness. If the headlights are very dim or do not come on at all, the battery is discharged. See **Jump Starting** on page 621.
- Turn the ignition switch to the START (III) position. If the headlights do not dim, check the condition of the fuses. If the fuses are OK, there is probably something wrong with the electrical circuit for the ignition switch or starter motor. You will need a qualified technician to determine the problem. See **Emergency Towing** on page 636.

If the headlights dim noticeably or go out when you try to start the engine, either the battery is discharged or the connections are corroded. Check the condition of the battery and terminal connections (see page 607). You can then try jump starting the vehicle from a booster battery (see page 621).

### **The Starter Operates Normally**

In this case, the starter motor's speed sounds normal, or even faster than normal, when you turn the ignition switch to the START (III) position, but the engine does not run.

- Are you using a properly coded key? An improperly coded key will cause the immobilizer system indicator in the instrument panel to blink rapidly (see page 76).

- Are you using the proper starting procedure? Refer to **Starting the Engine** on page 513 .
- Do you have fuel? Check the fuel gauge; the warning indicator may not be working.
- There may be an electrical problem, such as no power to the fuel pump. Check all the fuses (see page 630 ).

If you find nothing wrong, you will need a qualified technician to find the problem. See **Emergency Towing** on page 636 .

## Jump Starting

Although this seems like a simple procedure, you should take several precautions.

### **WARNING**

A battery can explode if you do not follow the correct procedure, seriously injuring anyone nearby.

Keep all sparks, open flames, and smoking materials away from the battery.

You cannot start your vehicle by pushing or pulling it.

## To Jump Start Your Vehicle:

1. Open the hood, and check the physical condition of the battery. In very cold weather, check the condition of the electrolyte. If it seems slushy or frozen, do not try jump starting until it thaws.

### **NOTICE**

*If a battery sits in extreme cold, the electrolyte inside can freeze. Attempting to jump start with a frozen battery can cause it to rupture.*

2. Turn off all the electrical accessories: heater, A/C, climate control, audio system, lights, etc. Put the transmission in neutral or Park, and set the parking brake.

CONTINUED

## Jump Starting

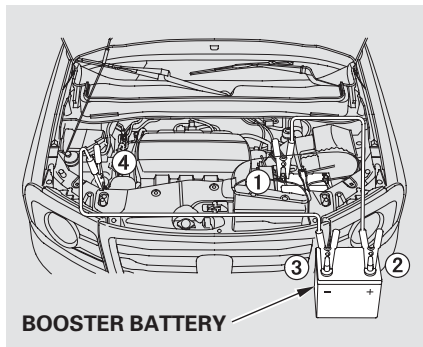

The numbers in the illustration show you the order to connect the jumper cables.

3. Connect one jumper cable to the positive (+) terminal on your vehicle's battery. Connect the other end to the positive (+) terminal on the booster battery.

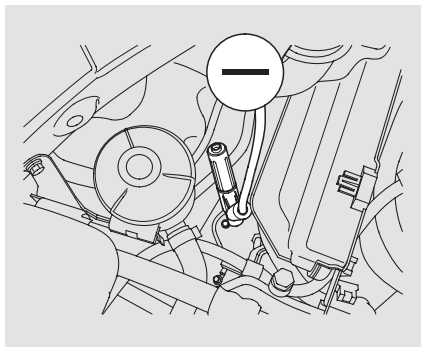

4. Connect the second jumper cable to the negative (-) terminal on the booster battery. Connect the other end to the grounding strap as shown. Do not connect this jumper cable to any other part of the engine.

5. If the booster battery is in another vehicle, have an assistant start that vehicle and run it at a fast idle.
6. Start your vehicle. If the starter motor still operates slowly, check that the jumper cables have good metal-to-metal contact.
7. Once the vehicle is running, disconnect the negative cable from your vehicle, then from the booster battery. Disconnect the positive cable from your vehicle, and then from the booster battery.

Keep the ends of the jumper cables away from each other and any metal on the vehicle until everything is disconnected. Otherwise, you may cause an electrical short.

The pointer of your vehicle's temperature gauge should stay in the midrange under most conditions. If it climbs to the red mark, you should determine the reason (hot day, driving up a steep hill, etc.).

If the vehicle overheats, you should take immediate action. The only indication may be the temperature gauge climbing to or above the red mark. Or you may see steam or spray coming from under the hood.

### NOTICE

*Driving with the temperature gauge pointer at the red mark can cause serious damage to the engine.*

### **▲ WARNING**

Steam and spray from an overheated engine can seriously scald you.

Do not open the hood if steam is coming out.

1. Safely pull to the side of the road. Put the transmission in Park, and set the parking brake. Turn off all the accessories, and turn on the hazard warning lights.
2. If you see steam and/or spray coming from under the hood, turn off the engine. Wait until you see no more signs of steam or spray, then open the hood.
3. If you do not see steam or spray, leave the engine running and watch the temperature gauge. If the high heat is due to overloading, the engine should start to cool down almost immediately. If it does, wait until the temperature gauge comes down to the midpoint, then continue driving.

CONTINUED

## If the Engine Overheats

---

4. If the temperature gauge stays at the red mark, turn off the engine.
5. Look for any obvious coolant leaks, such as a split radiator hose. Everything is still extremely hot, so use caution. If you find a leak, it must be repaired before you continue driving (see **Emergency Towing** on page 636).
6. If you do not find an obvious leak, check the coolant level in the radiator reserve tank. Add coolant if the level is below the MIN mark.
7. If there was no coolant in the reserve tank, you may need to add coolant to the radiator. Let the engine cool down until the pointer reaches the middle of the temperature gauge, or lower, before checking the radiator.

### **WARNING**

Removing the radiator cap while the engine is hot can cause the coolant to spray out, seriously scalding you.

Always let the engine and radiator cool down before removing the radiator cap.

8. Using gloves or a large heavy cloth, turn the radiator cap counterclockwise, without pushing down, to the first stop. After the pressure releases, push down on the cap, and turn it until it comes off.
9. Start the engine, and set the temperature to maximum heat (climate control to AUTO at “”). Add coolant to the radiator up to the base of the filler neck. If you do not have the proper coolant mixture available, you can add plain water. Remember to have the cooling system drained and refilled with the proper mixture as soon as you can.
10. Put the radiator cap back on tightly. Run the engine, and check the temperature gauge. If it goes back to the red mark, the engine needs repair (see **Emergency Towing** on page 636).
11. If the temperature stays normal, check the coolant level in the radiator reserve tank. If it has gone down, add coolant to the MAX mark. Put the cap back on tightly.





This indicator should never come on when the engine is running. If it starts flashing or stays on, the oil pressure has dropped very low or lost pressure. Serious engine damage is possible, and you should take immediate action.

### *On Touring models*

You will also see a “CHECK ENGINE OIL LEVEL” message on the multi-information display when this indicator comes on.

The indicator notifies you of low oil pressure and does not measure the oil level. Check your vehicle’s oil level at each refueling.

### **NOTICE**

*Running the engine with low oil pressure can cause serious mechanical damage almost immediately. Turn off the engine as soon as you can safely get the vehicle stopped.*

1. Safely pull off the road, and shut off the engine. Turn on the hazard warning indicators.
2. Let the vehicle sit for a minute. Open the hood, and check the oil level (see page 500). An engine very low on oil can lose pressure during cornering and other driving maneuvers.
3. If necessary, add oil to bring the level back to the full mark on the dipstick (see page 576).
4. Start the engine, and watch the oil pressure indicator. If it does not go out within 10 seconds, turn off the engine. There is a mechanical problem that needs to be repaired before you can continue driving (see **Emergency Towing** on page 636).

## Charging System Indicator, Malfunction Indicator Lamp

---



### Charging System Indicator

If the charging system indicator comes on brightly when the engine is running, the battery is not being charged.

#### *On Touring models*

You will also see a “CHECK CHARGING SYSTEM” message on the multi-information display (see page 93 ).

Immediately turn off all electrical accessories. Try not to use other electrically operated controls such as the power windows. Keep the engine running; starting the engine will discharge the battery rapidly.

Go to a service station or garage where you can get technical assistance.



### Malfunction Indicator Lamp

If this indicator comes on while driving, it means one of the engine’s emissions control systems may have a problem. Even though you may feel no difference in your vehicle’s performance, it can reduce your fuel economy and cause increased emissions. Continued operation may cause serious damage.

If you have recently refueled your vehicle, the indicator coming on could be due to a loose or missing fuel fill cap. Tighten the cap until it clicks at least once. Tightening the cap will not turn the indicator off immediately; it can take several days of normal driving.

If the indicator comes on repeatedly, even though it may turn off as you continue driving, have your vehicle checked by the dealer as soon as possible.

### NOTICE

*If you keep driving with the malfunction indicator lamp on, you can damage your vehicle’s emissions controls and engine. Those repairs may not be covered by your vehicle’s warranties.*

#### *On Touring models*

You will also see a “CHECK EMISSION SYSTEM” message on the multi-information display (see page 93 ).

### Readiness Code

Your vehicle has certain “readiness codes” that are part of the on-board diagnostics for the emissions systems. In some states, part of the emissions testing is to make sure these codes are set. If they are not set, the test cannot be completed.

## Malfunction Indicator Lamp, Brake System Indicator

If the battery in your vehicle has been disconnected or gone dead, these codes may be erased. It takes several days of driving under various conditions to set the codes again.

To check if they are set, turn the ignition switch to the ON (II) position, without starting the engine. The malfunction indicator lamp will come on for 20 seconds. If it then goes off, the readiness codes are set. If it blinks five times, the readiness codes are not set. If possible, do not take your vehicle for an emissions test until the readiness codes are set. Refer to **Emissions Testing** for more information (see page 654 ).



### Parking Brake and Brake System Indicator (Red)

The brake system indicator normally comes on when you turn the ignition switch to the ON (II) position, and as a reminder to check the parking brake. It will stay on if you do not fully release the parking brake.

If the brake system indicator comes on while driving, the brake fluid level is probably low. Press lightly on the brake pedal to see if it feels normal. If it does, check the brake fluid level the next time you stop at a service station (see page 584 ).

#### *On Touring models*

You will also see a “LOW BRAKE FLUID” message on the multi-information display (see page 93 ).

If the fluid level is low, take your vehicle to a dealer, and have the brake system inspected for leaks or worn brake pads.

However, if the brake pedal does not feel normal, you should take immediate action. A problem in one part of the system’s dual circuit design will still give you braking at two wheels. You will feel the brake pedal go down much farther before the vehicle begins to slow down, and you will have to press harder on the pedal.

#### *On Touring models*

You will also see a “CHECK BRAKE SYSTEM” message on the multi-information display (see page 93 ).

CONTINUED

## Brake System Indicator

---

Slow down by shifting to a lower gear, and pull to the side of the road when it is safe. Because of the long distance needed to stop, it is hazardous to drive the vehicle. You should have it towed, and repaired as soon as possible (see **Emergency Towing** on page 636).

If you must drive the vehicle a short distance in this condition, drive slowly and carefully.

If the ABS indicator and the VSA system indicator come on with the brake system indicator, have your vehicle inspected by your dealer immediately.

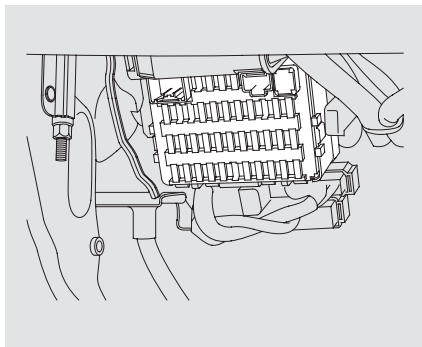

The vehicle's fuses are located in four fuse boxes.

The interior fuse box is underneath the dashboard on the driver's side.

**REAR**

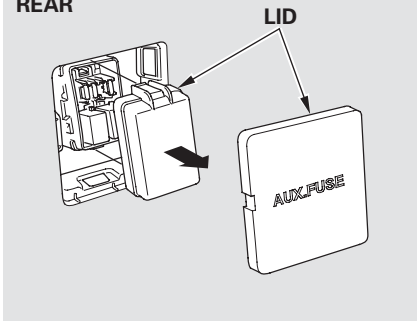

The rear fuse box is located at the left side of cargo area.

The primary under-hood fuse box is located on the passenger's side. The secondary fuse box is located next to the battery.

To open it, push the tabs as shown.

**UNDER-HOOD (PRIMARY)**

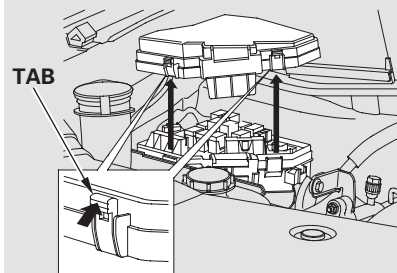

**UNDER-HOOD (SECONDARY)**

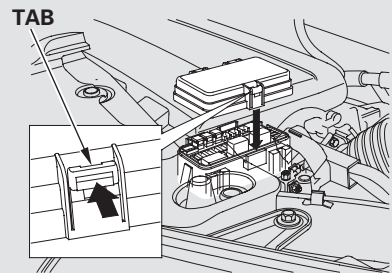

# Fuses

## Checking and Replacing Fuses

If something electrical in your vehicle stops working, the first thing you should check for is a blown fuse. Determine from the chart on pages 633 , 634 , and 635 , or the diagram on the fuse box lid, which fuse or fuses control that device. Check those fuses first, but check all the fuses before deciding that a blown fuse is the cause. Replace any blown fuses, and check if the device works.

1. Turn the ignition switch to the LOCK (0) position. Make sure the headlights and all other accessories are off.
2. Remove the cover from the fuse box.

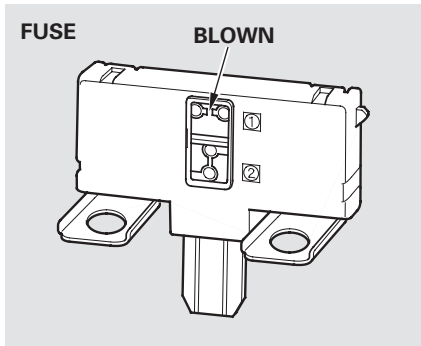

3. Check each of the large fuses in the under-hood fuse boxes by looking through the top at the wire inside. Removing these fuses requires a Phillips-head screwdriver.

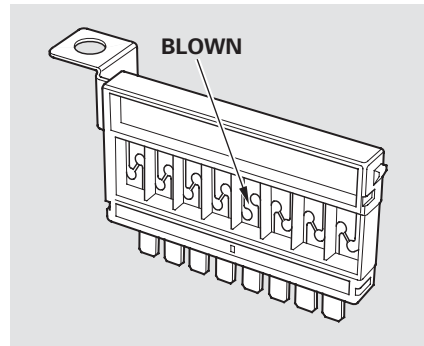

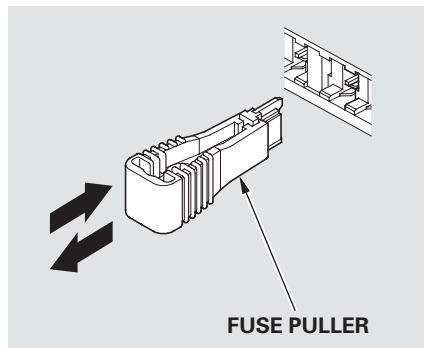

4. Check the smaller fuses in the under-hood fuse boxes and rear fuse box, and all the fuses in the interior and rear fuse boxes by pulling out each one with the fuse puller provided in the primary under-hood fuse box.

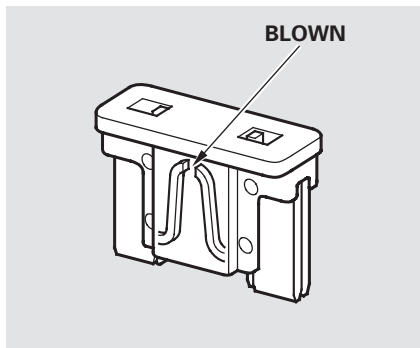

5. Look for a burned wire inside the fuse. If it is burned out, replace it with one of the spare fuses of the same rating or lower.

If you cannot drive the vehicle without fixing the problem, and you do not have a spare fuse, take a fuse of the same rating or a lower rating from one of the other circuits. Make sure you can do without that circuit temporarily (such as the accessory power socket or radio).

If you replace the blown fuse with a spare fuse that has a lower rating, it might blow out again. This does not indicate that anything is wrong. Replace the fuse with one of the correct rating as soon as you can.

*CONTINUED*

# Fuses

---

## NOTICE

*Replacing a fuse with one that has a higher rating greatly increases the chances of damaging the electrical system. If you do not have a replacement fuse with the proper rating for the circuit, install one with a lower rating.*

6. If the replacement fuse of the same rating blows in a short time, there is probably a serious electrical problem with your vehicle. Leave the blown fuse in that circuit, and have your vehicle checked by a qualified technician.



## PRIMARY UNDER-HOOD FUSE BOX

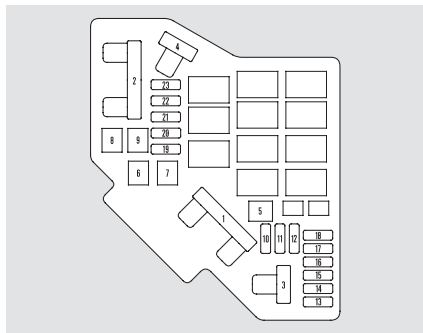

| No. | Amps. | Circuits Protected |
|-----|-------|--------------------|
| 1   | 120 A | Main Fuse          |
|     | —     | Not Used           |
| 2   | 80 A  | OP Main            |
|     | 50 A  | IG Main            |
| 3   | 40 A  | Blower             |
|     | 30 A  | AC Inverter        |
| 4   | 50 A  | Head Light Main    |
|     | 40 A  | Power Window Main  |
| 5   | —     | Not Used           |
| 6   | 30 A  | Condenser Fan      |
| 7   | 30 A  | Cooling Fan        |
| 8   | 30 A  | Rear Defroster     |
| 9   | —     | Not Used           |
| 10  | 20 A  | Front Fog Light    |
| 11  | 15 A  | Sub                |
| 12  | 10 A  | ACM                |

| No. | Amps. | Circuits Protected                     |
|-----|-------|--|
| 13  | 20 A  | Front Passenger's Power Seat Reclining |
| 14  | 20 A  | Front Passenger's Power Seat Slide     |
| 15  | 7.5 A | Oil Level                              |
| 16  | 7.5 A | FI ECU                                 |
| 17  | 20 A  | Radio                                  |
| 18  | 15 A  | IG Coil                                |
| 19  | 15 A  | Main                                   |
| 20  | 7.5 A | MG Clutch                              |
| 21  | 15 A  | DBW                                    |
| 22  | 7.5 A | Interior Light                         |
| 23  | 10 A  | Back Up                                |

CONTINUED

# Fuse Locations

## SECONDARY UNDER-HOOD FUSE BOX

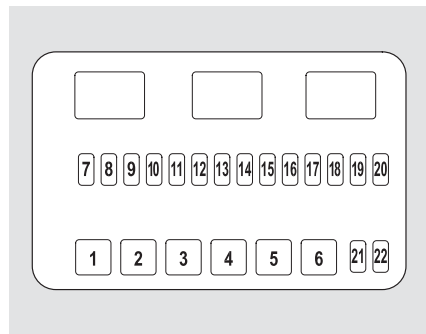

| No. | Amps. | Circuits Protected   |
|-----|-------|----------------------|
| 1   | 40 A  | Power Tailgate Motor |
| 2   | 20 A  | VTM-4                |
| 3   | 30 A  | Trailer Main         |
| 4   | 40 A  | VSA FSR              |

| No. | Amps. | Circuits Protected              |
|-----|-------|---------------------------------|
| 5   | 30 A  | Rear Blower                     |
| 6   | 30 A  | VSA Motor                       |
| 7   | 15 A  | Hazard                          |
| 8   | 20 A  | Power Tailgate Closer           |
| 9   | 20 A  | Driver's Power Seat Reclining   |
| 10  | 20 A  | Driver's Power Seat Slide       |
| 11  | 20 A  | Stop & Horn                     |
| 12  | 15 A  | Rear Console Accessory Socket   |
| 13  | 10 A  | Rear Wiper                      |
| 14  | 20 A  | Trailer E-Brake                 |
| 15  | 20 A  | Front Heated Seat               |
| 16  | 15 A  | Center Console Accessory Socket |
| 17  | 20 A  | Trailer Charge                  |
| 18  | 15 A  | Front Accessory Socket          |
| 19  | 15 A  | Rear Accessory Socket           |
| 20  | 20 A  | Glass Hatch Motor               |
| 21  | 15 A  | Rear Heated Seat                |
| 22  | 30 A  | Head Light Washer Motor         |

## REAR FUSE BOX

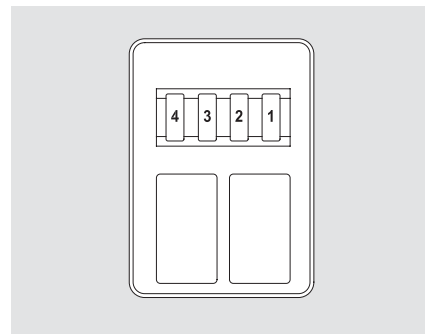

| No. | Amps. | Circuits Protected |
|-----|-------|--------------------|
| 1   | 20 A  | Small Light        |
| 2   | 7.5 A | Stop Lamp          |
| 3   | 7.5 A | Back Lamp          |
| 4   | 7.5 A | Turn Lamp, Hazard  |

## INTERIOR FUSE BOX

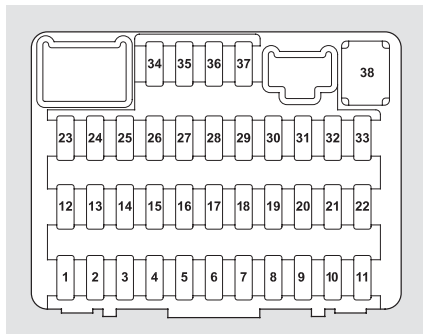

| No. | Amps. | Circuits Protected |
|-----|-------|--------------------|
| 1   | 7.5 A | VTM-4              |
| 2   | 20 A  | Fuel Pump          |
| 3   | 10 A  | ACG                |
| 4   | 7.5 A | VSA                |
| 5   | —     | Not Used           |

| No. | Amps. | Circuits Protected          |
|-----|-------|-----------------------------|
| 6   | —     | Not Used                    |
| 7   | 10 A  | Auto Light                  |
| 8   | 7.5 A | Auto Light                  |
| 9   | 7.5 A | ODS                         |
| 10  | 7.5 A | Meter                       |
| 11  | 10 A  | SRS                         |
| 12  | 10 A  | Right Daytime Running Light |
| 13  | 10 A  | Left Daytime Running Light  |
| 14  | 7.5 A | Small Lights (Interior)     |
| 15  | 10 A  | Small Lights (Exterior)     |
| 16  | 15 A  | Right Head Light Low        |
| 17  | 15 A  | Left Head Light Low         |
| 18  | 20 A  | Daytime Running Light Main  |
| 19  | 15 A  | Small Lights Main           |
| 20  | —     | Not Used                    |
| 21  | 7.5 A | TPMS                        |
|     | 20 A  | Head Light Low Main         |

| No. | Amps. | Circuits Protected                 |
|-----|-------|------------------------------------|
| 22  | 7.5 A | VBSOL2                             |
| 23  | 7.5 A | STRLD                              |
| 24  | —     | Not Used                           |
| 25  | —     | Not Used                           |
| 26  | 20 A  | Driver's Power Window              |
| 27  | 20 A  | HAC OP                             |
| 28  | 20 A  | Moonroof                           |
| 29  | 20 A  | Door Lock                          |
| 30  | 20 A  | Front Passenger's Power Window     |
| 31  | 30 A  | Audio Amp*                         |
| 32  | 20 A  | Passenger's Side Rear Power Window |
| 33  | 20 A  | Driver's Side Rear Power Window    |
| 34  | —     | Not Used                           |
| 35  | 10 A  | ACC                                |
| 36  | 10 A  | HAC                                |
| 37  | 7.5 A | Day Light                          |
| 38  | 30 A  | Wiper                              |

\* : On vehicles with rear entertainment system

## Emergency Towing

---

If your vehicle needs to be towed, call a professional towing service or organization. Never tow your vehicle with just a rope or chain. It is very dangerous.

### *4WD models*

**The only way you can safely tow your vehicle is with flat-bed equipment.** The operator will load your vehicle on the back of a truck. Any other method of towing will damage the drive system. When you contact the towing agency, inform them a flat-bed is required.

### **NOTICE**

*Towing with only two tires on the ground will damage parts of the 4WD system. It should be transported on a flat-bed truck or trailer.*

### *Except 4WD models*

There are two ways to tow your vehicle:

***Flat-bed Equipment*** – The operator loads your vehicle on the back of a truck. **This is the best way to transport your vehicle.**

***Wheel-lift Equipment*** – The tow truck uses two pivoting arms that go under the front tires and lift them off the ground. The rear tires remain on the ground. **This is an acceptable way to tow your vehicle.**

If your vehicle gets stuck in sand, mud, or snow, call a towing service to pull it out (see the previous page).

For very short distances, such as freeing the vehicle, you can use the detachable towing hook that mounts on the anchors in the front and rear bumpers.

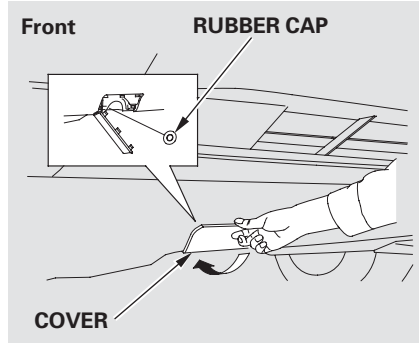

To use the front towing hook:

1. Remove the cover, put cloth on the edge of the cover to prevent scratches and carefully pry with a small flat-tip screwdriver or a metal fingernail file.

The cover is attached to the bumper with a tether.

2. Remove the rubber cap by pulling it out.

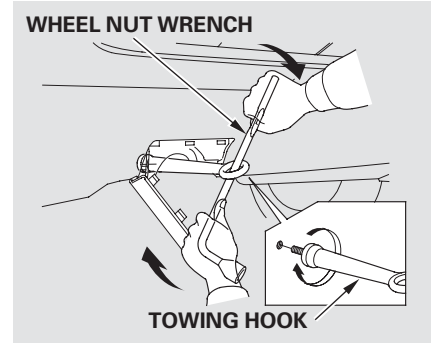

3. Remove the towing hook and wheel nut wrench placed behind a cover under the cargo area.
4. Screw the towing hook into the hole, and tighten it with the wheel nut wrench.

*CONTINUED*

## If Your Vehicle Gets Stuck

---

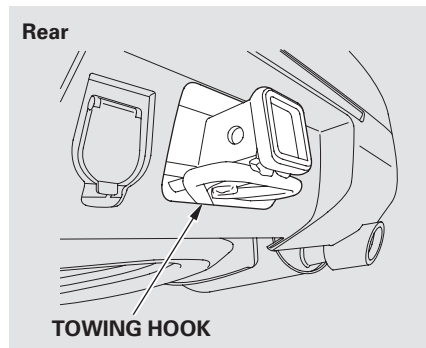

To use the rear towing hook:  
Remove the rear bumper cover.  
Refer to “Towing a Trailer” on page  
547 .

### NOTICE

*To avoid damage to your vehicle, use the towing hook for straight, flat ground towing only. Do not tow at an angle. The tow hook should not be used to tow the vehicle onto a flat bed. Do not use it as a tie down.*

The diagrams in this section give you the dimensions and capacities of your vehicle and the locations of the identification numbers. It also includes information you should know about your vehicle's tires and emissions control systems.

|  |     |
|--|-----|
| Identification Numbers.....  | 640 |
| Specifications .....   | 642 |
| DOT Tire Quality Grading<br>(U.S. Vehicles) .....                                | 644 |
| Tire Labeling.....   | 646 |
| Tire Pressure Monitoring System<br>(TPMS) – Required Federal<br>Explanation..... | 648 |
| Emissions Controls.....  | 651 |
| Three Way Catalytic Converter...   | 653 |
| Emissions Testing .....  | 654 |

## Identification Numbers

Your vehicle has several identifying numbers located in various places.

The vehicle identification number (VIN) is the 17-digit number your dealer uses to register your vehicle for warranty purposes. It is also necessary for licensing and insuring your vehicle. The easiest place to find the VIN is on a plate fastened to the top of the dashboard. You can see it by looking through the windshield on the driver's side. It is also on the certification label attached to the driver's doorjamb, and is stamped on the engine compartment bulkhead. The VIN is also provided in bar code on the certification label.

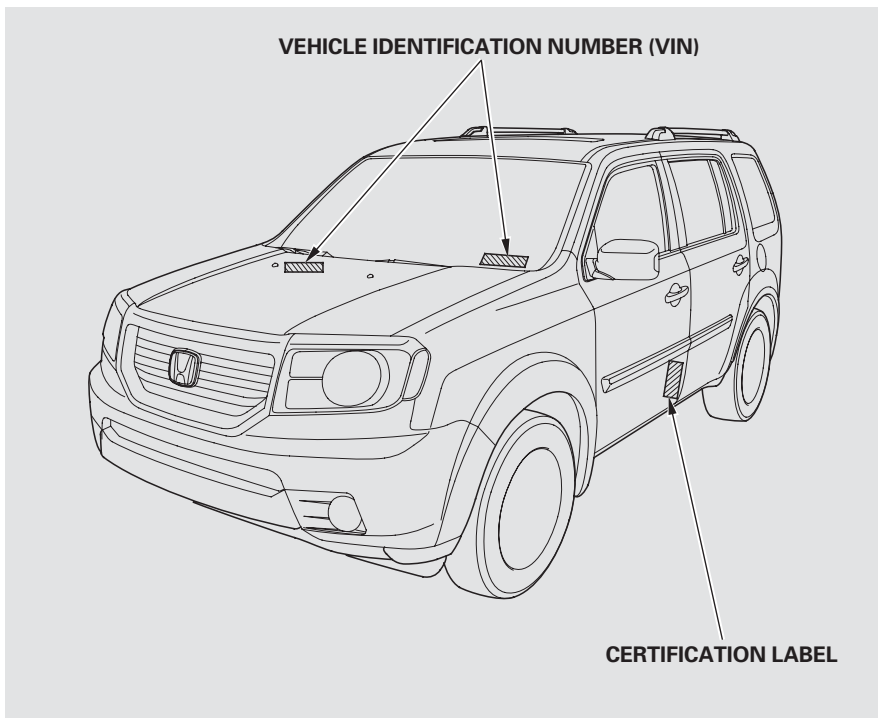



The engine number is stamped into the engine block. It is on the front.

The transmission number is on a label on top of the transmission.

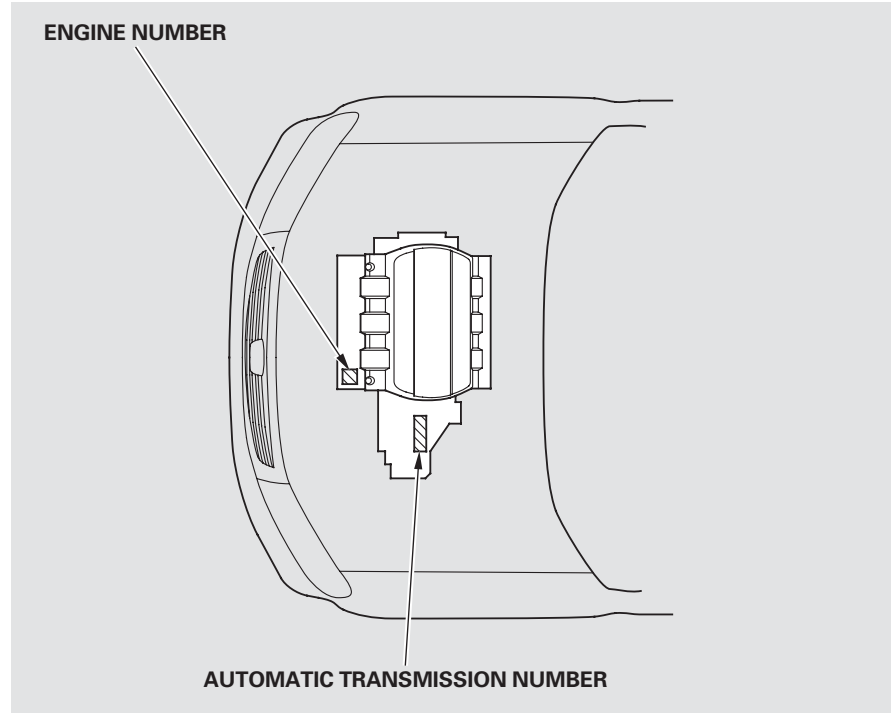

# Specifications

## Dimensions

|           |  |
|-----------|--|
| Length    | 191.4 in (4,861 mm)  |
| Width     | 78.5 in (1,995 mm)   |
| Height    | 70.9 in (1,802 mm)* <sup>1</sup><br>72.7 in (1,846 mm)* <sup>2</sup> |
| Wheelbase | 109.3 in (2,775 mm)  |
| Track     | Front 67.7 in (1,720 mm)<br>Rear 67.5 in (1,715 mm)                  |

\* 1 : U.S. LX models

\* 2 : Except U.S. LX models

## Weights

|   |  |
|---|--|
| Gross vehicle weight rating                       | See the tire information label attached to the driver's doorjamb.        |
| Gross combined weight rating (GCWR)* <sup>1</sup> | 8,466 lbs (3,840 kg) <sup>*2</sup><br>9,579 lbs (4,345 kg) <sup>*3</sup> |

\* 1 : The GCWR must be reduced 2 percent for every 1,000 feet (305 meters) of elevation.

\* 2 : 2WD models

\* 3 : 4WD models

## Air Conditioning

|                  |                              |
|------------------|------------------------------|
| Refrigerant type | HFC-134a (R-134a)            |
| Charge quantity  | 21.2 – 22.9 oz (600 – 650 g) |
| Lubricant type   | ND-OIL8                      |

## Seating Capacities

|        |   |
|--------|---|
| Total  | 8 |
| Front  | 2 |
| Second | 3 |
| Third  | 3 |

## Capacities

|                               |   |  |
|-------------------------------|---|--|
| Fuel tank                     |   | Approx. 21.00 US gal (79.5 ℓ)  |
| Engine coolant                | Change* <sup>1</sup><br>Total                                       | 1.98 US gal (7.5 ℓ)<br>2.48 US gal (9.4 ℓ)   |
| Engine oil                    | Change* <sup>2</sup><br>Including filter<br>Without filter<br>Total | 4.5 US qt (4.3 ℓ)<br>4.2 US qt (4.0 ℓ)<br>5.3 US qt (5.0 ℓ)  |
| Automatic transmission fluid  | 2WD Change<br>Total<br>4WD Change<br>Total                          | 3.3 US qt (3.1 ℓ)* <sup>3</sup><br>3.6 US qt (3.4 ℓ)* <sup>4</sup><br>8.0 US qt (7.6 ℓ)* <sup>3</sup><br>8.6 US qt (8.1 ℓ)* <sup>4</sup><br>3.6 US qt (3.4 ℓ)<br>8.6 US qt (8.1 ℓ) |
| Rear differential fluid (4WD) | Change<br>Total   | 2.79 US qt (2.64 ℓ)<br>3.01 US qt (2.85 ℓ)   |
| Transfer assembly fluid (4WD) | Change<br>Total   | 0.45 US qt (0.43 ℓ)<br>0.48 US qt (0.45 ℓ)   |
| Windshield washer reservoir   | U.S. vehicles<br>Canadian vehicles                                  | 4.2 US qt (4.0 ℓ)<br>6.9 US qt (6.5 ℓ)   |

\* 1 : Including the coolant in the reserve tank and that remaining in the engine

Reserve tank capacity: 0.196 US gal (0.74 ℓ)

\* 2 : Excluding the oil remaining in the engine

\* 3 : Without automatic transmission fluid cooler

\* 4 : With automatic transmission fluid cooler

## Lights

|  |       |            |
|--|-------|------------|
| Headlights (High)/<br>Daytime running lights |       | 60 W (HB3) |
| Headlights (Low)                             |       | 55 W (H11) |
| Front side marker lights                     |       | 3 CP       |
| Front turn signal/<br>parking lights         |       | 28/8 W     |
| Front fog lights*                            |       | 55 W (H11) |
| Rear turn signal/taillights                  |       | 21/5 W     |
| Stop/taillights                              |       | 21/5 W     |
| Rear side marker lights                      |       | 5 W        |
| Back-up lights                               |       | 18 W       |
| License plate lights                         |       | 5 W        |
| Individual map lights                        | Front | 8 W        |
|  | Rear  | 4 CP       |
| Cargo area lights                            |       | 8 W        |
| High-mount brake lights                      |       | 5 W        |
| Vanity mirror lights                         |       | 1.4 W      |
| Door courtesy lights                         |       | 2 CP       |
| Glove box light                              |       | 1.4 W      |
| Front console compartment<br>light           |       | 1.4 W      |

\* : Except LX models

## Battery

|          |                    |
|----------|--------------------|
| Capacity | 12 V — 60 AH/5 HR  |
|          | 12 V — 72 AH/20 HR |

## Alignment

|        |       |                  |
|--------|-------|------------------|
| Toe-in | Front | 0.00 in (0.0 mm) |
|        | Rear  | 0.08 in (2.0 mm) |
| Camber | Front | —0°30'           |
|        | Rear  | —0°30'           |

## Alignment

|        |       |
|--------|-------|
| Caster | 4°17' |
|--------|-------|

## Fuses

|            |  |
|------------|--|
| Interior   | See page 635 or the fuse label attached on the side panel.                 |
| Rear       | See page 634 or the fuse label attached to the inside of the fuse box lid. |
| Under-hood | See page 633 and 634 or the fuse box cover.                                |

## Engine

|                   |   |
|-------------------|---|
| Type              | Water cooled 4-stroke SOHC i-VTEC VCM 6-cylinder (V6) gasoline engine |
| Bore x Stroke     | 3.50 x 3.66 in (89.0 x 93.0 mm)                                       |
| Displacement      | 212 cu-in (3,471 cm <sup>3</sup> )                                    |
| Compression ratio | 10.5 : 1  |
| Spark plugs       | DILZKR7A11G<br>DILZKR7A11DS   |

## Tires

|      |            |  |
|------|------------|--|
| Size | Front/Rear | P235/65R17 103T *1<br>P235/60R18 102T *2   |
|      | Spare      | T165/80D17 104M  |
|      | Pressure   | 31 psi (210 kPa , 2.1 kgf/cm <sup>2</sup> )*1<br>35 psi (240 kPa , 2.4 kgf/cm <sup>2</sup> )*2 |
|      | Rear       | 33 psi (230 kPa , 2.3 kgf/cm <sup>2</sup> )*1<br>35 psi (240 kPa , 2.4 kgf/cm <sup>2</sup> )*2 |
|      | Spare      | 60 psi (420 kPa , 4.2 kgf/cm <sup>2</sup> )  |

\* 1 : U.S. LX models

\* 2 : Except U.S. LX models

## DOT Tire Quality Grading (U.S. Vehicles)

---

The tires on your vehicle meet all U.S. Federal Safety Requirements. All tires are also graded for treadwear, traction, and temperature performance according to Department of Transportation (DOT) standards. The following explains these gradings.

### **Uniform Tire Quality Grading**

Quality grades can be found where applicable on the tire sidewall between tread shoulder and maximum section width. For example:

**Treadwear 200**

**Traction AA**

**Temperature A**

All passenger car tires must conform to Federal Safety Requirements in addition to these grades.

### **Treadwear**

The treadwear grade is a comparative rating based on the wear rate of the tire when tested under controlled conditions on a specified government test course. For example, a tire graded 150 would wear one and one-half (1 1/2) times as well on the government course as a tire graded 100. The relative performance of tires depends upon the actual conditions of their use, however, and may depart significantly from the norm due to variations in driving habits, service practices and differences in road characteristics and climate.

### **Traction**

The traction grades, from highest to lowest, are AA, A, B, and C. Those grades represent the tire's ability to stop on wet pavement as measured under controlled conditions on specified government test surfaces of asphalt and concrete. A tire marked C may have poor traction performance.

**Warning:** The traction grade assigned to this tire is based on straight-ahead braking traction tests, and does not include acceleration, cornering, hydroplaning, or peak traction characteristics.

### Temperature

The temperature grades are A (the highest), B, and C, representing the tire's resistance to the generation of heat and its ability to dissipate heat when tested under controlled conditions on a specified indoor laboratory test wheel. Sustained high temperature can cause the material of the tire to degenerate and reduce tire life, and excessive temperature can lead to sudden tire failure. The grade C corresponds to a level of performance which all passenger car tires must meet under the Federal Motor Vehicle Safety Standard No. 109. Grades B and A represent higher levels of performance on the laboratory test wheel than the minimum required by law.

Warning: The temperature grade for this tire is established for a tire that is properly inflated and not overloaded. Excessive speed, underinflation, or excessive loading, either separately or in combination, can cause heat buildup and possible tire failure.

# Tire Labeling

The tires that came on your vehicle have a number of markings. Those you should be aware of are described below.

## TIRE LABELING EXAMPLE

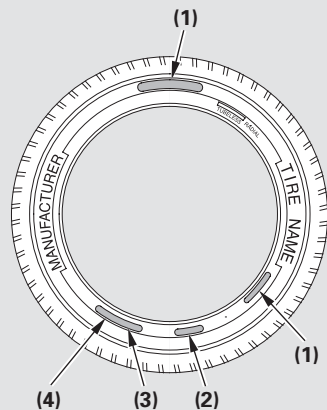

- (1) Tire Size
- (2) Tire Identification Number (TIN)
- (3) Maximum Tire Pressure
- (4) Maximum Tire Load

## **Tire Size**

Whenever tires are replaced, they should be replaced with tires of the same size. The following is an example of tire size with an explanation of what each component means.

P235/60R18 102T

- P – Vehicle type (P indicates passenger vehicle).
- 235 – Tire width in millimeters.
- 60 – Aspect ratio (the tire's section height as a percentage of its width).
- R – Tire construction code (R indicates radial).
- 18 – Rim diameter in inches.

102 – Load index (a numerical code associated with the maximum load the tire can carry).

T – Speed symbol (an alphabetical code indicating the maximum speed rating).

## **Tire Identification Number (TIN)**

The tire identification number (TIN) is a group of numbers and letters that look like the following example. TIN is located on the sidewall of the tire.

DOT B97R FW6X 2202

DOT – This indicates that the tire meets all requirements of the U.S. Department of Transportation.

B97R – Manufacturer's identification mark.

FW6X — Tire type code.

2202 — Date of manufacture.  
└───┬─── Year  
    └─── Week

## Glossary of Tire Terminology

**Cold Tire Pressure** — The tire air pressure when the vehicle has been parked for at least three hours or driven less than 1 mile (1.6 km).

**Load Rating** — Means the maximum load that a tire is rated to carry for a given inflation pressure.

**Maximum Inflation Pressure** — The maximum tire air pressure that the tire can hold.

**Maximum Load Rating** — Means the load rating for a tire at the maximum permissible inflation pressure for that tire.

**Recommended Inflation Pressure** — The cold tire inflation pressure recommended by the manufacturer.

**Treadwear Indicators (TWI)** — Means the projections within the principal grooves designed to give a visual indication of the degrees of wear of the tread.

## Tire Pressure Monitoring System (TPMS) – Required Federal Explanation

---

Each tire, including the spare (if provided), should be checked monthly when cold and inflated to the inflation pressure recommended by the vehicle manufacturer on the vehicle placard or tire inflation pressure label.

(If your vehicle has tires of a different size than the size indicated on the vehicle placard or tire inflation pressure label, you should determine the proper tire inflation pressure for those tires.)

As an added safety feature, your vehicle has been equipped with a tire pressure monitoring system (TPMS) that illuminates a low tire pressure telltale



when one or more of your tires is significantly under-inflated.

Accordingly, when the low tire pressure telltale illuminates, you should stop and check your tires as soon as possible, and inflate them to the proper pressure.

Driving on a significantly under inflated tire causes the tire to overheat and can lead to tire failure. Underinflation also reduces fuel efficiency and tire tread life, and may affect the vehicle's handling and stopping ability.

Please note that the TPMS is not a substitute for proper tire maintenance, and it is the driver's responsibility to maintain correct tire pressure, even if under-inflation has not reached the level to trigger illumination of the TPMS low tire pressure telltale.



## Tire Pressure Monitoring System (TPMS) – Required Federal Explanation

---

### *Except Touring models*

Your vehicle has also been equipped with a TPMS malfunction indicator to indicate when the system is not operating properly. The TPMS malfunction indicator is provided by a separate telltale, which displays the symbol “TPMS” when illuminated.

When the malfunction indicator is illuminated,



**TPMS**

the system may not be able to detect or signal low tire pressure as intended.

TPMS malfunctions may occur for a variety of reasons, including the installation of replacement or alternate tires or wheels on the vehicle that prevent the TPMS from functioning properly.

Always check the TPMS malfunction telltale after replacing one or more tires or wheels on your vehicle to ensure that the replacement or alternate tires and wheels allow the TPMS to continue to function properly.

## Tire Pressure Monitoring System (TPMS) – Required Federal Explanation

---

### *On Touring models*

Your vehicle has also been equipped with a TPMS malfunction indicator to indicate when the system is not operating properly. The TPMS malfunction indicator is combined with the low tire pressure telltale. When the system detects a malfunction, the telltale will flash for approximately one minute and then remain continuously illuminated. This sequence will continue upon subsequent vehicle start-ups as long as the malfunction exists.

When the malfunction indicator is illuminated, the system may not be able to detect or signal low tire pressure as intended.

TPMS malfunctions may occur for a variety of reasons, including the installation of replacement or alternate tires or wheels on the vehicle that prevent the TPMS from functioning properly.

Always check the TPMS malfunction telltale after replacing one or more tires or wheels on your vehicle to ensure that the replacement or alternate tires and wheels allow the TPMS to continue to function properly.

The burning of gasoline in your vehicle's engine produces several by-products. Some of these are carbon monoxide (CO), oxides of nitrogen (NOx), and hydrocarbons (HC). Gasoline evaporating from the tank also produces hydrocarbons. Controlling the production of NOx, CO, and HC is important to the environment. Under certain conditions of sunlight and climate, NOx and HC react to form photochemical "smog." Carbon monoxide does not contribute to smog creation, but it is a poisonous gas.

## **The Clean Air Act**

The United States Clean Air Act\* sets standards for automobile emissions. It also requires that automobile manufacturers explain to owners how their emissions controls work and what to do to maintain them. This section summarizes how the emissions controls work. Scheduled maintenance is on page 573.

\* In Canada, Honda vehicles comply with the Canadian emission requirements, as specified in an agreement with Environment Canada, at the time they are manufactured.

## **Crankcase Emissions Control System**

Your vehicle has a positive crankcase ventilation system. This keeps gasses that build up in the engine's crankcase from going into the atmosphere. The positive

crankcase ventilation valve routes them from the crankcase back to the intake manifold. They are then drawn into the engine and burned.

## **Evaporative Emissions Control System**

As gasoline evaporates in the fuel tank, an evaporative emissions control canister filled with charcoal adsorbs the vapor. It is stored in this canister while the engine is off. After the engine is started and warmed up, the vapor is drawn into the engine and burned during driving.

## **Onboard Refueling Vapor Recovery**

The onboard refueling vapor recovery (ORVR) system captures the fuel vapors during refueling. The vapors are adsorbed in a canister filled with activated carbon. While driving, the fuel vapors are drawn into the engine and burned off.

### **Exhaust Emissions Controls**

The exhaust emissions controls include four systems: PGM-FI, ignition timing control, exhaust gas recirculation, and three way catalytic converter. These four systems work together to control the engine's combustion and minimize the amount of HC, CO, and NO<sub>x</sub> that come out the tailpipe. The exhaust emissions control systems are separate from the crankcase and evaporative emissions control systems.

### ***PGM-FI System***

The PGM-FI system uses sequential multiport fuel injection. It has three subsystems: air intake, engine control, and fuel control. The powertrain control module (PCM) uses various sensors to determine how much air is going into the engine. It then controls how much fuel to inject under all operating conditions.

### ***Ignition Timing Control System***

This system constantly adjusts the ignition timing, reducing the amount of HC, CO, and NO<sub>x</sub> produced.

### ***Exhaust Gas Recirculation (EGR) System***

The exhaust gas recirculation (EGR) system takes some of the exhaust gas and routes it back into the intake manifold. Adding exhaust gas to the air/fuel mixture reduces the amount of NO<sub>x</sub> produced when the fuel is burned.

### ***Three Way Catalytic Converter***

The three way catalytic converter is in the exhaust system. Through chemical reactions, it converts HC, CO, and NO<sub>x</sub> in the engine's exhaust to carbon dioxide (CO<sub>2</sub>), nitrogen (N<sub>2</sub>), and water vapor.

### **Replacement Parts**

The emissions control systems are designed and certified to work together in reducing emissions to levels that comply with the Clean Air Act. To make sure the emissions remain low, you should use only new Honda replacement parts or their equivalent for repairs. Using lower quality parts may increase the emissions from your vehicle.

The emissions control systems are covered by warranties separate from the rest of your vehicle. Read your warranty manual for more information.

The three way catalytic converter contains precious metals that serve as catalysts, promoting chemical reactions to convert the exhaust gasses without affecting the metals. The catalytic converter is referred to as a three-way catalyst, since it acts on HC, CO, and NOx. A replacement unit must be an original Honda part or its equivalent.

The three way catalytic converter must operate at a high temperature for the chemical reactions to take place. It can set on fire any combustible materials that come near it. Park your vehicle away from high grass, dry leaves, or other flammables.

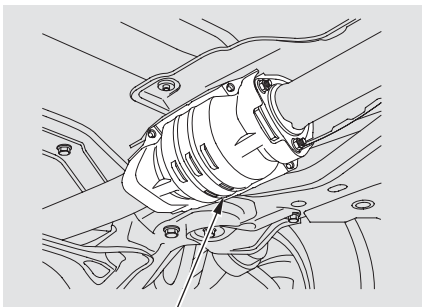

**THREE WAY CATALYTIC CONVERTER**

The defective three way catalytic converters contribute to air pollution, and can impair your engine's performance. Follow these guidelines to protect your vehicle's three way catalytic converters.

- Always use unleaded gasoline. Even a small amount of leaded gasoline can contaminate the catalyst metals, making the three way catalytic converter ineffective.

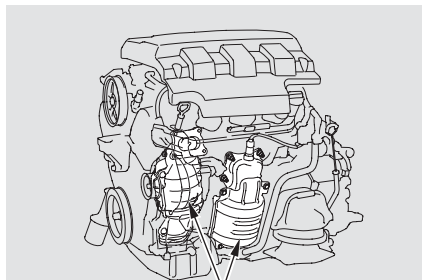

**WARM UP THREE WAY CATALYTIC CONVERTERS**

- Keep the engine well maintained.
- Have your vehicle diagnosed and repaired if it is misfiring, backfiring, stalling, or otherwise not running properly.

## Emissions Testing

---

### Testing of Readiness Codes

If you take your vehicle for an emissions test shortly after the battery has been disconnected or gone dead, it may not pass the test. This is because of certain “readiness codes” that must be set in the on-board diagnostics for the emissions systems. These codes are erased when the battery is disconnected, and set again only after several days of driving under a variety of conditions.

If the testing facility determines that the readiness codes are not set, you will be requested to return at a later date to complete the test. If you must get the vehicle retested within the next two or three days, you can condition the vehicle for retesting by doing the following.

1. Make sure the gas tank is nearly, but not completely, full (around 3/4).
2. Make sure the vehicle has been parked with the engine off for 6 hours or more.
3. Make sure the ambient temperature is between 40° and 95° F (4° and 35° C).
4. Without touching the accelerator pedal, start the engine, and let it idle for 20 seconds.
5. Keep the vehicle in Park. Increase the engine speed to 2,000 rpm, and hold it there until the temperature gauge rises to at least 1/4 of the scale (about 3 minutes).
6. Without touching the accelerator pedal, let the engine idle for 20 seconds.

7. Select a nearby lightly traveled major highway where you can maintain a speed of 50 to 60 mph (80 to 97 km/h) for at least 20 minutes. Drive on the highway in D. Do not use the cruise control. When traffic allows, drive for 90 seconds without moving the accelerator pedal. (Vehicle speed may vary slightly; this is okay.) If you cannot do this for a continuous 90 seconds because of traffic conditions, drive for at least 30 seconds, then repeat it two more times (for a total of 90 seconds).
8. Then drive in city/suburban traffic for at least 10 minutes. When traffic conditions allow, let the vehicle coast for several seconds without using the accelerator pedal or the brake pedal.
9. Make sure the vehicle has been parked with the engine off for 30 minutes.

If the testing facility determines the readiness codes are still not set, see your dealer.





|   |     |
|---|-----|
| Customer Service Information.....                 | 658 |
| Warranty Coverages .....                          | 659 |
| Reporting Safety Defects<br>(U.S. Vehicles) ..... | 660 |
| Authorized Manuals.....                           | 661 |

## Customer Service Information

---

Honda dealership personnel are trained professionals. They should be able to answer all your questions. If you encounter a problem that your dealership does not solve to your satisfaction, please discuss it with the dealership's management. The service manager or general manager can help. Almost all problems are solved in this way.

If you are dissatisfied with the decision made by the dealership's management, contact Honda Customer Service.

### U.S. Owners:

American Honda Motor Co., Inc.  
Automobile Customer Service  
Mail Stop 500-2N-7A  
1919 Torrance Boulevard  
Torrance, California 90501-2746

Tel: (800) 999-1009

### Canadian Owners:

Honda Canada Inc.  
Customer Relations  
180 Honda Boulevard  
Markham, ON  
L6C 0H9

Tel: 1-888-9-HONDA-9

Fax: 1-877-939-0909

E-Mail: honda\_cr@ch.honda.com

### In Puerto Rico and the U.S. Virgin Islands:

Vortex Motor Corp.  
Bella International  
P.O. Box 190816  
San Juan, PR 00919-0816

Tel: (787) 620-7546

When you call or write, please give us this information:

- Vehicle Identification Number (see page 640 )
- Name and address of the dealer who services your vehicle
- Date of purchase
- Odometer reading of your vehicle
- Your name, address, and telephone number
- A detailed description of the problem
- Name of the dealer who sold the vehicle to you

### U.S. Owners

Your new vehicle is covered by these warranties:

***New Vehicle Limited Warranty*** – covers your new vehicle, except for the emissions control systems and accessories, against defects in materials and workmanship.

***Emissions Control Systems Defects Warranty and Emissions Performance Warranty*** – these two warranties cover your vehicle's emissions control systems. Time, mileage, and coverage are conditional. Please read your warranty booklet for exact information.

***Seat Belt Limited Warranty*** – a seat belt that fails to function properly is covered by a limited warranty. Please read your warranty booklet for details.

***Rust Perforation Limited Warranty*** – all exterior body panels are covered for rust-through from the inside for the specified time period with no mileage limit.

***Accessory Limited Warranty*** – Honda accessories are covered under this warranty. Time and mileage limits depend on the type of accessory and other factors. Please read your warranty booklet for details.

***Replacement Parts Limited Warranty*** – covers all Honda replacement parts against defects in materials and workmanship.

***Replacement Battery Limited Warranty*** – provides prorated coverage for a replacement battery purchased from your dealer.

***Replacement Muffler Lifetime Limited Warranty*** – provides coverage for as long as the purchaser of the muffler owns the vehicle.

Restrictions and exclusions apply to all these warranties. Please read the 2012 Honda warranty information booklet that came with your vehicle for precise information on warranty coverages. Your vehicle's original tires are covered by their manufacturer. Tire warranty information is in a separate booklet.

### Canadian Owners

Please refer to the 2012 warranty manual that came with your vehicle.

## Reporting Safety Defects

---

### **In the US**

If you believe that your vehicle has a defect which could cause a crash or could cause injury or death, you should immediately inform the National Highway Traffic Safety Administration (NHTSA), in addition to notifying American Honda Motor Co., Inc.

If NHTSA receives similar complaints, it may open an investigation, and if it finds that a safety defect exists in a group of vehicles, it may order a recall and remedy campaign. However, NHTSA cannot become involved in individual problems between you, your dealer, or American Honda Motor Co., Inc.

To contact NHTSA, you may call the Vehicle Safety Hotline toll-free at 1-888-327-4236 (TTY: 1-800-424-9153); go to <http://www.safercar.gov>; or write to: Administrator, NHTSA, 1200 New Jersey Avenue, SE., Washington, DC 20590.

You can also obtain other information about motor vehicle safety from <http://www.safercar.gov>.

### **In Canada**

If you believe that your vehicle has a defect which could cause a crash or could cause injury or death, you should immediately inform Honda Canada Inc. and you may also inform Transport Canada.

If Transport Canada receives similar complaints, it may open an investigation, and if it finds that a safety defect exists in a group of vehicles, it may lead to a recall and remedy campaign. However, Transport Canada cannot become involved in individual problems between you, your dealer, or Honda Canada Inc.

To contact Transport Canada's Defect Investigations and Recalls Division, you may call 1-800-333-0510. For more information on reporting safety defects or about motor vehicle safety, go to <http://www.tc.gc.ca/roadsafety>.

## Purchasing Factory Authorized Manuals (U.S. only)

The publications shown below can be purchased from Helm Incorporated. You can order by phone or online:

- Call Helm Inc. at 1-800-782-4356 (credit card orders only)
- Go online at [www.helminc.com](http://www.helminc.com)

If you are interested in other years or models, contact Helm Inc. at 1-800-782-4356.

| Publication Form Number | Form Description   |
|-------------------------|--|
| 61SZA03                 | 2012 Honda Pilot Service Manual                                  |
| 61SZA03EL               | 2012 Honda Pilot<br>Electrical Troubleshooting Manual            |
| 61SZA30                 | 2012 Honda Pilot Body Repair Manual                              |
| 31SZA630                | 2012 Honda Pilot Owner's Manual                                  |
| 31SZA830                | 2012 Honda Pilot<br>Navigation System Owner's Manual             |
| 31SZAM30                | 2012 Honda Pilot Honda Service History                           |
| 31SZAQ30                | 2012 Honda Pilot Technology Reference Guide                      |
| HON                     | Order Form for Previous Years<br>Indicate Year and Model Desired |

## Service Manual:

Covers maintenance and recommended procedures for repair to engine and chassis components. It is written for the journeyman mechanic, but it is simple enough for most mechanically inclined owners to understand.

## Electrical Troubleshooting Manual:

Complements the Service Manual by providing in-depth troubleshooting information for each electrical circuit in your vehicle.

## Body Repair Manual:

Describes the procedures involved in the replacement of damaged body parts.



**A**

|  |          |
|--|----------|
| Accessories and Modifications ....         | 504      |
| ACCESSORY (Ignition Key<br>Position) ..... | 136      |
| Accessory Power Sockets.....               | 186      |
| AC Power Outlet.....                       | 187      |
| Active Head Restraints .....               | 159      |
| Additives, Engine Oil.....                 | 577      |
| Advanced Airbags.....                      | 30       |
| Airbag (SRS) .....                         | 11, 26   |
| Airbag System Components.....              | 26       |
| Air Conditioning System.....               | 192, 199 |
| Rear A/C Control .....                     | 197, 205 |
| Air Outlets (Vents) .....                  | 207      |
| Air Pressure, Tires .....                  | 600      |
| Antifreeze .....                           | 579      |
| Anti-lock Brakes (ABS)                     |          |
| Indicator Light .....                      | 70, 532  |
| Operation .....                            | 531      |
| Anti-theft, Audio System.....              | 394      |
| Anti-theft Steering Column                 |          |
| Lock.....                                  | 136      |
| Audio System .....                         | 209      |
| Auto Control Mode, Starting                |          |
| Engine .....                               | 513      |

|                                    |     |
|------------------------------------|-----|
| Auto Door Lock .....               | 114 |
| Auto Door Locking/Unlocking....    | 138 |
| Auto Door Unlock.....              | 115 |
| Automatic Climate Control.....     | 199 |
| Automatic Lighting.....            | 126 |
| Automatic Seat Belt Tensioners.... | 24  |
| Automatic Speed Control.....       | 430 |
| Automatic Transmission.....        | 515 |
| Capacity, Fluid .....              | 642 |
| Checking Fluid Level .....         | 582 |
| Shifting.....                      | 515 |
| Shift Lever Position               |     |
| Indicators.....                    | 515 |
| Shift Lever Positions .....        | 516 |
| Shift Lock Release.....            | 518 |
| Auxiliary Input Jack.....          | 391 |

**B**

|                      |         |
|----------------------|---------|
| Battery              |         |
| Charging System      |         |
| Indicator.....       | 68, 626 |
| Jump Starting .....  | 621     |
| Maintenance.....     | 607     |
| Specifications ..... | 643     |
| Before Driving ..... | 493     |

|                              |          |
|------------------------------|----------|
| Belts, Seat .....            | 9, 22    |
| Beverage Holders.....        | 181      |
| Bluetooth®                   |          |
| HandsFreeLink® .....         | 441, 462 |
| Booster Seats .....          | 57       |
| Brakes                       |          |
| Anti-lock System (ABS) ..... | 531      |
| Break-in, New Linings .....  | 494      |
| Bulb Replacement .....       | 589, 591 |
| Fluid .....                  | 584      |
| Parking.....                 | 171      |
| System Indicator .....       | 69, 627  |
| Wear Indicators .....        | 531      |
| Braking System.....          | 530      |
| Break-in, New Vehicle .....  | 494      |
| Brightness Control,          |          |
| Instruments .....            | 130      |

CONTINUED

# Index

---

|                               |     |
|-------------------------------|-----|
| Bulb Replacement              |     |
| Back-up Lights .....          | 589 |
| Brake Lights.....             | 589 |
| Fog Lights .....              | 588 |
| Front Parking Lights.....     | 587 |
| Front Side Marker Lights..... | 587 |
| Headlights .....              | 586 |
| Rear Bulbs .....              | 589 |
| Specifications .....          | 643 |
| Turn Signal Lights.....       | 587 |
| Bulbs, Halogen.....           | 586 |

## C

|                               |               |
|-------------------------------|---------------|
| Cancel Button.....            | 432           |
| Capacities Chart.....         | 642           |
| Carbon Monoxide Hazard .....  | 60            |
| Cargo Area Light .....        | 178           |
| Cargo Hook .....              | 510           |
| Cargo, How to Carry .....     | 506           |
| CAUTION, Explanation of ..... | iv            |
| CD Care .....                 | 332           |
| CD Player .....               | 219, 243, 319 |
| CD Player Error               |               |
| Messages.....                 | 226, 253, 331 |
| CD Library.....               | 254           |

|                                 |         |
|---------------------------------|---------|
| Certification Label.....        | 640     |
| Chains, Tires .....             | 606     |
| Changing a Flat Tire .....      | 613     |
| Changing Oil                    |         |
| How to.....                     | 577     |
| When to.....                    | 559     |
| Charging System Indicator ....  | 68, 626 |
| Checklist, Before Driving.....  | 512     |
| Childproof Door Locks .....     | 143     |
| Child Safety .....              | 38      |
| Booster Seats .....             | 57      |
| Child Seats.....                | 43, 46  |
| Important Safety Reminders..... | 38      |
| Infants .....                   | 43      |
| Larger Children .....           | 56      |
| LATCH.....                      | 48      |
| Risks with Airbags.....         | 39      |
| Small Children.....             | 44      |
| Tether .....                    | 53      |
| Warning Labels.....             | 61      |
| Where Should a Child Sit?.....  | 39      |
| Child Seats.....                | 46      |
| LATCH Anchorage Points .....    | 48      |
| Tether Anchorage Points ....    | 54, 55  |
| Cleaning Seat Belts.....        | 593     |
| Climate Control System.....     | 199     |

|                                |     |
|--------------------------------|-----|
| Clock .....                    | 294 |
| Coat Hooks .....               | 185 |
| Code, Audio System .....       | 394 |
| CO in the Exhaust .....        | 652 |
| Compact Spare Tire.....        | 612 |
| Console Compartment .....      | 180 |
| Consumer Information.....      | 658 |
| Controls, Instruments and..... | 63  |
| Conversation Mirror .....      | 184 |
| Coolant                        |     |
| Adding.....                    | 579 |
| Checking.....                  | 500 |
| Proper Solution .....          | 579 |
| Temperature Gauge.....         | 80  |
| Crankcase Emissions Control    |     |
| System.....                    | 651 |
| Cruise Control Indicator ..... | 76  |
| Cruise Control Operation ..... | 430 |
| Cup Holders.....               | 181 |
| Customer Service Office .....  | 658 |
| Customize Settings.....        | 95  |
| Door/Window Setup .....        | 113 |
| Lighting Setup.....            | 108 |
| Meter Setup.....               | 101 |
| Position Setup .....           | 106 |
| Setting to Default.....        | 98  |



**D**

DANGER, Explanation of ..... iv  
 Dashboard ..... 3, 64  
 Daytime Running Lights ..... 127  
 Dead Battery ..... 621  
 Defects, Reporting Safety ..... 660  
 Defogger, Rear Window ..... 129  
 Defrosting the Windows ..... 196, 204  
 Differential Fluid ..... 642  
 Dimensions ..... 642  
 Dimming the Headlights ..... 125  
 Dipstick  
   Automatic Transmission ..... 582  
   Engine Oil ..... 500  
 Directional Signals ..... 71  
 Disc Brake Wear Indicators ..... 531  
 Disc Care ..... 332  
 Disposal of Used Oil ..... 578  
 Doors  
   Indicator ..... 13, 79  
   Locking and Unlocking ..... 137  
   Lockout Prevention ..... 143  
   Power Door Locks ..... 137  
 DOT Tire Quality Grading ..... 644  
 Driver and Passenger Safety ..... 5

Driving ..... 511  
   Economy ..... 501  
 Driving Position Memory  
   System ..... 174  
 Dust and Pollen Filter ..... 593  
 DVD Player Error Messages ..... 424  
 DVD Player ..... 400

**E**

Economy, Fuel ..... 501  
 Electronic Stability Control (ESC)  
   System ..... 533  
 Emergencies ..... 611  
   Battery, Jump Starting ..... 621  
   Brake System Indicator ..... 627  
   Changing a Flat Tire ..... 613  
   Charging System Indicator ..... 626  
   Checking the Fuses ..... 630  
   Driving with a Flat Tire ..... 612  
   Hazard Warning Flashers ..... 129  
   Jump Starting ..... 621  
   Low Oil Pressure Indicator ..... 625  
   Malfunction Indicator Lamp ..... 626  
   Overheated Engine ..... 623  
   Towing ..... 636

Emergency Brake ..... 171  
 Emergency Flashers ..... 129  
 Emergency Towing ..... 636  
 Emissions Controls ..... 651  
 Emissions Testing ..... 654  
 Engine  
   Check Starter System ..... 514  
   Coolant Temperature Gauge ..... 80  
   If it Won't Start ..... 620  
   Malfunction Indicator  
     Lamp ..... 68, 626  
   Oil Life ..... 559  
   Oil Pressure Indicator ..... 68, 625  
   Oil, What Kind to Use ..... 576  
   Overheating ..... 623  
   Specifications ..... 643  
   Speed Limiter ..... 518  
   Starting ..... 513  
 Evaporative Emissions Controls .. 651  
 Exhaust Fumes ..... 60  
 Exhaust Gas Recirculation  
   System ..... 652

CONTINUED

# Index

---

Expectant Mothers, Use of Seat Belts by ..... 20

## F

Fan, Interior ..... 193, 203  
Features, Comfort and Convenience ..... 191  
Filling the Fuel Tank ..... 497  
Filters  
Dust and Pollen ..... 593  
Oil ..... 577  
Flashers, Hazard Warning ..... 129  
Flat Tire, Changing a ..... 613  
Floor Mats ..... 594  
Fluids  
Automatic Transmission ..... 582  
Brake ..... 584  
Power Steering ..... 585  
Windshield Washer ..... 581  
FM Stereo Radio  
Reception ..... 389  
Fog Lights ..... 127  
Folding the Second Seat ..... 160  
Folding the Third Seat ..... 161  
Four-way Flashers ..... 129

Front Airbags ..... 11, 28  
Front Seat ..... 154  
Adjusting ..... 154  
Airbags ..... 11, 28  
Heaters ..... 165  
Fuel ..... 495  
Fill Door and Cap ..... 497  
Gauge ..... 80  
Octane Requirement ..... 495  
Oxygenated ..... 495  
Reserve Indicator ..... 78  
Tank, Filling the ..... 497  
Tighten Fuel Cap ..... 498  
Fuel Economy ..... 501  
Fuses, Checking the ..... 630

## G

Gas Mileage, Improving ..... 502  
Gasoline ..... 495  
Gauge ..... 80  
Low Fuel Indicator ..... 78  
Octane Requirement ..... 495  
Tank, Refueling ..... 497  
Gas Station Procedures ..... 497

## Gauges

Engine Coolant Temperature .... 80  
Fuel ..... 80  
Speedometer ..... 80  
Tachometer ..... 80  
GAWR (Gross Axle Weight Rating) ..... 537  
GCWR (Gross Combined Weight Rating) ..... 538  
Gearshift Lever Positions ..... 515  
Glass Hatch ..... 148  
Glove Box ..... 183  
GVWR (Gross Vehicle Weight Rating) ..... 537

## H

Halogen Headlight Bulbs ..... 586  
HandsFreeLink<sup>®</sup> ..... 441, 462  
HFL Buttons ..... 442, 463  
Hazard Warning Flashers ..... 129

- |                               |          |                                    |         |                                   |          |
|-------------------------------|----------|------------------------------------|---------|-----------------------------------|----------|
| Headlights .....              | 125      | Ignition                           |         | Side Airbag Off .....             | 70       |
| Aiming.....                   | 586      | Keys.....                          | 133     | Seat Belt.....                    | 67       |
| Automatic Lighting .....      | 126      | Switch.....                        | 136     | SRS .....                         | 70       |
| Daytime Running Lights .....  | 127      | Timing Control System.....         | 652     | System Message.....               | 75, 92   |
| High Beam Indicator.....      | 76       | Immobilizer System.....            | 134     | Tire Pressure Monitor .....       | 73       |
| High Beams, Turning on .....  | 125      | Important Safety Precautions ..... | 6       | Turn Signal and Hazard            |          |
| Lights On Indicator .....     | 76       | Indicators, Instrument Panel....   | 65, 66  | Warning .....                     | 71       |
| Low Beams, Turning on .....   | 125      | ABS (Anti-lock Brake) .....        | 70      | VSA OFF.....                      | 71       |
| Reminder Chime.....           | 125      | A/T Temp.....                      | 74      | VSA System.....                   | 71       |
| Replacing Halogen Bulbs ..... | 586      | Brake (Parking and Brake           |         | Individual Map Lights .....       | 177      |
| Turning on .....              | 125      | System) .....                      | 69, 627 | Infant Restraint .....            | 43       |
| Headphones.....               | 426      | Charging System .....              | 68, 626 | Infant Seats.....                 | 43       |
| Head Restraints .....         | 157      | Cruise Control.....                | 76      | Inflation, Proper Tire .....      | 599      |
| Heated Mirror .....           | 173      | Cruise Main .....                  | 76      | INFO Buttons.....                 | 85       |
| Heaters, Seats .....          | 165      | DRL (Daytime Running               |         | Inside Mirror .....               | 172      |
| Heating and Cooling.....      | 192, 199 | Lights).....                       | 77      | Inspection, Tire .....            | 601      |
| High-Low Beam Switch .....    | 125      | Fog Lights .....                   | 76      | Instrument Panel .....            | 65, 66   |
| HomeLink® Universal           |          | High Beam.....                     | 76      | Instrument Panel Brightness ..... | 130      |
| Transceiver.....              | 437      | Key (Immobilizer System) .....     | 76      | Instruments and Controls.....     | 63       |
| Hood, Opening the .....       | 499      | Lights On .....                    | 76      | Integrated Sunshade .....         | 183      |
| Horn .....                    | 4, 122   | Low Fuel .....                     | 78      | Interface Dial.....               | 298      |
|                               |          | Low Oil Pressure .....             | 68, 625 | Interior Lights .....             | 176      |
|                               |          | Low Tire Pressure.....             | 72      | Introduction.....                 | i        |
|                               |          | Malfunction Indicator              |         | iPod® .....                       | 265, 363 |
|                               |          | Lamp .....                         | 68, 626 |                                   |          |
|                               |          | Security System .....              | 79      |                                   |          |

## I

Identification Number, Vehicle.... 640

CONTINUED

# Index

---

## J

- Jacking up the Vehicle ..... 615
- Jack, Tire ..... 613
- Jump Starting ..... 621

## K

- Keys..... 133

## L

- Label, Certification ..... 640
- Lane Change, Signaling ..... 125
- Lap/Shoulder Belts ..... 17, 23
- Light Control Switch ..... 176
- Lights
  - Bulb Replacement ..... 586
  - Indicator ..... 65, 66
  - Interior ..... 176
  - Parking..... 125
  - Turn Signal..... 125
- Load Limit ..... 507, 536
- LOCK (Ignition Key Position) ..... 136
- Locks
  - Anti-theft Steering Column ..... 136

- Fuel Fill Door ..... 497
- Glove Box ..... 183
- Lockout Prevention ..... 143
- Power Door ..... 137
- Tailgate ..... 143, 144
- Low Coolant Level..... 500
- Low Fuel Indicator ..... 78
- Low Oil Pressure Indicator ... 68, 625
- Lubricant Specifications Chart ... 642
- Luggage, Storing (cargo) ..... 506

## M

- Maintenance..... 557
  - Minder..... 559
  - Owner's Maintenance
    - Checks ..... 571
    - Safety..... 558
    - Schedule ..... 573
- Malfunction Indicator Lamp .. 68, 626
- Memory, Driving Position ..... 174
- Message Display..... 93
- Message Indicator ..... 75
- Meters, Gauges..... 80
- Mirrors, Adjusting ..... 172
- Modifications..... 505

- Modifying Your Vehicle..... 505
- Moonroof ..... 170
- Multi-Information Display ..... 85

## N

- Neutral Gear Position..... 516
- New Vehicle Break-in ..... 494
- NOTICE, Explanation of..... i
- Numbers, Identification..... 640

## O

- Octane Requirement, Gasoline .... 495
- Odometer..... 81, 87
- Odometer, Trip ..... 81, 87
- Off-Highway Driving..... 552
- Off-Road Precautions..... 552
- Oil
  - Change, How to ..... 577
  - Change, When to ..... 559
  - Checking Engine ..... 500
  - Life, Engine ..... 559
  - Pressure Indicator ..... 68, 625
  - Selecting Proper Viscosity
    - Chart ..... 576

|                                  |        |
|----------------------------------|--------|
| ON (Ignition Key Position) ..... | 136    |
| Outside Mirrors .....            | 172    |
| Outside Temperature.....         | 83, 88 |
| Overheating, Engine .....        | 623    |
| Owner's Maintenance Checks.....  | 571    |
| Oxygenated Fuels.....            | 495    |

## P

|                                     |         |
|-------------------------------------|---------|
| Panel Brightness Control .....      | 130     |
| Park Gear Position.....             | 516     |
| Parking .....                       | 521     |
| Parking Brake .....                 | 171     |
| System Indicator .....              | 69, 627 |
| Parking Lights.....                 | 125     |
| Parking Sensor System.....          | 484     |
| Parking Over Things that Burn...    | 521     |
| Passenger Airbag Off Indicator .... | 35      |
| PGM-FI System.....                  | 652     |
| Pollen Filter .....                 | 593     |
| Power Door Locks .....              | 137     |
| Power Seat Adjustments.....         | 154     |
| Power Socket Locations.....         | 179     |
| Power Windows .....                 | 167     |
| Pregnancy, Using Seat Belts .....   | 20      |

|                                   |    |
|-----------------------------------|----|
| Protecting Adults and Teens.....  | 13 |
| Additional Safety Precautions.... | 21 |
| Advice for Pregnant Women.....    | 20 |
| Protecting Children .....         | 38 |
| General Guidelines .....          | 38 |
| Protecting Infants .....          | 43 |
| Protecting Larger Children .....  | 56 |
| Protecting Small Children .....   | 44 |
| Using Child Seats with            |    |
| Tethers.....                      | 53 |
| Using LATCH .....                 | 48 |

## R

|                                  |          |
|----------------------------------|----------|
| Radiator Overheating.....        | 623      |
| Radio/Disc Sound System.....     | 209      |
| Radio Theft Protection.....      | 394      |
| Readiness Codes.....             | 654      |
| Rear A/C Unit.....               | 197, 205 |
| Rear Audio Control Panel.....    | 396      |
| Rear Entertainment System.....   | 396      |
| Rear Lights, Bulb Replacement... | 589      |
| Rearview Camera and Monitor .... | 491      |
| Rearview Mirror .....            | 172      |
| Rear Window Defogger .....       | 129      |

|                                   |          |
|-----------------------------------|----------|
| Rear Window Wiper and             |          |
| Washer .....                      | 124      |
| Reclining the Seat Backs .....    | 154, 155 |
| Reclining the Second Seats .....  | 160      |
| Recall a Memorized Driving        |          |
| Position .....                    | 153      |
| Reminder Indicators.....          | 67       |
| Remote Audio Controls.....        | 392      |
| Remote Control (RES) .....        | 406      |
| Remote Transmitter.....           | 150      |
| Replacement Information           |          |
| Engine Oil and Filter .....       | 577      |
| Fuses .....                       | 630      |
| Light Bulbs.....                  | 586      |
| Schedule .....                    | 573      |
| Timing Belt.....                  | 585      |
| Tires .....                       | 602      |
| Wiper Blades .....                | 595      |
| Replacing Seat Belt After a       |          |
| Crash .....                       | 25       |
| Reporting Safety Defects.....     | 660      |
| Reserve Tank, Engine Coolant .... | 500      |
| Restraint, Child .....            | 38       |
| Reverse Gear Position.....        | 516      |

CONTINUED

# Index

---

Rotation Tire ..... 602

## S

Safety Belts..... 9, 22

Safety Defects, Reporting..... 660

Safety Features ..... 8

Airbags..... 11

Door Locks..... 13

Head Restraints ..... 16

Seat Belts ..... 9, 17

Seats & Seat-Backs..... 15, 16

Safety Labels, Location of ..... 61

Safety Messages ..... iv

Seat Belts..... 9, 17

Additional Information..... 22

Automatic Seat Belt

    Tensioners..... 24

Cleaning ..... 593

Lap/Shoulder Belt..... 23

Maintenance..... 25

Reminder Light and

    Beeper ..... 22, 67

System Components..... 22

Use During Pregnancy..... 20

Wearing a Lap/Shoulder Belt... 17

Seats ..... 154

    Adjusting the Second Seat..... 160

    Folding the Second Seat ..... 161

    Folding the Third Seat ..... 162

    Head Restraints ..... 157

    Heaters..... 165

    Position Memory ..... 174

    Third Row Access ..... 161

Security System ..... 429

Sensors

    Driver's Seat Position Sensor .... 30

    Front Passenger's Weight

        Sensors..... 30

    Impact Sensors..... 26, 27

Serial Number ..... 640

Service Intervals ..... 559

Service Manual\* ..... 661

Service Minder ..... 559

Service Station Procedures ..... 497

Setting the Clock ..... 294

Shifting the Automatic

    Transmission..... 515

Shift Lever Position Indicator ..... 515

Shift Lock Release ..... 518

Side Airbags ..... 31

    Off Indicator ..... 34

Side Curtain Airbags ..... 33

Side Marker Lights, Bulb

    Replacement in ..... 587, 589

Signaling Turns..... 71

Snow Tires..... 605

Sound System..... 209

Spare Tire

    Inflating..... 600, 612

    Specifications ..... 643

Specifications Charts..... 642

Speed Control..... 430

Speed Limiter ..... 518

Speedometer ..... 80

SRS, Additional Information..... 26

    Additional Safety Precautions.... 36

    Airbag Service..... 36

    Airbag System Components..... 26

    How the SRS Indicator Works... 34

    How Your Front Airbags

        Work..... 28

    How Your Side Airbags Work.... 31

    How Your Side Curtain Airbags

        Work..... 33

SRS Indicator..... 34, 70

START (Ignition Key Position) ... 136

- Starting the Engine..... 513  
 Auto Control Mode..... 513  
 In Cold Weather at High  
 Altitude ..... 514  
 With a Dead Battery ..... 621  
 Steam Coming from Engine..... 623  
 Steering Wheel  
 Adjustment ..... 132  
 Anti-theft Column Lock ..... 136  
 Buttons ..... 392, 430, 442, 463  
 Stereo Sound System ..... 209  
 Storage Compartment..... 182  
 Storing Your Vehicle..... 608  
 Sunglasses Holder ..... 183  
 Sun Visor..... 184  
 Supplemental Restraint System  
 Servicing ..... 36  
 SRS Indicator..... 34, 70  
 System Components..... 26  
 Synthetic Oil..... 577
- T**
- Tachometer ..... 80  
 Tailgate ..... 143  
 Glass Hatch ..... 148
- Open Indicator ..... 13, 79  
 Opening the..... 143  
 Power ..... 144  
 Taillights, Changing Bulbs in..... 589  
 Taking Care of the Unexpected .. 611  
 Technical Descriptions  
 DOT Tire Quality Grading\* ..... 644  
 Emissions Control Systems..... 651  
 Three Way Catalytic  
 Converter..... 653  
 Temperature Gauge ..... 80  
 Temperature, Inside Sensor..... 208  
 Temperature, Outside..... 88  
 Tensioners, Seat Belts ..... 24  
 Tether Anchorage Points ..... 54, 55  
 Theft Protection, Radio..... 394  
 Three Way Catalytic Converter... 653  
 Tilt/Telescopic Steering Wheel .. 132  
 Time, Setting the ..... 294  
 Timing Belt..... 585  
 Tire Chains..... 606  
 Tire, How to Change a Flat ..... 613  
 Tire Labeling..... 646
- Tire Pressure Monitoring  
 System (TPMS) ..... 522, 648  
 Low Tire Pressure  
 Indicator..... 72, 525  
 Tire Pressure Monitor ..... 89, 526  
 Tires ..... 599  
 Air Pressure ..... 599  
 Checking Wear ..... 601  
 Compact Spare ..... 612  
 DOT Tire Quality Grading\* ..... 644  
 Inflation..... 599  
 Inspection ..... 601  
 Maintenance..... 602  
 Replacing ..... 602  
 Rotating..... 602  
 Snow ..... 605  
 Specifications ..... 643  
 Tire Chains..... 606  
 Tools, Tire Changing ..... 613

CONTINUED

# Index

|                                |             |
|--------------------------------|-------------|
| Towing                         |             |
| A Trailer.....                 | 536         |
| Emergency Wrecker.....         | 636         |
| Equipment and Accessories..... | 544         |
| Weight Limit .....             | 536         |
| Trailer Loading.....           | 536         |
| Trailer Towing Tips .....      | 549         |
| Transmission                   |             |
| Checking Fluid Level.....      | 582         |
| Fluid Selection.....           | 583         |
| Identification Number.....     | 640         |
| Shifting the Automatic.....    | 515         |
| Treadwear .....                | 601         |
| Trip Computer .....            | 90          |
| Trip Meter .....               | 81, 87, 292 |
| Turn Signals .....             | 71          |

## U

|   |          |
|---|----------|
| Unexpected, Taking Care<br>of the ..... | 611      |
| Uniform Tire Quality Grading* ...       | 644      |
| Unleaded Gasoline.....                  | 495      |
| USB Flash Memory Device..               | 274, 372 |
| Used Oil, How to Dispose of .....       | 578      |

## V

|  |             |
|--|-------------|
| Vanity Mirror .....                            | 185         |
| Vehicle Capacity Load .....                    | 507         |
| Vehicle Dimensions.....                        | 642         |
| Vehicle Identification Number.....             | 640         |
| Vehicle Stability Assist (VSA®)<br>System..... | 533         |
| VSA OFF Indicator.....                         | 71, 533     |
| VSA Off Switch.....                            | 534         |
| VSA System Indicator ...                       | 71, 93, 533 |
| Vehicle Storage.....                           | 608         |
| Ventilation .....                              | 195         |
| VIN .....                                      | 640         |
| Viscosity, Oil.....                            | 576         |
| Voice Control System.....                      | 200         |
| VTM-4 Lock .....                               | 520         |

## W

|  |     |
|--|-----|
| WARNING, Explanation of .....                        | iv  |
| Warning Labels, Location of .....                    | 61  |
| Warranty Coverages* .....                            | 659 |
| Washer, Windshield<br>Checking the Fluid Level ..... | 581 |
| Level Indicator .....                                | 78  |

|  |          |
|--|----------|
| Operation.....                           | 123      |
| Wheels                                   |          |
| Adjusting the Steering .....             | 132      |
| Alignment and Balance.....               | 602      |
| Aluminum Alloy Wheels.....               | 606      |
| Cleaning .....                           | 606      |
| Compact Spare.....                       | 612      |
| Wrench, Nut.....                         | 614      |
| Windows                                  |          |
| Auto Reverse.....                        | 168      |
| Operating the Power .....                | 167      |
| Rear, Defogger .....                     | 129      |
| Windshield                               |          |
| Cleaning .....                           | 123      |
| Defroster .....                          | 196, 204 |
| Washers .....                            | 123      |
| Wipers, Windshield                       |          |
| Changing Blades.....                     | 595      |
| Operation .....                          | 123      |
| Rear Windshield Wiper and<br>Washer..... | 124      |
| Worn Tires .....                         | 601      |
| Wrecker, Emergency Towing.....           | 636      |



|          |
|----------|
| <b>X</b> |
|----------|

XM® Radio ..... 237, 312

\*: U.S. only

## Service Information Summary

---

### **Gasoline:**

Unleaded gasoline, pump octane number of 87 or higher.

Premium fuel is recommended when towing in certain conditions (see page 549).

### **Fuel Tank Capacity:**

21.00 US gal (79.5 ℓ)

### **Recommended Engine Oil:**

API Premium grade 0W-20 detergent oil (see page 576).

Oil change capacity (including filter):

4.5 US qt (4.3 ℓ)

### **Automatic Transmission Fluid:**

Honda ATF DW-1 (automatic transmission fluid) (see page 583).

*4WD models only*

### **Rear Differential Fluid:**

Honda VTM-4 Differential Fluid.

*4WD models only*

### **Transfer Assembly Fluid:**

SAE 90 or SAE 80W-90 viscosity hypoid gear oil, API service classified GL4 or GL5 only.

### **Power Steering Fluid:**

Honda Power Steering Fluid preferred, or another brand of power steering fluid as a temporary replacement. Do not use ATF (see page 585).

### **Brake Fluid:**

Honda Heavy Duty Brake Fluid DOT 3 preferred, or a DOT 3 or DOT 4 brake fluid as a temporary replacement (see page 584).

### **Tire Pressure (measured cold):**

U.S. LX models:

Front:

31 psi (210 kPa , 2.1 kgf/cm<sup>2</sup>)

Rear:

33 psi (230 kPa , 2.3 kgf/cm<sup>2</sup>)

Except U.S. LX models:

Front/Rear:

35 psi (240 kPa , 2.4 kgf/cm<sup>2</sup>)

Compact Spare Tire:

60 psi (420 kPa , 4.2 kgf/cm<sup>2</sup>)